

AT MICROFICHE
REFERENCE
LIBRARY

A project of Volunteers in Asia

Demystifying Evaluation

by: Noreen Clark and James McCaffery

Published by:
World Education
210 Lincoln Street
Boston, MA 02111 USA

Paper copies are, \$7.50.

Available from:
Mr. Ananth Narayan
World Education
P.O. Box 5066
Kendall Park, NJ 08824 USA

Reproduced by permission of World Education.

Reproduction of this microfiche document in any form is subject to the same restrictions as those of the original document.

demystifying EVALUATION

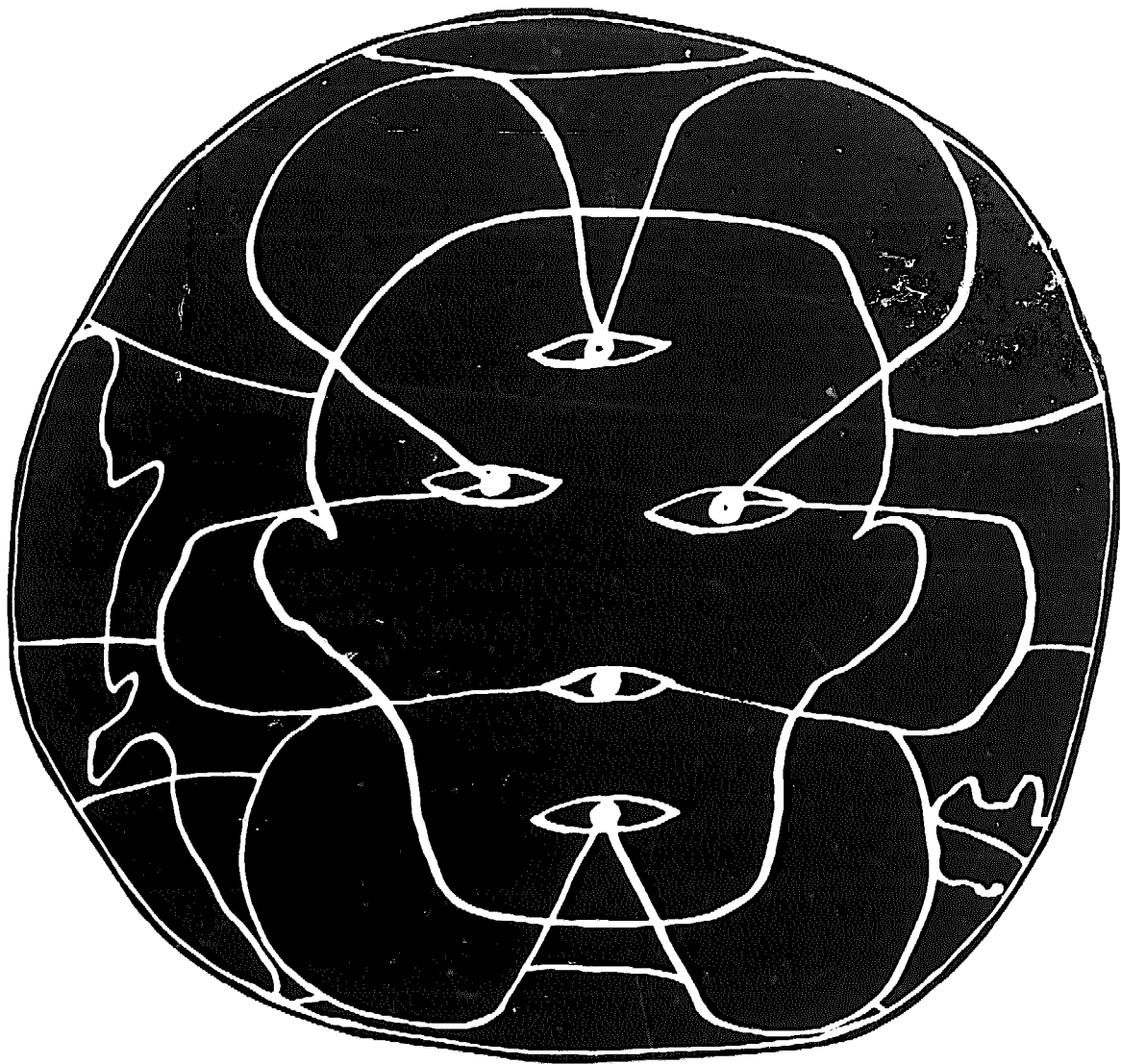

By NOREEN CLARK AND JAMES McCaffery

DEMISTIFYING EVALUATION



Training program staff
in assessment of
community-based programs
through a field-operational seminar

By: NOREEN CLARK AND JAMES McCaffery

Graphics: Karla Kaynee

© 1979 by World Education, 1414 Sixth Avenue, New York, N.Y. 10019
Library of Congress Catalog Card #78-65627
ISBN 0-914262-11-4
Printed in the United States of America

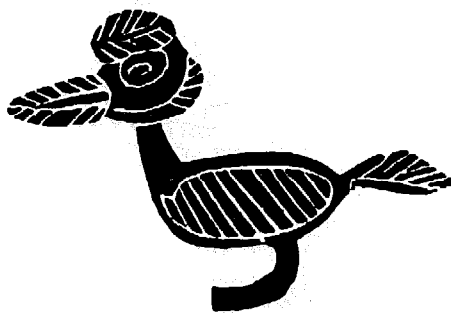

Cover drawing produced during the Mombasa seminar as part of small group activity during Phase I: Introductory, Activity B: Visualizing the Group.

African art reproduced from African Designs From Traditional Sources
by Geoffrey Williams, a Dover Publications book

TABLE OF CONTENTS

Acknowledgments	page
Introduction	1
Evaluation Approaches	5
The Case Study	7
Preparing for the Workshop	9
Notes About the Use of the Manual	11
Phase I: Introductory	13
The Very First Step	
Visualizing the Group	
Eliciting Expectations	
Phase II: Demystifying Evaluation	25
The Anatomy of Judgments	
Why Evaluate?	
Collecting Data	
Phase III: Introducing Field Reality	37
Background for Field Work	
First Site Visit	
Phase IV: Action and Reflection	43
First Impressions and the Evaluator's Responsibility	
Approaches to Data Collection	
Field Work and Analysis	
Phase V: Synthesizing	53
Preparation and Presentation of Field Team Reports	
Linking to One's Own Work	
Phase VI: Ending the Workshop	61
Participant Evaluation of Workshop	
Closure	
Appendix: List of Participants and Members of Planning Committee	67

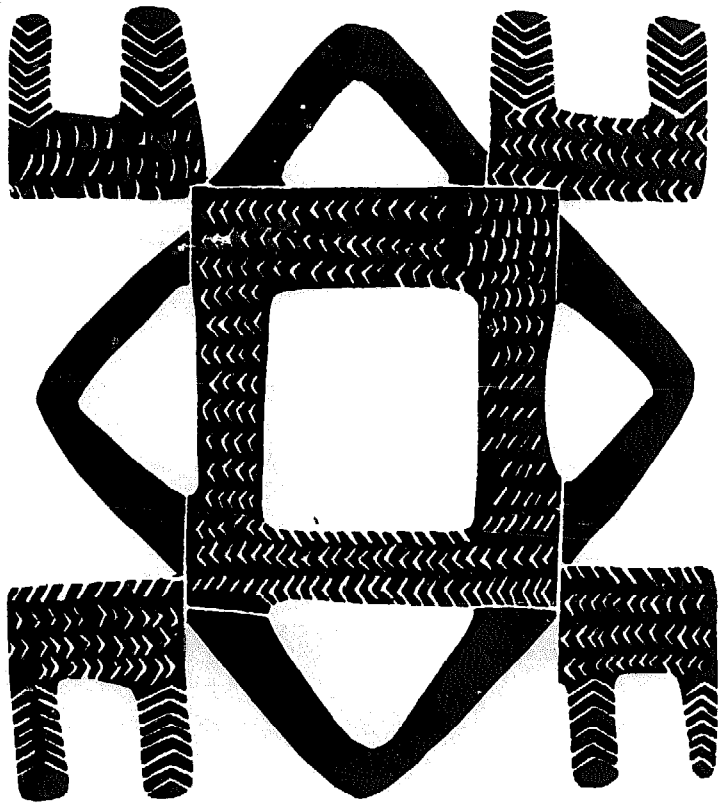

ACKNOWLEDGMENTS

We wish to extend our special thanks to Mr. Bethuel Kiplagat and the National Christian Council of Kenya for helping with the overall coordination of this project and providing strong support throughout. We are indebted to Mrs. Elvina Mutua and Tototo Home Industries for their kind cooperation in hosting the seminar and allowing us to learn with and from them. In addition, David Macharia and the Institute of Adult Study in Nairobi provided invaluable assistance in planning and conceptualizing this seminar and in making Daudi Nturibi's services available to us.

We wish also to express our thanks to the Carnegie Corporation, the Hazen Foundation, UNICEF, the United Nations Fund for Population Activities, and the Agency for International Development, whose financial support to World Education made possible the field-operational seminar on which this manual is based. The publication itself has been paid for through a Development Program Grant to World Education from the office of Private and Voluntary Cooperation, Bureau for Private and Development Cooperation, Agency for International Development. The opinions expressed are those of the authors and do not necessarily reflect the opinions of AID.

We accept full responsibility for any omissions or mistakes that occur in this manual. However, we wish to share any credit we might receive for the successful aspects of this work; the strength of this manual does not derive from us, but rather from the energy and output and electricity of the group that met and worked together in Mombasa, in October and November of 1977. This is an attempt to codify that exciting experience and make it available to the nonformal education community. We list in the appendix all those who took part in the seminar, for, in a very real way, they shared in the production of this manual.

Noreen Clark

James McCaffery



TRADITIONAL SEMINAR

INTRODUCTION

The organizations in Africa that have collaborated with World Education in nonformal education programs have at various times expressed interest in learning more about how to evaluate their programs effectively. Indeed, some of them have had no experience evaluating their projects while others have used comprehensive evaluation techniques. World Education therefore proposed an evaluation seminar, and the National Christian Council of Kenya (NCCCK) agreed to co-sponsor the event. Teams of staff members from World Education-assisted projects in Ghana and Ethiopia were invited to attend, as well as staff members from development projects in Kenya (under NCCCK sponsorship) and Sierra Leone.

Because World Education believes in experience-based learning, we decided early on that the participants would actually try out assessment techniques in a village setting. Further, each person invited to attend had rich experience in nonformal education; we wanted to capitalize on that extensive and varied pool of skills. We chose a participatory format. The seminar schedule was constructed to take into account both the logistics of field work and the need for situations where participants could discover and discuss evaluation methods. Within the basic structure, however, individual activities were to be highly flexible. Participants would be encouraged to emphasize the aspects of evaluation of most interest to them and would be given maximum opportunity to adapt from basic evaluation methods to create innovative village assessment techniques.

Every activity was to be participant-oriented and implemented through what we have termed "collegiality"—that is, with power and authority shared equally among colleagues. We tried to design each session of the seminar to ensure that responses to exercises and solutions to problems would come primarily from the experience, common sense, and ingenuity of those who took part. In many seminars and conferences professional colleagues are forced into teacher-student relationships. Here, we wanted to ensure that group members would interact like the professional colleagues they are—sharing ideas, engaging in dialogue, analyzing information, planning and carrying out actions—all the while serving as each other's consultants. Although we obviously had our own approach to evaluation, we did not impose lectures on the group, or teachers, or recipes on how to conduct evaluation. As a result, participants produced and used particular evaluation instruments and approaches that they had selected as most effective and manageable. And all the participants did develop assessment skills that would be useful on a daily basis in their own projects. This successfully brought evaluation out of the realm of theory and into actual practice.

The Resource People

The role of the "resource person" in a seminar like this is challenging. There are three facets of the role: workshop planner, process facilitator, evaluation specialist/learner. First, each of the five resource persons at the Mombasa seminar helped design the seminar: as the workshop progressed, the resource people met daily to refine and revise the design and to increase learning opportunities for all participants based on each day's experience. Second, responsibility for facilitating particular sessions was rotated among the resource people. Finally, the resource persons also acted as participants, members of the workshop group who struggled with and learned as much about evaluation as the other participants. Therefore, the resource person's role in this kind of seminar tends to be more complicated than that of the traditional trainer or evaluation expert.

Since this is so, those who serve as resource people should be carefully selected. They need a variety of skills that are only rarely combined in one individual—which is why a seminar like this requires a team of resource people. The team needs process trainers, skilled in working with groups; they must be especially good at facilitating group discussions and enabling people to take part in and contribute to the group's work. They also need some technical knowledge of program evaluation. And finally, they must be able to deal with—indeed capitalize on—their constantly shifting roles. Knowing when to play expert, facilitator, or participant demands great sensitivity to the goals of the workshop, the objectives of a particular session, and the ongoing needs of the group.*

In a participatory workshop, there is always a continuous effort to refine the workshop format to fit the emerging needs and interests of the participants. If the resource person states that something will be changed or redesigned in response to participants' wishes or expectations, some action will have to be taken. If the desired change cannot be made, the group should be informed why not. Unless promises to redesign are kept, the full participation and commitment of every person attending simply will not take place. The group may even begin to suspect that the resource people are manipulating workshop events, in order to make them appear participatory. It is far better to have a good nonparticipatory seminar than a workshop that is made to appear participatory but, whether through intent or neglect, is really not.

A Necessary Balance

Any seminar that takes place over several days should incorporate a balance of large group meetings, small group meetings, and individual work. But a field seminar stresses active participation: we wanted to include visits to the villages, seminar meetings, and time for individuals to read under the nearest tree. We even took care to ensure that there would be a bal-

**In this manual, the terms resource person, trainer, facilitator, and planning team member are variously used to refer to the same person, depending on the role being played.*

anced amount of time spent sitting in chairs and moving about the room to write on pieces of flip chart paper or read another team's product. Participation should be physical as well as mental; it should involve the process of experiencing as well as the discussion of experience.

The workshop groups in the Mombasa seminar were able to produce a great deal. One device we used to record information was a daily written summary. At the end of an exercise, after each small group had shared its results with the entire group, a resource person would summarize this product and distribute it for use in the next day's session. This simple but important clerical function makes it possible for each group to work from the record of the previous day's activity, and allows groups to learn from each other, to avoid each other's mistakes. The work produced also serves as concrete evidence of the group's accomplishments during the workshop, and provides something tangible to take back home at the seminar's end.

Workshop Groups

The participants in this workshop came from Sierra Leone, Ghana, Ethiopia, Kenya, and the United States. For the first several days we made sure, by frequently changing the makeup of the small groups, that each person had a chance to work with everyone else. For the six days of the field site visits, however, we tried to place one person from each country on each field team, to maintain a balance between men and women, and to have a Kenyan on each team who could serve as interpreter. Although there were good reasons for rotating teams from site to site, we found that assigning one team to one site increased the level of involvement of each village and allowed more continuity. Each field site team visited the same village four times. On the last day of the seminar, we reorganized the teams by country so that each one could consider and record the information they had discovered that had implications for the projects in their own country.



field-OPERATIONAL SEMINAR

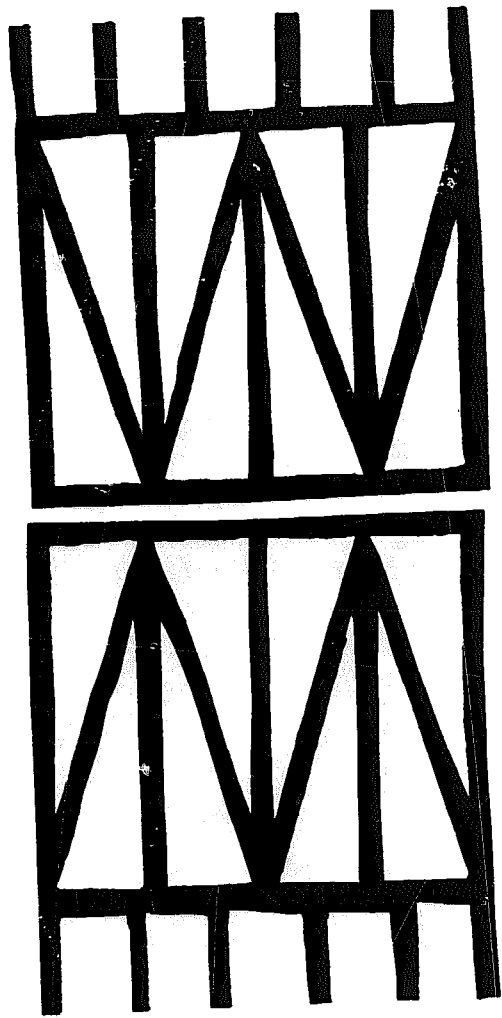

EVALUATION APPROACHES

Evaluation for most agencies is both internal (what the program staff does) and external (what the outside funder, parent organization, or evaluation consultant does). A premise of this seminar is that continuous internal evaluation can improve programs and put administrators in a stronger position to respond to outside evaluators.

To conduct a seminar like the one described here, therefore, it is important that individuals chosen as facilitators have some practical experience in evaluating community programs. The seminar concentrates on (1) helping program administrators and field staff become aware of the need for evaluation to improve decision making and (2) assisting them to ask the right evaluation questions about their projects. The seminar is not designed to produce experts in evaluation: it is intended to assist administrators to identify and initiate evaluation approaches to improve the operation of their organizations.

Those who have worked in community settings know that rigorous research designs are neither desirable nor possible in conducting village evaluation. The program staff member can use only those data collection techniques that fit the particular area in question and are acceptable to the people involved. Precise methodology and cumbersome assessment procedure must be retired in favor of more unobtrusive and less disruptive techniques. To be effective, evaluation steps must be easy to initiate and conduct, otherwise program staff will be unlikely to accept them as an ongoing part of their regular responsibilities.

In the Mombasa seminar, participants began their exploration of data collection approaches by using conventional techniques: interviews, using questionnaires, observation, using checklists, and informal interviews with key people. As time went on, however, teams began to think of other more innovative and simple ways to get information that might serve the purpose of program improvement. Some of these, although less frequently used by evaluators, might be successful if employed systematically in the village setting.*

In Mombasa, for example, teams tried out open-ended group and individual interviews using pictures to stimulate discussion, games related to particular skills or interests, and group problem-solving for identifying needed changes and change strategies. No doubt another group of seminar participants would come up with as many different ideas. The seminar trainers, therefore, should encourage creativity while helping participants devel-

**Some of these techniques are described in detail in a forthcoming World Education publication, A Training Kit for Nonformal Educators.*

op good evaluation techniques.

In other words, trainers should assist participants to recognize that a technique must be used systematically, must promote careful documentation and recording of data, must recognize and eliminate bias to the greatest extent possible, and must yield representative information. Trainers must then help participants fit data collection and analysis procedures into a comprehensive evaluation plan. There are several books and articles which may provide potential trainers with a refresher in the principles and practice of program evaluation. Some of these are listed below:

Hall, Budd, "Participatory Research: An Approach for Change," *Convergence*, Vol. III, No. 2, 1975.

Pettit, John J., *Integrated Family Life Education Project* (conducted by the Ethiopian Women's Association). New York: World Education, 1977.

Weiss, Carol H., *Evaluation Research*, Englewood Cliffs, New Jersey: Prentice-Hall, 1972.

World Education, *REPORTS: Special Issue on Evaluation*, No. 15, October 1977, pp. 3-13, 14, 15, 20, 24.

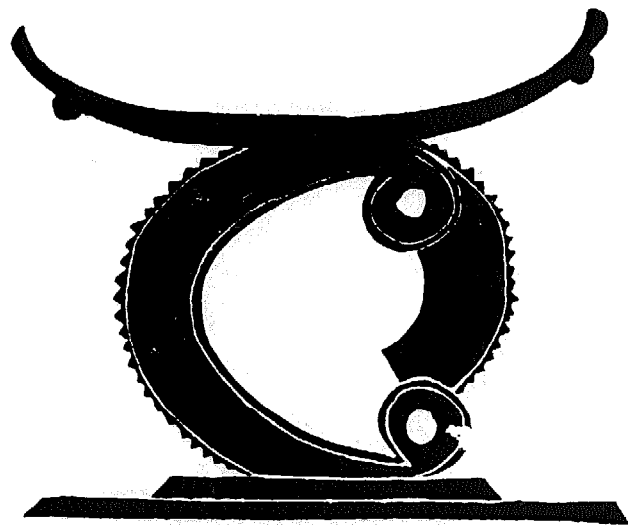

THE CASE STUDY

This seminar alternates between actual evaluation work done at a village site and learning in the seminar or small groups. The seminar, therefore, is best conducted by, or in collaboration with, an organization that is involved in community projects. The organization and its activities become a case study for the seminar to use, and if an actual case study is written up, it can be a valuable asset to the learning process.

The study provides participants with a common background for working together to develop evaluation approaches. The case study should do two major things: describe the organization, program and activities to be evaluated, and provide the major evaluation questions to be answered. In the Mombasa seminar, for example, the case study was written in four segments. The initial segment described the purpose, objectives, and administrative structure of Tototo Home Industries, the organization serving as co-sponsor of the seminar and as the case for study. The second segment described the six Tototo project villages. These were the communities that agreed to cooperate in the seminar by letting participants use the village as a site for practicing evaluation approaches. This segment provided a brief description of the villages and a history of Tototo's work in each.

The next segment outlined seven or eight questions the administrators of Tototo had about their project activities. Tototo administrators had not collected data to answer these questions and felt that such data would help them improve their program.

The final segment set forth the task that the seminar participants would accomplish. This task was the focus of the field work portions of the seminar and enabled participants to gain practical evaluation experience. The task required that each field work team (1) develop and try out data collection approaches answering one or two of Tototo's evaluation questions and (2) design, based on their field work experience, a plan for continuous evaluation which Tototo administrators might include in program operation.

The background of the organization serving as a case for study and its procedures for operating in the village must be presented descriptively and nonjudgmentally. Once the case is prepared, it is then the job of seminar participants to develop ways to collect data that will enable cooperating administrators to decide what things they will change about their program and to identify what is working well. Perhaps even more important, the end product could include suggestions for an appropriate evaluation system or methodology for the cooperating organization. The seminar provides an opportunity for participants to learn by addressing the real problems of a real agency rather than by engaging in hypothetical discussion. It

is obvious, therefore, that the success of the seminar must depend on careful selection of both the organization and the villages to study. The benefits to the organization include staff training and the evaluation plans participants develop during the seminar; in Mombasa these proved very useful to Tototo Home Industries.

Given the requirements discussed above, it is obvious that the organization serving as the case for study must be a strong one, confident in its program, and willing to have "outsiders" looking at its program in a learning situation.

Those interested in using the Mombasa case study as a model for writing their own can obtain more information from World Education.

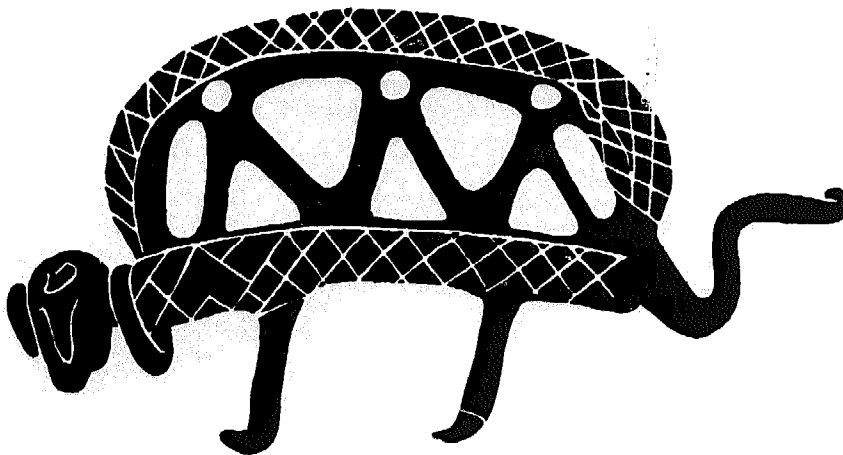

PREPARING FOR THE WORKSHOP

How much time is spent on the tasks outlined below will depend on the existing contacts and experience of the planners, on the difficulties encountered in working out arrangements with the host agency, and on how much help is available to do the groundwork. Planning for the seminar could take from several weeks to several months.

1. Collaborating agencies need to be identified and cooperating villages selected. To ensure a successful field experience, leaders in local communities must be involved from the outset. This cannot be overemphasized. The people in each village where seminar participants will do field work will need to be involved in the planning process. Seminar organizers must be sure that village leaders and residents understand and accept the objectives of the field experience. If the planners have no previous relationship with the local residents of the villages in which they intend to do field work, then the process of gaining entry and acceptance into their chosen field sites could take some time. Even if seminar planners have worked in these villages before, several visits, meetings and informal discussions will be necessary. As with most endeavors, the degree of participation and collaboration among those involved in planning—host agency, advisory group, seminar organizers, and the residents at the field sites—is bound to influence the extent of success achieved.
2. An advisory group can be very helpful. A group of local non-formal educators can be convened to define the scope of the seminar and identify resources. Two or three meetings should be enough to adapt the general seminar plan to the specific locale and to refine the activities accordingly.
3. A case study should be developed for use in the workshop, especially if participants come from different agencies and have had dissimilar work experiences. This case study will provide a common background for participants about the villages where they will be working and the evaluation objectives to be met.
4. This seminar is designed for teams of staff members of small, community based programs. It is helpful to establish criteria by which appropriate participants will select themselves or be selected by their agencies. Those who work at the field level and thus

have an opportunity actually to carry out project assessments are in the best position both to contribute to the seminar and get the most out of it. Obviously, the agencies that send participants must view the evaluation seminar as relevant to their own goals.

5. It is important to establish an initial measure of participants' abilities and interests related to program evaluation. This might be done in a variety of ways: by means of questionnaires, informal surveys, interviews conducted before the seminar, or any other device that the planners can design for this purpose. The results from this investigation can be used later to assess the seminar's effect on participants.*
6. Someone should be available to handle seminar logistics to ensure that the sessions run smoothly, are relaxed and enjoyable, and allow for cross-fertilization of ideas. This person would be responsible also for planning sufficient leisure time, setting up secretarial and other support services, and arranging travel plans and accommodations for trips to the field sites. In addition, this kind of advanced planning allows participants to get to know each other both within planned work sessions and during leisure time. It enables collegial exchange and sharing of ideas to be an aspect of all seminar activities.

**The instruments used to assess the Mombasa Seminar are available from World Education.*

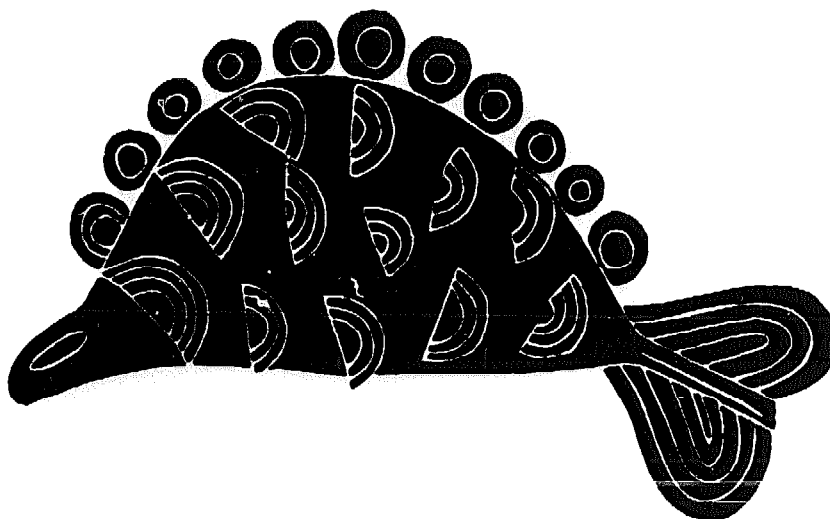

NOTES ABOUT THE USE OF THE MANUAL

The manual is organized according to the six phases that constitute the format of the evaluation seminar. Within each phase there are two or more activities. Some of the activities can be effective alone while others must be used in sequence. This seminar was designed for 20 participants and, of course, activities would need to be significantly modified to work with a larger or smaller number of people.

The manual is organized according to the six phases that constitute the format of the evaluation seminar that emerged from our work together at Mombasa. The six phases of the seminar are: Introductory, Demystifying Evaluation, Introducing Field Reality, Action and Reflection, Synthesizing, and Ending the Workshop. These, and the activities that comprise them, can be used as guidelines for the development of phases and activities more suitable for a different group.

Some of the activities can be effective alone while others must be used in sequence. Each activity is described in the same format, under the following headings:

1. *Reason for doing:* The objectives of and reasons for each activity.
2. *Conducting the activity:* Specific instructions or directions.
3. *Process/maintenance tasks:* Directions designed to make the trainer aware of those things he or she might do to ensure that the training process continues once an activity is actually underway. Here we use "training process" to mean the interaction of group members as they work together—certain things have to be done to examine this process and make sure it flows smoothly. A training group will be unproductive if a trainer does not perform certain process/maintenance functions during each session.
4. *Closure:* Things a trainer can do to bring the activity to an effective close. This may involve a review process that highlights what has been learned and places particular activities within the scope of the larger workshop plan.
5. *Things to be aware of:* What also might be termed contingencies or possible pitfalls. These are different from process/maintenance functions, and this section introduces methods that the trainer can use in case activities do not go as planned. This phase may include discussion of the complexities or nuances of par-

ticular activities. We have tried, in this training manual, not only to provide instructions for the ideal workshop but also to discuss unexpected occurrences that can enrich or inhibit learning.

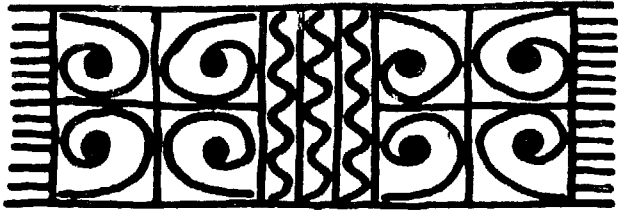

PHASE I: INTRODUCTORY

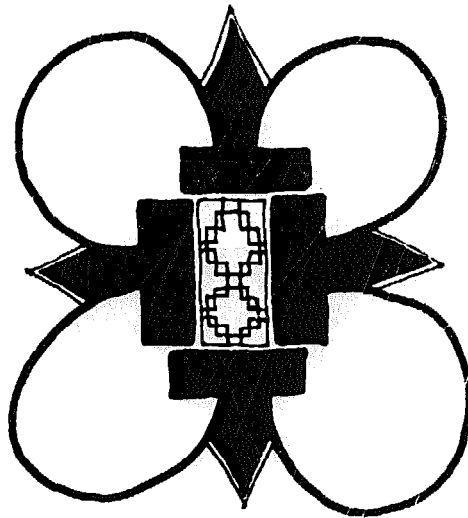

Activity A: THE VERY FIRST STEP

Activity B: VISUALIZING THE GROUP

Activity C: ELICITING EXPECTATIONS

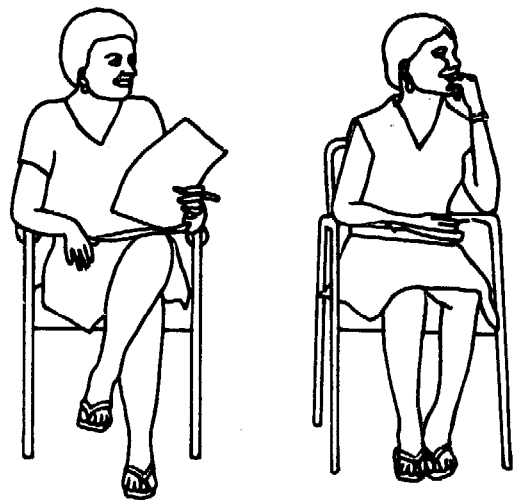
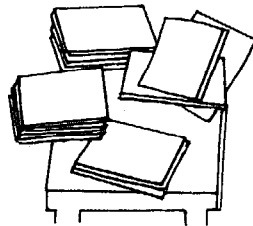

ACTIVITY A: THE VERY FIRST STEP



REASONS FOR DOING: *Total Time: 1 hour*

- To review basic seminar goals and objectives.
- To introduce and review seminar schedule and commitments.
- To take care of formalities and preliminary logistics.
- To emphasize the participatory and collegial nature of the seminar.

CONDUCTING THE ACTIVITY:



—At an opening dinner or similar initial event, before the first work session, the workshop organizers or another appropriate person should make a brief presentation touching on the points outlined above.

—A written preliminary schedule and objectives should be distributed.

PROCESS/MAINTENANCE TASKS:

—Keep the physical arrangements informal. Resource persons should be seated with the rest of the group.

—Make sure that any speeches given are absolutely necessary, and are kept brief.



CLOSURE:

Leave group with a summarized statement of general objectives.

TO BE AWARE OF: Because this is the very first session, it will, at least to some degree, set the tone for the entire seminar. This may present some difficulties, especially if there is a visiting dignitary who will, for one reason or another, be making a speech. You will want, therefore, to involve as leader of the activity an individual whose personal style is friendly and informal so as to erase any formal tone that might be cast upon the seminar.

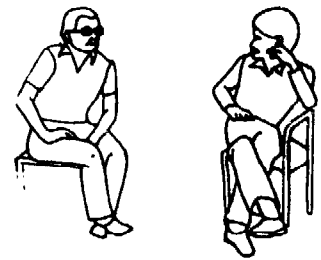

—Set aside another appropriate time to handle the logistics of the seminar and individual participants' questions about accommodations, travel, and so on. Don't intermingle discussion of these logistical arrangements with the seminar goals and history.

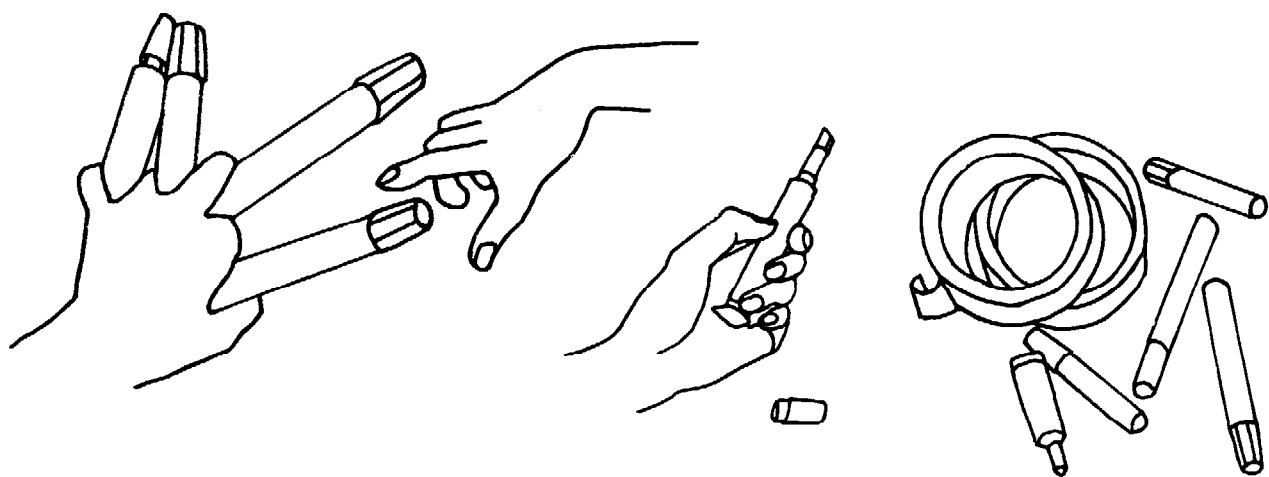
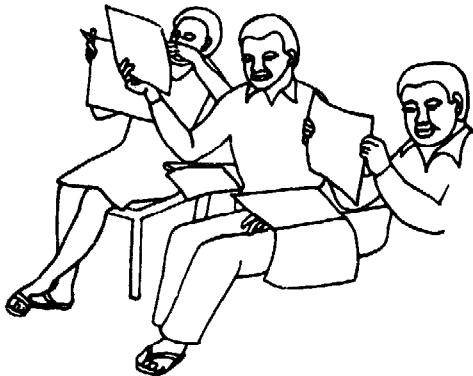
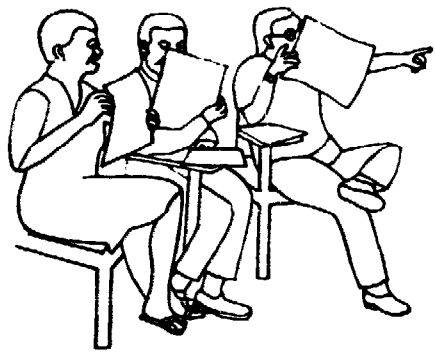

ACTIVITY B: VISUALIZING THE GROUP

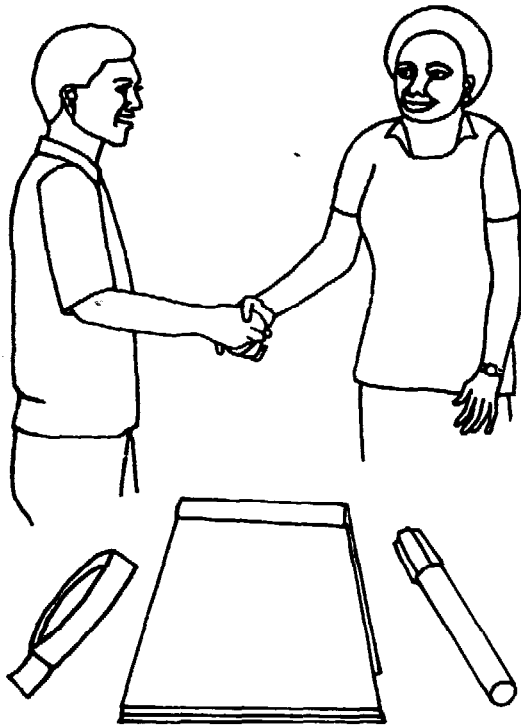

REASONS FOR DOING: Total Time: 1-2 hours

—To introduce people to one another, to open interpersonal communications and to learn about each other's experience.

—To begin with a participatory activity.

—To place a value on creativity, inventiveness, and innovative approaches to common activities.

—To introduce small group work early in the seminar.

—To characterize the trainers (resource people) as facilitators and participants rather than "leaders."

—To set an informal tone.

—To establish that reaching seminar objectives can be enjoyable.

—To acclimate participants to the context of the seminar.

CONDUCTING THE ACTIVITY:

—Ask participants to form small groups, joining others whom they don't know.

—Provide newsprint, ink markers, and masking tape for each group.

—Ask each group to spend 20-30 minutes getting acquainted, and then to draw a collaborative picture that will represent them and that will constitute their introduction to the large group. No words are allowed in the drawing.

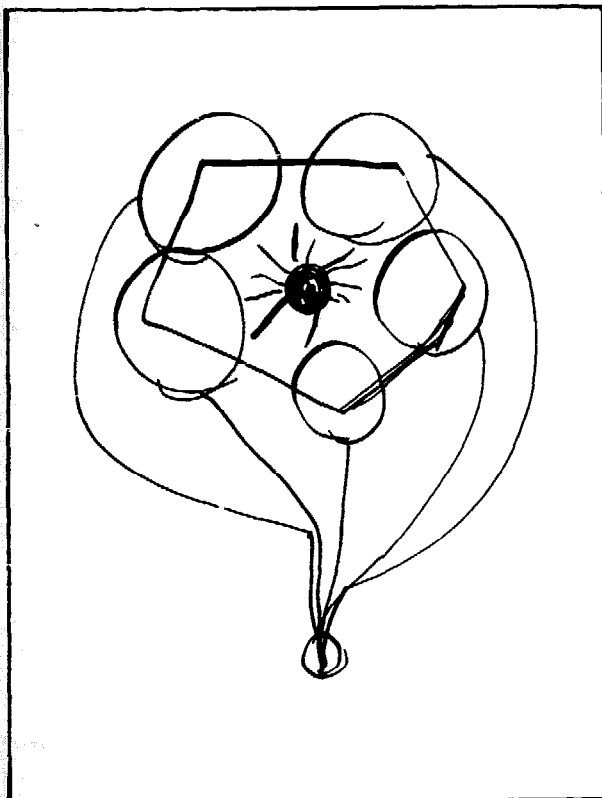

Group drawing

—Reconvene the participants and ask each small group, by using its drawing, to introduce itself to the others. Groups themselves decide how to handle this introduction.

PROCESS/MAINTENANCE TASKS:

—Set time limits for individual introductions in the small group, to prevent one or two people from dominating.

—Move group introductions along according to time available.

—Create an atmosphere of participation.

—Encourage individuals to ask questions or comment on each group's drawing.

—Initiate closure when the large group has finished talking about the drawings.

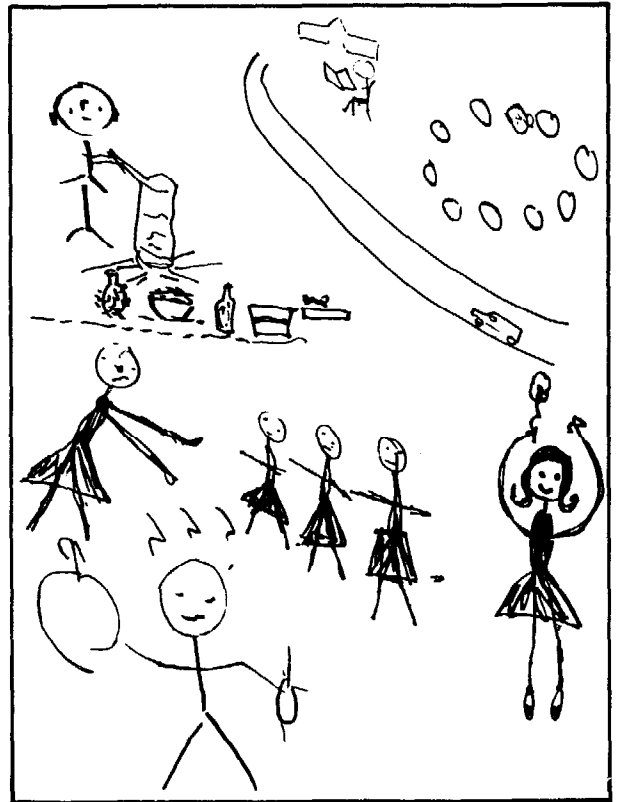

Group drawing

CLOSURE:

—Assist group to:

—Look for commonalities and differences among the groups;

—Generalize from the introductions some interesting and useful observations and relate them to evaluation;

—Recognize the range of experience, expertise, and interest within the group.

—Relate ideas from the introduction to the seminar objectives, the overall schedule, and the following day's work.

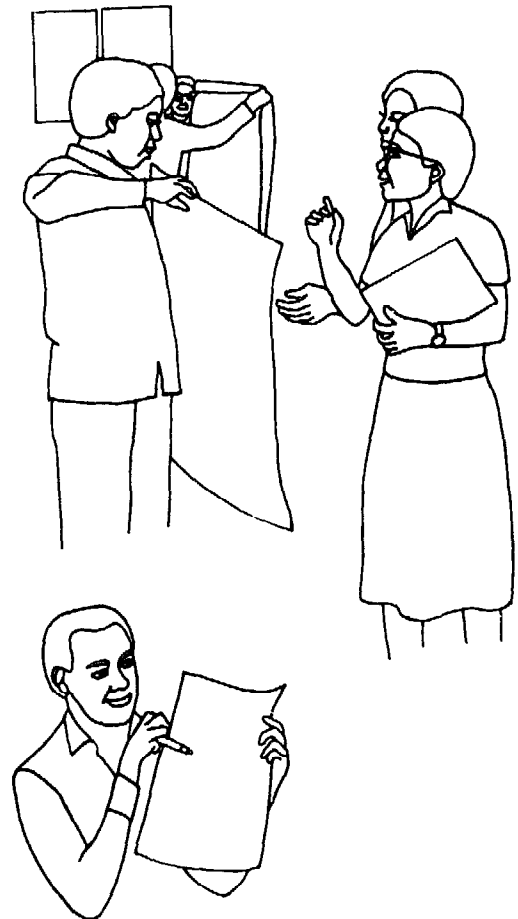

TO BE AWARE OF: This is not a test of artistic ability, but an opportunity to exercise creativity and to

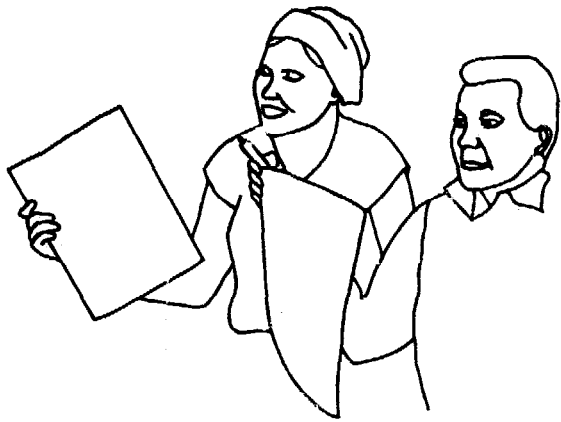

get acquainted. You will want to emphasize that the quality of the drawing is not a measure of success in this activity.

Some participants will enter wholeheartedly into the task; others will be more reticent. Acknowledge the contribution each person can make, being sure at the same time not to single out individuals in ways to make them appear more "expert" than others.

Encourage groups to have fun with the activity, and to be as innovative and creative as they want.

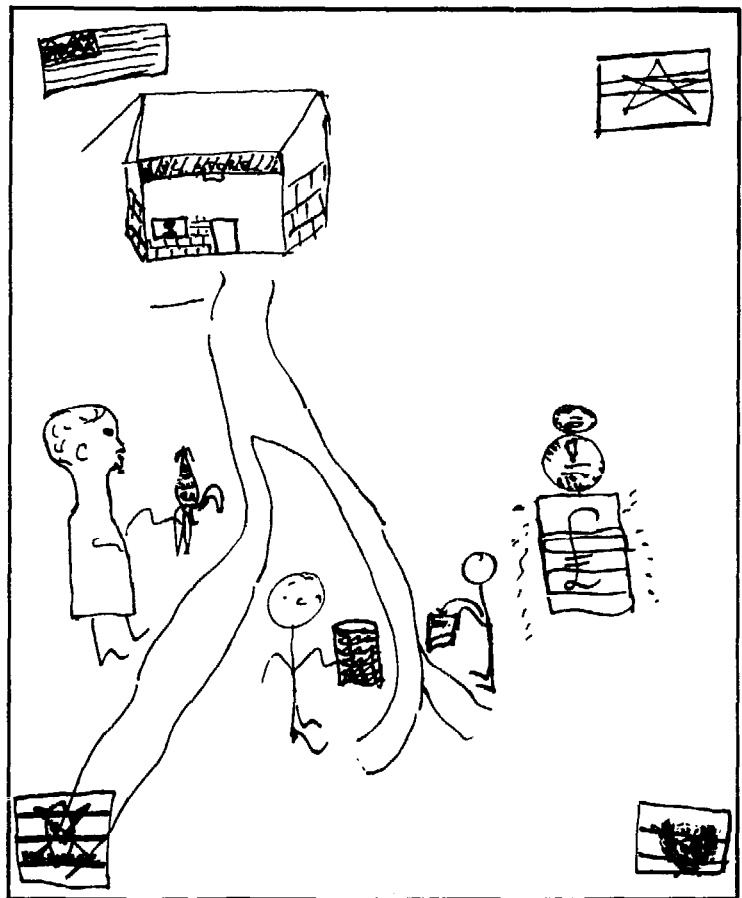
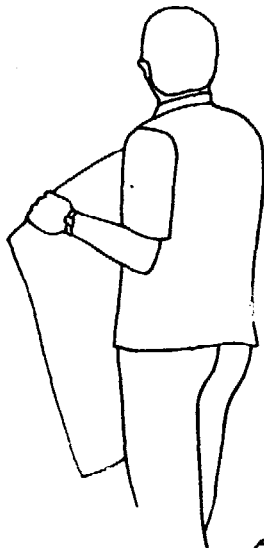
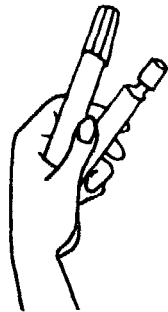
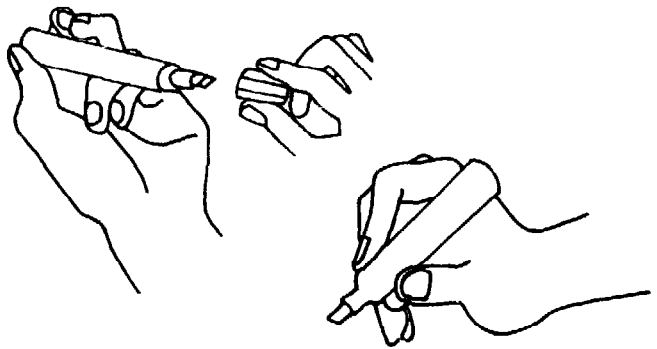
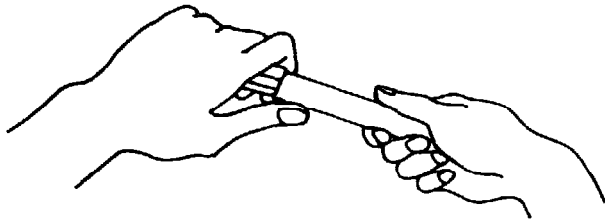

Group drawing

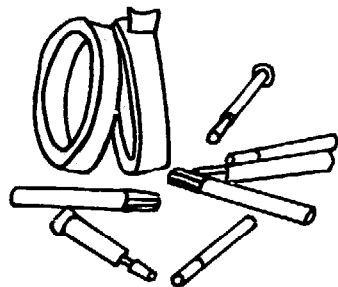
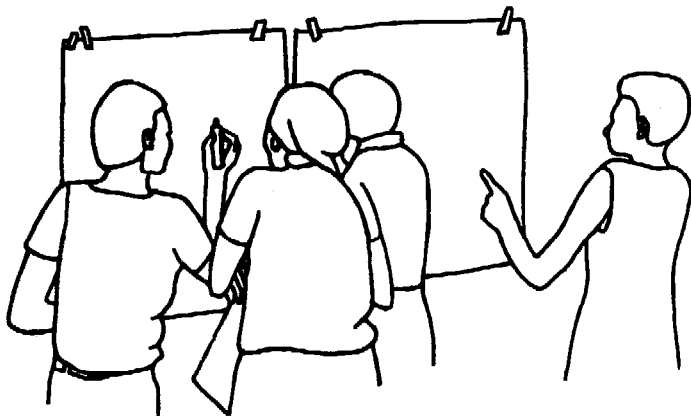
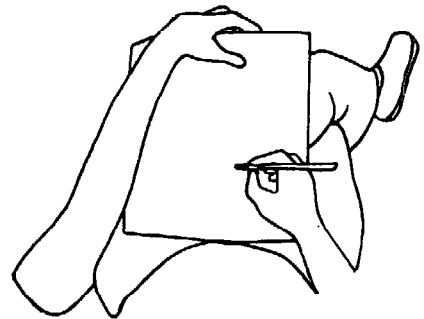
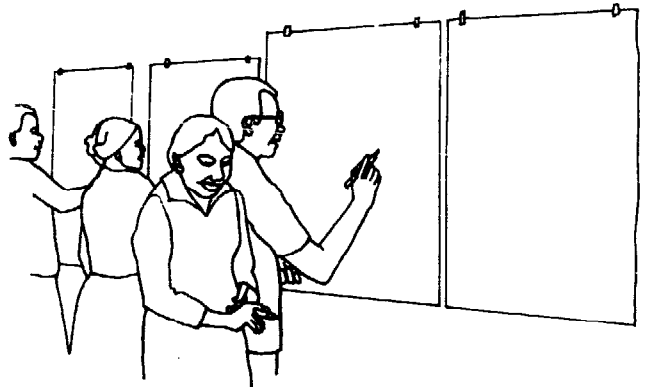

ACTIVITY C: ELICITING EXPECTATIONS

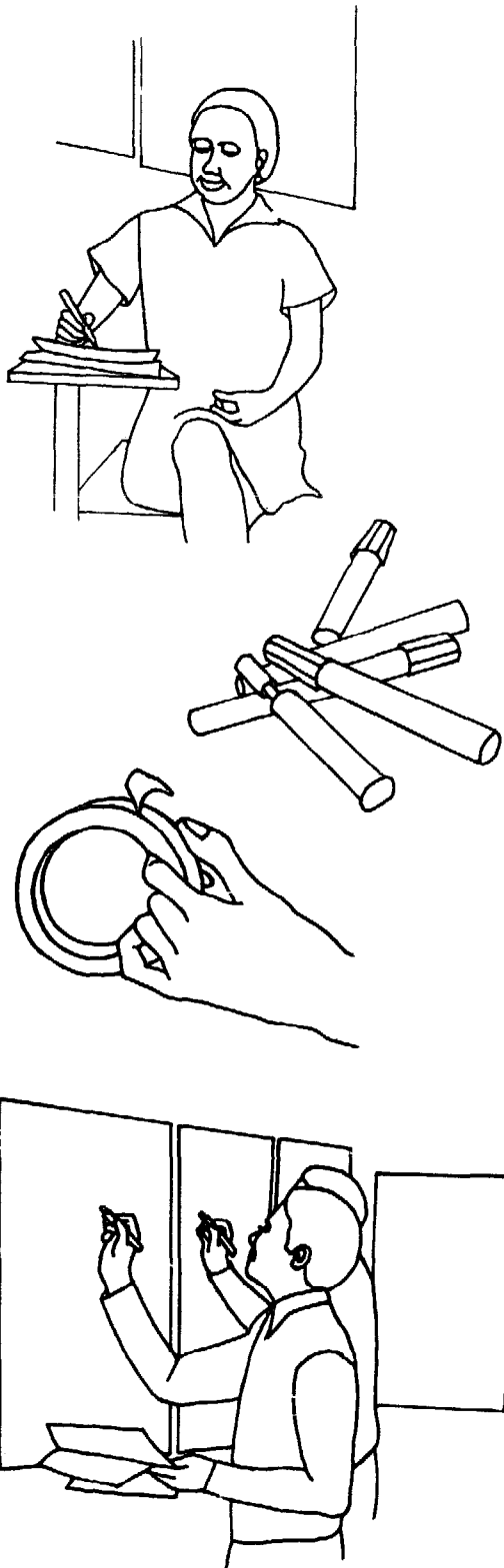

REASONS FOR DOING: *Total Time: 1½-2 hours*

—To give each participant a chance to air his expectations, to share and validate these expectations with the whole group.

—To determine how each participant's expectations fit with seminar objectives and activities; to identify those individual expectations the seminar should be able to meet and those it cannot meet.

—To continue the participatory approach.

—To adjust or refine seminar design, where appropriate and possible, to fit more closely the group's expectations.

—To establish that the seminar involves individual work, movement, everyone working together writing on flip charts, group discussion of products, etc. To emphasize that seminar participation involves more than just sitting and listening.

CONDUCTING THE ACTIVITY:

—Space pieces of newsprint on the walls around the room. Have lots of ink markers available.

—Ask participants to work individually and to write their expectations for the seminar on notepads. Spend approximately 15-20 minutes on this.

—When participants have finished, ask each to select the three most important expectations for him or her, move to one of the pieces of newsprint on the wall, and write those expectations on it.

—When everyone has listed three expectations, ask participants to walk around the room reviewing all expectations. Ask anyone who feels that an important expectation has been overlooked to add it to the list.

—Reassemble in a large group and, as a group, move to each list of expectations.

—Lead the group in reviewing each list for clarity, so everyone knows what was meant by each expectation.

—After this review, identify to the group which expectations the seminar should meet directly, those the seminar will touch on, those which the seminar might, with some changes, touch on and those the seminar, given limited time and resources, will not meet.

PROCESS/MAINTENANCE TASKS:

—Make the following ground rule and keep to it: Discussions or questions about expectations are for clarification only, not to register agreement or disagreement.

—Encourage openness regarding expectations—accept all as valid. Be straightforward about those that can't be met, without disparaging them, since they may be valid but beyond the scope of the seminar.

—Use your judgment to determine if slight modification of the seminar design will better meet the group's expectations (e.g., there is generalized agreement about the expectation and its feasibility). If you and the group agree that a change in the program will be beneficial, take the needed action and keep the group up-to-date on how the change is being integrated into the schedule. Don't suggest a change in schedule unless you are sure it is possible.

—Move the entire process along: don't get bogged down on one area. Summarize and generalize about expectations whenever possible.

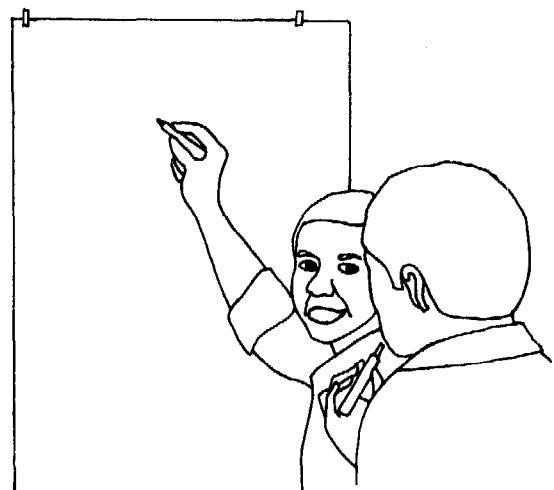
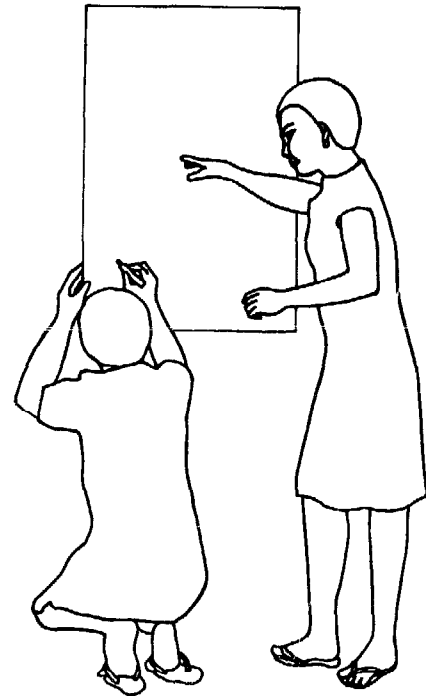
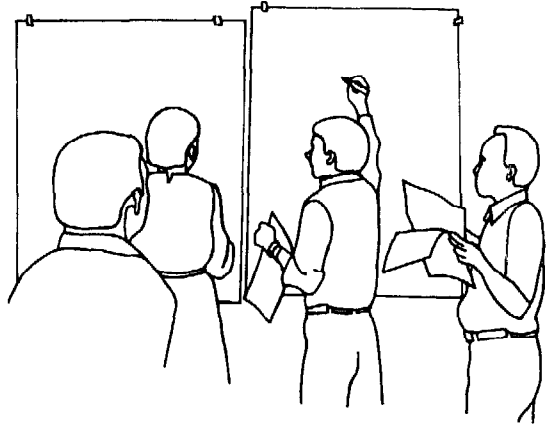

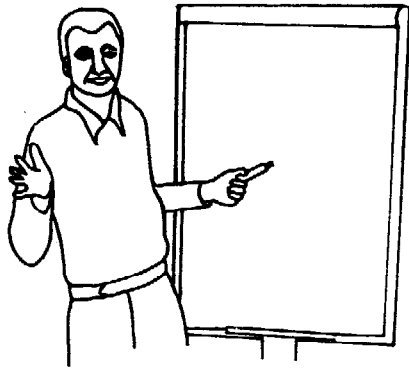

CLOSURE:

—Assist group to:

- Recognize common elements among the group's expectations;
- Summarize the extent to which the seminar should meet expectations;
- Review which sessions should meet particular groupings of expectations.

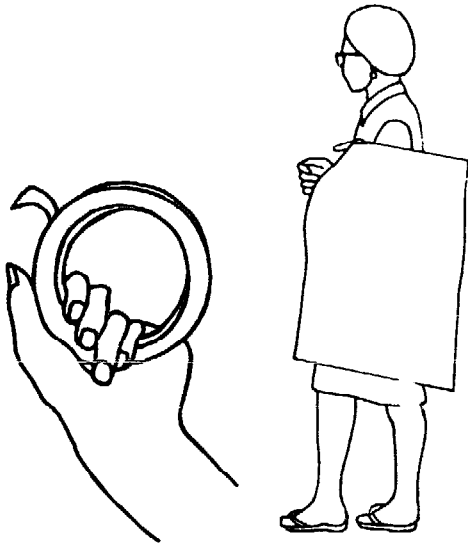

TO BE AWARE OF: Encourage people to be physically active: walk around, write on the newspaper, confer with each other, etc.

It is reasonable and acceptable for trainers to list their own expectations.

If discussion focuses on disagreement with or discounting of participants' expectations, then you will want to intervene and enforce the "clarity" ground rule. It is especially important for trainers to demonstrate that there are seminar ground rules and establish the extent to which they will be followed. Set the pattern in this activity.

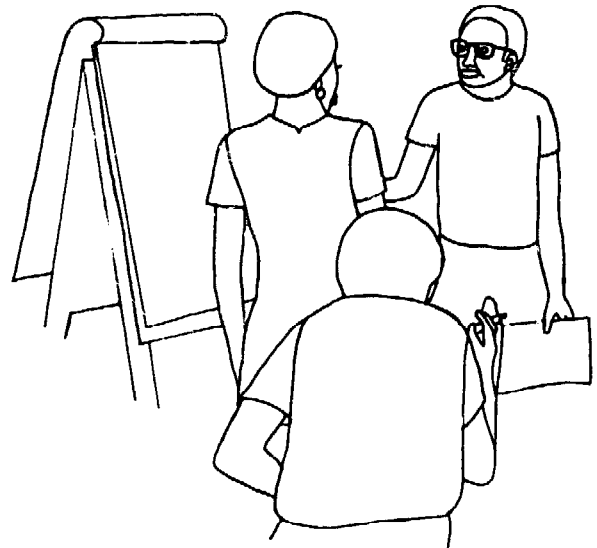
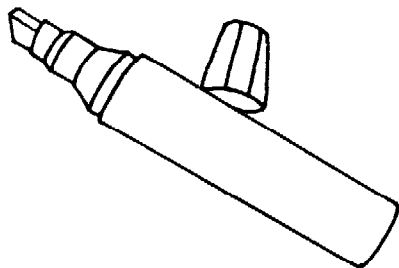

PHASE II: DEMYSTIFYING EVALUATION

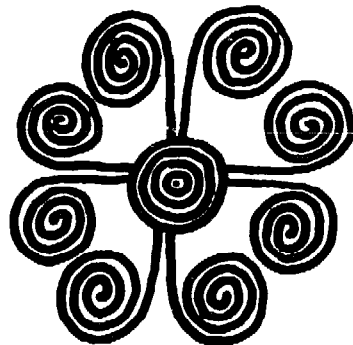

Activity A: THE ANATOMY OF JUDGMENTS

Activity B: WHY EVALUATE?

Activity C: COLLECTING DATA

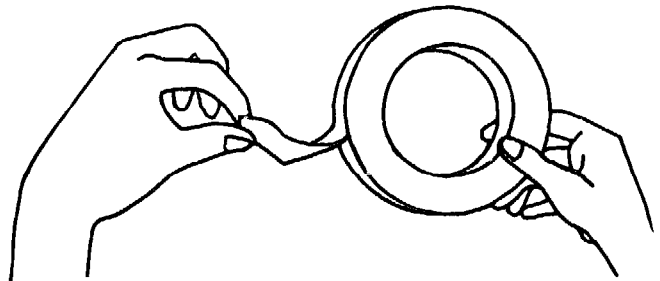
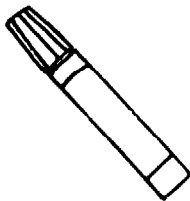
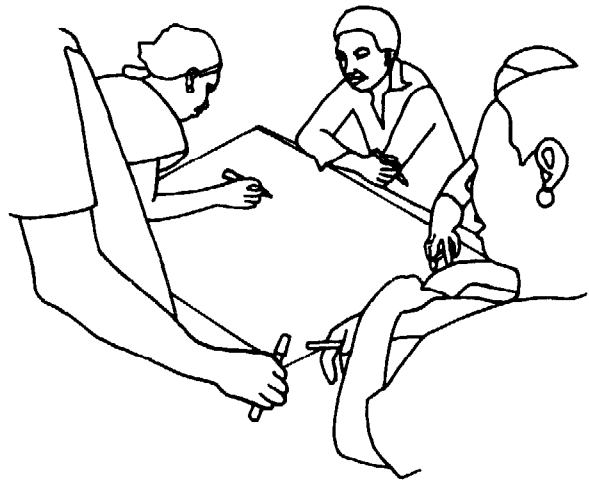
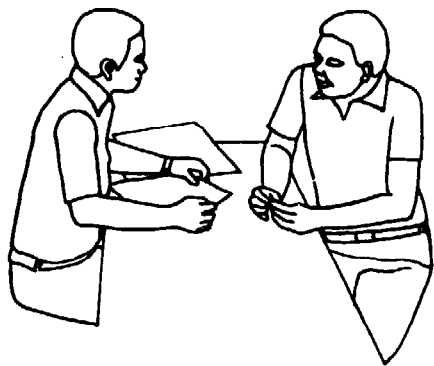

ACTIVITY A: THE ANATOMY OF JUDGMENTS



REASONS FOR DOING: Total Time: 3-4 hours

—To demonstrate that people constantly evaluate things. (“Evaluation” is not something done only by scholars or experts.)

—To use participants’ recent everyday experience as a basis for developing evaluation questions.

—To illustrate that participants already know—although perhaps only implicitly—processes of evaluation; to begin to make these processes explicit.

—To acknowledge participants’ experience and common sense as a legitimate basis for developing program evaluation.

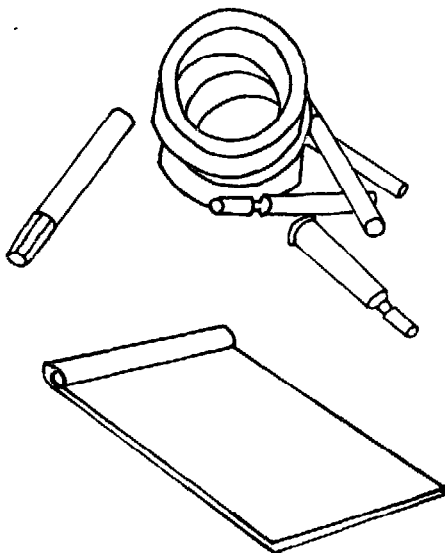

CONDUCTING THE ACTIVITY:

This activity has 3 stages:

Stage 1 (about an hour)

—Choose several topics common to the experience of the whole group, such as logistical arrangements for the seminar or the first group activity of the seminar.

—Divide the large group into a selected number of groups of 4-8 people according to the topic each individual chooses to evaluate.

—Provide markers, newsprint, and masking tape, and allow small groups about 30 minutes to discuss their topic and develop evaluative/judgmental statements about the topic. Ask each group to display its list on the walls in different parts of the room.

—Ask the large group to walk together from one list

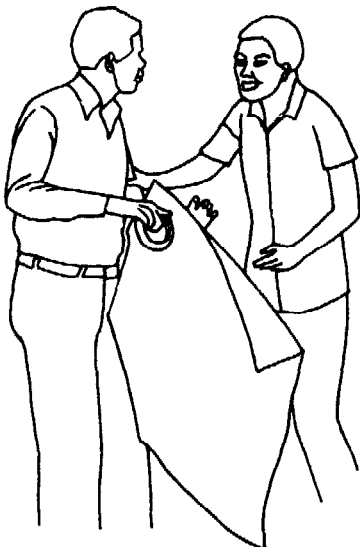

to another and review each; focus discussion on understanding and clarifying each evaluative statement on the list; that is, what did the group mean to convey in the judgment? Review each group's list in the same way.

Stage 2 (about 1½ hours)

—Reconvene the original small groups.

—Rotate them so that one group moves to another group's list.

—Give the small groups the following task, providing the example here or a similar one. Spend about an hour on this task: To generate questions from analysis of another group's evaluation. Each group is to ask these questions about another group's evaluative statements and then record answers on newsprint:

—What questions might the other group have asked to arrive at evaluative statements? What questions are implied in these evaluative statements?

—What additional questions are stimulated by the evaluative statement made by the group?

—What questions might evaluators have asked that they didn't?

Stage 3 (about 1-1½ hours)

—Assign two or three of the small groups to one part of the room and two or three to another; that is, divide the whole group in half but keep the working groups together. Give each group two or three of the lists of questions generated in Stage 2.

—A trainer in each of the two groups then assists participants to review the questions generated in Stage 2 and to translate each question into a question for program evaluation; for example, "Can one ask this or a similar question about one's own program or project?"

HERE IS AN EXAMPLE

This EXAMPLE is from the Mombasa seminar:

EVALUATIVE STATEMENTS

- a. The trip to Mombasa was good because it was free.
- b. Breakfast this morning was disorganized and the menu was inappropriate.

QUESTIONS ONE MIGHT ASK ABOUT THESE EVALUATIVE STATEMENTS OR THAT ARE IMPLIED IN THEM

- a. This trip was good because it cost nothing:
 1. What is the cost of the trip in money? Was it really "free?"
 2. What are hidden costs, if any?
 3. Where does the money come from?
 4. Given the cost—to someone—was it the best way to travel?
- b. Breakfast was disorganized and the menu was inappropriate:
 1. What kinds of food are appropriate for breakfast?

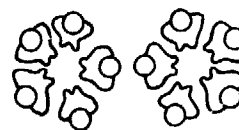
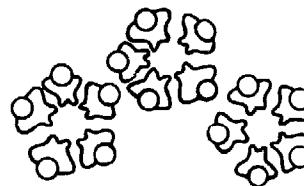
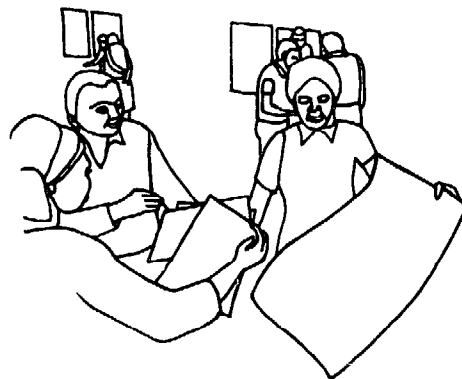

2. How should breakfast be organized?
3. What do people from different countries expect from breakfast?

PROGRAM EVALUATION QUESTIONS

- a. A specific question generated by the evaluative statement about the facilities in Mombasa was: "What kind of service did you expect at the seminar facility?"
- b. This was translated into the following program evaluation question: "What do our project-clients expect from services?"

Here's an example of the thought process that follows through the three stages:

Stage one: An evaluative statement is made by a group: "Service at the seminar facility is poor."

Stage two: One question among others raised by the statement is identified: "What kind of service does one expect at the seminar facility?"

Stage three: The question is translated into a program evaluation question: "What are the expectations of our clients regarding services of our project?"

PROCESS/MAINTENANCE TASKS:

—Help groups to follow the logical progression of the three stages of the activity.

—Give clear directions and specific examples at each stage.

—This is a somewhat complex exercise; go slowly if necessary and help people to participate.

CLOSURE:

—Inform the group that the product of this activity, the list of program evaluation questions they developed, will be used at the next seminar session, which will focus on collecting information to answer such questions.

—Mention the number and kinds of questions that were generated out of the everyday experience of the group members. Link this product to the idea that developing questions is not a mystical, scholarly activity; it's part of the evaluation that everyone does everyday. This exercise makes the process explicit and systematic.

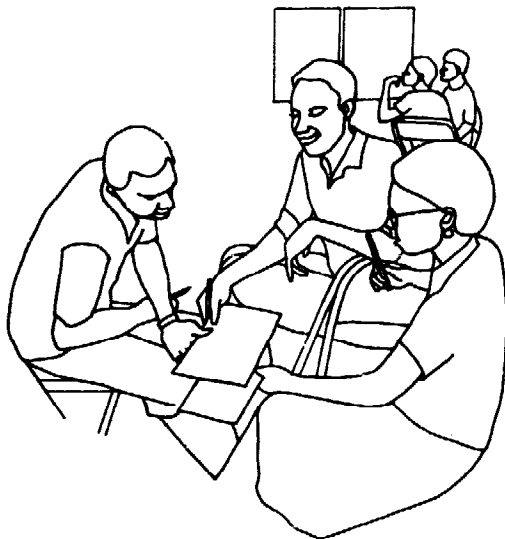
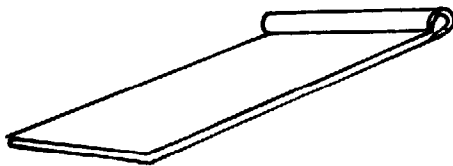

TO BE AWARE OF: In reviewing lists in Stages 1 and 2, the discussion may go beyond attempts to clarify and may develop into disagreement. If so, you will want to intervene.

Don't be surprised if some of the questions generated in Stage 2 are not easily translated into program evaluation questions. The group may get bogged down on a particular item. If so, suggest that they omit it and move on. Some items simply may not translate.

There will also be a temptation on the part of the participants to make judgments about questions. Reiterate that any question may be included if a member feels it would be useful for program evaluation.

At the end of the activity trainers may want

to re-emphasize the thought process with the group, using the example suggested, but it is advisable not to do it at the beginning. The exercise is best done step-by-step with directions for each stage given as that stage is reached.

The product from this session will be a long list of questions. It may be helpful for the trainers to consolidate this list and categorize it before the data collection session (Phase II, Activity C—Page 33). Questions related to administration, for instance, can be clustered together, as can those related to clients, project context and background, or communications.

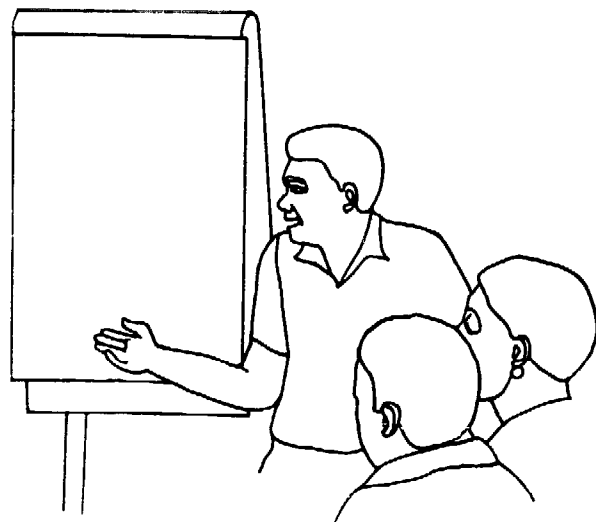
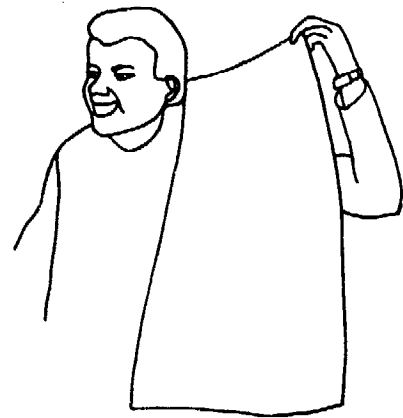

ACTIVITY B: WHY EVALUATE?

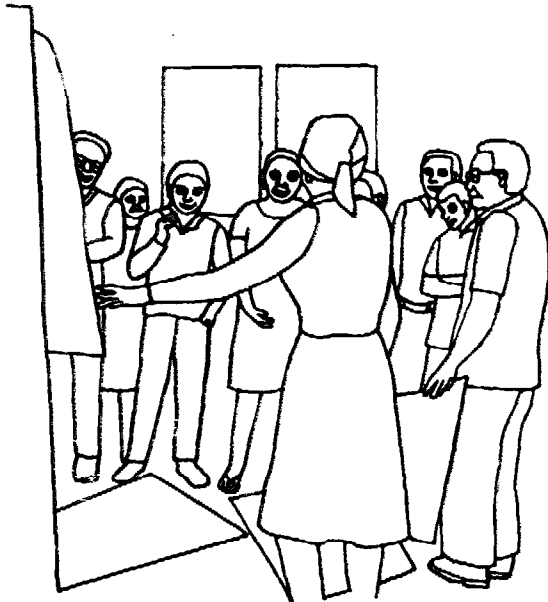

REASONS FOR DOING: *Total Time: 1 hour*

- To enable the group to recognize that there are several valid reasons for conducting evaluation.
- To assist group members to see that there are several ways to use evaluation data and findings.
- To introduce the idea that effective program evaluation has certain general characteristics.

CONDUCTING THE ACTIVITY:

—Convene participants in one large group. Ask group members to offer the reasons one evaluates a program or project.

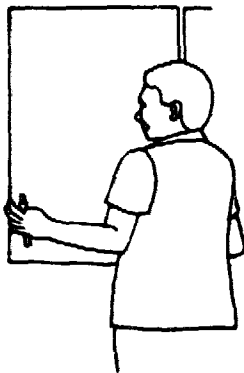

—List these reasons one by one on newsprint as they are suggested.

—When the group has run out of ideas, review the list and where possible summarize and synthesize the reasons given for evaluation. These may include, for example, "evaluation is helpful for effective decision making because it enables project staff members to: assess their own performance; anticipate needed changes; set project standards and criteria; and determine project benefits."

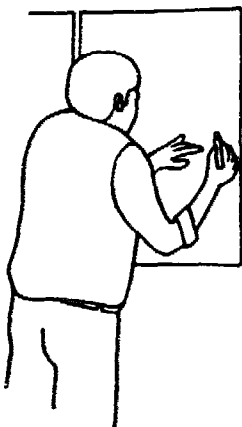

—Use the summary of reasons as the basis of a mini-lecture on the characteristics of effective evaluation: it is continuous, internal, external, participatory, and it is used for decision making.

PROCESS/MAINTENANCE TASKS:

—Accept any reason a participant offers for conducting evaluation.

—Refer to the list of evaluation reasons developed by the group in summarizing and describing characteristics of evaluation.

—Move the activity along; don't deliver a long lecture on evaluation.

—Elicit from the group members what reasons are acceptable and unacceptable to them for evaluating their own program.

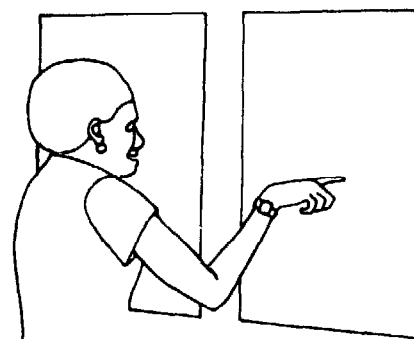

CLOSURE:

—Point out to the group that the reasons for evaluation and the characteristics of effective evaluation influence both the *kind* of data one collects and the way in which they are collected.

—Ask the group to keep in mind reasons for and characteristics of evaluation during the next activity on data collection.

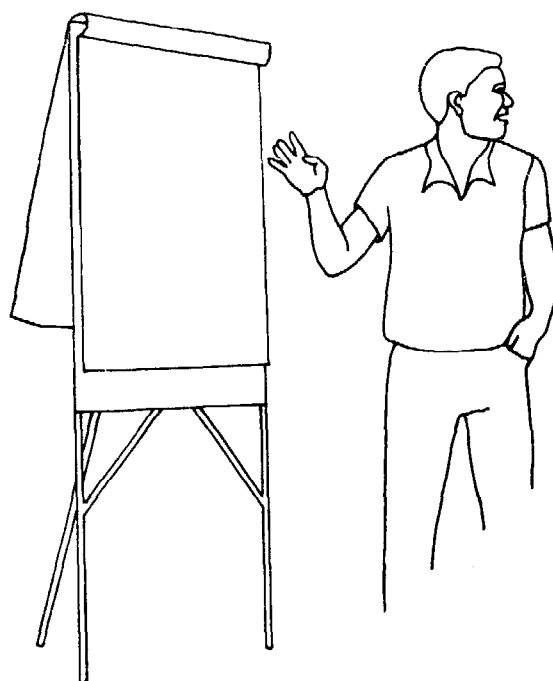

TO BE AWARE OF: Be straightforward in acknowledging that there are values associated with why and how one conducts an evaluation and help participants recognize their own values and biases.

Stress that a primary aim of evaluation is to collect data for decision making about elements of a project.

Stress that the more simple and practical the evaluation is, the more useful it will be for judging the effectiveness of community-based programs.

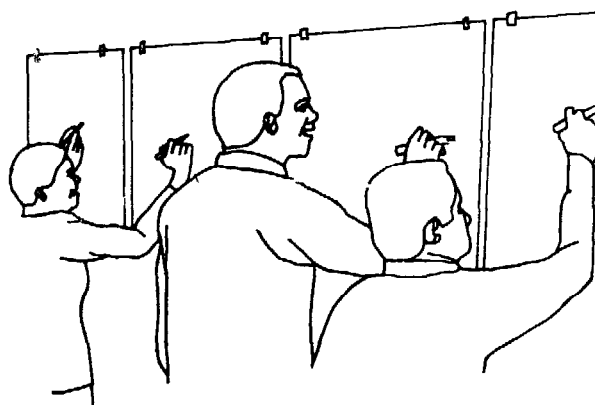

ACTIVITY C: COLLECTING DATA

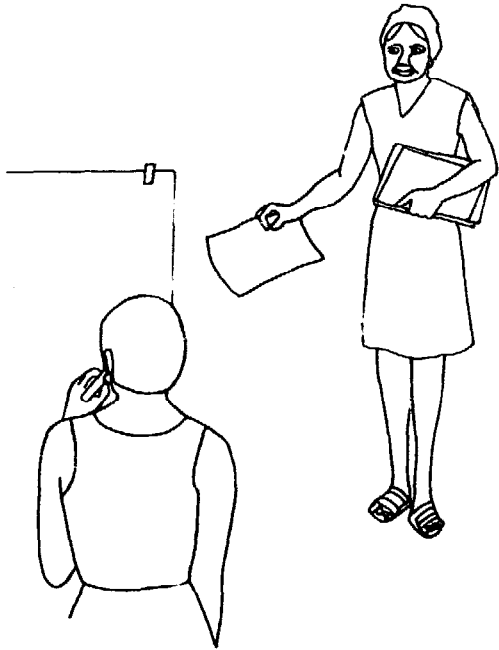

REASONS FOR DOING: *Total Time: 3-4 hours*

—To identify various ways to collect data.

—To demonstrate that criteria must be established for each evaluation question in order to answer it adequately.

—To illustrate that there are several basic methods for evaluation from which one can adapt and modify creative/innovative approaches.

—To reinforce that these basic methods are within participants' experience.

CONDUCTING THE ACTIVITY:

There are two stages to this activity:

Stage 1

—Hand out the list of categorized evaluation questions developed in Stage 3 of the "Anatomy of Judgments" activity (page 28).

—Ask small groups of 4-8 participants to select a question from each category.

—Give each group the following three-step task:

1. Clarify the question so all in the group understand what it means.
2. Determine what you will accept as evidence of success.
3. Determine how one would answer the question; how one would collect information about it.

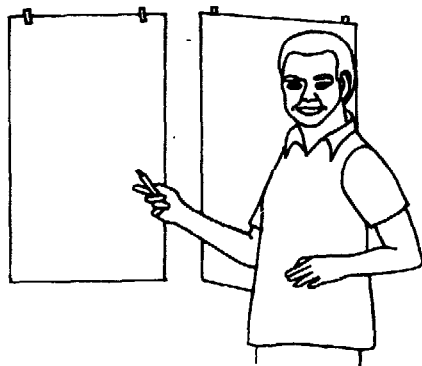

—Go through one example with the entire group.

—Give the small groups approximately an hour to complete this task and to summarize their work on newsprint.

—Reconvene participants into the large group after one hour and ask each small group to report on one of its questions; that is, to describe how members handled the three steps of the task.

—As groups report, the trainer summarizes Step 3 onto newsprint; that is, the methods suggested by the groups for collecting data.

Stage 2

—Through open discussion in the large group, assist participants to formulate guidelines for collecting data—what to do and not to do in carrying out the methods they have identified. Many issues, such as the ethics, manageability, acceptability, and practicality of evaluation techniques, may be included in the discussion.

—List the ideas discussed by the group on newsprint.

PROCESS/MAINTENANCE TASKS:

—Move the process along in Stage 2. Avoid long arguments over specific guidelines; if arguments occur seek consensus. If there is no consensus, acknowledge the fact and continue to the next item.

CLOSURE:

—Review the list of methods and guidelines proposed by the group.

—Emphasize that adapting evaluation methods to a specific field situation using the established guidelines will be the basis of the upcoming field-related activities.

HERE IS AN EXAMPLE

Here is a question from the list developed in Mombasa:

"Is the atmosphere in client group x good?"

1. The following would need to be clarified by the group regarding this question:

—What is meant by "atmosphere?"

"Atmosphere" might mean "open communication among participants."

—What is meant by "good?"
"Good" might mean "effective in meeting program goals."

2. Evidence of success would need to be agreed upon by the group for this question; e.g., almost all clients feel they can give direct feedback to program administrators.

3. One method of collecting data about the group atmosphere might be to interview a selected number of project clients about communication patterns. Another might be to keep track of the number of meetings program staff have with clients over a period of time. And who talks about what during meetings, etc.



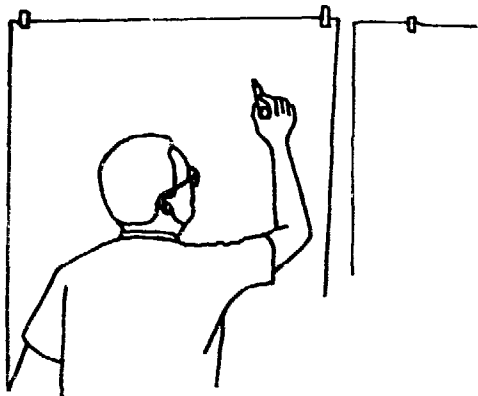

TO BE AWARE OF: It may not be possible to develop specific, detailed guidelines for conducting an evaluation, especially if seminar participants do not come from the same community. In this case it is important to help the group to step back and generalize about the *kinds* of things that must guide evaluation efforts.

There will be a temptation to change what the groups are saying into evaluation jargon. Try to avoid this, and at the same time encourage and acknowledge the various ways group members describe basic evaluation methods.

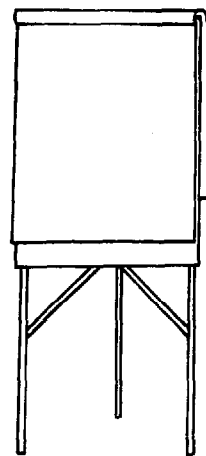
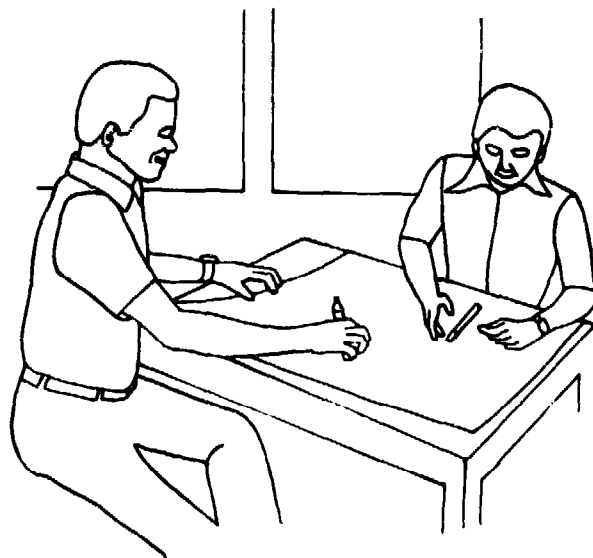

PHASE III: INTRODUCING FIELD REALITY

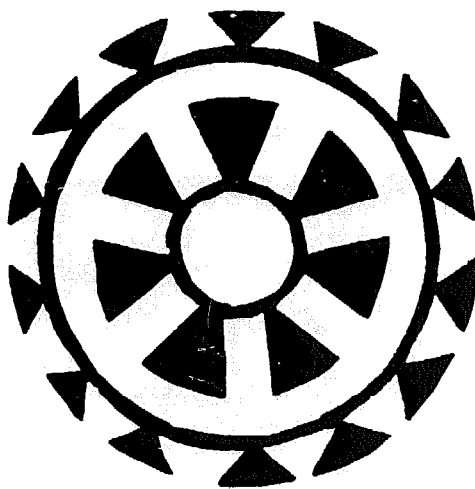

Activity A: BACKGROUND FOR FIELD WORK

Activity B: FIRST SITE VISIT

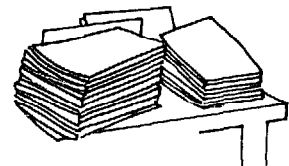

ACTIVITY A: BACKGROUND FOR FIELD WORK



REASONS FOR DOING: *Total Time: 3 hours*

—To provide brief history for each field site where evaluation approaches will be tested.

—To introduce participants to representatives from their assigned site, and give them a chance to get acquainted.

—To provide a common context for field activities.

—To delineate and clarify the field work tasks.

—To announce field site assignments.

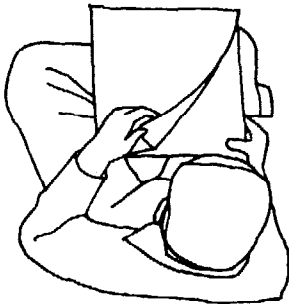

CONDUCTING THE ACTIVITY:

—Hand out the written case study describing each seminar field site, the evaluation objectives of the case study organization, and the teams' field-site tasks. Allow individuals an appropriate amount of time to read the material.

—Reconvene the large group.

—Give each person his/her assignment to a team and field site. (See "To Be Aware Of.")

—Allow time for field teams to congregate and chat with two or three representatives from each site who have been especially invited for this session.

—Allow time for someone to sort out travel and logistics with each team separately.

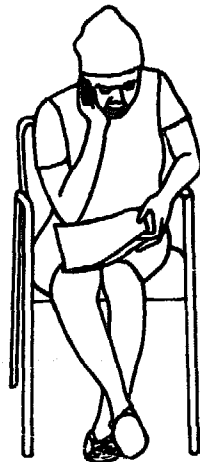

PROCESS/MAINTENANCE TASKS:

—To assure understanding and clarity, allow sufficient time in the large group for questions about the case study.

—Develop a policy for field site assignment before the session. Explain why it is or is not possible to change assignments.



CLOSURE:

—Encourage field site teams to meet informally to prepare for their first visit to the cooperating village.

—Point out that field teams may want to organize how they will operate as a team for the upcoming field work, including the important task of recording team activities.

TO BE AWARE OF: It is at this stage that the permanent field site teams are established. Some people may question their field assignment and ask for another site. This will be easier to deal with if the policy has been made clear earlier in pre-workshop planning.

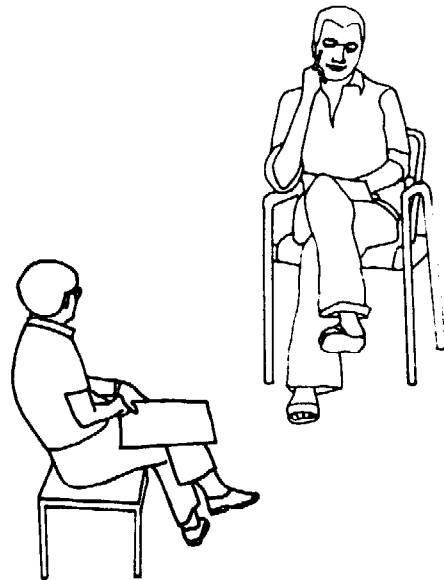

It is suggested that the planning team assign individuals to sites rather than having them make the selection. The following are considerations for making these assignments:

- Is there a cross section of participants on each team?
- Does at least one person speak the local language?
- Does someone know how to drive and does someone know the route?

Before this session, sufficient meetings need to have been held with representatives from each field site focusing on their role in the seminar, particularly in field visits.



ACTIVITY B: FIRST SITE VISIT

REASONS FOR DOING: *Total Time: One full day*

—To allow enough time for participants to meet residents at the site informally before beginning of seminar field tasks.

—To give people a general overview of the village field site.

—To acquaint people with logistical arrangements at the site.

—To establish rapport and a congenial, nonthreatening atmosphere for conducting later fieldwork tasks.



CONDUCTING THE ACTIVITY:

—At this time, the teams begin to function independently and organize their own schedule of events for the one-day field visit.

PROCESS/MAINTENANCE TASKS:

—Reassure the participants that their only "task" during the first visit is to get acquainted with the site and village residents.

CLOSURE:

—Inform teams that they should let field site representatives know they will return to the site in a day or two for follow-up discussion. Clarify what the village people can expect from the team on the next visit.



TO BE AWARE OF: Field site representatives must be on the spot to guide participants and handle the village formalities that may be required (e.g., initial courtesy calls on leaders, etc.).

Despite attempts to make the purpose of the seminar visits clear to village residents, it is inevitable that there will be some confusion. This condition is evident in any evaluation process with any group of people. Trainers should acknowledge this as a reality of conducting evaluation and assist teams to develop a plan for making their objectives and work as explicit as possible to those involved at the field site. It is also appropriate to discuss how the teams will try to assess their impact on the field site, whether they are being clear about their activities, and what happens if there are misconceptions or inappropriate expectations.



PHASE IV: ACTION AND REFLECTION

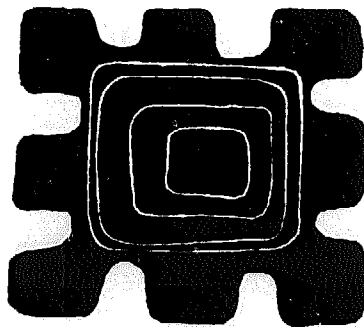

**Activity A: FIRST IMPRESSIONS AND THE
EVALUATOR'S RESPONSIBILITY**

Activity B: APPROACHES TO DATA COLLECTION

Activity C: FIELD WORK AND ANALYSIS

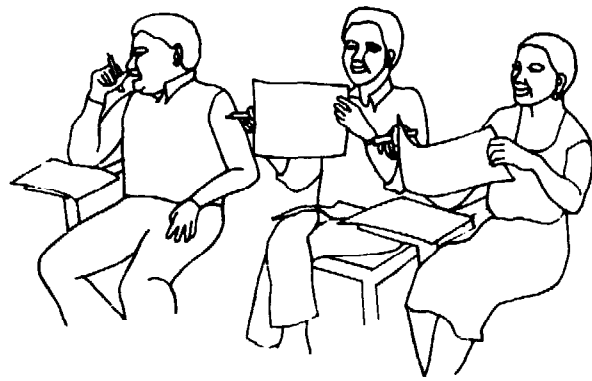
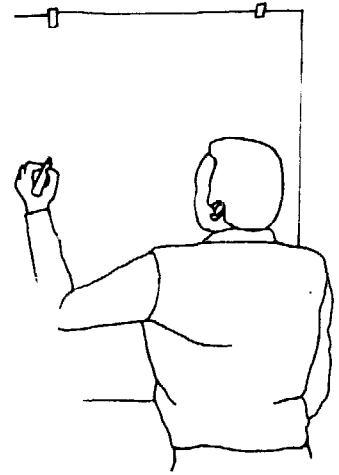

ACTIVITY A: FIRST IMPRESSIONS AND THE EVALUATOR'S RESPONSIBILITY

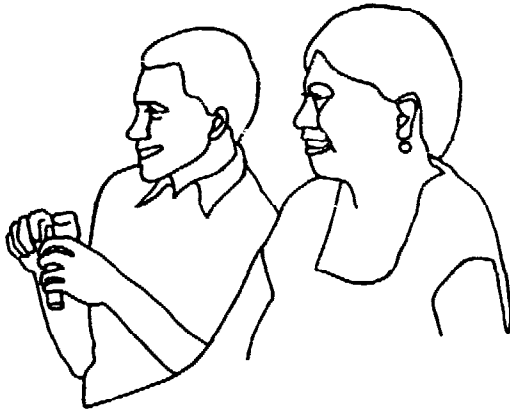

REASONS FOR DOING: *Total Time: 2-3 hours*

—To provide a structured setting for sharing observations about each site with the whole group.

—To demonstrate that people's first impressions lead them to initial judgments.

—To illustrate and discuss how initial judgments may affect the whole evaluation process.



—To demonstrate that initial judgments are generally based on limited evidence.

—To illustrate that initial judgments are frequently made without reference to a standard or criterion.

—To make initial judgments explicit and determine how to cope with them in carrying out evaluation process.

—To assist participants in identifying their own hidden biases.

—To delineate differences between initial judgments and evaluation.

—To define evaluation as a conscious process of systematic data collection and analysis with conclusions based on evidence.

—To discuss and enumerate the responsibilities of the evaluator.



CONDUCTING THE ACTIVITY:

—Convene large group. Encourage each person to give one first impression of the villages. After each person has spoken, open the discussion up for additional comments from anyone.

—Use newsprint to record these impressions, site by site, as they are given.

—Lead the group in discussion of selected observations and determine how individuals reached these conclusions, what evidence the conclusions were based on, what bias may have influenced conclusions.

—Assist the group to generalize about the nature of first impressions/initial judgments.



PROCESS/MAINTENANCE TASKS:

—The trainer's primary role here is to ask questions about the initial judgments made by participants. For example:

—"Would you be willing to clarify that?"

—"What led you to this conclusion?"

—"What evidence do you have for this statement?"

—"How many times did you note this occurrence?"

—"How do you know this to be a valid statement about this village?"

—"What is the criterion for your judgment about this?"

—In order to keep the process moving one trainer can list first impressions on newsprint while another facilitates discussion.

—In a nonthreatening way the facilitator should as-

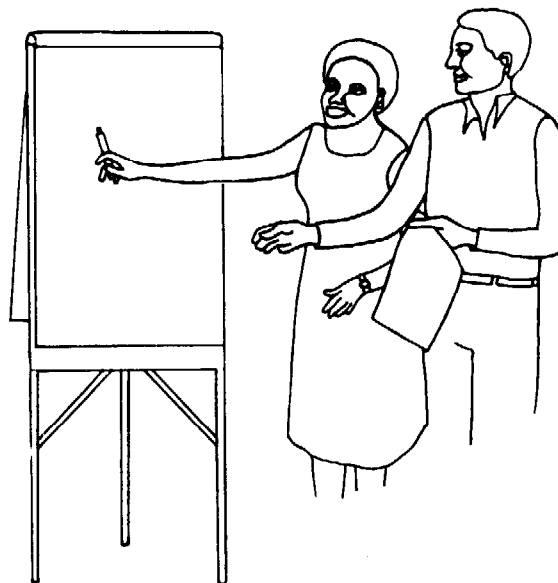



assist participants to recognize bias, insufficient evidence (e.g., if one sick baby is observed, it may be assumed that many babies in the village are sick), conclusions that don't follow from evidence, inappropriate standards (e.g., prices from one country may be used to judge prices of another).

CLOSURE:

—Assist participants in making some generalizations that differentiate between initial judgments and evaluation.

—State clearly that evaluators must decide how to deal with first impressions in evaluation process (e.g., systematically collect data to see if an impression is accurate, acknowledge and try to set aside first impressions, etc.). Point out that the problem of first impressions is similar to the earlier seminar activity (page 27) where participants were asked to make evaluative statements about seminar logistics without setting standards or systematically collecting data.

—Based on the group discussion, assist participants to draw conclusions about evaluator's primary responsibilities. For example, the evaluator:

—“Must not make statements without support.”

—“Must acknowledge biases.”

—“Must speak to the interests of those being evaluated.”

—“Must avoid taking sides.”

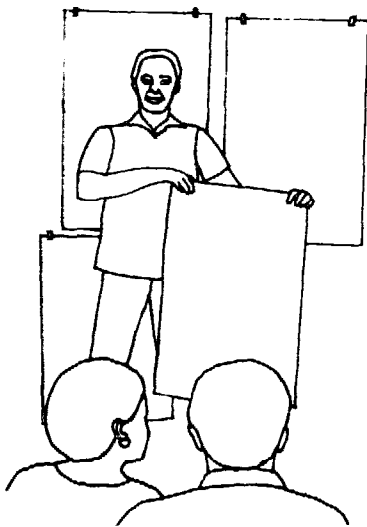

These are only examples and the discussion will undoubtedly generate a different and increased number of evaluation responsibilities.

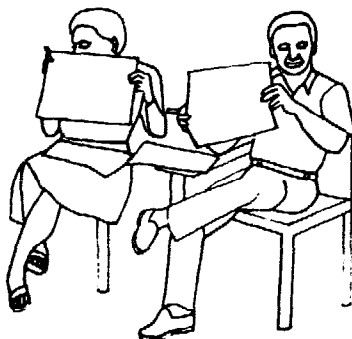

TO BE AWARE OF: It is very likely, given the nature of the field work, that an issue raised in the discussion of evaluator responsibilities will be, “Should

seminar participants give instant on-the-spot advice to people at the sites?" This is a complicated issue and the group should spend time discussing how it will be handled. In the Mombasa seminar, for example, it was decided that individuals would respond to villagers according to each situation using their own judgment, and that other team members would accept this. This issue involves some important ideas such as evaluator-client trust, appropriate use of information, confidentiality of data, the possibility that the advice given on the spot may be wrong and cause problems, or the converse—that withholding of information could cause problems or be viewed as uncooperative. These are important evaluation concerns and deserve full discussion by the group.

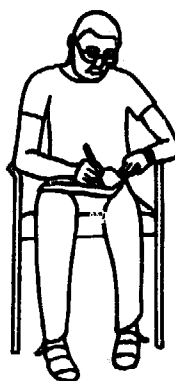
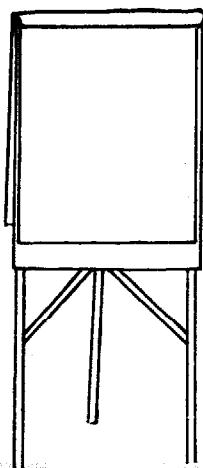
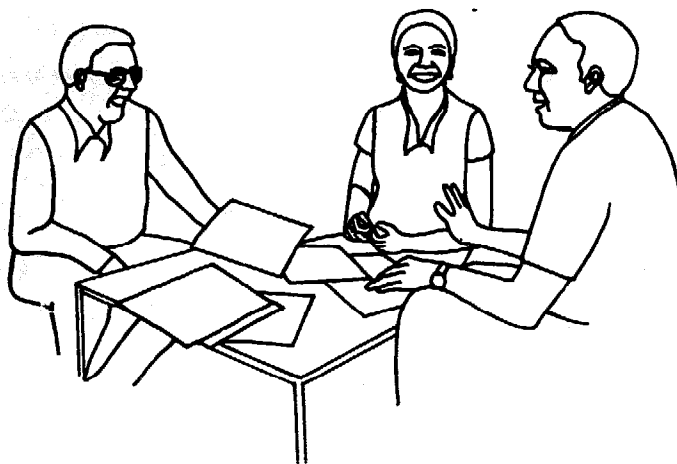
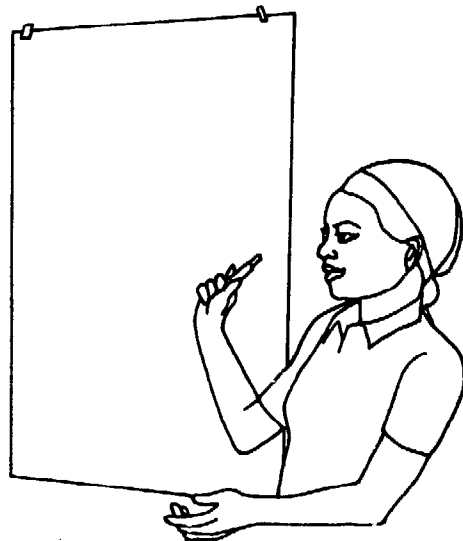

ACTIVITY B: APPROACHES TO DATA COLLECTION

HERE IS AN EXAMPLE

a. A question in the Mombasa case study is: *What do Tototo project participants use their project earnings for? Are they and their families benefiting?*

b. *Clarification of terms agreed upon by group members is:*

Participants

1. *individuals actually making the products sold by Tototo.*
2. *employees earning money from the Tototo project.*

Use

Whatever happens to money received by participants from the project.

c. *Evidence of success:*

1. *An agreed-upon percentage of Tototo participants will use the money for infant care and nutrition.*
 2. *An agreed-upon percentage use partial funds to reinvest in materials or set aside for their own business.*
- d. *Two methods identified for collecting information are:*
1. *Interviewing: e.g., select a number of project participants, and use a schedule of specific questions to determine how they use project earnings.*
 2. *Observing: e.g., note in a systematic way, how project participants spend their time and what items are purchased by them to carry out their activities.*

REASONS FOR DOING: Total Time: 4-6 hours

—To enable participants to test a process used earlier (Phase II, Activity C, page 33) in the seminar to identify approaches for data collection.

—To link data collection to the organizational goals and questions stated in the seminar case study.

—To select the questions to be investigated and develop a practical data collection method.

CONDUCTING THE ACTIVITY:

—Working with the large group, select one question from the seminar case study and help the group to clarify the question and identify ways to collect data to answer it. The process to be used is the same as in the previous Data Collection (Activity A, B, or C in the Demystifying Evaluation phase, pages 25-35).

—Break the large group into field site teams. Ask each team to select a question from the seminar case study and use the above process as a way to develop a practical instrument for data collection about it. Allot about 2-3 hours.

—Bring teams together for reports and feedback after each is finished.

—Allow sufficient time for teams to adjust their instrument based on group feedback. They will need to prepare a specific plan for using their approach to collect data during the following day's site visit, and for determining who will assume which responsibilities and carry out which functions.

PROCESS/MAINTENANCE TASKS:

—Stress that the items for data collection should be based on organizational questions and concerns outlined in the case study: link data collection to program needs.

—Emphasize to teams that their evaluation approach must be practical and manageable, since it must be carried out the following day.

—Encourage the large group to give helpful feedback to each team during the reporting session.

—Encourage each team to incorporate useful feedback into its data collection method.



CLOSURE:

—Wish people good luck in their field visits and set the time for the group to reconvene.



TO BE AWARE OF: This whole exercise is extremely important because it sets a pattern for how people will develop evaluation approaches, work together, and how groups and individuals will give and receive feedback on their daily work products. In other words, it becomes a model for teamwork throughout the action-reflection phase.

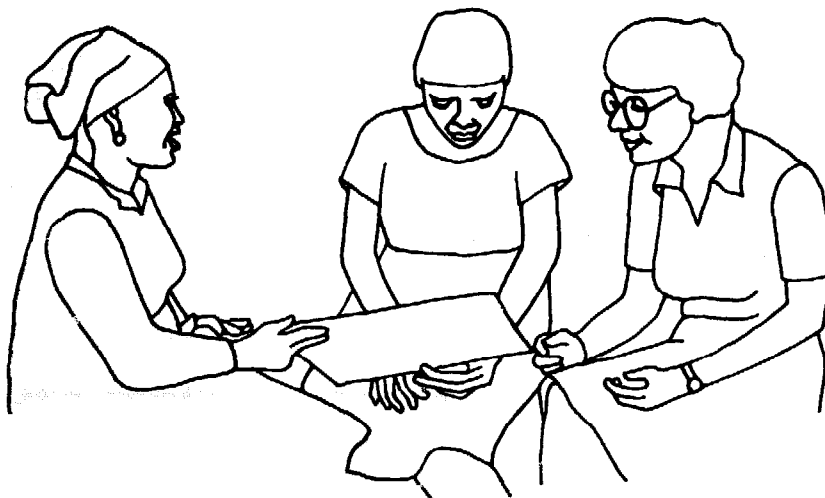

ACTIVITY C: FIELD WORK AND ANALYSIS



REASONS FOR DOING: *Total Time: 3 or 4 days*

—To give participants the opportunity to field test evaluation approaches and methods; to learn about other approaches; to analyze and refine methods; to share their experience with their colleagues; and to revise their evaluation approaches based on experience.

—To establish action and reflection as a continuous process.



CONDUCTING THE ACTIVITY:

—Plan ways for the teams to “do” a cycle including fieldwork, small group discussion and large group analysis, feedback about evaluation approaches and each team’s general progress, adjustments and new approaches based on feedback, and back to fieldwork.

—Make clear to each team that members are responsible for the range of the team’s efforts. Each team may refine a single method or technique over the three days or try out several approaches.

—Allow ample opportunity each day after field visits for discussion among team members and with the larger group.



PROCESS/MAINTENANCE TASKS:

—Encourage the development of creative approaches and adaptations of basic techniques for data collection. These adaptations are limitless and may in-

clude using such things as games, photographs or drawings, problem-solving exercises, group discussions, and so on.

—Continually encourage the collegial exchange of information and constructive criticism among team members and within the large group.

—Remind teams by what date and time their field work must be concluded to enable them to move to the next phase.

CLOSURE:

—Review purpose of field site visits and logistical arrangements of large group meetings planned over next several days.

TO BE AWARE OF: The trainer is being called upon to play a delicate and rather complicated role as both team member and trainer in this phase. One must guard against assuming the role of team leader or evaluation expert but must, at the same time, facilitate the group process and encourage the team to be innovative. The trainer will also want to guard against the tendency to withdraw from participating in order not to appear the expert. The trainer's primary responsibility is to be a good, active team member.

Some teams may encounter problems; they should be encouraged to seek help from other groups in discovering solutions.

Logistical arrangements should be reviewed each day.

At some point, groups might be reminded that they have a continuing responsibility to attempt to make clear to villagers what they can/cannot expect as a result of all this activity.

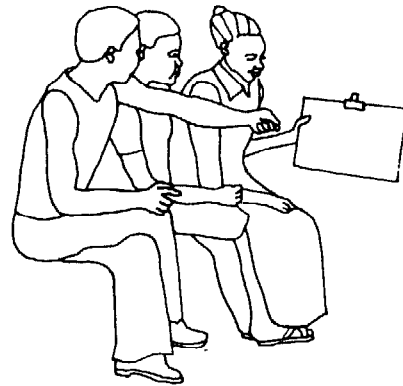

PHASE V: SYNTHESIZING

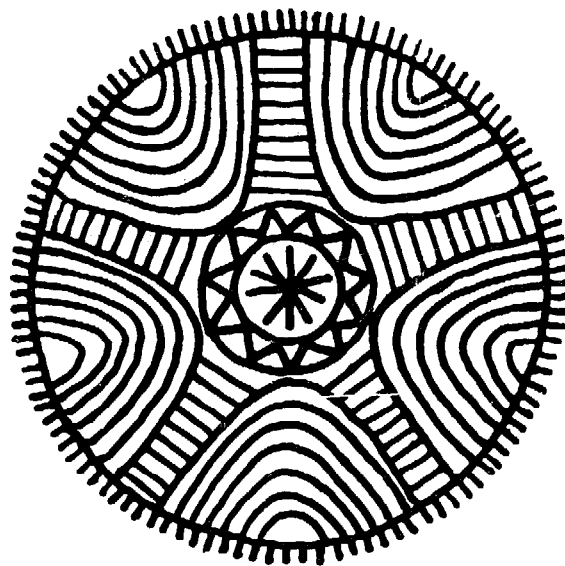

**Activity A: PREPARATION AND PRESENTATION
OF FIELD TEAM REPORTS**

Activity B: LINKING TO ONE'S OWN WORK

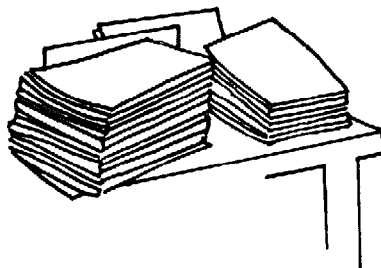

ACTIVITY A: PREPARATION AND PRESENTATION OF FIELD TEAM REPORTS

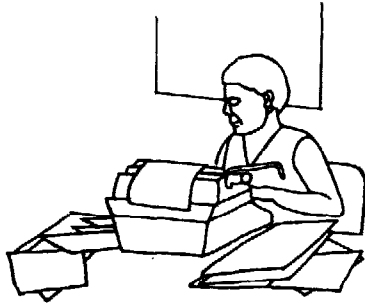

REASONS FOR DOING: *Total Time: 2 full days*

—To enable teams to reflect on their experiences collecting data.

—To provide a chance to interpret the data.

—To allow teams to pull together what they have learned about evaluation approaches into generalizations and conclusions.

—To produce a written report.



CONDUCTING THE ACTIVITY:

This activity has two stages:

Stage 1: Preparing the report

—Convene the large group for task assignment.



—Allow one day for each field site team to accomplish the following task: preparing a two-part report whose first part will present and interpret the data collected; description of the limitations of data and methodology; tentative conclusions based on the data; and recommendations to the host organization based on the conclusions. The second part of the report will cover development of a plan for ongoing evaluation of the case study project based on the team's experience on site and on field-tested evaluation techniques.

Stage 2: Presenting the report

—Allow one day to present and critique the team reports.

—Hand out a complete copy of each team's report to every participant before beginning the session.

—Give each team 20 minutes to write out on newsprint the tentative conclusions of its report, recommendations, and evaluation plan. Post these summaries on the walls.

—Give participants 15 minutes to walk around room and review each team's summary.

—Assign each team another team's report to critique and give 30 minutes for the team to develop questions and comments regarding their assigned report.

—Reassemble participants. Give each team its turn to role play as administrators of the case study. As project administrators, they are to ask questions related to both conclusions and approach of the team who prepared the report they were assigned to review. While one team plays the administrators and questions the team that prepared the report, other seminar participants observe the process. The seating should be arranged so the administrators and the team of evaluators sit face to face for their exchange. The rest of the participants might sit in a circle around the two teams.

Allot about ½ hour for each period of question and response, 25 minutes for exchange, and 5 minutes at the end for questions from observers and general discussion.

PROCESS/MAINTENANCE TASKS:

—After the critique of each team's report, reassemble the group to develop generalizations regarding field report evaluation plans. For example:

—they should be simple/workable.

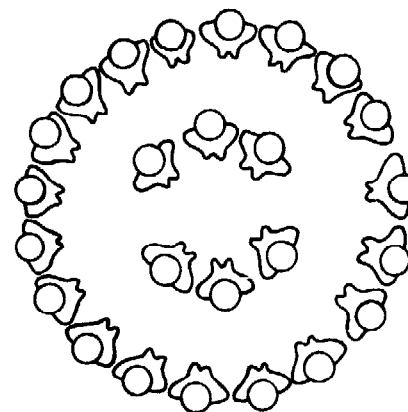
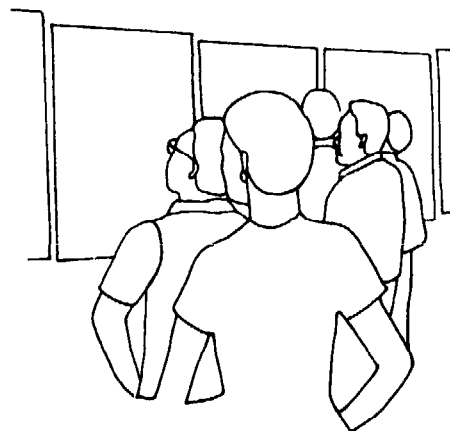



—decision makers must try to use data collected.

—there must be conviction within the organization that evaluation is not separate from other functions but a necessary part of decision making.

—data have to be documented and kept accessible.

—data should be in such a form that they can be easily understood by those who will have to use them.

—data must be timely and kept up to date.

—evaluation goals must be evaluated and altered as needs arise.

—as many project participants as possible should be involved in the process.



TO BE AWARE OF: This reporting session could be sensitive if the teams' analyses have uncovered major problems related to the administration of the agency that is being studied. Be sure to negotiate with host agency staff *beforehand* how best to conduct this session.

Emphasize that reports must be clear and concise.

There should be equal emphasis placed on both parts of each team's report, on both the results and the evaluation plan, although the temptation will be to spend most of the time on Part One.

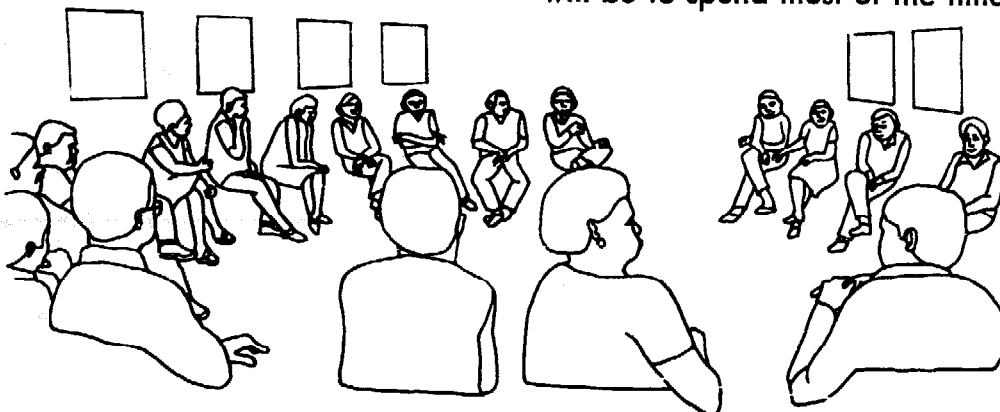

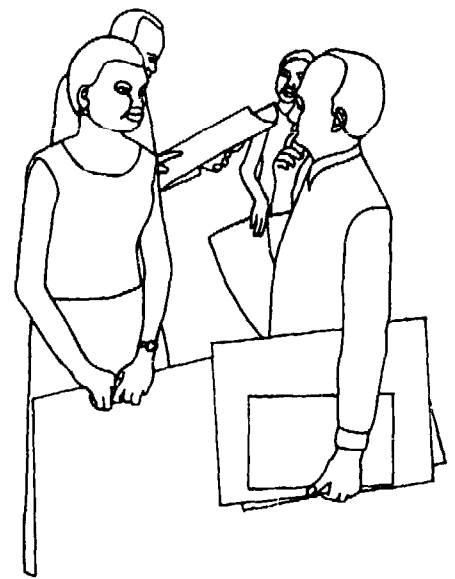

ACTIVITY B: LINKING TO ONE'S OWN WORK



REASONS FOR DOING: Total Time: 4-4½ hours

—To enable participants to put the seminar experience and learning into the context of their own projects.

—To enable country teams to make plans for using seminar learnings to design or modify their own evaluation system.

CONDUCTING THE ACTIVITY:

—Reorganize the large group into country teams and allow about two hours for the following tasks:

—discuss what was learned from the seminar.

—adapt learnings and ideas to their home project.

—summarize on newsprint the changes they recommend for more effective evaluation of their own projects.

—Reconvene the group and ask each team to report on its summary. Allow the group to discuss and critique each team's plan. Allow 1 to 1½ hours for this.

PROCESS/MAINTENANCE TASKS:

—Emphasize that country team reports should focus on new learnings and potential changes, not on what currently exists in a project.

—Limit each summary presentation to 10 or 15 minutes, with an equal amount of time for discussion.

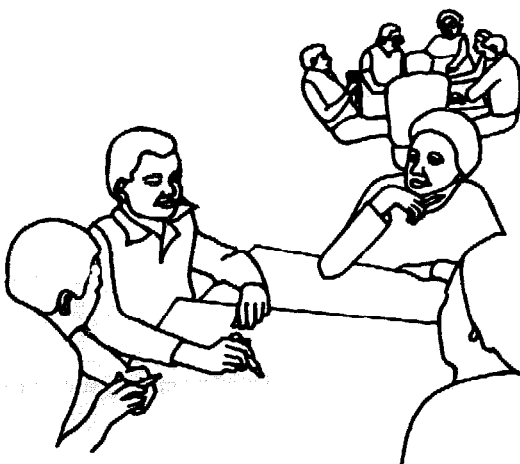
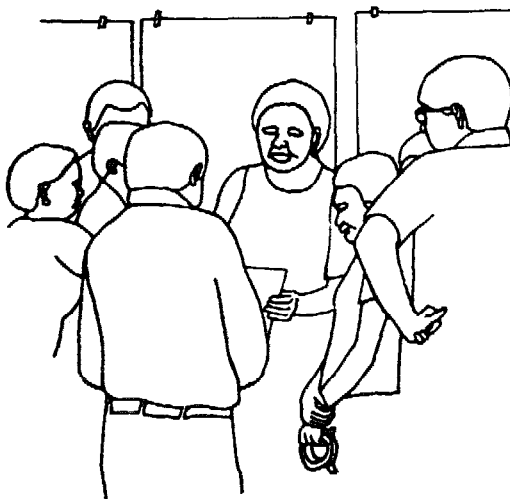

CLOSURE:

—Select one or two new ideas or changes from each report and highlight these as evidence of movement in the learning of the team.

TO BE AWARE OF: Country teams should develop their plans realistically, given their own work context at home. They should place special emphasis on identifying possible obstacles to evaluation.

During this session it is probably a good idea to point out to participants the value of keeping in touch with each other and sharing reports on their evaluation efforts after teams return home. The seminar participants might form a network for exchange of information and consultation on evaluation of field projects.

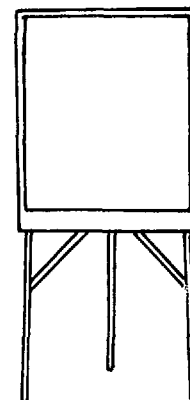
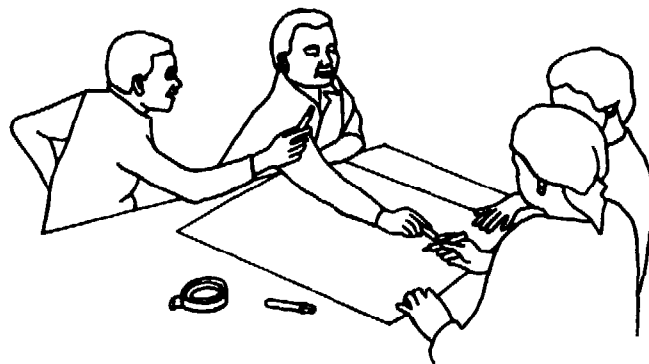
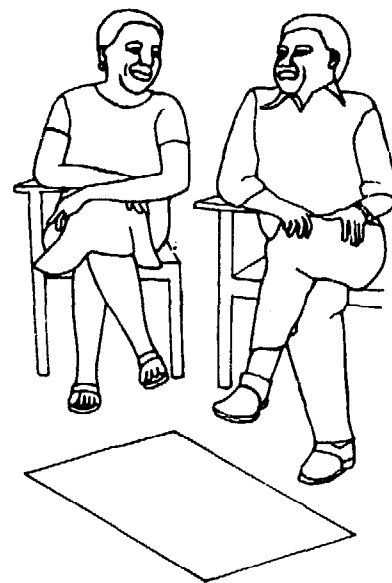

PHASE VI: ENDING THE WORKSHOP

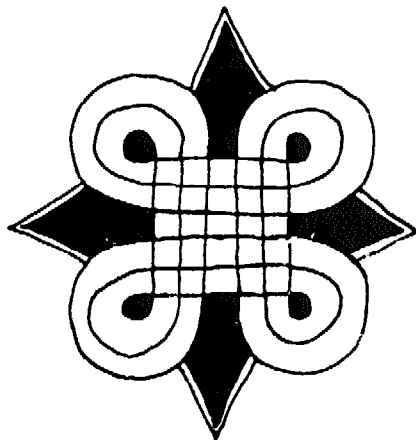

Activity A: PARTICIPANT EVALUATION OF WORKSHOP

Activity B: CLOSURE

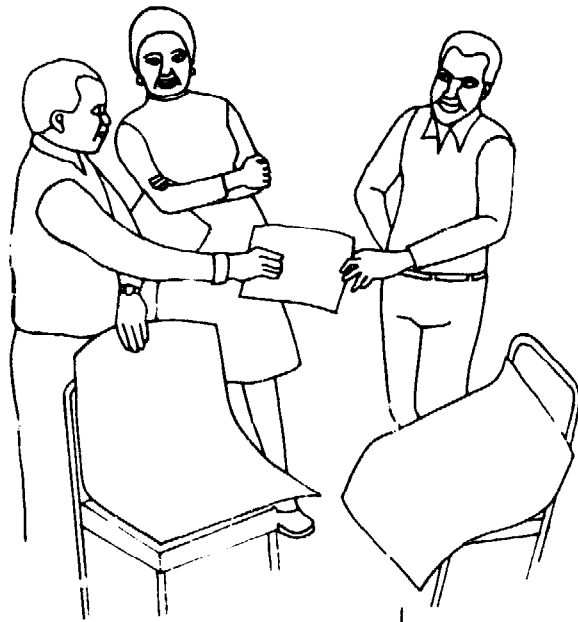

ACTIVITY A: PARTICIPANT EVALUATION OF WORKSHOP

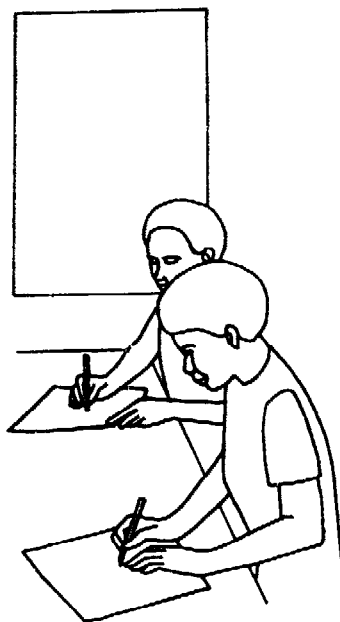

CONDUCTING THE ACTIVITY:

Total Time: 2-3 hours

—Allow sufficient time in a comfortable setting for participants to complete a post-seminar evaluation questionnaire. (Those interested in using the Mombasa evaluation as a model for developing their own seminar evaluation can obtain copies from World Education.)

—Reconvene the group and collect questionnaires.

—In the large group, as a final activity, ask each participant to volunteer one word that expresses his or her feelings about the seminar. List these on flip charts as they are offered.

—The trainer may ask for elaboration on two or three of the words.



PROCESS/MAINTENANCE TASKS:

—Don't press individuals to offer a word if they don't care to.

—Keep the process moving. It should be lively and snappy.

—Keep to the one-word ground rule except where clarification is needed.



CLOSURE:

—Point out to the participants that the list of words represents the group's current feelings about the workshop. The tabulation of the pre- and post-ques-

tionnaire will provide more data about seminar learnings and this information will be sent to participants. Inform the group that the trainers will contact participants some months later and ask their help to assess long-term seminar learnings.

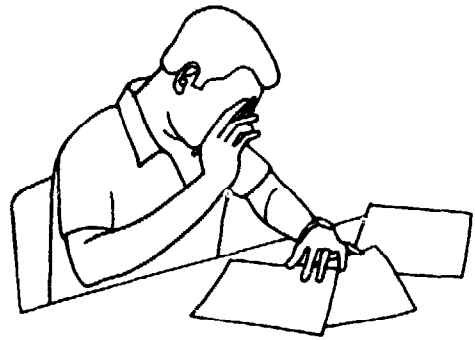

TO BE AWARE OF: The questionnaire can provide important information, so individuals should be given, and encouraged to use, sufficient time to fill it out thoughtfully. A trainer "pep talk" to stress the importance may help here.

As for the group activity, this is the final one in the seminar—it is important to keep it lively and have some fun!

Attend to any closing formalities that may be necessary.

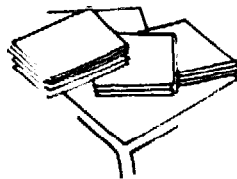
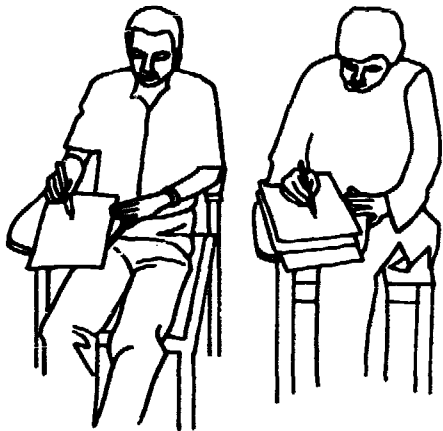

An evaluation of the Mombasa Seminar was carried out by Amos O. Odenyo, Ph.D., Department of Sociology, City University of New York, York College. The report, prepared for the Carnegie Corporation of New York, is available from World Education. Its title is Observations of the International Field-Operational Seminar on Practical Evaluation Techniques for Nonformal Adult Education Programs.

ACTIVITY B: CLOSURE

Total Time: as long as you want!



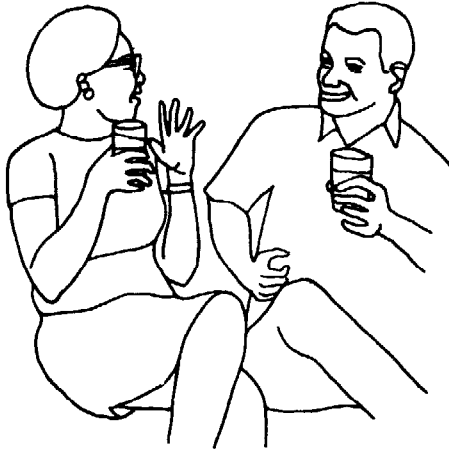

APPENDIX :

LIST OF PARTICIPANTS

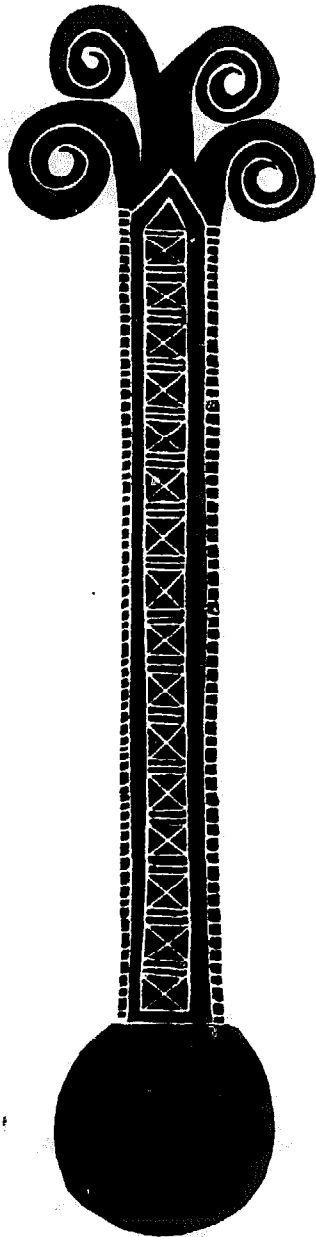

NATIONAL CHRISTIAN COUNCIL OF KENYA / WORLD EDUCATION

Evaluation Seminar, 10/23/77 to 11/5/77,
C.P.K. Guest House, Mombasa, Kenya

ETHIOPIA:

Name and Home Address:

Office Address:

Mamitu Buzuneh
P.O. Box 5041
Addis Ababa, Ethiopia

P.O. Box 30104
Addis Ababa, Ethiopia

Abebe Hailu
Tel. 110381
Addis Ababa, Ethiopia

P.O. Box 30104
Addis Ababa, Ethiopia

Neway Woldesadik

Ministry of Education
P.O. Box 1367
Addis Ababa, Ethiopia

Abeba Wolderufael
P.O. Box 30104
Addis Ababa, Ethiopia

P.O. Box 53538
Nairobi, Kenya

GHANA:

E. K. Abankwa
c/o P.O. Box 22
Aiakwa, Ghana

Department of Social
Welfare & Community
Development
P.O. Box 161
Asamankese, Ghana

J. N. Arthur
E 145/3 Amond Street
Cape Coast, Ghana

Department of Social
Welfare & Community
Development
P.O. Box M230
Accra, Ghana

W. Oppong
P.O. Box 161
Asamankese, Ghana

P.O. Box 161
Asamankese, Ghana, Tele: 64

C. K. Van Dyck
P.O. Box M230
Accra, Ghana

P.O. Box 84
Saltpond, Ghana

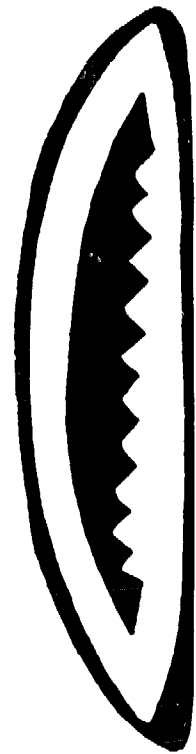

KENYA:

Elizabeth Agina
P.O. Box 86491
Mombasa, Kenya

National Christian Council of Kenya
P.O. Box 82275
Mombasa, Kenya

Nelson Kibathi
P.O. Box 25256
Nairobi, Kenya

P.O. Box 45009
Nairobi, Kenya

Holland Millis

Totata
P.O. Box 82275
Mombasa, Kenya

Elvina Mutua
P.O. Box 82969
Mombasa, Kenya

P.O. Box 82275
Mombasa, Kenya

Geoffrey Mwaura

Community Centre
Home Industries
P.O. Box 17166
Nairobi, Kenya

Noel Ntazinda
P.O. Box 45009
Nairobi, Kenya

N.C.C.K. Cottage Industries
P.O. Box 45009
Nairobi, Kenya

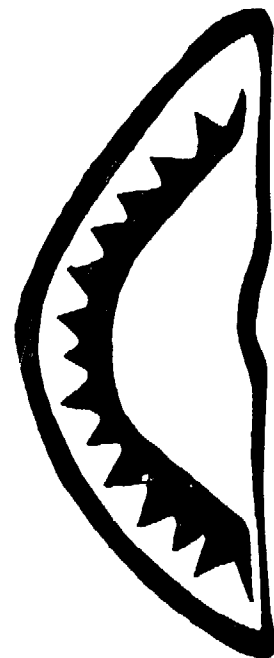

Daudi Nturibi

Institute of Adult Studies
P.O. Box 30688
Nairobi, Kenya

Philip Waita
P.O. Box 85356
Mombasa, Kenya

P.O. Box 82275
Mombasa, Kenya
Tele: 21004

SIERRA LEONE:

Fatmata Kassim
20 Prince Williams St.
Bo, Sierra Leone

6 Prince Williams St.
Bo, Sierra Leone

Marilyn Sawyerr
32A Pademba Road
Freetown, Sierra Leone

Juba Army Municipal School
Juba Barracks
Freetown, Sierra Leone

UNITED STATES:

Noreen Clark
315 E. 68th Street
New York, N.Y. 10021

Columbia University
School of Public Health
600 W. 168 Street
New York, N.Y. 10032

Jasperdean Kobes
10 W. 66th Street
New York, N.Y. 10023

World Education
1414 Sixth Avenue
New York, N.Y. 10019

James McCaffery
44 Winfield Avenue
Mount Vernon, N.Y. 10550

Amos Odenyo
43-11 203rd Street
Bayside, New York 11361

Department of Sociology
City University of New York,
York College
Jamaica, New York 11451



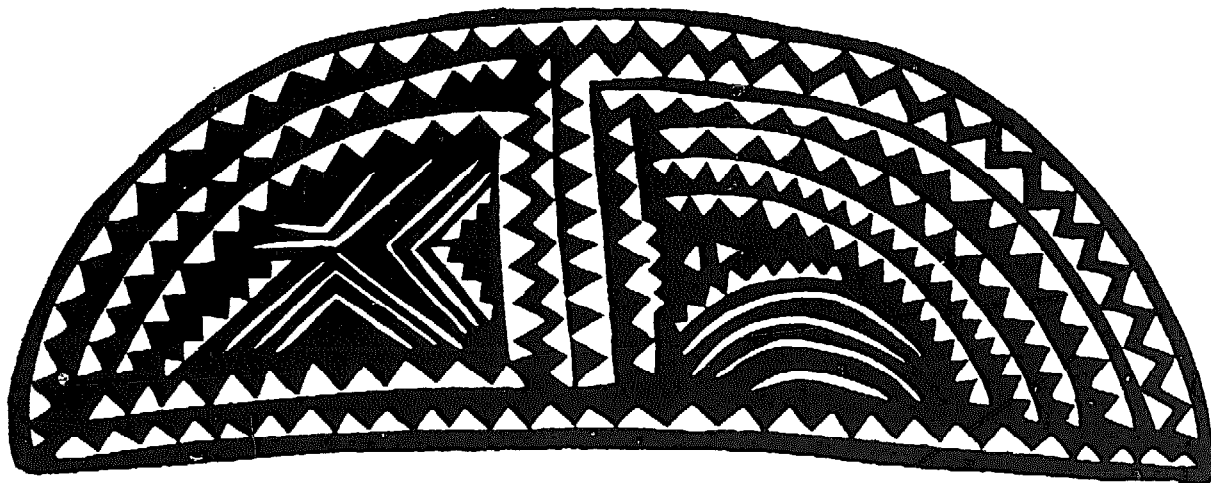

world education 1414 Sixth Avenue, New York, N.Y. 10019

US \$5.00