

AT MICROFICHE
REFERENCE
LIBRARY

A project of Volunteers in Asia

The Journal of the New Alchemists
Volume 3

Edited by: Nancy Jack Todd

Published by:
New Alchemy Institute
237 Hatchville Road
East Falmouth, MA 02536 USA

This publication is out of print in 1983.

Reproduced by permission of the New Alchemy
Institute.

Reproduction of this microfiche document in any
form is subject to the same restrictions as those
of the original document.

The Journal of

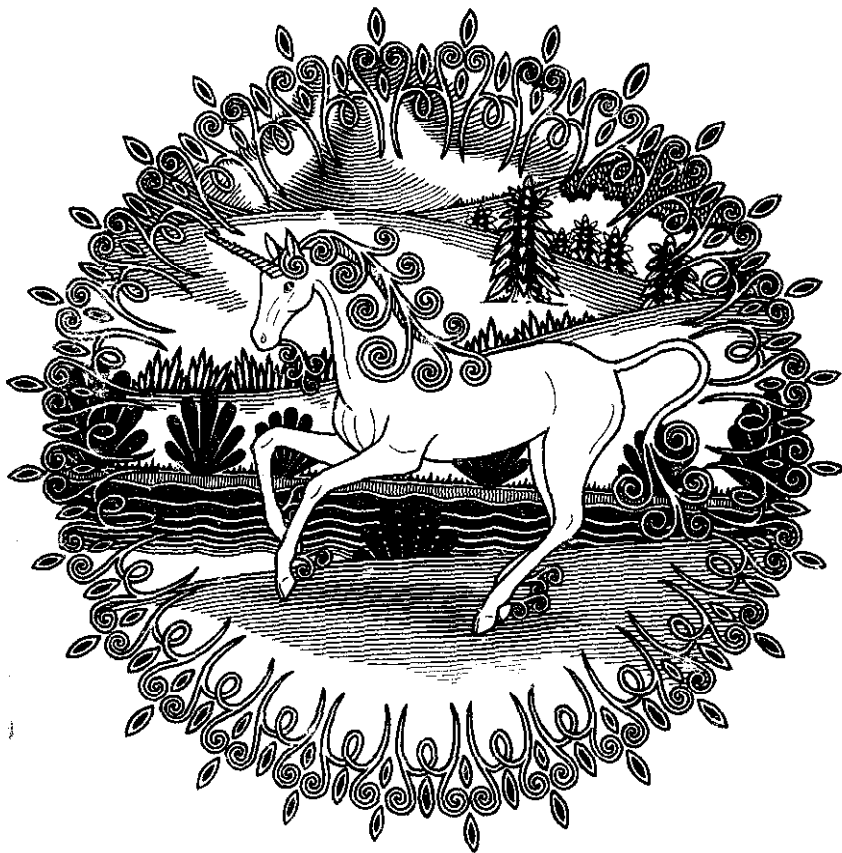

The New Alchemists

The New Alchemists

To Restore the Lands, Protect the Seas, And Inform the Earth's Stewards

The New Alchemy Institute is a small, international organization for research and education on behalf of humanity and the planet. We seek solutions that can be used by individuals or small groups who are trying to create a greener, kinder world. It is our belief that ecological and social transformations must take place at the lowest functional levels of society if people are to direct their course towards a saner tomorrow.

Among our major tasks is the creation of ecologically derived forms of energy, agriculture, aquaculture, housing and landscapes, that will permit a revitalization and repopulation of the countryside. The Institute has centers existing, or planned, for a wide range of climates in several countries, in order that our research and experience can be used by large numbers of people in diverse regions of the world.

The Institute is non-profit and tax-exempt, and derives its support from private contributions and research grants. Because we are concerned with ecological and social tools useful to small groups or individuals, many orthodox channels of support are not available. The success of the Institute will depend upon our ability to address ourselves to the genuine needs of people working on behalf of themselves and the earth, and to the realization by all our friends that financial support of our research is necessary if the task ahead is to be realized.

The New Alchemy Institute has an Associate Membership (\$25.00 per annum, tax-deductible) which is available to anyone with an interest in our goals. Upon joining, associates receive the most recent Journal, dealing with theoretical and practical aspects of new world planning. Over the years the support of our associates has been critical to the continuance of the Institute and its work.

Those wishing to have their membership payment qualify as a deductible contribution under the tax regulations of Canada should make checks payable to The New Alchemy Institute (P. E. I.) Inc.

ASSOCIATE MEMBERSHIP: \$25 per annum

Contributions of larger amounts are very much needed and, if you can afford more, that would be beautiful.

SUSTAINING MEMBERSHIP: \$100 or greater

PATRONS OF THE INSTITUTE: \$1,000 or greater

We invite you to join us as members of The New Alchemy Institute. A company of individuals, addressing themselves to the future can, perhaps, make a difference during these years when there is waning reason to have hope in the course of human history.

THE NEW ALCHEMY INSTITUTE
P. O. Box 432
Woods Hole, Massachusetts 02543 U. S. A.

*The light has gone out
and I have been sitting here in the dark
thinking:*

Is the power off or is the bulb no good?

*Very nice to wander in aimless anonymity
among the metaphysics of astrological signs,
but if I can't see where I am,
how can I see where I don't want to be?*

*I asked Someone in the room:
did you notice that the light is out?
and Someone said: I cannot see my Self in others
until I can see my own Self.
Then I asked Another: did you notice?
and Another answered: I have to get my head straight first.*

*Finally I asked Everybody:
DID YOU NOTICE THAT THE LIGHT IS OUT?
but Everybody was too busy
trying to find space in the dark.*

*Never mind.
I will strike a match
and see.*

— my

Photo by Hilde Atana Mangav





There has been little that has taken place in the year since the last Journal was published that has given us pause to think that the premises upon which New Alchemy was based were unduly pessimistic. Nuclear proliferation, political and economic instability, environmental pollution and famine are still very much with us. One way of summarizing the intervening year might be: the same, only more so. Voices from disciplines as varied as mythology and art, biology, economics and cybernetics find agreement in the opinion that we are rapidly approaching a point of crisis, or what William Irwin Thompson has called "the edge of history." It could be said with justification that the rational conclusion is that we are on a collision course with disaster. With the outlook so bleak, it is somewhat cheering to learn that the Chinese symbol for crisis means both danger and opportunity.



Photos by Hide Akema Masingay

Before the future can be thought to hold a promise of opportunity, there are two desperately urgent issues that must be dealt with. The first is that of nuclear proliferation. As of late summer 1975, according to public opinion polls, between seventy and eighty per cent of the American public saw nuclear energy as the only possible alternative when fossil fuel supplies begin to dwindle. Yet, as it has been said, it is the same atom whether in fist or glove. Edward Teller himself has been quoted as saying that the spread of nuclear weapons is inevitable because the nuclear materials in reactors can be easily converted to bombs.



He further openly acknowledges the threat of sabotage of a nuclear reactor by terrorists. I don't quite understand whether it is because of, or in spite of, this that the United States doggedly continues to produce three hydrogen warheads a day. Proponents of nuclear energy still seem undaunted by the possibility of breakdown or by the problems posed by the storage of radioactive waste materials. At New Alchemy we have thrown our collective hat in the nuclear ring by challenging a proposed nuclear project for Prince Edward Island with a system of electricity-generating windmills. A legislative decision is pending as of this publication.

The nuclear threat is not alone in endangering not only humanity but much of life as we know it. The delicate and critical ozone layer in the atmosphere is being damaged by a catalytic chain reaction caused by the propellants used in aerosol spray cans. As the spray cans represent a three billion dollar a year industry in the United States, it is unlikely that this form of destruction to the atmosphere can be stopped without extensive public effort. If these environmental threats are ignored, other attempts to alter the course of the future, political

or otherwise, will most likely prove futile.

Yet, over the past year, concurrent with the problems that seem almost insurmountable, there have been events taking place and patterns emerging that give cause for faint stirrings of hope. The critical question is whether there can be a widespread change of consciousness quickly enough to affect behaviour at the individual and social levels. It is nicely dealt with in the Vermont issue of *Io* when it says "the relation of the evolution of consciousness to who is working where and when is and always has been tough to catch hold of — like the wag of a tail."

Implicit in the time in which we find ourselves is the need for people addressing themselves to change at every level. Perhaps that is why names that once seemed isolated, like pin points on a map, slowly are beginning to reveal an interconnect- edness. New links are being formed in the network of individuals and associations, ideas and activities which, concomitant with the sense of impending crisis, are beginning to gain in strength and acceptance throughout a larger segment of society.

The need for fundamental political change is obvious. Saul Mendlovitz of the Institute for World Order has drawn up a proposal for what he calls global populism which postulates a workable, de-

centralized, libertarian international political struc- ture. Such a world view would provide a framework in which the Gandhian philosophy and appropriate technology of E. F. Schumacher and the ecological perspective of New Alchemy could have relevance for society as a whole. Cultural consciousness is being touched by the work of such people as Murray Book- chin through his teaching and writing on social ecology, by Stewart Brand's *CoEvolution Quarterly* and by the creative interplay of minds at centers like the Lindis- farne Association. Countless people, alone and in groups, are looking at themselves and at their lives differently and are beginning to evolve in new directions. The times are still a-changin' and much of it is good.

At New Alchemy we see ourselves rather as New Age suppliers, offering our energy and food growing strategies and our bioshelters as means by which people can not only survive, but perhaps find their way back to a unity with the living world which, as a cul- ture, we have somehow left behind. We are not un- aware of the quixotic quality of our gesture; our out- look could be characterized as one of mingled joy and despair. It does not seem impossible though that, given time, the transitions beginning to be felt more and more strongly now may yet, together, make a difference.

— NJT



Photo by Eric Goro

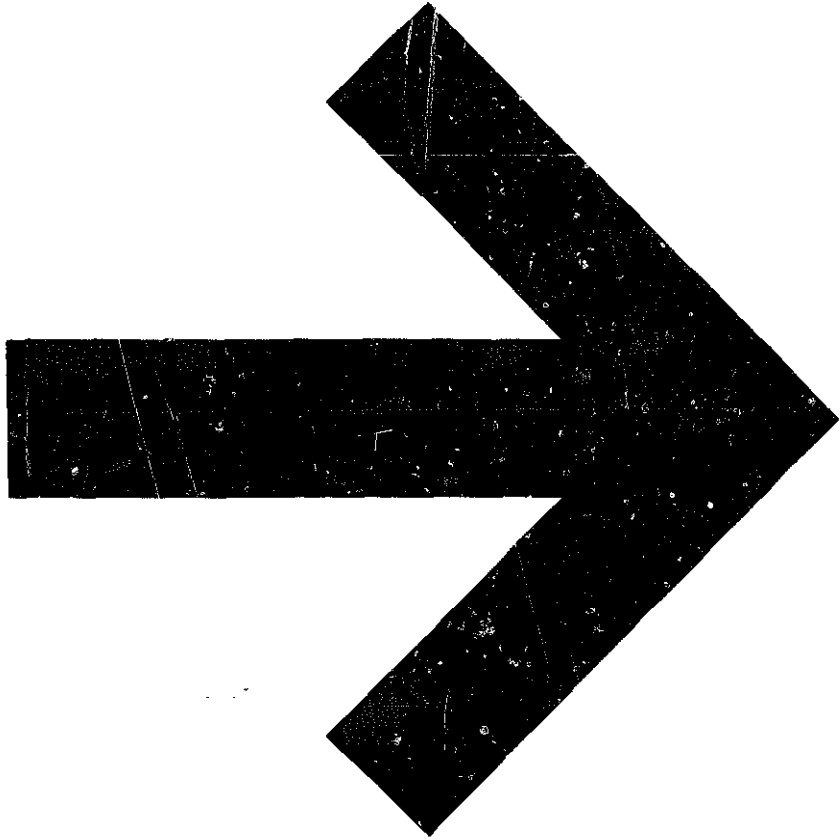

Table of Contents

NEW ALCHEMY

- Looking Back – *Nancy Jack Todd* 7
The Trash Fish Cook Book – *Bill McLarney and Bryce Butler* 15

ENERGY

- An Advanced Sail-Wing for Water-Pumping Windmills – *Earle Barnhart* 25
Savonius Rotor – *Earle Barnhart* 27
Solar Collector for Heating Water – *Earle Barnhart* 30
Earth Breath: Wind Power – *Jim Bukey* 32

LAND AND ITS USE

- An Ark for Prince Edward Island – *John Todd* 41
The Shape of Things to Come:
 The Architects' View – *Ole Hammarlund and David Bergmark* 44
Confessions of a Novice Compostor – *Tyrone Cashman* 45
Our Gardens... and Our Rabbits – *Hilde Atema Maingay* 48
Further Experiments in the Irrigation of Garden Vegetables
 with Fertile Fish Pond Water – *William O. McLarney* 53
The World in Miniature – *John Todd* 54

AQUACULTURE

- Midge Culture – *William O. McLarney, Joseph S. Levine and Marcus M. Sherman* 80
A New Low-Cost Method of Sealing Fish
 Pond Bottoms – *William O. McLarney and J. Robert Hunter* 85
Cultivo Experimental de Peces en Estanques – *Anibal Patiño R.* 86

EXPLORATIONS

- Populist Manifesto.... for Poets with Love – *Lawrence Ferlinghetti* 94
Meditation on the Dark Ages, Past and Present – *William Irwin Thompson* 96
Self-Health: Exploring Alternatives in Personal Health
 Services – *Nancy Milio, Ruth Hubbard* 102
Women and Ecology – *Nancy Jack Todd* 107

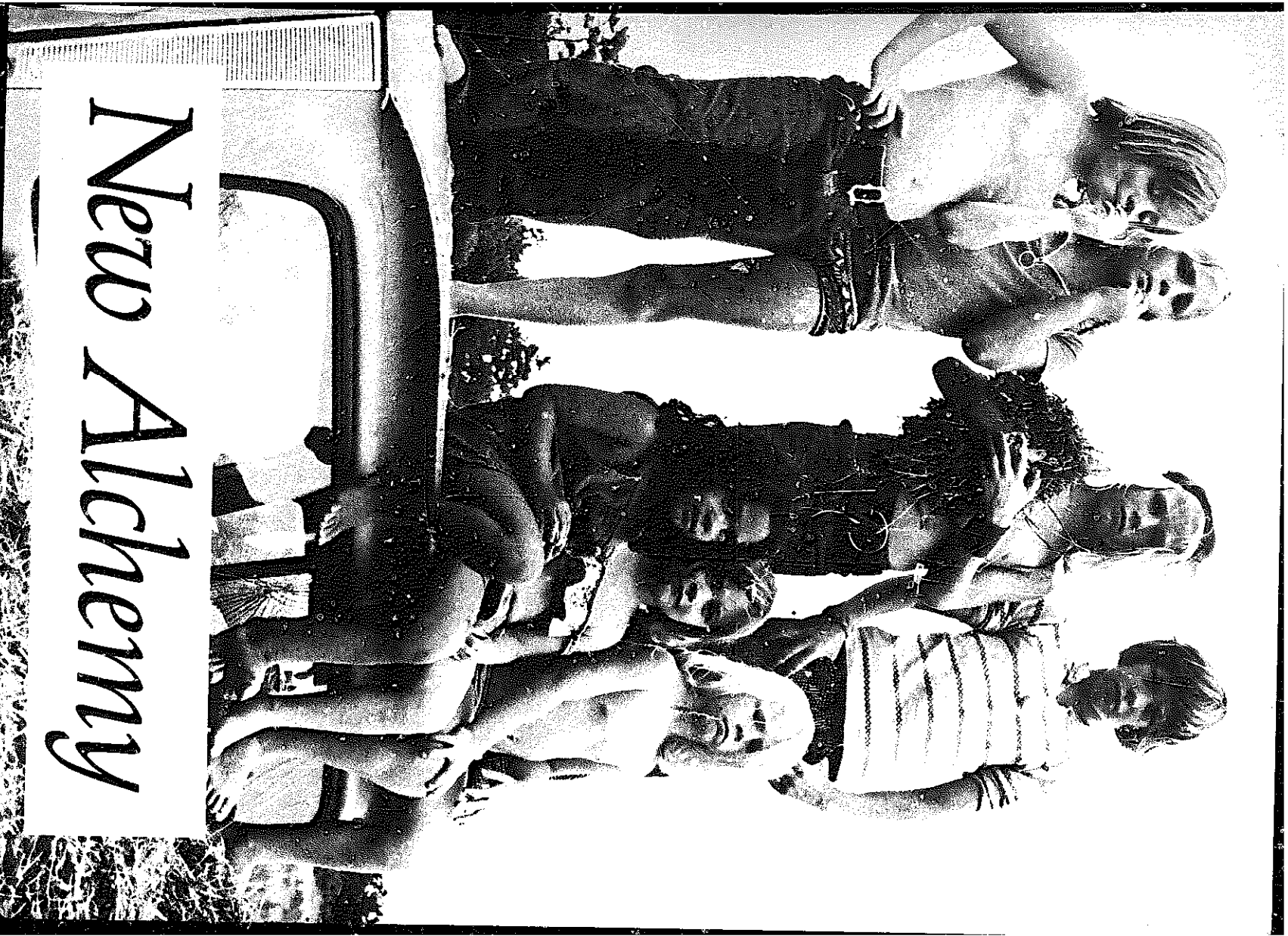

New Alchemy

DEAR CALLERS
 NEW ALCHEMY IS
 CLOSED NOVEMBER THROUGH
 MARCH
 MANY MORE PEOPLE ARE
 WORKING IN OTHER COUNTRIES
 FIRST OF THE MONTH
 APRIL ARE NOT SPENDING
 IN WINTER - SOME BEING
 RECOGNIZED & RESPECTED
 LITERATURE, INQUIRY
 JOHNSONS ARE AVAILABLE
 IF SOMEONE IS IN THE
 OFFICE.
 YOU ARE WELCOME
 TO WALK AROUND.
 See you at a spring
 or summer Saturday



Several years ago when New Alchemy was just beginning or, at least, starting to assume a more substantial form than a small filing cabinet containing a few proposals and some correspondence, there was little in our activities that was predictable from one day to the next. What has emerged gradually, with the passing of time, is a familiar, even rather comfortable rhythm flowing from day to day and from season to season. We have been occupied with gardens and fish and windmills for long enough to have a feeling for the scope and demands of the work so that, while the unexpected still frequently occurs, the pattern of work and meetings, visitors and Saturdays is within the realm of the known.

It is the same with the seasons. For those of us who stay at home there is the intense bright summer tapering toward the slower, rather mild, gray-brown Cape winter. For the rest of us, the New Alchemy summer is juxtaposed against other countries and cultures and our work there, related but different to that on the Cape.

But, with lengthening days and thawing ground, planting and spring rain, everyone returns and we find ourselves at the edge of another summer.

—NJT

Looking Back



In looking back over a period which is lengthening into years, enough time has passed and enough seasons changed to find oneself a bit vague as to what it was that distinguished one particular spring or summer from those that came before or after. Yet, there are always differences. The children have grown taller, the garden plots have been rotated, the sunflowers grew in a long soldierly line one year, another in a riotous field, and the apple tree did or did not bear fruit, although the mulberry always does.

The landscape, too, has changed. During our first summer, only the domes covering the fish ponds dotted the ridge that rims the gardens. By the next year, three windmills of varying sizes and shapes had taken up their positions. By the following summer, the mini-ark had been added, consisting of three shingled wedge-shaped structures, solar heater and the most elegant windmill yet, with red, wind-like sails that follow the wing. There was also a new fish pond, uncovered this time, for experimenting with white amur and Israeli carp, species of fish adapted to colder climates than the tropical tilapia can withstand. To pump water for this pond, the old oil-drum Savonius rotor was replaced by an updated, more streamlined version of itself. On the lawn behind the house, Earle's solar furnace provided another innovation. After several days of cutting tiny mirrors and mounting them on the wooden surface of the reflector, he had created, in addition to a

furnace, a wonderfully psychedelic toy. Peering into it when it lay flat beneath the apple tree gave one a dizzying feeling of hanging suspended in the air, surrounded by leaves and fragmented bits of sky.

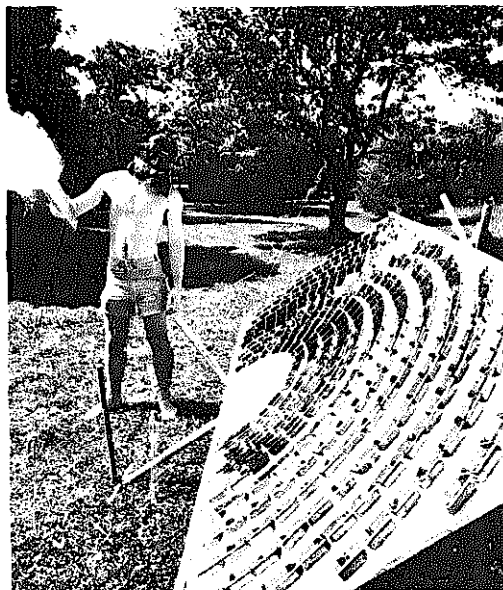

Photos by Hilde Atoma Mangay



*Wizened magic-man
Catches Sadness in gnarled hands,
Crumbles it to a fine frozen powder
And, tossing it into a dark sky,
Makes stars.*

— Don Esty
Died August 23, 1975.

There were other changes beyond the physical ones. Far more visitors have been coming to the farm over the past year than ever before and there have been more different kinds of people. In the main, in previous years, most of our visitors could have been loosely described as counter-culture, usually youngish, longish hair, faded jeans, etc. Recently it has become impossible to categorize, for, besides the more predictable types there are families; some with small children, some with teenagers, and some with grandparents. Gardening clubs of older people stop by. Classes of school kids, sometimes entire small schools, come. And there are homesteaders and architecture and every other kind of student, would-be dropouts from business or academe, tinkers who just like windmills, and fellow travellers in search of a less mechanized approach to life than society at present usually affords. On several Saturdays often seventy or more people have gathered. Certainly in numerical terms that would seem scarcely worth exclaiming over, but within our frame of reference of a few friends and friends of friends getting together to work and to have lunch it seemed like a lot. It certainly meant that the work dynamic could not remain if we were to give people the information and time to which we considered they were entitled. Previously it had seemed adequate to answer questions and explain our ideas in the gardens or at lunch. But there simply weren't enough of us to make this workable any longer. And so we adopted the tactic of 'the tour.' It started rather informally and spontaneously by a group gathering around one or another of us to hear some explanation, but it quickly expanded and became mobile until it was quite literally a tour, with one or several of us describing the background and details of the biological systems and the gardens, and visitors including kids tramping around gamely and asking questions. Now 'the tour' has become an institution, as invariable a part of Saturday as the work that precedes it or the feast that follows.

The gardens are different each year, of course. I doubt that a garden is ever exactly the same twice. Hilde discusses this in much more detail in her article. Not only have we experienced changes in the numbers and varieties of people who visit the garden. The same applies to the insects. The cabbage butterfly, such a persistent resident in the previous years, chose largely to by-pass us last summer. Not so the squash borer who had not before been a 'regular.' As a result, we had the novel and sad experience of too few zucchini. The scourge of the garden, however, what Zorba called the 'full catastrophe', was the Mexican bean beetle. We spent days and days hand-picking the creatures off the bean plants and yet they came, like the barbarian invasions, in wave after wave. They decimated the

lima beans, made pathetic, derelict stumps of the kidney beans, and, although we salvaged a few green beans, they were a mere handful in relation to the number of plants. To contemplate the cost of those beans in terms of work-hours would be unbearable. This year we are experimenting with a biological strategy for control.

This past summer saw a considerable stride forward with regard to composting. Ty Cashman, who was chief of this department, will describe his methods in more detail in his own article. This was the first year that we had someone specifically assigned to overseeing the compost pile, seeing to it that it was properly fed and brewing at all times, and the results have become markedly visible.

Several of us, when giving the tour of the gardens, have adopted the tactic of gesturing toward a pile of dirt, consisting largely of sand that has been dug up for the Ark, and pointing out that this was what the soil of the entire garden had been like prior to composting. Although the technique is faintly reminiscent of television commercials, one can then draw attention to the earth in the gardens, which, if not rich black loam, has become fine, dark brown soil. People, if not already converts, are generally favourably impressed with the merits of composting.

Apart from the usual run of activities that take place on the farm, there are a number of other, usually individual, preoccupations. They may be as various and as esoteric as fly-tying and ballet, batik, compulsive all-night fishing (see the Trash Fish Cook Book) and opera. Each of them affects the common life of all of us to a greater or lesser degree. The fish catch is the main protein base for most of us for the summer. Marsha's voice floating across the grass from the house or gardens as she practises adds immensely to the enjoyment of a day. The same would have to be said of the most recent activity introduced to us by Susan Ervin, the vegetable dyeing and weaving of yarn. Susan arrived in early May and once she had settled in and the summer had begun, she could often be seen in the fields, trailed by one or more of the children, gathering plants and wild flowers for her dyes. Then there would be great steaming pots on the fire near the apple tree as Susan stirred her brew and drew dripping strands of coloured yarn from the kettle. She was working one day with a friend as a storm threatened. As it drew closer, they hovered over their pots, silhouetted with wind-whipped skirts and hair against a menacing sky, racing to finish before the rain could put out their fire. A stranger arriving at that time may well have put a more literal interpretation on our use of alchemy.

One aspect to daily life at New Alchemy which, although heightened in summer is ongoing throughout most of the rest of the year, is the observation and recording of data and phenomena. Every system, biological or technical, is carefully monitored in order that we may have an accurate understanding of the efficacy of our experiments and so that we can obtain some idea as to the conditions under which various ideas may be transplanted to other environments. This puts us in a position to advise people as to the suitability of trying to raise tilapia, for example, in their area, and whether or not they would need an enclosed system to extend their growing season.

Bob Angevine keeps records of the weather, including the amount of rainfall we receive at the farm. Objective accounts of weather seem useful as it is a subject on which almost everyone is strongly opinionated and yet almost never agrees. I have heard an Englishman and a Californian issue absolutely contradictory statements about the state of the day within minutes of each other. Bob collects the data by which our readers and correspondents can judge whether what was a dry summer for us would also be considered as such for them. Actually, he tends to keep a quiet watch on all the systems, particularly with regard to their physical components, often making suggestions that dovetail simplicity of design with availability of materials. Earle watches the internal climates within our biological systems. He records and compares data from the mini-ark and the dome, checking air and water temperatures, humidity, and the turbidity of the water. The information is used for data on energy budgets and provides a basis for extrapolation of our work elsewhere. Being closely involved in the design and construction of the energy systems, he keeps an eye on the windmills, noting such things as pumping rates in relation to wind speed, and generally evaluating performance. He also has to have a realistic idea of the solar heater's capacity which involves measurements of input and output temperatures and flow. The recording and calculations, often painstaking, involved in Bill's experiments with fertile fish pond water and midge production are evident from reading his papers. His aquaculture work also involves a good deal of careful study. He has given a lot of thought to the feeding of fish, observing their preferences, the conversion ratio of various foods to growth, and the resulting yields. He is ingenious and

thorough in his quest for plants that, while not commonly considered part of a fishy diet, are acceptable and nutritious to the fish — hence our marigold nibbling tilapia — supplementing, we like to think, their vitamin A requirements. Marcus has long been Bill's deputy in the midge department and gathers productivity information on the midges in the larger systems, particularly with regard to various methods of fertilization and rate of water flow in the ponds.

Knowledge of the biochemistry of the aquaculture systems is vital. John makes regular tests of their chemistry including oxygen, nitrogen, carbon and phosphorus cycles, so that any imbalance in the systems may be detected and corrected. He watches algae production and studies the systems with regard to their ability to purify and regenerate the water in the fish culture ponds. This work enables us to incorporate both microscopic and flowering plants for water purification as well as for food for the fishes, both of which are essential in intensive aquaculture. The invertebrates being cultured are watched for productivity and food needs. He is also experimenting with the ability of the algae to absorb and retain the sun's heat, with the idea of their potentialities as living solar heaters.

As countless photographs will attest, Hilde spends considerable time gathering data on her cabbages. Arduous as it may seem every worm must be counted, its damage assessed and the health of the individual plant taken into account. Under her surveillance, too, is the state of the garden in general. She must know the chemistry of the soil, in the testing of which she gets some help from Bob, and evaluate companion planting arrangements, seasonal influences and changes, and the value of mulching and composting. With a grant from the Barnstable County Conservation Committee, Susan has launched a study of the feasibility of using Gambusia or mosquito fish in mosquito control and must record the findings of this work. There is, in addition, extramural, as it were, data being collected on our behalf. Ross McLain, one of our Associates, is working on a computer model of the dome as a solar trapping structure. Merrill Hall and Vince Dempsey are doing warm-ups for their new electricity-generating windmill by designing and testing smaller prototypes.

So, as data must be collected, pondered, and eventually applied, the prerequisite measuring, recording, testing and weighing are woven into our daily rounds.

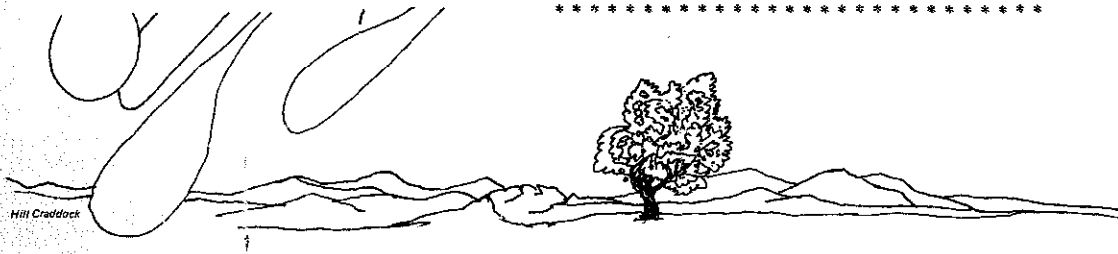

Hil Craddock



Photo by John Cressley

There remains one more change to be related, one which evolved almost imperceptibly. In *Journal Two*, under the heading 'Preservation of Food, Preservation of Self', I described some of the difficulties we were having in distributing the domestic work which seems unhappily inevitable to almost any kind of undertaking, more equitably between the sexes. I said at that time that resentment was high among the women, largely because of the tacit assumption that housekeeping and its attendant chores should be their responsibility. I think that this is often the key to much of the problem of shifting from traditional roles for both sexes. It is less the dreariness of the work in question than the acceptance, often unconscious, on the part of the male that, whatever mess ensues in the wake of his activities, it will sooner or later be dealt with by someone other than himself. And the odds are pretty high that that someone will be female.

It is really very nice to be able to say that this is not much of a problem for us any more. There were virtually no confrontations. What began to turn the tide was our (the women) realizing the necessity for articulating our frustration. The general male reaction was not outraged indignation, but the equivalent of McLarny's "I can dig it." And so they did, for now, although our housekeeping could not be called above reproach, it is done under the rotating leadership of a housekeeper of the week, and it is up to the individual as to

whether he chooses to toil alone, or in company, as long as the work is done. It hardly seems necessary to add that most of us prefer the latter.

The goal of balanced sex roles is, however, an elusive one, sometimes laden with unexpected and, for that matter, ill-fated pitfalls. The day is not won when the housework is divided. I mentioned earlier that we have adopted the practice of giving a tour on Saturdays as the best way of offering the maximum amount of information to our visitors. It somehow settled on its own time of right before lunch. This was probably because it seemed that people were ready for a break after working for the morning and that anyone planning on coming that day would have arrived by then. So a few of us would remain in the garden and start talking while the rest of us scurried up to the kitchen to start lunch. One day, as the lunch-preparing bustle was in full swing, one of us, I think it was Nancy Willis, looked around and said "Has anybody noticed----?" We raised our eyes from our work -- and there we were again -- all women. By process of elimination the tour was being conducted by ----- not by us. The women's caucus gathered in the kitchen once again. That we, too, should give the tour was self-evident. In the course of the discussion, we discovered that there were some details of the biological systems and the windmill mechanics about which we felt a bit shaky. Fortunately, we had among us a post-doctorate student in biology, Susan

Atlas, who was spending Saturdays with us. She would have no trouble with questions along that line. For the rest, we felt that we understood the basics and could manage one way or another. We emerged from the caucus having decided that we would monitor the tour the next week and conduct it ourselves the following one. We announced our intention to the men, who were entirely affable about it. The next Saturday we spent taking note of what was asked and making sure that we would omit none of the standard features.

And so our day came. As luck would have it, the same day brought an influx of visitors that was a galaxy of braininess, complete with a Nobel Prize and countless PhDs., most of them, ironically, biologists. It was not without qualms that we launched into a summary of our view of the world situation and the hearing of New Alchemy's work within the parameters of such a complex picture. Between us we answered most of the questions and managed to give our first tour without either disgracing ourselves or exasperating our guests. What we most need is the practice and the fine public manner that is hard to develop when addressing oneself to a stove or to a small child. Still, if a bit haltingly, another hurdle has been cleared.

As it had been the previous year, harvesting the wheat was one of the high points of the summer. Although one could never become blasé about the satisfaction of gathering the vegetables one has grown, there is somehow a jubilant quality about the days when we harvest wheat that is hard to account for. It is almost always hot and dusty. The shredder-grinder which we adapt for cutting the heads of the wheat from the stalks makes a horrendous racket, subduing all but the most determined conversationalists. So it is very noisy and dirty and any of us

Photo by Hide Atems Maingy

prone to allergies are driven to sniffing and coughing. Yet, for all that, there is an underlying joyous feeling that may be partly attributed to working in a ripe field and perhaps partly to the half unconscious knowledge that in harvesting and storing against the winter we are repeating a timeless act that links us to generations long before and, we hope, to those long after us.

Financial Support

The continuing existence of New Alchemy over the past year has been made possible through the support of our Associates and through grants from a number of foundations. We now have over two thousand Associate Members scattered around the world and we are pleased and encouraged by their faith in us.

Among the foundations which have come to our aid with grants ranging from \$1,000 to \$50,000 are the Arca Foundation, the Haymarket Foundation, the Jessie Smith Noyes Foundation, the Laras Fund, the Rockefeller Brothers Fund, Septimus II, and the New Century Education Corporation. In Canada, New Alchemy has been assisted by the Federal Government of Canada and by the Provincial Government of Prince Edward Island.

We should not have been able to function as a viable organization without the help of the above and more particularly without the efforts of a few individuals who have been dedicated in interpreting our work and our perspective. Their efforts are very much appreciated.

New Alchemy at this time has no long-term financial commitments or endowments. Further, we have only a fraction of the support we need for the next year or two. If any of our readers or friends are able to help, or to bring us to the notice of potential contributors, we would be most grateful.

— Nancy Jack Todd





Costa Rica Farm

After what seemed like an eternity of "shopping", New Alchemy is finally the owner of a farm in Costa Rica. Located in a remote and inaccessible area, far from roads, the sixteen acres include a small house, a small strip of Caribbean beach front, substantial quantities of coconut trees and platanos, a variety of other fruit trees, and a stand of virgin forest.

Bill McLarney and Susan Ervin were there this year to begin setting up a center. Top priority projects are the repair and remodeling of the existing house and/or construction of a new one, and planting of fruit trees and field crops. Second priority goes to a vegetable garden and perhaps construction of a brackish water fish pond.

It looks as though New Alchemy South will be a shoestring operation. There is presently no grant money available for use in Costa Rica. Initially, this may be an advantage of sorts, since we will be up against exactly the same problems as the local residents. At present the surrounding community is a stable one. However, the people are under the usual economic and social pressures to sell their land to prospective cattle ranchers, lumbermen, or tourist developers and to move to the city. There is also the problem of a typically unstable economy associated with a monoculture — in this case, of cacao. (Additional sources of income are coconuts and turtle hunting, but these are relatively minor and affect only the people along the beach.) The local economy is presently in good shape, owing to a succession of fair to good cacao years and high prices engendered by crop failures in West Africa. Should West African cacao make a comeback and/or the Costa Rican growers experience a poor year, the economy will slump. Of course, all the pressures on the community will be exacerbated if the area ever gets a road.

If we can help to provide some economically viable alternatives to cacao monoculture or increase regional self-sufficiency in food production, we may make a significant contribution to the preservation and stabilization of the local and regional communities.

— William O. McLarney

The Film

I am hoping that it won't be misunderstood or sound immodest when I say that the film "The New Alchemists", which was made by Dorothy Todd Hénaut for the Challenge for Change section of the National Film Board of Canada, is an unqualified success. I base this statement not on my own reactions, or on New Alchemy's collective response, for it is next to impossible for any of us to be objective. We tend to cherish such lines as McLarney's "You're stepping on the parsley" or John Hess's rather sarcastic asides while overlooking statements that might be more meaningful. My information on the impact of the film is drawn from reports brought to us by Dorothy Rosenberg who is responsible for its distribution in Quebec. The report states that "Its major use has been as a tool for the stimulation of education or a catalyst for action."

It has been shown to concerned citizens, educators, community organizers and environmentalists, to people in food co-ops, agriculture classes, women's groups, film festivals, ecology classes, Church groups, food and energy conferences, to back-to-the-landers, senior citizens, gardening groups and to native peoples. Some of the more concrete results have been:

- the plugging of elementary grade students into a local anti-pollution group
- added impetus to the roof and city gardening project of an urban community center
- the formation of an environmental group by a local community service
- increased public agitation by an urban anti-pollution association
- public discussion of nuclear energy, with regard to both the options to it and the disposal of radioactive wastes.

Although responses have varied, the overall reception to the film seems to have been very positive. Judith Farncomb, who distributed the film in Ontario, wrote "The New Alchemists' has a therapeutic effect on many individuals, particularly at this point in

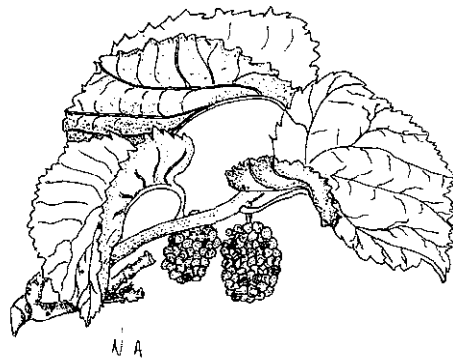

time when everything looks rather dismal. It gives people a sense of optimism by offering them a tangible example of what can be accomplished through a cooperative effort without further endangering the environment. And the film provides a needed stimulus to those groups who have already started work in the area of alternatives." Ms. Farncomb also felt that the film had served as a "connecting link" between people who were interested in or doing research along lines similar to ours, but who previously had not been benefitting from each other's experience and knowledge. Among Dorothy Rosenberg's screenings in Quebec was one for agriculture students who had had considerable background in biology. Their feeling was that it was the first time that many of them had seen "a whole integrated complex functioning in harmony."

So, in spite of occasional criticisms such as there being insufficient biological and technical detail in the film or that it suggests that New Alchemy has a male-dominated structure, it would seem that the film has done exactly what we had hoped it would. Certainly, it has reached far more people than we could have on our own. If, as the Challenge for Change credo suggests, film can be a powerful catalyst for change, and if enough people are encouraged by it to think, in Judith Farncomb's words, that "people must become involved and responsible for their own destiny instead of apathetically relying on experts and government legislation to solve problems everyone is responsible for", then "The New Alchemists" has done its work well indeed.

Intrigue in the Office

Several months ago we received in the office a listing, 27 pages long, of "Energy Related Literature" available by mail from John Roby of San Diego, California. On perusing it, we found what appeared to be references to nine different books and articles written by New Alchemists offered on this listing, No. E-200. Checking the offerings indicated that a person could send \$9.00, plus postage and handling fees, to John Roby and receive listing "No. 648. Sherman. SAILWING WINDMILL. High-capacity. Uses automobile crankshaft*** Journal article." Or, send \$7.00 plus postage and handling fee and receive "No. 658. TWENTY-FIVE FOOT SAIL WING WINDMILL****".

In order to learn whether our copyrights on *Journals One* and *Two* were being infringed upon we asked "our agent" to place orders for Roby's No. 648 and No. 658 and sent the necessary \$16.00 plus "postage-handling." In due course New Alchemy received an order from Mr. Roby for our *Journals One* and *Two* which was followed shortly by the receipt of the two volumes by "our agent." We subsequently received payment of \$10.00 from Roby.

So far as we can ascertain, all of this, although questionable, is quite legal; our copyrighted publications apparently are not being copied for resale by John Roby — he is simply acting as a clearing house — and in this case, picking up a cool 60% over his costs. We have no real hostility toward John Roby or any others who may be engaged in similar enterprises but we are dismayed to think that people seeking the information which we make available through our publishing program may pay such exaggerated prices and, worse, that they may think New Alchemy is actively sponsoring such an activity as a distribution means. We are not! We cannot refuse to sell our material to such clearing house activities. We are flattered by Mr. Roby's estimate of our worth, but we can hope that everyone knows that we sell our *Journals One* and *Two* for \$4.00 and \$6.00, respectively. Our *Windmill Bibliography* is free (not \$5.00) but we ask for a stamped self-addressed envelope. Our Newsletter No. 3 "Methane Digestors" is \$3.00 postpaid (not \$6.00).

— Robert C. Angevine

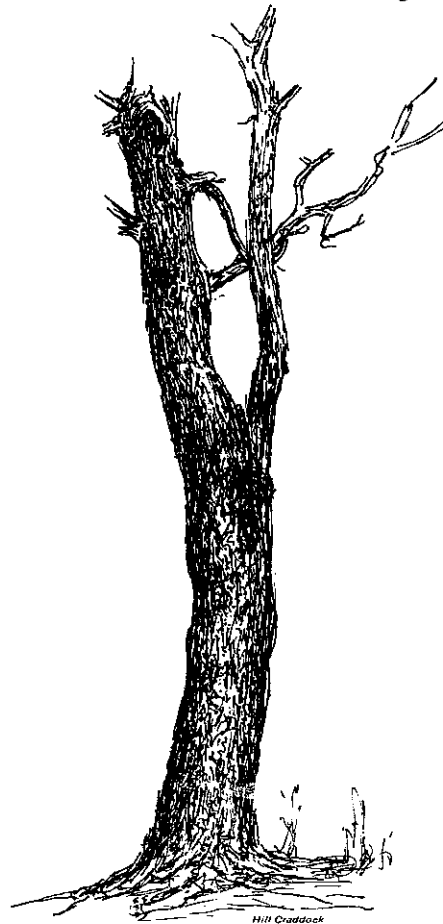

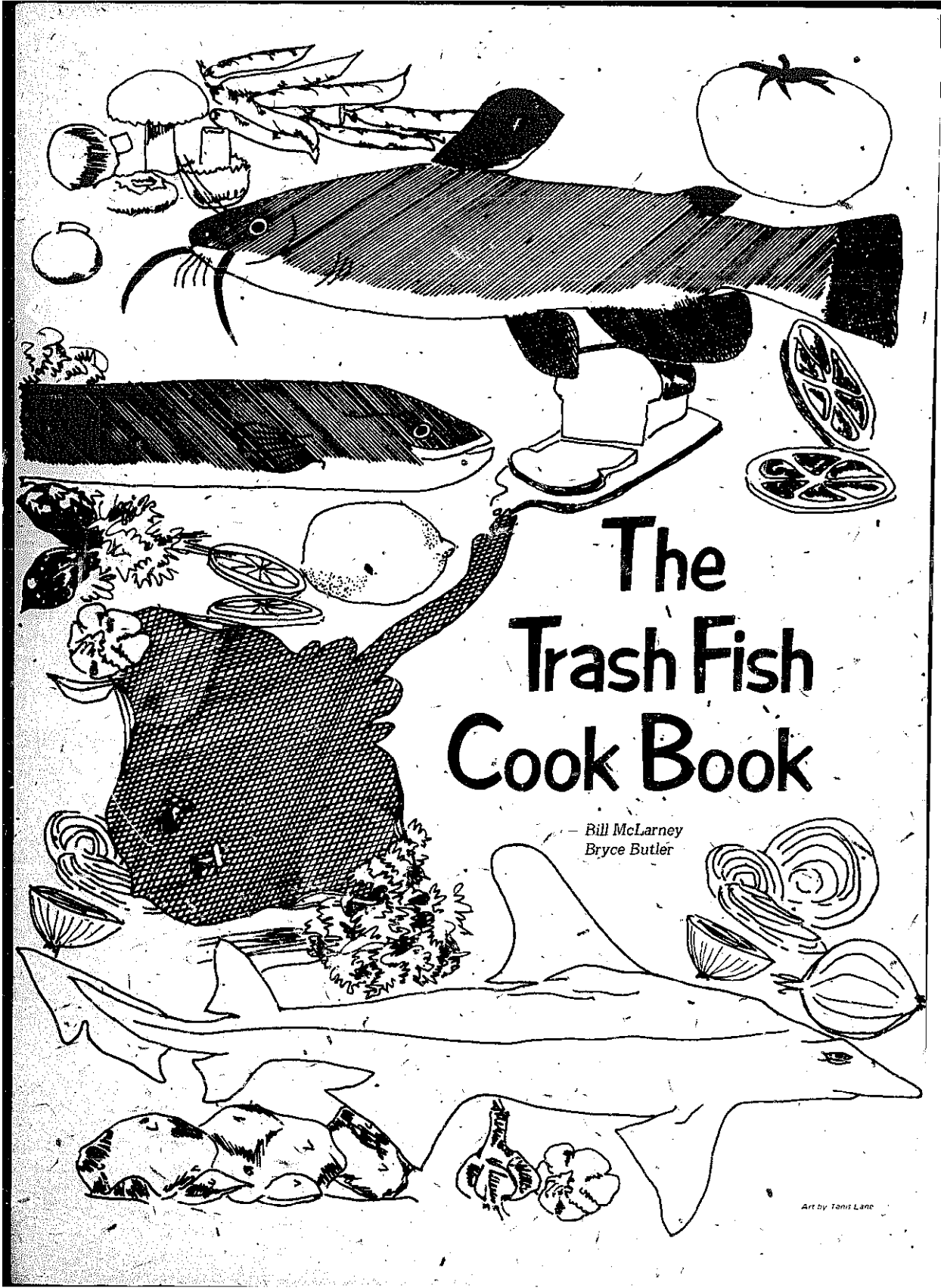

The Trash Fish Cook Book

— Bill McLarney
Bryce Butler

Art by Tami Lane

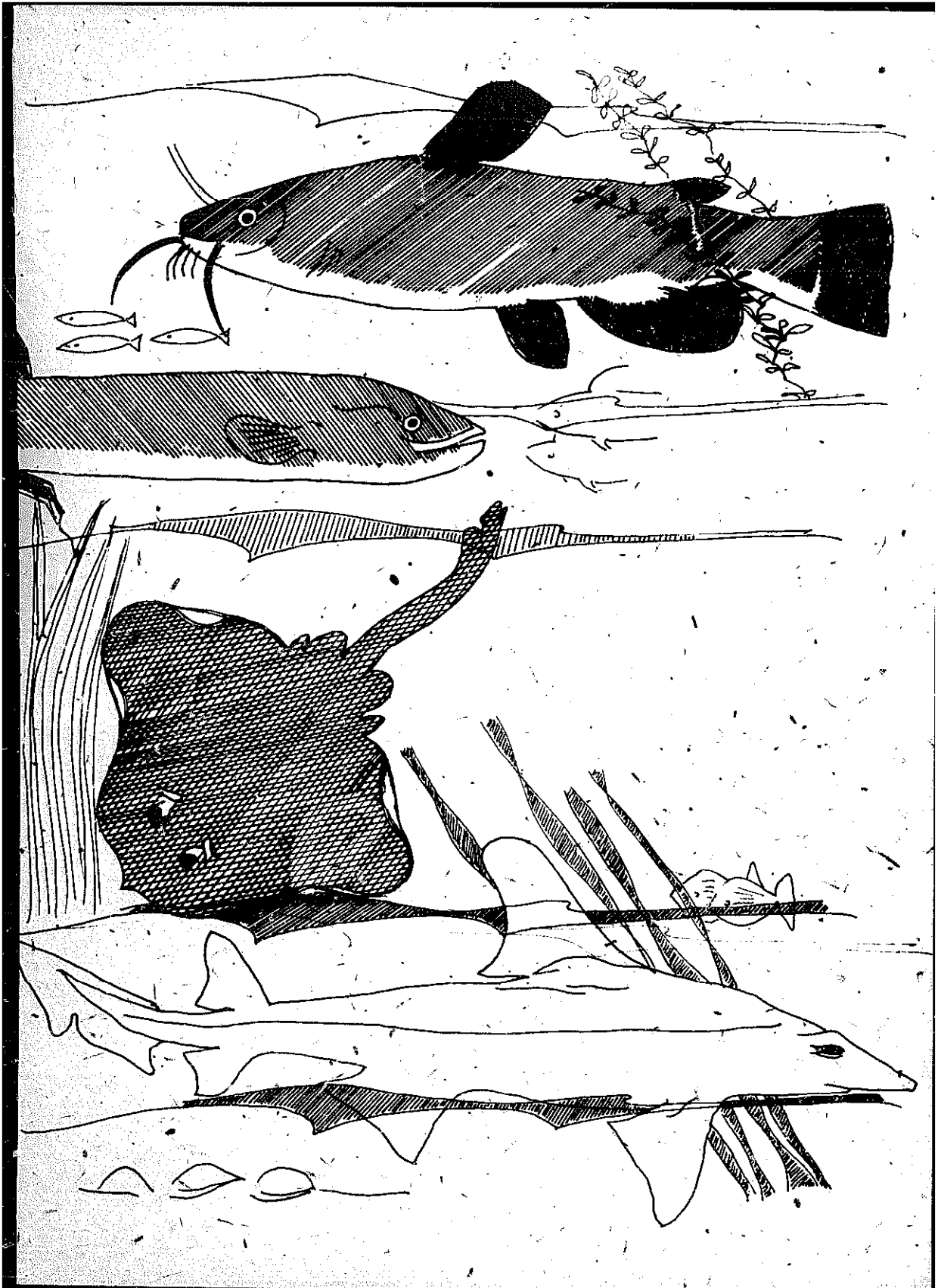



The Trash Fish Cook Book is the physical manifestation of a long unsung contribution to New Alchemy. The authors, our bold fishermen, Bill McLarney and Bryce Butler, frequently have been described as fish freaks. This is definitely an understatement. An addiction is the mildest term that could begin to convey the passion with which they discuss, care for, study, pursue, cook, and eat fish. In spite of the fact that summer is an intensely busy time for us, once word is out that the fish are running, they know no rest. However long the work day, with the coming of dusk, they are gone. Sometimes they are not back much before dawn. Whenever they do stumble in, there is the thankless chore, all too often blithely overlooked by the rest of us, of scaling and cleaning the catch. That done, they can fall into bed for a few hours before the daily round begins again. As the summer wears on, they grow increasingly hollow-eyed, but there is little, if any, slackening in their zeal. With the night, we all know that they'll revive, the gleam will return to their eyes and, rods in hand, they'll be off again.

There are eccentricities to be borne with in all of us, however, and if one's friends must succumb to fanaticism in some form, it's preferable when it results in something you can eat. The fish that Bill and Bryce catch for us are one of our summer staples. With vegetables from the garden and the previous night's catch, it's hard not to eat well.

I have acted as assistant or taken part in enough of the meals to testify that the cleaning and cooking methods enlisted below have received exhaustive personal attention from the authors. Their emphasis on so-called 'trash fish' is one we feel to be useful, in that it offers a way to broaden one's food base even while food prices seem bent on endless escalation. The field of advice and instructions for working with their more socially acceptable cousins has received, to date, considerably more coverage and, therefore, is not discussed. We hope that you will enjoy reading the 'cook book' and go on from there.

— NJT

Photos by Hilde Altema Maingay

THE TRASH FISH COOK BOOK

Man the hunter-gatherer vs. man the food-grower seems to be a topic of popular debate these days, even with respect to the aquatic realm. New Alchemy's work in aquaculture, and Gene and Marja Anderson's comments in *Journal Two* notwithstanding, some of us do enjoy fishing — for the sport, for the closeness with the environment it affords — and for the sake of the substantial amounts of protein we harvest. We suppose that some of you and some of your friends also fish and that you like to eat as well as we do. So, in the interests of both gustatory pleasure and nutrition, we offer some of our favorite fish recipes. A few are for popular game fish; the emphasis, however, is on the so-called "trash" fish. These unglamorous creatures are probably caught more frequently than the game species; certainly they are thrown back more often. This creates a disproportionate pressure on game fish populations. It is also wasteful, as often these rejects can be superior as food to the prized game fish.

We welcome feedback on these recipes and further contributions from our readers.



CONGERS

Congers may be skinned and dressed like American eels. In the case of both, you will find that the kidney tissue (the reddish strips along the spine) extends back past the vent, into the solid tissue of the tail, so cut back for an inch or so and remove it. The method of filleting eels is different from that used with other fish. I worked this one out on 40+ inch congers, but it ought to work with smaller specimens as well. Place the fish on its back and cut right along the spine, but not all the way through the flesh. Do this on both sides. The idea is to peel the spine right out in a long V-shaped strip. This



leaves the ribs in the fillet, but they aren't much trouble in eels. When you get to the back of the body cavity, where the spine no longer has lateral extensions, lay the eel on its side and cut all the way through as close as possible to the spine, as you would with an ordinary fish. Then turn it over and do the same thing on the other side. What you should be left with is a long swallow-tail fillet and a backbone. Cut the fillet into convenient pieces for your frying pan, batter, and fry. I find that if the fillet-halves are cut in two at the body cavity they show less tendency to curl, and thus cook more evenly. For battering, I dip the pieces in a mixture of egg and milk (about equal parts) and then a mixture of white flour and bread crumbs, with a dash of salt and pepper. They take a long time to fry, and the heat should be fairly low or you'll burn them. I use a fair amount of oil, flavored with a little butter (a quarter inch). Turn them frequently and, when they are tender, in twenty minutes or so, they are done. I have eaten fried conger side by side with fluke cooked the same way, and all of us who were eating preferred the eel; it's among the tastiest of fish.



SMOOTH DOGFISH

This is the "sand shark" commonly caught and cursed on the coast of New England. It may be recognized by the teeth, which are like miniature cobblestones, by the presence of an anal fin and by the lack of any stout spines on the dorsal fins. The latter two are respectively absent and present on the spiny

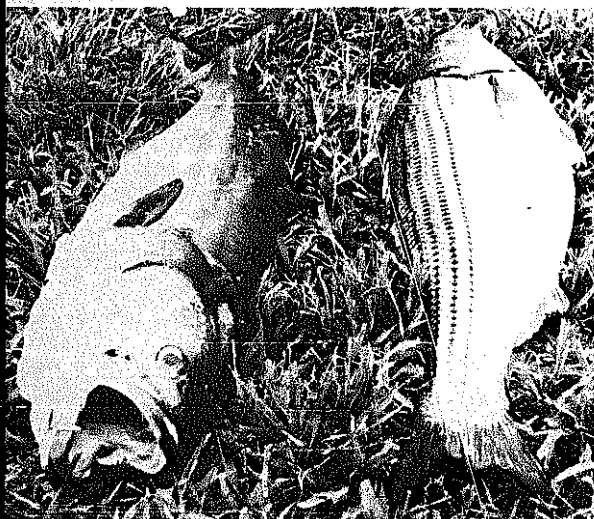

dogfish, a species which forms the basis of fish and chips in England, for which we haven't learned the proper cooking technique yet. Any suggestions from English readers?

Dogfish are cleaned like any ordinary fish. Don't bother to fillet them. They don't have bones, and the flesh is easily separated from the cartilaginous skeleton after cooking. Sharks store urea in their muscles, so they must be parboiled in water and vinegar (about six to one is at least enough) to remove the strong taste. Cut the unskinned shark into convenient frying steaks, not more than one inch thick, and put them in the boiling vinegar and water for two and a half to three minutes. If the skin comes off easily, the flavor should be all right. Don't overboil or they will fall apart. Peel the skin off with your fingers and fry the pieces of meat. They should be tender in five minutes or so. I have not used a batter for them and I don't feel they need it. They should be served with lemon.



SKATE

The only skate I have dealt with is the clear-nosed skate, which is commonly caught off Cape Cod. I don't know if these methods would work with other skates, although there is no reason to believe they wouldn't, as the other species are also edible. The clear-nose may easily be recognized by the translucent patches on either side of the snout. The part you eat is the "wings." These are cut off along the line of the ribs, and the rest of the body can be discarded. Wash the abundant slime off as well as you can, because it gives a bad flavor to the meat. Then parboil the wings for around two minutes or until the skin comes off easily with a fork. Be sure to remove the gelatinous layer under the skin. Do not overboil, or the whole thing will fall apart. Then batter and fry as described for conger eel. The cooking takes much less time, however. The wings smell almost exactly like scallops, while cooking, and taste like them too. Indeed, ersatz scallops have been made in the past with skate wings and a cookie cutter. The only fault I have found with skate is that, at times, the texture is stringy. This can be avoided by pushing up the boiling time slightly but, if you do this, it is especially important to remove as much slime as possible prior to boiling. The best skate I ever had was left overnight in the fridge between two sheets of newspaper, and the wings were stored for another day the same way. This may have drawn out some of the slime and allowed me to boil them for the three+ minutes I gave them without imparting a bad flavor to the meat. These wings tended to fall apart, however, and were difficult to handle. So experiment around - the flavor is worth it, when you consider the price of scallops.

MISCELLANEOUS GAME FISH RECIPES



The recipes we have just described have provided some of the best eating we have had here. For eating, I prefer conger eel over bluefish as much as I prefer bluefish over conger for catching. Life is like that. However, our daily bread during the summer is striped bass and bluefish, and these fish are commonly caught in such abundance that it is well to have a variety of ways to fix them. Here are the methods I used for the great majority of our meals during July, August and September.



BROILED FILLET *a la TeHennepe*

I learned this method, in its simpler form, from Dr. Eugene TeHennepe, a very excellent fisherman from New London, Connecticut. It applies equally well to striper, blue or weakfish (seatrout). His method is simply to lay the fillet in the pan, skin side down, sprinkle with paprika, and then pour on melted butter, put it four or five inches from the broiler, and broil until it comes apart easily with a fork. Serve with lemon. If your broiler is very hot, you may find it better to set the temperature down to 400° or so, with the control still on broil, so the heat is from above, or move the fish down some, farther from the flame. In any case, leave the broiler door ajar.

This is the basic method. I have changed it somewhat. I don't use paprika, but instead sprinkle on salt and pepper (freshly ground, if possible), and I squeeze a lemon over the fish before putting on the butter. If your fish is large enough, the cheek piece between the eye and the hard gill cover can be cooked the same way, but take it out a little earlier, before it burns. It is the best tasting piece of the whole fish.

BAKED STUFFED FISH



This is a recipe for the big one that didn't get away, which you want to bear in festive triumph to the groaning board. Clean it with the head on, for both festivity and food. The Orientals, when they eat fish heads and rice, aren't simply being thrifty or aesthetic, they are getting the best part of the fish. Five of us ate well one night on the head of a 23 pound striper. After cleaning, mix pieces of dried bread, celery and onions in a frying pan and fry with a little butter. I also use some salt pork, diced small and well dried out, because it adds flavor. Go easy on the grease, however, because part of the purpose of the stuffing is to dry out the flesh a little. Season the stuffing with salt, pepper and thyme. I would use perhaps a half teaspoon of thyme for a ten pound bluefish. Then fill the body cavity with the stuffing, put a few pats of butter on top, sprinkle with salt and pepper and

bake at around 375° until it's done. Test for doneness by sticking a fork in the back, at the thickest part, just in front of the dorsal fin. When it flakes all the way through to the bone, it is done. Serve with lemon. The eye turns white, which tends to discourage some. It can be covered decently with a slice of lemon or a sprig of parsley.



SNAPPER BLUES

The young of the year, which often appear in great numbers in late summer, are easy to catch and delicious to eat. They can be told from the various herrings by the strong tooth-filled jaw and the spiny dorsal fin. They should be fried simply without batter, just salt and pepper. Like other panfish, they are a little bony, but not as bad as perch, for instance, and they are much easier to clean and far, far easier to scale.



EELS

There are many kinds of eels, but on y two, other than the vicious and easily recognizable morays, that you're likely to come up with in the United States or Canada. These are the American eel and the conger eel. Both are superb food, but in very different ways. Alive, they are difficult to tell apart. If you catch your eels in fresh water or in shallow salt water, such as a marsh, they are almost certainly American eels. If they come from deep salt water, they might be congers. You'll know for sure when you clean your eels; if the flesh is a beautiful pearly white, it's a conger. If it has a grayish or bluish tint, it's an American eel. This cooking technique is for *American eels only*.

The first order of business is to skin the eel. Skinning an eel is very easy — if you know how. For skinning, leave the head on. It's the only handle on an eel. If there are two of you, one person can hold the eel by the jaw with a long-nosed pliers. Otherwise, you may find it more convenient to hang up or nail down the eel, particularly if it is large. Once you have a grip, there are three steps:

1. With a sharp knife, make a cut completely through the skin all the way around the body directly behind the pectoral fins. Try to cut as little muscle tissue as possible, as cutting it will make the skinning harder and, particularly in the case of a small eel, may cause the head, rather than the skin, to pull off.

2. Insert a thin-bladed knife between the skin and muscle tissue and work it completely around the body, completely separating the first half inch or so of skin from the muscle.

3. With a second pair of pliers, grasp the skin and pull it off over the tail like a glove.

Then proceed to clean the eel like any other fish. You will find that the gut contents and head are quite small. Dressing loss for eels is less than for any fish I know. This, plus the richness of the flesh, means that a few skinny-looking eels will make a bigger feed than you would guess.

The best way I know of to cook an eel is to stir fry.

First, fillet the eel; there will be surprisingly little waste. Then cut the fillets into strips about 1/2 inch wide; make your cuts from back to belly of the eel – not lengthwise. Cut whatever vegetables you want to use into pieces about the same size. (This is not a “recipe” in the sense that I’m going to tell you what vegetables – or spices – to use. This is just “how to cook an eel.”)

Place the pieces of eel in oil or butter (I prefer butter) in a frying pan, or better, a wok on high heat. Eel takes a long time to cook, so put it in before the veggies. Add whatever spices you like and stir. Keep it moving. When the flesh starts to turn white, you can think about adding the veggies. (This, of course, depends on the consistency of the vegetables you’ve chosen.) Stir some more. **KEEP IT MOVING.** The critical point is when the strips of eel suddenly curl up tightly and become firm. Another minute and a half of stir fry and it should be ready. If it takes a little more to finish up the veggies, it won’t hurt. The whole business might take twenty minutes from the time the eel hits the pan. Serve with lemon.

Using this method we’ve fed fourteen hungry people with six medium-size eels and some onions, celery and chard.

Eels are also among the best fish to smoke; for smoking, you don’t even need to skin them.

BULLHEADS

Bullheads are the smaller cousins of the channel catfish which are so popular and important commercially in the South. Where they are abundant, they are the ideal “kids’ fish”, which means that, if you’re an inexperienced but hungry fisherman, they’ll be ideal for you, too. You should be able to tell them from channel cats by their generally less graceful appearance. The tail, in particular, is different, being more rounded in outline and not so deeply forked. Once again, the sure clue comes in the cleaning. If the flesh is pink or red, it’s a bullhead. If it’s white, it’s a channel cat or one of his relatives.

Bullheads, like eels, have to be skinned. The procedure is the same, except that you’ll have to cut through the skin around the dorsal and anal fins and remove those pieces of skin separately.

Bullheads are not pretty fish, and a lot of people throw them away, but they have few rivals for flavor. As far as I’m concerned, the flavor of bullheads is too

good to mess up with spices, batter or any of that stuff. They should be fried in butter – period. Salt and pepper, or a little lemon, are permissible.

The smaller the bullhead, the better to fry. The big ones are good, maybe even as good as the little ones, but the shape of the body – much wider near the head than at the tail – makes them very hard to cook evenly. I think 5 to 6 inch fish are unbeatable.

Simply place the skinned and gutted bullheads in butter in a frying pan at medium heat. Check your first batch frequently. When the down side turns white and then starts to brown a bit, flip the fish over. This way you can arrive at a time which will work for a certain heat and a certain size of bullhead. Fry until the flesh is firm and the tails are crunchy like a potato chip. Be sure to eat the tails – they’re fun. When served, the meat should “unzip” cleanly from the backbone, so that there is no waste and virtually no bones in the flesh.

THE COSTA RICAN “FISH CHIP”

I developed this one while camped beside a stream in Costa Rica with no available supply of protein, other than some *really* small fish which we could net. I’m talking about 2 to 4 inch characins. (The characins are the most widely distributed, common and diverse family of fishes in Latin America. They include the various tetras familiar to aquarium keepers.) I haven’t tried the fish chip with North American minnows, but it should work. It’s not so good with spiny-finned fishes like sunfish and perch. Their bones are stouter and don’t react as described below. If you’re going to eat very small spiny-finned fish, I recommend you cook them just like large fish of the same species and handle the bones as best you can.

The fish in question (*Astyanax fasciatus* and young *Brycon guatemalensis*, for those who care) were, in addition to being abundant and easy to catch, of rather good flavor when cooked conventionally. Unfortunately, the texture of the flesh of *Astyanax fasciatus* was disappointingly soft, and both species, at that size, were disagreeably bony. Both of these problems are eliminated with the “fish chip.”

First clean the fish. This might seem like a lot of labor with a zillion tiny fish, but most such fish or, at least, the characins, are extremely easy to clean. Often scaling and gutting can be done in ten seconds with a fingernail. If the fish you are working with are herbivorous (you can tell from the *green* stuff in the stomach and intestine), be especially careful to clean out the gut cavity thoroughly. Some plants eaten by fish can impart a bitter taste to the flesh if they are left in contact with it.

Put the cleaned fish in high quality oil in a frying pan at high heat. (Cheap oil or lard doesn’t crisp them properly.) Apply lemon juice *while* they’re frying. When the fish curl up at both ends like a



"C" turn them over and push them back down flush with the frying pan. More lemon. The test of doneness is in the bones. They should be edible. You are not trying to cook them soft, as is sometimes done with salmon, but rather to cook them until they're hard and brittle. So brittle that they shatter into bits when bitten and represent no danger or discomfort whatever in the mouth or throat.

Serve the fish with slices of lemon and eat 'em whole. If you've done it right, the fins, skin and thin parts of the fish should be crispy and when you're done there shouldn't be a bone or scrap left on the plate.

This fish has the advantage of being easy to keep for a while without processing. Just wrap the fish up in a banana leaf. I have carried fish for three days this way while hiking in 85 degree weather and they remained delicious.

If, as you read this, you are camped by a stream in Latin America somewhere, don't forget to throw your meal scraps into the stream right there. Or wash your dishes there. This will build up a concentration of hungry characins for you to catch and make into fish chips. Which is a kind of recycling, I suppose.

—Bill McLarney
Bryce Butler

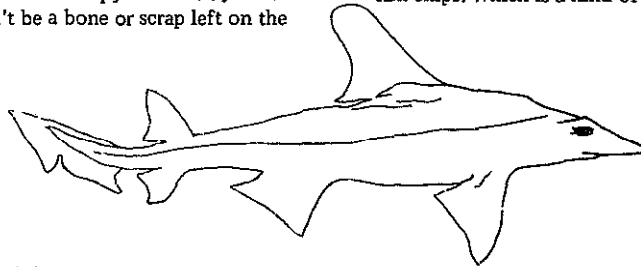



Gardens in bloom
And kids chasing each other
Saturday people

— Ate Atema

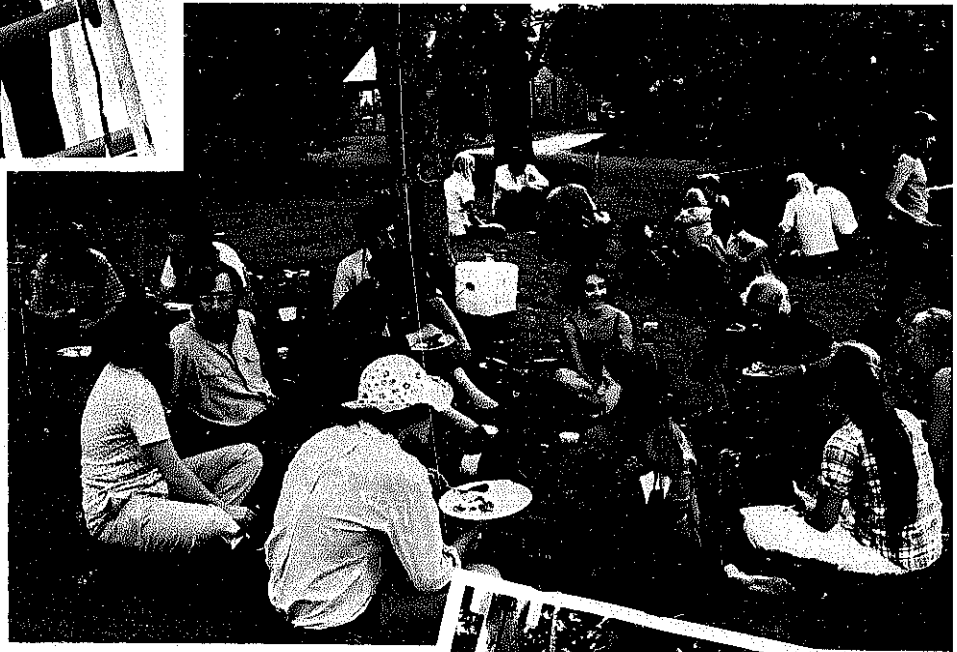

Center Photo by Fritz Goro — Others by Hilde Atema Maingay

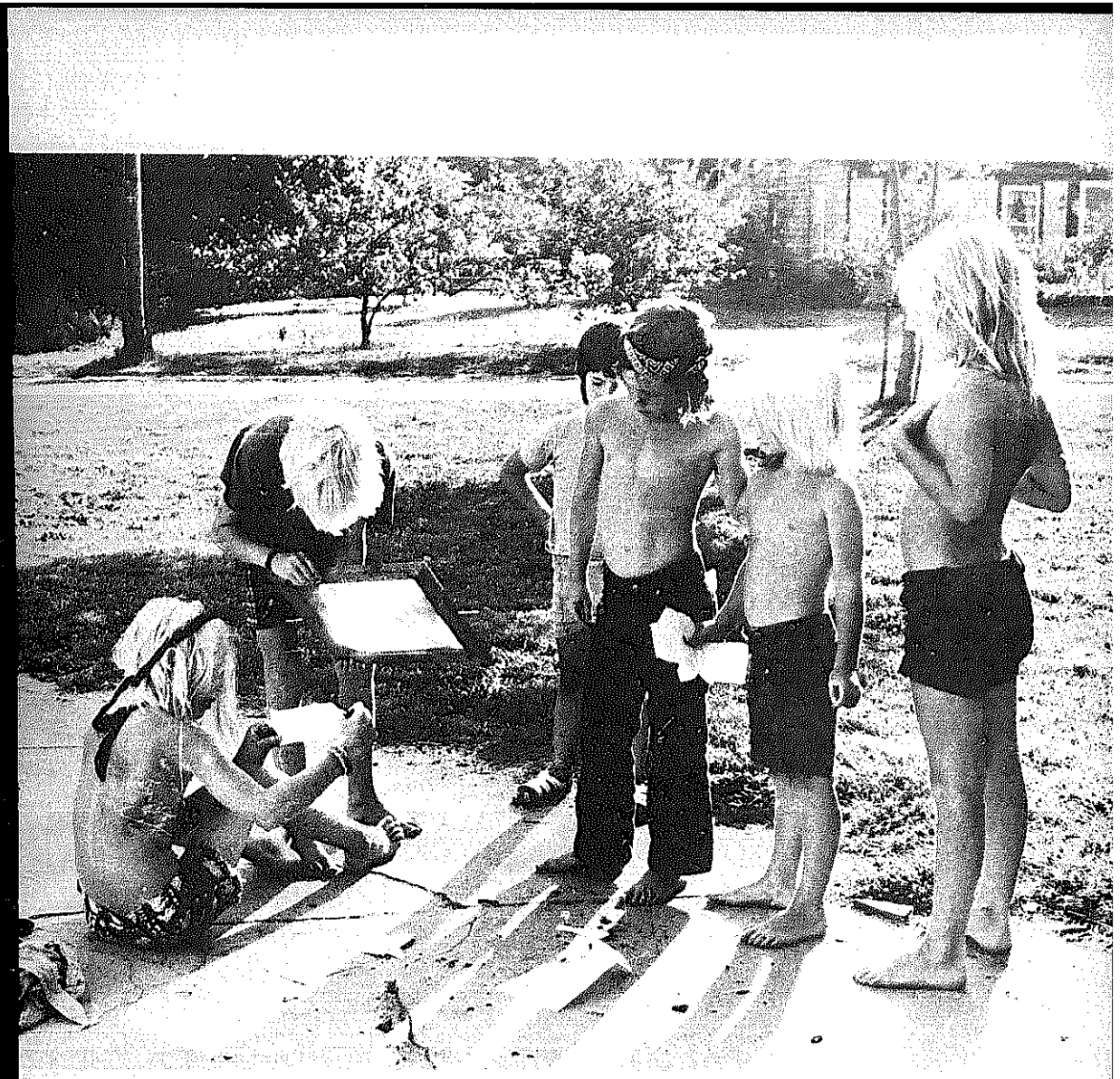

Photo by Hilda Alvares Alvarez

Energy



One of the great advantages in being closed for half of the year is that it gives us some time to assess the performances of the various systems for the season just past and to ponder possible modifications or changes in strategy. This is particularly true of the windmill work. In addition to pioneering new ideas, we are concerned that already existing models continually be evaluated and improved. Earle Barnhart's articles in this section discuss modifications on windmills that have been described in previous Journals and report on new systems as well. "An Advanced Sailing for Water-Pumping Windmills" is about Big Red, the first windmill to catch one's eye on arriving at New Alchemy. Big Red is modelled on Marcus Sherman's "Water Pumping Windmill That Works" (Journal Two) but the sails and rigging have been designed by Merrill Hall to withstand the Cape's gusty coastal winds. The old oil drum Savonius shown in Journal One has been succeeded by a silver J-wing model which Earle describes in "The Savonius Rotor." Our solar work is covered in his discussion of the solar

heater component of the mini-ark.

Finally, Jim Bukey, one of the authors of the "Energy Primer" has compiled a photographic essay on one of his favourite subjects: old windmills. In this case, "old" should be considered a relative term, as it does not cover ancient windmills of China or Crete or even the grinding mill of several generations ago in Europe and North America. His interest is in American electricity-generating and water-pumping windmills of the nineteen thirties and forties. The electricity-generating mills had achieved a high degree of efficiency before they were usurped by the rural electrification program. Jim's affection and admiration for these old mills is evident in his writing. It has taken a concrete form in the Wincharger which he has installed for us at the Cape Cod farm. It seems perfectly at home in a line with the Savonius and Big Red, and we like the idea of the best of the past being represented side by side with contemporary and future designs.

- NJT

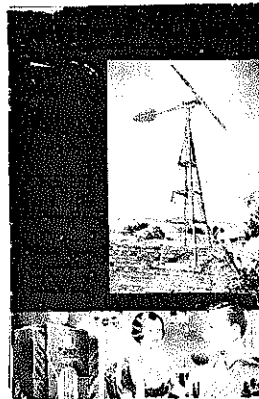

An Advanced Sail-Wing for Water-Pumping Windmills

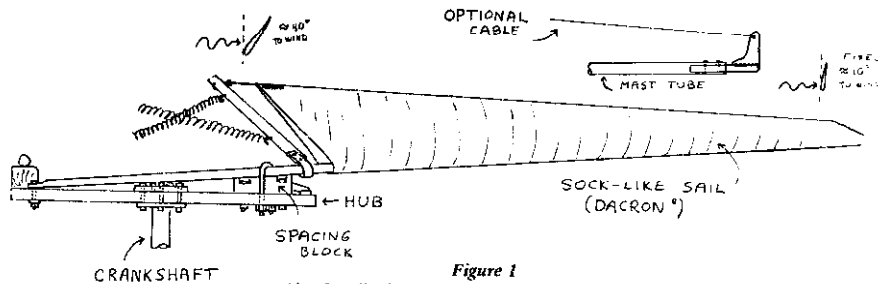

Figure 1
Simple sail-wing windmill details (one sail of three).

The development of sail-type windmills at New Alchemy was initiated by Marcus Sherman. The prototype was a water-pumping windmill which he had built in Southern India in 1972 to aid in irrigation. His windmill in Madurai used cloth sails, bamboo masts, teak pole tower legs and an ox-cart wheel (1). In 1973 Marcus built a similar windmill here on Cape Cod employing cloth sails to which had been added a spring-operated self-feathering mechanism (2). We have continued to develop the sail-wing windmill using it for aquaculture circulation and irrigation, and have found it to be, for our purposes, a workable and adaptable power source.

The vital part of the sail-wing windmill is the sail-blade, which consists usually of a fabric surface supported by a rigid mast. We have used Dacron (R) as a sail material because of its strength and durability. Figure 1 illustrates how the sail is slipped onto the mast like a sock and attached to the movable boom. The boom keeps the sail taut yet allows it to adapt to changes in the wind. Our first windmills had fixed-angle tips and feathering roots as illustrated.

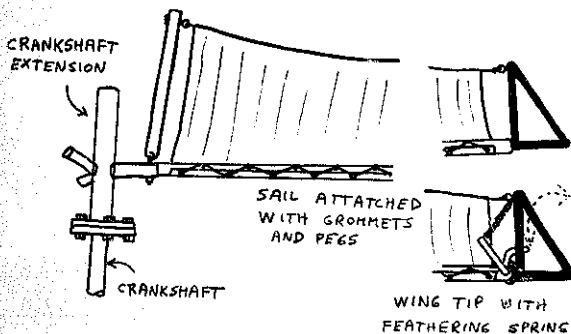

Figure 2
Advanced sail-wing details.

Figure 2 shows a later version of the sail-wing. An extension shaft holds the blades further from the tower. The sail is rigged with cord as on a sail boat, and the tip bracket has a feathering mechanism. Figure 3 shows how stabilizing cables may be positioned to prevent flexing of the blades.

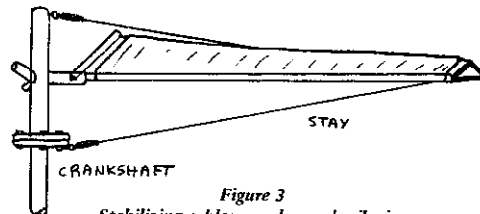

Figure 3
Stabilizing cables on advanced sail-wing.

The sail-wing windmill which we used for circulating water in the mini-ark in 1974 was strong enough to use two three-inch diameter piston pumps simultaneously. Figure 4 shows how the two pumps were connected by a swivel to the pump rod. The cast iron pumps were inexpensive. The packing boxes on each were fabricated from plumbing supplies (Fig. 5) (3). The double pumps were undersized for the strength of the windmill, however, and were replaced later by a higher capacity, more compact diaphragm pump which could be placed below ground (Fig. 6) (4). Figure 6 shows the buttresses on each leg of the windmill tower. It was felt prudent to strengthen the tower in order to give adequate support to the additional weight of the crankshaft, extension, cables and other hardware that were added subsequent to the original design.

The automobile crankshaft bearings used in the early windmills were adequate for the lighter type of blades, but required periodic lubrication on the

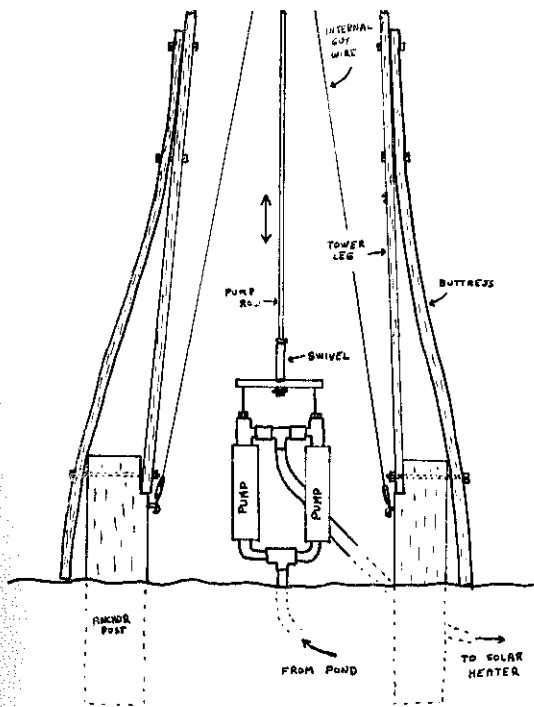

Figure 4
Sail-wing windmill with buttresses and two pumps.

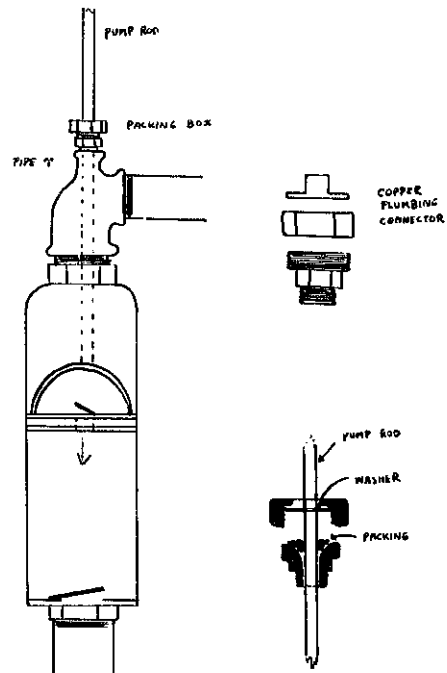

Figure 5
Inexpensive packing box for piston pump.

heavier models. Grease fittings are easily placed in each bearing clamp (Fig. 7). During one stormy period lasting several days, although there was no pumping load on the windmill, the extended period of high speed turning caused the bearing surfaces to wear through on the heavier blade end. It is advisable to balance the weight on each end of the crankshaft to maintain equal forces on the bearings.

The design for the latest windmill is moving into the realm of a heavy duty, long-lasting machine. Merrill Hail has constructed an experimental sail-wing windmill with several new features. The major change is that, for the first time, the blades face the wind. A tall, narrow tail tracks the blades into the wind. The main shaft, which has a two-inch diameter, runs in sealed bearings. Fitted to the end of the shaft is a plate on which a pin is fixed, offset from the shaft center point, to convert rotary motion of the shaft into cranking motion required for the vertical travel of the pump rod. The sail-wings are spring feathered at the base and centrifugally feathered at the tip. The results of these most recent innovations will be discussed after a season's operating experience.

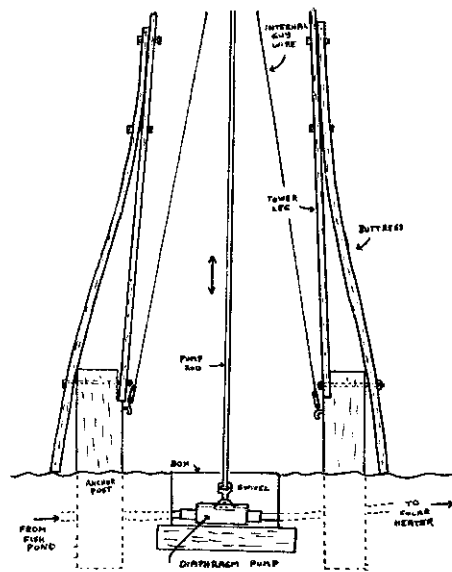

Figure 6
Sail-wing windmill with diaphragm pump.

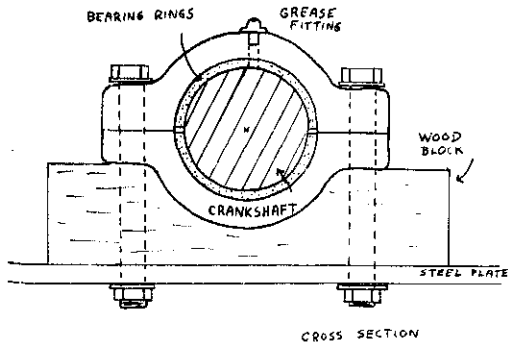

Figure 7
Windmill bearing showing grease fittings on crankshaft axle.

REFERENCES

1. Sherman, Marcus. 1973. "A Windmill in India." *The Journal of The New Alchemists* (1): 15-17 pp.
2. Sherman, Marcus. 1974. "A Water-Pumping Windmill That Works." *The Journal of The New Alchemists* (2): 21-27 pp.
3. Model No. 350 - Shallow Well Cast Iron Cylinder from Mid-West Well Supply Co., Huntley, Illinois - \$18.50 (1974).
4. Large capacity hand-operated diaphragm pumps, Edson Corp., Inc., 460 Industrial Park Road, New Bedford, Massachusetts - about \$100 (1974).

— Earle Barnhart



One of the most reliable yet simplest windmills at the Cape Cod Center is the Savonius rotor. It is used to pump fresh water out of the ground into our open aquaculture pond, intermittently displacing a portion of the pond water and stirring it in the process. Our first experience with the Savonius rotor was with a simple rotor comprised of steel drums, based on the Brace Research Institute's design (1, 2). It worked well, but its small size resulted in a comparable limitation in power. In his original developmental work on the rotor Finnish engineer, Sigurd J. Savonius, eventually decided that semi-cylindrical wings such as those made with steel drums may not be as efficient as wings resembling a modified J (3, 4, 5).

When we decided on a second Savonius rotor, we built a larger more efficient rotor of three tiers, each oriented 60° from the others. This results in an even starting and turning force regardless of wind direction.

Each of the three tiers has curved sheet-metal wings, three feet high and four feet in diameter. The special curves are formed by attaching the sheet metal to curved plywood templates. There are plywood discs placed between each tier and at the top and bottom of the rotor, which direct the wind through the rotor. The three segments and five discs are slid onto a ten foot shaft. Each one is attached with a flange to the shaft. The rotor assembly is then mounted on bearings inside a rectangular wooden frame.

The simplest and sturdiest tower for the Savonius rotor consists of a set of two permanent wooden posts, set in concrete, between which the rotor frame is placed. Each post has three guy wires. Two large bolts pass through the posts at chest level and through the rotor frame. This enables the rotor to be swung upright, as though on a hinge, for securing at the top. This method is a variation of the hinged tower used by Earthmind, a group doing valuable

research on vertical axis windmills (6).

One difficulty we have encountered in pumping water with a Savonius rotor is in tracking down a suitable pump. A diaphragm pump, as suggested by the Brace Research Institute, will not lift more than six feet. Centrifugal pumps invariably require very high RPM's. Rotary impeller pumps generally are quite hard to turn. Reciprocal pumps require some sort of mechanical linkage such as gears, cranks, V-belts, etc., which begin to get complicated. When one's water source is not directly below the windmill, the situation is even more difficult.

Our current plan is to have the Savonius rotor turn a small air compressor, to pipe air to the well, and to pump water with compressed air. This strategy solves the problems of variable speed and power input, freezing of pumps and pipes, and transmission of power from one place to another. While compressing air is somewhat less efficient than other means of energy transmission and storage, the simplicity and durability of the mechanism is an advantage. It is, however, no small matter to find a compressed air-driven water pump. We are aware of only one commercial model (7), which is excellent, but expensive.

We are working on a pump which is less efficient but much cheaper and combines the merits of a diaphragm pump with a simple air-control device. The pump design evolved from three sources; the commercial diaphragm pumps (8), C. J. Swet's solar pump (9), and the Stauffer's compressed air pump (7). In operation, compressed air forces the rubber diaphragm down simultaneously forcing water out. Eventually the pressure on the diaphragm pulls the exhaust plug from the exhaust opening, letting the pressure out and allowing the diaphragm to pull in new water. When refilled, the stopper seats in the exhaust opening and the cycle repeats.

It should be mentioned here that while this pump can undoubtedly be improved, its present form lends itself well to home-scale manufacture. Interestingly enough, enameled wash basins and metal dish pans have the appropriate shape and wide lip for such a pump. Inner tube rubber is also suitable.

Our future work in the development of the rotor/compressor/pump system will include using compressed air for other uses, such as fish pond aeration and circulation, and investigating the benefits of compressed air storage to cope with the fluctuation of the winds.

— Earle Barnhart

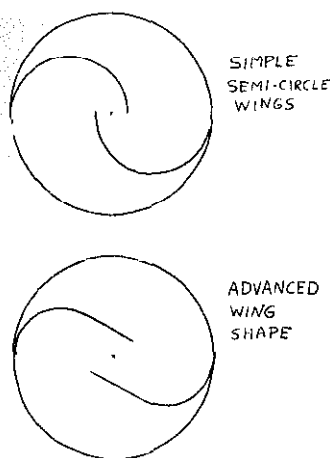

Figure 1
Simple and Advanced Shapes
for Savonius Rotor Wings.

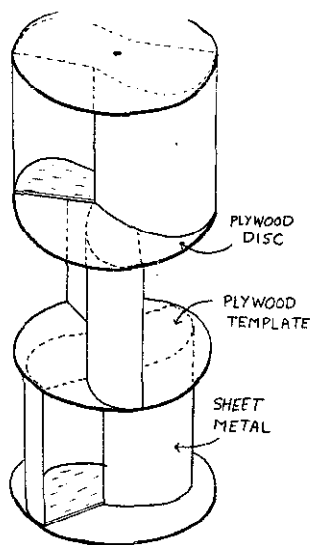

Figure 2
Three-tiered Savonius Rotor Showing
Wing Templates and 60°-60°-60° Twist.

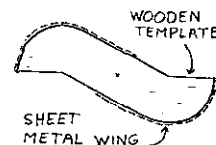

Figure 3
Use of Plywood Template to Form
Complex Curves on Savonius Wings.

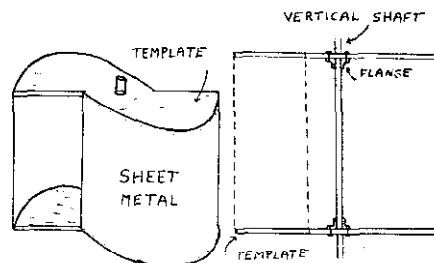

Figure 4
Savonius Wing Assembly.

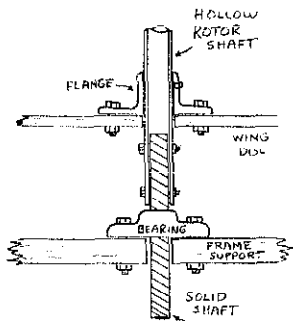

Figure 5
Details of Savonius Rotor Bottom
Bearing and Wing Attachment.

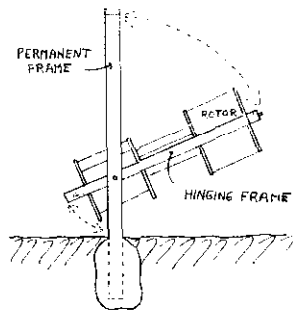

Figure 6
Savonius Rotor Tower - Permanent
Outer Frame and Hinging Inner Frame.

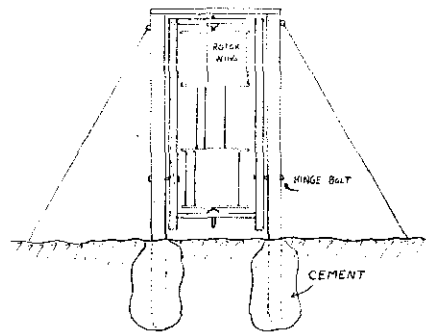
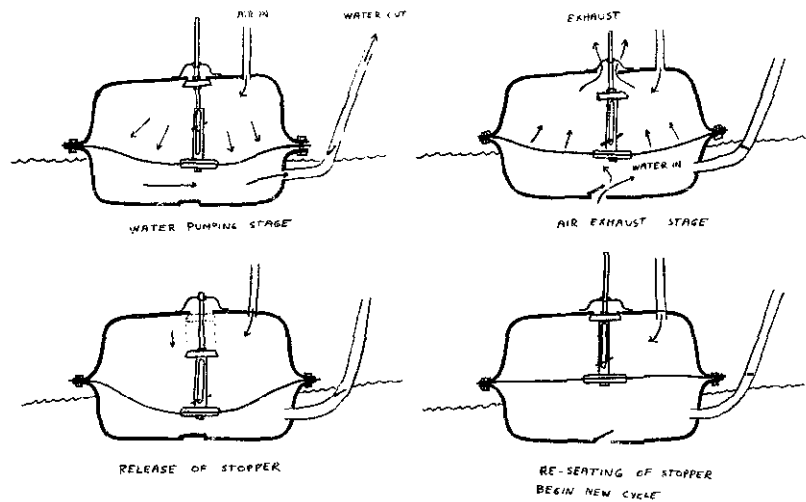

Figure 7
Savonius Rotor Tower -
Rotor is Swung into Position.



REFERENCES

1. Barnhart, E. 1973. "Savonius Rotor." *The Journal of The New Alchemists* (1): p.14
2. Bodek, A. 1973. "How to Construct a Cheap Wind Machine for Pumping Water." 15 pp. - \$1.00.
Simonds, M., and A. Bodek. 1964. "Performance Test of a Savonius Rotor." Tech. Report T-10. Both from: Brace Research Institute, MacDonald College of McGill University, St. Anne de Bellevue 800, Quebec, CANADA.
3. Savonius, Sigurd Johannes and Co. 1925. "The Wing Rotor in Theory and Practice." Norblad and Petterson, Helsingfors, FINLAND.
4. Klemin, Alexander. 1925. "The Savonius Wing Rotor." *Mechanical Engineering*, Vol. 47, No. 11: 911-912 pp.
5. Savonius, S. J. 1931. "The Savonius Rotor and Its Applications." *Mechanical Engineering*, Vol. 53, No. 5: 333-338 pp.
6. Hackleman, Michael. 1974. "Wind and Windspinners." Earthmind, 2651 O'Joesel Drive, Saugus, California 91350 - \$7.50.
7. Stauffer's Machine Shop Pump Division, R. D. No. 3, Ephrata, Pennsylvania 17522. Air-operated mesh-water pumps; drilled-well and open-well pumps. \$257.50 - \$339.50 (April, 1975).
8. Edson Corporation, 460 Industrial Park Road, New Bedford, Massachusetts. Hand-operated and power-driven diaphragm pumps.
9. Swet, C. J., and H. G. Fox. 1973. "Low Head Solar Water Pumping." Presented at the 8th Intersociety Energy Conversion Engineering Conference (IECEC), Philadelphia, Pennsylvania - August, 1973, 341-347 pp.

Solar Collector for Heating Water

The water in the mini-ark where the fish are raised is warmed in two ways. It receives heat directly from the sun's rays striking the pond surface, and from water which has been pumped through a solar collector. Our solar collector is a simple Thomason-type water heater in which water flows downward over a solar-heated black metal surface and is warmed in the process (1, 2). This collector is

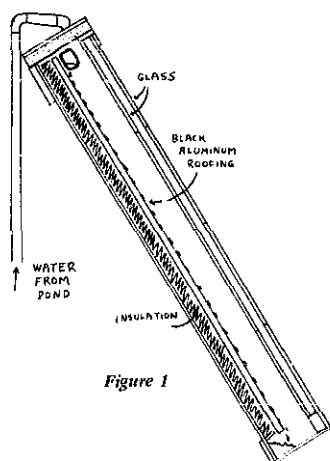

Figure 1

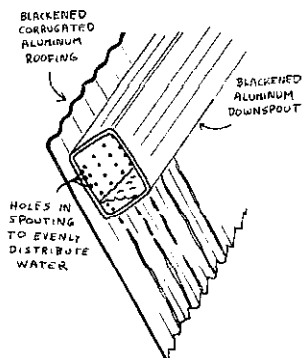

Figure 2

Aluminum downspout used as header in solar water heater.

simple to build, unlikely to freeze in winter and capable of operating with the variable water flow from the windmill. Our experience with this type of collector has resulted in a number of changes which have increased its effectiveness.

Insulation. The black corrugated aluminum plate which acts as the solar absorber will reach very high temperatures unless cooled by flowing

water. Even in the spring the plate can reach 180° F. by 10:00 A. M. Because styrofoam insulation panels in contact with the black metal melt and shrink, we find it is better to use fiberglass insulation which can withstand these high temperatures.

Water Distribution. To distribute water along the surface of the collector, we originally used rigid PVC pipe with holes along its length. Copper pipe, which would normally be used for this purpose, is toxic to fish. Unfortunately, rigid PVC pipe softened at the high temperature in the collectors and began to sag between supports resulting in uneven water distribution. Originally we had fed the main distribution pipe with water at two places one-quarter of the distance from each end and had drilled one row of holes along the bottom of the pipe. This is the normal distribution pattern of the Thomason collector. We found that the supply pipes, which were below the distribution pipe, remained filled with water at night, liable to freezing. The single row of holes were inadequate for the occasional high flow rates from the windmill. We replaced the PVC pipe with aluminum down-spouting feeding from the center of the top. The aluminum down-spouting is relatively cheap to work with and when painted black is an excellent heat absorber. To cope with our variable flow, we punched several rows of holes, one at the lowest point, and the others progressively higher on one side. This results in even distribution through the bottom holes at low flow rates and even distribution through successive rows of holes as the flow increases. The down-spouting has proved efficient and is kind to the fish.

Controls. While the windmill which normally pumps the water was being re-adjusted we attached an electric pump to the collector. Switching the pump on in the morning and off in the evening was not sufficiently responsive to abrupt weather changes. To remedy this, we used a type of thermostat normally found in hot water heaters to monitor the temperature in the solar collector and to control the pump automatically (3). A thermostat mounted directly on the collector plate does not work since the plate's temperature drops drastically as the water flow begins, causing the thermostat to switch on and off constantly. The thermostat sensor is best placed inside the collector near the top attached to its own small black absorbing plate, which duplicates the temperature of the main (4) plates but is separated from it. Once installed the thermostat was set to turn on the pump at 100°F and turn it off at 95°F. The pump comes on in response to morning sun, stopping if clouds pass over for more than one minute and shutting off in late afternoon. The precision of automatic control is impressive and its convenience is a real advantage.

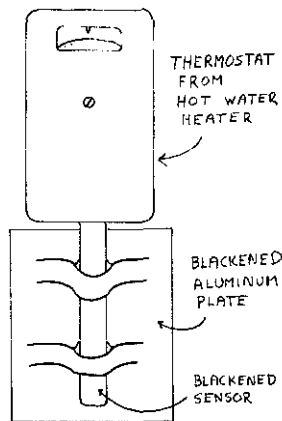

Figure 3
Solar collector thermostat absorber plate attached.

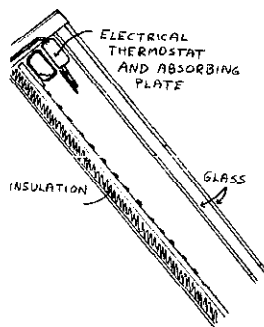

Figure 4
Position of thermostat in solar collector.

While the collector was connected to the electric pump, we tested some of its heating capacity. The area of the solar collector is approximately one hundred and twenty-eight square feet (four feet by thirty-two feet), a small portion of which is non-collecting wooden supports and edges. Our pump circulates 8.125 gallons per minute over the collector. On a very sunny spring day, the rise in temperature of water passing through the collector can reach 8°F around solar noon, and normally will be about 6°F from 10:00 A. M. to 3:00 P. M.

Measuring output of the collector when it is connected to the windmill is more difficult, as the flow rate is changing constantly. A simple and inexpensive method is to place a container at the point of outflow from the collector. Such a container should have a V-shaped opening cut on one side. The level at which

the water flows out of the V indicates the rate of flow from the collector. This method of determining flow rates can be used for many other purposes, such as water supply or irrigation control (5).

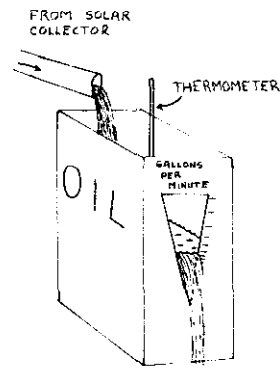

Figure 5

A five-gallon oil can works well for this, and the V opening can be marked in gallons per minute, pounds per minute, or any convenient unit. The flow from a garden hose can be used to calibrate this instrument initially. This is done by turning the hose into the can, marking the overflow level on the V and measuring the flow for one minute. Several repetitions at various flows will provide a scale. A tall, narrow V gives more precise measurements than a short, wide one.

To test the heating performance of the collector, a thermostat is placed in the can and simultaneous readings are taken of the water temperatures and the flow rate. By subtracting the input water temperature, which does not change very quickly, the rate of energy collection is easily calculated.

— Earle Barnhart

REFERENCES

1. Thomason, Harry E. 1972. "Solar House Plans." 36 pp. \$10.00 - Edmund Scientific Co., 150 Edscorp Building, Barrington, New Jersey 08007.
2. McLarney, William O., and John Todd. 1974. "Walton Two." *The Journal of The New Alchemists* (2): p. 96.
3. Minneapolis-Honeywell - L 4006 B 10151 Aquastat Controller. Hot water heater thermostat with adjustable on-off settings. Ask at your local plumbing supply store. Approximately \$25.00
4. Morgan, John. 1974. "Water Pipes from Bamboo in Mezan Teferi, Ethiopia." *Appropriate Technology*, Vol. 1, No. 2, 1974, 8-10 pp. - from Intermediate Technology Publications Ltd., 9 King Street, London WC2E 8HN, ENGLAND

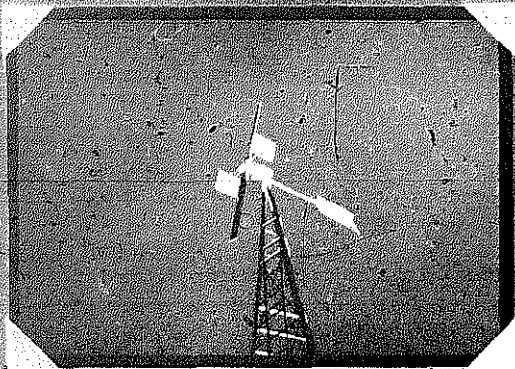

PHOTO 1. Wincharger 650 Watt - 32 Volt - Model 321 - 1936

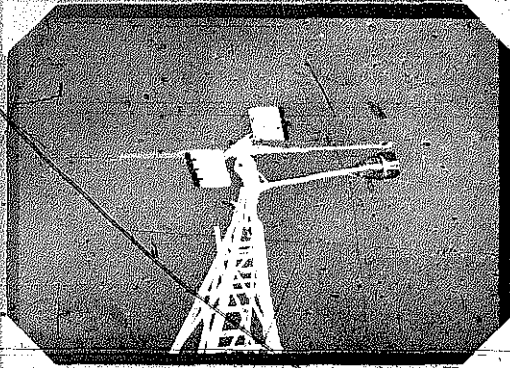

PHOTO 2. Wincharger 1200 Watt - 32 Volt - Model 3214 - 1940



PHOTO 2A. Wincharger 1200 Watt - 32 Volt - Model 3214 - 1940



PHOTO 3. Wincharger 1200 Watt - 110 Volt - 4 Bladed

Earth Breath: Wind Power

"Wind, water and solar power are running to waste."
1-14-1903 - DAILY CHRONICLE, England

The recently published book "Energy Primer" by Portola Inst. *et al*, listed a few of the companies that manufactured wind generators in the U. S. A. from 1910-1970. The largest number of them were doing business in the 1930's-1940's. Examples of most of these wind generator systems have been found, rebuilt and restored into working condition. The photos and copy that follow come from a portion of that finding.

The Wincharger Corp. of Sioux City, Iowa, was started in 1927 by the Alberts brothers, John and Gerhard. The wind generators pictured were constructed between 1928 to 1940. Photo number 1 is a 650 watt, 32 volt Wincharger produced around 1937. This unit has the bucket type governing system that Wincharger used for almost all of their two-bladed machines. The gearing system in this model was a fibregear and steel pinion with a 6 to 1 ratio in order to step up the RPM's delivered from the blades to the generator. It is interesting to note that in 1936 the generator for this wind system cost \$27.50. A comparable size generator at 1975 prices would cost around \$225.00.

Photo number 2 is a 1200 watt, 32 volt, model 3214 built around 1940. This was the largest model offered by Wincharger at that time. This unit had a gear ratio of 5.25 to 1 (note: Wincharger in their lifetime produced several hundred thousand wind generators). In the close-up picture the chain ex-

tending from the rear of the generator through the pulley and proceeding from there down the tower is used to collapse the tail of the machine out of the wind in high-wind, storm conditions.

Photo number 3 is a 1200 watt, 110 volt, four-bladed Wincharger. Photo 4 shows the hub configuration used on the four-bladed units. Photo number 5 shows a cast aluminum mounting of one of the later models of the four-bladed type which used extruded aluminum blades.

Photo number 6 is a 1974, 200 watt, 12 volt model 1222H. It is the only unit still produced by Wincharger which is now Dyna Technology Inc. Photo number 7 is a 1930's-1940's, 200 watt, 6 volt, model 622 Wincharger. This shows the bucket governing system and the brake used to shut the plant down in high-wind conditions. These smaller units were originally used to power radios manufactured by Zenith Radio Company and others.

About the same time that Wincharger was producing their small 200 watt wind plants, two other companies not quite so well known were also producing small wind generators to be used for running radios. They were Delco (photo 8) and Paris-Dunn (photo 9). Paris-Dunn also produced a 2000 watt, 110 volt wind generator.

In 1937 a small company by the name of Rurallite began producing a number of wind generators of which

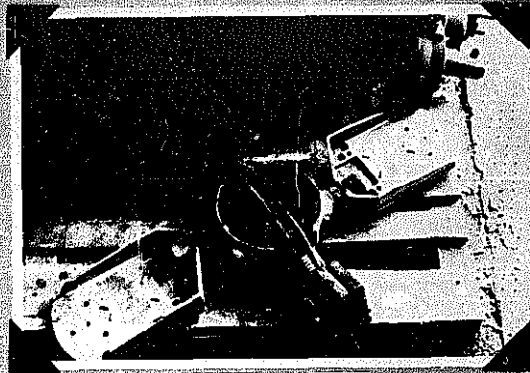

PHOTO 4. Wincharger Governor

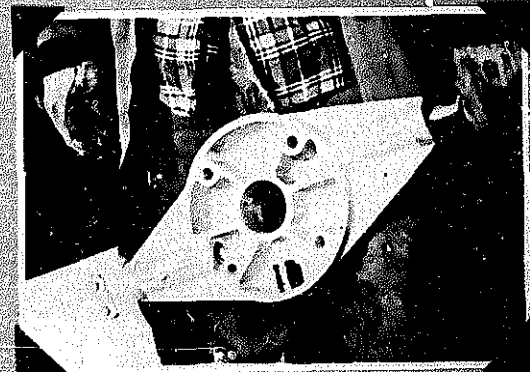

PHOTO 5. Wincharger Hub - Cast Aluminum

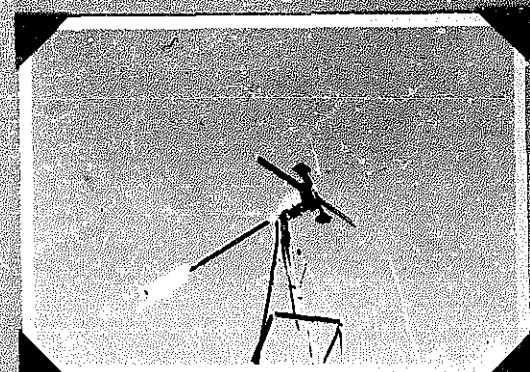

PHOTO 6. Wincharger 200 Watt - 12 Volt - Model 1222H - 1974



PHOTO 7. Wincharger 200 Watt - 6 Volt - Model 622 - 1950

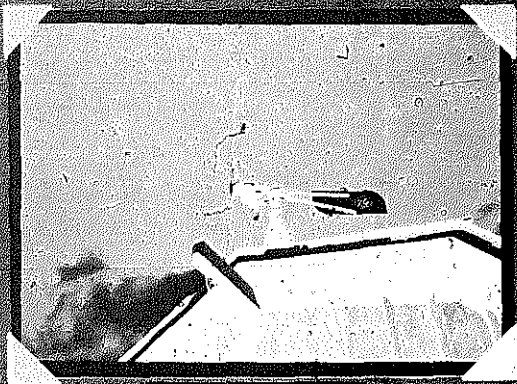

PHOTO 8. DeLoe 200 Watt - 12 Volt

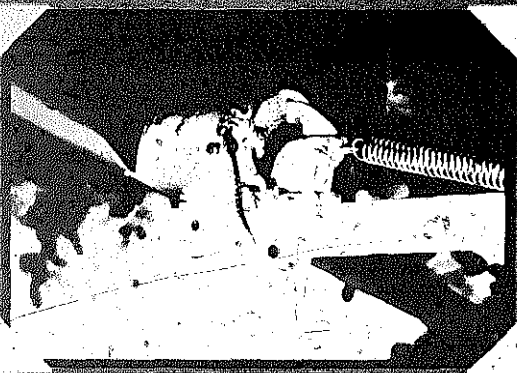

PHOTO 9. Parie-Dunn 170 Watt - 6 Volt

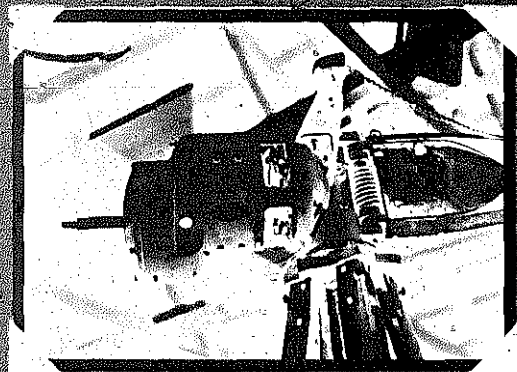

PHOTO 10. Rurallite 1250 Watts - 32 Volts

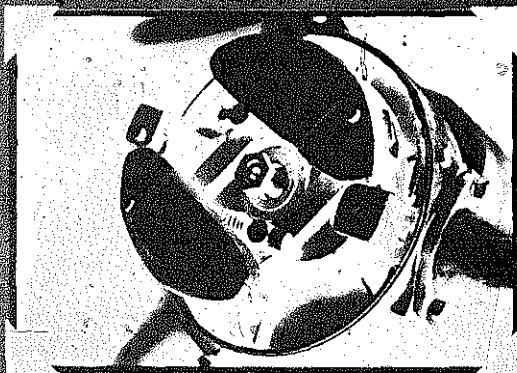

PHOTO 11. Rurallite Governor - Showing Flyball Weights

photo number 10 is an example. The hub and blades are removed. This unit was a gear-driven unit, 1250 watts, 32 volts. Photo 11 shows the governor used by Rurallite. It is the fly-ball type geared to the blade shafts.

Around the same era, not far north of Iowa in Minneapolis, Minnesota, the infamous Jacobs Wind

RIGHT SIDE VIEW OF MODEL-15

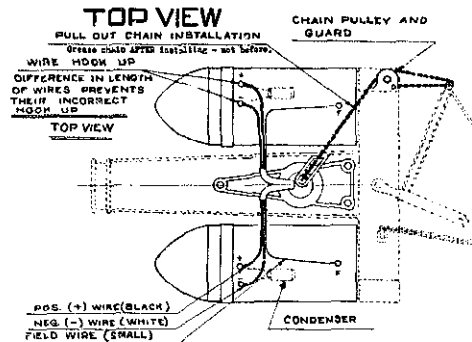
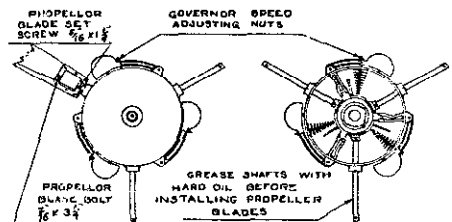
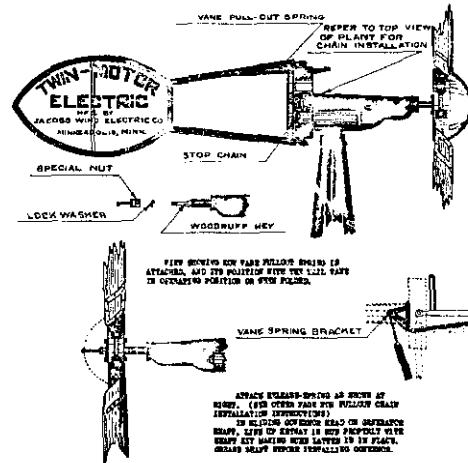

FIGURE B
Jacobs Twin-Motor 1500 Watt -
32 Volt - Model 15

Electric was engaged in producing another style of wind generator known mostly for its direct drive models. They produced gear driven models as well. From what we can tell, these models out-produce in Kw hrs/mo. the direct drive units. Photo number 12 shows a complete Jacobs 2500 watt, 110 volt direct drive unit. Photo 13 shows the brushes, end-bell and capacitor of a Jacobs 1800 watt unit which is not any different in configuration from the 2500 watt (see photo 13). Figure B shows a side view of the Jacobs twin model 15, 1500 watt, 32 volt unit. The Jacobs wind generators were much larger than the Wincharger units and more expensive.

Photos 14, 15 and 16: One of the more novel designs was produced by the Air Electric Company of Lohrville, Iowa. This was a 2000 watt generator in which the cowling and the tail were a continuous fuselage. Holes were drilled in the end of the tail which created a syphoning action thereby cooling the generator. The generator had, in addition, an 80 pound fly-wheel on the front of it which smoothed some of the choppy action of the two-bladed machine. It used paddle-air deflectors for the governing system and had a brake. Another model made by the Air Electric Company was an enormous 3000 watt, 32 volt generator with fly-wheel and paddle-type governor (photo 17).

In Iowa there was still another company known as Windpower, which produced a simple down-wind design, the more popular models being the 1250 and the 1800 watt direct drive. The only problem these machines apparently had was a very long shaft connecting the blades to the generator which had a tendency to bend. The feathering system allowed the blades to feather by attaching the roots of the blades to flyballs, so that when the blades are turning as fast as safety allows, the centrifugal pressure forces the blades to turn about their axis and spill the wind. Photo 18 shows the generator and feathering system with blades and flyballs removed. To shut the plant down in storm conditions, a brake located between the generator and the hub system under the "cowling" was used (see Fig. C).

The possibility for participation in the riddle of inter-relatedness of the natural world reveals a perspective beyond one's own. In any attempt of exchange — and this writing should be viewed as such — the medium is the message. (It is both medium and message that are one, kindness is wisdom, sound and silence, matter and energy, earth and breath, are one.) The connecting link between any two paradox is in itself a paradox. The set of belief structures, or concepts which are based on simul-sensory input, is apparent only when one realizes that immediate interpretation is not completely one's own, and that sensory input consists of much more than one's own amplification.

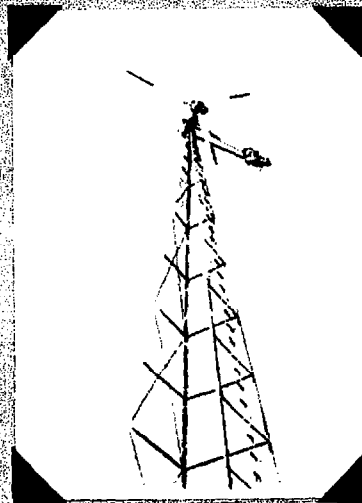

PHOTO 12. Jacobs 2500 Watt - 110 Volts - 1950

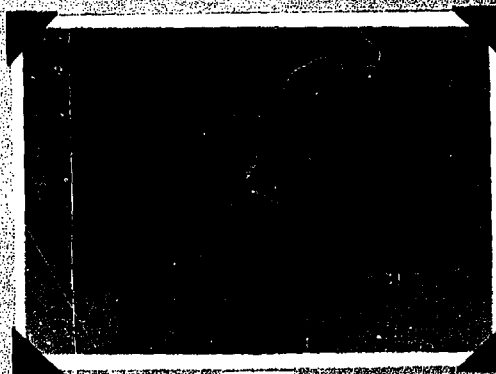

PHOTO 12a



PHOTO 13. Jacobs End Bell - Showing Brushes and Capacitor

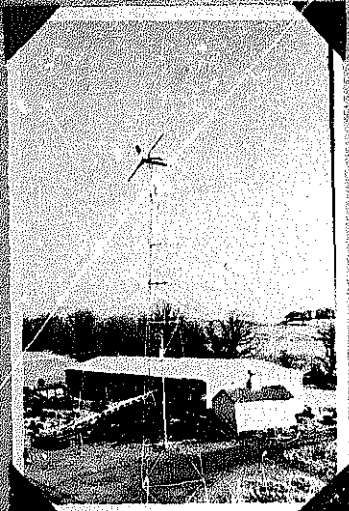

PHOTO 14. Air Electric 2000 Watt - 32 Volt - On Tower

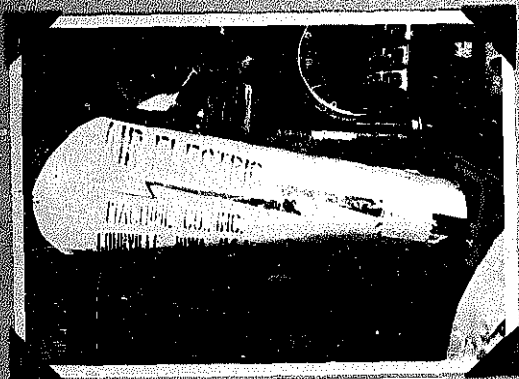

PHOTO 15. Air Electric 2000 Watt - 32 Volt - Tail Section

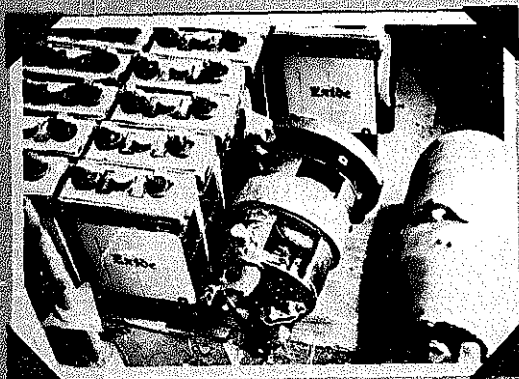

PHOTO 16. Air Electric 2000 Watt - 32 Volt - Generator Against Batteries

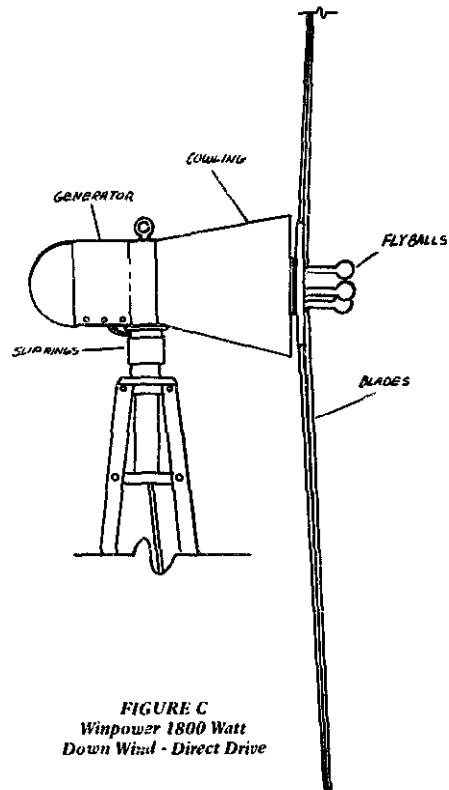

FIGURE C
Winpower 1800 Watt
Down Wind - Direct Drive

The joy of our riddle or paradox does not lie in "the answer", but in the perception of the inter-relatedness of that which appeared unrelated.

One always gets what one needs -

- Jim Bukey



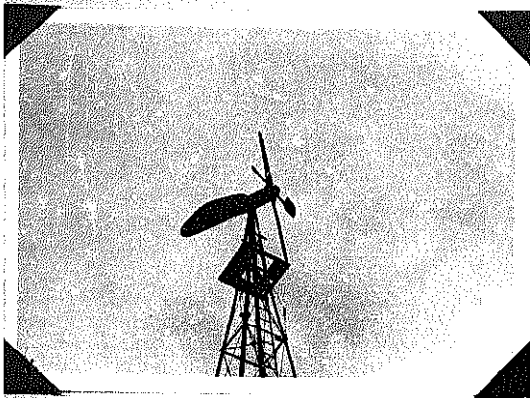

PHOTO 17 Air Electric 3000 Watt - 32 Volt - Paddle type Governor

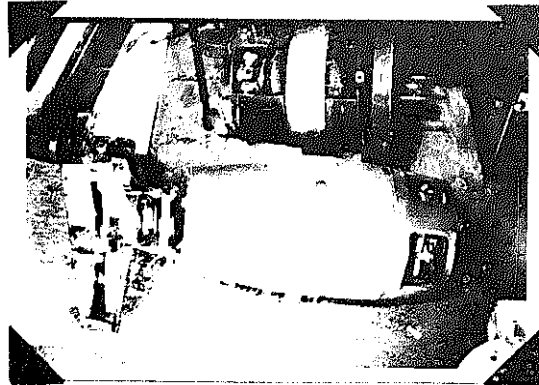
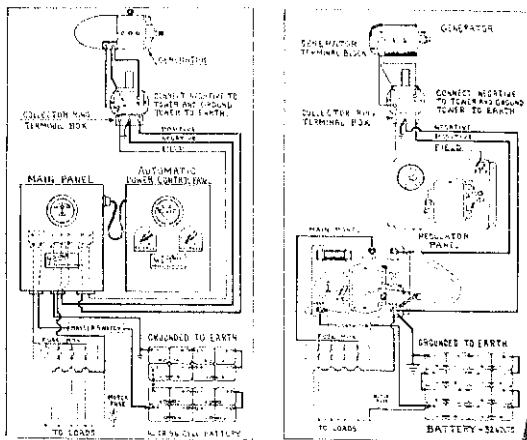

PHOTO 18 Win Power 1800 Watt - 32 Volt - 1952 - Direct Drive, Down Wind



Two different wire systems used by Win barge





Perhaps this section of this particular issue of the Journal might better have been called "Land: Its Use and Misuse", although the articles by Tyrone Cashman, Hilde Atema Maingay and Bill McLarney remain within the restorative theme we like to think is characteristic of much of our work. Ty describes his on-the-job-training as New Alchemy's Chef de Compost in Confessions of a Novice Composter. In the article entitled "Our Gardens" Hilde relates several years' accumulated gardening observations and experience. Bill reports the final results of our experiments in watering vegetables with fish pond water. With John Todd's article "The World in Miniature", the aptness of the term "Misuse" becomes apparent as he traces the 7000 year history of humanity's assault upon its environment through the heedlessness of its agricultural practices. Although otherwise exhausted soils have been revived temporarily, with the application of fossil fuel fertilizers, this obviously cannot be sustained indefinitely. John gives strong evidence that agriculture, not only as it is practised in its present monocrop/agribusiness form, but also throughout much of history, has altered and ultimately threatens the ecosystem of which humanity is only a part, although we often seem oblivious to this.

"The World in Miniature" is a variation on a chapter in John's forthcoming book, "The Sun Dries Us While We Dance: A New Alchemist's Tale of Pioneering for the Twenty-first Century" which is to be published by Knopf.

A strong possibility for intensified yet non-destructive food growing lies in the idea of enclosed growing structures. We have been working with these at New Alchemy since we built the first dome in the early summer of 1971. The later domes, the flat-top or alter-ego, and the mini-ark all have been further experiments in the same line. The Ark for Prince Edward Island and the Cape Cod Ark are logical extensions of the early work but on a much larger scale. John Todd and architects Ole Hammarlund and David Bergmark discuss the design for the Ark for Prince Edward Island in the article by that name.

-NJT

Land and Its Use



Photo by Alan Kaufman

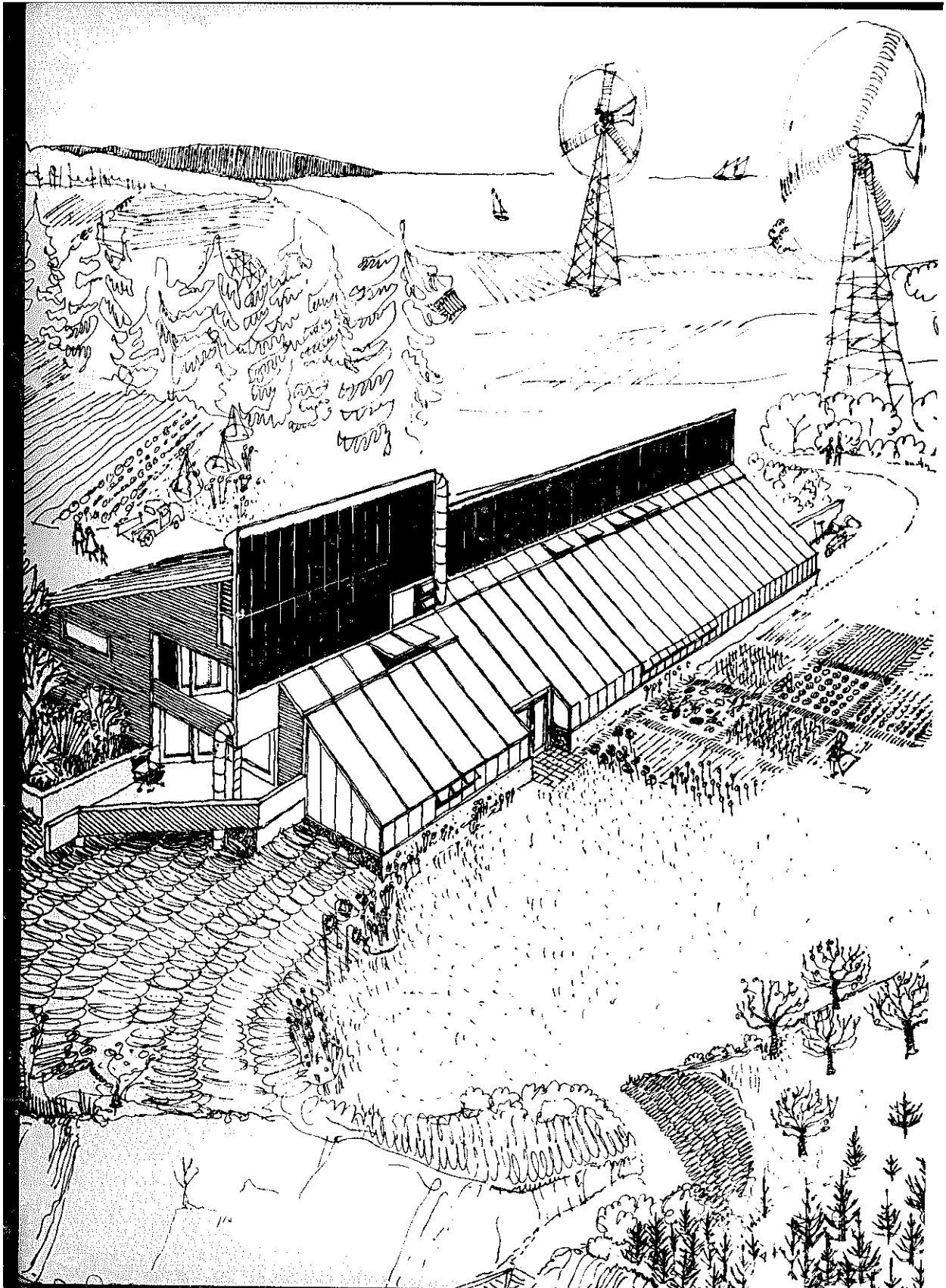

An Ark for Prince Edward Island

For a number of years we have been creating and studying small enclosed bioshelters for the culture of food. Our first effort was a backyard fish-farm/greenhouse, enclosed by a dome and heated by the sun. While continuing to evolve and refine the dome mini-farms, we built several alternative aquaculture systems which employed a number of other biological and energy strategies. In 1974 with the experience gained from these we built the miniature ark, a small wind-powered and solar-heated complex for culturing fishes and greenhouse foods in ecologically linked cycles. These are described in some detail in the second Journal of the New Alchemists.*

The experience was enlightening. We began to learn how to contain and miniaturize ecosystems capable of producing human foods and the intricacies of powering them by the renewable energies of the wind and the sun. The little bioshelters or mini-farms worked, providing food year round on Cape Cod. The theoretical basis of our endeavors was beginning to be vindicated.

The next stage in their evolution was the concept of the ark. We have designed and are now building two arks, quite different from each other but sharing common roots. The Cape Cod ark is to be a food producing bioshelter exclusively although we are going to study ways of making it productive enough to be valuable in micro-economic terms whereas our smaller backyard fish farms and the mini-ark were designed for household use and as small and inexpensive teaching systems. They were intended to become the basis for more experimentation in a variety of environments.

The Cape Cod ark employs similar principles to its forerunners but on a larger scale, with higher rates of energy and nutrient exchange and more sophisticated energy production and conservation elements. Beyond being a structure containing an ecosystem designed for self sufficiency it is intended to be a bioshelter capable of providing income for its tenders. An appropriate comparison between earlier systems and the Cape Cod ark is the difference between a homestead and a farm. We are interested in finding out whether arks that are ecologically designed can operate throughout the year and be sound economically in terms of the present and the future. Could they become the "farms" of tomorrow enabling regional food production to flourish in somewhat populated areas? The question is central as my article *THE WORLD IN MINIATURE* suggests. It will be several years before the answer is known.

The second ark we call An Ark for Prince Edward Island. It too arose from a question; namely, would it be possible to create an autonomous structure, powered and heated primarily by the sun and the

wind which would house and sustain a variety of basic human activities. This would be an ark for living in addition to encompassing and integrating a living area, a laboratory, a production aquaculture system and a greenhouse under one roof. It would trap, store and transform its own energy, recycle its own wastes and water and provide a liveable climate for the household within as well as much of the food for its inhabitants.

Ultimately, when the biological components are fully developed it is our intention that the Prince Edward Island ark be productive enough to generate sufficient income to provide its residents with a new economic base. Such structures might conceivably initiate new concepts of household economics, income and self sufficiency. Another factor underlying the ark concept was that once built it would not impinge heavily on the external world, by polluting neighbouring ecosystems, consuming scarce and expensive fuels or utilizing nuclear power. Rather than stimulate growth in energy needs, arks might lead to conserver concepts as yet only dimly foreseen.

The ark, although it looks and is built much like a modern house, is in many ways its antithesis. Whereas houses draw heavily upon power grids and expensive fuels at the same time polluting lakes, rivers and watertables with their wastes, ark structures which are integrated with and dependent upon living systems should have the opposite effect, teaching us how the world works. Their inhabitants conceivably might become better stewards of the earth. With its internal spaces modelled after the workings of nature, the ark for Prince Edward Island may give us a glimpse of one possibility for the future.

Designing living arks for rigorous Canadian winters is not an easy task, but an opportunity to transform our fantasy into a reality occurred in November 1974. New Alchemy was asked to submit an ark proposal to Canada's Ministry of State for Urban Affairs as part of their Urban Demonstration-United Nations Human Settlement Program. The proposed project fitted well with our plans to establish the beginnings of an Institute in the province of Prince Edward Island.

All of us became involved in the project, but the yeomen's share of the task of creating the preliminary plans fell on Earle Barnhart and Hilde Atema Maingay, who did the original design. In January 1975 the Minister of Urban Affairs announced his approval of the project although it was to be over half a year later before an approval contract was received. Nevertheless in January on the basis of the Minister's statement we decided to risk proceeding with the designing of the ark, testing materials and designing an advanced windmill system to power it.

* Available from N. A. I., Box 432, Woods Hole, Ma. 02543 @ \$6.00

At this point, architects Ole Hammarlund and David Bergmark of Solsearch were commissioned to contribute their professional skills and have subsequently proved equal to the enormous task of designing an autonomous structure. The New Alchemy-Solsearch association has become symbiotic as the architects started delving into biology, energy conservation and appropriate technologies while we in turn learned about architectural problems and possibilities. Since bioshelters are not just structures this relationship was critical in creating a working ark. The architects evaluated a range of heat capture, storage and climate regulation approaches as well as a number of structural configurations. Model after model was built, evaluated, argued over and a number of consultants were asked to keep a critical eye on the proceedings. After seven months of steady work the design shown here began to take its final shape. Work on the biological systems continues as we have designed a number of new components including solar ponds for simultaneously trapping and storing solar heat as well as raising algae and warm water fishes.

All along there has been considerable discussion of the ark's aesthetics. It is to be situated in an extraordinarily beautiful place on the edge of the sea and must be worthy of the site. The architects were especially sensitive to our request that it prove a powerful statement for an emerging solar aesthetic, for the ark must not only work, but echo the slogan of the Province "The Place To Be."

A decision to design, fabricate and test for the ark what we hope would be one of the finest wind driven power plants was based upon our conviction that windmills should become a major future power source for many regions that now have to import power. A number of recent analyses have substantiated our belief that wind power can be a sound and economical energy source for a nonnuclear future^{1,2}. Commercially available windplants could have been purchased for the project, but we felt they were not large enough, nor did they represent the end point in a technology which has been relatively ignored for the past forty years. While there are a number of exciting designs being tested it is a field ripe for a lot of creative research. Windmills should come in many different sizes and shapes adapting to their function and location.

Prince Edward Island seems ideally suited as a testing ground for wind power. Situated on the Gulf of St. Lawrence, the Island has an excellent wind profile and being primarily rural it does not have the large per capita demands for power of a manufacturing region. We envisaged windmills coupled to the existing power network with the fossil fuel generating station in Charlottetown acting as a "storage" component for the whole system at some future date. Under such a scheme it would be possible for the

province to develop a coal-wind-solar energy economy with the latter two increasingly predominating in the years ahead.

The ark windmill then might become a working demonstration of what might be possible especially as we planned to couple it to the network and sell the power the ark didn't use. Work on the mill began in January despite the lack of a contract from Ottawa, because Prince Edward Island was considering opting for the nuclear future in partnership with New Brunswick across the Northumberland Straits. We had hoped that the windmill might trigger a debate on the Island's energy future, but we fear our efforts may have come too late in this instance. The nuclear nonsolution seems to be riding on a crest of popularity and will probably win out in maritime Canada.

With the Island as well as other non-industrial regions in mind four criteria for the windmill were established at the outset:

i. That it be powerful enough to provide overall power needs for the ark or for a largish farm. A 25 kw mill seemed an appropriate size for Prince Edward Island.

ii. That it be possible to scale up the windmill to a larger size at some future date to be capable of providing power for Island villages or the power network.

iii. That it be designed so that it could be manufactured regionally so that the energy future of the Provinces could be linked to its economy and could provide employment. Nuclear technologies obviously do not lend themselves to regional manufacture so that their adoption harms regional economies in the sense that they are money sinks and do not recycle wealth through the populace.

A design group headed by two consulting engineers, Merrill Hall and Vince Dempsey, were asked to create the power plant. Merrill and Vince had worked with New Alchemy previously on the development of Big Red, the large capacity sailing. They conceived and designed an innovative windmill dubbed HYDROWIND* and a full scale plant is expected to be running at New Alchemy's site on Prince Edward Island by the summer of 1976.

The HYDROWIND (illustration) incorporates a number of major innovations, beginning at the interphase between the wind and the windmill, namely the blades, which utilize a new light weight design based upon an internal tension system. Another radical design difference is that the electricity will not be generated on the top of the towers, as in most horizontal axis mills, but on the ground thereby opening the door to both significant cost reductions and increased generator sizes. The design is such that the turning blades will drive a hydraulic pump on the tower and the energy will be transferred via hydraulic lines to a

*N. A. I. trademark

hydraulic motor on the ground. The Prince Edward Island Power Plant for the ark incorporates four windmills each with a 20 foot diameter blade sweep which are linked together energetically via a hydraulic equalizing chamber on the ground. Their aggregate power operates a hydraulic motor.

The blades will be tuned hydraulically as well to match a given wind velocity. Pressure in the lines will determine blade position. At very high wind speeds, the blades will feather to avoid damaging the overall system.

While the HYDROWIND has yet to prove itself, we are hopeful that it will be a fitting component to the ark, and, in its small way, assist in helping others towards utilizing the sun and the wind to provide some of their basic energy needs. For its part the ark should help illustrate the potential of renewable sources of energy and biology in aiding in the design of living structures. The ark and its windmill may help us unlock new ways of pioneering for tomorrow.

— John Todd
August, 1975

1. Brent Sorensen, 1975: Energy & Resources: Science 189 - 4199 pages 255-260
 2. Amory B. Lovins, 1975: Nonnuclear Futures: Supplement to "Not Man Apart" . 8 pp. Vol. 5 (No. 15)
- Also: To appear Fall, 1975 in Nonnuclear Energy, by A. Lovins and J. Price. Friends of Earth Books, 529 Commercial Street, San Francisco, California 94111.

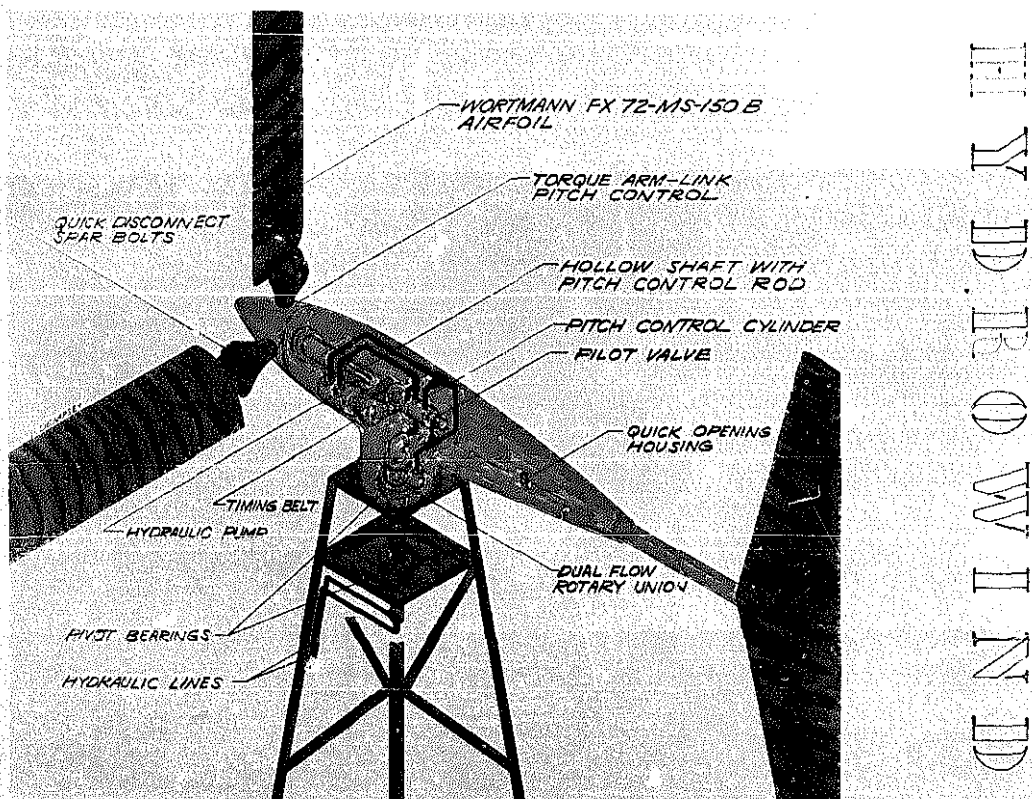

The Architects' View of The Shape of Things to Come

Integral to the design of the Prince Edward Island ark was the incorporation of a residence, an extensive greenhouse and seven hundred and fifty square feet of collector area — all competing for a place in the sun. To maintain a compact plan yet maximize the south oriented surface, the solar collector extends straight upwards, billboard fashion, along the entire south facade. This vertical wall shelters the greenhouse from the severe northwest winds and takes advantage of the reflections from the greenhouse roof and the snow covered ground. The vertical configuration also eliminates any danger of snow build-up on the collector surface during winter months when the collection of solar energy is crucial to the operation of the structure and its integrated systems. Behind the greenhouse wall are the residence and the laboratory, warmed by the moist air and lit by the diffuse light of the greenhouse.

The ark has its north side towards the road; and not unlike the conventional farmhouse one enters the house between the barn and the tool shed. The surrounding terrain slopes ten feet downwards along the east facade giving further protection from the northerly winds and allowing for a greater exposure to the south light. The south facade is almost industrial looking with the tremendous expanse of collectors, greenhouse and air ducts. With the west gable, however, the house takes on a more inviting scale. Here there is a spectacular view of the sea; the afternoon sun is let freely into the living room, dining room and bedrooms. The rooms have direct access to the out-of-doors via protected porches.

In the plans for the ark no effort has been made to conceal the energy systems within the envelope of the building; the idea was rather to express the systems visually in an attempt to develop a new aesthetic and consciousness for energy producing and conserving structures. The exposed ducts on either side of the residence circulate the air downward through the collectors to the rock storage underneath the living area. When the collectors are receiving a sufficient amount of sunlight this air is continuously recycled from the storage to the collector and back again. At night or on cloudy days hot air from the rock storage is circulated through the residence.

The south oriented greenhouse is unlike a conventional greenhouse in that the north wall is not transparent but heavily insulated against heat loss. The highly reflective rear wall is angled to reflect the maximum amount of light available in the winter back onto the aqua/agriculture area. On days with any sun the temperatures at the peak of the greenhouse may quickly reach 100° F or more. This air, which is normally vented to the out-of-doors, in the ark is sucked through the rock storage under the garage.

The air loses its heat to the rocks and is returned to cool the greenhouse. At night when the heat loss from the greenhouse is considerable the cycle is continued with the opposite effect. The returning cool air of the greenhouse is heated by the warm rocks and distributed back throughout the greenhouse to prevent temperatures from falling below freezing. The large number of fish tanks will also contribute to a stable temperature in the aqua/agriculture area. To maintain a productive temperature of 60-90° F in the fish tanks the water is heated by liquid type solar collectors which also serve to heat the soil in the deep planting beds.

All the surfaces in the structure store heat from the sun. The following are figures of heat collection from the major storage elements. The 20,000 gallons of fish pond water, which may cool to 50° F without damage to the fish, will store 6.6 million useable British Thermal Units. The 3,000 cubic feet of rock under the living unit will release 4 million BTU's during a temperature drop from 150° to 75° F. The 3,000 cubic feet of rock under the garage can store 2.6 million BTU's with a temperature drop from 95° F to 45° F. The total available stored heat, 13.2 million useable BTU's together with some additional heat from a wood stove will heat the house in the month of December should the sun not shine at all.

The sections and plans show the relationship of the different elements of the ark. The ark was originally designed to contain large concrete pools to grow the fish. As research progressed at N. A. I. it was found that round, transparent fiberglass tanks were more effective for the production of algae. This required a change in plans but initiated an even bigger change in the approach to the design. For the ark to remain a viable integrated system over time, the bio-systems as well as the energy systems are designed to be flexible, reflecting the long range experimental possibilities and anticipating future technological developments.

— Ole Hammarlund
David Bergmark

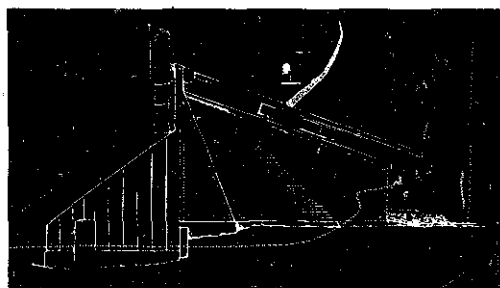



Photo by Fritz Goro

Confessions of a Novice Composter

Susan and I arrived at New Alchemy on a sunny day in May. During our first week we saw that one gap that needed filling was in the area of making more compost for the sandy garden soils. Susan had had considerable gardening experience, but I had spent the last four years closeted in libraries writing about "Nature" in 17th Century French philosophy, but as yet had never turned the soil.

As we set to work, one truth struck my keen philosophic mind at once. The difference between making humus from plants and writing a thesis on "Nature" is that in writing you do the work, in composting nature does the work. My first lesson in stewardship.

From our initial reading, we found that most compost piles take three to six months from building the heap of rough material to spreading humus on the ground. We didn't want to wait that long. Searching around, we came across a method developed at the University of California that claimed to turn out usable compost in 14 days. The

recipe called for 100 lbs. manure, 100 lbs. grass clippings and 100 lbs. dried leaves. We had plenty of leaves. The previous fall, a sign had been put up at the dump nearby, directing the town's leaf dumpers to bring them round to us if they wanted to make them useful. That pile had already partly decayed over the winter. Since we have no large animals, we had to search for the manure. Cape Cod, once farming country, is now a vacation area. The only large animals around are riding horses, but there are enough of them to enable us to get the manure we needed by offering to take it away in our pickup truck.

Grass clippings were available from early summer on as lawns began to yield their harvest. We intercepted bags full of clippings at the dump. We often had substitutes for grass clippings: green weeds from the gardens as they began to grow, fish heads and entrails and scraps from Saturday potluck lunches. One day, one of our salt-water fishermen asked me if I would like some fish for the pile — the

menhaden were running in vast numbers. He normally didn't fish for them, he said, but he would catch me a couple dozen if I could use them. He said the Indians of Massachusetts taught the first white settlers to bury one of these at the base of each corn stalk for fertilizer. Next morning, there they were in a plastic bag by the doorstep. I left them in the sun for half a day and was rewarded with the realization that the bacteria of decay had started their work whether I was ready or not. The menhaden were about 8 inches long and very bony. I cut them up in

vegetable trimmings. When we needed it, a couple of restaurants would save their table and kitchen scraps for us. A school cafeteria provided table scraps asking only that we bring the plastic garbage cans (small ones, they get heavy, and put up a sign for the kids explaining that the food scraps should be separated from other refuse.

As the summer progressed, we were turning out a pile 4' x 8' x 8' (about 8 tons) every four weeks. The contents changed as the grasses and weeds from untilled parts of the farm were cut. These were scythed



Photo by Hilde Atema Maingay

thirds — head, middle, tail — and spread them throughout a pile that had been started a few days before. Two days later, we got out our pitchforks to turn the pile and were amazed to discover that we could not find the fish. I don't recall the smell as having been bad either. On the other hand, when our fishermen would take the fish guts from a night's catch and dump them on the top of the pile with a light covering of straw, there was a distinctive odor. But when dug in throughout an active pile, they seem to return to their constituent elements so quickly there is little time for offense.

Other sources of green matter were supermarkets, restaurants and a school. We came away from each visit to the supermarket with half a truckload of

and carried to the piles. Some of the more fibrous weeds we chopped up with a machete.

The "14 day method" takes 14 days in hot California. Allowing for our colder Massachusetts nights and frequent chilly days, we called them finished in about three to four weeks. We always interlayered one-third green vegetation or garbage, one-third dried vegetation (last year's leaves, field grasses, corn stalks, etc.) and a third or less manure. We sometimes interlayered small amounts of granite dust for potassium, and rock phosphate. These we bought. If our weeds had no dirt clinging, we threw in some garden soil every couple of layers to be sure we had all the bacteria we needed.

The final ingredient was water. The pile must be

kept moist but not soaking wet. One should be able to squeeze a handful and feel it quite wet, but not be able to squeeze water out of it. A pile of this type generates high heat very quickly, so it is important to be sure it stays wet enough. We usually watered ours each time we turned it.

Besides the above ingredients, the recipe calls for two operations:
For fast composting, all the matter should be shredded before piling. This is essential for quick decay. Shredding multiplies the surface area of the material by many times, giving more working surface for the bacteria. We use a commercial gasoline engine-powered shredder-grinder. You can use a rotary power lawn mower. Lay your material near a wall for a backstop and run over it several times.

The second operation is turning the pile. The "14 day" pile is aerobic, needing lots of oxygen. When the material is forked from one spot to another all of it is exposed to oxygen. For fastest results, the pile should be turned every other day. Obviously, this method is labor intensive. You put much more muscle into a quick pile than you do into a long-term pile. But the shredded material is easy to fork and even when wet is somewhat light and crumbly. By the middle of the summer, I and those who regularly helped me with the turning were in fine shape. With three forks and two friends, the turning of the pile can be a pleasant half hour. We often did it as the last part of the day's work when the sun was slanting low over the gardens. It left us physically tired and very relaxed -- a good feeling at the end of the day.

But the crowning reward of this first-time composter was the week I saw a row of beans pushing up out of the ground looking yellowish and limp. We put two or three handfuls of new compost gently around the base of each plant. It rained that night, soaking the roots with the nutrients, and within a couple of days every little bean plant was standing upright and vibrantly green.

From our experience, good compost can be made by anybody. Although no one seems to know exactly what goes on in a compost pile yet, you don't have to know exactly. Susan says that making compost is like making a casserole. You just get a feel for the ingredients. The ground leaves and dried grasses are the filler or bland part -- not too active. The sappy ground-up green matter is the sauce -- the protein more active. The manure is the spice -- you don't need as much but it brings everything together, makes it work.

With a simple recipe, the beginner can get started (I read a total of five pages on composting before getting underway on the first pile). Once he or she has gone through the process, seen it work more or less, then a curiosity will probably develop to know what can be done with different materials in different time spans.

The classic book is J. I. Rodale's *The Complete Book of Composting*, Rodale Books, Inc., Emmaus, Pennsylvania, 1960, 1,000 pages. There has been progress in understanding composting in the last fifteen years but this old standard is still full of good lore. We also used the chapter on Compost in *The Organic Method Primer* by Bargyla and Glyver Rat-eaver, 1973. Our edition was published by the authors, Pauma Valley, California, 92061. It discusses the conflicting information of various "schools" of composting. A good book I've come across recently is *Let It Rot!* by Stu Campbell, a paperback from Gardenway Publishing, Charlotte, Vermont 05445, 141 pages, \$3.95. This book is pretty complete and well written. At the end, Campbell provides a list of 34 books and pamphlets in the way of further reading. But, as Campbell says, compost making need not be esoteric. After all, every piece of material we put in our piles would have decomposed anyway if left where we found it.

— Tyrone Cashman

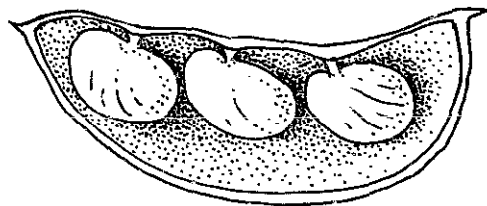



Photo by Hilda Atona Mangay

Our Gardens... Trying to think of where to begin the story of our 1974 gardens, I find myself torn as to whether to start in January or in May of that year, or maybe even in the fall of 1973. But how can I describe the fall harvest without mentioning the preceding summer's activities which, too, were the result of a unique time and combination of people, thoughts, labor, weather and land. Much of our concern is that we come to a better understanding of our land and its productivity, the land being as much alive as any living creature.



Our first year (1972) got off to a late start. Just small strips of land were plowed, tilled and planted. Other pioneering work had to be done then in the form of structures, sheds and compost piles. With that year's experience, some books, a few hands and lots of labor we planned a much bigger garden for the following year. We decided to maintain it in a conventional enough way using clean cultivation between plants in rows, lots of compost, lots of flowers, a little mulch and some companion planting. The harvest was a great success. With a bit more confidence we drew up strategies for 1974. Besides more companion planting, we decided to try several different mulching methods. The results of that summer were intriguing. A close look at the effects of mulch made us understand that it is a more complicated process than we had realized. It affects the moisture content of the soil as well as the soil temperature. Plants that have been mulched

need watering less frequently and can better withstand dry spells. Mulching is an ally in discouraging weeds and, at the end of the season, offers a final bonus of added organic matter for the soil.

Cool-weather plants thrive on the Cape until December. This makes planning ahead for their placement very important. The 1973 summer gardens left us with rows of leeks here, carrots there, and the broccoli and cabbage again elsewhere. Rototilling and discing became very complicated and in some instances impossible. Such a dilemma! — to have two more months of fresh vegetables, or to have the land ready for the winter cover crop, keeping in mind the future fertility of the soil. We compromised, perhaps too much, leaving some areas bare. Other plots, because of late planting, had only a thin carpet of winter rye at the time of the first snow. In the big fields, however, the winter cover crop grew well.

We still rank ourselves as beginners in food preservation. We mentioned in *Journal Two* our canning and freezing. They are the most costly ways of preserving food in time, material and fuel, but have the advantage of storing hard-to-keep vegetables and those which otherwise would lose their flavor. From an ecological view, investigating other methods of food preservation is definitely a good idea. The carrots were given a thick seaweed cover and kept their crisp, sweet flavor over the whole winter. Thanks to the generally mild character of the winters here, digging them out of the ground was only an occasional battle. Winter squash, potatoes and cabbage lasted well in the root cellar.

With food stored and the land ready, we can accept the coming of winter. We wish for snow to come over Christmas vacation, but it seldom is here before January. The outside is for kids, sleds and play; inside we think and write about last year and plan for what is coming next. We study piles of seed catalogs with tempting pictures of the best-tasting, highest yielding, most resistant, everbearing, everlasting vegetables and fruits. Everybody's request for new varieties are coming in. Also to be considered are specific demands for plots in the gardens from several of us who want to do experiments. We need to plan crop rotation to cut down possible accumulation of pests and diseases and to maintain soil fertility.

In February we filled wooden flats with a mixture of soil and sifted compost, with an inch of vermiculite on top to give the seedlings a "clean" and easy start. An early start for seedlings which can withstand transplanting prolongs the season. Starting seeds in flats also gives plants a head start over pests, diseases and weeds, a practice which is useful throughout the growing season.

When time for spring clean-up hit us all, we made quite a few improvements in landscaping; paths were made wider and smoother; steps and slopes were evened out so we could get a wheelbarrow uphill.



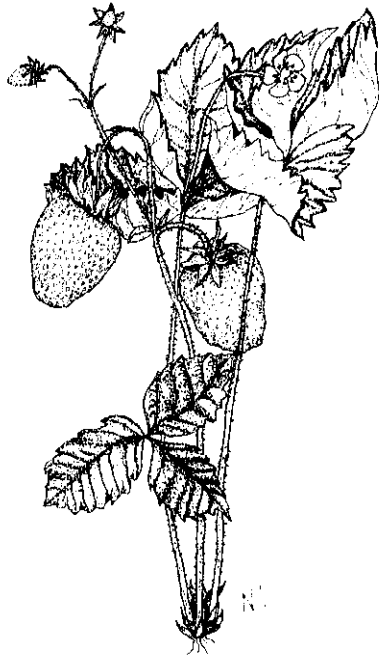

Hills were seeded with vetch and pathways with grass to avoid erosion. Several compost piles were started. For anybody who had time to spare, a seaweed run to the beach was a useful thing to do. We need great quantities of seaweed as, for us, it serves as both compost and mulch. For those new to mulching, it is better to do half a row thickly enough to prevent the soil from drying out and the weeds from germinating, rather than a whole row thinly. Mulch six inches-thick and as wide as you think the root systems go should be a good start. It will soon pack down to one to two inches and sometimes need an additional thin layer.

New to all of us was the idea of trying white Dutch clover as a combination mulch/ground cover/nitrogen fixer and, eventually, a green-manure fertilizer and soil conditioner. It was grown among the cabbages, broccoli and Brussels sprouts. Where we had mulched the seedlings with seaweed and had sprinkled the clover seeds between the rows, the plot needed little attention. There were few insects or weeds, lots of birds, and little watering was needed, even in a drought period. There were no bumper crops, but in comparison with other parts of the garden where the weeds flourished and drought had stunted growth, it was productive. In the same plot we tried the clover with the same vegetables but without the seaweed mulch around the plants. The plants grew taller, were stalky and produced less. This may have been because the plants had to compete with the clover, but as controls were insufficient-

ly rigid, we're not ready to make a definitive statement.

For the new gardens we plan an expanded use of the clover. We'll make one foot-wide walkways covered with clover between beds four feet wide and six to twelve inches high. The clover will cover the bare ground, but will not interfere with the food crop. After the season is over, it will be rototilled under and all the beds will be moved up one foot, so what was path one year will become part of the bed the next year.

Our experience with the tomatoes offers a fine illustration for learning-by-doing gardeners. We set them out when they had developed several true leaves. We planted each one in a hole well filled with compost and covered the soil generously with seaweed. What we did not realize was that tomatoes require warm soil and that we were preventing the soil from warming up. At lower temperatures, water flow slows down and plant roots cannot absorb water as readily. With a limited supply of water, the concentration of nutrients from the compost becomes too strong, making it harder for the roots to draw the water up into the plant. It was probably this combination that stunted the growth of the tomatoes. The plants remained stunted until we took off the seaweed, loosened the soil and gave them a good supply of water.

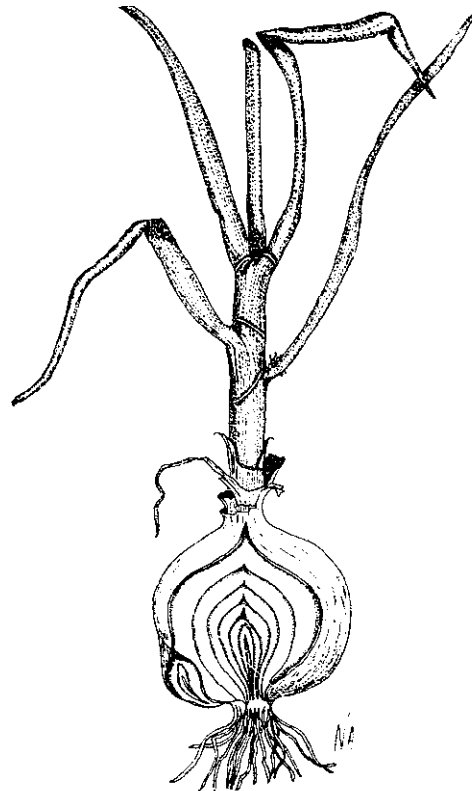

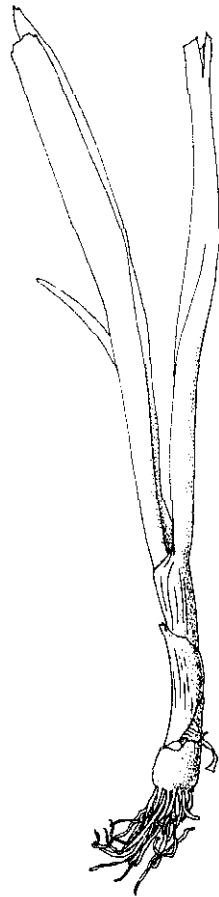

The tomatoes suffered yet another handicap. We had interplanted them with mint and, by the time the tomatoes finally were ready to take off, so did the mint. It soon took over all the space between the tomatoes. These tomatoes housed just as many tomato hornworms as those without the benefits of mint. We also tried interplanting mint with squash. The squash had just as many borers whether they were grown with or without the mint. In general, we haven't been too impressed with this herb unless it's been protecting us from evil of which we are unaware. It grows like mad, gets out of control and takes as much as it can get in space and nutrients. We tried another companion planting idea on the squash. We planted nasturtiums to half the pumpkin and squash hills to repel insects. When we began to notice considerable wilting, we cut a long slit in the stem and found one to six borers per plant. There was no difference between those plants with and those without nasturtiums. As a result of the borers and the slitting, most of the plants died. The summer squash survived because the plants were younger and the borers had not had time for extensive damage. Interestingly enough, the winter squash which came up voluntarily

around the compost piles was not attacked by borers and produced our entire crop of winter squash.

The lesson from last summer's garden learned, as seems inevitable, the hard way was the absolute necessity of constant surveillance and care. After a good start in the gardens, many of us had to leave for a lecture series. Our absence coincided in time with the beginning of a period of drought, which lasted six weeks. The weeds, as usual, were prepared to take off at any opportunity and did so. It meant hard work to repair the damage. But we did.

With a communal spirit rarely surpassed, except perhaps at feasts, we tackled a conspicuous interloper, the Mexican bean beetle, first. They were taking more than their fair share. Why so many more of them than last year? With the combination of drought and weeds, it is hard to say. Were the plants weakened under the stress situations? Do weak plants attract pests? Or did the dry weather create a population boom? Or was it that we were just too late starting the hand-picking?

What restored our self confidence was a little plot, thirty by forty feet in size. In mid-July, with just enough time to start a new garden, we cleaned the plot carefully and made beds with one foot-wide pathways. We left it bare for a week and weeded it again. Previously, we had planted in flats which were ready to go in. Several sowings of bush beans, lettuce and carrots went directly into the ground. With care in companion planting, high levels of plant density and a lot of mulching, we had a fine crop from that little plot.

The rest of the gardens revived too, and we always had enough vegetables for our meals, even a freezer full of food for the winter, but nothing like the previous year's quantities to give away. We shall be better tuned in next time. It was a good learning experience.

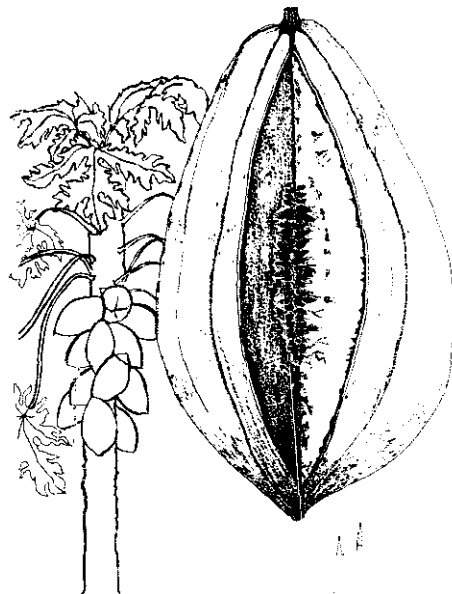



Photo by Hilde Atema Maingay

...and Our Rabbits

We have never fully told the story of our rabbits; over several years we raised rabbits for meat, but we were not interested in super production in a commercial sense. If our growth rate was low by comparison, so were our costs, since half the food, such as vetch, lambs quarters, kale, purslane and carrot tops, came from the land. The rabbits were also fed some of our soybeans and sunflowers which are high in protein and low in labor since the rabbits did their own shelling. By providing good food and avoiding overcrowding, we had no cost in medicines and antibiotics. The only real difficulty was the time involved in maintenance of the cages. An open, outdoor rabbit pen seemed to solve this problem. We enclosed a thirty-by-thirty piece of land next to the gardens with a fence reaching two feet under the ground and at least three feet above the ground. We dug little trenches and half covered them with boards or rocks. The rabbits took cover immediately in these trenches. Having been born and raised in cages, they had never had the experience of digging nor even of jumping, hopping and running. They started to work in no time on their tunnels and nests. It really was exciting to see them go at it, living a life.

They would come out in the day if tempted with some fresh greens, but most of their activities took

place in the early evening and at night. They never seemed to want to escape through an open gate or under the fence. When we dug up the whole place a year later, their network of tunnels extended far under the fence to the "outside", but they never had tried to come up and out.

But all did not end happily. Neighborhood dogs had noticed the attraction. They were already a great nuisance, running over the gardens, under or over the fences, getting into the chickens, and, surprising our free prize rooster in the night, finally killing him. After the first rabbits were killed by dogs, we started to build up the fence with barbed wire. There was another massive killing and the barbed wire went up to six feet. The homey rabbit warren acquired the appearance of a concentration camp. And our interest in raising rabbits waned. Even the excitement of ten little ones appearing out of their nests one early morning, while the ground was still covered with snow, did not help. Later we killed all but a couple of them. The kids took these home and cared for them for many months. They finally gave the last one to a little neighborhood boy who wanted to learn about raising rabbits.

— Hilde Atema Maingay

Further Experiments in the Irrigation of Garden Vegetables with Fertile Fish Pond Water

Those of you who have read *Journal Two* know about our successful experiments in "Irrigation of Garden Vegetables With Fertile Fish Pond Water". Based on experiments with two varieties of leaf lettuce and one variety each of beets and zucchini, we tentatively concluded that fish pond water "would be beneficial to most shallow-rooted leaf crop vegetables, particularly those, which, like lettuce, favor abundant moisture and high levels of nitrogen" (McLarney, 1974).

In 1974 we further pursued our investigations by repeating our experiments with spinach (Bloomsdale Long Standing, Burpee), chard (Fordhook Giant, Burpee) and collards (Georgia, Burpee). (The latter two cannot be considered "shallow-rooted".) Planting and growing procedures were the same as those used in 1973 (McLarney, 1974) except that all three test plants were thinned to four individuals per hill, and the hills were paired to facilitate data analysis. Each individual plant was harvested only once, at which time the entire weight of edible material was determined. This does not conform to usual harvesting procedures for these plants and certainly adversely affected the total yield. However, we could not conceive any other harvest method which would be bias-free.

Germination of spinach plants was so poor that no attempt was made to gather spinach data. The data for collards are summarized in Table 1 and that for the chard in Table 2.

The chard displayed the same perverse tendency as the beets in last year's experiments; total weight of edible greens was slightly higher for plants watered with tap water than for those receiving pond water. This may be attributed to the fact that, for unknown reasons, one of the tap water hills produced plants which averaged 2.3 times the weight of the next largest plant on each harvest date. If the data from this hill are eliminated, the overall mean weight of chard plants receiving pond water was higher than that of those receiving tap water, 30.9 grams and 25.0 grams, respectively. However, examination of the data gave no reason to believe that, with or without this hill, the differences were significant. Thus no statistical analysis was performed.

The collard data more nearly resemble last year's lettuce data. However, the non-parametric rank sum test used in analyzing the lettuce data (Kendall Coefficient of Concordance) (Siegel, 1956) indicated significance for the collards only at the 25% level. We suspect that, had sample size been larger or harvesting techniques conformed more nearly to conventional practice, the significance would have been greater. We are inclined to recommend fertile fish

pond water for use on collards, but not on chard.

If this were an agricultural experiment station, we might elect to pursue this matter in another season. But we prefer to pass the question, and our partial answers, on to our readers. As of 1974, we conclude that irrigation with fertile fish pond water is of no particular value in growing most root and fruit crops, but that it definitely enhances the growth of leaf lettuce and will probably prove beneficial to many other leaf crops, with the likely exceptions of beets and chard. While we do not plan to carry out further scientific research on this subject, we are sufficiently convinced of its efficacy to continue to make use of pond water in the New Alchemy gardens.

We invite feedback from our readers on this matter, particularly from those in arid areas, as we think the fact that pond water is slower to evaporate may well have beneficial application there.

— William O. McLarney

REFERENCES CITED:

- McLarney, W. O. 1974. New Alchemy Agricultural Research Report No. 2. Irrigation of Garden Vegetables with Fertile Fish Pond Water. *THE JOURNAL OF THE NEW AL-CHEMISTS* (2): 73-76.
- Siegel, S. 1956. Non-parametric Statistics for the Behavioral Sciences. McGraw-Hill, New York

Table 1.

MEAN EDIBLE WEIGHT OF COLLARDS WATERED WITH FISH POND WATER AND WITH TAP WATER			
Type of Water	Harvest Date	No. of Plants	Mean Weight (grams)
Pond	9/10	9	79.5
Tap	9/10	10	73.9
Pond	9/11	9	72.2
Tap	9/11	10	45.2
Pond	9/12	9	34.0
Tap	9/12	9	31.6
Pond	9/13	7	38.7
Tap	9/13	7	19.8
Pond	TOTAL	34	57.1
Tap	TOTAL	36	44.3

Table 2.

MEAN EDIBLE WEIGHT OF CHARD WATERED WITH FISH POND WATER AND WITH TAP WATER			
Type of Water	Harvest Date	No. of Plants	Mean Weight (grams)
Pond	10/1	10	44.7
Tap	10/1	10	50.3
Pond	10/2	10	40.1
Tap	10/2	10	37.2
Pond	10/4	10	27.7
Tap	10/4	10	41.3
Pond	10/5	9	9.0
Tap	10/5	10	15.0
Pond	TOTAL	39	30.9
Tap	TOTAL	40	35.9

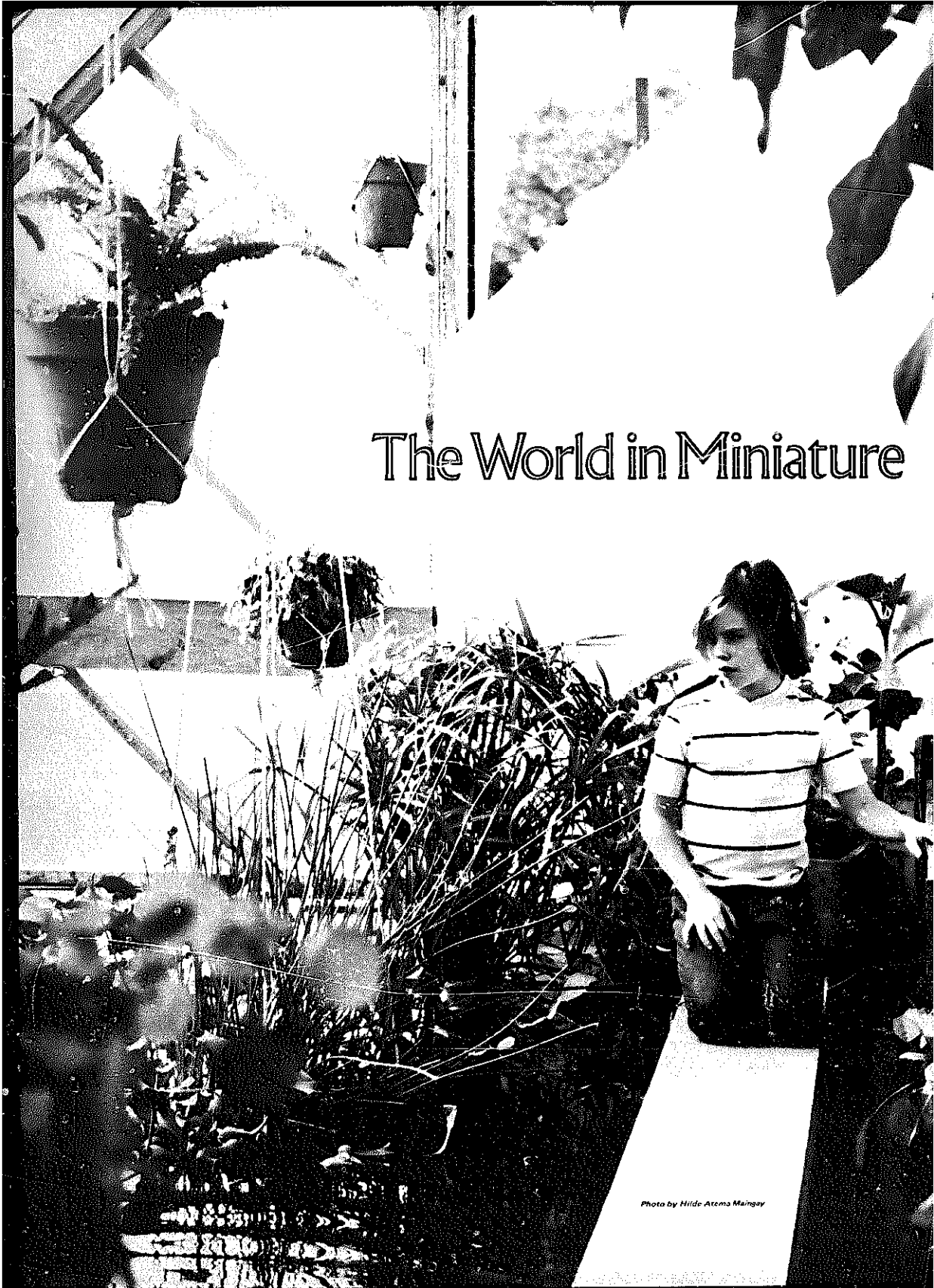

The World in Miniature

Photo by Hilde Atema Malingay



Winter days and nights have a way of revealing the nature of things. In the valley below my window there is a small pond, frozen to the bottom. The woods are stilled with a blanket of snow. The bark predominates on the bare trees extending upwards in jagged pathways to diffuse without canopy into the sky. The leaves, so recently transformers of life from the sun, now carpet the ground awaiting decomposition and the liberation cycles of spring. Winter holds life suspended in abeyance. Looking outward I feel the structure and composition of this place, how its particular beauty is dependent upon this period of quietude. The essence of the northern woods would be lost without the seasons and the pulses, including the silent ones. The earth's mantle is shaped by and inextricably intertwined with the forces of the weather and the seasons. It is an ancient and sacred relationship. Only within historical times have men tampered with it, tearing at the threads for short-term gain rather than protecting and extending the environments of which they are a part.

A powerful dichotomy threatens people and place alike. Human societies unlike most plants, almost all insects and many mammals do not oscillate in harmony with the seasons. Because our needs are greatest then we come up hard against nature when she is silent and has least to give. When the cold winds blow our needs for shelter and clothing increase, and if we work outdoors our food needs are greater. In the north, humanity makes its heaviest demands in winter. This fact has influenced our use of land and the nature of our societies. It may be no accident that agricultural and industrial capitalism reached its climax in the temperate regions of the world. An expansion of the deep-rooted need to accumulate and store against the de-

mands of winter may have been a factor in its subsequent extension outward eventually encompassing the globe.

Our lives are enmeshed in this process. Below my window, goats are feeding upon alfalfa hay cut and dried last summer in a meadow in upper New York state. To keep them warm and to sustain their milk production, I feed them a daily ration of a mixture of grains and molasses. These grains were grown months, even years ago, in areas across the continent. The corn is from the midwest, and the wheat from the far west. The molasses originated in the cane fields of the Indies or the tropical Americas. Only the oats could be considered a crop suited to the cool coastal regions of the northeast. To carry over the winter, I am dependent on extensive high-energy transportation systems as well.

The goats are, for me, a reminder that my meat, eggs, cheese and milk are plant energies temporarily stored in animals, which unlike the plants can withstand the vicissitudes of winter. If I were to shift to a more vegetarian diet as a resident of a region unfavorable to grain production, it might prove necessary to search even further afield in order to locate food. My rice would have to be transported from the southern U. S. or Central America. Most of the nuts would originate in tropical or Mediterranean climates and the fresh vegetables and fruits of winter from south Florida and Mexico.

I cannot escape a mood of reflection brought on by the coldness of the day. I am drawn to attempt to comprehend sustaining networks as if the woods, bared of leaves, has become a map with its structure etched in tree shapes, in flow patterns on the ground and in the formations of ice upon the banks. Linkages

now unmasked stand out in relief against the brightness of reflected light. Nature's time moves more slowly and in this simple state, reveals its strengths and frailties.

At this moment millions of people are suffering from want of food. A great many more will yet join their ranks. Modern agriculture, a petroleum-based industry, is at odds with a hungry world, and the grains which fatten the hordes of cattle could be used better to feed hungry humans directly. Feedlots for cattle or miles of batteries for egg-laying hens are the endpoint of an agriculture long estranged from nature by its industrial course. It was brought about by the development of massive amounts of fuels and machinery at a time when it was believed that the flow of oil would continue indefinitely. But this story is not a simple one. There is a tendency to blame cattle raising for our plight. Yet, in the ecology of things, it is plants and animals together which produce the essential gases, such as oxygen and carbon dioxide. It is the mutual interdependency of plants, bacteria and animals which create soils. Plants feed animals and animals in turn nurture the soils. The plants with their wastes, as well as the bacteria and other micro-organisms govern many of the relationships between the soil and animals. The husbandry of animals for food and clothing need not threaten the health of the planet if carried out wisely. There is a place for cattle in husbandry, but it is not the dominant one they occupy presently in this culture. There are many inhabited parts of the world which produce grains poorly, if at all, yet can sustain cattle. Certain breeds are hardy enough to thrive on fog-shrouded pastures on the edge of the northern seas, while others can withstand great heat foraging upon plants that no human could digest. To husband cattle will involve learning where they belong and in what numbers. Ecosystems rather than economies should determine their numbers and their place. In temperate areas cattle, like humans, overwinter on stored foods. Should feeds be in short supply, the food and energy demands of cattle can be minimized by slaughtering all but the breeding stock.

Even as complexities of plant-animal-human relationships are difficult to grasp, the task of feeding humanity becomes increasingly challenging because ultimately it must be done within a biological and socially restorative context. There will be no panaceas, no single solutions. It will have to be based on a system of knowledge that re-establishes a kinship with all life and on a way of seeing the interdependent nature of all life. A true alternative to present agriculture will require us to emulate the workings of the biosphere and to seek from it combinations of elements which lend themselves to caring for human societies while neither depleting or destroying the planet's living mantle. Our best guide will not be the past, although there have been

cultures that have much to teach us. History frequently shows a record of despoilation, loss of topsoil, destruction of forests and expansion of deserts from overgrazing and exploitation. Powerful civilizations invariably waned when their fundamental ecologies were harmed or irreversibly simplified.

It is true that a few generations ago our ancestors did well enough without the fossil-fueled food networks of today. They were, however, far fewer in number and the majority worked on the land. Initially their agriculture was decentralized and bountiful, but it lasted only as long as there were forests to clear and woodlots to cut for fuel and shelter. Before the soils were exhausted, their fields produced a diversity of grains, fruit and vegetables, many varieties of which were grown because they stored well over long winters. Animals flourished in newly-planted pastures and substance was won from hard work. With few exceptions these farmers were, in no sense, stewards of the earth. Their knowledge rarely included a comprehension of the biological basis of their wealth. In a moment of history, they consumed the legacy of the ages in the stored fertility of forests and soils. The full impact of these destructive practices was never deeply felt in America despite the decimation of cotton land in the south and the dust bowls of the plains in the thirties, for, at the last minute, in the best U. S. Cavalry tradition, agriculture was saved. Fossil fuels in the form of fertilizers, biocides and electric power, as well as fuel for the construction and operation of machinery galloped in rescuing spent soils and debilitated rural landscapes. There was, for a while, a stay of execution. But now we are entering a new phase in which some of the wrongs of the past will return to haunt the present and determine the future.

It might be argued that the virgin forests and soils were the price for creating a powerful, global society. Yet in our time the pillage has expanded to encompass and to affect the whole world in the attempt to replace resources exhausted at home. If this dynamic is viewed as a prerequisite for a powerful society and that the consumption of the planetary resource legacy was necessary to build a great civilization, such an assumption denies the validity of the diversity of native American civilizations. Many of these peoples had a rich culture yet maintained a highly evolved appreciation of ecology and humanity's adaptive relationships with nature. For millennia they trod upon the surface of this continent as gently as any peoples in history. For many of them, their lives and numbers were tuned to the living world which sustained them. We are just beginning to realize the depth and substance of these civilizations. They defied many of the forces that orchestrate the workings of the planet and their religious worldview brought together elements of ecosystems themselves. For them the earth was alive, a sacred entity through which the human passage was unique in the scheme of things.

The immense difference between the cultures of the Indian rooted in nature and our own has been well documented. Our method of food transportation and storage in winter is but one illustration. The basis of our foods is fuels which are rapidly being consumed. A future in which the foundation of our nourishment is a hydrocarbon pedestal is terrifying. Dependence on fossil fuels permeates and dominates our culture. As I write, my physical comfort is derived from the warmth of a gas-fired furnace, and in this I am no different than more than half of the householders in America. Yet the natural gas upon which much of our foods and our heating and manufacture depends is disappearing at a rate close to eight per cent annually. Within a few years, according to petroleum industry forecasts, it will be severely curtailed.

Last night under the light of a newly-rising sliver of moon, I picked my way along the edge of a frozen pond. The little valley was almost completely topographic, each element standing out in stark relief. Some of the boulders, higher than my head, stood out as dramatic wind, rain and ice sculptured shapes, providing the framework for the hillocks along which I walked carefully. Those boulders, pushed down long ago by ice fronts from the north, linked me with latitude and place, and the influence they hold over the affairs of all living things. The pond I had left had its origins, thousands of years ago, in a block of

Photo by Fritz Gara

ice buried in an outwash plain. After the retreat of the glacier it melted and the ice block pattern shaped the water's home. Thoreau's Walden Pond has a similar legacy from the southern advance of northern ice and this thought comforts me.

As human settlements extend northward there is a greater need to counter the limits of climate. In earlier times, the forests and their inhabitants provided sustenance and shelter, but with larger populations and declining resources the need to import foods and energy grew as did the need for storage capacity. With increasing latitude there is a concurrent rise in the demands for technology and energy to maintain a given standard of living. A northerner's future is more closely tied to global dis-economics than a southerner, for example, or a resident of a tropical region with sufficient rainfall. Whereas the latter two have at their disposal extended seasons and close to year-round growing seasons, New Englanders require much more energy, transport and storage capabilities to maintain a comparable level of well being. Canadians living in the yet more rigorous maritimes have again greater requirements or must suffer a lower standard of living. I began to appreciate the latitudinal and climatic influences upon societies from working with appropriate technologies in regions as diverse as the tropics and Prince Edward Island in Canada. A windmill that works elegantly and serves a critical function in the welfare of the people

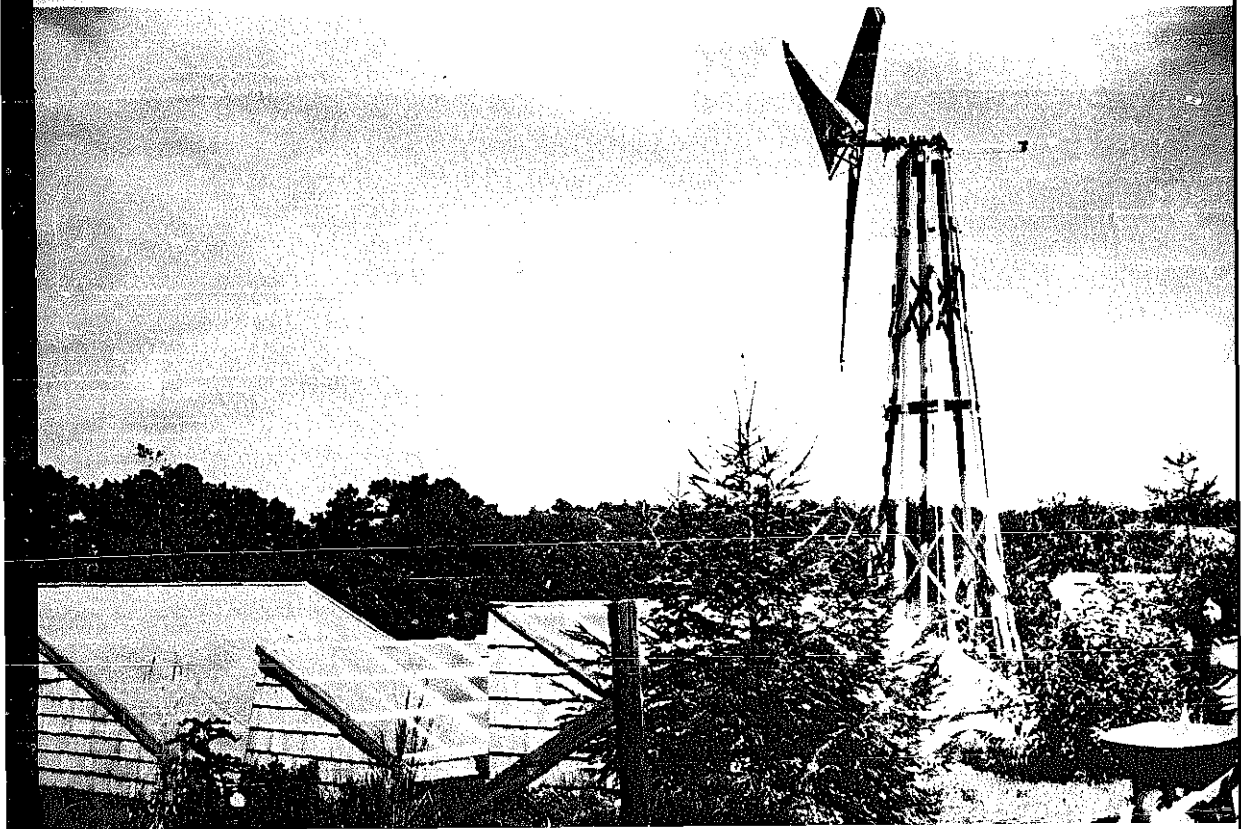

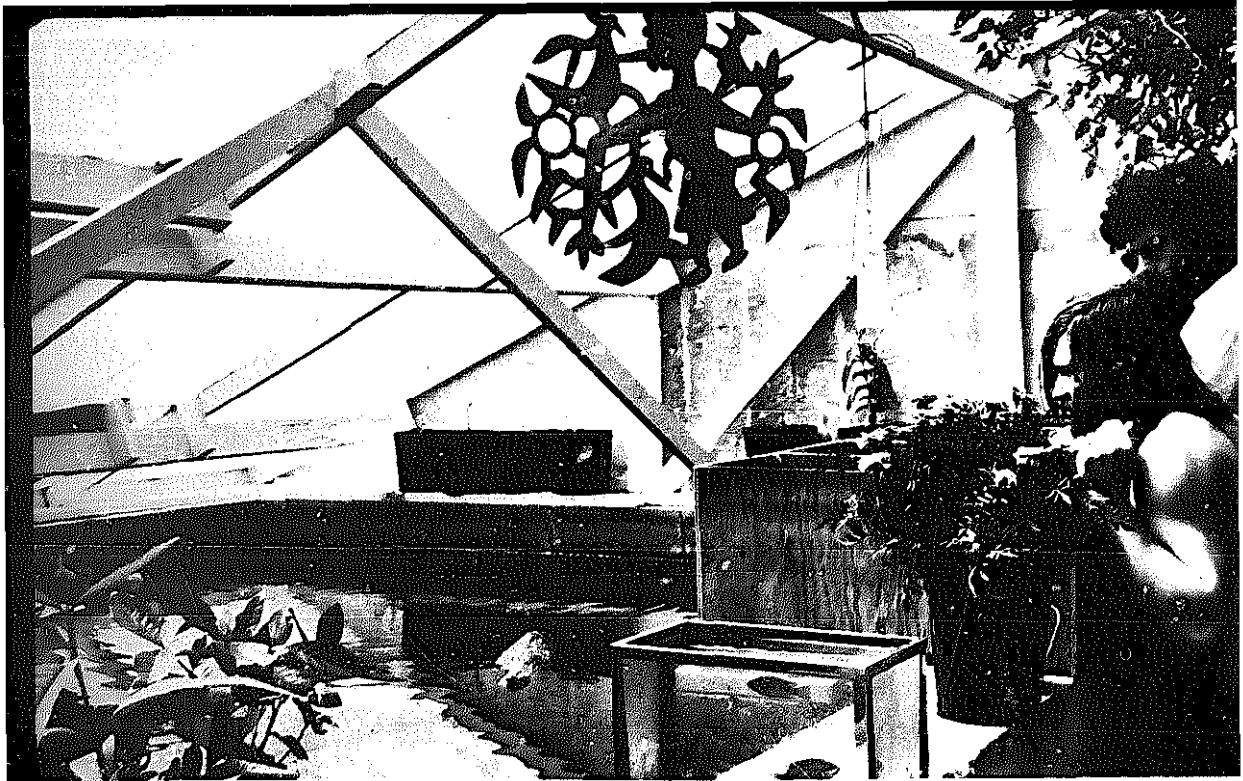

Photo by Fritz Gurr

of southern India will not survive the winds and ice of the Atlantic coast, nor will it provide the levels of power critical to northern coastal residents. The ruggedness and sophistication of northern windmills must far exceed those of more temperate areas to affect the same amount of beneficial change. Windmills are just one example of the continuum tied to climate. Though we are employing a common philosophic outlook and comparable stratagems in the design of food culture systems and shelter at different places, we are beginning to appreciate the diversity of societal end points shaped by place, climate and resources. As climate and physical resources have shaped the biosphere, so should they determine future civilizations more strongly than in the past. The rise of industrial and global societies has resulted in a discontinuity and a cleavage from nature. To find our way back is the fundamental task for the remainder of the century. Such basic necessities as foods and fuels are now sustained by waning forces over which few of us have any control. Yet I believe that there are a number of paths leading to a restoration of much that is good available to all who desire to follow them.

Last night temperatures on the Cape dropped to seven degrees, as the bright, clear skies drew up what warmth remained in the ground. At New Alchemy, we have built a structure which, when you enter, seems set apart in place and time. On a winter day, it is

warm within, with the sun's heat and filled with the sight and smells of earth, moisture and plants from temperate and tropical lands. The air within is seventy-six degrees Fahrenheit, the pond water some twenty-five degrees cooler. These temperatures are gratifying particularly because the windmill and solar heating panels which heat and power the system are temporarily shut down for repairs. Ringing the pond are food crops and flowers in full bloom. Some of the seeds originated in the deep tropics and one of the tropical fruits is bearing despite the fact that it is our coldest day outside. Several fish break the surface of the water, herbivorous white amur from China and mirror carp from Israel. This structure is our first terrestrial capsule, to be powered solely by the wind and the sun and is a miniature, enclosed ecosystem for the year-round growing of foods. It is the first generation of our arks, named because of their self-sufficient nature and because of the diversity of living things within. It may represent the beginning of a viable alternative which could help pilot us towards a fossil fuel free method of producing food in northern lands, and to do so throughout the winter. Counterparts, utilizing less technology but as many or more organisms could be adapted to arid or warmer areas.

The first ark, for all the flaws and the crudeness of early design, has altered my thinking on the future of agriculture and human communities. What once

seemed difficult or impossible, no longer seems so. Through emulating nature it should be possible to create highly productive food-producing ecosystems, independent of fossil fuels or nuclear power, which will use the wind and the sun on a year round basis to sustain and regulate the climates within. Once established terrestrial capsules such as these could produce foods at little cost apart from the time and labour involved in tending and harvesting.

If it were possible, and I believe that it is, to design and create semi-contained ecosystems, such as our ark, that trap and store the sun's heat and sustain biological food webs with food for humans as end products, and to do so without continuing recourse to waning or dangerous energy sources, and if the skeletons or frameworks of these ecosystems were made of long-lived materials, then they might prove potent enough bio-social tools to initiate fundamental changes in the societies which adopt them. The theoretical ideal of an agriculture that incorporates self-regulating, semi-autonomous ecosystems is appealing in both ecological and social terms. I think not to explore the possibility of an agriculture based to a large degree on terrestrial capsules would be to overlook a major potential biological contribution to the reconstruction of the planet within an ecological framework.

Some efforts in this direction have been made by those working on life-support systems in space. These

have neither been powered by renewable energy sources nor primarily concerned with food production, but the principles developed may prove apt for such purposes. Further aspects of an appropriate strategy have been developed by the Chinese with their polyculture ponds. The New Alchemists are combining in many respects "space-ship", ecological and Chinese approaches in their terrestrial capsules.

If modern industrial agriculture were replaced with a diversity of alternatives that included small, biologically-gardened or farmed regions during the normal growing season and terrestrial capsules such as arks for year-round production of foods, then a good deal beyond agriculture would be affected.

Such a transformation would benefit society in many ways. The replacement of fossil fuel agriculture might alleviate some of the impact of the seemingly inevitable economic crash or famine. It would encourage agriculture to be less corporate, and to re-establish it as a local and regional pursuit, involving, as it eventually must, a much larger proportion of society. The massive food transport and storage systems which are dominated by powerful corporations and reflect non-productive energy drains would be minimized. Such a decentralization of agriculture would shift food production back to the basic units of society, permitting it to become an urban as well as a rural pursuit. This decentralization might in turn lead to a repopulation of the countryside and per-

Photo by Fritz Goro



haps even to the re-birth of a diversity of cultures and customs which are bioregional in their content.

With a year-round supply of fruits, vegetables, poultry, fish and crustacea produced in self-renewing food ecosystems, the need for grain acreage would drop. Grains are used predominantly as animal feeds, because they produce rapid growth in cattle and hogs. They also predominate in many human diets, simply because, of all the plants, they are the easiest to store and to use in breads and gruels. Yet grains are shallow-rooted, heavy feeders and are much harder on soils and soil fertility than beans, peas and other legumes, many of which are deep-rooted and capable of bringing up nutrients from sub-soils. Unlike grains, legumes in association with root nodules fix atmospheric nitrogen, thereby improving soil fertility. With increased decentralization grain production could again become a local concern, dependent on varieties indigenous or highly adapted to various regions. Where sensitive land stewardship is practised, grains would be grown in rotation with soil building crops. Rice, my favorite, would be grown on a small scale. It could be started in terrestrial capsules and matured in shallow ponds adjacent to them in association with nitrogen-fixing blue green algae. We grew rice to maturity in the miniature ark last year despite a late start.

A new biological agriculture would bring with it many advantages, not the least being a much reduced need for hardware, such as the big machinery and the giant tractors used today. The massive storage barns of a few generations ago would be replaced by terrestrial capsules with transparent covers enclosing food gardens and aquaculture ponds. Apart from these structures, hardware would be used less. Much of the work should be done by hand and processing such as threshing of grains and legumes could be accomplished with the aid of compact engines powered from wind or solar sources.

Villages and towns as well as the whole countryside would be dramatically altered under a restructured agriculture. If productive encapsulated ecosystems were adopted widely as an adjunct to farming, people working the land might tend to cluster in settlements that would incorporate many facets of community, including micro-manufacture. Villages, buildings and shops for manufacturing would be designed around and would utilize regional materials. They would be powered by its primary resources — generally wind or sun. This ideal, which is not too far-fetched, could be achieved through the reintegration of existing knowledge into an earth-and-people-kindly integrated whole. These communities would be different and more complete than their counterparts in this present industrial period. I want to pursue further the theme of planetary reconstruction but before doing so we should look at the nature of nature itself. Modern civilizations are in conflict with the non-human living world and within

this schism originate the crises of our times.

Throughout my life I have known places which were, for me, sacred. More than once I have suffered their destruction for the profit of someone who was bent on improving property for private ends. There is such a place nearby now which Nancy and I visit when we can. It has FOR SALE signs. Since it is beyond my financial means to stop the destruction, I shall witness the tragedy again.

As a small boy I spent long hours beside a watering hole in a diverse, climax forest. Some of the life forms within it had extended their range northward by hundreds of miles to thrive in a sheltered pocket in the lee of an escarpment overlooking Lake Ontario. On summer evenings I used to lie waiting for deer and other animals to come to the hidden pool. On that spot now are the offices of a manufacturing concern. A huge expressway rather than deer tracks leads to my watering hole.

I guess I have pulled through by saying, "It must not always be this way." I longed for a society that had simplified its needs so that much of the land could be taken out of private ownership and returned to nature. Throughout the countryside would be a labyrinth of inter-connected wild places, encompassing a full range of ecosystems. They would wind along the ancient topographies, the ridges and river valleys, and through the mountain passes. Later, I was taught that such visions were unrealistic, the realm of fantasy and poetry, and not the sort of dream for a practical world proud of its ability to control the forces that shaped and created the biosphere.

I have subsequently become a student of the earth, as an organismic entity, of its respiration and cycles, its connections and health. I began to realize that our fate is linked to the natural history of the planet and to wonder if the evolved natural landscapes known by humanity in its hunting and gathering epoch are essential for the long-term survival of humanity. I am not yet certain that this conclusion is true, but I am beginning to read signs that may bear it out.

One of the men wisest with regard to the workings of the world is G. Evelyn Hutchinson, an internationally respected limnologist or student of lakes. He perceives the planet as a functioning organism. In "Biochemistry of the Terrestrial Atmosphere" he explores some of the relationships between the living matter of the earth and the atmosphere above it, including the gases and environmental elements necessary for healthy human life. One of the most interesting substances produced by organisms including plants is the gas, carbon dioxide, a substance essential to plants for the transference of light energy into organic matter. The carbon cycle, of which carbon dioxide is a component in nature, consists of the photosynthetic reduction of carbon dioxide by green plants and a certain number of bacteria. During ordinary

photosynthesis by green plants, the hydrogen donor is water, H₂O, and the by-product is the oxygen produced from the water. Breathable air for animals and man is made available through this process.

In recent years there has been concern that the burning of fossil fuels by industrial societies would lead to an increase in atmospheric CO₂, possibly upsetting global ecologies. Initially it was assumed that the oceans would absorb the changes as carbon dioxide passed across their surfaces, because the oceans were thought to act as regulators of this element of human activities. The oceanic regulatory role is now considered to be relatively insignificant as the oceans seem to generate and use their own carbon dioxide. The bulk of the CO₂ they receive from the terrestrial component of the planet is the result of erosion, via drainages and river waters.

The increase of carbon dioxide in the atmosphere as a result of industrial production has been estimated at close to ten per cent since the turn of the century. Professor Hutchinson suspects that a goodly share of this shift has not been the result of industrial practices as much as the intensified deforestation and the changing ratio on a global basis in favor of agricultural over forest land. A shift from forests to open field culture lowers photosynthetic efficiencies although, in some instances, the amount of photosynthesis is increased for a brief period following deforestation. More important than the reduction of photosynthetic efficiency of the vegetative cover is the fact that under modern agricultural regimes soils lose their respiratory carbon dioxide to the atmosphere at a much greater rate than the forests which are more efficient and complete biologically. He suspects that this increased rate of loss of carbon dioxide from the soil has contributed significantly to the increased carbon dioxide within the atmosphere.

But the process of degrading environments does not stop with an initial loss of respiratory CO₂. The exchange of a forest for a crop, for example, is a complex one and the end result is by no means clear. Forests are capable through photosynthesis of fixing approximately twice as much carbon dioxide as a cultivated system, so initially the widespread destruction of forest vegetation would raise carbon dioxide content because of the diffusion of respiratory carbon dioxide, which is then taken up into the atmosphere. This is what is happening today. However, if the process continues and the landscapes are further degraded, then carbon dioxide levels eventually will fall as exhausted soils decrease their rates of respiration. The forests are much more stable in respiratory terms than bared fields with declining fertility and occasional crops. The health of the atmosphere may rely upon the self-regulating role of forests.

The myriad forces with which we tinker so heedlessly are by no means predictable, but the elimination

of forests and the subsequent damage to soils through exposure is leading to changes in the overall photosynthesis and respiration patterns of the earth and is affecting the liberation of oxygen and the fixation of carbon dioxide by plants for their growth and reproduction. Not only are photosynthetic efficiencies of plants being reduced by large scale land degradation for crops, the resulting shifts in levels of carbon dioxide could influence the heat balance of the atmosphere. This, in turn, might cause relatively rapid and deleterious climatic changes. We must begin to see that the earth's biosphere is vulnerable, and much of agriculture represents no less than cancer on its skin. Restructuring agriculture is fundamental to the future.

The ecologists Howard Odum and Ariel Lugo came to a similar conclusion after studying terrestrial microcosms. They worked with the components of the floor of a tropical forest in Puerto Rico before and after exposure to gamma radiation from a radioactive cesium source. The "before" exposure experiments yielded interesting information relevant to the present discussion. Their studies of microcosms or elements of the forest including plants and soils encapsulated in glass chambers suggested to them that large ranges or variation of steady-state carbon dioxide over the earth were possible because of changes in the biota of the planet through evolutionary time. This led them to the idea that ice ages may be the result of changing ecological systems. In their experimental chambers it was found that ratios of litter to consumer organisms and plants varied as did associated carbon dioxide levels. The differing ratios resulted in different gaseous equilibrium points shortly after closure of the systems. In short, they created differing atmospheres within their glass chambers.

They concluded: "This may be an important demonstration of the control of the atmosphere of the planet by the biotic components existing in the system. The physical properties of the atmosphere of the earth are a result of biological evolution as much as vice versa. Since very large changes in the CO₂ level at balance may occur and since carbon dioxide is implicated in the thermal-radiation balance on the earth in relation to ice cap maintenance, it is not unreasonable to suspect that ice ages may be caused by the relative evolution of plants and animals and their excesses or deficits in organic matter production."

It seems the insights of Professor Hutchinson some seventeen years earlier are beginning to receive further experimental verification.

A more recent and intriguing dimension may be added to this story. Three scientists, James Lovelock, Sidney Epton, both English, and the American biologist, Lynn Margulis, are studying the ancient concept of the earth as a single living organism. The Greeks had a name which suits the concept, Gaia, meaning earth goddess. It is at the root of Hopi

mythology. The belief in Gaia has been a deep-felt part of many traditional cultures. It resurfaced in the Renaissance with the translation of the *Corpus Hermeticum* as well as in other writings. Marsilio Ficino, Giovanni Pico della Mirandola and Giordano Bruno, who was burned at the stake during the Inquisition, spoke of the planet as an entity having an awareness of itself and its place in the cosmos. In more recent times Goethe, the poet-biologist, and Rudolph Steiner and his disciples have made attempts to reveal and study the earth as a living entity. I suspect there are many inheritors of this tradition, but in the main they have yet to recognize each other, for their means of expressing their beliefs are so different.

What makes the work of Lovelock, Epton and Margulis unique and extremely relevant is that they are attempting to verify the idea of Gaia — the earth as a living creature. Out of their work we are beginning to have some inkling of the threat posed to the earth by agriculture. Like Hutchinson and Odum they are looking to gaseous exchanges for clues.

Lovelock and Epton have stated: "As already pointed out, in early times, when the Sun was cooler than it is now, ammonia served to keep the earth warm. At the present time the need for ammonia is different and just as important, because we believe that ammonia keeps the soil near to pH 8 which is an optimal value for living processes. It is needed because a consequence of having nitrogen and sulphur-containing substances in the air in the presence of a vast excess of oxygen is their tendency to produce strongly acid materials — thunderstorms produce tons of nitric acid and if there were no regulator such as ammonia the soil would become sour and hostile to most organisms."

The climate too is elemental and sensitive feedback from the earth may prove critical. Lovelock and Epton have this to say:

"For more than 3,500 million years in the face of a big increase of solar output, the mean temperature of the Earth's surface must have remained within the range of 15-30°C. How did Gaia do this? She must have used several ways to keep temperature so constant. Before there was a significant amount of oxygen in the air, the emission and absorption of ammonia by simple organisms may have been the control process, so making use of its heat absorbing and retaining properties. Variations of the concentration of ammonia in the air would therefore be a means of temperature control."

Thermal control of the earth's surface shifted when photosynthesizing organisms evolved and, in concert with respiring organisms, began to dominate. At this time oxygen became a major constituent of the air and temperatures were stabilized through the control of carbon dioxide which, like ammonia, is a heat absorbing and retaining gas. In order to comprehend the earth's

present climate, Lovelock and his associates approach it from the perspective of systems specialists, yet view it as a single entity struggling to optimize and protect itself from deleterious changes.

"If one showed a control engineer the graph of the Earth's mean temperature against time over the past million years, he would no doubt remark that it represented the behavior of a system in which serious instabilities could develop but which had never gone out of control. One of the laws of systems control is that if a system is to maintain stability it must possess adequate variety of responses, that is, have at least as many ways of countering outside disturbances to act on it. What is to be feared is that man-the-farmer and man-the-engineer are reducing the total variety open to Gaia."

This scientific team is presently experimenting with another gas that may, like CO₂, act as a biological climate regulator. This is nitrous oxide which is produced naturally by microorganisms at the rate of hundreds of millions of tons annually. Rates of production are beginning to vary because of changing land use, and, perhaps equally important, through the massive use of nitrogenous fertilizers, themselves petroleum derivatives, which characterize industrial agriculture and the green revolution.

Again Lovelock and Epton:

"We do not know how nitrous oxide could modify the climate, but the evidence suggests that it has been increasing in concentration and it is known to penetrate the stratosphere where its decomposition products could affect the ozone layer."

To the question of Gaia's self-regulation and health, I should like to add one more dimension, one I have pondered for some time. No doubt there are others immersed in the same theory. In my own case, I have had neither the instruments nor the desire to mount a large-scale research project to explore its validity. It is my belief that the planet's climate, to a high degree, is determined biologically and that differing vegetative types may have an influential role in stabilizing the earth's living mantle.

In my front yard I have placed three five-gallon glass jars one of which is filled with a dense brew of a dark-colored green algae which I cultured from household wastes. Next to it is a bottle of algae of different species composition. Its populations are less dense and the overall color effect is somewhat lighter than the first bottle. The last is filled with ordinary tap water and is clear. They react to the sun quite differently. For example, I note from my diary that, on March eighteenth, a clear, cold day with the temperatures hovering just under forty degrees Fahrenheit at noon, the water temperature of the clear bottle was fifty-three degrees Fahrenheit. The one with the less dense algal population was fifty-eight degrees Fahrenheit and the dark algae was sixty-four

degrees Fahrenheit. In the brief span of the morning, each gallon of the dense algal bottle had picked up approximately ninety BTU's more heat than the clear jar. This is by no means the most dramatic example that I recorded.

Might these jars be a micro-model or an analog of how vegetation regulates climate; might the dense jar be equivalent to a forest, the intermediate jar to regularly cropped fields and finally, might the clear jar, like the deserts, act more as a reflector than an absorber? Admittedly the above analogs do not account for changes through evaporation or transpiration. But, I think there is reason to pursue the idea further. Agriculture, as it replaces forests on a global scale, could well be shifting weather patterns in ways that are subtle and as yet not understood.

The surface of the earth varies according to its vegetative types. Associated with this is a varying ability of different bio-regions to absorb or reflect heat and light. If one were able to float or hang-glide over the earth, drifting from place to place, the reaction of one's eyes alone would provide clues of genuine relevance. They would, for example, squint to shut out the intensity of a desert's reflected light. The pupils would widen as one passed from monocrop fields to deep, dark forests with several stories of dense vegetation. Not only would reflectivity change from one vegetative type to another, the capacity to absorb and store heat from the sun would vary from place to place, as would the micro-climates and the air currents generated by the vegetation in concert with the regional topography and the sun. Vegetation may also help to draw down rain, whereas highly reflective desert surfaces have an opposite effect, tending to reinforce and extend their drying tendency.

The ecology of the planet has been affected since the beginnings of agriculture over ten thousand years ago. Deserts and arid zones have expanded into areas that were once forested and had readily available water. Much of this change has been brought about by human interference as we felled trees and planted crops. As populations grew soils were exposed under more intense usage. A field with a crop on it is very different from a forest metabolically as well as structurally; just how different it is in the earth's terms we as yet dimly realize. The albedo, or ratio of the biosphere's light reflected to that received, has shifted away from Gaia's sensitive ecologies into the crude hands of humans. We have fallen heir to a powerful obligation, to protect not only ourselves, but every living thing.

The spectre of changing climates and shifting gaseous relationships in the terrestrial atmosphere is cause enough for alarm, and on this basis alone we should re-evaluate the impact of human societies upon the earth's abilities to care for itself. There is yet another dimension to the question of biological

stability on a global scale. As a result of the processes of agriculture and urbanization, there is a trend towards a higher degree of environmental homogeneity. The reduction of the earth's living mantle has proceeded further than is generally acknowledged. The overall health of many major ecosystems, not to mention the long-term survival of humanity, may well be threatened by the reduction of wild or relatively undisturbed lands. At the present the diminution of biotic diversity is being intensified by pressure from rising human populations whose priorities are in conflict with those that characterize healthy and stable ecosystems. The trend towards global biological homogeneity must be reversed, with some of the land presently being farmed or intensely forested being allowed to revert back to nature. Contrary as it might seem to current patterns, one of the highest priorities on the agenda for the future is the creation of interconnected wild lands which span continents and encompass all the biomes or distinct ecological regions.

Replacing much of what is currently farm and urban area with zones of undisturbed natural vegetation will serve many ends. Not only will biological diversity be restored, and climates and soils become more stabilized, these wild lands will act as reservoirs for presently threatened plants and animals. This last point may seem insufficient rationale for suggesting the removal of farm lands from agricultural production, but in the long run humanity may be better served, especially since substitute methods of food culture can be developed to compensate for the loss. Returning the task of restoring the planet biologically to nature could well prove vital for reasons which biologists are just beginning to discover. Our greatest natural allies may be organisms for which we have little appreciation or understanding at the present. Little studied organisms may be found to play key roles in the biosphere as biological regulators and as tuners of complex ecosystems. There may be, in nature, orchestrators upon which the regulation of the whole depends. Some of them may be relatively rare though their tasks are critical, comparable to the role of switchmen on the early railways who knew when and how to throw switches in order to prevent collisions and disasters.

In a related vein, the ecologist, Ramon Margaleff, has argued that lost genotypes are irretrievable treasures. He suggests moreover that mature ecosystems, many of which are dwindling rapidly in number and complexity, are factors in bio-environmental stability and that destabilizing effects, if continued, could begin to affect the planet as a whole. It could be possible that destabilization is reaching a critical point. This makes the work of Margulis and Lovelock so timely, for what they are trying to do is devise a planetary early warning system that we

should learn to heed.

The heavy-handedness of human exploitation of environments has been amplified with the introduction of industrial techniques and the amount of damage is increasing. When complex ecosystems, whether forests or coral reefs, are exploited, a total collapse of rich biological organization can result. The addition of potential sources of energy, such as chemical fertilizers, can lead to the breakdown of many natural self righting mechanisms. High energy industrial agriculture has already eliminated many such mechanisms on farm lands. When fossil fuels and their derivatives in the form of pesticides, herbicides and fungicides become scarce sometime in the fairly near future, the havoc will be much greater because of the destruction of these stabilizing elements. The creation of wild corridors would do much to buffer effects of pest, disease and weed outbreaks after initial dislocations have run their course.

Initially, I became interested in chronicling the course of exploited environments through observing plants and animals which I found curious or exciting. It is no accident that the species that suffer most at the hands of humans are often those that are the most beautiful, colorful or unique. We seem most inclined to threaten those organisms which stand out rather like icons in the course of evolution such as immense tropical trees, birds with striking colors and elaborate behavior patterns and delicate flowers highly tuned to weather, season and even the time of day. The butterflies and the mimics which deceive their predators have a special fascination and are collected in large numbers. Yet the meaning of their existence becomes discernible only when they are viewed in complete terms. There is a reason for plants and animals looking and behaving as they do. There are delicate and complex bonds which link creatures to their own kind, to other organisms and to the larger realm which they inhabit. As I have suggested, many of these creatures are performing a function for an ecosystem in much the same way that a heart or lung sustains a human, or that we as individuals perform functions as parts of the larger societies.

The discovery of the beauty of such systems has brought with it an awareness of their fragility. Within this fact may lie a powerful lesson. In my own investigations into the influences of pollutant stresses on the behavior and social organization of fishes, I found that there are fish species which are highly evolved socially, containing over one hundred elements of behavior in addition to communication signals and other characteristics of higher animals. Some, for example, exhibited individual recognition and even cooperative behavior. In a polluted world the very complexity of their social organization condemns them in many respects to life on a razor's edge. The survival of the highly evolved social species depends upon

somewhat stable and predictable environments. The ability to respond to normal oscillations and natural stresses is somehow contained within their genetic codes. However, they are not designed to deal with abnormalities and I found that insidious levels of sublethal chemical and thermal stresses could affect their social organization dramatically. In some cases their powers of individual recognition, upon which their social organization was based, was lost. Once this breakdown had occurred, formerly peaceful coinhabitants within a small community were observed to fight to death. While these studies were conducted in laboratories, they did indicate changes almost assuredly taking place in nature.

I also studied fish species which exhibited simple and intermediate levels of social organization. Ironically, at the opposite end of the social spectrum these fish with relatively simple behavior consisting of a small number of social interactions turned out to be much tougher physiologically. They were capable of withstanding artificially induced environmental stresses almost to the death point, whereas the socially complex animals were, in fact, being "killed" in behavioral and psychological terms long before they reached the pollution levels at which they died. They were not able to function normally and it is doubtful that they would be capable of reproduction. The species with the simplest behaviors continued to behave normally until the stress levels which caused death were approached. In evolutionary terms they had adopted a strategy of physiological toughness in lieu of sensitively tuned interdependent behavior.

The conclusions my co-investigators and I were beginning to draw from the research disturbed us deeply. We were starting to decode a possible correlation between the evolution of higher social behavior in aquatic animals and their vulnerability to civilization's pollutants. The most highly evolved creatures socially were, in the instances we studied, the most vulnerable. It struck us that what we were observing indicated the possibility of humanity's insensitivities reversing ecological processes on a global scale, leading away from stability and diversity to a kind of backwards evolution where the most social creatures were being selected against. These fishes and perhaps other animals having what we generally think of as higher behavior may be slowly, but nevertheless surely, snuffed out. I have no doubt that we were uncovering information that has a bearing on the relevance of protecting ecosystems in nature, especially since it may be the animals with intricate social organization that act as the biological regulators and tuners of the ecosystems they inhabit. To continue to ignore the biological lessons in phenomena such as these may prove in the long run a little bit like serving cyanide to the pilot of an aircraft while pouring champagne for the passengers. Fun for a while, but not exactly adaptive.

The messages from the living world are building to a desperate cacophony. For humanity to extend the human experiment and to survive its present travesties against the biosphere there will need to be a complete attitudinal change towards nature. Nature in all its states, and especially its diverse mature ones, will need to be seen as a living entity from which patterns can be drawn to create our future food culture systems.

The whole relationship of agriculture to society and the biosphere is rarely considered in the affairs of our time. Yet it has been instrumental in determining the present and its course will shape the future. Historically, agriculture has been biologically reductive and modern agriculture is unsound energetically. The American ecologist Howard Odum is convinced that our present society is based on cheap, widely available fuels. As these fuels, especially oil and gas, are withdrawn or become less available he fears it will be almost impossible to shift quickly to an alternative form of producing foods. Such a shift requires a long period of transition preceded by much research and testing of solar-based, ecologically sound food culture methods. One possibility he has proposed for the future is the creation of terrestrial capsules similar to New Alchemy's arks and backyard greenhouse-fish farms, and the planned larger bioshelters of designers Day Charoudi and Jean Wellesley Miller from M. I. T.'s solar laboratories. But many of these systems are still either on the drawing boards or in their infancy, and there is much to be learned before their effectiveness can be judged. Since the agricultural establishment has displayed little interest in supporting this type of work or in creating other adaptive agricultures based on solar or wind energies, there is little likelihood that the shift will be easy, graceful or in time to avoid widespread crises in food supply. There is some awareness of the problem. Many homesteaders who have returned to the land within the last decade have tried to reduce their fuel dependencies with little of the necessary resources or knowledge of alternatives. That a few are succeeding is, in most cases, a testimonial to their ingenuity and ability to work extraordinarily hard.

As the changes now taking place could overtake and overwhelm agriculture within a few decades, it might be worthwhile to look back and see how we came to this point of crisis. Agriculture's weakest cornerstones currently are its energetics and its petroleum power base, unlike one hundred years ago when it was scarcely subsidized by fossil fuels. Then farm machines were drawn by draft animals which were sustained by solar products in the form of plants. Transport was local and primarily horse powered. Some coal was used in the manufacture of farm machinery. When long distance transport of food did occur, it was done by sailing vessels and steam locomotives many of which were fired by wood. In short, food production despite marginal fossil fuel inputs was solar based. It was carried out on

recently cleared farm lands, the fertility of which had not yet been depleted through ignorance and bad husbandry. Nineteenth century farmers were able to produce about 1.28 kilocalories of harvest per square meter per day. A marked change has taken place in the twentieth century. Fossil fuels, especially oil and gas, have been coupled to the solar base of food production. The result has been the dramatic upswing in the amount of food produced. As a consequence of this infusion farmers and agriculturalists were beginning to believe that nature would place few limits on what they could do, but what was giving the illusion of limitlessness during the middle decades of the twentieth century was cheap fuel. Nature for its part was being stressed by the biocides and additives of an unnaturally productive agriculture. The infusion of external, non-renewable sources of energy into food production and agriculture resulted in its industrialization. Farm activities were mechanized and by the late 1960's, farm land management had become totally dependent upon chemical controls and the chemical manipulation of biological processes.

The basic shift in our food production techniques evolved in three distinct stages and was extraordinarily rapid. The first wave of change followed closely on the heels of the industrial revolution which made it possible. Newly developed harvesting machines began to replace agricultural laborers and small ox drawn implements. Towards the end of the nineteenth century, big threshing machines powered by steam engines were being used in Britain and North America. The shift from men to machine was not always peaceful, particularly in England, where there were occasional agricultural rebellions. Despite the fact that their work was hard, agricultural laborers did not want to be replaced. The shift to large machines and steam engines brought the first major infusion of non solar-based energies into rural communities. This change resulted in the migration of displaced agricultural laborers into mill and manufacturing towns.

The next major stage in the changing agricultural landscape proved more dramatic than the first. Following the 1914-1918 war and the introduction of assembly line production in industry, a new and much larger external energy source was injected into agriculture. Gas powered internal combustion engines were introduced onto the farms to take over most of the tasks which until then had been done by animals or farm workers. Tractors, combines, pumps, self propelled cultivators, harvesters and sprayers became commonplace. Not only did they require large amounts of energy in manufacturing; even larger amounts in the form of fuels were necessary to keep the engines of agriculture running. By the end of the period between the two world wars a mass exodus of people from the countryside was underway and the nature of the countryside and rural societies had been profound-

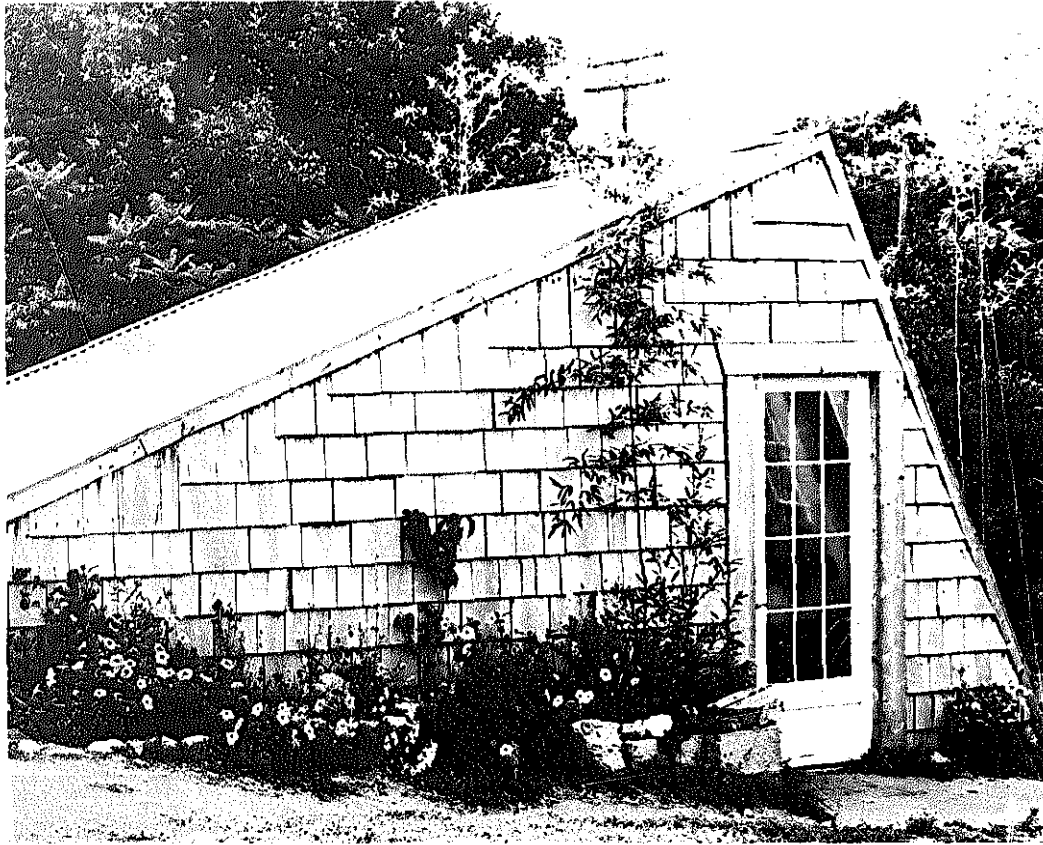

Photo by Hilda Atona Munguy

ly changed. The second war added impetus to the process. I believe that the depopulation of the farmlands of North America has been a major factor in forming the character of the present rootless society. Like a rudderless ship we are at once abstractly global, yet lack a sense of place.

The final stage in the agricultural revolution, the one in which we currently find ourselves, is the most insidious, little understood and potentially dangerous of all. It had its origins in the munitions and chemical warfare industries spawned by the second world war. Many of these are the now giant chemical corporations which have, over the past thirty years, completely chemicalized agriculture. In recent years farm lands have become managed by veritable arsenals of compounds some of which were developed initially through nerve gas research of the 1940's. Almost all of the chemicals are derived from petroleum. The emergence of a petroleum-based chemical agriculture is one of the most significant developments in food production. There are few areas of modern farming that are exempt.

Fertilizers, grain drying, weeding, timing of ripening, disease and pest control, fruit thinning, planting, harvesting, storage, storage protection, packaging and transport are now dependent upon products derived from petroleum. The agricultural revolution has, in fact, been a chemical revolution made possible by inexpensive natural gas and oil. The whole process is bizarre energetically and based upon non-renewable substances. For every calorie of food served at an American table, from five to twenty calories of petroleum derived inputs have been involved in the process of growing and getting it there. In short we are eating oil converted to foodstuffs and lots of it.

The shift from a predominantly solar to a predominantly oil and gas basis for food production has been extremely profitable for every link in the food chain except for the farmer. Most of the chemical, manufacturing, packaging and distributing corporations have assiduously avoided this primary level in the food producing process. While they have been accumulating unprecedented profits, farmers and exclusively farm-

ing corporations have not. They have rather shouldered a huge burden of debt to sustain a high energy, industrial agriculture. In 1973 farm debts supervised by the farm credit bureau amounted to \$21,842,785,000. There is, however, no discussion of the dilemma in the "trade" publications read by farmers. Chemical and manufacturing concerns control, through advertising and grants, farming publications and many agricultural university departments. This tends to block or disguise the true nature of the crisis facing farmers. The problem is compounded by the fact that farmers, in the main, are caught up in the myth created by the industry-science mill of the modern farmer as scientific business man. He has been brainwashed to see nature as an enemy, and computers and chemicals as his weapons of control. One look at any number of the ads in farm magazines amply illustrates this point. At present it is almost impossible for farmers to see through the sham, but in a few years as gas and oil become scarcer their plight will be felt around the world.

Nature is being sidestepped in almost every way. This point deserves further elaboration. As has been pointed out, with the transformation over the last hundred years from biological to chemical and industrial agriculture, oil, gas and to a lesser degree coal, have been instrumental to the changes. The planting of crops shifted from a task done by hand or simple animal drawn implements to a highly mechanized and complex process involving, for example, "integrated seeders" comprised of split press wheels, anticrustants, liquid starter fertilizer dispatchers, seed injectors and clumpers or seed plates pulled as a unit by hefty tractors. Seeds are no longer a local concern. Seed production often takes place at great distances from the point of use. Regional varieties have all but disappeared, having been replaced by the few "leading" varieties which are most profitable for seed production business. Seeds are treated with a variety of poisons to protect them from spoilage and from disease after planting. The natural mineral recycling systems which return plant and animal products to the land have been replaced by manufactured fertilizers. The nitrogen fertilizers, responsible for many of the increased yields in recent years, are derived from natural gas. To protect crops from competition, weeds were discouraged traditionally by tillage and mulching techniques which also returned organic matter to the soil. Now, herbicides are used. The salting of the soil with chemical fertilizers to a large degree has replaced the best soil building techniques including the use of manures, cover crops, natural recycling in soil humus systems and even the age old techniques of leaving fields fallow to rest and restore themselves. Biocides, which include in-

secticides, fungicides and herbicides manufactured from crude oils, have replaced biological and chemical regulation systems which prevent disease epidemics and massive destruction of plants by herbivorous insects in healthy and diverse ecosystems. Nature has equivalent processes but they are little acknowledged because they cannot be treated as a commodity by the corporations which dominate agriculture. Food varieties which are such biological freaks they would not produce at all without chemical and other forms of energy-expensive protection have been developed for ease of mechanical harvesting. Further, each time a disease begins to overtake the new varieties, as is inevitable every few years, newer ones have to be developed in order to keep one step ahead of crop vulnerability. Efforts to mold agriculture into an industrial image have succeeded to the extent that chemicals similar to plant hormones have been developed which when applied to some crops cause them to synchronize their maturation to facilitate harvesting by machines. Hand picking has been eliminated from most crops including fruits. Some fruits are now thinned in the spring by chemical spraying which causes just enough of them to fall off to optimize the size and uniformity of those that remain. The trend seems endless and the only limits on the horizon are the availability of fuels and the vulnerability of nature.

One of the most dramatic social effects of the oil revolution in agriculture has been the shift of the bulk of the population from a direct land base to an urban environment. At the present each person actually on the land supports some thirty-two city dwellers. This is without precedent in the ten thousand years of human history. This is generally looked on as progress, but it is a substitution of effort made possible through the manufacturing, transport, chemical and informational industries which sustain food production. Almost all of these profound changes have been made possible by the injection of fuels into farming on a large scale.

What has all of this done to the quantity of production? The modern farming "miracle" has definitely caused it to be increased. Since 1880 there has been a five and ten fold increase in America's food production on a per unit land base measure. The population to be supported, however, has increased six fold. To stay ahead of the population we use somewhere between five and ten or more calories of irreplaceable fuels to produce one calorie of food. We have made quick use of finite resources. Energetics alone suggest that there are troubles ahead.

The substitution of solar based inputs including draft animals, human labor, biological regulators and land restoring processes by highly concentrated forms of energy, oils and gas which can only be biologically replaced extremely slowly has placed humanity well out on a limb. There are indications that the fuel subsidy to agriculture will begin to be withdrawn within

the next five years when natural gas will be in short supply. This trend could grow towards the end of the century when oil products will be increasingly scarce. Should no cheap and effective substitutes be found to sustain chemicalized agriculture, the nation will be confronted with ravaged farm lands. Most farms will be unable to revert quickly to predominantly biological regimes. Their present level of indebtedness alone would impede a transformation to a non-mechanized solar base. Despite an increase in gross farm profits in the last twenty-five years farm indebtedness has jumped eleven fold. Modern farms are operating on borrowed capital. Their modernization has created economic instabilities that would be unlikely to withstand a shortage of any of the fertilizers, fuels or chemical control agents. If their ability to produce was curtailed for a single season, economic disaster could follow.

Should farms be compelled to revert to the methods of 1880, at best they would be able to produce approximately one-tenth what is grown today. My conclusion is based upon production figures from that time. I have assumed that the farmers making the shift would not be as skilled as their grandparents or great-grandparents who were intimately familiar with the appropriate production techniques. I have not included in my estimate the lack of draft animals, should a shift to traditional modes be necessitated by fuel shortages. Professor Odom's projections are even more dour. "If fossil or nuclear fuels were cut off we would have to recruit farmers from India and other underdeveloped countries to show the now affluent citizens how to survive on the land while the population was being reduced one hundredfold to make it possible."

I don't think Prof. Odom is taking into account such unknowable factors as the ingenuity latent in the populace or present excesses in the system or, for that matter, our overstuffed eating habits. Still his point should make it clear that the onus of food production would quickly fall back on the bulk of the population, as has traditionally been the case in human societies, and is still the case in China and throughout much of the third world. There are, unfortunately, fundamental differences between our situation and theirs. Most North Americans are now urban dwellers without agricultural traditions. We have little education in the workings of nature or in the direct culture of foods. It is this tragedy that presents one of the greatest threats to the possibilities for restabilizing populations during periods of food shortage or dramatic change.

At this juncture in the discussion of our agricultural history it seems we must conclude that our present methods of food production are not inherently wiser or better than those of our ancestors. Ways have not nor cannot be found to make nature

perform miracles. An important first step in looking at the future is to depose the technocratic-agricultural myth of eternal plenty. Ultimately life-sustaining systems are based upon energy from the sun which strikes the surface of the earth and upon the amount of photosynthetic energy available to a given region. These overall limits cannot be surpassed even by fossil fuel and dollar subsidized agricultures. There is no ever-expanding opportunity for humanity to continue to increase its numbers on the assumption that some newer and better technology will liberate us from nature's constraints.

It is true that in the laboratory it has been possible to devise algae cultures which approach the upper production limits inherent in biological processes. The results are impressive and have generated a false optimism. But it must be emphasized that huge energy subsidies were involved in these experiments, particularly in the form of complex back-up systems including pumps, aerators, injection of gases, mainly carbon dioxide, centrifuging, climate control, auxiliary lighting and so forth in order to optimize algae production. The subsequent transformation of the algae into edible and appetizing human foods was again energy expensive. As the solution to the world's food problems, systems such as these could be taken seriously only in highly affluent, energy rich societies. If one reflects on the nature of the support and the high cost of the scientific, technical and energetic components involved in the algae-as-food experiments, they represent a giant step backwards from a small kitchen garden. In the case of the latter there is a relatively large output compared to the energy that goes into it in the form of seeds and human labor. In fact, a well-designed household garden represents a good standard against which all forms of food culture should be evaluated.

There will, no doubt, be many new schemes proposed in the domain of agriculture in the years ahead. Some may prove sound but the majority, I fear, will smack of a bio-engineering mentality which still dreams of the right machine, perhaps one that might pull nitrogen, carbon, oxygen and other elements from air and water and transform them into minerally balanced amino acid or protein soups. This penultimate machine would represent a triumph for technocratic man, and nature could at last be left behind.

Shifting to a political perspective, the great productivity pouring forth from American farms can be seen in a truer light. Industrialized western agriculture is imperialistic and global. The ability of modern agribusiness to generate immense amounts of food is due less to its clever organization than its power to draw on the resources of other countries. It is quite accurate to visualize many farming operations as "feed lots", or sinks, where most of the in-

puts that sustain them are brought in from outside. To increase its productivity, the farm has extended its barnyard to encompass much of the globe. The new bounty has come about through the importation of basic materials and feedstuffs over great distances. For example, anchovies harvested off the coast of Peru became a key ingredient in the mechanization and modernization of the chicken industry. Instead of feeding people in Latin America, these fish are processed into poultry feeds in the U. S. and Europe. This is but one example. There are many other commodities including fertilizers and raw materials which are brought half way around the world to sustain American farms. Morocco is the major source of phosphorous and crop yields are dependent upon our keeping the supplies coming. When agricultural productivity is evaluated, it must be seen as involving the exploitation of global resources. We must be prepared for the possibility that donor nations may one day re-think their role in world agriculture in much the same way as oil producing nations have done recently. This will prove serious, for the green revolution could only have been brought about by our prior colonization of the world in an economic sense. Raymond Williams, the English political philosopher, has delineated this process. His analysis suggests that the imperialization of much of the globe by western powers was an essential precursor to the new agriculture which has shifted food production from regional and self sufficient strategies to international ones. In the past farms were organized as fairly complete entities, rather than as links in a lengthy world-encompassing chain, as is the case today. Traditionally the plants and animals that were cultured were nurtured by the farm's overall productivity as were the people who occupied and worked the land. The needs of the farms and farmers were not usually tallied when overall farm productivity was considered despite the fact that the bulk of population was rural. Although this is often overlooked in accounting for farm productivity, it is true that farms were sustained from within, not without. There was a high degree of self sufficiency. The autonomous approach to food culture involved a wholistic perspective. The responsibility for such a perspective and knowledge was on the shoulders of the individual farmers. They grew plant and animal varieties which yielded less than those of today for good reasons. They bred for such characteristics as the ability to produce or grow without the modern arsenal of protective devices and chemicals. This meant that some energy was husbanded for self protection rather than growth. In contemporary food varieties this protection is supplied from outside, particularly derivatives of petro-chemicals, and growth is optimized artificially.

Plants and livestock were not inferior because they yielded less, the cant of agriculturalists to the contrary.

The self-protective processes enabled them to withstand climate, pests or predators through such measures as special structures and growth rates tuned to climate and droughts, or, in the case of some animals, through complex behaviors through which they could minimize the impact of weather, disease or external attack. A chicken which can roost in the tops of trees will not grow like one that is housed in a regulated climate cage in Egg City, but it will be better prepared to protect itself from foxes or dogs or from a malfunction in an air conditioned unit. The pre-empted biological approach to farming is far more efficient energetically and takes advantage of "free" subsidies from nature. The green revolution can only work with an abundance of cheap fuels to sustain the food organisms that have been created.

One of the most maddening aspects of the arrogance of modern agriculturalists is that they have permitted many older plant and animal strains and varieties which were uniquely adapted to specific regions throughout the world to become extinct or nearly so. The genetic base of global food production is narrowing rapidly as thousands of local varieties are replaced by a few modern types. This is especially true of the grains. Only the far sighted efforts of a few plant breeders, farmers and the odd horticultural society have resulted in the saving of the relatively few genotypes upon which our future depends. I share the qualms of a number of experts in plant genetics that not enough has been saved.

The paths that wind historically through the agricultural landscape are those that wind their way

Photo by Hilde Aterma Mangaw



throughout the whole human experience. As the future looms large and is so difficult to grasp and as the pace of events is so swift, I feel drawn to question the nature of agriculture and its place in the evolution of humanity. I don't believe it is necessary for societies to come up so hard against nature. Are there not lessons to be gained from nature itself? Is it not possible to realize a visionary landscape in which nature and humans live in harmony? Single visions are not sufficient, nor are they up to the task of remaking the world.

Ecologists have the ability to grasp the meaning of the changing of ecosystems through time, a process they call succession. Succession implies an unfolding towards a point where the living and non-living move together in a harmony of complexities. I am drawn to such notions, antithetic as they are to the agricultural history of our species, in designing for the future.

Looking into one of New Alchemy's tropical pond ecosystems which is sustained by other adjunct ecosystem elements in addition to the wind and the sun, I can see the beginnings of a world in miniature with its various elements in tightly knit concert. A marigold falls to the surface and looming out of the depths come the various fishes which are sustained within. The small tilapia begin to nibble at the petals, then the mirror carp rise, gleaming with their scales reflecting the sun's light. Finally the white amur, each about a foot in length, approach in slow moving schools and within moments the flower is consumed. The fish are growing well. We are learning to emulate nature for human ends as well as for Gaia's, but I wonder if we and others like us can learn enough, and in time. Leaving the mini-ark, the cold of the outside chills me as does the thought that what must transpire in our time is no less than a conscious change in our relationship to nature.

It seems necessary, in order to understand this relationship, to probe back further in history to the very roots of agriculture. It has not been my desire in the course of this piece to ridicule contemporary farmers. It is difficult enough for them to keep going and they are not the primary villains. They are cogs in our capitalist, centrally-controlled society and have their counterparts in many other cultures throughout the world. Nor am I nostalgic about pre-capitalist agriculture. Although it did sire the present crisis the origins of the dilemma extend backwards into the very nature of agriculture itself.

I am beginning to fear that much of agriculture always has been destructive to the earth. With this fear comes the realization that traditional farming methods are inadequate to the task of restoring the land, and that practices based on an ethic that is higher and more subtle must evolve in its place. A vision of Gaia mending abandoned lands and rocky hillsides is slowly and imperfectly unfolding. The question is where now do

we turn to create futures that are adaptive and kind to the earth and people alike.

Traditional farming methods cannot pave the way to a peaceful transition when the oil and gas age ends. Agriculture had a bad record long before it shifted to a fossil fuel base. Farming has enslaved and oppressed much of humanity for the past ten thousand years. It has brought about the wholesale destruction of one landscape after another and has been critical to the rise and fall of civilizations. A number of visionaries including the agricultural scientist Sir Albert Howard, the novelist-farmer Louis Bromfield, the geographer J. Russell Smith and the Rodales, both father and son, have tried to chronicle the record of agriculture to the English speaking world. Their messages describing the insensitivity of many agricultural practices to nature as well as people has gone largely unheard in the arena of world affairs.

Apart from the economic imperatives of the two world wars, one of the major reasons we in the west rushed so unhesitatingly into fossil fuel farming was because farms were often unpleasant places to live. Farm life frequently involved incessant toil, economic deprivation and a high degree of intellectual insularity. Urban pastoral poets aside, a lot of country living wasn't very exciting. The mass exodus from farms was prompted by hardship, poor farming practices, spent soils and the nature of land ownership, and land reform is still a major issue throughout the world. The problem is close to home even in the United States where over sixty per cent of the private lands are owned by five per cent of the populace. The Jeffersonian dream of landed freeholders is gone. In northeastern Brazil a few landowners have managed to keep the bulk of the population in a state of partial starvation so that they can continue to grow commodity crops for export markets. Comparable if perhaps less dramatic inhuman practices are carried out throughout the world.

The ecologist Paul Shepard inspired by a study carried out for the U. S. Department of Agriculture by Dr. Lowdermilk reported, under the title "Conquest of the Land Through 7000 Years", takes perhaps the harshest view of traditional agriculture. He is convinced that agriculture, especially when organized on a large scale, is little short of a planetary disease and that for *Homo sapiens* to have shifted from hunting to farming for his food may well turn out to be an evolutionary mistake. It is an extreme position, but it is not the first time I have heard it expressed. Shepard and Lowdermilk have given it a concrete dimension.

Shepard begins with the argument that agriculture was founded on the systematic genocide of hunting peoples over the past ten thousand years. He contends that this slaughter has included peoples with complex cultures, elegant modes of living and profound re-

ligious beliefs. As a result of depriving them of their dwindling hunting resources, they were unable to survive. The clash of white against Indian cultures in North America provides one recent reminder.

Shepard makes the point that, rather than being primitive in a backward sense, non-agricultural civilizations were in fact highly evolved, living in tune with their environments and with the rhythms of nature. Agriculturalists traditionally have justified genocide of such peoples on the basis of cultural superiority, stating that nomadic and hunting-gathering peoples were hostile and aggressive. An opinion of the human paleontologist Richard Leakey may help dispel this image, or perhaps more accurately, this rationalization for inhuman behavior. Leakey is the son of Drs. Mary and Louis Leakey who unravelled so much of early human history from fossils uncovered from the Olduvai Gorge in Tanzania. He made his most famous paleontological finding near Lake Rudolph in Kenya. There he found the skull and leg bones of a woman who three million years ago walked with an upright stride, ate a mixed diet of vegetables and meat and may have been capable of speech. Richard Leakey's views on human aggression may bear repeating here as there might be some connection between his speculations and the practice of genocide against hunting-gathering peoples.

Leakey explains: "What we are seeing at Rudolf is a vision of man, bipedal, omnivorous, moving over a rather large area as a hunter-gatherer with a primitive sense of tool making. So far nothing we have developed leads to the "killer-ape" concept. We have no signs of aggression..... When we finish piecing together our history we will find it wasn't until very recently — ten thousand years ago or less — that man had the inclination and leisure to attack his own kith and kin. Between one and four million years ago certain species were unable to compete and eventually became extinct. But apparently they did so without physical aggression."

The meaning of this can only be pondered but it may be relevant to our present story. Perhaps there is a link between concepts of land use and the rise of aggressive behaviors. Paul Shepard's argument of the systematic elimination of hunting people by agriculturalists carries force because the process has continued into the present. Peter Farb in "Man's Rise To Civilization" has outlined its course in North America. It is known that there were more than five hundred different languages spoken by the Indians of North America alone, many as different as English is from Chinese. Almost every category of religious system known to human history had evolved here. Of particular interest to an age that relies upon a few foods to feed humanity, North American Indians used over two thousand different kinds of plants and har-

vested a wide variety of animal resources. Indians who planted crops used swiddening or long term rotational methods which allowed cultivated areas to be returned to a natural state at frequent intervals. So light was the imprint of their passing on the land that when the white man arrived the continent seemed in a virgin state, filled with game, untrammelled by the plow or axe. Further south, in the Aztec states, the Spaniards found a culture comparable to their own. Hydraulic, primarily monocrop grain agriculture was practised. There were social castes and slaves. The ruling class was obsessed with writing their view of history, a fact which led Farb to speculate whether this might be a mark of dictatorships.

Upon his arrival, the white man destroyed or undermined culture after culture until those that survived did so by becoming poor shadows of his own, giving him justification for his atrocities. Clearing the land for agriculture encroached upon what had once been sacred lands. Present attempts to drive Amazonian tribes to extinction by destroying their habitats to create farm land is one contemporary example of aggression against peoples who neither farm nor understand land ownership. Since the last Ice Age, the persecution of these non-farmers has continued until now, at the beginning of the nuclear age, only some twenty-odd tribes of hunter-gatherers remain. They have been driven to remote areas which are not as yet coveted by agro-industrial societies.

I find it extremely difficult to live with this reality. As a boy I was exposed to some vestiges of Indian culture. Years later on the edge of Hudson Bay in the area where the tundra meets the northern forest I came in contact with it again. Most of the tribe had been interred in the south a generation before. Now there was just one family on the coast led by a young man. Although we never spoke, we acknowledged each other and I learned something about him and his family. Though the caribou are long gone, they still trekked the ancient trails between Hudson Bay and Labrador. Once I came across one of his caches inland, mounted high in a small stand of trees, and later we fished the same river mouth when the arctic char were running. I was there as an observer in the name of science. They were there because it was their life.

Things have been harder for that family since the caribou have been gone from the region. I kept hoping that some relic herd might be lost somewhere in that vast terrain. I can't help but share the burden for their loss, because I know that the same culture that sent me there will not rest until all the resources, from the char to the water power, have been funneled south and until the last Naskapi has been assimilated or is gone. I never saw the young man or his family again but when winter came early and caught us unprepared we opened one of his hunting caches and used his

traps to procure small game in order to survive.

Unlike farmers, hunting peoples do not feel land can be possessed. They believe it is sacred and one must live upon it and within it, as a participant in something that is much larger. If we do not come to grips with these dualities, and with the fundamentally aggressive nature of land use by agriculturalists, the hope for restoration is bleak indeed.

With the gradual displacement of hunting peoples, the long slow transformation of the planet by agriculture began. This period which represents at the most one hundred centuries in an evolutionary sense is but a moment in the history of the species. By focusing his argument on the planetary insensitivity of agriculture, Paul Shepard places it conceptually in the mainstream of social, ecological and political thought. He does not see the development of agriculture as progressing along a tidy linear path of cultural advance, but rather as a powerful and dangerous offshoot in the historical process rationalized and justified by one culture after another. It may have been that ecological and climatic shifts in certain regions originally forced agriculture on people. With its subsequent spread the ecological and human violence which characterize our species may have been perpetuated.

Seven thousand years ago slaves were used to tend the monocrop grain fields in the alluvial valleys of the Tigris and Euphrates. Their subjugation provided the energy, and subsequently the agricultural surpluses, which contributed to the establishment of wealth. During following centuries, towns developed and, with them, the need for a reliable food supply from the hinterland. This placed increasingly heavy demands upon the surrounding countryside. Expanding herds of cattle, sheep and goats began the slow destruction of vegetation across the Sahara, Persia, Morocco and Ethiopia, eventually leaving deserts in their wake.

There is evidence that the rise of states initially may have been based on wealth from the exploitation of previously untapped ecosystems as was the case in the United States and Canada in the nineteenth century. As the agricultural activities of growing populations destroyed the ecosystems, the soil, water, climate and subsequently their wealth began to deteriorate. War was one method used to attempt to replenish dwindling resources and wealth. It was, of course, only a short term remedy, an aggressive attempt to recapture lost resources and basic forms of power.

This entropic process stretching back into antiquity continues in many parts of the world. I have seen it most recently in Haiti, which has a population of five million people living in an area of ten thousand square miles. The land and the mountain forests have been scalped by browsing goats, by woodcutters in search

of fuel and other materials and by farmers who have exposed their soils to tropical sun and drying winds. Trees are not left to grow. They are cut as saplings for charcoal. The charcoal is essential to them to cook grains to make them digestible. Haiti offers a living example of the destructive land use forces that are the theme of Shepard's work.

In the ancient world there was a continuity in the destruction brought about by agriculture, extending from Rome eastward to the heart of China. Lowdermilk, in his lengthy study of agricultural civilizations, was able to trace, through the story of soils, a dynamic in history that makes earth stewardship a central theme. He found, for example, that the low bottomlands along the great rivers of the ancient civilizations are still fertile today though they presently support one-fifth of the populations of three thousand or more years ago. The debacle that overran Babylon, Kish, Ezion, Geber, Tingad, Petra, Carthage and other cities was linked in no small way to two phenomena — hydraulic agriculture and deforestation. The now barren, rocky slopes beyond the city walls from Portugal to Palestine, through much of the near east, North Africa, India, China and Mexico were once covered by soils, grasses and woody plants. On this paleontological, geological, archaeological and historical sources agree. Lowdermilk observed ancient temples on rocky barren, wind-swept hills. Within their walls, he found in some instances tiny forest groves which by virtue of being in hallowed places had been saved from grazing animals and woodcutters. A church in Cyprus told a strange, revealing tale. It was surrounded by an eight-foot wall of silt. A new floor had been installed recently within the church some thirteen feet above an earlier silt-covered floor. Since the building of the church, clearing, farming, burning and grazing had caused twenty-one feet of silt to wash and blow down from the surrounding hills. Today a desolate and unproductive landscape sustains a small population of impoverished inhabitants.

Like deforestation, hydraulic agriculture played a heavy hand in the fates of civilizations. Through its use many states gained much of their initial power and wealth. It was the ancient equivalent to the infusion of fossil fuels in rich farming countries of today. The nature of farming shifted. With massive irrigation, made possible by the construction of ditches, canals, aqueducts and other ingenious means of moving water, a few high yielding crops could be grown. In any given region these were usually one or two grains. Production on irrigated lands soared. As might be expected, the growth curves for populations rose sharply on a similar, although smaller scale, to those taking place in the world today.

Expanding populations of grain-fed people needed wood for cooking their grains, timber for their shelter and ships, and mutton for meat. Consequently more slopes beyond the population centers were cleared. As cutting and growing extended further outward from the cities, the effort required to deliver these resources to the emerging centers of power was greater. At the same time, and this is a critical element in the process, the erosion of exposed and misused lands caused the silting up of the irrigation channels and the hydraulic works that had initiated the changes in the first place. In some instances this process of silting and clogging took place so quickly that no amount of human effort could win out over the accumulation of the silt. One city, Jerash, which had a population of one quarter million at its zenith now lies under thirteen feet of earth. Today upon the sediments there is a small and poor village of three thousand.

Large scale efforts were inaugurated to slow down siltation but they only succeeded in exaggerating the original causes of decline. Legions of slaves and serfs were brought in to keep the channels free, but slaves had to eat in order to work, and surplus grain was consumed so that in the end the initial basis of wealth, in many instances, was gone. In terms of

energetics, these societies were no longer able to yield a net surplus because of the changing dynamic associated with the maintenance of the hydraulic systems. The only direction possible for them as societies was downward towards less stable states.

The story of Rome follows a comparable pattern although the geographic complexity of the empire added a further dimension. It had had its origin as a region of free farmers tending their lands. The success of their crops created conditions for expansion and a need for labor which, in turn, led to enlarged populations. Ultimately pressure from this population caused the holdings to be fragmented into smaller units. Over the years soils were eroded and often exhausted. Social change followed inevitably on the heels of land despoilation and farmers fell back to bare subsistence levels. The weakened countryside was restructured along estate and feudal lines. Some of the serfs and slaves were sons and daughters of free farmers. The countryside, thus reorganized, was vulnerable to the exploitation of labor on behalf of hydraulic agriculture.

During the period of her rise, Rome accomplished some of the most marvelous engineering feats of all times. Most of them were linked to an imperialist agriculture. Farming and urban regions were transformed

Photo by Hilde Ateña Mangay

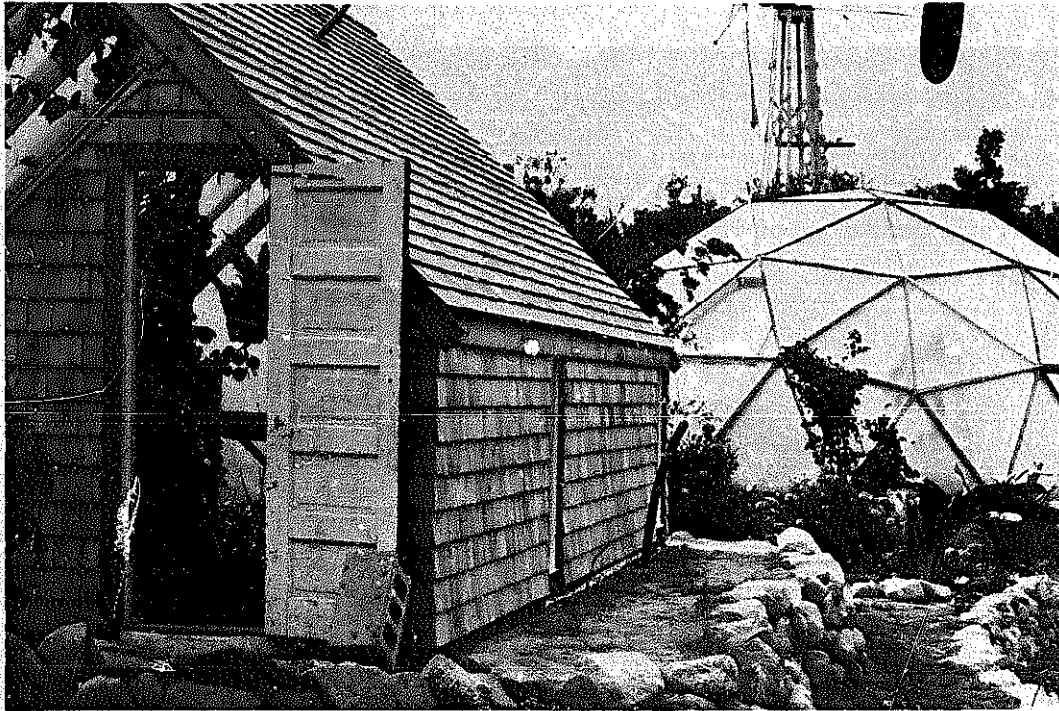

by flumes, ditches, pipelines, conduits, terraces, reservoirs and dikes that spanned the empire. But they could not be maintained indefinitely. As had happened before, misuse of the land caused them to fill with mud and silt. The same land which had been the source of wealth was strained and eventually eroded in the attempt to maintain the network which had originally given Rome its power. Rome became increasingly vulnerable to the wars, famines, invasions and social disruption which finally ended the empire.

Although the factors contributing to the rise and fall of Rome or any other culture are many and complex, it is evident that land use is at the root of wealth and that a decline in agriculture seems interlocked with the process of decay. I do not think it likely that powerful nations can transcend land abuse indefinitely. The quality of land stewardship must ultimately set the stage for any state. We are, as a species, manipulators of lands and the course of this manipulation affects our fate.

This story is not confined to Rome or any particular region or time, for, as Shepard states:

"The destructive combination of hydraulic agriculture and theocratic state has been a major force in the creation of our over dense society and apocalyptic culture. Outside the great valleys other combinations have been chewing at the earth's skin just as effectively although less dramatically. In Morocco pastoral nomadism and other grazing, charcoal making, wood burning and land clearing by fire have combined to deforest a once verdant and shady country."

The highly touted wisdom of the Chinese notwithstanding, the Orient has followed equivalent patterns. In China for some four thousand years lowland people toiled to check the ravages of land abuse by those living higher on the watershed. As their crops and animals destroyed the plant cover and soil, dwellers upstream allowed gullies as deep as six hundred feet to form. Topsoils were swept down to the rivers below. As a result the rivers had to be maintained with man-made dikes. The expenditure of human energy needed to accomplish this over centuries is beyond imagination. Even so, such rivers as the Yellow could not be contained. The flood of 1852 drowned hundreds of thousands when the mouth of the river shifted its position some four hundred miles in one season. About five thousand, five hundred years ago the Tigris River had a comparably disastrous flood due to much the same causes. The story has come down to us in the tale of the biblical flood upon which Noah sailed his ark.

Hydraulic and, in modern times, fossil fuel agricultural cultures have helped create some of the most powerful states the world has known. As civilizations they have proved destructive and imperialistic. It would seem inobdurately short-sighted if by harnessing nuclear energy we should permit the cycle to be repeated once again after the fossil fuel age has waned.

In reviewing history with a wholistic perspective, it would appear that those societies which have loved the earth, treating it as a sacred entity, have been selected against by nation states. Gentler, more earth-bound, conserver societies do not survive amidst exploitative peoples. Steady-state cultures, which usually are organized regionally and in smaller units, are not as destructive of nature as are states. By the conscious extension of their own existence into that of nature they may have, in fact, the opposite effect, acting as sustainers of regions and protectors of lands that in turn sustain them. Many of these people have found means of controlling births without the practice of infanticide and through a variety of methods have attuned their numbers to the carrying capacity of their lands. For reasons not fully comprehended, the history of such people is rarely recorded and their myths are not taken seriously by citizens of a literate world. When people see nature as sacred it is more difficult to understand the value in amassing power, wealth and armies. Without a possessive or ownership attitude towards land it often has been difficult for non-agricultural peoples to defend themselves. To create the mind set and the means for defense they would have had to abandon their traditional ways and beliefs. This becomes increasingly true in the technological era as their weapons are no match for ours.

The practice of an earth ethic accumulates energy in the lands in the form of forests, rich prairies, deep soils and game. This richness attracts exploitative peoples and such corporations as the great fur trading companies of England and France. Invariably there comes a time when the inhabitants become expendable in order to have access to and to make commodities out of those things which have been so carefully sustained by them. I saw this in the lowland jungle where the logging trucks with their cargoes of giant trees were snaking their way out through mile upon mile of rain and mud. For the past seven thousand years the meek have not been the inheritors of the earth. Within our own industrial societies the dichotomy between imperialism and conserver societies remains evident.

The growth of population over the past two centuries has changed the world. Industrial nations have exploited the globe for raw materials and commodities and then have made the third world into markets for the manufactured feeds, fertilizers, medicines and technologies. As a result, the exploited countries are caught in the same rising population curve. They have largely abandoned their traditional farming methods for those of agribusiness. As fuels become scarce the outriders of this technological age will be the first to be victimized. Feeds, fertilizers and medicines will flow less freely from powerful states.

Poorer countries will not receive support in times of rapid transition.

I am painfully aware that in describing agricultural societies I have oversimplified some elements of a much larger whole. However, as an aquarium can be a model of a pond, there is truth within the elements. The methods by which we feed ourselves control much beyond our food. It helps shape the nature of our society. The choice is not a simple one between vegetarianism and non-vegetarianism. Too many people have been enslaved in the rice and wheat fields over time.

At this juncture my greatest hope is that we shall have enough decades ahead in which to learn how to make the transition peaceful and without oppression. If humankind is to restore and reconstruct the earth it will have to begin by rethinking its agricultures and its landscapes. Existing knowledge will have to be re-integrated into healing wholes, and land tenureship first will have to encompass the vision that a sacred ecology can provide.

It is not going to be easy. Although agriculture has shaped the fate of nations, the relationship between land and society is difficult to teach or see. Most intellectuals, business and government leaders, as well as radicals, are urban dwellers many times removed from the forces that sustain them. It is not possible to guide a ship through troubled waters without an intimate knowledge of both the ship and the waters. Most political theory takes little account of the food and energy elements within political systems, and there is yet another related dilemma we must face. At present the scale of contemporary affairs is so great that we can only deal with the world in the form of abstractions which are themselves conceived from imperfect notions. In the future the scale of human endeavors should be reduced and regionalized, so that by so doing we shall become more sensitive to the direct effects of our actions.

These wanderings through the switchbacks of the last seven thousand years have forced me to the conclusion that this is not our world. The theatre belongs to nature and the play is by evolution. It is through this realization alone that adaptive human communities may arise. We need to inquire whether agriculture is merely sick or inherently a planetary cancer. Our species did without it for over a million years. This question is fundamental but rarely asked. I would suggest that farming today is an illness, and that in aggregate only is agriculture a cancer. Yet it need not be. A visionary landscape is possible. On theoretical grounds I would argue that we could generate new agricultures which would be mirror images of nature and that these agricultures would not be cancerous but legacies from the living world. It is in the restoration of nature that we will decode the truly creative forces for the future. One of the major

intellectual and actual missions of New Alchemy is the search for ways to replace the engines and the hardware of twentieth century technology with knowledge from nature which when linked to a gentle and appropriate technology can sustain human communities. We are interested in re-integrating existing knowledge to create new wholes which on a smaller scale will begin to mend both lands and peoples. It is just possible that through such activities a transformation of place and consciousness may ensue and that there may be a rebirth of all that is good on the mantle of the earth. I began this writing on a winter's day which imparted a reflection of nature in abeyance. This led to a discussion of the impact of humanity upon the living world and an attempt to trace the history of agriculture from an ecological perspective, or through Gaia's eyes.

Perhaps we can gain strength from an old prophecy.

"This is What the Rebirth
of the World Will Be
A Renewal
of All Good Things
A Holy and Most Solem
Restoration
Of Nature Herself"

—*Corpus Hermeticum*

attributed to Hermes Trismegistus

The future must touch all of us, for it is within our power as individuals to counter so many things including the continuing loss of biological diversity and the wholesale destruction of soils and forests before the plow.

We can also begin to assist in correcting the imbalances in the gaseous exchanges between the earth and atmosphere. If the subjugation of humans by humans and the rise of warring states has been linked closely with agriculture, the path away may also lie within our reach, through the realization that the future must become a part of us through our every act. That will make the critical difference. Humble things like planting trees in vacant lots become as important as anything. A little garden in a box on an apartment ledge becomes an affirmation of the emerging power, a symbolic and actual measure of change. It may yet come about that the joy and creativity of the human experience, expressed until now through art and music and loving, will yet have their moment in the sun. It is no coincidence that our health and that of the planet are one. We are a part of it in a way we only dimly comprehend. The question is far more subtle than just pollution and destruction. There is a continuum of being in a hillside brook which extends outward to encompass the world while reaching inward into ourselves. We are a mirror image, a tiny reflection of the earth itself and our collective psyche is a superimposition of images of humanity's experience on earth over time. The same forces which have

shaped us have shaped the world. There can be no real separation. The continuities in nature between the design of cells and ecosystems extend from organelles outward to the smallest freshwater pools with their myriad living entities to the oceans and ultimately to the whole planet. These ties are embodied in us too. We look out at the world, and yet are of it. It is no accident that our attempt to affirm these mysterious linkages involves touching upon that which is considered holy or sacred. Such feelings cause me to wonder if there are further threads outward in this continuum. If so, is it possible that there is a relationship between what we do in the world and our religious reconstructions of it? Might there be such a thing as a monocrop of the mind? It seems reasonable to ask whether some of the masculine, monistic religions of the world are a reduction of much that is holy, and a reflection of our mindscape and the imprint of our surroundings upon it. I think perhaps that our mindscape might be an internal ecology with its images in the landscapes of the world.

Our present conception of ourselves and our society may have doomed us. The mushroom cloud is the logical

end point of the abuse I have partially chronicled. The epoch of agricultural man seems to be nearing its end. I hope that it is only the end of a journey rather than the end of the road, that new voyages are being planned and that the prophecy of Hermes will one day come true.

I have come to believe that there are many unimagined paths ahead. In our hurry to dominate and control the earth we have become blind to its possibilities. This feeling for the future comes from my experience with many images and ideas contained in miniature at New Alchemy. One evening under the light of the moon I sat down to absorb what we had done. The big sailing mills turned quietly like dancing ghosts against the sky. One cast its faint shadow against the flickering light emanating from the surfaces of a growing structure. It seemed alive. High overhead was the more distant powerful whirr of the high speed blades of the wind powered electric generating plant. Within the miniature ark it was warm and the earth and plants reeked of fertility and growth. In the distance there was laughter after the day's work.

That moment became the future.



Photo by Hilde Aterna Mangav

REFERENCES

- Anon., 1975. *The World Almanac and Book of Facts*. Published by Boston Globe. 977 pp.
- Charoudi, D., and S. Wellesley-Miller. 1975. Buildings as Organisms. *Architectural Design*, pp. 157-161.
- Farb, Peter. 1971. *Man's Rise to Civilization*. Paladin, London. 332 pp.
- Hutchinson, G. E. 1954. The Biochemistry of the Terrestrial Atmosphere, pp. 371-433. In *The Earth As A Planet*. Edited by Gerard P. Kuiper. The University of Chicago Press. 751 pp.
- Jaffe, Andrew. 1975. Paleontology's Daring Young Man: Richard Leakey. *International Wildlife* 5 (3) pp. 4-11.
- Lovelock, J. E., and L. Margulis. 1974. Homeostatic Tendencies of the Earth's Atmosphere. *Origins of Life* 5, pp. 93-103.
- Lovelock, James, and Sidney Epton. The Quest for Gaia. *New Scientist*, Vol. 65, Number 935, February 6, 1975, pp. 304-306.
- Lowdermilk, W. C. 1953. *Conquest of the Land Through 7,000 Years*. U. S. Department of Agriculture Information Bulletin 99.
- Margaleff, Ramon. 1968. *Perspectives in Ecological Theory*. The Chicago Series in Biology, Volume 1. The University of Chicago Press. 111 pp.
- Margulis, L., and J. E. Lovelock. 1974. Biological Modulation of the Earth's Atmosphere. *Icarus* 21, pp. 471-489.
- Margulis, L., and J. E. Lovelock. The Atmosphere as Circulatory System of the Biosphere - The Gaia Hypothesis. *The CoEvolution Quarterly*, Summer 1975, pp. 30-39.
- McLarney, W. O., D. G. Engstrom and J. H. Todd. 1974. Effects of Increasing Temperature on Social Behavior in Groups of Yellow Bullheads (*Ictalurus natalis*). *Environmental Pollution* (7), pp. 111-119.
- Odum, H. T., and Ariel Lugo. 1970. Metabolism of Forest-Floor Microcosms, Chapter 1-3, in *A Tropical Rain Forest: A Study of Irradiation and Ecology of El Verde, Puerto Rico*. H. T. Odum, Editor. Division of Technical Information, U. S. Atomic Energy Commission.
- Odum, H. T. 1973. Energy, Ecology and Economics. Paper Invited by Royal Swedish Academy of Science. 26 pp. Widely reprinted. See *The CoEvolution Quarterly*, No. 1, Spring 1974, and the *Journal of the New Alchemists* (2), 1974.
- Power, M. E., and J. H. Todd. 1975. Effects of Increasing Temperature in Territorial Groups of Pumpkinseed Sunfish, (*Lepomis gibbosus*). In press: *Environmental Pollution*.
- Shepard, Paul. 1973. *The Tender Carnivore and the Sacred Game*. Charles Scribner's Sons, New York. 302 pp.
- Todd, J. H., J. Atema and J. Bardach. 1967. Chemical Communication in the Social Behavior of a Fish, the Yellow Bullhead, *Ictalurus natalis*. *Science*, Vol. 158, pp. 672-673.
- Todd, J. H. The Chemical Languages of Fishes. *Scientific American*, May, 1971, pp. 98-108.
- Todd, J. H., D. Engstrom and W. O. McLarney. 1972. An Introduction to Environmental Ethology: A Preliminary Comparison of Sublethal Thermal and Oil Stresses on the Social Behavior of Lobsters & Fishes from a Freshwater and Marine Ecosystem. Woods Hole Oceanographic Institution Technical Report 72-42. 104 pp.
- Wellesley-Miller, S., and D. Charoudi. 1974. Bioshelter. *Architecture Plus*, Nov./Dec. 1975.
- Williams, Raymond. 1973. *The Country and the City*. Oxford University Press. 335 pp.
- Yates, F. A. 1964. *Giordano Bruno and the Hermetic Tradition*. Vintage Book. 466 pp.

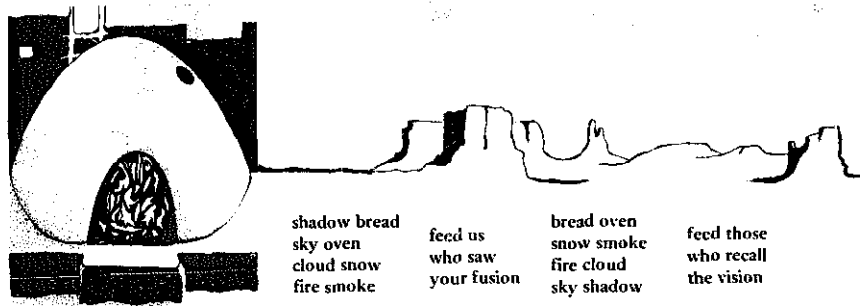

shadow bread	feed us	bread oven	feed those
sky oven	who saw	snow smoke	who recall
cloud snow	your fusion	fire cloud	the vision
fire smoke		sky shadow	

- Meredith Fuller-Luyton

The Aquaculture section for this issue contains one paper based on a project done at the Cape Cod Center and two articles for which the work was done elsewhere. The report entitled "Midge Culture" is a scientific description of the research done by Bill McLarney, Marcus Sherman and Joe Levine on chironomid tetans or midge larvae. As this particular paper is concerned with the growth-promoting attributes of the midge larvae, a point which is not discussed at length is the prolific quantities in which Bill and Marcus have learned to grow them. An estimate of the 1974 results is that 10 square meters of pond surface could satisfy the protein requirements of some 80,000 young fish. This would seem to make midge larvae well worth considering as an economical and nutritious protein source for fish.

The second paper is a translation by Bill McLarney of a report by Professor Anibal Patiño R. of the Universidad del Valle, Cali, Colombia. Professor Patiño's work speaks for itself. I can only add that most of us have found it heartening to learn that the thinking in aquaculture in Colombia is so advanced and that its application is being so carefully considered, holding as it does the prospects of greater self-sufficiency and higher nutritional levels for small farmers throughout much of Central and South America.

The third article, although not a scientific paper, seems an appropriate follow-up to that of Professor Patiño. In many areas of the world, one of the major obstacles to aquaculture seems to be the inability of a pond, once dug, to hold on to the water. In Journal One (page 35), John Todd described the work of Russian biologists in reproducing "gleys" a sort of biological plastic similar to the sub-strate of bogs which, of course, do very well at retaining water. This seemed at the time, and still does, an important breakthrough. We were anxious for corroboration of the Russian results. A fortuitous opportunity for doing so was provided by a rather muddy hole in Sarapiquí in Costa Rica, known as McLarney's Folly. It had been dug as a preliminary step to an aquaculture project. The work had not gotten underway because the pond, unobliquely, had refused to hold water. Bill and Bob Hunter decided to adapt the Russian methods. It is their efforts which are described in "A New Low-Cost Method of Sealing Pond Bottoms."

— NJT



Aquaculture

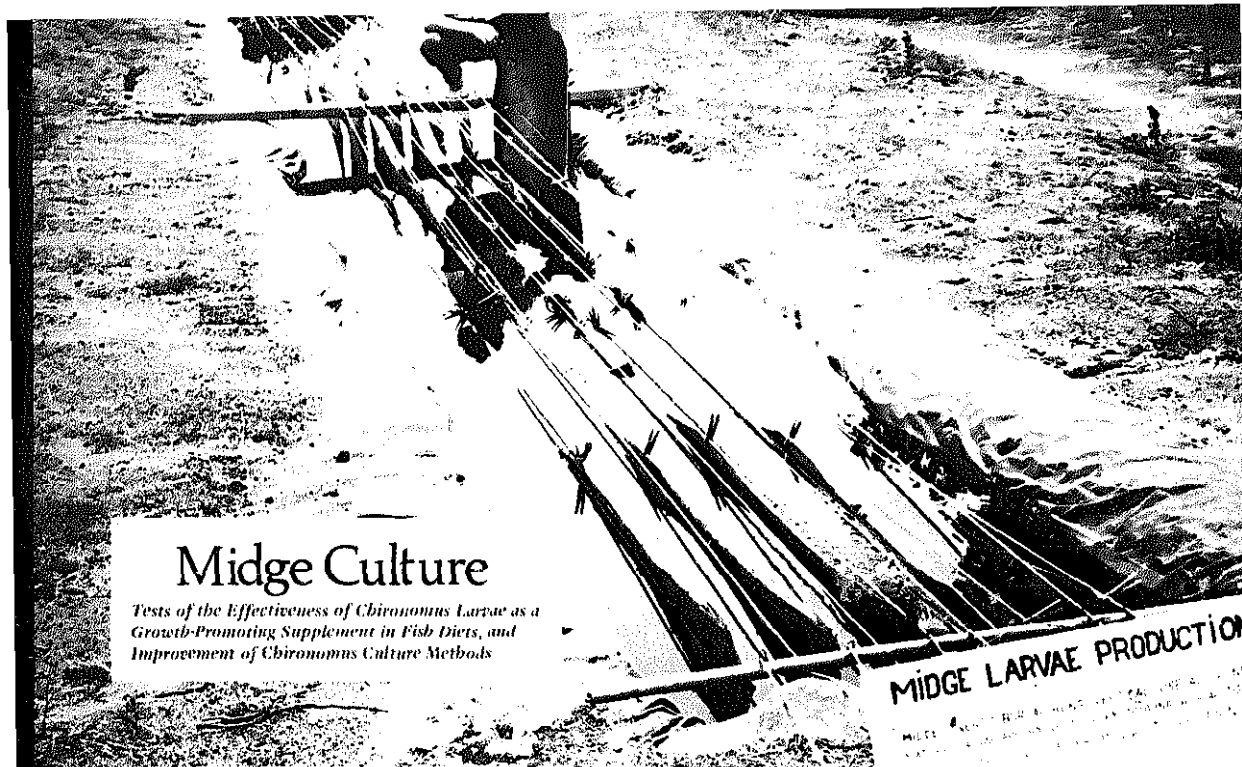

Midge Culture

Tests of the Effectiveness of *Chironomus* Larvae as a Growth-Promoting Supplement in Fish Diets, and Improvement of *Chironomus* Culture Methods

MIDGE LARVAE PRODUCTION

Photo by Fritz Guro

INTRODUCTION:

Our work with midge (*Chironomid*) larvae in 1974 concentrated on two areas: further improvement of culture methods and tests of the effectiveness of the larvae as a growth-promoting supplement in fish diets.

For details of the technique used in our low labor midge culture system, as developed in 1973, see McLarney, Henderson and Sherman (1974) and McLarney (1974). A major change in the culture system in 1974 was the adoption of a two stage culture system utilizing nursery ponds and growth ponds. Burlap culture substrates were first laid horizontally in small pools for natural inoculation by wild adult midges. These ponds were fertilized with a mixture of Milorganite (R), soy meal, pond mud and fine sand which settled onto the burlap to provide an optimal substrate for larval attachment and growth. After a culture of early stage larvae had developed, the burlap substrates with attached larvae were transferred to deeper ponds where they were hung vertically until the larvae grew to optimum size for fish food. Using this two stage method it appears that some improvement was made over 1973 yield rates. However, due to circulation problems in the high volume

growth pools and significantly increased labor in the two stage system, we are currently doing further research with simpler methods before publishing details of an optimum cost and labor-effective midge larvae culture technique.

The feeding trials (McLarney, Levine and Sherman, in preparation) were very successful and will be reported here in some detail.

Our research has been predicated on the "hunch" of some aquaculturists that *Chironomid* larvae are not merely good fish food, but have unusual growth-promoting qualities, even when fed in very small quantities. This assumption was tested, on a pilot scale, by Yashouv (1956) and Yashouv and Ben Shachar (1967), but their samples were not large enough to provide definitive information. Our studies represent the first statistically meaningful test of the food value of midge larvae.

We tested our cultured midge larvae (*Chironomus* sp., a member of the *C. tentans* Fabricius group) on *Tilapia aurea* (Steindachner) and Israeli carp (*Cyprinus carpio* var. *specularis* Lacépède), the two major fish varieties cultured at New Alchemy East. Concurrent-

ly, Joseph Levine of the Boston University Marine Program tested our larvae as a food for juvenile American lobsters (*Homarus americanus* Milne-Edwards). *T. aurea* is generally considered to be highly herbivorous, but it has been shown that the young feed extensively on invertebrates (McBay, 1961). Israeli carp are omnivorous at all life stages, while lobsters are largely carnivorous.

FISH FEEDING TRIALS:

Methods: Both species of fish used in the experiments were housed in a series of twelve fifty-five gallon aquaria kept in a plastic greenhouse. The tanks were aerated, but filtration was not provided. Cleaning was effected by siphoning off twenty-five per cent of the water weekly and replacing it with fresh tap water; most fecal matter and other detritus was removed in this process.

Each group of fish received a standard diet composed of seventy-five per cent rolled oats and twenty-five per cent roasted soy meal. The standard diet was fed at the rate of two per cent of the total weight of fish, six days a week. As the tanks all soon developed dense green algae blooms, the fish were able to augment their diet by filter feeding. In four control tanks, the fish received no additional food. In a second group of four tanks, the fish received a supplement of midge larvae (*Chironomus* sp., a member of the *tentans* group) comprising two percent by (wet) weight of the grain diet. The final four tanks received midge larvae at the rate of ten per cent of the grain diet. Each group of fish was weighed three times at the start of the experiment, two weeks later, and four weeks later. All fish were fin-clipped so that individual, as well as group, growth rates could be determined. Data from the full four-week period of the tilapia trials and the first two-week period of the carp trials are presented here.

Test groups of fish were chosen to have approximately the same total weight of fish in each tank at the start of the experiment. In the first experiment

with *T. aurea*, six fish were stocked per tank and weights of individual fish varied from 0.7 to 18.0 g; group weights were 31.1 to 48.0 g. In the second *T. aurea* experiment, only five tilapia were stocked per tank, and these fish were chosen to be more nearly uniform in size than those in the first experiment. Individual weights ranged from 1.0 to 7.3 g; group weights from 16.1 to 23.5 g. The carp trials involved six fish per tank. Total weight of groups ranged from 58.3 to 72.3 g and weight of individuals from 2.3 to 21.2 g.

Water temperatures were 22 to 33°C during the first *T. aurea* experiment, 27 to 33°C during the *T. aurea* experiment and 20 to 32°C during the carp experiment.

Results: In the first *T. aurea* experiment, there was a slight increment in growth rate with the amount of midge larvae fed, but the difference was not significant and certainly would not justify any effort to provide midge larvae for young *T. aurea*. However, if the fish are broken down into two size groups, the differences in growth rate are more striking. Since it is well known that younger fish generally have a greater need for animal food, the data for all fish weighing less than 5 g at the start of the experiment were considered separately. Among these fish, those receiving a two per cent midge larvae supplement increased their weight considerably more than those receiving no midges. Those receiving a ten per cent midge larvae supplement grew faster than those receiving a two per cent supplement, but the difference was not as great as between the fish receiving a two per cent supplement and those receiving no larvae.

It was decided to repeat the experiment using more uniform sized, smaller fish. The results are similar to those obtained with the small fish in the first experiment. Results of all the *T. aurea* trials are shown in Table 1.

For purposes of statistical analysis, growth data from the smaller fish in the first trial were combined with those from the second trial. Each set of three aquaria (those receiving 0, 2% and 10% midge supplement

TABLE 1
Feeding trials with *Tilapia aurea*

	First Trial June 1-28			First Trial June 1-28*			Second Trial July 5 - August 2		
	No Midges	2% Midges	10% Midges	No Midges	2% Midges	10% Midges	No Midges	2% Midges	10% Midges
No. of Fish	24	23	24	11	9	12	20	20	20
Final Weight (grams)	236.1	241.8	235.1	53.1	43.6	69.2	144.8	149.5	151.1
Initial Weight	163.5	162.9	153.9	32.2	21.9	32.2	88.5	80.0	74.2
Gain in Four Weeks	72.6	78.9	81.2	20.9	21.7	37.0	56.3	69.5	76.9
Per Cent Gain	44.4	48.4	52.8	64.9	99.1	114.9	63.6	86.9	103.9

*Fish weighing five grams or more at start of experiment excluded.

TABLE 4

Feeding trials with American lobsters, including significance values determined by T-test for independent samples

	Average Intermolt (days)	Increase in Carapace Length (mm)	Absolute Weight Gain (gms)	Per cent Weight Gain
Control (Artemia only)	18.6±3.2	1.0±0.4	0.05±0.0	27%±4
Artemia + 2% Larvae	19.3±1.5	1.5±0.3	0.18±0.10	77%±33
Artemia + 10% Larvae	16.0±7.4	2.0±0.4	0.19±0.06	76%±25

Significance values (T-test) are indicated by brackets and labels: NS (Not Significant), .05, .01, .05, NS, .01, NS, NS.

The early life stages are at once the most critical period for the fish culturist, and the time when it is easiest to provide a relatively high percentage portion of larvae.

The difference in growth between fish receiving the ten per cent midge supplement and those receiving the two per cent supplement was in all instances less than the difference between those receiving the smaller supplement and the controls. In interpreting this data, it should be kept in mind that while rolled oats and roasted soy meal are essentially dry, eighty-six per cent of the weight of a live *C. tentans* larva is water. On a dry weight to dry weight basis, then, the rates of dietary supplementation with midge larvae in the fish experiments were 0.28 per cent and 1.40 per cent. Such a pronounced effect on growth rate from such small weights of midges suggests that we are dealing, not with the effect of increased quantity of protein, but with a vitamin or amino acid effect.

In the lobster trials, both absolute and percentage weight gain showed the same effects observed in the tilapia. The carapace length data, however, show significant differences not only between the controls and the experimental groups, but also between the two experimental groups. This apparent discrepancy can be explained by observing that carapace length alone, though a standard measurement in the literature, does not reflect possible differences in claw size and length of abdomen.

While the weights of midge larvae and frozen brine shrimp used in the lobster trials were reckoned on a dry weight - dry weight basis, the differences in growth rates of midge-fed and control lobsters are greater than one might expect. To postulate a protein or amino acid effect here does not seem satisfactory. Chemical analysis of larvae of the midge *Chironomus plumosus* and various other invertebrates cultured for use as fish foods in the U. S. S. R. (Ivleva, 1969) did not indicate that *C. plumosus* larvae differ notably from the rest, except in that *Artemia salina* do not contain

Vitamin A. It should also be noted that Chironomids are unusual among invertebrates in containing large amounts of hemoglobin.

Artemia are a standard component in the diet of many cultured aquatic animals. In some cases, including some lobster cultures, they are the sole food. It has been shown recently that in such cultures, live *Artemia* are superior to frozen (Schleser and Gallagher, in preparation). No technical explanation has been advanced for this phenomenon, but it has historical precedent in the "live food mystique" of aquarists. It is possible that some nutrients are lost in the freezing process. If this were true, the addition of a small amount of live food, e. g., the midge larvae in our experiments, might provide a factor critical to the growth of cultured animals.

In the present instance the picture is further complicated by the results of studies in which lobsters were reared in the same system used in these experiments and fed on one hundred per cent live food diets. Percentage weight increment of our two experimental groups reared on frozen *Artemia* and small amounts of live midges (seventy-seven per cent ± thirty-three; seventy-six per cent ± twenty-five) did not differ significantly from that of lobsters reared on a *Ceramium - Jassa - Mytilus* association (eighty-one per cent ± twenty) (Levine, in preparation) and on high density *Capitella capitata* cultures (seventy-one per cent ± fourteen) (Mencher, in preparation).

From the results of work done to date, we cannot say whether or not there is a unique growth-promoting component or combination of components in midge larvae, or what that component or combination of components might be. We can say that midge larvae added in small quantities to standard fish and lobster diets resulted in significant enhancement of growth and that the ease of their cultivation and utilization renders them desirable for use in many forms of aquaculture.



We do not recommend midge larvae for culture as the principal food for any type of fish. There are many other good foods which can be provided more easily in bulk. As can be seen from our work, the effectiveness per weight of midge larvae is greatest when they constitute only a small proportion of the total diet. We do recommend their inclusion as a supplement in the diets of cultured fresh water and marine animals. If we assume a larval production rate of 100 g/m² of water surface/week (which we have attained in our best pools), then 10 m² of ponds could provide a two per cent supplement continually for eighty thousand young fish averaging 5 g each. If the increment in growth of the fish were comparable to that achieved in our experiments, a midge culture system would certainly be a worthwhile expenditure of time and space.

ACKNOWLEDGMENTS:

As in previous years, the midge work was done under the auspices of the Woods Hole Oceanographic Institution, and both sets of feeding trials were carried out on the Woods Hole Oceanographic Institution's premises. To offer a blanket acknowledgment of that Institution, however, would be to overlook the massive bureaucratic interference and the attitudes of certain scientists and administrators which nearly prevented our 1974 work from being carried out — a fine example of the sort of frustration which added impetus for some of us to leave "establishment" science and join forces in New Alchemy. We do wish to give special thanks to Dr. Derek Spencer of the Department of Chemistry, who was instrumental in overcoming the institutional pettiness which threatened our work. Drs. Jelle Atema and John Ryther provided facilities for the fish and lobster work, respectively. Camas Lott was especially helpful with the tedium of setting up the experiments, maintaining and weighing fish. Dr. Woolcott

Smith made valuable suggestions concerning the analysis of the data.

— William O. McLarney
Joseph S. Levine
Marcus M. Sherman

REFERENCES

- Ivleva, I. V. 1969. Mass cultivation of invertebrates: Biology and methods. Academy of Sciences of the U. S. S. R., All-Union Hydrobiological Society. Published for the National Marine Fisheries Service by the Israel Program for Scientific Translations. 148 pp.
- Levine, J. (Manuscript in preparation for W. H. O. I. Technical Reports). The *Ceramium* — *Jassa* — *Mytilus* association as an experimental link in a lobster polyculture system.
- McBay, L. G. 1961. The biology of *Tilapia nilotica* Linnaeus. Proc. 15th Ann. Conf. Southeastern Assn. Game and Fish Commissioners: 208-218.
- McLarney, W. O. 1974. An improved method for culture of midge larva for use as fish food. The Journal of The New Alchemists (2): 118-119.
- McLarney, W. O., S. Henderson and M. M. Sherman. 1974. A new method for culturing *Chironomus tentans* Fabricius larvae using burlap substrate in fertilized pools. Aquaculture. (4): 267-276.
- McLarney, W. O., J. S. Levine and M. M. Sherman. (In preparation). Midge (Chironomid) larvae as a growth-promoting supplement in fish and lobster diets.
- Mencher, F. (Manuscript in preparation for W. H. O. I. Technical Reports). *Capitella capitata* and *Chondrus crispus* as experimental links in a lobster polyculture system.
- Shleser, R. and M. Gallagher. (Manuscript in preparation). Formulations of rations for the American lobster, *Homarus americanus*.
- Siegel, S. 1956. Non-parametric statistics for the behavioral sciences. McGraw-Hill, New York.
- Yashouv, A. 1956. Problems in carp nutrition. Bamidgheh, 79-87.
- Yashouv, A. and R. Ben Shachar. 1967. Breeding and growth of Mugilidae. II. Feeding experiments under laboratory conditions with *Mugil cephalus* L. and *M. capito* (Cuvier). Bamidgheh 19: 50-66.

A New Low-Cost Method of Sealing Fish Pond Bottoms

In no part of the world is aquaculture less developed than in Latin America, despite its great potential there and the shortage of protein foods in much of the region. One of the constraints on the development of Latin American aquaculture has been the porosity of many of the soils — a problem which is by no means limited to Latin America. Such was the case with a 200 m² pond constructed in 1973 at Finca El Uno, located at Tirimbina, Provincia de Heredia, Costa Rica. Compaction of the soil alone was not enough to enable the pond to hold water. The soil at the pond site appears to contain quite a high percentage of clay, but there is a porous, sandy layer at a depth of 2-3 feet. Rainfall in the area is about 120 inches annually.

Similar problems have been solved in a variety of ways in the United States and other affluent countries. Bentonite clay is the most common sealing agent; when mixed with the pond bottom soil in the proper proportions it forms a colloidal seal. A similar effect may be achieved through the application of certain chemical salts. Many American fish farmers have lined their ponds with sheets of polyethylene, butyl rubber, and other synthetics, which are then buried. In extreme cases, small ponds may be cemented.

All the sealing methods mentioned so far share the characteristic of being expensive. This is a disadvantage anywhere, but in situations where capital is a major limiting factor, the expense can be prohibitive. We were able to circumvent this problem by applying a virtually cost-free method of sealing at Finca El Uno. The technique does not originate with us, but is of Russian origin and has not been well publicized. We became aware of it when Marsha Zilles of Santa Barbara, California, sent us a copy of an abstract from an architectural design journal briefly describing how Soviet scientists had sealed ponds by artificially inducing the formation of a "gley" or "biological plastic", as occurs naturally in bogs.¹ The process, as adapted for use in Costa Rica, proceeded as follows:

1. The pond bottom was completely cleared of debris, rocks, etc.
2. The bottom and sides were covered completely with wastes from nearby hog pens. Care was taken to apply the material to the vertical sides of the pond as well as to the bottom. This layer and each subsequent layer of material was added in

quantities sufficient to just cover the previous layer.

3. The hog pen waste was completely covered with freshly cut grass and banana leaves, plus a few discarded cardboard cartons.

4. A third layer, of soil taken from near the pond site, was added and tamped down firmly.

5. After between 2 and 3 weeks, the pond was flooded.

The pond retained water immediately upon filling, with no leakage whatsoever. The cost of sealing was limited to labor costs; the materials used were all "wastes" which would have been discarded in the course of normal farm operations.

The process involved in forming the seal is a bacterial one, which requires anaerobic conditions. It is possible that plastic and rubber pond liners actually act in the same way. While great care is taken to prevent punctures in the installation of such liners, it may be that their long-term effectiveness is, in fact, a result of the creation of anaerobic conditions underneath the liner. The suggestion is that a variety of waste materials, if properly applied, would seal porous soils, thus enabling the Russian method to be adapted for use practically anywhere.

So far as we know, the experience reported here is the first test of the gley formation method of pond sealing in the tropics, or anywhere outside the U. S. S. R. If its application turns out to be universal, as appears likely, the implication is that many areas of the world which, up to now, have been closed to aquaculture (except perhaps by large corporations or government agencies) can now be opened to this method of food production. We would very much like to hear about any experiences our readers may have with pond sealing.

— William O. McLarney
J. Robert Hunter

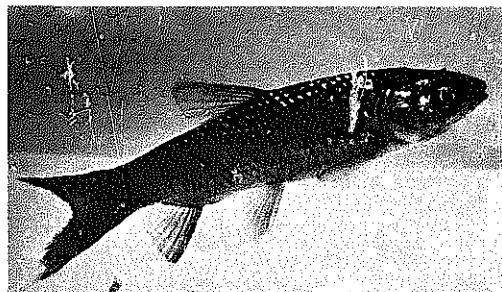

Photo by Fritz Gara

1. *The Journal of the New Alchemists* (1) p. 35.

Cultivo Experimental de Peces en Estanques

PREFACE

While one of the roots of New Alchemy lies in the disenchantment some of us feel with the framework of institutional science, we do not wish to present the attitude that there is little of value in the work being done in universities and research stations of the world. Science and technology do make important contributions and from time to time we shall describe some of the work which seems especially relevant from a New Alchemy point of view.

Such an editorial effort is handicapped by the impossibility of keeping up with all the scientific literature in even one field. We are indebted to Sr. Alberto Donadio, of Medellin, Colombia, for bringing to our attention the work of Prof. Anibal Patiño R. of the Universidad del Valle, Cali, Colombia.

Professor Patiño's work is especially gratifying to me, since he has arrived independently at many ideas similar to my own for the development of tropical aquaculture (McLarney, 1973a), and has demonstrated that they will work — biologically and economically.

The following account, which should be of interest to anyone involved in tropical ecologies or economies, is excerpted and paraphrased, with Professor Patiño's kind permission, from his paper "Cultivo experimental de peces en estanques", which appeared in *Cespedesia*, Vol. II, No. 5, pp. 75-127. For information on obtaining the original paper (in Spanish), write *Cespedesia*, Jardin Botanico del Valle, Apartado aereo 5660, Cali, Colombia.

INTRODUCTION

Professor Patiño's work parallels New Alchemy schemes for tropical aquaculture in four respects:

1. He advocates polyculture of certain species of *Tilapia* and local fish species.
2. The primary foods for the fish, apart from those produced by fertilizing the fish pond, are weeds, agricultural wastes or various plants which can be cultivated with a minimum of effort.
3. Selected fish are grown to market size in cages. The remainder are left, essentially unmanaged, in a pond which serves as a hatchery.
4. Excess small fish are fed to other farm livestock, such as hogs and chickens. The wastes from these animals are used to fertilize the pond.

Professor Patiño has demonstrated the economic feasibility of this approach for the campesino (small farmer). He has also outlined plans for the implementation of this sort of fish culture in the countryside.

We shall discuss these features of Professor Patiño's work in the order listed above. All of the work described

was carried out in four ponds fed by the Rio Tuluá in El Jardin Botanico del Valle, Matiguadua, Colombia. The ponds, each 10 m x 30 m x 1.2 m, were lined with polyethylene and fertilized with cow manure. Professor Patiño and four students from the Universidad del Valle accomplished all of the work from the construction of the ponds with pick and shovel to the conclusion of the experiments in a year and a half.

POLYCULTURE

Four species were chosen for the initial studies: *Tilapia mossambica* Peters, *Tilapia rendalli* Boulanger (= *Tilapia melanopleura*), and two native characins, the bocachico (*Prochilodus reticulatus magdalenae* Steindachner) and the jetudo or patalo (*Ichthyoelephas longirostris* Steindachner). The two tilapia were chosen because of the ease with which they may be cultured, and because of their different feeding habits. As both species are already established in the Rio Cauca drainage, which includes the Rio Tuluá, there are no ecological objections to the use of these exotics. The native species were chosen because both are valuable food fishes currently threatened by environmental change, and because they might fill ecological niches complementary to the tilapia.

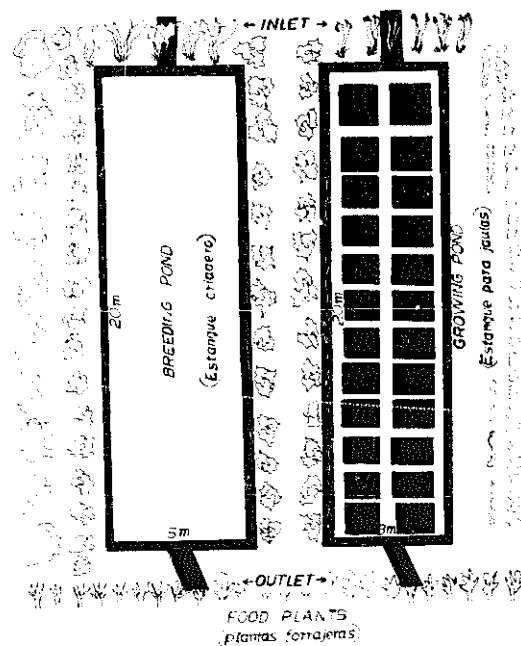

To describe briefly the four species:

T. mossambica is omnivorous, but feeds mostly on phytoplankton and benthos. It is a mouthbreeder and multiplies very rapidly, which leads to overcrowding and sometimes enables it to out-compete valuable, but less prolific or aggressive species. *T. rendalli* is herbivorous by preference. Though not a mouthbreeder, it is, nevertheless, more prolific than either of the characins studied. Both species of tilapia are considered good food fishes.

The bocachico is economically the most important fish in the Cauca valley. It feeds on algae and detritus, obtained by sucking up mud and periphyton. In the Cauca valley, it may compete with *T. mossambica*. The bocachico lives mostly in standing or slow-moving waters, but requires running water to breed.

The jetudo, in nature, is entirely a creature of swiftly flowing waters. It feeds primarily on algae attached to rocks and river bottoms and is described as having a "delicate" flavor.

Professor Patiño has only begun to investigate the possibilities of culturing the two native species, but he has raised two important questions:

1. What is the behavior of the jetudo when confined in standing water?
2. What is the effect on growth of the bocachico in ponds when combined with *T. mossambica* or *T. rendalli*?

With respect to the first question, it was demonstrated that the jetudo will survive and grow in standing water. This is also true of another edible characin, the machaca, *Brycon guatemalensis*, which occurs naturally only in flowing waters (McLarney, 1973b). Sixty-four jetudo, with a mean weight of 69.3 g, were introduced into one of the ponds. Over a period of twelve months they grew to a mean weight of about 115 g. Only four died. Prior to the introduction of the fish the pond was fertilized with commercial 14-14-14 fertilizer and planted densely with *Elodea canadensis* to maintain high levels of dissolved O₂. The lowest concentration recorded during the experiment was 6.8 ppm. This experiment was disrupted somewhat by the accidental introduction of some young *T. mossambica*, which may have competed for food with the jetudo.

Two ponds were used in the tilapia - bocachico experiments. One was stocked with 150 juvenile bocachico with a mean weight of 34.7 g and 100 *T. mossambica* with a mean weight of 6.0 g. The other pond received an identical lot of bocachico plus 80 *T. rendalli* with a mean weight of 47.6 g. (It should be noted here that a possible limiting factor in culture of the bocachico is its delicacy with respect to handling. Mortality of bocachico during capture, transport and stocking was thirty-five per cent, that of tilapia less than five per cent.) Prior to stocking, both ponds were fertilized with 14-14-14 at the rate

of 1 kg/pond; at the time of stocking the water in both was light green. The *T. rendalli* pond was densely planted with *Elodea canadensis*. Three months later, *Elodea* was placed in the *T. mossambica* pond as well, to aid in oxygenation.

Periodic examination of the stomach contents of sample fish showed that there was more overlap between the feeding niches of the bocachico and *T. mossambica* than between bocachico and *T. rendalli*. While the ponds differed in such respects as size and reproductive rate of tilapia, dissolved O₂ concentration, provision of supplementary food (leaves of various plants supplied daily to the *T. rendalli*), and abundance of aquatic plants, the evidence suggests that the combination bocachico - *T. rendalli* is complementary, while the combination bocachico - *T. mossambica* - is not.

This conclusion is more strongly supported by the relative growth rates of the bocachico in the two ponds. After twelve months the bocachico confined with *T. mossambica* had reached a mean weight of about 94 g, while those in the *T. rendalli* pond had reached a mean weight nearly double that - about 175 g.

If bocachico or jetudo are to be used in practical fish culture, they must be bred in captivity. This has not been done to date, but Professor Patiño does not foresee this as a serious problem. He thinks that the process of pituitary injection, which has been successful in inducing many other typically rheophilic South American fishes to spawn in standing water (de Menezes, 1966), is likely to succeed with these species also.

The remainder of the work was carried out solely with the two *Tilapia* spp. Some of this work has further implications for polyculture.

USE OF AGRICULTURAL WASTES OR WEEDS AS FISH FOOD

A variety of terrestrial and aquatic plants were tested for acceptability for food for *T. rendalli*. Fifteen, including the aquatics *Elodea canadensis*, *Potamogeton crispus* and *Cbara* sp. were consumed readily. Ramos (1971) and Huet (1970) offer additional lists of plants accepted by herbivorous tilapia. Hickling (1971) states that *T. rendalli* will accept a daily ration of 15% of its weight in yuca leaves (*Manihot esculenta*) or 33% in *Colocasia*. The difference reflects the water content of the leaves.

Of the plants tested, Professor Patiño recommends yuca, bore (*Alocasia macrorrhiza*) and chayamans (*Cnidocolus chayamansa*), an edible euphorb shrub indigenous to Mexico. He lists four advantages of these plants:

1. Their leaves are high in protein (17.2 per cent, 23.25 per cent and 24.2 per cent, respectively).
2. They are easy to grow and can be propagated vegetatively.
3. They grow rapidly and produce large amounts

of useable vegetation.

4. They are tolerant of poor soils.

Professor Patiño suggests the consumption of aquatic plants by *T. rendalli* might be useful in weed control. I would like to suggest that in some instances they could be "pastured". In general, the provision of vegetable foods for tilapia should be left up to the individual farmer who best knows his local resources. If the leaves of a plant, such as yuca or banana, which can also provide the farmer with food or a cash crop, can be employed, so much the better.

CULTURE OF *T. RENDALLI* IN CAGES

The major problem in tilapia culture is overpopulation resulting in stunting. Three solutions have been applied.

1. Careful selection of only male fish for the culture pond.

2. Production of "monosex" hybrids -- one hundred per cent male or nearly so.

3. Careful use of predatory fishes to thin, but not eradicate, the tilapia.

These techniques all require inputs of energy and managerial skill which cannot ordinarily be expected of the Latin American campesino embarking on a completely new food-raising enterprise. Cage culture solves the problem more simply. The eggs of all species of tilapia sink and are initially deposited in a nest dug in the bottom of the pond. When the fish are confined in wire cages suspended off the bottom, the eggs pass through the cage bottom out of reach of parental care. The pond in which the cages are placed or preferably, another pond, can be used as a natural "hatchery" in which tilapia are left to multiply virtually unmanaged. From time to time, stock can be selected from this pond for intensive culture to market size in the cages.

Other advantages of cage culture include:

1. Intensive culture with minimal labor and materials.

2. Technological and economic feasibility for the campesino.

3. Facilitation of feeding, inspection of the stock and harvest.

4. Continual harvest and replenishment of growing stock.

5. Rendering many types of water bodies useable for fish culture.

The first two cages constructed by Professor Patiño and the students were made of galvanized wire mesh and chanu or chano (*Humiriastrium procerum*) a local water-resistant wood. The cages, 2 m x 1 m x 1 m, were situated on legs which raised them 25 cm off the pond bottom. Later cages were constructed more economically by making four of the sides from such indigenous materials as cane. Wire was used for the bottom so that enough light could penetrate to permit the growth of oxygenating plants underneath the cage.

The cages were placed 1 m apart in one of the ponds, over a dense growth of *Elodea*. Each cage was stocked with 50 or 100 three month-old *T. rendalli* with a mean weight of 22.5 g. Each cage received a handful of bore leaves twice daily. Two cages received an additional daily supplement of wheat bran. At the beginning of the experiment each cage was given ½ kg of bran daily. This was gradually increased to 1 kg/day.

The result was excellent growth and low mortality (four per cent). For the first month the young fish, which had been reared previously on commercial pelleted food, refused to eat the bore leaves. Subsequently they accepted the leaves and grew rapidly. After five months in the cages, when the fish were eight months old, the mean weight of the fish not receiving the bran supplement was 165 g. Those receiving the supplement averaged 200 - 250 g. Growth slowed considerably after five months, indicating the logical time to harvest.

After five months, the tilapia which did not receive the bran supplement had increased their weight by a factor of 7.33. The comparable factor for the supplemented fish was 8.89 - 11.11.

For purposes of comparison, Professor Patiño cites Kuronuma (1968) who describes the cage culture of various marine fishes in the fertile Inland Sea of Japan. Kuronuma considered an annual production of 29 kg/m² remarkable. These fish were fed a high quality dry food with a conversion ratio of 1.6. In Professor Patiño's experiments, the unsupplemented *T. rendalli*, stocked at 100 fish/cage, produced 28.5 kg/m² of pond surface in five months. While no attempt was made to determine the conversion ratio of bore leaves, it was undoubtedly much higher than 1.6. At New Alchemy East we have achieved a good conversion rate of 1.5 with *Tilapia aurea* and *Tilapia zillii*, and believe that part of our success is due to small amounts of animal protein (earthworms, insects, etc.) in their diet, particularly when the tilapia are small (McLarney and Todd, 1974).

"One-upmanship" in terms of weight/surface area data is an occupational disease of fish culture. Undoubtedly the production achieved by Professor Patiño could be bettered by using concentrated foods or by technological improvements. What matters is not competition among fish culturists, but the fact that his technique is inexpensive and does not require great sophistication on the part of the farmer, yet can result in the production of hundreds of kg of fish in a short time within a small area.

INTEGRATION OF FISH CULTURE WITH CULTURE OF HOGS AND CHICKENS

Professor Patiño points out that, while Colombian farmers commonly raise chickens and hogs for sale or their own use, growth of these animals is limited by their diet, consisting chiefly of corn, platano peels,

minced sugar cane and table scraps, plus whatever the animal can forage. Such a diet is usually deficient in animal protein. Colombian campesinos cannot afford to make up this deficit by the use of concentrates, as is done in more affluent countries. Professor Patiño suggests that excess small cultured tilapia could fill this gap. For this purpose he recommends *T. mossambica*, which can be maintained without supplemental foods on plankton in fertilized ponds, and multiplies more rapidly than *T. rendalli*. The two species could be grown in polyculture, or a separate small pond could be set aside for *T. mossambica*. The pigs or chickens could be maintained near the fish pond so that the ponds can be fertilized with their manure.

Young *T. mossambica* were tested for acceptability as food for chickens and pigs. The tests on chickens were preliminary and established only that chickens prefer cooked fish. Tests with hogs were more extensive. These animals eagerly accepted whole, raw young *T. mossambica*. They had no difficulty with bones or fin rays.

One quantitative feeding experiment was conducted with hogs. Four one month-old Duroc Jersey hogs were divided into two pairs (one male and one female per pair). The control pair, which had a mean weight of 8.6 kg, was fed twice daily with cooked platanos (including peels) and minced sugar cane, in increasing quantities as the animals grew. The experimental pair, with a mean weight of 7.5 kg, received the same diet, plus a daily ration of whole, raw *T. mossambica* measuring up to 8 cm in total length. The daily tilapia ration was 100 g per hog at the start of the experiment and was increased to 250 g over the experimental period.

After four months, the hogs were weighed again. The mean weight of the control animals was 16.5 kg, that of the test animals 24.5 kg, or 33.1 per cent more, even though they had started the experiment being slightly smaller. The mean weight gain of the controls was thus 7.9 kg, or 48 per cent, while the hogs whose diet was supplemented by tilapia had a mean weight gain of 17.0 kg, or 69.4 per cent.

Professor Patiño does not consider the final weight of either pair of hogs satisfactory, due to irregularities in the feeding regime. Neither can his results be considered statistically significant. Nevertheless, the experiment indicates what might be achieved.

THE "CAMPESINO FISH CULTURE UNIT" AND ITS ECONOMICS

Based on the results of the experiments described here, Professor Patiño has drawn up a plan for a "Unidad Piscícola Campesina" (Campesino Fish Culture Unit), using *T. rendalli*, with the potential to accommodate additional species. The physical layout of such a system is illustrated in Fig. 1.

His plan for the UPC, as he calls it, includes the following instructions:

1. Select a pond site with the help of an expert. New Alchemy's new method of pond sealing should render site selection easier (McLarney and Hunter, see page 85).

2. Plant the area around the pond site with fish food plants. Professor Patiño suggests one hundred stalks of yuca, one hundred roots of bore, chayamansa and other suitable plants as available locally. These need occupy less than ½ hectare. It is important to plant before beginning pond construction, so that the plants are producing by the time the fish need food.

3. Build two ponds:

- a. A nursery pond ("estanque criadero"), 5 m x 20 m x 1 m, connected by a ditch to a good water source, with another ditch for drainage. When filled, the nursery pond should be fertilized. When the water turns green, add five hundred to one thousand juvenile *T. rendalli*.

- b. A growing pond ("estanque para jaulas") near the nursery pond, also provided with inlet and outlet ditches. The growing pond should be at least 3 m x 20 m, and 1.5 m deep. Plant this pond with aquatic plants and introduce twenty-four cages, each measuring 1 m x 1 m x 1 m, spaced equidistantly. Each cage should be equipped with legs to keep it 30 cm off the bottom.

4. When the tilapia start to grow, select individuals 6-8 cm in total length and stock them at 200 per cage. All the cages can be stocked at once, or stocking can be staggered to suit the culturist.

5. Feed the fish in the cages twice daily, in the morning and late afternoon, with leaves of the food plants. Feed as much as the fish will consume, but no more. If feasible, supplement their diet with wheat or rice bran.

6. Inspect each cage monthly to determine if health and growth of the fish are satisfactory. For this purpose, the cages may be lifted slightly so that the quantity of water in them is reduced. They should not be lifted completely out of the water or held up too long, as the fish will become very excited and subsequent losses due to jumping out may occur.

7. Harvest after five months, or when the fish have reached the desired size.

Using the costs reported by campesinos who have built ponds in the vicinity of Mateguadua, and the results of the experiments reported here, Professor Patiño makes the following economic projection (Table 1).

According to Professor Patiño's projection, in the first year, with only one harvest and all of the initial costs of construction, a profit of \$1,740 Colombian dollars could be realized. In subsequent years, with harvests up and expenses down, the projected profit would be \$10,980 Colombian, with only two harvests per year. To any such evaluation the benefit of in-

TABLE 1: PROJECTED INVESTMENT
IN AND INCOME FROM A CAMPESINO
FISH CULTURE UNIT

<i>Investment</i> (in \$ Colombian):	
Pond construction, with pick and shovel	\$ 800
Construction of inlet and drainage ditches	400
Cost of twenty-four cages, at \$40 each	960
Food plants	300
Unforeseen costs	540
Total Investment	\$3,000
<i>Annual Maintenance Cost:</i>	
(Including repair of cages)	\$1,500
TOTAL	\$4,500
<i>Income</i>	
Net Production per cage, first year 26 kg	
Production of twenty-four cages,	
first year	624 kg
Value of harvest, first year (assuming a price	
of \$10/kg of fish)	\$6,240
Value of the harvest, second year (minimum	
of two harvests)	\$12,480
<i>As of Summer, 1975, \$28.50 Colombian was the</i>	
<i>equivalent of \$1.00, U. S. Funds</i>	

creased nourishment provided by the fish to the campesino family and to their livestock must be added.

DISCUSSION

Professor Patiño envisions that such ponds could be set up not only on campesino farms, but also "in grammar and high schools, in training schools, vocational agricultural institutes, in SENA, and even in the universities" where they would serve educational, scientific and recreational functions, as well as provide food. He suggests that the crop could be used in school cafeterias or shared among the students. "The development of fish culture should be conceived as a great crusade operating throughout the national educational system," he writes, "How much more useful and functional this type of activities and educational experiences would be than the bland and repetitive textbook instruction which is now given in our centers of education."

I can only add that the need for the type of education and action urged by Professor Patiño extends

far beyond Colombia. The lack of effective aquaculture programs in most of Latin America is obvious. Those few which have been proposed or enacted are mostly concerned with taking advantage of long growing seasons and cheap labor supplies to produce a product for export or sale to the relatively affluent, and confer economic benefit only to the entrepreneur and a handful of laborers. A few plans which have taken better aim at the important economic, nutritional and ecological problems have foundered for a variety of reasons — biological bottlenecks, lack of research funds, failure to approach the problem at a level meaningful to the campesino, etc. Professor Patiño has surmounted these problems to design and test a fish culture system that is ecologically and economically sound with great potential to alleviate some of the problems of Latin America.

— Anibal Patiño R.

Precis by William O. McLarney

REFERENCES

- Hickling, C. F. 1971. *Fish Culture*. Faber and Faber, London. Revised Edition.
- Huet, M. 1970. *Traite de Pisciculture*. Editions Ch. de Wyngaert, Bruxelles. Fourth Edition.
- Kuronuma, K. 1966. *New Systems and New Fishes for Culture in the Far East*. World Symposium on Warm Water Pond Fish Culture. Rome, FAO. FR: VIII-IV/R-1.
- McLarney, W. O. 1973a. Possible Latin American Analogs of Oriental Pond Polyculture Using Indigenous Fishes. Paper presented at the 53rd Annual Meeting of The American Society of Ichthyologists and Herpetologists, San Jose, Costa Rica.
- McLarney, W. O. 1973b. Studies of the Ecology of the Characid Fish *Brycon guatemalensis* in the Rio Tirimbina, Heredia Province, Costa Rica, with Special Reference to Its Suitability for Culture as a Food Fish. *The Journal of The New Alchemists* (1): 52-57.
- McLarney, W. O., and J. R. Hunter. 1975. A New Low-Cost Method of Sealing Pond Bottoms. *The Journal of The New Alchemists* (3): 85.
- McLarney, W. O., and J. H. Todd. 1974. Walton Two: A Complete Guide to Backyard Fish Farming. *The Journal of The New Alchemists* (2): 79-117.
- de Menezes, R. S. 1966. *Cria y Seleccion de los Peces Cultivados en Aguas Templadas en America del Sur y Central*. FAO World Symposium on Warm Water Pond Fish Culture. FR: IV/R-5.
- Ramos, H. A. 1971. Las Tilapias en Colombia. *Revista Esso Agricola*, No. 6.



NA

The poem "Populist Manifesto" by Lawrence Ferlinghetti, which opens this section of Explorations, was a totally unexpected windfall. Apparently Ferlinghetti had given the poem, without copyright, to a few of his close friends and favourite publishers trusting that they would know where to place it. Happily for us, we share a friend with Ferlinghetti, and it was our mutual friend, Sasha Hoffman, who gave us the poem for publication in the Journal.

With "Meditations on the Dark Ages, Past and Present" by William Irwin Thompson, we move into heady terrain indeed. Bill Thompson, one of the visionaries of the New Age, is known for his books, "At the Edge of History" and "Travels About Earth", and as the founder of the Lindisfarne Association. Like so many Irishmen, he is a spellbinding talker, but in his case his words are backed by profound knowledge of cultural history and a unique ability to bring together and synthesize apparently disparate ideas and philosophies.

The second article was prompted by a meeting one afternoon with an old friend, Ruth Hubbard, and her co-worker, Nancy Milio. We were so impressed with the potentialities of their ideas for offering genuine alternatives in health care that we asked them to write a short description of them for the Journal. The concept of a demystified, decentralized preventive approach to medicine is surely as critical as that of appropriate technology and, so far, has received far less attention. We hope that their project will be a giant first step toward change in both the practice of medicine and the maintenance of health.

My own article "Women and Ecology" was written for the 1974 summer session of the Social Ecology course given by Murray Bookchin at Goddard College in Vermont. Quite a lot has happened in the year since it was written. It is too soon to know what, if any, the far-reaching consequences of the United Nations Women's Year will be. The authoritarianism of Indira Gandhi gives little encouragement to the idea that the emergence of the feminine voice will result in fundamental change but what I think we are beginning to see is a groundswell of hitherto unknown participation by women in human affairs. It may be a generation or so before we shall be able to assess the results.

-NJT

Explorations



Photo by Hilde Ateni Mairgov



Populist Manifesto for Poets with Love

Poets, come out of your closets,
Open your windows, open your doors,
You have been boled-up too long
in your closed worlds.
Come down, come down
from your Russian Hills and your Telegraph Hills,
your Beacon Hills and your Chapel Hills,
your Brooklyn Heights and Montparnasses,
down from your foot hills and mountains,
out of your tepees and domes.
The trees are still falling
and we'll to the woods no more.
No time now for sitting in them
As man burus down bis own bouse
to roast his pig.
No more chanting Hare Krishna
while Rome burns.
San Francisco's burning,
Mayakovsky's Moscow's burning
the fossil-fuels of life.
Night & the Horse approaches
eating light, heat & power,
and the clouds have trousers.
No time now for the artist to hide
above, beyond, behind the scenes,
indifferent, paring his fingernails,
refining himself out of existence.

No time now for our little literary games,
no time now for our paranoias & hypochondrias,
no time now for fear & loathing,
time now only for light & love.
We have seen the best minds of our generation
destroyed by boredom at poetry readings.
Poetry isn't a secret society,
It isn't a temple either.
Secret words & chants won't do any longer.
The hour of oming is over,
the time of keening come,
a time for zeening & rejoicing
over the coming end
of industrial civilization
which is bad for earth & Man.
Time now to face outward
in the full lotus position
with eyes wide open,
Time now to open your mouths
with a new open speech,
time now to communicate with all sentient beings,
All you 'Poets of the Cities'
hung in museums, including myself,
All you poet's poets writing poetry
about poetry,
All you poetry workshop poets
in the boondock heart of America,
All you bouse-broken Ezra Pounds,
All you far-out freaked-out cut-up poets,
All you pre-stressed Concrete poets.

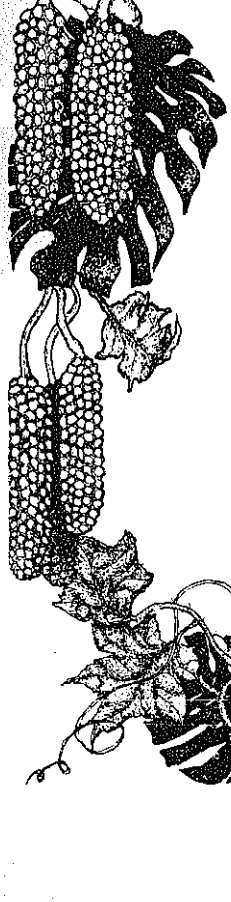



*All you cumilingual poets,
All you pay-toilet poets groaning with graffiti,
All you A-train swingers who never swing on birches,
All you masters of the sawmill haiku
in the Siberias of America,
All you eyeless unrealists,
All you self-occluding supersurrealists,
All you bedroom visionaries
and closet agitpropagators,
All you Groucho Marxist poets
and leisure-class Comrades
who lie around all day
and talk about the workingclass proletariat,
All you Catholic anarchists of poetry,
All you Black Mountaineers of poetry,
All you Boston Brahmins and Bolinas bucolics,
All you den mothers of poetry,
All you zen brothers of poetry,
All you suicide lovers of poetry,
All you hairy professors of poezie,
All you poetry reviewers
drinking the blood of the poet,
All you Poetry Police --
Where are Whitman's wild children,
where the great voices speaking out
with a sense of sweetness & sublimity,
where the great new vision,
the great world-view,
the high prophetic song
of the immense earth
and all that sings in it
And our relation to it --
Poets, descend
to the street of the world once more
And open your minds & eyes
with the old visual delight,*

*Clear your throat and speak up.
Poetry is dead, long live poetry
with terrible eyes and buffalo strength.
Stop mumbling and speak out
with a new wide-open poetry
with a new commonsensual 'public surface'
with other subjective levels
or other subversive levels,
a tuning fork in the inner ear
to strike below the surface.
Of your own sweet Self still sing
yet utter 'the word en-masse' --
Poetry the common carrier
for the transportation of the public
to higher places
than other wheels can carry it.
Poetry still falls from the skies
into our streets still open.
They haven't put up the barricades, yet
the streets still alive with faces,
lovely men & women still walking there,
still lovely creatures everywhere,
in the eyes of all the secret of all
still buried there.
Whitman's wild children still sleeping there.
Awake and walk in the open air.*

- Lawrence Ferlinghetti





Meditation on the Dark Ages. Past and Present

All forms hold energy against the flow of time. Spread the energy of a sun equitably throughout space, and you will subtract a star from the heavens. Gather up the galactic dust of space in a spiral, and you can compress the dust into a sun. Expansion and contraction, expression and compression: so the universe goes. Once it was a single atom that began to expand in an explosion; and now it will continue to expand until it reaches the ultimate limit of entropy. With the energies of the aboriginal cosmic atom spread equitably throughout space, it will all be over in the heat-death of the universe. It is only a matter of time, or, rather, the matter of time. From hot to cold, from order to disorder, from creation to entropy: over it all the Second Law keeps watch, and black holes compose the light of gravity-collapsing stars.

Modern optimists like Buckminster Fuller like to speak of "synergy," as if there were some magic form that could hold out against the laws of thermodynamics. Surrounded by the signs of an impending tragedy, the collapse of his whole industrial civilization, the liberal optimist refuses to believe in tragedies anymore: the past was tragic because they did not have computers in those days. Liberals like Zbigniew Brzezinski and Herman Kahn believe we can eliminate the tragic flaw in man: following Brzezinski, we can replace the chaos of politics with the systems of management; following Kahn, we can hook up the brain to computers to create an electronic superman.¹ In the science-fiction vision of Arthur C. Clarke², the ultimate society of the future will be programmed by a giant computer, and politics, economics, art, and entertainment will be taken care of in a domed city whose magic circle keeps out chaos and old night.

Although that miracle seems far off, Buckminster Fuller is still reaching out for it and has already drawn a sketch of a dome over Manhattan. For men like Fuller, Brzezinski, and Kahn, tragedy is inconceivable. Their faith in progress is so unthinking that they cannot help but believe that some technological miracle will deliver us at the last dramatic moment. Though we have not been reared on myth, we have all been raised on movies and believe that just as all seems lost and the savages are about to burn the circle of covered wagons, the cavalry will charge in with a joyous noise of bugles and salvation.

The Greeks knew better. Anaximander presided over the case in 560 B. C. and delivered the following judgment:

The Non-limited is the original material of existing things; further, the source from which existing things derive their existence is also that to which they return at their destruction, according to necessity; for they give justice and make reparation to one another for their injustice, according to the arrangement of Time.³

They make reparation for the sin of their existence, for the breaking up of the One into the many. The pieces of the One are things, and things are what man holds onto to maintain the vanity of his own existence.

And before Anaximander, Homer knew better. When the Achaeans invade Troy, they build a wall upon the shore where their ships are beached. Nature builds permeable membranes, but only man is vain enough to build a wall. Behind that human form set between the opposites of sea and land, man holds out for a while. But after that while, the forces of erosion wear it down, and all that bright armor is tumbled into mud.

So within the shelter the warlike son of Menoitos tended the stricken Eurypylos, and meanwhile the Argives and Trojans fought on in massed battle, nor was the Danaans' ditch going to hold them back nor the wide wall above it they had built for the sake of their ships, and driven a deep ditch about it, and had not given to the gods grand sacrifices so that it might guard their running ships and their masses of spoil within it. It had been built in despite of the immortal gods, and therefore it was not to stand firm for a long time. So long as Hektor was still alive, and Achilles was angry, so long as the citadel of Lord Priam was a city untaken, for this time the great wall of the Achaeans stood firm. But afterwards when all the bravest among the Trojans had died in the fighting, and many of the Argives gone in their ships to the beloved land of their fathers, then at last Poseidon and Apollo took counsel to wreck the wall, letting loose the strength of rivers upon it, all the rivers that run to the sea from the mountains of Ida, Rhesos and Heptaporos, Karesos and Rhodios, Grenikos and Aisepos, and immortal Skamandros, and Simoeis, where much ox-hide armour and helmets were tumbled in the river mud,

and many of the race of the half-god mortals. Phoibos Apollo turned the mouths of these waters together and nine days long threw the flood against the wall, and Zeus rained incessantly, to break the wall faster and wash it seaward. And the shaker of the earth himself holding in his hands the trident guided them, and hurled into the waves all the bastions' strengthening of logs and stones the toiling Achaeans had set in position and made all smooth again by the hard-running passage of Helle and once again piled the great beach under sand, having wrecked the wall, and turned the rivers again to make the way down the same channel where before they had run the bright stream of their water.⁴

As long as Achilles is angry, the war goes on. As long as passion is attached to form, the conflict rages.

Beneath us is the molten core of earth, above us is the burning radiation of the solar wind. Behind the wall of the earth's magnetic field, we keep ourselves together until those apocalyptic times when the poles reverse themselves and every valley is exalted and every hill made plain.

Whether it is the thin film of the biosphere, or the thin wall of the Achaeans, man lives at an interface between opposites: earth and sky, sea and shore, life and death. Yet it is precisely the interface between opposites that is the place of transformation, and the energy of that transformation comes from remaining poised at the perilous edge; a slight movement to either side brings dissolution into uniformity.

We live at an interface between order and disorder, and cannot move into one singly without destroying the disequilibrium that is basic to change and evolution. Order and disorder, energy and transformation: it almost seems molecular. Put enough energy into the lattice and the metal will turn into a gas; slow down the volatile gas, and you can have metal to outlast an eon. Once again, the Greeks seem to have understood the nature of the choice. In Thucydides' *Peloponnesian War*, the choice is dramatized in the conflict between Sparta and Athens. Be like Sparta and you can live with your highly ordered, barrack-like institutions intact for eight hundred years; be like Athens and you can create everything we know as Greek culture and burn out in ninety years. It is a choice between a Spartan death in life, or an Athenian life in death. And the choice is all a matter of values.

How does one hold onto values in an age of the collapse of values? How does one create forms in an age when all forms are coming apart? Like the wall of the Achaeans, our industrial civilization has been built in despite of the gods and now the forces of nature are wearing away at it. But this is not the first time individuals have had to live on while the light of their civilization sputtered.

Like the sixth century A. D., the sixth century B. C. was an age of darkness. The civilizational waves of Sumer and Egypt were receding; whatever was left of the original cultures was lost in the mud and shallows of militaristic states. R. M. Adams has shown that, in the evolution of urban society in Mesopotamia and Mesoamerica, cultures began as theocracies, became militaristic politics, and ended up as conquest states.⁵ Another way of looking at this evolutionary process is to see that a culture begins in an explosion of myth, a sacred image of nature, self, and society that unites all men in a common dream, and then slowly the forces of routinization take over and the dream begins to fade. The prophet becomes a priest; the shepherd-king becomes a Solomon the Magnificent. As the forces of palace, marketplace, and army develop, the myth decays until nothing holds man together but brute force. The disintegrating polity is finally compressed into the militaristic fascist state. Since every state organized for conquest also organizes its enemies to conquer it, such militarism creates the dismal cycle which leads to the destruction of civilization.

According to tradition, Pythagoras was carried away from Egypt to Babylon by the conquering armies of Cambyses. One can picture the historical landscape against which the sage moved: nothing left of the civilization of either Egypt or Babylon, only a recent memory of the unending movement of armies: Hebrew, Assyrian, Persian, and Mede. The light of civilization that had flamed up in the fourth millennium B. C. was now going out, but in the dim light the shadows threw into greater relief the very weakness of that form of human culture.

Civilization had been based upon writing, on the break-up of the unity of the tribe into the literate and the illiterate. It had been based upon urbanization, on standing monuments and standing armies, and, ultimately, upon slavery. The polarities of the age of civilization were the center and the periphery, the temple of the priest and the desert of the prophet. As the centers had decayed, the pastoral vision of the eternal desert had been expressed by Abraham, Moses, and Amos. Then in the sixth century B. C. a new wave of prophecy arose and addressed itself not merely to the moral decay of one center, but to the moral decay of the very idea of civilization itself. Across the world, from Italy to China, a new race of prophets confronted the contradictions of civilization. The vision of the prophets was one of universal religions. It was not a validation of one's own tribal god, for that too easily could grow into the civil religion of a conquest state; it was a vision of the aboriginal brotherhood of man that stood before the walls and battlements of civilization had been raised.

The sixth century B. C. is one of the darkest and the brightest periods in history; it is the age of the Second Isaiah and Daniel, Jeremiah, of Pythagoras and Zoroaster, of Buddha, Lao Tzu, and Confucius. Why did they all come at the same time? A Jungian would invoke the collective unconscious of the race, a Hopi would speak of the *kachinas* from other worlds who supervise our evolutionary development, and a Christian poet would answer:

*Because the Holy Ghost over the bent
World broods with warm breast and with ab!
bright wings.*

Let us indulge in a Pynchonesque paranoid fantasy to image that the prophets of the sixth century are part of one universal conspiracy. Religion is, after all, supposed to be a subversive conspiracy. "For we wrestle not against flesh and blood, but against principalities, against powers, against the rulers of the darkness of this world, against spiritual wickedness in high places."⁶ Certainly the conspiracy-theory of history would explain what Pythagoras and Zoroaster were doing together in Persia.⁷

From Egypt and Mesopotamia, Pythagoras took his experience of the mystery schools to the western lands of Magna Graecia in Italy to establish something new, not a hierophantic mystery school for temple initiates, but a secular school for the leaders of society. In short, Pythagoras built the first university and laid the foundations in mathematics, music, and physics for the science upon which Western Civilization is built.

Marshall McLuhan has described the process of change as one in which the sloughed-off environment becomes a work of art in the new invisible environment.⁸ This is one way to present the Hegelian dialectic of historical growth. A visual image of the process of *aufheben* is the spiral: we turn back to the past, reconstitute it, and then turn away from it in a new direction. The strategy of change for Pythagoras was to make a synthesis of the religion and science of the dying Near Eastern civilizations, and then miniaturize them as a work of art in the new and still invisible environment of Western Civilization. The old culture became a curriculum in the new culture. In terms of paleontology, this kind of evolutionary change is an example of the principle of Romer's Rule: "The initial survival value of a favorable innovation is conservative, in that it renders possible the maintenance of a traditional way of life in the face of changed circumstances."⁹

At the time of Pythagoras, the Egyptian mystery schools were no longer forces of culture and civilization-building; they were probably priestly bureaucracies subsidized by the state to pass on harmless traditions by rote. The only way to recreate the original purpose of the mystery school was to do something radical, radically conservative. And so Pythagoras created the secular school, the university.

As civilization was moving toward entropy, he created a new form to hold old values against the flow of time.

The tragic background against which the school of Pythagoras at Croton was figured continued, however, to its end. Many were accepted into the Pythagorean discipline, but some were rejected as morally unfit. One of the rejected students is reputed to have raised a rebellion against the influence of the school. In the conflict, the school was burnt to the ground. The Pythagoreans fled throughout Greece, but, in their flight, they took the message to the Greek world. Like a seed-pod exploding in its death, the school created new lives, and one of those lives was Plato and his Academy.

Plato's Academy lasted from 385 B. C. to 529 A. D.; it became the archetype for all the universities that followed. Pythagoras's school at Croton lasted for only twenty years. The Pythagorean tradition went underground, but like an underground spring it flowed beneath the foundations of many of the schools that came after. Iamblichus in Syria, Ficino in Florence, Copernicus in Frauenberg, Bruno in Nola, and Heisenberg in Munich: all identified themselves as Pythagoreans. Pythagoras may have died as an old man in exile and despair at the destruction of his life's work, but the success of his short-lived experiment rivals the success of institutions that endured for centuries.

The Pythagorean school at Croton and the Platonic Academy in Athens exemplify two different ways to hold values against the forces of disorder. One form is the cultural strategy, the other is the permanent institution. One short-lived strategy that affected the life of British civilization, with such longer-lived institutions as Canterbury, Oxford, and Cambridge, was the monastery-school of Lindisfarne. Founded in 634 on Holy Island off the coast of Northumbria, Lindisfarne was another attempt to create light in an age of darkness.

Once again, the sloughed-off environment became a work of art in the new invisible environment. The old Graeco-Roman civilization became a curriculum in the new invisible environment of Christian civilization. The school at Croton was not an Egyptian mystery school, and the monastery-school at Lindisfarne was not a Roman Catholic church, but an Irish one. The Roman Church was based upon the imperial model; each city contained a bishop who was answerable to the bishop of bishops in the mother of cities in Rome. There were no cities in ancient Ireland and Scotland, and so the monastery was set in a totally different culture. The abbot of a monastery was no prince of a church, but a common priest. The Irish Church was no outpost of an imperial ecclesiastical Roman legion, but the continuation of archaic religious forms derived from pagan Ireland and syncretistic Egypt.

If, according to Romer's Rule every innovation is conservative, it is easy to see that the innovations of the Celtic Church enabled some of the old mystical traditions, of archaic Ireland to live on under changed historical circumstances. As Pythagoras had out-mystified the hierophants of the mystery schools of Egypt, so St. Columba out-druided the druids.¹⁰ In each case, the innovator was more in the spirit of the tradition than the traditionalists.

The Celtic Church identified itself as the mystical Church of John and not the temporal Church of Peter, and, until the Synod of Whitby in 664, which was to shift the influence away from the Celtic to the Roman Church, Lindisfarne was the voice of Christianity in England. With the monastery school as their base, the great saints Aidan and Cuthbert went forth to convert pagan England. In less than thirty years, the work was done. After the defeat of the Synod of Whitby, the Irish monks under Colman went back to Iona from Lindisfarne. Though some monks stayed behind, the great age of Lindisfarne was over. At the turn of the eighth century, the Lindisfarne Gospels were illuminated in memory of Cuthbert, but even great art could not defend the vision. A few years later, Lindisfarne was overrun by the Danes and burnt to the ground.

The burning of Lindisfarne, like the burning of the school at Croton, reveals that many of these efforts to create light are figured against intensely dark backgrounds. In modern times the Bauhaus seems to be a preeminent example of a cultural force arising at the same time that the opposite forces of Nazism were growing all around it. And once again, it was the very dissolution of the Bauhaus that carried its energies to London and Chicago.¹¹

What we can learn from Croton, Lindisfarne, or the Bauhaus is that a small and short-lived community can serve as a catalytic enzyme to effect a change in the entire organism of a civilization, and that sometimes these changes are as important as the more obvious contributions of permanent institutions. Institutions are appropriate structures for the continuation of a tradition, but they are not appropriate forms for the creation of the new or the revitalization of the old.

The other principle we can learn from Croton and Lindisfarne is the necessity of conserving a civilization by intensifying it through miniaturization. Pythagoras miniaturized the Near-Eastern civilization; the Irish monks miniaturized Graeco-Roman civilization; now we need to miniaturize industrial civilization.

The sloughed-off environment is industrial civilization; the invisible environment is what Teilhard de Chardin called "the Planetization of Mankind." To turn industrial civilization into a work of art in this still invisible environment, we must not only miniaturize our factories, we must also miniaturize the great universal religions which created the basis

of internationalism. The universal religions were created in response to the contradictions of civilization, but we are no longer living in civilization. The polarities between elitist center and provincial periphery have been overcome by modern communications and spiritual consciousness. Planetary culture is not the international civilization of London, Paris, Tokyo, and New York; it is the new consciousness in which "The center is everywhere and the circumference nowhere." The universal religions were the precursors of planetary culture, but now that we are moving from civilization to planetization, we need to take up (*aufheben*) these religions and miniaturize them in a curriculum for a new culture.

If we are going to humanize a technology that now contains thermonuclear warfare, ecological destruction, and such subtler destructions as psychosurgery, electronic manipulation of the brain, aversive therapy, and behavioral modification, we will need more than the liberalism expressed in the implicit system of values of the behavioral sciences and the traditional humanities. The world view of the liberal intellectual is a Marxist-Freudian mapping of the outer world of society and the inner world of the psyche; but that sophisticated world view does not contain the celestial and ethonic energies we need to appreciate the machine for what it is worth. To see technology in proper scale, we need cosmic consciousness, and that consciousness comes more often from meditation than from reading Marx or Freud.

If we cannot humanize our technology with liberal humanism, we can with animism. And that is the importance to the contemporary world of animistic communities like Findhorn.¹² If we can converse with plants, hear the spirits of wind and water, and listen to the molecular chorus singing the ninety-nine names of God in the crystal lattice of the metal of our machines, then we can have the consciousness we need to live in a culture in harmony with the universe.

In an unconscious fashion, man has already begun to shift away from materialism to information, and the giantism of the machines he once worshiped is giving way to tiny circuitry. If the space program sent off rockets to the moon that were taller than skyscrapers, it spun off to earth machines in which millions of electrons danced on the head of a pin. As our entire technology becomes as miniaturized as our hand-held calculators and desk-top computers, the whole scale of the human body to technology changes. Like paleolithic hunters of the Solutrean culture, whose tools were pieces of sculpture in their hands, we will hold our technology and not be held by it.

As the scale of man to machine changes, so does the scale of the individual to institutions. In an electronic technology, one need not drive to a

Berkeley-type university to watch a lecture on a television console with four hundred other students; he can stay home to watch the Berkeley university program on cable television, and, if he doesn't like Berkeley, he can switch the channel to Harvard or Oxford. As more students stay home, and as more information is carried on cable, the university will no longer have to sustain a huge complex of buildings. The university will grow smaller as it grows larger and the university will be everywhere and the campus nowhere.

As more and more information is carried in the home, the individual will experience a need for new groupings. On the turn of the spiral, man will return to the tribal forms of the hunters and gatherers, and in these societies, "The magic numbers are 25 and 500."¹³ As the individual moves out of the environment of the institution, a symbolic environment in which he gains his information through the reading of buildings and books, he moves into the larger environment of the Noosphere, a vibratory environment he experiences through meditation, ritual chanting, and dance. As the cosmic environment expands in the Noosphere, the human community compensatorily contracts into the hunting band of 25 or the planetary village of 500.

As one moves from the institutions of civilization in church, university, and capital-intensive factory into the new planetary villages, he moves into a religion without priests, a university without professors, and manufacture without factories. The factory mass produces cheap goods with built-in obsolescence, but in an era of scarcity of materials in which "The Limits to Growth" are envisaged, we will no longer be able to afford the waste of energy and materials contained in the mass production of cheap goods. Of necessity, we will have to return to the medieval craft-guild workshop. Since the goods will have to be crafted to last a lifetime, they will have to be built with a Zen mindfulness to every detail, and so the labor-intensive workshop will contain, not an army of workers, but a mystery-guild of contemplatives. Like the furniture of the Shakers, the goods of the planetary village will be very good indeed.¹⁴

In a labor-intensive community of contemplatives, more is done with less capital, so money is surounded, compressed, and miniaturized by a culture not based upon greed. As inflation prices industrial civilization out of existence, communities of caring and sharing are brought into being and families are forced into finding other means than money to structure their lives. In a culture of Buddhist "Right Livelihood", money is not eliminated, any more than technology; both are miniaturized. The Buddhist tone of "Right Livelihood" may sound foreign to the American Way, but, interestingly enough, just

such a political economy was envisioned by Jefferson. In words that ring out as a startling prophecy of our contemporary fascination with decentralized China, Jefferson wrote to Hogendorp in 1785:

You ask what I think on the expediency of encouraging our States to be commercial? Were I to indulge my own theory, I should wish them to practise neither commerce nor navigation, but to stand, with respect to Europe, precisely on the footing of China.¹⁵

As the Church lost the vision of its founder, so has the country lost the vision of its founding fathers. But now that industrial society is strangling in its own contradictions, we have one last chance to re-vision human society.

The Protestant Ethic and the Spirit of Capitalism spurred the growth of industrial civilization, so it is natural to assume that the growth of planetary culture is being spurred by a new spiritual sensibility. Side by side with the miniaturization of technology, we are also experiencing the miniaturization of the great universal religions. The esoteric is the miniaturization of religion, and just about every esoteric school is now opening itself to the new global culture of our technological society. Yoga, Sufism, Tibetan and Zen Buddhism, Yaqui Shamanism, and Celtic animism: the planet has become a Ptolemaic Egypt of syncretistic religious movements and the Alexandria of it all is America. And this is no accident, for all these esoteric techniques have what we need to transform our exoteric technologies. Europe and Asia groan under the burden of their own past greatness, but America is still the place where all the cultures of the world can come together in consummation of the past and realization of the future.

At the contemporary Lindisfarne in America, we have tried to turn the old culture into a new curriculum. We have neither guru and disciples nor Church and worshippers, but we do have a spiritual fellowship in which men and women serve as teaching fellows in Yoga, Buddhism, Sufism, Esoteric Christianity, and Mystical Judaism. In a college, the curriculum is based upon the Great Books of Western Civilization, but at Lindisfarne the curriculum is based upon the Great Techniques for the transformation of consciousness. Lindisfarne's scientists, artists, and scholars have one thing in common: their lives are rooted in one of the great contemplative paths of transformation. As the school at Croton was not a mystery school, and as the monastery at Lindisfarne was not a Roman Catholic Church, so we are not a simple continuation of the past. We have a farm, but are not a farm; we have children in the community; but we are not a private school; we have post-doctoral fellows, but are not a think-tank; we have retired people, but are not a retirement community; and we have yogis, but we are not an ashram. We

have gone back on the spiral to the pre-industrial community to create, on a higher plane with the most advanced scientific and spiritual thought we can achieve, the planetary village. We have moved in consciousness out of the large nation-state into the even larger planet; we have moved out in body from the city to the smaller multi-generational community. With the economic thought of E. F. Schumacher of London, the technological thought of the New Alchemists, the agriculture of Findhorn, the scientific philosophy of Whitehead, and the religious thought of Sri Aurobindo and Teilhard de Chardin, we are trying to create an educational community that can become a mutational deme in which cultural evolution can move from civilization to planetization to planetization.

In the nineteenth century the polarities of culture were the romantic artist and the industrial engineer. Then Shelley could say that: "Poets are the unacknowledged legislators of the world." But now that is no longer true. In the shift from civilization to planetization it is the mystic who has become the unacknowledged legislator of the world: a Sri Aurobindo or a Teilhard de Chardin, and not a Norman Mailer or an Andy Warhol. The artist cannot save civilization, and in the search for form it is not the artist who will discover and create the new culture. We have lived long enough with the myth of The Artist, and now that the paintings decorate banks and the poems lead to suicide, it is time to move on and let the artist remain behind, whimpering in the corners of his mind.¹⁶

In abandoning The Artist we will not lose the beautiful, we will regain the beauty the artist lost sight of. Pythagoras, Columba, Quetzalcoatl: the builders of cultures were themselves versed in the arts of civilization and could provide the myths that would sustain new artists for generations.

Art is dead. Science is dead.¹⁷ Now even the Pope is willing to say that: "It seems the Church is destined to die."¹⁸ Our entire civilization is dying. But what is death? Consider the yogi: when he stops his heart consciously, he is dead by technical definition, but actually he is reborn, for in taking the energy out of the cardiovascular into the central nervous system, he experiences ecstasy and enlightenment. He does not die,

he dances his death. So now we need to dance out the death of industrial civilization and experience, not its painful, apocalyptic destruction, but its joyous, millennial de-structuring. And if we cannot, then we will not create our destiny, but be forced to endure our fate.

1. Herman Kahn and Anthony Weiner, *The Year 2000: A Framework for Speculation on the Next Thirty-Three Years* (MacMillan, New York, 1967). Zbigniew Brzezinski, *Between Two Ages: America's Role in the Technetronic Era*, (Viking, New York, 1970).
2. Arthur C. Clarke, *The City and the Stars* (Macmillan, New York, 1953).
3. Kathleen Freeman, *Ancilla to the PreSocratics* (Harvard, Cambridge, 1962), p. 19.
4. Homer, *The Iliad*, trans. Richmond Lattimore, Book XII, 11. 1-33 (University of Chicago, 1961).
5. R. M. Adams, *The Evolution of Urban Society*, (Aldine, Chicago, 1966).
6. Letter to the Ephesians, 6:11-12.
7. W. K. C. Guthrie, *A History of Greek Philosophy: Volume One, The Early PreSocratics and the Pythagoreans*, (Cambridge University Press, 1971), p. 254.
8. Marshall McLuhan, *Understanding Media*, (McGraw-Hill, New York, 1966).
9. Charles F. Hockett and Robert Ascher, "The Human Revolution," in Yehudi Cohen's *Man in Adaptation: the Biosocial Background*, (Aldine, Chicago, 1968), p. 216.
10. Lucy Menzies, *St. Columba of Iona* (The Iona Community, Glasgow, 1974), p. 45.
11. Hans Winkler, *The Bauhaus: Weimar, Dessau, Berlin, Chicago* (M. I. T. Press, Cambridge, 1969).
12. See my *Passages About Earth*, Chapter Seven, (Harper & Row, New York, 1974).
13. John Pfeiffer, *The Emergence of Man* (Harper & Row, New York, 1971), p. 332.
14. See E. F. Schumacher, *Small Is Beautiful: Economics as if People Mattered* (Harper & Row, New York, 1974).
15. As quoted in *Thomas Jefferson on Democracy*, ed. Saul K. Padover, (Mentor, New York, 1939), p. 69.
16. Saul Bellow, "Machines and Storymakers", *Harpers*, August 1974, p. 48-59.
17. Gunther S. Stent, *The Coming of the Golden Age: A View of the End of Progress* (The American Museum of Natural History, New York, 1969).
18. *Newsweek*, November 4, 1974, p. 69.

The ideas of miniaturization used in this essay come from Teilhard de Chardin (*See Man's Place in Nature*, p. 47), and from Paolo Soleri's development of Chardin in *Arcoology: the City in the Image of Man*. (M.I.T., Cambridge, 1969).

- William Irwin Thompson

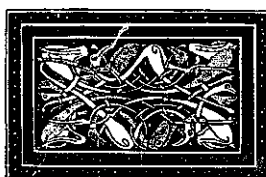

Self-Health:

Exploring Alternatives in Personal Health Services

THE PROBLEM COMPLEX

Health Services and Society

In recent years much of the discussion about health care problems has centered on a "crisis" which is defined in terms of rising costs, lack of necessary primary (basic) services, and inequitable access to existing services by certain groups, particularly poor people, rural dwellers, older people, blacks, and women.¹ Underlying these and related problems is the fundamental issue that modern health services, of which the United States has the high technology prototype, make the same excessive use of natural resources and capital as do many other phases of our energy intensive, oligopolistic society and therefore serve to reinforce them. The common root lies in the manner in which our society directs the use of its resources, including its technology, toward accelerating the growth of affluence especially for those who are in positions to decide on the allocations of resources and the direction of private and public policy.

Defining the "best" and "quality care" to mean specialized services, a system has been developed for the care of health and its repair which overwhelmingly emphasizes specialized facilities, equipment, and personnel. Of necessity, centered in large and therefore impersonal (inpatient) institutions, these services are energy and capital intensive to develop, use, and maintain. The costs must be seen to include the length and types of training required for the more specialized and highest earning personnel. The training of physicians now absorbs from two-thirds to three-fourths of all health training funds from private and public sources.

Such patterns have built-in cost escalators. These arise principally from the increasing costs of energy and capital, and from the entrepreneurial nature of drug and equipment firms as well as physicians, who have the greatest influence on the patterns of health services utilization. The current system is further *inequitable* in its effects. This is not only because high costs deny access to those with low incomes. Inequities arise because (1) the system must be based in large urban areas in order to sustain itself and also because (2) the structure of the occupational pyramid most often allows only those privileged by long, costly educations and advantageous family connections to reach the higher paying, more secure positions, with the results that these are filled mainly by white men from metropolitan, affluent backgrounds.

Effects of Health Services

As is well known, the resulting pattern of health services is quite different from what it would be if its design were based on illness patterns of the vast majority of people in this country.

The most prevalent acute and chronic diseases, with few exceptions, are either simple and self-limiting or untreatable, and usually bothersome for those who have them. Basically, therefore, symptomatic relief is in order. Extensive attempts at diagnosis and treatment, especially in large, specialized settings, expose patients to such risks to their health as drug reactions, infections, and the unnecessary use of radiation and of surgery. These are incurred more frequently by poor people, women, and children. No less important is the almost inevitable sense of isolation and helplessness fostered by these large organizational settings.

In brief, the most frequent acute problems (e. g., respiratory diseases, injuries, dental caries), chronic processes (sinusitis, arthritis, high blood pressure, varicose veins, hemorrhoids), and death-causing illnesses (heart disease, lung and gastro-intestinal cancer, stroke) are closely tied to our societal patterns, which are reflected in the amount and types of food we eat, the stresses of competition and of compressed time schedules, speed, noise, accidental and other violence, and the consequent use of artificial and purchasable forms of relaxation (nicotine, alcohol, caffeine, and other drugs), passive leisure and the concomitant lack of exercise, and the pollutants that stem from our uses of technology.

The illness patterns of poor people in societies as affluent as ours differ somewhat from those of the majority, because they are deprived of the possibilities of health sustaining resources, such as adequate food, access to fresh air, and good housing. They tend therefore to have more severe forms of the acute diseases, which the affluent can prevent or have treated successfully. They also incur more of the chronic diseases typical of a modern, affluent society, and with more disabling effects. The crux of the matter is that, just as the pattern of health services reflects the society, the pattern of illness stems from the life patterns we follow. In the face of damaging life situations, health services, as we know them, can do little to prevent or cure most present illness. At best, they can control some of the damage and delay a few debilitating and life-threatening processes.

Reinforcement by Reforms

Reform efforts have centered largely on (1) increasing the supply of primary services, which are less costly and can be delivered in ambulatory health centers, (2) distributing services to areas which lack them — mostly rural and poor communities, and less energetically to date (3) determining which services are, in fact, beneficial and cost-effective for improving health. This last point has become increasingly urgent as tax funds pay increasingly larger shares for the development, use of, and training for health services.

However, typical of U. S. social change, reforms are not systematic and well-planned. The sheer, often organized, strength of those who see their interest in maintaining the status quo permits only piecemeal compromises in legislation and in implementation of policy. This places severe limits on whatever positive impact reforms might have for consumers.

Further, most of the types of changes now being developed are not likely to be more equitable and cheaper than the health services we have at present. Such changes are mainly (1) energy intensive in that they require specialized satellites, computers, record-keeping, monitoring by hardware and ever-changing, repair-demanding information systems. (The lack of cost effectiveness of multiphasic screening and the overuse of laboratory and other diagnostic tests by physicians and non-physician practitioners are but two examples.) (2) Where the innovations are more labor intensive and involve training new types of non-physician primary care personnel such as physician assistants and nurse practitioners, the reforms are inequitable. Lower-income people, minorities, and women, who are entering these new ranks, receive cheaper, shorter training, and end by working for modest salaries under the direction of highly paid, fee-for-service physicians, serving proportionately more lower-income, rural, non-white patients.

Thus, in spite of some attempt at reform, the occupational pyramid that characterizes the 4½ million health service personnel is not changing its shape. More steps are merely being inserted. Should this continue, under the current delivery patterns, basic health services will be given to the lower income groups by non-physician generalists and to the more affluent by physician specialists. In this way, the "new health professions" relieve the specialized of the pressure to change.

To the problems raised by the piecemeal approach and by the cost-inflationary, inequitable character of reforms must be added the doubt that reforms so packaged could convey to the patient the sense of being-cared-for which seems crucial in the mobilization of whatever internal-external resources for healing he possesses, whether these be tangible and measurable or not.

One or two extensive and systematic proposals for reform have been introduced into the Congress, but their net effect may well neither reach the desired equity and cost-effectiveness, nor substantially improve health in this country. This is mainly because their eventual passage and consequent implementation, even if unencumbered by many all-too-likely weakening compromises, would take at best ten to fifteen years, by which time they would be outdated. By then it will be clear to more than the few, who now are "crying in the wilderness", that even an excellent system of personal health services, as we know them (currently costing over a hundred billion dollars a year), cannot do much to improve the health of a high technology, affluent society as we know it.

Successes Elsewhere

Other countries, both affluent and poor, which have improved the health of their populations, have done so by taking some of the things we attempt piecemeal and added other components. These have been integrated into a unified system of health services, which is decentralized in its delivery of care to the population and is operated on a non-profit basis. More importantly, they have tied the system into the planning and implementation of programs of community development which assure the production and improved distribution of critical health-sustaining resources, including food, water, income, housing, environmental protection, transportation and communication, etc.²

The Context for Alternatives

Those who seek to improve health rather than repair damage must view the problem in the context of

- (1) the environmental conditions for health, including
 - (a) the supply of critical health-sustaining resources, avoiding forms with negative effects, and
 - (b) the distribution of those resources to avoid both excesses and deficits; and
- (2) the impact and limitations of a personal health service system on prevention and amelioration of illness, and repair of damage, including
 - (a) the production and supply of safe and efficacious services and
 - (b) their distribution to those who need them (see the diagram).

A SEARCH FOR AN ALTERNATIVE

With this overall perspective, we have formed an organization called Alternatives in Health Care, which is undertaking to develop a self-health system. Our specific aim is to develop systematically the information base and methods for an organized, community-based program of self-health, with linkages to health and other community services and health-sustaining resources (e. g., food co-ops, transportation, etc.), and to plan for its implementation and evaluation.

We envisage the content of self-health to be a systematized, contemporary "folk wisdom", that has been checked for its safety and, where needed, includes the use of appropriate (i. e., simplified, low cost) technology. Such a program of self-health would allow persons as individuals and as members of various family-household arrangements to develop their capacity to perform periodically and when necessary, a self-assessment, including a health history. This would be intended to prevent, ameliorate, or repair common bodily abnormalities without reliance on, and prior to contact with, a formally organized system of health services.

Our particular focus, within the whole program, is on the development of an alternative to basic formal, primary medical care for use by persons, who, whether for economic or geographic reasons or by personal preference, do not have ready access to the conventional medical system.

The need, or at least the potential usefulness, of a systematic self-health program seems evident, given the current situation of health, health services, and the distribution of health-sustaining resources in this country. Under the present system, outcast groups (rural dwellers, poor people, certain minorities, elders, women) most likely will continue to be deprived of protective resources and to be overly vulnerable to illness, to be unnecessarily damaged, and so to be in greater need of repair than others — and will have less access to repair (medical) services.

Past experience has shown that "health education" does not change behavior unless people gain access to alternatives from which to make new choices. Further, health service utilization patterns show that:

- (1) people seek services for symptoms which can be dealt with on an ambulatory basis and handled by non-specialist practitioners;
- (2) adults' assessment of their own and their children's health is relatively accurate;
- (3) much illness is self-treated;
- (4) where self-care has been taught to sick people and their families (e. g., home care), the effects have been beneficial;
- (5) given the high average levels of education in this country and the wide availability of informal teaching and training media and methods, current self-assessment and self-care could be improved;

(6) integrating conceptually and clinically the now separate categories of mental, emotional, and physical states — something that people looking upon their own illness tend to do, anyway — is efficacious for the care of personal health.

At present, the vast majority of people, either affluent or poor, have no alternative to the formal system of health services to the extent that they have access to alternative resources in other areas. With regard to food supply, energy, transportation, communi-

cation, small construction and machine repair, there are effective do-it-yourself resources in the form of home gardens, cooperatives, bicycles and tools. In recent years, organized systems have begun to be developed that offer alternatives to ordinary people. The New Alchemists, for example, are working in food and energy production. The Clivus-Multrum is a simple effective solution to organic waste disposal and recycling. In transportation and tools, the Intermediate Technology Development Group has opened options to people in the poor countries.

The development of an appropriate, simplified technology which would demystify medical specialism and provide for the care of personal health are infantile in comparison. Ironically, many people who otherwise think and live in quite radical ways often pay conventional obeisance to the symbols and myths that enshroud medical care.

Some self-help efforts have been made and are of great value to those to whom they are available. Most common has been the translation of certain kinds of medical information, which can alert consumers to symptoms they are then encouraged to present to physicians; others add patient advocates to steer consumers and interpret for them during their subsequent encounter with the medical system. Less conventional alternatives are described most often in books and are therefore suited primarily to individuals who buy books and learn well by reading. Other methods include small groups which within their circle emphasize the psychic component of healing and maintaining health ("health-ing").³

The women's movement and a few Third World political and labor groups (e. g., Black Panthers, Young Lords, United Farm Workers) have gone beyond education, self-referral into the system, or individual self-care as isolated methods. In a few cities, women's clinics have been established which teach women self-care and give them the information and the other tools they need to be independent of the clinic. Limitations are inherent in the focus which is on women mostly in their childbearing years and also in the lack of contractual ties with the system of formal health services or with the other systems that control the production and distribution of the more crucial health-sustaining resources — food, transportation, jobs, etc. Some Third World groups have attempted the latter, to some extent successfully.

The form of organization within which self-health is taught and practised determines the possibilities for its effectiveness. If it is packaged in print, its usefulness will most likely be limited to isolated individuals. If it is practised in a small, mutual-support group, its effectiveness will depend on the life of the group. With the addition of clinic resources, it would extend its usefulness to a geographic population over a longer time span and may ameliorate and repair some damage to

health. But without ties that create influence over at least some of the resources that are essential for sustaining health in a community — such as the availability and distribution of food, jobs, control of air and water pollution, etc., there is little likelihood for fostering the changes in available options and, hence, the personal decision-making that can prevent damage to health.

THE SHAPE OF SELF-HEALTH

With these uncomfortable realities in mind, we ask, what would an organized self-health program look like? Among the basic questions we must address are:

What is the essential content of self-health?

Within the limits of safety and efficacy, what should ordinary people learn about recognizing, assessing and ameliorating the signs and symptoms of the most common causes of illness, disability, and death?

What techniques should they know, such as history taking, observation, inspection, palpation, percussion, auscultation? What other tools and skills should they have in order to assess or prevent problems, and apply therapies? What conventional techniques, tools and equipment could be adapted for home or small community use in simplified form and at low cost?

As we plan the implementation of such a program, we shall have to do so on two levels. At the individual/small group level, there are such questions as:

What are the limits of self-health that will be safe and efficacious? What are the risks to health relative to the risks of having no ready access to any form of care, alternative or traditional? At what point(s) is it appropriate for an unwell individual to make contact with the formal system of medical services to obtain consultation, and the parallel question, what organized means might a community develop to assure such contact, when needed?

A Context for Alternatives in the Care of Health: EFFECTS OF ENVIRONMENT AND PERSONAL HEALTH SERVICES ON HEALTH*

Nancy Milio

ENVIRONMENTAL CONDITIONS FOR HEALTH**		IMPACT OF PERSONAL HEALTH SERVICES†	
positive	negative	positive	negative
(ecological-technological aspects of health-sustaining resources)		(treatment aspects)	
DIRECT EFFECTS (what is produced, how, and how much)	widely available, diverse food choices food fortification sanitation sewage disposal temperature, humidity control H ₂ O purification, indoor availability rapid transportation, communication high plant/animal food production	non-nutritive, anti-nutritive foods (empty calories, chemicals) air and H ₂ O pollution food contamination (pesticides, nuclear fallout) superconsumption of energy; urban decay work place contaminants and carcinogens	††Px (unwanted births; certain communicable diseases) ††Rx (antibiotics; Tbc; HBP††; tumor excisions) decreased discomfort, pain decreased disability decreased unwanted death selective and early screening with follow-up Rx (lead poisoning, diabetes HBP, glaucoma) health education combined with alternatives to current practices
(socio-economic distribution of health-sustaining resources)		(health resources distribution)	
INDIRECT EFFECTS (what is accessible to whom)	Majority of people having secure moderate or affluent incomes; widespread access to food, clothing, housing, education, transportation, communication, health services	supereconsumption life-style: observer/passive leisure; work pressure; sedentary work; alcohol, nicotine, drugs; obesity, HBP††, non-questioning attitudes; impersonal relations in large scale orgs.; injury, accidents; non-systematic alternatives. minority lacking income and/or health sustaining resources (food, clothing, housing, transp./communic., education, health services)	iatrogenic (diagnostic tests; x-ray; drugs; cancer seeding; anaphylactic shock; microbe resistance) nosocomial (hospital-induced infection; disfigurement; sex bias in Rx) unnecessary surgery (gynecologic, tonsillectomy; mastectomy; vein stripping) mental (demeaning treatment; passive Rx; lack of or uninformed consent) screening without follow-up overtreatment (diabetes, pregnancy; delivery; cardiac intensive care) inequities in services: location and types; personnel (entry, movement restricted; pyramids of privilege & pay); decisional input (patient level; policy, delivery levels). lack of systematic, safe & efficacious alternatives

*Data cited in N. Milio *The Care of Health in Communities: Access for Outcasts* (N. Y.: Macmillan, 1975).

**See J. Powles "On the Limitations of Modern Medicine" *Science, Med. & Man* 1:1-30 (1973); T. McKeown et al. "An Interpretation of the Modern Rise of Population in Europe" *Pop. Studies* 26: 345-83 (Nov. 1972)

†See A. L. Cochran, *Effectiveness and Efficiency* (London: Nuffield Provincial Hosp. Trust, 1972); I. Illich *Medical Nemesis* (London: Calder and Boyars, - 975).

††HBP = high blood pressure; Px = prevention; Rx = treatment

What forms would the content (information) of self-health take?
What methods (interpersonal and other) would be used to convey the necessary knowledge and skills initially and on an on-going basis (e. g., from labor intensive to electronic technologies)?
What media and equipment would be needed?

At the community/institutional level, there are further questions:

How would policy be made and implemented?
Operationally, who would convey self-health information (e. g., indigenous trainers); how would the trainers be trained (e. g., as practitioners or as monitors, support personnel, and connectors with formal health services)?
What other informational and support resources are needed to be either locally available or/and to have potential for development?
What linkages with formal health training and services systems and other health sustaining resources (food, housing, etc.) should be made, formal or informal, from indigenous or external sources?
How could such a self-health program be adapted to a low income area such as rural poor, and an affluent one such as suburbia?

There are, finally, questions of monitoring and evaluation as well as of long-term support, should the system be accepted in a given community. Woven into the entire structure also must be some mechanism to estimate

and analyze potential problems and to develop usable contingency plans.

EXPECTATION AND REALITIES

The minimum hopes from our efforts over the next two years are that we shall have a printable program and plans, which can be made available to individuals, community groups and organizations. Students and others in the health services fields may find uses for the content, methods, or data base of our self-health program. People in other countries, who have shown interest in self-health, may find applications for parts of our work.

During this initial period, we hope to establish a working relationship with two communities — one in a rural, low-income area and one in a relatively affluent suburban one — that would like to implement the program over a three to four year period, in order to test its effectiveness.

— Nancy Milio

Ruth Hubbard

Alternatives in Health Care
255 Massachusetts Avenue, No. 1010
Boston, Massachusetts 02115

References:

1. For data and analysis concerning these problems and their interrelations, see N. Milio, *The Care of Health: Access for Outcasts* (Macmillan, 1975)
2. One of the best analytic descriptions of these is found in E. K. Newell, ed., *Health by the People* (Geneva: WHO, 1975)
3. See several articles in *Futures Conditional*, Fall, 1974 (Northwest Regional Foundation, Box 5296, Spokane, Washington 99205)

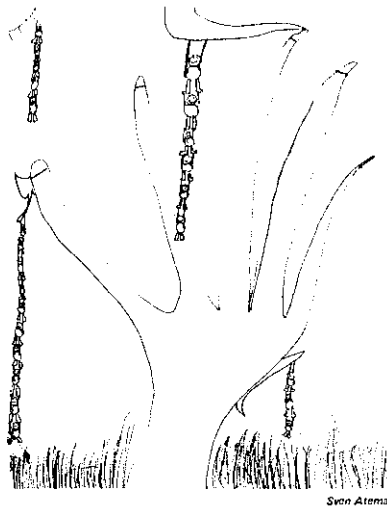

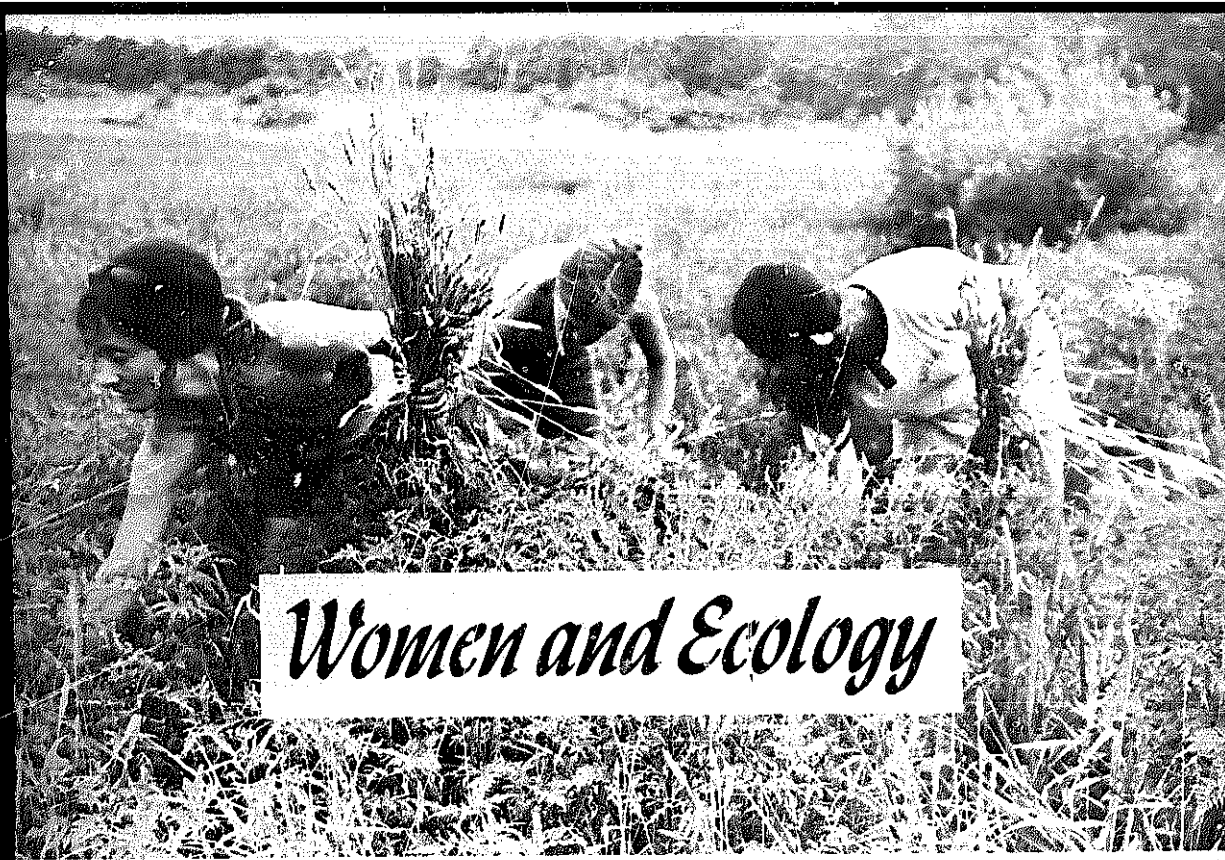

Women and Ecology

Photo by Ann Plattner

Prepared for the Social Ecology Course at Goddard College

I have long had in mind the idea of writing something on women and ecology. Such a project had its beginnings in two causes that have been very important to me. After several years in the peace movement, crowned with the rather hollow triumph of replacing Johnson with Nixon, I had become discouraged with the prospect of reform within the system and began, to borrow a phrase from biology, to look more closely at the microcosm — meaning my more immediate environment. Talk of pollution and ecology was everywhere, and surrounded (as I was at the time) by biologists engaged in issuing gloomy prophecies, the concepts and implications of ecology seemed well worth exploring.

My interest in the state of women is self-explanatory.

The link between the two subjects was originally rather intuitive and vague, based on two tentative, hopeful assumptions. The first was something that continually distressed me in the fastness of southern California suburbia, and that was the amount of wasted energy in a physical, psychic and economic sense that

We women went from there into wider fields. A dozen or so of us organized a "March 8th" tree-planting team. We had no saplings, as we had not yet a tree nursery, so we would walk for miles in a day collecting tree seeds. In three years we had over 110,000 trees planted on more than 20 hectares of sandy wasteland. By 1971, we women, whose labour force was augmented by that of the poor and lower-middle peasants of our village, had planted more than a million timber and fruit trees, covering 220 hectares of sandy land with green. This checked wind and shifting sand, and we began to have good harvests every year. Our grain yields increased in some cases by as much as 650 per cent. The old view of women's "place" underwent a change, and people were saying, "The women are really doing their share of the collective work!"

*International Working Women's Day, established in 1910.

*— from "New Women in New China"
(Foreign Languages Press
Peking 1972)*

(Unless otherwise credited, photos are by Hilda Aterna Mangwa)





I saw in the lives of so many women. Particularly among the privileged, so many hours are spent in front of the television, shopping, having hair done, in short on an enormous variety of empty activities and meaningless busyness. Yet beneath the vacuousness, I felt, were untapped resources of brain and energy, which could surely be put to use for the common good. The second assumption, even more conjectural, was that women with their life-giving powers, could they be made to understand the desperateness of our ecological plight, would never permit the world to gutter to a smoggy and ignoble end. Not for this do we bear children!

The ideas kept nagging at me, but when it actually came to putting pen to paper I procrastinated — successfully-knowing that I was afraid that all the ideas that bubbled about so satisfyingly in my head might fade to little or nothing on the impersonal medium of the blank page.

Help came unexpectedly via Gregory Bateson. According to an article in *Harper's*, Bateson is reported to have said, "My complaint with the kids I teach nowadays — graduate students and such — is that they don't really believe anything enough to get the tension between the data and the hypothesis. What they may find out doesn't really impact on theory, because they don't have any theory they're willing to hold tight enough to get an impact. It slides all the time." I understood this to mean a certain stick-to-it-iveness in riding the current of one's thoughts without being sure of the destination or endpoint. This is what I decided to do.

On the one hand we have slightly more than half of humanity operating well below its potential. On the other, we have a world threatening collapse and disaster for much or all of humanity. What I hope to do in this paper is to describe my own exploration of these two ideas and the tension of their relation to each other.

I begin with the assumption that there is some agreement on the status of women, although my own path toward liberation has been hindered by the fact that I was, for a long time, either too thick-skinned or too dim-witted to realize fully the limitations placed on women by virtue of their sex. I am, perhaps, a case of reverse programming. As a child, I had no brothers to envy either their penises or the greater favours bestowed on them in the way of freedom or education. In our family, there was a great deal of laughter shared between the women and the children. We told rambling family tales and talked endlessly as we worked in the kitchen. The men, my father or my uncle, came home from the office, almost always tired, sometimes irritable. Occasionally they joined us in the kitchen. More often they did not. From time to time I thought, but perhaps I was wrong, that there was an aura of wistfulness emanating from behind the newspaper. They would have liked to have joined in our laughter



but were not sure how. Whatever they felt, my childhood memories of home are that it was for all of us a refuge, with the kitchen at the heart, cheerful and warm. Women, I understood, stayed and tended this heart and men went off to offices that had ugly desks and chairs and a few interesting machines. This to me was WORK, the OFFICE. It had much the same significance to me as is attached to Mr. Banks' work in *Mary Poppins*. "Now the City was a place where Mr. Banks went every day – except Sundays, of course, and Bank Holidays – and while he was there he sat on a large chair in front of a large desk and made money. All day long he worked, cutting out pennies and shillings, and half-crowns and three-penny bits. And he brought them home with him in his little black bag."

And my feelings as a child and on through my teens – even now – were that rather than face work that seemed so dull and unrewarding, yet so tiring. I would choose the bright kitchen even if it meant attendant chores of housekeeping and laundry. The smells of baking, the companionship and the chatter seemed more tangible and capable of producing results that were directly and observably useful.

Then through my childhood echoed the guns of World War II. The radio was an oracle, around which the grown-ups hovered anxiously. It brought news of air raids, bombings, invasions. The name my sister and I gave to evil and fear that is so often nameless for children was Hitler. He used to visit us in the night. He lived in a drawer in Barbie's dresser and curved around the top of my mirror. Stories of children whose fathers would never come home were whispered among the adults and we overheard them with dread. War meant, never drums and trumpets and brass buttons and dashing young soldiers, but destruction, fear, loss, death – valiant young men lost over Germany. And in my mind, then, and perhaps still, war joined dreary offices in my comprehension of the world of men. So it took me an awfully long time to realize that I was barred from this world because, in the main, I didn't want any part of it.

This has been my own peculiarity. I do entirely accept the fact that women have been dominated and exploited far beyond recorded history.

WHY?

The why is very important to me. I have never felt inferior to men. I am not. We are not, as a sex,

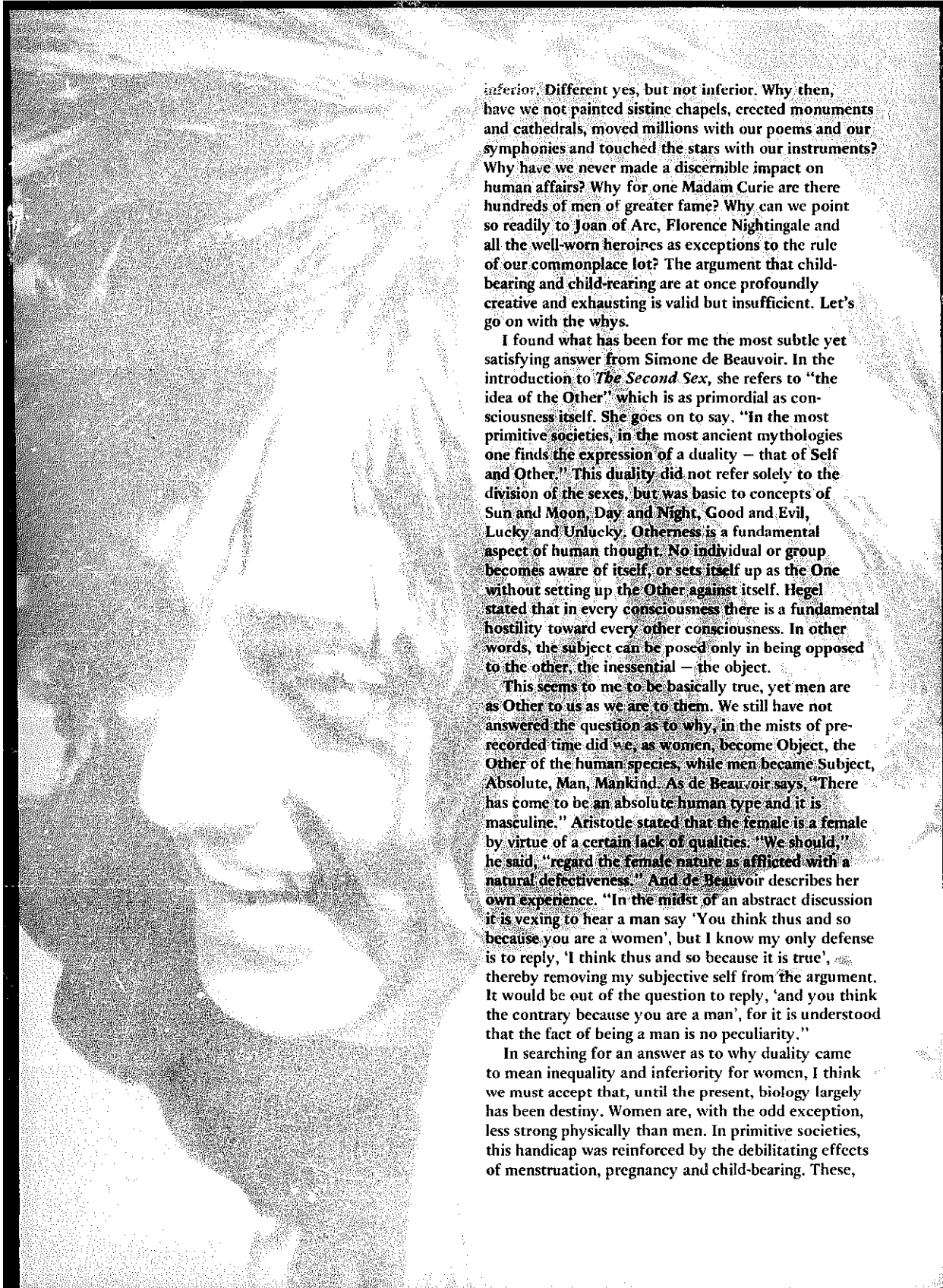

inferior. Different yes, but not inferior. Why then, have we not painted sistine chapels, erected monuments and cathedrals, moved millions with our poems and our symphonies and touched the stars with our instruments? Why have we never made a discernible impact on human affairs? Why for one Madam Curie are there hundreds of men of greater fame? Why can we point so readily to Joan of Arc, Florence Nightingale and all the well-worn heroines as exceptions to the rule of our commonplace lot? The argument that child-bearing and child-rearing are at once profoundly creative and exhausting is valid but insufficient. Let's go on with the whys.

I found what has been for me the most subtle yet satisfying answer from Simone de Beauvoir. In the introduction to *The Second Sex*, she refers to "the idea of the Other" which is as primordial as consciousness itself. She goes on to say, "In the most primitive societies, in the most ancient mythologies one finds the expression of a duality — that of Self and Other." This duality did not refer solely to the division of the sexes, but was basic to concepts of Sun and Moon, Day and Night, Good and Evil, Lucky and Unlucky. Otherness is a fundamental aspect of human thought. No individual or group becomes aware of itself, or sets itself up as the One without setting up the Other against itself. Hegel stated that in every consciousness there is a fundamental hostility toward every other consciousness. In other words, the subject can be posed only in being opposed to the other, the inessential — the object.

This seems to me to be basically true, yet men are as Other to us as we are to them. We still have not answered the question as to why, in the mists of pre-recorded time did we, as women, become Object, the Other of the human species, while men became Subject, Absolute, Man, Mankind. As de Beauvoir says, "There has come to be an absolute human type and it is masculine." Aristotle stated that the female is a female by virtue of a certain lack of qualities. "We should," he said, "regard the female nature as afflicted with a natural defectiveness." And de Beauvoir describes her own experience. "In the midst of an abstract discussion it is vexing to hear a man say 'You think thus and so because you are a woman', but I know my only defense is to reply, 'I think thus and so because it is true', thereby removing my subjective self from the argument. It would be out of the question to reply, 'and you think the contrary because you are a man', for it is understood that the fact of being a man is no peculiarity."

In searching for an answer as to why duality came to mean inequality and inferiority for women, I think we must accept that, until the present, biology largely has been destiny. Women are, with the odd exception, less strong physically than men. In primitive societies, this handicap was reinforced by the debilitating effects of menstruation, pregnancy and child-bearing. These,

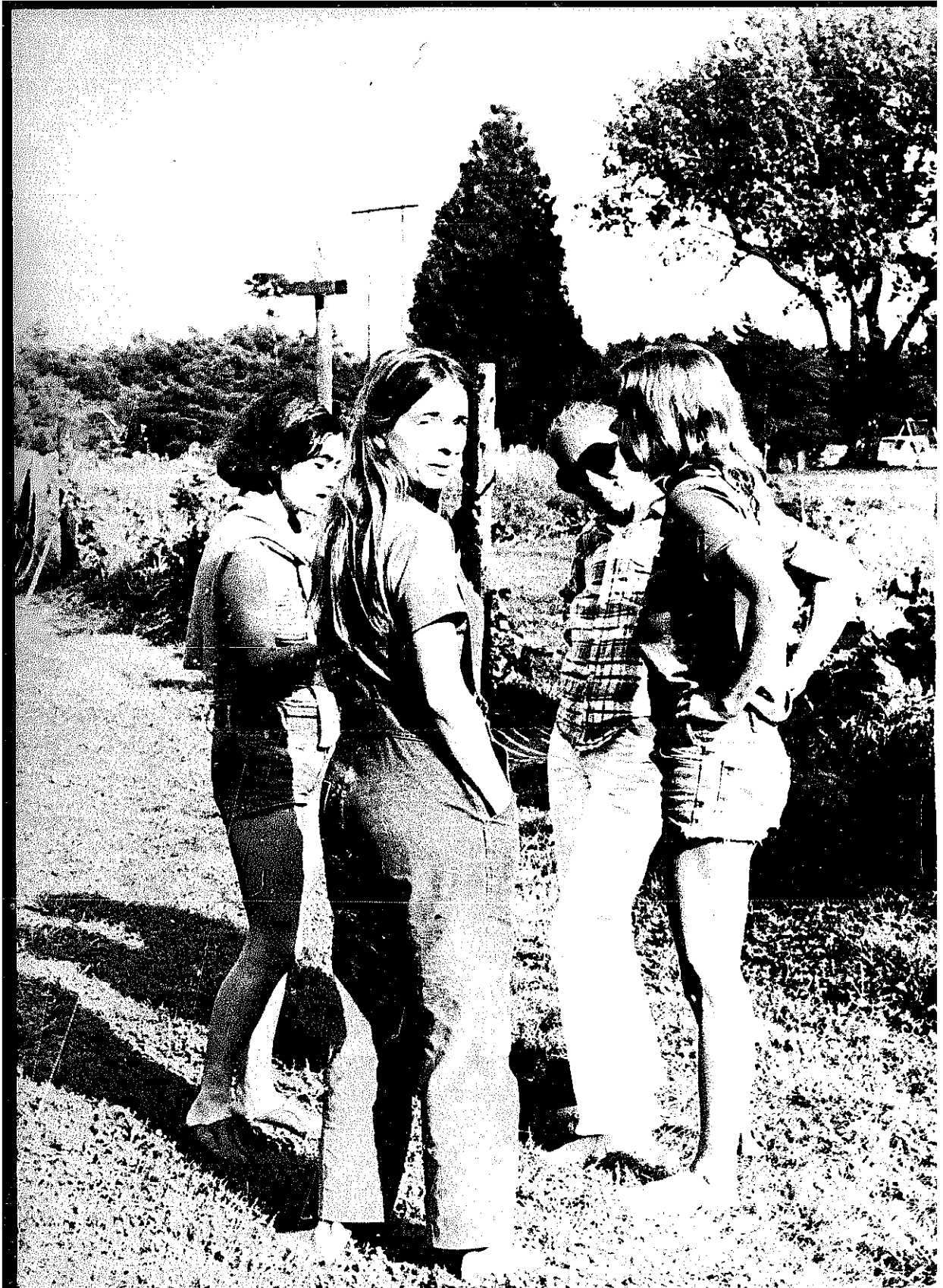

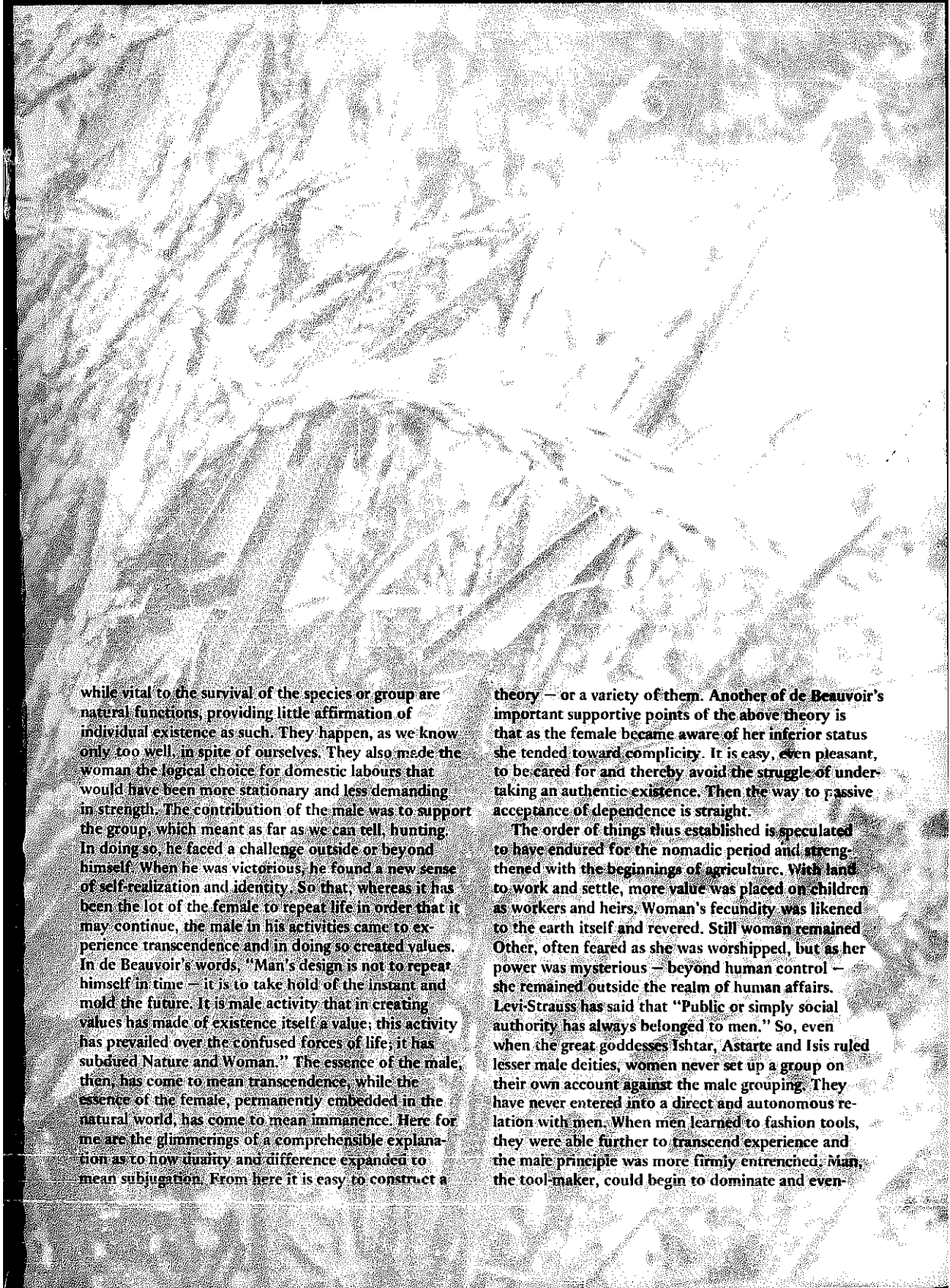

while vital to the survival of the species or group are natural functions, providing little affirmation of individual existence as such. They happen, as we know only too well, in spite of ourselves. They also made the woman the logical choice for domestic labours that would have been more stationary and less demanding in strength. The contribution of the male was to support the group, which meant as far as we can tell, hunting. In doing so, he faced a challenge outside or beyond himself. When he was victorious, he found a new sense of self-realization and identity. So that, whereas it has been the lot of the female to repeat life in order that it may continue, the male in his activities came to experience transcendence and in doing so created values. In de Beauvoir's words, "Man's design is not to repeat himself in time — it is to take hold of the instant and mold the future. It is male activity that in creating values has made of existence itself a value; this activity has prevailed over the confused forces of life; it has subdued Nature and Woman." The essence of the male, then, has come to mean transcendence, while the essence of the female, permanently embedded in the natural world, has come to mean immanence. Here for me are the glimmerings of a comprehensible explanation as to how unity and difference expanded to mean subjugation. From here it is easy to construct a

theory — or a variety of them. Another of de Beauvoir's important supportive points of the above theory is that as the female became aware of her inferior status she tended toward complicity. It is easy, even pleasant, to be cared for and thereby avoid the struggle of undertaking an authentic existence. Then the way to passive acceptance of dependence is straight.

The order of things thus established is speculated to have endured for the nomadic period and strengthened with the beginnings of agriculture. With land to work and settle, more value was placed on children as workers and heirs. Woman's fecundity was likened to the earth itself and revered. Still woman remained Other, often feared as she was worshipped, but as her power was mysterious — beyond human control — she remained outside the realm of human affairs. Levi-Strauss has said that "Public or simply social authority has always belonged to men." So, even when the great goddesses Ishtar, Astarte and Isis ruled lesser male deities, women never set up a group on their own account against the male grouping. They have never entered into a direct and autonomous relation with men. When men learned to fashion tools, they were able further to transcend experience and the male principle was more firmly entrenched. Man, the tool-maker, could begin to dominate and even-

MUTATION

Brand-new
one katydid adds
its leaf to a branch
unfolds its green deception
and floors its neighbors with its find:
a perfect dewdrop
etched on each wing
illusory and dry
as a dead painter's
canvas.

Framed.
Sure to be famous

as peacocks
lungfish
or the child
emerging from our dark yard
holding a lightning bug
to feel the explosion
in her hand.

—Meredith Fuller-Luyton

tually control Nature. Needless to add, his awe of woman, at the same time, was correspondingly lessened, "and the great god Pan begins to fade when the first hammer blows resound and the reign of man begins."

While we are still immersed in prehistory and in the solely speculative stage of the evolution of the race, I should like to introduce the subject of one of my favorite books. It was written by Elaine Morgan and is called *The Descent of Woman*. It could be described as a rerun of some of the evolutionary tours of the last decade or so, in which social historians have cast an appalled look at the present human situation and fumbled for an explanation. Like Desmond Morris and Robert Ardrey, she returns us to the trees and tries to trace it all from there.

I shall try to resist too much of a detour which, although fascinating, is off the main track. No woman can help but be drawn to such a statement as, "The longer I went on reading his (i. e., Men's) books about himself, the more I longed to find a volume that would read: When the first ancestor of the human race descended from the trees, she had not yet developed the mighty brain that was to distinguish her from all other species." As Ms. Morgan goes on to say, "Of course, she was no more the first ancestor than he was — but she was no less either."

Her theories on human evolution are based on those of Sir Alister Hardy F. R. S. and very briefly go like this. There lived long ago, back in the mild Miocene, a generalized vegetarian, prehomimid, hairy ape. She got her food from the trees and slept in their branches. When the scorching heat of the Pliocene reduced the forests, she was forced to try life on the ground, and it is here that Ms. Morgan inserts her own chapter in our evolutionary history. A four-legged vegetarian was ill-adapted to life on an open plain. The generally accepted theory goes that in this crisis, our ape rose to its feet the better to flee an attacker or pursue a quarry, thereby freeing a foreleg for carrying a weapon, which it rapidly learned to aim and to hurl with efficiency at passing game. Thus we learned to survive on the treeless savannah.

Ms. Morgan would not dispute that this indeed probably did happen, but not without an intermediate phase. It is likely that the dwindling forests remained longest along riverbeds and that our forebears remained as long as possible in their arboreal homes. Their reluctant descent was most likely to have been in the vicinity of a riverbed which would have led eventually to the sea. And so, between our final descent from the trees and the millennia on the savannah which gave rise to man-the-hunter, woman-the-subordinate and all that that entails, she postulates ten million or so years — on the beach. I guess, for readers of T. S. Eliot or Neville Shute, there is a grim bit of irony here, but anyone who has spent as many shamelessly idle and happy summer days on the beach with her children as I have is at once drawn to the idea. Ms. Morgan offers considerable evidence in support of her thesis, including a long list of physical features from our hairless hides to our layer of subcutaneous fat. To go on would involve wandering well off the main topic. The point of this diversion has been to offer the happy thought that there may have been a ten million or so year period when humanity lived on the beaches, inlets and lagoons, and women, having less need for physical protection and some access to their own food, enjoyed something of a reprieve from domination and subordination.

I'm not sure how much any of this matters now. No matter how or why, we have for all history been "other", "object", and "secondary." All that is beginning to change now. Not fast enough or far-reaching enough, but with an increasing momentum and, in comparison to the ages of oppression, with breath-taking speed, a revolution in feminine consciousness is taking place.

Of primary importance to me is the question of the direction of change. Elaine Morgan deals with the issue of what women want with typical largesse. "Freud, toward the end of his life," she says, "bewailed the fact that even after spending years trying to pinpoint it, he had never succeeded in finding

out 'what women want.' " She goes on "It's a rather silly question. If anyone had assembled a string of names of well-known human beings — say, Albert Schweitzer, Attila the Hun, Casanova, Gandhi, Al Capone, Einstein, Henry Ford, Peter the Hermit, Gauguin, Elvis Presley -- and asked him to encapsulate an answer to the question, "What do men want?", he would not have found that too easy, either. Any answer that he came up with that holds true for that list would be so abstract and general that it would also hold true for all women.

"But many people have a subconscious idea that women are an altogether less complex species, more like, shall we say, rhododendrons, or beans, so that somewhere just around the corner is a simple answer on the lines of 'they need plenty of phosphates', and that once this secret has been discovered, life will be simpler. Women can be given what they want and they will then keep quiet, thus enabling the time and attention of real (i. e., male) people to be devoted to the important and difficult business of conducting their relations with other real people."

The answer may not be phosphates but the idea of women as other with different parameters for their lives than men seems almost universal.

I want to turn later to the changes that must come about and the demands we must make if we are to achieve equality. Fundamental to our liberation as a sex, and beyond that, to human liberation is that we begin to exist for ourselves — to cease to be other and to become, for ourselves, subject. Perhaps this is self-evident, but it is still not the norm of popular consciousness or myth. In my childhood, the old maid was pitied, the object of mild derision. Not so the bachelor. He chose freely. When I was in university, it was felt to be a humiliation not to be engaged by graduation. The chorus of a popular song which went:

"A man without a woman
Is like a rag upon the sand.
There's only one thing worse in the universe
And that's a woman without a man."

seemed to reflect a certain tacit understanding that was prevalent at least then in society. I know that many women, mostly younger than I, are far less hampered by such vestigial assumptions, but they haunt us as a sex yet — one look at the popular culture from television to magazines tells you that to live at all you must please a man.

Our goal for every woman must be a sense of completion; of destiny as a person, not as wife, mother or mistress, but as herself first, all other roles being secondary. This, of necessity, would include liberation from the feelings of guilt and inadequacy admitted or concealed that have been chronic to our history. With an end to our age-old crisis in confidence, we might well be ready for anything.

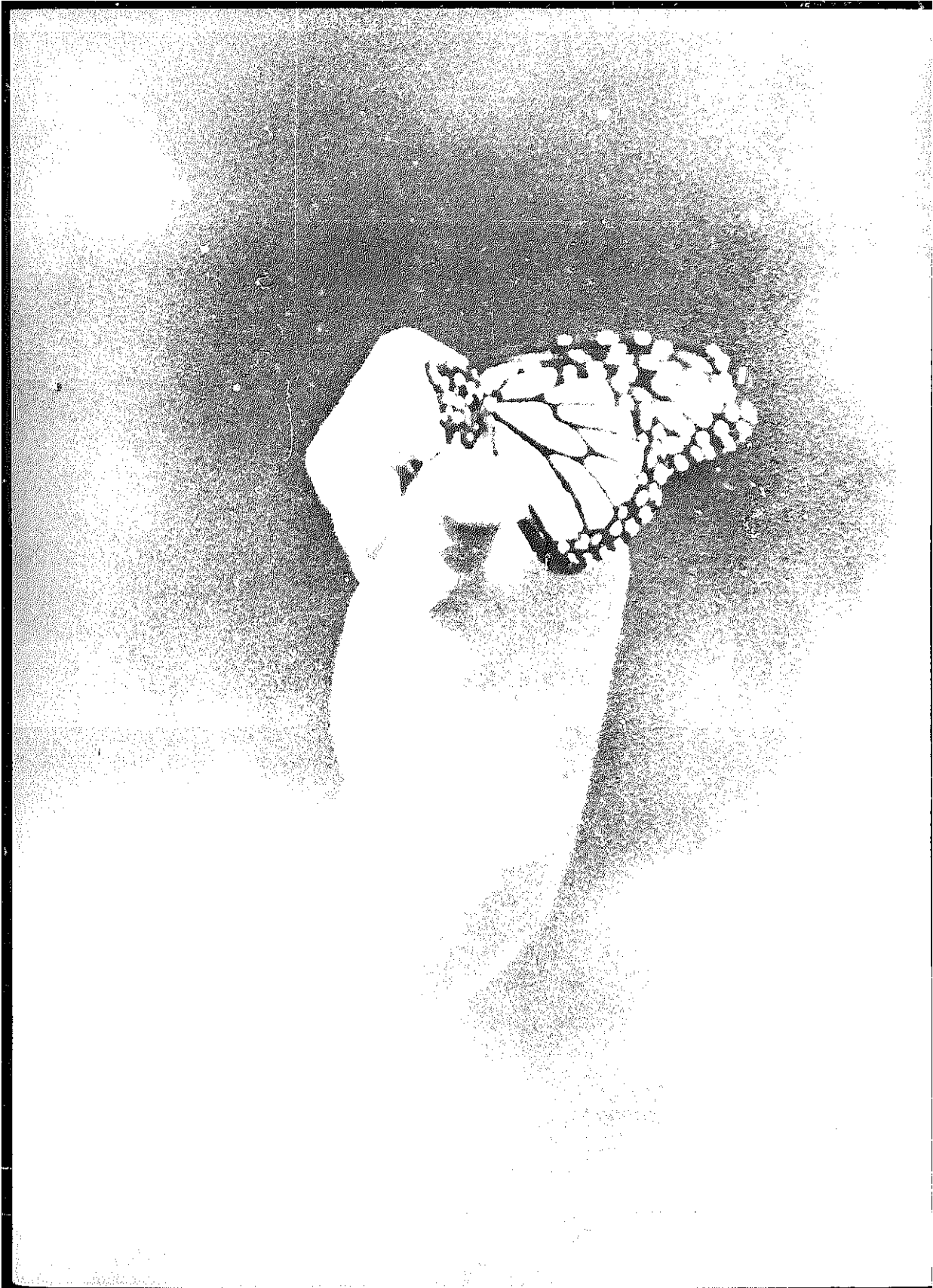

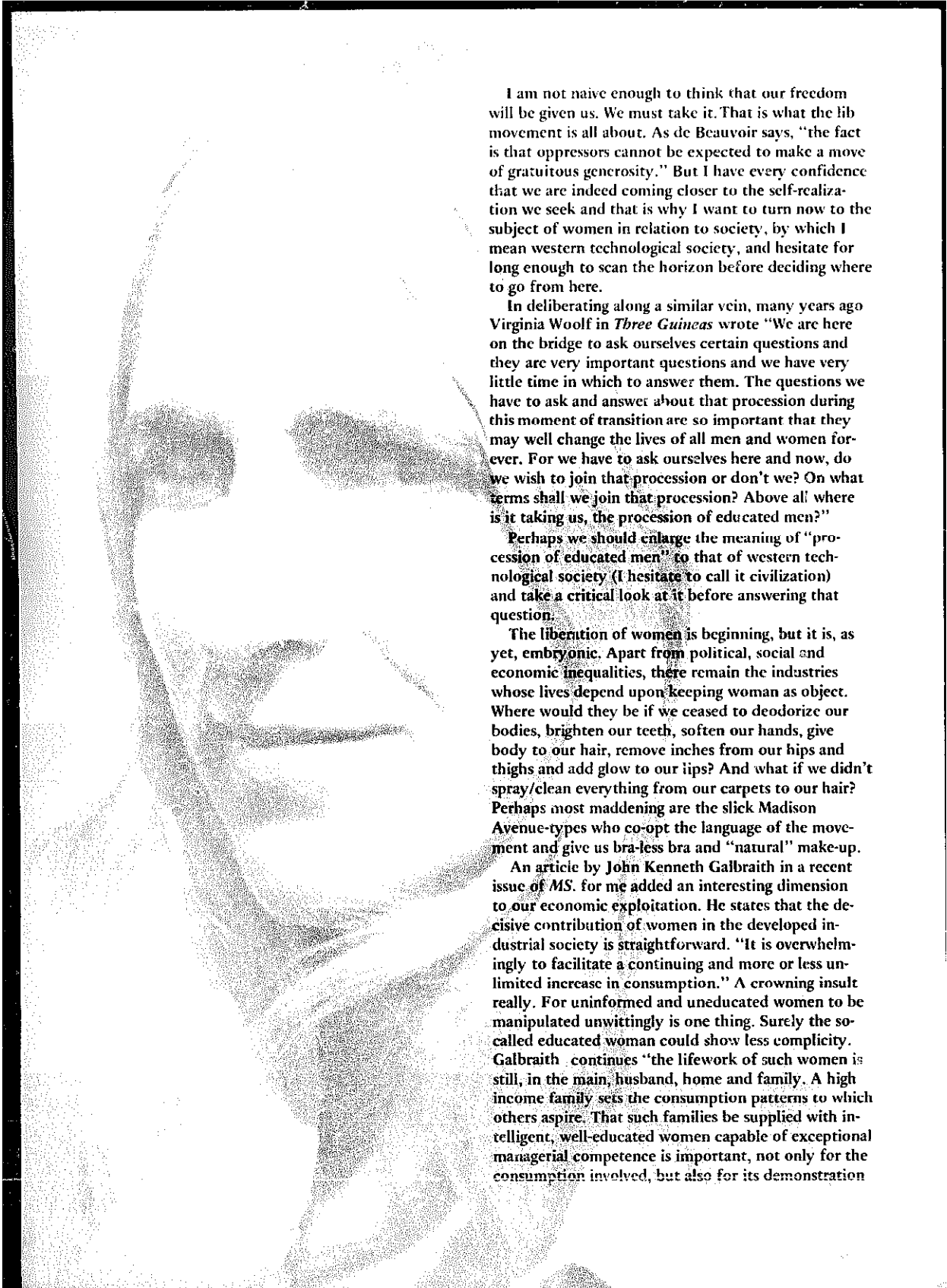

I am not naive enough to think that our freedom will be given us. We must take it. That is what the lib movement is all about. As de Beauvoir says, "the fact is that oppressors cannot be expected to make a move of gratuitous generosity." But I have every confidence that we are indeed coming closer to the self-realization we seek and that is why I want to turn now to the subject of women in relation to society, by which I mean western technological society, and hesitate for long enough to scan the horizon before deciding where to go from here.

In deliberating along a similar vein, many years ago Virginia Woolf in *Three Guineas* wrote "We are here on the bridge to ask ourselves certain questions and they are very important questions and we have very little time in which to answer them. The questions we have to ask and answer about that procession during this moment of transition are so important that they may well change the lives of all men and women forever. For we have to ask ourselves here and now, do we wish to join that procession or don't we? On what terms shall we join that procession? Above all where is it taking us, the procession of educated men?"

Perhaps we should enlarge the meaning of "procession of educated men" to that of western technological society (I hesitate to call it civilization) and take a critical look at it before answering that question.

The liberation of women is beginning, but it is, as yet, embryonic. Apart from political, social and economic inequalities, there remain the industries whose lives depend upon keeping woman as object. Where would they be if we ceased to deodorize our bodies, brighten our teeth, soften our hands, give body to our hair, remove inches from our hips and thighs and add glow to our lips? And what if we didn't spray/clean everything from our carpets to our hair? Perhaps most maddening are the slick Madison Avenue-types who co-opt the language of the movement and give us bra-less bra and "natural" make-up.

An article by John Kenneth Galbraith in a recent issue of *MS* for me added an interesting dimension to our economic exploitation. He states that the decisive contribution of women in the developed industrial society is straightforward. "It is overwhelmingly to facilitate a continuing and more or less unlimited increase in consumption." A crowning insult really. For uninformed and uneducated women to be manipulated unwittingly is one thing. Surely the so-called educated woman could show less complicity. Galbraith continues "the lifework of such women is still, in the main, husband, home and family. A high income family sets the consumption patterns to which others aspire. That such families be supplied with intelligent, well-educated women capable of exceptional managerial competence is important, not only for the consumption involved, but also for its demonstration

effect on the entire economy, making possible its infinite expansion."

All this offers a most unwelcome aspect to the view from the bridge. Looking beyond the consumerism of our own society we are confronted with a world threatened by terrifying dark shadows; over-population, famine, a heedless scramble for the last of the world's finite energy sources, the threat of war, possibly nuclear, from countries who have suffered our affluence too long, and the development of nuclear plants with the age-long radioactive wastes they will produce. Howard Odum, the well-known ecologist, postulates the return of chronic disease and epidemic as modern medicine based largely upon cheap, readily available fuels fails us. At best then, the view affords a future that is bleak, at worst, utterly hopeless. From our vantage point on the bridge that is beginning to crack beneath us, asking again the question, do we wish to join the procession of Armageddon-bound western technocracy? The answer can be, I think, only if we are highly resolved to try to alter its course.

This seems to lead to another question, equally difficult. Should we make the decision to join the mainstream of human affairs, is there any reason to believe that we could effect any change for the better? De Beauvoir says, "in truth, women have never set up female values in opposition to male values." And further, that "women have never as a sex sought to play a historic role." If this is the case then it would seem that the triumph of scientific rationalism could be attributed to the dominance of male thinking. So that, with regard to the question as to whether women might conceivably alter the path we are on, there is, as yet, no way of knowing. One wonders, though, if man with his transcendent quality has dominated nature and brought us to this point in history, is it possible that the immanent essence of women, rooted more firmly in the processes of nature, might find a way to shape a better world? Could we be more capable of a better understanding of what might be called human ecology?

We are about to reach the point where the tension between the subjects of women and ecology will be felt, but, prior to that, it would probably be useful to look very briefly at the concept of ecology *per se*. A common understanding of ecology is to consider that it is the study of the natural web of life. Paul Shepard, in his introduction to "*The Subversive Science, Essays Toward an Ecology of Man*" says, "The image of the web is too meagre and simple for the reality. A web is flat and finished and has the mortal frailty of the individual spider. Although elastic, it has insufficient depth. Ecology deals with organisms in an environment and with the processes that link organism and place. It must be a scope and a way of seeing." He goes on to say (and the use of the word *mar* for all of us is his, not mine),

"Man is in the world and his ecology is the nature of that inness. He is in the world as in a room, and in transcendence, as in the belly of a tiger or in love. What does he do there in nature and what does nature do in him?" And he concludes, "affirmation of its own organic essence will be the ultimate test of the human mind."

This is the point at which the tenuous bridge between the subjects begins to suggest itself. Is it possible that the female mind might have less difficulty in making such an affirmation — in seeing through the glass a little less darkly? Since time began, our bodies have been rhythmically bonded to the moon. Unlike men, who at times have felt that they have transcended Nature, we are bound in her. Perhaps the time has come when women, by virtue of their immanence or "inness", albeit involuntary, will learn to listen to and trust themselves, and from there accept their responsibility in sharing in the guiding of the course of human history.

One thing I am very sure of is that the only way we can hope to rise to such a role is as liberated and self-actualized human beings. Diffident, inadequate or apologetic, no one will listen to us. We won't even listen to each other. This may well be the biggest hurdle — and we don't have much time.

Before formulating tentative first steps, it might be useful to inquire as to whether there is hope that even as free women we can hope to improve the world situation. It might be noted that at least three states which have granted equal or close to equal rights to women have not been known for their beneficent ways. These were Ancient Sparta, Nazi Germany and Soviet Russia. With women in many influential and professional fields, these states have been hostile, aggressive and warlike. Yet, for all their apparent equality in these states, women lived or are living in a masculine society, in a masculine-run state, and have adopted or been instilled with masculine values. From this we cannot judge conclusively that women cannot or will not make an impact upon the society in which they live. I find that I have assumed, rather smugly, in regarding the question of women's increased participation that it will, of course, be for the better. This, no doubt, stems from echoes of such outworn clichés as "behind every great man...." and "the hand that rocks the cradle....", etc. Beyond a vicarious glow of self satisfaction, is there any basis to foresee potential improvement?

Lionel Tiger in "*Men in Groups*" states that the real, universal and indisputable difference between cohorts of males and groups of females is that the males are more aggressive and that this is true, in the main, for most species, particularly the primates. He goes on to say that male bonding is one of the functions of aggression. No doubt, a good deal of the variance in male/female levels of aggression can be

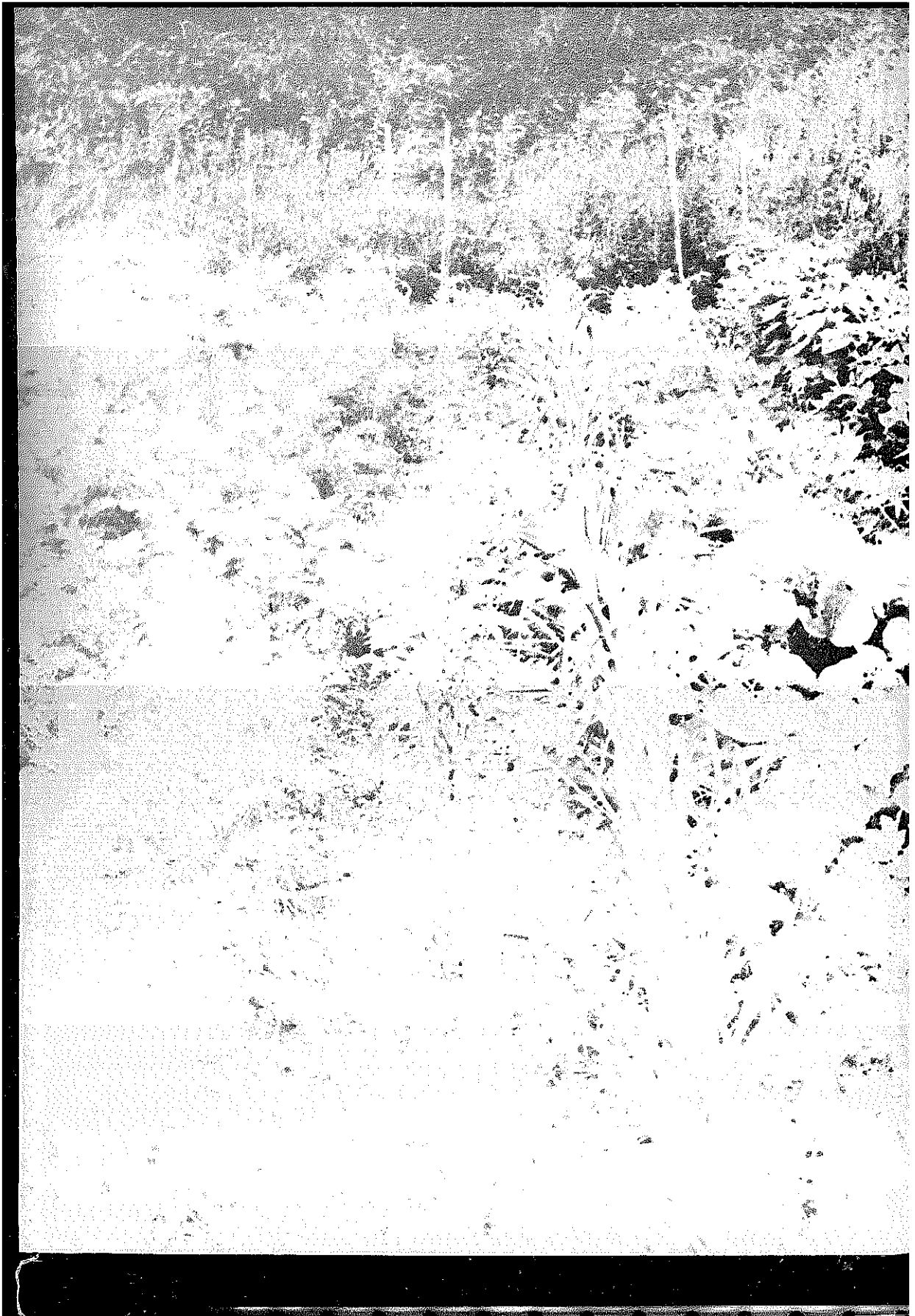





accounted for by conditioning. One of my close friends gives a well-attended course in assertive training for women, and it would be hard to accuse someone of being very aggressive if they are having to be encouraged to assert themselves. Elaine Morgan reports that "if you inject a female monkey with male hormone she will behave more aggressively; and if you inject a male monkey with female hormone he will behave less aggressively." She goes on to say that "anthropologists studying the cultures of different tribes have found almost no occupation which isn't somewhere or another considered to be 'women's work', and somewhere else considered to be 'men's work' whether it's pottery, or weaving, or agriculture, or cooking, or even caring for the children. The one exception is killing people. No one has found a primitive tribe where women are the warriors. War, like aggression, is a function of male bonding." Certainly, in the main, this has remained true, in spite of legends of Amazons and gory tales from the French Revolution and elsewhere, not to mention elements in the feminist movement who would have us demand equal participation in everything, however insane or immoral. If, then, aggression is an attribute found in larger doses in males and the stuff of male bonding, and these are surely two powerful elements current in the management of the business of the world, then it seems possible to postulate, at least, that if women were to have their say there might be less violence, even less war, and that we might be less inclined to wreak havoc upon the living world around us. This remains in the realm of hypothesis.

Murray Bookchin has written that "the very essence of the matricentric world is that it vitiates rule as such." He maintains that polarities cannot be found between patriarchy and matriarchy as two differing forms of rule; the comparison must be between rule and anarchy, between the presence and absence of domination. A world with less of the hierarchy that seems inherent to male society would be a far cry from the very structured one we now inhabit.

In the realm of the concrete, the point has come for us to ask, as John Platt did on contemplating the plight of the world several years ago, "what we must do." In this regard, it seems our approach should be two-pronged. We must keep in mind what must be done to improve the lot of women in particular and humanity in general within the present. At the same time, we must be creating and evolving and learning to make a transition to ways of living that are at one, and not at odds with all other life -- towards the day when we shall better understand how, in Gary Snyder's phrase, "to live lightly on the earth."

Within the context of the present and perhaps as a precondition to any fundamental social change, we must continue and intensify the struggle for liberation

Photo by Fritz Gara

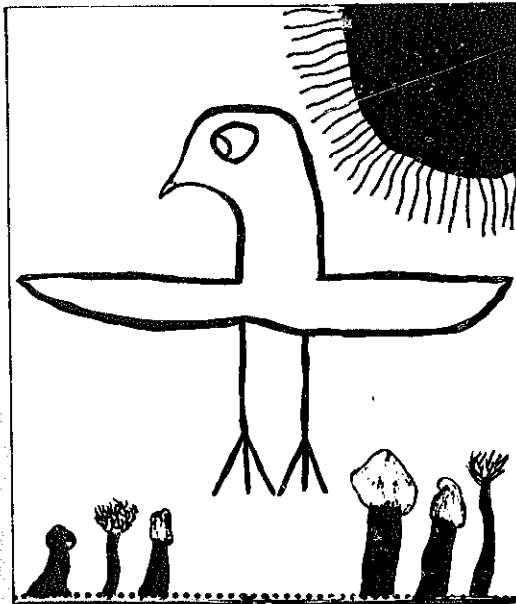

Sven Aterns

and self-actualization for women. I don't mean that this is important only for women. There can be no understanding of ecology, with its underlying wholistic conceptual basis, without people who have begun the search for heightened consciousness and self-awareness. We must find ways of reaching women trapped in their domestic and social rounds, often unaware of their exploitation. This does not imply that they will at once throw off their fetters and abandon home and children, as Germaine Greer has suggested, but that they may begin to know better who they are and to develop a full sense of their own identity. This is not easy to do. So many women are resistant, even hostile, to the idea of liberation. They are, of course, frightened. In these cases, I think the magazine *MS.* is doing an inestimable amount of good with its non-threatening, low-key approach. I think that it has been, so far, the most successful feminist vehicle for reaching more women than any other. After such an introduction, many women become ready for consciousness-raising which can be followed by a more active attitude in shaping the form and directions their lives will take. Subsequent steps within the social framework are best determined by the individual community — another instance of thinking in terms of the microcosm. In my area, as women emerged from consciousness-raising groups several years ago, there was a glaring need for a day care center and for some form of family planning and counselling. Both

have been established since. In other areas, friends of mine have organized community gardens, craft co-ops, investigations of pollution practices, and environmental information centers.

Women interested in careers have a decisive role to play. There is so much useful work to be done and yet, in a society so permeated with false values, it is easy to be misled. We must constantly remind ourselves that the values of the society around us are male values and that we must guard against being tempted to win male recognition and approval. I saw a distressing letter to an editor a while ago. A girl wrote in, complaining about the fact that there had been no women in a certain beer commercial on television. In the same vein, we must refrain from basking in a reflected glow in the accomplishment of women who achieve the pinnacle on Madison Avenue. As the old saw goes, they are part of the problem. It was a blow to me when an acquaintance, a good student in biology, took to selling real estate. Such employment only furthers the status quo and offers nothing that would initiate the process of change.

But we do need doctors. I do not mean to launch into horror stories of indignities suffered by women at the hands of male doctors, but they are countless. The same applies to lawyers. The need for women helping women in law is immediate. The list of fields where the demand is equally urgent is long. We must have women in psychiatry and psychology, in politics and government, in media and communication and in education. With sensitive teachers, little girls could be spared a great deal of confusion and pain in coming to know themselves. In addition to the service that they render directly, professional women provide models for others, particularly children, something that has long been needed. We need thousands more Bella Abzugs and Shirley Chisholms. The same can be said for the arts. The example of an independent — at least spiritually — artist struggling for her own fulfillment is one of the most compelling. We could go on and on. The essential point is that times are far too critical for us not to give our choices of career or occupation the most painstaking evaluation.

One idea that would seem well worth exploring for women with some free time would be the formation of some kind of consumer vigilante groups. These could be useful in a variety of ways, not the least being educational. I find, as a woman, that it is devastatingly insulting to have an economy structured around the fact that I am malleable and stupid enough to be manipulated into buying whatever I am told, in order to keep a small cog in the economic machine turning. Secondly, the machine itself is endlessly wasteful, unaesthetic, immoral and unecological. Perhaps study and research groups could be formed which could, among other things, separate



the wheat from the chaff as far as useful and totally superfluous or actually harmful products go. This could be applied to food, cosmetics, cleaning products, appliances and beyond. Based on such studies, committees to establish information services for the public could be set up or similar existing groups expanded. Conceivably this could lead to strong pressure groups which, armed with the threat of boycott, could begin to have some influence. Hopefully, there would be eventually congressional lobbies to voice opinions other than those of large corporations and manufacturing concerns. As women, we have few weapons in the struggle for a less destructive society. In this country, we do have buying power. It seems preposterous not to use it. To be cautioned that such actions could threaten the economy is rather like

telling someone who is dying not to do something because it is bad for him.

I have only touched on practical, tangible steps, conceivable in our society as we know it at the present. There are our other occupations, which, while not political, are in themselves most fulfilling and well-adapted to both the needs and ground-rules of a more ecologically-oriented society. Within this context, motherhood seems well worth a second look. It is worth re-evaluating because it is rapidly becoming, for the first time in human history, largely voluntary. Reliable contraception, giving women the freedom to choose whether or not they will have children, has been called by a Jungian analyst, Irene Claremont de Castillejo, the "second apple." Given woman by technological

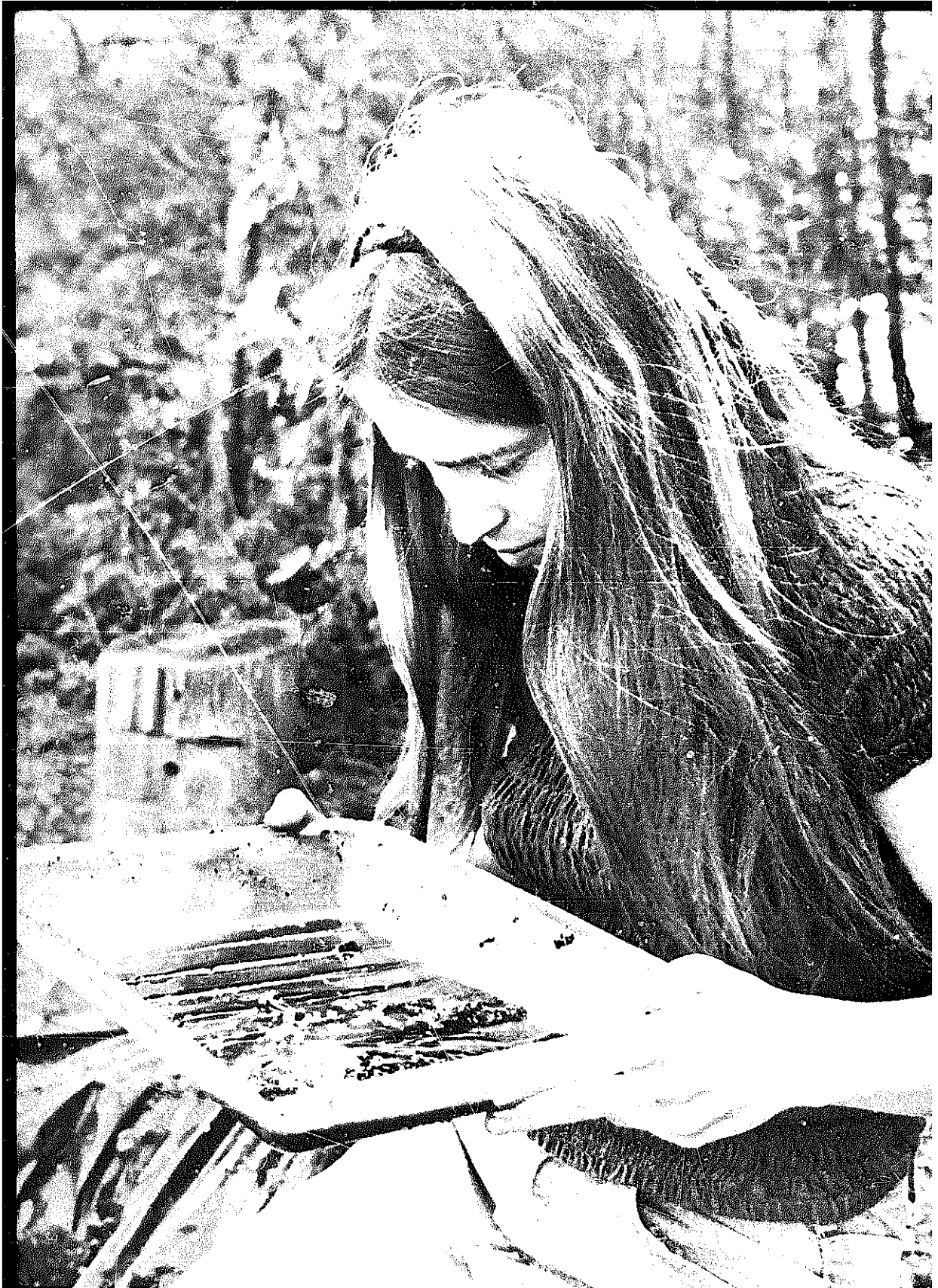

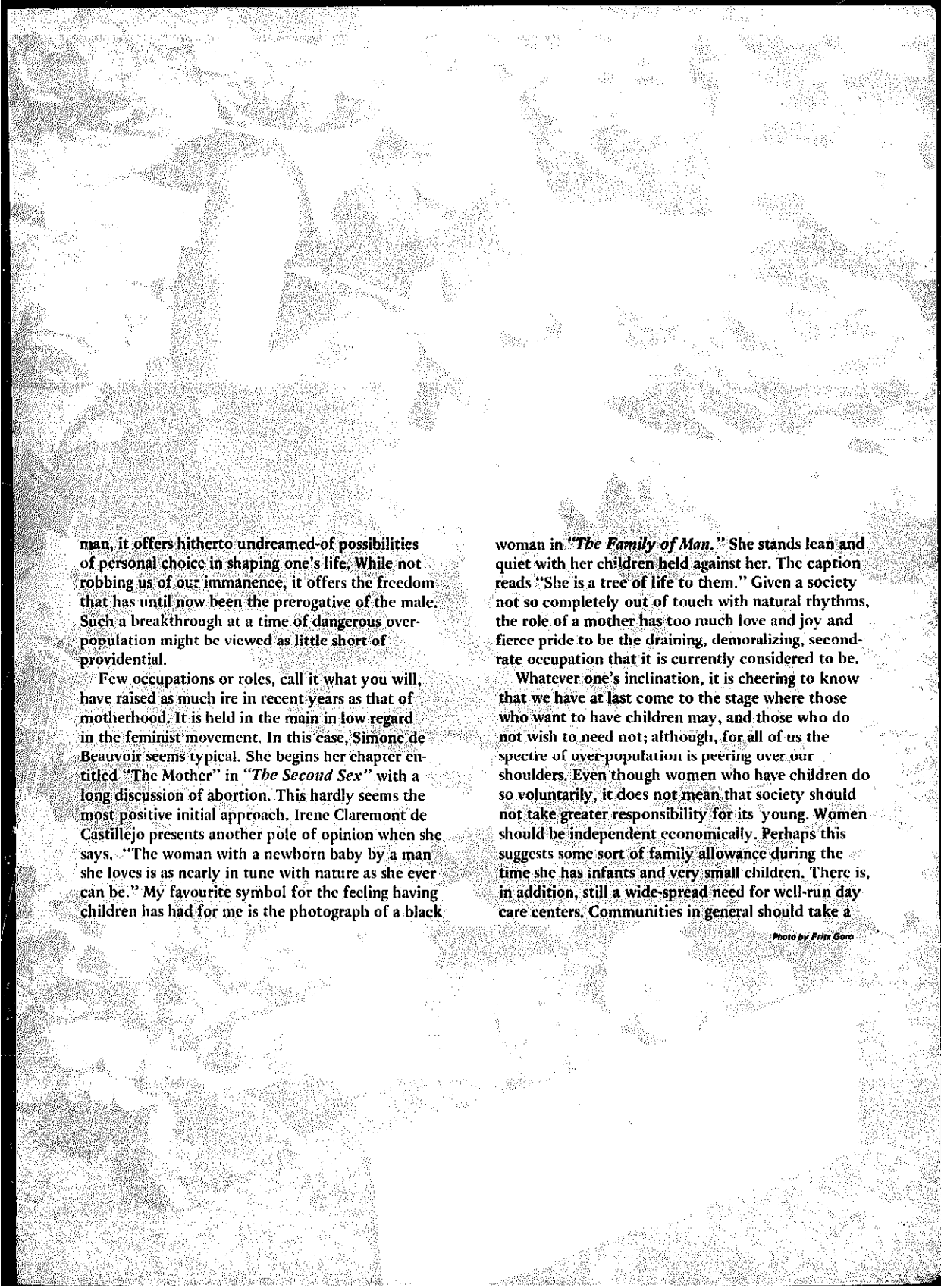

man, it offers hitherto undreamed-of possibilities of personal choice in shaping one's life. While not robbing us of our immanence, it offers the freedom that has until now been the prerogative of the male. Such a breakthrough at a time of dangerous over-population might be viewed as little short of providential.

Few occupations or roles, call it what you will, have raised as much ire in recent years as that of motherhood. It is held in the main in low regard in the feminist movement. In this case, Simone de Beauvoir seems typical. She begins her chapter entitled "The Mother" in *"The Second Sex"* with a long discussion of abortion. This hardly seems the most positive initial approach. Irene Claremont de Castillejo presents another pole of opinion when she says, "The woman with a newborn baby by a man she loves is as nearly in tune with nature as she ever can be." My favourite symbol for the feeling having children has had for me is the photograph of a black

woman in *"The Family of Man."* She stands lean and quiet with her children held against her. The caption reads "She is a tree of life to them." Given a society not so completely out of touch with natural rhythms, the role of a mother has too much love and joy and fierce pride to be the draining, demoralizing, second-rate occupation that it is currently considered to be.

Whatever one's inclination, it is cheering to know that we have at last come to the stage where those who want to have children may, and those who do not wish to need not; although, for all of us the spectre of over-population is peering over our shoulders. Even though women who have children do so voluntarily, it does not mean that society should not take greater responsibility for its young. Women should be independent economically. Perhaps this suggests some sort of family allowance during the time she has infants and very small children. There is, in addition, still a wide-spread need for well-run day care centers. Communities in general should take a

Photo by Fritz Goro



greater interest and joy in their children. And men should spend more time with them. It would be good for both of them.

As for women who decide against having children, and many splendid women have, the field that is most in need of improvements is that of reliable, safe contraception. This burden must be shared more broadly by men. Perhaps there could be a male pill. Certainly a reversible vasectomy shouldn't be beyond neurosurgery. It would be cheering to see some of the stigma clouding the idea of vasectomy dissipate in cases of men who have had their children or do not plan to have them. Pursuing the subject of reproduction in a slightly different direction, there is one radical feminist idea to which I am unalterably opposed, and

it is that of test tube babies. Besides being totally unecological, the concept with its science-fiction overtones is aberrant and potentially dangerous.

Elaine Morgan characteristically looks on the bright side of the whole child-bearing issue. Women who do not want to have children and would therefore likely have made indifferent mothers will not, thereby selecting themselves out. Those who then choose to raise children might be expected to make a better job of it. They might be inclined to be more selective in choosing father material as well. Ms. Morgan postulates that this for the first time could give woman "her finger on the genetic trigger." What will happen we cannot foresee, but Ms. Morgan expresses the hope that, in considering men to father their children, "extreme manifestations of the behaviour patterns of dominance and aggression will be evolutionarily at a discount."

Aside from, and often harmonious with, child-rearing, there exists the possibility of a host of earth-kindly skills. Some of these can provide for one's needs directly, others used for a source of income. Either way they are good for the soul. Gardening is high on this list. Apart from its obvious usefulness, it is endlessly interesting and rewarding. It is, perhaps, one of the most direct ways to study and form a bond with the earth, establishing a relationship that is profound, instructive, changing and changeless. Much of the drudgery and hard work, and admittedly it is hard work, can be relieved by working with friends — or is it that gardening together makes people friends? Pottery, carpentry, spinning, weaving, and making hand-crafted jewelry are other types of work that are at once satisfying and non-destructive. The study of herbal medicine, nutrition, and the care of animals are rewarding in themselves and engender a heightened awareness of the environment.

One possibility for exploring human potentialities, both male and female, is within the context of the small group. Countless communities, communes, co-ops and guilds have been and are being formed, perhaps to replace a sense of place and community

Photos by Fritz Gara



that has been lost in the impersonal mobility of society at large. People in them may be bound by a common idealism, a need to share their work or craft, or more simply a desire for companionship. Generally, they offer an accepting framework for personal change and transition. One such group, having a primarily ecological orientation, is the one with which I work, called New Alchemy.

It has been through working with New Alchemy that my understanding of ecology has moved from the theoretical toward some inkling of how the world works, in a biological sense. The philosophy behind the work of the group is wholistic, yet small-scale — to see only a small part of the world perhaps, but to view it in the complexity of its entirety. When one's primary sources of energy are the sun and wind, they play a greater part in one's life and one's awareness of them is markedly increased. To become involved in process develops a sense of stewardship, of interdependence between oneself and the land and its creatures, and wind and sun and water. The most concrete embodiment of our work that I can give is the greenhouse-aquaculture complex we call the Ark. Within the same structure, fish for food are grown in pools flanked by beds for the production of vegetables. The sun and the wind are the exclusive sources of energy and are transformed through biological processes into food. Living space will be the next concept to be incorporated. The fish feed mainly on algae which grows with them in the pond, and pond water irrigates and fertilizes the vegetable beds. It is a small, largely self-contained world in itself, and one cannot work with it without becoming a part of it.

When we first began working together as a group, there was considerable resentment on the part of the women over the housekeeping and more domestic work which necessarily accompanies almost every effort. When we articulated our feelings, we discovered in our case, and this may not be in any way typical, that our domestic orientation had been largely the result of

long-ingrained habits on our part as well as that of the men. As the men came to understand how we felt, the transition to sharing equally the work that we found to be most oppressive psychically was immediate. Group clean-ups usually resemble a brawl more closely than housework, but the results are adequate and the karma fine. Our other work is still somewhat divided along traditional sex lines. We don't have with us, at the moment, women with mechanical aptitude or engineering training, so our windmills and energy systems are largely in the hands of the men. But women do carpentry and rototilling and heavy garden work and carry their share of the physical burden. We still do more of the cooking, but the men do their share and like it. The kitchen staff is always bisexual and both sexes clean up.

The major advantage to working or living in something akin to a small group is the experience, being shared alike by both sexes, hopefully with minimal antagonism, of outgrowing and casting off sexist conditioning, and of learning that neither sex is bound by the limitations or inhibitions of traditional roles. This offers an unusually free and affectionate environment where immanent feminine qualities and the transcendent aspects of the male can grow toward each other and toward a more androgynous type of mind. Such a possibility, like the alchemists' gold or the holy grail, has long been the object of human longing.

In 1928 Virginia Woolf told a story based on her fantasy of a sister of Shakespeare who apparently died very young and never wrote a word. Virginia Woolf goes on to say, "Now my belief is that this poet who never wrote a word and was buried at the crossroads still lives. She lives in you and in me, and in many other women who are not here tonight, for they are washing up the dishes and putting the children to bed. But she lives; for great poets do not die; they are continuing presences; they need only the opportunity to walk among us in the flesh. This opportunity, as I think, is now coming within your



power to give her. For my belief is that if we live another century or so — I am talking of the common life which is the real life and not of the little separate lives which we live as individuals; if we have the habit of freedom and the courage to write exactly what we think; if we escape a little from the common sitting room and see human beings not always in their relation to each other but in relation to reality; and the sky, too, and the trees or whatever it may be in themselves; if we face the fact, for it is a fact, that there is no arm to cling to, but that we go alone and that our relation is to the world of reality and not only to the world of men and women, then the opportunity will come and the dead poet who was Shakespeare's sister will put on the body which she has so often lain down. Drawing her life from the lives of the unknown who were her forerunners, as her brother did before, she will be born. As for her coming without that preparation, without that effort on our part, without that determination that when she is born again she shall find it possible to live and write her poetry, that we cannot expect, for that would be impossible. But I maintain that she would come if we worked for her, and that so to work, even in poverty and obscurity, is worth while."

I find this among the most moving statements of feminism, perhaps the more effective for the fact that it is in the form of a metaphor. With regard to women's hopes for personal fulfillment there is little one can add. But in relation to the potential influence women possess for the possibilities for drastic change in the course of human history, I found an encouraging statement from Irene Claremont de Castillejo. She wrote, "The deeply buried feminine in us whose concern is the unbroken connection of all things is in passionate revolt against the stultifying, life-destroying anonymous machine of the civilization we have built. She is consumed by an inner rage which

is buried in a layer of the unconscious often too deep for us to recognize. She becomes destructive of anything and everything, sometimes violently but often by subtle passive obstruction.

"I believe it is often this inner protest which breaks out in neurotic illness in sensitive men as well as women, or turns destructive in places where it was not intended. With more consciousness feminine anger could be harnessed, to a creative end."

The reference to "more consciousness" surely justifies the countless hours so many of us have spent, in these times of rapid transition, in the search for identity and self definition. And surely "the deeply buried feminine in us whose concern is the unbroken connection of all things" is another way of defining feminine immanence and brings us back full circle to the question of our place in nature — to our own organic essence. For it would be a truly bitter irony were we to inherit the world just in time for its death throes. And it would be a poor world without dolphins and butterflies.

I should like to end with a story about women and ecology that took place around New Alchemy's compost pile, which seems a suitably earthy and symbolic place to close. A while ago, a group of us were turning the compost late one Saturday afternoon, an activity that has acquired the status of near ritual. As we shovelled, someone commented on the smell which was at that moment, as I remember, largely vintage cabbage. "Smell", said Hilde, who is our chief gardener and thinks well of compost. "That's the new perfume." To which one of the men, who has a voice which has been described accurately as stentorian tones, thundered, "If this is the new perfume, then women's liberation has gone far enough."

And Hilde said, "It's just beginning."

— Nancy Jack Todd

Photo by Alan Peartman

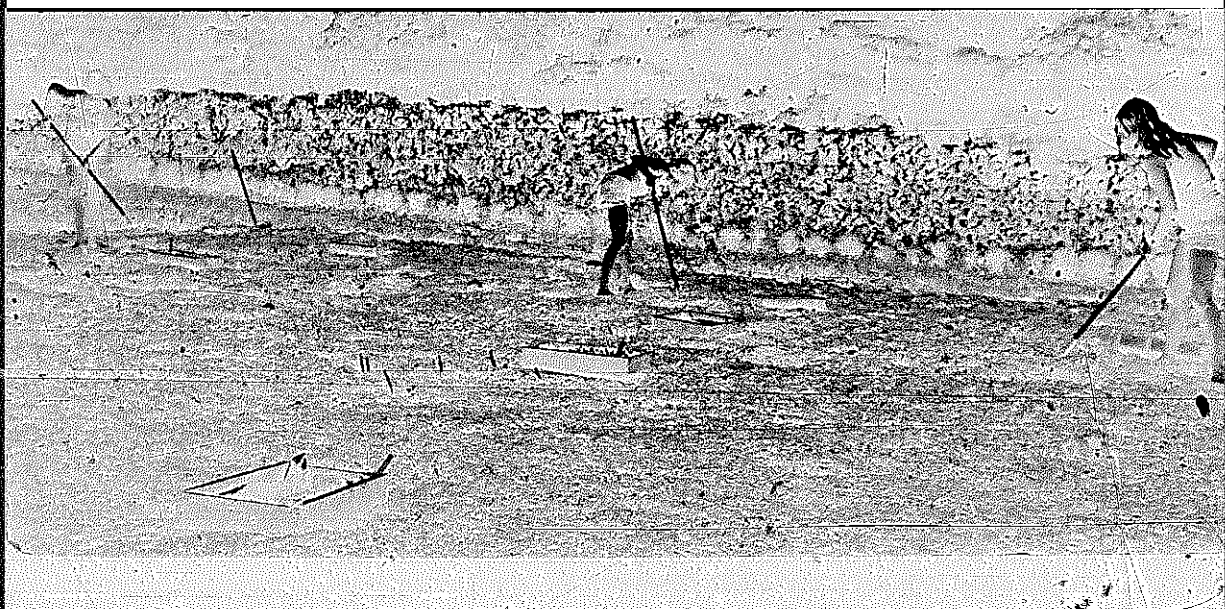

So one sleep every year I dream
The end of Ramadhan
Or some high holy day
When fathers whistle and mothers sing
And every child is fair of face
And sticks and stones are loving and giving
And sun and moon embrace.

A unicorn runs on this fly-by-day,
Whiter than milk on the grass, so white is he.

—Anne Wilkinson

(From *"The Wind Has Wings – Poems from Canada,*
Oxford University Press, Toronto, 1968)



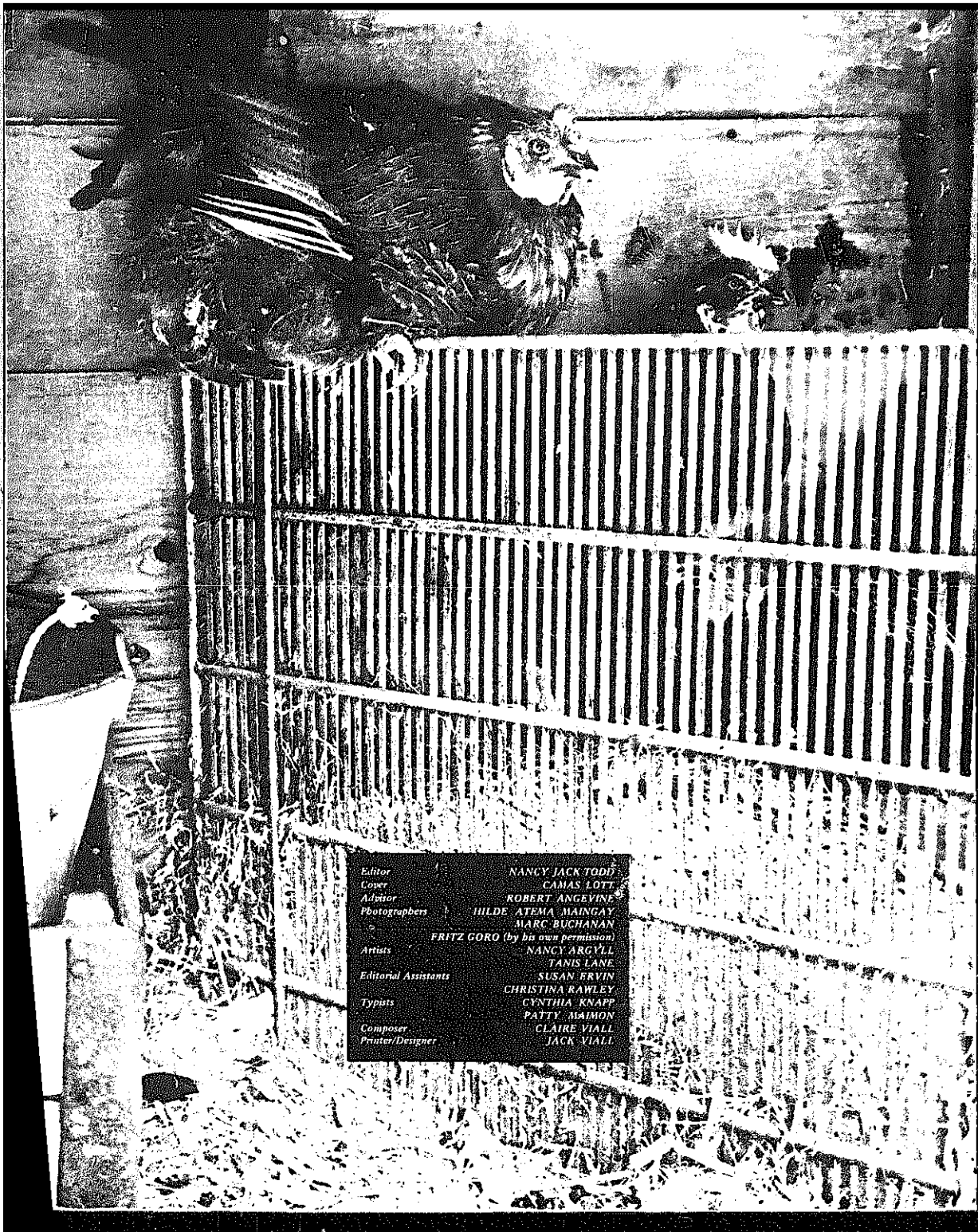

Editor NANCY JACK TODD
Cover CAMAS LOTT
Advisor ROBERT ANGEVINE
Photographers HILDE ATEMA MAINGAY
MARC BUCHANAN
FRITZ GORO (by his own permission)
Artists NANCY ARGYLL
TANIS LANE
Editorial Assistants SUSAN ERVIN
CHRISTINA RAWLEY
Typists CYNTHIA KNAPP
PATTY MAIMON
Composer CLAIRE VIALI
Printer/Designer JACK VIALI