

**AT** MICROFICHE  
REFERENCE  
LIBRARY

A project of Volunteers in Asia

Septic Tank Practices

by: Peter Warshall

Published by.

Doubleday & Co., Inc.  
501 East Franklin Avenue  
Garden City, NY 11530 USA

Paper copies are \$ 3.00.

Available from:

Doubleday & Co., Inc.  
501 East Franklin Avenue  
Garden City, NY 11530 USA

Reproduced by permission of the author.

Reproduction of this microfiche document in any form is subject to the same restrictions as those of the original document.

# SEPTIC TANK PRACTICES

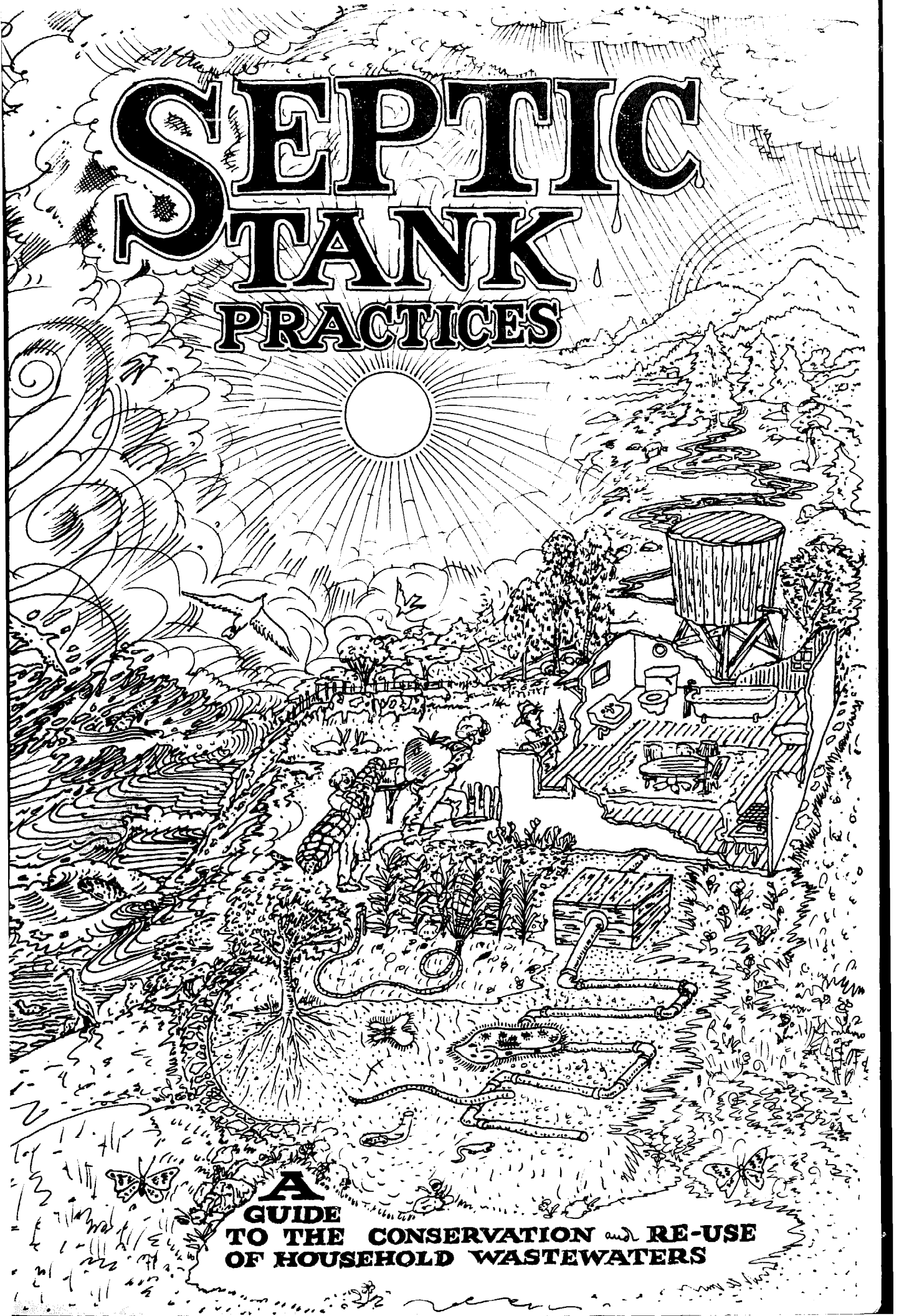

**A**  
**GUIDE**  
**TO THE CONSERVATION and RE-USE**  
**OF HOUSEHOLD WASTEWATERS**

## SEPTIC TANK PRACTICES

A primer in the conservation,  
and re-use of household  
wastewaters.

Revised Edition

Written by Peter Warshall  
with the generous assistance  
of J.T. Winneberger and  
Greg Hewlett

Copyright © by Peter Warshall (1976)

Box 42, Elm Road  
Bollinas, CA 94924

Cover by Arthur Okamura



printed on the  
MESA PRESS

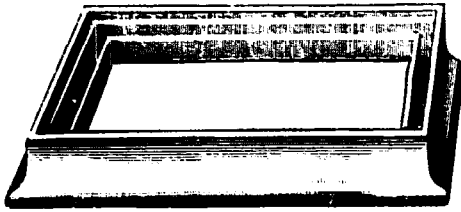
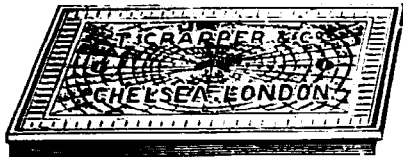

# CONTENTS

*Title illustration: Box for toilet paper sold by Thomas C. Crapper — inventor of the modern flush toilet.*

<b>PROLOGUE</b>	<b>1</b>
<b>1. INTRODUCTION TO THIS BOOK</b>	<b>3</b>
<b>2. SEWAGE AND SEWAGE TREATMENT</b>	<b>5</b>
Grey vs. Black Water/5	
The Meaning of Pollutant/5	
Biological Oxygen Demand/6	
The Definition of Sewage Treatment/6	
<b>3. HOME-SITE SEWAGE TREATMENT</b>	<b>7</b>
Pit Privy or Outhouse/7	
Compost Privy/8	
Septic Tank and Drainfield/9	
Aerobic Unit/11	
<b>4. GOOD SOIL, CLEAN WATER</b>	<b>13</b>
The Soil Community/13	
The Aerobic Community/14	
The Anaerobic Community/15	
The Organic Mat/15	
Infiltration/16	
Soil Texture/17	
Soil Structure/18	
Soil Profile/19	
Soils and Human Health/19	
<b>5. THE IMPORTANCE OF SAVING WATER</b>	<b>21</b>
The Big Picture/21	
Septic Tank and Drainfield Function and Water Use/22	
Water Use in America/22	
Household Water Conservation/23	
<b>6. SEPTIC TANK DESIGN</b>	<b>29</b>
What Happens In a Septic Tank/29	
Feeding Microbes/30	
Retaining Solids/30	
Septic Tank Size/32	

<b>7. DRAINFIELD DESIGN</b>	<b>33</b>
Maintaining Infiltration/33	
The Best Drainfield Hole/33	
Drainfield Size/35	
Drainfield Layout/37	
Soil Aeration and Dual-Drainfields/37	
<b>8. ECOLOGICAL PROBLEMS</b>	<b>39</b>
Slopes/39	
Hardpans and Watertables/40	
Shallow and Impermeable Soils/41	
Artificial Drainfields/42	
Luxury Septic Tank Equipment/43	
Cold Climates/43	
<b>9. PLANNING AND CONSTRUCTION</b>	<b>45</b>
Home-Site Plan Sketch/46	
Decisions/46	
Home-Site Ecology/47	
Percolation Test/49	
Calculating Drainfield Area/50	
The Exact Map/52	
Materials/54	
Construction/56	
<b>10. HOME CARE AND MAINTENANCE</b>	<b>59</b>
Home Map/59	
Water Conservation/59	
Chemicals/59	
Runoff/60	
Pumping/60	
Diagnosing Problems/61	
<b>11. SEWERAGE AND COMMUNITY LIFE</b>	<b>65</b>
Codes and Health Officers/64	
A Classic Story/65	
Home-Site Sewage Treatment vs. The Big Sewer/66	
False Failures and Real Surveys/67	
Effects on Community Life/71	
<b>BIBLIOGRAPHY</b>	<b>75</b>
<b>ACKNOWLEDGMENTS</b>	<b>75</b>
<b>APPENDIX: WATER-TIGHT CONCRETE</b>	<b>76</b>

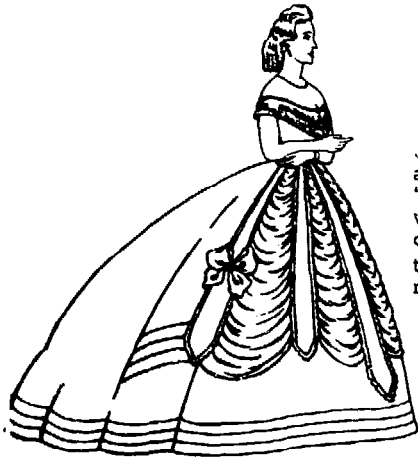

1865

Just last year Prince Philip walked into the Ladies Room of a British railway station. Surprised, he found no signs saying "Ladies" or "Gentlemen." He found out that Queen Victoria was embarrassed by her subjects going to the bathroom. She ordered all signs removed from her presence. So, every time the Royal train arrived at a station, all signs were covered or removed. Prince Philip has finally rescinded the decree.



1870



When hygiene was commercialized, the last hope that sewage could be re-used and handled sensibly was lost. (From "The Underground Sketchbook of Tomi Ungerer," Dover paperback, 1973. A wonderful series of taboo-breaking cartoons.)

When we reflect upon the depleted fertility of our own older farm lands, comparatively few of which have seen a century's service, and upon the enormous quantity of mineral fertilizers which are being applied annually to them in order to secure paying yields, it becomes evident that the time is here when profound consideration should be given to the practices the Mongolian race has maintained through many centuries, which permit it to be said of China that one-sixth of an acre of good land is ample for the maintenance of one person, and which are feeding an average of three people per acre of farm land in the three southernmost of the four main islands of Japan.

From "Farmers of Forty Centuries" — 1908.



*Sanitation in the Middle Ages,  
from an old woodcut*

# PROLOGUE

As industrialization intensified, Western civilization became more and more alienated from the body's plumbing and its connection to Nature's pathways. Instead of eating, defecating onto the ground, fertilizing plants with feces, and eating again, we simply reach behind our backs and pull a little chromium lever. Instead of defecating into the earth, we sit on a toilet filled with good drinking water which comes from some unknown river and, after flushing, goes to some unknown destination. Instead of taking responsibility for our excrement, we are embarrassed by defecation and avoid direct discussion by substituting all kinds of diversionary vocabulary ("caa caa" and "poo poo" or abbreviations like "No. 1" and "Number 2" or sidewise expressions like "May I be excused.").

Western civilization is caught in a paradox: while having the most modern sanitary equipment, its mentality has become more primitive than any pre-literate society. While each citizen consumes more food and water than any previous society, these same citizens are totally ignorant of the simplest and most basic concerns of humanity since before the Plesitocene: where does your water come from? where does it go after you urinate? where does your food come from? where does it go after you defecate? whose life is changed and how by your feces' destination? Compared to the Dark Ages of Europe, a New Yorker or Los Angeles resident has the most "primitive" mind. Turn the faucet and magically "clean water." Flush and "magically" everything empties into the unknown.

Four events created our alienation from the circle of feces-fertilizer-food-feces. Piped water eliminated the out-house and bedpan and led to the invention of the flush toilet. The flush toilet itself allowed the Victorian flush-and-forget mentality to flourish. Modern medicine, having conquered all the dangerous diseases caused by sewage, reduced the necessity to connect feces with the human body. Finally, the use of petroleum-based fertilizers temporarily broke the necessity of needing feces for growing food.

By the mid-forties, excrement became known as "waste" and flushing as "waste disposal" -- all part of the same semi-embarrassed (though now couched in technical-sounding lingo) vocabulary. By the fifties, America had developed a full-blown "excrement taboo" which was widely commercialized and exploited by the cosmetic industry. Adding sex to embarrassment, any excrement (sweat, exhale, even tears) was to be hidden, disguised, and buried in pine scent.

Meanwhile, in Asia, the people of Japan, Korea and China regarded feces as "night soil" -- as fertilizer given freely back to the land. In pre-War Japan, rent was lowered in Hiroshima in proportion to the

amount the house privy was used. In Vietnam, outhouses are still placed along the road with signs encouraging travelers to use the facilities. A balance existed between city "wastes" which were transported to farms for fertilizer and the food, fertilized by human manure, returned back into the cities.

The era of flush-and-forget is ending. New Yorkers cannot avoid the sewage sludge returning to their shores. Mid-Westeners cannot but regret the loss of fishing and swimming in polluted Lake Michigan. Californians are increasingly aware that sea urchins -- fed by a continuous supply of rich city sewage -- are devastating offshore kelp, ruining both the nursery of many fish and a profitable industry. The U.S.A. has become the world leader in dumping rich sewage into rivers, lakes and oceans while digging up the rest of the world for petroleum-based fertilizers.

We are learning: wastes are not wastes. They are misplaced natural resources. We cannot "dispose" of anything on Earth without sending it to outer space. "Wastes" can only re-enter the Nutrient and Water Cycles on this planet. We cannot avoid our "wastes." Because we exist in the bio-sphere of Earth and are connected to the Nutrient and Water Cycles of the planet, "wastes" return -- usually with a vengeance. But as humans, we can encourage "wastes" and "waste water" to re-enter only certain, specific natural cycles and communities where they can benefit us and other living creatures and plants. By understanding our "wastes," by connecting our body's plumbing to Nature's pathways, we can learn to eliminate current practices that now damage both our bodies and planet life.

This booklet is dedicated to a rebirth of responsibility toward earth, air, and water; to breaking the "excrement taboo," and to healing the somewhat disconnected and schizophrenic mentality that hinders this re-awakening. If you eat, you defecate. And it is every citizen's responsibility to make sure that defecation means the fertilization of the land that feeds him.

---

On the farm of Mrs. Wu, near Kashing, while studying the operation of two irrigation pumps driven by two cows, lifting water to flood her twenty-five acres of rice field preparatory to transplanting, we were surprised to observe that one of the duties of the lad who had charge of the animals was to use a six-quart wooden dipper with a bamboo handle six feet long to collect all excreta, before they fell upon the ground, and transfer them to a receptacle provided for the purpose. There came a flash of resentment that such a task was set for the lad, for we were only beginning to realize to what lengths the practice of economy may go, but there was nothing irksome suggested in the boy's face. He performed the duty as a matter of course and as we thought it through there was no reason why it should have been otherwise. In fact, the only right course was being taken. Conditions would have been worse if the collection had not been made. It made possible more rice. Character of substantial quality was building in the lad which meant thrift in the growing man and continued life for the nation.

In 1908 the International Concessions of the city of Shanghai sold to one Chinese contractor for \$31,000, gold, the privilege of collecting 78,000 tons of human waste, under stipulated regulations, and of removing it to the country for sale to farmers.

Dr. Kawaguchi, of the National Department of Agriculture and Commerce, taking his data from their records, informed us that the human manure saved and applied to the fields of Japan in 1908 amounted to 23,850,295 tons, which is an average of 1.75 tons per acre of their 21,321 square miles of cultivated land in their four main islands.

From "Farmers of Forty Centuries" -- 1908. (See Bibliography.)





# 1. INTRODUCTION TO THIS BOOK

In the past two decades, there has been a bandwagon of pressures pushing small communities to sewer up. Health officials said that home-site systems like septic tanks were just unmanageable and sure-bet health hazards. Engineering firms peddle big sewers to make profits that were impossible with *at home* sewage treatment. Water companies favored big sewers because they used more water. Real estate agents wanted big sewers because they allowed smaller lots. The Federal and State governments liked them because more big sewers were equated with more progress and a higher standard of living. Even the Environmental Protection Agency, until recently, believed centralized sewers would lead to less pollution than home-site sewage treatment. Between 1950 and 1970, 10 million homes with home-site sewage treatment were connected to new centralized sewer systems.

This is perhaps the first booklet to argue that home-site sewage treatment pollutes less, costs less, uses less energy resources, and is less of a health hazard than centralized sewage treatment. In addition, home-site sewage systems treat domestic sewage in soils and soils are, by far, the best purifiers known to man. We hope to persuade health officers and government agencies and actual communities that home-site sewage treatment (Chapter 2 and 11) is superior to centralized sewerage.

At the same time, and equally important, this booklet tries to make home-site sewage treatment as ecologically and technically sound as possible. Every aspect of septic tank and drainfield design from materials to maintenance (Chapter 5 through 10) is explained using information from the last twenty years of research.

We will necessarily disagree with the Public Health Service *Manual of Septic Tank Practice* because, frankly, this publication is now obsolete. The PHS has not up-dated their information and has been sadly lax in spreading new information among the people of this country.

We will not *push* septic tanks as the best and only home-site sewage treatment. Chapter 3 clearly indicates that other kinds of home-site systems are preferable to septic tanks in many circumstances.

Throughout, there are warnings about septic tank/drainfield limitations (especially in Chapters 8 and 9) and alternatives like

50% of rural North America and 17% of Urban America use home-site sewage systems. This is one-quarter of America's housing (20 million dwelling units) in which about 50 million Americans live. Until the oil shortages, inflation and recession, about 300,000 new homes with home-site sewage treatment were being built each year.



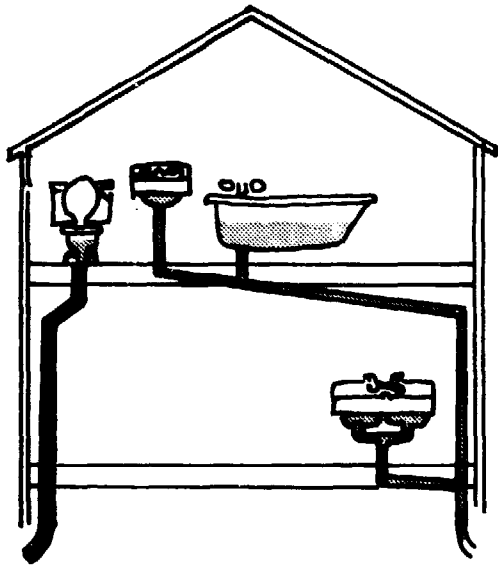

## 2. SEWAGE AND SEWAGE TREATMENT

Household sewage is simply everything a family flushes down the toilet and washes down the drains. About 60% of sewage wastewater comes from lightly polluted sources. This water, called *grey water*, drains from the laundry, kitchen, and bathroom sink, shower and/or bathtub. The other 40 to 50% of sewage wastewater comes from the toilet. Since this water carries feces out of the house, it is considered heavily polluted. It is called *black water*.

*A house with grey water separated from black water. This kind of plumbing makes sewage treatment easier and water recycling easier. Chapter 5 gives the details.*

Sewage is 99.9% water. In other words, sewage is highly diluted because we use so much water (50 to 350 gallons per person per day) just to flush and wash away a tiny amount of "undesirable" solids (16 to 100 ounces per person per day).

One tenth of one percent of sewage water is solid substance. These substances are both organic (80 to 85%) and inorganic (15 to 20%) substances. Organic substances come from feces and urine, detergents, soaps and food wastes (especially in homes with garbage grinders). The inorganic substances originate from household chemicals: water softeners, borax and chlorox, paints and photo chemicals.

### **What is a Pollutant?**

These substances can either be beneficial or harmful to humans and other living creatures. They are "pollutants" only if humans *cannot* recycle them for their own and other creatures' benefit. *Sewage treatment is basically directing and controlling the recycling of excrement and other household substances back into the Water Cycle and Nutrient Cycle of Earth.*

For instance, if all of North America's 22 million on-site sewage treatment systems were functioning well, one million tons of fixed nitrogen and one quarter million tons of phosphorus would recycle each year for better plant growth and better evapo-transpiration. Recycling is easier with home-site sewage because it occurs *in soil*. This recycling saves about 8 to 9 million tons of petroleum-based commercial fertilizer.

On the other hand, centralized sewers waste a minimum of 1.1 million tons of fixed nitrogen because sewage is released *in surface waters* (lakes, rivers, oceans). This wasted nitrogen is equivalent to about 10 million tons of petroleum-based, commercial fertilizer. By not re-

cycling quickly in soil, the nitrogen upsets natural communities, causes unwanted and suffocating algae growths, can ruin various economic enterprises like the kelp industry and can even cause a rare disease in infants called methemoglobinemia. (This disease produces "blue babies" and can be spread by the mother during breast feeding.) Nitrogen, in home-site sewage treatment, is a beneficial resource. In centralized sewers, a horror show. (More in Chapter 11.)

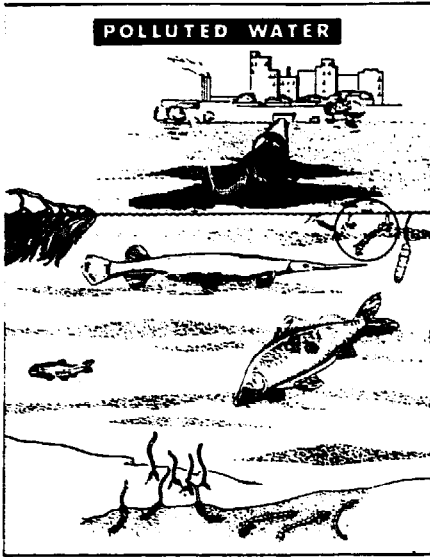

#### Biological Oxygen Demand

All the organic and many of the inorganic substances in sewage are large, complicated molecules. They must be broken down by sewage treatment. This process requires oxygen. The oxygen required to treat sewage is a "demand" on the dissolved oxygen in the water. If the demand for oxygen is too great, the sewage goes untreated and polluted water will enter lakes and oceans. This deprives other animals like fish or shrimp of their oxygen. In extreme situations, like the pipe from a city sewer into the ocean, fish and other animals suffocate. Natural wildlife is greatly reduced and many natural balances are totally upset. This "demand" for oxygen to break down large molecules is one of the main concerns of sewage treatment. Not surprisingly, it is called the *Biological Oxygen Demand* or *BOD*.

#### Pathogens

Finally, microbes are found in sewage. Bacteria, viruses and fungi -- some dead, some alive -- come from your stomach, blood, lungs, and even your skin. A small number of these microbes cause human diseases. They are considered *pathogens*.

### SEWAGE TREATMENT

To recycle sewage for the benefit of all living creatures, sewage must be altered with human help. Humans must:

1. Reduce the amount of sewage by reducing water use which, in turn, will reduce the difficulties and costs of sewage treatment.
2. Help breakdown the solids so that microbes can more easily digest them and release the nutrients quickly into the natural cycles.
3. Kill the disease-causing microbes so that other humans will not be harmed.
4. Use as much of the organic substances as possible, before they travel by soil or water, to some natural community where their presence upsets the existing balance of plant and animal (including human) life (i.e., reduce BOD).
5. Remove harmful chemicals (like DDT) before they harm plants and animals (including us) by accumulating in the food-chains.

All domestic sewage treatment systems should be judged by these standards and their ability to attain these standards cheaply.

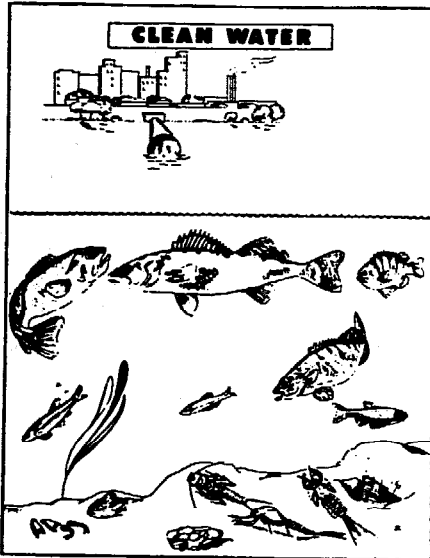

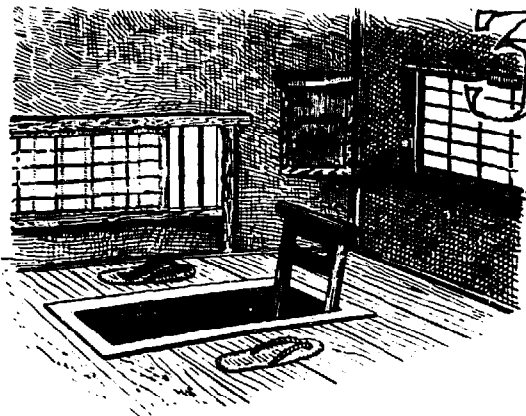
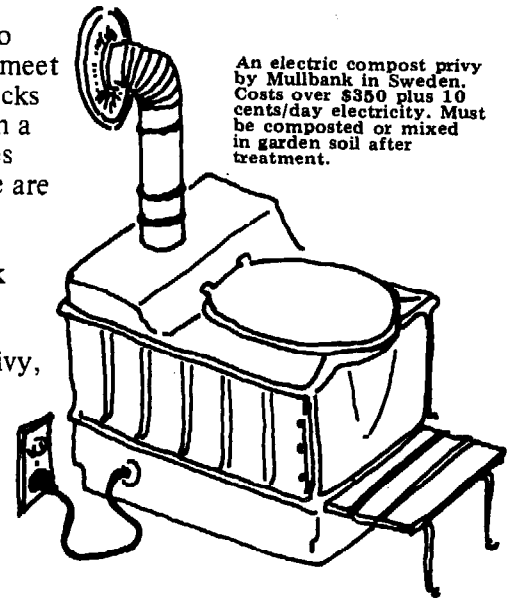

FIG. 220. — INTERIOR OF A PRIVY IN ASAKUSA.

# 3. HOME-SITE SEWAGE TREATMENT

Spaceship technology has brought to earth an incredible variety of appliances and contraptions for sewage treatment. There are destrolets that burn excrement to ashes. These can be attached to motor homes and the fumes, filtered through the exhaust pipes, meet air pollution standards. There are freeze toilets that make ice-blocks of excrement which must be carted away by trucks. There is even a Swedish "sausage toilet" that catches excrement in plastic baggies that come on a roll, then seals them for the garbage collector. We are not concerned with these hi-tech solutions because they are very costly, require extravagant amounts of electricity or petroleum-based fuels, never recycle, and, with so many parts, tend to break down. Instead, we will treat four low tech, small scale, sewage treatment systems. All treat sewage at the home site. Each in its own way. They are: the pit privy (or out house), the compost privy, the septic tank/drainfield system, and the aerobic home unit.



An electric compost privy by Mullbank in Sweden. Costs over \$350 plus 10 cents/day electricity. Must be composted or mixed in garden soil after treatment.

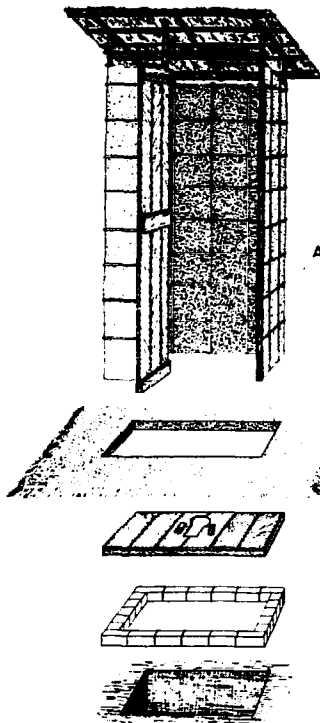

## PIT PRIVY

The *pit privy* or out-house uses no water. No water greatly reduces the volume of sewage, simplifies treatment, recycling and pollution potential. The pile of excrement decomposes: faster when it's warmer; slower when it's cold. Decomposition reduces bulk so the privy can be used longer. The heat or extreme cold of the pile kills some disease-causing microbes. But, even more important, the time spent without us, the protective human host, means most pathogens die (Chapter 4). In addition, as the pile decomposes, some of the microbes and nutrients find their way into the surrounding soil. The soil, the planet's most astounding filter, absorbs and strains out the nutrients and remaining disease-causing organisms (Chapter 5). A well placed (away from water) and fly-proofed privy cannot pollute or be unsanitary.

In summary, the pit privy is the most reliable, easily managed and replaced, cheapest and least polluting of all home sewage treatments. Where water is scarce or the water system is not pressurized, the pit privy is the only device that makes sense.

## COMPOST PRIVY

The *compost privy* also decomposes excrement *and* all other organic household wastes like vegetable scraps. Like the pit privy, it does *not* use water. But, the process of decomposition in a compost privy is very different from a pit privy. The pile is not let to rest. It is aerated by either turning it with a shovel or forcing air through perforated pipes in the pile. The extra air (and in some cases, extra heat) means the decomposition is faster and has fewer odors. The composted wastes are not allowed to filter into the soil. Instead, after a year, they are shovelled out of the compost privy and used directly for fertilizer. A year of composting is too long for pathogen survival.

Compost privies are reliable but need lots of attention: keeping the right mixture of feces with other organic wastes as well as insuring proper aeration and warmth. There is absolutely no pollution possible because compost privies are self-contained units. There are expensive and cheap compost privies available.

An additional expense for both pit and compost privies may be the "grey water system." To repeat, grey water is lightly polluted because it has no feces. It is the wastewater from sinks, baths and washers. This water needs some kind of disposal system – usually just a pit. But, some Health Departments require expensive grey water systems (see next Chapter). Some Health Departments also ban compost privies.

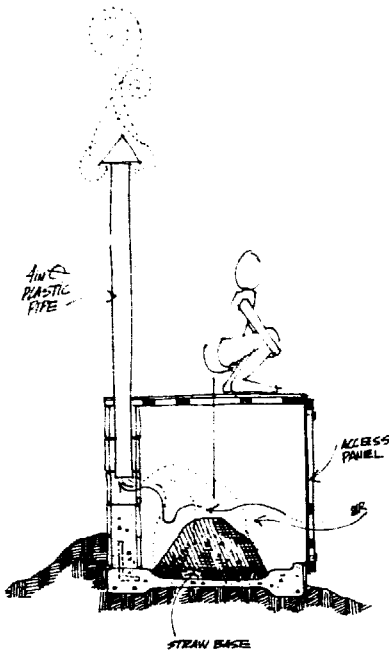

The Farallones Institute Composting Privy (Tech Bulletin No. 1, Farallones Institute, 15290 Coleman Valley Rd., Occidental, CA 95465, \$2.00) is for rural homes. It needs a 4'x8' area. You build it and maintain it by following procedure illustrated below. Requires a grey water system as well as Health Department approval. In use in California. Toilet or seat can be used with this privy if you are adamant against squatting. Maximum use is about 15 persons/daily.

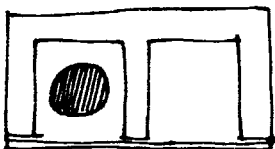

First chamber is used for 6 months.

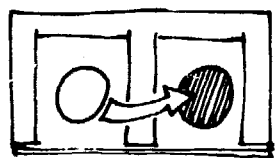

After six months, the pile is moved to the aging compartment.

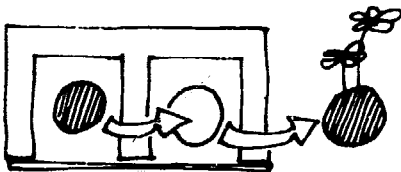

After one year, the first pile is ready for garden use.

The Clivus Composting Toilet is totally enclosed, fiber-glass privy. It digests aerobically through ventilating pipes. In use in some states but accepted officially only in Maine. Costs vary from \$600 to \$1,600. An excellent privy for city installation. Available information from Clivus-Multrum, 14A Eliot Street, Cambridge, Mass. 02138.

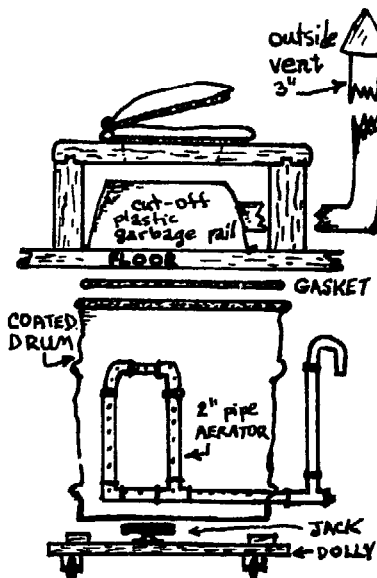
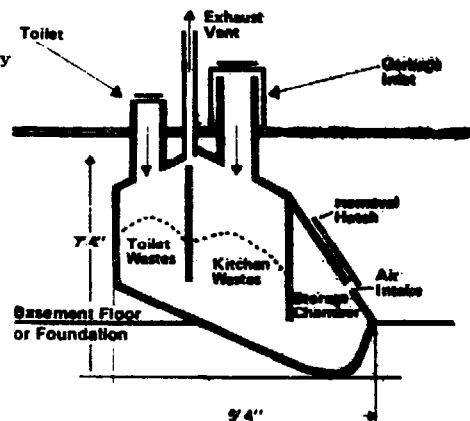

A coated 55-gallon drum makes an excellent compost privy. If there is room under house, the drum is jacked up against the floor to keep flies out. A 2 inch plastic aerator keeps moisture low and speeds composting. The toilet is a cone attached to floor. An elegant wood platform with toilet seat should be built over "shoot" to further seal against flies. A vent pipe is attached to the shoot. The drum can be alternated with a second drum like the Farallones model. Or, the contents can be added to an already steaming compost pile (140° F.) during the best composting season. Write United Stand Sanitation, P.O. Box 191, Potter Valley, CA 95469 (\$1.00) and read the CoEvolution Quarterly, Box 428, Sausalito, CA 94965 for continuing news.

## SEPTIC TANK/DRAINFIELD SYSTEM

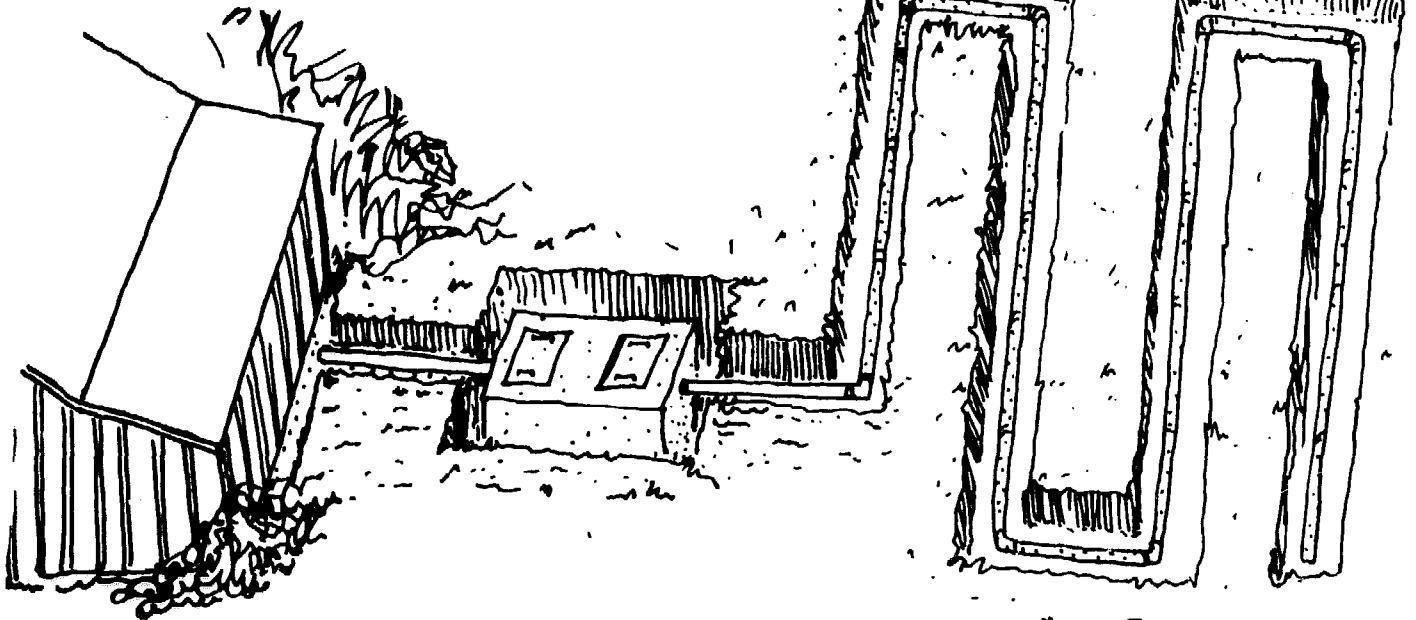

The *septic tank system* is a homesite sewage treatment system that uses the flush toilet. Wastewater from all the appliances (sinks, toilets, showers, etc.) is combined. Septic tank systems can pollute more than compost or pit privies because feces are diluted in water and the volume of waste is greatly increased.

The septic tank system actually has two distinct sections: the septic tank itself and the drainfield. The septic tank itself is a box which eliminates, at least, half the excrement by allowing time for solids to settle and be eaten by microbes. The treatment occurs without much oxygen. It is slow but reliable. The wastewater (minus much of the solids) then passes into a hole in the ground. The hole can be almost any shape and depth. The most common shape is a linear trench usually between 3 and 6 feet deep. This trench design is called the drainfield (or leachfield, filter-field or sub-irrigation field). The hole may also be pit-shaped or within a man-made mound.

The wastewater from the septic tank receives further treatment in the drainfield. The soil adsorbs viruses, strains out bacteria, filters large wastes and chemically renovates them into nutrients that can be used by plants. In the drainfield, there is usually more oxygen for sewage treatment as air circulates in and out of the soil. Treatment is reliable for the lifespan of the drainfield.

The cleaned water from the drainfield is disposed of by moving through the soil to aquifers and streams, evaporating from the ground surface and by ingestion by thirsty plants.

In summary, the septic tank system requires a high initial cost for materials and installation compared to a pit privy. Its ability to pollute or cause unhealthy conditions is almost as low as the pit privy. Septic tank systems require a pressurized water supply, low maintenance, and a home surrounded by a garden, lawn, or other green space. Through sub-irrigation in the drainfield, septic tank systems recycle the nutrients and cleaned water.

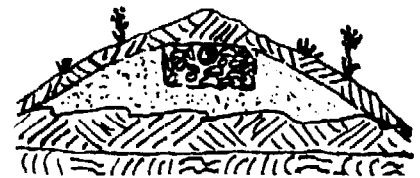

A **MOUND** is a man-made drainfield when soils are poor or water-table is too high. The trench is built above the ground level by trucking in enough good soil to treat the septic tank's effluent. More in Chapter 8.

A **SEEPAGE PIT** is simply a deep, vertical hole as opposed to a shallower trench. Seepage pits make fine drainfields in deep soils with low-water tables. The pipe comes from the septic tank.

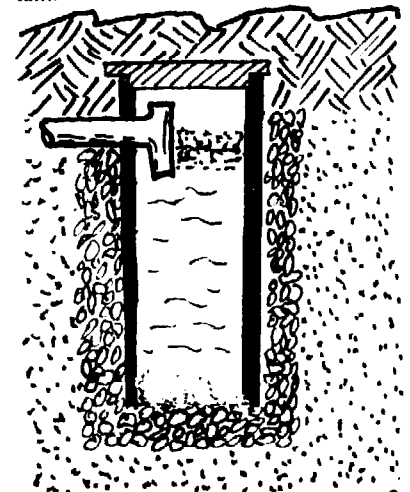

**PIT PRIVY**

**COMPOST PRIVY**

**SEPTIC TANK/  
DRAINFIELD**

**AEROBIC UNIT**

RELIABILITY

Aerobic & anaerobic composting with some infiltration. Very stable.

Mostly aerobic composting. Stable when proper carbon/nitrogen balance maintained.

Settling, floatation, & anaerobic digestion in tank. Aerobic & anaerobic filtration and digestion in drainfield. Very stable if not overloaded.

Aerobic digestion least stable due to "shock" loading and mechanical complexity.

MAINTENANCE

Very easy. Minimal labor.

Not so easy. Proper amounts of vegetable matter must be added to feces. Manual labor required weekly in some models.

Easy. Labor minimal. Needs checking for pumping about every two to four years. If dual-field, needs yearly manual switching.

Difficult. Many mechanical parts needing specialist labor. Outside energy source can be a problem. Needs cleaning each year.

COSTS

INITIAL: Very expensive (\$50). Grey water system may be required.

OPERATION: None  
MAINTENANCE: None

INITIAL:  
(a) Farallones model (about \$150). Home made.  
(b) Clivus (\$600 to \$1,700)  
(c) 55-Gallon drum (\$50 to \$100). Home made.

Grey water system may be required.

OPERATION: None  
MAINTENANCE: None

INITIAL: Pretty expensive (\$800 to \$4,500) depending on size, contractor, and materials. Home-made can be cheaper.

Grey water system used to advantage.

OPERATION: Water costs.  
MAINTENANCE: Pumping every 3 to 10 years (\$40 to \$85).

INITIAL: Very expensive (\$1,600 to \$3,000+). Drainfield not included. Filtration and chlorination not included.

Grey water system used to advantage.

OPERATION: Water costs. Electric.

OPERATION: Water costs. Electricity costs (\$150+ each year). Filtration and chlorination (\$300+ each year).

LIFESPAN

About 10 years for a family of four.

As long as materials last. (a) 20 years  
(b) 60 years (?)  
(c) 10 to 15 years

10 to 75 years depending on soils and design.

Less than 10 years before major parts replacement necessary.

POLLUTION & SANITATION

If not near or in water, no pollution or sanitary problems.

No pollution. No sanitation problem with proper composting. Overloading may be a problem when daily use exceeds 4-6 people (55-gal. drum), 8-12 people (clivus) 15+ people (Farallones).

Larger pollution & sanitation problems because of water-feces mix. Soils, groundwater, slope and over-load can be problems. Negligible problems outside property line because of in-soil discharge.

Larger pollution & sanitation problems because of water-feces mix. "Shock" loadings, mechanical breakdown, power black-out & inadequate treatment can be problems. If above-soil discharge, more dangers than in-soil. In-soil has negligible pollution potential outside property line.

RECYCLING

Ultimately by burial & planting a tree. Adds nutrients & humus.

Great fertilizer for gardens, etc.

Sub irrigation in drainfield ultimately: fertilizes plants & may re-charge water supplies.

Water and nutrients recycled ABOVE GROUND by spray irrigation. IN GROUND by absorption. In water courses, they are pollutants.

COMMUNITY

Accommodated high-densities in cities - if away from water. Politically, not available for city use. Discouraged even in rural areas.

Can accommodate high-densities in cities. Need pick-up of compost. Politically, new to city & rural Health Departments. Rarely accepted with ease.

Low densities only -- need green space for drainfield(s). Rural use. Accepted home-site system but many badly designed.

Low densities with in-soil discharge. High-density with above-soil discharge. Rarely accepted by Health Depts. because of erratic behavior.



## CESS-POOL

The *cess-pool* is essentially a kind of combined septic tank/drainfield. The hole which now serves as both a septic tank and a drainfield must be much larger than the hole needed for a septic tank and drainfield separately. Cesspools tend to clog more quickly because solids fill up the soil pores. An understanding of cesspools is equivalent to understanding septic tank/drainfield systems. No special mention will be made in this book.

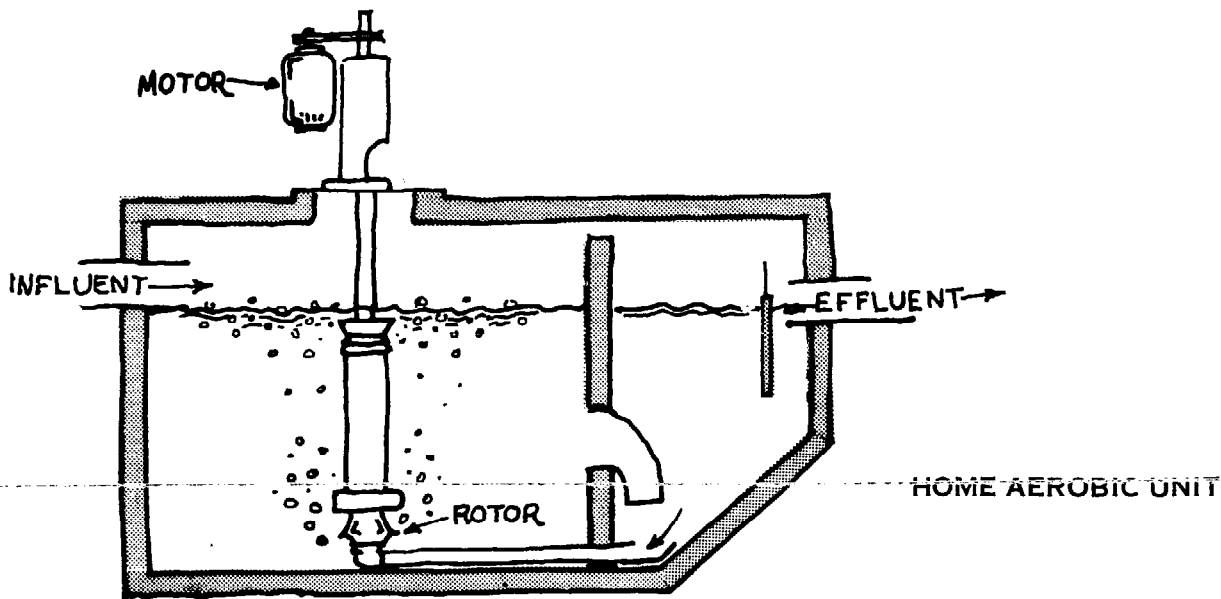
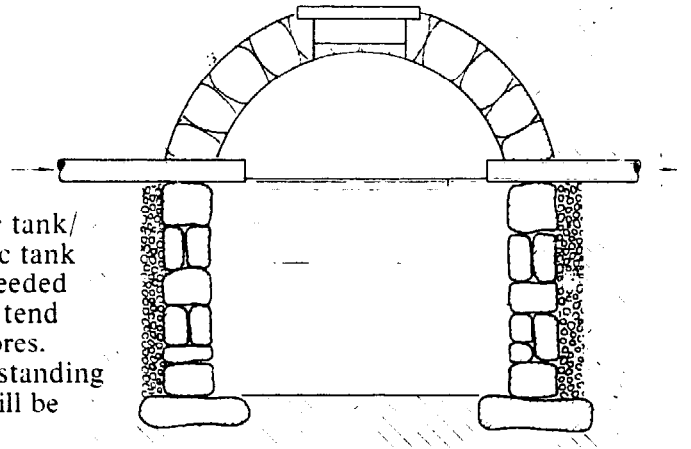

The *home aerobic unit* is a recent invention that pumps air into the wastewater so that the Biological Oxygen Demand will not become a problem. When working, home aerobic units also treat sewage faster and better than septic tanks. But, these modern contraptions should be avoided. They are expensive, require continuous energy for the air-compressor, can easily break down because of all the mechanical parts, and require high-cost maintenance. They all need cleaning about once a year. In addition, they give unreliable treatment. If you have a party, the aerobic home unit can temporarily

“give up” from the shock and discharge untreated sewage. Some manufacturers have tried to avoid the high costs by saying that sewage treatment is so good, you can discharge directly into streams or on land. But, most government authorities recognize the shock-loading problem and require a drainfield or chlorination -- adding costs. Finally, while septic tanks remove 20 - 40% of the nitrogen in sewage, aerobic units do not remove nitrogen or phosphorus or potassium to any significant degree. Discharging these nutrients directly into a stream is pollution.

## AUTOMATED SEWAGE TREATMENT SYSTEMS

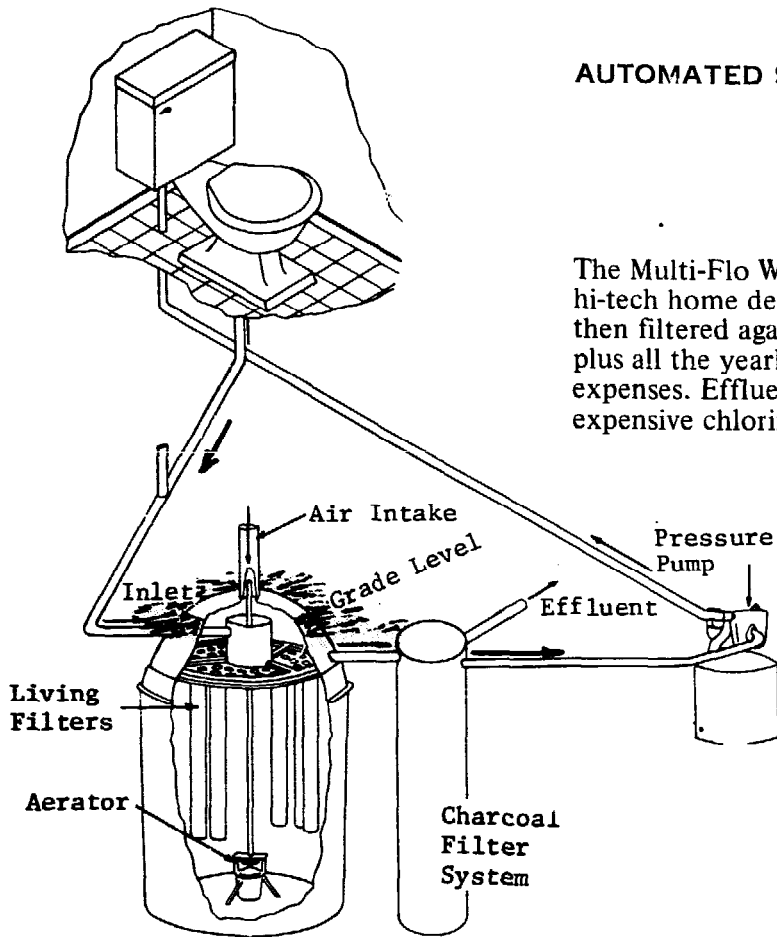

The Multi-Flo Wates Treatment System is typical of hi-tech home devices. Has a pump, aerator, filter and then filtered again by charcoal. Costs close to \$3,000 plus all the yearly maintenance and replacement expenses. Effluent still requires drainfield unless expensive chlorinators are added.

### Summary

If water is scarce, use a pit privy or compost privy. If water and good soil are available, still use a pit or compost privy because they are cheaper and save water. If you must combine grey water with feces or must have a flush toilet or want sub-irrigation through a drainfield, then consider the septic tank system. Avoid home-site sewage treatment systems that have a continual need for outside energy and have many moving, mechanical parts.



# 4. GOOD SOIL, CLEAN WATER

Soil is the key to clean water. It is a living filter better than any filter man has invented. No material cleans nutrients or disease-causing microbes from wastewater as well as earth. Soil works as a *physical* strainer, a *chemical* renovator, and a *biological* recycler of all wastewater passing through. The use of soil is the oldest and most tried form of wastewater treatment - refilling lakes and underground aquifers with drinkable water as well as adding humus and food to the plant world. This chapter is a thumb-nail sketch of the surface layer of the Earth's crust and how it does the job of cleaning and recycling household water.

*A nematode - just visible creatures found in well-aerated soils. They eat protozoa like the amoeba (below) who, in turn, eats bacteria. Nematodes also prey directly on bacteria. In sewage treatment, their presence indicates aerobic conditions. Nematodes keep soil pores open by eating and moving.*

## THE SOIL COMMUNITY

*"A teaspoon of living earth contains five million bacteria, twenty million fungi, one million protozoa, and two hundred thousand algae. No living human can predict what vital miracles are locked in this dot of life, this stupendous reservoir of genetic materials that has evolved continuously since the dawn of life on earth (about two billion years ago)."*

Soil is not just an inert arrangement of pore openings among particles of dirt. Billions of microscopic creatures live among the textures and layers of soil. Amoebas slide over grains of sand hunting bacteria. Bacteria swim through micro-rivers in search of nutrients. Viruses attack bacteria, entering their bodies and using their protoplasm. Nematodes (a kind of segmented worm) swim through the teeming forests of algae and microbes, eating almost anything that lives.

In the ideal soil community for sewage treatment, this microscopic matrix of living creatures recycles nutrients and water and transforms disease-causing organisms into harmless protoplasm. The tiny animals bulldoze and devour organic debris that clogs the open spaces between soil particles. In the process, pore spaces open, cleaned water seeps downwards, evaporates upwards and is utilized by higher plants.

This ideal kind of soil will have lots of air (oxygen) and be moist but not water-logged. It is called an *aerobic* ("with air") community. The soil community that works slower and less effectively has little oxygen and is too dry or too wet. It is called *anaerobic* ("without air"). Aerobic vs anaerobic is the most biological distinction in this whole booklet.

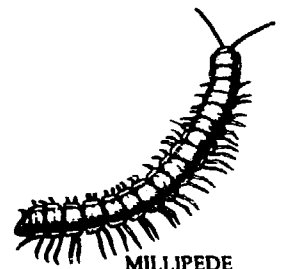
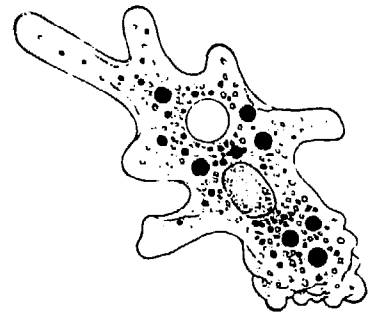

MILLIPEDE

## THE AEROBIC COMMUNITY

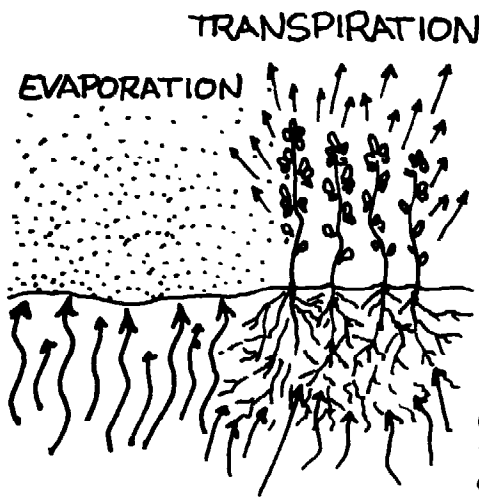

When the soil is well ventilated because of open pores and spaces, oxygen dissolves in the soil's water. The more dissolved oxygen, the faster feces and food wastes can be digested ("burned") by bacteria. The fast-eating species of bacteria get fat and multiply quickly. Consuming all the feces and household food wastes releases heat and actually warms the soil. The solid wastes are thoroughly digested and thoroughly transformed (again think "burned" or "cooked") by the bacteria. The final excrement of the bacteria are stable chemical compounds. Compounds that, like ashes in a fire place, need no more oxygen to digest them further. They have no "demand" for more oxygen.

One step up the food chain are protozoa – single-celled animals that prey on the bacteria. Well-aerated soils provide enough oxygen for the active protozoa to thrive. They can eat up to one million bacteria a day but probably eat about 100,000 per day under typical situations. The transformation of bacteria into protozoa is important because dormant bacteria (in times of little food) or dead bacteria can pile up in the soil pores. This pile-up prevents circulation of air through the pores. This may seem incredulous until you think that a quart of wastewater may have 100,000 million bacterial bodies. In short, a good predator/prey balance keeps air circulating within the soil.

Stomata are small openings in the skin of leaves. This honeycomb lattice of air spaces within the leaf takes up about 1% of the total surface. But, more than 90% of the water given off by the plant transpires through stomata.



Higher plants are aided by the aerobic community. The excrement of aerobic bacteria is very soluble in water and easier and quicker for higher plants to absorb. Much of the bacterial excrement is nutrient.

Water and the nutrients travel up, out of the ground, into the stems and leaves. Here, part of the water is transpired from the breathing pores and a smaller part evaporates from the leaf surface.

Up to 20% of the water in a soil (in humid-temperate regions) is absorbed and returned to the atmosphere by ordinary crops. This process, called *evapo-transpiration*, is one of the primary ways clean water is returned to the Earth's water cycle and wet soils are drained. Under aerobic conditions evapo-transpiration is strong.

Finally, the warmer, moist, well-aerated soils of the aerobic community also encourage root growth which brings even more air and draws more water from the soil.

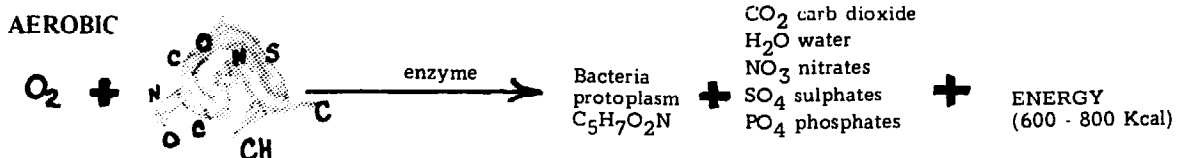

## THE ANAEROBIC COMMUNITY

Without enough oxygen, the bacteria and other soil microbes that need lots of energy die off or go dormant. The predators (protozoa) that need lots of energy to hunt bacteria die off or go dormant. In their place, an *anaerobic* community of bacteria, fungi, actinomycetes and other organisms take over.

Without oxygen, nutrient and water recycling by higher plants slows drastically. Some of the pollutants are changed to chemical compounds that can be toxic to higher plants. Most anaerobic bacteria excrete compounds that must be further digested ("burned"). These compounds "demand" more oxygen which must come from another natural community. In addition, the bio-chemistry of the anaerobic soil community can destroy soil drainage.

Nitrogen, carbohydrates, sulfur, iron and manganese are all changed to entirely different compounds from their forms under well-aerated conditions. In anaerobic soils, the carbohydrates change to acids -- not sugars. These acids, under extreme conditions, accumulate and can become toxic to higher plants.

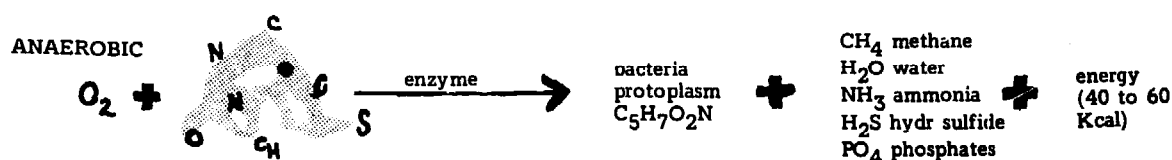

### The Organic Mat

Without dissolved oxygen, iron combines with sulfur (instead of oxygen). This substance, Ferrous Sulfide, is black and insoluble. The black gum or slime combines with dead bacteria and algae to clog the pores of the soil. Soil drainage becomes drastically reduced. If this black gum, called the *organic mat*, spreads throughout a soil, and if the soil does not periodically aerate, the drainfield may ultimately "fail."



Finally, under anaerobic conditions, there are fewer forms of *useable* nitrogen and too little oxygen -- both needed to power nutrient-absorption. The root systems of higher plants do not get enough energy from the soil. Consequently, nutrient recycling and evapo-transpiration are reduced in anaerobic soil communities.

To summarize, aerobic bacteria and other microbes work ten to twenty times faster than anaerobic bacteria and microbes. Aerobic microbes do a complete job. Anaerobic microbes produce some chemicals that "demand" more oxygen to become stable and others which, in strong concentrations, become toxic to higher plants. Higher plants in the aerobic soil community recycle nutrients (by growing) and water (by evapo-transpiration) more rapidly than the anaerobic community. The soil drainage is better and root growth is strong when soils are well-aerated. Most soils have anaerobic and aerobic communities. Providing air is one of the most important principles of drainfield design.

## WATER MOVEMENT IN SOILS

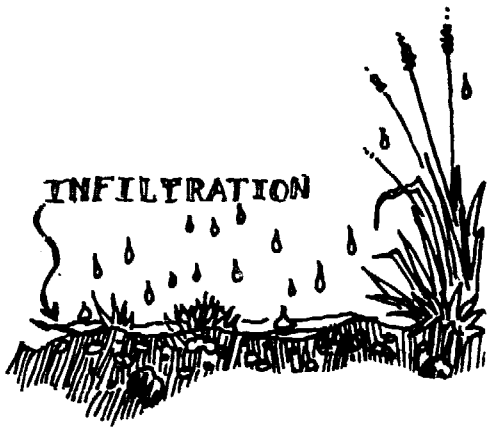

To bring nutrients to plants, to bring oxygen to all the soil creatures, to purify wastewater by straining and filtering it through the soil mesh, *water must move*. The organic mat *biologically* slows air and water flow through soils. But, the *physical* arrangement of soil pore spaces, their numbers and sizes, also effect soil life, water and air transport, and, ultimately, sewage treatment.

### Infiltration and the Organic Mat



Picture wastewater entering a hole. It covers the bottom. It passes through the air/soil interface and then penetrates inside. The ability of water to pass *through* the surface (*into* the soil) is called *infiltration*. Infiltration is very different from movement *inside or within* a soil. Passage of water *within* a soil is called *percolation*.

As water infiltrates into the soil, the pore spaces fill with water (replacing air). If the water keeps coming, the soil surface becomes saturated and no air is left. As soon as little or no air is available, the organic mat accumulates. Since the bottom of a hole becomes saturated first, the organic mat accumulates there. Soon, the bottom *surface layers* of the hole become less and less pervious to the incoming water. The hole begins to fill and water infiltrates through the sidewalls only (B).

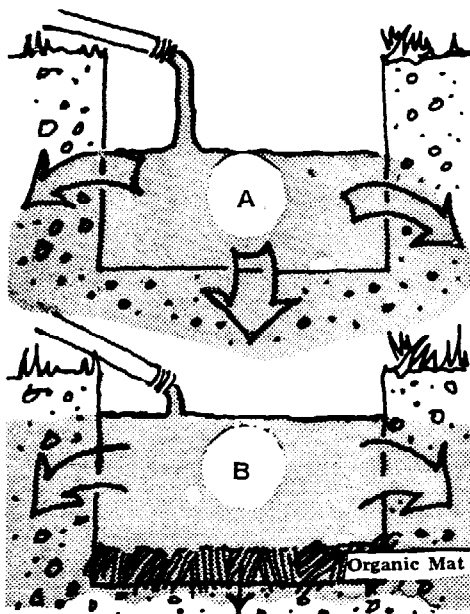

As the hole fills, micro-erosion occurs. Dirt particles slough off the walls, sink and seal the bottom even more. If water keeps coming, the sidewalls begin to turn anaerobic. The organic mat spreads, and, eventually the anaerobic mat covers the whole inside surface of the hole. Ultimately, if the hole was never given a chance to empty, the anaerobic mat could seal both the bottom and sides of the hole. When water can no longer infiltrate, it surfaces above ground (C).

We have just detailed two fundamental principles of soil ecology and water movement. Soil clogging occurs *on the surface* and the organic mat makes *infiltration fail before percolation*. Many holes in the ground can be filled with standing water for days but the soil, two feet away, is bone dry.

Sewage treatment by soils is basically a matter of maintaining infiltration in order to prevent clogging of the soil surface.

### The Void Space of Soils

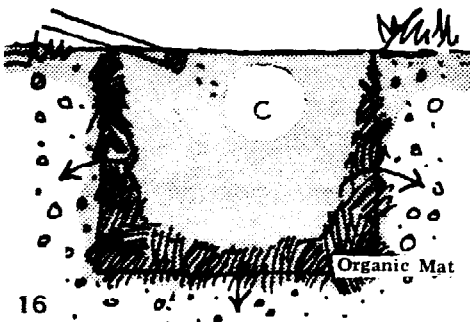

Each kind of soil has beautiful and intricate 3-D patterns and arrangements of particles, clumps, and pores. The pores can be filled with air, water or plants and animals. The 3 D network of pores (the void space) create mini-aqueducts and underground rivulets for water transport and animal and plant movement. In some clay soils, the pores are so small that protozoa can't squeeze through the openings. In other soils, worms create the shape of the void space by eating dirt and excreting it covered

in a kind of glue. The gluey particles stick together to form the walls of earthworm tunnels which, in turn, act as micro-tunnels for water to flow in. Other gravelly soils are so coarse that water rushes through the void space so quickly that plant roots can't absorb the nutrients. To help judge the ability of soils to transport water, a distinction is made between *soil texture* and *soil structure*.

### Soil Texture

The texture of a soil comes from the proportions of its particles. The particles are separated into three groups, according to size. Sand grains are the largest; then silt particles and, finally, clay particles are the smallest. In general, the fine-textured soils are clays, clay loams, silt and silt loams. They have small pores which slow down water movement. Sands, loamy sands, and sandy loams all have large pore spaces and transport water easily.\*

Particles of mineral matter in soil. This diagram shows them magnified about 50 times.

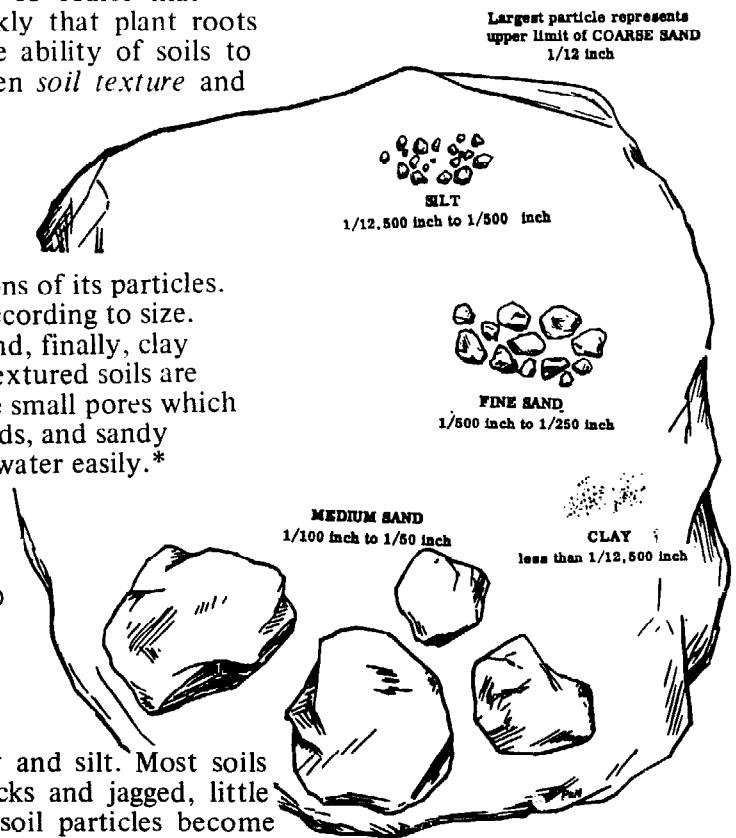

### Soil Structure

But, soils are not just mixtures of sand, clay and silt. Most soils come in chunks, crumbs, clods, irregular blocks and jagged, little slabs. These *aggregate* clumps occur because soil particles become cemented together by natural glues (silica, sesquioxides, and organic colloids). These cemented clumps of soil increase the ability of air and water (and earthworms and plant roots) to move through the soil. This clumping is said to give *structure* to a soil.

There are two extremes of soil structure. Sand dunes, for example, have no structure because all the sand grains are separate. There are no clumps. Old over-used agricultural land, on the other hand, can become a solid mass with very few cracks randomly spaced. This massive soil has no small clumps. It also has no structure.

In between the single grain sand dunes and the over-used agricultural land, there are many kinds of clumping. Granular (round clumps) and blocky (cube-like clumps) soil structure allow water and air to move freely. Especially if the clumps do not overlap, the water moves quickly through mini-tunnels and mini-aqueducts formed by the clumps. Platy (many flat plates) and blocky soil structure with a lot of overlap impede water movement. Water must find a path around these overlapping clumps. The water moves slowly and tends to back up. In short, soil structure is the whole story in subsurface water movement.

\*Humus is organic - consisting of decomposed leaves and animals. It can hold soil moisture because it is spongy. Humus is not considered part of soil texture analysis because it is found only in the top layers and varies so much from soil to soil. It is important for spray irrigation sewage treatment but it is not crucial to drainfields which irrigate underground.

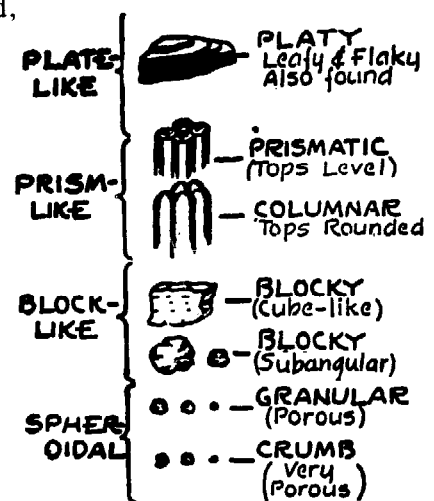

## A THUMB-NAIL SKETCH OF SOIL TYPES

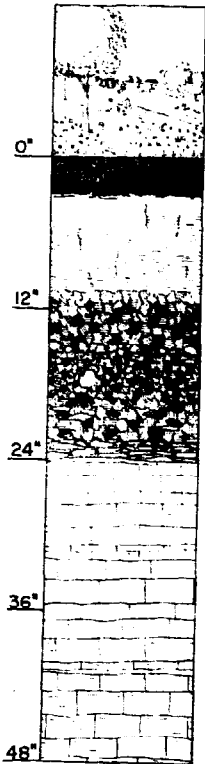

**SOIL PROFILES**

Soil profiles show the layers of different kinds of soils and bed-rock. Knowing the soil profile is crucial to a good design of a drainfield.

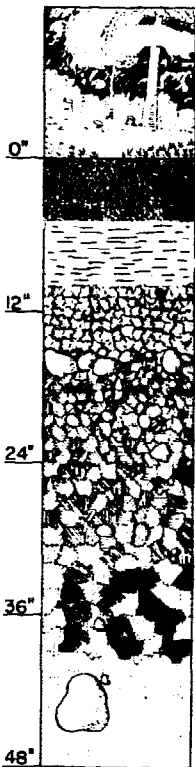

**Clay** particles are the smallest of all soil particles. They are so small that the total surface area of all the particles of clay in one pound of soil equals twenty-five acres of exposed surface area! Particles this small have electric charges that have significant influence on a soil's activity. The charged particles and great surface area perform numberless, astounding chemical and physical feats: hold viruses so they can't move, react with nutrients and proteins so they will not wash away, precipitate chemicals like Strontium 90 so they can't poison or pollute and react with lime to change soil acidity. The small pores and their chemical powers make clay the great *retainer* or holder of moisture. Plants have time to use nutrients and water in the soil. In short, clay prevents wastewater from moving too quickly into wells, streams and aquifers. It filters and chemically renovates as the water moves through. But, it should be remembered that the pore size and particles are so small, that *un-structured* clay soils can't transport water quickly. Wastewater may move so slow that no oxygen circulates. Other clays have good, open structure. Water moves easily.

**Silt** particles are smaller than sand grains but larger than clay particles. Similarly, their pore spaces are smaller than sand pores but larger than clay pores. They can stop viruses and react with nutrients like clay. Silt soils have lousy structure. They "melt" and can block drainage by filling in the cracks among rocks or gravel. Only in sandy soils do silts help by slowing drainage and giving the soil a better structure.\*

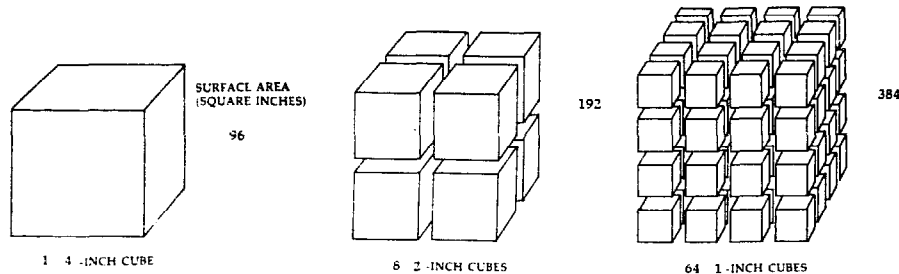

Although the total volume of the cube remains the same, the total surface area exposed to air increases as the cube is divided into smaller and smaller parts. The more surface area, the more cleaning power of the soils. One pound of top soil has as much surface area as the whole state of Connecticut.

**Sands** are the largest soil particles before gravel. They are chemically less active than clays. The surface area of a pound of sand is much less than clay (about three to five acres per pound of sand). But, sand particles fit together in a way which results in large pore spaces between particles. Large pore spaces allow the soil to drain well, allows air to circulate in the soil, and protozoa to rush around and eat bacteria. A *pure, coarse sand* soil may be too pervious for good sewage treatment. The wastewater may move too rapidly to a stream or well and cause pollution. Fine sands filter bacteria but coarse sands do not.

\*A silt is not the same as a loam. A loam is a mixture of silt, sand, and clay and humus. A loam has about 40% sand, 40% silt, 20% clay and humus. When there is lots of humus, we call it "topsoil".



## The Soil Profile

All these variations in soil texture and soil structure came from millions of years of soil evolution. Rocks disintegrate, plants decompose, rivers flood and recede, oceans rise and fall leaving deposits of mud and sand, volcanoes and forest fires burn and chemically combine and restructure all the Earth's elements. These processes produce a layer-cake of different soil types. The layering of one kind of soil on top of another is called the *soil profile*. Each layer differs in its texture, structure and humus, its depth, slope and color.

The best sewage treatment by soils occurs in thick soil layer(s) that can be well-aerated and moist. The soil community is predominantly aerobic and the organic mat is kept to small anaerobic pockets. There is enough water for protozoa, nematodes, earthworms and plant roots to thrive.

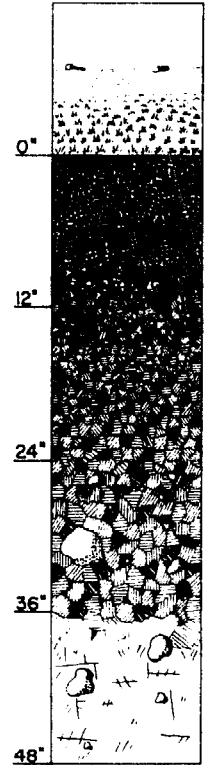

## THE SOIL COMMUNITY AND HUMAN HEALTH

The natural soil community eliminates disease-causing creatures (called *pathogens*) in six devastating ways: (1) it out-competes pathogens for food; (2) the soil bacteria, fungi and other microbes produce antibiotics that poison pathogens (penicillin is a soil mould); (3) the clay in soil adsorbs the viruses and keeps them from traveling to a place where they could re-infect humans; (4) the soil structure acts as a physical strainer to the larger bacteria; (5) the bacteria and many viruses in the bacteria are preyed upon by protozoa; and, (6) the soil environment is so different from the inside of the human body that most pathogens simply die from the radically different acidity, temperature, moisture, or shelter. Soils are so proficient that disease from septic tank systems has never been proven in the United States. Health fears from home-site systems are totally exaggerated. This fear and other aspects of the myth of "dirty septic systems" have had terrible political consequences in the last twenty years of American life. They are discussed in the final chapter.

A stalked and free-swimming ciliate (a kind of protozoa) in a soil of silt and sand. Bacteria and viruses can also be seen swimming in the space between the soil grains. The particles are about 100 microns wide; the viruses about 0.02 microns wide; the bacteria about 5 microns.

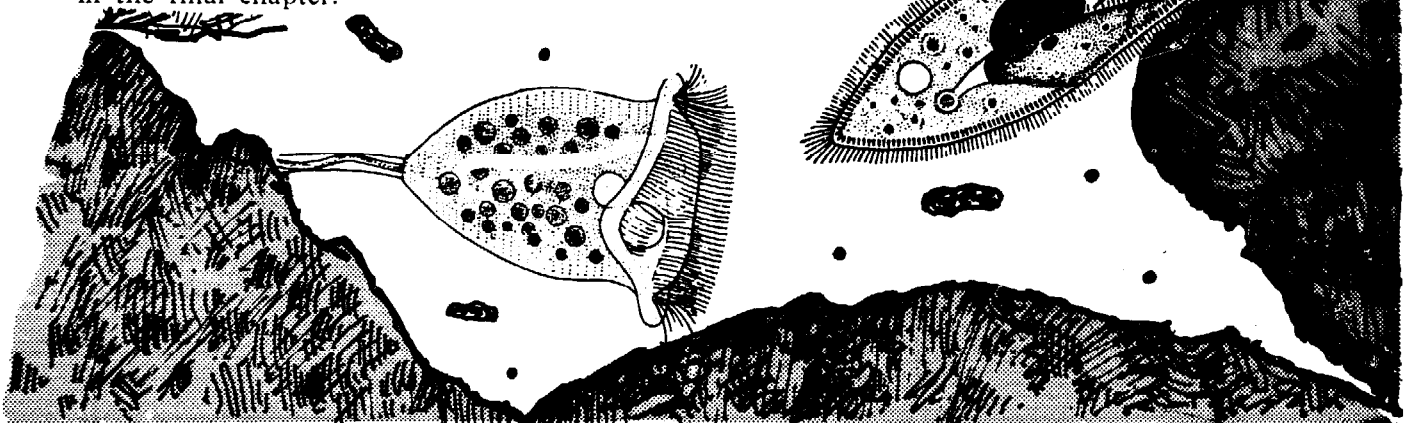

---

## A THUMB-NAIL SKETCH OF MICROBES

---

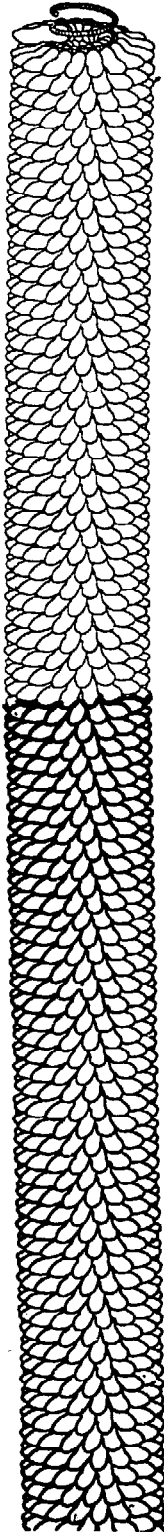

A VIRUS

**Viruses** are the smallest pathogens -- harmful organisms. In most soils, they have an electric charge. This charge comes from the protein coating surrounding the virus. The electric charge controls the virus' destiny because the virus is so extremely small. While moving through a soil in water, viruses are electrically attracted to clay particles. They "stick" to the surface of the clay particle. A pure clay soil can *adsorb* ("sorb onto the surface") viruses within 4 *inches* of travel. Even in sandy soils, viruses are adsorbed in about one foot of travel!

A sewer project called the Santee Project wanted to use treated wastewater for swimming. Polio virus was poured into a natural aquifer of rocks, sand, and only about 1% clay. Two hundred feet later (at the first testing station) not one virus showed up. The ability of clay to adsorb viruses is tremendous. One-hundred feet between drainfield and well (a typical safety margin) is obviously more than adequate (if not over-safe).

**Bacteria**, as opposed to viruses are rarely associated with disease. They are the simplest, independent form of living creature. (Viruses are parasites on bacteria.) Bacteria are responsible for almost all the transformations of pollutants into protoplasm and atmospheric gases. Bacteria eat the pollutants and their "waste" is the recyclable nutrients, water, gases, and energy that humans call good sewage treatment.

Pathogenic bacteria are weak outside the human body. They become easy prey for protozoa. Bacteria are much larger than viruses and are further removed from wastewater by straining and anti-biotics produced by fungi and other creatures. The chance of bacteria escaping filtration through more than a few feet of any soil (except gravels or very coarse sand) is slight. Water-born bacterial disease has never been traced to septic tank effluent in recent years.

Health Departments usually use the presence of one kind of bacteria (Coliform) to spread health fears. ("High Coliform Counts Close River Bathing.") Know this:

- Coliform bacteria are not harmful. They are used to indicate pollution because they can be cheaply and easily identified.
- Coliform *may* indicate human feces. But, horses, cows, fish, ducks, even insects, produce coliforms.
- Some harmless coliform grow wildly in lakes and rivers -- totally exaggerating the illusion of pollution.
- One type (*fecal coliform*) is a better indicator but even fecal coliform come from all warm-blooded creatures.
- What does coliform mean? *If* coliform can be proven to be from humans, than **MAYBE** there are disease-causing organisms as well. (See Bibliography.)

**Protozoa** are the simplest animals. They eat bacteria. Some can adjust to pore spaces in the soil by changing shape and help keep the soil from becoming clogged with bacteria. To hunt well, they need oxygen and are much less effective in anaerobic soils. There are no important diseases caused by sewage protozoa in the United States.

# 5 THE IMPORTANCE OF SAVING WATER



Improving soil texture and soil aeration is expensive and, at times, the most difficult way to improve home-site sewage treatment. To replace one kind of soil with new soil requires excavation, trucking, and purchasing someone else's more porous earth. Adding air to the septic tank or drainfield requires pumps and more pipes and, sometimes, an outside, expensive source of energy for the pumps. On the other hand, water is easy to regulate. You can simply use more or less. Water is the most economical way to reduce waste volumes. Water conservation helps everything from septic tank/drainfield function to balancing the earth's huge water cycle.

## THE BIG PICTURE

Your body's plumbing (from mouth through intestines) is connected to your household plumbing through faucets, toilets, and drains. The sinks, showers and toilets are, in turn, connected to the pipes and aqueducts of a utility company's water supply. And, finally, the water supply is connected to the reservoirs, lakes, rivers, and oceans of the Earth. Modern Americans have become somewhat schizophrenic by blanking out the connection between their body's plumbing and the Earth's. Where does the water that comes from your faucet originate? Where does the water that you flush down the toilet go? In Los Angeles, I made a spot check by asking this question and found that most people said "Water? The City provides it." This kind of ignorance is more primitive and uncivilized than the Dark Ages of Europe. Like true schizophrenia, it is disconnected.

So, before considering septic tank systems, stop and think more about the Big Picture. America continues the practice of doubling water supply by damming yet another "wild river" rather than halving consumption by reasonable water conservation measures. Remember, the less water used and the more recycled, the less need for new dams and pipes as well as the bond issues and increased taxes that accompany construction. Water conservation can be accomplished by the small acts of many

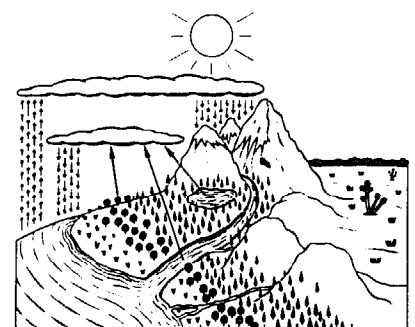

Water Cycle on West Coast of California. Sun causes evaporation. Clouds rain. Rain becomes streams, rivers and back to ocean. All of these water bodies evaporate water back to atmosphere. Plants and animals evapotranspire water back. Cover drawing shows water cycle with home use and septic tank/drainfield return to soil & water cycle.

people in their homes. Household water conservation can replace the need for new water works and help preserve the integrity of small American communities as well as natural lakes and free-flowing rivers. When you turn on the faucet, picture the network that binds your body to the biosphere.

### **SEPTIC TANK/DRAINFIELD FUNCTION AND WATER USE**

It is obvious that the less water you use, the smaller (and less expensive) the septic tank and drainfield needed. Even more important, a septic tank will treat sewage more completely when water use is low. First, the excrement from your toilet must remain in the tank to be treated. If water pours through continuously and rapidly, the septic tank overloads. Instead of settling to the bottom and being eaten by bacteria, large pieces of undigested feces may be pushed into the drainfield. The soils clog.

In addition, over the years, soils become more and more packed as water rearranges particles and clumps. In a sense, water settles the soil particles and clumps like shaking a box of crackers compacts them towards the bottom. Obviously, the less water passing through the soil, the more porous and the longer the life of the drainfield.

Finally, we have seen how aeration and infiltration are closely connected. Cutting down on the amount of water passing through an already built drainfield, will give the soil surfaces more time to aerate.

### **PRESENT DAY WATER USE IN NORTH AMERICA**

A typical North American household uses between 50 and 60 gallons of water per person per day. A city household uses between 100 and 150 gallons per person per day if street cleaning, park watering and fountains are included. The Public Health Service estimates 75 gpppd to design septic tanks. But, these are just averages. Some Native American tribes in the Southwest use only 5 gallons per person per day. While some of the wealthiest communities – with garbage grinders and a multitude of other luxury appliances – use up to 350 gpppd!

Water consumption decreases when the household water supply is metered – no flat rates. It increases with wealth (about 50%), garbage grinders (about 20%) and washing machines (30%). It decreases for low income families (25%) and with conscious effort to conserve (25% or more).

The most extravagant use of water is flushing the toilet. About 45% of a household's water (anywhere from 25 to 60 gpppd) is used to flush the toilet. The average North American family uses about 88,000 gallons of water each year. Over 35,000 gallons are just flushed. This extravagance is built into the modern flush toilet which uses 5 to 7 gallons of good drinking water to flush about one-half pound of feces and/or one quart of urine. After mixing such a huge volume of good water with such small quantities of wastes, the septic tank/drainfield system tries to separate them – usually within moments after they were mixed!

Obviously, in areas where water is scarce, the conventional flush toilet is costly and wasteful. But even when water supply is not a problem, the flush toilet is costly and wasteful. Costly because you pay a Utilities District to purify water to drinking standards (chlorination and aeration) and then use the drinking water simply to *carry* your wastes from your home. Costly because you pay to treat the *carrier* of feces and other wastes – *not* the wastes themselves.

**Crapper's Valveless Water Waste Preventer.**

(Patent No. 4,990)

One moveable part only.

Equally suitable  
for  
Private Residences  
or  
Public Institutions.

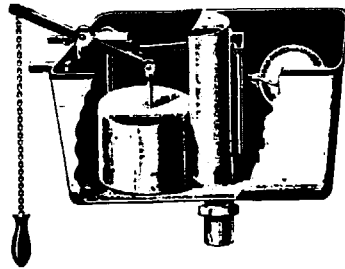

Silent Action.  
Certain Flush  
with  
Easy Pull.

No. 814

Quick and Powerful Discharge maintained throughout.

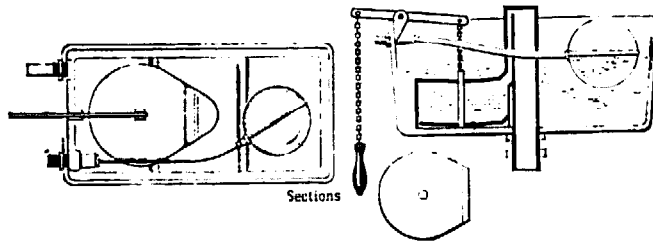

In the old days the water for a flushing toilet was provided from a cistern in which there was a valve at the outlet to the flush pipe. When you pulled the chain it simply lifted up that valve and released the water. In other words you just pulled the plug out. Some people would tie the chain down so that the valve was perpetually open and the water flowing ceaselessly – either because they were too lazy to pull the chain every time or because they were ultra fastidious and wanted to ensure an immaculate flushing of the bowl.

This sort of thing horrified the Board of Trade, which used to be the ministry responsible for our water supply. They envisaged enough people doing it to cause all the reservoirs to dry up, and drought and pestilence could strike the land.

But even worse was the second factor, although it would have seemed to have been of lesser importance. This was the fact that try as they might the makers of the valves could not ensure a snug fit. Each valve would start off watertight but it would not be long in use before it was failing to lodge properly after each flush.

This trickle, multiplied by thousands, was the Board of Trade's big worry. So the call went out for somebody to evolve a 'Water Waste Preventer'.

The trick was to make water flow uphill. If you consult the drawings opposite you will see how this was done. Or if you want to study it in the round, as it were, go to your nearest cistern and lift the cover and you will see precisely the same principle Thomas Crapper and his aides evolved at his Marlboro' Works in Victorian times.

From "Flushed With Pride, The Story of Thomas Crapper," by Wallace Reyburn, Prentice-Hall, Inc.

**HOUSEHOLD WATER CONSERVATION**

To save wild rivers, stop pollution of lakes and oceans, to save taxes and bond issues, to give a longer life to your septic tank/drainfield system and to let it work better, water can be conserved. Major household conservation measures are (1) matters of habit; (2) devices and appliances that reduce water use and (3) water re-use.

MATTERS OF HABIT



Improved Aeneas with raised ornamentation

**Avoid Flushing the Toilet for Trivial Reasons like Facial Tissues and Cigarette Butts.**

Use a wastepaper basket near the toilet.

**Plug the Bathroom Sink When Shaving or Washing**

**Don't Use a Garbage Grinder. Compost Garbage Instead.**

Garbage grinders use incredible amounts of water. The ground-up garbage heavily burdens the septic tank.

**Use a Dishwasher or Clotheswasher Only When You Have a Full Load**

Dishwashers use between 6 to 19 gal/cycle. This does not include rinsing in the sink before loading. Clotheswashers use from 20 to 33 gal/cycle. Front load clotheswashers use about one-half the amount of water as top load washers.

**Limit Your Shower Time. Turn Off Water When Soaping Up. Take a Shower with Friends or Relatives. Showers Use Less Water than Baths.**

**Be Sure Water isn't Escaping From Your Toilet**

Check leaks by putting a few drops of food coloring in the tank of the toilet. Wait a few minutes or hours to see if color shows up in bowl. If it does, your ball valve needs replacing or the support-assembly needs adjustment.

**Plug bathtub before starting water. Fill only one-quarter full.**

**Use a Brick in the Tank of Your Toilet (See Diagram)**

You can cut the water needed to flush your toilet adequately from the six gallons to three gallons. Try one brick. Most homes can fit two bricks. This may conserve 20% of your household water use.

**Make Immediate Repairs on Dripping Faucets**

You can waste 12 gallons in 24 hours with drips.

**Water in the Morning**

Evaporation is lowest

**Use Mulches Around Plants**

They save water as well as help build soil.

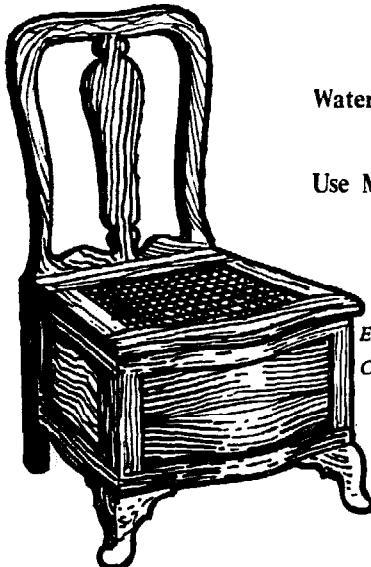

Elastic Valve Closet with Chair Enclosure

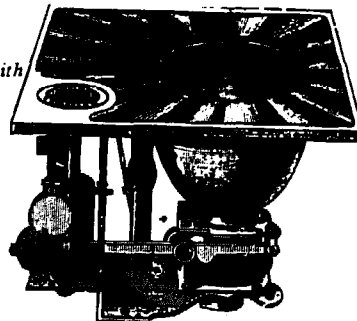

Dolphin, 1880

cut here

## WATER SAVING APPLIANCES

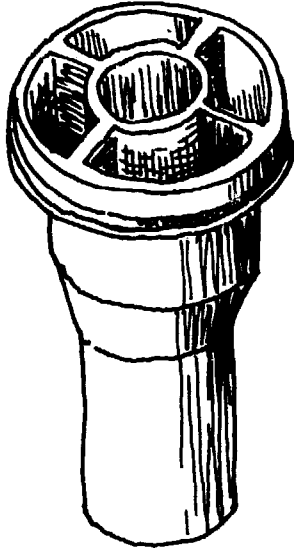

A cheap and simple device to decrease water use in the shower by mixing the water more thoroughly with air. Shown about twice its size. See next page for distributor (Noland).

### Aerators and Other Flow Control Devices on Sinks & Shower

Manufacturers say you can reduce shower flow rates by 50% (from 5-10 to 2.5 to 3.5 gallons per minute)! Actually, if you have a bath and prefer it or if your house has high water pressure you save much less (10% of bathing water or 1% of total water in one study). But, if you only shower or prefer it or shower a lot, these are good water-savers for their price. In addition, you save on costs of heating water – one of the largest expenses in every home.

### Instant Hot Water

Waiting for the water to heat up? That's a big waste. Try to minimize the distance between your water heater and the sink, shower and bathtub – the shorter the run of pipe, the less cold water sitting in the pipes. *Insulate* the pipes. Cost is about \$1 per foot. This will save on energy costs of heating as well as water.

### Front-loading Clotheswashers

These clotheswashers use half the water as top loaders. Distributors for commercial laundermats sell front-loaders. They're stronger machines, too.

---

## WATERSAVING DEVICES AVAILABLE

---

**American Standard**  
San Francisco District Office  
4 W. Fourth Street  
San Mateo, CA 94402  
(415) 342-8621  
Shallow trap toilets (M,D), Faucet control valves, Mixers and aerators (M,D).

**Borg Warner**  
Abalone Drive  
Torrence, CA 90501  
(213) 320-3801  
Shallow trap toilets (M,D,W).

**Briggs**  
5200 W. Kennedy Blvd.  
P.O. Box 22622  
Tampa, Florida 33622  
Shallow trap toilets (M).

**Crane Co., Plumbing & Heating Div.**  
300 Park Avenue  
New York, NY 10022  
(212) 752-3600  
Shallow trap toilets (M).

**Eaton Corp., Controls Division**  
191 East North Avenue  
Carol Stream, Illinois 60187  
Shower flow control devices (M).

**Irrrometer Company, Inc.**  
P.O. Box 2424  
Riverside, CA 92506  
(714) 689-1701  
Faucet control valves, mixers, aerators (M,D,W,R).

**Kohler Company**  
Kohler  
Wisconsin 53044  
Shower flow control devices (M).

**Noland Company**  
1700 Warwick Blvd.  
Newport News, VA 23601  
(804) 244-8441  
Shower flow control devices (M,D,W,R).

**Speakman Company**  
P.O. Box 191  
Wilmington, Delaware 19899  
Faucet control valves, mixers and aerators (M); Shower flow control devices (M).

**Ultraflo Corporation**  
P.O. Box 191  
Perkins Industrial Park  
Sandusky, Ohio 44870  
(419) 626-8182  
Faucet control valves, mixers and aerators (M).

**Western Pottery Company, Inc.**  
11911 Industrial Avenue  
South Gate, CA 90280  
(213) 636-8124  
Shallow trap toilets (M).

**Moen**  
A Division of Stanadyne  
377 Woodland Avenue  
Elyria, Ohio 44035  
(216) 323-5481  
Shower flow control devices (M).

Abbreviations: "M" is manufacturer; "W" is wholesaler; "D" is distributor; "R" is retailer.

## BRICK-IN-THE-TANK

CHERRY HILL, N.J. (Associated Press). — Six months ago, Tilly Spetgong, a serious gal with a goofy idea, walked into city council carrying a brick. Councilman Steve Morgan ducked under his desk.

“He must have thought I was going to throw it,” she said, “but all I wanted was to put one into every toilet tank in town.” The unusual proposal to save water stunned the council, but it was approved.

The council anteed up \$2,000 to buy 34,000 hardened bricks, the kind that won't break up in any kind of water and enough for every toilet in the town's 17,000 homes.

Last weekend, about 175 persons distributed 27,000 bricks, two to a house. They will finish this Saturday.

Mrs. Spetgong said: “If the average family of four flushes a total of 20 times a day we would save 34 million gallons of water every year in Cherry Hill.”

Use hard-fired brick. Or, any plastic bottle like an empty plastic beach bottle. Cut off neck portion, fill bottle portion with water to weight it down and place like brick in tank. Don't bend down float-arm because the water pressure (which causes the bowl to siphon-flush) depends on height.

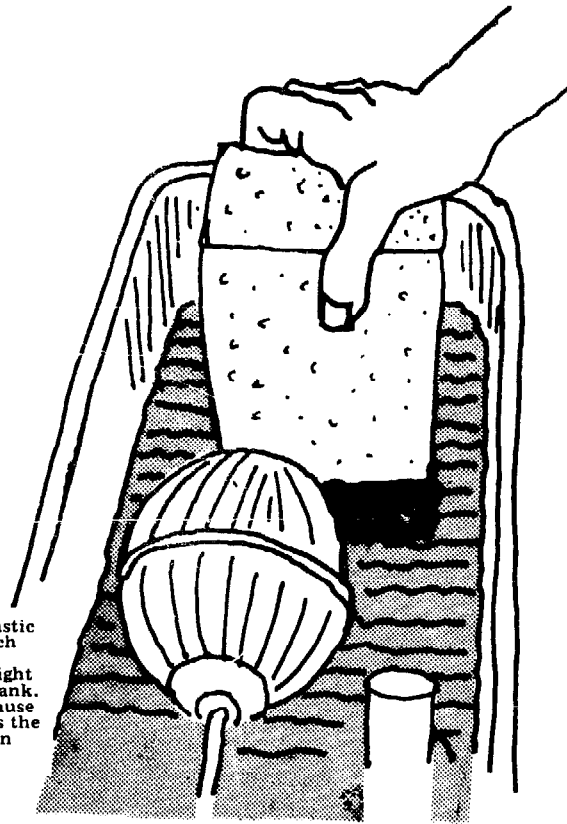

### Low Flush Toilets

If you have a toilet, put a brick in the tank (see drawing). If you're buying, get a low-flush toilet. The most popular kind is the “shallow trap” water closet which costs about \$10 more than regular toilets but uses only 3.5 gallons per flush (a 30 to 40% water savings). If you're metered, you save immediately. There are also dual-flush toilets with a low flush for urine and a big flush for feces. These devices are easily inserted into the toilet tank, except new flap-valve types.

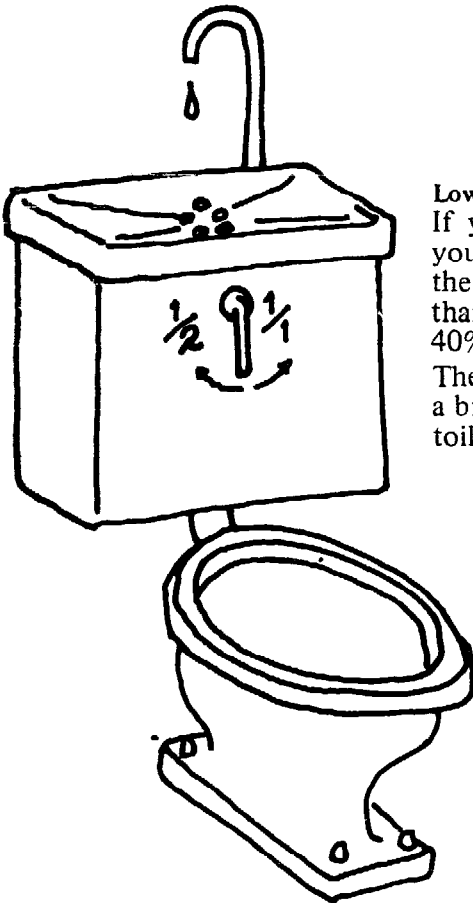

A Japanese-made toilet with two flushes: one for urine and a larger flush for feces. Note that toilet tank is filled from a faucet. You can wash your hands and the wash water re-fills the toilet tank. Other toilets can be found in “Stop the Five Gallon Flush” (see Bibliography).

### IN THE CITY

City water use can be curtailed by using the clivus in single-family homes (page 8) and vacuum toilets in apartment or business buildings. Vacuum toilets suck wastes through the pipe — requiring about three pints per flush. Write Colt Industries, Water and Waste Management, 701 Lawton Ave., Beloit, Wisc. 53511.

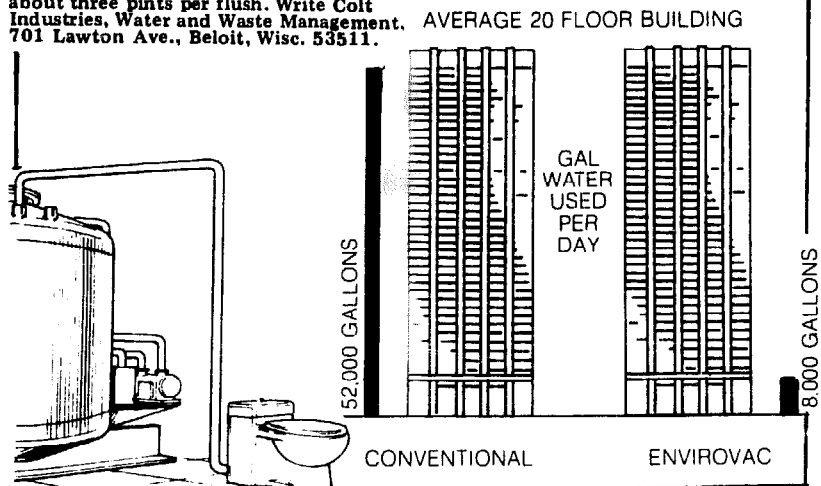



## WATER RE-USE

Water from your dishwasher, clotheswasher, sinks, shower, and bath does not have the disease carrying organisms or pollutants found in toilet wastewater. This lightly polluted water is called "grey" water as opposed to "black" water from the toilet. The major failing of American sanitary codes, plumbing fixtures and designs, as well as water conservation measures, has been lumping "grey" water and "black" water together.

While water should be very high quality for drinking, these standards can be somewhat reduced for bathing and cleaning and greatly relaxed for irrigating and flushing. America's attitude toward water quality has become so confused that we use the greatest amount of top quality water for flushing – a water use that requires the least sanitary conditions. The most direct, practical and responsible way to change America must finally come from government recognition that water quality should be related to its use and that codes and laws must distinguish between grey and black water. These legal changes would encourage grey water recycling. Below are two practical suggestions which may be illegal in your county.

Grey water is very variable depending on the home. 50% of the phosphorus in a home presently comes from grey water, mainly detergents. Only 10% of the Nitrogen is in grey water. The other 90% comes from urine and feces. According to one study (Monogram), only 2% of the total coliform bacteria reside in grey water.

### Re-Use For Irrigation

In most countries, grey water simply goes into the backyard. Open ditches direct the grey water to trees or crops that need watering. This *above* ground irrigation is banned in most parts of the USA – although it would save water and watering time. This re-use of grey water is called the Mexican Drain.

In the USA, grey water can be legally discharged *underground*. Grey water must, to satisfy up-tight health officers, go through a "mini" septic tank and seepage pit like the one illustrated. The "mini" septic tank acts as a grease trap for kitchen wastes and hopefully a lint trap for laundry. When grey water systems are used with waterless toilets (like pit or compost privies), drainfield size *for the grey water only* is half the size (or less) than a drainfield for grey plus black water. A substantial savings.

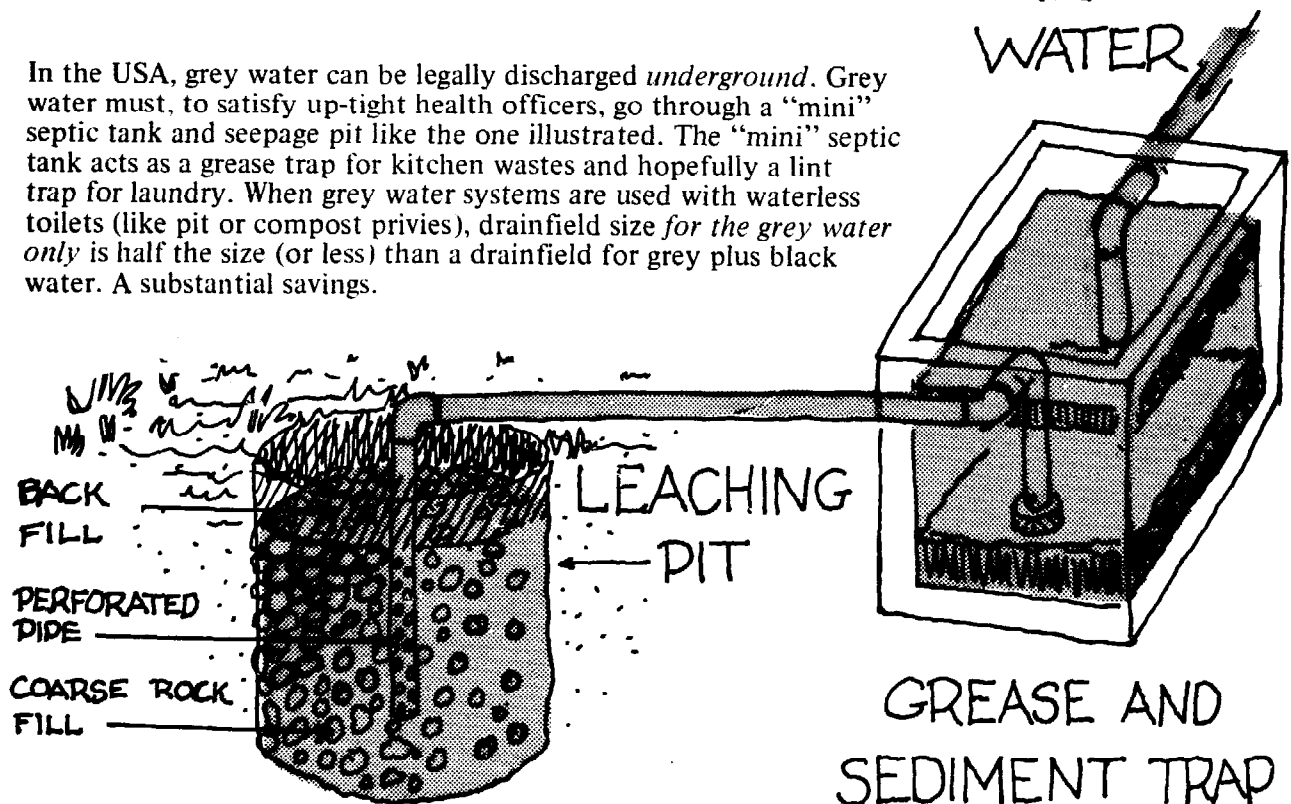

Sand filters can easily be built and used for grey water treatment. They can be above ground or below. Since grey water use is sporadic, these beds receive intermittent aeration (aerobic). They do not need dosing siphons. They do need more care than modern filters but are much less expensive. They need back-washing to clean sand and/or occasional raking or removal of top 1" to 2". No sand filters have been designed just for grey water. But, sand filters for the much more potent septic tank effluent can be scaled down. See "Excreta Disposal for Rural Areas" (Bibliography) and "Environmental Sanitation" by Joseph Saluato (Wiley & Sons, Inc., 1958), pages 229-238.

Two compartments make this sand filter easier to clean and aerate. They can be built of stone, masonry, redwood or any old steel tank. "B" are faucets on grey water pipe from house. "C" is coarse sand (2 feet is plenty). "D" are under-drains to garden, creek, lawns, storage facilities, whatever. "E" are splash plates. Adapted from "Excreta Disposal for Rural Areas." Loading rates can be

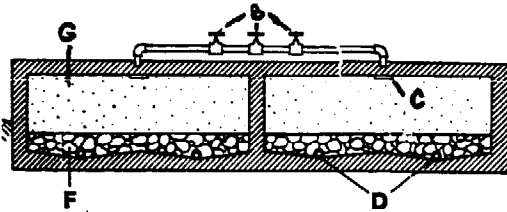

greater in hot vs. cold climates, with coarser vs. finer sand, with open vs. closed filters. About 1 sq. ft. of surface area is required for each 6-8 gallons (per day) but the area will vary with amount of solids and grease in grey water. In rainy seasons or winter, open sand filters must be covered.

Many of us living in drought areas are experimenting with *above ground* disposal of grey water. These include mini-lagoons, replaceable sand filters, pressure tanks with lawn sprayers and sub-surface drip irrigation. Health departments are still up-tight worrying about pathogens in the kitchen sink. But, disease spreading, although possible, is less likely than coughing, kissing, breathing or sharing food.

Mini-Lagoon Treatment see United Stand Sanitation, P.O. Box 191, Potter Valley, CA 95469, \$1.00 and Farallones Institute (page 8).

### The Grey Water Toilet

You may not be aware that commercial airlines use grey water (which they color blue) to flush the airplane's toilets. The Grand Canyon National Park has been recycling partially treated wastewater for toilet flushing since the 1930's. Obviously, it is ridiculous to use drinking water simply to carry urine and feces away. Especially when the additional water complicates sewage treatment and increases treatment costs. Recycling grey water would obviously help septic tank function and save water.

Re-use of grey water at home is not only possible -- but saves up to 30% of the total water used. In homes with grey water toilets *and* lawn sprinkling, even more water can be saved. The costs of building and operating the grey water toilet make it most attractive when sewer and water rates are high, when multiple (condominium)-type housing is involved, and when septic tank systems are in poor drainage soils.

This re-cycling system helps septic tank systems by reducing the loads, sudden party surges, and saving water.

Here is the design (without the lawn sprinklers):

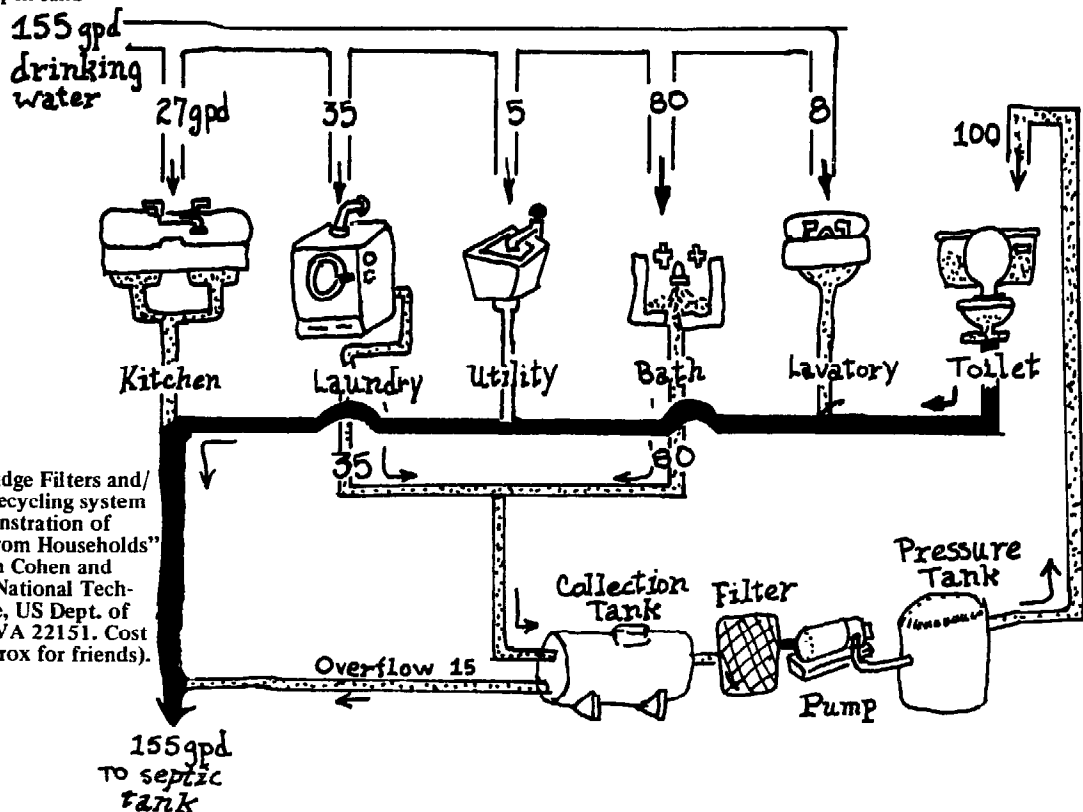

For Diatomite and Cartridge Filters and/or complete grey water-recycling system construction, see "Demonstration of Waste Flow Reduction from Households" (PB-236 904) by Sheldon Cohen and Harold Wallman. Write: National Technical Information Service, US Dept. of Commerce, Springfield, VA 22151. Cost is \$5.25 (buy one and xerox for friends).

# 6. SEPTIC TANK DESIGN

As humans learned more and more about wastewater and soils, the design of the septic tank changed. A little before the turn of the century, a Frenchman and his friend, Mouras and Moigno, discovered that a big box (septic tank) placed between the house and the cess-pool trapped the excrement, reduced the amount of solids, and produced a clarified liquid (effluent) that more quickly entered the soil. In the 1960's, when the principles of soil clogging were studied, further modifications of the box were suggested. These newly designed boxes kept even more solids from entering the soil, gave more time for bacteria to eat the feces, and made it easier to remove the undigestible sludge that accumulates inside the box. At the moment, the main ecological reason for having a septic tank is to protect the soils from clogging quickly. Maybe, in the 1980's, these boxes will be considered a home-source of good fertilizer for the garden.

*The best design to trap solids inside the septic tank is based on the meander of old rivers. These rivers move slowly and collect the most silt.*

## WHAT HAPPENS IN A SEPTIC TANK

When household sewage enters the septic tank, the heavy particles settle downwards. Other suspended particles may coagulate to form heavy particles. These settle downwards at a slower rate. 70 to 80% of the larger particles have settled to the bottom of a four foot deep tank within 3 hours. The accumulation of settled solids is called *sludge*.

Meanwhile, substances lighter than water (like grease and fat) float upwards. Bubbles of gas, given off by well-fed bacteria, carry some of the settled solids back up to the surface. The combination of floatables is called *scum*.

Part of the scum and sludge is not edible by bacteria. This undigestible part must be stored in the septic tank for removal by pumps or pails. So the septic tank not only gives bacteria enough time to reduce pollutants but also has enough room to store the indigestibles.

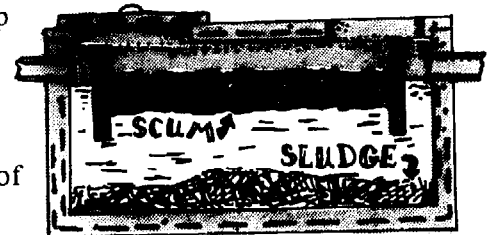

A one-compartment septic tank. This old-fashioned design is not as effective as multi-compartment tanks. Some solids enter drainfield and clog soils.

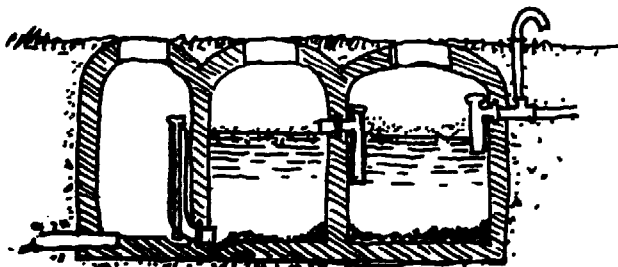

The first septic tanks appeared in the USA about 1883, when a two chamber, round, vertical tank, equipped with a dosing siphon for discharge was designed by Edward S. Philbrick of Boston, Mass.

## GIVE MICROBES FOOD THEY CAN EAT. DON'T POISON THEM.

The micro-organisms in a septic tank can eat quite a varied diet but some substances are just impossible. Cigar and cigarette butts, filters, sanitary napkins, facial tissues, hair, paper towels and napkins, bandaids, old toothbrushes and broken children's toys – all belong in the garbage pail, not the toilet. They can't be eaten *and* take up precious space in the septic tank.

Grease and fat will not digest in a septic tank. Most will float to the top as scum. But, grease will combine with laundry detergents and wash through the septic tank into the drainfield. There, it clogs the soils. Put grease in a can (glass breaks).

Be wary of any products that claim to clean septic tanks. Many of these products temporarily precipitate solids – giving the illusion of success. But, they cause a solid bulk that is more difficult for bacteria to eat and change the water's acidity so much that many bacteria perish. Products with sodium or potassium hydroxide are the worst. They not only ruin long-term digestion but significantly speed soil clogging.

There are over 1,200 products claiming that "enzymes" will help septic tank digestion. Bacteria produce their own enzymes and can only eat as much as their *own* enzymes can digest. So far, no enzyme product has been proved beneficial.

Obviously, large amounts of any single chemical will hurt the septic tank ecosystem. Chemicals from dark rooms or large amounts of paints should be directed into a separate dry well.

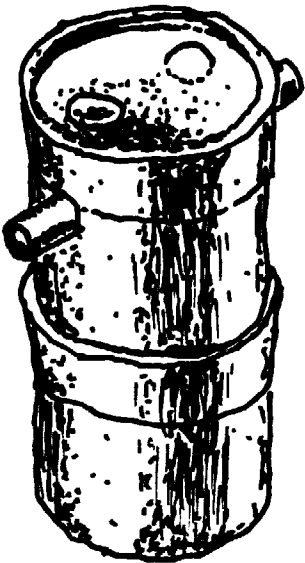

A series of three cylinder tanks made from agricultural pipe removed more solids than any other combo. The study was done under the Public Health Service during the 1950's.

## KEEP THE SOLIDS IN THE TANK

The septic tank is, in some ways, a miniature ecosystem. Bacteria will flourish or struggle along depending on the water temperature, the amount of oxygen, the rhythm of water use, the chemicals used by the household, the acidity they create, and the family diet. For instance, bacteria like temperatures between 70 and 80° F (21 to 27° C). They slow down if the water temperature is a lot lower. There are all kinds of arguments about how long wastewater must sit in a septic tank in order for the predominantly anaerobic bacteria to eat as much as they can. Obviously, the longer the better. It is currently believed that a sizeable portion of the solid wastes are eaten, under "typical" conditions, within three to five days.

The solid waste from your household must be given time to settle down or float up and out of the wastewater. Otherwise, household wastes flow in one end of the tank and out the other. The soil clogs quickly. Many advancements have been made in septic tank design to keep solids from escaping the tank. Only a few of these new design features have been incorporated into the codes or government pamphlets on septic tank practices.

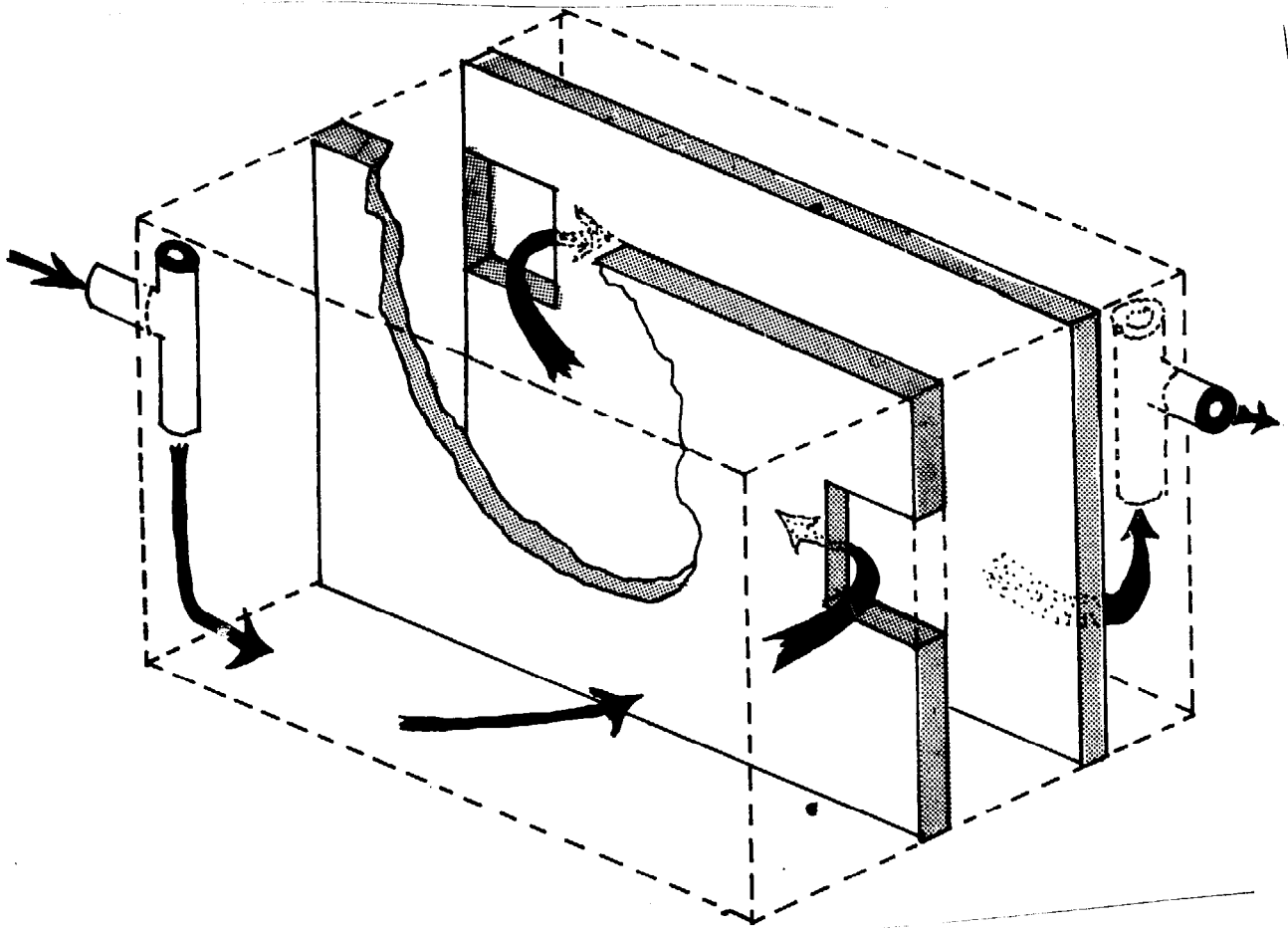

### THE THREE COMPARTMENT "MEANDER" TANK

The main "trick" of septic tank design is to create an old, deep river. Make it deep so the solids will settle out of the main flow. Make it wide enough so the flow isn't tight and restricted and fast like a new-born stream, but not so wide (like an alluvial plain) or there will be corners with no flow at all. Make the volume large so the incoming wastewater flood can disperse its energy into the huge "lake" of the tank. (When the flow loses energy, the sediment sinks and air bubbles let the scum float up.) Give the tank compartments (which act like a river's "water gaps"). Each compartment only lets a small stream flow through. All the rest of the suspended scum and sludge hit a wall and float up or settle down. Finally, make the wastewater river reverse its direction of flow again and again. This "meander" makes the wastewater river slow down and, like the old Mississippi, drop its sediment at each bend (see Chapter illustration).

In summary, Dr. Timothy Winneberger, in the 1960's, perfected the three compartment, meander tank. Deep, large and divided into 3 compartments in a meander-flow design, this tank retains more solids and produces a clearer effluent than all other designs.

## SEPTIC TANK SIZE

Besides detaining solids long enough to settle or to float, the septic tank stores undigested solids. After a period of time, the sludge and scum occupy a significant volume of septic tank space and wastewater starts rushing through into the drainfield. Sludge and scum should be removed before this happens.

Undigested solids accumulate in fickle ways. One kind of family diet will lead to lots of sludge, another to lots of scum. Sludge and scum become compacted over the years and some of the "indigestibles" finally break down. So, over the years, less and less sludge and/or scum appears to accumulate. Because septic tank storage is so erratic, it is impossible to recommend "such-and-such a size for five years storage." With no "scientific" way to size a septic tank, we make semi-knowledgeable guess estimates.

We do know that 70 to 80% of the solids in a septic tank are digested after 3 to 5 days. In other words, the septic tank should be able to hold at least three days volume of wastewater. For example, a family of four wasting 75 gallons of water per person per day (300 gallons for the whole family) might buy a tank of 900 gallons capacity.

But, the longer the solids sit the better. The family of four could reduce their water consumption. If they only used 50 gallons per person per day (200 gallons for the family), a 600 gallon tank might be plenty.

But, then again, the longer the solids sit in the tank, the more will be digested and the clearer the wastewater entering the drainfield. The same family might decide to use less water and the bigger tank. The solids would then sit in the tank 4½ days instead of 3.

There is nothing sacred about these numbers. Size is best estimated by water use and balanced by cost. If it doesn't cost too much, get a larger tank. But, don't get a larger tank as an excuse to waste more water. Remember, it may be cheaper to have a grey-water dry well, a smaller septic tank and a smaller drainfield.

Given present-day construction practices, most new homes have a septic tank between 800 and 1,200 gallons. A general estimate is given in the chapter on installation (Chapter 9).

### Summary

The septic tank has been improved in shape, with compartments, baffles, and man-holes.\* The size and design allow solids to settle or float out of the wastewater, to be eaten by microbes, and to store sludge and scum for a reasonable length of time. Keeping water use low and indigestible wastes (like cigarette filters) from being flushed down the toilet cannot be designed into the septic tank. They require the understanding and thought of the household. Please, care for your microbes and they will respond in kind.

\*This chapter does not cover certain features of septic tank design because they are obvious. But, they do require attention when installing or renovating an old tank. They are the man-hole covers, the materials and construction of the septic tank, and the kinds of baffles to prevent solids from moving into the drainfield. They are described in Chapter 9.

Inlet and outlet baffles prevent sludge and scum from backing up into the household plumbing. They come in all shapes and materials. Top is a "tee." Center is an "eel." Bottom is a type found in old metal tanks and some new concrete tanks. The current best buys are plastic "tees" since they allow easy cleaning and venting from the top. If agricultural pipe is available, it works just fine, too.

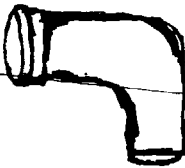

# 7 DRAINFIELD

## DESIGN

*This is an ideal trench design that allows wastewater to infiltrate the surrounding soil easily and quickly. It uses sidewall areas (vs. bottom) for maximum infiltration. See Chapter 9 for Construction Details.*

The drainfield soil filters, strains, and chemically renovates the polluted effluent coming from the septic tank. These soils are nature's astounding purifier. The best drainfield will let effluent infiltrate into the soil and then percolate away year after year. Since infiltration is the first aspect of water transport to fail, drainfield design is based on maintaining the infiltrative surface – keeping it from clogging.

At the moment, these three guidelines help keep the soil infiltrating:

- Use as little water as possible.
- Dig the drainfield in the best soil layers for water movement.
- Encourage the aerobic soil community in the drainfield.

These three ecology guides interact. If you use little water, then the surfaces of the hole get more air. If you use the more pervious soil layers, then the cleaned water will move away faster and the walls of the drainfield hole will again be better aerated. Aeration, infiltration and percolation mutually effect each other. The amount of water, the kinds of soil, and aeration all effect one another.

### THE DRAINFIELD HOLE

Until 1926, Western Man improvised all kinds of holes in the ground for the effluent coming from the septic tank. Then, in 1926, Henry Ryon, a sanitary engineer working for the State of New York, became fed up. Too many complaints came into his office each day. Henry Ryon became the first human to consider how soils provided sewage treatment. He was succeeded by a group of scientists at the University of California who investigated soil clogging. They added to Ryon's knowledge and recommended that the drainfield hole have a specific shape and depth.

First, they found that the bottom of any drainfield hole is quickly saturated with effluent. The organic mat grows quickly in the saturated bottom and clogs the soil. In short, the bottom is not an infiltrative surface for long. Only the sidewalls are effective because they receive some air as effluent levels go up and down. The sidewalls also erode stripping off the organic mat. The bottom cannot erode. The shape of any drainfield hole should emphasize the sides -- not the bottom area.\*

\*An exception to this rule occurs when evapo-transpiration (vs draining) becomes the most important method of removing water. The shallow bed which allows root penetration is preferable. Situations like this occur in the Southwest. See the next chapter for details.

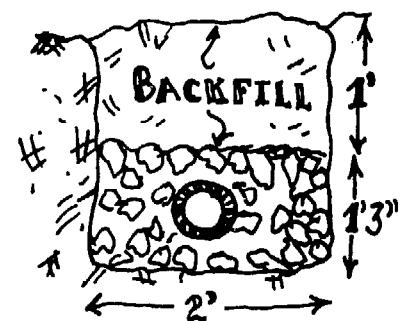
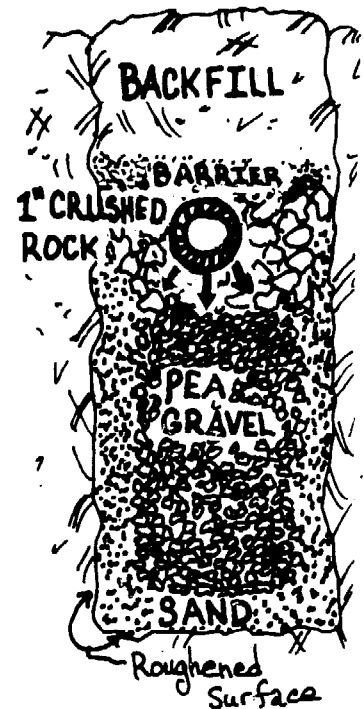

A typical old-fashioned drainfield trench. It functions poorly because it relied on bottom area which clogged quickly. This trench is still standard in several states, e.g., Kentucky. Other problems include gravel size and pipe placement.

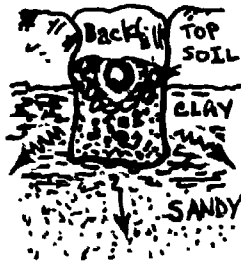

Top: a poorly placed trench with sidewalls in clay layer.



Bottom: a well placed trench using sandy layer for parts of its infiltration area.

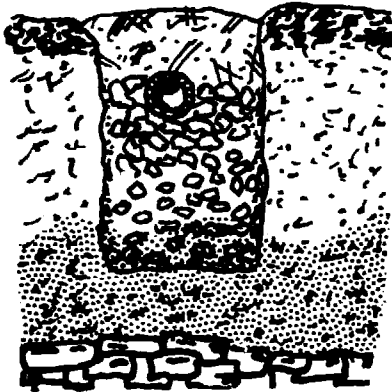

A trench may be flooded by water that "perches" on a rock layer. Permanently flooded trenches may cause anaerobic conditions in poor soils, especially if the condition lasts for many months. A fluctuating watertable does not permanently flood the drainfield. There is temporary aeration. Temporary flooding is tolerable if the septic tank is high enough to force effluent into the drainfield - preventing sluggish drains.

This recommendation is contrary to the US Public Health Service's *Manual of Septic Tank Practice*. It says, soil absorption area in the hole "is figured as the trench *bottom* area, and includes statistical allowance for the vertical side walls areas." This is ecologic nonsense and should not be followed. Again, only the sidewalls are effective surfaces.

#### The Best Soil Layers

Second, try to use the layers of soil that will transport water away quickly. Obviously, avoid putting the drainfield hole in heavy clay, which impedes water transport and aeration. The soil profile exposes the best layers for water transport. If, for instance, there is a layer of clay and then, below it, a layer of sand, it is best to dig the hole deep into the sand. On the other hand, if the soil is all sandy loam, then the depth and shape of the hole are not critical. There is no one best shape or depth. The shape and depth depend on your local soils. Sometimes narrow trenches are best. Sometimes deep, seepage pits work better. Look at the soil layers before you design.

#### Avoid Groundwater

Third, the shape and depth of the drainfield hole(s) are influenced by the big geological and water picture. The most common concern is the combined effect of an impermeable layer of rock or soil plus heavy rains. If the impermeable layer is near the surface, water "perches" or sits on the solid rock or hardpan. The groundwater level rises and begins to flood the drainfield. *Sometimes* this causes anaerobic conditions and the growth of the organic mat.

There are lots of superstitions about impermeable layers and groundwater. Some drainfields work totally flooded in water. Others fail when the groundwater is within two feet of the drainfield's bottom. It is best to avoid flooding your drainfield. But, unless the big picture of underground water movement, the degree of flooding and the period of continual flooding is known, there is no *one* depth that is right.

Every authority in North America has advice on how far the bottom of the drainfield hole should be from groundwater or bedrock. Some say four, some eight, and others say the bottom itself. These "magic" numbers have nothing to do with local geology or watertables. They have become punitive rules discouraging septic tank systems in many parts of North America. To repeat, excavate the drainfield to avoid flooding by perched water. But, also remember, some drainfields work even under temporarily flooded conditions. Ask your neighbors about their rainy season experiences.

#### Fractured Rock WITH Soil

Finally, some geologists and health officials fear that wastewater travels too fast and is not cleaned in *fractured* bedrock and *gravelly* soils. Polluted water could arrive at a well or stream. But, these fears are most often unjustified. Neither fractured bedrock nor coarse soils are *ipso facto* bad for sewage treatment. Some coarse soils with just 1% clay will provide adequate filtration (page 18). In fractured bedrock (with some cracks filled with soil) water transport and sewage treatment are superb. Only a few fractured bedrocks with totally no soil in the cracks *might* be dangerous. In short, if the soils seem too pervious, try to dig the drainfield where it must travel through some finer soil. Or, import some finer soil (Chapter 8).



**Summary**

Sidewalls, the soil profile, hardpans and solid bedrock, coarse gravels and fractured bedrock are the environmental guides to drainfield shape and depth. The most common shapes are trenches and pits.

**THE DRAINFIELD SIZE**

Ecologically, the size of a drainfield depends on the long-term ability of your soil to infiltrate wastewater and the amount of wastewater that must be infiltrated each day. Obviously, the better the long-term infiltration and the less wastewater, the smaller the drainfield. Economically, the size of the drainfield depends on the costs of hiring someone and his machine to excavate the hole. Politically, you may feel you must follow the local Codes -- no matter how inappropriate their sizing procedures.

At present, there is a lot of confusion about sizing a drainfield. No scientist, engineer or layman can predict long-term soil infiltration. There is no "test" that can give anything but crude guesstimates. These guesstimates are the percolation test, soil texture analysis, and asking your neighbors. Even more than septic tank size, appropriate drainfield size has more to do with horsebetting than science.

**The Percolation Test**

The "percolation test" is actually misnamed because it measures both infiltration and percolation. You dig a very small hole, pour in water, and measure how fast the water disappears.\* The test is very fickle. The way the hole is dug, how long the surrounding soil is soaked, the shape of the hole and the way the water drop is measured can all change the rate of water drop. One professional will say his water disappeared quickly. Another, equally competent, says too slow.

In addition, the relation between an *overnight* test and long-term soil receptivity is hard to demonstrate. If the water in the hole doesn't disappear, you can be sure that there will be problems with aeration and the organic mat. But, if the water disappears in an hour or so, you still don't know if it will *always* disappear in an hour or so. Maybe, after a year's use, the water will take two hours or half an hour. Nobody can say.

A very general chart of how fast a gallon of water might disappear into a square foot of a particular soil surface has been worked out by Henry Ryon and up-dated (by eliminating bottom area) by Dr. J.T. Winneberger. This chart simply comes from their experience and is a very rough estimate. You can see, for instance, that if it takes three minutes for the water to drop one inch, you might use 1.6 sq. ft. of *sidewall* surface for each gallon of household water.

**The Soils Texture Test**

The soil texture test does not measure infiltration or water movement of any kind. It simply analyzes the soil for the amounts of clay, silt, and sand. The sandier the soil, the better the soil is for water movement -- so the story is told. Of course, the test by itself is very crude. Infiltration is a combination of soil texture *plus* soil

Wastewater passing through rock with some soil. Wastewater can easily be treated if passage is over 100 feet.

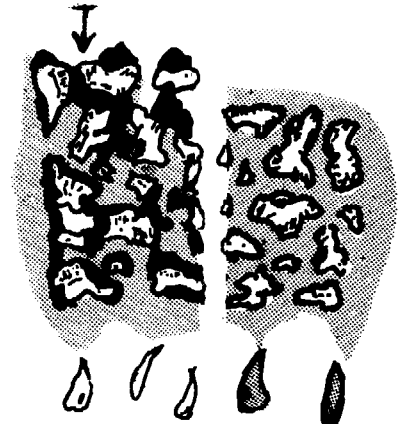

Wastewater passing through rock without any soil. Wastewater is not treated.

**RYON'S CORRECTED CRITERIA, MAXIMUM WASTEWATER LOADING RATES FOR DRAINFIELDS**

Percolation Rate Min./in.	Maximum Loading Rate gal./sq. ft./day
1 or less	2.5
2	2.0
3	1.6
4	1.4
5	1.3
10	1.0
20	0.72
30	0.48
40	0.42
60	0.36

\*Active Infiltration surfaces are sidewalls of disposal fields.

See page 36 for Bernhart's Chart and Abney Chart. Two other calculations of "percolation" rates.

\*Details of Percolation Procedures for actual use are given in Chapter 9.

structure, aerobics, the kind of clay, and all the other things discussed in Chapter 5.

**ABNEY'S LOADING RATES**

Soil texture	Sidewall for each gallon
Clay/silt (less than 0.1mm)	4 sq. ft.
Sandy soils (greater 0.1mm; less than 1.0mm)	2.5 sq. ft.
Coarse sands* small gravel (greater than 1.0mm)	1.5 to 2 sq. ft.

\*When soils are this coarse, check drainage to make sure no nutrients or pathogens can reach them.

Abney's chart extrapolates from soil texture to how many gallons of water a square foot of the soil could infiltrate. Pretty sloppy - but, if you can afford a soil texture analysis *and* a perc test, you will begin to get a mystic feeling about the amount of sidewall area you minimally need.

**Neighbors and Other Humans**

If your neighbor's drainfield works that is the best indication that yours will work. Check to see if the soils are similar. Ask them about problems. How much water they use. The size of their drainfield. Nothing beats their (and a local honest contractor's) experience. They might just say, "Oh my drainfield's half the size and mine's worked for forty years."

**BERNHART'S WASTEWATER LOADING RATES FOR DRAINFIELDS**

Percolation Rate Min./in.	Maximum Loading Rate gal./sq. ft./day
Sand 1	0.63
medium sand 5	0.56
fine sand 10	0.47
fine sand-silt 15	0.39
silt-sand 20	0.32
silt-loam-sand 30	0.23
loam-silt 45	0.12
loam-clay-silt 60	0.05

Obviously, if you can afford the percolation test (or five) *and* the soil texture analysis *and* talk to your neighbors, local contractor, and local Soil Conservation Service man - you're doing the best possible.

All these people will have different opinions. Some, especially the professional "hard" advice, is probably nonsense. If you want a drainfield with a long life - *excavate as much sidewall area as you can easily afford*, using these tests as guides. But, don't be pressed into some super-expensive holes because the Codes say so. If you feel you will use significantly less water than the Codes estimate or feel they are not using the percolation test or soils texture tests appropriately, go before the appeal board. Use this book. Every Code has to have an appeal process in the USA. Most times, with a little intelligence, the appeals board will give you the go ahead.

- See Page 41: Soil Colors as Helpful Hints
- See Page 48: Soil Conservation Service for Helpful Advice

**TWO POPULAR BUT LOUSY METHODS TO SIZE A DRAINFIELD**

Amazingly, the NUMBER OF BEDROOMS in the house is rapidly becoming the most popular "standard" used by local health departments to determine drainfield design. These estimates are obviously ridiculous. Bedrooms do not waste water -- people do. At one end of the American spectrum are communal life-styles and Native American homes where everybody essentially shares one large room. At the other end is the middle-class ideal where each individual has his/her own bedroom (kids too!). Bedrooms, according to this crazy notion, all waste water into identical soils.

The AVERAGE WATER USE, based on somebody's idea of what a typical American household must waste each day, is also used to size a drainfield. Most often this standard assumes you are a slob and waste water extravagantly. The drainfield usually ends up bigger than needed (which means it may last longer) but also is punitive: it makes conservation minded homes pay more than necessary for their water-saving ethics.

## DRAINFIELD LAYOUT ON FLAT GROUND

On *flat ground*, the drainfield can have any layout that allows wastewater from the septic tank to flow into the total excavation. The interconnected trenches (or pits) let the wastewater spread throughout the whole drainfield until the wastewater reaches the same level as inside the tank. There are many variations for flat-ground layouts (fork-like, serpentine or grid). The layout design does not matter as long as the ground is level. On *slopes*, these flat-ground layouts do not work. They distribute wastewater unevenly so that one section is flooded while another remains dry. The flooded section will become anaerobic and clog before the others. The highest trench on a slope may, in fact, be empty while the bottom is overflowing. The only way to prevent this unequal distribution is to divide the serpentine-like trench into separate units and make certain (by pipe arrangement) that the first is totally full before the second, the second before the third, etc. This slope-layout is called *serial distribution* and will be described in the next chapter.

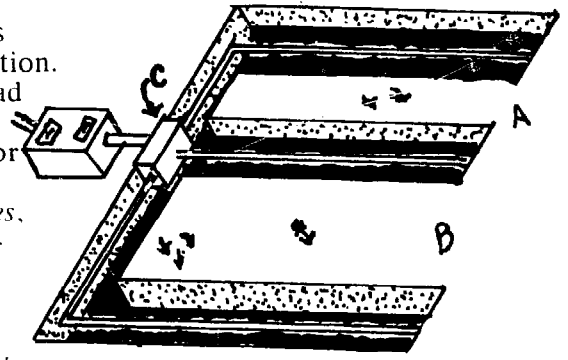

The **FORK-LIKE LAYOUT** has this advantage: If one of the "tines" should clog or a truck run it over and crush it, the other "tines" would work. It has the disadvantage of wasting useful infiltration area ("A" + "B"). The layout sketched above uses a distribution box ("C"). (See explanation below.) If clogging occurs in the distribution box, one trench may never get used.

Water always seeks its own level. In an interconnected drainfield, wastewaters spread out until the whole drainfield is filled to tank level.

### FLAT GROUND

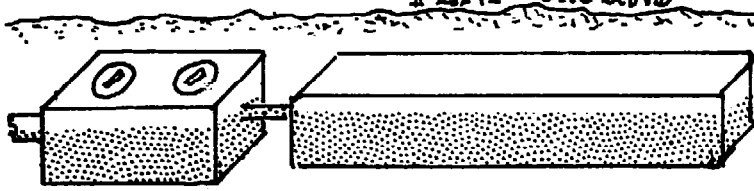

schematic drawings

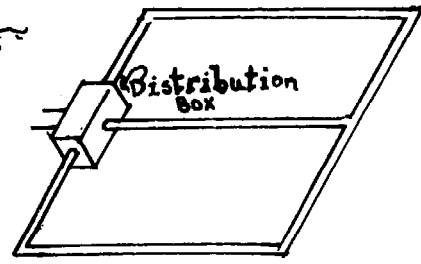

The **RECTANGULAR** or **GRID LAYOUT** has the advantages of using the soil area most efficiently and still using all the trenches if a break occurs. The grid-drainfield cannot be used in an inter-laced dual-drainfield (page 53).

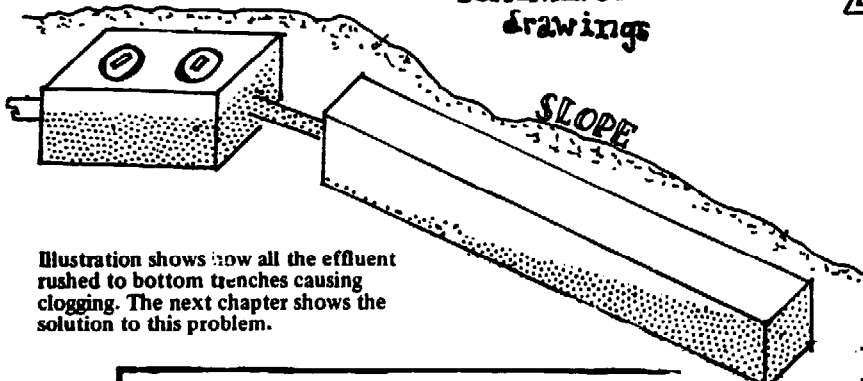
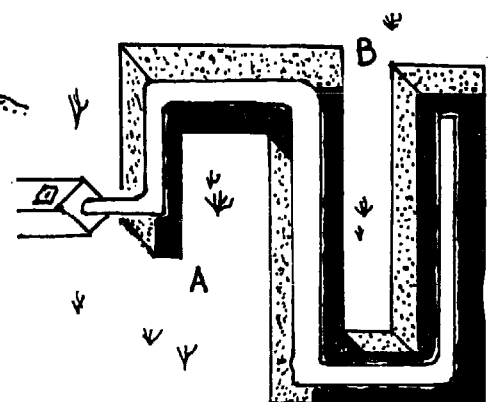
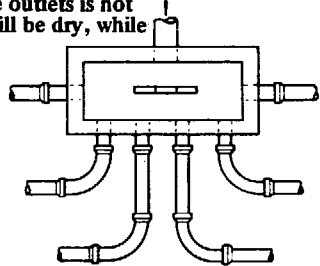
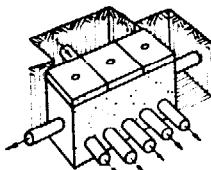

Illustration shows how all the effluent rushed to bottom trenches causing clogging. The next chapter shows the solution to this problem.

The **DISTRIBUTION BOX** is a chamber which shunts effluent into the drainfield pipes. If easily accessible (it should be), the distribution box is also an inspection manhole to see if any large solids are entering the drainfield. Distribution boxes work well on flat land but, on slopes, tend to let effluent go out only one of the many outlets. Distribution boxes should be checked yearly to make sure one of the outlets is not clogged. The clogged trench will be dry, while the others are overloaded.



The **SERPENT-LIKE LAYOUT** has the advantage of being able to wander to where you want it. If you are sub-irrigating with the wastewaters, you can lay out the pipes near the crops rather than put the trenches where the trenches are. Disadvantages: wasting infiltration area ("A" + "B") and a break or clog toward the beginning of the trench will prevent the rest of the trench from being used.

## SOIL AERATION, DUAL-DRAINFIELDS, AND LONG LIFE

To assure air gets into the soils, engineers have recently invented a drainfield design which allows much greater aeration. This is called the dual-drainfield or alternate bed system.

Two drainfields are built instead of one. Each is a *complete* drainfield. The two drainfields are connected to the septic tank by a "flow control" box or diversion valve. Each drainfield receives effluent for one year. Then, the flow of effluent is manually switched to the other drainfield. The first drainfield gets a rest and a chance to aerate. The decomposed humus developed after several years of alternate loading and resting may even improve clay soils and help sandy soils hold nutrients.

Details of the flow-control box and how to arrange a dual-drainfield system are given in Chapter 9. These boxes are commercially available but, they can be easily made.

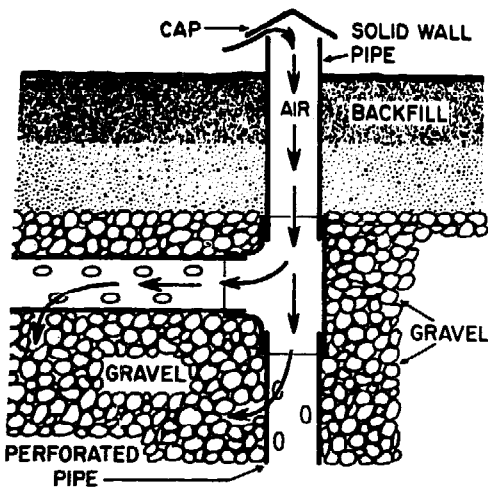
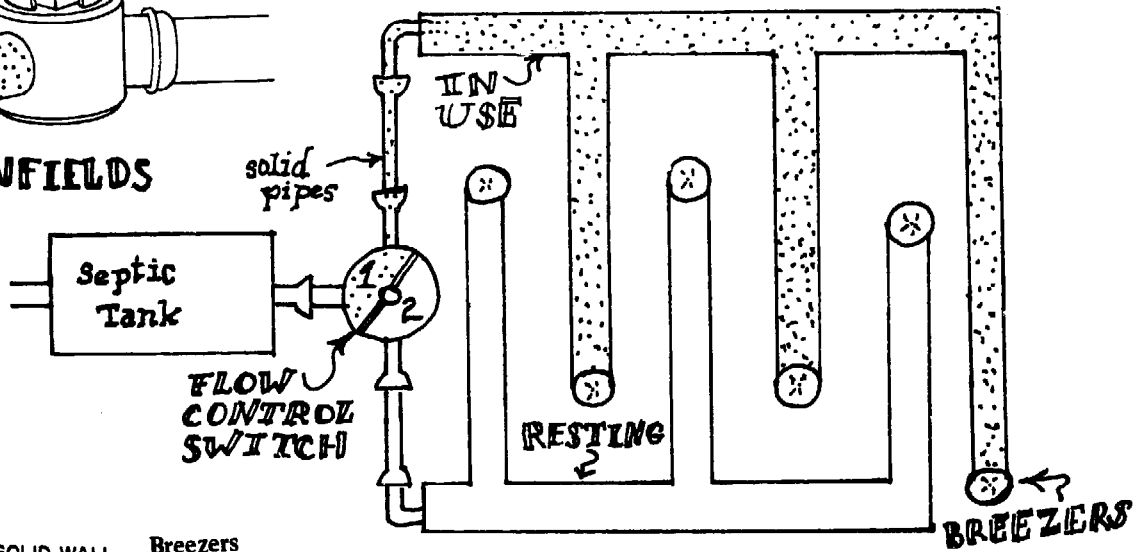
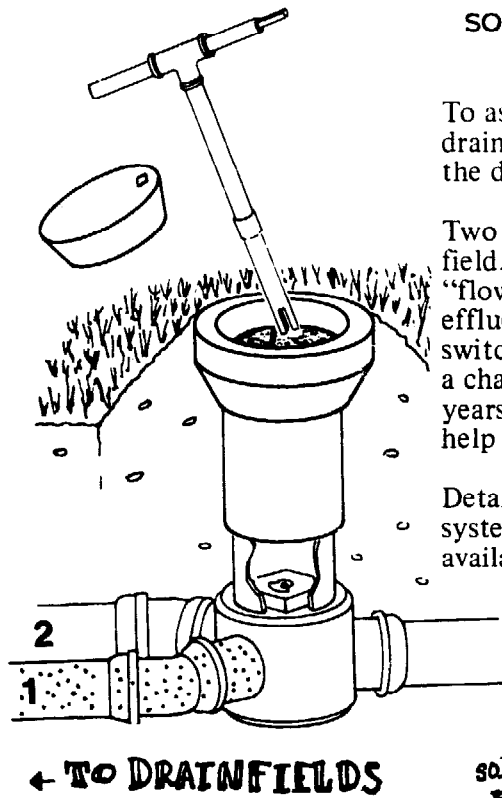

### Breezers

Daily aeration can be improved by the use of *breezers* or breathers. A breezer is a pipe perforated at the bottom and opened to the air on top. A breeze enters the pipe and pushes air into the trench. Breezers function best when placed at the end of each trench or in each connected seepage pits.

### Summary

Drainfield design and function improves when you use as little water as possible, encourage aeration of the soil, and dig the drainfield in the best soil layers for water transport. These three ecology guides are only recently understood. Most codes and manuals are unaware of how soil, air, and water interactions influence drainfield design.

Only the major aspects of drainfield design have been outlined. The kinds of pipe, gravel backfill, and techniques to encourage evapotranspiration have not been discussed. In addition, we assumed basically flat soils with good drainage for drainfield construction. Problem soils and slopes as well as details of construction are given in the next two chapters.

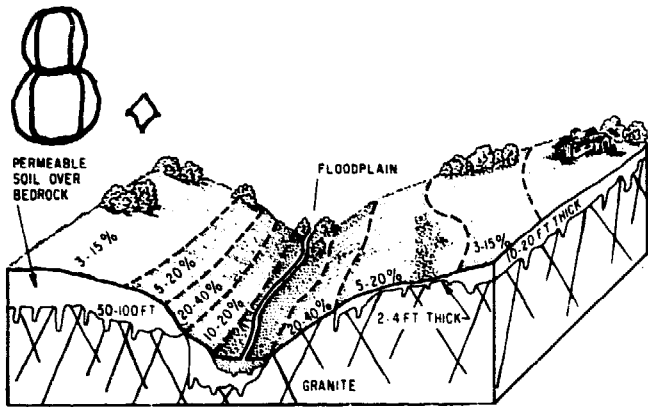

# ECOLOGICAL PROBLEMS

In some situations, septic tank systems may be difficult to install and/or operate. The topography may be unsuitable because the slopes are steep. The house may be located in the flood-plain of a creek. The soils could be impermeable or have one layer (called a "pan" or "fragipan") that is impermeable. The soils may be too shallow (e.g., three feet to the bedrock). Or the water table may be too high for too much of the year - preventing air from entering the drainfield.

Slopes, soils and bedrock must all be considered when planning a drainfield. Slopes over 20% are hard to dig on. Most soils that are 2 feet thick or less need special man-created drainfields. Floodplains are difficult for all kinds of sewers -- on-site or centralized. They are best avoided.

When installation of a septic tank system seems questionable, think of the alternatives: maybe a compost privy or a system that recycles most of the water. When septic tank systems are difficult to use, there is usually so much water that the wastewater can't be treated. The easiest solution is a waterless toilet and a grey water recycling system.

If there are soil and watertable problems, the septic tank system will cost more for construction (and maybe operation) than a simple drainfield in well-suited soils. But, except for the dosing tank, the solutions suggested below do not use additional electrical or gasoline energy. In other words, before going to a community sewer or buying a super-mechanical contraption, or giving up altogether, try these "tricks" of the sanitary engineering trade.

## HILLSIDES AND DRAINFIELD CONSTRUCTION

Slopes, in themselves, are not necessarily a bad place to distribute effluent. They can provide better drainage than a flat area in some cases. Many times daylighting of wastewater from the drainfield occurs because the soils were too shallow or too clayey in the first place - not the slope. *Soils and slopes must be carefully separated in judging a site for a drainfield.*

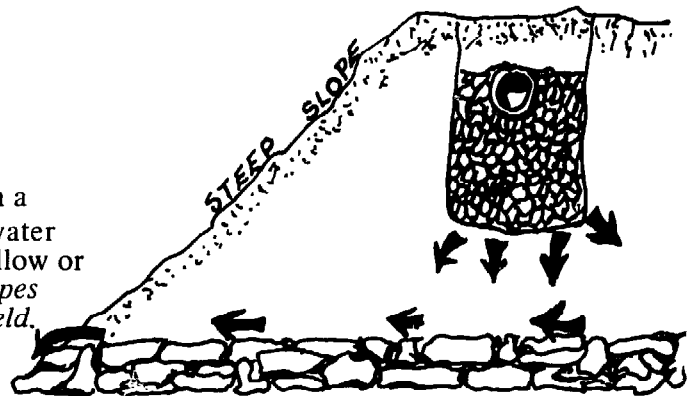

If the problem is slopes, then follow these recommendations:

**IMPERVIOUS LAYER  
(CLAY or ROCK)**

**SERIAL LOADING IS A MUST FOR SLOPES.** Many contractors try to use trenches stemming from a distribution box. Many times all the effluent flows quickly to the lower trenches (pg. 37) and the top trenches wind up totally unused. With or without distribution boxes, flat-ground drainfields do not work well on slopes.

*A slope may cause problems if the soils are too shallow to clean the water before it re-appears on the surface or if the water causes erosion when it reappears (at the "seep" point). Deep soils on slopes (left section of top drawing) can be fine for slopes. Above 20% slopes, it is difficult to use backhoes.*

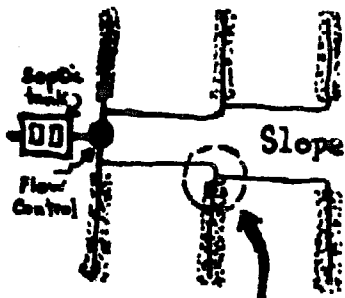

Serial loading can be accomplished by the "drop box" method (see Public Health Service Manual) or by the use of plastic fittings. The latter is cheaper. Three plastic fittings (2 90° elbows, and a 45° ell) are attached so one infiltration trench must "jump" to the next. This forces the first infiltration trench to fill before the second can be used. An undisturbed area of earth between the infiltration trenches as well as the "jump" prevent wastewater from filling the bottom trenches first.

Caution: Do not dig the undisturbed earth "dam" between trenches. Dig only deep enough for the "jump" pipe.

For serial (slope) layouts, a dam of undisturbed earth helps prevent wastewater from flowing to bottom trench first. The pipe arrangement causes the top trench to be used.

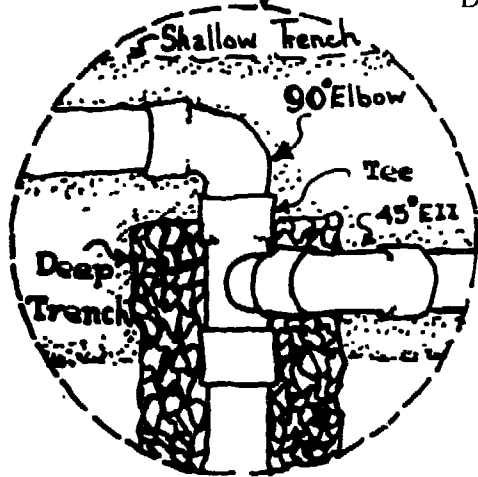

Top view of pipe arrangement using a "tee," a 90° elbow, and a 45° ell.

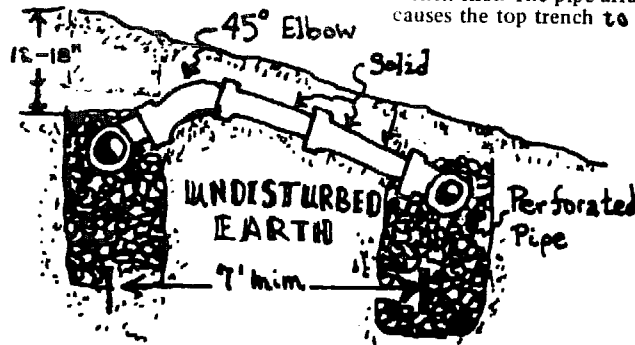

TRENCHES SHOULD BE PARALLEL TO THE CONTOUR.

TRENCHES SHOULD BE AS LONG AS POSSIBLE. Many codes insist that trenches be only 100 feet long. This is a nonsensical rule, especially for drainfields on slopes.

AVOID BUNCHING TRENCHES on top of each other. For back-hoe construction, the outer-wall of a trench should be about 7 feet from the next nearest trench. This is a super-safety factor -- not a hard-fast rule (see page 52).

TRENCH BOTTOM SHOULD BE ABOUT LEVEL. On slopes, off-grade trenches lead to unequal ponding and use of trenches.

**OFF-GRADE**

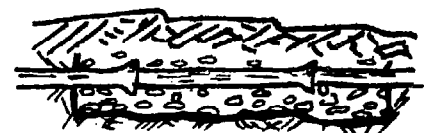

**ON-GRADE**

NEVER BENCH A DRAINFIELD. ON STEEP SLOPES, USE HAND TOOLS.

Slopes with 20% angles cause most of the problems. 20% slopes are about the uppermost angle that a back-hoe can work on safely. So humans, insistent on their machines, "bench" (i.e., make a series of "stairs" from the slope) instead of using handtools. This excavates the soils down to impermeable bedrock and exposes vertical cuts where seepage can occur. "Benching" also compacts and smears the soils so much that the earth can no longer infiltrate and drain the wastewaters.



## SOILS WITH HARDPANS AND SEASONAL WATER TABLE

When water perches on a hardpan or bedrock, it can flood the drainfield. If the drainfield is flooded for too long, it may turn anaerobic and clog. It is important to know: how close is the bottom of the drainfield to the groundwater? how long does the groundwater remain either in or right below the drainfield? is the groundwater just sitting or is it moving through the drainfield? is it fluctuating or permanent groundwater?

Three ways can help you decide how good or bad your groundwater situation is for a drainfield. Ideally, you can dig a small hole and watch the groundwater during the wet season. See how far up and down it fluctuates and for how long it is closest to the ground surface. This assumes you have a wet season available before you want to start building

Another clue to the groundwater level are the soil colors and mixture of soil colors. If soils are saturated (permanent groundwater), the iron in the soil forms a gray compound (Ferrous oxide). When the soils get good aeration ("insignificant" groundwater), the iron in soils turns red-brown (Ferric oxide or hematite). Fluctuating groundwater produces a mixture of red-brown and gray colors. In addition, a third form of iron, called limonite, which is yellow in color develops. Intermingling of gray, yellow, red and brown indicate a seasonal groundwater table and the general depth of fluctuation.

These mottled soils usually show good percolation in dry seasons but, come the wet seasons, the soils are easily saturated and may drain the effluent.

Last, permanent or semi-permanent groundwater tables nurture special water-loving plants. The presence of these plants is a warning that there may be wet season troubles.

Drainfields in mottled or seasonally saturated soils can sometimes be made to work if artificially installed drains are provided. These are called "Curtain Drains" or "French Drains" because French farmers have used them for centuries to control the wetness of their land. Curtain drains essentially divert the surface runoff during rain storms around the border of the drainfield and intercept some of the moving, underground water and divert it from the drainfield. There are many designs.

Areas of seasonal groundwaters are very common in the West, they are best solved by on-site investigation of the soils and watertable. In general, the main problem with *occasional* high groundwater is a slow-flush or sluggish drain in the house. Making sure the toilets and sinks are built well above the septic tank helps in this situation. The greater drop between toilet/drains to the septic tank helps force the wastewater into the tank.

**REMINDER:** Mottled soils are usually found 2 to 3 feet below ground surface. Colored soils much above or below this level could be indicative of something else like humus or bedrock color.

**REMINDER:** Slopes can have seasonal groundwater (and mottling) just like flat ground. *But, draining effluent is not as difficult on slopes because the underground water moves downhill diluting, purifying and moving the effluent.*

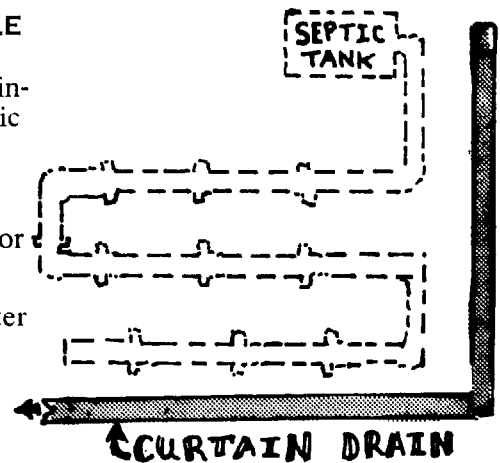

This curtain drain is catching sub-surface water that moves down slope (right to left). The curtain moves the sub-surface water around the drainfield. This helps prevent flooding. The curtain drain water goes somewhere like a ditch or stream.



Soils that are continually wet from prolonged water tables or ponding nurture special plants. These plants like the rushes pictured above love water. Possible water-logged soils can be easily spotted if you can recognize these plants. Others include brambles, poison hemlock, sedges, etc.

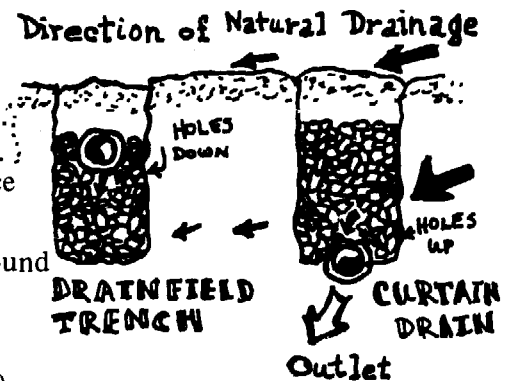

Note differences between drainfield trench and curtain drain trench. Further details are given on page 58. Holes up to keep soil out of pipe.

**WARNING:** Curtain drains will not solve severe watertable problems. If the groundwater completely floods the trenches, other techniques (see below) must be used.

**Community Drainage**

Finally, many subdivisions or communities must solve their high water table problems on a community basis. Culverts, ditches, surface runoff and underground water movement of a complete area or watershed must be understood. Otherwise, one home dweller is just shunting his or her water into a neighbor's drainfield.

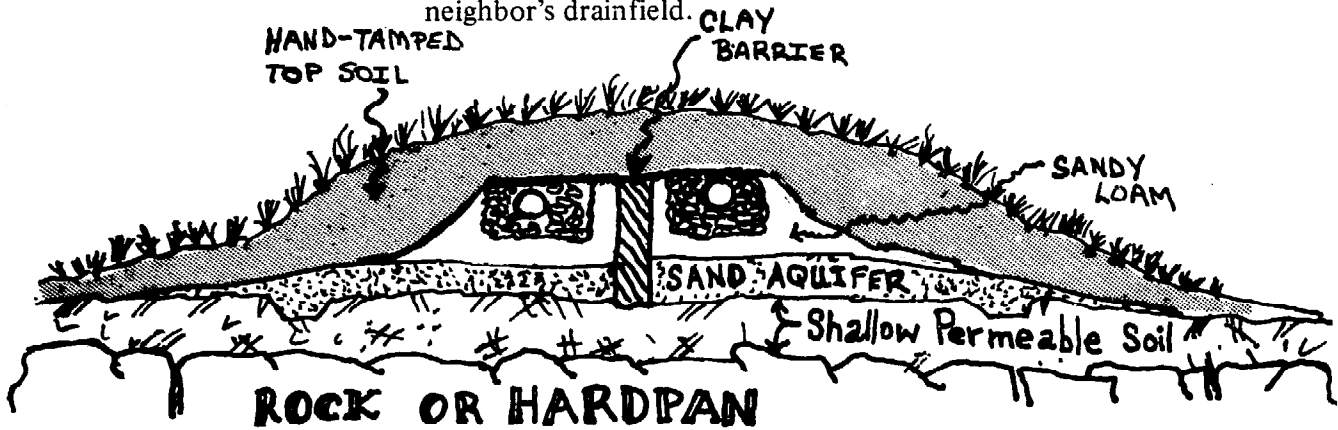

Mounds are usually constructed on the surface. They can take the form of redwood planter boxes or sculpted landscaping. On flat ground, effluent must be pumped to the mound or box because the drainfield is higher than

the household plumbing (see "Luxury Equipment" on next page.) If the ground slopes away from the house, gravity feed is possible.

**SHALLOW OR IMPERMEABLE SOILS AND LONG-TERM GROUNDWATER**

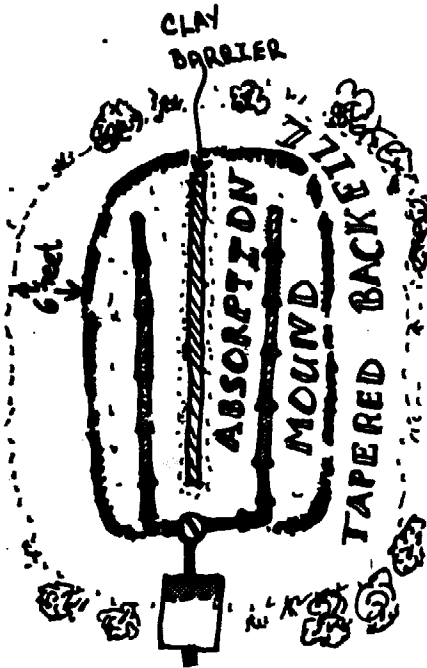

TOP VIEW with plants and top layer of soil removed.

Where soils are too shallow or soil is very impermeable or the soils are permanently saturated, septic tank systems can be modified. Essentially, there are ways to *construct and plant a soil profile* which will filter, drain and evapo-transpire the wastewater. Each system must be custom-designed for the soils, slope and evapotranspiration rates of your region.

Common kinds of these humanoid soil filters are called "the mound," "the evapo-transpiration bed," and the "inverted sand filter." The shapes of these human-made beds of soil and the exact layering of sands and loams vary with the scientist.

**Creating a Soil Profile**

Making your own soil filter-bed means trucking sand, gravel and soil (usually sandy loams or loam) to your home site. The native ground surface beneath the mound is cleared of all plants and, if there is some soil, this should be roto-tilled and left rough. To insure clean water, at least two feet of loam or sandy loam should be laid out between the native ground surface and the bottom of the drainfield pipes. If loams are impossible to find or very expensive, a series of finer and finer sands can be used.



See Winneberger, Abney, Bernhart and, especially, Wisconsin Alternate Sewage Manual in Bibliography.

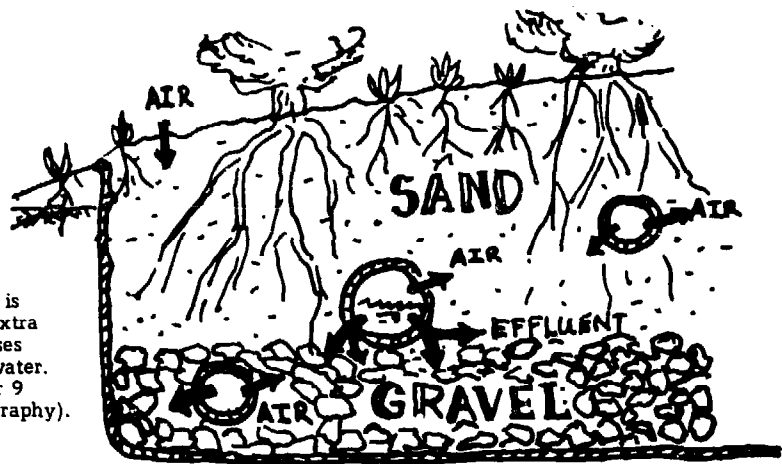

An EVAPO-BED designed by Fernhart. It is totally enclosed by plastic sheeting with extra air brought in by small "vent pipes." It uses only evapo-transpiration to recycle wastewater. This design is further described in Chapter 9 and Bernhart's excellent book (see Bibliography).

The drainage pipes (pressurized or un-pressurized) are laid in gravel above these two feet of soil filter. In the "mound" design, the filter bed and drainage pipes are covered with, at least, 3 feet of top soil.

To increase the cleaning powers of the soil, all the engineering tricks to increase aeration should be used: dosing tanks, breezers and alternate bed. In some mounds, especially those that want to use evapo-transpiration, air vents are laid next to the drainage pipes. This brings air into the soils in a more reliable way - increasing water absorption by plant roots and microbial action.

TYPICAL DOSING SIPHON

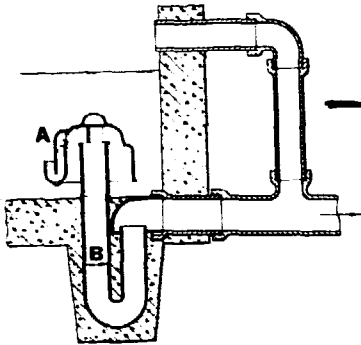

Non-electric dosers (the Miller siphon) are available but tend to corrode within 5 years. The use of dosing tanks with regular drainfields is possible. But, recent claims by dosing tank manufacturers that this will allow a 50% reduction in drainfield size have not been proven to our satisfaction.

### LUXURY SEPTIC TANK EQUIPMENT

#### Even Drainfield Flow

In most cases, effluent must be pumped to the mound. To insure the wastewater can move evenly through the mound and won't puddle, pond or daylight in one small section, Winneberger has made the following suggestion: Place the pressure pipe inside the regular drainpipe to protect the small holes of the pressure pipe from clogging. For example, the pressure pipe of 1 1/4" (with 1/8" holes every foot) is placed inside a 4" diameter drainfield pipe.

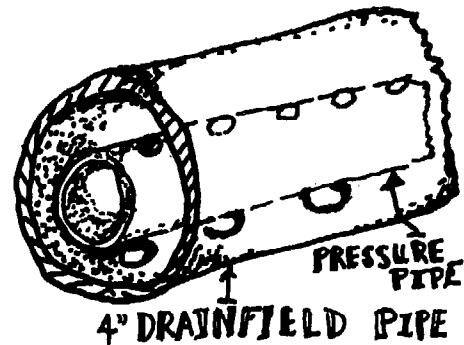

#### Pumping Chamber with Dosing Pumps

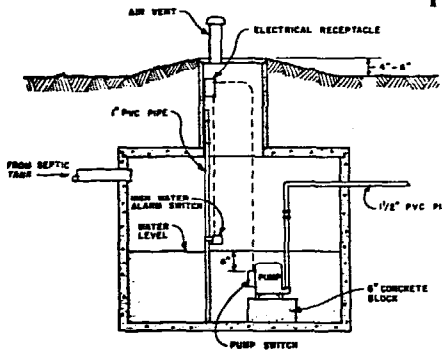

With many mound systems, it is necessary to pump effluent after pre-treatment in septic tank. This assures even distribution of effluent within mound (stops puddling) and aids aeration. A special pumping chamber is usually constructed between septic tank and mound. These chambers have 500 - 750 gal. volume to store one day's effluent plus one day emergency load. Pump should be selected on performance curve (total head vs. capacity) - not horsepower. Pumping distance

must be kept short (less than 150 ft.) to avoid friction losses. Head is usually twice the elevation between pump and drainfield pipes. Capacity is 25 to 35 gallons per minute depending on water usage. See Franklin Research (4009 Linden St., Oakland, CA 94608) for the "Cadillac" of pumps (the Air-O-Pump) and Wisconsin Alternate Sewage Manual for further details.

### **Moving the Clean Water**

Moving the cleaned water away from the treatment site demands the ingenuity of the designer. In areas where evapo-transpiration is possible, the mounds are usually larger with pipes spreading the cleaned water among the plants. Some designers, preferring not to use drainage pipes, use sand conduits to whiz the water about. These sand "aquifers" can be cheaper depending on the cost of pipe. Sand aquifers also provide some further treatment.

When evapo-transpiration cannot be completely relied upon, the filter bed size is increased to insure water will be cleaned. A curtain drain directs the cleaned water away from the filter bed. Either sand conduits or plastic pipes will work and the choice depends on your home ecology.

The next chapter contains information on how to size your special septic tank system and what books are available. These systems have been tried and used successfully all over the country. They are still cheaper than public sewers.

### **COLD CLIMATES**

The Northern States of the United States are all aware of frost penetration problems. Following their manuals and local advice is the best guide to keeping drainfields working in deep cold. In general, little trouble occurs when the tank is, at least, one foot below the ground and the drainfield pipe 18 to 24 inches below ground surface.

Flushing with warm water is said to help in winter months. Placing the tank below the frostline is usually not necessary, especially if you cover the septic tank/drainfield area with straw. Freezing occurs most often when you don't use the system continuously.

**WARNING:** Sewer pipes under driveways and other hardpacked surfaces suffer most. This usually occurs because the insulating layer of snow is shovelled off. It's best to insulate sewer pipes under driveways.

Evergreens, like cedar, continue to evapo-transpire during the winter. They can help drainfield function in cold climates.

### **Summary**

Geology and water movement set the limitations for drainfields. Major considerations are: (1) texture of the soil receiving effluent; (2) thickness of the soil; (3) depth and season(s) to ground water; (4) depth to bedrock or hardpan; (5) texture of bedrock (fractured or solid, with or without soil); (6) extent of bedrock or hardpan (where it directs effluent); (7) direction of surface runoff; (8) direction of subsurface runoff; (9) slope of land; (10) closeness to road cuts or embankments; and (11) closeness to natural watercourses. Any of these eleven limitations may, if extreme, or not considered when designing the drainfield, increase the chances of failure.

# 9. PLANNING AND CONSTRUCTION

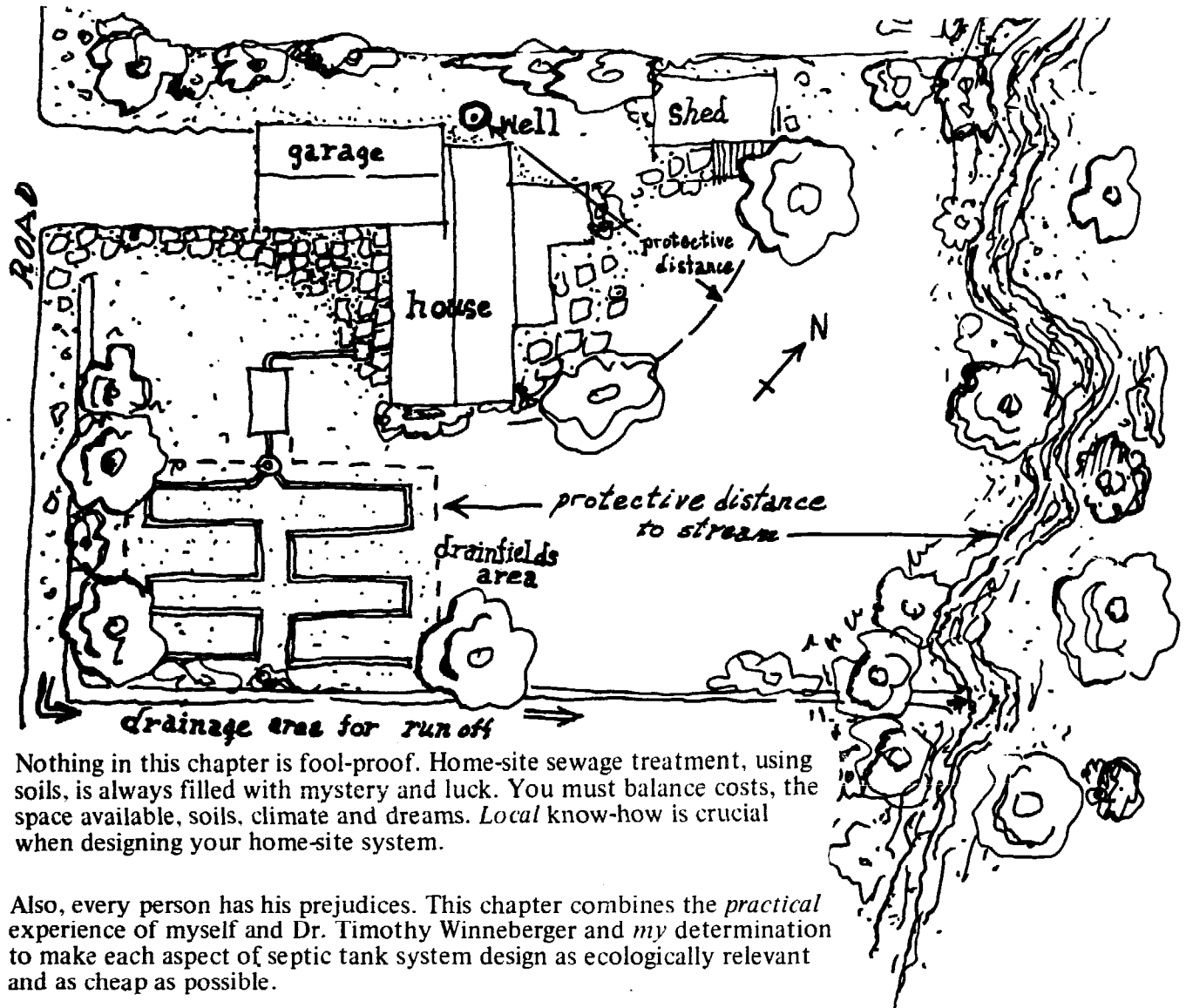

Nothing in this chapter is fool-proof. Home-site sewage treatment, using soils, is always filled with mystery and luck. You must balance costs, the space available, soils, climate and dreams. *Local know-how* is crucial when designing your home-site system.

Also, every person has his prejudices. This chapter combines the *practical* experience of myself and Dr. Timothy Winneberger and *my* determination to make each aspect of septic tank system design as ecologically relevant and as cheap as possible.

The design and installation of septic tank/drainfield systems has been arranged by stages: (I) Sketching the Home Site; (II) Decision Making; (III) Learning your Home-Site Ecology; (IV) Calculating the size of the drainfield; (V) Mapping the drainfield; (VI) Purchasing Materials; (VII) Constructing the System. It is meant to provide the most up-to-date knowledge and provide you with a home-site treatment system that will last as long as the house (50 to 75 years).

## I. SKETCHING THE HOME-SITE PLAN

On an outline map of your property (usually a scale of about 1/8" equals one foot is easiest to draw on), try sketching:

- a. The North Arrow.
- b. The size and shape and location of your home, proposed buildings, other out-buildings, hardened surfaces such as patios, decks, walkways, driveways and swimming pools.
- c. The location of any wells, springs, creeks or drainage channels on or near your land.
- d. The area you would like to remain green. This is the area of the drainfield, septic tank, and expansion area (if you need one).
- e. An eyed sketch of the contour lines showing slopes and maybe a side-view if you think there will be grading or flattening.

**WARNING:** Slopes are special cases in home-site sewage treatment and must be carefully analysed. Read Chapter 8 before proceeding if you have a slope greater than about 5%.

**REMINDER:** The southern exposure will help evapo-transpiration and gardening.

This sketch will become the "hard" blue-print when you add County Codes and drainfield size. Before you get too exact, a series of decisions have to be made.

## II. DECISION MAKING

You must decide, thinking over the amount of land you have, how much you can afford and how much you know about its climate, soils and geology:

- a. Do you want to have a grey-water drainfield and a septic tank drainfield? The grey-water drainfield requires separate plumbing for the sinks, showers and bath. Grey-water drainfields use about half the amount of sidewall for the same amount of wastewater as black-water drainfields.
- b. The surface runoff must be planned. Directing the runoff from the roof or patios away from the drainfield area (in areas of heavy rainfall) and knowing where the runoff will leave the property line are both important.
- c. Determining geological and climatic limitations that might need further investigation or might restrict the possibilities. These include:
  1. a permanent high water table;
  2. a rise in the ground water during the rainy season that might enter the bottom of the drainfield;
  3. the amount of rainfall;

4. the amount of evapo-transpiration;
5. the depth to bedrock and the kind of bedrock;
6. the existence of hardpans which are impermeable to water;
7. near-by water courses and man-made cuts or embankments;
8. the depth and texture and structure of the soil.

Much of this information will be discovered by doing a soil bore and asking neighbors about the water table, etc. This is explained in the next section.

**REMINDER:** Curtain drains (Chapter 7) are useful to lower seasonal high water tables.

- d. As your understanding of climate, soils, cost and re-use of water become more and more connected to your land the kind of drain-field that best suits you needs will become increasingly obvious. If the soils are deep with few geologic or water table limitations, then *seepage pits* are usually preferred. If the soil or water limitations occur three to six feet below the ground surface, then *trenches* are usually preferred. If limitations are severe, then *shallow trenches* or a *seepage bed* must be used. In many areas, seepage beds can work with evapo-transpiration only. These are called *evapo-beds*. Finally, if there is really no useful soil, then you must build a soil profile (Chapter 8) and/or switch to waterless toilets (Chapter 3).
- e. Trenches, pits and seepage beds can be used in alternation. One complete drainfield used for a year, while the other rests. You must decide between:
  1. a single-drainfield;
  2. a single-drainfield with an expansion area;
  3. a dual-drainfield;
  4. a dual-drainfield with an expansion area.

If you have only the smallest lot, a single-drainfield (1) is a necessity. If you have the space and can afford the price, a dual-drainfield will last longer and work better than a single-drainfield (Chapter 7). In short, always chose "3" over "2" if possible. A dual-drainfield with an expansion area (4) is, of course, ideal but means you must have a large lot.

### III. LEARNING YOUR HOME-SITE ECOLOGY

You want to know what the highest groundwater level might be, if the bedrock is fractured or solid, if the bedrock cracks are filled with soil or have empty spaces, if the soil permeabilities will allow water to infiltrate and how fast, which layers of soil are the best to use for infiltration, if there is a hardpan, etc.

**BERNHART'S WASTEWATER LOADING RATES FOR DRAINFIELDS**

Percolation Rate Min./in.	Maximum Loading Rate gal./sq. ft./day	
Sand	1	0.63
medium sand	5	0.56
fine sand	10	0.47
fine sand-silt	15	0.39
silt-sand	20	0.32
silt-loam-sand	30	0.23
loam-silt	45	0.12
loam-clay-silt	60	0.05

These loading rates are for totally anaerobic conditions.

**ABNEY'S LOADING RATES**

Soil texture	Sidewall for each gallon
Clay/silt (less than 0.1mm)	4 sq. ft.
Sandy soils (greater 0.1mm; less than 1.0mm)	2.5 sq. ft.
Coarse sands* small gravel (greater than 1.0mm)	1.5 to 2 sq. ft.

\*When soils are this coarse, check drainage to make sure no nutrients or pathogens can reach them.

**RYON'S CORRECTED CRITERIA, MAXIMUM WASTEWATER LOADING RATES FOR DRAINFIELDS**

Percolation Rate Min./in.	Maximum Loading Rate gal./sq. ft.* /day
1 or less	2.5
2	2.0
3	1.6
4	1.4
5	1.3
10	1.0
20	0.72
30	0.48
40	0.42
60	0.36

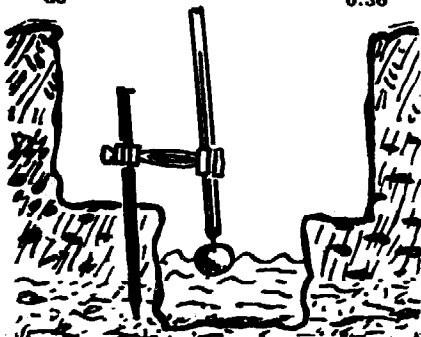

To make a perc test in deep soils, dig a larger hole down to the layer you will be using to infiltrate effluent. Make the perc test in a smaller hole within the large hole as pictured above. Don't attempt perc tests in holes over 10 feet deep. You might wind up buried alive.

**Soils**

The best way to get soils information is by asking honest and knowledgeable local people. They may be the sanitarian, the contractor, the next door neighbor, the local representative of the Soil Conservation Service, or the local engineering firm. You can get your own information by doing a soil bore, collecting soil samples, having the SCS analyze the soil texture for you, and performing your own percolation test.

**WARNING:** The Soil Conservation Service has general classifications of soils but these are *general* and may not apply to your own local lot. Only by bringing soil samples (with depth indicated) to the SCS, can they tell you if your soils are typical. The SCS usually will do this for free. Some pleasant members of SCS will even help you take the soil bore, collect samples, and analyze them right on your home land. Remember, even if official SCS classification says "very severe for drainfield use," your home-site soils could be unique and good for sewage treatment.

The *soil bore* should be about ten feet deep. If you encounter groundwater, record the depth. If you encounter bedrock, try to collect some and see if there is soil in the crevices or not. If you encounter a hardpan, see if you can dig deeper. Sometimes, you can perforate a hardpan and find soils below it that infiltrate well.

**REMINDER:** Look for mottling of all layers to see if there may be a seasonal groundwater problem (page 41).

**REMINDER:** You must know if the soils are predominantly clay, silt, or sand. Do not guess. A sieve analysis, used by the Dept. of Agriculture, is the most economical way to analyze soil. You do not want to be slipshod about the soil texture or your guess at drainfield size will be nonsensical.

**Percolation Test**

The *Percolation Test* should be done in the soil that will receive the effluent. If there are many different layers, then a percolation test should be done in each.

**WARNING:** Some seepage pits in desert areas are 30 to 40 feet deep. Don't do a perc test in these holes. Try to extrapolate permeability from the soil sample (see Abney's chart). It's hard to climb out of a collapsing hole.

**REMINDER:** The Percolation Test is most accurately performed in the wettest season.

## THE PERCOLATION TEST

**REMINDER:** Perform at least one test for each layer to be used. The wettest season of the year is the best time to make the test.

### The Test Hole

- a. Dig or bore a hole with handtools either 12" square or 13" to 14" in diameter.
- b. Remove any smeared surfaces from the sides of the hole to provide as natural a soil interface as practical to infiltrating waters. Remove loose material from the bottom of the hole and add an inch or two of coarse sand or fine gravel to prevent the bottom from scouring.
- c. Presoak the hole carefully, never filling it deeper than about 8" with clean water. Do not drop the water into the hole from much distance. Ease it in gently. If it is known that the soil has low shrink-swell potential and clay contents are not much (perhaps less than about 15%), proceed with the test. If not, let the hole rest overnight.

### Measuring the Stabilized Percolation Rate

- a. Fill the hole with clean water to exactly 6" above the soil bottom of the hole (do not consider a layer of protective gravel as the bottom of the hole). With a float gauge and a timepiece, determine the time for the water to recede exactly 1". Refill and repeat the process until successive time intervals needed for 1" to be absorbed indicate that a stabilized rate has been obtained. Do not allow much time to pass between refillings.
- b. Report the stabilized percolation rate in minutes per inch.

### Results

If the percolation rate is more than 60 min/inch, then the soil is of questionable value as a disposal field. In these questionable areas, a minimum of three to five percolation tests should be run. The tests should be distributed over the area proposed for the drainfield and future expansion of the system. If these percolation tests indicate all the soil area to be of questionable value, then alternate means of waste disposal must be considered.

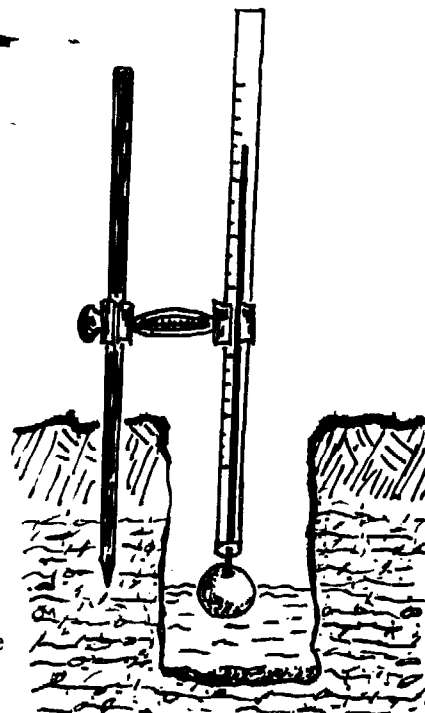

A smooth metal rod,  $\frac{1}{2}$ " in diameter, and about 18" long, has a sharpened end which is driven into the ground beside the percolation test hole. With experience, one can position the rod to best advantage.

The graduated, transparent plastic tub is about  $\frac{1}{2}$ " in diameter and 14" long. Graduations are provided by a plastic tape, printed in inches, graduated in tenths (SCALAFIX is one brand sold through chemical supply houses.)

A solid plastic rod about  $\frac{1}{8}$ " in diameter slides into the graduated tube and the bottom end is glued into a spherical plastic float, about 2" in diameter. The length of the rod is about 18", but should be adjusted so that enough is inside of the graduated tube to hold the rod as rigidly in place as practical. The gauge is left in place during the course of the test; the graduated tube should not be moved. The graduations permit interpolation to within about 0.02". This accuracy is more than adequate for the test.

A universal clamp fits onto the rod. This clamp, available from chemical supply houses, twists conveniently in different directions. It has two thumb screws at each end; it can clamp onto the rod and at the same time hold a graduated plastic tube vertically over the test hole.

From: Current and Recommended Practices for Subsurface Waste Water Disposal Systems in Arizona by John Timothy Winneberger, Ph.D. and John W. Klock, Ph.D.

## COLLAPSEABLE SOILS

If soils tend to collapse, place a perforated pipe vertically in the hole and carefully pack gravel or some supporting material between the pipe and the hole wall. Perform the test within the vertical pipe and adjust calculations to account for the displacement of water by the gravel or whatever is used to support the sides of the hole.

**NOTE:** Without taking into account the gravel in the hole, you will get a faster rate of drop than actual water absorption. Out of 1" drop, only 60% was actually water. 40% was gravel space. For example, a 2" drop in water level, is really only a 1.6" drop. Remember to adjust each 1" drop by accounting for gravel.

## IV. CALCULATING THE DRAINFIELD AREA

### Step 1: Total Water Use

If you have no luxury appliances and take care not to waste water, you should estimate 55 gallons per person per day for your household. If you have luxury appliances (dishwasher, clotheswasher, garbage grinder), then estimate 75 to 100 gallons per person per day. If you have lots of forgetful people in your house with extravagant water habits they just can't change, then estimate 150 gallons per person per day. If you think you need more than that, you are greedy.

### Step 2: How Much Will Go Into the Septic Tank

Not all the wastewater must go into the septic tank. The grey water can be separated from the black water. The grey water (or part of it) could go directly into a seepage pit or sub-irrigation system. For instance, if a family wastes 200 gallons a day but only the toilet goes into the septic tank, then only 100 gallons a day actually enters the septic tank each day.

### Step 3: Loading Rate

The Loading Rate is the amount of wastewater one square foot of your drainfield soils can infiltrate each day. The Loading Rate can be determined from the Percolation Test and/or the Soil Texture Test. It can be modified by neighbors, contractors, local sanitarians, and the Conservation Service reports and comments. The Charts on page 48 are useful in translating the Perc test and Soil Texture test into Loading Rates.

**Example:** If 200 gal/day goes into the septic tank and your clayey soils require 4 square feet of sidewall for each gallon of wastewater, the amount of sidewall required is:  $200 \times 4 = 800$  Sq. Ft. of sidewall.

### Step 4: The Amount of Sidewall

To determine the amount of sidewall needed, you simply multiply the Water-to-Septic-Tank x the Loading Rate.

**WARNING:** Do NOT use the "number of bedrooms" or "number of persons" to determine sidewall area as prescribed in many Codes. Only use actual estimates of water use and the perc test and/or soil texture test.

**WARNING:** Never use the bottom area in calculating the amount of infiltrative surface. USE SIDEWALLS ONLY.

#### TWO DIFFERENT SOIL LAYERS

If there are two different soil layers, then you will want to use the most permeable. With two different soil layers, the amount of sidewall calculating the amount of sidewall is more complicated.

- a. Estimate the proportion of each soil layer to be used for infiltration. Example: The sandy layer may be 1/3 of the total infiltration surface and the clay layer 2/3 of the total infiltration sidewall.
- b. Determine separately the amount of sidewall area to be used for each layer. Multiply the fraction x the loading rate x Waste-to-Septic-Tank. Example: 4 sq. ft. (clay layer loading rate) x 2/3 (Proportion to soil infiltration surface) x water.
- c. Add up all the sidewall areas for all the layers utilized. Go to STEP 5.

#### THE CONSERVATIVE APPROACH

If your neighbor says that his/her drainfield works all right and you don't want to pay for perc tests, you can be very conservative. This conservative approach says that if water percs at all, then use 1/4 gallon per sq. ft. (1 gallon for each four sq. ft.) of sidewall. This is equivalent to saying all your soils are clayey.

You must still look at geologic limitations to see how deep the trench or pit must go. But, you can avoid certain County Codes requiring very expensive perc tests. This conservative approach results in more sidewall, a bigger drainfield and higher costs. You must decide.



**Step 5: Translate Sidewall Area into the Amount of Trench or Seepage Pit by Considering Climate and Local Geology**

Using all the geology, soils and climate information available, you must now translate the amount of sidewall needed into the trench, pit or seepage bed.

**A. Trench**

The trench depth is considered from the top of the pipe down. For instance, if the top of the pipe is one foot below the level of the soil and the trench is five feet deep, the *effective trench* is only four feet.

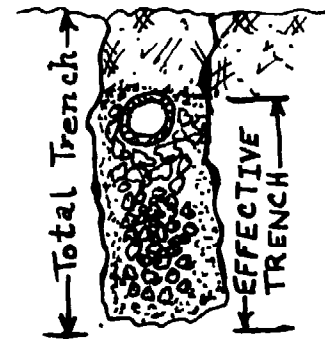

The number of running feet of trench needed

$$= \frac{\text{the total sidewall required}}{2 \times \text{the depth of effective trench}}$$

Example: If 1,600 sq. ft. of sidewall area are needed and the effective trench depth is four feet, then  $1,600/2 \times 4 = 200$  linear feet of five foot trench. (The "2" on the bottom of the formula is because each foot of linear trench has two sides. Both infiltrate effluent.)

**B. Seepage Pits**

The effective depth of a seepage pit also starts from the top of the pipe down.

Seepage pits are commonly 3 to 8 feet in diameter and 7 to 16 feet deep. Some are much deeper. They are a definite safety hazard and it may be impossible to perform perc tests. To calculate the number of seepage pits you need, *first* determine the diameter and depth of the hole you can excavate. *Second*, determine the amount of effective sidewall area in this pit (see example). *Third*, divide the effective sidewall area of your pit into the total sidewall needed. This will give you the number of seepage pits required.

EXAMPLE: You decide you can dig seepage pits with a 4 foot diameter and an effective depth of 14 feet. (The depth from the ground surface is 15 feet.) The surface area is:  $\pi \times \text{Diameter} \times \text{Height} = 22/7 \times 4 \times 14 = 176 \text{ sq. ft.}$  If you need a total of 1,600 sq. ft. of sidewall, then you will need 9 seepage pits of this size.

**C. Seepage Beds**

Seepage Beds are usually no more than 18" deep. They use both infiltration and evapo-transpiration to recycle wastewater into the soil and atmosphere. Bernhart has developed an empirical charge based on soil texture and assuming 0.12 gal/sq. ft. of seepage bed will be evaporated each day. This evapo-transpiration data is for southern Ontario and will increase as you go south into the U.S.A. It assumes 200 gal/day from the household. No more. It also assumes the seepage bed is well ventilated, well planted and well crowned to remove most rain.

Some seepage beds are lined with plastic so that effluent will not escape. Bernhart estimates that 1700 sq. ft. of evapobed will just about work anywhere in the USA. This is a 40 x 45 piece of land set aside only for *permanent* greenery and *aerobic* seepage bed construction. Details change as you move south or to areas of high rainfall. We refer you to his book.

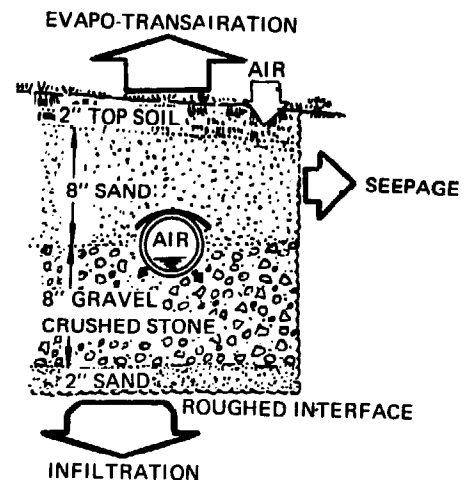

## V. MAKING THE EXACT MAP TO BE USED FOR CONSTRUCTION

Now, we must re-do the sketch with "hard" numbers. Starting from the property line is usually easiest. First, draw in all the setbacks either required by the County or needed for well protection, etc. Next, draw the outlines of the drainfield, dual-drainfield, grey water drainfield and/or replacement areas. Always draw within the setback borders. Follow these guidelines:

- a. Serial distribution within the drainfield is definitely preferred. On slopes, it is a must. Special designs are needed in difficult ecologies (pg. 42).
- b. Where linear trenches are used, each trench can be as long as possible but should be separated from the next trench by a non-perforated overflow pipe in *undisturbed* earth. (If sloping, go to Chapter 8.)
- c. The drainfield trenches or seepage pits should be spaced apart. Measure from the outer wall of one drainfield unit to the outer wall of the next nearest. This space should be  $1\frac{1}{2}$  times the effective depth (depth below the pipe).
- d. If you are using a curtain drain around the drainfield (Chapter 8), make sure you have allowed room for it. Care must be taken when installing curtain drains to avoid contamination from the drainfield. Digging the drain about 10 feet away from the nearest trench or pit is usually more than adequate.

**Example:** A trench with a four foot effective depth would have the nearest outer-wall of the next nearest trench about 6 feet away:  $3/2 \times 4 = 6$ .

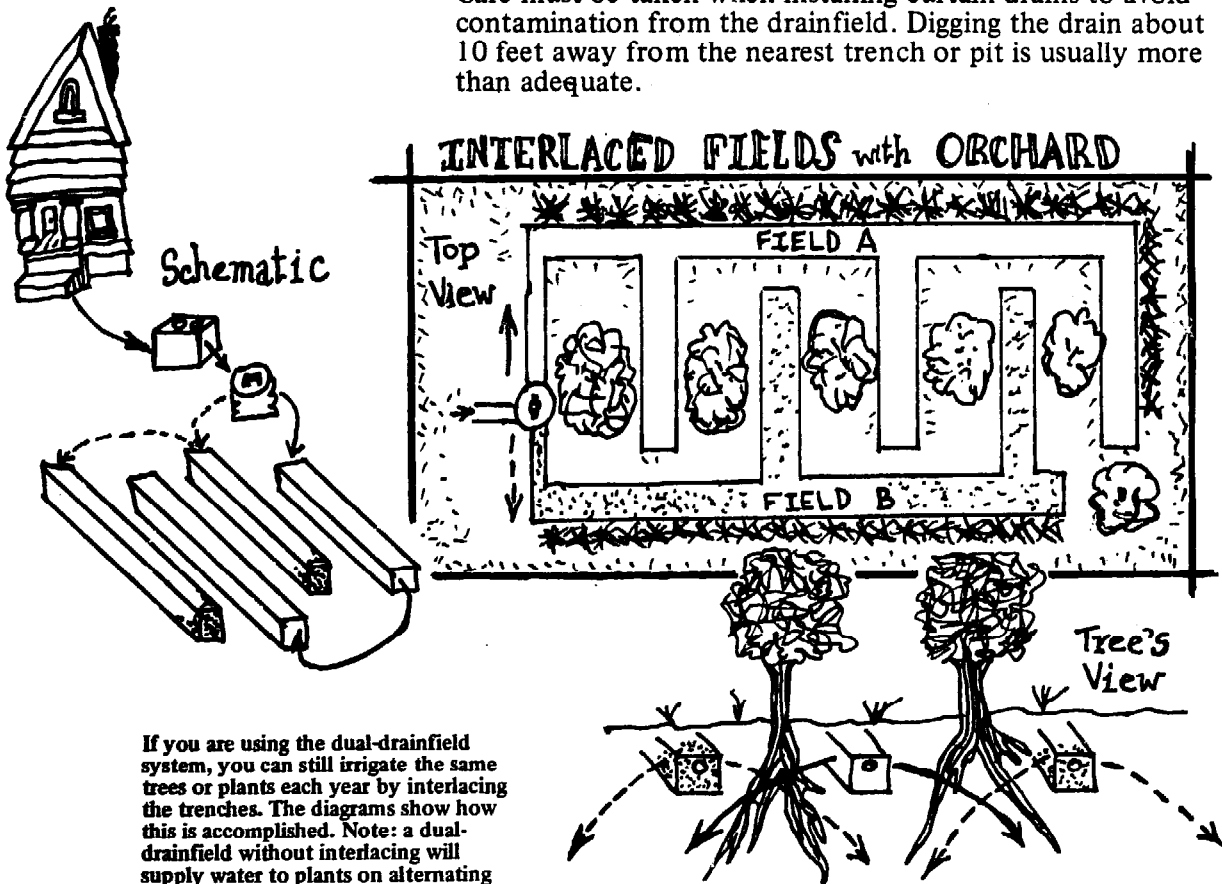

If you are using the dual-drainfield system, you can still irrigate the same trees or plants each year by interlacing the trenches. The diagrams show how this is accomplished. Note: a dual-drainfield without interlacing will supply water to plants on alternating years. This may kill plants.

### Conservative Setback Requirements

Site Features	Setback to Septic Tank	Setback to Drainfield
Buildings	5 feet	5-10 feet
Adjoining property lines	5 feet	5 feet
Wells (on site or neighboring)	50-200 feet	50-200 feet
Natural watercourses	25 feet	50-100 feet
Cuts or embankments	25 feet	50-75 feet
Swimming pools	10 feet	25 feet
Water lines	10 feet	10 feet
Walks and drives	5 feet	5 feet

All these requirements are very conservative for clayey soils but could be lenient for shallow wells in medium to coarse sand.

Well siting depends on the depth of the well as well as soils. Bernhart is a useful reference. For example, he states that a 90 ft. horizontal distance from well to drainfield is enough when the well is:

140 ft. deep and the soils are medium sand	80 ft. deep and the soils are loam and silt
120 ft. deep and the soils are fine sand and silt	60 ft. deep and the soils are loam, clay and silt
100 ft. deep and the soils are silt, loam and sand	40 ft. deep and the soils are clay and silt.

### A DUAL DRAINFIELD USING TRENCHES

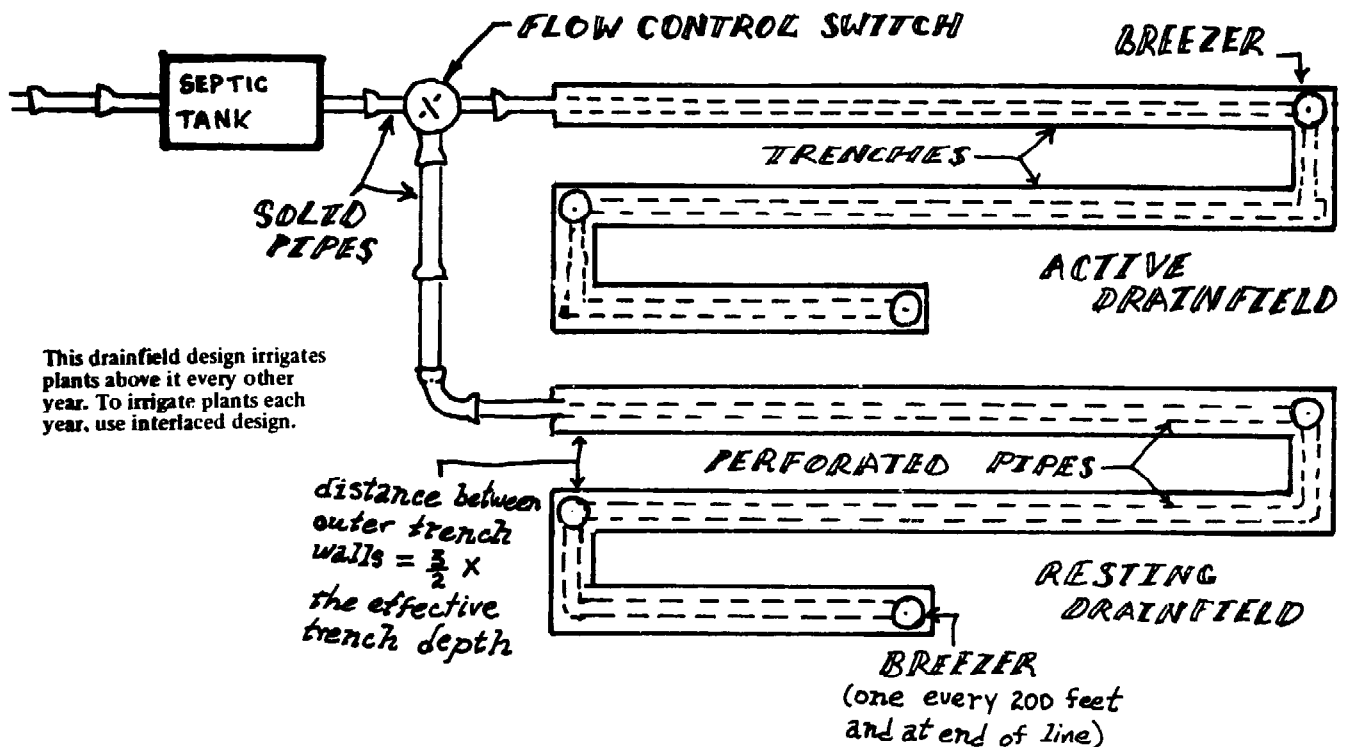

## VI. PURCHASING AND REPLACING MATERIALS

### DIVERSION VALVES

These flow switches should be durable, acid-resistant materials. You can make your own.

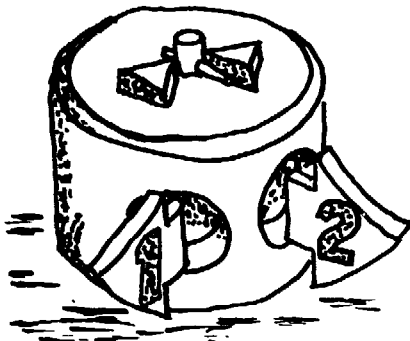

Hancor, Inc. (Findlay, Ohio 45840). Makes a Flow Control Switch and drainfield pipes in plastic. Franklin Research (4009 Linden St., Oakland, CA 94608) also makes a Flow Control Switch (above) plus many other septic tank/drainfield control devices like level-sensors, effluent pumps, etc.

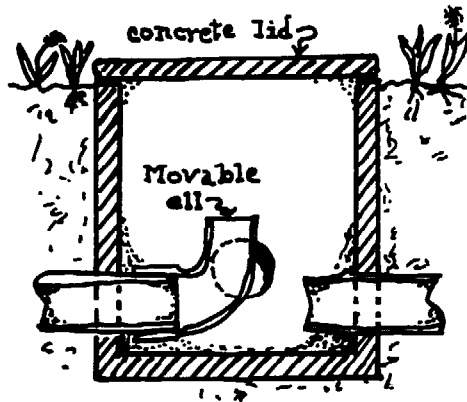

Homemade Flow Control Switch using a concrete box and plastic ell. The turned-up ell stops effluent from going into drainfield on left. Next year, the ell will be inserted on the right. Pipes and ell are all the same diameter (usually 4"). A rubber ball can be inserted in the pipe instead of the ell. Concrete box should be made of Portland Cement (see Appendix).

### SEPTIC TANK MATERIALS, SIZE, AND DESIGN

1. The tank itself should be water-tight. Durable, non-corrodable materials should be used like re-inforced and pre-cast concrete or fiber-glass. **DON'T USE METAL.**
2. The tanks should be coated with bitumastic tar. This will retard corrosion.
3. Minimum tank size should be about 800 gallons for a single-family dwelling. Remember, the bigger the better – if the cost increase is not prohibitive. For two or three family dwellings, the Public Health Service *Manual* is useful. A 1,200 gallon tank is the biggest you'll need for a single family.

### SEPTIC TANK MATERIALS

#### REDWOOD

Lifespan: 30 years. Rots more quickly at waterline or from outside in. Should be tarred on inside. Costs vary.

#### FIBERGLASS

Lifespan: 30 years (?). Most fiberglass tanks are too thin. Water in surrounding soils causes buckling. Some float. Buy or use fiberglass standards in the Uniform Building Codes. Make sure you can add compartments. Expensive.

#### PLASTIC

Lifespan: 30 years (?). Not yet manufactured. Believed to be a good re-use of non-biodegradable plastics.

#### CONCRETE BLOCK

Lifespan: 20 years. Use heavy-weight blocks to prevent collapsing. Hard-burned brick is a good material. Bitumastic tar inside.

#### PREFORMED CONCRETE

Lifespan: 20 years. Should be properly cured. Walls should be re-inforced. Portland cement useful on inside (2 1/4"). Bitumastic tar inside.

#### TILE CYLINDERS

Lifespan: 20 years (?). Usually terra-cotta. Used in a series.

#### METAL

Lifespan: 7 years. Corodes easily. Coated metal only - if you must.

Instructions for Preparation of Water-tight Cement Given in Appendix.

4. Tanks with compartments are much better than a plain box. The dividers can be redwood, treated plywood, properly prepared and treated concrete or concrete block. The best design has the three-compartment meander design. Next best is the three-compartment flow-through design. Next, the two-compartment flow-through.

5. Rectangular tanks should be, at least, four feet deep below the waterline. A series of connected cylinders (page 29) will serve just as well.

6. Inlet and outlet tees (or vented ells) should be used. If plastic "tees" and "ells" are cheap and available they function well. Concrete designs are also fine. These tees and ells prevent solids from backing up.

7. The tank should be easily accessible to permit maintenance. The tank should have two man-hole covers each allowing entrance to the different compartments and easy cleaning of the baffles. They should be water-tight and, if you want added ease of access, risers as shown in the diagram.

8. Inlet pipe from the house should be, at least, 4" in diameter. Outlet pipe should be the same diameter as the drainfield pipe.

Tees: Can be made of cast iron, vitrified clay or concrete or plastic. They should be chosen to, at least, match the life span of the septic tank materials. Between compartments, two tees can be attached to form an "H." This is the most effective baffle to prevent suspended solids or grease from flowing from one compartment to the next.

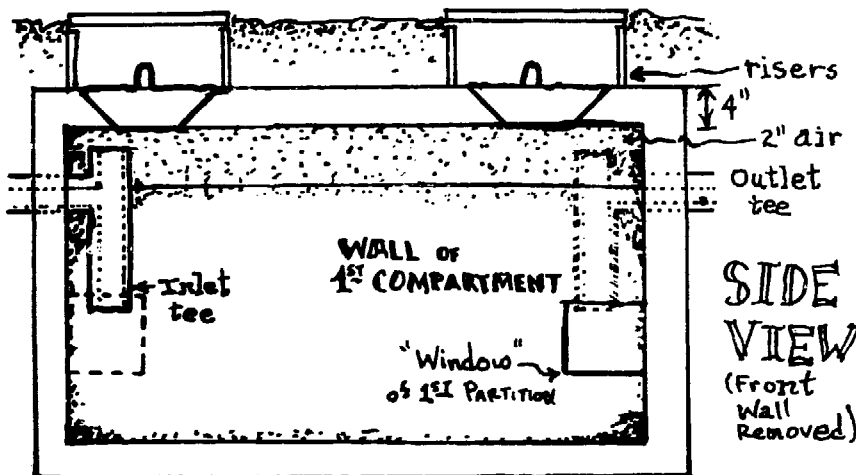
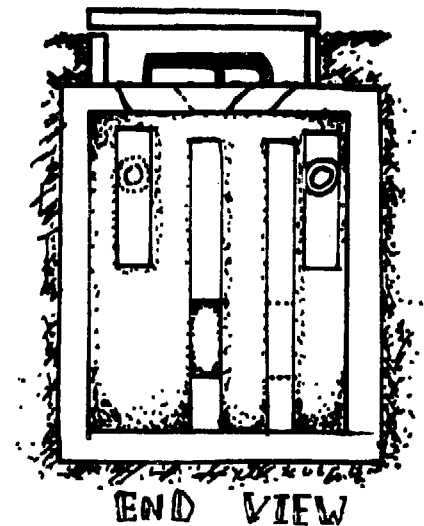
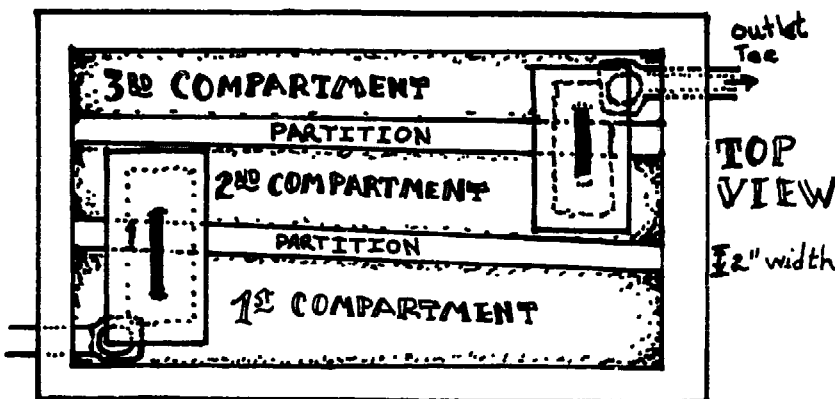
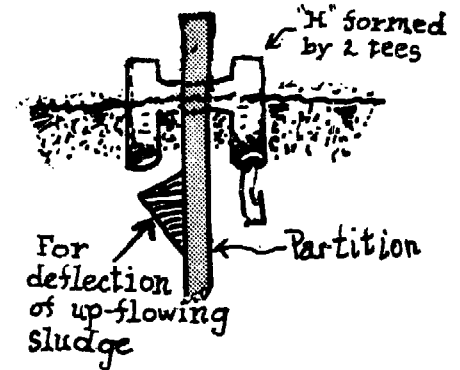

A 1,200 gallon tank might be 4 feet wide, 4½ feet deep and 10 feet long.

- Baffles or tee to reach 18" below water level.
- partitions do not have to be watertight.
- wastewater depth, at least, 4 feet.
- width, at least, 4 feet, in rectangular tanks.
- tank top not more (probably less) than 2 feet below ground.
- If tee is used for inlet and outlet, then it should reach 18" below wastewater and as high as practical (6" is plenty) above waterline. Top of tee should be no closer than 2" to tank top.
- first compartment should have the largest volume (40 to 50%). Second compartment should be larger than third (30 to 40%) - in meander design.
- windows can be replaced by double tees.
- outlet tee must be 1" to 3" below inlet.

## DRAINFIELD MATERIALS

1. *Gravity flow pipes* should have a minimum diameter of three inches. Greater diameter is OK as long as they are not fragile or a safety hazard. Pressure pipes (pumped effluent from dosing tanks or pumps) need only be as big as the outlet pipe from the pump. (Holes in pressure pipes can be hand-drilled). All the pipes should be of strong and durable material like vitrified clay and certain plastics.

**WARNING:** Bituminous paper pipes (like those produced by Orangeburg) will uncoil and rot real fast. Don't use.

2. The ideal *trench fill* grades evenly from large stones near the drainfield pipe to sand (near the sidewall). Large stones lying next to the infiltrative surface can stop infiltration at the point of contact. To minimize soil texture differences between fill and natural soil, use a column of pea gravel in the center of the excavation, flanked by two columns of sand. This is time-consuming and more expensive fill but also better for infiltration. Diagram on opposite page.
3. For a good standard trench (no sand or pea gravel and no layering), use smallest gravel available. The best is  $\frac{1}{2}$ " to  $\frac{3}{4}$ ". Larger than  $\frac{3}{4}$ " will significantly reduce infiltration.

Drawing on left showing how infiltration is reduced when large stones are placed next to soil. Drawing on right shows how a gradual change from gravel to sand to soil makes for ideal infiltration.

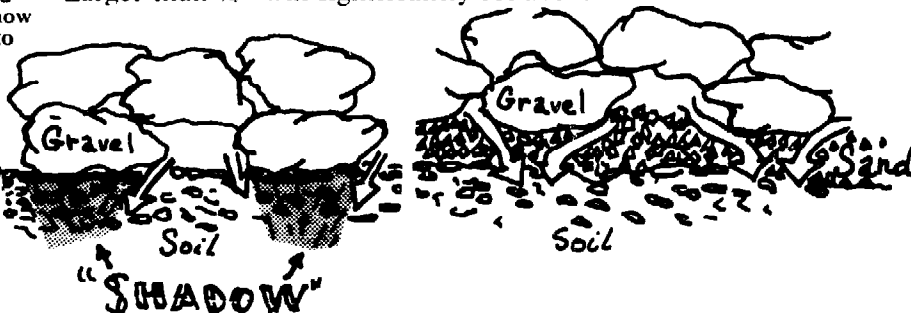

4. Materials for barrier between trench fill and backfill on the next page.

## VII. CONSTRUCTION PRACTICES

**WARNING:** If construction is on slope, see Chapter 8.

### SEPTIC TANK

1. The septic tank should be located so that it easily drains the household plumbing by a gravity flow. No sink, bath or toilet should be lower than the septic tank.
2. Because of the possibility of leakage, the septic tank should be set back from the building foundations (5 feet is plenty).

**WARNING:** A septic tank may sink and bend or break its pipe connections. Be sure the septic tank rests on solid ground. Allow time for it to settle before connecting pipes. Water the hole to help compaction.



**WARNING:** If pre-fab and installed by contractor, make sure its not put in backwards.

3. The top of the septic tank should not be over-loaded with back-fill. One foot of earth on top is plenty. Don't dig the hole deeper than necessary.
4. Risers make access to pipe real easy. Install if possible (see diagram page 55).
5. Remember to vent pipe(s) from house.

#### **DRAINFIELD CONSTRUCTION**

**WARNING:** Trenches should be dug with a back-hoe or by hand tools. Seepage pits can be dug with a back-hoe, bucket auger or hand tools. Do not use spiral augers or trenchers. This equipment will compact the sidewalls and smear the infiltration surface - totally ruining permeability.

**WARNING:** Do all drainfield digging in dry season and/or cover trenches if there is no dry season. Wetting the exposed infiltration surface may clog soils before they are even used.

**REMINDER:** Serial distribution is always preferred. Flat-el ground distribution is ok on flat ground. Never use flat-ground distributions on slopes.

1. The minimum linear trench width should not be less than one foot.
2. The ideal *trench fill* can be installed by the use of removable plywood sheets as shown.
3. The tops of the drainfield pipes must be lower than the tops of the septic tank pipes.

**WARNING:** Water in the drainfield can back up into tank. Drainfields that are higher than septic tanks cause many problem systems.

4. Gravel fill must be covered with a solid, but permeable barrier to allow evapotranspiration. Ideal barrier is a thin layer of roofing gravel, then a thin layer of coarse sand, and finally a thin layer of fine sand. But, any layering of permeable materials (such as straw) that forms a solid barrier between the trench and soil cover is acceptable.

**WARNING:** Trench covering of tar paper, plastic sheets, or other impermeable materials will prevent upward movement of water to plants and soil surface.

5. Drainfield pipe should be laid just about level. Little variations (1 to 2%) don't matter. If you can eye it, that's fine. A casual use of the level helps, too.

**SEEPAGE PIT WARNING:** If pit is over ten feet deep, it should be filled with stones for safety's sake. It's real hard to climb out of a thirty foot seepage pit.



IDEAL TRENCH FILL  
(Expensive and more difficult)

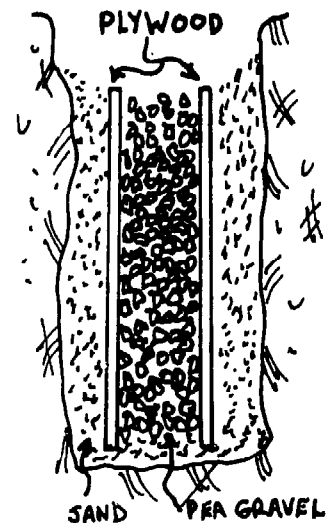

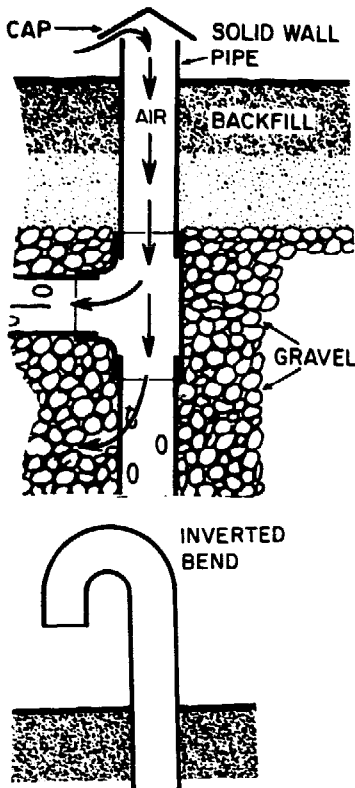

**BREEZERS**

A minimum of one breezer for every 200 lineal feet of distribution pipe *and* one breezer at the end of the distribution pipe are adequate. Seepage pits should have one breezer for each pit. If wide, two are good.

**CURTAIN DRAINS**

They should be the same material and diameter as the drainfield pipe.

The curtain drain should be as narrow as feasible. Wider saves little.

If the curtain drain is to remove perched groundwater, then the pipes of the curtain drain should be laid into the top few inches of the hardpan. The perched water, sitting on the impermeable layer will be drained away faster.

Curtain drains should be about 10 feet from the nearest drainfield trench. When pipe is used, the curtain drain trench must be as deep as the drainfield trench. If no pipes are used (the trench is filled with sand), then the curtain drain should be about 2 feet deeper than the drainfield trench. Curtain drains move water by gravity away from the trenches. Grade should be 5%. (See page 41.)

Outlet is usually a stream or a street drain. Make sure you have an outlet that can take added water.

**WARNING:** A common mistake of contractors is connecting drainfield pipe to the curtain drain pipes. Be careful.

Location of breezers can be found on page 51. Breezers are either inverted bend pipes or stove pipes connected by a tee to drainfield pipe.

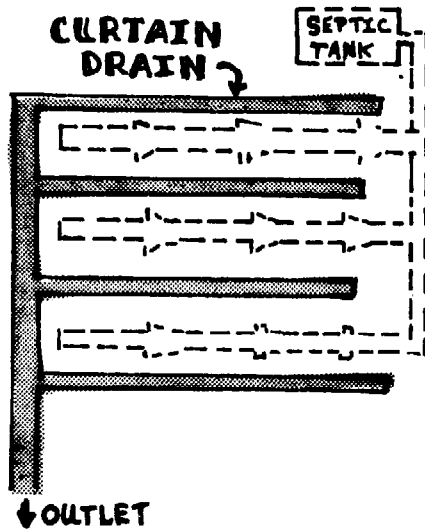

The holes are up to keep soil out of pipe. If you put gravel under curtain drain pipe then the direction of the holes doesn't matter.



# MAINTENANCE

## 10. HOME CARE

Most readers will not have the luxury of installing and guiding the construction of their own septic tank system. Instead, they are saddled with a former contractor's work, details of which may be unknown and long forgotten. They also do not know what the habits and water use of the previous home owners were. Was the septic tank system used all the time? Maintained? Abused? Neglected?

### KNOW YOUR SYSTEM

Many home owners may not even know they have a septic tank system, especially when they move from the city or just have a weekend home. The toilet flushes and that's all they care about. This ignorance is bound to backfire and be costly. The first act after reading this booklet should be to make a map of your septic tank system. This map should always be available. For instance, you pay the man who pumps your tank by the hour. It can take two to three hours just to find some septic tanks because the resident doesn't have the slightest idea where to look. Many new home owners cement a driveway or patio right over the drainfield -- totally eliminating aeration and plant life. Knowing the history and location of your septic tank system will enable you to predict when the tank needs pumping, what the cause of any problems could be, how to plant your garden, and landscape.

### WATER CONSERVATION

We have stated again and again that the less water used, the longer the lifespan of the drainfield and the better the septic tank system will work. Chapter 4 lists all the do's and don'ts.

### CHEMICALS AND MICROBES

In Chapter 6 we emphasized that you must treat microbes well, if you want them to digest sewage thoroughly. Small amounts of soaps, detergents, bleaches, drain cleaners or lye will not harm large septic tanks. But, an overdose can be fatal to your bacteria.

Waste brines from household water softeners will change the clays in your drainfield. Never use (or have a special drain) as they result in soil clogging.

For other Do's and Don'ts, see Chapter 6.



**WILL CUT THROUGH**

**ROOTS RAGS  
GREASE**

**OR ANY TOUGH  
HARDENED  
ACCUMULATED  
OBSTRUCTION**

## RUNOFF

A common mistake in home maintenance is letting water run onto the drainfield or even asphaltting or cementing atop the drainfield. All gutters should direct water away from the drainfield. All rooves shedding rain toward the drainfield should have gutters to prevent this. Patios and driveways should be located far from the drainfield or be ditched so water from their surface will flow in another direction.

## PUMPING AND THE SLUDGE

The septic tank can only store so much sludge and scum. After that, the sludge and scum begin to flow into the drainfield clogging the soils. If this condition is allowed to persist, the toilet won't flush and the sinks won't drain. This is too long... much damage to the soils will have occurred. *Every year or two the septic tank should be opened and the sludge and scum level checked and removed if need indicates.*

If the septic tank permits easy access, the whole process takes half an hour. To measure sludge depths, take an old whitish rag and twist it around one end of a broomstick. Lower that end slowly into the tank. Sometimes you can feel the dense sludge. Estimate how deep it is by the push after you feel the dense accumulation. Remove the stick slowly and many times you can see the line between the clearer liquid and the black sludge. If there is sludge in the *last* chamber, pretty near the outlet, then you should pump the tank.

A tank should be pumped when the total depth of sludge and scum is about one-third of the total tank space. But, this is just a guess. If sludge or scum are approaching or entering the outlet or inlet, then pump.

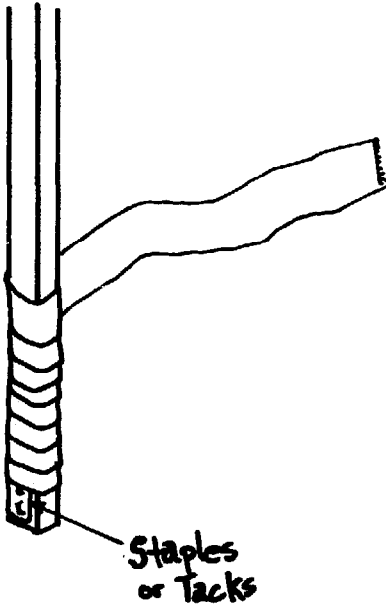

To determine the *scum* level, gently break the scum till a clear space can be seen. This should reveal how deep the scum is. If there's lots of scum in the first chamber but none in the last chamber, then scum is not the problem. If the scum in the last chamber looks like it's about to go into the outlet pipe (within 3"), then it is best to pump.

In most communities, there is a nearby septic tank pumper. You call the truck and it arrives and sucks all the sludge, scum and clarified liquid into a tank. *Don't ever wash your tank.* The remaining liquid contains enough bacteria to start a new colony of digesters.

If no truck service is available or you can't afford it, then you must pump the tank out yourself. This is illegal in some places because of the health risks. As said earlier, if no person with a water-borne disease has recently used the toilet, then it is impossible to have the disease living in your tank. Anyway, take precautions like wearing gloves and keeping children away. Dig a pit (two feet deep abouts) away from the house and daily traffic and buy a bale of straw or get your own leaves or some other mulch. Using buckets, transfer the liquid and the scum from the tank to the pit. Compost the sludge (layer of sludge, layer of straw). Cover with about a foot of dirt and, if children are around, a plastic tarp. Leave until composted thoroughly (six months to a year).

If your tank is commercially pumped, make sure the pumper is not emptying your sludge into a river or a storm sewer. *That's gross pollution.* The pumper should either take the sludge to a sewage plant (and hope it doesn't pollute too badly) or have a pit similar to the pit you would dig at home.

The price of pumping has sky-rocketed in many parts of the U.S.A. In parts of California, a single pumping may cost 80 to 90 dollars. Don't pump unless you need to. The Public Health Service has studied scum and sludge accumulation. For a family of four, a tank

accumulates 98 gallons of scum and sludge by the end of the first year; 188 gallons by the end of four years. For an 800 gallon tank, this means that less than one quarter of the tank is being used for solids storage (22.5%) after four years of service. Even after eight years, 60% of the tank space will be free for the wastewater to pass through. Larger tanks store even more. In short, if you are not overloading, tanks need to be inspected less than once every two years. Some tanks go for twenty years without needing pumping. But, until you know your tank (and its bacterial abilities) check it every year or two.

## SEPTIC TANK PROBLEMS AND CURES

The symptoms of septic tank problems are very few: foul odors, poor flushing or draining of sinks, and evidence of erosion near-by. But, these few symptoms may have innumerable causes. Good persistent detective work is needed to trace the symptom to the cause. The "Detective Chart" gives a pretty complete series of steps to determine the cause of any septic tank problem.

Detective Chart  
on next page.

If you did not install the septic tank system yourself, remember:

- faulty installation is a strong possibility. Check design. Is the septic tank in backwards? Are all the pipes connected? Are they collapsed? Is the septic tank or drainfield too high above the house, sewer or each other? Are all the necessary pipes perforated?
- The septic tank system may have been designed for a smaller family or weekend use. The size may be inadequate. Is this a cess-pool (Chapter 3) or truly a septic tank system?
- the septic tank system may have been constructed in a terrible location. Are you in a creek flood-plain or a drainage swale? Are the soils any good?

Most problems are caused by a combination of conditions. In one town, a neighbor drove over the pipe between the house and septic tank. The bent pipe worked fine, until his son flushed his toothbrush down the drain. It caught in the bend. Another neighbor paved a patio over his drainfield. It worked fine all summer but when the fall rains started, the drains didn't drain nor the toilets flush. Many times watertable problems worsen minor mechanical failures.

When the pipe between the house and the septic tank is long or curved, grease accumulates at the turn. The grease gets hard and can cause a back-up in all the household utilities. DrainO and Liquid Plumber sometimes do not work. Even a plumber's snake may not work. A pressure nozzle or a hose (see next page) or the hard-to-find Drain King (made by Scoville) is most effective.

Whenever the problem appears to be a "major drainfield problem", read the Chapters 7, 8 and 9 on drainfields and ecological problems. You can always *improve* aeration.

Many times, an extra trench or seepage pit or a dry well for the grey water will allow your system to repair itself. The common source of septic tank problems is overloading. Try water saving devices!

**SYMPTOMS**

**DIAGNOSIS OF SEPTIC TANK/DRAINFIELD**

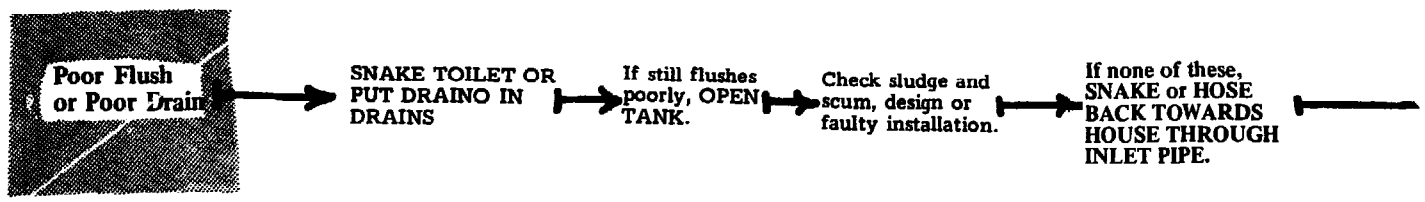
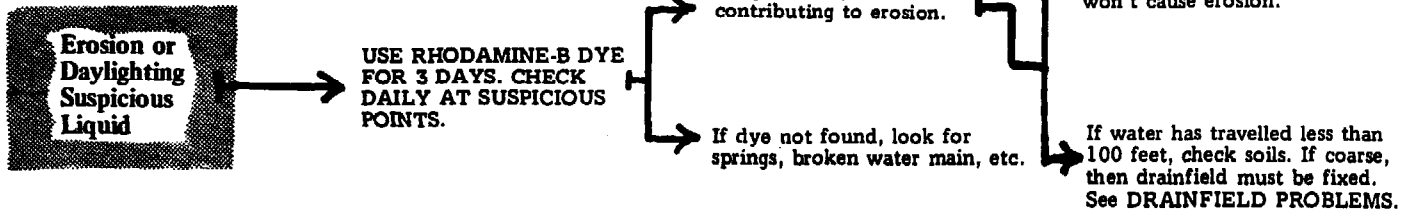
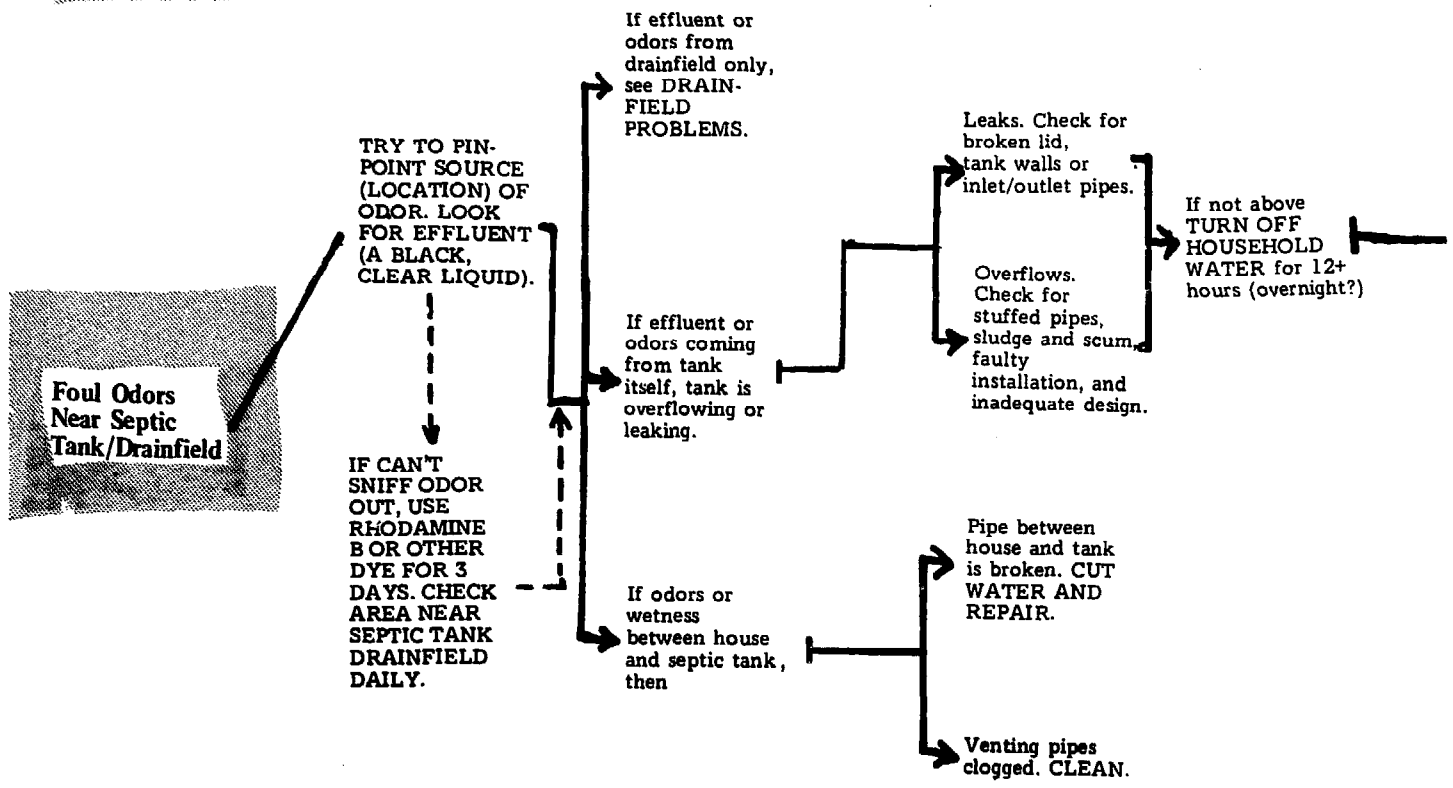

## PROBLEMS

Check clogged outlet again if water remains above outlet pipe, see **DRAINFIELD PROBLEMS**.

If tank continues to fill, then water system leaks.

**TO DE-CLOG PIPES** use a plumber's snake or a garden hose with the nozzle turned to the most forceful jet. The hose or snake can be twisted back toward house from inside the septic tank.

Rhodamine B is a dye that can tell you if the liquid in the back yard comes from the septic tank/drainfield. Most sanitarians will tell you where it can be purchased. It also has the special property of glowing under black light. Even in very small amounts. Other dyes are also available.

## MAJOR DRAINFIELD PROBLEMS

Symptoms	Likely Causes	Solutions
Lush growth. Wet spots. Black liquid on surface.	Overloading (too many people, too small a system).	-Water Conservation -Additional Drainfield -If black mat is present, new drainfield required. (Dig up drainfield area to 2' to 3' in a few spots. Look for black mat that stinks).
Above plus steep slopes, clay soils, bedrock, etc.	Bad location and/or bad soils.	Alternatives to drainfield (Chapters 3 and 8).
Works in dry season only.	High water table.	-Remove all runoff from rooves -Conserve water -Dig curtain drain and drainage ditches -Consider waterless toilets and grey water systems.
Near-by trees (and slow flush).	Clogging of drainfield pipes by roots.	Roto-rooter pipes from septic tank.
Impermeable surfaces.	-Drainfield covered by patio or driveway. -Water from surfaces flooding drainfield.	Remove.  Dig curtain or peripheral drainage ditches.

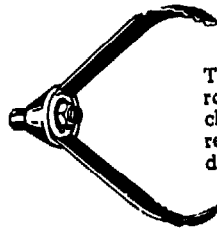

The Roto-rooter has blades which cut roots or churns out soil that may be clogging your drainfield. They can be rented or you can hire someone to do it.



If still poor flush, **DON'T USE ANY WATER FOR 12 HOURS (OVER-NIGHT)**.

If tank empties slowly to below outlet, **SNAKE OUTLET TOWARD DRAINFIELD**.

If still bad flush, see **DRAINFIELD PROBLEM**.

County and State Codes are more than mere minimum design standards. Their original purpose was to prevent septic tank systems from becoming a health hazard, to protect the consumer from contractors that might install badly designed and ultra-chincey systems, and to reduce Health Department workloads.

But, the Codes original purposes have backfired. They have not been updated and lack new understandings of home-site sewage treatment. State and County codes blandly copied Federal guidelines which had mistakes. Many times, Federal guidelines were misinterpreted -- further codifying nonsense. And worst of all, health officers and sanitarians never had time to go back to school and receive further education about the new techniques and design features that could be used to improve home-site sewage treatment. Instead, the under-educated sanitarian had to rigidly interpret the Codes rather than interpret them with an understanding for special ecological conditions. The result is that *the codes themselves caused, in part, the failing septic tank systems and the bad reputation of home-site sewerage.*

The Codes obviously need change. They need to address themselves to *permanent* home-site sewage treatment and to all kinds of home-site sewage systems. They need to be rewritten with in-built flexibility so that, for instance, water conservation minded homes could use compost privies. (At the moment, they are accepted only in Maine.) Health Departments assume a home cannot learn to compost.

Most of all, like this booklet, County Codes should have a built-in self-destruct button so codes won't stay on the books way after they have served their usefulness.

Since the Codes lost touch with ecological reality, they compensated by making design standards super fail-safe. This purposeful over-design makes for expensive septic tank systems -- so expensive that costs appear just slightly less than the Big Sewer.

With government grants for centralized sewers, home-site systems soon disappear. Note that government grants will *not* pay to improve home-site systems although this is just as important to clean water as centralized sewers.

A new alternative is being tried in many states. A local agency (either County or special district) may own or simply regulate the on-site disposal systems of a community. This allows better designs, federal funding to be used to improve the home-site sewage systems, and public maintenance of home-site sewage systems. If public agencies begin to care for home-site systems, the bad reputation that somehow goes along with pit privies and septic tanks could change. Home-site sewage treatment can be a permanent, sanitary and much praised practice. The legal questions about the relative authority of local, County, and State health officials or utility districts or sanitary districts over regulation, control, and ownership of home-site sewerage are currently in flux. The next five years will bring the questions to court. The results will establish the future precedents of home-site vs. centralized sewerage.

---

**Federal grants are good for centralized sewage treatment. Why can't Federal grants be made to public agencies to upgrade, maintain and construct home-site systems?**

# 11. SEWERAGE AND COMMUNITY LIFE

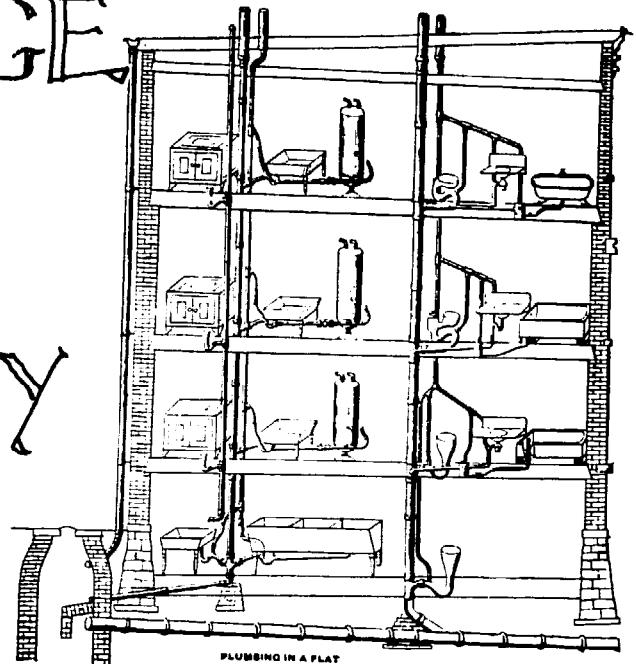

In some towns, especially older towns, there are sometimes more septic tank/drainfield problems than seem tolerable. The local health department does a survey and reports the percentage of failing tanks. Newspapers blare “HEALTH MENACE” or “SURFACING SEWAGE” and an editorial demands that the town sewer up.

*An apartment house in Chicago around 1901. Note how solids are held in tank for removal and somewhat clarified effluent (wastewater) enters sewer. This design still occurs in Japan. Pumped out solids are sold to farmers for fertilizer.*

Most often, it is totally unnecessary for the town to sewer up. Most septic tank surveys confuse “failures” with problems of human neglect (like forgetting to pump). Rather than recommending the much cheaper alternative (repairing the problems), these surveys simply recommend that everybody sewer up. Instead of investigating how many septic tank systems need minor work or even major replacements, these surveys say: “Too many failures. Sewer up.” Finally, the sanitarians who usually make the surveys have been working so hard that they have never read or taken classes in the new septic tank/drainfield designs available or new tricks of the sanitary engineering trade (like evapo-transpiration beds). These under-educated sanitarians can’t even imagine home-site sewage treatment alternatives that would substitute for the Big Sewer.

Meanwhile, everybody gets railroaded by high-profit construction companies and super-tech engineering firms. Their representatives lobby the Health Departments, the Utilities Districts, and the government agencies concerned with water quality. They convince government agencies and townspeople that just another small grant would allow replacement of horrible septic tank systems by a gold-cadillac super-sewer.

Many communities have been thoroughly boon-doggled – especially by the technical lingo of “professional” consultants from the engineering firms, health fears, and the “carrot” of Federal Grants. Phrases like “Mass Failures,” “Inevitable Progress,” “Economically

## CONFLICT OF INTEREST

There is actually a conflict of interest when an Engineering Firm (which makes profits on Big Sewers) is allowed to decide if septic tanks are working well. First, wearing the hat of “consultant,” the Firm says the septic tanks are failing. Then, wearing the hat of “engineer” the same Firm says it will build the Big Sewer to replace the septic tank systems. The consultant can hardly be considered un-prejudiced if a fat contract will only occur when septic tanks fail. Laws should not allow the consultant firm to become the engineering/construction firm for the same project.

## Phoney Failures

### Build-out

A Phrase frequently used by engineers and Health Departments to convince people that a centralized sewer is necessary. They claim that "science" says that "after 25% of all the lots have been built upon then too many failures occur and a sewer is needed." This kind of statement does not take into account the size of lots, their soils or seasons. It is not documented and is scientific nonsense.

### Interaction Failures

The phoney explanation used to explain how 25% build-out causes septic tank problems. Supposedly, there are so many drainfields, so close together, that they are "interacting" or interfering with each other. Supposedly, water cannot be drained away. These interaction failures are a total hipe. Minimally, the drainfields should be next door neighbors so they could interact. These neighbors should all have problems because of the "interacting drainfields." I have never seen one documented case of a community with many next door neighbors with problem drainfields. Somebody created a dragon of fear to try to scare communities into an expensive sewer.

Feasible." or "Ultimate Dilution will Lessen Pollution" warp the straight-shooting, simple talk of early American town meetings. Finally, after the bond issue has passed, it is too late to stop the rapid housing development, tax increase, and, usually, added pollution caused by the Big Sewer. The town turns into suburban sprawl.

This chapter sketches the consequences on community life of the Big Sewer and tries to arm health departments, government agencies, conservationists, and small communities with enough information to fight Big Sewers through the Environmental Impact Report now required for all large-scale sewer projects. It compares, point by point, the centralized sewer with *at-home* sewage treatment.

## HOME-SITE SEWAGE TREATMENT VS. THE BIG SEWER

The Big Sewer can be identified by a "collection system" which collects all the wastewater from many homes and funnels the wastewater into one big pipe ("the public sewer"). The public sewer then, hopefully, empties at a treatment plant where some of the pollution and health hazard is reduced. Finally, the "treated" sewage is dumped out another pipe into a river, lake, or ocean.

Compared to the Big Sewer, home-site systems are very small-scale. This smallness gives home-site systems their incredible superiority to the Big Sewer. Small is beautiful because it means more reliability, less pollution and sanitation hazards, lower costs, and lower exploitation of our energy resources (water and electricity).

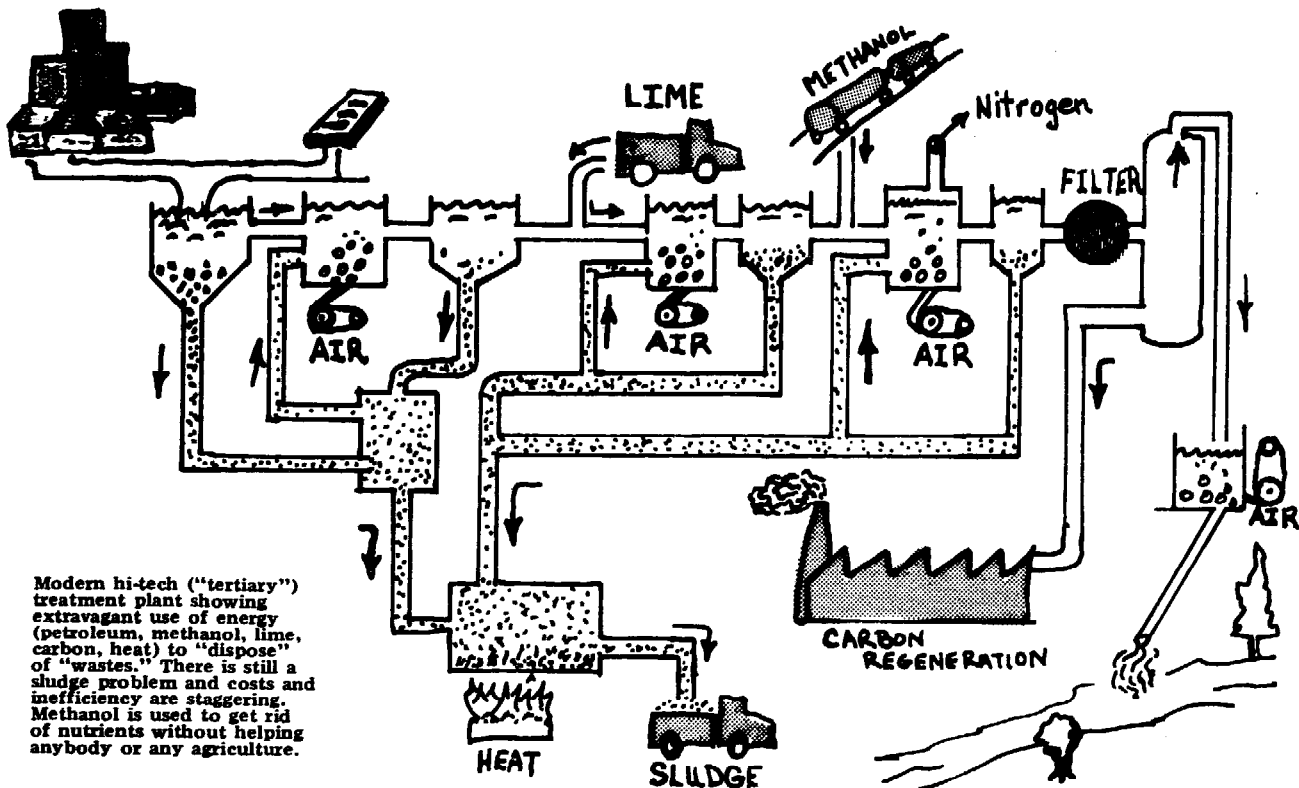

Modern hi-tech ("tertiary") treatment plant showing extravagant use of energy (petroleum, methanol, lime, carbon, heat) to "dispose" of "wastes." There is still a sludge problem and costs and inefficiency are staggering. Methanol is used to get rid of nutrients without helping anybody or any agriculture.



In some towns, especially older towns, there are sometimes more septic tank/drainfield problems than seem tolerable. The local Health Department does a survey and reports the percentage of failing septic tanks. Newspapers blare "HEALTH MENACE" or "SURFACING FECES" and an editorial demands that the town sewer up.

This, by now, classic American tale, has spread the belief that towns with home-site sewage treatment frequently have health disasters and mass failures. The story is rarely true because one word -- "failure" -- has been twisted in a sneaky fashion.

Septic tanks can always be repaired or replaced or improved. A drainfield is really a failure only when it is unrepairable -- when there is absolutely no room for a new or an artificially constructed drainfield. Any *repairable* drainfield is simply neglected and temporarily broken, not a failure. Almost all reported "failures" in Health Department or private surveys are simply a matter of neglect or ignorance. Even though the "failure" is repairable, these surveys call them failures as if the drainfield could never again be made to work.

**So Rule no. 1: Always distinguish between "failures" -- drainfields that cannot be repaired or replaced -- and "a problem" which can be corrected.**

Many bureaucracies, in pursuit of possible health hazards, try to insist that a "failure" means (1) a septic tank system with effluent day-lighting above ground; (2) chronic back-up of the toilet or drains; (3) slumping or seepage that causes erosion; or, less often, (4) records of pumping by septic tank pumpers are considered "failures." But, these "failures" are really *symptoms* of septic tank problems and the need for repair. To jump from symptoms of a problem to abandoning septic tanks or drainfields all together, is like throwing out the baby because it has measles.

So, Rule no. 2: **Beware of being duped by stupid definitions. Symptoms indicate a need for concern but not hopeless abandonment of your septic tank system.**

For instance, a town in California surveyed close to 400 septic tanks. The survey reported 12% of the septic tank systems showed symptoms of possible failure. But, the town did not stop at the problem. It investigated the cause of each malfunction. It discovered that most of the causes were totally unrelated to clogged soils. (Clogged soils might require a new drainfield -- often impossible on small lots.) Instead, the causes of malfunction were minor and easy to repair: broken pipes, neglected pumping, roots in the drainfield pipes, etc. By understanding the causes, two-thirds of the possible "failures" were working fine by the end of the survey. The newspapers didn't even carry the story.

So, Rule no. 3: **Always distinguish the symptoms from the cause. The cause will explain clearly if a septic tank system needs a minor or major repair or is unrepairable.**

In fact, almost all surveys report about 20% problems (read: "failures"). This occurs regardless of soils, water-use, design or build-out. The "20%" simply says that, all over the United States, about 20% of the residents have neglected to care for and maintain their home-site sewage treatment systems.

Finally, there is a world of difference between temporarily broken septic tanks and the ability of soils and drainage to allow septic tank systems to function. There is no way to jump from the number of "failures" or "repairs" discovered by a survey to the ability of soils to adequately provide sewage treatment.

So Rule no. 4: **The ability of septic tank/drainfield systems to work for a long life (50 years) can only be known from an ecological survey of the soils, bedrock, water table and evapo-transpiration rates. A community with many "failures" may only be a community of maximum neglect.**

---

	Mass Failures
More	Used to describe mass neglect. Only if soils are incredibly lousy -- like a subdivision built on a filled-in swamp --
Phoney	might unrepairable mass failures occur. The failures would occur immediately or within two years. They would not be
Failures	staggered -- a few one year, a few the next. Failures are only systems that can't be repaired or replaced.

## Reliability

Maintenance and repair are the bogey-men of the Big Sewer. For instance, look at the typical "advanced" treatment plant shown on page 66. The resulting water is pollution free but look at the number of mechanical parts needed to power the operation and the heavy dependence on transportation for the required chemicals and for sludge removal. To maintain such a system requires many skilled laborers and still presents a problem of what to do with the sludge.

Recently, sewage systems have also been plagued by strikes all along the line (truckers, chemical manufacturers, parts and equipment producers, plant operators). The combined cost of high wages and the need for petroleum power and electrical energy make maintenance and repair increasingly impossible. This is more true of small cities and large towns than metropolises -- money is tighter and experienced personnel are harder to find.

In addition, as the *size* of the collection system grows, more sewers clog and overflow, more pipes break and need repair, and the more difficult it becomes to keep drinking water pipes separate from sewage pipes. (In New York, seepages from one pipe to another are common.)

The unreliable performance of the Big Sewer has been tolerated for many years. First, American citizens have confused freedom from personal worry with reliability. "Out-of-sight, Out-of-mind" has somehow come to mean "Out-of-sight, No problems." This attitude persists even though the transfer of sewage awareness and responsibility to public authorities has *not* led to better treatment. As we all know, water pollution has become terrible. Second, since a public authority does the work, citizens as well as sanitarians from County or State Health Departments may never hear of Big Sewer problems. Third, Americans are weird. They will accept sewage running down the street from a breached sewer as inevitable. But any suspicious odor or trickle from a neighbor's septic tank will send them hysterical and running to the nearest Health authority. In short, centralized sewerage problems have been covered-up by public authority and American Don't-want-to-think-about-it attitudes ("the excrement taboo"). On the other hand, home-site sewage systems have been unjustly called "unreliable" by the same people who make money building the centralized sewerage systems and, until recently, we all believed them.

## Health and Sanitation

The fear of disease from sewage is totally exaggerated in the U.S.A. The Dragon of Disease was alive when water supplies were drawn from rivers and lakes that were also used for sewage disposal. In the 1800's, whole cities of Europe got typhoid or hepatitis. In 1975, there are very few water supplies that also allow sewage disposal. All water supplies are so highly chlorinated that no pathogens can survive. Almost every citizen is inoculated in childhood against the big killers: cholera and typhoid. Even sewage plant workers contract water-borne diseases at a rate equal to everybody else.

The real water-borne diseases of the 1970's are practically ignored. They are caused by industrial pollutants like asbestos, petroleum by-products, lead, and even flourine and chlorine when they combine with carbon-based molecules. They all cause cancers and blood disease. These can be prevented by drinking bottled spring water and stopping industries from polluting.

Yet, in spite of the accomplishments of modern medicine, the Dragon of Disease thrives in our imagination.

Home-site sewerage is safer than the Big Sewer – although, with heavy chlorination, both are pretty safe. Home-site sewerage is safer because of its small scale. The sewage quantity is small and treatment occurs in a small, confined area. The home-site automatically *acts as a quarantine* – restricting the spread of disease (if by chance the drainfield should have problems). The Big Sewer takes everybody's sewage and makes one big volume of it. The pathogens can multiply in this sewage greatly increasing the chances of infection. The huge sewage systems are also more subject to break-down with consequences far worse than a problem drainfield.

There has been no proven case of water-borne illness caused by septic tank effluent in over ten years. Yet Health Departments, engineers and the newspapers still consider septic tank systems more dangerous than the Big Sewer.

Home-site systems usually treat sewage in soils. The powers of soil to clean sewage water have been described in Chapter 5. The Big Sewer tries to clean wastewater with many processes – only a very few use in-soil treatment. Usually, even after treatment, wastewater from the treatment plant must be heavily chlorinated. This kills pathogens and many other creatures. The killing of the "other" creatures has upset many natural balances in oceans and lakes. In other words, sanitation in home-site systems has no bad side-effects while the Big Sewer always kills more than just disease microbes.

#### Pollution and Resources

Again and again, we have emphasized the recycling advantages of home-site systems. In Chapter 2, the amount of nitrogen saved by home-site systems and used as fertilizer was mentioned. Similarly, phosphorus, the junior partner of nitrogen, can be channeled to benefit plants or destroy ecosystems. As with nitrogen, large scale sewage treatment plants have incredible difficulty removing phosphorus. To remove 90% (by flocculation with alum, lime or ferric iron compounds) costs about \$60 for every million gallons. The process, of course, kills protozoa and other creatures that are useful for self-purification.

"Land retention" or recycling sewage treatment using earth as filter. It is a fine alternative to the Big-Techno-Treatment Plant shown on page 66. Note lack of mechanical parts (aerators are for emergency conditions). Each pond (in series) treats and re-treats wastewater. Side benefits are preservation of green space around cities, shorter distances for food transport, cheap agricultural water and lower food prices. The best and easiest introduction is "Clean Water": by Leonard Stevens (1974, Dutton or Whole Earth).

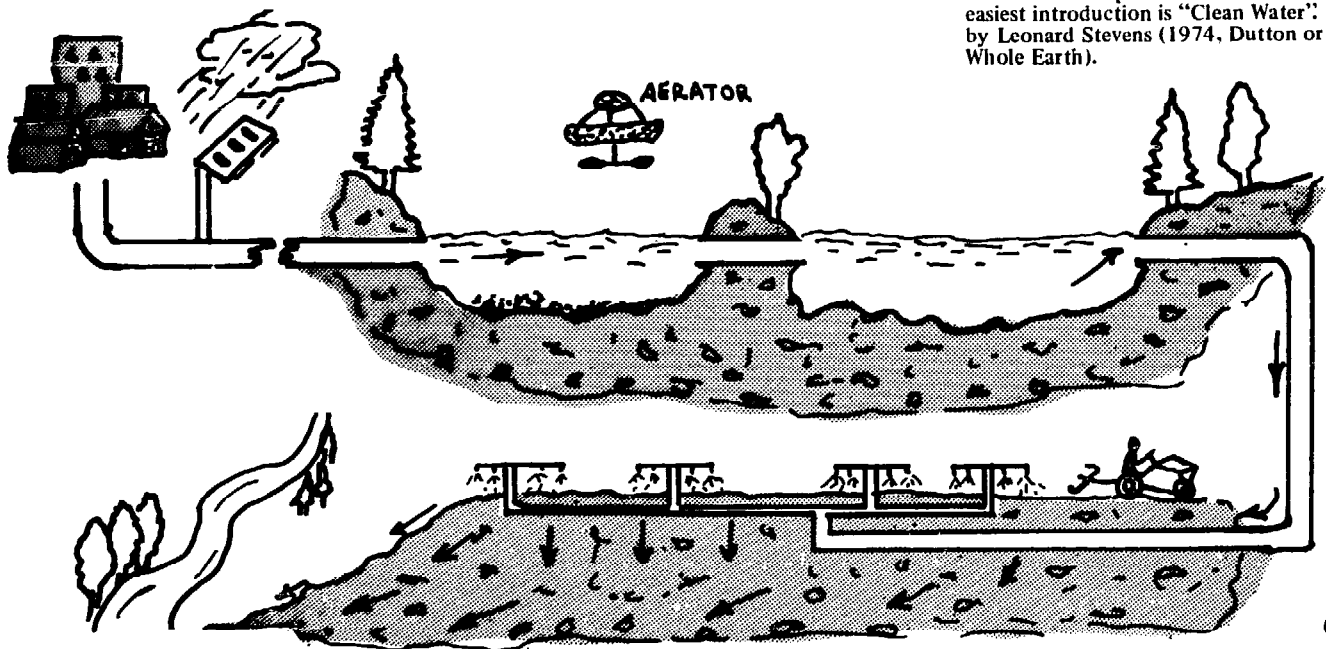

Home-site systems easily remove phosphorous. One estimate states that about 210,000 tons of wastewater phosphates are recycled by home-site systems saving \$100 million dollars (by avoiding the chemical processes of the Big Sewer) and \$800 million (by avoiding the price of equivalent petroleum-based fertilizer).

**The Algal Bowl** by John R. Vallentyne, S4.32. From Information Canada, Ottawa, Canada K1A 0S9.

A great book about lakes and eutrophication – the over stimulation of lakes with detergents and other human wastes.

In spite of this, there are still sanitary engineers and “respectable” scientists that argue that dilution of “wastes” is the solution to pollution. But, with rivers like the Hudson and lakes like Tahoe – all over the U.S. – becoming deader and deader, these scientists are sounding dumber and dumber. With increasing costs of petroleum-based fertilizers, throwing “wastes” out in rivers sounds more and more ridiculous. Home-site systems are gems of man’s ingenuity compared to Big Sewer inefficiency.

#### Costs

Of course, most North Americans are most concerned about money. And, it is in this arena that home-site systems offer the greatest advantage. At each stage of financing (initial costs, maintenance costs, replacement costs), home-site systems save money.

For instance, a survey of 60,000 households in Kentucky estimated costs of home-site systems to be \$72 million. To sewer the same area with worse treatment, the cost was estimated at \$354 million – a difference of \$282 million dollars! While the maximum cost of a home-site system was about \$2,000 per home, the cost of the centralized sewer averaged between \$2,500 and \$6,000. Some homes had to pay over \$18,000.

*Maintenance costs* are always very high for centralized sewer plants. You pay the public authority to pay wages to many workers to watch over your sewage. You pay for all the electricity and chlorine that is required to minimally treat sewage. If treatment is advanced, you pay for special chemicals and filters. You pay for sludge disposal and, of course, all the up-keep for machines with many moving parts. A cared-for home-site system might have to be pumped once every four years at a cost of \$30 to \$85.

*Replacement costs* are equally ridiculous. If a community receives Federal aid to build a treatment plant, they *must* pay the replacement cost – *while the treatment plant is wearing down*. At the end of 25 years, they have paid for the treatment plant twice – for the initial treatment plant and its replacement! This is called the Wastewater Capital Replacement Fund.

In addition, the Big Sewer lasts no longer than a well-built designed and constructed home-site system. Usually, the Federal government estimates 25 years before the treatment plant of a Big Sewer needs replacement. A good septic tank/drainfield system could last three times that long. Of course, there is a huge difference in scale for replacement costs. Big Sewer, Big Costs. Little at-home sewer, little costs.

American citizens have readily accepted Big Sewer costs because of our “Buy Now, Pay Later” atmosphere. Like TV, homes, cars or furniture

Americans are used to going into debt. The debt seems less bad when engineering firms and financial consultants say Federal aid makes the Big Sewer "feasible." In addition, the debt is usually hidden inside taxes or other utility charges. Again, out-of-sight, means no problem. This indebtedness has provided fast money to the sanitary engineers and left small towns struggling with their bills. Most debts, unless there is a new version of the Boston Tea Party, take 40 years to pay.

The subsidizing of the Big Sewer is really a subsidy for the engineering and construction business. It increases their contracts. You notice the government has never had a program to subsidize home-site systems (which it could) or encouraged home-site systems over centralized systems. There's no home-site lobby in Washington, D.C.



#### COMMUNITY EFFECTS OF A COLLECTION SYSTEM

Centralized sewers have destroyed many American communities. Their immediate costs have forced retired citizens on fixed-incomes and less wealthy citizens (especially the young) to migrate away from the increased sewer charges. The costs of bond issues, taxes, or sewer charges have polarized communities: putting the haves against the have-lesses. Indirectly, the Big Sewer raises property taxes. The Tax Assessor assumes that a centralized sewer is an "improvement" over the home-site system. All "improvements" mean the property is worth more and so your taxes go up.

Perhaps, more important, collection systems encourage high-density development. Sub-dividers can squeeze more homes into the same piece of land when a collection system is installed. This changes a town's character and induces suburban sprawl. The Environmental Protection Agency, which gives grants for Big Sewers, discovered this last year (1974). They were shocked to find that their grants caused increased air pollution, subsidized private developers, promoted high population growth, and did not reduce water pollution. Their report is so important to future sewage and land use policies, that many quotes are reprinted on this page. The EPA is now (1976) restructuring their grants. One of their main concerns is to decrease water wastage that Big Sewers encourage. Obviously, they will soon understand how home-site systems keep low density villages, keep property taxes down, reduce water consumption, reduce pollution, and reduce costs. At any rate, all communities should be very aware that a centralized treatment plant and collection system can destroy the very life of towns.

Quotes from "Interceptor Sewers and Suburban Sprawl" prepared for the Environmental Protection Agency.

The policy analysis performed as a part of this study suggests that certain changes could be made in current EPA procedures to encourage local communities to coordinate interceptor construction and land use planning and to ensure that federal monies are used for their primary purpose — pollution control — and not the subsidy of low density residential development of vacant land.

Current financing procedures — on both the local and federal level — may encourage the construction of sewerage systems tailored to the needs of future developers rather than the control of pollution problems. Where communities intend to finance the local share of project costs by connection fees on new development, this creates pressure to encourage rapid growth and thus ensure the financial viability of the project.

Generally, over half the land served by a project is vacant. The mean cost of the excess capacity is \$145 per capita based on the existing population and 75% of that, or about \$108, is being paid by EPA. Clearly, EPA is funding the future development of vacant land on a large scale.

Improve population forecasting techniques and review procedures. Population forecasts used in interceptors design should be better justified in the grant applications submitted.

Use realistic standards for per capita flow. The frequent practice of encouraging engineers to size interceptors on the basis of a standard 100-125 gpcd water use measure should be replaced by employing actual water use statistics. There is evidence that the standard 100 gpcd measure is excessive for many areas, and its use simply builds in additional excess capacity.

Increase public participation in the planning process by publicizing community costs and benefits of interceptor-induced growth.

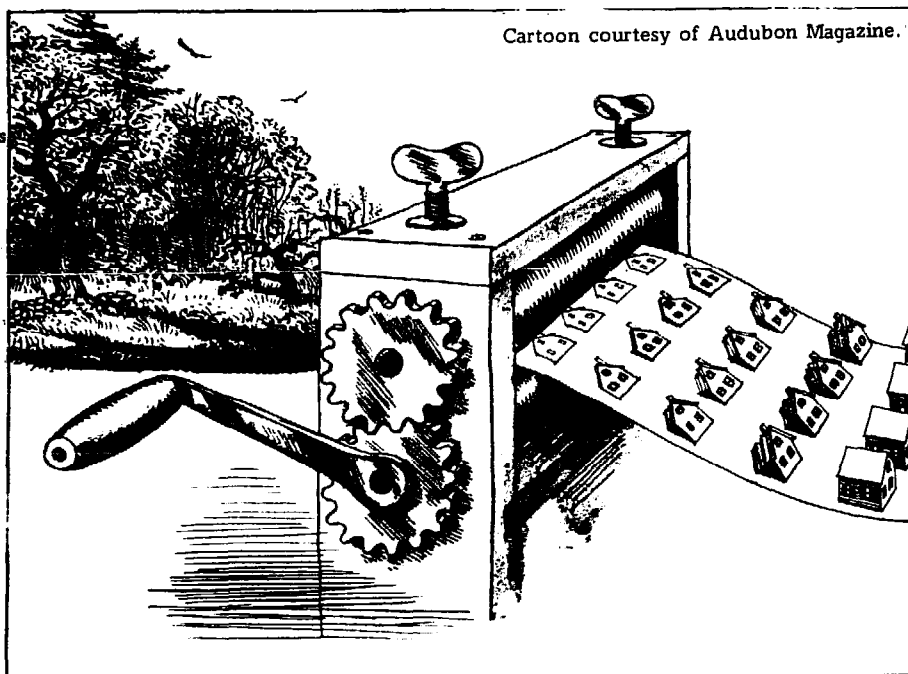

Cartoon courtesy of Audubon Magazine.

As a general rule, the design life of interceptors should be established at a maximum of twenty-five years, rather than at the current fifty year/ultimate population design period.

Do not provide federal funds for excess capacity. EPA should participate in financing only that portion of the interceptor project costs which represent the sewer capacity necessary to serve the needs of the existing population.

Finally, the Big Sewer works against American freedom of choice. If a sewer runs by your house, you *must* hook up to it and pay the costs. In other words, you are not allowed to keep your home-site system with all its advantages – even if it's working beautifully. This loss of option is killing the old American sense of self-reliance and responsibility. Undoubtedly, some back-woods Benjamin Franklin, unimpressed by the language of city-educated sewage experts, will soon stand up and say: "I won't." It will be a fine American court battle.

#### Summary

Home-site sewage treatment is cheaper, pollutes less, recycles more, slows or controls suburban sprawl, has fewer health hazards, and remains personal and intimate with the necessities of water, nutrients, and the lives of other creatures. Centralized sewage disposal, shielded by public authorities, has kept citizens unaware of sewage costs, inadequate treatment and disposal as well as their own natural responsibility for recycling their own wastes and keeping other plants and animals productive and healthy.

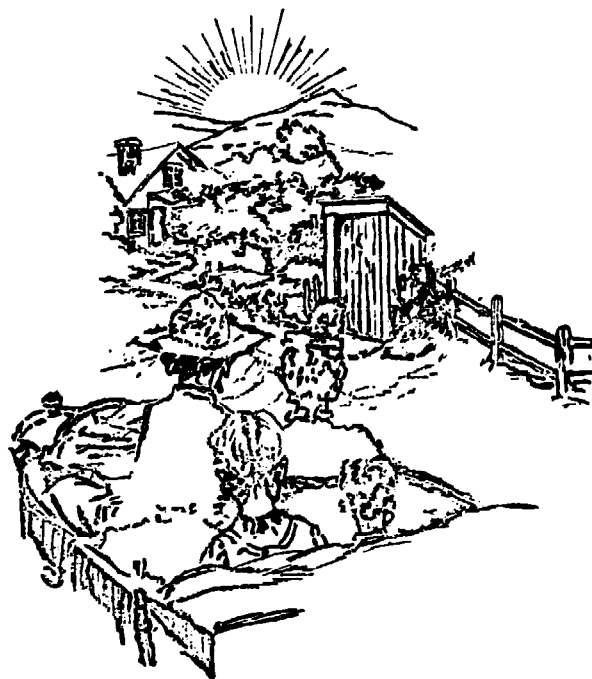

## ABOUT THE AUTHORS AND THEIR REVELATIONS

During the San Francisco oil spill, I tried to help clean about 3,000 oceanic birds. All died. During the spill, I met Greg Hewlett and we discussed saving community life (human and all other creatures). A town nearby was polluting the ocean with sewage and with our new interest we began to ask questions. The local Utilities District had hired engineers to solve the sewage problem. Their answer was incredible. Combine the town's sewage with a neighboring towns, add all the people who still remained on septic tanks to the Big Sewer and then dump it all further out in the ocean. Since the "cure" seemed worse than the disease, we followed our vision to save the Pacific. We called the Environmental Protection Agency, the State Water Quality Control Board, the County Health Department. We learned the words "out fall," "effluent," "interceptor sewer," "primary" and "secondary treatment." We wrote letters, attended Utilities District meetings, finally challenged the "expert" engineers and biologists. Most of all we tried to convince everybody we met that the solution to pollution was *not* dilution in the ocean.

Simultaneously, other townspeople began to notice the consequences of the sewer: increased taxes and sewer charges, increased human population and decreased animal and plant life, increased pollution from the

increase in people, forced exodus of towns people with fixed or low-incomes, etc. A combination of financial and ecological worries inspired a little-used American option: the re-call election. (If 10% of the registered voters want, an elected official can be forced back into running again or quitting). The concerned towns had two recall elections. The anti-Big Sewer crowd won. The State Water Quality Control responded by de-certifying the Big Sewer — even though they had previously given the Big Sewer their blessings. The Environmental Protection Agency said a new Impact Report would be required which would take six months. The Big Sewer "expert" engineer engineers and biologists smelled a sinking gold Cadillac and backed off.

The newly elected officials of the Utilities Districts still had a pollution problem. Enter the third author — Dr. J.T. Winneberger. He explained about septic tanks and drainfields, about lousy vs. intelligent surveys. He convinced the part of the town with septic tanks to stay with these beautiful, small-scale recyclers. Meanwhile, the sewered part of the town (the part that was dumping sewage into the ocean) designed a recycling system like the one illustrated on page 69. This land disposal, meant the ocean received no pollution, all nutrients would be used to grow plants and the green spray irrigation land would be safe from sub-dividers. It cost one-fourth the cost of the Big Sewer.

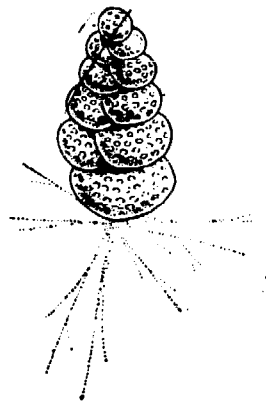

## ACKNOWLEDGEMENTS

*Special (revised edition) love to Joanne. Dr. Winneberger and Greg Hewlett are practically the authors — especially by influence. Lloyd Kahn and Shelter Publications provided the spirit and direction to make all this come about. Minor Wilson, a dear friend, provided many of the drawings, the space to work, and the music to keep it all going. Arthur Okamura's cover (his third septic tank book cover!) is, of course, the best. Joe Bacon has proven again to be the fastest typist and composer west of the Rockies. A fine*

*driving companion. Bill, Diane, Noel and Becky Johnson made lay-out laid-back and a pleasure. Sarah Kahn and Jane Bacher helped me understand orders and checking accounts. No small feat.*

*Important financial assistance came from Point Foundation. The composer was used in the office of the Co-Evolution Quarterly. I thank Stewart Brand for his generosity. The photos were made at Shelter Publications. The Mesa Press printed the booklet on a multi-lith.*



## BIBLIOGRAPHY

**Current and Recommended Practices for Subsurface Waste Water Disposal Systems in Arizona, 1977**, by J.T. Winneberger and others (\$3.50). From the School of Engineering, College of Engineering Sciences, Arizona State University, Tempe, Arizona 85281.

This is the definitive encyclopedia of septic tank practices. Good advice on everything: percolation tests, use in the United States, bad surveys, good designs, proper management, government headaches, privies and sewers. A must for every health department, engineering firm and home-site sewerage connoisseur.

**Treatment and Disposal of Waste Water from Homes by Soil Infiltration and Evapo-Transpiration**, 1973 by Alfred P. Bernhart (173pp in Volume I). University of Toronto.

No cost analysis. No maintenance discussion. A little super-tech for my taste. Nevertheless, the best overall book on all other aspects of anaerobic + aerobic drainfield and septic tank design. Especially good on how living creatures clean wastewater.

**Alternate Sewage Manual**, available from P.O. Box 309, Madison, Wisconsin 53701. Price unavailable.

The best written descriptions of mound drainfields using septic tank and dosing chambers. Three parts: impermeable soils; shallow soils with porous bedrock and high groundwater. Excellent discussions of pumping size, etc. A little hi-tech.

**Stop the Five Gallon Flush! (A Survey of Alternative Waste Disposal Systems)**, 1973; 60pp. \$2 postpaid from Minimum Cost Housing Group, School of Architecture, McGill University, Montreal, Canada or Whole Earth.

A list of every toilet imaginable from the destolet (burns your waste) to the Markt (a freeze toilet). Find discussion of the pros and cons of each. For those who want to know all the possibilities.

**Clean Water**, 1974 by Leonard Stevens. 289 pp. From E.P. Dutton & Co., NY or Whole Earth Truck Store. Hardback: \$10.00. Will be available in paper.

The first history of sewage farms and the great ability of the earth to clean water. Lots of fine examples of existing recycling systems. Gives hope in an America of extravagant waste. Beautifully written.

**On Site Sewage Disposal**, by Jack L. Abney. Private publication, \$1.00 welcomed. From: Air Pollution Control Department, Room 207, Civic Center Complex, Evansville, Indiana 47708.

The best short design manual for on-site systems, especially "mound" systems.

**Farmers of Forty Centuries**, 1911 by F.H. King (441pp.). \$9.95 postpaid from Rodale Press, Inc. (33 East Minor, Emmaus, PA 18049) or Whole Earth (558 Santa Cruz, Menlo Park, CA 94025).

A beautifully written travelogue on the agriculture and the recycling of all wastes that have been perfected through the forty centuries of Chinese, Korean and Japanese attentiveness.

**Manual of Grey Water Practice, Parts I & II**, available from Monogram Industries, 100 Wilshire Blvd., Santa Monica, CA 90401. \$1.00 each.

The very beginnings of much needed research of grey water. Part I treats grey water by "mini" septic tanks and drainfields. Part II gives grey water quality data. See United Stand (pg. 8) for more adventurous ideas.

**On-Site Waste Management, Vol. II**, by J.T. Winneberger. From: Hancor, Inc., Findlay, Ohio, 45840. 52 pg. No price given.

Two essays: "Pertinent Points in the Nitrogen Cycle" and "Setback Needed to Protect Water Supplies from Viruses." Both reduce fear levels to reasonableness. The nitrogen essay indicates actual quantities and how to determine them for waste management. The viral essay turns worries into soil adsorption analysis. Great bibliography.

**Excreta Disposal for Rural Areas and Small Communities**, 1958 by E.G. Wagner and J.N. Lanoix. 187pp. \$8.50 plus 75 cents handling. Available from Q. Corporation, 49 Sheridan Ave., Albany, NY 12210 or Whole Earth Truck Store.

Still the best book on waterless toilets of all kinds and how to construct them. The Farallones Compost Privy (page 8) is a modification from this book. Published by World Health Organization with a fine pan-cultural attitude.

**Soil Survey Manual**. Anon. USDA Handbook No. 18. Washington, D.C. U.S. Govt. Printing Office. August 1951.

Soils are the crucial focus: you must squeeze them, roll them, dig them, contemplate their colors. This book is far-and-away the best for on-site sewage students and farmers.

**Biology of Plants**, Peter Raven and Helena Curtis, 1970, 706pp. Available from Whole Earth.

A college text of great beauty on every aspect of plant life: DNA to the tropical jungle.



**Interceptor Sewers and Suburban Sprawl**. No. PB 236 477/AS. \$5.50 from the National Technical Information Service, Dept. of Commerce, Springfield, VA 22151.

Study showing that government financing is encouraging growth in communities that did not want it, that citizens must pay for this future growth by paying for super-large systems, and systems designed for extravagant water use. Perfect document to fight a sewer.

**Septic Tank Practices, Bolinas, California 1973**. By P.J. Warshall and P. Fransworth. From Peter Warshall, Box 42, Elm Rd., Bolinas, CA 94924.

This is the most complete septic tank survey that is sympathetic to home-site disposal. It demonstrates all the fallacies in surveys that don't distinguish failures from problems, soils from slopes and drainage. It gives methods for your own community survey. OUT OF PRINT but will be restored if enough requests are received. Do not send money. Includes a local ordinance and procedures for formation of Home-Site Sewerage District.

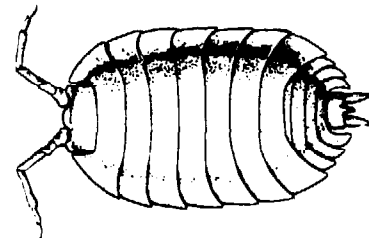

**Demonstration of Waste Flow Reductions from Households**, by S. Cohen & H. Wallman. PB - 236 904/AS, \$5.25. From National Technical Information Service, U.S. Dept. of Commerce, Springfield, VA 22157.

Herein lies the vision of a saner America. Good, technical know-how on dual-flush toilets, grey water recycling, shallow trap toilets, flow reduction valves, and more. Buy a copy, copy pertinent parts for friends.

**Sanitary Significance of Fecal Coliforms in the Environment**. By E.E. Geldreich. Federal Water Pollution Control Admin., Pub. WP-20-3, Nov. 1966.

Explains the many sources of coliforms from humans, ducks and even fish and the confusions of most health departments. A book that lowers fear levels.

**Nature and Properties of Soils**, by H. Buckman and N. Brady (7th Edit., MacMillan, 1969, 650pp). Available from Whole Earth.

The technical text on soils with good solid facts.

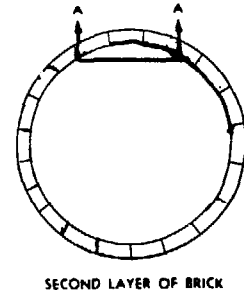
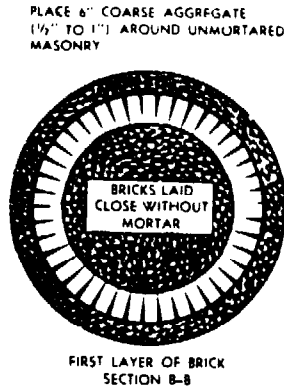
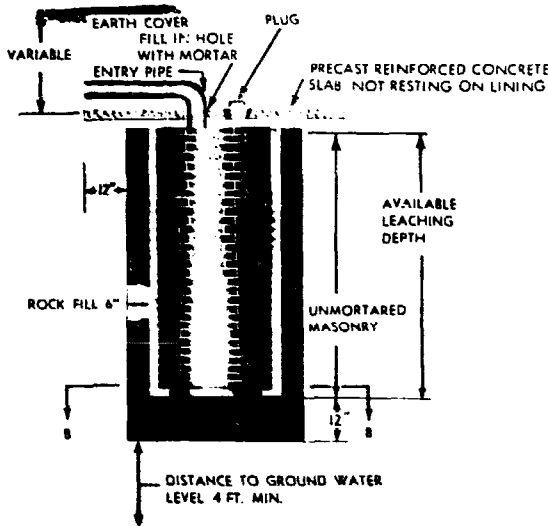

NOTE SECOND AND REMAINING LAYERS ARE LAID END TO END AND AT RIGHT ANGLES WITH FIRST LAYER OF BRICK

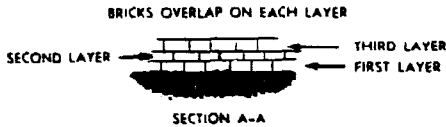

From THE MANUAL OF SEPTIC TANK PRACTICE, PHS Pub. No. 526.

SUGGESTED SPECIFICATIONS FOR WATERTIGHT CONCRETE

1. Materials

Portland cement should be free of hard lumps caused by moisture during storage. Lumps from dry packing that are easily broken in the hand are not objectionable.

Aggregates, such as sand and gravel, should be obtained from sources known to make good concrete. They should be clean and hard. Particle size of sand should range very fine to 1/4 inch. Gravel or crushed stone should have particles from 1/4 inch to a maximum of 1 1/2 inches in size. Water for mixing should be clean.

2. Proportioning

Not more than 6 gallons of total water should be used for each bag of cement. Since sand usually holds a considerable amount of water, not more than 5 gallons of water per bag of cement should be added at the mixer when sand is of average dampness. More mixing water weakens the concrete and makes it less watertight. For average aggregates, the mix proportions shown in the table below will give watertight concrete.

3. Mixing and Placing

All materials should be mixed long enough so that the concrete has a uniform color. As concrete is deposited in the forms, it should be tamped and spaded to obtain a dense wall. The entire tank should be cast in one continuous operation if possible, to prevent construction joints.

4. Curing

After it has set, new concrete should be kept moist for at least seven days to gain strength.

Type V portland cement may be used when high sulfate resistance is required.

Average Proportions for Watertight Concrete

Max. Size Gravel (in.)	Cement (volume)	Sand (volume)	Gravel (volume)	Water <sup>1</sup> (volume)
1 1/2	1	2 1/4	3	3/4
3/4	1	2 1/2	2 1/2	3/4

<sup>1</sup> Assuming sand is of average dampness.