

AT MICROFICHE
REFERENCE
LIBRARY

A project of Volunteers in Asia

Small Boat Design

edited by Johanna M. Reinhart

Published by:

ICLARM
Manila
PHILIPPINES

Available from:

International Specialized Book Services
10230 S.W. Parkway
Portland, Oregon 97225
USA

Reproduced by permission.

Reproduction of this microfiche document in any form is subject to the same restrictions as those of the original document.

Small Boat Design

Edited by Johanna M. Reinhart

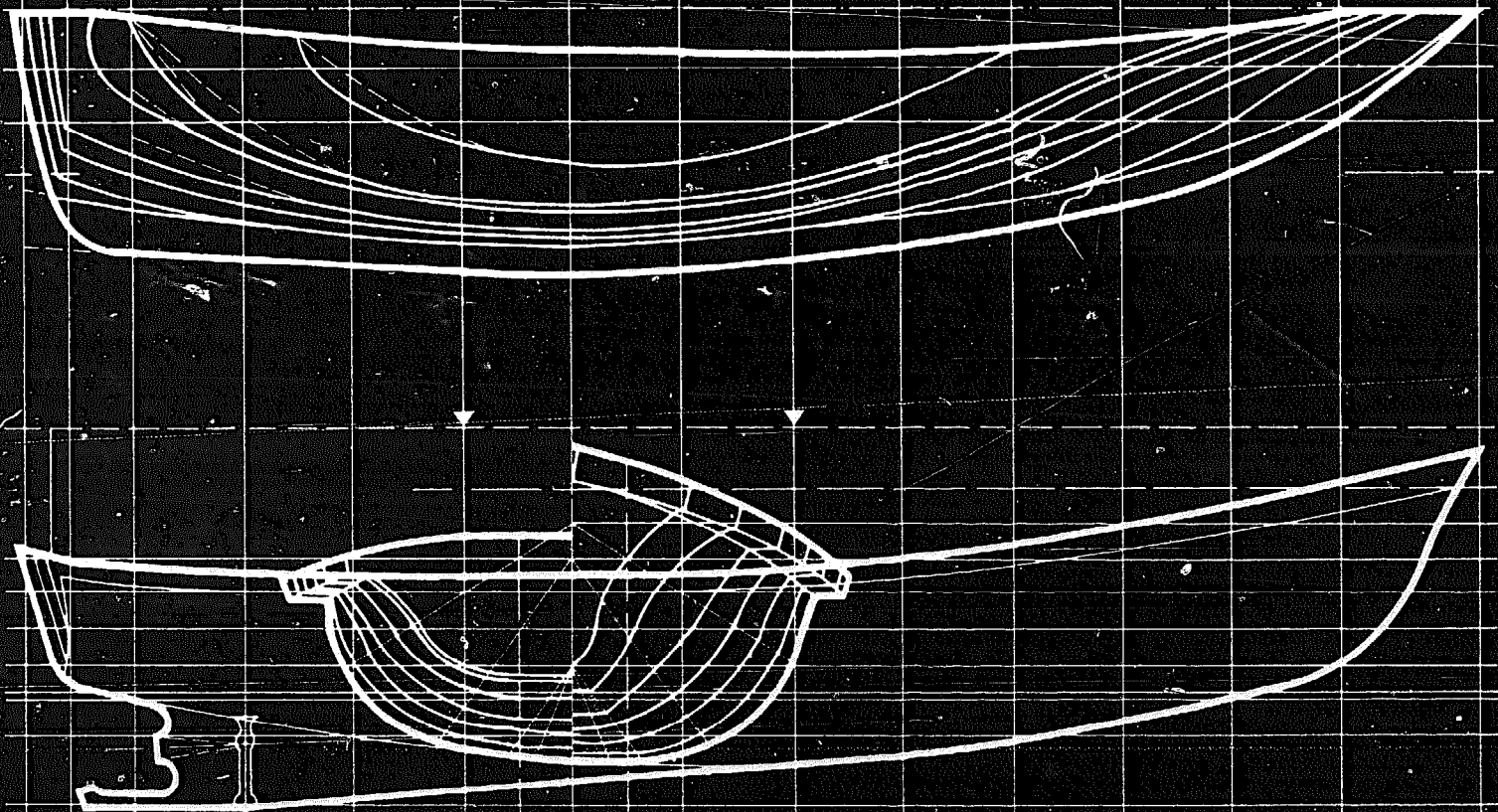

Small Boat Design

The Proceedings of the ICLARM Conference on Small Boat
Design, Noumea, New Caledonia, October 27-28, 1975

Edited by

Johanna M. Reinhart



INTERNATIONAL CENTER FOR LIVING AQUATIC RESOURCES MANAGEMENT
MANILA, PHILIPPINES

Small Boat Design
Proceedings of the ICLARM Conference
on Small Boat Design
Noumea, New Caledonia, October 27-28, 1975

Edited by J. M. REINHART

Copyright 1979 by

The International Center for Living Aquatic Resources
Management. Manila, Philippines

ALL RIGHTS RESERVED.

No part of this publication may be reproduced
in any form without written permission
from the publisher.

Printed in Manila, Philippines

correct citation:

Reinhart, J.M., Editor. 1979. Proceedings of the ICLARM
Conference on Small Boat Design. ICLARM Conference
Proceedings No. 1. International Center for Living
Aquatic Resources Management. Manila. 79 pp.

ISSN 0115-4435

Exclusive Distributor
ISBS, Inc.
P.O. Box 1632
Beaverton, OR 97075

Preface

Historically the Pacific Islander easily satisfied the protein requirements of his subsistence economy by fishing from his outrigger canoe within the lagoons and along the edges of the reefs that surrounded his island. For centuries the traditional outrigger was eminently well-suited to this task. However, after the Second World War, island populations began increasing dramatically and their island economies began to change from a subsistence to a monetary orientation. The traditional forms of fishing could no longer meet the islands' growing demand for food. Although vast stocks of fish remained virtually untouched in the ocean beyond the reef, the Pacific Islands became fish importers. For example, by 1974 Western Samoa was importing over US\$1 million in canned fish annually, and fish imports in Fiji account for almost 10% of all imported food products.

The process of change has occurred so quickly that the traditional outrigger canoe, rather than evolving, has been displaced. As a substitute, one western design after another has been introduced by various national and international development programs; and each in its time has been touted as the answer to the requirements of small fishing craft design in the Pacific. These boats were designed to move fishermen in the least amount of time to previously inaccessible fishing grounds beyond the reef. Size and speed were the design factors most often emphasized. None of these introduced hulls proved completely satisfactory; in fact, many were immediate and near-total failures that, for the Pacific Islander, involved too great a jump in either technology, investment cost, or work requirements.

To the staff of the International Center for Living Aquatic Resources Management (ICLARM), the history of the Pacific Island fisheries development provided a classic example of how direct transfers of technology

developed from a nation to other areas of the world can go wrong. Together with the South Pacific Commission (SPC) in Noumea, New Caledonia, ICLARM proposed to organize a conference that would (1) review the results of past fishery development programs based upon introduced boat designs and (2) provide a forum for discussion for which the fishery officers from the countries and territories of the South Pacific could be brought together with naval architects and with representatives from the marine industry. Although the SPC convenes a yearly meeting among the region's fisheries officers, this was the first conference in which members of the marine industry were invited specifically to discuss boat and engine designs applicable to the requirements of the Pacific Islander.

The Conference on Small Boat Design was held in Noumea, New Caledonia, on October 27-28, 1975. Its goal was to develop basic guidelines and recommendations for the development of small-scale fishing craft for future fisheries programs. Because of the diversity of opinion on the requirements for an optimal small-boat design, it was recognized that no single design is adaptable for use throughout the entire Pacific Basin. Boats must be designed not only for specific types of fisheries and sea conditions, but also for the technological and financial capabilities of the various island groups.

At its conclusion, the conference recommended the design and construction of new small-scale fishing craft be, above all, energy-conscious. The selection of boat designs and marine engines should be based on the least input of petroleum products. In any fisheries program the propulsion system should be selected only after its reliability and ease of maintenance are determined and the ready supply and availability of spare parts ascertained. Consideration should be given to standardizing both the

engine model and horsepower range to simplify the stocking of spare parts.

As a component of the regional fisheries development program, thought also should be given to forming a consultative design group that could advise the Pacific Island governments on implementing small-scale fishery develop-

ment programs. This group, in conjunction with ongoing fishery programs, would test combinations of hulls and propulsion systems applicable to the South Pacific.

STEPHEN RITTERBUSH

Opening Remarks

It is said that a significant discovery was made in 1973. In coastal Asia, an authority from an international organization observed an artisanal fisherman—a single man out in a canoe, fishing with a hook and line. It was recognized that he could make a substantial contribution to the world food problem, and since then the artisanal fisherman has received more and more attention.

This conference is held in recognition of the importance and needs of artisanal fishermen in the Pacific Islands. Past history of the Pacific could be briefly summed up as follows: Exploration, Exploitation, Expatriation, Examination and Explanations as to why imported fisheries schemes have not worked.

We do not wish to ignore the progress made by many dedicated people working in aquatic resources in the Pacific, but my experience in the past 22 years in the region is that the schemes which were unsuccessful are those you hear the most about. The slow, steady progress that has been made by some people is too often overshadowed by the “instant expert” from outside problems and too often sails over the horizon, leaving the debris of yet another unsuccessful scheme.

In the area of small-boat development, the Pacific Islanders have had more than their share of entrepreneurial schemes. It seems time to take stock of a rapidly changing world now reaching the most remote Pacific Islanders to see if there is not “a better way” for the small boat fishermen in the Pacific, a way that is economically and culturally compatible with the Pacific Islander’s life-style.

The evolution of small boats in the Pacific has taken a curious course. The Pacific Islanders’ basis of existence relates directly to their superb skill as boatbuilders, seamen, and navigators. With such a rich heritage of the sea, one might expect to see an evolution of present-day small

boats from the native canoes. But for a number of reasons there has generally been a substitution rather than an evolution; the canoe has been abandoned for a variety of plank, plywood, fiberglass, and aluminum craft, powered by an equal variety of propulsion systems.

I do not wish to criticize the small boat introductions that have been successful in meeting the needs of island people, but again, it is those schemes which have failed to meet the needs of islanders that have prompted us to convene this conference.

We have therefore gathered together an impressive group of knowledgeable people to reassess the small-boat needs of Pacific Islanders in 1975; we hope to encourage frank, objective discussion based on the following premises:

1. There is no one small-boat design that is the final answer to the varied needs of Pacific Island fishermen.
2. The operational terms of reference for Pacific Island fishermen are changing with such things as the increased price of fuel and manufactured items, making previously acceptable systems no longer tenable.
3. There is a strong argument in favor of critically discussing the relative merits of various boat/propulsion systems available (or being developed), and working toward providing an optimal system for any given set of socio-cultural, economic, or operational circumstances faced by Pacific Island fishermen.
4. Individuals with various points of view can contribute to the best solution or solutions so that some degree of consensus can be obtained.

It is envisaged that this conference will elucidate the problems facing the artisanal Pacific Island fishermen

today, and that potential, viable solutions to these problems can be proposed. Too often conferences are not as effective as they might be, because they culminate in sound proposals and resolutions which fail to be translated into effective action.

The sponsors of this conference intend that the collective input of the participants will result in an action program which will make more efficient and effective small boats available to Pacific Islanders who need them.

G. D. F. BETHAM

Contents

PREFACE	v
OPENING REMARKS	vii
The Honorable G.D.F. Betham	
FISHERIES DEVELOPMENT IN THE SOUTH PACIFIC	
Small Boats for Pacific Islanders: A Perspective and Plan of Action. PHILIP HELFRICH	1
Guidelines for Selecting Boat Design and Motors for Small-Scale Fisheries Programs in Isolated Island Communities. STEPHEN RITTERBUSH	4
Pacific Island Small Boat Development: A Distributor's Viewpoint. ANDY JONES	10
An Assessment of the Ponape Dory Project. STEPHEN RITTERBUSH	15
Cultural Aspects of Economic Development Efforts in Ponape. EDWELL SANTOS	22
BOATS DESIGNED FOR SMALL-SCALE PACIFIC FISHERIES	
<i>Ongoing Projects</i>	
Boats Designed for a Village Fishery in Western Samoa. ØYVIND CULBRANDSEN AND ARILD OVERAA	24
Boats of the SPC Outer Reef Fisheries Project. REGINALD EGINTON	28
<i>Proposed Designs</i>	
Small Fishing Boat Designs for Use in the South Pacific Region: Displacement and Medium Speed Fishing Boats. JOHN FYSON	31

Design and Construction of the ICLARM Experimental Small Fishing Boat.
 GLEN FREDHOLM 43

Plywood Boats for Offshore Fisheries. DAVID EYRES 48

A New Use for an Old Idea: A Small Multi-purpose Hawaiian Style Fishing
 Boat for Developing Fisheries in Island Areas. ROBERT T. B. IVERSEN 54

Fiberglass Reinforced Plastic and Its Application to Boatbuilding. RON SHAFER. 62

MARINE ENGINES FOR SMALL-SCALE FISHERIES

Factors to Consider in Selecting Power Units for Small Fishing Boats.
 BRIAN FALCONER. 64

Air-Cooled Gasoline Engines. J. H. COOK. 69

The Modern Outboard as Applied to the Fishing Industry. BRIAN STAFFORD 71

Drive Requirements for Small Fishing Craft: The Jet Unit as Compared to
 Direct Drive. T. R. HITCHCOCK 76

LIST OF PARTICIPANTS 77

Small Boats for Pacific Islanders: A Perspective and Plan of Action

PHILIP HELFRICH¹

*The International Center for Living Aquatic
Resources Management, MCC P. O. Box 1501
Makati, Metro Manila, Philippines*

The cultural heritage of the Pacific islanders is closely tied to the sea. They initially migrated across this vast ocean to all of the major island groups and later utilized their superbly constructed canoes for further travel over great distances between island groups.

The development of large sailing canoes, coupled with remarkable navigational skills and feats of seamanship, attest to the extraordinary mastery of the marine realm by Pacific peoples. Variations and refinements of the basic wooden hull sailing craft with outriggers and movable masts evolved in various island groups. All were extremely well adapted to the sea and wind conditions of the Pacific.

Many of these traditional craft are still in use today in some of the more remote Pacific islands, and a few old men still possess some of the navigational skills passed down through generations of mariners. Unfortunately, these traditional craft are being abandoned by many of the islanders for a variety of manufactured boats, and the skills of boat construction, sailing, and navigation that evolved over the centuries are being lost. Any con-

siderations of fishing craft designs for the Pacific islanders should certainly take into account their heritage in the sea and the craft which played such an important role in their migrations and in their daily lives.

The Pacific was explored, settled, fought over, and resettled by the Spanish, Portuguese, Dutch, British, French, Russians, Americans, and others during the past 400 years. Each introduced their own boats, marine technologies, and traditions. In recent years, foreign commercial fishing interests and international development agencies have come to the Pacific Islands, each organization seeking to introduce modifications, innovations, and refinements to provide for the fishing craft needs of islanders. As a result, boats in the Pacific Islands are as varied today in design and construction as any place in the world, a fact which has not been to the benefit of islanders.

Unlike other areas of the world, there has not generally been a modification of the traditional canoe to the fishing craft frequently used today. Some canoes have been adapted to accommodate outboard motors but a more general trend has been to abandon the traditional hull and sail and replace them with a great variety of designs, construction materials, and propulsion systems from other areas of the world.

¹Present address: Office of Research Administration, University of Hawaii, 2540 Maile Way, Honolulu, Hawaii 96822, U.S.A.

A notable example of an attempt to modify a traditional craft for present-day use occurred in Western Samoa. Two canoe hulls were joined together with timbers, a plywood platform was constructed, and an outboard motor was attached to produce a modern version of the "alia" double canoe used by early Polynesians in travelling great distances. This existing craft was utilized in Samoa for nearshore fishing, and was an attractive alternative to new construction.

In assessing the status of small boats utilized by Pacific islanders for their present-day fishing needs, one gets the impression that there has not been a gradual evolution from their traditional craft but rather that the islanders have acted in an entirely opportunistic manner in adopting boats to meet their needs.

Ideally, small boats and propulsion systems should be specially designed and selected to meet the intended use patterns, the sea conditions of the region, and the economic and social needs of the local people.

In many areas of the world, technical innovations and modifications gradually changed the traditional design and construction of small fishing craft. Those aspects of the prototype boat which were beneficial were incorporated with modern propulsion systems, materials, and fishing gear. For reasons not clearly understood, the Pacific islander has abandoned his traditional craft and substituted modern materials such as plywood, planks, aluminum, ferroconcrete, and fiberglass with a variety of hull designs ranging from modified Japanese sampans to Oregon dories. Power supplies for these craft are just as varied; high-technology outboard engines are being widely adopted, probably because of their high performance, compactness, and ease of operation.

Theoretically, an optimum hull design/propulsion system for each type of small-scale fishery operation in the Pacific could be utilized in achieving maximum efficiency and productivity. However, several factors including economic constraints prevent this. In addition, the best propulsion systems may be too technologically complex for efficient maintenance in some geographical regions.

An optimal hull design/propulsion system should at least be considered by the commercial enterprises and government agencies responsible for determining what equipment is made available for use by the small-scale fisheries of a given region. In the past, the choice of boats and propulsion systems was often restricted and related to availability from a number of local suppliers. Selection of their stock was probably based upon business considerations rather than on a conscious effort to provide the Pacific fisherman with a means of increasing his productivity while utilizing the most efficient system available.

Small boat construction and maintenance programs in the Pacific have been sponsored by several island governments and/or regional and international agencies. These programs have been in addition to those of small-scale entrepreneurs (the island or village boatbuilders) who are probably responsible for building a majority of the boats used in the Pacific Islands today. In fact, many of the present-day island boatbuilders obtained training in such programs.

Noteworthy among boatbuilding courses in the Pacific were those offered from 1930 to 1939 by the government-subsidized School of Boat Building and Maintenance on Kwato Island in Papua New Guinea. The School was conducted by Mr. Arthur N. Swinfield, an Australian naval architect who later published the two-volume "Boatbuilding Guide" in conjunction with the South Pacific Commission. This publication presents step-by-step instructions for the construction of a 26-ft multipurpose boat.

In 1960, a 2-yr course in boatbuilding, repairs, and engine installation and maintenance began at Auki, Malaita, in the Solomon Islands to train Pacific islanders. This endeavor was organized by the South Pacific Commission in cooperation with the United Nations Bureau of Technical Assistance and the Government of the British Solomon Islands Protectorate. The Auki school, under the direction of Mr. C.R. Fisher, initially concentrated on the construction of the 25-ft craft designed by Swinfield, but also constructed a 52-ft patrol vessel. In 1963, an additional course was inaugurated in Nouville, New Caledonia, for French-speaking trainees. This course began with the construction of 8-ft skiffs, but later engaged in the construction of 25-ft vessels. Both the Auki and Nouville courses have made a substantial contribution in the training of boatbuilders throughout the Pacific Islands.

In Micronesia, the renovation of the old Japanese shipyard at Malakal, Palau, made it possible to build and maintain wooden boats up to 125 feet long. The program of boatbuilding gained momentum under the direction of Mr. Peter Wilson by the acquisition of a master boatbuilder, Mr. Kiyoshi Matsumoto, who had experience in the construction of a variety of small boats. He was particularly experienced with the Japanese sampan hull, which is relatively easy to construct of its hard-chine configuration. The same basic design can be used for boats 20 to 100 ft long, which is an added advantage. In the first 3 years of its operation, the Palau installation constructed more than 75 boats, from 8-ft skiffs to a 75-ft commercial tuna sampan. This program also served an important training function.

A modest boatbuilding program was pursued in the Cook Islands by Messrs. Ron Powell and Iopa Marsters,

and three fishing crafts were completed, but recent reports indicate they were not being fully utilized for fishing.

One of the notable efforts in small-boat construction in the Pacific has been the fleet of fast bonito boats operating out of Tahiti in French Polynesia. These boats are largely single-purpose boats utilizing the rapid trolling method with mother-of-pearl shell lures for capturing small surface-schooling tuna. They are high performance boats that operate in local waters, supplying a high value commodity to a restricted market in Papeete, Tahiti.

Perhaps the best known introduction of a small fishing craft to the Pacific Islands is exemplified by the efforts of Mr. Barry Fisher, fisherman and entrepreneur from the northwestern United States. Mr. Fisher's "Oregon Dory" was introduced in programs that involved construction, maintenance, training, and cooperative operational activities in three Pacific territories: Ponape in the Caroline Islands, American Samoa, and the Gilbert and Ellice Islands. Each program encountered special problems, some of which will be analyzed in other workshop papers.

The dory program in American Samoa has probably been the most successful, providing a means by which Samoans have made a substantial contribution to the

local protein requirements with demersal and pelagic species in nearshore waters.

These are descriptions of a few of the many efforts to provide modern boats which would permit Pacific islanders to exploit the resources of their nearshore waters. The success of these efforts is difficult to assess; some have resulted in increased productivity for only a limited period of time. Almost all of these programs have encountered problems relating to the funding of boat construction and operation, with loans and their repayment and repossession of equipment being particularly troublesome. Few have provided an economically viable enterprise that was also compatible with the local cultural norms.

A significant number of small boats for Pacific islanders have had their origin in the construction centers of Hawaii, Australia, New Zealand, and North America. These boats are often "off-the-shelf" models that are generally designed and constructed for the recreation-oriented market in developed countries, and do not adequately answer the needs of Pacific islanders.

Thus, it was considered opportune to gather knowledgeable persons together to reassess the small-boat needs of Pacific islanders in 1975.

Guidelines for Selecting Boat Design and Motors for Small-Scale Fisheries Programs in Isolated Island Communities

STEPHEN RITTERBUSH¹

*The International Center for Living Aquatic
Resources Management, MCC P. O. Box 1501
Makati, Metro Manila, Philippines*

Introduction

Since 1969 small-scale fisheries programs in the South Pacific have been initiated in Western Samoa, the Gilbert and Ellice Islands, the Cook Islands, Fiji, and Ponape. In addition to these programs, numerous small boats designed for coastal fishing off Australia, New Zealand, and the United States have been introduced on an individual basis to the Pacific Islands. The main purpose for their introduction was to provide an improved fishing platform that would enable the village-level fisherman to reach fishing areas previously inaccessible to him, and to allow him to utilize new types of fishing gear and methods technology.

Although each of these development projects may have been successful to some degree, each was also beset with numerous problems, especially in the areas of boat design and propulsion systems. Some of the problem areas were common to two or more of the projects. This paper will briefly discuss some of the major problems and will suggest general guidelines for selecting suitable

boat designs and motors for future small-scale fisheries programs in isolated island communities.

Experience has shown that no single, ideal design is appropriate for use in the entire Pacific region. Designs must suit both the financial capabilities of the different island areas, as well as the types of fishing methods for which the craft will be used. With the startling rise of fuel prices in the past 2 years, boats that demand a large input of petrochemicals in their construction, or power sources that require large quantities of gasoline for daily operation, are no longer economical to construct or operate. Rising fuel costs will likely place additional constraints on the types of boat designs that can be introduced in the future. Designs are now required that give the best performance for the least input of horsepower. Serious thought must be given to a return to hull shapes which are easily driven and power sources that are both reliable to operate and simple to repair and maintain with only a limited knowledge of mechanics.

The selection of a boat design and motor should depend mainly on the type of fishery in which the craft is to be used. The second most important criterion is cost. In previous programs, either government or development bank loans were required to provide the initial capital for the purchase of boats and motors. In many

¹Present address: P. O. Box 61, Tufts University Branch, Medford, Massachusetts 02153, U.S.A.

instances, however, it was not uncommon for costs of boat operation to exceed the value of the average daily catch. The local fishermen's inability to catch enough to repay their loans was a major problem in all projects, and in some instances, the primary reason for their failure.

Determination of Construction Costs

Although the design of a boat will depend primarily upon the fishery and the typical sea conditions in which the boat will operate, its cost should be governed by: (1) the anticipated earning power of the boat, including operating costs, (2) its anticipated life span, and (3) available loans and rates of interest.

To calculate the anticipated earning power of a boat, one must estimate and project the local market price of fish, the average anticipated catch, the amount of fish that local custom decrees be given to either the church or to the village chief, and the number of fishing trips. The western concept of a commercial fisherman, such as found in Japan or the industrialized western nations, is largely alien to most Pacific cultures. Therefore, estimates of the average number of fishing trips per year must be reduced accordingly. In many previous programs it was found that the rural village fisherman would not fish consistently even at the height of the fishing season, because of cultural preferences and constraints. In addition, allowance must be made for repairs and the extremely long shipping time required for spare parts to reach many of the more remote areas of the Pacific.

A reasonable approximation of an anticipated yearly catch can be made by multiplying average daily catch in pounds by the estimated number of trips per year. This estimate is then multiplied by the average local price of fish. The result yields hypothetical yearly earnings of a boat operating at the village level.

After both operating and maintenance costs and approximate shares for both owner and crew are deducted, a net yearly figure remains that can be applied toward repaying the loan on the boat and motor. Multiplying this repayment figure by the estimated life span of the boat and motor yields a total investment figure that the rural small-scale fisherman can apply toward repaying a development loan. This figure will determine the costs in selecting a boat design, the construction materials to be used, and the selection of an appropriate power source.

These steps can be outlined as follows:

1. d = estimated average daily catch (in pounds)
2. t = estimated number of trips per year
 $d \times t = y$ (anticipated yearly catch in pounds)
3. p = local market price of fish
 $y \times p = h$ (hypothetical yearly earnings)

4. m = maintenance and operating costs
5. s = share of catch (in dollars and fish) distributed to crew
 $(h - s) - m = n$ (net yearly earnings to be used for loan repayment)
6. l = anticipated life span of boat
 $n \times l = i$ (total investment figure)

For each of the six variables involved, certain factors must be considered when data for these calculations are collected. The average daily catch varies from island group to island group, but from data acquired from previous fisheries programs, this figure appears to range between 150-100 lb/1-day trip on the village level. Since reliable data are rarely available, a preliminary assessment should be made of the fishing villages where the project is to be implemented to determine the volume of fish that are currently captured with locally available craft and gear.

A major constraint in the Samoan culture was that for any substantial increase in catch made on additional trips, the fisherman was expected to distribute the surplus to his matai (chief), to other members of his family, or to the church. Thus, once a village fisherman caught enough to meet his immediate obligations, he was reluctant to go on additional trips. Consequently, for the Samoa program a more realistic figure of 80-100 days of fishing was used for the calculations.

The local market price of fish in many South Pacific countries is determined not so much by species as it is by size or method of fishing for pelagic fish (e.g., skipjack and yellowfin tuna, Pacific dolphin) as opposed to bottom fish (e.g., snapper). Daily operating costs depend primarily on the type of power system used, while the shares earned by the owner and crew vary with local customs.

An example of the type of village-level economic analysis described above can be made for three separate fishery development programs currently in operation in the South Pacific: in Western Samoa; in American Samoa; and on the island of Ponape in the Eastern Caroline Islands, Trust Territory of the Pacific Islands.

Ponape and American Samoa Dory Projects

The Ponape and American Samoa dory projects are similar in many respects, having been developed from the same conceptual base: the need for a highly mobile fishing platform that would allow small-scale fishermen to get to and from previously inaccessible outer reef fishing areas in the least amount of time, and allow them to utilize more technologically sophisticated types of fishing gear. Both projects were based on the local construction and operation of an Oregon-type dory. Data from records maintained in Kolonia, Ponape, and Pago

Pago, American Samoa, since the inception of these two projects make possible the calculation of the average catch rate, the ex-vessel price of fish in the two territories, and the operating and maintenance costs borne by local fishermen over the past 5 years. From these data the dory's earning capabilities estimated before the projects' inception can be compared.

In both projects the original estimates called for a dory fisherman to land 300-400 lb of fish per trip and to make an average of 180-200 fishing trips per year. Both estimates proved to be overly optimistic. Initial operating costs of the dories were approximately US\$12¹ per trip, but due to the dramatic increases in the price of gasoline in early 1974, expenses have now risen to 2½ times this amount. The price for fish paid to the fisherman in both American Samoa and Ponape averages between \$0.40-0.60 per lb. Boat crews in both territories receive approximately 40% of the landed catch, either in cash or fish. After deducting operating and maintenance expenses from this subtotal, the owner claims what he deems appropriate as his own share, using the remainder to repay his initial loan investment.

With the above figures, it is possible to calculate the hypothetical earnings of a typical dory and the total investment figure that was anticipated before the inception of the project.

$$\begin{aligned} d &= 300 \text{ lb} \\ t &= 190 \text{ trips (average of 180-200 trips} \\ &\quad \text{per year)} \\ d \times t &= y = 57,000 \text{ lb per year} \\ p &= \$0.50 \text{ per lb (average price)} \end{aligned}$$

Thus, the hypothetical yearly earnings of the dory were conservatively calculated to be:

$$h = \$0.50 \times 57,000 \text{ lb per year} = \$28,500 \text{ per year}$$

Maintenance and operating costs (m) were \$12 per trip \times 190 trips per year or approximately \$2280 per year.

The crew's share, assuming a crew of two or three men per boat, was 40% of the hypothetical yearly earnings, \$14,800 remains to cover the owner's share and his loan repayment obligation.

Using these figures, it should have been a relatively simple task for the village fisherman/boat owner to repay his initial investment of \$5500 for a dory within at least the first year and a half of operation, even after deducting a major portion of this amount for his own support. However, most of the initial estimates regarding the number of trips per year, the catch rates, and the operating costs proved to be unrealistic.

From 1973 to 1974, actual landed catch rates ranged between 120-180 lb per trip in Ponape (see Ritterbush,

"An Assessment of the Ponape Dory Project") to 200-225 lb per trip in American Samoa. The actual number of trips made per year ranged between 80-100 in American Samoa and 90-110 in Ponape. Moreover, operating costs in both areas rose to \$30 or more per trip, and the total cost of the dory rose from \$5500 to \$8200 from 1971 (when the first project was initiated in American Samoa) to the present.

Using these figures, the actual return from an average dory can be calculated for both the American Samoa and Ponape dory projects during the last 4 years.

AMERICAN SAMOA

$$\begin{aligned} d &= 225 \text{ lb of fish per trip} \\ t &= 90 \text{ trips per year (average of 80-100} \\ &\quad \text{trips per year)} \\ d \times t &= y = 20,250 \text{ lb} \\ p &= \$0.50 \text{ per lb} \\ y \times p &= h = \$10,125 \\ m &= \$30 \text{ per trip} \times 90 \text{ trips per year} \\ &= \$2700 \text{ per year} \\ s &= 40\% \text{ of } \$10,125 \\ &= \$4050 \\ (h - s) - m &= n = \$3375 \text{ for the net yearly} \\ &\quad \text{earnings of a dory} \end{aligned}$$

If the boat owner retained only 12-15% of these earnings for his own yearly support, and no unforeseen major repairs were required, an annual surplus of \$1350 could be applied to the repayment of the loan. At this rate, it would require more than 6 years to amortize the present cost of a dory.

PONAPE

Loan repayment data for Ponape are similar to those of American Samoa. However, Ponape compares somewhat less favorably when the decline in the average catch per trip between 1973 and 1974 is considered.

In 1973 the dory fleet averaged 180 lb per trip.

$$\begin{aligned} d &= 180 \text{ lb of fish} \\ t &= 100 \text{ trips per year (average of 90-110} \\ &\quad \text{trips per year)} \\ d \times t &= y = 18,000 \text{ lb per year} \\ p &= \$0.50 \\ y \times p &= h = \$900 \text{ per year} \end{aligned}$$

Yearly maintenance and operating costs (m) were about the same in Ponape as in American Samoa, \$2700. The crew's share (s) was 40% of the hypothetical yearly earnings, approximately \$3600. Deducting maintenance and operating costs and the crew's share from the hypothetical yearly earnings left \$2700 that the boat owner could apply toward his own support and repayment of the loan.

¹All figures in US dollars.

In 1974 when the average landed catch of a typical dory declined to only 120 lb per trip, the yearly earnings dropped to about \$6000. Using the same figure for operating and maintenance costs and the same 40% figure to calculate the crew's share, the amount available for loan repayment was reduced to only \$900. At that rate it would take longer than 9 years to repay the initial loan of \$8200.

WESTERN SAMOA

In contrast, Western Samoa has adopted an approach to small-scale fisheries development in which the introduced technology appears to be both financially and conceptually within the capabilities of the fishermen. The Fisheries Division of Western Samoa estimates that the traditional Samoan double-hulled fishing craft, the alia, can be constructed for \$390 (US\$1.30=WSS\$1.00). The 20-hp outboard required to drive the alia can be purchased for \$520 with an additional \$65 required for fishing gear. This entails a total investment of \$975 without the owner's receiving any personal remuneration.

Records maintained by the Fisheries Division over the past 6 years indicate that the typical village fisherman make two trips per week, or about 100 trips per year, and lands an average catch of 800-100 lb of fish per trip. Fish sells for about \$0.40 per lb. Using these figures the approximate earning power can be calculated:

$$\begin{aligned}d &= 90 \text{ lb of fish (average of 80-100 lb} \\ &\quad \text{per trip)} \\ t &= 100 \text{ trips per year} \\ d \times t &= y = 9000 \text{ lb per year} \\ p &= \$40 \\ y \times p &= h = \$3600\end{aligned}$$

After deducting \$975 per year for maintenance and operating costs (m), and crew and owner shares of 40% and 15% (s=\$1980) respectively, from the hypothetical yearly earnings, a total of \$645 remains that can be applied toward repaying the initial loan. At this rate it is feasible that an initial investment of \$975 can be repaid within a 2-year period.

Under the new boat-building scheme initiated by the government in which the Fisheries Division subsidizes all labor costs, an 18-ft, open V-bottom fishing craft can be produced for \$520 and a 28-ft open V-bottom boat can be produced for \$885 (see Gulbrandsen, "Boats for Village Fishery in Western Samoa"). By purchasing motors in bulk, the price of each unit can be reduced by \$65. The cost of boat, motor, and gear brings the total investment of the fisherman to approximately \$1040 to \$1400, depending on the type of boat he selects. At the present level of catch, it appears that these investment costs rest well within the financial capabilities of the rural village economy, and can be amortized within

2 or 3 years without placing a large economic burden on the community.

Boat Construction

Unlike many countries in Southeast Asia, the fishing craft of the Pacific Islands have not evolved in a manner that allows them to be easily adapted to modern technology (e.g., motors or fishing gear). In many areas of the Pacific, both the indigenous skills of boat building and fishing have declined with increasing western influence. The Samoans and Tongans once constructed some of the largest seagoing craft in the Pacific (e.g., the alia), which now have all but vanished.

Any development of small-scale, village-level capture fisheries in the Pacific must be based on the design, development, and construction of a suitable, easily maintained small boat and power source. Boats are needed which are easily constructed and seaworthy, and which give the greatest amount of speed from the least amount of horsepower.

Due to high inter-island and island-mainland freight costs, it should be more economical, and more beneficial in terms of employment and the development of local skills, to construct boats from imported material (and local materials if available) rather than import the finished craft.

Selection of appropriate construction materials for the proposed craft is of vital importance. In general, a lack of hardwood trees, lumber-production facilities, and a lack of skilled shipwrights precludes the use of planks for most island areas. Western Samoa is currently an exception. A lack of shipyards and metal shops in most islands preclude both the construction and repair of steel or aluminum-hulled boats, although, Fiji, Tahiti, and Guam are exceptions. Ferroconcrete construction is currently unsuitable for small-scale fishing craft because of constraints on hull size and a minimum weight per surface of hull.

Fiberglass is a practical medium with which to work providing that proper humidity and temperature can be maintained when storing the matting, roving, and resin. Because of the high initial outlay required to prepare a mold, a minimum number of fiberglass boats must be constructed to defray the initial investment costs.

Marine plywood, although not an ideal material, is another alternative that can be used in village-level projects. It is easily worked out and requires no specialized shipwright techniques. Plywood is moderately cheap in terms of both cost and bulk-freight rates, and is easily stored. In addition, it can be used to construct most parts of a boat (hull, deck, ribs), and with epoxy-type finishes, it can be rendered impervious to rot and shipworm. However, there are drawbacks to this material.

It must be imported, incurring shipping costs in addition to the original purchase cost; it tends to warp in a tropical climate and thus cannot be ordered in large quantities or stored for long periods; and because of its utility to other groups in the community, marine plywood tends to be stolen and used for other purposes.

Motor Selection

For small-scale, village-level fisheries, the selection of an appropriate power source can be limited to four choices: low horsepower diesel engines, automotive-type gasoline engines, small air-cooled gasoline engines, and outboard motors. Each has its own distinct advantages and disadvantages.

Although the diesel may offer the greatest reliability and longest operating life, it costs nearly twice as much as a gasoline engine of the same horsepower. This results in a higher initial investment cost that must be amortized over the life of the boat. However, because of the difference in prices of diesel fuel and gasoline, diesel engines are substantially less expensive to operate. The lack of an electrical system on the diesel engine also eliminates a major problem encountered with other motor types—corrosion and short-circuiting of the ignition system. A minor drawback to the use of a diesel is the high engine weight to horsepower ratio. Not only is a heavier diesel engine required to deliver the same horsepower output as a gasoline engine, but the added engine weight also reduces the catch load a small boat can safely carry. Because of the high initial cost of a diesel, this engine should be used only if the anticipated catch returns are high enough and the life of the boat is long enough to warrant the initial expense.

In comparison, automotive-type gasoline inboard engines are relatively inexpensive to purchase. Also, because of the wide familiarity of many island people with these engines, they are easy to maintain and service. In the Ponape Dory Project, for example, many spare parts that were normally unavailable for other types of imported motors were readily available from the local automotive dealer. In almost all island groups, mechanics are available who understand the operation of an automobile engine. However, this engine type suffers from two serious disadvantages: (1) its electrical and ignition system is very susceptible to saltwater corrosion (a major problem in many of the boat projects), and (2) in the 100-250 hp range, this engine has a rather large fuel cost. As an example, the dories constructed in Ponape are fitted with automotive gasoline engines that have been adapted for marine use. At the current cost of gasoline, daily operating expenses average more than \$30, and these will rise even higher since continual worldwide

price increases for petroleum products are anticipated.

Although the air-cooled gasoline engine is used extensively throughout Southeast Asia, it has only recently been introduced into the Pacific. It is substantially lower in price than either the diesel or automotive-type gasoline engine. In fact, it is perhaps the only alternative that compares favorably to the outboard motor in terms of price. Both this engine and the outboard can be used to power the smaller dugout outrigger or canoe-type fishing craft. It can be used as an auxiliary power source for sailing craft as well. In addition to its low purchase price, the air-cooled gasoline engine is inexpensive to operate since it is adaptable for use with either gasoline or kerosene. The engine is constructed with a minimum of moving parts and easy to maintain. In addition, it is lightweight; it can easily be removed from the boat and transported to the nearest repair facility.

There are, however, several disadvantages to the air-cooled engine. It has not been specifically designed and constructed for use under highly corrosive saltwater conditions, although manufacturers have taken precautions to provide special protection to some of the more vulnerable parts of the engine, such as the magneto. In the Philippines where these engines are used extensively, the average life expectancy of a motor is more than 5 years. The air-cooled gasoline engine is manufactured only in the 3-16 hp range, thus limiting the size of the boat in which it can be effectively used. Because this engine requires a straight shaft and through-the-hull fitting, the propeller is in a fixed position beneath the keel of the boat and is more susceptible to damage by submerged objects. A hull design that utilizes this type of motor will require the addition of a keel to protect the propeller, which in turn, will increase the draft required for safe operation.

Outboard engines provide a number of advantages not offered by other motor types. The initial purchase price for an outboard motor is low, and it requires a relatively low level of technical skill for operation. Presently, the outboard is the best alternative to the air-cooled gasoline engine for use in small-scale development programs when the cost of a boat and motor must be kept as low as possible. Unlike the air-cooled gasoline engine, outboards allow fishing boats to be beached in shallow waters, and they are easily removed and transported for repair and security purposes.

Using the outboard, however, has several drawbacks. It is an engine manufactured primarily for recreational, rather than continuous, intensive, commercial use. It can be difficult to maintain and repair without comprehensive training. Spare parts for outboard motors are unavailable in many island areas and supply of these parts by

manufacturers' representatives has been less than adequate in the past.

Conclusion

Any future small-scale fisheries development effort in the South Pacific should build upon the experience of previous programs, and the social and economic conditions of the rural communities where the project is to be implemented should be ascertained simultaneously. Before initiating any program, differentiation should be made between subsistence and small-scale fishery operations. If a fishery is at the subsistence level where the catch rates of the rural fisherman support only his immediate or extended family, any technology to be introduced should involve as little cost as possible. An example would be the purchase of an outboard motor or modified fishing gear for use with a traditional outrigger canoe. The most important fact to consider is whether or not the recipient of the assistance, the rural fisherman, is forced to assume an inordinately large financial burden that is totally alien to his cultural and economic lifestyle.

On the small-scale level where catch rates are higher and marketing systems are more fully developed, the economic assistance provided to the fisherman can be on a larger scale. Assistance can be provided not only for engines which require a higher initial investment (the diesel engine), but also for the development and construction of boats that will extend the rural fisherman's range of operations. The development of boats for any small-scale fisheries project should be based on an easily-driven and easily-maintained hull that is capable of achieving its design speed with the least input of horsepower.

The selection of both the power source and the materials for boat construction will always involve a compromise. The two questions that must be answered in any project are: (1) Can the craft be easily maintained and repaired? (2) What are the costs and avail-

ability of the materials and spare parts?

Providing the small-scale boat with an auxiliary form of power (e.g., sail) should also be considered. As the fisherman's range of operations is extended with the introduction of new boats and power sources, the chances of his becoming stranded and lost at sea increase dramatically. At present, most Pacific Island nations and territories are not capable of mounting emergency search and rescue operations.

Power sources must be reliable and easily maintained and repaired. The cost of fuel will probably become even more prohibitive in the future. A serious effort must be made to keep operating costs at a minimum. Because of a low initial purchase price, either the air-cooled gasoline engine or the outboard is applicable to development efforts directed to either a subsistence or small-scale village fishery. However, for a successful project, these two types of engines require a readily available supply of spare parts and an active training program in motor maintenance and repair. For a small-scale fishery in areas where catch rates are higher, the economic base broader, and the local fishermen capable of working with more sophisticated technology, the diesel engine is probably the best choice due to its reliability and low maintenance requirements. Because of its relatively high purchase price, it must first be ascertained whether or not the existing or anticipated catch rates and the life of the boats to be used in the project warrant the initial investment.

Small-scale fisheries development is fundamentally a process of education followed by change. The transfer of technology in the development process must be effected in a gradual and systematic manner, and at a rate that is acceptable, both economically and culturally, to the small-scale fisherman. To do otherwise is counter-productive and wasteful in terms of both money and human resources.

Pacific Island Small Boat Development: A Distributor's Viewpoint

ANDY JONES

*McWayne Marine Supply
1125 Ala Moana Boulevard
Honolulu, Hawaii 96814, U.S.A.*

Introduction

The transition by islanders from sail and paddle to modern power sources for propulsion has been inevitable. As individual income has increased and more information about power boats has reached the islands over the past few years, increasing numbers of islanders have turned to modern propulsion systems. Because of low cost and comparative ease of repairs, the most popular form of propulsion has been the outboard motor.

In the lower horsepower range, both price and technical knowledge are presently within reach of most islanders. It is estimated that the total motor population of Micronesia, as an example, is approximately 8,000 units in a population of only 100,000 people (excluding Guam).

The majority of those engines sold in all of the island areas are 40 hp and under, with the 25-hp and 40-hp models being the most prevalent. Above 40 hp the motor count drops dramatically. Exceptions exist such as in Palau in Micronesia, but the dominance of small horsepower engines basically holds constant throughout the Basin. Experience gained from participation in various development programs established during the last decade has demonstrated the two-cycle outboard to be

avored as perhaps the best form of marine propulsion for immediate and near future needs.

This paper considers criteria which govern choice and maintenance of boats in the Pacific Basin, as seen from a commercial boat distributor's viewpoint.

Propulsion Systems

The use of motorized fishing craft in the Pacific Basin is controlled by three factors: the cost of the engine in relation to income levels in any island area, repair and maintenance source, and availability of spare parts.

Cost-Ability to Purchase. Currently the larger horsepower outboard, inboard/outboard engines are too expensive and complex to maintain and repair. For the average islander a diesel, however, operates much less expensively than a four-cycle or two-cycle gasoline engine of equivalent horsepower. A cost comparison of a single 40-hp diesel and a small 40-hp Johnson reveals the greatest problem with the diesel to be the initial purchase price. A 40-hp diesel has an initial cost of approximately US\$3,000, while a 40-hp outboard costs only about US\$817. However, the major argument in favor of a diesel is in the direct operating costs. For an equivalent number of hours, the 40-hp

outboard costs approximately US\$9 more per day to operate than a 40-hp diesel. The same economics would apply when comparing a single 8-hp diesel to twin 40-hp outboards.

Further calculations, however, using a 20-day month as an operational factor, indicate that it would take 1 year to amortize the difference in the cost of the diesel. Further, smaller horsepower diesels are functional only in a displacement hull with top speeds of 12-13 knots. With outboards wedded to planing hulls, a fisherman can theoretically get to and from fishing grounds faster and more economically.

Regardless of the power comparison, the economic restrictions remain the same, and most Pacific islanders have limited resources to expend on propulsion systems. Local economics must be the guiding factor for any program involving the purchase of modern marine engine.

Availability of Trained Repair Personnel. Even in the more developed countries, when an outboard engine is subjected to heavy saltwater use, the life span of the engine is considerably decreased while malfunction due to corrosion is increased. In the Pacific Basin where preventive maintenance is not common practice, engine life and trouble-free operation is of even shorter duration. Marine operations, whether an individual, cooperative, or governmental effort, can be successful only if the equipment remains operational.

Wherever a particular type of motor is found in quantity, qualified repair personnel are generally available, too. In recent years, McWayne has provided on-the-job training to approximately 75 islanders who were, in most cases, funded by various government programs and agencies. Other trainees were sponsored by import/export companies and churches, and in several cases individuals attended on their own initiative.

The number of trainees from a given area was directly related to the number of engines in that area. For example, on the island of Truk where outboards are used extensively, there is no lack of repair personnel. The greatest shortage of trained personnel in outboard motor occurs where there is only a limited number of motors. This requires many programs to train personnel specifically for the advanced technical repairs required to keep the units operable. Thus, the success of an entire program can revolve around one mechanic. To alleviate this dependence on a single individual, a marine program should therefore ensure that one or more backup mechanics are available.

Even where there is an adequate number of mechanics, the quality of their training is sometimes questionable. This problem is not so much due to lack of talent, but rather a lack of updating. A 1968 training course does

not provide adequate knowledge for proper repairs on a 1975 engine.

Continuous training is necessary merely to keep existing service personnel technically aware of innovations. Repair schools offered by international motor companies, distributors, and domestic factories should be utilized when possible. Updated training material is available in cassette form, such as the cassette sight and sound instruction systems offered by both Johnson and Evinrude. In addition, numerous periodicals, repair manuals, and trouble-shooting booklets serve as information sources.

Parts Availability. Parts availability in the Pacific Basin is directly related to the numbers of an engine type in use. In Truk, for example, there are an estimated 2,000 engines of which approximately 50% are 25 hp and 30% are 40-hp engines. Parts orders shipped to both government and commercial concerns are mostly for replacement parts for these two horsepower models, and complaints of parts shortages for these engine types are infrequent. However, for the 100 or less small marine diesels in Truk, replacement parts remain a problem.

Thus, with a smaller number of motors, the appropriate parts are less readily available and there is greater difficulty in obtaining quick and efficient repairs. This applies to the general situation throughout the Pacific Basin. It is recommended that any new grass roots marine program should use propulsion units already established so as to eliminate these problems.

The difficulty in maintaining an adequate parts supply for a small number of engines is enormous. A supplier is almost obligated to stock enough parts for one or more total replacement engines to ensure that all needs are met. Despite such a stock, until a history of breakage develops (i.e., the identification of repetitive problem areas), a program invariably finds itself short of important replacement items.

In addition to replacement parts, another consideration is the availability of special repair tools. Every manufacturer offers special tools to expedite repairs. The use of improper tools can hinder efficient and effective repairs as badly as the lack of parts or technical skill. A few programs have a comprehensive inventory system for their back-up parts, but most do not. It is important to establish a documentation system to identify chronic problem areas of shortages and surpluses.

Unless every part is made available to complete a job, even a single and inexpensive part can keep a \$5,000 motor inoperable for a month or more. Also, the more parts a propulsion unit requires, the more stocking problems that will occur. An example would be a comparison of a 70-hp Johnson outboard and a Volvo MD21 75-hp diesel; the outboard has 746 parts, whereas the diesel

has approximately 1,250, or over 67% more individual parts.

Individual Maintenance. Motors used commercially have a much shorter warranty period than those used for pleasure. Although most marine engines are designed to handle all water conditions, heavy commercial use and saltwater conditions greatly tax marine propulsion units.

Fifty percent of the engine failures observed in the Pacific Basin have originated from owner negligence and lack of maintenance. Training owners on the proper care of engines should be automatic. Discussions with import/export companies selling to individuals have emphasized the provision of such courses in engine care and preventive maintenance in every island community.

Boat Designs

As with the selection of propulsion systems, boats designed for use in the Pacific Basin are restricted primarily by the income levels of the island communities. Is it possible to design and produce the perfect small boat for fisheries development that will fit the needs of all Pacific Basin island communities?

Assuming that economic requirements can be met, it appears that a design compromise is the answer. Past and present fisheries programs have shown that most Pacific Island fishermen do not spend continuous days at sea like their Korean or Japanese counterparts. Instead, they prefer to fish on a daily basis for perhaps 3 or 4 days per week. Time and economic development may change these habits, but currently the type, size, and cost of the boats used are dictated by existing social attitudes. The typical islander, therefore, cannot afford a \$10,000 boat and motor from present income sources whether from "land" jobs or from offshore "casual" fishing.

Cost Restrictions. Most hulls used in the Pacific Basin are locally built, since those boats produced in the U.S. are generally produced wooden boats. Furthermore, by work boat standards, most small pleasure boats are equipped with extraneous, unusable features. In addition, freight costs can add as much as the original cost of the boat when delivered from a foreign source. Unless local income levels rise dramatically, the extensive use of mass-produced U.S. boats is impossible.

A small boat of acceptable hull design must, therefore, be produced in island communities themselves. The goal would be to produce a locally built boat in a short period of time from a lasting and easily repairable material.

Material. Fiberglass is considered to be the best base material. Once a mold is available, hulls can be built quickly, maintenance is minimal, and repairs are easier than for any other type of material. The problem is to produce an efficient, high-quality mold and to develop

the technical skills to produce "low cost" fiberglass boats quickly.

Design. A wide range of opinion exists on the subject of boat design. Several observations are presented:

A deep V planing hull rides much better in rough water but is expensive to operate, since high horsepower propulsion is needed to plane. With insufficient horsepower a deep V is relegated to the displacement hull (nonplaning) category.

A flat bottom skiff bearing even heavy loads can reach planing speeds with only a minimum of horsepower. Also, the shallow draft characteristics of a flat bottom offer more versatility of operation in shallow, protected lagoon waters. A flat bottom skiff is also quite stable. Characteristics, however, of flat bottom skiffs, make these boats inappropriate for use in rough open seas.

The answer rests in a compromise—a shallow, semi-V favoring a flat bottom design. The ride would be less comfortable than that offered by the deep-V in rough open seas, but operational costs would outweigh crew discomfort. Other design factors to be considered in the design are minimum weight with maximum strength and simplicity of construction.

Hardware and Accessories

Selection of boats and motors is one problem in developing fisheries programs. Proper selection of hardware and accessories is another critical problem.

The marine industry is not as well coordinated as are some others, such as the automotive industry. Many suppliers are prone to peak and trough merchandise availability according to season. Thus, while it is sometimes difficult to obtain merchandise in the summer, the situation then reverses and the same items become readily available in winter. The solution, therefore, is to stock adequate quantities of identified, high demand items.

Many manufacturers direct their production to the competitive price market and focus their product on freshwater pleasure boats. These accessories are made from such materials as Zaemac dye cast and plastic. Experience has shown that cutting hardware costs at the expense of quality is a mistake. For example, brass or chrome/brass hardware is mandatory for saltwater conditions. In addition, it is necessary to select products from manufacturers that honor warranties and provide adequate technical information.

In small boat construction, hardware and accessories can be grouped into five major categories: deck hardware, steering, lights, gas tanks, and electrical components. The goal is to buy equipment that will be as trouble-free as possible. As with motors, poor main-

tenance can ruin even the best quality equipment. A mechanical steering assembly that is not greased regularly can result in a frozen cable at any temperature under heavy use in saltwater conditions.

Logistical Problems

Some of the logistical problems of supply are freight, communication/order information, discounts, shipping sources, and payment terms.

Freight. Water freight into the Pacific Basin is unreliable and sporadic. Two shipping lines serving Micronesia, as an example, have gone out of business during the last 7 years (Mille and Transpacific Lines).

Shipping companies cannot afford to give good continuous service to areas which do not create a sufficient volume of freight, and communities of the Pacific Basin simply do not offer the kind of volume shipped to or from, for example, Singapore, Japan, or the U.S. Water

freight is directed to large volumes, and shipping by sealed container load to protect goods against water and theft is ideal but not always possible.

For smaller shipments, air freight is recommended. A schedule attached to this paper shows some comparative air and water freight costs to various parts of the Pacific Basin from Hawaii and the U.S. mainland. The various costs of shipping a 40-hp outboard motor valued at US\$900 are estimated in this table. The charge to ship this motor from Honolulu to Pago Pago by air freight is only 13% of the cost of the motor, while the charge from Los Angeles to Pago Pago is 28% of cost, with a delivery time of 3 days.

The same shipment by water freight from both Honolulu and Los Angeles is only 5% of the motor's cost, but with a delivery time of 6 to 8 weeks. Thus, if the need for the equipment justified air freight charges, the additional cost would be well worth the expense. For parts replacement, the suitability of air freight is even

Table 1. Comparative costs of shipping freight by air and sea in the Pacific. Prices are current as of November 1975 and based on shipping a 202-lb, 25 cu ft, 40 E 76 motor costing \$899. Frequency of planes and/or ships is 3-5 days in all cases.

From/to	Via air freight	% of cost	Via surface (sea)	% of cost	Frequency/arrival time	Air/surface	Difference
HNL ^a /Truk	210.08	24%	\$90.04	10%	once a month	210.08/90.04	\$120.04
	\$1.04 per lb		44¢ per lb.		8 weeks	24/10	14%
LA ^b /Truk	272.70	30%	\$90.04	10%	once a month	272.70/90.04	\$182.66
	\$1.35 per lb		44¢ per lb		8 weeks	30/10	20%
HNL/Pago	121.20	13%	\$49.03	5%	once a month	121.20/49.03	\$72.17
	60¢ per lb		25¢ per lb		26 da	12/5	8%
LA/Pago	256.54	28%	\$49.03	5%	twice a month	256.54/49.03	\$207.51
	\$1.27 per lb		25¢ per lb		7 da	28/5	23%
HNL/Fiji	228.26	25%	\$62.20	7%	once a month	228.26/62.20	\$166.06
	\$1.13 per lb		30¢ per lb		26 da	25/7	18%
LA/Fiji	337.34	38%	\$64.48	7%	once a month	337.34/64.48	\$272.86
	\$1.67 per lb		32¢ per lb		30 da	38/7	31%
HNL/Gilbert	331.28	37%	No surface information is available to this area.				
	\$1.64 per lb		This land is government controlled.				
LA/Gilbert	624.18	70%	Ditto				
	\$2.09 per lb						
HNL/Tahiti	204.02	23%	\$57.80	6%	once a month	204.02/57.80	\$146.22
	\$1.01 per lb		29¢ per lb		6 da	23/6	17%
LA/Tahiti	321.18	36%	\$60.09	7%	once a month	321.18/60.09	\$261.09
	\$1.59 per lb		30¢ per lb		9 da	36/7	29%
HNL/Apia	270.68	30%	\$65.40	7%	once a month	270.68/65.40	\$205.28
	\$1.34 per lb		33¢ per lb		33 or 63 da	30/7	25%
LA/Apia	361.58	40%	\$65.40	7%	twice a month	361.58/65.40	\$296.18
	\$1.79 per lb		33¢ per lb		varies depending on feeder vessel	40/7	33%
HNL/Noumea	272.70	30%	\$152.01	17%	once a month	272.70/152.01	\$120.69
	\$1.35 per lb		75¢ per lb		21 da	30/17	26%
LA/Noumea	383.80	43%	\$152.01	17%	once a month	383.80/152.01	\$231.79
	\$1.90 per lb		75¢ per lb		21 da	43/17	26%

^aHonolulu

^bLos Angeles

more obvious and is recommended.

Communication/Ordering Information. The most serious problem that distributors encounter in the Pacific Basin has been one of communication, that is, when items have been ordered by improper names. The time required for proper descriptions via correspondence is uneconomical in terms of operation for both the project and the distributor.

Discounts. A distributor normally strives for a profit of 20-25%. This profit margin is derived from selling in volume to commercial outlets and resale dealers who buy in quantity. Since one- or two-item sales at full discount are uneconomical, and large volume sales are profitable to the distributor, it is felt that if the volume is large enough, an additional discount bonus is valid. In many cases, if the volume is large enough, the buyer is entitled to buy directly from the manufacturer.

Thus, in boatbuilding projects where the volume is great, the project may qualify as an OEM account (Original Equipment Manufacturer Account). Otherwise, when a limited quantity of multiple pieces of equipment is desired, purchasing through a distributor is recommended. At the same time, some distributors may treat a fisheries program as a commercial account with a smaller than maximum discount.

Payment Terms. Open accounts tend to discourage distributors. After the distributor has paid the manufacturer, each month of nonpayment by the buyer results in a 1% loss (not including warehousing, overhead, and other costs). Today's market dictates that prompt payment is worth money. Thus, when establishing terms, if the client pays promptly, most suppliers will give better service.

An Assessment of the Ponape Dory Project

STEPHEN RITTERBUSH¹

*The International Center for Living Aquatic
Resources Management, MCC P. O. Box 1501
Makati, Metro Manila, Philippines*

Introduction

The Ponape Dory Project has been in existence for almost 3 years. It was begun in August 1972 with a Federal Office of Economic Opportunity grant of US\$150,000. The initial grant was for a 2-year period during which seven Oregon-type dories were to be constructed.

The three objectives of the project were:

- (1) to develop a program that would train Ponapeans to build, equip, and operate small, highly mobile, open fishing craft without assistance;
- (2) to initiate a training program in boat handling and motor maintenance and repair; and
- (3) to institute a similar training and demonstration program in the fishing methods deemed most applicable to Ponapean waters in an effort to exploit the full potential of the dory as a fishing platform.

This program was designed to provide the foundation for a practical ongoing commercial fishery in Ponape. Even though there is a small subsistence fishery that utilizes

locally built plywood boats and outboard engines operating out of Kolonia in conjunction with the Ponape Fisherman's Cooperative, the Dory Project can be considered as the only real attempt made to date to develop a commercial fishery in Ponape.

Although this project has met certain aspects of its proposed goals—most notably the construction, outfitting, and operation of dories by Ponapeans—the fact remains that the dory fishery, as it is presently operating, has not developed as a self-sustaining, economically viable enterprise.

Of the 15 dories constructed by the project to date (seven in the initial stage and eight in the second phase), only three dories are actively fishing on a continuous basis. Currently, the Ponape Community Action Agency (CAA), the parent agency of the Ponape Dory Project, is subsidizing the boat shop with approximately US\$70,000 per year.

Thus in this report, both the major problem areas of the Dory Project and its achievements will be discussed for the benefit of future fishery programs similar to the Ponape Project. The major problem areas encountered by the Ponape Dory Project fall into three distinct categories: (1) ongoing maintenance and repair of dories and engines, (2) loan repayments, and (3) fishing tech-

¹Present address: P. O. Box 61, Tufts University Branch, Medford, Massachusetts 02153, U.S.A.

niques.

While the project has been in operation, it has been constrained by two major problems over which it has had little or no control and which have seriously affected the financial operation of the project. When the project was initiated in August 1972, it was impossible to anticipate the massive repercussions that worldwide inflation and the dramatic increase in the price of gasoline would bring. Since 1973, gasoline prices in Ponape have more than doubled, drastically affecting the daily operation of the dories. The original construction cost of a fully equipped dory was US\$5,500. The second group of eight dories was estimated to cost US\$7,000 each. However, subsequent inflation boosted this price to US\$8,200 as of August 1974; and the price undoubtedly has increased in the past year. This represents more than a 49% increase in the construction costs of the dory during the past 2½ years.

Inflation has even more severely affected a similarly run dory project initiated by the Government of the Gilbert and Ellice Islands where the most recently constructed dories eventually cost A\$11,200 (approximately US\$15,000).

Ongoing Maintenance and Repair

The Ponape Dory Project is 24 ft 6 in long and is constructed of mahogany frames covered with ½-in grade AA marine plywood. The dories utilize a 155 hp, model 250, six-cylinder Ford engine converted for marine use and coupled with a two-stage Hamilton jet.

The first objective of the project has been almost completely met. The dories constructed in Ponape are of high quality and superior workmanship. The Ponapeans who were trained to build and equip the dories have become skilled craftsmen. Dories constructed more than 2 years ago are still in operation.

The same situation does not exist for the installation, maintenance, and repair of engines. Only as late as a year ago, the engine workshop on the Dory Boat Works was in extremely poor shape. However, this situation appears to have been remedied recently with the hiring of a new mechanic who is reputed to be possibly the best in Ponape. His skill is clearly evident in that motor repair (other than the lag time required for the delivery of spare parts) no longer appears to be a major problem.

However, daily maintenance operations are still a persistent problem. Maintenance costs on the boat are estimated by the Ponape Dory Works to run approximately US\$60 per month and remain a problem despite the maintenance and repair policy instituted by the Ponape Dory Works at the initiation of the project. This policy was:

1. All parts and labor on necessary repairs not occur-

ring through negligence would be covered by the Community Action Agency for the first 90 days of boat operation.

2. Thereafter, parts would be supplied free for the next 90 days, but labor would be charged.
3. After 180 days, parts, maintenance, and labor would be charged for in their entirety.

The monthly maintenance costs appear to be the direct result of problems encountered with the dory engines and with the continual need to replace motor parts. The mechanical problems of the Ford 155 hp engine most frequently encountered by the project mechanic were:

- (1) Many of the Ford engines have cracked exhaust manifolds. This problem is possibly the result of engine racing at excessive rpm. The manufacturer recommends that the jets be run at approximately 3,500 rpm; but in trials, engine speeds of 3,700 to 4,500 rpm were often noted. On flat bottom dories, the high engine rpm appear to result directly from inability of the Hamilton jet unit to function efficiently in short, steep, choppy seas and on turns. Under these sea conditions the intake unit of the jet is unable to supply the required volume of water to the propulsion system. As a result, air pockets are formed, causing the motor to race excessively and overheat; these conditions possibly result in the cracked manifolds.

- (2) On the Ford engine, the starters are placed so low on the motor block that they are almost in the bilge of the dory. During the heavy rains that frequently occur in Ponape, the starters are often submerged in the bilge water and are eventually lost through rust.

- (3) The dory utilizes 40-gal aluminum gas tanks that are custom-made on the U.S. mainland and shipped intact to Ponape. Approximately six tanks from the last shipment are useless due to poor welding of tank seams by the supplier. These tanks have corroded and the seams have split. The project has been forced to absorb the cost of the entire shipment. Another problem resulting from the gas tanks is that the welded tank seams pull apart as a result of the constant pounding of the flat bottomed dories in short, steep, choppy waters.

- (4) In many dories, the electrical system shows signs of advanced corrosion in the wiring, especially in areas near the bilge. Apparently, this is the result of a lack of daily maintenance.

- (5) Initially, the original seven dories had hydraulic steering systems. Unfortunately, the rams on these steering systems tended to jam. To simplify boat maintenance and operation, the manager of the Dory Works replaced the entire hydraulic system with a simple cable steering mechanism.

- (6) A constant problem with the dory engines is

overheating. This is probably the result of insufficiently ventilated motor covers.

(7) The outdrive unit of the Hamilton jet is constructed of aluminum. At the outset of the project, the dories developed extensive corrosion problems on the outdrive units as a result of electrolysis. This problem has been remedied by placing zinc plates on the outside of the hull. However, some of the dory operators have been negligent in replacing the zinc plates, and the aluminum outdrive units continue to corrode.

(8) In the engine workshop of the Dory Works, there is a box filled with engine parts that have been replaced from the first 10 dories. If the parts in this box are to be taken as any indication, the weak links in the engine are primarily the starters and the generator, and in some cases the carburetor.

(9) The hydraulic line pulling systems placed on several dories in the first phase of the project have never been utilized and consequently have been abandoned, and in some cases removed.

The question has been raised as to why gasoline engines were initially selected for use in the dories. Although many shortcomings are involved in utilizing gasoline engines for a project of this type, a major advantage is that this motor is basically an automobile engine that has been modified for marine use. A number of mechanics are located on Ponape as well as other Pacific Islands (such as the present mechanic employed by the Dory Project) who have had wide experience working on automobile engines and require no extensive training for the dory engine. The Ford dealer on Ponape presently carries a line of appropriate spare parts. A former situation of a severe backlog of spare parts due to delay in reordering practices and poor management has been solved to some extent, but there is still a 3-month time lag from the moment parts are ordered until they arrive on Ponape.

Another problem is the lack of follow-up on the initial motor maintenance training and trouble-shooting program. Initially, only 30 hours of training were given to each new boat owner. This training included boat handling, engine starting and trouble-shooting, and minor maintenance and repair.

In the case of most of the dory owners, this was the first time that they handled anything larger than an outboard motor. Thus, the introduction of the dories caused an extremely large jump in technology transfer. This particular training program should have been one of the foundations of the entire Dory Project; yet the initial session was the only training in motor maintenance that the dory owners ever received. Although the facilities for doing so presently exist, and although the services of an exceedingly capable mechanic are available,

no follow-up maintenance and repair training programs have been organized.

Many of the problems regarding engine maintenance and repair could have been alleviated by simple preventive maintenance measures. Thus, any future programs should provide for long-term and sustained training programs in these particular areas.

Loan Repayments

Discussions were held with the Economic Development Loan Officer responsible for loans made to dory owners by the Trust Territory Government. Of the 15 dories constructed by the Ponape Dory Project, two are currently owned outright by the Community Action Agency; one belongs to the Office of Marine Resources; two have been repossessed by the Government for non-payment of loans and are kept at Marine Resources; two belong to government employees (a high school principal and a doctor) who paid for the dories from their government salaries and are only casual weekend fishermen; one dory was lost at sea off Guam; and one dory is used primarily on one of the outer islands. The remaining six dories have loans outstanding through the government-sponsored Production Development Loan Program. The boat owner most up to date in repayment is still 2 months behind; the next best is 5 months behind. All others are 11 to 15 months in arrears on payments. Out of a total loan of US\$5,500, the largest sum that has been repaid to date on any dory is US\$1,400 (Table 1). No set standards have been made for repossession of the dories when an owner has fallen in arrears on his payments. Although the *Marda* and the *Lisa* have been repossessed, the *Suana*—15 months in arrears—is still in operation; apparently not one payment has been made to date.

According to the Economic Development Loan Officer, the primary excuse for nonpayment of loans is that not enough fish are caught to cover the operational cost of the dory and payment of the crew, as well as the monthly loan repayment. However, he is not of the opinion that this excuse is in fact always the case, since even the most effective dory in the fleet, the *Luck*, is still 5 months in arrears on its loan payments.

Other owners have complained that the Dory Works does not provide sufficient help in maintaining and repairing the dory engines. The fishermen believe there is evidence that when a dory is experiencing mechanical problems, the crew is hesitant to go beyond the outer reef to the primary fishing grounds.

The fishermen's preference for trolling for skipjack tuna rather than on diversifying the fishery by incorporating other techniques (such as bottom handlining) is one of the main reasons the dory owners are not making

Table 1. Loans for financing dories obtained from government-sponsored Production Development Loan Program, April 24, 1975.

Dory	Original loan	Months in arrears	Loan balance
<i>Lisa</i>	\$5,000.00 ^a	11	\$4,196.31
<i>Luck</i>	5,600.00	5	4,749.86
<i>Suana</i>	5,550.00	15	5,550.00
<i>Marda</i>	5,550.00 ^b	12	5,402.35
<i>Y. Fin</i>	5,550.00	2	4,351.24
<i>Anatoki</i>	5,000.00 ^c	0	0
(Marine Resources <i>Nekton No. 3</i>)			
<i>Marlin</i>	5,550.00 ^b	0	0

^aRepossessed^bPaid off by insurance company after destruction^cBought by Marine Resources

money. Even during the off-season for skipjack, the dory fishermen still persist in trolling. This method of fishing uses an inordinate amount of fuel. With gasoline presently selling for US\$0.62 per gallon, operating expenses for the dories have risen from US\$12.50 per day in 1972 to more than an estimated US\$30 per day. The present catch rates from trolling are not enough to cover this expense as well as payment of the crew and the monthly loan repayment.

The financing of the boats is for 3 years at 3% interest with a 6-month grace period before the first payment is due. The monthly payments have ranged from US\$150 per month for the first seven dories to US\$210 per month for the second set of eight dories. Apparently, the original purpose of the period was to give each dory owner an opportunity to learn the operation of his boat, to improve his fishing techniques, and to establish himself economically.

Since the project has already been in operation for 2½ years, it appears that the grace period has not proved to be an incentive for the dory owners to make their loan payments on time. It is apparent that the dory owners feel little or no pressure to meet their loan responsibilities after this 6-month period expires.

The failure in the loan repayment system is that many of the fishermen have had little or no experience with systems of credit. A solution to this problem would be to require both a downpayment and immediate monthly loan repayments. The fisherman should be required to put some of his own equity into the dory; mere participation by the individual fisherman in the construction and outfitting of the dory is not sufficient.

An excellent sample of a fisheries development program which required equity participation is one initiated in early 1970 in Western Samoa. The government there

provided outboard motors on credit; but each village wishing to participate in the project was required to construct its own fishing craft from locally available material as part of its equity contribution.

Fishing Techniques

Neither catch rates nor the number of trips per boat came close to the levels anticipated in the original project proposal (Table 2). The number of trips per month is approximately one-half of what was initially projected. The two main problem areas apparently were a general failure to train the fishermen to use the proper methods for the appropriate seasonal fishing, and a general failure to maintain the fishing activities of each dory for a sustained period of time.

Trolling, as mentioned, is by far the preferred method of fishing used by the dory fishermen in Ponape. Although bottom fishing is more economical in terms of fuel costs, very few fishermen consistently utilize this method even during the off-season for skipjack when it probably would prove profitable to do so. During the early training stages of the Dory Project, the initial bottom fishing trials showed considerable promise. In three successive nights of bottom fishing in April 1973, 900 lb of fish were landed the first night, 1,200 lb the second night; and 700 lb the third night. The few boat owners that go bottom fishing at present are not successful, primarily because they are not fishing at night in areas that are deep enough water beyond the main reef and away from the main population at Kolonia. The initial bottom fishing trials were carried out on the outer reef edge in 40 to 120 fathoms of water, mainly off the southwest tip of the island. Other successful trials were conducted along the outer reef on the northeast side of the main channel near Kolonia.

When the Dory Project was begun, training courses in appropriate fishing methods applicable to the waters surrounding Ponape were an integral part of the program. However, these training programs were only 2 weeks long. Various methods of trolling and bottom handlining were demonstrated to the dory owners. When these initial training demonstration courses were completed for the first six dory owners, the program was discontinued by the project. To date, there has been no follow-up program. A sustained and ongoing fishermen's training program in suitable bottom fishing methods for deep water reefs species is greatly needed. A major problem with this fishery at present is an overdependence on a one-species (i.e., skipjack) seasonal fishery. There is a great need to diversify the methods of the dory fishing fleet.

The other serious socio-cultural problem is that fishermen will not fish for more than 3 or 4 days in

Table 2. Average tuna catch per trip for the first nine boats in the Ponape dory fleet, March 1973-June 1974. Data from catch statistics forms submitted by dory owners in the Ponape Fishermen's Cooperative Association and the Department of Natural Resources. Analysis concentrates on skipjack since prices paid for skipjack and bottom fish at the Ponape Co-op were not differentiated on the data forms and because 82% of the dory trips between March 1973 and June 1974 were for skipjack.

	<i>Limwehtu</i>	<i>Lisa</i>	<i>Anatoki</i>	<i>Marlin</i>	<i>Luck</i>	<i>Marda</i>	<i>Sea Queen</i>	<i>Suana</i>	<i>Yellowfin</i>	Totals
Total no. trips	44	162	78	71	97	82	63	82	12	691
Tuna catch (lb)	3474	24527	9788	13871	10749	11536	7400	10074	301	91720
No. reef trips	13	6	15	8	29	11	38	25	10	155
Avg. no. fishermen	3.31	2.67	2.91	2.94	3.05	2.32	3.05	3.0	3.25	2.86
Avg. no. trips/mo	4.99	12.46	7.09	7.89	9.70	8.20	7.0	10.25	6.0	
Avg. catch/mo	386.0	1886.69	889.82	1541.22	2074.9	1153.6	822.22	1259.25	150.5	
Avg. no. reef trips/mo	1.44	0.46	1.36	0.89	2.9	1.10	4.22	3.13	5.00	
No. months fished	9	13	11	9	10	10	9	8	2	81
Avg. catch per trip	78.95	151.4	125.49	195.37	213.90	140.68	117.46	122.85	25.08	147.21
Avg. catch/fisherman	23.85	56.7	43.12	66.45	70.13	60.64	38.51	40.95	7.72	51.47

succession. As in many areas of the Pacific, fishing activity is sustained only long enough to earn sufficient cash to meet a family's immediate needs or to pay off local village obligations. Once these responsibilities are met, it is not unusual for fishing activities to be discontinued for up to as much as a week at a time until cash reserves are again depleted. The concept of a "commercial" fisherman, as is known in the United States or Japan, is alien to their culture.

Originally, it was anticipated that the dories would carry trained, permanent crews. Currently, none of the dories has a permanent crew, unless it is entirely a family operation. Dory owners have found it difficult to maintain permanent crews, and at present they normally select crews on a short-term basis only. A general consensus of opinion among the management personnel of the Dory Project is that the most successful boats are those operated on a family basis. A similar situation was true for the Dory Project in American Samoa. It thus appears that family operations provide a cohesion which does not otherwise exist.

The dories were designed to hold a total catch of greater than 1 ton. From March 1972 to June 1974 (the period for which catch data are available), the most any one boat caught in a single month while making no less than four trips is a little more than 1½ tons. Catches by the dories initially increased from an average 103 lb per trip to a peak average of 237 lb in October 1973 (Fig. 1). Thereafter, catches fell considerably. The initial increases in dory catch rates can probably be attributed to two factors: existence of the fishermen's training program, and the onset of the 1973 skipjack season during the summer months. Catches dramatically declined immediately after the skipjack left the Ponape area. To help subsidize the fleet during this period, the CAA allowed boat owners to purchase gasoline for dory operations on credit. Until this credit subsidy was stopped in early 1974,

the boat owners managed to incur a US\$10,000 debt to the CAA in fuel purchases.

In July 1974, the CAA instituted a new policy. Fuel purchases were no longer allowed on credit. Dory owners were expected to buy their own fuel supplies and simultaneously pay off the US\$10,000 debt. This was accomplished by deducting 10% of the total purchase price of each catch landed and sold at the Ponape Co-op and by applying it toward payment of past bills owed to the CAA. The initiation of this new fuel repayment policy placed an additional financial burden on the fishermen, making it difficult for them to meet the payments for the dory loans, the crew's wages, and the boat's operations. This may be just one more reason why the volume of the catch landed by the dory fleet at Kolonia declined. Faced with this further 10% deduction on their catch earnings, the fishermen apparently felt that their operations were even more unprofitable than before the initiation of this policy. It appears that at present, this policy is no longer in operation.

Another major setback for the Dory Project was that

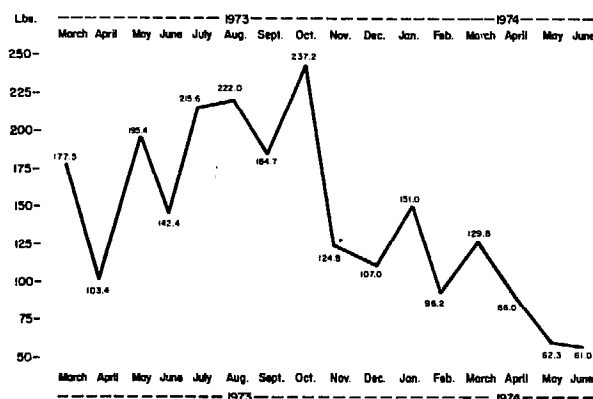

Fig. 1. Average catch per trip by month for the first nine boats in the Ponape dory fleet, March 1973-June 1974.

the number of skipjack found off Ponape during the summer of 1974 was smaller than had been anticipated. High catch rates did not materialize during this period and thus earnings fell even further.

Catch and Effort Analysis

The *Lisa* and the *Luck* also made the greatest number of trips per month (Table 2). Differences in the fishing skills of the crews of the various dories were quite apparent. For example, the *Luck* made 40% fewer trips than the *Lisa*, but caught only 15% less than the *Lisa* in terms of total catch. Although the *Lisa* registered the largest total catch in pounds during the period of study, the *Luck* had an average catch per month and per trip that was considerably greater than any other boat in the dory fleet. The *Luck* also had the highest catch per effort in the dory fleet with 70.1 lb per fisherman per trip. In fishing efficiency, the only other boat with a similar catch per effort was the *Martin* with 66 lb per fisherman per trip. As would be expected, catches were strongly correlated with the number of trips per month; total landings (in pounds) of fish increased as the number of trips increased.

In the original proposal for the Ponape Dory Project, it was anticipated that the fishermen would fish approximately 200 nights per year. However, the dories were averaging only 8 to 12 trips per month, one-half of the number of fishing trips predicted (Table 2). In terms of maximizing the revenues for each dory, it should be noted that the number of fishermen on any particular trip apparently had no significant impact on the total tuna catch landed. This result is not too surprising, given the method used to catch skipjack. To maximize the individual fisherman's share on future trolling trips, only the minimum number of fishermen necessary (probably two fishermen and one helmsman) should be carried aboard each dory. More than two fishermen per dory only reduces the total share received per trip. Because the dory is designed for both trolling and bottom-fishing, the optimum crew size will vary with the type of fishing being undertaken. Each dory owner should maintain flexibility in varying the number of crew; a small crew should be used for trolling, while a larger crew should be used for evening bottom fishing.

Dory Performance

While in Ponape, I made several short trips in both a flat bottom dory and a modified V-bottom dory to ascertain their performance capabilities. Due to heavy seas on the outer reef, the dories were run only in the channel area inside the reef near Kolonia. Currently the flat bottom dory is being used by the Office of Marine

Resources, while the modified V-bottom dory is owned by the Community Action Agency. Both dories are powered by a Ford Model 250 C.I.D. six-cylinder engine equipped with marine conversion at 155 hp and coupled to a two-stage Hamilton jet. According to personnel at both offices, the performance of each dory was considered typical of other dories in the fleet.

As stated in the original proposal, the dories were expected to achieve an estimated maximum speed of 28 mph at 3,800 rpm. Both the flat bottom and modified V-bottom dories performed far below this predicted speed. The Marine Resources dory, the *Nekton No. 3*, formerly the *Anatoki*, is one of the original flat bottom dories utilizing the Hamilton jet. In tests with this dory, the maximum speed was approximately 19 mph. The engine tended to race occasionally due to the slight chop in the inner reef, and the hull was unable to reach a planing position even when running at maximum speed.

After the initial phase of the Ponape Dory Project, the dories were redesigned and constructed with a modified V-bottom to attain better performance with the Hamilton jet, especially in the short, steep, choppy seas around Ponape. The CAA owns one of the new modified V-bottom dories. This boat is also powered by a Ford marine engine connected to a Hamilton jet.

In test runs, it performed somewhat better than the flat bottom dory, attaining a top speed of approximately 21 mph and showing no engine racing. Even so, the V-bottom dory was still unable to reach a planing position running at a top speed of 3,700 rpm.

Similarly designed dories in the American Samoa Dory Project were powered by a 135-hp gasoline Volvo-Penta with inboard-outboard drive. These dories were able to attain a top speed of approximately 28 mph. Although the American Samoa Dory utilized 13% less horsepower than the Ponape V-bottom dory, it was able to achieve approximately 25% more speed. Translated into savings on fuel expenses, it is apparent that the American Samoa Dory is approximately 25 to 30% less expensive to operate than the Ponape Dory.

Thus, a major problem appears to be that the jet drive unit mounted on the Ponape Dory was incompatible with the dory design. Landed in Ponape, the Hamilton jet unit costs approximately US\$800 each. Its use was to allow the dories to travel in waters which were too shallow for either outboard or conventional through-the-hull straight shaft propeller driven boats. It was believed that the jets were a necessity in Ponape due to the extensive surrounding outer reef. However, a trade-off must be considered when the high initial investment required to purchase a Hamilton jet is compared to the cost of a conventional straight-shaft direct inboard drive. Every effort should be made to reduce the cost of the

dory to a level that can easily be afforded by the Ponape fishermen. Conventional through-the-hull direct-drive units can be installed for only a fraction of the cost of a jet unit. Utilization of a jet unit should be considered only in areas where it is absolutely essential that either wide expanses of shallow reef be crossed on a continuous basis or where boats must be beached daily.

The boatbuilders, the engine mechanics, and the manager of the Ponape Dory Works generally agree that the price of the dory was far beyond the means of the average Ponape fisherman and that the price of any future design introduced into Ponape should be in the range of US\$2,000-\$3,000. This figure was based on the cost of a locally constructed plywood boat (approximately US\$600-\$800) and a 25-hp outboard (US\$800), with the consensus that the local fisherman would be willing to pay a slightly higher price for a more seaworthy and reliable design, capable of outer-reef fishing in all but the most serious weather conditions. Even so, the ability of the fisherman to afford a fully outfitted fishing craft costing between US\$2,000-\$3,000 may be questionable. The apparent repayment rate for the locally constructed fishing boats is not much better than that of the dories.

Serious consideration should be given to scaling down the design of the dories presently being constructed at the Ponape Dory Works. Although the dory is designed to carry a catch load of 1½ to 1¾ tons, to date, daily catch rates have fallen far below this design capacity. The maximum fish load presently required for the Ponape fishery is apparently no greater than 800 to 1,000 lb (Table 2). Further consideration should be given to constructing a boat with a hull that can easily be driven at a top speed of 14 to 15 mph, that is no greater than 18 to 20 ft long, and is capable of carrying a maximum fish load of 800. The power source should be not only reliable, but also economical in terms of fuel consumption.

A 1974 report on the Ponape Dory Project stated that if the mechanical problems the project was encountering were corrected and that if the price of fuel were lowered, the project could begin operating on a financially sound basis. The first point has been rectified somewhat with the hiring of a new mechanic. However,

the price of fuel has not been reduced, nor can it be expected to be lowered in the foreseeable future. Given the present catch rates and the high operating expenses required to run the dory, the Ponape fishermen are faced with an inordinately large financial burden.

One major problem area with the Ponape project was a lack of ongoing sustained training programs for fishing techniques applicable for use in the dory, use and operation of the dory, and maintenance and repair of dory engines. In most instances, initial training programs were discontinued after the opening phases of the project. Although seriously needed, no follow-up occurred in this area, especially in fishing techniques and motor maintenance.

The original estimates of catch rates (upon which the economic feasibility of the Dory Project was based) proved to be highly optimistic not as to the general availability of fish, but in regard to the fishermen's performance. In particular, the projected plan called for 200 fishing trips per year. On the average, the actual performance came to less than half this number. The dories averaged only 5 to 12 trips per month (Table 2).

Another major problem was the almost total dependence of the fishermen on a seasonal skipjack fishery and their unwillingness to adopt fishing techniques other than trolling. It was not uncommon for the dories to continue trolling for skipjack during the off-season. The consequent catch rates were so low that they were inadequate to cover the operating expenses, the crew payments, and the loan repayments.

The choice of jet-power for the dory propulsion system seems to have been a mistake. The incompatibility of the jet system with the dory design has resulted in poor speed, high engine rpm, and consequently poor fuel economy and high operating expenses. The carrying capacity as designed for the dories is far too great for the present landed catch rates.

It appears that the dories are overdesigned and uneconomical for the type of artisanal fishery operation required for Ponape. They are too great a technological jump from the fishing craft previously utilized by the Ponapeans. Thus, a scaled-down design capable of outer-reef fishing should be seriously considered.

Cultural Aspects of Economic Development Efforts in Ponape

EDWELL SANTOS

*Ponape Community Action Agency
Kolonja, Ponape
Eastern Caroline Islands 96941
Trust Territory of the Pacific Islands*

The traditional fishing techniques commonly used by Ponape Islanders are gillnetting and the use of the poisonous vine. Trolling for skipjack, bottom handline fishing for other reef and lagoon fish, and skindiving with spear gun were introduced into Ponape by the Japanese and people from other island areas in the Pacific.

For the 20 years of the American administration, Ponapeans have used small 18-ft boats powered by outboard engines for fishing. The adoption and use of this type of fishing equipment has been extensive and is quite easy for a Ponapean fisherman to handle. Beginning in 1972, the Oregon dory was introduced with a higher horsepower engine and a jet drive propulsion system. Though the dory is quite easy to handle, several components exist which Ponapean fishermen, who often are not mechanics, must learn to operate and maintain. In addition the dory is equipped for several types of fishery operations which are not commonly performed with the small 18-ft boats. As indicated in Ritterbush (this volume) . . . "the introduction of the dories caused an extremely large jump in technology transfer."

From a cultural perspective, Ponapeans are commonly known for being too gentle and generous. Most Ponapeans would say "let it be done as it is, or let those in command or who have been to school take care of it

for us. We wait to see what happens. If it is good or productive, we'll join in later, otherwise not." The initiative towards development is somewhat limited if not totally lacking. Our people have lived under four different foreign administrations—Spanish, German, Japanese, and now American. Older Ponapeans have been influenced one way or another under these different administrations.

One influence has been religious teachings which have stuck in the minds of many Ponapeans and have become an integral part of their behavior. An example of this influence is found in the Bible, Matthew 6:34: "Therefore do not be anxious about tomorrow, for tomorrow will be anxious for itself. Let the day's own trouble be sufficient for the day." This Biblical statement, as implanted in the minds of many of our old folks, has resulted in what may be the best termed as "short-term, goal-oriented people," thus creating a stumbling block to future development in Ponape.

Ponapeans are accustomed to working for short periods or only long enough to gain what they want for the day, for an occasion, or for a feast. Once they have achieved such a short-term goal, they feel satisfied and relax. The concept of the long-range goal is, in many Ponapean minds, limited, if not totally lacking. The idea of working in a shop or in one area for 8 hours or 24

hours per day to earn a living is not that important, nor is it a part of Ponapean work habits.

Ponape has an integrated society where everyone knows everybody. If a man dies in a community, everyone in that community attends the funeral which lasts for at least 3 days. If one is an employee of the government of business, or if any important work has been scheduled when someone dies, both work and plans must be delayed so that everyone can attend community affairs. If one does not attend, the rest of the people will consider the individual disrespectful, unloving and nonconforming to the values of the community. This social factor does affect a fisherman's time.

Ponapeans do not concentrate on one type of work to earn a living. Previously, four basic items were necessary for a Ponapean to be referred to as a "man to be honored": (1) house, (2) yam, (3) kava, and (4) pig. As new material things are being continuously introduced, i.e., cars and outboard motors, these are being added to this list.

When a fisherman acquires a new boat for small-scale commercial fishing, he does not divorce himself completely from these four items. If he goes fishing 5 days a week and obtains enough money to buy food and other necessities for his family for the next few weeks, then normally he will stop fishing to work on his yam and his kava, to feed his pig, or maintain his house. This attitude affects his fishing time. Conversely, if he had fished and made more money, he might spend the money to build a new house or to buy a car, while disregarding his obligation to repay his loan.

An important facet of the Ponapean system of life is to maintain a harmonious family, and to do so, certain family obligations must be observed. For example, if one person from a family is employed, he is obligated to divide his wages among the members of his family to enable them to buy necessities. The effect of this is that the wage earner does not often have enough surplus either to deposit in a bank to earn interest or to invest in other business ventures that have economic potential.

Most Ponapeans have developed the attitude that the Government can take care of their affairs. For example, if one is indebted to the Government or any other institution, he is inclined to believe that the Government or the institution is rich and therefore would not come after him for the debt. In one instance, a dory boat owner was asked what he would do if he could not make enough money by fishing to repay his loan. He said, "I don't care if I do not make enough money to pay for the loan because it is Government money, and the Government is supposed to help the people."

Ponapeans want to think of the present and get what they want now, not in the future. If they set out on a

business venture, they like to see immediate results. The concept of deferred gratification is limited in the minds of many Ponapeans, particularly the elderly whom the young do respect.

The Trust Territory Government's loan requirements and their administration are perhaps not stiff enough to encourage the average Ponapean to meet his monthly payments. Also, orientation and follow-up services are inadequate for the people who have received economic development loans. As a result, the purpose of the economic development project is defeated when the person finds himself unable to pay back the loan because he is not producing. When he does produce, he often finds there is no market for his products and thus is discouraged and stops the operation of his business. Additionally, when he does make money, he tends to spend it on other things which he does not already have.

Generosity is a Ponapean characteristic. If, for example, one has \$100 budgeted as a monthly installment for a repayment loan, and a relative or friend asks for help to buy some rice or kerosene for his family, the Ponapean would naturally respond favorably to him. The Ponapean would assist, in this case, even if an insufficient amount of money, or nothing at all, remains to pay toward the loan for that month.

Traditionally, our economy had been mainly one of subsistence. A monetary economy is a foreign concept which is, however, finding its way into our present lifestyle. It is not easy to completely and immediately divorce ourselves from a subsistence economy to adapt to the newly introduced cash economy, because our way of life depends on both systems.

Thus, if a Ponapean goes to an honored feast or funeral, he does not need money to contribute to these affairs. He must have yam, pig, and kava as his main contributions, and money becomes secondary. Perhaps the next generation will adopt the cash economy as their primary way of life as opposed to the combined subsistence and cash economy that we live with today.

When considering any economic development venture in Ponape, one must consider these cultural aspects of our people. To devise positive remedies, perhaps the most important matter one should consider is the availability of an efficient orientation program and follow-up services throughout the term of the project. When a Ponapean realizes that after a certain period of time, he may earn a certain amount of money from an investment, that is the time that the majority will join in. This will break the barrier of the "let's wait and see" or "let the government take care of it" attitude. Only when the concept and purpose of development efforts are completely understood will the average Ponapean realize and accept such ideas as long-term goals or planning for the future.

Boats Designed for A Village Fishery in Western Samoa

ØYVIND GULBRANDSEN AND ARILD OVERAA

*FAO/DANIDA Village Fisheries
Development Project
Apia, Western Samoa*

Introduction

A survey conducted throughout Western Samoa in December 1974 showed the following number of fishing craft and engines:

Fishing Craft	Local Name
1,130 Small outrigger canoes	paopao
140 Bonito canoes	va'aalo
10 Western-type boats	va'aafi
83 Outboard motors, 6-40 hp	alia

The paopao is unsuitable for use in the open sea and only the larger va'aalo can be fitted with outboard motors. The alia are always used with an engine as are most of the va'aafi. The number of fishing craft, either paddled or mechanized, used outside the reef is thus about 170 compared with 1,130 paopaos, which are used primarily for inshore fishing. This emphasizes the heavy reliance on the lagoon fishery in Western Samoa. The only resource capable of sustaining increased catches, however, is situated outside the reef, mainly skipjack tuna and bottom fish at the 60-150 fathom (110-274 m) depth. Presently Western Samoa is annually importing

more than US\$1 million in tinned fish and there is a need to expand local production of fresh fish to counteract this heavy drain on foreign exchange. The Government has, in its Five-Year Development Plan 1975-1979, put the main emphasis on strengthening the economic foundation of the outer villages. The Fisheries Division within the Department of Agriculture has prepared a village Fisheries Development Project with an aid input of US\$408,000 from the Danish International Development Agency (DANIDA) channelled through FAO.

Boat development within this project falls into three phases: (1) Support to viable fishing units using traditional craft and outboard engines, (2) Introduction of new boats, and (3) Expansion of boatbuilding.

The motorization of traditional craft began 6 to 7 years ago. Several setbacks occurred at the start, partly due to difficulties in keeping the engines running and partly through an undue reliance on village fisheries cooperatives. The fisherman often had to wait 6 months for spare parts and there was also a lack of trained mechanics. The Fisheries Division in 1973 established an outboard engine repair shop with the assistance of the Japanese Overseas Volunteers Organization (JOCV) and in late 1974 the Government placed a bulk order for 50

outboard engines of 20 hp with spare parts. This had the advantage of reducing the price from WSS\$400 to WSS\$350¹ per engine and at the same time facilitating the spare-part supply through standardization. These 50 engines arrived in February 1975 and were sold out within 2 weeks, indicating a tremendous demand on the part of the village fishermen for further motorization.

Records show that a typical fishing unit consists of a traditional craft with outboard motor, employs two to three men, makes 100 trips per year (two per week) and has an average catch of 80-100 lb (36-46 kg) per trip. The yearly catch is approximately 4 tons per unit, valued at WSS\$2,500. The investment cost for a traditional fishing unit is about WSS\$400 for the alia, WSS\$410 for the engine, and WSS\$100 for fishing gear. The total investment is, therefore, around WSS\$900 (approximately US\$1,125).

In early 1975 the Government established an "Agriculture Store" where fishing gear, engines, and spare parts are sold with only a 5% duty. This has been of major assistance to the village fishermen and has removed one of the major obstacles to development in the past—essential gear and equipment were not available or were available only at high cost.

Introduction of New Boat Designs

CHOICE OF BOAT TYPES

The motorization of existing local craft was the first logical step in the development of the village fishery outside the reef. These craft, although excellent for their original purpose, do not always perform well with an outboard motor and new boat types were required for a further expansion of the fishery. After 1 year of building and testing various types of boats ranging from 18 ft to 28 ft (5.5-8.5 m), the choice had been narrowed down to two types.

Type A : 28-ft (8.5 m) single-hull, V-bottom boat with a 20-hp inboard engine. Cost of boat and engine is WSS\$2,500. Maximum speed is 9.5 knots (Fig. 1).

Type B : 28-ft (8.5 m) a catamaran with 25-hp outboard engine and a 5-hp spare engine. Cost of boat and engines is WSS\$1,420. Maximum speed is 13 knots (Fig. 2).

Extensive fishing trials proved that the smaller boats of 18-20 ft (5.6-6.1 m) were more hampered by weather and proved inferior for bottom handlining. Type A is an inboard engine version of a 28-ft outboard powered boat. The long and slender hull has proven to be easily driven for medium speed in the region of 9-10 knots. This speed

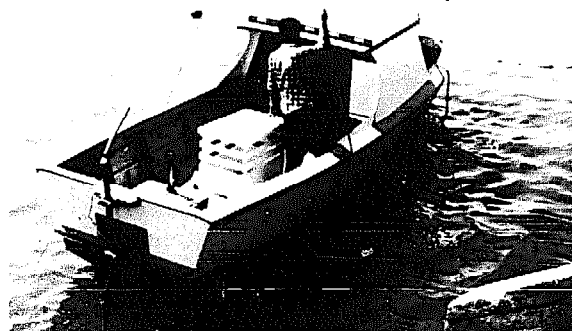

Fig. 1. Type A boat: a 28-ft, single-hull, diesel boat with removable propeller for shallow draft.



Fig. 2. Type B boat: a 28-ft alia with 25-hp outboard engine.

is considered essential for catching skipjack which often move in fast-running schools. A faster boat, such as used in Tahiti with a speed of around 25 knots, is of course advantageous when chasing tuna schools, but the power requirements increase out of proportion and it is also difficult to maintain the high speed of a planing-type boat in the average sea conditions around Samoa. A speed of 9-10 knots can be maintained economically and relatively comfortably with a 20-hp inboard engine, in a hull specially designed for this "medium-speed." The main feature of such a hull is a sharp bow, length/beam ratio of 4-5, and a flat transom stern. A planing-type hull of length/beam ratio of 3 is uneconomical to operate below a speed of 15 knots.

Experiments were made with an inboard petrol engine of an air-cooled, industrial type installed in a 23-ft (7 m) boat. Although the basic engine is very cheap, we found that by the time a gear, propeller shaft, propeller, and a rudder had been added, together with the extra work involved in preparing an engine bed and skegs, the total cost was about the same as an outboard motor. We found

¹US\$1.30 = WSS\$1.00

the electric ignition system of this engine more vulnerable to humidity and spray than the sealed CDI ignition system of a modern outboard engine. A marine diesel engine of moderate horsepower was therefore selected for the inboard powered boat. So far four boats of Type A have been delivered.

Type B is a catamaran and represents a further development of the local-type alia, with very much improved seaworthiness. The local alia are made from hollowed-out tree trunks and the heavy weight and low freeboard make them very wet in an average sea condition. The new alia is made of marine plywood and, although longer than most local catamarans, is considerably lighter. The distance from the bow to the deck is long enough to avoid most slamming in a head sea. Trials with an alia of 19 ft (5.8 m) showed that length is important, especially for the performance in head sea and the 28-ft version proved superior. Compared with a 28-ft single hull boat, the alia is about 2 knots faster with a 25-hp engine and the movements are more acceptable to the local fishermen who are used to outrigger canoes. The position of the engine between the two hulls reduces the risk of getting the trolling lines caught in the propeller, and the greater beam reduces the chance of tangles when using bottom lines. The alia is fitted out with four fishing reels of a local manufacture which reduces the effort in hauling up fish from 100 fathoms (183 m) or deeper. The 28-ft alia has proven very popular with the local fishermen and so far 10 have been delivered since May 1976 with 20 more on order.

CHOICE OF CONSTRUCTION MATERIAL

When the boatbuilding program started in 1975, local timber was used as much as possible. The boats were built with a 12-mm planking and seam batten construction. It soon proved necessary to use Dynel sheathing to above the waterline due to the shrinkage and swelling opening up the seams. With Dynel sheathing and epoxy resin, the construction method has proven satisfactory. Due to scarcity of local timber that would take pressure treatment, it became necessary to look for alternatives, and from the beginning of 1976 we have imported pressure-treated plywood from Papua New Guinea. This plywood has proven superior for planking and not much more expensive, taking into account the saving in labor. We consider it essential to use pressure treatment, and not just specify marine plywood. A boat belonging to the Fisheries Division built of nontreated marine plywood required extensive repairs due to rot damage after only 4 years of service.

Aluminum is probably the ideal material for small boats used in a village fishery where they are subject to knocking against coral heads and dragging up the beaches.

FRP would require extensive protection to avoid damage to the Gel coat and thereby possible future deterioration. We are planning to build the two hulls of the alia in aluminum to evaluate this material versus the present wooden construction.

CHOICE OF ENGINE

Boat construction in the village is feasible only when using relatively simple boats powered with outboard engines. The proper installation of a diesel engine requires care and should be done by an experienced marine mechanic. The inboard powered boat is much more difficult to build. Is it worth it? What will be the yearly operating costs of a 28-ft boat with an outboard engine compared to a diesel? Although the diesel has a more efficient propeller, it is also 250 kg heavier. We have found that with the same load the 28-ft with a 25-hp outboard is 3 knots faster than the 28-ft diesel-powered boat.

The diesel-powered boat is about WS\$291 lower in annual costs than the outboard (Table 1). This must be balanced against the considerably higher investment cost of the diesel (Table 2) and the inconvenience of not being

Table 1. Comparison of annual costs of operating outboard and diesel-powered fishing boats in Western Samoa.

Item	Annual costs (WS\$)	
	Outboard	Diesel
Depreciation of boat over 5 years at 8% interest	207	325
Depreciation of engine (outboard—2 years, diesel—5 years)	330	330
Fuel costs, 600 h/year, ¾ speed (outboard—1.8 gal/h at \$0.62/gal diesel—0.9 gal/h at \$0.52/gal)	670	281
Maintenance and repair of boat	30	40
Maintenance and repair of engine	60	60
Repair and replacement of fishing gear	80	80
Wages, in cash or fish, 4 men	1,200	1,200
Total yearly costs	2,577	2,316

Table 2. Investment costs of outboard and diesel-powered fishing boats in Western Samoa.

Item	Investment cost (WS\$)	
	Outboard	Diesel
Cost of boat with accessories including engine installation	830	1,300
Cost of engine and accessories	590 ^a	1,200
Total cost	1,420	2,500

^aIncludes 5-hp spare engine.

able to remove the engine easily and transport it to an experienced mechanic when breakdown occurs. Breakdowns of diesel engines occur less frequently than with outboards, but are usually more serious, and repairs in a village might be difficult. In Western Samoa a bus leaves from almost every village each day, and an outboard engine can be transported quickly to one of the two workshops of the Fisheries Division. Although a diesel engine is preferable when fishermen are operating out of a protected port with the service facilities, for a village fishery there is no clearcut advantage of one over the other. In June 1976 the Government started to provide petrol mixed with outboard motor oil to registered fishermen at 5% duty. This has cut down the cost of fuel from WSS\$0.90 to WSS\$0.62 per gallon.

Boatbuilding Project

In the middle of 1976 a new boatyard was completed outside Apia and at present employs 16 men, mostly ex-leper patients. Two alia and one diesel boat are built simultaneously using jigs. The construction time for a 28-ft alia, using four men, is 8 working days.

The cost of the alia is nearly 40% less than that of a 28-ft diesel (Table 3). The boats are sold fully equipped through a hire purchase scheme whereby the fisherman pays \$150 in deposit for the 28-ft alia with a repayment period of 18 months. If the fisherman repays the loan within 9 months, a 20% rebate in the sale price is made. The deposit for the diesel boat is \$200 and repayment is made over 3 years.

A pilot project for building the alia in the villages rather than at the central boatyard was started in the middle of 1976. Two 28-ft alia were built by the fishermen themselves with supervision from an experienced boatbuilder. The results were encouraging, but much organization and supervision were required in the initial stages. As the boatbuilding program expands, boat construction will be introduced in other districts.

The boat construction program is financed by FAO/DANIDA Village Fisheries Development Project which

Table 3. Comparative costs of constructing a 28-ft alia and a 28-ft diesel boat in Western Samoa.

	28-ft alia	28-ft diesel boat
Timber	WS\$ 260	WS\$ 290
Paint and glue	100	100
Bronze fastenings	70	90
Dynel sheathing	100	120
Miscellaneous	40	40
Total Materials:	570	640
Labor, overhead and profit	260	650
Boat Price Only:	830	1,290
Engine	410 (25 hp)	1,200 (20 hp)
Spare engine, 5 hp	180	—
Fishing gear and equipment	250	250
Total (Fully equipped boat)	WS\$1,670	WS\$2,740

plans to introduce 120 new boats within 2 years. Repayments on loans go into a revolving fund in the Development Bank which will be used to finance future boat construction. The boatyard established near Apia will operate as an independent company along commercial lines. The project also includes a fish marketing scheme which will bring fresh fish into the main population centers and thereby reduce the present large dependency on imported canned fish. Fishing by a demonstration team belonging to the Fisheries Division shows that the 28-ft boat can catch 20,000 lb (9091 kg) of fish per year, mainly from bottom handlining. At an average price of \$0.25 per lb (\$0.55/kg) this corresponds to gross earnings of WSS\$5,000. The yearly earnings necessary to cover all costs including repayment of the loan for the 18-ft boat is WSS\$2,600, based on 100 trips per year. There should therefore be an ample margin to permit fast repayment of the loans. However, according to traditional customs a considerable quantity of fish is given away, which is good for the nutrition of the village population but not for loan repayment. This does not, however, materially detract from achieving the main objectives of the project such as reduced import, better nutrition, and higher employment in rural areas.

Boats of the SPC Outer Reef Fisheries Project

R. EGINTON

*Outer Reef Artisanal Fisheries Project
B. P. 5, Noumea Cedex, New Caledonia*

Two boats have been used to date on the SPC Outer Reef Artisanal Fishing Project. They are an aluminum boat named *Norman Kirk* and a plywood boat named *Manulele*.

The *Norman Kirk* was designed and built in New Zealand. It has a hard chine hull of 24 ft, a beam of 9 ft 6 in, and a draught of approximately 9 in. The vessel is powered by a Nissan model SD33 six-cylinder diesel engine of 52 hp at 2600 rpm (the maximum revolutions obtainable) although the engine has an intermittent rating of 72 hp at 3200 rpm. The information leaflet for this engine gives the horsepower as 92 at 4000 rpm. Designed as a planing hull, the vessel, at top speed, becomes a displacement hull with the disadvantages of both types.

The *Norman Kirk* is constructed of aluminum. This has advantages as it requires virtually no maintenance and is not subject to attack. However, there are also disadvantages. If repairs are necessary (except small ones which can be made by riveting) special welding equipment and operators are required. Even small structural alterations and modifications are difficult to carry out, as all the dissimilar metals used (including nuts and bolts) must be insulated from the hull. Otherwise serious electrolysis occurs even above the waterline.

The vessel has a large workspace aft; has good stowage for ropes, anchors, and other equipment, in the forepeak; and carries 100 gallons of fuel giving approximately 35 hours of steaming. The insulation of the fish boxes is good; they have adequate stowage space and are positioned fore and aft on either side. More room to fish would be available if the boxes were athwartships; then another electric reel could be fitted forward, and handling would be more comfortable if one were standing at the gunwale rail rather than squatting on the boxes as at present.

The vessel is too slow to be used for trolling for tuna, especially skipjack. This is a serious disadvantage as skipjack and mackerel tuna are excellent bait for deepwater fishing, and alternative bait in some areas is not plentiful.

The high freeboard aft makes landing large fish and sharks difficult. In addition, with the straight sides aft, there is no flare and the wire fishing line tends to drag over and cut into the aluminum chine piece.

Due to the shallow draught, the large flat underwater section aft (no propeller, skeg or rudder) and the lack of any keel, the vessel yaws badly at anchor. It also tends to be easily swung by any breeze, irrespective of the tide or current. This is a big disadvantage when line fishing in deepwater as the lines on one side of the vessel are

swept under the chine.

The foredeck is adequate for handling the anchor and warp but the anchor warp fairlead could be improved.

The vessel has two electric fishing reels operated from a bank of 12-volt batteries charged by the main engine. The electric reels are very efficient, particularly in deep-water (i.e., over 100 fathoms); however, it is difficult to keep the batteries charged during a night's fishing due to the method used to drive the jet unit.

The jet unit is driven directly from the engine. The manufacturers of the jet unit, in listing its advantages, state: "Full steering response at all speeds and direction of travel, *including* the stationary position". This is a distinct disadvantage with the *Norman Kirk* or any fishing vessel. A helmsman is required to steer the vessel at all times when the engine is running, even at anchor—a rather soul-destroying occupation.

The vessel is difficult to steer and in a moderate following sea it is almost impossible to handle, swinging through an arc of 180 degrees. The boat rides down at the head and it would require about 1000 lb of ballast to correct this. Unfortunately with the aluminum hull, it is not simply a matter of placing metal ingots in the bilges, because of the electrolysis set up between the two different metals. The ballast would therefore need to be totally insulated from the hull. Concrete would not be dense enough to give the required weight in the space available in the bilges.

The visibility from the steering position in a head sea is inadequate, especially at night, and an efficient wind-screen wiper is required.

There is no self-draining cockpit although two small apertures located in the stern of the hull can be opened, when the vessel is at full speed, to drain the cockpit. At other times the water drains forward and empties into the bilges through numerous unsealed openings in the cockpit deck.

This vessel is of excellent construction and makes a good, stable working platform, but trim and propulsion problems make it a difficult boat to handle, with poor performance.

The *Manulele* is a 24-ft plywood Pago Pago style dory powered by a Lees Ford Falcon gasoline engine of 200 cubic inches with a 12-hour rating of 56 hp at 2800 rpm, driving a Hamilton Model 750 jet unit. The vessel has a top speed of 13 knots at 3200 rpm.

This vessel is in some respects better designed for deepwater line fishing than the *Norman Kirk*. It has a lower freeboard aft and more flare on the sides which are distinct advantages. It has the speed to troll for tuna although the jet unit creates a great deal of turbulence at the stern, necessitating the use of very long trolling lines to correct this problem.

The absence of a keel, combined with the flat underwater hull section aft, tends to make the vessel yaw badly at anchor, as with the *Norman Kirk*. The foredeck is entirely inadequate to handle the anchor and warps. The vessel is fitted with two hand reels for deepwater fishing.

The *Manulele* has the same problems with the jet drive as the *Norman Kirk*. It is difficult to steer unless the engine revolutions are kept above 2600 per minute. It does not have a self-draining cockpit but there is a plug which can be removed at speed to drain the bilges. Whether the *Manulele* could be altered economically to correct the design faults is problematical.

A more powerful engine is needed if the boat is to reach its design speed. A diesel of at least 150 shaft horsepower driving a conventional propeller would be required. Weight then becomes a problem if the engine is installed amidships. The boat would tend to ride deeper at the bow unless drastic changes to the hull were made. A Vee drive would perhaps be the easiest solution with the engine installed at the stern, although fishing space would be reduced in the after cockpit. A great deal of alteration would be necessary to fit a propeller drive but the vessel's handling would be improved if a keel were fitted also.

The project has just taken delivery of another Pago Pago-built dory. This vessel is powered by a Chrysler Nissan diesel of the same horsepower as the *Norman Kirk's* engine, but drives a conventional propeller. The vessel's top speed is 13 knots at 3000 rpm and the cruising speed is 9.5 knots at 2600 rpm.

Although only three short trolling trips for tuna were made in the new dory, the advantages of the propeller drive were obvious: a much cleaner wake, easier steering, and better maneuverability at all speeds.

The *Manulele* could be converted to a propeller drive with much less trouble than the *Norman Kirk*, but the plywood bottom has serious athwartship cracks. To repair these cracks without strengthening and altering the shape of the frames to take the plywood skin would require the advice of a competent shipwright or boat designer.

Experience with the two vessels used by the project to date show the basic requirements for a vessel that is capable of both deepwater handling and trolling for tuna:

1. Speed: A minimum of 10 knots is needed. However, if the vessel is not to be used for skipjack fishing, then speed is not such a critical factor unless the fishing grounds are a considerable distance from the base.
2. Weighing Anchor: Weighing anchor, when fishing in depths up to 200 fathoms, presents problems, although one can stream and then float the anchor with the aid of a large float. Retrieving

the warp in moderate to rough seas is difficult and time-consuming, but a simple cathead, driven by a flat belt from the main engine and controlled by a jockey pulley, would alleviate this problem. The anchor warp could be led by suitable blocks to the cathead and all hauling could be done from inside the vessel, a far safer procedure than

at present.

3. Visibility: Good visibility from the steering position in all conditions is essential.
4. Hull Design: Low freeboard aft, a self-draining cockpit and adequate flare to the sides of the vessel aft are necessary.

Small Fishing Boat Designs for Use in the South Pacific Region: Displacement and Medium Speed Fishing Boats

J. FYSON

*Fisheries Technology Service
Fishery Industries Division
Department of Fisheries
Food and Agriculture Organization
Rome, Italy*

Introduction

In most of the islands of the South Pacific, small-scale fishing activities are very largely those of a subsistence fishery, the greater part of which are based on the harvesting of the inner reef and lagoon areas. Many of these inner reefs and lagoons have reached or exceeded the limit of their harvest potential. This is particularly the case where population concentrations have occurred, a result of urbanization. Underexploited lagoon resources are usually found in isolated islands where sufficient fish are harvested for the small local requirements but where lack of a marketing and transportation infrastructure inhibits the catch of more fish than can be consumed by the local village population.

Potential for increasing the catch and extending the local fishery from the lagoons and inner reefs to the submerged banks, shelves, and reef slopes around the perimeters of the islands out to the 100-fathom line appears good in most of the territories studied, while the offshore pelagic fishes of the tuna-like species, which are seasonally abundant near many of the islands, offer opportunities for increased local production as well as the possibility in certain cases for establishing an export industry.

No detailed information about standing stocks or potential sustained yields of shelves, banks, and outer reef slopes exists in the region but potential production from these tropical coastal waters is not considered large enough to withstand the type of industrial fishery that occurs in temperate coastal regions. Relative to local need, however, potential is expected to be adequate in a large percentage of island coastal areas, most of which are at present virtually untouched.

Apart from those cases where bait fish are available in commercial quantities, catches of demersal and nearshore pelagic fishes are not expected to be high enough to warrant the setting up of an export market. Fishery effort will therefore be small-scale and designed to provide the local markets with adequate supplies of fishery products.

Fishing Methods and Suitable Vessel Types

Fishing methods expected to be used can be broken down into three main groups characterized by the water depth and feeding characteristics of the species caught. The first of these, shallow water fishing in lagoon areas, is practiced in restricted depth with cast nets, traps, beach seines, and handlines for bottom-feeding species.

Species feeding at greater depths on isolated banks and the outer reef slope can be caught by deep lining techniques either by hand or more efficiently with reels.

Surface-schooling pelagic fish pose a more complex problem due to the clarity of the water and consequent difficulty in using either purse seines or gill nets. The methods commonly consist of pole-and-line fishing with live bait, pole and line using pearl shell lures, and trolling with lures.

Commercial longlining for deeper swimming pelagic fish with wide ranging offshore vessels is a more sophisticated method and is outside the purview of this paper.

Shallow water fisheries in lagoon areas can best be carried out by simple low-cost flat or V-bottomed wooden boats. Suitable types are shown in FAO Fisheries Technical Paper No. 117 (Rev. 1), Fishing Boat Designs: 1 Flat Bottom Boats; and FAO Fisheries Technical Paper No. 134, Fishing Boat Designs: 2 V-Bottom Boats.

In island communities where distances to be covered to the fishing grounds are small, deep lining on the reef slope can be most economically carried out by simple displacement boats. In the case of isolated village communities where the fishing effort is directed to supply of the community alone and no marketing outlet exists for excess fish caught, flat or V-bottom boats of the types described in the FAO papers cited above could be built economically and powered by simple low hp outboard engines to keep the cost of fish production as low as possible. For exploitation of isolated banks or reefs some distance from an urban center, a slightly larger vessel with insulated hold and carrying nested dories on deck could well be the most useful.

Where the need exists for a boat capable of at least medium speed (10-15 knots) to range widely in the search of surface-schooling pelagic fish, the higher cost of a faster boat can be amortized by increased catch rates. However, where the fishery is seasonal, a very careful cost analysis should be made to ascertain the profitability of higher operating costs when compared with the yearly return.

Suitable boats equipped with inboard diesel engines could be found in the size range 24-35 ft. Inboard/outboard Z-drive engines are not considered sufficiently robust to stand up to the requirements of such a fishery in a developing country.

Boats should be capable of multiple trolling and pearl shell luring and possibly have limited live bait capacity. The most economical solution is to provide a vessel which is designed to operate efficiently and comfortably in the medium speed range (10-15 knots) with enough hp to maintain these speeds even when loaded. The semi-displacement hull of this type would be of moderate dead rise (up to 15°) with a relatively long, narrow, easily

driven hull. Such a hull would be more comfortable, less inclined to hull damage due to pounding when driven at speed, and should have considerably lower running costs than higher speed planing vessels. The 28-ft boat designed for Western Samoa and the proposed 35-ft extension of this type were designed to take these operating characteristics into account.

Where distance, fishing methods, or economic and social factors dictate a wide-ranging daily operation, the possibility of using light, medium speed boats should be considered. However, the catch rate and value of the catch landed must be sufficient to justify the higher operating costs, plus the fact that the greater hp and higher rpm engine needed for this type of boat is not only more expensive but requires considerably more care in use with particular attention to fuel quality and regular maintenance.

In many of the oceanic islands bait fish are not available in sufficient quantity to justify commercial exploitation of the surface schooling pelagic tuna resource by pole-and-line live bait fishing. Due to extreme clarity of the oceanic waters of the area, this has proved to be the only intensive fishing method for these species which could justify the provision of larger, more sophisticated fishing vessels needed for catches on an industrial scale. Project activities in this area should therefore be focused on fish production using relatively small unsophisticated boats and equipment.

Medium Speed Boat Design and its Application to Fishing Boats

Naval architects and boatbuilders frequently use the terms displacement, semi-displacement, and planing to describe the three principal operating conditions of small craft. These conditions can be recognized in broad outline by the speed at which the vessel operates, the measure of the different forces acting on the hull, and the wave patterns generated by forward motion.

Speed is a relative quantity which is dependent on boat length. This dependence is due to the wave systems created as a boat moves through the water. Speed of the boat at any moment is that of the transverse wave system formed by this motion. In quantitative terms this speed depends on the distance between wave crests in the system and increases with increasing wave length. A long vessel produces a long wave system more easily than a shorter boat, and her potential for absolute speed is therefore greater. A performance comparison between two vessels can be made by examining the speed-length ratio obtained by dividing the speed in knots by the square root of the waterline length in feet. Two boats of different lengths at speeds giving the same length ratio have a number of operating characteristics in common, e.g., their wave

patterns are similar and their power requirements in horsepower per ton are comparable, as are the proportions of buoyant and dynamic lift forces operating on the hull.

A second factor considered by naval architects when discussing boat operational characteristics is the components of the various forces acting on the hull through a range of speed-length ratios. These vary from the "at rest" condition, when the entire load is supported by buoyant forces, to the high speed planing condition when dynamic lifting forces predominate.

Looking at these two factors together with the wave systems generated, one can recognize in which of three categories a small boat is operating and establish appropriate design requirements.

Below speed-length ratios of unity, frictional resistance makes up more than 50% of the resistance to forward motion, with the remaining resistance due to formation of wave system previously described. Buoyant forces are predominant and dynamic lift forces negligible. These operating speeds are characteristic of large merchant and passenger ships and considered too slow for the majority of small craft.

Speed-length ratios of 1-1.34 are the normal operating range for small craft of the displacement type and in this range resistance to forward motion increases rapidly with an increasingly high proportion due to wave-making disturbance. Small boats designed to operate in this range are characterized by deep-load-carrying hull forms with curving buttock lines which, as speed increases to the top of the range, sink progressively deeper in the water. Hp requirements in this range are of the order of 3 to 5 hp per ton of displacement. At a speed-length ratio of 1.34 the length between transverse wave crests is equal to the waterline length of the boat. Increasing the speed up to a ratio of 1.5 with this type of hull results in further sinking, increasing resistance caused by the deep waves produced by this hull at the higher speeds. Beyond this speed with this hull form, stern trim becomes excessive and the boat will finally become unmanageable.

Transition into the second category, that variously known as semi-displacement or semi-planing, requires a fundamental change in hull design. With speed-length ratios larger than 1.34, the distance between crests of the transverse wave system is longer than the boat and the aftercrest is located at an increasing distance aft of the transom.

To operate with the maximum efficiency in this condition, suitable designs must be of comparatively light displacement with small draft and with flat aft buttock lines which will produce a shallow wave system, avoid the excessive aft trim, and greatly increase resistance of the deep-wave-making displacement hull.

In this range, with a suitable hull, increase in resistance becomes less until at a speed-length ratio of about 2, it flattens to a relatively constant rate of increase comparable to that at speed-length ratio of 1. Hp requirements will be from 20-40 hp per ton of displacement. Dynamic lift forces begin to become significant. At speed-length ratios between 2.2 and 2.5 the hull will have risen to its original static trim level, and as speed increases further, will begin to rise above this until at speed-length ratios between 3 and 4, dynamic lift is predominant, the wave-making component of the total resistance decreases, and frictional resistance component again becomes increasingly important.

The third category of operations, the region of pure planing, is well known to anyone familiar with developments in the high speed pleasure craft field. Resistance to forward motion in this region is of the order of 110-150 kg (250-330 lb) per ton of displacement, requiring 50 and more hp per ton, and except for certain special cases with a low weight, high value catch, horsepower requirements, and operating expenses make continuous operation by fishing boats in this range uneconomical. Accordingly, for fishing operations in which speed is an advantage boats will need to be designed for the middle of the three ranges discussed.

To avoid confusion from conflicting terms, such as semi-displacement and semi-planing, I define the term medium speed to apply to boats with speed/length ratio range greater than 1.5 and less than 3.

Feasibility of Medium Speed in Small-Scale Fisheries Operations

Speeds higher than those of the displacement range can be expensive, both in the capital cost of the increased hp required and in the higher operating costs of the larger engine. Successful fishing boat design requires the production of a safe and efficient working platform that can pay its way and leave a reasonable profit margin for the operator.

To justify the increased expenditure required for a medium speed boat, some or all of the following conditions should be fulfilled:

1. Weight and bulk of average daily catch required to cover total costs should be low in comparison to vessel displacement.
2. The catch can be increased by the use of a highly mobile vessel during fishing operations.
3. Travelling time to and from the fishing grounds is a large proportion of total vessel time.
4. The price obtained for landed catch is sensibly higher for fish landed in optimum condition due to reduction in travel time.

5. Sea conditions in the area will permit operation in the medium speed range for a high proportion of total possible vessel time.

6. Geographic, economic, and/or social conditions dictate a 1- or 2-day operation.

Design Requirements for Medium Speed Fishing Boats

Boats designed to operate at medium speed should be of light displacement with hull forms producing shallow wave systems with minimum water disturbance. When vessel cost must be at a minimum and load carrying ability can be much reduced as in the typical village fishery, narrow beam, light draft and a low displacement/length ratio can be used to obtain speed economically. For example, a boat with a 25-ft waterline length and waterline beam of 5 ft fitted with a lightweight 25 hp inboard engine weighing around 220 kg (500 lb) has been quoted at a speed of 15 knots in when carrying a light load. It is therefore possible to obtain operating speeds of 11-12 knots with narrow beam, light draft vessels of this type if loaded displacement can be kept to around 1,500 kg. At this displacement, average fish catch could probably not exceed 200 kg if speed in this range is to be maintained.

A medium speed boat is best for small-scale fisheries one step up from the subsistence fishery level where low load-carrying ability is acceptable.

A boat with greater load-carrying capacity and a greater return per unit effort by the crew is required in more urbanized communities. In this case, design requirements for economical operation in the speed/length ratio range 2.0-2.5 are as follows:

Basic hull dimensions. An easily driven hull shape depends on the correct choice of minimum displacement for the operating requirement. Displacement has the greatest single effect on speed. A close estimate of average daily catch will permit a good approximation of operating displacement. It is important in the design of a medium speed vessel not to overestimate the required carrying capacity. As high a length to displacement ratio (L/D) as possible should be chosen and this should range between 5 and 7 depending on the particular design requirement. As large a length/beam ratio as can be accommodated consistent with stability should be chosen. A minimum prismatic coefficient should be 0.65 with a value of around 0.7 as a satisfactory compromise between the need for adequate buoyancy forward to maintain good trim and sufficient fineness not to increase resistance unduly. A constant angle of deadrise in the after sections is desirable but this is conditional on correct placing of the LCB in relation to operating center of gravity. The chine beam should be appreciably narrower

at the transom than at the midship section to aid water separation, with chine and transom running dry in the medium speed range.

Powering. The boat should have sufficient hp to operate in the medium speed range when carrying the average daily catch. This will generally require between 20 to 40 BHP per ton of displacement, the variation depending on the length/displacement ratios chosen for a particular design requirement.

Stability and handling characteristics. Transverse stability should be sufficient to permit the loading of three times the expected average daily catch in safety. Determination of chine immersion aft and the length of chine immersed will depend on transverse stability. Directional stability should be sufficient to avoid any tendency to broach while travelling at speed in following seas. To retain good directional stability, deadrise aft should be around 15° . Less will entail loss of directional stability, while increase in deadrise much over this figure will result in a higher hp to maintain medium speed. The change in static trim due to change in variable weights should be kept to a minimum.

Medium Speed Fishing Boats in the South Pacific

THE INTRODUCTION OF MEDIUM AND HIGH SPEED FISHING BOATS IN THE REGION

Requirements for economic operation of medium speed fishing vessels have been given previously. Sufficiency in these requirements has been met in certain areas and by certain fisheries in the region to justify the use of vessels using speeds greater than that of a normal displacement vessel.

Medium and high speed boats have been commonly used in the crayfish (rock lobster) industries of Australia and New Zealand where a high value, low volume catch in combination with the greater range of daily operations attainable, has made the higher speed boats economically viable. Small high speed boats are also used by divers in the abalone fishery in Australia for similar reasons.

Of more direct application to the South Pacific islands is the Tahitian pole-and-line/pearl shell lure fishery for bonito. At least 500 people are engaged in this fishery and the reasons for adopting higher speed boats are of considerable interest in outlining areas where medium speed can be viable. Local custom demands fresh caught fish which have not been iced, which indicates a daily operation. As fishery activity has increased, boats venture farther offshore, thus requiring increased speed to return to market in time for the sale of catches. Fishermen locate schools of feeding bonito by flocks of seabirds diving on the school. As the schools may surface for

only a few minutes at a time, it is important that boats arrive among the fish in the shortest possible time after the school begins to feed. A boat capable of high mobility during the fishing operation can therefore be expected to increase its catch over that of a slower vessel. Where a number of boats are working the same area, the fastest boat reaches the school first, makes its total catch, and returns to market in a shorter time, thus fetching a higher price for fish caught. This has resulted in competition for speed to the point where present boats, which are 10-11 m (33-36 ft) long are using high speed diesel engines of around 300 hp giving cruising speeds of 17 knots and maximum speeds of 25 (speed ratios of 3-4.4) which are in the pure planing range discussed previously.

A typical example, a boat built in Tahiti, is equipped with a 280 to 300 hp diesel engine and costs approximately \$30,000. The high speed and consequent high capital and operating costs of these boats are acceptable in the particular conditions of this fishery due to the high price received for fresh bonito landed in good condition. Prices in the height of the season (November to June) range from US\$1 to US\$2 per kg but may reach three times this level in the off-season (July to October).

The use of such high power is not recommended. Speed in this fishery is expected to increase catch or quality of fish landed and thus is relevant to the use of the more economical medium speed boats proposed in this paper.

The flat-bottom, high-speed dory that was developed for fishing off the Northwest Coast of the United States has been tried in several countries in the South Pacific but does not appear to have provided a satisfactory solution to the need for boats with sufficient speed for the skipjack fishery. The original intention was to introduce a type of boat that could be operated from villages with beaches and shallow lagoons and consequently the boat was flat-bottomed and fitted with a Z-drive and high-speed gasoline engine of 130 hp. The advantages were in simplicity of hull construction and relatively low initial hull cost but against this must be weighed the higher operating costs and relative delicacy of the light-weight, high rpm, gasoline engines used, plus the small carrying capacity of the hull. Serious technical problems have occurred. The inboard gasoline engine and the Z-drive has shown itself too vulnerable for the job and the repair bills have been very high. There have been no construction problems with the plywood hulls, but the fishermen complain about the pounding and rough ride.

This experience has led to various modifications in the last dories. A moderate V-bottom has been introduced to diminish the pounding. The Z-drive has been replaced by a Hamilton two-stage Waterjet, Model 752 and the Volvo engine with a Ford Falcon 6-cylinder engine rated

at 135 hp/5,000 rpm. The engine is normally run at 3,500 rpm.

It is doubtful whether the dory equipped with a high speed engine will be able to operate successfully from a village lacking essential service facilities. It will have some of the same drawbacks as the outboard engine—short service life, vulnerable electric parts, and relatively high fuel consumption—without the advantages of easy removal from the boat for storage and transport to a central workshop for repair.

MEDIUM SPEED BOATS DESIGNED BY FAO

Medium speed boats designed by FAO include the 28-ft open boat for outboard power (Fig. 1), the 30-ft, flat-bottom, double chine, inboard-powered version of a sampan express hull (Fig. 2), and the 28-ft boat in Figs. 3-8.

The 28-ft boat has been designed as an easily propelled, narrow beam, light displacement craft suitable for village fishery operations (Fig. 1). The outboard-powered version of this boat, designed by Mr. O. Gulbrandsen, has been built in Western Samoa at a price of \$1,250 and, with a 20-hp outboard, has achieved a speed of 12 knots in the light condition and 10 knots with four crew and 200 kg of catch.

The 30-ft flat-bottomed boat has a hull based on a Texas dory Sampan Express 30, modified by FAO for inboard propulsion (Fig. 2). The intention behind this design was to provide a hull of simple construction for local builders which, while achieving medium speed, would combine the relative simplicity and low cost of a dory-type hull with the improved operating capability of the medium speed inboard diesel. A prototype has been built by local builders in the West Indies and repeat orders are expected to cost \$8,000-\$9,000. Fitted with a marinized Ford diesel engine of 80 BHP at 2,650 rpm, the boat has achieved speeds of 13 knots in trial.

The 28-ft boat (Figs. 3-6) was designed for the small-scale pole-and-line/pearl lure skipjack fishery and was built in Fiji for use in Western Samoa. Fitted with a GM Bedford diesel giving 80 BHP (at 2,200 rpm), the boat achieved a maximum speed of 12.4 knots and is capable of extended operation in the 10- to 12-knot range. The hull is fitted with two small bait tanks with circulating water and a water spray system run from an engine-driven pump, and has a hold capacity of 2,000 lb in insulated hold compartments with individual hatches. A feature of the design is the individual hatch system which permits an open afterdeck with plenty of working space, while allowing easy access to fish storage, propeller shaft, and staffing box (Fig. 7). With good afterdeck space, the design is suitable for the fitting of mechanical reels for deep line fishing for skipjack in the off-season. The boat is estimated to cost around \$16,000 at 1975 prices.

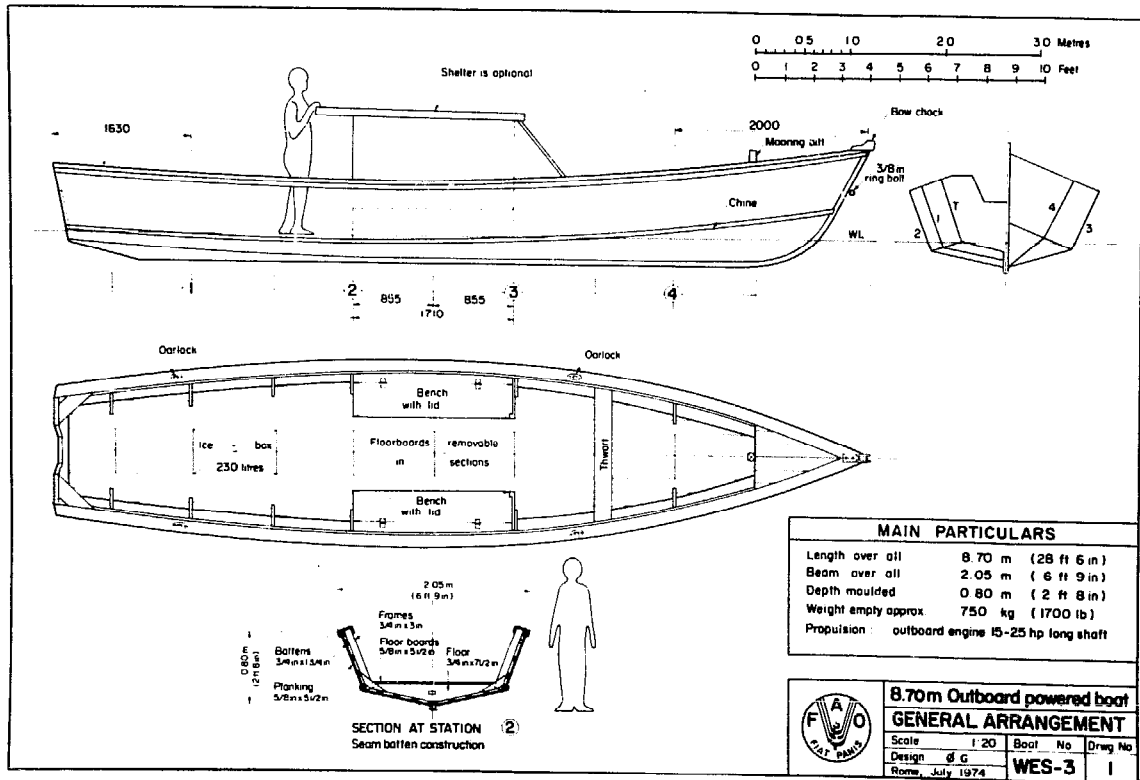

Fig. 1. A 28-ft outboard powered boat suitable for village fishery operations.

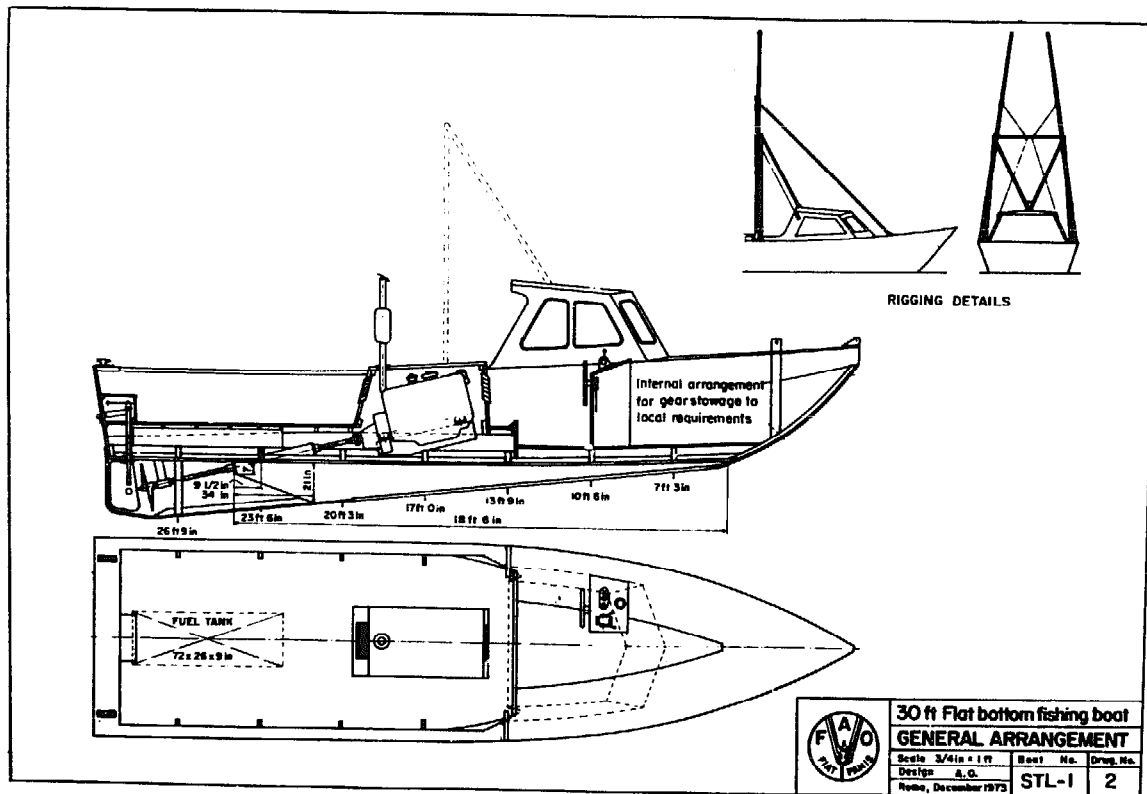
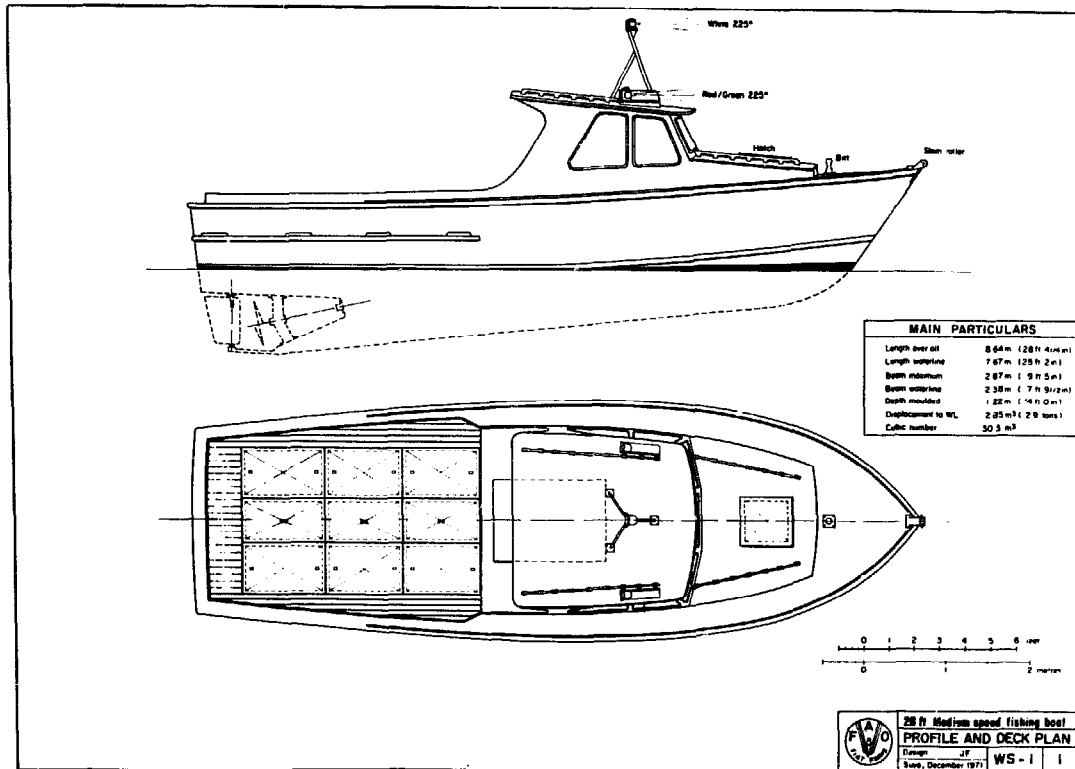
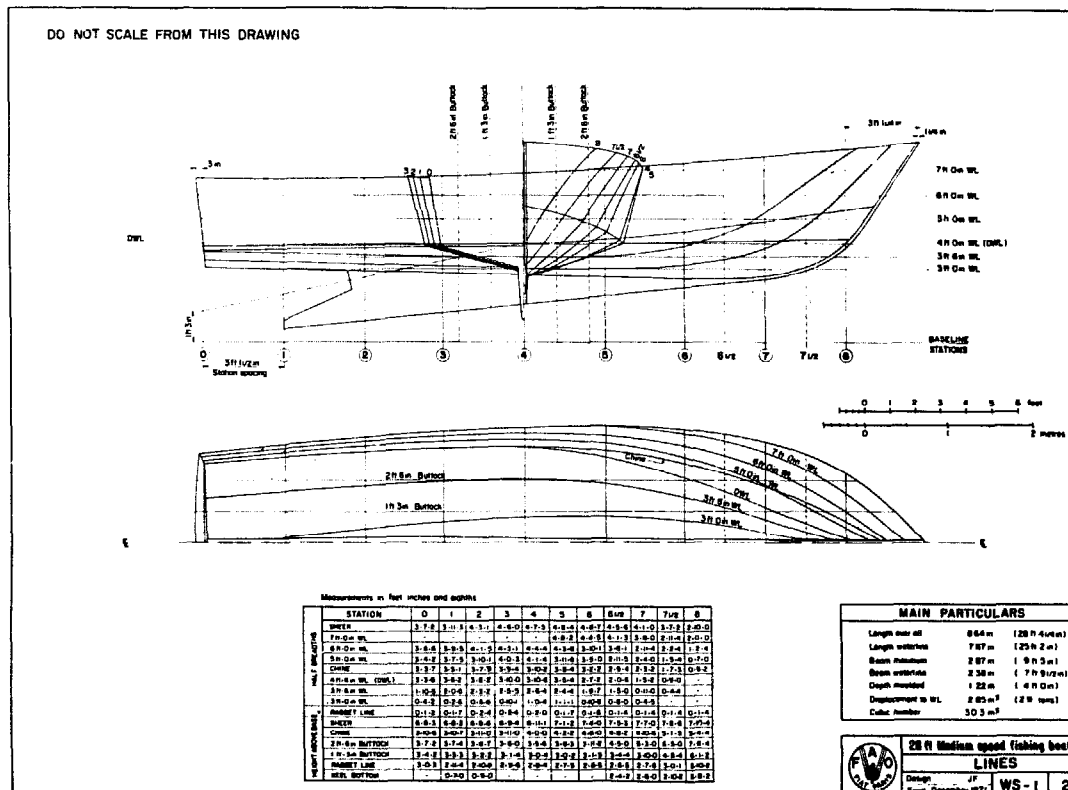

Fig. 2. A 30-ft inboard powered boat based on a Texas dory Sampan Express 30.



3



4

Figs. 3-4. A 28-ft outboard powered boat designed for small-scale pole-and-line/pearl shell lure skipjack fishery.

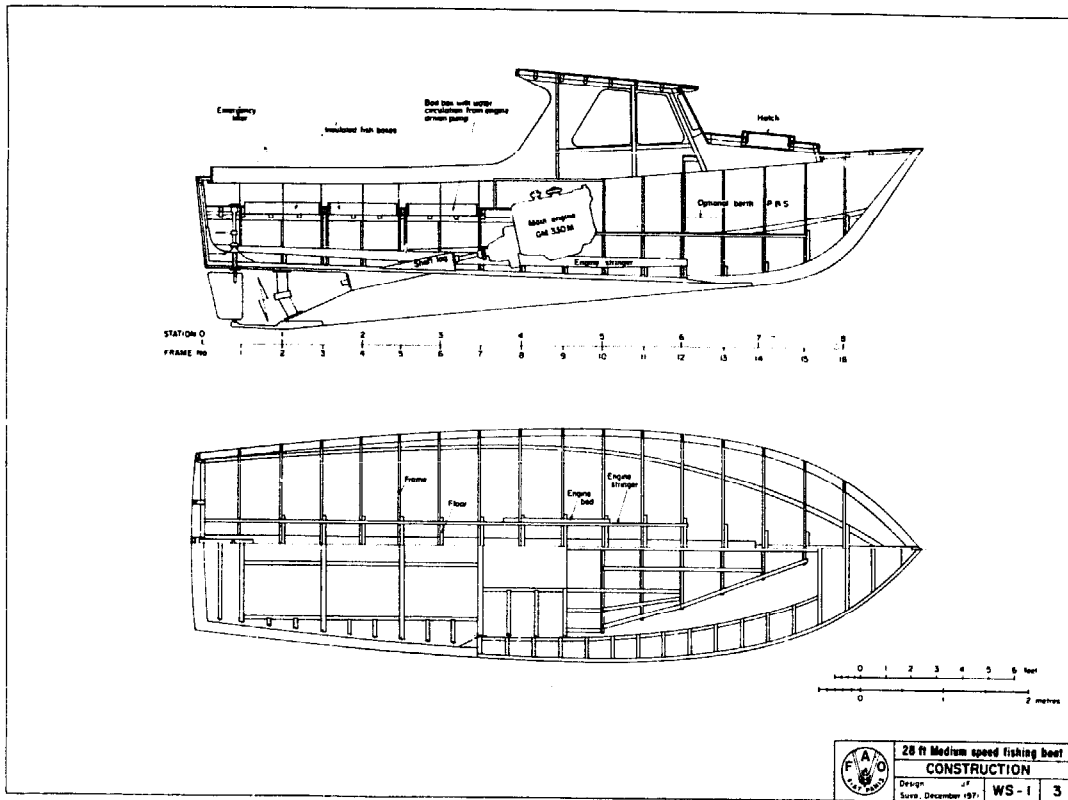

5

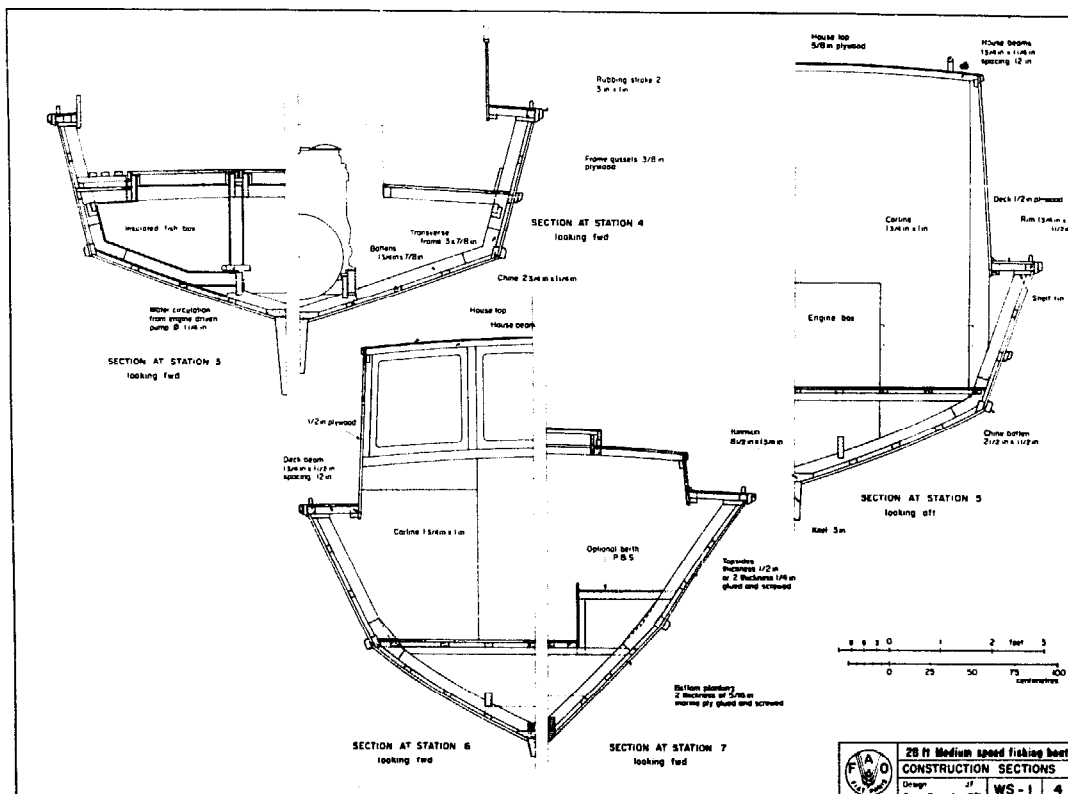

6

Figs. 5-6. A 28-ft outboard powered boat designed for small-scale pole-and-line/pearl shell lure skipjack fishery.

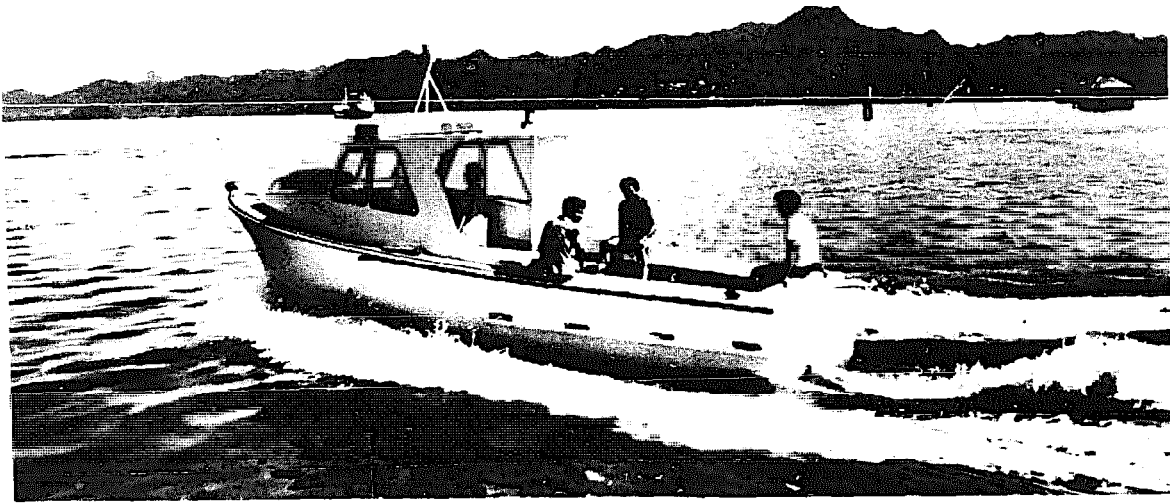

Fig. 7. Boat built from Fig. 3 design, running at 12 knots at design trim.

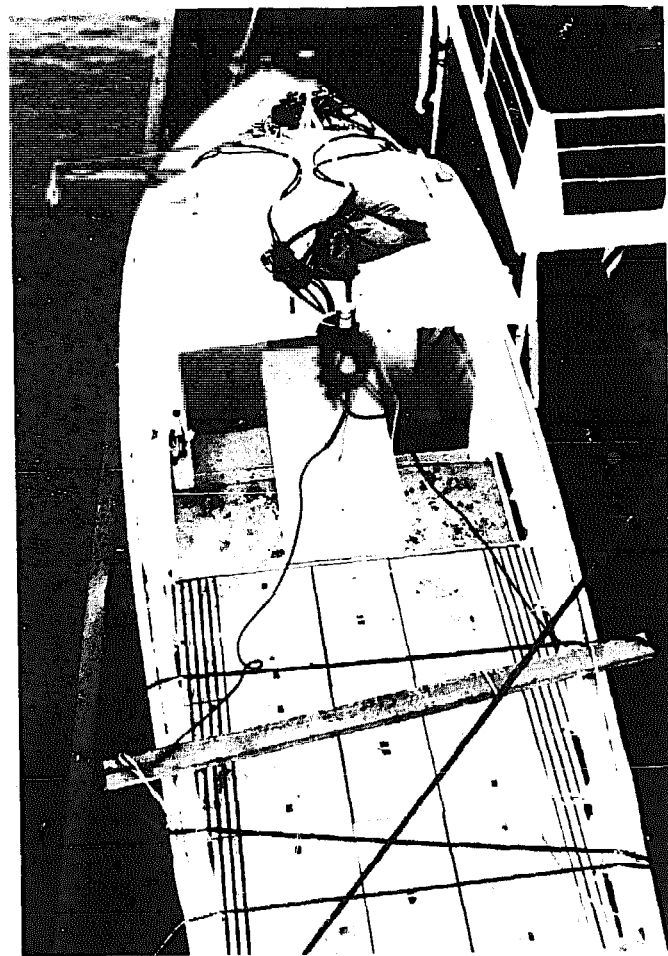
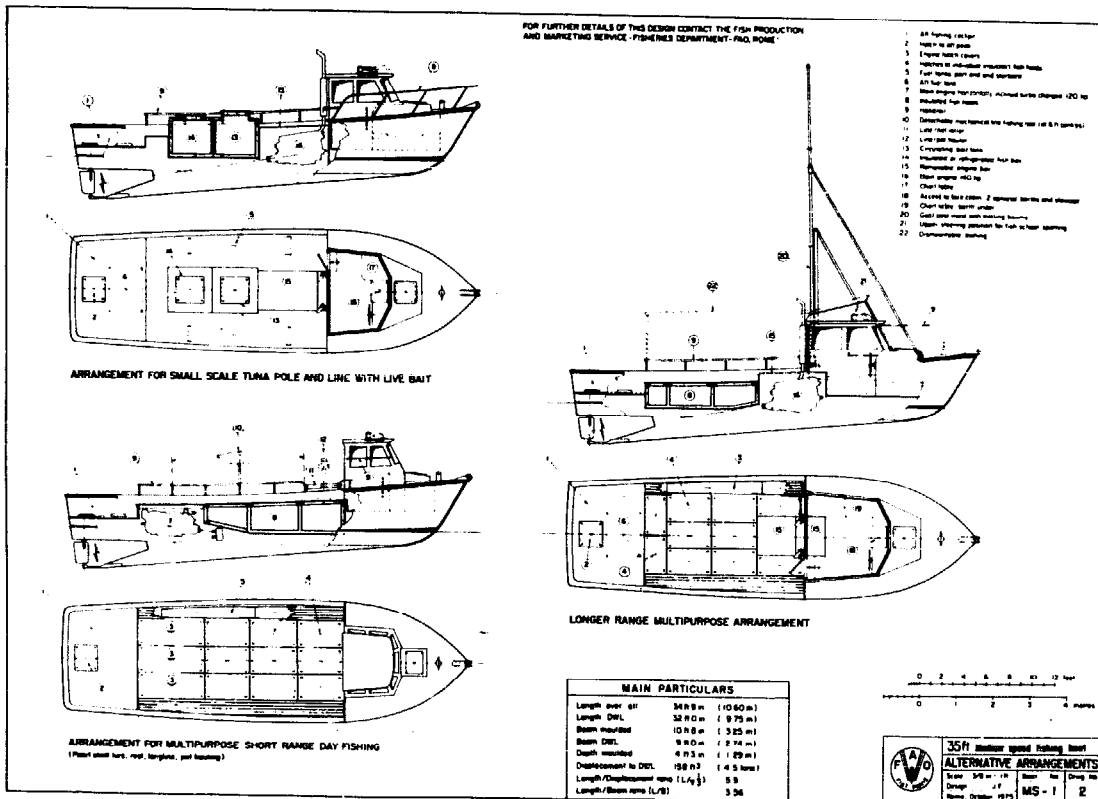
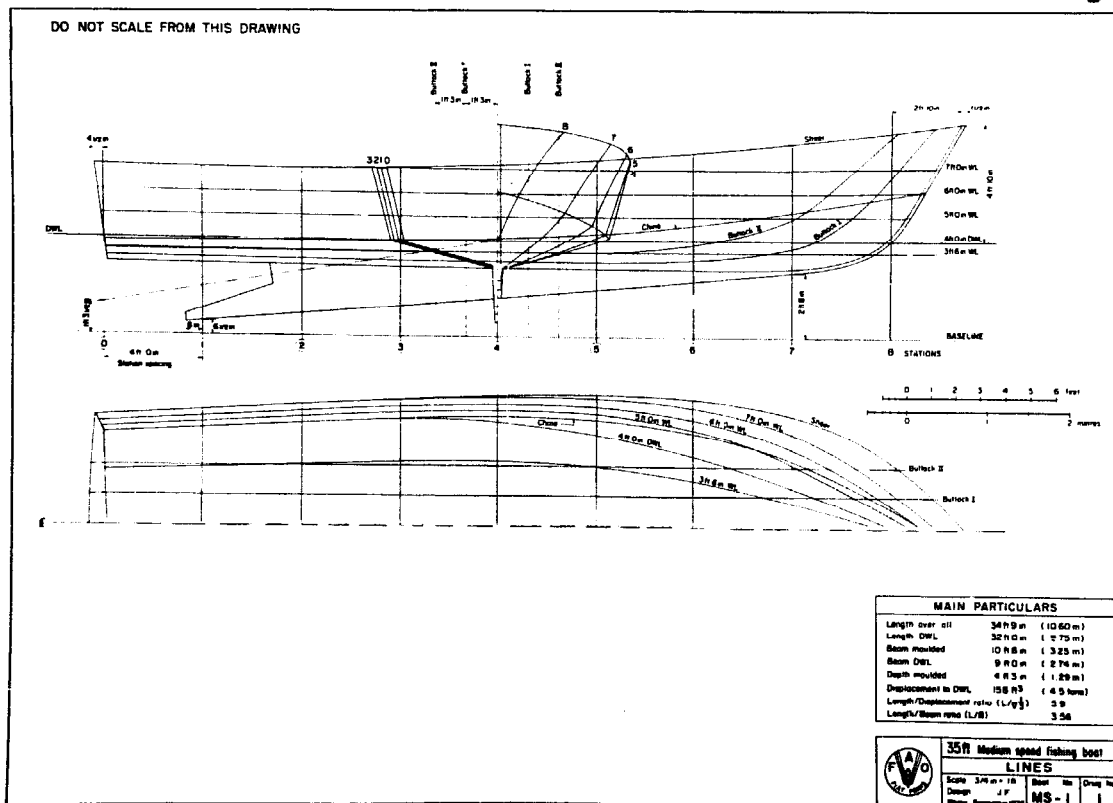

Fig. 8. Boat in Fig. 7 during transportation to Western Samoa. Note arrangement of flush hatches to give clear aft working deck space.



9



10

Figs. 9-10. A 35-ft vessel fitted with a medium speed diesel engine of 120-140 BHP running at 12-14 knots.

For fishing from established harbors in urban communities where boats are to work a wide ranging daily operation, a larger version than the 28-ft boat with a greater carrying capacity may prove advantageous.

A 10.67-m (35-ft) vessel fitted with a medium speed diesel engine of 120-140 BHP and an insulated hold capacity of 1.5 tons would be expected to operate at a displacement of around 5 tons, giving an expected speed of 12 to 14 knots (speed/length ratio 2.1-2.5) (Fig. 9, 10). Cost of complete boat is estimated at approximately \$24,000, depending on engine installation.

ECONOMIC RETURNS FOR DIFFERENT BOAT SIZES AND TYPES

To investigate economic returns for different boat sizes and types, I compared three vessel sizes: (1) the simple outboard-powered boat for village communities (Table 1), (2) the 28-ft inboard powered boat with somewhat more sophisticated design (Table 2) which could be considered suitable for more urban communities with some port facilities but not requiring large carrying capacity or long range, and (3) the 35-ft boat (Table 3) for operation from an established port, capable of ranging further afield and having an increased capacity making it suitable as a fishing unit operating from large urban communities where necessary operating maintenance skills are more readily available. Fuel costs, crew wages and other expenses are based on present costs in one island group and converted to US dollars. Local costs should be substituted to obtain equivalent results in other island communities.

Fresh fish in this particular urban market retails at around \$0.66/lb. It is assumed that price paid at the boat will be approximately half that of the retail price, i.e., \$0.33/lb. This will frequently be a conservative estimate as the fisherman himself or his family may well also handle retail sales in smaller island groups.

The analysis which follows includes all annual and daily expenses necessary to operate the vessel. An estimate is then made of the average daily catch required to cover the operating costs. A further estimate is then made, allowing for a 20% return on investment (before taxation) and including an amount for crew incentive bonus which is estimated as a daily average of 30% of regular wages. For the case of the village community, the outboard powered boat is assumed to operate on an average of 100 days per year, the fisherman being otherwise occupied during the remainder of the year in other village occupations or subsistence crop raising for his own family use. For the second and third case, a total of 200 fishing days per year is assumed with time lost due to bad weather, vessel maintenance, and repairs. The figure for main-

Table 1. Cost of operating the 28-ft outboard powered boat as shown in Fig. 1. Initial cost of vessel's hull and equipment is \$1500 and the outboard motor \$600, for a total of \$2100.

Operating costs	Annually	Daily assuming 100 fishing days/year ^a
Depreciation:		
Hull - 5 years	\$ 300)	
Engine - 2 years	300)	\$ 6.00
Interest on capital at 10% on reducing balance	150	1.50
Petrol/oil mixture, average operation 6 hours/day = 10 gal at \$1/gal	1,000	10.00
Crew wages:	990	9.90
1 captain at \$6.60		
3 crew at \$3.30		
Food \$1 per day per man	400	4.00
Maintenance and repair, 5% of vessel cost, 20% of engine cost	195	1.95
Total	\$3,335	\$33.35

^a Average daily catch to cover costs = 101 lb of saleable fish.
Average daily catch to assure a 20% return on investment = 124 lb.

Table 2. Cost of operating the 28-ft inboard powered decked boat as shown in Fig. 3. Initial cost of vessel's hull and equipment is \$11,000 and engine and installation of \$5000, for a total of \$16,000.

Operating costs	Annually	Daily assuming 200 fishing days/year ^a
Depreciation:		
Hull - 10 years	\$ 1,200)	
Engine and Equipment - 5 years	800)	\$2,000
Interest on capital at 10% on reducing balance	800	4.00
Insurance, 5% of vessel cost	800	4.00
Diesel fuel, 10 hours full power (\$0.66/gal) operation/day	2,640	13.20
Lubricating oil, 15% of fuel cost	400	2.00
Ice, 250/day at \$0.66/50 lb block	660	3.30
Crew wages:	3,500	17.50
Skipper at \$7.50/day		
3 crew at \$3.33/day		
Food \$1 per man/day	800	4.00
Maintenance and repair, annually 10% of vessel cost (including crew wages on maintenance work)	1,600	8.00
Total	\$13,200	\$66.00

^a Average daily catch to cover costs = 200 lb.
Average daily catch for 20% return on investment = 264 lb.

Table 3. Cost of operating the 35-ft inboard powered boat as shown in Fig. 9. Initial cost of vessel's hull and equipment is \$15,000 and engine and installation \$9000, for a total of \$24,000.

Operating costs	Annually	Daily (200 days) ^a
Depreciation:		
Hull - 10 years	\$ 1,500	\$ 16.50
Engine - 5 years	1,800	
Interest on capital at 10% on reducing balance	1,200	6.00
Insurance, 5% of vessel cost	1,200	6.00
Diesel fuel, 10 hours/day average = 60 gal (\$0.66/gal)	7,920	39.60
Lubricating oil, 10% of fuel	792	3.96
Ice, 400 lb/day	1,056	5.28
Crew wages:	4,000	20.00
Skipper at \$8/day		
3 crew at \$4/day		
Food, \$1 per man/day	800	4.00
Maintenance and repair, 10% of vessel cost (including crew wages on maintenance)	2,400	12.00
Total	\$22,668	\$113.34

^aAverage daily catch to cover costs = 344 lb.

Average daily catch for 20% return on investment = 435 lb.

tenance is estimated at 10% of vessel cost and would cover wages paid to crew members engaged on maintenance tasks as well as slipping and repair costs.

The total catch figures arrived at can be used to estimate profitability for various boat types and hence of

choice of boat for an area based on present catch rates of local boats or on data which can be obtained from experimental fishing.

Conclusions

Economically driven hulls, designed to operate in the medium speed range, are expected to be viable in comparison with lower powered boats, especially in the skipjack fishery, due to increased catches resulting from higher mobility in the catching operation and greater operational range in a day fishery. Prices received for better quality landings can also be expected to be higher.

For a village fishery where daily catches can be smaller due to a lower acceptable return per crew effort, the outboard boat of Fig. 1 or its inboard-powered equivalent will provide a satisfactory return. For larger, urbanized communities and operation from deepwater harbors, vessels in the 28- to 35-ft range of Figs. 3 and 8 can be chosen. Decision of optimum size of boat depends on expected average daily catch and operational range required. FAO interest in medium speed fishing boats is expected to result in a volume in the FAO Design Series illustrating vessels of this type.

Further details of designs illustrated in this paper can be obtained from the Fisheries Technology Service, Department of Fisheries, FAO, Via delle Terme di Caracalla, 00100 Rome, Italy.

Design and Construction of the ICLARM Experimental Small Fishing Boat

GLEN FREDHOLM¹

*1121 Wilder Avenue, 900B
Honolulu, Hawaii 96822, U.S.A.*

Introduction

As part of the ICLARM program of evaluating fishing craft for use in tropical small-scale fisheries, the report on the Ponape Dory Project was assessed. Conclusions drawn from that report indicate a need for further research in developing suitable designs for small fishing craft. To meet this need, a design committee was formed to conduct this research as part of the ICLARM program. Members of the committee were Stephen Ritterbush, ICLARM Program Coordinator; Glen Fredholm, a noted Honolulu marine designer; and William Travis, former Fisheries Officer for Western Samoa and currently a successful commercial fisherman in Kona, Hawaii. This paper presents the recommendations of the committee and design of a new boat potentially well suited for use in tropical small-scale fisheries.

Design and Construction of the Experimental Boat

The committee concluded that (1) no single design could fulfill all requirements and meet all conditions im-

posed by various inner and outer reef fisheries; therefore, a compromise design must be accepted; (2) no boat can be developed on paper only, that full-size prototypes must be built and true operating costs established; and (3) no boat should be mass-produced until a prototype has been completely sea-tested and evaluated.

Two primary design criteria were proposed by the committee: (1) The hull should be 20 ft long, easily driven, non-pounding, dry, and beachable. It should have a shallow draft with protected propeller, large fishbox, and a crew capacity of three or four. (2) The engine should be inboard, low cost, lightweight, gasoline/kerosene- or diesel-powered with parts easily repaired or replaced and speed enough for trolling.

The problem of hull design was approached by re-examining boats produced during the early decades of powerboat development. The boats of this period had one- or two-cylinder, low rpm, 5- to 15-hp marine engines with swinging propellers of large diameter and blade area.

Many of these boats developed speeds in excess of 10 knots for two important reasons: hull design and propeller shove. According to Weston Farmer, a well-known marine architect and author of articles on early power boats, this performance resulted from both the use of a propeller at least 25% of the size of the mid-

¹Present address: 5303 Sunset Drive, Anacortes, Washington 98221, U.S.A.

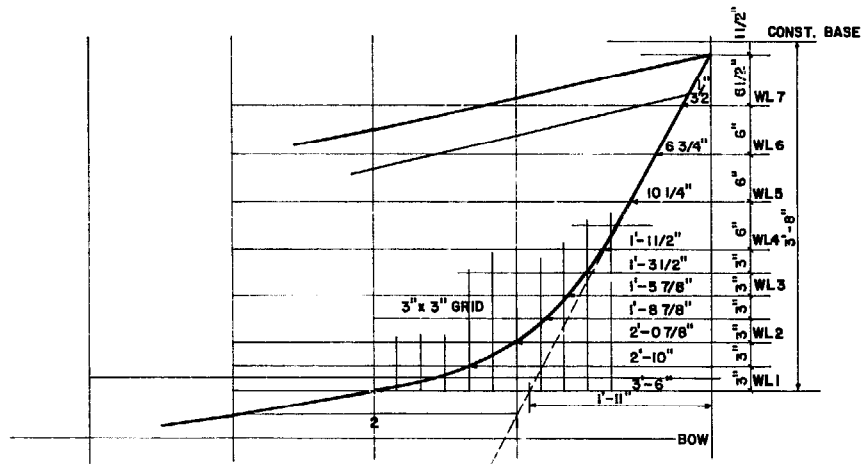
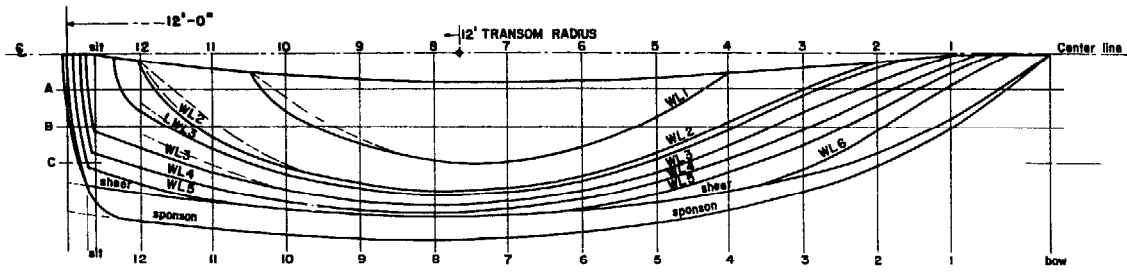

BOW DETAIL

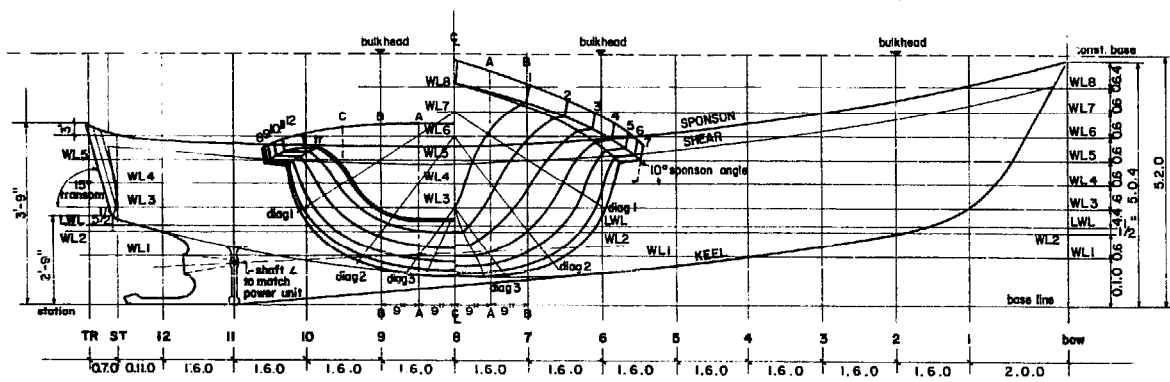

SEC. 6 SPONSON NTS

Fig. 1. Design plans for 1/12-scale model of 20-ft ICLARM prototype boat.

section area and an easily driven hull.

Small 10- to 20-hp engines and low-power "Seagull" outboards, which are used to aid in the mooring of 20- to 40-ft sailboats with ease and speed, are unable to effectively propel modern hard chine powerboats.

ICLARM's experimental small fishing craft has features which can later be developed for sail-assisted power. The boat's design includes: (1) a flat section along the keel, 15-in-wide midships as used in the old "Jersey sea skiffs" and in local sampans for ease in beaching; (2) a full skeg for propeller protection and help in steering in the following seas; (3) a narrow entry with a high sheer forward and sheer sponsons. The latter were designed to help solve spray problems. The narrow entry allows efficient operation in typical 20- to 30-knot trade winds.

After developing lines and offsets based on the above specifications (Fig. 1), a 1/12th-scale model was built.

This flotation model was used to give the designer an idea of the general wave pattern created by the hull. In addition, the designer could check, load, and trim, as the displacement of a model and prototype will vary arithmetically with the cube of their linear ratios. In other words, three factors (length, breadth, and width) change as a boat's size is increased, and experimenting with sizes of crew and fish loads is thus possible by varying these calculations and engine weights.

The committee found the problem of power to be more difficult. Simplicity of engine operation and availability of parts became prime considerations. Cost was critical from an amortization standpoint, and the designer was concerned with weight. After consultation on prices with many engine manufacturers and distribution and service centers, the committee decided to test first a 16-hp air-cooled gasoline/kerosene engine with a reduction gear assembly manufactured in the Philippines.

STATION		1	2	3	4	5	6	7	8	9	10	11	12	ST	TR	
HALF BREADTHS	SPONSON	1-6.4	2-3.7	2-10.3	3-3.1	3-6.3	3-8.5	3-10.0	3-10.5	3-10.2	3-9.3	3-7.6	3-5.6	3-0.6	—	—
	SHEER	1-4.1	2-3.4	2-6.3	2-10.4	3-1.2	3-3.2	3-4.3	3-4.7	3-4.3	3-3.1	3-1.2	2-11.0	2-9.2	2-8.6	—
	WL 6	0-8.0	1-7.2	2-4.7	—	—	—	—	—	—	—	—	—	—	—	2-4.2
	WL 5	0-4.6	1-2.2	1-11.0	2-5.7	2-11.1	3-2.6	—	—	—	—	—	3-0.7	2-8.6	2-5.0	2-0.6
	WL 4	0-2.6	0-10.3	1-2.1	2-2.4	2-8.1	3-0.3	3-3.0	3-4.0	3-3.0	3-1.2	3-5.5	2-4.5	2-1.0	1-7.2	—
	WL 3	0-0.3	0-7.2	1-2.7	1-11.1	2-5.6	2-10.3	3-1.0	3-2.1	3-1.0	2-10.2	2-5.6	1-11.6	1-7.4	—	—
	LWL	—	0-3.5	0-8.6	1-7.2	2-2.3	2-7.7	2-10.6	2-11.5	2-9.7	2-6.3	2-0.0	1-2.3	—	—	—
	WL 2	—	0-2.2	0-9.1	1-5.3	2-1.0	2-6.6	2-9.5	2-10.3	2-8.5	2-4.4	1-9.1	0-2.0	—	—	—
	WL 1	—	—	—	0-5.1	1-4.1	1-11.4	2-3.3	2-3.0	1-10.7	1-2.4	—	—	—	—	—
	BOTTOM	0-0.3	0-2.2	0-3.6	0-5.1	0-6.3	0-7.1	0-7.3	0-7.2	0-6.5	0-5.5	0-4.0	0-2.0	—	—	—
TRANSOM ST ← TR	CENT. LINE			0-2.1	0-3.5	0-3.2	0-6.7									
	A			0-1.5	0-3.2	0-4.6	0-6.4									
	B			0-0.4	0-2.0	0-3.5	0-5.1									
	C				0-0.4	0-2.0	0-3.4									

A

STATIONS		BOW	1	2	3	4	5	6	7	8	9	10	11	12	ST	TR
HEIGHTS ABOVE BASE	CONST. BASE	5-2.0														5-2.0
	SPONSON	5-0.4	4-6.5	4-2.6	3-11.5	3-8.7	3-6.5	3-4.7	3-3.6	3-3.2	3-3.0	3-3.3	3-4.0	3-4.6	3-6.1	—
	SHEER	—	4-1.6	3-10.1	3-7.2	3-4.4	3-2.3	3-0.6	2-11.5	2-11.0	2-10.6	2-11.3	3-0.5	3-2.0	3-2.6	3-3.1
	SEC. B	—	—	3-4.7	2-4.3	1-6.3	1-0.7	0-9.5	0-8.1	0-8.6	0-10.3	1-0.6	1-4.6	1-8.6	1-11.1	1-11.3
	SEC. A	—	3-7.3	2-3.0	1-6.0	1-0.7	0-9.7	0-8.0	0-7.0	0-7.3	0-8.5	0-11.1	1-2.4	1-6.3	1-8.7	1-9.1
	BOTTOM	—	2-0.2	1-5.7	1-2.4	0-11.7	0-9.4	0-7.7	0-7.0	0-7.2	0-8.3	0-10.6	1-1.7	2-6.0	1-8.6	1-9.1
	KEEL	—	—	—	—	—	—	—	0-6.2	0-4.5	0-3.0	0-1.4	0-0.2	0-0.2	—	—
DIAGONALS	DIAG. 1	—	0-10.0	1-6.6	2-1.6	3-8.3	3-1.5	3-6.0	3-8.4	3-9.4	3-8.4	3-6.0	3-2.2	2-10.0	1-6.4	—
	DIAG. 2	—	0-7.7	1-4.2	1-11.4	2-5.4	2-10.1	3-1.6	3-3.5	3-3.1	3-1.4	2-11.0	2-7.1	2-3.1	1-0.6	—
	DIAG. 3	—	—	0-5.6	0-10.0	1-2.0	1-5.4	1-7.6	1-9.0	1-8.2	1-6.5	1-4.0	1-0.0	0-7.3	0-3.7	—
	DIAG. 1 CENTER LINE AT WL 7 INTERSECTS SEC. B AT WL 5 DIAG. 2 CENTER LINE AT WL 6 INTERSECTS SEC. A AT WL 4 DIAG. 3 CENTER LINE AT WL 3 INTERSECTS SEC. A AT WL 1															

B

Table 1. Offsets for 1/12-scale model of ICLARM prototype fishing boat. Dimensions are given in feet, inches, and eighths of inches.

Two such engines were donated to ICLARM by Briggs and Stratton for the experiment. The light weight of this engine allows installation in the dry, forward compartment of the boat, away from all fishing activity.

Although ICLARM had not intended to build boats, this activity was necessary to gain firsthand information on a newly developed construction method and to obtain a full-size prototype.

The compound curves and complex shape of the proposed hull ruled out the use of plywood, and a standard bent frame plank construction of this design would be too complicated and slow. We decided to use a new material called "C-FLEX," a fiberglass planking made by Seeman Plastics of New Orleans. This material was specifically developed for building fiberglass boats without a traditional mold. The material is composed of parallel rods of fiberglass and reinforced polyester resin alternating with bundles of continuous fiberglass rovings. The whole is held together by two layers of lightweight, open weave fiberglass cloth. Each C-FLEX "plank" is 12 in wide. The grade used for this project was "CF-65" (65 oz) per square yd in a 250-ft coil). These "planks" were laid over lightweight plywood frames 18 in on center running fore and aft. (The C-FLEX is somewhat self-supporting and conforms easily to compound curves). The "planks" were tacked in place and wetted down with fiberglass resin. After the resin hardened, fastenings were then removed and the hull was lightly sanded. Fiberglass layup was then applied at right angles over the C-FLEX with alternating butt joints. The following layup was used in the project:

Outside Hull	1 layer C-FLEX
	1 layer 1½ oz mat
	1 layer 18 oz woven roving
	1 layer 1½ oz mat
	1 layer 18 oz woven roving
Keel	Additional layer of mat and woven roving
Finish	1 layer mat veil and resin
Inside Hull	1 layer 1½ oz mat
	1 layer mat veil and resin

Microballoons and resin were used as filler and fairing compound, with the hull to be painted for a final finish.

The C-FLEX system has an additional advantage in that a minimum of tools and equipment are required. Only three power tools were used on the project: an inexpensive 6-in disc sander, a ¼-in drill, and a Saber saw.

Currently, the exterior hull layup is complete except for final sanding and finishing. Actual man hours already spent on the project equal 162½, and an additional 176 hours are estimated as needed to complete construction (Table 2).

Table 2. Number of hours required for each step in constructing ICLARM prototype boat.

Days	Work performed	No. man/hours	Man hours
I. Man Hours to Date			
1st	Set up; construct base and level; start frame layout	2/8	16
2nd	Set up; complete frame cut out; start assembly	2/8	16
3rd	Set up; complete frame; set up and fairing	2/8 2/2	20
4th	Prepare frames: tape/wax form for rub rails;	3/2	6
	install C-FLEX	3/4	12
	wet down C-FLEX	1/1½	1½
5th	Line up and set shaft tube; built up rub rail; mat lows; pick up supplies	2/8	16
6th	Light sand; first layup mat and roving	2/8	16
7th	Sand hull; built up and foamed and matted skeg;	2/3	6
	second layup mat and roving	3/2 1/1	7
8th	Clean up work area; complete skeg forming; spot fill with microballoon	2/8	16
9th	Sand hull; add extra layup to keel and skeg; level fill with microballoon; sand hull	2/6 1/10	22
10th	Faired hull with filler	2/4	8
	Total man hours to date		162½

II. Estimated Man Hours to Complete

Exterior of hull; finish/paint	48
Interior mat; filler	32
Glass in bulkheads and fish box	16
Install seats and hatches	32
Finish and paint interior	16
Mechanical/hardware installation	32
Total estimated man hours to complete	176

Grand Total—Man hours 338½

The 20-ft hull can be constructed for \$983 (Table 3). The fiberglass material accounts for about 66% of the costs, with lumber and other supplies accounting for 18% and 16%, respectively.

Table 3. Materials required for constructing 20-ft ICLARM fishing boat by C-FLEX method.

Fiberglass Material	US\$ Prices ^a
C-FLEX: 1 coil 1-ft wide, 250 ft long = 250 sq ft @ \$0.94	\$235
3 pieces 1½ oz mat 38 in wide, 80.5 ft long = 241.5 lin. ft @ \$0.20	48

Continued next page

Table 3 contd.

2 pieces 18 oz woven roving 38 in wide, 80.5 ft long = 161 lin. ft @ \$0.27	44
Fish box/bulkheads: mat/roving 60 lin. ft @ \$0.47	28
6 five-gal buckets laminating resin = 30 gal @ \$6.70	201
Fillers, catalyst, lacquer thinner	60
Miscellaneous: roving tape, veit mat, etc.	30
Subtotal	\$646
Lumber	
Plywood for frame ^b , bulkheads, seats, etc.	\$120
Other lumber: setup base, battens, rail form	60
Subtotal	\$180
Other	
Sandpaper, brushes, rags, respirators	\$ 40
Paint: monoxoxy, bottom	32
Miscellaneous: screws, protective face cream, small hand tools	35
Contingency: power tool rental	50
Subtotal	\$157
Grand Total-Hull, complete ^c	<u>\$983</u>

^aPrices shown are F.O.B. Honolulu, Hawaii from stock (no volume discount shown).

^bMulti-use item.

^cNot including engine, gear, and hardware.

Plywood Boats for Offshore Fisheries

D. J. EYRES

*Marine Division, Ministry of Transport
Private Bag
Wellington 1, New Zealand*

Introduction

Every year thousands of small plywood pleasure craft are constructed in New Zealand and elsewhere from stock plans produced for the amateur builder by several New Zealand designers.

These designs, with some modifications, are often used by owner-builders and some professional boatbuilders in New Zealand as the basis for fishing vessels. These usually constitute what we regard as inshore fishing vessels where higher speed, lighter scantling craft are employed in cray fishing and longlining. These craft can easily be adapted for offshore, tuna/skipjack fishing in the Pacific region. This paper describes construction of small plywood fishing craft from modified stock pleasure craft designs.

Design

All stock designs are of hard chine form and some have a gull wing configuration in the after sections. Basic designs for pleasure cruisers usually have extensive cabin structures which are unnecessary for fishing craft and can be replaced with a smaller wheelhouse forward with aft cockpit and fish boxes.

Typical layouts for a modified 27-ft stock hull are

shown in Figs. 1 and 2. This design is illustrated in Fig. 3 in a modified form and was used to build three boats which were shipped to Fiji under the New Zealand aid program.

This form of construction may also be used for small craft involved in slower fishing operations in inshore areas. Fig. 4 shows a 27-ft general purpose vessel designed by the author for shrimp trawling and gillnetting. Two of these vessels have been supplied for a UN training school in Indonesia under the New Zealand aid program.

Construction

Construction is simple; sawn frames, ply bulkheads, and transom are cut from full size paper templates. These transverse members are aligned in the upside-down mode and the longitudinal members, hog, sawn timber stem, inner chines, gunwales, and finally stringers are then glued and screwed to the frames. The ply skins are glued and nailed to the closely spaced longitudinal stringers. Ply hulls may be of single skin, but on larger fishing vessels requiring stronger hulls, double skins bonded with a suitable glue are usually used. A developing hull form is used so the ply can be laid on in panels. But right forward, particularly in the area of the topside flare, it may be

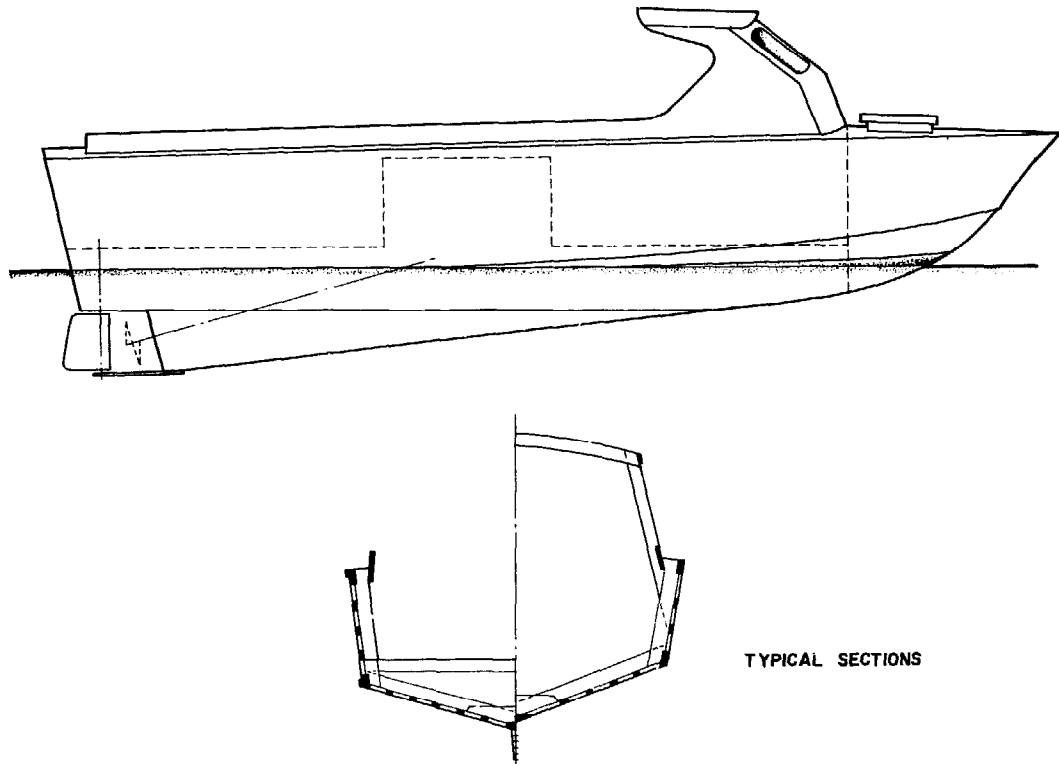

Fig. 1. Typical layout for a modified 27-ft stock hull.

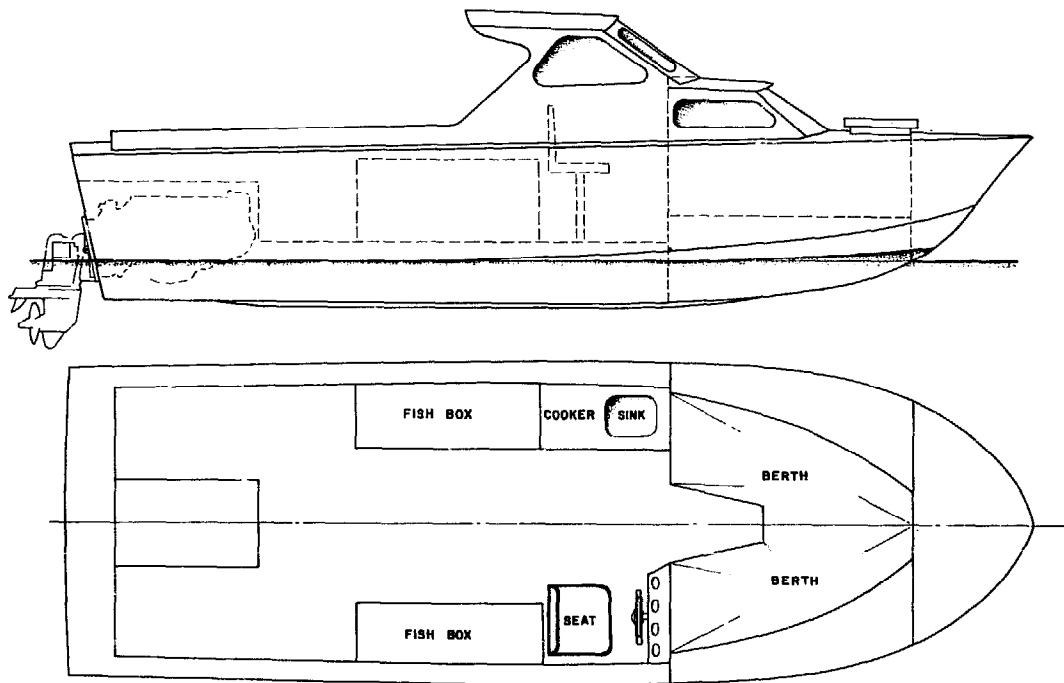

Fig. 2. Typical layout for a modified 27-ft stock hull.

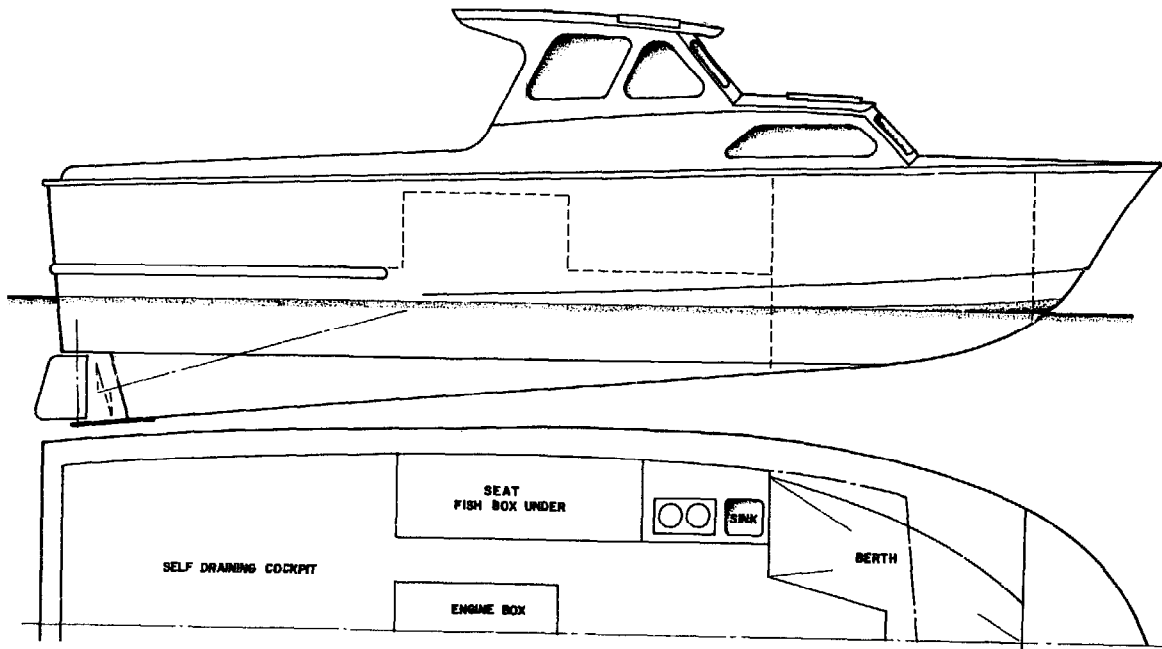

Fig. 3. Layout for a modified 27-ft stock hull used to build boats which were shipped to Fiji.

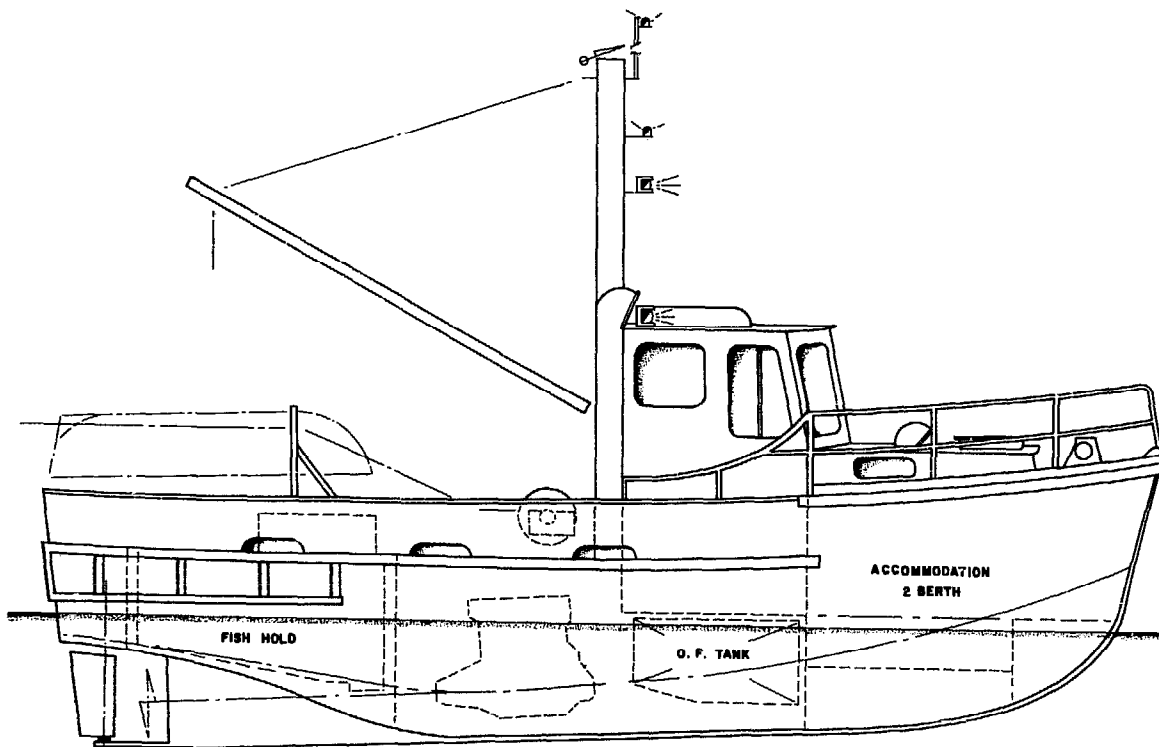

Fig. 4. A 27-ft general purpose vessel suitable for shrimp trawling and gillnetting.

necessary to lay the ply in strips. The width of strips is dictated by the hull curvature. In double glued skins, the ply panels are butted at the joints which are staggered in each skin. Single skin joints are scarfed the length of the scarf to thickness of ply being at least 8 to 1. Deck ply with transverse beams can be butted and fitted with butt straps between beams.

While still upside-down, the hull may be skinned with cloth and resin and the rubbing strip (for inboard-engined craft the sawn or laminated keel) glued and bolted on. Bolts for the keel are placed through the sawn floors which are fitted adjacent to the frames and midway between them. The solid keel is normally an addition to stock designs and is sided to suit the propeller shaft with bolts on both sides of the shaft. A boat may then be turned over, the deck and house fitted, and the outfit completed.

The construction of a sturdy fishing boat often requires greater scantlings than some of those specified for stock pleasure craft designs. These scantlings are usually the hog molding and siding of inner chine and gunwale to provide the desirable surface of at least 2½ times the thickness of the finished ply. Additional floors or siding to take the keel bolts, reduced stringer spacing, and increased deck ply thickness may also be necessary. Other scantling increases depend on the original design specification where there is often some variation between designers. A number of designs terminate the stringers in the forward third of the boat, where short diagonal stringers are extended to the stem even if

more skill is required of the builder to prevent them from twisting, in the interest of maintaining strength.

Typical scantlings and fastenings for plywood offshore fishing craft are presented in Tables 1 and 2.

Plywood and Timber

Marine plywood to BS 1088 is preferred and is available from Australia and the United Kingdom. Marine plywoods with kauri or pacific maple veneers reputedly to NZS 3613 are available from New Zealand, but are not of the same quality as plywood to BS 1088, since the cores are inferior. Marine plywood of good quality is also available from Papua New Guinea.

Timber for these craft should be of superior softwood variety—light, tough, and durable with long straight grain and reasonably free of defects. Examples of this type of wood are Kauri from Fiji, Papua or Klinki Pine from Australia or Papua New Guinea; Huou Pine from Tasmania, and Vitex from Papua New Guinea.

The timber should be subjected to preservative treatment prior to use. In New Zealand various grades of preservative treatment are specified. The most severe treatment is that for timber intended to be immersed in seawater but may be specified for boatbuilding timbers provided that care is taken to prepare glue surfaces and that a suitable epoxy resin is used as the adhesive. If resorcinol glues are used, the timber preservation treatment must be the same as that specified for posts and sawn timber which come in contact with the ground.

Table 1. Typical scantlings used for plywood offshore fishing craft

Boat size (ft)	Hog form (in)	Frames at 36 in	Stringers at 5 in apart	Ply bottom topsides	Deck (in)
25	5 × 1.5	4 × 0.87	1.5 × 0.87	1.35	0.56
30	6 × 2	4 × 1.25	1.75 × 1.12	1.24	0.62
35	7 × 2.25	4.25 × 1.37	2 × 1.25	1.20	0.75
40	9 × 2.75	5 × 1.37	24 × 1.37	1.08	0.87

Table 2. Typical fastenings used for plywood offshore fishing craft.

Boat size (ft)	Keel bolts (in)	Screws ^a (stringers to frames)	Nails ^b
25	0.37	1.75 × 12G	0.83 × 10G
30	0.37	2 × 14G	0.85 × 10G
35	0.43	2.5 × 14G	0.87 × 8G
40	0.50	2.75 × 16G	0.88 × 8G

^aScrew size is British Standard Gauge.

^bNail size is Imperial Standard Wire Gauge.

Fastenings

For this type of craft, bolts are often used only for the keel fastenings. The bolts should be of copper, silicon bronze, or monel. The bolt material may be purchased in rod form, threaded at one end, and headed at the opposite end to suit design requirements. Bronze nuts are often used with the copper bolts; brass nuts should not be used as they deteriorate rapidly in seawater when used in association with copper.

Countersunk wood screws are used for attaching stringers and other longitudinal members to the frames. The best material for these screws is silicon bronze. Although expensive, silicon bronze is vastly superior to galvanized iron or brass in stressed or corrosive conditions.

Modern practice dictates the use of serrated nails for nailing the plywood to stringers, hog, chine, and gunwale. These are great labor savers in comparison to the traditional clenched nail or turned copper nail. The serrated nails should be of silicon bronze or monel.

For pleasure craft construction in developed countries, the practice of stapling of ply in association with adhesives is not uncommon. This practice is not recommended for commercial craft, except for pulling laminated ply skins together while the glue line sets in areas of difficult curvature clear of the framing. The use of stapling puts too great an emphasis on the glue line.

Glues

Since the resorcinol glues and epoxy resins, which conform to BS 1204/1965, are weather- and boil-proof, these gap-filling and close-contact adhesives are used. For many years resorcinol glues have been the approved adhesive for boatbuilding timbers. They are mixed with an appropriate hardener to provide a joint of maximum water resistance and durability. Once mixed with the hardener, the usable life of the adhesive depends on the ambient temperature. In tropical zones pot life is extremely limited. At 68°F a typical resorcinol glue has a pot life of 4½ hours, while at 90°F pot life is only 70 minutes. At higher temperatures, the setting time is reduced. The initial setting time at 68°F for a typical resorcinol glue is 22 hours and at 90°F only 3 hours. The setting time is defined as the period in which the joint has sufficient strength to allow the pressure to be released and the joint lightly worked. The full cure at 90°F takes approximately 2 days.

Epoxy resins now available as timber adhesives have a wood-to-wood shear strength twice that of resorcinol glues. Initially there was a reluctance among boatbuilders to use epoxy resins for laminating because they were thick, pasty, and more difficult to apply to the timber surface. Now, however, these drawbacks have been

overcome with the introduction of low viscosity resins which can be brushed on like resorcinol glues. At 90°F the pot life of a typical epoxy is only 20 min with a full cure of 1 to 3 days. Epoxy resins should not be used on timber treated with boron.

The moisture content of the timber is an important factor, regardless of the type of adhesive used. In theory, moisture content should be around 10%, but resorcinols will produce a satisfactory glue joint with up to 15% moisture content. Epoxy resins are even more tolerant and will glue satisfactorily with a moisture content of up to 18%. If joints are glued before adequate drying, drastic shrinkage can occur, resulting in what appears to be failure of the glue joint but which in fact is a failure of adhesion between the timber fibers.

Surface preparation is important in achieving satisfactory adhesion. All surfaces should be clean and resinous, with oily or hardwood timbers washed with carbon tetrachloride and then washed and dried out.

Sheathing

Plywood boats used in tropical waters must be sheathed with a reinforced plastic skin. The reinforcement can be either a fiberglass cloth or dynel fabric, and an epoxy resin should be used. Early plywood boats were often sheathed with a polyester resin which did not permit adequate adhesion to the ply and which eventually led to delamination between the sheathing and ply.

Where fiberglass reinforcement materials are utilized, it is normal to use a 6-oz or 8-oz cloth on the hull, a 6-oz cloth on superstructures, and a 24-oz woven roving on the working deck. A small amount of sand may be mixed with the final resin application to give decks a nonslip surface. Dynel cloth is more expensive but also superior to fiberglass in most respects and is easier to lay over complex curves.

Epoxy resins for sheathing are not recommended for use where the humidity exceeds 90%. At higher humidities the resin has a tendency to absorb additional moisture which is not emulsifiable to a certain extent, and this results in a milky and under-cured finish. Epoxies generally should not be used below 50°F; high temperatures, however, will have no adverse effect on the curing other than shortening the pot life and final cure time. Due to shortened pot life at high temperatures, the amount of resin and hardener mixed at one time should be limited. For example, at 90°F manufacturers recommend that 1 litre of resin and ½ litre of hardener be mixed (for a pot life of 20 min) and the mixture then transferred to a shallow tray. The application of the resin should not be carried out in direct sunlight.

The actual skinning should be done carefully according

to the resin manufacturer's recommendations. Careful surface preparation and mixing of the resin is essential. The resin hardener mixture is applied with a mohair paint roller directly onto the fabric which has been tailored to shape and smoothed out on the surface of the boat with all joints butted together. Great care must be taken to remove all air bubbles and wrinkles. Excessively heavy coats of resin should be avoided since they will cause the fiberglass to ripple and the lighter dynel to float on the surface. When the resin begins to set up, which in hot weather can be within 1 hour after application, the edges overlapping the gunwale, etc., should be trimmed off. The entire hull skinning operation should be completed

in 1 day and left to harden.

Conclusions

Sheathed plywood boats suitable for offshore fisheries can be produced from modified stock pleasure craft designs. These can be built by personnel who have only a rudimentary knowledge of carpentry, but not necessarily boatbuilding experience, using everyday woodworking hard tools. Provided the correct materials are selected and recommended practices followed, a sturdy and durable craft can be built at a reasonable cost.

A New Use for an Old Idea: A Small Multi-purpose Hawaiian Style Fishing Boat for Developing Fisheries in Island Areas

ROBERT T. B. IVERSEN

*Western Pacific Program Office
Southwest Region
National Marine Fisheries Services, NOAA
c/o Honolulu Laboratory, P. O. Box 3830
Honolulu, Hawaii 96812, U.S.A.*

Introduction

One of the problems faced by those interested in introducing a new boat for use in developing island fisheries is whether the boat should be a single- or multi-purpose fishing platform. There is no one precise answer to this question, but two important considerations are the type of social unit that will operate the boat and the level of technology available to maintain the boat and support fishing operations.

The purpose of this report is to describe a relatively small Hawaiian style multi-purpose fishing boat, which has the capability of being operated by several types of social units and which does not require an excessively high level of technology for maintenance and support. The boat under consideration is a 37-ft-long wooden sampan type that is capable of at least five different types of fishing and has a range of approximately 330 miles with a 165-hp diesel engine. It has minimal crew accommodations.

Some Characteristics of Developing Island Fisheries

For convenience and simplicity, the social units which operate fishing boats in island areas are characterized as

being at the family level, village level, or the commercial level. Each has its own requirements for the number of species caught or types of fishing it undertakes, depending on the ultimate use of the catch. A family-operated boat might engage in only one type of fishing for a few species; a village-operated boat might engage in additional types of fishing for a greater number of species; and a commercially operated boat would probably engage in the most varied fishing operations, assuming it is not a very large commercial activity which could utilize high technology craft for only one or two types of intensive fishing. There is no one small fishing boat that will satisfy all the different requirements of the family, village, and commercial levels, but the one that can adequately satisfy the largest number of fishing requirements will make the most significant contribution toward developing an island's economic potential.

The social units that might operate such a vessel and the level of available technologies fall into several types. Examples are:

Type 1: A small atoll, with very few people and families, very limited shore facilities, lack of carpentry and diesel engine skills, and irregular delivery of fuel. This situation is probably best met by canoe-type fishery and could not possibly accommodate a larger scale fishery.

Type 2: A larger atoll or island with larger numbers of people, several villages, and some experience in ship's carpentry and diesel engine maintenance. An example is Lukunor Atoll in the Mortlock Islands, where it has been possible to operate a wooden sampan-type boat about 30 ft long, the *Fordham Ram*. A key factor here is probably the presence of a resident seaman of wide accomplishments.

Type 3: An atoll or island which is a district center and which has good repair facilities for small boats, communications, fuel, harbor facilities, several commercial enterprises at different levels, and large numbers of people in several or many villages. An example is Majuro, Marshall Islands.

Type 4: A concentration of many villages and people coupled with a higher level of technology and a modern type economy, good shipyard facilities, drydock and marine railway, machine shops, and good communications. An example is American Samoa.

Type 5: A cluster of islands around a large metropolitan center, providing a high level of technology and a widespread market, such as the Fiji Islands.

Some Requirements of Small Fishing Boats for Developing Island Fisheries

The basic requirements for small fishing boats include the following: adequate size, speed, seaworthiness, useful range (sea endurance), versatility (multiple species/multiple fisheries), dependable engines, low fuel consumption, ease of maintenance, and minimal crew accommodations that are adequate. A boat to be used on the smaller islands and atolls should be capable of being hauled completely clear of the water and not just careened. The overriding consideration is that the above factors should be keyed to the concepts of simplicity and dependability of operations, machinery, and equipment.

The use of a multi-purpose fishing boat does assume that a certain minimum level of a technology is available to provide maintenance and repairs. However, since the key criteria are simplicity and dependability, a high level of technology and support facilities is not required. Technology that might be categorized as being in the low to medium range is needed. Dry-docking and marine railway facilities are not absolutely essential, but are highly desirable. Electronic repair facilities are not essential. Individuals with knowledge of ship's carpentry and experience in maintaining dependable diesel engines are required.

For boats in the 35- to 40-ft category, a sea endurance of at least several hundred miles is needed to provide sufficient range to seek fish and reach alternate islands, and for safety. Diesel engines are preferred over gasoline

because of simplicity, lower fuel costs, and fewer systems requiring maintenance. Radios are considered essential for safety. Depth finders and other types of electronic equipment are desirable but are not considered essential. Hydraulics are not considered essential, but provision for power to run hydraulic systems, should they be desired in the future, would be useful.

Construction can be of either wood, fiberglass, or ferro-cement. The use of wood has been generally preferred because the expertise and materials for repairs to fiberglass hulls are not widespread on the smaller islands. This situation is changing particularly in district centers, and the use of fiberglass boats can be expected to increase. However, when wooden boats are properly maintained, they can give years of service, even in the tropics.

Use of Small Fishing Boats in Hawaii

TYPES, SIZES, MULTIPLE USE

There is a variety of types of small fishing boats in Hawaii in the 30- to 40-ft-long range. It is beyond the scope of this report to discuss all the different types of small fishing vessels in Hawaii, but a few comments are in order concerning some features of sampan types from 30 to 40 ft long whose use has been proven over the years.

Hawaiian waters are noted for their roughness and No. 3 seas with waves 5 to 8 ft high and whitecaps are common; therefore, small sampan-type fishing boats are often characterized by a high raked bow, sponsons, hard chine, anti-rolling chocks, and relatively small house to reduce windage. There are dozens of this type of fishing boats successfully used in Hawaii.

This so-called "sampan"-type boat is capable of: (1) Midwater handline fishing for big-eyed scad (*akule*), *Trachurops crumenophthalmus*, and mackerel scad (*opelu*), *Decapterus pinnulatus*, (2) Bottom fishing for a variety of snappers (*Lutjanidae*) and groupers (*Serranidae*), (3) Trolling for tunas and mahimahi, *Coryphaena hippurus*, (4) Occasional netting for reef fish, and (5) "Ika-shibi" fishing, which is midwater handline fishing at night for large tuna using squid for bait while drifting 10-15 miles offshore.

This latter fishing method is a recent development in Hawaii. "Ika" is the Japanese word for squid and "shibi" is an old word for tuna. The boats nightlight for large squid which are placed on hooks fishing from 5 to 20 fathoms. It is not unusual for boats 30 ft long to catch 5 to 10 yellowfin tuna (*Thunnus albacares*) per night, all weighing over 100 lb. Some individual yellowfin tuna caught exceed 200 lb.

Accommodations for crew vary on these boats, with the smaller (e.g., 25 to 39 ft) usually having none, while boats in the 30- to 40-ft range may have accommodations

ranging from rough bunks alongside the engine to regular bunks in commodious berthing spaces. The house may be large enough to provide enclosed steering facilities and crew accommodations or may be just large enough to provide shelter from wind and spray. While drifting, crew members often obtain shelter from sun or rain by spreading a large tent-link tarpaulin over a long wooden boom extending aft from the top of the house. Cooking facilities are usually housed in a small box when not in use and consist of a two-burner propane or kerosene stove, plus a minimum of kettles, pots, frying pans, and dishes. Only the larger boats, which are sometimes used for recreational purposes, have toilets.

Most boats have at least one or two live wells which receive water circulation through screened holes in the floor of the well.

GENERAL DESCRIPTION OF THE SANDRA ANN

The *Sandra Ann* (official number 516-414), a wooden Hawaiian style multi-purpose fishing boat, was built in 1953 by Funai Custom Boats, P.O. Box 17869, Honolulu, Hawaii 96817. It is 37 ft long, and has a beam of 9.8 ft and a draft of 4 ft. Tonnage is 8.87 gross and 6.00 net. General lines appear in Figs. 1-9. Fig. 1 is the only existing construction drawing for the *Sandra Ann*. Many of the sampan-type fishing boats built in Hawaii were constructed mainly from designs that existed in the builder's head, and as a result there are few available plans for this type of vessel. At present the *Sandra Ann* is primarily engaged in bottom fishing for Kona crabs (*Ranina ranina*) using hoop nets and in bottom fishing for snappers. It is powered by the original engine, a General Motors¹ (Detroit Diesel) GM6-71 diesel engine rated at 165 hp. It features four live wells, each with a capacity of 375 gallons of water.

The main fishing characteristic of the *Sandra Ann* is that it is capable of conducting at least five different types of fishing: (1) bottom fishing for snappers; (2) mid-water handlining for akule, opelu, and tunas; (3) bottom fishing for crustaceans; (4) trolling for mahimahi and surface tunas; and (5) live bait fishing for skipjack tuna (*Katsuwonus pelamis*) (most important). With a minimum of further fitting out and the addition of a mechanical line hauler, it probably can be rigged for a modest amount of longline fishing for tunas and billfishes.

The hull and superstructure are wooden with a small enclosed house just forward of the steering wheel. The forward part of the house provides the upper portion of the engine room and leads into a small gear locker forward of the engine room. The house has been extended

aft a few feet on the starboard side by plyboard sheeting to provide a sheltered area for the small winch used for hauling the Kona crab bottom trot line and to provide a lee for preparing food.

The hull has a raked stem with a medium flare just aft of the stem. The forward portion of the hull is bluntly tapered to about one-quarter of the way aft, which provides for a quick recovery when entering a high wave. This allows for a relatively small amount of freeboard forward of the house resulting in excellent visibility forward while steering. The hull is characterized by a fairly low freeboard throughout and a long unobstructed working area aft. According to the builder and owner, the *Sandra Ann* has very good seakeeping characteristics.

Live baitfish used for pole and line fishing for skipjack and live akule, opelu, snappers, and Kona crabs caught by midwater and bottom fishing may be kept alive in four live wells located just aft of the house (Fig. 4). Each well measures 40 x 45 x 48 in and has a capacity of 375 gal of water. Water circulation and oxygen exchange are obtained through nine screened holes in the bottom of each live well. Each hole is 3 in in diameter and can be plugged if necessary. Wooden slats form the covers to the live wells and rest on the ridges of the small combing.

A large fish hold measuring 30 x 36 x 80 in runs thwartship aft of the live wells. This hold has two hatches. Aft of this fish holds are three small holds measuring 22 x 24 x 30 in that are used to store gear, food, or fish if necessary.

Crew accommodations are minimal. Two narrow bunks are formed by the floor boards on either side of the main engine, but for all practical purposes sleeping is done on deck. There is no toilet. Food is prepared on a small propane stove which is housed in a covered box measuring 22 x 24 x 30 in when not in use. There is no mechanical refrigeration and any food that requires chilling is kept on top of ice kept in the fish holds.

An important consideration is the keel, which is 26 in wide. In areas without marine railways, this should allow the *Sandra Ann* to be winched ashore on a sloping beach using rollers made of coconut logs. According to the builder, the *Sandra Ann* should not require any unusual bracing to maintain an upright position when hauled ashore. The present keel, however, ends in a downward angled skeg, which makes leveling the boat a little harder once hauled ashore. During haulout, the propeller is protected by a shoe extending from the skeg.

For use in developing island fisheries, a similar boat's keel should be designed to be on the same plane throughout, with no skeg or shoe under the propeller extending downward. Also, the keel could be shoed with a steel plate to prevent damage when being hauled out on a beach. Elimination of gouges in the keel will help prevent

¹Reference to trade names does not imply endorsement by the National Marine Fisheries Service, NOAA.

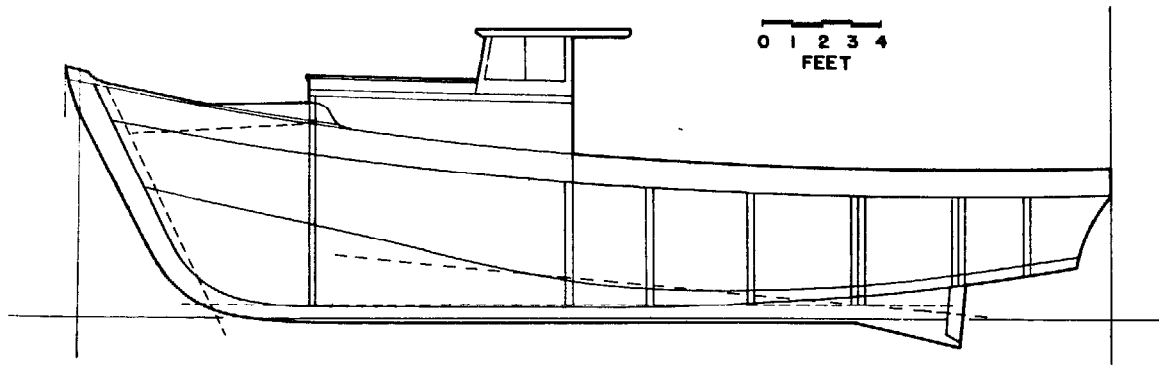

SANDRA ANN

Fig. 1. Outline drawing of the *Sandra Ann*, a 37-ft long Hawaiian style multi-purpose fishing boat wooden construction. The drawing shows the original lines of the house, which has since been worm damage.

Similar wooden sampan type boats in the 30- to 36-ft length range were constructed in the Koror (Palau Islands) shipyard during the 1960s. Several of these boats have received adequate maintenance and are still operational. The *Fordham Ram* at Lukunor Atoll is one.

MAIN ENGINE, HYDRAULICS, ELECTRONICS AND STEERING

The *Sandra Ann* is powered by a GM 6-71, which drives a three-bladed 36-in propeller coupled to a 3:1 reduction gear. A direct takeoff from the main engine provides power for a Vickers hydraulic pump delivering about 10 gal/min. This runs the winch used for Kona crab fishing and for the Kolstrand hydraulic pulleys used for bottom fishing. In developing island fisheries, however, use of a hydraulic system is not envisaged, with bottom fishing gear and crab fishing gear hauled by hand-cranked reels or drums. At present, the *Sandra Ann* employs a Raytheon white line depth finder, Model DE-721A, which runs on a 12-volt DC system. It has a maximum depth range of 280 fathoms, but again, its use is not envisaged in developing fisheries unless competent maintenance and service facilities are available. The *Sandra Ann* also has an auto pilot, Bendix Model 125. In developing fisheries steering would be by hand via the wheel attached to the house, or by a wooden tiller while hauling the crab line or sometimes during live bait fishing for skipjack tuna (Fig. 6). A Kaar Model 37 radio provides the *Sandra Ann* with ship-to-ship and ship-to-shore communications.

OPERATIONAL CHARACTERISTICS

According to the owner, the *Sandra Ann* is capable of making 7 to 8 knots at 1,400-1,800 rpm with a fuel

modified as shown in Figures 2 and 3. (Drawing courtesy of the builder, Mr. Teruo Funai, Funai Custom Boats, Honolulu, Hawaii).

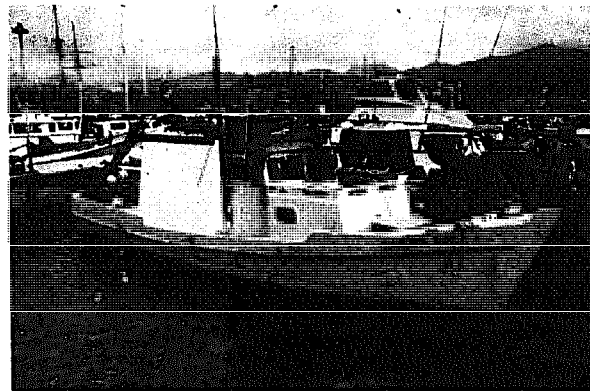

Fig. 2. Side view of the *Sandra Ann*. Note plyboard sheeting aft of the house, which forms a shelter deck for equipment and food preparation.



Fig. 3. Stern view of the *Sandra Ann*. Note bottom fishing hydraulic pulleys on port side of stern. Bamboo markers and plastic floaters for Kona crab fishing gear are stored on the starboard side.

consumption of 5 to 6 gal/h. Fuel tank capacity is 285 gal. Assuming a speed of 7 knots, and a fuel consumption of 6 gal/h, the range of the *Sandra Ann* is approximately 330 miles. Allowing a 10% fuel reserve for safety, the useful radius of operations is about 150 miles. The fresh-water capacity is 40 gal.

Since the *Sandra Ann* was designed to operate in rough waters and also to undertake live bait fishing for skipjack tuna, a heavy duty engine (165 hp) capable of producing a speed of at least 7 knots was selected. Another influence in the selection of the engine was the fact that in the years following World War II, there were a considerable number of GM 6-71 diesel engines available in Honolulu at low cost due to their being surplus to government needs. In waters less rough, and if a speed somewhat less than 7 knots is acceptable, repowering of such a boat with a lower horsepower engine should be considered. For example, a GM 3-53 diesel rated at 101 hp might be expected to have a fuel consumption of about 1 gal/h for every 15 shaft horsepower (shp). At 2,400 rpm, shp is 73 (approximately 4.9 gal/h); at 2,000 rpm, the shp is 60 (approximately 4.0 gal/h). A GM 3-53 diesel weighs 1,090 lb and costs about US\$12,500 in Honolulu. With a smaller engine, the sea endurance and radius of operations should increase significantly.

MULTIPLE FISHERIES APPROACH

The *Sandra Ann* is capable of being fished in at least five different modes for a wide variety of species. A good description of fishing for akule by handline is given by Powell (1968a). The same general technique is also used for opelu fishing by handline. Hoop net fishing for opelu is described by Powell (1968b), and bottom fishing for Kona crabs is described by Onizuka (1972). At present, the technique of midwater handlining for tuna with squid (ika-shibi fishing) as practiced off the island of Hawaii has not been described.

The use of the *Sandra Ann* as a skipjack tuna fishing boat deserves greater explanation. June (1951) provides a good description of live bait fishing for skipjack tuna in Hawaiian waters. In Hawaii, such fishing requires the use of live bait, which is predominantly an anchovy called nehu (*Stolephorus purpureus*). The usual skipjack fishing vessels in Hawaii are of sampan design, but in the 60- to 80-ft length range, and have crews of 8 to 12 individuals. The live bait is captured either by day with a large net (ca 60 to 80 fm long) together with a 20-ft long net skiff, or at night with a large net deployed from the fishing vessel in conjunction with a submerged underwater incandescent light (June 1951). Since the *Sandra Ann* is operated with a crew of only three or four individuals, night baiting is the only feasible method of bait capture, for day baiting requires a minimum of six or seven

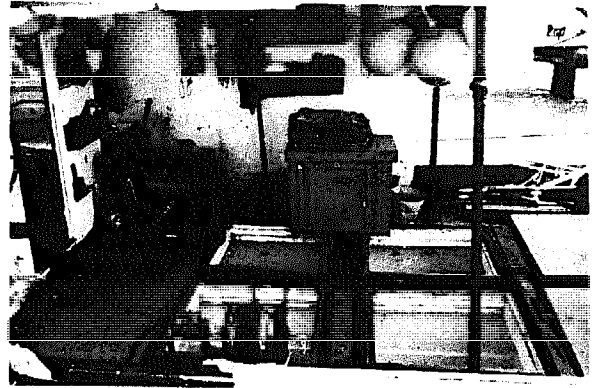

Fig. 4. View of *Sandra Ann*'s deck space just aft of the house. The small winch for hauling Kona crab gear is in the upper left and next to it is the box containing a propane stove. The forward hydraulic pulleys for bottom fishing are shown at bottom center, and the four live wells (covers removed) are in the center.



Fig. 5. View of *Sandra Ann*'s deck space looking aft from door of the house. The four live wells are shown in the foreground with the slatted covers in place. The main fish hold (hatch covers removed) is behind the live wells. Box with the stove is at left. Note the long unobstructed working space extending aft.

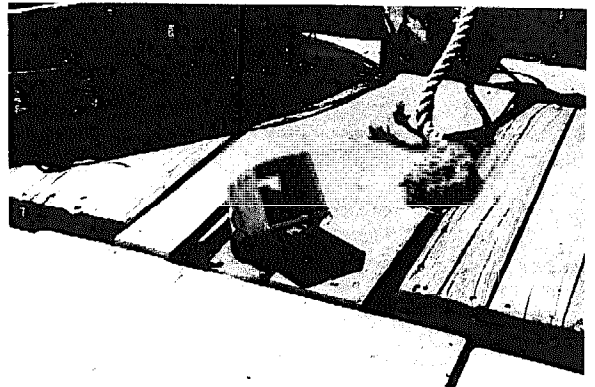

Fig. 6. The rectangular fitting for a removable tiller is shown just forward of the stern rail of the *Sandra Ann*.

fishermen. By using the night baiting techniques and concentrating on skipjack tuna fishing when the abundance of skipjack tuna was high, the *Sandra Ann* could often land from 1,500 to 2,000 lb of skipjack per day on a fairly regular basis, and on a few occasions as high as 5,000 to 6,000 lb of skipjack per day. Each of the *Sandra Ann's* live wells is capable of holding about five to six buckets of live nehu. A bucket of nehu weighs about ± 3.4 lb. The Hawaiian nehu is similar to the anchovy (*Stolephorus heterolobus*) captured by night baiting in Palau, where about 80,000 buckets are captured each year (Muller, MS).

The bait holding capacity of the *Sandra Ann* is one of its strong characteristics. With a bait capacity over 20 buckets, the boat is capable of successfully competing with the larger Hawaiian skipjack vessels when skipjack are plentiful and accessible to a slower boat such as the *Sandra Ann*, which does not have the speed (12 to 14 knots) of the larger vessels. In areas where there are no faster vessels, a boat like the *Sandra Ann* should be able to conduct skipjack fishing even during the off-season. Maximum bait holding capacity per live well in tropical waters might be less than in Hawaii because of higher water temperatures. The live wells can also be used to hold the live catch taken by handlining and bottom fishing until the boat returns to its home island.

A description of trolling and bottom fishing techniques is assumed to be unnecessary in this report.

TRADEOFFS

The essential characteristics that make a small fishing boat like the *Sandra Ann* useful for developing island fisheries are (1) proven design and construction; (2) dependable engine; (3) low fuel consumption; (4) adequate range; (5) live wells for bait and catch; (6) capability of being beached for maintenance; (7) no need for high technology support facilities; and (8) multi-purpose fishing. In short, the boat can do a variety of fishing jobs using a minimum of simple and highly dependable equipment. Overall, simplicity is the key factor.

Special accommodations for the crew have been sacrificed because the length of fishing trips in most developing areas is often only 1 or 2 days and the climate for the most part is favorable for living on deck. Hydraulics would increase the effectiveness of such a boat, but is not considered necessary unless good maintenance and repair facilities are available. A larger engine capable of higher speeds might be desirable, but is not considered essential because of higher costs, high fuel consumption, and the fact that high speeds are not needed to get to the fishing grounds or to compete with higher speed boats for skipjack tuna fishing using live bait. A radio

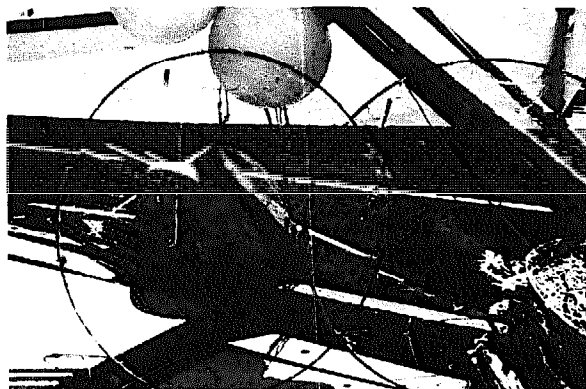

Fig. 7. Hoop nets used for Kona crab fishing on the *Sandra Ann*. Each hoop is about 36-in diameter. Netting is double layer to entangle the legs of Kona crabs, which live on a sandy bottom.

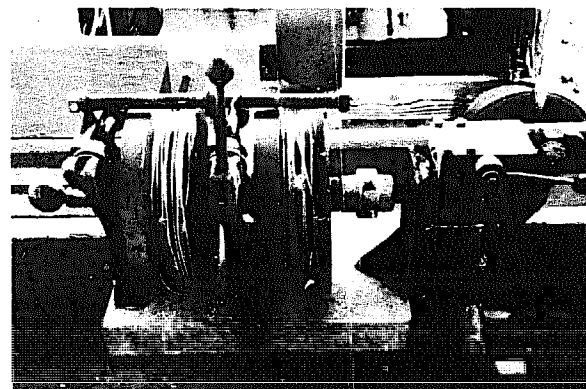

Fig. 8. Closeup of two of the hydraulic pulleys and for bottom fishing on the *Sandra Ann*. Each reel contains several hundred fathoms of braided line.

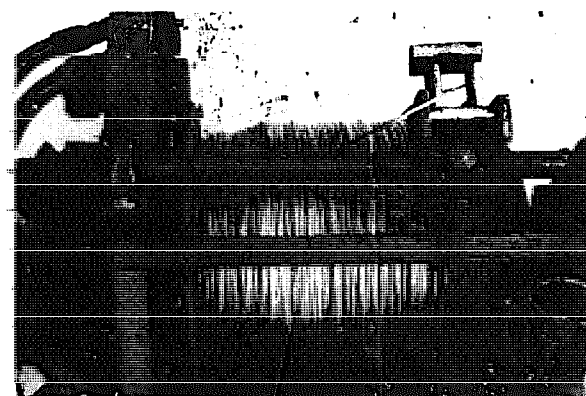

Fig. 9. Closeup of the hydraulic powered small winch used for pulling the bottom line used for Kona crab fishing on the *Sandra Ann*. The winch contains several hundred fathoms of stainless steel wire. Note the level wind.

should be carried for safety. Provision should also be made for the use of a sail in an emergency.

The use of ice is highly desirable and is considered necessary for all the atoll types except those where there is no surplus fish left over after the boat returns home and the catch is distributed following a day's fishing trip. Most trips resulting in very large catches (e.g., skipjack tuna) would probably be only 1 day, since the survival of bait is expected to be a limiting factor. Shading the catch and keeping it wet will help keep the catch in a consumable condition. It is conceded, however, that such a catch will not be in number one condition upon arrival unless ice is used. For longer trips, if ice is not available, catches can be dried or salted, or kept alive in the live wells.

Ice is the single most important item that should be obtained in any attempt to upgrade support facilities for a boat similar to the *Sandra Ann*. It will greatly increase its effectiveness.

Finally, a word about costs. A detailed discussion on the costs of construction and operation of such a boat is beyond the scope of this report, other than the figures given on diesel engine costs in Honolulu and the fact that construction costs of such a vessel in Honolulu today are probably in the range of US\$1,500-\$2,000 per running ft with the engine and US\$1,000-\$1,500 per running ft without the engine.

It is assumed that construction will take place outside the United States in a yard where reasonably priced construction materials are available and labor costs are lower than those in Honolulu. Diesel engines are assumed to be purchased overseas, but the important factor here is dependability, and probably not cost. Paying an extra 20% for a diesel engine that with a reasonable level of maintenance will operate trouble-free for many years is well worth the cost, rather than buying a cheaper engine that is more susceptible to breakdown.

Summary and Conclusions

A small multi-purpose fishing boat that emphasizes the concepts of simplicity and dependability of hull, machinery, and fishing gear in its design and operations can be expected to make a more significant contribution to developing an island's fisheries and economic potential than a single- or dual-purpose fishing boat. Under certain conditions, a small multi-purpose fishing boat can probably satisfy the requirements of the various social units which might operate the boat, namely the family, village, or commercial concerns.

A Hawaiian style multi-purpose sampan type fishing boat should be capable of successful operations from all but the smaller islands or atolls, providing low to medium level technology is available for maintenance and repairs.

Skills in ship's carpentry and diesel engine maintenance are required.

Hawaiian style sampans such as the 37-ft long *Sandra Ann*, a wooden boat capable of at least five different types of fishing, including live bait fishing for skipjack tuna, are suggested as excellent fishing platforms for use in developing island fisheries. A description of the *Sandra Ann* is given.

The overriding considerations in operating such boats in outlying areas are simplicity and dependability, and several systems have been eliminated to meet this end. Crew accommodations are minimal, sleeping is done on deck, and there is no toilet. Electronics (except for a radio), hydraulics, and automatic steering are not considered essential. Such a boat should be capable of being hauled out on a beach; however, a small marine railway is recognized as highly desirable.

A range of at least several hundred miles is needed to seek fishing grounds and for safety.

Diesel engines are preferred over gasoline engines because of dependability, low fuel consumption, and fewer systems to maintain. Mechanical refrigeration is not considered essential, but the use of ice is needed in all fisheries except those where there is no surplus fish from each fishing trip and fishing trips are much longer than 1 day. Ice is the single most important factor for upgrading the operations of small multi-purpose fishing boats.

Since there are few representative sets of plans for the Hawaiian sampan type of boat, it would be useful if some agency or individual would undertake preparation drawings based on existing boats.

Acknowledgments

I would like to sincerely acknowledge the cooperation of the *Sandra Ann*'s builder, Mr. Teruo Funai, and its owner, Mr. Toshio Yoshimoto, for providing technical information. I also appreciate advice and suggestions made by Messrs. John J. Naughton, Richard S. Shomura, and Peter T. Wilson, who read the manuscript.

References

- June, Fred C. 1951. Preliminary fisheries survey of the Hawaiian-Line Islands area. Part III—The live-bait skipjack fishery of the Hawaiian Islands. *Comm. Fish. Rev.* 13(2): 1-18.
- Muller, Robert. 1978. Some aspects of the population biology of *Stolephorus heterolobus* from Palau. In Shomura, R.S. (ed.) *Collection of Tuna Baitfish papers*. NOAA Tech. Rep. NMFS Circ. 408. 167 p.
- Onizuka, Eric. 1972. Management and development investigations of the Kona crab, *Ranina ranina* (Linnaeus). Final report. Division of Fish and Game, Department of Land and Natural Resources, State of Hawaii, Honolulu, Hawaii, 28 p.

Powell, Ronald. 1968a. "Akule" night fishing gear. South Pacific Commission, Noumea, New Caledonia. 13 p.

Powell, Ronald. 1968b. Hawaiian "opelu" hoop net fishing gear. South Pacific Commission, Noumea, New Caledonia. 10 p.

Fiberglass Reinforced Plastic and Its Application to Boatbuilding

RON SHAFER

*Marshall Islands Development Authority
and Island Fiberglass Co.
Majuro, Marshall Islands
Trust Territory of the Pacific Islands*

Fiberglass reinforced plastic (FRP) is the correct name for what is commonly called fiberglass. It is a unique combination of two very different materials which have been blended together to make one product. While it is not the panacea for all types of boat construction, it has definite potential for use in the South Pacific.

Properly used, it can solve many problems which have previously plagued local boatbuilding operations. It will not rot, rust, or corrode. Given minimum maintenance, it will far outlast any material currently used in boat construction. However, it would be wrong to think that fiberglass products can be built and then neglected. Minimum maintenance must include at least one good cleaning and waxing a year. Also, any nicks or gouges that are found in the gelcoat (the water sealant coating of a fiberglass product) should be touched up.

In the Pacific there is a mystique that has caught people to shy away from fiberglass in the past. It is certainly not a new product and has already undergone several research and development phases. FRP found its first use during World War II as a quick method of repairing leaking wing tanks in airplanes. Since that time, improvements to the major constituents of FRP have been developed on an almost monthly basis.

Stories exist about fiberglass boats that have cracked,

split, or turned green. These problems have most probably originated from faulty design, economical corner-cutting, or sloppy workmanship. However, as an example, U.S. Coast Guard testing of a fiberglass boat that has been used full time for over 15 years shows a deterioration factor of less than 10%.

Resins and material selections are the key to a successful venture. A reputable supplier can assist in the proper selection of FRP products and provide advice on how to avoid problems with their use. The only problem that has been encountered when importing fiberglass to the Marshall Islands is in proper storage and logistics. This problem can be solved by storing the raw materials in a controlled environment until time for use.

Both resins are affected by temperature and humidity, and care must be exercised in their procurements and storage. Most resin manufacturers will blend resins for use under specific, predetermined conditions. Shelf life can be extended by storing the resins under specific, predetermined conditions. Shelf life can be extended by storing the resins under environmentally-controlled conditions. The catalysts and hardeners can also be varied to control the length of cure time.

While resins are flammable, problems can be prevented if one uses common sense. It should be noted that the

flash point is in the range of 95 degrees (any good Scotch whiskey is in the range of 85 degrees).

Glass reinforcements are available in a wide variety, from finish veil which is "010" thick, to woven rovings exceeding 24 oz /yd². The correct material is normally specified by the designers, and methods of application vary according to the material used. It is possible to build fiberglass products as one-of-a-kind items using

"one off methods" (i.e., the ICLARM boat), or to mass produce identical parts using a mold.

For those interested in fiberglass boat construction, the following references are recommended:

"How to Fiberglass" by Glen-L Publications

"Fiberglass Boat Design and Construction" by

R.J. Scott

Both are available through *National Fisherman*.

Factors To Consider in Selecting Power Units for Small Fishing Boats

BRIAN FALCONER

*Marine and General Engineering Division
Andrews and Beaven Limited
Auckland, New Zealand*

Engine Horsepower Selection

Various factors must be considered when selecting an engine that is best suited to a particular vessel and fishery:

1. The required speed of the vessel, keeping in mind that the hull has a maximum speed irrespective of the engine's maximum speed.
2. The types of tasks required of the vessel, e.g., line fishing, trolling, and trawling.
3. The auxiliary power requirements of the engine, such as supplying power to a voltage alternator, freezer compressor, deck and bilge pump, trawl winch, etc. These auxiliary duties all require additional horsepower from the engine.
4. The lines of a vessel, as well as its displacement and weight. These factors determine the engine's placement in the hull. If a displacement hull is used, the ratio of engine weight to horsepower is not a critical factor; with a planing hull, however, this ratio becomes a major consideration.
5. The amount of available clearance that the hull design allows for a propeller. With a planing hull with twin engines, the propeller shaft is extended on a strut or "A" frame. This structure has the disadvantage of leaving the propeller unprotected and therefore more

liable to damage from flotsam, reefs, etc.

From the above facts, a general rule for determining appropriate engine horsepower to hull length can be derived:

- Vessels up to 4 m in length require up to 6 hp
- Vessels of 7 m require 6-15 hp
- Vessels of 8 m require 15-25 hp
- Vessels of 10 m require 25-50 hp
- Vessels of 12 m require 50-100 hp

Engine Type Selection and Drive

A first consideration in choosing between gasoline or diesel engines is the availability of fuel. Assuming that both types of fuel are available, the cost per gallon (or litre) should be assessed against the amount the engine will burn per hour.

In addition, the dangers of gasoline must not be overlooked. Gasoline exhaust fumes are toxic, whereas diesel fumes are not. Also, the electrical system of a gasoline engine is very susceptible to damage from moisture and in general, this engine type is more difficult to maintain. The diesel engine will generally provide more hours of trouble-free service than the gasoline engine.

Having selected an engine, one must next consider the

drive unit. Several types exist: a conventional shaft directly coupled to the gear box, vee belt drive from engine to propeller shaft, inboard/outboard drive, outboard motor, jet unit, or vee gear box drive.

Gear boxes can be either hydraulic or manual. An advantage of the hydraulic gear box is its "fingertip control." Within this gear box, or bolted directly behind it, are the reduction gear and thrust bearings. As a rule, with a smaller number of propeller revolutions, slip is reduced and a greater operating efficiency is thus achieved.

When using the vee belt drive between engine and shaft, it is important to fit a thrust bearing onto the propeller shaft. A "jockey pulley" can be incorporated in this drive unit which will allow the propeller to idle while the engine is running. Unlike a gear box which can reverse the propeller's rotation, the vee belt drive is restricted to one direction only.

The inboard/outboard motor requires that the engine be mounted in the aft section in the vessel. In both cases, the purchase price includes a complete unit, including propeller, shaft and other parts. These units offer the advantage of being able to raise the propeller clear of any obstructions. The outboard motors with lower horsepower can be readily removed for servicing as well. The jet unit must also be placed near the stern of the vessel and requires a high rpm engine. The absence of a propeller has definite advantages, but this type of drive is very inefficient at low rpm and thus is inapplicable for activities such as longlining and trolling.

Selection of Engine Systems

"Optional extras" offered by manufacturers are additional considerations when purchasing a marine engine:

Cooling. Three cooling systems are available. A salt-water cooling system involves pumping salt water directly through the engine. This system is simple to install, but often subjects the engine to severe internal corrosion.

Air cooling is a second system. If the motor is located in an open cockpit, this method poses no problem but if the engine is installed in an engine room, an air flow must be maintained to and from the engine.

The best cooling system is perhaps that of freshwater cooling. The simplest method is to "keel cool" an engine; the fresh water is first circulated through external pipes on the hull where it is cooled by water and then passed through the engine. The other freshwater method uses a head exchanger whereby salt water is pumped through a stack of tubes while the fresh water is circulated around these tubes and through the engine.

Starting System. The simplest starting method is hand starting. The other common type of starting is electrical,

which relies on battery power and is more difficult to maintain. Some manufacturers, however, offer both forms of starting and this is a major advantage.

Auxiliary Drives. If other tasks are required of the engine, such as powering a trawl winch, line hauler, or freezer, it is advantageous to purchase a clutch-operated power takeoff. Generally, if no power takeoff is available, vee pulleys can be mounted on the front end of the crankshaft.

Instruments. Instruments can be either mounted directly on the engine or remote-mounted on the dash, and can be of the capillary tube variety or electrical. They should include a tachometer (preferably with a service house meter), oil pressure gauge, and water temperature gauge. If electricity is available, alarm units for low oil pressure and high water temperature should be fitted as they forewarn of problems before a serious breakdown occurs.

Operation of Engine

For maximum engine reliability and performance, some simple training should be provided to the operator. Initially, the operator should read the manufacturer's handbook for familiarization with the engine.

Any proficient boat operator should be capable of changing the engine lubricating oil and lube oil filters as specified by the manufacturer. For all engine types it is imperative that the correct grade of lubricating oil be used. In addition, the oil level in the sump should be checked daily, together with the freshwater level if applicable.

The operator should also be able to trace the fuel system from the tanks, through the primary filter/water trap, to the lift pump and thence to the fuel pump via the secondary fuel filter. All fuel filters should be changed and the water trap drained periodically. In the case of gasoline engines, a basic knowledge of electrical connections is necessary. For example, an operator should know how to deal with dampness on leads.

In addition, an operator should know how to check battery water levels, clean engine air filters and assess daily fuel consumption. A working knowledge of the bilge pumping arrangements is necessary as well.

If a diesel engine is difficult to start but has fuel, it can be assumed that the compression is down and the cylinder head should be removed so that the valves can be ground. In general terms, all modern engines require a valve grind at about 3,500-4,500 service hours, which should be done by qualified engineers. The number of hours varies with different engine makes and models, however, and this figure serves as a guide only. All engines give better performance and lower running costs if they are not "overpropped," i.e., they must obtain

their designed rpm when underway.

In summary, three major factors are involved in selecting an appropriate engine type: the size of the boat, the desired speed, and the type of work required of the boat.

For greater reliability and economy the diesel engine is the better choice. After the horsepower and weight of a unit, the next important consideration is the availability of replacement parts and servicing. From experience gained, I would recommend the engines listed in Table 1

for marine use. These are drawn from those in the larger list in Table 2.

The necessary accessories (i.e., the type of gear box) must also be considered. Correct and careful installation of the engine is an additional critical factor. With regular and intelligent maintenance by the operator, many motors can be operated almost continuously, without frequent overhauling, for many thousands of hours.

An important point to remember is that when at sea and a breakdown occurs, you cannot get out and walk.

Table 1. Brands of motors recommended for marine use with comments on their best features.

Up to 12 hp

Yanmar YSF 8	Simple to operate and install.
Yanmar YSE 12	Economical and very reliable. Has hand and/or electric starting.
Lister SRIN/G	For air-cooled applications.
Volvo Penta MD1B	Similar to Yanmar.
Stuart Turner	Good reliable gasoline engine.

12 to 17 hp

Yanmar 2QM20	Simple to operate. Reliable, economical and has optional starting.
Lister ST2MG/R	For air-cooled applications.
Volvo Penta MD2B	For inboard use.
Volvo Penta MB2A	For gasoline fuel.
Volvo Penta MD11C/100B	For Diesel inboard/outboard use.

27 to 50 hp

Lister ST3MG/R	For air-cooled applications.
Volvo Penta MD3B	For diesel inboard.
Volvo Penta MB20C	For petrol fuel.

50 to 80 hp

Fiat CO3M	Reliable diesel.
G.M. Detroit 5.53	Compact 2-stroke diesel. Has good power to weight ratio.
Volvo Penta AQD21A/2700	Reliable diesel for inboard/outboard application.
Ford Cortina	Compact gasoline engine.

80 to 100 hp

Fiat OMCP3M	Compact and reliable.
G.M. 4/53	Compact 2-stroke diesel. Has good power to weight characteristics.
Lister HR6	For air-cooled applications.
Volvo Penta AQ115A/100	Gasoline inboard/outboard.
Volvo Penta BB115C	Gasoline inboard.

Table 2. Brands of motors available in various ranges of horsepower and selected features of each brand.

Type	Diesel or gas	Hand-Elec start	Cooling	Budget price ^a
<u>Up to 12 hp</u>				
BUKH. DV10M	D	H or E	Sea water	NZ\$2,000 ^b
Lees One - 11	D	E	Sea water	1,650
Stuart Turner	D	H	Sea water	-
Yanmar YSE 8	D	H or E	Sea water	850/\$1,350
Yanmar YSE 12	D	H or E	Sea water	960/\$1,550
Penta MD 1B	D	H or E	Sea water	1,200
Kubota	D	H or E	Sea water	1,300
Lister SRIMG	D	H or E	Air	1,200
Petter AC1WM	D	H or E	Sea water	2,000
Stuart Turner	G	H	Water	1,050
Honda	G	H or E	Air	200 (up to)
Kawasaki	G	H	Air	415 (up to)
Briggs & Stratton	G	H	Air	350 (up to)
Various makes of petrol outboards	-	-	Water	700 (up to)
<u>12 to 27 hp</u>				
Petter PH2W	D	H or E	Sea water	NZ\$1,640
Yanmar	D	H or E	Sea water	2,000
Volvo Penta MD2B	D	H or E	Sea water	2,800
Lister ST2MG/R	D	H or E	Air	2,300 + tax
Lister SW2	D	H or E	Sea water	2,300 + tax
Volvo Penta MD 11C/100B (inboard-outboard)	D	H or E	Sea water	3,650
BUKH DV20M	D	H or E	Sea water	2,700
Lees 4/27	D	E	Fresh water	3,100
Volvo Penta MB 10A	G	E	Sea water	2,000
Wisconsin THOM	G	E	Air	-
Briggs & Stratton	G	H	Air	400
Outboards up to	-	-	-	850
<u>27 to 50 hp</u>				
Lister ST3MG/R	D	H or E	Air	NZ\$2,700 + tax
Lister HRW3	D	H or E	Water	5,450 + tax
Lister HR3	D	H or E	Air	3,800 + tax
Perkins 4/108M	D	E	Water	-
Perkins D3/152	D	E	Water	-
B.M.C. Captain	D	E	Water	2,700
Volvo Penta MD3B	D	H or E	Water	3,800
Lees 4/53	D	E	Water	3,400
Volvo Penta MB20C	G	H or E	Water	3,000
Ford Escort	G	E	Water	2,300
Wisconsin WH4DM	G	E	Air	-
Outboards up to	-	-	-	1,500
<u>50 to 80 hp</u>				
B.M.C. COMMANDER	D	E	Water	NZ\$3,300
Perkins 4/236M	D	E	Water	-
Lees 4/75	D	E	Water	5,320
G.M. Detroit	D	E	Water	7,000
Volvo Penta MD21A	D	E	Water	7,000
Fiat CO3M	D	E	Water	6,800
Volvo Penta AQD21A/2700 (inboard-				

Continued next page

Table 2 contd.

outboard)	D	E	Water	5,100
Lister HRW4	D	E	Water	8,750 + tax
Lister HR4	D	E	Air	5,800 + tax
Ford Cortina	G	E	Water	2,400
Outboards up to	-	-	-	1,900
<u>80 to 100 hp</u>				
Ford 2715	D	E	Water	NZ\$6,500
Perkins 6/354	D	E	Water	-
Caterpillar 3304	D	E	Water	10,000
G.M. Detroit 4/53	D	E	Water	7,500
Fiat OM CP3M	D	E	Water	8,600
Lister HRGMG/R	D	E	Water	9,100 + tax
Lister HR6	D	E	Air	7,100 + tax
Volvo Penta AQ115A/100 (inboard- outboard)	G	E	Water	2,300
Volvo Penta BB115C	G	E	Water	3,800
Outboards up to	-	-	-	2,300
<u>Jet Units</u>				
Berkeley 5J5	G	7 - 10 hp		NZ\$ 160
Berkeley 6JA	G	10 - 40 hp		260
Hamilton 751	G	50 - 150 hp		670

^aPrices quoted are as of September 1975.

^bUS\$1.03 = NZ\$1.00

Air-Cooled Gasoline Engines

J. H. COOK

*Far East and Pacific Sales
Briggs and Stratton Corporation
P. O. Box 702, Milwaukee
Wisconsin 53201, U.S.A.*

Many participants in this workshop are perhaps not familiar with Briggs and Stratton, or if they do know the name, may only associate it with lawn mowers.

The factory is located in Milwaukee, Wisconsin, U.S.A., where single-cylinder, four-cycle, air-cooled gasoline engines rated from 2 hp through 16 hp are manufactured. Engines rated from 2 to 10 hp are constructed of die-cast aluminum alloy, whereas a second range of engines rated from 9 to 16 hp is constructed of cast iron. Annual production averages 7 million to 9 million units. Briggs and Stratton is the largest manufacturer of small gasoline engines in the world. All major components of the engine are produced by the company. Only those parts which are uneconomical to manufacture internally—piston rings, spark plugs, gaskets, springs, nuts, and bolts—are purchased from other sources.

It is estimated that 50 million Briggs and Stratton engines are in use throughout the world, supported by a worldwide service organization which may be the most important factor in the success of the company. There are few areas of the world where Briggs and Stratton does not maintain a service and parts distributor. Recently, a Central Service Distributor has been appointed for Guam and the Trust Territory of the Pacific Islands. A service distributor is also located in Papeete, Tahiti.

The marine application of the Briggs and Stratton engine had its origin in the Philippines immediately after World War II, when Filipino fishermen adapted surplus U.S. Army generator engines, made by the company, to the local fishing craft, the banca. There are now about 250,000 engine-powered fishing boats operating in the Philippines, of which at least 90% are powered by Briggs and Stratton engines. Thousands of the 10-hp cast iron model 243431 and the 16-hp cast iron model 326431 are sold in the Philippines every year for use by fishing boats.

The question is often raised as to the reliability and durability of an engine that has not been designed and constructed for marine application, but is used for that purpose. Many of the older model Briggs and Stratton engines are still in service. For example, a Model ZZP (7.7 hp) manufactured in 1948 is still being used in the Philippines. Another example, a Model 23A-FB (9 hp) has been used since 1954—about 8 hours per day, 6 days per week, and traveling 20 miles each way to and from the fishing grounds. These are not isolated examples, but admittedly, these engines are owned by individuals who have taken good care of them and exercised good preventive maintenance. The owner of the Model 23A-FB reports that he painted the blower housing, inside and

outside every year, changed oil two times each month, and sprayed exposed parts weekly with used oil. He also replaced the crankshaft in 1973, changed piston rings annually, and replaced blower housing every 2 or 3 years. The intake valve has never been replaced. The engine is still easy to start and in good running condition.

According to our studies, the average life of an engine used in the local Philippine fishery operation is 5 years. However, these engines are not specifically designed for use in this highly corrosive saltwater atmosphere. The principal use of these engines in the United States is on small garden-type tractors, and others are used on pumps and generators.

Briggs and Stratton has modified the standard production of 10-hp and 16-hp engines for this fishing application, as much as assembly line production will permit it to be done economically. These modifications include (1) coating the flywheel with an epoxy in the area where the magnet is inserted to inhibit saltwater corrosion, (2) supplying a rubber spark plug cover, (3) installing the exhaust elbow at an angle which will result in less interference with the narrow area where the engine is installed, (4) installing a ground wire terminal at the ignition breaker box with a stop switch instead of the standard stop switch located at the spark plug, and (5) installing a remote throttle control to enable the fishing boat operator to control engine speed easily from a forward or aft position.

In addition, the Briggs and Stratton Philippine distributor recommends, through informal training classes held in fishing villages, the following preventive maintenance procedures:

1. Wash the engine with fresh water after returning from the sea.

2. Repaint the steel components inside and outside (blower housing, backplate, armature core laminations, etc.) to inhibit saltwater corrosion.
3. Provide protection for the hot engine from water splash and provide louvers for ventilation of the engine compartment.
4. Check the alignment of driveline from engine to propeller frequently.
5. Prevent too much tilt of the engine along its crankshaft axis which could cause problems in lubrication and carburetor flooding.
6. Check end-play of the crankshaft every time the engine combustion chamber is cleaned (every 100-200 hours).
7. Retain the air cleaner assembly to inhibit corrosion of carburetor parts (most fishermen tend to discard the carefully designed air cleaner as superfluous in their clean air environment.)
8. Spray the engine weekly with used oil to inhibit corrosion.

The most frequently encountered problems, according to service records, have been corrosion and breaking of the connecting rod due to either low oil level or to over-speeding. A special remote throttle control has now minimized this latter problem. These problems are generally caused by careless operation or maintenance.

An engine specification sheet for each engine model is available from Briggs and Stratton. These sheets provide complete power data and specification standards as well as complete dimensional data. A transmission for the 10-hp and 16-hp engines is manufactured by GWAM, Inc., Manila, Philippines and sold by Muller and Phipps Industrial Corp. of the Philippines.

The Modern Outboard as Applied to the Fishing Industry

BRIAN STAFFORD

*Outboard Marine Australia Pty. Ltd.
P. O. Box 82, Bankstown
N.S.W. 2200, Australia*

During the past 50 years, over 11½ million outboard motors have been sold in the U.S. Of these, two-thirds are still in use today, and approximately 50% of the motors are used for fishing purposes (estuary as well as deep sea and commercial fishing).

Available figures indicate a growing preference for outboard powered craft. In 1976 the range of outboard motors will begin with a 2-hp model and extend to a new 200-hp V6 motor, and the design of the various models will derive from the many applications of their commercial use.

Almost all modern outboard motors employ two-cycle gasoline engines for several reasons. The two-cycle engine, in its most refined form, is relatively simple in design and function when compared to the four-cycle engine. The piston of a two-cycle engine performs most of the work for which a four-cycle engine requires a large quantity of parts. The one up-stroke and one down-stroke of this piston compresses the gas for combustion, opens the exhaust, allows burnt gas to escape, draws in a fresh charge of gas, closes the exhaust and inlet, and again compresses the gas. This simplicity reduces both the weight and the cost of the unit.

Weight is an important factor in outboard motor design, and most outboards below 60 hp are light enough

to be either portable or semi-portable. An output of 135 hp can be obtained from a power-head (complete with a starter, generator, automatic choke, ignition components and carburetor) weighing less than 130 lb. This favorable power-to-weight ratio is achieved by only a few moving parts, a high output per cubic inch of capacity, the extensive use of aluminum, and the use of lightweight components, made possible by low compression ratios and with subsequent lower pressures.

Although the tolerances on most of the motors' components are tight, die cast aluminum used to best advantage, a high volume output, and the inherent simplicity of the two-cycle design brings the price of an outboard motor within reach of the man on the street. The outboard motor manufacturer's continuous rating is a true representation of the horsepower claimed. The ratings are controlled by the Boating Industry Association which employs horsepower certification procedures that conform to SAE procedures accepted worldwide. A manufacturer who is a member of this American organization submits sample power-heads to independent testing laboratories which measure and certify the hp output in the presence of competitive manufacturers.

The horsepower output of the modern outboard is high in relation to its cubic capacity. It is common to

have greater than 1 hp per cubic inch, which is achieved with engine speeds in a range of 4,550-5,500 rpm.

The torque curve of the engine is flat, which means that a high propeller rpm can be maintained even at low boat speeds. This is ideal for putting boats onto the plane rapidly without overspeeding the engine and without needing to change over when the boat reaches its full speed. The hp curve indicates a flat torque curve (Fig. 1). The hp falls off rapidly after maximum brake horsepower is reached. This is an advantage, because to get the best speed from the motor, a propeller should be fitted that permits the motor to reach the maximum hp rpm. Thus, there is no advantage in fitting a propeller that allows a motor to run to high rpm, because performance drops off.

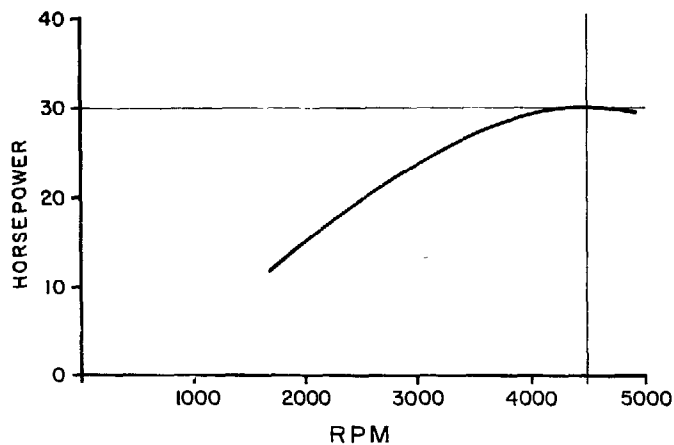

Fig. 1. Relation between horsepower and rpm. The ascending line indicates that up to a certain point, an engine will continue to develop power as rpm increases. The engine represented by this curve would be rated at 30 hp at 4,500 rpm.

The reason why power of the outboard drops rapidly when the engine rpm becomes excessive is that breathing is hindered. The inlet and exhaust ports are not open long enough to allow the fuel vapor inertia and friction to be overcome and still charge the cylinder or crankcase.

The intake port of a typical two-cycle engine is open for 120 degrees of crankshaft travel and the exhaust port for about 145 degrees. At 4,500 rpm the inlet port is thus allowed only 1/220 sec to charge the cylinder and the exhaust port 1/185 sec to discharge the exhaust from the cylinder. If the rpm's are increased to 5,100, only 1/1,250 sec is available for intake and 1/210 sec for exhaust.

Incoming gas and exhaust is directed so that complete scavenging of the combustion chamber is effected with little loss of fresh, unburnt gas. This deflection is accomplished by either of two methods:

1. Most two-cycle outboards use the cross-flow prin-

ciple. The intake and exhaust ports are positioned opposite each other in the cylinder walls. The incoming charge enters the cylinder through the inlet port, deflects upward into the combustion area via the deflector cast on the piston crown, and bounces off the cylinder head and through the exhaust port.

2. The loop charging method has been popular in single-cylinder air-cooled engines. Until recently, no method of incorporating this design into a multi-cylinder water-cooled engine existed. The two intake ports are located almost opposite each other in the cylinder walls, slanted upwards and slightly back. The exhaust ports are positioned on the far side away from the direction of slant of the inlet ports. The piston is slightly domed and does not deflect the gas. The two gases enter through the opposing inlet ports, impinge, and deflect up and around the domed cylinder head and out through the exhaust port.

The air-fuel ratio requirement of most outboard motors varies between 12:1, the rich mixture for idle and maximum power, and 18:1, the leaner mixture for maximum economy at cruising speeds. The carburetors used to achieve this are of single- or multiple-throat side draught. Usually one carburetor or carburetor throat feeds a maximum two cylinders and for large engines, one carburetor or carburetor throat per cylinder is common. This is because a high inlet velocity is important for crankcase efficiency and a high carburetor venturi velocity is necessary for quick motor response. Some outboard carburetors have an adjustable low speed jet for a smooth idling and easy starting, but the high speed jet usually has a fixed orifice.

Magneto ignition is used on most outboard motors of up to 40 hp. The magneto is usually mounted under the flywheel. For a two-cylinder engine, it consists of a mounting plate (or armature plate) on which the components are mounted, one ignition coil per cylinder, one condenser per cylinder, and one set of primary breaker points per cylinder operated by a cam on the crankshaft (Fig. 2). Permanent magnets are cast into the rim of the flywheel which revolves around the armature plate; as the poles of the magnets pass the heels of the coils, a magnetic field is built up around the coil and causes a current to flow through the primary winding. The breaker points, when closed, complete the primary circuit and collapse the current. The condenser is connected across the points to prevent arcing and burning of the points, and this helps reduce the collapsing primary current to zero rapidly. This rapidly falling current in the primary windings permits an abrupt change in the direction of the magnetic flow in the core of the coil. This change then induces, in the fine secondary windings

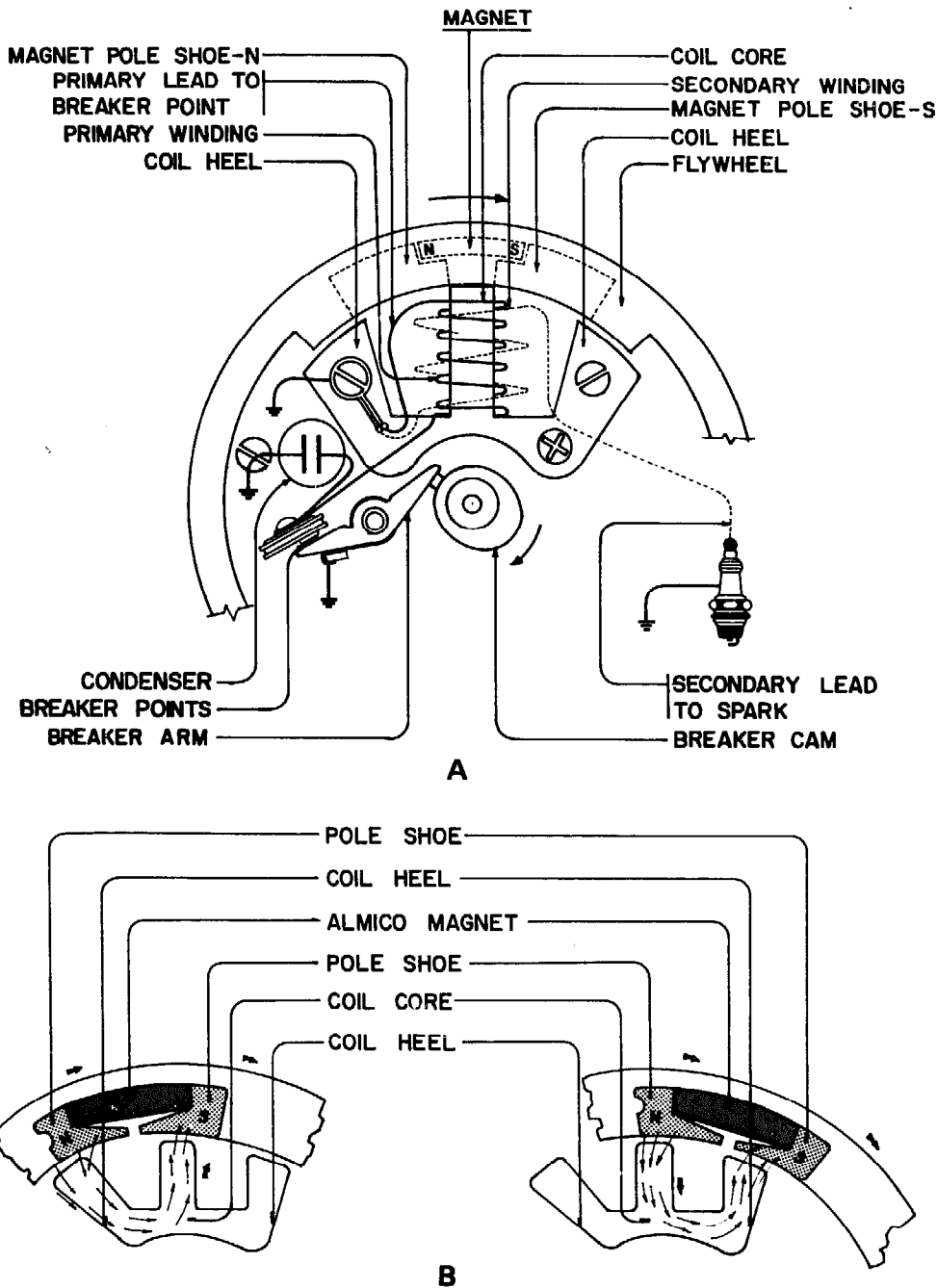

Fig. 2. A typical flywheel magneto system.

of the coil, a current of extremely high voltage which is carried through a high tension leading to the spark plug.

The throttle is synchronized with the spark timing. The first one-third of engine speed is achieved by spark advance only, with no opening of the throttle; the second one-third is reached by advancing the spark to its maximum, with minimal butterfly opening; and the top one-third is achieved by complete throttle opening. Thus, full power can be used to a point where there is maximum

spark advance but very little throttle opening. This results in a good turn of speed with relatively low fuel consumption. A typical fuel consumption curve for a high hp outboard motor is shown in Figure 3.

Two-cycle outboard motors have always been lubricated by mixing oil with gasoline. The petrol-oil ratio recommended for almost all modern outboard motors is 50 to 1.

Optimal lubrication has been a goal of outboard

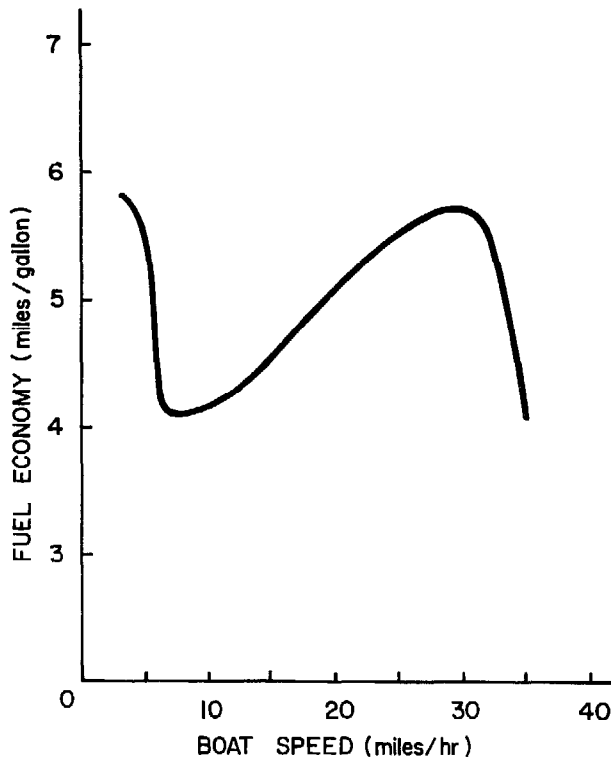

Fig. 3. Fuel consumption curve for an outboard with high horsepower.

designers and the oil companies as well. A few years ago, coil companies realized that four-cycle engine development headed in one direction and two-cycle outboard development in the opposite. They recognized that the automotive oil generally available would soon not be suitable for water-cooled two-cycle outboards. As a result, they developed an oil designed specifically for use in outboard motors.

This "outboard" oil is a carefully blended mixture of bright stock and neutral basics. It includes ash-free detergent dispersant additives which prevent the accumulation of deposits on the piston crown, the cylinder head, and particularly around the piston rings, thereby eliminating the prime cause of pre-ignition and plug fouling. This outboard oil is not suitable for use in four-cycle engines, and four-cycle engine oils cannot be used in outboard motors.

Because outboard motors are generally used in waters of an even temperature, most of them are water-cooled. Because the cooling water is maintained at a fairly low temperature, most outboards have thermostatically controlled systems. The cooling water is circulated through the exhaust covers, around the cylinder sleeves, through the cylinder head, and through the thermostat, and is then discharged or returned to the pump. The pump is driven directly by the driveshaft and is mounted as low

as possible to facilitate priming. The pump consists of a neoprene rubber impeller and an offset pump housing. Because the housing is offset, the impeller blades flex as they rotate, thus varying the space between them. The pump inlet port, located in the stainless steel plate which forms the lower part of the pump housing, is open to the blades when the space between them is increasing. The pump outlet port in the impeller housing is open to the blades when the space between them is decreasing. Thus, at low speeds the impeller works as a displacement pump. At higher speeds, when water resistance keeps the blades from flexing and the pump acts as a circulator, enough water is provided by the forward motion of the motor through the water. The pump design can pass solids and sand through the pump without damage.

Almost all outboard motors are made of die-cast aluminum. Because of the economic advantages of using this material and process, special attention has been given to the composition of alloys that will withstand corrosion under hostile conditions. One of the best alloys is an 11% silicon alloy with copper content below 0.6%.

The internal water passages of the powerhead are specially treated with a high-solids varnish. The varnish is applied under vacuum and baked to resist the high salt atmosphere inside the passages after the motor has been switched off. Special paints developed for outboard motors are subjected to extreme exposure and salt spray acceptance tests. The method of application on some motors is to heat thick paint to spraying viscosity while spraying takes place, which allows a heavier coat to be applied without sags or runs. Then when baked, the

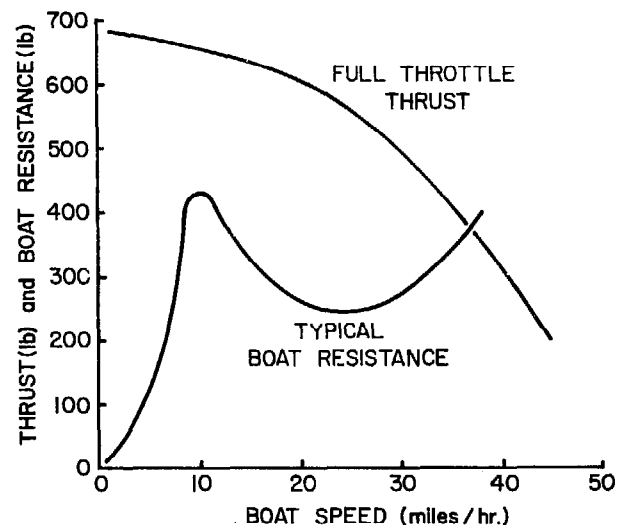

Fig. 4. Resistance of typical 17-ft boat with load of four passengers. Full throttle thrust curve is net driving thrust of an 80-hp engine using 10-in diameter x 10-in pitch propeller.

coating is denser because less solvent must be evaporated out.

The propeller of an outboard motor performs somewhat the same function as the gear box of a car. A propeller too low in pitch gives exceptional acceleration, low top speed, and excessively high engine rpm. A propeller too high in pitch gives poor acceleration, low top speed, and low motor rpm, because the motor is overloaded. The correct propeller is one that allows the motor to reach its maximum break horsepower rpm. This gives good acceleration then, because of the flat torque curve of an outboard motor and optimum top speed.

Propellers rely entirely on slip to do their work, slip being the difference between the theoretical advance (pitch times rpm) and the actual advance of the boat. As the propeller slips through the water, it accelerates a volume of water to the rear, and the reaction causes the boat to move forward. Large displacement hulls, because of their high resistance, require a great deal of slip, 50 to 60% to get the required reaction to drive the boat forward. Planing hulls with comparatively small resistance, operate at a low slip of 10 to 20%.

The two main variables in the design or selection of the propeller are pitch, for which a large range exists for each hp outboard, and diameter, over which the outboard user has limited choice. The manufacturer makes a compromise between a large diameter which produces a high theoretical efficiency under low-speed, high-thrust conditions, and a small diameter which is more efficient at higher boat speeds where skin friction losses become significant.

The outboard user has limited choice in the selection of propeller diameter because the gearcase design limits the diameter by distance between the propeller shaft

center line and the underside of the anti-cavitation plate. Thus, gearcase design is also a matter for compromise.

The major problem facing designers is to determine a shape which yields the least drag and the highest possible speed for the horsepower of the outboard, while eliminating the possibility of cavitation. Cavitation occurs when the pressure on the surface of the object equals the vapor pressure of the liquid in which the object is immersed.

The two-cycle water-cooled outboard motor designed for constant and continuous power output is an economical propulsion unit for small fishing craft. By using either single or dual installation of engines from 6 hp and up, a high power-to-weight ratio is available for efficient propulsion of boats ranging from dugout canoes to the landing barges used by major defense forces.

In areas where roads are rare or inaccessible, the outboard motor can be serviced readily because of its portability. Because the motor "clamps" onto the boat, a greater range of power sources is possible, and by correct propeller selection, smaller hp motors can be employed.

One result of using the two-cycle outboard motor is a lower initial investment. Lower operating costs are another benefit. While the design of the outboard motor is sophisticated, the actual product has been kept simple to permit simple and cheap servicing. In addition, only a low level of technical skill is required for normal maintenance and service.

The use of lightweight low-cost boats and outboard motors can provide employment for large numbers of people, enabling the increased cash returns from the fishing resources to be spread over a wider area than if bigger and more technically oriented fishing vessels were used.

Drive Requirements for Small Fishing Craft: The Jet Unit as Compared to Direct Drive

T. R. HITCHCOCK

*Lees Marine Ltd.
Auckland, New Zealand*

An attraction of the Jet unit is that in terms of the power pack, only three items are required: the engine, the coupling, and the Jet. The Jet is a self-contained drive unit. Installation, especially of the smaller Jet, is relatively simple, the unit being light enough for one man to handle and fit. Operation of the steering and reverse levers are sufficiently light for conventional push-pull cables to be used. In addition, moving parts for the Jet are restricted to the central drive shaft which carries the impellers. The shaft, normally of stainless steel, is carried in sealed bearings.

The larger Jets, while adhering to the same basic principles, are more complex. Weight and size increase substantially, and the pressures needed for the operation of the Jet controls, especially for reverse, require the use of expensive equipment. Installation of these units is more involved due to their wedge-shaped configuration whereby the entire Jet unit is housed outside the boat.

With the increasing use of sophisticated electrical equipment, it is necessary to ensure that the Jets, the bodies of which are normally aluminum, are adequately protected from possible damage caused by electrolytic action. Failure to check and replace the anodes periodically could result in the necessity to replace the entire Jet unit.

A serious drawback with certain Jet applications occurs when air is entrained in the water flowing through the intake grill. This causes surging and not only is performance impaired, but the stresses on the engine from sharp fluctuations in load can also eventually result in damage to the unit. It should be noted, however, that correct design of the craft, together with a lower operating speed especially in rough water, can do much to obviate this fault.

The greatest benefit of the Jet unit is that it leaves the hull clear of projections, thus allowing it to operate in shallow water and to be easily beached.

Weed and other floating waste like polythene can block the intake grill, as can fish netting in a compacted form. Once this occurs one cannot reverse the flow of water, and even in neutral, the sucking action continues. The other problem is that steering is inseparably linked to the drive so that blockage causes not only loss of drive but loss of steerage as well.

The handling characteristics of Jet boats differ slightly from more conventional craft. Steering can sometimes feel heavy. This is because steerage is achieved by physically deflecting the Jet thrust. Therefore, the boat operator must ensure that the steering cable moves freely in its outer cable to avoid any additional stresses.

List of Participants

S. ALLEN
TTPI Field Representative
Community Services Administration
Region IX
100 McAllister Street
San Francisco, California 94102

R. BAIRD
Fisheries Adviser
South Pacific Commission
B. P. 5
Noumea, New Caledonia

A. CHAPMAN
UNDP Project Manager
P. O. Box 14
Nuku'alofa, Tonga

J. COOK
Director, Far East and Pacific Sales
Briggs and Stratton Corporation
P. O. Box 702
Milwaukee, Wisconsin 53201

W. COOPS
Administrator
Research Corporation of the University of Hawaii
1110 University Avenue, #402
Honolulu, Hawaii 96814

R. EGINTON
Masterfisherman
SPC Outer Reef Artisanal Fisheries Research
South Pacific Commission
B. P. 5
Noumea, New Caledonia

D. J. EYRES
Naval Architect
Marine Division
Ministry of Transport
Private Bag
Wellington, New Zealand

B. FALCONER
Manager
Marine and General Engineering Division
Andrews and Beaven, Ltd.
29 Halifax Street
Nelson, New Zealand

G. FREDHOLM
Naval Architect
1121 Wilder Ave. #900-B
Honolulu, Hawaii 96822

W. LE GALLEY
Director
U. S. Sea Grant Program
American Samoa Community College
Pago Pago, American Samoa

D. H. GIBSON
Acting Chief Fisheries Officer
Fisheries Division
Ministry of Commerce and Industry
P. O. Box 508
Betio, Tarawa, Gilbert Islands

Ø. GULBRANDSEN
Fisheries Adviser
P. O. Box 295
Apia, Western Samoa

PWONSY HADLEY
Chief Mechanic
Ponape Dory Project
Ponape, Eastern Caroline Islands
Trust Territory of the Pacific Islands

P. HELFRICH
International Center for Living Aquatic Resources
Management (ICLARM)
MCC P. O. Box 1501
Makati, Metro Manila
Philippines

V. HINDS
Assistant Director
Fisheries Management Division
Ministry of Agriculture and Fisheries
Wellington, New Zealand

T. HITCHCOCK
Manager
Lees Marine, Ltd.
Private Bag
Papakura, New Zealand

R. JAMES
Principal Fisheries Officer
Ministry of Natural Resources
Honiara, Solomon Islands

A. JONES
President
McWayne Marine Supply
1125 Ala Moana Blvd.
Honolulu, Hawaii 96814

G. LOUBENS
Océanographe biologiste
Section Océanographie
Centre ORSTOM
Noumea, New Caledonia

T. LUDWIG
Manager
Ponape Dory Project
Ponape, Eastern Caroline Islands
Trust Territory of the Pacific Islands

J. MORET
Observer
Small Boat Designer
B. P. 2602
Noumea, New Caledonia

R. NAGAI
Fisheries Officer
Department of Agriculture, Stock and Fisheries
Konedobu, Papua New Guinea

E. OSWALD
Deputy/Program Leader
UNDP/FAO South China Sea Fisheries Development
and Coordinating Programme
MCC P. O. Box 1184
Makati, Metro Manila
Philippines

A. OVERAA
UNDP/FAO Boatbuilder
P. O. Box 295
Apia, Western Samoa

S. PULETASI
Director, Extension Services
U. S. Sea Grant Program
American Samoa Community College
Pago Pago, American Samoa

R. RECHEBEI
Marine Resources Coordinator
Marine Resources Division
Department of Resources and Development
Saipan, Mariana Islands
Trust Territory of the Pacific Islands

I. J. REAL
Sales Director (Observer)
Salthouse Brothers (Ltd.)
Boat Builders and Designers
Greenhithe
Auckland, New Zealand

S. RITTERBUSH
International Center for Living Aquatic Resources
Management (ICLARM)
MCC P. O. Box 1501
Makati, Metro Manila Philippines

E. SANTOS
Executive Director
Ponape Community Action Agency
P. O. Box 400
Kolonias, Ponape, Eastern Caroline Islands
Trust Territory of the Pacific Islands

M. LE COMMANDANT YVAN SERVE
Ingénieur de Marine
Ingénieur-Conseil et Expert Maritime
B. P. 2387
Noumea, New Caledonia

R. SHAFER
Consultant
Marshall Island Development Authority
General Manager, Island Fiberglass
Majuro, Marshall Islands

B. R. SMITH
Acting Principal Biologist
Department of Agriculture, Stock and Fisheries
Konedobu, Papua New Guinea

H. SPERLING
Regional Fisheries Coordinator
c/o United Nations Development Program
P. O. Box 1864
Manila, Philippines

B. STAFFORD
Australian Service Manager
Outboard Marine Australia Pty., Ltd.
P. O. Box 82
Bankstown, N.S.W. 2200, Australia

R. M. STONE
Principal Fisheries Officer
Ministry of Agriculture, Fisheries and Forests
Suva, Fiji

P. VEILLON
Ingénieur Halieute
Association Territoire/CNEXO
Papeete, Tahiti