

# PRELA'S BEE-V-GER MULT

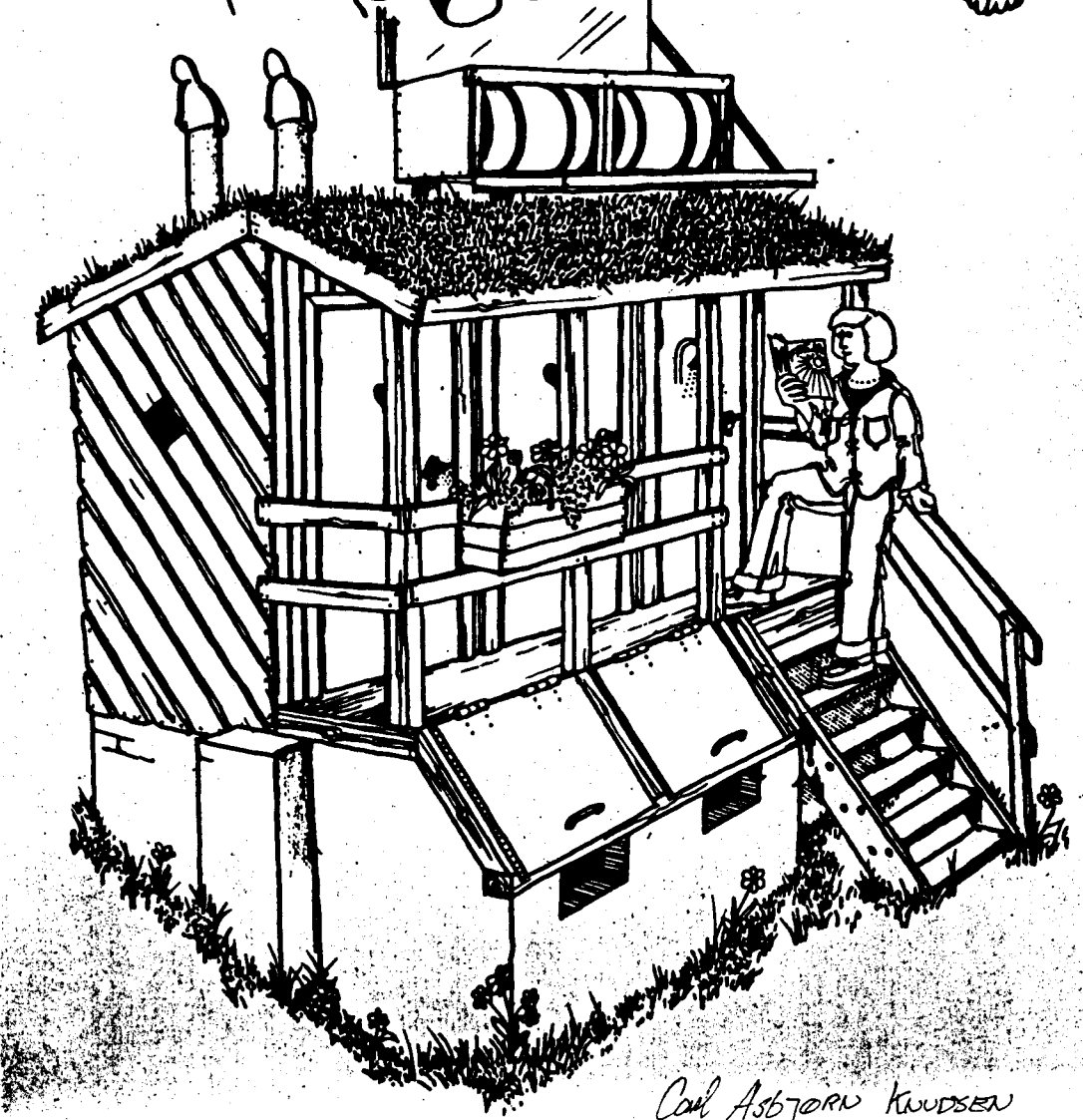

Carl ASBJORN KNUDSEN

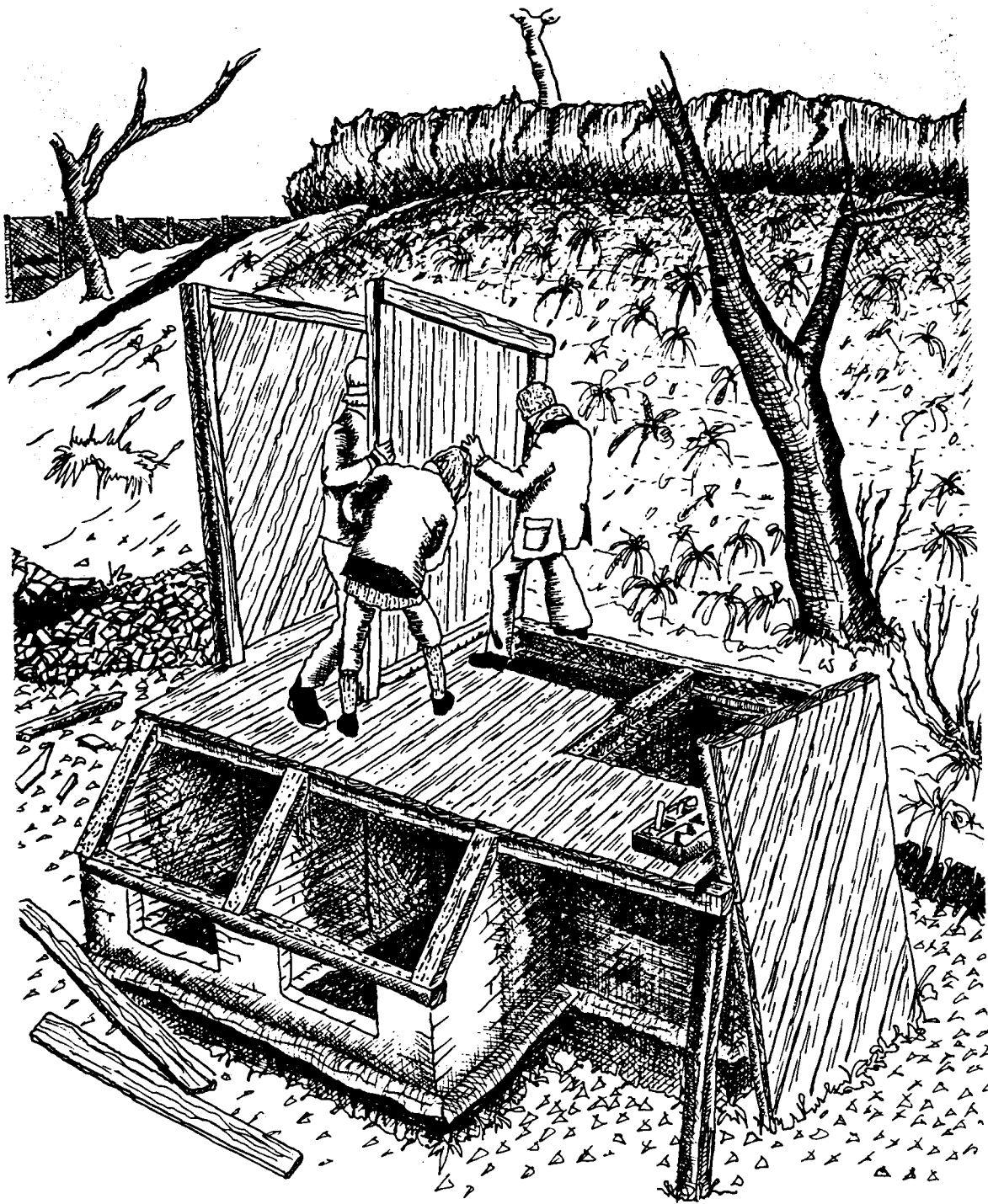

1:20

×30×

176

310

145 140

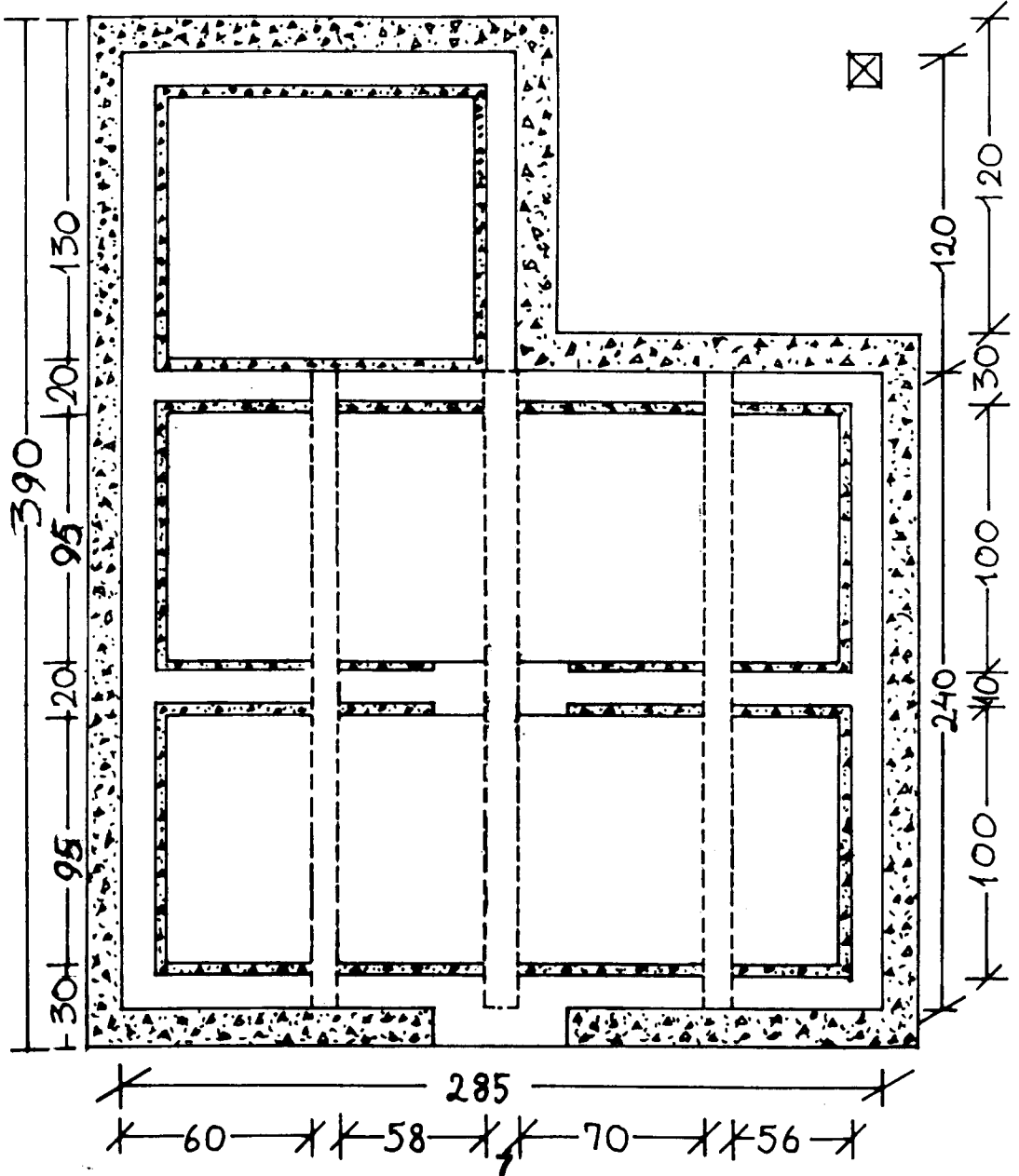

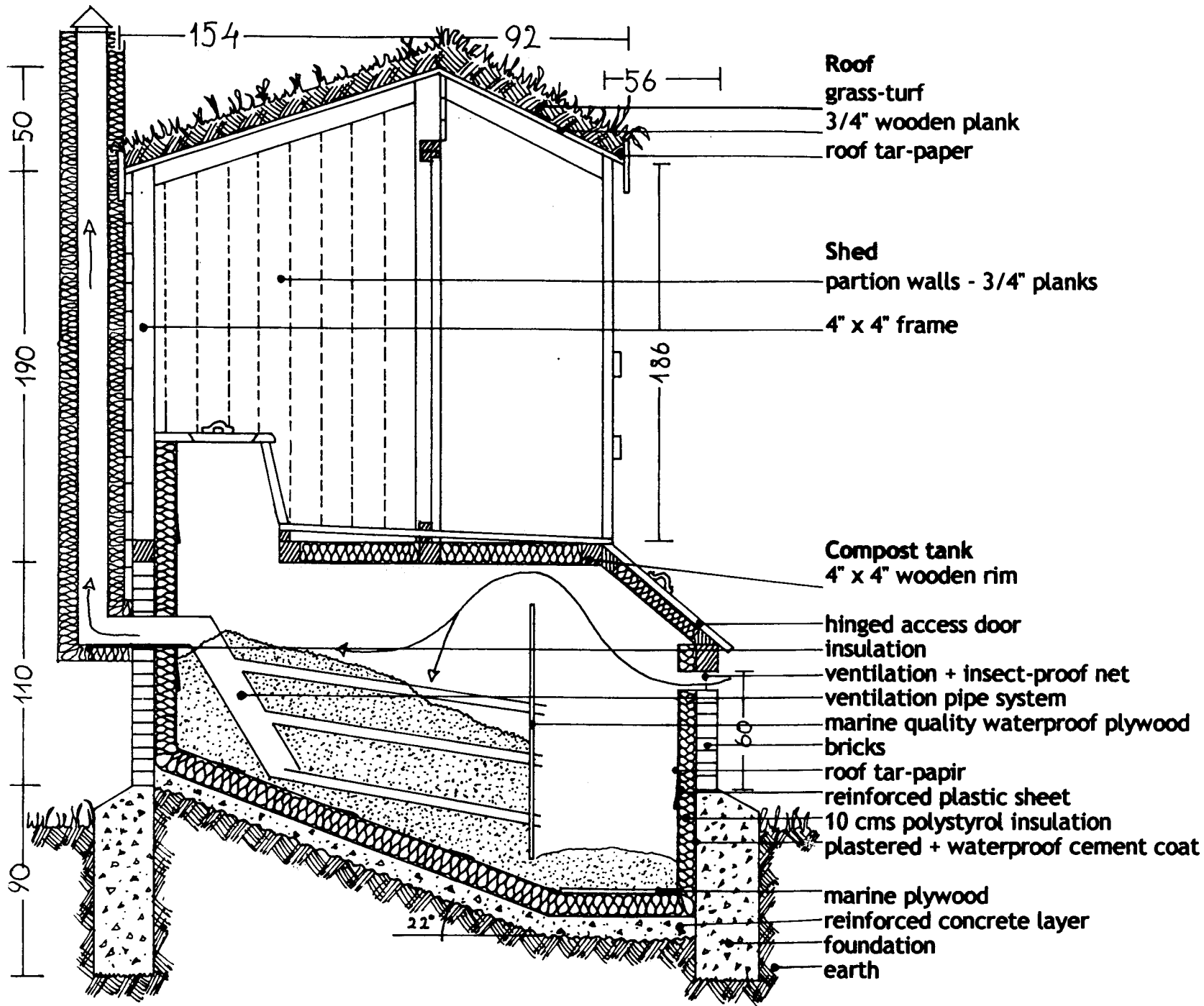

**Plastic ventilation tubes in the actual compost mass - must be U-shaped or V-shaped with the opening facing downwards and the rounded or pointed side facing upwards.**

**The ventilation pipe from the container to the roof - must be insulated to prevent condensation.**

1:20

Solar batch heater

Shower/bathroom

Wash basin, taps etc.

Water inflow pipe

Wooden slatted floor

Drain

Greywater drain to leach system

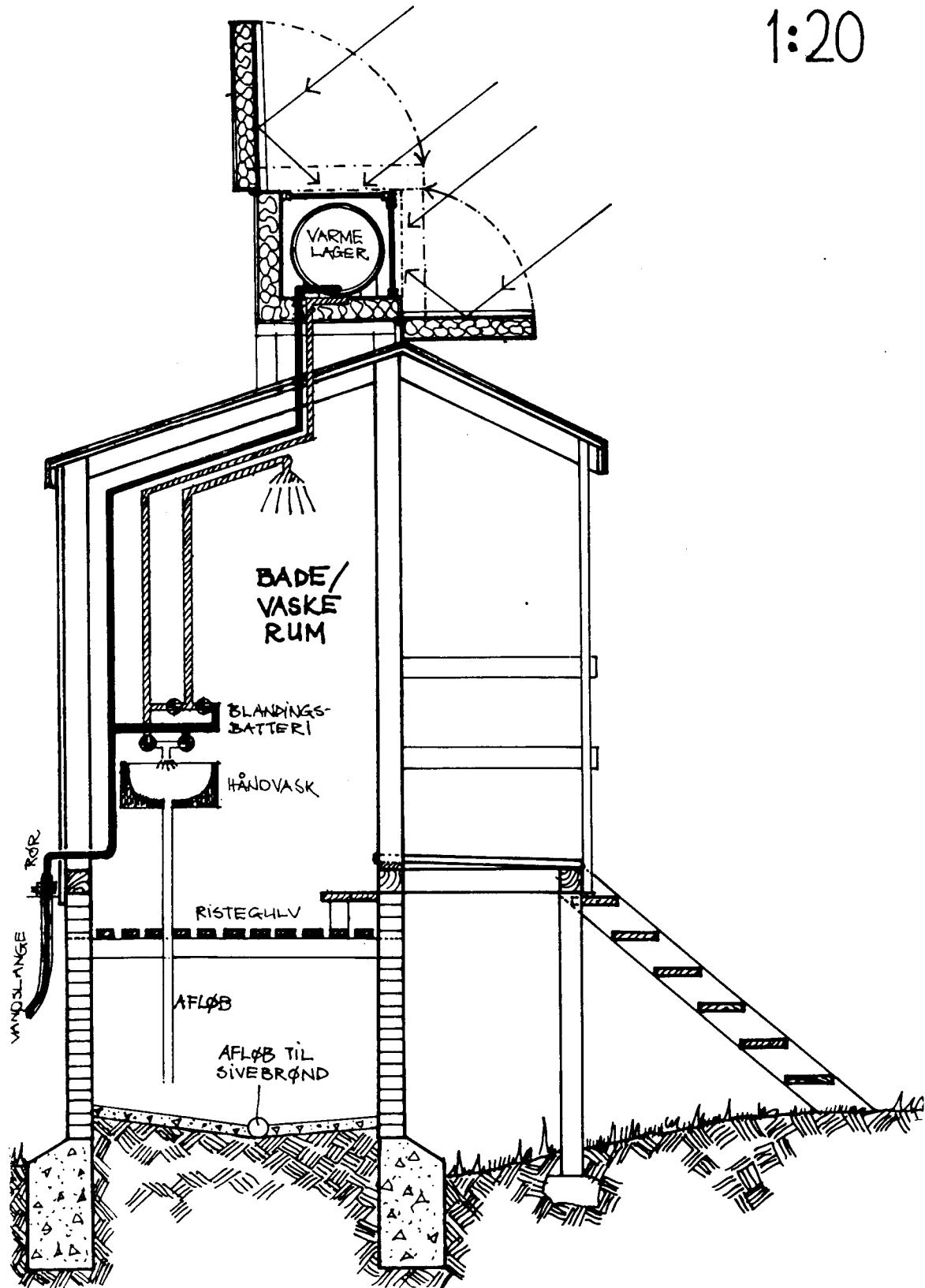

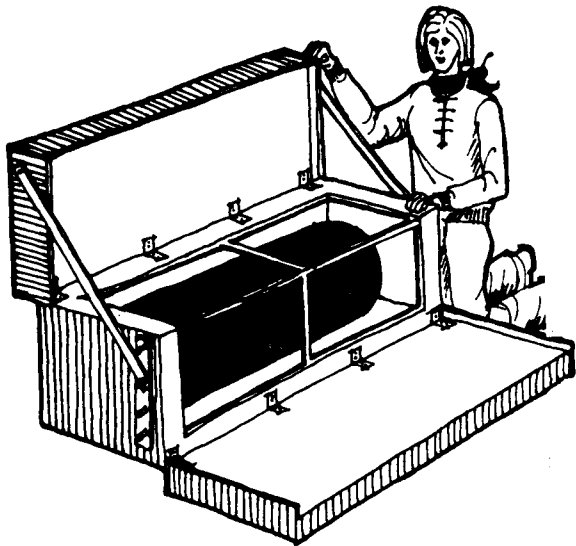

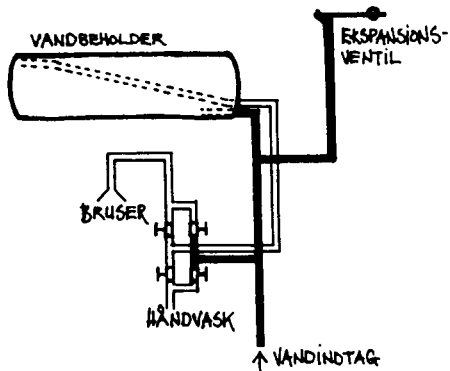

Expansion valve

Water tank

Shower

Wash basin

Water inflow



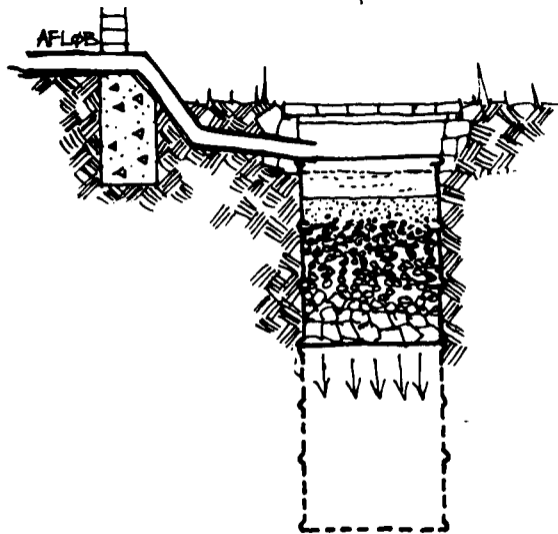

**Water reservoir**  
**Peat filter for soap**  
**Sand**  
**Gravel**  
**Small stones**  
**Larger stones**

**In clay soils - 2 oil  
drums are recommended.  
The upper drum as an  
extra water reservoir**

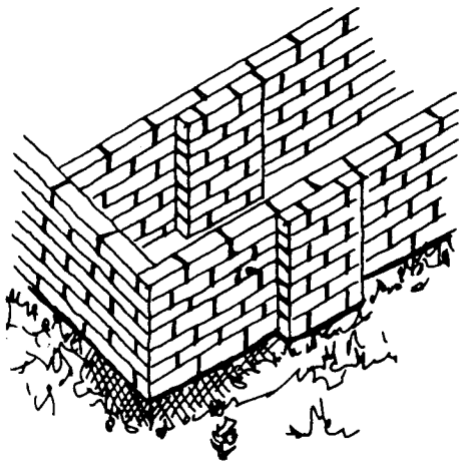

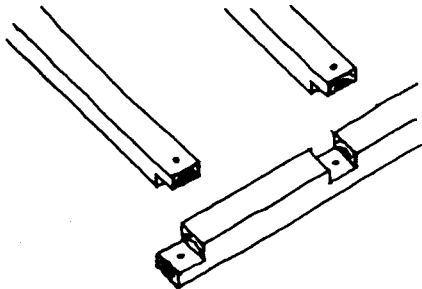

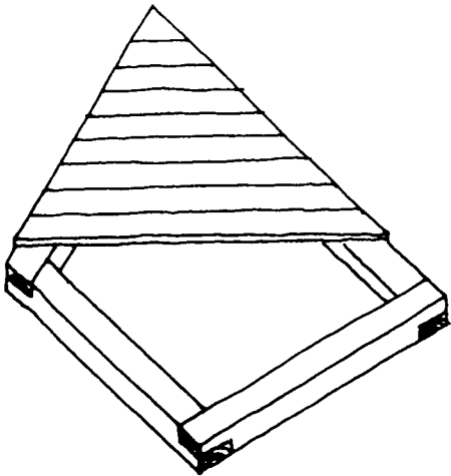

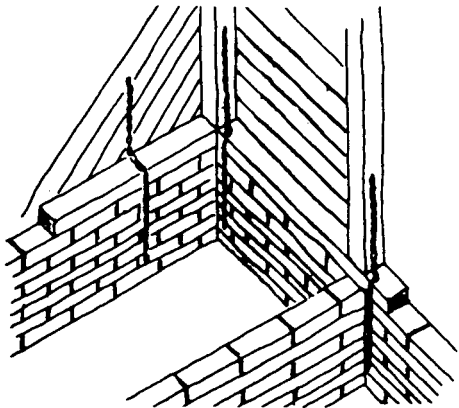

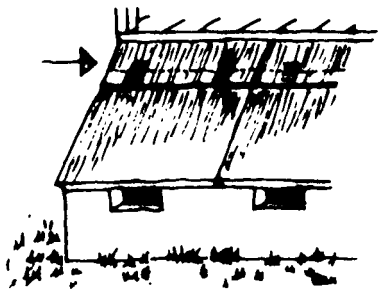

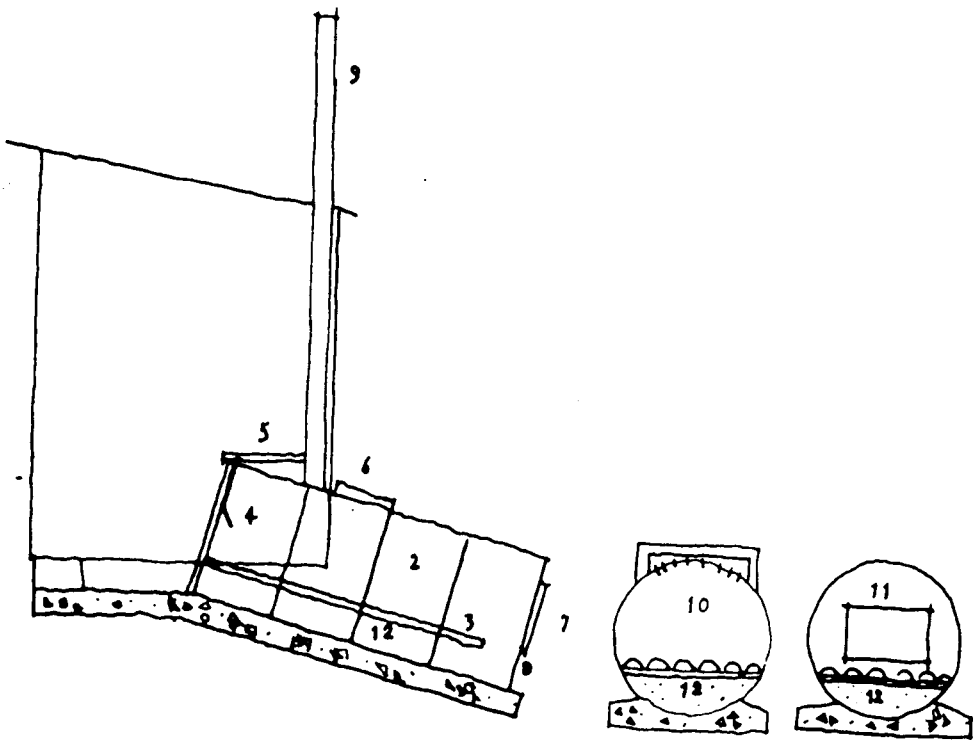

### FOUR-RING COMPOST TOILET

- 2: 4 concrete rings - 60 cms long, 100 cms diameter  
- placed on reinforced concrete bed
- 3: plastic roof-guttering placed upside down for aeration
- 4: metal splash-sheet for spread of urine
- 5: toilet seat cover
- 6: hatch for kitchen and household organic waste
- 7: hatch for removal of decomposed material
- 8: air entry holes
- 9: ventilation pipe
- 10: frontal view of plastic guttering
- 11: rear view of plastic guttering and hatch
- 12: bed of peat and earth

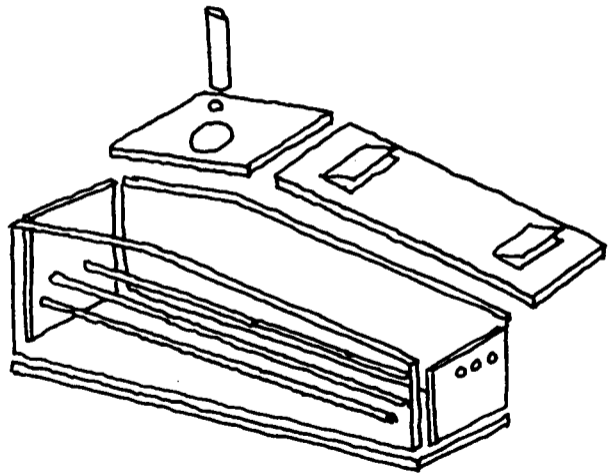
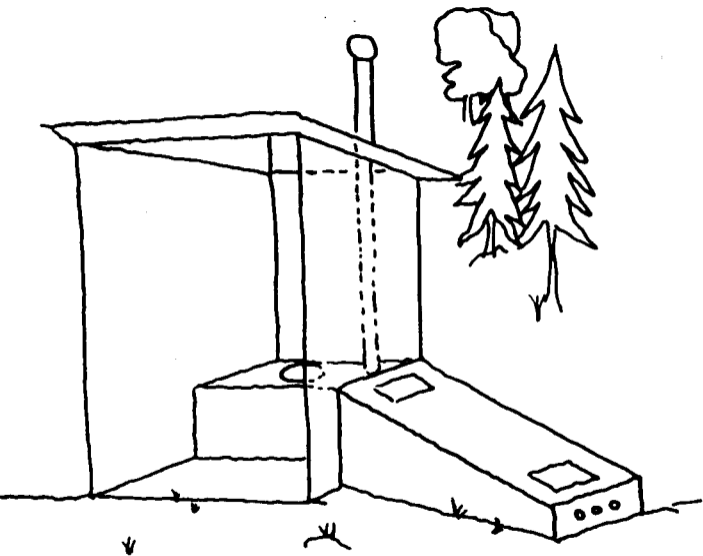



1.500 mm

1.000 mm

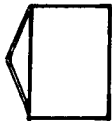

220 mm

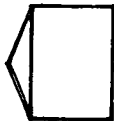

80 Kg med 30 mm

Top

150 cms

100 cms

2 hatch openings  
with rain barriers

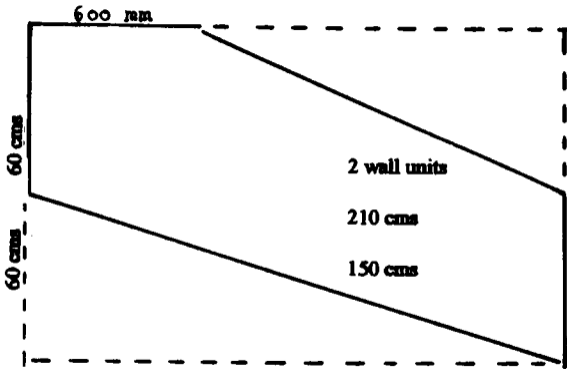

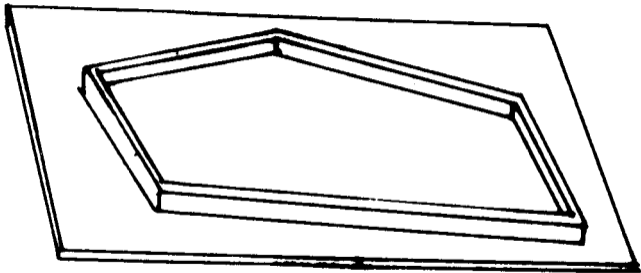

form

2.100 mm

Bottom

210 cms

100 cms

120 kg med 30 mm

1.000 mm

800 mm

600 mm

Front wall

60 cms

80 cms

600 mm

Rear end wall

60 cms

80 cms

600 mm

Front top

60 cms

100 cms

1.000 mm

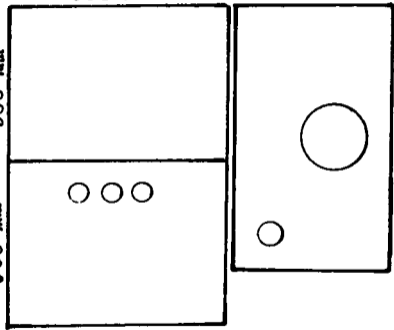

**All elements are made of 3 cms [30 mm] thick concrete, reinforced with strong chicken net.**

**Aeration channels or tubes are V or U-shaped with the openings facing downwards.**

**The unit must be insulated if it is used during the winter months and is built outside an already existing building.**

# Simple Home-made Clivus Composter

from - "Vi prøvede en ø- Vejlø"- NOAH/Fremad Denmark [1970's]

