

Finalizing a hydro-electric installation

By Michael Hackleman

Once the snow cleared off the land, I was able to walk the newly-installed pipe track to inspect for damage. The wet, heavy snow had blanketed the area, felling scores of trees or their branches. The temperate climate had permitted an above-ground pipe track for this hydro system, increasing its vulnerability to falling debris or slides. Luckily, all 300 feet of pipe track were unscathed. I was ready to finish the hydro-electric system begun many months ago.

This article will cover the installation of the water diversion system at the culverts (the source of water for the system), electrical connections to the existing RE (renewable energy) system's batteries, fabrication and siting of a basic monitoring system, and first operation of the hydro-electric unit.



[This is the fourth in a series of articles on hydropower which details the processes and hardware involved. In *Do-it-Yourself Hydro Survey* (BHM, Jan/Feb 2001), a site survey established the potential to generate power from the seasonal flow of water in two streams. In *Restoring A Hydro Unit* (BHM, Mar/Apr 2001), the alternator of a Burkhardt turbine was rebuilt and a simple, practical control unit was fabricated for it. In *Installing a Hydro System* (BHM, May/June 2001), most of the system's components—pipe track, hydro unit, wiring, and sediment barrel—were installed and connected together.

This article reflects the completion of the actual installation at Motherland outside Willits, California.]

1. Donna D'Terra and PV system (roof panels to right of stovepipe) will get wintertime help from the hydro unit.

2. Safety belt attached, Michael Hackleman installs the culvert dams.

3. The hydro unit is temporarily sited for a season's use.

Water diversion

I left the method to tapping the culvert for the water that would feed the system to the very last. I've been intrigued with this idea for some time. A culvert's job is to collect a flow of runoff and safely pass it under a road. Need a source of water for a hydro system? Why not siphon off most of this water while it's still all gathered together?

There are challenges to tapping a culvert for its water. The water may be accelerated through the culvert. It will vary considerably in flow rate. The water may be transporting debris, sometimes large rocks and tree parts. Somehow the water must be diverted into a pipe while letting the bigger stuff move on.

I'm not afraid of benefitting from the experiences of others. Unfortunately, every hydro installer I knew had *not* tried to tap a culvert as an inlet for a hydro system. Darn, I'd have to figure out everything by myself. I sketched out possible designs. Clearly, I wanted any debris to move on *without* accumulation. At the same time, the water must freely find its way through the diversion pipe to the sediment barrel, through the filter, and into the intake of the pipe track.

I considered and rejected many ideas for tapping the culverts. One was a multi-holed metal pipe running along the floor of the culvert for some distance. Or several of them. Or extending a lip out from the culvert with its lower portion screened to funnel water into a pipe. Or some kind of partition (dam) to block part of the flow. Each had its merits and shortcomings. The fact that a sediment barrel existed in the system—and that it incorporated two stages of filtering for the intake—helped me see that whatever system diverted the water could also initially handle mud, sand, and rocks up to 1 inch in size. For this reason, I elected to fab-



4. Old Hibachi grills were used for the deflection plate in the culvert dam.

ricate what I've come to refer to as a culvert dam.

The culvert dam assembly consists of 4 pieces: the dam plate, the intake tee, the deflection grate, and a weir (Fig. 7). Briefly, the dam plate seats against the inside curve of the culvert and pools the water. The intake tee collects the water and channels it through a pipe that penetrates the dam plate, runs 20-30 feet to the sediment barrel, and shoots the water out across the screened top. The deflection grate is designed to assist large rocks over both the intake tee and the top of the dam plate. A weir is cut into the top of the dam plate to lower the dam height and provide a means of measuring overflow.

The dam plate. Both of the 18-inch culverts I would tap had a spiral form to them, like the threads of a screw. This gives the culverts strength *and* slows the water that passes through them. The spiral is coarse (sharper angled) in the middle and finer (more round) toward each end. I wanted my dam to fit down into one of these grooves so it could benefit



5. A flattened and hot soldering tip slices its way through plastic refrigerator shelves that are recycled into dam plates.

6. The grills are fastened to the 2-inch intake tees with plastic ties.



7. The culvert dam for the south culvert is ready to install.



8. Front and rear views of the culvert dams show few differences between the two assemblies.

from the support it got all through its curve against the flow of water. Working from the culvert's end and measuring from the *inside* of the spiral on each side, the diameter was close to 18 inches. Measuring from the *outside* of the spiral on each side, it was about 19.2 inches. A 9.5-inch

radius (half of a 19-inch diameter) of dam curvature, then, allowed for a snug fit and some allowance for a gasket.

While I was tempted to use thin steel plate for the dam, I elected to first try plastic material. Why? With prototypes, it's best to build fast and

modify as needed. Plastic can be worked with simple tools. I searched first my own house and shop for suitable materials to no avail. I had no luck at hardware stores, either. I fared better at a local surplus store, finding two heavy plastic shelves sal-



9. A split rubber hose acts as a gasket for the culvert dam.



10. Holes are drilled for the barrel bolts that secure the diversion dams in the culvert ends.

11. PVC pipe attached to the culvert dam is not glued so that it may be easily removed.



12. With my old tower safety belt secured to a bolt I had added to the northern culvert, I worked hands-free adding the culvert dam.



13. The diversion pipe from the culvert dam can be removed and tied off when not in use.

14. ... or slipped into its fitting to route water to the intake of the hydro system.

15. Water in pipes from the culvert dams shoots across the barrel's brass screen.

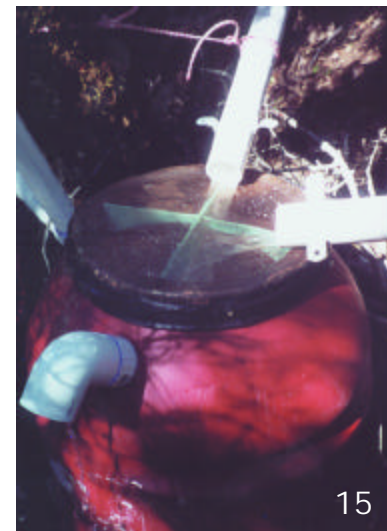
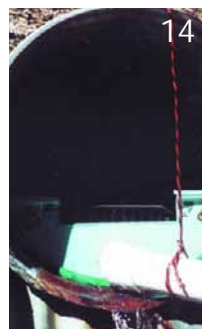

vaged from refrigerators that were big enough to work.

I already knew that I did *not* want the dam plate to be very high. Obviously, any *material* captured by the water's flow must pass over the dam plate *or* out through the intake *or* find itself trapped. This debris (rocks, sand, soil, leaves, and bugs) would build up and could block the intake. The lower the dam plate, the more likely any large debris would be flushed over it.

Meanwhile, I also needed to work out a method of securing the dam plate to the inside of the culvert. I wanted it to be easy to remove the culvert dam to release debris accumulated behind it. And—if the plastic dam plate was broken (by big rocks tumbling through the culvert), I would need to replace it with an improved design. Either way, since

the system was capturing seasonal water, it would be cold *and* flowing. This led me to want to anchor the dam plate on both sides near the widest point of the culvert so the anchor hardware was never underwater. The two plastic refrigerator sections were just a little too wide to fit inside the culvert. Checking this fit, I could see that it was possible to retain a lot of the structural integrity of the refrigerator shelves *and* have some strong anchor points IF I used the strongest of the original *edges* of both pieces. Unfortunately, this would result in a high dam, which was somewhat mitigated by cutting a weir shape in the final dam plates.

I was ready to fabricate the dam plate. I used a second circular laundry basket with a 19-inch diameter to actually scribe (mark) the arc onto the dam plate. Rather than use a jig

saw to cut out the dam plate, I again opted to use the soldering iron and *slice* (melt) my way through it, as a melted edge is generally stronger than a cut one. As well, it also eliminated any chance the plastic would shatter as it might with a cutting blade. It took 2-3 minutes to melt my way around the curve.

I tested the fit of this piece in each of the two culverts my next trip out to the site and was satisfied with the result. At the same time, I solidified the anchoring scheme. While the dam plate anchors needed to be strong, I also wanted them easy to remove. I could satisfy both factors by attaching ordinary barrel bolts (for doors or gates) to the top of the dam plate on each side and sliding the bolt through holes drilled in the sides of the culverts. With the dam plates pushed down into one of the

Is Your House Too Dark?

Put light into your dark home while lowering your energy bills



HOW IT WORKS

A small clear dome on the roof allows sunlight to enter a highly reflective tube that guides sunshine to your ceiling. A translucent diffuser lens disperses natural light evenly throughout your room.

Two Kit Sizes to Choose From

Both fit easily between ceiling joists and include 4' of tubing -2' and 4' (bead & crimp) extensions available. 13" kit can extend to 20' for two story applications!

8" kit easily lights up to 100 sq. ft. (10'x10' room). The choice for small areas; bathrooms, closets, hallways, etc. - **\$219.00.**

13" kit lights up to 400 sq. ft. (20'x20' room). The single best choice and solution for average to large sized rooms, task areas, workshops, etc. - **\$329.00.**

Sunshine Lighting

Visa MasterCard

2123-B Bering Dr.
San Jose, CA 95131
1-800-815-5001
Website: sslsj.com

800/ cfm



Free Natural Daylight

Tubular Skylight™

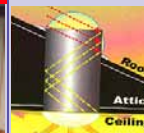

The quality light pipe chosen by NASA & the U.S. COAST GUARD. Superior design & performance.

Both are Easy to install under 2 hrs.
No structural changes required.
Significant energy cost savings.



The Solar Powered

ATTIC FAN

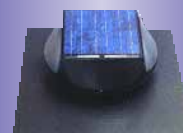

Cool Your Hot Attic For Free!

\$349.00

culvert's spiral grooves, it wouldn't be pushed out by the rushing water.

I brought all the parts home with me and purchased the barrel bolts and other hardware. I fashioned the second dam plate with a lower dam height, angled barrel bolts, and a shallower weir. I used the heated soldering gun blade to make the hole for the intake manifold at each culvert dam and to otherwise shape each plastic piece for a strong, good fit.

Intake tee. To increase the amount of water diverted from each culvert, I added a 2-inch tee to the pipe positioned through the culvert dam. Since the sediment barrel had *two* methods of eliminating debris (screen and filter), I added no filter at the intake tee in the culvert dam. Instead, I figured to let anything smaller in size than 1-inch in diameter flow *into* the intake tee and down the pipe to the barrel to be ejected when it hit the brass screen. Hopefully, this would go a long way toward preventing the buildup of rocks, gravel, and sand behind the dam plate over time.

I already knew the outside diameter of 2-inch pipe to be 2.375 inches. I would need to cut or slice (melt) this size of hole at a low point in the dam plate to pass the intake pipe. Since the dam plate actually sits in one of the big spiral grooves, I was able to test fit the dam plate and mark where the pipe should be when the fittings were installed.

Time to make parts. I used the soldering gun to slice out the 2.375-inch hole. I used a large quarter wood file to smooth the ragged edges. Next, I cut a piece of 2-inch pipe just long enough to glue to the inside tee, go through the hole, and end in a 45° elbow, sandwiching the tee and elbow flush against the dam plate. I elected *not* to glue the second PVC connection, relying instead on silicone sealant to keep this assembly

together. To later take it apart, I needed only to cut through the sealant and pull the fittings apart.

So that the 2-inch holes in the intake manifold (tee) would not ingest a rock big enough to jam them, I drilled several holes to pass a 16-penny nail vertically through each side of the tee to form a rough grate. Why a nail? It could be lifted out to release debris and dropped back in—all *without* the need for tools. To facilitate this, I added a rubber grommet to the nail to hold the head of it above the tee for easy removal.

Deflection grate. I was concerned that a large rock carooming through the culvert might shatter the dam plate, crack the intake manifold, or snag. I went in search of a grate that would work like a ramp and deflect any large stuff up and over the dam plate. Since it needed to absorb the impact, I wanted it to be hard. Part or all of a grill like that used in barbecue sets sounded right.

I found nothing I could buy new in a store. In a local Salvation Army store, I was blessed to find two small Hibachi grills with handles that were identical in size. I removed the handles and positioned them over the tee and up to the lip of the culvert plate. I used a plastic tie on each end of the intake tee to secure the grate's cross-piece. This proved strong and nicely adjustable.

Weir. The weir cut in the dam plate was an afterthought. Some kind of cutout in the lip of the dam plate was needed. I wanted the anchor points for this plate high but the overall height of dam should be low so debris would be flushed out at the flow rates the hydro system was designed to handle.

It was at this point that I first thought about making the cutout weir-shaped. A weir is a special fitting shaped to aid in calculating stream flow (depth of flow x width of weir x lookup value in table)

throughout a season, establishing the highest, average, or lowest of flows.

A weir-shaped hole in the dam plate would assist in calculating any overflow of the culvert dams. Eventually, it might be worthwhile to modify the culvert dam (i.e., larger intake tee or more pipe) to direct more water to the sediment barrel where it could be used by the hydro system to generate more wattage.

I used the soldering gun to cut/melt out the 8-inch wide weir and used a big, flat wood file to smooth the edges. I used a marker pen to mark each ½ inch of weir depth (beginning from the bottom of the weir).

Water diversion pipes

I was ready to install the culvert dams. The outflow of the northern culvert was not easily accessible—it exits on a steep, unstable grade—so I first drilled a hole in the top of the culvert near the lip. Here, I used a ¼-inch bolt to secure a fitting to the top to which I was able to attach a clip of my tower-climbing belt. This safety harness enabled me to work hands free while installing the culvert dam. I tested the fit of the plate and drilled the holes for the barrel bolts in the culvert's wall. With each culvert dam in place, I joined the diversion (culvert dam-to-barrel) pipes *without glue* to each culvert dam through the appropriate adapter. I then slid back the barrel bolts and tested the extent to which I could shift, lift, turn, or remove the culvert dam assemblies for periodic cleanout (or replacement) *and* safely re-install them.

Once the culvert dams were in place, I added lengths of 2-inch pipe and fittings until I had the other ends of both pipes sitting on the edge of the screened lid of the sediment barrel. I tied these off with nylon rope to a nearby tree, securing the pipe ends directly over the plastic support framework under the brass screen.

Incidentally, I did not glue every joint in the pipes that led from the culverts to the sediment barrel—including the one right at each culvert dam.

Two reasons. First, I wanted Donna to be able to halt the flow of water to the sediment barrel if, for some reason, she wanted to shut down the hydro system. To do this, she need only jiggle the pipe loose from the culvert dam fittings and tie it off out of the flow. Second, unlike the pipe track, these sections of 2-inch pipe experience only a *flow* of water rather than any pressure. Since they cross steep, unstable terrain and are attached to culvert dams that could blow out in a real deluge, I actually liked the idea that they might fall apart fairly easily if hit by rocks, a mud slide, or sliding and falling tree limbs. These would be easier to reassemble than glued joints which

might cause the pipes to fracture or shatter.

I made sure the diversion pipes were well supported with nylon rope at critical joints.

Electrical connections

In the last article I described the method of finding the size of the main electrical cables, purchased 75 feet of two (black and white) #6 sheathed wires, and routed them under a deck and through a PVC pipe under a footpath to connect the hydro unit with the existing RE system near the battery pack.

I bolted the hydro unit to redwood beams straddling a small creek near the house (its temporary home for one year of service to assess noise abatement). The two #6 wires were looped up and cut to reach the alternator. I crimped and soldered heavy lugs to both #6 power wires, added heat-shrink tubing over the exposed wires, and secured the respective lugs to the alternator's terminals—black at the positive, white at the negative.

I had already bolted the alternator's control panel to the hydro unit, added terminals to its wires, and connected them to the appropriate terminals on the alternator. The only remaining job was to route the twisted wires (from the remote shunt) to the control panel and screw them down to the terminal strip inside. I added silicone sealant to seal the hole where the wires

exit the box *and* the plastic pipe under the footpath.

At the other end of these wires, I discovered an unused 30A dc breaker in an existing box. Here I would connect the hydro unit's wires to the RE system's wiring. Since this box was large enough to house the shunt, I drilled several holes in its side and bolted down the shunt block inside. I then cut and stripped both of the power cables and secured them to the breaker and common junction inside the box. Since the dc breaker for the PV (solar-electric) modules was adjacent to the one for the hydro unit, I brought their combined output out with a short piece of big cable to which I crimped and soldered a big lug and secured it under the big hex bolt of the shunt. I crimped and soldered a lug to the wire that originally came from the B+ terminal of the battery pack and secured it to the other side of the shunt. The shunt was now inline between both the PV panels and hydro unit and the battery pack.

Next, I connected up *two* pairs of twisted shunt wires under the smaller screws on the side of the shunt body. One pair of wires feed the control unit at the hydro unit to assist with tuning the system. There, a multimeter's leads will plug into the terminals on the control unit, and give accurate current (Sidebar A) readings while the field rheostat is adjusted for highest output. I figured to run the second set of twisted wires into the dining room and attach them to a monitoring station I wanted to add to the system.

By installing the shunt between the battery pack and both the solar array and hydro-electric unit, power from both sources can be monitored. Of course, in the daytime there is a *combined* reading of power from the solar array and the hydroturbine. At night, the power reading reflects the output of the hydro unit alone. At

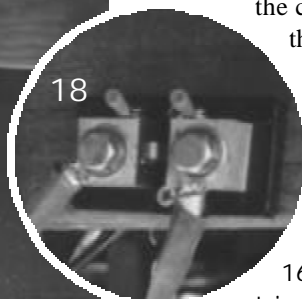

16. Jim Cassetta strings the power and shunt wires under the deck.

17. The shunt was temporarily installed above the battery bank during initial system tests.

18. A 100A/100mV shunt

any time, breaker switches can be thrown to isolate either system.

Monitoring station

Monitoring equipment in an RE system, even if it only displays volts and amps, is important. This lets you

know things are working (or not), gives you numbers about incoming energy, helps you determine the battery pack's state of charge, assists in forming strategies on how best to use the available energy and storage capacity, and helps troubleshoot problems.

Sidebar A: A monitoring station

I wanted a monitoring station for Donna's combined solar and hydro-electric system. To keep it simple, I purchased a pocket multimeter and a plastic project box from the local Radio Shack. From my parts' stock, I pulled out a DPST toggle switch and two (red and black) panel-mounting test points (TPs). I wanted to wire the center terminal of the switch to the TPs so the meter, with its test leads plugged in, could read either system voltage or amperage simply by throwing the switch's toggle one way or the other.

Jim Cassetta (who will soon install his own hydro system and helped me finish this one) drilled the holes in the project box for the toggle switch and TPs. I added small velcro strips to the bottom of the multimeter and the front of the project box so the meter would adhere to the box. This multimeter is designed to hold its own test leads in its lid. I cut a small V in this lid so the wires of the test leads could exit the casing with the lid closed. The test leads then plug into the TPs on the project box, red to red and black to black. This setup permits the owner the option of removing the multimeter from the monitoring station for other duties. Since I had extra velcro strips, I also added several to one of the bowls of the hydro unit itself. This way, the meter could be "stuck" to the bowl for any streamside adjustments of the hydro unit's control box.

Three wires were routed from the nearby battery pack—two from the shunt and one from the negative terminal of the battery—and wired to the switch (Fig. 20). With the toggle in the up position, the meter (plugged into the test terminals) will read battery voltage. With the toggle in the down position, the meter reads across the shunt, displaying a value which, when multiplied by 10, represents the current flowing through the shunt.



19. Velcro strips secure the meter to the project box so it may be used elsewhere. Meter leads plug into test terminals in the box end. A switch (right of meter) selects voltage or current (shunt) readings.

20. Wiring diagram for the monitoring station

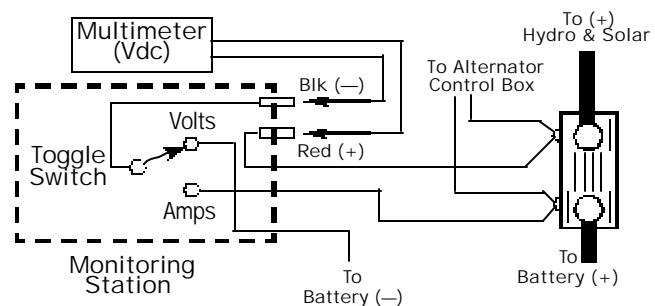

shunts which are restricted in size for lack of room. A separate shunt, then, is an inexpensive way to see what's going on, and gives more information than voltage readings in a system will provide alone.

Any shunt is a good investment for the homebuilt RE system—whether solar, wind, hydro, or combinations—but a shunt rated at 100A/100mV is magical. Why? It produces a 100 millivolt (0.1V) reading for each amp that flows through the shunt.

Let me translate that. This shunt (\$20) combined with an inexpensive digital meter (\$25), then, will provide a precise reading. When the decimal point of this value is moved one place (to the right), the value of the reading reflects the actual value of current. For example, a 15A current through the shunt results in a 1.5V reading on the digital meter (which is connected to the shunt's meter terminals). A 50A current yields a 5V reading. Multiplying these readings by 10 (or moving the decimal point one place), then, yields the correct value of current.

[Note: The meter is not actually measuring current from the shunt. It's measuring the *voltage drop* across the shunt. So, the meter's switch is rotated to the **dc volts** position for this task.]

Of course, a large analog meter (like that used in older-style multimeters, with a needle that moves across a face) will provide an accurate way to measure current, too. If there's a 0-10V or 0-100V scale on

the meter, this shunt will give them good functionality.

Instruments that measure and display power also consume power. So, you may not want your display to be on all the time. Digital meters generally use less power than analog meters. That's because LEDs (light-emitting diodes) and LCDs (liquid-crystal displays) consume little power compared with the needle-movement assembly and indicator light needed for nighttime illumination of analog meters. So, it's best to set up the monitoring system so that its display is off when not in use.

Since most digital multimeters have an auto-ranging feature and are not polarity sensitive, I was tempted to put the shunt inline with the positive battery terminal so Donna could read inverter current, charger current, and the draw of any dc loads, too. However, this additional functionality would interfere with reading the incoming electricity from the solar panels or hydro unit (unless everything was turned off) at any particular moment. This setup might be one that I would use for its troubleshooting capacity, but it wouldn't fit Donna. She concurred. She has lived for 10 years with her PV system (only adding battery water) without *any* instrumentation so even the ability to read volts and amps was a big leap.

With these factors in mind, I designed a simple monitoring station, acquired the parts, and fabricated the unit (Sidebar A and Figs. 19 and 20).

There are many alternatives to this homebuilt monitoring station. One is to spend another \$25 and get two meters. This lets you see both voltage and current simultaneously. For \$150-200, the next best thing is an Ah (Amp-hour) meter. This will show the accumulated charge and discharge of your system's battery pack over time. Effectively, it sums



21. With the bowl removed, nozzle jets may be exchanged.

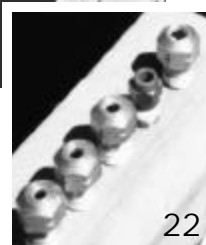

22. Flows of 5-50 gpm can be handled with these 5 jet sizes.

input and output current with voltage many times each second during operation, and resolves these in a meter reading. Some meters have the ability to simply designate a full pack a 100% value and show percentage of discharge from this value, working like a fuel gauge in a car.

Many of these meters will, at the flip of a switch, show instantaneous voltage or current values or even both in the same display. The price goes up as more features—low-voltage disconnect, alarms, load shunting, etc.—are added in other models. These aren't bells and whistles. They're the eyes and ears of your system, and will help you make good decisions and spot trouble early. At best, it will make you master of your energy-generating system. At least, it provides a solid sense of security when it comes to energy matters.

Hydro unit changes

The flow rate through a Pelton-type hydro unit is controlled by the size of the orifice (jet) in the nozzle

and the system's head (pressure). So, for any specific orifice size, a Pelton-wheel type of hydro-electric system, then, is virtually a fixed-flow device. Large-scale, high-capacity, multi-nozzle hydro units get around this somewhat by offering additional fixed-flow jets that can be valved on or off to take advantage of varying flow.

In the single-nozzle hydro unit I was installing, jet size determines the flow rate. If your water source cannot deliver it, the system will bleed down (slowly drain itself), thereby lowering the pressure and power output to zero. So, once a specific size of jet has been installed, the system is unable to take advantage of any additional water available from the intake source unless a larger jet size is substituted.

How was Donna to know if there was *enough* water available to the system to work for any given size of jet in the turbine's nozzle? At first, this is a trial-and-error process. With the smallest jet installed in the nozzle that was capable of producing power, Donna could simply open the ball valve, excite the alternator (red button on the control box), and see if it worked. If the system didn't bleed down within a few minutes, the hydro unit is getting enough water to work. Subsequently, noting the amount of overflow from the sediment barrel would help assess the possibility of using the next larger size of orifice. Again, if the system doesn't bleed down within a few minutes time, there's sufficient water from the source and the system will operate at that capacity. If bleed-down does occur, the next smaller size of jet should be used. With practice, the process of changing the size of jet in the nozzle—to kick up power generation a notch or back it off—should be a 5-minute job.

To facilitate an easy change of jet in the nozzle of the hydro unit at the

base of the hill, I decided to modify the way the two bowls were attached to each other. The original method used 10 bolts (each with its attendant nut, washer, and lockwasher) around the perimeter. Working with 40 tiny parts—first to remove the bowl and then to re-attach it—was ridiculous. I visited the local hardware store and found allen-head bolts. An allen-head wrench will hang onto its bolt where a flathead or Phillips head

screwdriver won't. I also found some thin metal clips that work like captured nuts, each sliding over the bowl's rim and seating themselves in a hole, thereby eliminating the need for a nut, washer, and lockwasher.

Adding the clip nuts created a small gap between the two bowl halves. Since the bowls are designed primarily to act as spray shields, I knew water would escape through the gap and the spray would wet

everything in close proximity. I rejected using a gasket (too much work), opting instead to use plastic *wire wrap* (like that used in automobiles to sheath multiple wire runs). Wire wrap is split along its length, so it was easy to run it *over* and *around* the rim junction and its bolts with its two ends positioned at the bottom. This effectively captured any water sprayed through the gap and channeled it safely away at the base of the bowls.

Once the wire wrap was in place, I realized that I could also *reduce* the number of bolts holding the bowls together. Sure enough, three worked just fine and shaved a few minutes off the time it took to change the jet.

Donna's hydro unit came with one orifice size of jet. While it was approximately the right size for the measured flow and pressure of her system, it would still limit her system to one output. Other sizes of jet were available off-the-shelf but they were expensive. Fortunately, a neighbor who owns a similar hydro unit offered to fabricate jets—three smaller and one larger—for Donna's unit. Her hydro unit will now be able to utilize small *and* large flows from her source of water.



23. The drain valve, inline ball valve, and pressure gauge are clustered together about 10 feet from the hydro unit.

24. I attached my multimeter to the test points of the control panel for system current. I borrowed the multimeter from Donna's monitoring station to read system voltage.

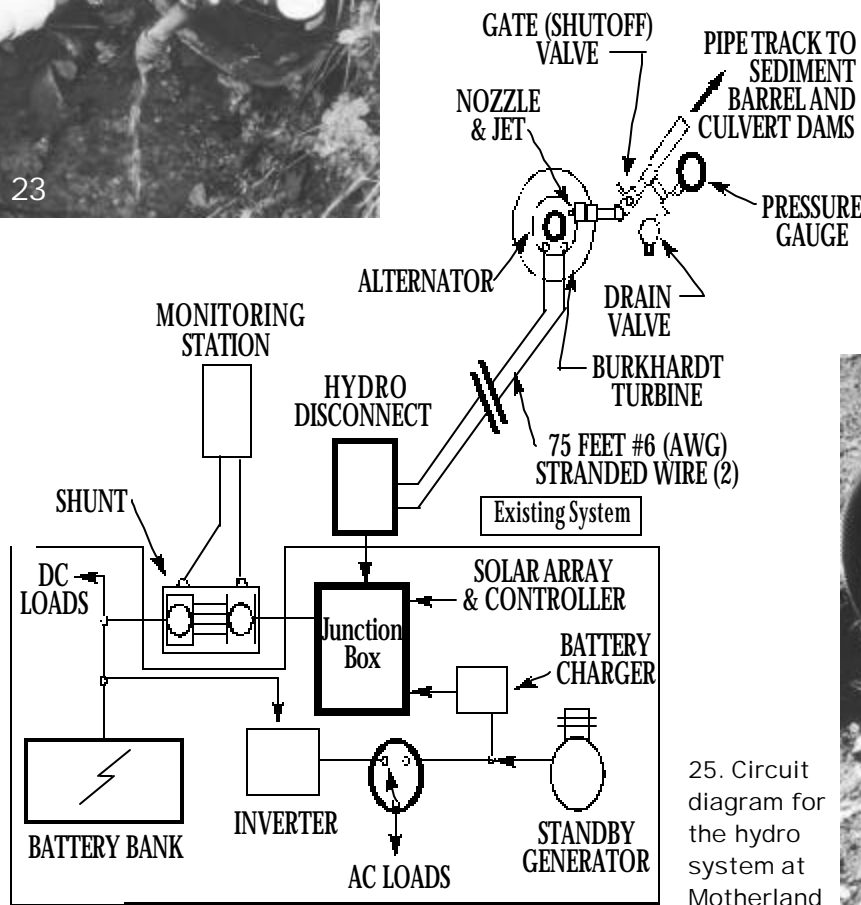

25. Circuit diagram for the hydro system at Motherland



Static vs dynamic head

The hose-and-pressure gauge method of estimating head for a hydro-electric system results in a value that represents *static* head, where the water is at a standstill in the pipe. With the lower ball valve closed, the reading on a nearby pressure gauge will reflect this static head. In this system, the pressure gauge read 50 psi.

However, once the gate valve is opened and water starts to flow in the pipe, the pressure reading on the gauge will actually drop. Is this surprising? Turbulence and the resistance offered by the pipe's inner surface and fittings to the flow of water are responsible for this drop. And, the greater the flow of water, the greater the drop in pressure as these losses increase.

[Note: The pressure drop here is analogous to the voltage drop in electrical wires as the flow of current increases. Just as a larger size of electrical wire between the power source and its load will offer less resistance to the flow of electricity through it, a larger diameter of pipe will offer less resistance to the flow of water.]

When the flow of water in the pipe reaches the limit dictated by the size of jet (orifice) in the nozzle assembly, the new (lower) pressure reading reflects the system's *dynamic* head. It is this value that should be used in all calculations of system performance or the owner/operator may be displeased with the actual power the hydro unit produces.

So, in selecting 2-inch PVC pipe over, say, metal pipe of the same size, I had chosen a pipe with a smooth interior wall compared with metal pipe. Of course, the *greater* the pipe diameter, the *less* the difference between static and dynamic head, too. The same motivation kept me from using any 90° fittings in the pipe track and led to my choice of a

Hydro parts & complete units

I asked Steve Willey at Backwoods Solar, a reputable RE dealer, for quotes on hydro parts, alternators, stators, complete units, and sources of more information.

Pelton wheel, polyurethane, by ESD, 4-in pitch diameter, just right for spinning permanent magnet motors or car alternators at 1,000 to 2,000 rpm for up to ½-inch water jets. Shape is a bit flat to be a true pelton action, but works quite well for the price. Has ½-inch center hole and can be drilled for attachment to a hub. \$113

Pelton wheel, bronze, by Harris Hydro, 4-inch pitch diameter, for up to ½-inch nozzle, up to 4 nozzles. Integral hub threaded to screw onto shaft of Delco or 80-A Ford Alternator. \$240.

Turgo wheel, bronze, 4-inch pitch diameter, integral hub threaded to screw onto shaft of Delco or 80A Ford alternator. Takes water jet up to 1-inch, up to 4 nozzles, for generation from much lower head pressure than a pelton of similar size. \$737

Low-cost **Delco alternator**, rebuilt and guaranteed, stock, rated 62A. With pulley and fan removed, units limited to 10A continuous power w/o overheating. (Still, that's 240Ah per day.) \$35. Replace stator with 2V winding for lower rpm operation, usually double output in low power applications. **Replacement stator** upgrades to 24V, or 12V at half the rpm of stock. \$25.

Complete **Harris Hydro Unit**. Alternator, housing, nozzles, field control panel (meter and rheostat). Uses efficient Motorcraft Ford alternator. Custom-configured with windings optimized for your sites' head, water volume, and battery voltage. 1 nozzle (up to 20 gpm), \$820. 2-nozzle (up to 40 gpm), \$925. Four nozzle (up to 80 gpm), \$1,080. (Performance limit about 25A at 12, 24, or 48V.)

Educational small-residential **hydropower video**. Installation and design methods, visits and tours of hydro-powered homes, pipeline and intake solutions, battery diversion charge control, and balance of system used by owners. \$20

(Backwoods Solar, 1395 Rolling Thunder Ridge, Sandpoint, ID 83864. Phone: (208)-263-4290 Fax (208) 265-4788 Website: www.backwoodsolar.com)

low-resistance, large diameter ball valve at the base of the system.

Hydro experts warned me to expect as much as a 30% difference between static and dynamic head for a given size of orifice in the nozzle jet. In this system, then, it would be normal to expect my 50 psi static head to be reduced to a dynamic head of 35 psi (70% of 50 psi). If the pressure reading dipped lower, the hydro unit's capacity to generate power would be better served by installing the next smaller size of jet in the nozzle assembly.

Think about it. Once the pipe track is installed, both the static head (vertical distance separating intake and hydro unit) and the pipe resistance are *fixed* values. Using this one rule of thumb—dynamic head should dip no lower than 70% of the value of static head—an owner/operator can be assured of selecting the right size

of orifice (smaller or larger) for the water (source) in gpm available to the hydro unit.

Fill-and-flush cycles

When we first diverted water from the culverts and filled the sediment barrel, my intent was to flush the debris from the pipe track by opening the ball valve (at the base of the hill). The pipe immediately clogged up with dirt, rocks, and leaves just beyond the ball valve. I ran a reshaped clothes hanger wire through the open valve to break up the clogged material, and it rushed out. This convinced me to run several fill-and-flush cycles, all easily handled by closing and opening the bottom valve.

Next, I let the system fill with water by shutting the valve. While the needle on the pressure gauge climbed, I added the pipe between

Parts and Costs

1. **Site Survey.** 4 hours
2. **Burkhardt Turbine overhaul.**
Parts: bearings, sandblasting (\$18).
Labor: Disassemble, clean, test, tune, assemble. 6 hours
3. **Fabrication.** Sediment barrel, culvert dams, alternator control, monitoring system. Parts: \$75.
Labor: 14 hours
4. **Installation.** Culvert dams, sediment barrel and pad, pipe track, valve-gauge-drain assembly, hydro unit, electrical wiring, monitoring system, and system check. Parts: \$600 (mostly pipe) Labor: 20 hours

the ball valve and hydro unit. Since the hydro unit was fully wired into the RE system, we were ready for a test.

First tests

In our initial site survey, we had established a calculated head (100 feet) from a summation of pressure readings (hose-and-gauge method) that totaled 50 psi. Also, we had measured the flow of the seasonal stream (bucket-and-stopwatch method) at 22 gpm in the middle of winter.

A table exists that describes the flow rate through a full spectrum of nozzle (jet) sizes for many differences values of head. It was a good sign in this installation that the one jet installed in Donna's hydro unit would, at a head of 100 feet, pass 22-25 gallons per minute of flow.

This near perfect match illustrates another point. The two measured components—pressure and flow—at your site may not be fully utilized if the combination falls just short of a specific nozzle size. I can see on my table—Sorry, I don't have permission to print it here—that the jump in flow rates between nozzle sizes, even for the same head, is significant.

Since we did not have full seasonal flow in the streams at Motherland, I

knew my first test run of the hydro system would be brief. That is, with just the original jet size (³/₈-inch orifice) and a small flow, I knew I had about a minute before the pipe track would begin to drain. That's because the flow rate, at the calculated 24 gpm, would use up the 22-gallon reserve (water between the intake filter and overflow port) in the sediment barrel in that time.

[Why didn't I use a smaller jet for the first test? They didn't exist. They were made a few weeks later. Even so, I wanted very much to see how much real power the turbine would produce at the design head and flow. That's because I was hearing that Delco alternators were not particularly efficient. So, I first wanted to see what the hydro unit would do "as is" rather than wait until next year.]

My first test of Motherland's system was exhilarating. After hooking up multimeters to read both voltage and current at the hydro unit (Fig. 24), I slowly opened the ball valve.

It is a delightful experience to hear the impeller and alternator spin up for the first time, and watch the water spray out of the system. With the ball valve fully open, I ran over to the control box and punched the red excitation (field) button. The unit immediately slowed down as the alternator began to produce power.

I think I read 16V and 3A before my minute was up. I consider these nonsense ratings since I was fiddling with the rheostat control. Still, the unit had generated a voltage higher than the battery pack (12.6V) with *some* current flowing. So, the unit had produced power. During this time, the pressure reading on the gauge steadied at 40 psi. I was happy that it represented no more than a 20% difference between the static and dynamic head.

Incidentally, most hydro experts warned me *not* to try to "tune" the system with the lower ball (or gate)

26. Michael and Donna sit with the new hydro-electric system.

valve. It should be open or closed. Any setting in between is resistive, reducing pressure. So, while a partial opening of the valve *may* limit the flow of water to the point that a too-large orifice might *seem* to work, its own resistance will also reduce system pressure. In practice, this scenario will yield less output wattage than a smaller jet working at optimum water flow *and* full dynamic pressure.

In a few minutes, the test was over as the pipe track slowly drained.

Afterthoughts

In the *next* test a week later, I moved the field rheostat too far (alternator control panel) or held the red button down too long, popping a diode (or two) in the alternator. Darn, I hate it when I do that. I plan to replace the diodes with ones rated to handle 100V (peak inverse volts) instead of the standard 50V ones.

Still, this may have been a blessing in disguise. I discovered many things in this project and I'll share three of them with you.

1. For above-ground installations of the pipe track, I'd check out 2-inch polypropylene pipe. It's black, comes in 100-foot coils, is reportedly better in UV (ultraviolet) resistance to sunlight than white PVC pipe, and is less expensive. It's definitely worth checking out.

2. In my first article, I described the power that one could get from a hydro system as expressed in the formula:

$$\text{Power} = \frac{\text{Head} \times \text{Flow}}{9}$$

with power in watts, head in feet, flow in gpm (gallons per minute), and 9 as a conversion factor.



26

This suggested that the power this hydro system would produce would be:

$$\text{Watts} = \frac{100 \text{ feet} \times 24 \text{ gpm}}{9} = 267\text{W}$$

Not true! I had overestimated the efficiency of Delco alternators (65%

versus true 35%-45%). This modifies the conversion factor from 9 to 11 in the formula. Instead of rebuilding the original Delco unit, then, I might have opted to find a Motorcraft alternator. Or begun a search for a suitable dc unit (i.e., PM motor working as a generator) with a wattage rating closer to that of the system (more probable now that I've blown a few diodes in the existing alternator.)

3. I had used 2-inch pipe to ensure no real difference between static (measured) head and dynamic (operating) head. Yet I saw a 10 psi drop (from 50 to 40 psi) in the pressure gauge, *reducing* the effective (dynamic) head to as low as 80 feet. I've since discovered that this gauge is meant for air, *not* water. Still, I would think that would affect its longevity rather than its accuracy.

Plugging the *corrected* numbers back into the formula yields a new answer:

$$\text{Watts} = \frac{80 \text{ feet} \times 24 \text{ gpm}}{11} = 174\text{W}$$

Actually, the estimate I *initially* gave Donna was closer to 120W of power. I had wanted to account for (up to) 36W for field current, line losses, and all the other things that crop up. Yet, I was watching the final numbers erode. The site is marginal at best, yet requires an investment (hardware, money, and time) in its careful installation. I feel fortunate that Donna is happy with the installation on all accounts and has one more reason to feel blessed with a prediction of rain.

(Michael Hackleman, P.O. 327, Willits, CA 95490. e-mail: mhackleman@saber.net.

Donna D'Terra teaches and hosts workshops. e-mail: motherland@pacific.net) Δ

Clean air
Clean water
A healthy environment

Be part of the solution.
GO SOLAR TODAY

SOLAR TODAY readers are

INFORMED

SOLAR TODAY's award-winning editorial provides readers with reliable information to make environmentally sound purchasing decisions.

INFLUENTIAL

SOLAR TODAY provides timely, detailed information on energy policy issues to help readers choose policies that support environmentally sound energy technologies.

INVOLVED

SOLAR TODAY supports readers to make a difference in their communities by covering other communities' success stories and by providing access in each issue to the 20 state, regional and student chapters of the American Solar Energy Society.

SUBSCRIBE TODAY! For more information, visit our web site at www.solartoday.org or call (303) 443-3130.

SOLAR TODAY magazine
American Solar Energy Society
2400 Central Avenue, G-1
Boulder, Colorado 80301
(303) 443-3130 • FAX (303) 443-3212
e-mail: ases@ases.org
web site: www.solartoday.org

