

---

# Concepts for ecologically sustainable sanitation in formal and continuing education

**Published in 2006 by the international Hydrological Programme (IHP) of the United Nations Educational, Scientific and Cultural Organisation (UNESCO)**

1 rue Miollis, 75732 Paris Cedex 15, France

and the

**Deutsche Gesellschaft für Technische Zusammenarbeit (GTZ) GmbH**

Dag Hammarskjöld Weg 1-5, 65726 Eschborn, Germany

IHP-VI Technical Document in Hydrology N° [in press]

UNESCO Working Series SC-2006/ [in press]

© 2006 UNESCO/IHP and Deutsche Gesellschaft für Technische Zusammenarbeit (GTZ) GmbH

The designations employed and the presentation of material throughout the publication do not imply the expression of any opinion whatsoever on the part of UNESCO concerning the legal status of any country, territory, city or of its authorities, or concerning the delimitation of its frontiers or boundaries.

This publication may be reproduced in whole or in part in any form for education or non-profit use, without special permission from the copyright holders, provided acknowledgement of the source is made. As a courtesy the authors should be informed of any use made of their work. Any use of this publication or of parts of this publication for commercial purposes needs the prior written authorisation of the copyright holders.

---

## A Preface

This publication dealing with educational aspects linked to ecologically sustainable sanitation (referred to as ecosan) is the result of a substantive collaborative effort between UNESCO's International Hydrological Programme (IHP) and the German Technical Cooperation Agency GTZ (Deutsche Gesellschaft für Technische Zusammenarbeit GmbH, Eschborn). The reader will find below some relevant background information that should prove useful to grasp more clearly the nature and scope of the publication.

Urban water issues have been addressed by the IHP for over twenty years and along with groundwater can be considered one of the oldest topics covered by IHP. However, the initial urban water programmes had little in common with contemporary challenges, which consider the sustainable management of water resources with due consideration of social and institutional issues. The aspects considered by IHP have thus gradually changed so as to arrive to today's approach. This development applies not only to urban water but also, in general, to the whole IHP. With the change of approach of the IHP, new aspects came into the picture, but these constituted an evolution in broadening the thematic scope without lessening the focus on sound science.

This innovative approach needs to be considered in order to fully understand the scope and the spirit in which this report has been conceived. The first historical development concerned the aspects of management since it had become apparent that science and management couldn't be separated. The initial focus, concentrating on scientific aspects, was expanded by adding environmental, particularly ecological, fields. With the introduction of environmental considerations anthropogenic aspects naturally followed. Thus, human attitudes in their eco-sociological context had to be included. A further step was to place the natural system in proper relation with man-made changes and to recognise the vulnerability of natural systems. Risk analysis helped to understand the fragility of nature and to propose remedial actions.

The Sixth Phase of IHP (2002-2007) "Water Interactions: Systems at Risk and Social Challenges", currently under execution, considers five major themes: (1) Global Changes and Water Resources; (2.) Integrated Watershed and Aquifer Dynamics; (3) Land Habitat Hydrology; (4) Water and Society; and (5) Water Education and Training. Theme 3 considers to water management in specific settings including a focal area on "Urban Areas and Rural settlement" which addresses different aspects of urban water management issues through specific projects.

In addition, one major activity channels the technical and scientific elements developed in connection to these urban water related projects into the context of education and training. The purpose is to offer in an integrated fashion the educational tools to enable training activities. The elements thus developed carry a dual purpose, one is to transmit knowledge relevant to a concrete field and the other is to provide the appropriate educational frame for this purpose.

In order to demonstrate the usefulness of this dual approach, a specific area has been selected: that of ecologically sustainable sanitation, ecosan. While ecosan clearly has the potential to become a promising alternative, for the developed and developing world alike, there is still a large gap on transmission of the relevant knowledge and capacity building on how to apply ecologically sustainable sanitation.

In these circumstances, IHP and GTZ identified their common interests and agreed on a joint venture to produce this publication. In this pursuit, IHP, GTZ and other ecosan partners held several meetings (Eschborn, May 2004; Paris, September 2004; Paris, February 2005; Delft, May 2005) and a concluding workshop in Paris, September 2005 in order to prepare this document.

The publication is largely derived from an ecosan source book issued by the GTZ in 2003 with regard to the first three chapters. The chapters on research and development as well as on education and training fully constitute innovation. IHP wishes to recognise a large number of contributors and reviewers but in particular is grateful to the main authors: Dr. A.R. Panesar, Mrs C. Werner, Dr. E. von Münch, Prof. C. Maksimovic, Mrs. A. Scheinberg, Prof. R Schertenleib, Mr. P. Bracken, and Mr. W.H. Gilbrich. The authors themselves wish to express their appreciation for UNESCO's interest and material help by arranging for meetings and consultancies. Mr. J.A. Tejada-Guibert, the project manager on behalf of UNESCO, with the assistance of Mrs. B. Radojevic, took charge of the corresponding technical-administrative duties.

Feedback on a first draft of this publication was given from many members of the wider working group. Detailed comments were received from J. Kalbermatten, A. Cordova, D. Lapid, A. Papa-Fall, N. Raeth, M. E. de la Pena, L. Yang, E. K. Menger-Krug, J. Lehn and C. Kotz. Substantial text contributions were made by Arno Rosmarin and Jan Olof Drangert for Chapter 4 and by John Kalbermatten for the whole text. Final editing of the text has been undertaken by Arne Panesar, Christine Werner, Wilfred Gilbrich and Patrick Bracken.

Material for the Annex came from a large number from organisations, including EcosanRes (Sweden), WASTE (The Netherlands), UNESCO-IHE (The Netherlands), EcosanClub, (Austria), International Ecological Engineering Society (Switzerland), University of Agricultural Sciences (Norway), Technical University Hamburg Harburg (Germany), University of Science and Technology Beijing (China). A helpful restructuring and mid-way re-editing of the text was undertaken by Anne Scheinberg (WASTE).

UNESCO and GTZ financed in large measure the production of this document. Additional in-kind contributions were made by WASTE, and Eawag/Sandec, EcoSanRes and UNESCO-IHE and are all gratefully acknowledged.

An ecosan-resource CD has been developed parallel to this publication and includes material from a range of organisations. It can be found attached to this publication or obtained via [ecosan@gtz.de](mailto:ecosan@gtz.de)

For UNESCO the achievement of the sanitation Millenium Development Goals (MDGs) is one of the major challenges for sustainable development in the next decade. With this publication emphasis is put on education and research for ecologically sustainable sanitation to contribute in reaching this goal and to the achievement of the paradigm shift towards a holistic view on sustainable sanitation.

*Paris, January 2006*

*Dr. András Szöllösi-Nagy*

*Director of UNESCO's division of water sciences  
Secretary of UNESCO's International Hydrological Programme (IHP)  
Deputy Assistant Director-General of the Natural Sciences Sector of UNESCO*

## B Table of Content

A	Preface .....	I
B	Table of Content .....	III
C	Executive Summary .....	V
<b>1</b>	<b>Motivation: The new development paradigm - Millennium Development Goals and the Johannesburg Plan .....</b>	<b>1</b>
<b>2</b>	<b>Introduction: education and the paradigm shift in sanitation .....</b>	<b>3</b>
2.1	Sanitation is failing in sustainability .....	3
2.1.1	Sanitation and the world water crisis .....	3
2.1.2	Limitations of conventional sanitation systems .....	4
	Water-borne sewer systems .....	4
	Shortcomings of "conventional" pit toilets .....	6
	Lack of attention to macro-nutrient cycling .....	7
2.1.3	Conclusion .....	9
2.2	Education is failing the sanitation system .....	9
	Problems in education for sanitation .....	9
2.3	Knowledge management in the urban environment needs to be updated .....	10
<b>3</b>	<b>The new sanitation paradigm: ecological sanitation (ecosan) .....</b>	<b>11</b>
3.1	Ecosan, the new paradigm .....	12
	Ecological sanitation systems .....	14
3.2	Material cycles in ecological sanitation (ecosan) .....	14
3.3	Technologies in ecosan .....	17
3.4	Tools for the planning and implementation of sustainable sanitation projects .....	18
3.5	Types of ecosan projects and stakeholders involved .....	21
3.5.1	The 4 basic types of ecosan projects .....	23
3.5.2	Stakeholders in ecosan projects .....	25
<b>4</b>	<b>Capacity building - education and training in ecological sanitation .....</b>	<b>32</b>
4.1	Purpose of this chapter .....	32
4.2	The unique challenge .....	32
4.3	Overview of the new training and education content that needs to be conveyed .....	34
4.4	Who needs to be reached? .....	35
4.4.1	Stakeholders .....	35
4.4.2	Target groups .....	36
4.5	Education and training methodology .....	39
4.5.1	Preparatory activities .....	39
	Preparation for training programmes .....	39
	Preparation for educational programmes .....	40
4.5.2	Selection of relevant subject areas .....	40
4.5.3	Matrix of subjects and target groups .....	42
4.5.4	Available and emerging education and training tools .....	43
4.6	Proposed implementation strategy for modernising the educational and training system in sanitation .....	43
<b>5</b>	<b>Knowledge management, research and development for sustainable sanitation: the need for a change .....</b>	<b>48</b>
5.1	Historical perspective on sanitation knowledge and experimentation .....	48
	Examples for early alternative sanitation initiatives .....	52
	Recent renewed designs .....	54
5.2	Evaluating sustainability in sanitation systems .....	55
	Criteria for comparative sustainability assessment .....	57
5.3	Development and field testing of sustainable sanitation systems in the urban context .....	61
5.3.1	The need for large series of pilot research and demonstration projects .....	61
5.3.2	The transition from conventional to closed-loop sanitation systems .....	64
5.4	Research and development of tools and instruments for sustainable sanitation .....	65
5.4.1	Financial and economic feasibility of sustainable sanitation .....	65
	Financing mechanisms .....	69

	Development, design and marketing of environmentally sound products from recyclates .....	72
5.4.2	Research on ecological sustainability .....	73
	Material Flux Analysis .....	73
	Ecosan, urban agriculture, food security and quality of life in the city .....	76
	Agricultural research .....	77
	Monitoring ecosan systems, quality control and environmental impact assessment .....	79
5.4.3	Health related risks and benefits.....	80
5.4.4	Technical and performance aspects of ecological sanitation .....	83
5.4.5	Socio-cultural aspects of sustainable sanitation .....	84
	Research on sanitation, reuse knowledge and traditions .....	86
	Participatory planning, knowledge management and decision making .....	87
	Willingness to pay and degree of participation in the system operation and maintenance.....	89
	Policy and institutional aspects, enabling environment.....	90
	Awareness raising .....	91
<b>6</b>	<b>Conclusion: The role of educational institutions in stimulating and supporting the paradigm shift towards sustainable sanitation .....</b>	<b>93</b>
<b>7</b>	<b>Annex - Examples of workshop contents, curricula outlines and an awareness raising presentation.....</b>	<b>95</b>
7.1	Example: A three-minute awareness raising presentation at CSD12.....	95
7.2	Example: Advanced 3 plus 2 weeks ecosan training course in Sweden .....	99
7.3	Example : Schedule of a 5-day ecosan introduction course in Norway.....	105
7.4	Example: Workshop in the frame of the large urban ecosan project in Erdos, China .....	108
7.5	Example: Schedule of a 2-day ecosan workshop in Eritrea .....	110
7.6	Example: Schedule of a 3-day ecosan symposium in Syria .....	112
7.7	Example: Schedule of a 3-day ecosan workshop in Zambia .....	113
7.8	Example: Schedule of a 3-day ecosan workshop in Botswana .....	116
7.9	Example: Schedule of a 4-day ecosan workshop in El Salvador.....	117
7.10	Example: Schedule of a 2-day ecosan workshop in Turkey .....	120
7.11	Example: 2-day workshop held in the frame of an Indian ecosan network.....	122
7.12	Example: Expert meetings held in the Netherlands on a shift in the sanitation paradigm .....	123
7.13	Example: Schedule of an ecosan e-course .....	127
7.14	Example: General set interactive modules produced for teaching ecosan, including PowerPoint-presentations .....	128
7.15	Example: ecosan as part of a M.Sc. curriculum for students of environmental science and engineering at the University of Science and Technology Beijing, China .....	131
7.16	Example: Description of a 1 week ecosan course in China for alumni.....	132
7.17	Example: Introducing ecosan concepts into a M.Sc. programme.....	133
<b>8</b>	<b>References .....</b>	<b>136</b>
8.1	Literature .....	136
8.2	Selected links with information on ecosan research and education .....	145
<b>9</b>	<b>Glossary and Abbreviations .....</b>	<b>149</b>
9.1	Glossary .....	149
9.2	Abbreviations.....	151
<b>10</b>	<b>Lists of Figures, Tabellen and Boxes.....</b>	<b>154</b>

## C Executive Summary

The basic concept of collecting domestic liquid waste in water-borne sewer systems, treating the wastewater in centralised treatment plants and discharging the effluent to surface water bodies became the accepted, conventional approach to sanitation in urban areas in the last century. Although these conventional sewer systems have significantly improved the public health situation in those countries that can afford to install and operate them properly, the large number of people, particularly in the developing world, who still do not have adequate access to adequate sanitation is a clear indication that the conventional approach to sanitation is likely to be unable to meet needs universally.

The conventional sewer system was developed at a time, in regions, and under environmental conditions that made it in many cases an appropriate solution for removing liquid wastes from cities. Today with increased population pressure, changes in consumer habits and increasing pressure on freshwater and other resources, this human waste disposal system is no longer able to meet the pressing global needs and ideas of recycling have been developed.

A few decades ago it thus became a priority to:

- Identify appropriate simple, affordable decentralised sanitation systems and promote their adoption
- Implement appropriate technologies with the participation of the communities to be served, and
- Focus on health and hygiene education so that physical facilities would be properly used and maintained, and that hygienic behaviour would support the improvements brought about by the infrastructure.

Over the years, it became clear however that this health and hygiene driven paradigm shift was still incomplete: In practice faecal sludge management problems were often overlooked, as were negative downstream effects of effluents from sewer systems. Protection of the environment, resource conservation and waste reuse remained secondary concerns at best, or were neglected entirely, and operational problems reduced the health improvements expected of the technologies.

In the concept of ecological sanitation (ecosan) not only health issues but also conservation of water and other resources as well as the protection of aquatic ecosystems are taken into consideration. The ecosan approach places the emphasis on the hygienisation of the contaminated flow streams, and shifts the concept from waste disposal to resource conservation and safe reuse.

In addition to paying particular attention to the health aspects at household level, ecosan also emphasises:

- The destruction of pathogens through flow stream separation, containment and specific treatment.
- Resource conservation through a reduced use of potable water as a transport medium for human waste and by recovering wastewater for irrigation
- The elimination or minimisation of wastewater discharges to the environment
- The need to close the resource loops through the productive use of the nutrients contained in excreta

The modern ecosan concept thus represents the culmination of the paradigm shift initiated in response to satisfying the health needs of unserved, mostly poor population groups.

Education has a clear role to play, both in acknowledging the paradigm shift in sanitation and in incorporating the interdisciplinary theme of innovative sustainable sanitation systems into teaching curricula. Education on ecosan should enable the people to develop, plan and implement eco-sanitation systems that are hygienically safe, socially acceptable, economically feasible, environmentally sound and technically appropriate.

Educational institutions, universities, and technical schools can contribute to the mainstreaming of the new sanitation paradigm by fully integrating the discourse and criteria for sustainability into their curricula. They should make clear that defining criteria for sustainable sanitation is a political act and influences what is the accepted, legitimate form of sanitation, including the impacts from sanitation on other sectors. Sanitation capacity building should take the stakeholders in a sanitation project not as objects, but as partners for jointly developing sustainable sanitation solutions.

The education system has to prepare students to think about urine and faeces and grey/black water as resources. Emphasis has to shift from the simple disposal to the hygienisation of contaminated flow streams, and to resource conservation and safe reuse. Teaching must make clear that health and a healthy environment is a prerequisite for human productivity, and productivity determines economic well being.

Sanitation engineers and practitioners, policymakers, managers, and operators get their ideas and information during their education. Therefore the curricula of universities, continuing education programmes, technical schools, research institutes and training centres have to include the ecosan philosophy. Thus several objectives, such as the improvement of human health, poverty reduction in developing countries, the conservation of natural resources and sustainable water and sanitation management systems in both, industrialised and developing countries may be addressed. Those responsible for the content of curricula should be informed about the new developments in this field.

The present publication therefore constitutes a means of providing educational tools, up grading existing ones, and suggesting revised teaching plans. The educational platform being developed under IHP auspices could serve as an opportunity to include ecosan-related subjects in modernized course curricula.

Many proven technical elements are available for ecological sanitation systems and the number of pilot demonstration and research projects, and of large scale applications is continuously increasing. The pilot research and demonstration projects should showcase innovative solutions in a variety of climatic, social, cultural, economic and geo-morphological contexts, and should enable the development of a series of model solutions covering the whole range of sanitation needs.

However, given the broad variety of local framework conditions and the large number of open question in this complex interdisciplinary field, there is still a great need to further develop technical and operational solutions and to enlarge the knowledge base with respect to public health, risk management, economics, logistics, material-flow-streams, socio-cultural and many other aspects. Research in these disciplines will require trans-sectoral and interdisciplinary co-operation and inputs from a range of research fields.

Research should concentrate on comparative studies between a range of conventional and innovative solutions comparing them against a set of sustainability criteria. It should also help in developing field tested and proven sustainable sanitation components and systems, and contribute to forming a knowledge base for drawing up technical standards. Documentation and case studies for innovative sanitation solutions should be easily made available in a uniform comprehensive format, and technical information for components of innovative sanitation solutions should be provided to accelerate their dissemination.

The achievement of the sanitation MDGs is one of the major challenges for sustainable development in the next decade. Putting emphasis on education and research for ecologically sustainable sanitation may largely contribute to reaching this goal.

# 1 Motivation: The new development paradigm - Millennium Development Goals and the Johannesburg Plan

## Box 1: Millennium Development Goals and the Johannesburg Plan

The **Millennium Development Goals** aim to:

- Eradicate extreme poverty and hunger
- Achieve universal primary education
- Promote gender equality and empower women
- Reduce child mortality
- Improve maternal health
- Combat HIV / AIDS, malaria and other diseases
- Ensure environmental sustainability
- Develop a global partnership for development

With particular regard to water issues the goal of ensuring environmental stability the United Nations adopted the target of halving the proportion of people without sustainable access to safe drinking water by 2015.

(United Nations 2000: United Nations Millennium Declaration – September 2000)

### **Johannesburg Plan of Implementation**

In the Johannesburg Plan of Implementation the goals of the United Nations Millennium Declaration were reaffirmed and further elaborated. With respect to the MDGs and water supply and sanitation they aim to:

**(1) Halve, by 2015, the proportion of people without access to safe drinking water – thus reaffirming the target set in the Millennium Development Goals.**

and

**(2) Halve, by 2015, the proportion of people who do not have access to basic sanitation.**

(United Nations 2002: Key commitments, targets, and timetables from the Johannesburg plan of implementation)

For many years, the international focus has been to provide safe drinking water supply. The Millennium Development Goals (MDGs) however represent a clear commitment to address sanitation with the same priority as water supply.

An analysis of existing data on global sanitation coverage from most recent international reports (e.g. UN 2005) reveals that the backdrop in sanitation provision is highest among the development goals. The UN Millennium Project Task Force on Water and Sanitation's Final Report (UN Millennium Project 2005) urges governments and stakeholders to move the sanitation crisis to the top of the international agenda.

How best to achieve the Millennium Development Goals has been recently discussed in the report "Health, dignity, and development: what will it take?" (UN Millennium Project 2005). Hans Olaf Ibrek, Member of the MDG Task Force on Water and Sanitation points out during the launching of the report: "Efforts to reach Target 10 must focus on sustainable service delivery, rather than construction of facilities alone".



The world-wide endorsement of the millennium development goals calls for a radical re-thinking of the conventional, accepted approaches to urban infrastructure in general and sanitation in particular. Only a change in the basic paradigm from linear flow streams and disposal towards a cycle oriented management of renewable resources has the potential to deliver the kind and degree of change which the millennium development goals demand. While the new paradigm is partly in place and implemented in solid waste management, energy, and agriculture (to name a few leaders), the process of paradigm shift in sanitation is still in its infancy. Just how difficult it is to change from conventional approaches to better alternatives is demonstrated by the fact that forward looking engineers proposed to move from the linear to circular systems of managing water and wastewater (including excreta, and rainwater) back in the 1970s (Shaeffer and Stevens 1983). Today, 30 odd years later, the circular approach remains the exception.

This paper looks at this paradigm shift in sanitation in three ways. First, the paper focuses on the necessary changes in the sanitation system itself, and presents a vision of the new paradigm and its impact on the sectors related to water and sanitation (e.g. health and hygiene, solid waste and wastewater management, water resources management, natural resources management, environment, agriculture, urban planning, poverty reduction, food security, job creation, micro and macro economic development). The second focus is the education system, especially as it relates to the training of water- and environmental professionals and practitioners, as well as to brief and influence policy makers. The third relates to other aspects of knowledge management besides education: research, case studies, and also to the discourse around sanitation.

## **2 Introduction: education and the paradigm shift in sanitation**

The paradigm shift in sanitation has not yet made structural inroads into the professional and university educational system. There is an urgent need for a different approach to professional and scholarly sanitation education and training, an approach that takes into consideration the need for holistic solutions, thus comprising all dimensions of sustainability, from health and socio-technical aspects to natural resources management, agriculture, micro- and macro-economics and institutional aspects. The current educational and training infrastructure is failing the field of sanitation and development in primarily two ways:

- most institutions uncritically continue to offer curricula in the basics of centralised sewered sanitation and end-of-pipe wastewater treatment and disposal, continuing to turn out sanitation engineers and planners whose education and training has led them to believe that this is the only adequate and serious approach; and
- despite almost 20 years of practice in participatory and holistic interdisciplinary planning approaches, the basic framework of education and training in sanitation (like that in other urban environmental fields) remains narrowly focused on the technical aspects, so that neither students nor scholars are learning the basic process skills to arrive at sustainable solutions.

There are three identifiable problems in relation to sanitation and education.

1. Sanitation is failing in sustainability and in serving the world's poor. The current sanitation paradigm delivers neither equity nor sustainability. There are alternatives, but they are neither fully developed nor fully legitimatised.
2. Education is failing in adapting to the required changes in the sanitation system. While the sanitation system is in transition, the educational system remains fixed on the old paradigm, with the result that young professionals look backwards towards 20th century models, rather than forwards towards a sustainable future.
3. Knowledge management in the urban environment is outdated and obsolete. Failures to support the new sanitation paradigm can be found in abundance in the areas of research, development, documentation, and the sanitation discourse – that is, in the area of knowledge management in sanitation. These failures compound and reinforce the failures in the education system, rather than challenging and counteracting them.

Each of these failures is further developed in the section below.

### **2.1 Sanitation is failing in sustainability**

#### **2.1.1 Sanitation and the world water crisis**

The problems raised by the decreasing quality and quantity of fresh water resources are becoming increasingly serious. All indicators show that the world is facing a serious world water crisis which will affect all of us, but particularly the poor. The poor suffer most from this decrease in fresh water resources, and bear the brunt of water-related diseases and a damaged environment. This water crisis is in part a direct result of the failure of the current sanitation paradigm. Sewered sanitation, established in the era of European urbanisation in the 1870s, has the status of a widely accepted solution, or scientific truth. There is little discussion about its core problems, which result in health and environmental problems around the world. The fact that our current sanitary systems are, for the most part, directly connected to the water cycle requires that both the sanitation and water crises be considered, before we can begin trying to de-couple them.

A look at some of the figures of both these crises provides an insight into the scale of the problem facing us today:

- The estimated mortality rate as a result of illnesses caused by contaminated drinking water and poor sanitation and hygiene in developing countries is approximately 2.2 million people per year, most of them children under the age of five (WHO/UNICEF JMP 2000)
- An estimated 2.6 billion people, representing almost half of the world population do not have access to adequate sanitation / wastewater treatment facilities (WHO/UNICEF JMP 2005)
- 1.1 billion people do not have access to safe drinking water (WHO/UNICEF JMP 2005)
- In the developing regions of the world between 100% (Africa) and 65% (Asia) of the urban wastewater are not treated appropriately (WHO/UNICEF JMP 2000)
- 80 % of all diseases and 25 % of all deaths in developing countries are caused by polluted water (UN 1992)
- World-wide, over 200 million people were infected with schistosomiasis and intestinal helminths, of which 20 million suffered serious illness, most of them children under the age of 5 (WHO 2003)

The current global population is expected to increase by 2 billion people, to 8 billion, within the next 25 years. Most of these people will be born in developing and emerging market economies and will live in urban areas. Without a concerted effort, many of these people are doomed to poverty and will increase the number of those lacking basic water and sanitation services.

The United Nations Summit on Sustainable Development, held in Johannesburg, South Africa, in autumn of 2002, returned to the targets set by the Millennium Development Goals with regard to water supply and extended it to also include the provision of sanitation. The current international target is therefore to halve the proportion of people without access to safe drinking water and to adequate sanitation by 2015.

### **2.1.2 Limitations of conventional sanitation systems**

Conventional sanitation systems, based on water-borne sewerage, are the accepted manner for removal of human waste from cities. However, in recent years they have proven to be unable to make a significant impact on the backlog of nearly half of the world's population. Moreover, even if a sufficient investment could be made, so that conventional sanitation systems could be provided to address who lack access to adequate sanitation, the resulting sanitation systems would not be sustainable.

In many places, sewered sanitation results in polluted ground and surface waters. It can therefore lead to a whole new series of problems. In India, the idea of every person having their own car brought to the public eye vivid images of a social and environmental catastrophe. Today, the idea of every family having access to a flush toilet evokes images of a much greater disaster, as this would both sharply increase drinking water consumption, and lead to increased water pollution and health hazards (Narain 2004; Werner et al. 2003b).

### **Water-borne sewer systems**

“Modern” water-borne sewer systems are a relatively new technology, which only began to spread in European cities from around the end of the 19th century, when piped water supplies and the use of flush toilets lead to an increased water consumption, and wastewater production. This led to streams and stagnant pools of wastewater in city streets, causing outbreaks of cholera and other diseases. To tackle this problem, sewer systems were gradually introduced. Later, when this was seen to cause serious water pollution, step by step mechanical wastewater treatment plants, biological treatment for the degradation of organic substances, and tertiary treatment for the removal of nutrients were added to reduce the pollution and resulting eutrophication of the receiving water bodies. These now represent the present state-of-the-art in wastewater treatment.

Such wastewater treatment plants have improved the hygienic situation in a large number of urban areas, particularly in those where water is in abundant supply, treated wastewater can be relatively harmlessly disposed of, and the costs of operation and maintenance can be assured. When built and functioning correctly, conventional water-borne sewers and treatment plants allow a relatively well assured hydraulic transport of excreta, used water and rainwater away from urban areas. They also help avoid the pollution of surface waters within urban areas, which are often a source of health and

environmental problems. This very obviously improves the hygienic situation of those inhabitants of urban areas being served by well functioning sewer systems.

However, due mainly to a lack of adequate human and financial resources, these systems cannot be correctly operated in many countries in north and south. As a result, improvements in the sanitary situation in sewered areas of towns (which most often cover the wealthier section of the population) often directly lead to a deterioration in the sanitary situation in surrounding, unsewered, and usually poorer, neighbourhoods, as sewage is often discharged with little or no treatment into water bodies. Poorer communities are often exposed to these contaminated waters in their every-day life, perhaps using them as a source of drinking or washing water or during flooding. These problems become particularly serious when there is a rapid increase in the urban population.

Conventional centralised systems require a huge financial investment, and have relatively high maintenance and operation costs. The difficulties caused by these expenses do not only prevent developing nations from correctly building and operating centralised sanitation systems, but industrialised nations also face huge problems in the maintenance and operation of their sewer systems and treatment plants. In Latin America less than 20% of the wastewater collected is actually treated, whilst in Europe, of 540 major cities, only 79 have advanced tertiary sewage treatment, 223 have secondary treatment, 72 have incomplete primary treatment and 168 cities have no or an unknown form of treatment of their wastewater (EcoSanRes 2005a).

Outside of the cost considerations, conventional water-borne sanitation systems have further fundamental shortcomings. As water is used to transport the wastes, they have a high water-consumption, making them unsuitable in the long term for regions with water scarcity. In many places this has already led to an over-exploitation of the limited renewable water resources. Overuse is resulting in drinking water becoming an expensive good, only available to the better off, who are usually connected to the central water supply and receive piped water at such a low price that flushing it down the toilet does not seem to be a worry. Clean drinking water is too precious a resource to be flushed down the toilet, and the use of flush toilets in areas where the water supply only operates for a few hours per week clearly makes no sense.

Even if such systems contribute to a healthier environment in the cities where they are installed, they do the opposite for those living downstream. When functioning properly, the discharge from conventional wastewater treatment plants is still not safe from a health point of view, failing to meet the quality requirements of bathing water, if the dilution is not sufficient. Conventional treatment plants have been developed for the removal of large particles, biodegradable organic substances and nutrients in order to protect receiving waters. The reduction of pathogenic organisms is, however, insufficient.

The effluent from these plants also contains other potentially dangerous substances. For example, recent research has highlighted the effects of endocrine substances, contained in human excreta, on fish populations, reducing their fertility, and even changing the sex of male trout. The effects of pharmaceutical residues in the effluent and their impact on the environment and humans living downstream who obtain their drinking water from the same river are also being discussed. For combined sewer systems (carrying both storm water and wastewater), a further problem, is that heavy rainfall generally leads to the diluted wastewater being discharged untreated directly into rivers as treatment plants are only designed for a limited influent.

### **Shortcomings of "conventional" pit toilets**

Conventional on-site sanitation systems have been used for centuries to provide excreta disposal at the household level. There are two basic types, dry systems (pit toilets) and water based systems (flush toilets). The former have been used in the "North" until the mid 19th century, when water-borne sewerage started its triumphal march across industrialized nations and became the accepted standard for excreta disposal worldwide. Given the limited financial means of most developing countries, the pit toilet has remained their principal means of excreta disposal except for their well to do classes who are often provided with government subsidised sewerage systems. On-site pour flush toilets are today popular and widely used in South-Asia, especially in India.

Neither pit toilets nor pour flush toilets development included resource recovery as part of their function. Indeed, the health impact of underground waste disposal, particularly its impact on groundwater, was rarely considered. Fortunately, pathogenic organisms as a rule, did not survive in the ground, and in any event did not travel very far. However, the increasing density of populations meanwhile often has led to situations where the required minimum distance between drinking water well and pit toilets can not be respected.

In many densely populated areas, for example in Dakkar, the capital of Senegal, the use of pit toilets has also led to nitrate concentrations in groundwater, which exceed the maximum level recommended by the WHO for drinking water and which have been linked to serious health problems, particularly for babies. This became a concern when low income societies adopted the western custom of bottle feeding their babies, thus exposing them to the danger of methemoglobinemia (blue baby syndrome).

Shallow groundwater is still a major source of water supply in rural and peri-urban areas, especially for the poor. The design of the conventional "drop and store" pit-toilet (and of most other on-plot systems) pollutes this precious groundwater as it deliberately aims to retain only solid matter in the pit and infiltrates as much of the liquids as possible into the subsoil. As these liquids contain all the soluble elements of the excreta as well as viruses and pathogens, this type of sanitation, depending on the hydro-geological situation, can be a highway to groundwater contamination.

Pit toilets should be emptied when they are full, with the content being treated before being put to any other use (e.g. in agriculture). In practice, however, faecal sludge management aspects are often overlooked and old pits are often simply abandoned, with users preferring to dig a new pit toilet than to attempt the unpleasant job of emptying the old one.

For a household, digging a new pit, and providing a new superstructure each time the old pit is full, can prove to be an expensive business. This is added to by the difficulty faced by homeowners living in densely populated areas, where plots are small and tend to already be crowded with old, previously abandoned pits. Many conventional latrines also smell quite badly, are a breeding place for flies, insects and other vectors and are very inconvenient to use, especially for children, women and girls, as they have to be built at a distance from the house, making night-time visits highly undesirable. Added to this are the problems of pit construction in areas with a high groundwater table, or where the ground is rocky, making the use of a pit extremely impractical. Pits are also susceptible to flooding during heavy rainfall and subsequent collapse.

### Project Box 1: The Durban experience, South Africa (Macleod 2005)

The Municipality of eThekweni (Durban), South Africa, is aware that emptying full toilet pits is a difficult and costly task. Here the municipality had given the task of emptying pit toilets to a private service provider, however the cost of emptying the pit often exceeded 1.000 Rand (or 135 EUR) per pit toilet. These costs were a result of several factors, including the inaccessibility or precarious location of many of the toilets, and the heterogeneous nature of the contents which included rags, household refuse, and plastic bags, which made pumping extremely difficult. The emptying cost were seen as being unacceptably high as the price of a new pit toilet was between 1.000 and 3.000 Rand.



**Figure 1: Emptying conventional pit toilets required special equipment (left picture) and turned out to be extremely costly - often exceeding 1000 Rand per pit. The urine diversion dehydration toilet (right picture) was selected by the communities as preferred solution after extensive awareness raising measures (Macleod 2005).**

As a result alternative, innovative sanitation systems, with higher initial installation costs but lower running costs, became increasingly economically interesting. After extensive community education and awareness raising in the peri-urban and rural communities, and after a number of different options of toilet designs were constructed and demonstrated to the communities, they decided upon the “double vault urine-diverting dehydration toilet” (overall construction cost in Durban around 3.500 Rand), with emptying offered by a private service provider for 25 Rand (or 3-4 EUR) per toilet.

The criteria against which the different toilet designs were measured included: (1) Construction and maintenance costs; (2) Ease of emptying by the household, or at an affordable price by a service provider; (3) Environmental sustainability; (4) Compatibility with the available water supply (preferably requiring no water for its effective use); (5) Acceptability to the communities using the toilets.

Over 20.000 double vault urine-diverting dehydration toilets have been installed in eThekweni with some having been in use for a sufficiently long period of time to prove that emptying them is not a problem. Currently research projects are underway to analyse how to make best use of the nutrients collected by the toilets in the given context.

### Lack of attention to macro-nutrient cycling

Our conventional wastewater systems are largely linear, end-of-pipe systems where drinking water is misused to transport waste into the water cycle, causing environmental damage and hygienic hazards, and contributing to the water crisis. If we continue to promote these technologies in order to meet the Millennium Development Goals, the overall result could be disastrous as the hygienic situation of our waters would be further deteriorated and even more resources would be dissipated and introduced into water bodies.

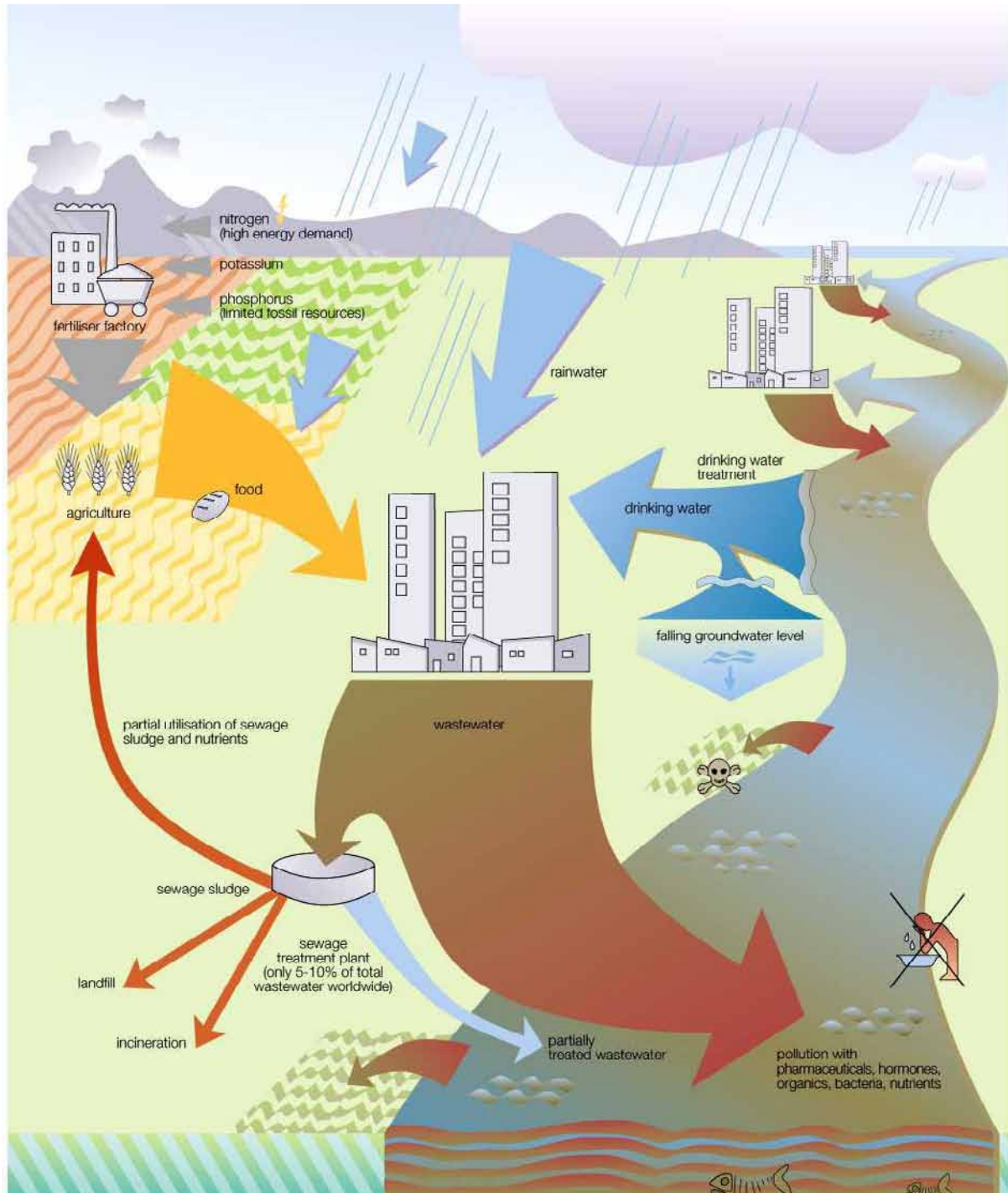

**Figure 2: Schematic illustration of the main limitations of conventional wastewater management systems (GTZ)**

While the above are serious disadvantages of both water-borne and dry conventional sanitation systems, a far more fundamental problem is that they do not facilitate the reuse of macro and micro nutrients present in excreta and wastewater. This lack of nutrient recovery and -use leads to a linear flow of nutrients from agriculture, via humans to recipient water bodies. The valuable nutrients and trace elements contained in human excrement are very rarely re-channelled back into agriculture in conventional systems. Even when sewage sludge is used in agriculture, only a very small fraction of the nutrients contained in the excrement are reintroduced into the living soil layer. Most are either



destroyed in the treatment process (e.g. by nitrogen elimination) or enter the water cycle, where they pollute the environment, causing the eutrophication of lakes and rivers.

Not returning the nutrients to the soil has led to a situation where there is an increasing demand for chemical fertilisers, in response to the problem of decreasing soil fertility. To produce the required chemical fertilisers, large amounts of energy are needed, and finite mineral resources, such as phosphorous, must be exploited. Current estimates say that phosphorous reserves will be exhausted in between 60 and 130 years at the present rate of consumption (Rosemarin 2004). The relatively inexpensive phosphorous used today will almost certainly cease to exist in the next 50 years. Farmers around the world yearly require 135 Mio. tons of mineral fertiliser for their crops, while at the same time conventional sanitation dumps 50 Mio tons of fertiliser equivalents flows into our water bodies - nutrients with a market value of around 15 Billion US dollars. Figure 2 schematically illustrates the main limitations of conventional wastewater management systems.

### **2.1.3 Conclusion**

The current sanitation paradigm is failing the world, with the poor suffering most, threatening the integrity of fresh water supplies, and in general creating unsustainable linear flows that can ultimately make life on earth difficult or no longer feasible. The problems with conventional sanitation are fundamental, and a radically different approach is needed. Ecological sanitation, presented in Chapter 3, represents a different paradigm, one that offers a path out of the current vicious circles of water over-consumption and undervaluing by the rich, lack of access to safe water and sanitation and high costs for the poor, water and environmental pollution and depletion of nutrients.

## **2.2 Education is failing the sanitation system**

In spite of the serious problems with the conventional sanitation paradigm, educational institutions, universities, and technical schools continue to present it to new generations of students as the only legitimate form of sanitation. The problem is compounded by the fact that the training treats the sanitation system as the focus, and pure removal of faeces and urine (and the water that bears them) as the goal. The users are objectified, and their ideas and preferences are largely ignored. If the users of the sanitation system are considered at all, it is as objects of PR campaigns aimed at "changing behaviour", "enforcing" payment or use norms, or "stimulating" compliance. The potential users of the recycling products are usually completely neglected (e.g. with regard to their quality and logistical requirements how the products reach the users). The conventional sanitation discourse as presented in engineering and technical schools simply does not accord the system users any status at all in the decision-making process, thus often leading to inappropriate expensive and/or unsustainable solutions.

The current education system also fails in preparing students to think about urine and faeces and grey/black water as resources. The emphasis, as one would expect in a removal-based approach is on their negative or dangerous physical, chemical, and biological characteristics, and not on their resource value as sources of nutrients, energy, or water for irrigation or other purposes. This is the reflection of an education system influenced by the culture of the North, where societies are wealthy and still behave, as if they could afford to have a linear attitude towards resources.

### **Problems in education for sanitation**

Sanitation engineers and practitioners, policymakers, managers, and operators get their ideas and information during the education process. And here is one key problem: Curricula of Universities, continuing education programmes, technical schools, research institutes and training centres mostly continue to present conventional sanitation as the only legitimate approach. Indeed those responsible for the content of curricula are often even unaware of the new developments in this field.



## **2.3 Knowledge management in the urban environment needs to be updated.**

Failures in the areas of research, development, documentation, and the sanitation discourse – that is, in the area of knowledge management in sanitation – compound and reinforce the failures in the education system, rather than challenging and counteracting them.

Research is still concentrated on the optimisation of centralised and unsustainable systems. It is e.g. proposed to burn sludge from centralised treatment facilities, to extract phosphorus from the ashes in a highly energy consuming process - instead of separating streams at the source by collecting phosphorous rich material like urine with urine separating devices (comp. below).

Development and applied research follows the same line. In Europe currently applied research is suggested for acceleration of providing up-to-date systems for the eastern European countries. The danger is that what happened in several cases in East-Germany (uncritical provision of costly and oversized centralised systems) will now be repeated in large scale in Eastern-Europe. Examples of environmental approaches in East-Europe are rare (Samwel and Gabizon 2005). However they illustrate, that neither the science community nor the exporting or local industry are equipped to facilitate the participatory processes necessary for the introduction of innovative sanitation solutions.

Documentation, criteria and case studies for innovative sanitation solutions are therefore urgently needed. A first start for such efforts can be seen in the GTZ-ecosan website, where demonstration projects from all over the world are presented in a uniform comprehensive format, and technical data sheets for components of innovative sanitation solutions are provided to accelerate their standardisation.

Textbooks and scholarly articles usually are restricted to the description of centralised sanitation systems or on-site pit toilets as described above. They usually do not address the interrelation between sanitation, agriculture, food-security and job-creation - hence the inter-sectoral approach needed to address the sanitation crisis in a holistic and sustainable way. A positive exception can be seen e.g. in a Swedish textbook for master students, with references to the Baltic Sea Basin situation (Hultman and Levlin 1999).

The discourse on sanitation in the urban environment, while largely dominated by the discussion of the conventional systems, is slightly changing in the recent years. Some impact can be noted e.g. for the conferences on ecological sanitation held in Bonn, Germany (2000), Nanjing, China (2001), Lübeck, Germany (2003), Durban, South Africa (2005). Holistic approaches to sanitation in Mega-cities get increasing attention, and were discussed e.g. during the meetings of the UN Commission on Sustainable Development (CSD) in 2004 and 2005 as well as during the Stockholm Water Week of the respective years.

Professional associations increasingly start addressing ecosan: The International Water Association (IWA) has since several years a specialist group on ecological sanitation and during the 4th IWA world-congress ecosan was an important topic. The Indian Water Works Association (IWWA) recently organised a larger international ecosan conference in Mumbai (Nov 2005) and is actively engaged in a series of ecosan projects in India. The German Water Association (DWA) has now put up several expert groups to focus on different aspects of ecosan, aiming at the provision of standards and reliable fact sheets for the innovative ecosan approach.

### 3 The new sanitation paradigm: ecological sanitation (ecosan)

In order to reach the MDGs and achieve sustainability in the field of wastewater management and sanitation, a new paradigm is clearly needed. This was the unanimous conclusion of a group of experts from a wide range of international organisations involved in environmental sanitation that met in February 2000 in Bellagio, Italy. The group called for a radical rethinking of conventional sanitation policies and practices world-wide. This group formulated the four “Bellagio Principles” the basis for a new paradigm and approach in environmental sanitation (SANDEC/WSSCC 2000a).

#### Box 2: The Bellagio Principles

##### The Bellagio Principles (2000)

(1) Human dignity, quality of life and environmental security at household level should be at the centre of the new approach, which should be responsive and accountable to needs and demands in the local and national setting.

- solutions should be tailored to the full spectrum of social, economic, health and environmental concerns
- the household and community environment should be protected
- the economic opportunities of waste recovery and use should be harnessed

(2) In line with good governance principles, decision making should involve participation of all stakeholders, especially the consumers and providers of services.

- decision making at all levels should be based on informed choices
- incentives for provision and consumption of services and facilities should be consistent with the overall goal and objective
- rights of consumer and providers should be balanced by responsibilities to the wider human community and environment

(3) Waste should be considered a resource, and its management should be holistic and form part of integrated water resources, nutrient flow and sanitation.

- inputs should be reduced so as to promote efficiency and water and environmental security
- exports of waste should be minimised to promote efficiency and reduce the spread of pollution
- wastewater should be recycled and added to the water budget

(4) The domain in which environmental sanitation problems are resolved should be kept to the minimum practical size (household, community, town, district, catchment, city) and wastes diluted as little as possible.

- waste should be managed as close as possible to the source
- water should be minimally used to transport waste
- additional technologies for waste sanitisation (sic) and reuse should be developed

These principles were endorsed by the members of the WSSCC during its 5th Global Forum in November 2000 in Iguacu, Brazil (SANDEC/WSSCC 2000b).

### 3.1 Ecosan, the new paradigm

The new paradigm in sanitation must be based on ecosystem approaches and the closure of material flow cycles rather than on linear, expensive and energy intensive end-of-pipe technologies. Sanitation systems are part of several cycles, of which the most important cycles are the pathogen-, water-, nutrient- and energy cycle. In order to ensure public health, sanitation approaches primarily aim at interrupting the life cycle of pathogens. In addition, the new approach is recognising human excreta and water from households not as a waste but as a resource that could be made available for reuse, especially considering that human excreta and manure from husbandry play an essential role in building healthy soils and are providing valuable nutrients for plants. While conventional sanitation restricts health security to the in-house environment and sometimes leads to a disastrous situation in the neighbourhood or the receiving water body, the new approach is aiming at sanitizing the products instead of exporting problems and apply a health oriented multi-barrier concept of treatment, crop-restriction and exposure control.

This approach, mostly addressed as “ecological sanitation” or ecosan offers an alternative to conventional sanitation. It is based on an overall view of material flows as part of an ecologically and economically sustainable sanitation system tailored to the needs of the users and to specific local conditions. It does not favour or promote a specific sanitation technology, but is rather a new philosophy in handling substances that have so far been seen merely as wastewater and water-carried waste for disposal. It carries with it a new approach to sanitation education, a new discourse, and a new way of managing knowledge.

Ecosan systems restore a remarkable natural balance between the quantity of nutrients excreted by one person in one year and that required to produce their food (7.5 kg nitrate, phosphorous and potassium to produce 250 kg of grain) and therefore can greatly help in saving limited resources. This is particularly urgent with regard to fresh water and mineral resources – for example current estimates for phosphorus state that economically extractable reserves risk to be exhausted in the foreseeable future. Ecosan does not favour a particular technology but is rather a philosophy in recycling oriented resource management and offers modern, convenient, gender friendly and desirable solutions, in accordance with the Bellagio Principles as formulated by the WSSCC (Water Supply and Sanitation Collaborative Council) (SANDEC/WSSCC 2000a).

The core principle of ecosan is to close the loop between sanitation and agriculture, enabling and bringing about “agricultural reuse”, along with other means of closing flow cycles.

#### **Box 3: What is “agricultural reuse” in ecologically sustainable sanitation?**

Ecosan approaches uniformly strive to close the nutrient loop between sanitation and agriculture, enabling an almost complete recovery of the nutrients, organic material and water discharged in conventional sanitation systems. Closing nutrient loops and recycling organic material contributes to safeguarding soil fertility and improving its structure and water retention capacity, while providing a natural alternative to chemical fertilisers.

In ecosan, the term “agricultural reuse” refers to a wide range of productive, ecosystem oriented, reuse options. This includes reuse in what could be considered traditional agriculture, i.e. on farmers fields where crops such as cereals are grown, but also in silvaculture (forestry), aquaculture, market gardening, horticulture, etc. It also includes the reuse not only of nutrients but also of grey water, the organic content of wastewater and energy.

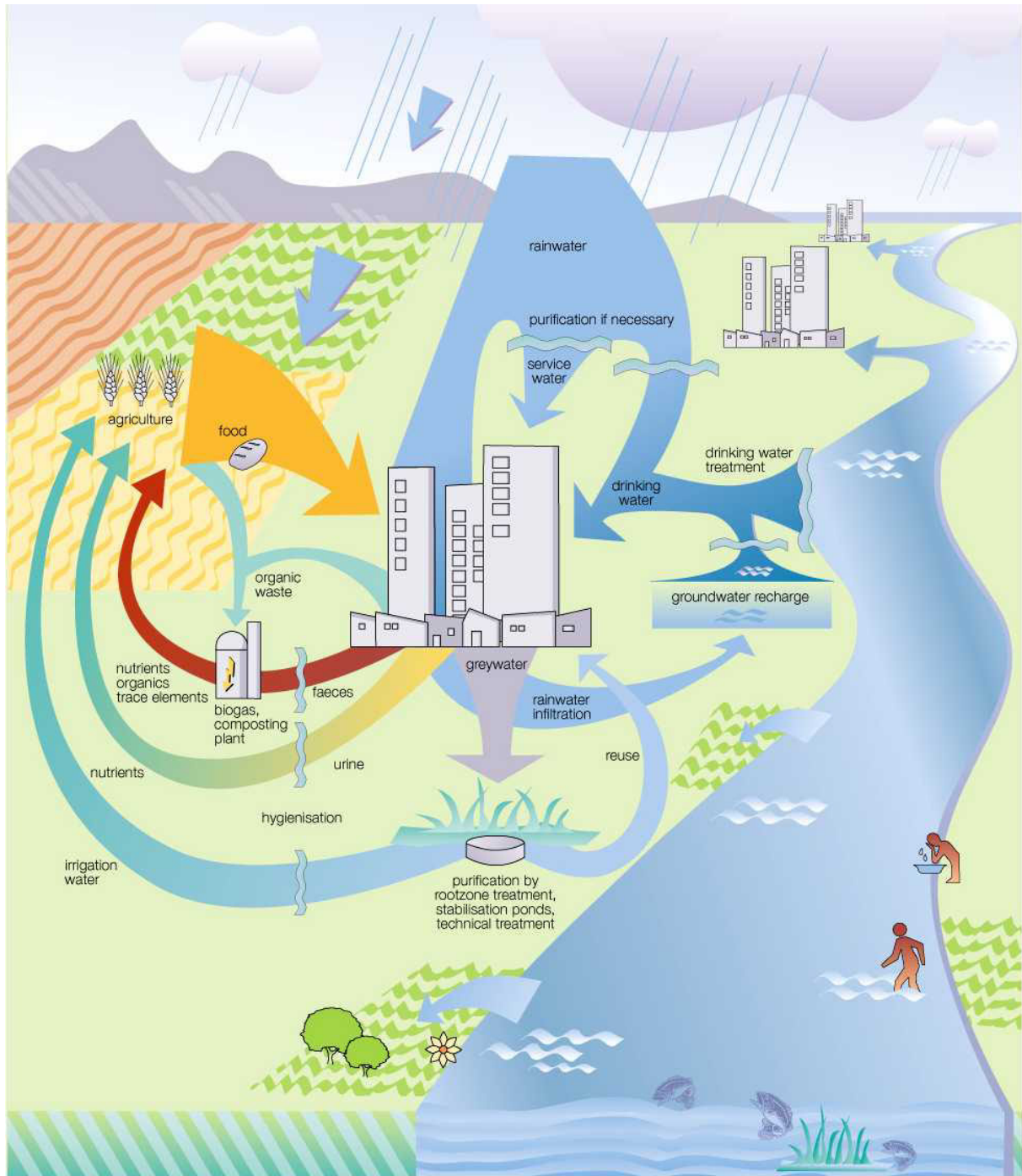

Figure 3: Schematic illustration of the main advantages of ecological sanitation systems (GTZ)

## **Ecological sanitation systems**

In general, sanitation service systems identify several stages in the management of the flow of materials, in which appropriate sanitising and handling of the materials throughout the entire system is essential. Each of these stages can be considered as a specific tactic to deal with specific materials after they have been consumed. Which tactic is applied depends on the requirements needed to fulfil the function of each element in a specific situation. Ecological sanitation systems include the collection – storage – transfer & transport – treatment – and the resource management & reuse stage.

In practice a frequently applied strategy in ecological sanitation management services is to separately collect and treat faeces, urine and grey water, which minimises the volume of valuable drinking water needed to flush away excreta. This has other important advantages as the different fractions have different characteristics and can be treated more easily according to the specific reuse requirements (see Figure 4). Although the recovered material from human excreta is predominantly used in agriculture, urine as direct fertiliser and faeces as organic matter for soil improvement, the reuse options within ecological sanitation are not limited to agriculture only, especially considering grey water. Other reuse options include the domestic reuse of grey water, following suitable treatment, for example for flushing toilets, or possibly its use as service water in industry, or its use to recharge groundwater. Rainwater use could also be incorporated into this, with rainwater possibly being treated and being used for drinking water. Organic material can also be recovered to generate biogas, or perhaps even as a general soil amendment. Biogas production allows to recuperate the energy contained in liquid and solid household wastes, and to put it to an array of uses, such as cooking, electricity generation, heating purposes or even for industrial use.

Considering resource management, the 'market' is the major player in the design of the reuse stage. Taking into account this 'market' affects the whole design of a sanitation system and means e.g. that there is a need for a product with certain characteristics in terms of chemical and hygienic quality, concentration, volume, liquid or dry status, etc.

Concluding, the split-stream collection, treatment and reuse of different waste(water) flows often offers new possibilities for more specific and cost-efficient solutions and enables a more active involvement of the solid sanitation sector, where there is already a great deal of experience in the logistics, treatment and marketing of discarded resources. However, as stated above: Ecological sanitation does not favour a particular technology but is rather a philosophy in recycling oriented resource management and offers modern, convenient, gender friendly and desirable solutions for all.

## **3.2 Material cycles in ecological sanitation (ecosan)**

Closing local nutrient cycles by recovering and using the nitrogen, phosphorus, potassium, micro nutrients and organic components contained in excrement is important not only because it can help minimise the energy and resource intensive production of mineral fertilisers, but also because it makes such agricultural inputs available even to the poorest farmer. Mineral fertilisers are often too expensive in many parts of the world or are simply unavailable to local farmers, who often turn to using the untreated contents of toilet pits or septic tanks on their crops. The long-term effects of mineral fertilisers on soil and food quality are also in dispute.

Whilst often making treatment easier and less expensive, the separate collection and treatment of the flow stream is however not a prerequisite in ecosan systems, and ecological sanitation is also possible in centralised and combined flow systems.

Separated waste (water) flows can be characterised as follows:

- black water - a mixture of faeces and urine with or without flushing water
- yellow water - urine only or mixed with flushing water
- brown water - black water without urine, with flushing water
- grey water - domestic water without toilet wastewater

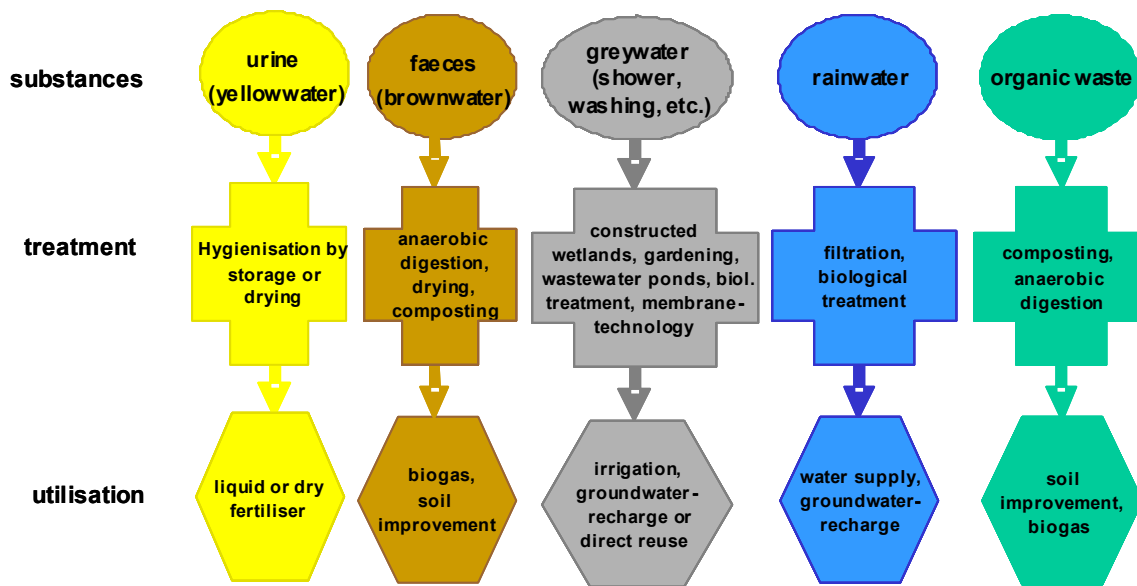

**Figure 4: Separation of substances and examples of possible ecosan elements (GTZ)**

Ideally, ecosan systems enable an almost complete recovery of all nutrients, trace elements and energy contained in household wastewater and organic waste and their reuse in agriculture. An essential step in this process is the appropriate treatment and handling of materials during the entire treatment and reuse process to ensure a sufficient sanitisation of the excrement and the protection of the public health. Therefore, ecosan systems not only control the direct hygienic risks to the population but also protect the natural environment.

It is the enormous economic potential which makes ecosan so attractive, particularly with respect to the water and energy balance.'

Human faeces obtained after separation, show valuable soil improvement qualities (particular improving the structure of the soil and raising its water retention capacity). If required, they can be treated together with the organic fraction of solid waste and/or animal manure and in a way suited to local conditions (climate, power demand, socio-cultural acceptance etc.) using the processes of aerobic composting, dehydration, stabilisation, or anaerobic digestion. This allows the organics and nutrients contained in faeces to be used in a concentrated and hygienically safe form as a dry fertiliser, compost or a fluid fertiliser. Depending on the type of treatment energy can be produced if necessary in the form of biogas after anaerobic digestion.

Urine, the yellow water, contains approximately 90% of the total nitrogen, 55% of the total phosphorus and a substantial portion of the potassium contained in human excrement. These nutrients are in a form directly available to plants, and can be used as effectively as some mineral fertilisers. A partial flow separation and use of urine is advisable due to its low volume and the high concentration of nutrients in it. In order to obtain the yellow water fraction devices such as urine diversion toilets or waterless urinals can be used.

The water used for domestic purposes such as washing clothes, or from showers is known as grey water. This makes up the largest proportion of the total wastewater flow from homes, but has only a very low nutrient content. It can therefore be fairly easily treated to a high quality using simple techniques such as constructed wetlands, ponds, bio-films or activated sludge processes. For high-tech applications more sophisticated treatments, such as membrane filtration or activated carbon filters, may eventually be added. Treated grey water can be put to particularly good use for agricultural irrigation (especially in water scarce regions), but may also be used for groundwater recharge, industrial or urban reuse or discharged into surrounding watercourses.

**Table 1: Characteristics of flow streams**

Fraction	General characteristics
1. faeces	<ul style="list-style-type: none"> <li>hygienically critical, potentially containing a series/array of pathogens, leading to water-borne diseases (e.g. bacteria, viruses, protozoa, nematodes, worm-eggs)</li> <li>consists of organics, nutrients and trace elements</li> <li>improves soil quality and increase its water retention capacity</li> <li>average production ca. 50 kg/cap/a</li> <li>consists mainly of organics submitted to decomposition processes and a minor proportion of nutrients</li> </ul>
2. urine	<ul style="list-style-type: none"> <li>hygienically uncritical</li> <li>contains the largest proportion of nutrients available to plants</li> <li>may contain hormones or medical residues</li> <li>average production ca. 500 l/cap/a</li> <li>consists mainly of nutrients available to plants and very little organics, therefore no need for stabilisation</li> </ul>
3. grey water	<ul style="list-style-type: none"> <li>usually of no major hygienic concern</li> <li>volumetrically the largest portion of wastewater</li> <li>contains usually almost no nutrients (simplified treatment)</li> <li>may contain a vast range of various substances</li> <li>average production 25 – 100 m<sup>3</sup>/cap/a</li> </ul>

Diverse technologies can therefore be used in ecological sanitation systems, from quite simple low-tech to sophisticated high-tech solutions. These currently range from compost toilets or urine-diverting dry toilets, to water-saving vacuum sewage systems, possibly with separate collection and subsequent treatment of urine, faeces and grey water through to membrane technology for material separation and decontamination. Generally, in ecosan systems precedence is given to appropriate modular and decentralised facilities, although in very densely populated areas centralised systems may still be needed.

The essential advantage of the modular components is their flexibility allowing an optimal adaptation to the local social, economic, ecological and climate conditions. As a result, they offer a more rapidly realisable and economic alternative to conventional systems. Another advantage is, that even simple dry ecosan toilets can be constructed directly indoors in very poor areas. These toilets do not require a pit and so do not endanger the stability of the house, and have neither flies nor odour when well managed. Indoor toilets contribute to the security of the user, particularly women and girls who use the toilet at night. They also save a good deal of time, as adults, normally women, can help children, sick, elderly or disabled people to the toilet with only a minimal delay in other activities.

Of particular importance in ecosan approaches are innovative institutional arrangements, financial mechanisms, and logistics to return the nutrients to farmland, marketing strategies for the recovered nutrients and directions for their safe application in agriculture. New ecosan schemes may also entail setting up service enterprises and hence kick starting income generating measures for the construction and easy and safe operation of the installations as well as the collection, treatment and marketing of the recyclates.

### 3.3 Technologies in ecosan

The technology in ecosan is not necessarily characterised by the development of completely new elements, but by their use in other contexts and functions. The designer of medium and larger scale systems is recommended to make use of existing standardised elements such as pumps, armatures etc. It should be recalled that many parts of ecosan components, although field-tested in pilot projects and described in literature are far from standardisation in their new context. For example in vacuum toilets and vacuum sewers there is a long experience gained from the use of these components in ships and aircrafts. However they have to be adapted for the large-scale use in urban conurbations.

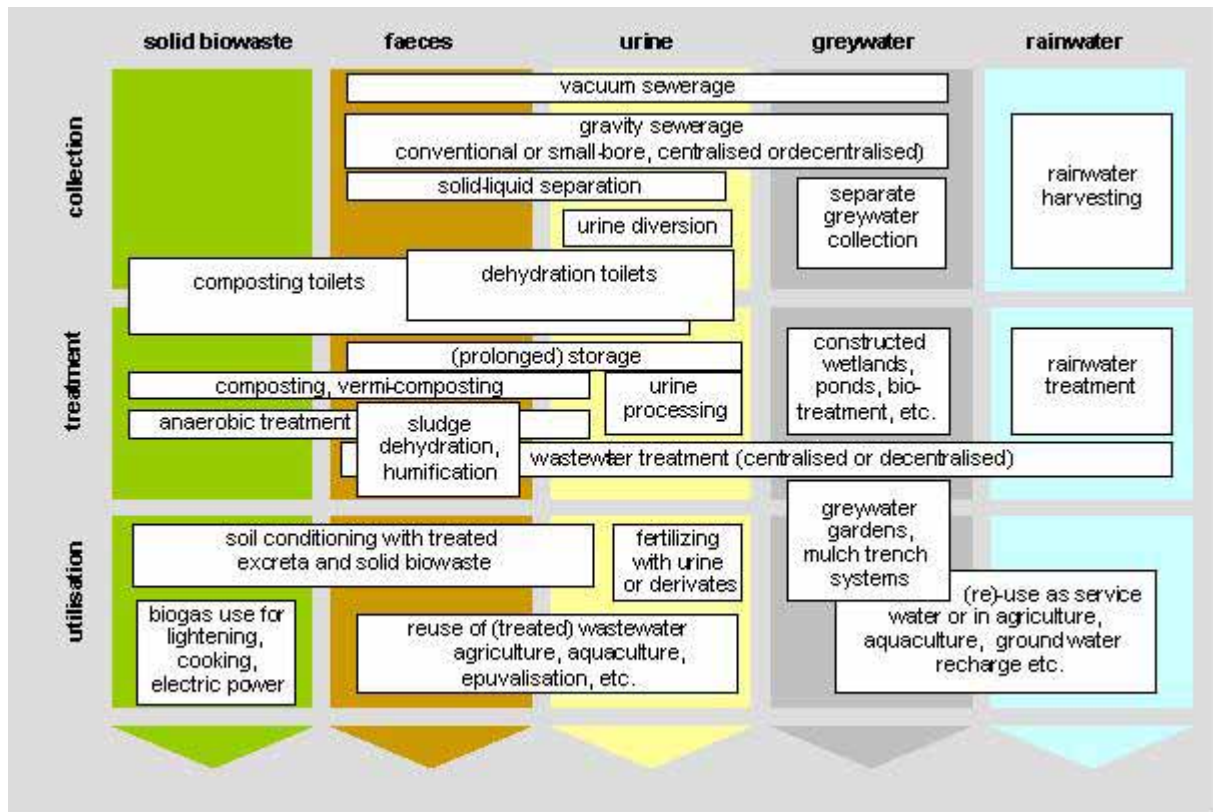

**Figure 5: Essential technological components used in ecosan (GTZ)**

The GTZ-ecosan sectoral project has started to develop “technical data sheets” as well as “project data sheets”. These contribute to a standardised knowledge management and allow collecting first standard information on components, systems and projects. This shall form the basis for future research on components and systems to get a state-of-the-art design with well defined and reliable parameters (GTZ –technical data sheets 2005, GTZ –project data sheets 2005).



### 3.4 Tools for the planning and implementation of sustainable sanitation projects

To date most participatory approaches applied in sanitation projects have been developed mainly with a rural context in mind, with similar tools for densely populated urban areas still lacking. As these approaches were developed for, or adapted to, programmes dealing with conventional systems of water supply and sanitation, they require adaptation in order to adequately address issues which are of vital importance in ecosan programmes, such as the hygienically sound reuse of recyclates from household sewage in agriculture, and the needs of the user of the recyclates. In an urban environment one of the few publications dealing directly with participatory approaches are the “Tools to Support Participatory Urban Decision Making”, from the United Nations Centre for Human Settlement (UN-Habitat 2001).

While lacking ecosan specific elements, these participatory tools have in many cases shown a great deal of success in water supply and sanitation programmes. They therefore have a proven track record that should not be neglected. These tools should be adapted wherever possible to the specific needs of ecosan programmes enabling them to address the philosophy of a closed loop approach to sanitation.

A relatively new tool for environmental sanitation is seen as being almost ideal for ecosan projects. This is the Household Centred Environmental Sanitation Approach (HCES), a new approach for planning environmental sanitation services, with the promise of correcting current unsustainable practices in planning and resource management by concentrating on the below given two main components (Eawag 2005).

#### **Box 4: The two main components of the HCES**

- |   |
|---|
| <p>(1) The focal point of environmental sanitation planning should be the household, reversing the customary order of centralised top-down planning. The user of the services should have a deciding voice in their design, and sanitation issues should be dealt with as close as possible to the site where they occur. With the household as the key stakeholder women are provided with a strong voice in the planning process, and the government’s role changes from that of provider to that of enabler;</p> <p>(2) A Circular System of Resource Management should be used emphasising the conservation, recycling and reuse of resources, in contrast to the current linear sanitation service system.</p> |
|---|

First, planning with a household or neighbourhood-centred approach places the user at the core of the planning process. The HCES responds to the knowledge, needs and demands of the users.

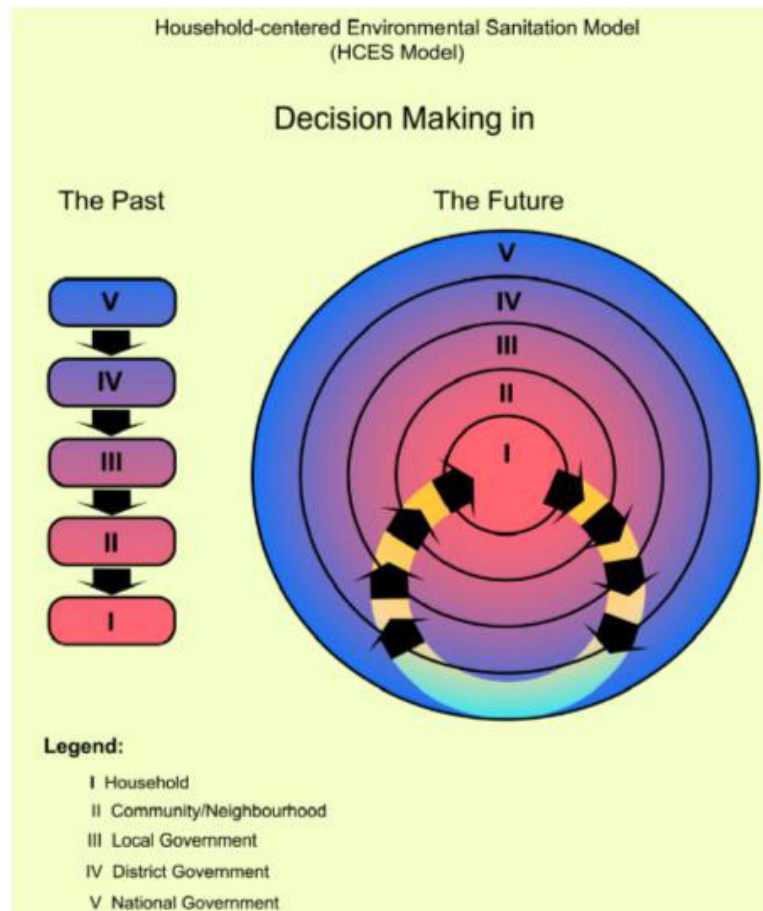

**Figure 6: Decision making in the past and in the future according to the HCES (Eawag 2005)**

The above figure presents the radical re-think of current planning practices, proposed by the HCES. This approach attempts to avoid the problems resulting from either “top-down” or “bottom-up” planning approaches, by employing both within an integrated framework.

Secondly, HCES is suggesting to minimise the transfer of waste across circle boundaries by reducing waste producing inputs (e.g. water) and by maximising reuse and recycling activities. Ecosan projects are obviously promoting and applying this concept in a very systematic way. The HCES approach refers to the Bellagio principles, but not specifically to the ecosan philosophy. However, the HCES and the Bellagio principles are both fully compatible with the ecosan philosophy. The draft of a guideline for implementation of projects in line with the HCES approach is available now (Eawag 2005). Field testing of the guideline and the collection of feedback are foreseen as the next phase.

A specific adaptation of the HCES for ecosan projects was established in the GTZ ecosan source book (Werner et al. 2003a). As discussed there, certain key tasks and moments in the course of an ecosan project may determine whether and how the programme will continue. The simplified flowchart of the process (see figure below) shows these key moments as being either workshops or reports, although in reality a wide range of different tools and methods could possibly replace them. In our view this flowchart and description of these key moments is useful as it transforms the theoretical steps into an idealised practical example.

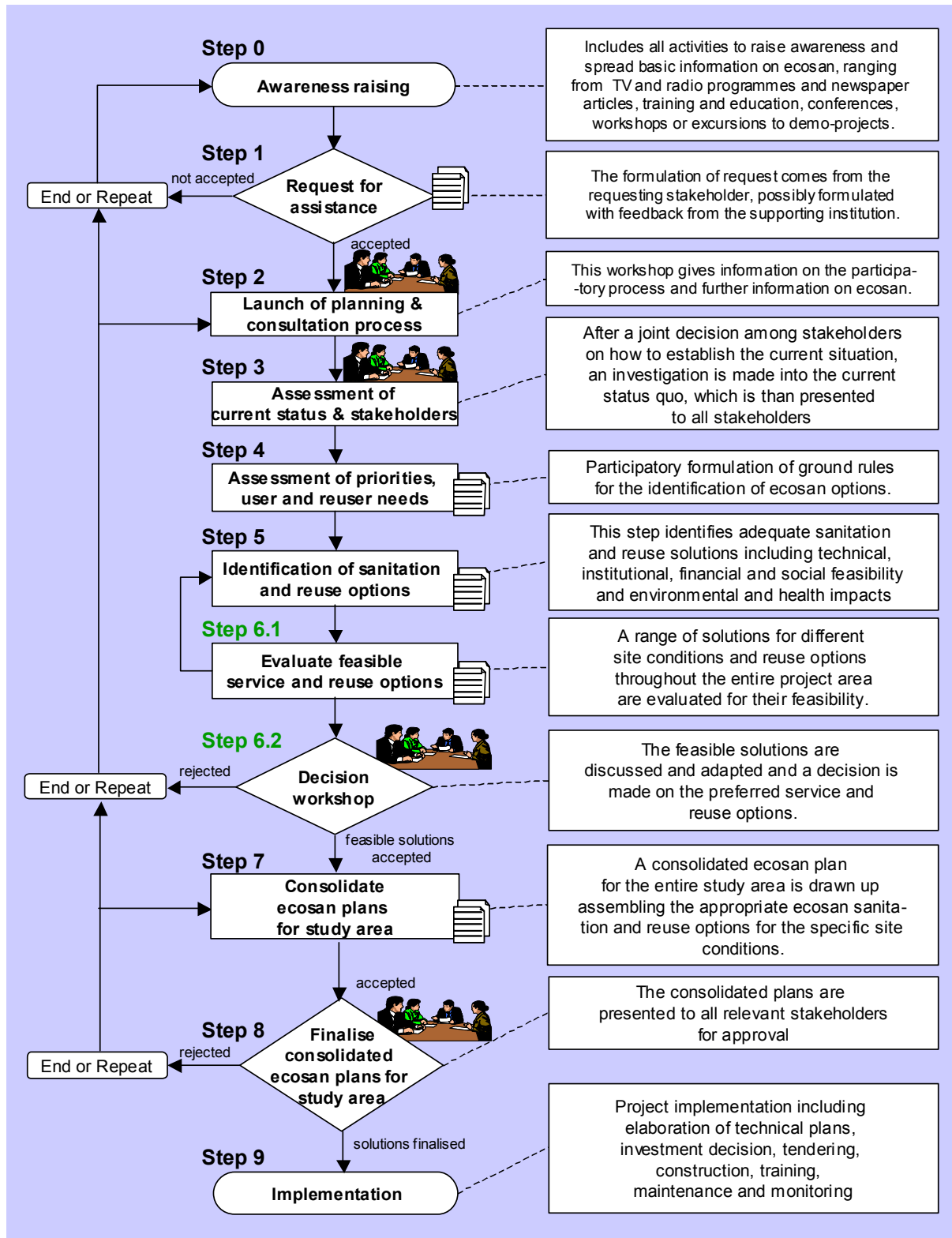

Figure 7: The “ecosan project steps” – key moments, necessary activities and expected results (GTZ)

### 3.5 Types of ecosan projects and stakeholders involved

Ecosan projects have proven themselves around the world in a rich variety of applications. Environmentally friendly settlements in the temperate climates of northern Europe have employed closed-loop sanitation systems, treating their grey water locally and providing agriculture with fertiliser from urine diversion or from the sludge of biogas plants, as can be seen, for example, in Germany, Norway and Sweden. In China, the combined treatment of human excreta and animal manure in small scale bio-gas plants is common and from 1997 to 2005 around 1.000.000 urine diverting dry toilets have been constructed in a project that started in Guanxi province (Liu and Mi 2003, GTZ –project data sheets 2005-005).

#### Project Box 2: Urine diverting dehydration toilets in China (GTZ –project data sheets 2005-005)

The “Urine diverting dehydration toilet dissemination programme, Guanxi province, China” was initiated in 1997 by the Chinese Government in co-operation with Sida and UNICEF. The initial demonstration project began with just 70 toilets. There are now more than 1 million installed double vault urine diverting dehydration toilets spread across several provinces.



**Figure 8: ecosan urine diversion squatting pan (left); ecosan in-house toilets (middle and right) (SIDA)**

A plastic urine-diverting squatting pan is produced locally for approximately 8 EUR.

To improve the dehydration and sanitisation of the faeces, a shovel full of ash is thrown onto the faeces chamber after defecation. When the first chamber of the double vault is full, the squatting pan is turned round, and the second chamber is used. The dried faeces from the vault are removed once or twice a year, depending on the chamber filling cycle. They are applied by digging them into the roots of plants. Urine is collected once or twice a week and applied directly to crops.

The basis of the success and acceptance of this system is the traditional use of urine and excreta in agriculture in China, and the absence of prejudices and questioning of their agricultural value. Other advantages noted by the users include: the system is simple and easy to construct, can be easily adapted to local needs and is affordable. In addition water consumption is reduced, the toilets are clean, do not smell, and have no flies. This allows the toilet to be directly constructed inside homes, making them more comfortable, convenient and safe for families to use, particularly for women and children, and resulting in savings for the construction of an external superstructure, and in a better operation and maintenance.

At present a dry urine diverting system is being installed for 7.000 people in Erdos City in inner Mongolia, whilst in Mexico an ecosan programme began in 2002 to address the sanitation needs of the population of Tepoztlán, an urban centre with approximately 40.000 inhabitants just south of Mexico City. In southern Africa, pre-fabricated dehydration toilets have been available on the local market since 1994, with over 18.000 of this type of decentralised units installed world-wide. Each one of these projects employs a different technology, tailored to the needs of the user and the local market.

**Project Box 3: TepozEco municipal ecosan pilot programme, Mexico (GTZ –project data sheets 2005-012)**

The town of Tepoztlán, located within a national park in Mexico, has an enormous contrast between poor, indigenous areas and luxurious weekend homes. It also has a special history of environmental activism and has become an important tourism destination.

The objective of the TepozEco project is to establish a functioning example of urban ecological sanitation, including household eco-toilets, a system of communal collection of organic refuse, greywater and organic solid waste management, eco-stations for the secondary treatment of toilet output (urine and dehydrated faeces), and recycling of nutrients for urban agriculture.

The technologies, which have been applied in the project, include urine-diverting dehydration toilets with a dehydrating chamber with two large plastic recipients, a urine collecting container, a vent pipe and fly trap.



**Figure 9: Dehydrating chamber with 2 containers and urine collection (left); organoponics (right) (TepozEco)**

Low cost shallow pit composting sanitation system prototypes were also installed for poor peri-urban and rural populations (using the arborloo and fossa alterna systems pioneered initially in southern Africa) as well as public and institutional waterless male and female urinals. Reed-bed or mulch greywater filtering systems for mechanical and biological treatment, and rainwater harvesting and filtering systems with sedimentation and volcanic gravel filtration were constructed. To promote urban agriculture and nutrient recycling, a cultivation technique called organoponics was introduced. It works in any type of container or garden bed, which is mostly filled with compacted dry leaves, soaked with fermented human urine, and topped with a layer of soil to produce vegetables and aromatic plants.

The introduction of a reuse system of organic residues in the urban context of Tepoztlán is seen as a strategy for recovering and recycling valuable nutrients to support local agricultural production and to stimulate self-reliance. An additional aim is to conserve water, considering the increasing amount of tourism in the municipality.

The work of the TepozEco project to date has in many cases resulted in the integration of dry toilets into households and a demystification of human waste for use as a fertiliser.

The mix of different framework conditions, technical options, stakeholders involved and motivations, serves to ensure that no two ecosan projects are alike. For the moment therefore, there is no such thing as a typical ecosan project. However, on the basis of experience gained, it is possible to broadly identify four basic types of ecosan projects, and give a general description of the stakeholders involved, their degree of participation in the process, and the activities to be undertaken. This helps with the identification of the tools and instruments that may be necessary, and who may need them, at different stages throughout the project.

The four broad categories of ecosan projects given here are quite general in their description. Projects in reality may not fit so neatly into one of the categories and individual projects may lie somewhere in between two types. The four basic types are therefore mainly intended to provoke reflection on who the stakeholders in a project might be, what their roles and information needs could be, and what tools should be foreseen to encourage their participation.



### 3.5.1 The 4 basic types of ecosan projects

**Project type A (rural upgrade)** corresponds to what could be considered as the “classic” ecosan-project. Farming households, in rural areas, receive support to establish ecological sanitation systems either on their compounds or in their houses. The farming households are usually responsible for the handling of the recyclates (most often only urine and faeces), using them on their own fields as fertiliser and soil conditioner. Grey water treatment and reuse, rainwater harvesting, and organic waste management can be integrated into the system, although this is rarely practised in this type of project.

The decision to implement ecosan may result from the initiative of a local NGO or CBO engaged in ecological development. The organisation may start their activities by contacting local opinion leaders, informing them of the ecosan approach and asking for their support. It is hoped that once these people have accepted the system, a broader introduction among the farming households will be facilitated and accelerated.

The decision can also however be made at the political macro-level, for example within the framework of a rural development programme. This would involve a large number of farming households in the project, enabling economies of scale to be made, but possibly complicating the participation process. In this case, information structures (public/private) and appropriate financing methods would generally be provided by the government.

**Project type B (peri-urban and urban upgrade)** corresponds to ecosan projects implemented in all existing urban or peri-urban areas of cities and towns in the course of renovation or rehabilitation work. Here more or less well functioning existing sanitation systems are converted to closed loop systems. This therefore applies to all areas, from informal settlements to luxury multi-storey apartment or office blocks, where the existing infrastructure is to be upgraded to ecosan systems. The implementation of such projects generally tends to be much more complex than those in areas of new development, for several reasons. The use of the existing infrastructure may still be foreseen in the project, which means that ecosan solutions must be built around this system, which may cause a considerable degree of technical difficulty. Private households may also only reluctantly agree to convert their sanitary facilities to ecosan, as they will most likely have to foot the bill for the change over. Private investors may also not be willing to participate in such projects as there is a considerably smaller opportunity for them to make a profit. Additionally, these built-up areas may have very little space for the installation of decentralised solutions. Projects in this context may therefore have to adopt a long term approach to the completion of an ecosan system, with innovations being introduced gradually over many years.

The ultimate handling and reuse of the recyclates (faeces, urine, grey water, rain water, storm water, organic waste and energy) is carried out, either only partially or for a particular recyclate, by the householders themselves in an urban context (in vegetable gardens, urban agriculture, for toilet flushing etc.). More usually, however, the households may not have the opportunity, or the need, to use the recyclates themselves. In such cases external service providers, working either privately or for the municipality, can be charged with collecting, treating, storing and marketing the recyclates, eventually transporting them to a reuse site, for example in urban parks or to farmers cultivating on the outskirts of the town, for energy production or for producing service water for private or public users.

The initiative for projects of this type can come from a variety of sources. The households concerned may themselves initiate the project on a local level, but it can also come from the macro-level, for example in the case of improvement projects for informal settlements implemented by the municipality or the government. The projects in this case address a large number of households, with the degree of support from the authorities (government/ municipality) being considerably stronger (regulation, financial support) than from local micro-initiatives.

#### Project Box 4: Gebers collective housing project Sweden (GTZ -project-data sheets 2005-008)

The Gebers collective housing project is located near a nature reserve in Orhem, a suburb of Stockholm. It was promoted by a network of friends and neighbours, who converted a deserted and vandalized building complex into 32 apartments with a total of 80 inhabitants. With the installation of a closed-loop system for toilet- and organic waste, the project contributes to the environmental protection of the reserve.



**Figure 10: Gebers apartment building (left); composting of faeces and organic waste (middle); urine application on a barley field (right) (VERNA)**

Urine-diverting toilets were installed to separate urine and faeces, which is then further treated before reuse. The urine is flushed with water and piped to polypropylene collection tanks under the house. The faeces are collected without flushing water and fall straight into individual ordinary plastic bins in the cellar. The plastic bins are housed in a special compartment which is constantly under negative pressure through ventilation. This improves dehydration of the faeces and prevents odours from entering homes. The urine tanks are emptied about twice a year by a tanker truck and the treated urine is used as fertiliser in agriculture.

The faeces are composted together with other organic household wastes. The resulting compost has a soil-like appearance. It is planned to use it as a soil conditioner in agriculture to produce horse feed.





Generally the project highlights how motivated the users are able to implement appropriate solutions for a more sustainable lifestyle.

**Project type C (new development)** is to be found when new dwellings or development areas are being constructed either by the authorities (national, regional or local government) or by private developers (these are normally private businesses, but may sometimes also include citizens groups who wish to build their own homes in an ecological way). The dwellings come equipped with ecosan systems, and these systems are therefore considered from early on in the planning stage, facilitating considerably the consideration of all relevant aspects of town planning, land use, (urban) agriculture, water management and so on, as well as their rapid and comprehensive introduction. They are often sold or rented to a relatively well-off section of the population, if the developers themselves do not occupy them. There is however also the possibility of new development areas with closed-loop ecological sanitation systems being constructed specifically for low-income households. Because of the urban location and the favourable planning conditions, all the treatable resources (urine, faeces, grey water, rain water, storm water and organic waste) may be integrated into these sanitation systems.

Depending on the social status and activities of the users of the sanitary facilities, the handling and reuse of the recyclates may proceed in two ways: (1) they could be collected and treated by a service provider (either private or from the municipality) at a certain cost to the users. The products are then used by a third party (e.g. farmers, city parks etc.) who may have to buy and transport the products or (2) the households themselves collect and reuse the recyclates on their own plots of land (gardens / urban agriculture).

In projects of type C, the initiative to opt for an ecosan system often comes directly from the investors (i.e. the private developers or citizens group) or the local, regional or national government and their respective planners. Householders then first come into contact with the system when they move into

their bought or rented property. They should, at the latest, be informed at this point of the principles and operation of their ecosan system.

<b>Basic types of ecosan-projects</b>				
<b>Project-type</b>	<b>A</b> 	<b>B</b> 	<b>C</b> 	<b>D</b> 
<b>Characteristics</b>	rural upgrading	urban upgrading	new development areas	non-residential (schools, offices ..)
• User of sanitation facilities	household	household / neighbourhood	household / neighbourhood	tourists, employees, pupils ...
• User of the end products (Range: in house / other)	household	household (partly) farmer, external user (partly)	household (partly) farmer, external user (partly)	user-institution (partly) farmer, external user (partly)
• Level of initiative and Decision (min / max)	micro macro	micro macro	macro	micro macro
• Considered resources (minimum / optimum)	faeces + urine only plus greywater, rainwater harvesting, organic waste	faeces + urine + greywater only plus rainwater harvesting, stormwater management, organic waste	faeces + urine + greywater + stormwater-management plus rainwater harvesting, organic waste	faeces + urine + greywater + stormwater-management plus rainwater harvesting, organic waste
• Service provision for operation, transport, treatment and marketing (Range: in house / other)	household	household public/private service provider	household public/private service provider	user institution public/private service provider

**Figure 11: The characteristics of the 4 basic types of ecosan projects (GTZ)**

**Project type D (non-residential)** covers all ecosan applications in buildings and areas that are not intended for normal residential use. Examples of these include public institutions, such as schools or hospitals, private establishments, such as banks or offices, as well as hotels or holiday lodges situated in sensitive areas (e.g. in national parks or on islands), or in regions that are not being served by the public sewer network. Projects of this type may address the upgrading or rehabilitation of an existing conventional sanitation system to ecosan or the construction of a new building with a closed-loop sanitation system. Depending on the circumstances, upgrade or new construction, different levels of technical difficulty may be encountered.

All recycling options are possible in such projects, with the integration of grey water, rainwater and organic waste into the system along with the use of faeces and urine. The handling of the recyclates can be carried out either by the users of the building (e.g. employees, pupils etc.) or service providers are engaged, requiring a marketing and transport of the recyclates to the end users.

The decision to use an ecosan system in this case can be taken at the micro level, if the owners of an individual building, for example a hotel, voluntarily opt for closed-loop sanitation. Alternatively, macro level decisions, for example that all schools should implement ecosan or that certain natural resources in a region must be protected, can be taken at governmental level.

### 3.5.2 Stakeholders in ecosan projects

In general stakeholders are those groups of individuals or organisations who have an interest in the outcome of a particular process. They can range from households and community based organisations to local, regional and national government, and can also include private sector institutions, social services, such as health and education, national and international donor institutions



and civil society at all levels. Relevant stakeholders are those who should be involved in a particular process, as well as those who are mainly affected by it or involved in the related decision making process. The relevant stakeholders in ecosan projects are described below. However, the relevance of a certain stakeholder is dependent on both the type of ecosan project as well as on the project phase, with their roles and tasks varying. Therefore, not all the stakeholders presented in the following stakeholder analysis will always need to participate in the programme.

The number of different stakeholders that may be involved in a project can be quite large, depending on its type and scale, and will include very different individuals, groups, institutions, etc. Even within stakeholder groups there may be smaller sub-groups, who may in turn be sub-divided into even smaller groups. For example a community based organisation may be considered as representing a stakeholder community, however this community consists of different interest groups such as men, women, the elderly, the young, the poor, the wealthy, etc. who may also consist of other small sub-groupings. It is therefore extremely difficult to directly address the needs and concerns of all stakeholders. However, a detailed stakeholder analysis should be carried out at the start of an ecosan project in order to identify who are the individuals, groups or institutions that will be relevant to the process and to work out ways in which large stakeholder groups may be effectively addressed and represented in the process.

The stakeholder analysis given below, aims to give an overview on the possible types of stakeholders who may be involved in a project. This list aims to assist reflection on who the stakeholders might be, by providing a general overview of the types of stakeholder.

- **(I) Users of sanitation facilities:** In many cases the user of the sanitary facilities can be considered as the individual households. In the context of most sanitation projects the term household is generally applied to describe the smallest user unit, composed of different individuals (e.g. women, men, children, the elderly, handicapped people, the rich, the poor, etc.) each with perhaps their own needs and expectations with respect to levels of comfort, hygiene, privacy, ease of use and maintenance, construction and maintenance costs, etc.. Due to the wide range of household types and their different expectations, the role of the household in an ecosan programme varies enormously. In projects of type A (rural upgrading) the households are usually the final decision makers and are often responsible for the construction and maintenance, as well as the collection and treatment of the recyclates, whereas in projects of type B, the households may be only very marginally involved in these processes, with service providers collecting the recyclates, possibly for further treatment, generally against payment. In practice it is often necessary to determine if the user of the facilities in a house is also the homeowner as this may have a decisive impact on the decision to invest in an ecosan system. In urban areas the household may prove to be too small a unit to work with (for example in a large apartment block or neighbourhood). In such cases it may make more sense to consider all the people living in a building or settlement as a single unit and to work with a neighbourhood group.
- **(II) Users of the recyclates:** In some cases, these may be the users of the sanitation facilities (e.g. the households) themselves. In urban areas, the users of the sanitation facilities **may** not be able to fully reuse the recyclates due to their particular situation (confined space, no gardens etc.) and may only be able to partially reuse the different flow-streams (e.g. using of rainwater for washing, grey water for toilet flushing, energy for cooking etc.). Here the majority of the recycled organic material and nutrients will be reused outside of the urban area by external users such as farmers or foresters. They may also be used within the town in urban agriculture, by market gardeners, municipal parks etc. who receive the recyclates from a service provider or directly from the households. Recycled water (including grey water and rainwater) may be used as service water by industry or small businesses, or to irrigate recreational areas, or even in aquaculture.
- **(III) CBOs and self-help groups** are generally formed by user-groups. These organisations may already be in existence before the introduction of ecosan or may be created in response to an ecosan project. CBOs and neighbourhood groups provide the households or other users involved, the opportunity to **exchange** experiences and to obtain advice from their peers. These groups may also support their members to organise the delivery of the different services needed (maintenance, collection, treatment etc.) and the use of the produced fertiliser at the level of the CBO/ neighbourhood-groups. In an ecosan programme CBOs may eventually develop into (market-oriented) service providers (maintenance, collection, treatment etc.)

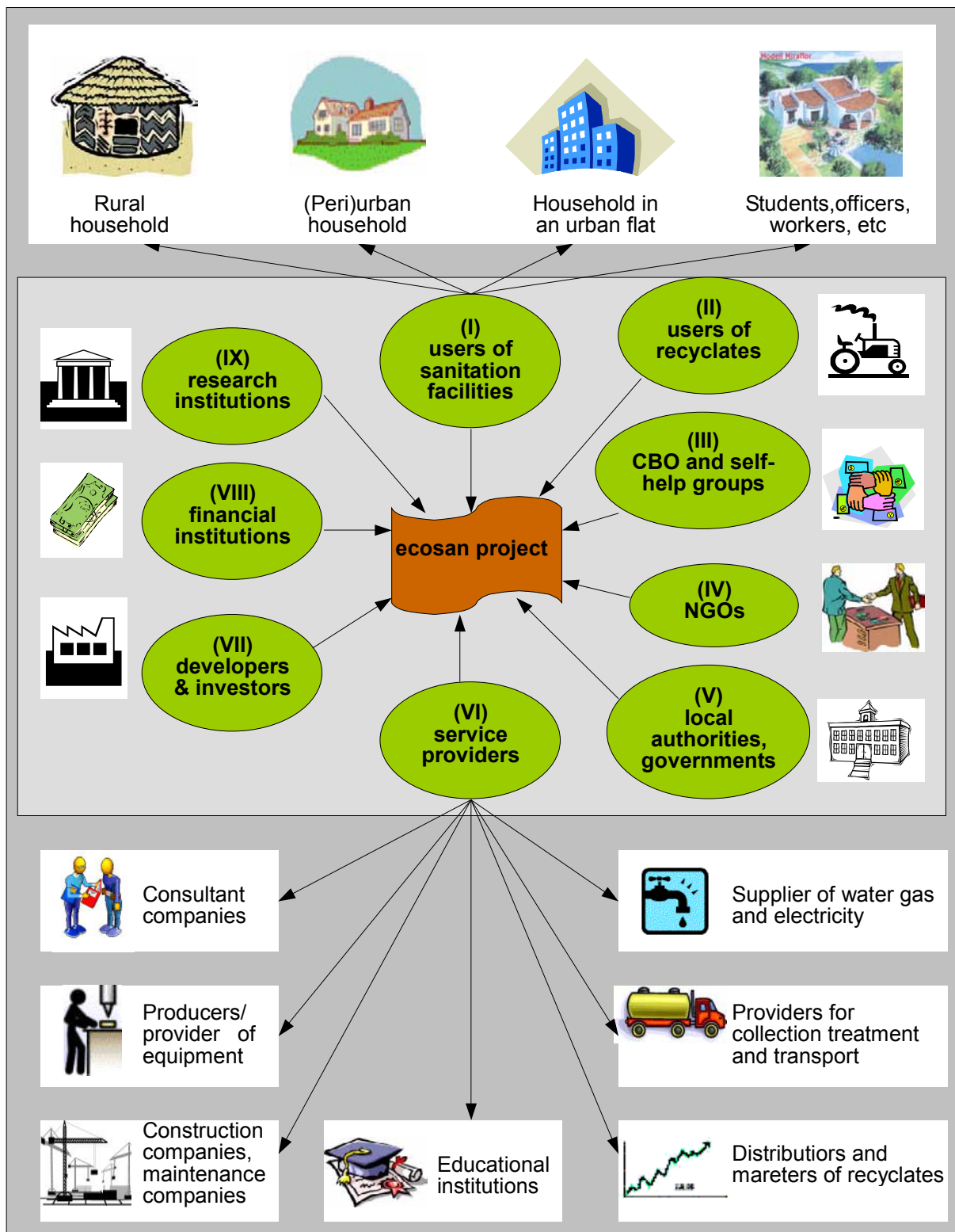

Figure 12: Principal stakeholders in participatory ecosan projects (GTZ)

- **(IV) NGOs** are generally of great importance regarding information and awareness raising among potential users. They also often support the households in forming CBOs and neighbourhood-groups and advising them on the use of eco-sanitation systems, and support (poor) households by connecting them to financing institutions, municipalities, producers of ecosan equipment (bulk-buying) etc.
- **(V) Local authorities** and governmental institutions are responsible for establishing the framework conditions for the implementation of ecosan systems. They can however also be directly involved, for example by initiating local or regional sanitation programmes promoting or even requiring ecosan, providing subsidies to households, collecting user-fees and disseminating information to potential user households. Governments are also responsible for ensuring the creation of a legislative enabling environment making it possible to install and use ecosan systems to their full potential.
- **(VI) Service providers** is a term that encompasses a wide range of diverse stakeholders, engaged in public or private market oriented activities of service provision, for situations where user households are either not willing or unable to carry out certain activities on their own. In an ecosan programme these could include planners, consultants, equipment producers / suppliers, construction companies, academic institutions, utilities providers, and companies involved in recycle collection, transport, treatment, packaging and marketing services. Service providers carry out their different tasks against payment. Along with being users of the recycles, farmers could also act as service providers in ecosan projects by collecting and treating excreta from the users of the sanitary facilities.
- **(VII) Developers and investors:** These can be either private or public investors, who initiate the construction of residential units to be sold or rented. The introduction of ecosan is thus tightly related to the demand for houses / flats with such systems anticipated by these investors. In these cases, the developers themselves may be very actively involved in the planning and implementation process of the entire programme.
- **(VIII) Financial institutions:** The introduction of new infrastructure generally requires that the investment and operation costs are secured. Initially in conventional sanitation systems, investment costs for public sewer systems and treatment plants are generally initially covered by local authorities. The costs for both the public part of the system and its operation are however later recovered from the users through fee collection. The private owners of the buildings have to provide the investment and operation costs for the in-house installations and on-plot part of the system (bathroom equipment, house installations, branch and house drains, or on-plot treatment). With the introduction of ecosan, it is assumed, that the total costs of the system (i.e. of the private and public parts together) will be considerably reduced, however the costs to be borne by the private householders may possibly increase (on the other hand, if one were to take into account the initial cost to connect to a conventional sewerage network into the private costs of conventional systems, it quickly becomes apparent that this is also a considerable sum to be covered by private money and ecosan systems may also be cheaper in this regard). In any case, new financing instruments may have to be developed in ecosan projects in order to support these private investments as only a small part of the user households may be able to pay these costs immediately, at the time of the installation of the sanitation system. Large scale application of ecosan sanitation systems may therefore necessitate the introduction of corresponding subsidy or credit schemes, and thus the involvement of financial institutions, such as local or international banks or donor agencies. During the piloting and development stage of new ecosan-systems, additional funds are also needed for the start-up phases of projects, the development and introduction of new technologies, technical, agricultural, environmental and social research, and the market introduction of hardware producers or service providers.
- **(IX) Research institutions:** These may be universities or other research oriented institutions or organisations. They can fulfil different tasks by providing advice to programme initiators, such as developers, municipalities and NGOs. Universities and research institutions can also initiate ecosan programmes for research purposes, usually with external financial assistance. They also have the important role of providing research results regarding their research, which can then be disseminated and used for information, advocacy and lobbying activities among the different stakeholders.

The table below (Table 2) presents some of the factors that may either encourage (motivating factors) or discourage (constraints) different stakeholders to opt for ecosan solutions. The table does not present an exhaustive list of all the motivating and constraining factors all the stakeholders may have, but should serve to provoke thought on what these factors may be. In many cases the motivating factors represent expectations of the stakeholders involved, while the constraints represent their fears. It is important that all stakeholder groups are well informed of how an ecosan system could work for them to avoid unrealistic expectations and groundless fears.

**Table 2: Factors motivating and constraining stakeholders to participate in an ecosan programme**

<b>Principal stakeholders</b>	<b>Examples of motivating factors</b>	<b>Examples of constraints</b>
<b>I. Users of sanitation facilities</b> households, neighbourhoods tourists, pupils employees, ...	<ul style="list-style-type: none"> <li>• hygiene improvement,</li> <li>• structural stability,</li> <li>• local physical factors (high groundwater table, rocky ground...)</li> <li>• reduced costs,</li> <li>• increased comfort,</li> <li>• improvement of quality of life,</li> <li>• greater security,</li> <li>• interest in recycles,</li> <li>• prestige,</li> <li>• ecological reasons,</li> <li>• water scarcity,</li> <li>• unreliable water supply,</li> <li>• ...</li> </ul>	<ul style="list-style-type: none"> <li>• culture, habits, taboos,</li> <li>• hygiene concerns,</li> <li>• unfamiliarity,</li> <li>• fear of loss of comfort,</li> <li>• unavailability of structural elements,</li> <li>• legislative restrictions,</li> <li>• economic factors (e.g. for start-up etc.),</li> <li>• ...</li> </ul>
<b>II. User of recycles</b>	<ul style="list-style-type: none"> <li>• economic reasons,</li> <li>• local and reliable availability of agricultural inputs (water, nutrients, organics),</li> <li>• increase of crop yields for either the market or for family needs,</li> <li>• improvement of self sufficiency,</li> <li>• ecological reasons,</li> <li>• ...</li> </ul>	<ul style="list-style-type: none"> <li>• culture, habits, taboos,</li> <li>• lack of logistics,</li> <li>• fear of negative consumer perception,</li> <li>• fear of negative long term effects on soil,</li> <li>• ...</li> </ul>
<b>III. CBOs and self-help groups</b>	<ul style="list-style-type: none"> <li>• failure of conventional / existing sanitation system,</li> <li>• local improvement of quality of life,</li> <li>• Agenda 21,</li> <li>• interest in recycles,</li> <li>• reduced costs,</li> <li>• local physical factors (high groundwater table, rocky ground...)</li> </ul>	<ul style="list-style-type: none"> <li>• culture, habits, taboos,</li> <li>• lack of information,</li> <li>• insufficient financing,</li> <li>• inappropriate legislation,</li> <li>• influence of interest groups,</li> <li>• hygienic concerns,</li> <li>• ...</li> </ul>
<b>IV. NGOs</b>	<ul style="list-style-type: none"> <li>• failure of conventional / existing sanitation systems,</li> <li>• economic reasons,</li> <li>• ecological reasons,</li> <li>• agricultural reuse of recycles</li> <li>• improve quality of life,</li> <li>• ...</li> </ul>	<ul style="list-style-type: none"> <li>• culture, habits, taboos,</li> <li>• lack of information,</li> <li>• insufficient financing,</li> <li>• inappropriate legislation,</li> <li>• influence of interest groups,</li> <li>• hygienic concerns,</li> <li>• ...</li> </ul>

(continued ...)

(...continued)

<p><b>V. Local authorities, governmental institutions</b></p>	<ul style="list-style-type: none"> <li>• political reasons,</li> <li>• economic reasons,</li> <li>• ecological reasons,</li> <li>• Agenda 21,</li> <li>• failure of conventional / existing sanitation system,</li> <li>• possibility of financial support,</li> <li>• sustainability of system,</li> <li>• support regional self-sufficiency,</li> <li>• promotion of (urban) agriculture,</li> <li>• job (and income) creation,</li> <li>• long-term security of social services (water supply etc.),</li> <li>• ...</li> </ul>	<ul style="list-style-type: none"> <li>• culture, habits, taboos,</li> <li>• lack of information,</li> <li>• lack of start-up funds / insufficient financing,</li> <li>• monitoring of treatment / handling etc. more difficult for decentralised system,</li> <li>• distrust of alternative systems,</li> <li>• not recognised as state of the art technology,</li> <li>• reluctance to change status quo,</li> <li>• contradiction of existing legal framework / long term plans,</li> <li>• powerful lobby from conventional centralised sanitation industry,</li> <li>• corruption,</li> <li>• ...</li> </ul>
<p><b>VI. Service providers</b> Planners / consultants; constructors (builders); maintenance service providers; producers of equipment; providers of collection, treatment, transport and marketing of the recyclates</p>	<ul style="list-style-type: none"> <li>• increase profit,</li> <li>• opening up of a potentially huge new market,</li> <li>• request / need for particular product,</li> <li>• further develop their own know-how,</li> <li>• ethical / ecological reasons</li> <li>• ...</li> </ul>	<ul style="list-style-type: none"> <li>• absence of technical knowledge,</li> <li>• absence of products,</li> <li>• inappropriate legislation,</li> <li>• lack of suitable tools,</li> <li>• economic interest of (waste) water monopolies,</li> <li>• fear of failure (economic risk),</li> <li>• not yet recognised as state of the art,</li> <li>• reluctance to make the necessary increase in effort,</li> <li>• lack of experience in decentralised planning / participation,</li> <li>• lack of start-up funds,</li> <li>• fear of reduced profit margins in smaller / decentralised projects,</li> <li>• regulatory obstacles;</li> <li>• ...</li> </ul>
<p><b>VII. Developers &amp; Investors</b></p>	<ul style="list-style-type: none"> <li>• increase attractiveness of developments (eco-label),</li> <li>• safe and secure “disposal” (especially in tourist areas),</li> <li>• user satisfaction,</li> <li>• economic reasons,</li> <li>• legal requirements,</li> <li>• ...</li> </ul>	<ul style="list-style-type: none"> <li>• absence of service logistic,</li> <li>• culture, habits, taboos,</li> <li>• lack of information,</li> <li>• lack of start-up funds,</li> <li>• monitoring of treatment / handling etc. more difficult for decentralised system,</li> <li>• distrust of alternative systems,</li> <li>• not recognised as state of the art technology,</li> <li>• reluctance to change status quo,</li> <li>• contradiction of existing legal framework / long term plans,</li> <li>• powerful lobby from conventional centralised sanitation industry,</li> <li>• corruption,</li> <li>• less«commission»for ecosan projects,</li> <li>• ...</li> </ul>
<p><b>VIII. Financial Institutions</b></p>	<ul style="list-style-type: none"> <li>• economic reasons,</li> <li>• failure of existing / conventional systems,</li> <li>• improving sustainability,</li> <li>• guarantee repayment of credit,</li> <li>• ...</li> </ul>	<ul style="list-style-type: none"> <li>• absence of specific financing instruments,</li> <li>• not recognised as state of the art technology,</li> <li>• need for research and development,</li> <li>• ...</li> </ul>
<p><b>IX. Research Institutions</b></p>	<ul style="list-style-type: none"> <li>• Need for research and development,</li> <li>• availability of research funds,</li> <li>• ecological reasons,</li> <li>• ...</li> </ul>	<ul style="list-style-type: none"> <li>• availability of research funds,</li> <li>• prestige,</li> <li>• ...</li> </ul>

Both the motivating factors and the constraints of the stakeholders can vary enormously and may not always be obvious to outsiders. It is therefore important in a participatory approach that the stakeholders have the possibility to voice their motivating factors and the reservations they may have about the programme. When these are known for all stakeholders it may then be possible to tailor the ecosan programme to their needs and to adequately address their concerns. It is important and very useful to continually refer to the motivating factors and to confirm that they will be addressed by the project. Equally important is to check that the constraints have been convincingly dealt with. To map the motivations and constraints is therefore an important prerequisite, which should be adapted during the course of the project, becoming increasingly specific.

Most stakeholders will be relatively new to the ecosan approach in the beginning of a programme and will almost certainly require a degree of training in order to familiarise them with it and enable them to complete their task and fulfil their responsibilities. Such training may include the following: instructing the users of the sanitation facilities on the correct use and maintenance of their facilities, informing the users of the recyclates of the correct and safe use of the recyclates, possibly with the aid of agricultural extension agents, training CBOs and NGOs to provide their members or partners with the necessary information for the programme to function correctly, capacity building measures in local and regional authorities governmental institutions to support inter-ministerial and inter-sectoral co-operation and co-ordination, a wide range of training measures for the service providers (including technical training for technicians, such as plumbers, or construction companies), informing developers and investors of the opportunities offered by ecosan systems and their particularities, introducing financial institutions to ecosystem based sanitation and their long-term financial sustainability and highlighting the need for start-up funds and new financing mechanisms for such systems, and informing research institutions of the current state of the art on an international level and the need for locally relevant research.

## **4 Capacity building - education and training in ecological sanitation**

### **4.1 Purpose of this chapter**

The role of this chapter is twofold:

1. to discuss specific aspects of education and training in the field of ecological sanitation as a part of capacity building activities; and
2. to begin to formulate strategies for education and training people in this area.

In this chapter, emphasis will be placed on the methodologies for transferring the paradigm shift in sanitation to the people who need to know about it. Equally important is to transfer that knowledge to the people who will implement the technologies and systems. Special attention will also be given to defining the relevant target groups who are likely to embrace the ecological sanitation concept. These people will have different roles to play in the implementation process: (i) to plan and enable implementation, (ii) to establish the necessary framework (political, social, economic) and (iii) to use these facilities. This publication is designed to assist all these groups and furthermore to be used by professional educators and trainers who will assist in knowledge transfer to all of the above training target groups.

Although this publication is primarily geared towards professionals who would be in charge of implementation of ecological sanitation education and training, it should also prove useful to a broader audience. Indeed a broad audience for this publication is desirable as the concept of ecological sanitation has yet to find its place in the curricula of many different disciplines, levels and forms of education and training, including:

- formal education at the secondary and university level; and
- continuing education and vocational training of special target groups in the form of specialised courses and other means of training and capacity building.

In presenting and promoting the educational concept of ecological sanitation, in this chapter, we do not discuss technical issues, but refer to the technical material presented in the other chapters of this publication.

### **4.2 The unique challenge**

Many of the required measures to integrate ecosan into education and training programmes and curricula can be achieved relatively easily. Several forward looking educational establishments have in fact already started to do this, for example at the UNESCO IHE or in several universities in Sweden, Norway and Germany. However in order to achieve a complete integration of eco-sanitation into curricula and training programmes there are several challenges that need to be overcome. These challenges include:

The highly inter-disciplinary character of ecological sanitation, requiring it to be integrated in curricula not only for engineers and natural scientists but also for many other professions.

- The relative novelty of the closed-loop approach to sanitation is implying that education for ecosan should be a mixture of teaching and promotion at all levels (advocacy). An additional challenge caused by the relative novelty of the approach is that for many contexts every-day practical experience is lacking from which direct lessons can be drawn.
- The majority of practical examples have been implemented on a relatively small scale and there are only a limited number of large-scale examples.

- The existing instruments for design, feasibility assessment, monitoring / performance assessment of sanitation have not yet been adapted to the new paradigm.

As with many new paradigms, education for ecological sanitation should serve as a model for the kinds of processes which are to be encouraged in this new approach to sanitation. Ecological sanitation calls for participatory planning, so education should also be participatory. Ecological sanitation gives special attention to users, as active participants rather than passive recipients in a planning process. So students should also become active players rather than objects of the educational process. This change of attitudes between teacher and pupil is desirable in any case, but of particular importance in topics as complex as ecosan. This places rather challenging demands on the educational system, forcing the educational institution, in effect, to move into a new educational paradigm in order to support the new paradigm in sanitation.

The inter-disciplinary nature of ecological sanitation is depicted in Figure 13. Ecological sanitation draws on a wide range of expertise, including:

- Integrated water management and other natural resources
- Resources protection and recycling
- Sustainable agriculture, soil conditioning and replacement of fertilisers
- Public health enhancement and reduction of children mortality
- Food security
- Job creation and unemployment reduction
- Climate change and variability
- Flood control and management

Changing the conventional sanitation mindset and creating a favourable environment for the implementation of ecological sanitation will not be an easy task. It will require time and will not happen overnight. In order to increase the success rate of ecological sanitation projects and to generate a more positive perception amongst its future users, education and training in all of its aspects must reach a wide range of society members.

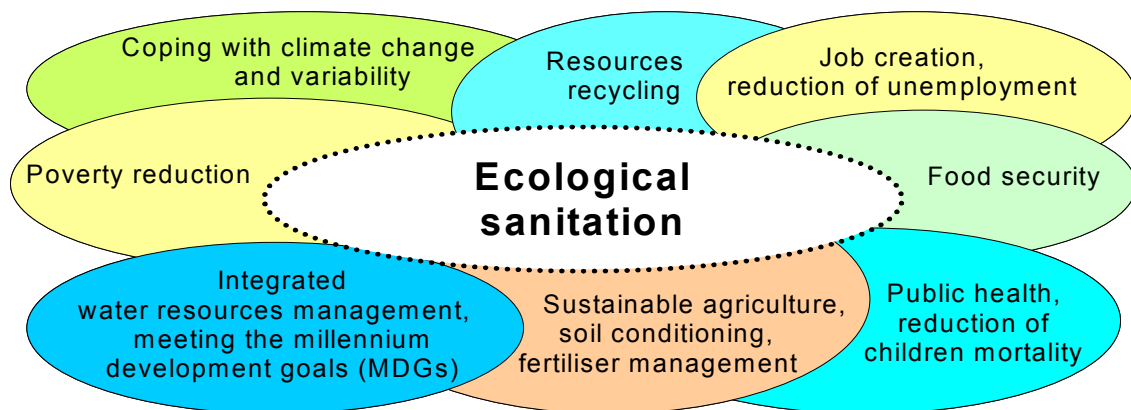

**Figure 13: Ecological sanitation is an inter-disciplinary field and is related to many aspects of modern societies in both developed and developing world (GTZ)**

The authors believe that there is a growing need and pressure to provide sound educational tools in order to encourage capacity building and to support the world-wide implementation of ecological sanitation. There is also a need for a broad analysis of existing curricula and education systems in both formal education at all levels and continuing education in water and environment related disciplines, with a view to introducing the holistic concept of ecological sanitation.

In the developed world the role of ecological sanitation education and training is to contribute to broader application of its concept, especially in areas where the advantages are directly obvious (e.g.



individual homes or groups of houses in areas where there is no sewer network, in small communities, vacation areas and in other similar contexts).

In developing countries and countries in transition, ecological sanitation education and training is even more important and urgent, especially in the context of achieving the Millennium Development Goals for sanitation and environmental sustainability (see UN Millenium Project 2005).

### **4.3 Overview of the new training and education content that needs to be conveyed**

As has been stated previously the basic principle of ecological sanitation is to close the loop between sanitation and agriculture, enabling reuse and recycling rather than disposal. Therefore, a wider range of disciplines need to be included in education about planning techniques and processes, when compared to planning processes in conventional sanitation. Included in these are, for example, training in techniques for the assessment of the current agricultural situation with respect to soil quality, types of crops cultivated, agricultural practices, water and fertiliser needs, practices concerning the treatment and reuse of manure and so on.

As ecological sanitation solutions also aim at reducing water consumption for sanitation (e.g. by integrating rainwater harvesting systems along with grey water treatment and reuse), water supply systems may often have to be reviewed and modified within an ecological sanitation project. Hence, it is important that teaching integrates sanitation with issues of water supply, water efficiency, and water productivity.

Ecological sanitation solutions ideally lead to the closing of material flow cycles on the minimum practical level (i.e. reuse close to the point of generation of excreta or wastewater). We therefore need to consider aspects of urban planning (e.g. in order to provide space for the integration of a constructed wetland in an urban park, to support urban agriculture or to provide small scale service providers with an area for the treatment and storage of ecological sanitation products in the neighbourhood). Ecological sanitation education therefore should include the methods and theory of integrating the various sectors in urban environmental planning and practice.

The materials that can be recovered in an ecological sanitation system may have a high nitrate concentration and therefore lend themselves to integrated management of water and waste: They can be treated together with the organic kitchen, garden, and animal wastes from households and even paper and cardboard from households, institutions, and businesses. For this reason, it is important to teach the integration of sanitation with certain aspects of solid waste management (especially organic solid waste treatment).

The educational systems need to broaden their content to include a mix of centralised and decentralised, conventional and closed-loop, high-tech and low-tech, traditional and innovative, separate-stream technical solutions. The curriculum for both formal and continuing education needs to be developed so that it familiarises students not only with technical approaches, but also with the corresponding institutional and management solutions. In practice, the huge variety of different technical and operational combinations may represent a considerable challenge for educators.

The consideration of appropriate sanitation solutions (i.e. technology and management system choice) in an ecological sanitation approach will require that students acquire more varied know-how and experience than is currently the case. They should then be able to consider a larger range of technical and service options, rather than focussing the planning process on a narrow range of commonly implemented systems (e.g. sewer networks or pit toilets). Hence, we need to teach methodologies that encourage inclusion of a broad range of sanitation solutions in all planning, feasibility, design, and construction phases of projects.

Classical evaluation criteria currently taught in sanitation curricula also tend to bias the results of decision making processes towards conventional sanitation systems. For example, the criteria for the limiting parameters for discharge into receiving water bodies are no longer applicable in sanitation options based on ecological sanitation techniques, where in many cases, discharge is either zero or

close to it. Therefore, new criteria have to be developed, analysed, field tested and then integrated into curricula for planners and sanitary engineers.

The new evaluation criteria need to adopt a much broader approach to carefully account for all the potential impacts of the sanitation system. Examples of what the new criteria need to consider include access to resources, water reuse efficiency, system energy demand and energy efficiency, resources recovery rates, public health risks<sup>1</sup> (both in ecological sanitation and conventional systems), environmental risks, lifecycle analysis, self-help criteria. Ecological sanitation education hence needs to include the application of new, wide-ranging evaluation criteria for water supply and sanitation services.

Another issue is that students must understand that an entirely different approach will be necessary to supply the relevant information to stakeholders so that they can make an “informed choice”. Sanitation professionals of the future need to understand the necessity to focus on the needs of the users of the sanitary facilities and other relevant stakeholders of the sanitation system (particularly the service providers and the end users of the recycles). On the other hand, of course they also need to have knowledge of the techniques for doing so. This implies creating knowledge on the potential subordination of technical criteria to participatory project preparation and implementation processes.

Students will need to learn how to analyse the context specific options, to provide unbiased performance indicators and to propose viable solutions. We therefore need to teach them about promoting the consideration of smaller planning units and a greater number of decentralised options.

Finally, the requirements of the project preparation and planning process in ecological sanitation as a part of integrated urban water management are comparatively much more demanding than those of conventional sanitation projects. Several guidelines are currently being prepared by various organisations each addressing some of the above mentioned aspects (Eawag 2005, Kvarnstrom and Petersens 2004, Werner et al. 2003a). Students have to learn about the integration of educational, institutional, and capacity building aspects into planning instruments.

## **4.4 Who needs to be reached?**

An ecological sanitation focus in education and training systems produces responsible, realistic professionals whose work supports sustainable sanitation solutions. Such an educational system is focused on creating intellectual and social capacity in relation to the integration of reuse aspects in the assessment of the current sanitary situation and in all the relevant planning activities and conceptual work. Thus, it is aimed at a broad spectrum of individuals and at various groups of stakeholders (described in the Section 3.5). They should have a vested interest in raising the awareness and competence level of various target groups that they deal with so that they can pursue ecological sanitation projects together.

### **4.4.1 Stakeholders**

The educational system, if effective, will change the view or perception towards sanitation amongst the wide range of target groups, which are part of or under the sphere of interest of stakeholders discussed in Section 3.5. Although the principles of ecological sanitation are “universal” (in that they apply to all projects), different stakeholders work with various target groups that have different backgrounds, priorities and abilities to accept the “new paradigm” of ecological sanitation. Accordingly, the stakeholders should encourage, organise and/or endorse education and training programmes in ecological sanitation.

Educators thus need to prepare, for each of the target groups a different educational strategy and a different (target group specific) implementation methodology to be used in this endeavour. Some stakeholders are highly knowledgeable of the ecological sanitation, whilst others would benefit from attending some of the course on the specific topics. Most of the stakeholders likely to undergo the

---

<sup>1</sup> Public health risks with regards to: in-house hygiene, hygiene of neighbourhood and impacts on receiving water bodies, hygienic aspects of the handling, processing and reuse of the products etc.

education and training process will belong to one of the target group shown in Table 3, so the training programme will be specifically designed with these target groups in mind. However, some new subgroups may emerge in the future.

#### **4.4.2 Target groups**

In order to support changes in formal education and training to include ecological sanitation in mainstream curricula, it is necessary to know who the education is for. In Table 3 we identify and describe the major characteristics and features of the six major target groups, each having very specific education and training needs. The boundaries between the target groups are not fixed, and there is therefore a degree of overlapping.

Some of these target groups will be receiving the information for the first time, thus making the design of curricula relatively easy. Others, especially the first two groups, need to understand the critique of conventional sanitation so that they can “unlearn” a great deal, before they are ready to accept the new technology. The target group of professionals (planners and designers with the expertise in conventional sanitation) also requires special attention and “re-training”. Only then will they open themselves up to accept new information (the first stage), accept to treat alternative sanitation options as “equal opportunity options” (the second stage) and to become an active promoter and “implementer” of this approach (the third stage).

With respect to target group 4, the Professional Practitioners, it should be pointed out that it may not always be easy to motivate practising sanitary engineers to attend further training in ecological sanitation. Some individuals or organisations in this group may have a strong bias in favour of conventional water-borne sanitation which they may not readily give up or modify. The institutions which are addressed in this publication could possibly achieve a part of this re-training via their active alumni communities. A variety of “marketing” approaches is needed to invite these practitioners to further their knowledge and at least consider (if not embrace) the alternative approach of ecological sanitation. Again, this will not happen overnight, but is a process that should be set in motion now.

Failures of some pilot systems may also serve to block some stakeholders from accepting the eco-sanitation approach. It will therefore be necessary for educators to analyse the exact causes for these failures and to integrate the lessons learned into their teaching programme, thus acknowledging that closed-loop sanitation systems are, like many other innovative approaches, in need of further optimising. Stakeholders who have already experienced unsuccessful projects will have different issues, and additional effort has to be made in analysing the specific causes of the failure (learning from the past errors) before they are convinced to try it once again.

**Table 3: Target groups for education and training in ecological sanitation**

Target group	Example	Comments regarding training needs and strategies
<p><b>Group 1a:</b>  <b>Existing users of the sanitation facilities and general public.</b>                      For example this group could include users who have an access to these facilities, are taking part in a demonstration project or a full-scale implementation of ecological sanitation technologies. With respect to the general public, it is included because members may be exposed to an ecological sanitation-compatible toilet if these are incorporated into public toilet blocks for example.</p>	<p>Mr. Smith who has a urine-diversion toilet at his house. After initial teething difficulties with the device it is now functioning perfectly, however he now has difficulties in training his visitors to correctly use it.</p>	<p><b>Training needs:</b>                      Current users' needs. Existing users have to be given support in the correct use of the toilets facilities and possibly in the collection, treatment and safe use of the products if they are to be used "on-site".                      Future user's needs: Future clients have to be "educated" in advance.</p> <p><b>Training strategy:</b> should be organised to cover both informing the users of the existing facilities ("making best out of it") and disseminating information on the options and benefits among the potential users and those who are yet to be convinced on the potential benefits.</p>
<p><b>Group 1b:</b>  <b>Students, and pupils in formal education at primary, secondary or university level (future users of sanitation facilities).</b>                      Obviously the teaching methods are going to be very different for the different age groups (teaching children, young adults or adults). Also, the younger children will need more guidance, whereas students can use self-study methods. They will also have more choices in choosing the topic of their future study (with more or less "ecological sanitation content").</p>	<p>A 12-years old girl at primary school who leads a local action to improve sanitation conditions in their school.</p>	<p>Teaching young people about the ecological sanitation paradigms will prepare them for a changing world, where water-borne sanitation will no longer be the scenario that everybody aspires to.</p> <p>Training needs: The needs are big at all levels in all educational institutions in the world, especially in developing countries.</p> <p><b>Training strategy:</b> Use the existing channels for vocational training</p>
<p><b>Group 2:</b>  <b>Markets and end-users of the recyclates,</b>                      e.g. farmers who are using ecological sanitation products as fertilisers on their land.</p>	<p>Mrs. Myambelo owns an organic food production farm and a farm guest house. She is refurbishing her farm house, to introduce eco-sanitation to attract more eco- movements visitors to her "integrated eco-farm" with healthy organic food.</p>	<p>People in this group will mainly be interested in the safety aspects of handling ecological sanitation products and using them in food production and in economic benefits. There is overlap with Group 4 (e.g. agricultural specialist), but Group 2 is meant to be mostly people without a university degree. The consumers of products that have been fertilised with ecological sanitation products are not meant to be part of this group, but rather part of Group 1a (i.e. general public).</p> <p><b>Potential needs:</b> Case by case analysis of the needs to cover all users who are spatially disperses.</p>
<p><b>Group 3:</b>  <b>CBOs and self-help groups representing users, NGOs</b></p>	<p>Church in Kibera Slum in Nairobi. They have a complex challenge of providing advice and support to low income communities. However, they have potential of relying on the access to small international grants and community support in project implementation.</p>	<p><b>Training needs:</b>                      need to select and train local champions                      need to train future users of the facilities</p> <p><b>Strategy:</b> Provide the concept of integrated clean-up programmes and decompose it into parts (action plans) that include ecological sanitation.</p>

Target group	Example	Comments regarding training needs and strategies
<p><b>Group 4: Professional practitioners: engineers, sociologists, other scientists, and other professionals</b> who are currently working in the fields of water, environment, civil engineering or related disciplines.</p> <p>To give some general examples, Group 4 would include: Water and environmental specialists (hydrologists, treatment specialists, sanitary-public health engineers, designers, contractors and developers) Planners, landscape architects, biologists, municipal officers Agriculture specialists Researchers and MSc and PhD students<sup>2</sup> Professionals interested in starting- up or upgrading their businesses in the ecological sector</p>	<p>An environmental chief engineer working for an environmental consultancy firm which just got an ecological sanitation project and all his team's past experience was based on the "conventional" technologies.</p>	<p>This is an important target group because they can both promote implementation or create obstacles to implementation of these facilities. For example, consultants might be asked to develop sanitation alternatives but if they have no knowledge of these technologies, they will not offer, or they will oppose, alternatives along these lines.</p> <p>This group would also include "newcomers" i.e. professionals which traditionally had "nothing to do with sanitation" but have realised that time has come when it is important to raise their "green credentials".</p> <p>One of the most important aspects for this group is that the awareness of the ecological sanitation approach needs to be created, because it is likely that during their university studies, they have not been exposed to it to the degree that would guarantee their full commitment to this concept. It is one of the aims of this publication to change this situation and ensure that in the future ecological sanitation gradually becomes a part of the regular curricula in water and environment related study areas.</p> <p>Additionally, there is the need to increase their awareness of the multi-disciplinary nature of ecosan. Particularly the importance of the socio-cultural aspects of sanitation that may have a primary role in the failure of a sanitation system.</p> <p><b>Potential needs:</b> Not continuous, concerted action through professional associations could be helpful.</p> <p><b>Strategy:</b> Short courses should be run frequently, publications</p>
<p><b>Group 5: National, provincial and local authorities, top-level decision makers</b> (managers, politicians, civil servants in leading positions, etc.)</p>	<p>A Minister of Agriculture or Ms Pinzon (medical doctor) Deputy minister or public health.</p> <p>None of them had time to be briefed about ecological sanitation but are ready to give a speech on the topic.</p>	<p>This group does not have much time to undergo lengthy training courses. Therefore, short briefing sessions need to be arranged for them. When planning training sessions or briefings for this group one should also bear in mind that there are laws and regulations by health authorities, which may (unintentionally) limit the use of technologies based on ecological sanitation.</p> <p><b>Potential needs:</b> Deal with the education in the post-election period.</p>
<p><b>Group 6: Service Providers, MSEs, labourers, technicians and general staff</b> who are in daily contact with installation, operation and management of ecological sanitation-related facilities.</p>	<p>This could be people who build composting toilets, collect faecal matter for processing off-site, manage public toilets, market urine-diversion toilets etc.</p>	<p>This group is also thought to include people working in small to medium enterprises (SME's) who are creating a business in and around the "ecological sanitation market".</p> <p><b>Training needs:</b> There is a need to do search in order to identify the local needs on the case by case basis</p>

<sup>2</sup> Undergraduate students, on the other hand, are thought to be part of Group 1b.

## **4.5 Education and training methodology**

The technical material presented in chapters 1 to 3 of this publication can serve as background literature introducing the basic ecological sanitation concept. However for an in-depth studying of the matter, more comprehensive sources are needed. How the content and methodology of a training course should be tailored to the specific target groups is described below.

### **4.5.1 Preparatory activities**

Any education or training programme has to be carefully planned by knowledgeable people (i.e. the teacher<sup>3</sup>) or by a qualified Education Development Body (e.g. a task force for preparation of the educational material), which is authorised for such activities. Systematic preparations are required to be undertaken, followed by selection of the didactical methodology, teaching/training material, adjusted to the particular target audience and circumstances. At this point, one needs to distinguish between training and education, for which the preparatory activities are described separately as follows:

#### **Preparation for training programmes**

In this context, a “training course” is a course that teaches specific aspects of ecological sanitation during a period of several days up to several weeks only. The course duration typically being 1-3 weeks, but possibly spread out over a longer time period if the trainees are studying at their own pace, e.g. the literature provided or some form of distance-learning.

It should be pointed out here that this document is not limited to serve institutions of higher learning. Indeed, there are many technical training and vocational schools for technicians and practitioners who do not aspire to provide university-level courses, but will in fact train the majority of the people “on the ground” who will implement ecological sanitation. This results in a wide variety of needs and level of knowledge of the participants in the training programme.

Preparations for running training programmes may differ from one case to the other, but generally it has to take into account the local socio-economical situation, availability of suitable case studies, availability of qualified trainers, technology level, and public perception. During the preparation, some or all of the following activities have to be carried out:

---

<sup>3</sup> The word “teacher” is used in what follows, and is understood to be synonymous with “trainer” or “educator”.

- Assessment of training needs
- Definition of the training objectives
- Decision on length of programme
- Selection of candidates (if appropriate)
- Planning for provision of resources such as human (lecturers and supporting staff), financial, logistic
- Evaluation of education level of the target audience, i.e. how much prior knowledge exists, and what pace and method of teaching / training would be appropriate
- Design of the curriculum (e.g. selection of content according to the identified level of the students and the assessed training needs)
- Include social and cultural aspects (consult the specialist if needed) to address the local area specific issues
- Selection of training method(s), e.g. up-front teaching, hands-on training, field trips for on-site training, workshops, excursions, discussion fora or other methods
- Relevant content preparation
- Preparation of training material and production of handouts for the participants
- Preparation of rooms, computers, projectors, copiers
- Preparation of field trips, access to the site, local champions, transportation, accommodation and subsistence
- Provision of the safety and hygiene at work
- Preparation for reporting, evaluation, post-training follow-up
- Planning of promotional activities and publishing (if appropriate) and analysis of the feedback

### **Preparation for educational programmes**

Education, in contrast to training, refers less to passing on concrete knowledge (although this is also part of education), but more to teaching people how to think critically and analytically. This is mainly done in formal education institutions, such as schools, colleges, universities. It is about conveying concepts, attitudes and learning methods. It is not advocated here that a separate educational programme for ecological sanitation be created but rather that the closed-loop paradigm is included into the relevant existing educational programmes at all levels of formal education.

Modifying curricula and syllabi is a long process which usually has to be approved by the appropriate governmental institution (university council, ministry of education or equivalent). Accreditation procedures may also slow down the process. Hence, the preparation activities for educational programmes are more difficult to define and carry out than for training programmes. To be implemented they have to be initiated at the appropriate instance and a broader consensus has to be achieved among the members of the initiating body.

### **4.5.2 Selection of relevant subject areas**

Depending on the target audience and the specific circumstances, the teacher should make a careful selection from the following broad range of subjects (see also the following section, which shows a matrix of target groups and subjects to be taught):

**Table 4: Range of subjects to be taught in ecological sanitation training and education**

<b>1. Introduction to ecological sanitation</b>
Paradigm shift and ancient technologies revisited (source separation) Basic principles, biological, chemical and physical processes involved Benefits to be achieved by ecological sanitation and integrated solutions Advantages and disadvantages of ecological sanitation vs. conventional sanitation systems Resources needs and availability
<b>2. Technologies applied in ecological sanitation</b>
Potential for co-management of liquid and solid waste flows from households; separation at the source Relevant toilet types (e.g. dry/wet sanitation, urine separation, vacuum toilets) Sanitisation of faeces or black water (e.g. anaerobic digestion, composting, dehydration) Storm water management including rain water harvesting, flood management Water saving and water reuse principles and technologies Balance of resources (including energy efficiency)
<b>3. Resources recovery and agricultural reuse (nutrients, organics, water and energy)</b>
Principles and prerequisites Technologies and selection principles Wastewater reuse (principles, technologies, health and safety) Bio-solids, e.g. organic kitchen wastes (recovery, application, disposal) Food safety Energy recovery (small scale – decentralised vs. centralised facilities) Climate and factors affecting suitability and efficiency Marketing of the recyclates in agriculture or other areas
<b>4. Implementation, operation and maintenance management</b>
<b>5. Practical skills for operation and maintenance</b>
<b>6. Environmental and health aspects</b>
Interactions of ecological sanitation with the broader environment Health and safety, including performance verification Hygiene education
<b>7. Economic and financial aspects</b>
Full cost comparison between different ecosan / conventional options; influence of system boundaries, Impact of health related costs, private versus national economy, shadow prices, Micro credit financing schemes, impact on job creation, small scale enterprises, Role of the private sector, potential for cost recovery, infrastructure ownership, fees and charges
<b>8. Social and cultural aspects</b>
Social perception, motivation and obstacles for broader application Cultural issues Gender: sanitation and men, women and children
<b>9. Policy and Legal aspects</b>
Local legal framework affecting implementation of ecological sanitation and reuse Building codes and permits Strategies for the future
<b>10. Institutional and organisational aspects</b>
Institutional framework (stakeholders, relationships, decision making) User management, monitoring, evaluation Participatory principles (with respect to users of services) Implications for bureaucratic attitude towards sanitation New roles for formal institutions
<b>11. Case studies: successes and failures</b>
<b>12. Enabling search for up-to-date information on ecological sanitation (e.g. internet)</b>
<b>13. Interactions of ecological sanitation projects with existing infrastructure</b>
<b>14. Evaluation criteria for sanitation systems</b>
<b>15. Promotion and public awareness</b>



### 4.5.3 Matrix of subjects and target groups

The following table attempts to select relevant subjects for the six target audience groups defined earlier. This should be seen as a guide only. Final selection and shaping of the training programme should be based on a case-by-case investigation taking local conditions into account.

**Table 5: Matrix of relevance of subjects for different target groups**

Subject	Group 1a and 1b Users of facilities and students	Group 2 Farmers / users of ecological sanitation products	Group 3 CBOs and NGOs	Group 4 Professionals	Group 5 Decision makers	Group 6 Service providers
1. Introduction to ecological sanitation	■	■	■	■	■	■
2. Technologies applied in ecological sanitation	■	■	■	■	■	
3. Resources recovery and agricultural reuse (nutrients, organics, water and energy)		■	■	■	■	
4. Implementation, operation and maintenance management				■	■	■
5. Practical skills for operation and maintenance						■
6. Environmental and health aspects	■	■	■	■		■
7. Economic and financial aspects	■	■	■	■	■	
8. Social and cultural aspects	■	■	■	■	■	■
9. Policy and legal aspects		■	■	■	■	
10. Institutional and organisational aspects			■	■	■	
11. Case studies: successes and failures	■	■	■	■	■	■
12. Enabling search for up-to-date information on ecosan		■	■	■		
13. Interactions of ecosan projects with existing infrastructure				■		■
14. Evaluation criteria for sanitation systems			■	■		
15. Promotion and public awareness			■	■	■	

#### **4.5.4 Available and emerging education and training tools**

The teacher can make use of existing tools, both relating to content and didactical methods, which will enable an “active learning”<sup>4</sup> environment. The resources available to teachers with regards to the content include:

- Conventional educational material such as books, brochures, guidelines, leaflets, posters etc.
- Educational material in electronic (multimedia) form such as text in PDF and Word format, Power Point presentations, video clips etc. Selected sample material that belongs to this group is available on the “ecosan resource CD” (GTZ 2006) and from the organisations mentioned in chapter 8.2 and their webpages.
- Web based material and other on-line training courses and materials (e.g. SDC/myNetworks 2003; EMWater 2005; UNESCO-UWETTT training material [in prep.]).

Possible didactical tools to enable an active learning environment include:

- Lectures / classroom sessions, or briefing sessions with up-front teaching
- Individual or group assignments
- Field trips
- Work with local champions
- Work with local users of the facilities and with local stakeholders’ groups
- Case studies - learning by doing (analysis of successes and failures of existing ecological sanitation projects; analysis of interactions with other infrastructure projects)
- Practical workshops
- Role playing games
- Analysis of interactions with other infrastructure projects
- Group work, e.g. technology selection, analysis of sustainability and risks
- Tutorials for preparations for pre-feasibility and feasibility studies

As mentioned before each of the target groups requires the appropriate set of contents and didactical tools to be tailored taking into account local technical, socio-economic and cultural conditions.

#### **4.6 Proposed implementation strategy for modernising the educational and training system in sanitation**

Knowledge of ecosan-related issues has increased considerably over the last decade, as has the number of ecosan pilot projects. This period can be seen as a phase of primary advocacy which now needs to move towards a phase of wider dissemination of the latest scientific research results, capacity building and training for a new generation of professionals to prepare them for jobs in the sustainable sanitation sector.

Whilst the academic resource base is currently very limited around the world, it can still be geared towards an effective leverage function for sustainable sanitation activities in institutions in both industrial and developing countries. The academic and professional resource base should focus on inspiring local and national authorities, institutions and other interested parties in both the North and the South to engage in training and research, involving itself intensely with research collaboration and providing inputs to training given by these institutions.

Several international organisations have already begun working in this direction, illustrated by the two examples below:

---

<sup>4</sup> “Active learning” refers to a mode of learning where the student takes an active role in acquiring the knowledge (See for example <http://edweb.sdsu.edu/people/bdodge/Active/ActiveLearning.html>)

### **(1) North-South: Research Partnerships for Mitigating Syndromes of Global Change**

Within the framework of the “Swiss National Centre of Competence in Research (NCCR) North-South: Research Partnerships for Mitigating Syndromes of Global Change” which is co-funded by the Swiss Agency for Development and Cooperation (SDC) and the Swiss National Science Foundation, a project on environmental sanitation is managed by Eawag-Sandec. The overall aim of this NCCR is to enhance sustainable development in selected contexts through research partnerships involving institutions within Switzerland as well as their partners in developing countries. Interdisciplinary exchange and transdisciplinary integration and dialogue is promoted in nine geographical Joint Areas of Case Studies (JACS), where concrete efforts are undertaken jointly with local partner institutions. Sandec’s Project aims at enhancing knowledge and contribute to the scientific basis for improving environmental sanitation in developing countries, with particular emphasis on the situation of the most vulnerable populations in urban and peri-urban areas. (Morel, Zurbruegg and Schertenleib 2005).

### **(2) Regional Nodal Development**

The second phase of the EcoSanRes Programme, which started in January 2006 will emphasise capacity building and knowledge management through the development of regional nodes in the South. This means working with a series of dynamic institutions that have good regional networks that can provide support in training, research and development, knowledge management, demonstration and pilot projects in order to build regional capacity. The EcoSanRes Programme will provide leadership and stimulate this development in collaboration with several other actors in the North and South. An International Board and Review Panel will provide governance. A global fund for local and regional initiatives is in place, and a series of international Thematic Working Groups ensure that cutting edge knowledge is properly shared among leading specialists and institutions involved in capacity building. (EcosanRes 2006)

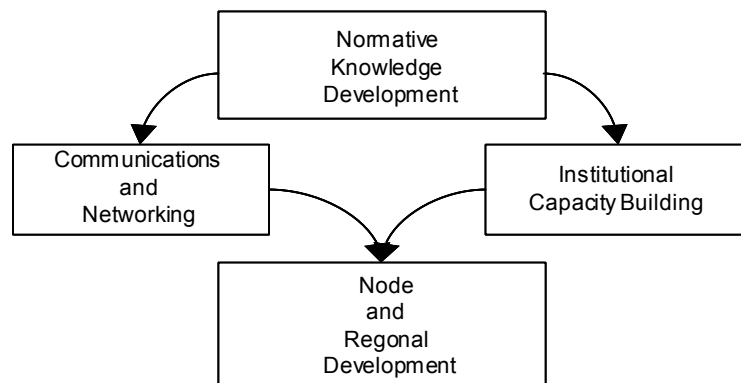

**Figure 14: Modus operandi in Nodal Development. (EcoSanRes 2006)**

### **How to accelerate ecological sanitation education and training?**

The implementation strategy for ecological sanitation education and training will involve extensive and intensive work with educational and training institutions. The lack of capacity is presently considered as a crucial limiting factor in meeting the increased demand for implementation of ecological sanitation. All actions aimed at encouraging regional, national and local institutions are however limited by this lack of capacity.

In an ad hoc meeting on “Ecological Sanitation Capacity Building” held during the 3rd International Ecological Sanitation Conference in Durban, South Africa (24 May, 2005) it was suggested to establish an international network of interested organisations and training institutions, in order to accelerate the formation of a capacity building initiative for ecological sanitation.

Some institutes have already included or are planning to include ecological sanitation in their regular educational programmes. A non-exhaustive list of examples is given below:

- Sida/EcosanRes (Sweden): Annual course for professionals in two regions alternating between Latin American countries, Africa and Asia
- Norwegian University of Life Sciences: Summer school and courses for students and professionals
- Technical University of Hamburg-Harburg (Germany): ecosan integrated in university degrees
- CREPA: Training courses for sanitary professionals in the West Africa Region
- My Networks: Internet courses on ecosan
- UNESCO-IHE (The Netherlands): Integrated into MSc programmes, e.g. Municipal Water Infrastructure MSc programme (in preparation)
- UNESCO endorsed network of centres for urban drainage / urban water (IRTCID/CUW network)
- German Water Association (DWA): Training courses for professionals (in preparation)
- Order of Syrian Engineers and Architects (OSEA): creating an inter-institutional professional network (IPN) on ecosan for the advancement and dissemination of knowledge and training
- Indian Innovative Ecological Sanitation Network: Regular capacity building workshops and joint pilot case studies
- Centre for Science and Environment, India: Training on water pollution & water-waste management
- Philippines Ecological Sanitation Network: Regular capacity building workshops and joint pilot case studies (e.g. Center for Advanced Philippine Studies: Capacity building and training with Ecosan pilot projects and research; University of the Philippines / Philippine Women's University: Integrated of ecosan into an MSc programme on Environmental Engineering / Management).
- GTZ-ecosan project (Germany): Local capacity building workshops in the start-up phase of ecological sanitation projects for decision makers, professionals and other stakeholders
- WASTE (The Netherlands): Local capacity building workshops in the start-up phase of ecological sanitation projects for decision makers, professionals and other stakeholders
- World Toilet Organisation / World Toilet College: Training of trainers in ecological sanitation

#### **Box 5: Example for a funding programme to strengthen ecosan research capacity**

A Funding programme for ecosan related research was started in 2005 by the Swedish International Development Cooperation Agency (Sida), the Stockholm Environment Institute (SEI) and the International Foundation for Science (IFS). (IFS 2005)

In the programme up to US\$ 12,000 (EUR 9,600) are being offered in research support for projects on Sustainable Sanitation and Grey-Water Reuse. Grants are intended for citizens of developing countries carrying out research in a developing country, attached to a university or non-profit making research institution in a developing country. The age limit for this programme is 40 (for Chinese applicants 30, for applicants from Sub-Saharan Africa 45).

##### **The topics funded are: (1) Ecological Sanitation**

- monitoring the reduction of environmental impact;
- pathogen destruction;
- secondary treatment of excreta and organic waste;
- safe agricultural reuse;
- identification of pollutants (e.g. pharmaceuticals);
- perceptions/attitudes related to excreta reuse in food production;
- economic value of nutrients and humus.
- Other forms of sustainable sanitation
- development of other sustainable sanitation methods;
- monitoring the reduction of environmental impact.

##### **(2) Reuse of grey-water for irrigation**

- monitoring improved availability of water for agriculture;
- identification of geographical areas where re-use of grey-water is feasible;
- development of treatment systems;
- identification and reduction of pollutants (e.g. detergents, pesticides, pharmaceuticals);
- public acceptance and management of systems.

One important way to increase capacity is to develop funding programmes for research in the new field. A funding programme for ecosan related research has been started in 2005 by the Swedish International Development Cooperation Agency (Sida), the Stockholm Environment Institute (SEI) and the International Foundation for Science (IFS). Its design, topics, and target group of researchers are given in Box 5 above. The funding programme shows what are currently seen as the promising fields for young ecosan researchers in southern countries.

### **Training of Trainers with a partly e-based approach is needed**

Whilst these initiatives are to be welcomed and further encouraged, it is also clear that alone they will not be able to meet demand as long as they continue to reach only a fixed number of participants (e.g. reaching several hundred people per year and courses). An exponential increase in capacity is now required, with training being aimed at trainers, who in turn can pass their knowledge on, establishing a large network for capacity building.

An important target group should therefore be trainers at professional training institutions such as schools of public health, departments of water and sanitation for civil engineers, agriculture and horticulture training institutions, schools of architecture, university departments for social and economic development, etc.

This new direction of capacity building activity requires well designed materials for the training of professionals and students soon to become professionals.

Some material has already been developed for such courses, as can be seen from the examples given in Chapter 7. Most of these materials are to some extent e-based, and many of the courses are divided into two, with one section done by the students in their home countries (preparatory activities, case studies, collection of local background data, introduction into the topic) and another section being carried out with the trainer in a face to face situation (including discussions of the case studies, group work, etc.).

### **E-based Learning Materials are suitable for ToT-schemes**

E-based learning material has particular advantages when being used in Training of Trainer (ToT) schemes: It can be made informative, up-to-date, and presented in a way that catches the teachers' interests. It can include "Power Point" presentations with accompanying text / instruction, film clips, video-taped interviews and lectures, and an extensive reference list. E-learning material can be made available on the web or on a CD for teachers and instructors in recognised institutions for training of professionals in various ecosan-related subjects. Teachers are free to choose the sections which he or she deems relevant for courses they are conducting. The material is thus easy to adapt to the needs of the individual teacher, from a full course to parts to be included in some lectures. The CD / website is easy to update on a periodic basis.

E-learning material is already available that covers the major ecosan management issues, policy, household routines, hygiene and sanitation systems, primary treatment/handling, secondary treatment, reuse in agriculture and energy generation, selection criteria for sanitation systems and systems analysis. It can also include suggestions on how to use the material in learning and gives examples of syllabi for a variety of courses.

### **Starting a knowledge base for ecosan training and education**

As a contribution to the currently available e-learning resources and ecosan knowledge dissemination, GTZ together with several other organisations have collected, assembled and made available published material relevant for education and training purposes on a "ecosan resource CD" (GTZ 2006), which either accompanies this publication, or is also available from [ecosan@gtz.de](mailto:ecosan@gtz.de). This CD will be useful for interested teachers to develop their own teaching material. The content of the CD comprises:

- Basic ecological sanitation literature (e.g. the new edition of the EcoSanRes book on ecological sanitation from Winblad and Simpson-Hébert (2004))
- Guidelines (e.g. for the reuse of excreta and grey water, and for project planning)
- Proceedings of ecological sanitation conferences
- Project data sheets and technical data sheets
- Example curricula and Power Point presentations used in existing university courses on ecosan
- Concepts for local capacity building workshops

This CD is seen as the core of the current ecological sanitation knowledge base, and may be used as a starting point for a web-site on education and training material for ecological sanitation capacity building. Further activities in this respect may comprise the exchange of information on ongoing training activities, resource experts, development of a joint e-learning courses etc.

To provide inspiration for the development of your own ecological sanitation courses, a range of samples of ecological sanitation syllabi and workshop contents and an awareness raising presentation are given in Chapter 7 of this publication.

Learning material from all sources shall be used in a joint effort to develop a comprehensive capacity building programme to support sustainable sanitation. This certainly will contribute to the task over the next 10 years to meet the Millennium Development Goals.

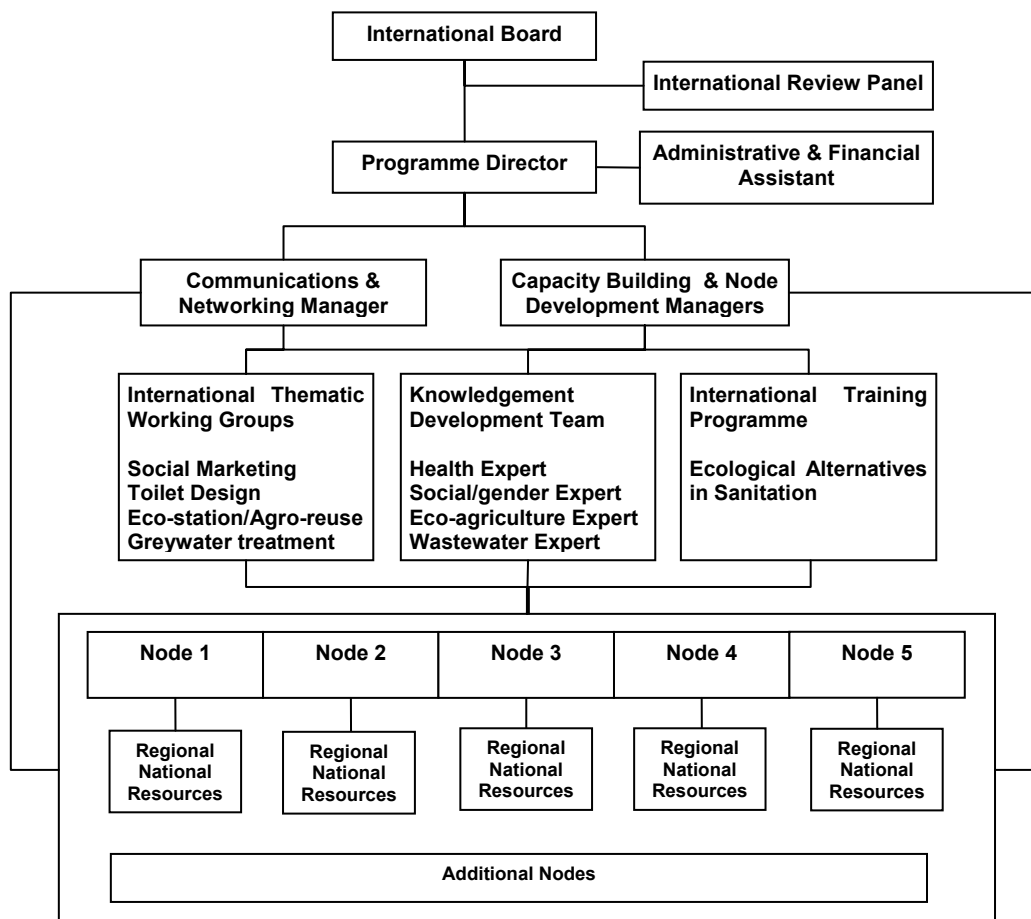

**Figure 15: The organisational structure of the “nodal concept for capacity building”, as suggested for the EcoSanRes Programme Projectphase 2. (EcoSanRes 2006)**

## **5 Knowledge management, research and development for sustainable sanitation: the need for a change**

Many successful, individual examples of ecological sanitation systems can be found in various countries. However there is still a great deal of research and development work needed before ecologically sustainable sanitation systems are broadly accepted and implemented internationally as state of the art solutions. Most of the systems installed to date have been in rural areas, whereas experience in urban and peri-urban areas remains limited. However, faced with rapid urbanisation world-wide there is a pressing need for practicable sanitation solutions in such densely populated areas.

If the Millennium Development Goals are to be reached, a dramatic acceleration in the rate of progress in sanitation coverage is necessary. If they are to be reached sustainably, knowledge management, research and further development of sustainable sanitation systems with a proven track record and a large potential for multiplication are urgently required. This can be best achieved through a combination of demonstration projects and action research, the development of field-tested standardised systems and the compilation of a broad knowledge base on innovative and sustainable sanitation solutions. Demonstration projects are also needed to illustrate how robust, sustainable ecological sanitation systems can be provided at a high enough rate to make the sanitation targets of the MDGs achievable.

The holistic approach needed for knowledge management, research and development for sustainable sanitation solutions should be multi-faceted. It needs to comprise not only traditional water supply and sanitation issues, but also other disciplines such as agriculture, town planning, public health, environmental protection, resources management, economics, marketing, and sustainability assessment. At the same time the development of sanitation systems should adopt a life-cycle approach. This should be applied to the material flows that enter the system and must subsequently be managed or reused, as well as to the infrastructure itself.

It will not be enough to simply change the topics being researched. The way in which sanitation research is carried will also have to change to an extent, making better use of “learning alliances”, and “action research”. The bridge between academia and practice, or formal and practical knowledge in sanitation also needs to be improved, taking behavioural and cultural aspects and the actual needs of the stakeholders into consideration.

### **5.1 Historical perspective on sanitation knowledge and experimentation**

Most old agricultural societies practised use of night-soil, and lived for centuries in closed loop systems, where the nutrients from liquid and solid household wastes were reused as fertiliser. Using this practice, China managed to keep the soil fertile for several millennia, despite having a relatively high population density. This knowledge however was not based on scientific research, but was rather culturally codified and traditional practical knowledge. In general, historical descriptions on this theme are sparse.

This practical knowledge has been used for water saving, greywater recycling and the reuse of nutrients from excreta. In Yemen, for instance, the separation of urine and excreta was common practice for many centuries resulting in a sanitation system, which required very little water, with the dried faeces eventually being burned. In modern times this traditional sanitation system has been changed with the introduction of water-flush toilets, which appeared to offer a more convenient and “modern” solution. However this has led to water shortages and a dramatically falling water table in the area of the Yemeni capital city of Sana’a, and to structural damages of the existing multi-storey clay-buildings (Winblad and Simpson-Hébert 2004). In Central Europe human excreta were commonly used together with animal manure in agriculture as a source of nutrients. In many places, including colonial America, fruit trees were planted when an outdoor latrine was moved, and the trees were fertilised by the excreta.

Over the last centuries however, traditional reuse practices have been abandoned, due to the reasons discussed below. Today however, in view of the degrading quality and fertility of our soils, the limited availability of mineral phosphorous reserves and the high energy demands to produce fertiliser, and the need to protect our freshwater reserves, the recognition of excreta and greywater as resources should again be reinforced and systematically implemented, using modern technological and operational solutions, and ensuring maximum health protection.

The practice of using the nutrients in excreta for agriculture was prevalent in Europe until the middle of the 19th Century, and the marketing of fertiliser derived from excreta and organic waste was a thriving small scale business. Farmers were eager to get these fertilisers to increase their yields and the value of human waste was clearly recognised.

In Paris for example, in 1850 urban agriculture was practised on 15% of the city's area and Paris was exporting vegetables, compost and fertiliser from pits to the surrounding regions (Illich 1987, Lange 2002). With the introduction of flush-toilets, the system was no longer able to manage the increased amount of liquid waste leading to overflowing pits and a rise in pollution of the inner cities, and exceeded the transport capacity of the traditional night soil management systems. In addition the dilution of human excreta with flush water decreased the nutrient concentration and thereby the market value of the wastes and the invention of artificial fertilisers finally introduced a cheaper alternative into the market.

All this led to the increased use of existing storm water drains to transport liquid waste out of the city. The concept of the water-borne sewer system quickly became the standard approach to solve the sanitation problems in urban areas of industrialised countries during the second half of the 19th century (van Zon 1986).

With the widespread introduction of flush-toilets and water-borne sewers however, pathogen laden black water entered rivers, lakes, and other surface waters. This pollution problem got worse with increasing population density and the number of inhabitants and industries connected to the sewer system. Consequently these sewage disposal systems had to be successively upgraded with additional sewage treatment plants, increasing investment and operation and maintenance costs.

Waste-water treatment technology has been further refined over the years, targeting different substances and using a variety of physical, biological, mechanical and chemical water treatment technologies. As knowledge of environmental science increased, the aim of these treatment steps has evolved from the simple removal of larger solids to the elimination of oxygen-consuming organic substances, and later the removal of nutrients. Today the need to degrade or remove micro-pollutants, such as hormones and medical residues, is being discussed as a further treatment step. It has taken about a generation to research, invent, develop, test, up-scale, and institutionalise each additional major waste water treatment step.

The refined treatment processes however, resulted in the production of larger quantities of sewage sludge, which again posed problems of handling and disposal. With the replacement of the traditional reuse oriented dry sanitation systems through sewer systems and wastewater treatment plants, the recycling of nutrients now was limited to the small insoluble fraction contained in the sewage sludge, whilst the soluble fraction was either discharged into the water bodies or degraded into volatile substances in energy intensive processes. Making the issue more complicated was the fact that sewage sludge from large centralised systems often were contaminated with toxic substances (e.g. from industries), and therefore had to be disposed of in landfills instead of being reused.

The abandoning of reuse oriented sanitation systems led to an increased use of mineral fertilisers to maintain soil fertility (although their long-term effects on the soil and on the quality of the food produced are still being debated). Where finances have been limited, for example in developing countries, soil quality and fertility has degraded dramatically, while the misuse of water bodies as a sink for human waste reduces their quality and causes severe hygienic and environmental problems. In addition the consumption of limited natural resources for the production of artificial fertilisers (especially phosphorous) led to a new debate on sustainable reuse oriented sanitation concepts.

After water-borne sanitation became the prevalent approach in the 20th century, the search for efficient reuse-oriented sanitation in industrialised nations basically came to a standstill until the 1970s,



when mainly Scandinavian research on ecological sanitation started with projects on composting toilets, urine separation and reuse (compare figure below). The widespread acceptance and promotion of water-borne systems can be mainly attributed to the following:

- The availability of cheap artificial fertiliser ensured there was no market for the products of human excreta
- Large centralised sewer systems and treatment plants were seen as the state of the art and as the unquestioned modern solution
- Environmental problems had been recognised, but were not perceived with the urgency they are recognised today. One reason is that the global population and urbanisation were less, and so were the resulting problems.
- Mineral fertilisers were seen as a panacea for soil fertility problems, with the problems that it can cause, (for example the depletion of micro nutrients and organic material from the soil or the contamination of phosphorous fertiliser cadmium and uranium) not being widely known
- The displacement of nutrients and organic material from the soil-sphere to the water bodies was not recognised as a problem
- The discussion on the limitation of natural resources (such as oil and phosphorus) and on the sustainability of our way of life only arose in the 1970s

In many ways development studies and the investigation of failures of the European models in the South have revitalised the interest in alternative solutions to the conventional sanitation approach. Sewered sanitation and centralised waste water treatment were regarded for several decades, and indeed still are by many people, as the most appropriate solution to solve sanitary problems world wide, with the main difficulty being how to finance the required investment. This was followed by the realisation that the implementation and operation of these systems was only possible in rich countries and in high income areas of developing countries, and still required huge subsidies by governments, and resulted in the poor being left to fend for themselves.

Today with greater population pressure and scarce water resources this human waste disposal system is no longer able to meet needs.

In recognition of these shortcomings, a movement towards developing and providing appropriate alternative sanitation began some decades ago. The movement was largely driven by the realisation that the health of unserved, unconnected populations was in dire need of improvement and that these improvements were unlikely to be come through conventional sewerage. It thus became a priority to:

- Identify appropriate simple, affordable decentralised dry and wet sanitation systems, such as VIP-latrines or pond systems and promote their adoption
- Implement appropriate technologies with the participation of the communities to be served, and
- Focus on health and hygiene education so that physical facilities would be properly used and maintained, and that hygienic behaviour would support the improvements brought about by the infrastructure.

Progress in the adoption of appropriate technology was initially slow as it required nothing less than a paradigm shift away from the traditional technology fix to one based on the participation of the intended beneficiaries assisted by multidisciplinary teams of professionals.

Over the years, it became clear, that this health and hygiene driven paradigm shift was incomplete: In practice faecal sludge management problems were often overlooked, as were negative downstream effects. Protection of the environment, resource conservation and waste reuse remained secondary concerns at best, or were neglected entirely, and operational problems reduced the health impact of these technologies.

For many practitioners and researchers this led to a revival of interest in the reuse of excreta and urine that had been ignored by mainstream research.

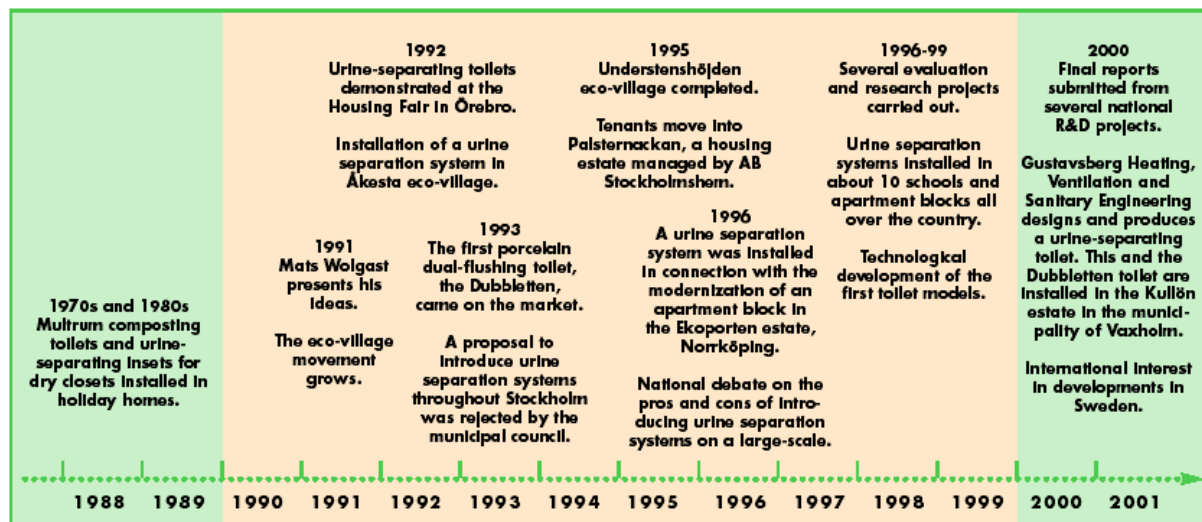

**Figure 16: Swedish research on urine separation and reuse in the end of the 20th century (Johansson et al. 2000)**

Figure 16 illustrates the increasing number of research and demonstration projects for excreta reuse carried out in Sweden from the 1980s to the early 21st century aimed at developing hygienically safe closed-loop sanitation systems. Similar lines of research began elsewhere, for example in North America (del Porto and Steinfeld 1999), in Africa (Morgan 2005), in the Netherlands (Zeeman and Lettinga 1999, Lettinga 1996), Norway (Jenssen et al. 2004) and Germany (Wilderer et al. 1997, Wilderer, Schroeder and Kopp 2004).

These closed-loop sanitation systems became popular under the name “ecosan”, “dewats”, “desar”, and other abbreviations. They placed their emphasis on the hygienisation of the contaminated flow streams, and shifted the concept from waste disposal to resource conservation and safe reuse.

In addition to paying great attention to the health aspects at the household level they also emphasised:

- The destruction of pathogens through flow stream separation, containment and specific treatment.
- Resource conservation through reducing the use of potable water as a transport medium for human waste and by using wastewater for irrigation
- The elimination or at least the reduction of wastewater discharge to the environment
- The need to close the resource loops through the productive use of the nutrients contained in excreta

The modern ecosan concept thus represents the culmination of the paradigm shift initiated in response to satisfying the health needs of unserved, mostly poor population groups. Ecosan adds resource conservation and waste reuse to improve both the economic conditions and the health of the population served. These two issues are linked, as health is a prerequisite for human productivity, and productivity determines economic well-being. The ecosan paradigm shift thus uniquely contributes to several objectives: the improvement in human health, poverty reduction in developing countries, the conservation of natural resources and sustainable water and sanitation management systems in both, industrialised and developing countries.

### Examples for early alternative sanitation initiatives

Historical research on the urbanisation of 19th century Europe sheds some light on the driving forces behind sewerage, water-borne sanitation, and end-of-pipe treatment systems in Europe. The historical research of Lange (2002) and some earlier work of van Zon (1986) are useful to help us understand the alternatives that have been discussed and tested, and to gain some preliminary insight as to why these were ultimately rejected or accepted on only a small scale.

Vacuum technology, currently used for sanitation systems in ships, aircraft and trains, as well as in hospitals where patients are exposed to radioactivity, was a major contender to become the sanitation system of choice in Europe in the 20th century. The advantage of vacuum systems is that they use very little water, so that the concentration of organic matter in black water is high enough to allow fermentation and bio-gas production. The low pipe diameter and water volumes also ensure more modest construction and maintenance costs.

Urine diversion and collection was common practice in many cultures and has a long history. For example in Roman times urinals were put up in alleys by laundry services who collected the urine and used it in washing clothes.

In the second half of the 19th century special urinals were developed for saving water, but also for extracting phosphates and nitrates, which were used as fertilisers or for the production as gunpowder and could be sold well until in the 20th century, when saltpetre (an alternative source for nitrates) was discovered in Chile.

#### Box 6: Urine separation and reuse technology in the 19th century

A patent for waterless urinals was given in 1885 to the Company BEETS from Vienna. In Vienna, as in several other cities, the water consumption of public urinals was too high to be provided with an adequate public supply (over 100 Litres per single urinal stand and hour). Beets' idea was a siphon in which a liquid lighter than urine (oil) formed a layer on top of the urine thus preventing its evaporation and stopping smells. The design of the siphon has since been further developed. In the last 40 years more than 200 000 waterless urinals have been sold, mainly in Switzerland, by the successor of the Beetz Company, which is the Company Ernst. (Lange 2002; Lange and Otterpohl 2000; GTZ-technical data sheets 2005)

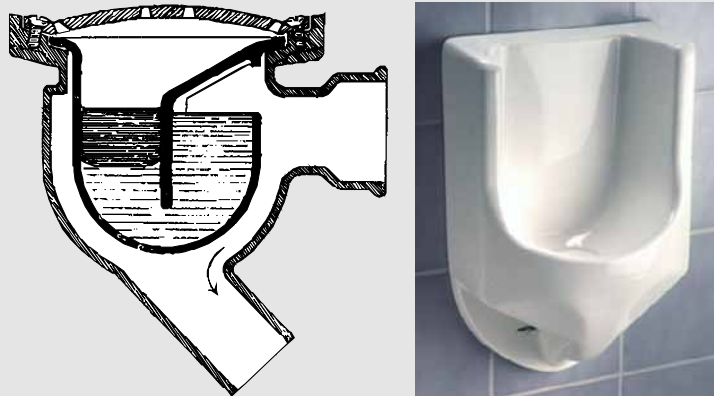

**Figure 17: Siphon for waterless urinals invented by Beets, 1885: Oil forms a layer on top of the urine and stops smells (left) (Lange 2002). Modern waterless urinal (right). (GTZ-technical data sheets 2005-01.B2).**

**Box 7 : Vacuum technology in the 19th century**

In 1865, Prince Heinrich der Niederlande had asked T. Charles Lienur to remove the sewage from Castle Luxembourg without polluting the River Elz and without using wagons. The introduction of sewer systems in the second half of the 19th century had provoked hefty discussions on their pros and cons, as treatment plants were not existent (the first German treatment plant was built in 1887 in Frankfurt-Niederrad) and they were resulting in an increasing pollution of surface water bodies.

The system developed by Lienur consisted of two pipes. One carried rainwater, greywater, and industrial water, while the other was what could be considered the ancestor of modern vacuum sanitation systems, and was used to transport blackwater and water from stables and slaughter houses. The vacuum toilets required very little water and the blackwater collected was used to produce “poudrette” (French for dried natural fertiliser from dung or compost).

At that time the industrial production of mineral fertiliser had not yet started (the first factories were built in 1870) and the price for fertiliser was high enough to allow the production and successful marketing of “poudrette”.

In developing areas of Amsterdam in 1906 more than 4 500 vacuum toilets were connected to a Lienur-system. Soon however the production of poudrette was seen as being too costly as prices for industrial mineral fertiliser decreased.

Although some information on Lienurs system is available, a thorough investigation of why the system could not compete with central sewer systems in urban areas, particularly under the specific and very difficult conditions in a city like Amsterdam, has not been carried out (Lange and Otterpohl 2000, Lange 2002).

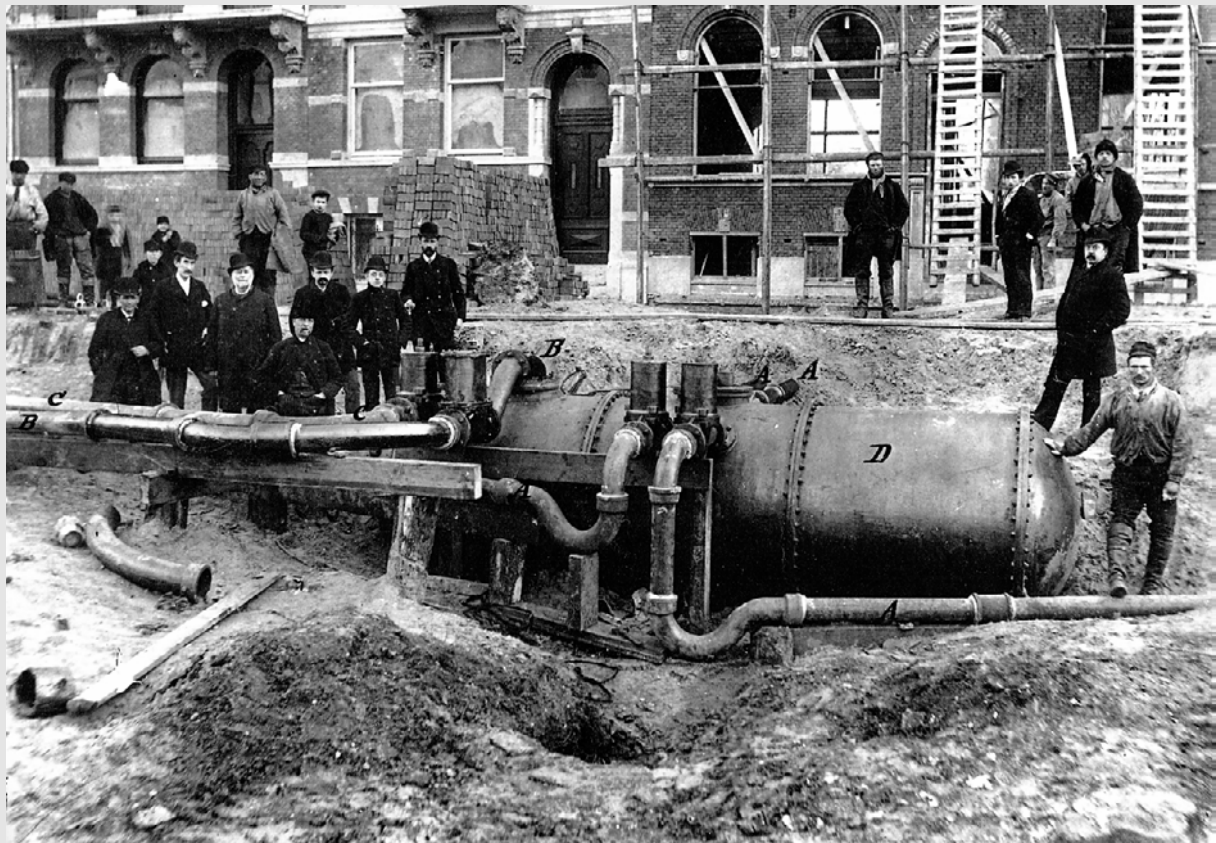

**Figure 18: In Amsterdam in 1906 more than 4.500 vacuum toilets were connected to a vacuum based Lienur-system (Lange 2002). (Foto Roediger)**

## Recent renewed designs

Today vacuum technology, waterless urinals and urine diverting toilets belong to the many technologies available as components of innovative eco-system oriented sanitation systems. Examples for vacuum based ecosan projects include the headquarters of the KfW-Bank in Frankfurt, Germany (comp Box 5 below), or the Building Initiative “Wohnen & Arbeiten”, Freiburg, Germany (Panesar and Lange 2004). Waterless urinals are becoming increasingly common in Europe and can be found in many public buildings today. In the new GTZ-Headquarters in Eschborn, near Frankfurt, Germany (comp Box 6 below) for example, waterless urinals are used together with urine diverting toilets for a urine separation and reuse demonstration and research project (GTZ –technical data sheets 2005).

### Project Box 5: Vacuum sewerage and greywater recycling at the KfW office building, Germany (GTZ-project data sheets 2005-001)

A recent extension of the headquarters of the KfW Bankengruppe, in Frankfurt, Germany, offers space for around 300 workplaces and has 13 apartments on its two top floors. In the building an innovative water and wastewater management system has been installed that includes vacuum technology and meets economic and ecological requirements.



**Figure 19: KfW office building “Ostarkade” (left); Vacuum toilet and pumping unit (right) (KfW)**

Office areas and apartments are equipped with vacuum toilets and vacuum urinals which are connected to the central vacuum pumping station in the basement by a vacuum pipe system. Blackwater from toilets and urinals is currently discharged to the communal sewerage system. However it is planned to include on-site anaerobic treatment of the blackwater in the next phase of the project.

Greywater from hand washing, cleaning and kitchens is collected in a separate gravity pipe system. It is treated using compact activate sludge reactors, membrane filtration and UV-light. The treatment guarantees pathogen free water for reuse. The treated greywater is used for toilet flushing and for cleaning.

The innovative sanitation concept is currently repeated in other extensions of the KfW office complex.



**Project Box 6: Urine separation and reuse at the GTZ-Headquarters in Germany (GTZ - project-data sheets 2005-016)**

During the renovation of the main GTZ office building in Eschborn, a modern, ecologically sustainable concept for the management of the wastewater from toilets is being installed. The main building will be equipped with waterless urinals and water flushed urine diversion (UD) toilets. Through the separate, undiluted collection of urine, the water demand for flushing toilets will be significantly reduced. With this concept, the GTZ not only saves 900 m<sup>3</sup> of water per year, but also the load of substances and nutrients from the urine on the water treatment facilities is reduced.



**Figure 20: The main building of the GTZ headquarters (left - tsp-HWP-Seidel); urine diversion toilet (middle - ROEDIGER) and waterless urinal (right; Keramag)**

After treatment the urine will be used in agricultural tests carried out as part of a research project. The information collected from the project will also help to improve agricultural production with fertiliser originating from urine. When finished, the system will serve as a model for similar facilities, also in countries where water is scarce and fertiliser is needed in local agriculture. As the building receives thousands of overseas visitors per year from developing countries, a large public relations impact is expected.

For the treatment and reuse of the brownwater originating from the UD-toilets an additional research component is foreseen. Treatment with an activated sludge reactor, followed by membrane filtration, is currently being discussed as one possible technological option.

## 5.2 Evaluating sustainability in sanitation systems

Overall sustainability has been largely overlooked in decision making processes and in planning and implementation of sanitation systems. Many systems have failed to provide sustainable services with regard to their social, economic and ecological impact, and in their operation. As a recent unofficial figure from the World Bank highlights, currently only 25% of all centralised wastewater treatment plants built in developing countries actually function correctly, as the sustainable operation of these cost intensive facilities is often not feasible. In terms of the social, economic and ecological sustainability and in protecting human health, these systems are failing in most cases.

Current legislation, norms, standards and decision-making procedures for choosing sanitation systems are determined by conventional thinking toward end-of-pipe solutions. They focus on the quality requirements of treatment plant effluent, which initially have been set for not polluting the receiving water bodies beyond their so called self-purification capacities. The decision-making is based largely on the net present value of investment, operation and maintenance cost of the system. However, if a sustainable operation of the system is to be achieved, a more holistic planning and decision making process is needed, geared towards finding sustainable systems. Sanitation decisions therefore need to be made on the basis of a much broader range of criteria than at present. They should include

social, ecological, technical, and economic and health aspects, and respond to long term sustainable resources management needs.

This is an urgent requirement given the current global sanitary crisis and the international commitment to address this, particularly the plan of action to reach the Millennium Development Goals. With this pressing need for action to meet the MDG sanitation target however, there is a huge risk that in developing countries the focus will fall simply on the provision of toilets and sewer connections, overlooking what is needed for a sanitation system and the related services to be sustainable from an overall perspective. That these conventional solutions usually are a subsidy for the rich, leaving the poor without service, was expressed by Sunita Narain, the director of the Indian Centre for Science and environment (CSE) (Narain 2004) (see Box 8).

There is therefore a need to integrate the more holistic considerations of sustainability into current decision making processes for sanitation, from the micro to the macro level.

**Box 8: Conventional sewerage leaves the poor unserved**

In her key-note speech at the international symposium on ecological sanitation “ecosan - closing the loop” in Luebeck 2003 Sunita Narain, the director of the Indian Centre for Science and environment (CSE) said:

“The political economy of sewers is extremely atrocious in poor developing countries. Hardly any poor city is able to recover its investments in sewer systems. As a result the users of these sewer systems get a subsidy. But almost all users in poor cities are the rich. Thus, sewers only lead to a subsidy for the rich to excrete in convenience. The poor always remain the ‘unserved’ in this waste disposal paradigm.” (Narain 2004)

One way of guiding decision making processes towards social, economic and ecological sustainability is to use sustainability oriented criteria when comparing and choosing sanitary systems. Such criteria should be used across the entire range of planning, implementation and operation levels – from the macro to the micro level. Developing and using a context-specific list of criteria to indicate the overall sustainability of a sanitation system therefore helps gearing the decision making process towards the issues relevant to the different stakeholders, and away from basic economic and techno-centric discussions. This allows more room for the implementation of innovative sanitation solutions that are tailored to the needs of the system users (Tischner and Schmidt-Bleek 1993).

The use of criteria in order to assess sustainability of sanitation systems has been suggested by several researchers. Larsen and Gujer (1997) underlined the need to focus on the functions the urban water management system should provide in order to be sustainable. Computer-based multi-criteria analysis tools to assess sanitation systems have been proposed by different actors, including the Swedish water and sanitation research group “Urban Water” (Urban Water 2004) and the Dutch researcher van der Vleuten-Balkema (2003).

However, despite this work, the use and usefulness of sustainability criteria in sanitation decision making remains largely unrecognised in real-life project planning and implementation. This may be due to the fact that much of this work has so far been mainly the domain of a relatively small circle of academics. The use of abstract theories and complex computer models may actually be serving to discourage practitioners from using sustainability criteria in their decision making processes.

In literature, many references to sustainable sanitation can be found without any accompanying definition of what this term might actually imply. To identify criteria that can be used to assess the sustainability of sanitary systems, a definition of sustainability with regard to sanitation is needed. However in order to do this, clear boundaries defining the limits of a sanitation system are a prerequisite

These should comprise from the cradle to the final destination all parts of the sanitation system, including: the users and other stakeholders demands and needs, collection, transport, treatment, reuse or final disposal of human excreta and domestic wastewater, organic household wastes, with option to include as well industrial wastewater, storm water, solid waste, animal manure or other agricultural wastes.

This broad definition explicitly recognises that sanitation is more than simply an element contained entirely within the water cycle. These boundary conditions also deliberately include the social aspect of sanitation, the economic and logistical side, and the idea of resource management, as well as any indirect impacts, costs or benefits of the system. Setting the boundaries of the sanitation system sets the basis for the comparison of entire systems, rather than simply comparing different technical elements of the system.

The list of criteria presented below is based on the understanding that a sanitation system that is sustainable, protects and promotes human health, does not contribute to environmental degradation or depletion of the resource base, is technically and institutionally appropriate, economically viable and socially acceptable.

The sustainability assessment of different sanitation systems is a holistic way of comparing systems with regard to their ecological, economic, organisational and societal impacts. This important method to compare conventional and ecosan systems constitutes a research field for itself.

### **Criteria for comparative sustainability assessment**

An example of a general list of sustainability criteria that could be of importance in the assessment of the sustainability of sanitation systems, can be seen in Table 6. This list was first presented by Bracken et al. (2005) and is based to a large extent on criteria/functions/indicators outlined in the literature (van der Vleuten-Balkema 2003; Hellström, Jeppsson and Kärman 2000; Larsen and Gujer 1997; Larsen and Lienert 2003; Lennartsson 2004, Urban Water 2004).

The criteria in the list are grouped into categories which are an expansion of the conventional triple bottom line usually accepted as the three pillars of sustainability – economy, society and the environment. This table contains five main categories; health, environment, economy, socio-culture, and the technical function. The protection of human health was and is the main aim of providing sanitation. To stress this fact, health has been taken as a category in itself and not as an element of environmental or social considerations. The technical function of the system was also considered an important criteria for sustainable operation, and this could not be satisfactorily addressed under the triple bottom line. The categories are described in more detail after the table.



**Table 6: Examples of general sustainability criteria for the evaluation of sanitation systems (modified from Bracken et al. 2005). The contents of this table is intended to assist planners, decision makers and other stakeholders to identify their own context specific sustainability indicators, and not to serve directly as a general checklist for sustainability.**

Criteria	Indicators
<b>Health</b>	
Exposure to pathogens and risk of infection related to all system elements including collection, treatment reuse and final destination of products / wastes	Risk assessment or qualitative
Risk of exposure to hazardous substances: heavy metals, medical residues, organic compounds	Risk assessment or qualitative
Health benefits due to improved hygiene, food production, nutrition status, livelihood	Risk assessment or qualitative
<b>Environmental</b>	
Use of natural resources, construction and O&M	
Land (investment, constr. and O&M)	m <sup>2</sup> /pe
Energy (constr. and O&M)	MJ/pe
Construction material (constr.)	Type and volume
Chemicals (constr. and O&M)	Type and volume
Fresh water (O&M)	
Discharge to water bodies	
BOD/COD	g/pe/yr
Impact on eutrophication	g/pe/yr of N and P
Hazardous substances: heavy metals, persistent organic compounds, antibiotics/medical residues, hormones	mg/pe/yr
Air emissions	
Contribution to global warming	kg of CO <sub>2</sub> equivalent/yr
Odour	Qualitative
Resources recovered	
Nutrients	% of incoming to the system
Energy	% of the consumption within the system
Organic material	% of incoming to the system
Water	% of incoming to the system
Quality of recycled product (released to soil)	
Hazardous substances: heavy metals, persistent organic compounds, antibiotics/medical residues, hormones	mg/unit
<b>Economic</b>	
Annual costs, including capital and maintenance costs	Cost/pe/yr
Ability to pay – user (% of available income)	Disposable income/pe
Environmental and health costs	Cost/pe/yr or qualitative
Benefits from reuse	Generated income/pe/yr
Local development, business and income-generation effects	Qualitative
<b>Socio-cultural (including user, institutional and policy aspects)</b>	

Criteria	Indicators
Acceptance by the users and willingness to contribute through work and or money for sanitation services (% of available income)	Reasonable % of time or income – defined by users
Convenience (comfort, personal security, smell, noise, attractiveness, adaptability to different age, gender, and income groups)	Qualitative
Current legal acceptability and institutional compatibility	Qualitative
Appropriateness to current local cultural context (acceptable to use and maintain)	Qualitative
System perception (complexity, compatibility, observability – including aspects of reuse)	Qualitative
Ability to address awareness and information needs	Qualitative
<b>Technical</b>	
System robustness: risk of failure, effect of failure, structural stability,	Qualitative
Robustness against extreme conditions	Qualitative
Robustness of use of system: shock loads, abuse of system	Qualitative
Possibility to use local competence for construction and O&M	Qualitative
Ease of system monitoring	Qualitative
Durability / Lifetime	Qualitative
Complexity of construction and O&M	Qualitative
Compatibility with existing systems	Qualitative
Flexibility / adaptability (to user needs and existing environmental conditions – high groundwater level, geology etc.)	Qualitative

### Health

The entire sanitary system should minimise risks and safeguard public health. This covers the use of the sanitary installation, collection, transport, treatment and destination of the treated products. For instance, the risk of being infected through ground water or surface waters, contaminated from leaking sewers, pit toilets, or wastewater disposal should also be considered, as well as the risk of being infected when consuming vegetables from fields irrigated with insufficiently treated wastewater and bathing in lakes or the sea near overflows or waste water treatment plant outlets.

### Environment

In many industrialised countries sanitation systems have been further developed to protect the environment against possible detrimental effects of the discharge. When considering the environmental sustainability both emissions to different recipients (water, soil, and air), as well as resource use by different sanitation systems during the construction and operation phase must be accounted for. Moreover it is important to consider the suitability of the treated product for possible reuse in agriculture or aquaculture.

### Economy

The ability to pay for sanitation is clearly a decisive factor in choosing the system. Among the users, the ability to pay is an important criterion for sustainability. However in the end it may be their willingness to pay that will define within what range the costs (both for construction and O&M) can vary and services be sustained financially by the population. Some experts argue that the other criteria may eventually be reducible to purely economic considerations. Considerations such as the impact on local development (e.g. local private sector), health benefits etc. might be expressible in monetary terms. However, this reduction of criteria to their estimated economic value is probably not sufficient to allow a thorough consideration of all of the aspects.

### Socio-culture

Clearly the objectives of sanitation are to protect human health and the environment, however, sustainability in sanitation cannot be based only on these objectives. There is an obvious need to

include social criteria as they are crucial to the sustainability of the use and the services provided by the system. It is possible to distinguish at least three very different types of important criteria within this category, namely cultural acceptance, institutional requirements, and perceptions of sanitation. Society is more dynamic and flexible than criteria such as human health and the environment and therefore the socio-cultural criteria are subject to a more dynamic change with time than human health and the environmental criteria. How the system is perceived, legislated for and accepted is therefore changeable with time. Although improving human health and protecting the environment are the main objectives for planners and politicians, this might not be enough to sell the sanitation concept to future users. It is also important to recognize that the prime driver for sanitation might be security and status rather than health and environment as recent studies have shown (Holden 2003, Kgomotso et al. 2004). Another sanitation driver could be the possibility of increased food security if the sanitation solution can provide hygienically safe fertilisers.

### **Technical function**

The technical reliability and performance of the system is key to its success and ultimately its sustainability. One of the more important sub-criteria under this category is probably robustness and flexibility, both within the system (to be able to receive varying loads) and externally (to be able to withstand varying extreme environmental conditions as well as user abuse). The technical functioning of the system is seen as perhaps the most flexible group of criteria. In this regard, it is important to adapt technologies to the needs of the situation rather than trying to make a situation comply with the demands of a favoured technology. It is also much easier to adapt a technology to what people need than to adapt people to what a technology requires.

The list of criteria presented here is intended to provide inspiration when trying to identify context specific sustainability criteria. The requirements of sustainability are dictated by context, and can change with time. This list should serve to inspire sanitation planners on all levels to include the concept of sustainability criteria in their planning processes, and to actually define, in a participatory manner with the relevant stakeholders, what criteria their planned sanitation system should fulfil in order to optimise sustainability in the given context. The list presented here should provide certain "core" considerations of sustainability, which should be considered as a minimum in any basic list to assess a sanitation system.

One way in which the criteria may be used would be as the focal point of a multiple criteria decision making process. There is a broad range of techniques which can be employed for this. This does not need to be an extremely complicated process and methods are available that could facilitate this when working with grass roots level groups. In such cases it is often considered appropriate to allot agreed weights to the criteria identified, relative to their importance to the stakeholders, and to use these weighted versions when deciding. Each stakeholder group may have criteria which are of particular importance to them, and different criteria may be of greater relevance at different times in the decision making process.

## **5.3 Development and field testing of sustainable sanitation systems in the urban context**

### **5.3.1 The need for large series of pilot research and demonstration projects**

The highest research priority for sustainable sanitation is to gain experience of implementing innovative, sustainable sanitation systems on small, medium and large scales, in industrialised and developing countries and in countries in transition.

A large series of research and demonstration projects are therefore needed which can serve to further develop and field-test a broad variety of technical and operational sanitation systems in a range of climatic, social, cultural, economic and geo-morphological conditions. In short: pilot systems are needed to develop a series of model solutions to cover the entire range of sanitation needs.

The research needs cover all the following key aspects for the sustainable operation of a sanitation system:

- technical and performance issues
- environmental and health aspects
- financial and economic aspects
- institutional and organisational aspects
- socio-cultural aspects
- policy and legal aspects

Research needs to seriously address:

- technologies for the collection, treatment, storage, transport and use of excreta and greywater
- logistical and operational concepts
- capacity building issues for decision makers, planners, technicians, users and other stakeholders
- development of local service providers to plan, install, operate and maintain the systems and to market the products
- identification of different reuse options
- market analysis for the complete range of products that the system can be recovered
- development of planning, capacity building and management tools
- development and field testing of different financial instruments and models
- assessments of health and environmental impacts
- full cost-benefit analyses of all types of sanitary systems

A great challenge for ecosan research and development is the introduction of reuse systems in urban areas, where the production of excreta or greywater, their treatment and their reuse can rarely occur in the same location and cannot be carried out by the same person. In introducing ecological sanitation in urban areas, it is therefore necessary that research does not only concentrate on purely technical “hardware” issues. Logistical and institutional issues must also be given a high research priority to encourage the development of more sophisticated logistical arrangements by service providers for the collection, transport, and treatment of excreta. Even more critical is economic and health research in the marketing of these products, leading to an increase in their potential for agricultural use, and social acceptance in cultures where the use of treated excreta is not currently considered appropriate for the food chain.

Technical research is of course also needed. System components that have proven successful on a small scale (for example vacuum sewers) need to be up-scaled and new technical components are needed to ensure that eco-sanitation services can be provided in a variety of demographic and geographic settings.

**Project Box 7: China-Sweden project of Erdos eco-town in China (Rosemarin et al. 2004)**

Erdos is a cluster of cities in a coal mining belt of Inner Mongolia, where a new eco-town is being developed in a suburban area a few kilometres from the city centre of Dong Sheng.

New houses for 7.000 peoples in the eco-town are being equipped with modern porcelain urine-diverting dry toilets. Toilets and related equipment and fixtures are being developed and manufactured in China.

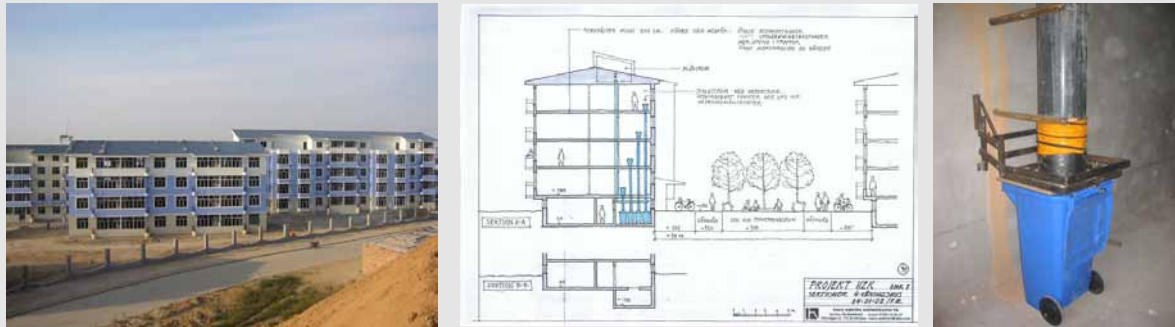

**Figure 21: Front view of the apartment buildings (left); straight drop urine diversion toilet design (middle); collection of faeces in cellar containers (right). (EcoSanRes)**

Faecal material will be collected in dry form in cellar containers, which will be regularly emptied. The faeces will then be composted together with household organic wastes and used as a soil conditioner. Urine will be collected on site in tanks and used in local agriculture.

Greywater will be collected and treated on site in small aeration and filtration treatment facilities. Organic and other solid wastes will be sorted and collected in eco-stations. Storm water will be collected separately using drains.

The project will undergo a period of development and testing prior to its full-scale implementation. Once in operation the model town will be the object of further performance studies by water and sanitation specialists, urban planners, urban agriculturalists and others.

**Urine**

Research into the technical and logistical aspect of urine separation in an urban context and the associated management of transport services to return the nutrients to agriculture have been carried out in Sweden. One result of this research was that for a given context, the transport of urine was economically and ecologically sustainable for distances of up to 120 km (Johansson et al. 2000). The institutional and commercial basis for doing this, however, remains largely unexplored, and represents an important challenge.

**Rainwater**

There are many successful examples for the integration of rainwater management in urban planning, with significant implications for domestic water use, or ground water recharge. Zero run-off concepts and rainwater-collection can make an important contribution to water supply, the replenishment of falling groundwater levels, flood protection and the reduction of costs for storm-water sewers. Green roofs, ponds, and infiltration ditches have a positive impact on the local climate, reduce run-off, and their integration into urban environments can contribute to improving the quality of life for the population. These examples illustrate clearly that rainwater management must be an integral element of urban water and sanitation management systems.

**Greywater**

The technical and social base for the reuse oriented management of greywater appears to be even more favourable since it can easily be treated and then reused to a large extent near the point of generation, within the same house or housing complex for toilet flushing, irrigation, or groundwater recharge. The municipality of Hamburg is promoting grey water reuse in a pilot programme with the argument that it reduces the consumption of high quality drinking water, and that the innovative treatment system may prove to be a technology ideal for export (comp. Box below).

**Box 9: Grey becomes clear: Hamburg, Germany, promotes greywater recycling**

"Greywater" is water from showers, wash basins and bathtubs. The most modern recycling technology for this wastewater is smaller than a wardrobe. The treatment and reuse of this water can reduce consumption by approximately 30% and the treated water is of a high enough quality to be used for swimming, bathing, flushing toilets, watering gardens and for washing clothes.

The municipality of Hamburg now provides subsidises of 1 500 Euro per treatment plant, and can subsidise up to 30 plants. "We are doing this for two reasons: (1) Drinking water in Hamburg is of excellent quality and too precious to use as a transport medium for excreta, and (2) Greywater recycling is an innovative approach which could become an important export technology, for example for water scarce regions in the south." said Dr. Herlinde Gundelach, a member of the Hamburg state parliament during a presentation of this new environmental programme – the first one of its kind in Germany. (Stadt Hamburg 2004)

**Faeces and blackwater**

Large scale experience in the use of urine diverting toilets and the anaerobic digestion of black-water (most usually combined with pig slurry) has been gained in China. In rural and peri-urban of China around 700.000 urine diverting dehydration toilets were installed between 1997 and 2004, and over 10 million of the biogas generating 4-in-1- and 3-in-1- models have been installed (Zhou et al. 2004). These systems have been designed to recover and use the materials at or very close to the point where they have been generated (in agriculture or gardening), and whilst highlighting clearly that ecosan systems can provide sanitation to large numbers of people, they have not provided a great deal of experience with regard to the development of the logistics and infrastructure necessary when ecosan is applied in areas where the materials cannot be directly used.

In the development of this infrastructure efforts should be made to ensure that they enable material flow cycles to be closed on the minimum practical level (i.e. that use can occur close to the point of generation), thus ensuring that transport requirements are minimised, and that any possible export of problems associated with the use of treated excreta and greywater is avoided. This clearly requires urban planners to be involved in the development of the system, and to avail of practical knowledge to enable them to plan appropriately.(e.g. in order to provide space for the integration of a constructed wetland in an urban park, to support urban agriculture or to provide small scale service providers with an area for the treatment and storage of ecosan products in neighbourhoods). In contrast to infrastructure development for conventional, centralised sanitation systems, the required infrastructure for ecosan systems may include the possibility of using smaller planning units and of a greater number of decentralised systems.

The installation of such service structures, and of creating appropriate financing mechanisms to ensure their sustainability, is crucial for the introduction of ecological sanitation in urban areas. This clearly still requires a good degree of research and development to optimise new technical and management solutions.

Research needs to particularly focus on decentralised solutions and systems as integral parts of larger sanitation systems. These systems may consist of combinations of different technologies with services for the transport, storage, distribution, marketing, and safe and sustainable use of the produced materials. Large scale pilot projects are therefore urgently needed, allowing applied research on their performance under different circumstances.

### 5.3.2 The transition from conventional to closed-loop sanitation systems

The introduction of closed loop concepts in central systems will most probably begin in small pockets, for example in new development areas, where the sanitary system can be designed from scratch and implemented comparatively easily using material flow cycle principles. Such systems provide alternative solutions, which can quickly be used for the sanitation solutions in fast growing cities in developing countries. However, in industrialised nations, where vast sums of money have been invested in centralised water-borne-systems over many years, the transition to closed loop systems will be a much more demanding task. Nevertheless this transition is equally required, probably best being realised during the renovation of the existing infrastructure. For both the installation of new, and the upgrading of existing infrastructure, a step-wise approach will most often offer the best solution. In a first step a series of generic pilot projects can be implemented in a range of typical urban and / or rural settings. These should be both tested in, and adapted to local conditions. In a second step this experience can be repeated and scaled up to eventually cover the whole settled area.

So far very little experience of the transition from end-of-pipe towards closed loop approaches is available. In Europe massive investments have been made in centralised sewers and waste water treatment plants, and a move away from these end-of-pipe systems will prove extremely difficult, as sewers are designed and built to last for several decades. Here, transition towards ecosan solutions will be a slow process, requiring perhaps several generations.

However, in countries where these investments have not yet been made, there is the possibility to avoid the mistakes of the end-of-pipe approach. It will therefore be essential to make any investment decision here on the basis of sustainability, using suitable, context relevant criteria in selecting a sanitation system.

The step-wise transformation of an existing end-of-pipe system will have to take into account the existing structures and making best use of what is available. An example for this approach with a vision for closing the nutrient cycle in an existing central system was developed and described by the Novaquatis –research project, carried out at EAWAG, Zurich, Switzerland (Larsen and Gujer 1996). One of the concepts developed here was to separately collect urine from individual households, and to conveying it to a central collection point using the central system at a specific schedule at night, on dry days, when the system is usually not being used by anybody else.

In the framework of the AKWA 2100 research project, Hiesl and co-workers (2003) developed a series of scenarios for future central, semi-central and decentralised sanitation solutions in an urban context, analysing them both from an economic and a sustainability perspective. In a follow up to this research project it is planned to outline how the transition from the existing situation to the desired future situation can be addressed.

#### **Box 10: Urban ecosan pilot project for 100 new urban houses in southern Germany**

In the construction of around 100 new residential buildings in Römerhof, near Knittlingen, southern Germany, a unique form of community water management will be implemented. Advanced technologies will be used, ensuring a sustainable and affordable operation of the entire water infrastructure, supported with 2 Million Euro from the German Federal Ministry for Education and Research.

The project, led by the Stuttgart Fraunhofer Institute for Interfacial Engineering and Biotechnology (IGB), plans to recycle rainwater and nutrients from household wastewater. The black water will be collected by vacuum sewer and transported to a central biological treatment reactor with integrated membrane technology. In this process organic material will be fermented, producing methane, and phosphorus and nitrogen salts will be converted into agricultural fertiliser. The bio-gas generated will be used to provide the plant with electricity and heat, with surplus electricity being fed into the national grid. The treatment technique is designed to produce minimal volumes of sludge and after treatment the water can simply be infiltrated into the ground.

(IGB 2004)

## **5.4 Research and development of tools and instruments for sustainable sanitation**

As a complex, holistic, and innovative approach, involving disciplines from engineering to public health, and the social sciences, research fields for eco-sanitation are extremely broad and this publication can only try to highlight some of the more pertinent areas where research is needed. Identifying knowledge gaps and posing the appropriate questions to fill them will remain a major task for interdisciplinary research teams in the future.

Research and development is needed within, between and across many different disciplines, addressing topics such as the fertiliser value of the recycled nutrients or the degradation rates of micro pollutants, as well as practice oriented tools and instruments for planning, implementation and operation of reuse-oriented sustainable sanitation systems and marketing strategies for ecosan products.

Some specific areas where there is a need for additional research and development of tools, or instruments related to sanitation planning, implementation and operation are discussed below.

### **5.4.1 Financial and economic feasibility of sustainable sanitation**

One of the difficulties in considering economic aspects in decision making for ecological sanitation systems is that very few economic studies have been carried out so far. The information available is mostly anecdotal or gathered from pilot or demonstration projects, which are notoriously unreliable for cost analysis related to economy of scale (Anschütz, Ijgosse, and Scheinberg 2004). Pilot and demonstration projects generally have unusual expenses, such as those for technology introduction, limited, small scale production of system elements, or initial awareness raising activities. Most existing studies also tend to consider only a particular aspect of the system rather than adopting a holistic analysis. However, first results indicate that; even within studies which have only considered investment, reinvestment and operation and maintenance costs, closed-loop systems have an economic advantage over more conventional systems (see comparative investigation examples in the Boxes 11 and 12 below).

In order to make a fair comparison between the full investment, operation and maintenance costs, there is a need for a comprehensive, dynamic, integrated, cost/benefit or multi-criteria analyses of different types of systems to be performed over life cycles or planning periods.

This will establish the investment, operation and maintenance cost, as well as additional benefits such as improved public health, the fertiliser value of recovered material, the value of improved agricultural production, the energy generated, etc., that are all a result of using the system.

A difficulty with traditional economic appraisals for sanitation is that the setting of the boundaries of the system often leads to many important external costs, or even benefits of the system being overlooked completely. An example of how far these externalities actually reach can be seen by taking a brief look at externalities in relation to centralised wastewater treatment and an ecosan system.

Conventional water-borne sanitation relies on disposing treated wastewater to a surface water body. In addition to the investment, reinvestment and operation and maintenance costs of the sewer network and plant, and the expected health benefits, the environmental externalities arising in the receiving water must be considered, as should the social loss of a recreational area, the possible effect on subsequent drinking water treatment, the loss of natural habitats and effects on coastal areas, the effect of medical residues (hormones, antibiotics etc.) which pass through the treatment works virtually intact, the eventual rehabilitation costs, the impoverishment of soils as a result of nutrient loss, and the costs of using high quality drinking water to flush the system. Each one of these external costs in turn may incur further costs.



### Project Box 8: Sanitation for a rural school in Uganda (EcoSan Club, [www.ecosan.at](http://www.ecosan.at))

Kalungu Girls Secondary School, an all girl boarding school with about 350 pupils is nestled in the hilly landscape of Southern Uganda (in Masaka District). A typical problem of this region is that although water is plentiful, water quality is poor. Problems with the water quality led the school administration to ask for support to improve the situation. Due to the shallow ground water level and the location of the soak pits and pit latrines directly upstream of the schools and the nearby villages' water sources the situation was clearly unsatisfactory and potentially dangerous. Additionally the pit latrines were smelled badly and were unhygienic. There was no further wastewater treatment.

The project was implemented in 2003 with 45 dry urine diversion toilets being built for the pupils (mainly outdoor but additionally 2 indoor dry toilets for each dormitory to avoid the pupils having to go out during the night), with treated urine and faces being used in the schools agricultural activities. Additionally a constructed wetland was installed for the biological treatment of greywater, and a dry toilet demonstration unit for teachers and visitors (with a urinal) was constructed.

A special focus was put on training the students, teachers and the O&M personal, to ensure that the newly constructed toilets would not end up in the same state as the old latrines. A main concern was the involvement of the teaching personal, especially the ones responsible for health issues. The design of the demonstration unit was carried out in a participatory way: the details of the unit were developed together with the teachers to create a feeling of ownership and responsibility. The contractor who installed the system was responsible for the education of the students and O&M personal, with a special focus on involving the local technicians from the beginning of the planning/construction process.



**Figure 22: Training of students (left); dry toilets with wooden containers for collecting the separated faecal material (middle - view from the back) and demonstration toilet (right). (EcoSan Club)**

The toilets are a great success and delegations from all over the country and from abroad come to visit the school toilets. The pupils and the teachers are proud of their well working toilets which are kept clean and well maintained. Since this was such a successful project, visits or families are picking the idea and requests are increasing.

For ecosan systems these external costs may include the necessary transformation costs to adapt the existing sanitary infrastructure, additional awareness raising activities, and the need for continued research and development of different parts of the system.

In contrast to conventional systems, however, ecosan systems offer significant external benefits, which ordinary appraisal tools also fail to capture. These include securing the drinking water supply, through the use of treated greywater and by reducing the discharge of effluent to potential drinking water sources; the improvement of soil structure and fertility; increased access to fertilising agents and phosphates, particularly for poor and for subsistence farmers; reduced energy consumption in the treatment works, and during fertiliser production; nutrient and resource conservation; and the potential for energy production. In order to account for all these externalities the boundaries for evaluating sanitary systems are significantly expanded, and the tools for appraisal need to be expanded accordingly.

**Box 11: Examples of cost comparisons - Uganda**

**School Sanitation in Uganda**

In Kalungu Girls Secondary School in Uganda poor sanitation facilities was putting groundwater at risk. This served as the main source of potable water. From February to December 2003, a project was implemented to renew and improve both water supply and sanitation facilities. Additionally a training programme aimed on ensuring an understanding and proper use of the facilities installed.

Prior to deciding on the sanitation scheme to be installed a detailed comparison of costs was conducted and served as one instrument among others in the decision making progress. Two alternative sanitary solutions were compared:

Option 1: Source separation concept: dry urine diversion toilets, sewer line for greywater and a horizontal subsurface flow constructed wetland.

Option 2: Conventional concept: flush toilets for the students, separate sewer system for black water, mechanical pre-treatment, pumping station and a vertical subsurface flow constructed wetland. (EcoSanClub 2004)

The comparison considered investment and reinvestment and operating costs. The calculation was carried out over a 50 year time frame, with reinvestments depending on individual system parts and an interest rate of 8% p.a.(EcoSanClub 2004).

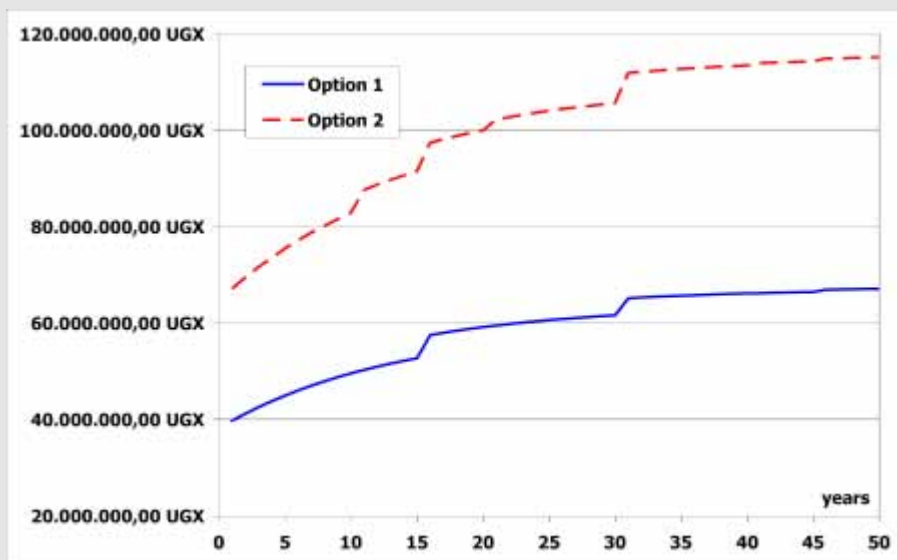

**Figure 23: Cost comparison for the installation, operation and maintenance of the two systems for the school (EcoSanClub 2004)**

Research is therefore needed to identify and test methods and approaches that can be used in economic analyses to ensure that its boundaries are set wide enough to account for all the expected positive and negative effects of a sanitation system.

The cost comparison in the example from Uganda clearly shows that the safe use option is significantly less expensive. The main difference results from the significantly smaller wastewater treatment system for this option and the pumping station additionally required for the conventional option (EcoSanClub 2004).

**Box 12: Examples of cost comparisons – Berlin Brandenburg**

**New housing estate in Berlin Brandenburg Germany**

In Brandenburg near Berlin, Germany, cost comparisons have been made for three different sanitation concepts for a planned new housing estate, where the population is expected to increase from 672 to 5,000 inhabitants within 10 years. The three systems were:

**Gravity sewer system (conventional):** Flush toilets, normal gravity sewer system, pumping station with transport sewer to the existing sewer network, system operated by the public supplier.

**Source separation concept I (gravity, composting of faeces):** Gravity separation toilets, collection and storage of urine, transport and agricultural use on a nearby farm, faeces transported in gravity sewer with aerobic treatment in a compost separator, utilisation of compost in horticulture, transport of greywater in gravity sewer system, treatment in a constructed wetland, transport to the receiving water.

**Source separation concept II (vacuum, digestion of faeces):** Vacuum separation toilets, gravity urine transport, storage of the urine transport and agricultural use on a nearby farm, faeces transported by vacuum sewerage, common treatment with organic waste in a biogas plant, biogas used to produce energy, transport of the digested sludge to the farmer nearby and utilisation in the agriculture, transport of greywater in gravity sewer system, treatment in a constructed wetland, transport to the receiving water.

The three systems were calculated over a lifetime of 50 years, with an annual interest rate of 3.5% p.a. . The results of this cost comparison can be clearly seen in figure 1, for the situation where 5000 inhabitants are served and the local Berlin water company are responsible for the operation of the system. Other service scenarios have been calculated with different population numbers and operational models which also revealed a significant price advantage for the closed-loop systems over the system lifetime. (Peter-Fröhlich et al. 2004).

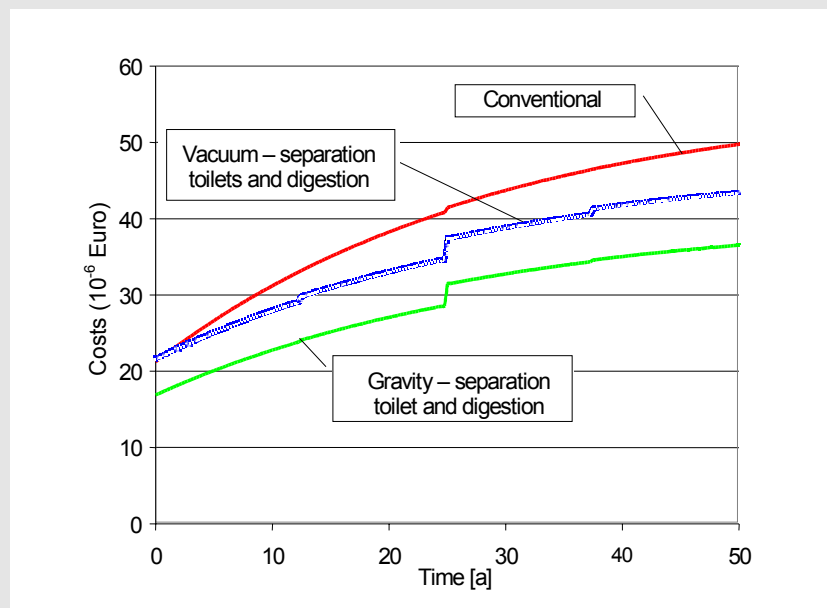

**Figure 24: Cost comparison for the installation, operation and maintenance of the three systems for a population of 5000 (Peter-Fröhlich et al. 2003)**

Excreta and greywater use projects strongly influence the individual as well as the national economic well-being, since proper management and treatment of excreta and greywater reduces health risks and associated costs for medical care. On the individual (household) level the time gained through reduced illness can be used for education or income generating activities. On the national level monetary and professional resources are relieved from cases of faeco-oral diseases and can be concentrated in other areas. Some of the tools needed to measure these effects are available and

transferable from related disciplines, but require a certain degree of adaptation to sanitation system planning, whilst others need to be developed.

Economic appraisals should also recognise that the real cost or value of an item to a country's economy is not always the same as the price paid for it. For example, foreign exchange may be more valuable than the formal, controlled exchange rate would suggest. On the other hand, the labour of workers who would otherwise be unemployed costs less to the economy than their wages, since no production is lost elsewhere by offering them a job. Economists use a "shadow price" to approximate the "real" value of an item to the national economy. Thus the shadow price of foreign exchange is usually higher, and that of unskilled labour lower, than the rate actually paid for it.

The proper use of shadow prices in this context may also be a relevant research subject. It is thought that reuse oriented systems will perform better than conventional systems when shadow prices are considered for at least two reasons:

- The construction of the system such schemes can most often be carried out using locally available skills, and tradesmen, and using locally available material and thus requires less imported equipment than other processes; at shadow prices, it is more likely to be cheaper.
- The prices of many of the products grown for local consumption are often held below the world market price (if one exists). Whether they are grown for export or for import substitution, a shadow price for foreign exchange will show their true value to the economy.

This however needs research and verification.

### **Financing mechanisms**

Research has a large role to play in developing appropriate financing instruments, putting particular emphasis on the possibility to finance the users' investment for on-site and neighbourhood systems, and recognising that systems to recover and use excreta and greywater have a different cost structure from conventional sanitation systems. This can result in the total costs of the system being less than that of end-of-pipe systems, but the costs that the private households themselves have to pay can increase (see below). Innovative financing alternatives including start-up funds, community based finance programmes, micro-credit programmes and cost recovery mechanisms may therefore be required.

In researching financing mechanisms, allowances should be made not only for the investment, reinvestment, and operation and maintenance of the system but also for the opportunity and environmental costs as well as the systems external impacts on individuals and communities (Cardone and Fonseca 2003). Allowances should also be made for the financing of institutional capacity building and skills training, monitoring and assessment, and policy and the development of an enabling environment for sanitation. The latter includes awareness raising campaigns, hygiene promotion etc. Most of these activities are of a public nature with both the broader community and the individual households benefiting. Financing for sanitation however mainly comes from two sources: the individual or household, and an external source such as government (Evans 2001). Trying to mobilise individual household financial resources for activities targeted to the broader community has however proven difficult. This raises one of the main challenges in developing financing mechanisms for sanitation: How can the needs, interests and finances of individuals and households be effectively co-ordinated and reconciled with those at the community / national level? Ideally this should be achieved in a way to recover costs, but also to ensure equitable access to sanitation, particularly to poorer members of society. This represents quite a challenge to researchers.

Sanitation systems that recover and use excreta and greywater, generally have a different cost structure than conventional systems. This needs to be recognised and practice oriented research should focus on developing appropriate financing mechanisms to support private households in their decision to install them. As shown in Figure 25, the total costs to install such systems tends to be lower than some other for more conventional sanitation systems. This is mainly due to the decentralised, modular nature of source separating systems, which do not require large sanitary infrastructure, such as centralised treatment works, sewerage, or pump stations. In comparison to traditional decentralised sanitation (such as pit latrines or VIPs), they normally provide permanent solutions, and thus do not have to be replaced when full, representing a significant saving over time.

However, although the overall costs are less, those to be covered by the private household may very well increase be higher as a result of having to replace or transform domestic sanitary facilities (for example by installing a urine diversion toilet).

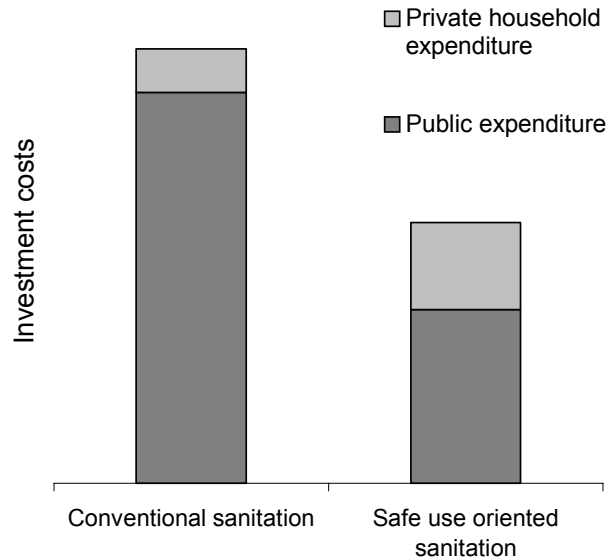

**Figure 25: The cost structures of conventional and safe use oriented sanitation systems (GTZ)**

Research also needs to examine the possibilities of integrating the local private sector into sanitation provision. The introduction of innovative systems to the market have to be field tested and evaluated.

Further research and demonstration projects are needed in order to develop a variety of viable solutions for densely populated urban areas and obtain results concerning the costs and performances of different systems in both industrialised and developing nations. Generally, for cost and ease of management reasons, a commonly accepted solution must be found based on a participatory planning approach as it is suggested e.g. in the Household-centred Environmental Sanitation approach (Eawag 2005) and taking into account the specific local socio-economic conditions.

Recent international research on the relation between poverty and sanitation indicates that investments in sanitation have a huge positive impact on the national economy, with relatively high cost-benefit ratios, averaging 5.5 for all targeted regions (SEI 2005). The fact that money put into sanitation provides a huge return on investment has also been stressed recently in the joint monitoring report from the WHO / UNICEF MDG Joint Monitoring Programme, where they point out that “access to safe drinking water and basic sanitation will bring dividend many times larger than the investment required.” (WHO/UNICEF JMP 2005)

Meeting the sanitation Millennium Development Goal (MDG) target (halving the proportion of the world’s population in 1990 lacking basic sanitation services by the year 2015) is estimated to cost between US\$ 9 billion (Evans 2001) and US\$ 15 billion (SEI 2005), but the payback would be an injection of between an extra US\$ 65 billion (Evans 2005) and US\$ 84 billion (EUR 69.4 billion - WHO/UNICEF JMP (2005)) per year into developing economies – money saved by averted deaths, lower health care costs and productivity gains. Improved water supplies and basic toilets generate returns ranging from 3 to 34 times the original investment, depending on the type of investment and the country, the report says (WHO/UNICEF JMP 2005).

For closed loop sanitation systems the return on investment is expected to be even higher. A recent debate in the magazine of the International Water Magazine, WATER21, on the economics of urine

diverting double vault dehydration toilets with reuse highlighted that such systems not only cover the extra costs that may occur, but that the total investment for the system could be amortised over a ten year period. (Jönsson et al. 2005 ; as part of the discussion on ecosan in Water21 in 2005, see also: McCann 2005, Mara 2005a, Ashworth 2005, Otterpohl 2005 and Mara 2005b)

Further cost comparisons between conventional and eco-sanitation systems have been made and are presented in the table below.

**Table 7: Sanitation cost ladder for conventional and ecological sanitation methods (including initial capital cost and O&M for the first year of operation) (SEI 2005)**

<b>Conventional Sanitation</b> (sourced from UN Millennium Project, 2005; original source UNEP, 2004)		<b>Ecological Sanitation</b> (various sources see below)	
Method	Estimated cost per person (USD ) incl. operation and maintenance	Estimated actual initial capital cost per person (USD ) and household incl. operation and maintenance (hh size is 4.5 unless otherwise given)	Method
<b>Mainly urban</b> Tertiary wastewater treatment	<b>800</b>	340 (1190 per hh) (China, hh size 3.5)* (source: Dong Sheng EcoSanRes Programme)	Urine-diverting high standard porcelain dry toilet ( indoor and multistory); piped urine system, dry fecal collection and composting, decentralised piped grey water treated using septic tank, and aeration treatment; local collection and transportation costs included
Sewer connection and secondary wastewater treatment	<b>450</b>	330 (1500 per hh) (Sarawak)* (source: Mamit et al, 2005)	Conventional indoor toilet with sealed conservancy tank, black water collection by truck; local biogas digester; decentralised piped greywater treated using septic tank and vertical biofilm filter technique
Connection to conventional sewer (assumed without treatment)	<b>300</b>	150 (675 per hh) (estimated)	Indoor dry single-vault urine-diverting pedestal toilet; decentralised piped greywater treatment using constructed wetland; local transportation included

(continued ...)

(... continued)

<b>Mainly peri-urban</b>	Sewer connection with local labour (assumed without treatment)	<b>175</b>	88 (400 per hh) (South Africa) 25 (110 per hh) (Mexico, El Salvador, India, South Africa, Zimbabwe) (source: Morgan, 2005)	Dry single- or double-vault urine diverting squatting pan or pedestal toilet with permanent upper housing structure; greywater treatment using on site infiltration pit; transportation assumed as local labour
	Septic tank latrine	<b>160</b>	12 (55 per hh) (source: Lin Jiang, Nanning, Guangxi, China)	Dry single or double-vault urine diverting squatting pan or pedestal toilet (LASF or Skyloo) with permanent upper housing structure; greywater treatment and disposal onsite; local recycling
<b>Mainly rural</b>	Pour-flush latrine	<b>70</b>	8 (35 per hh) (West Africa) (source: Klutse & Ahlgren, 2005)	Soil composting pit with cement slab and simple upper housing structure (Arborloo or Fossa Alterna); grey water treatment and disposal onsite; local recycling
	Ventilated improved pit latrine	<b>65</b>	8 (40 per hh) (Zimbabwe, Mozambique) (source Morgan, 2005)	soil composting shallow open pit; soil added after each use
	Simple pit latrine	<b>45</b>		
	Improved traditional Practice	<b>10</b>	3 (10 per hh) (estimated)	

\* initial cost calculations based on ongoing large scale pilot projects

The authors note that, apart from the data collected as part of the few large projects, mainly in Asia, the costs should be seen as a first indication based on pilot projects of limited size (SEI 2005). Hence, in order to get comprehensive data much more research in this topic is required.

### Development, design and marketing of environmentally sound products from recyclates

Products of ecosan schemes may include soil conditioner, plant nutrients, irrigation water, energy from biogas and heat. To complete the cycle in sustainable sanitation systems, further research is required to make sure that these products are safe, to market them and to propose measures that they can better compete in the open market. Marketing will require tailoring the products to local needs, meeting regulations and establishing suitable distribution systems.

Advocates of eco-sanitation make the plausible claim that human excreta have been used to restore soil fertility for centuries. However, that does not mean that the products of ecosan systems are economically, institutionally, or legally marketable in many countries. For this to happen there is a need for research on the use and marketability of excreta products. Do health regulations allow households to use their own excreta for home gardening? If such products are put on the market, what standards do they have to meet? Which government agencies have jurisdiction over these types of questions: ministries of health, ministries of agriculture, ministries of commerce?

Appropriate marketing of ecosan products is essential to ensuring the sustainability of the system, however producers may have problems in finding, stimulating or establishing their market. Research can help in this process by developing tools and methods to assist producers in analysing their markets. An outline of how this can be done is given in "Sustainable Composting – case studies and guidelines" by Ali and Rouse (2004).

### **5.4.2 Research on ecological sustainability**

In addition to safeguarding public health, ecological sanitation is also addressing ecological sustainability by introducing a closed loop approach to water and sanitation. In order to compare the ecological sustainability of different sanitation systems, the impact on natural resources, soil fertility, energy consumption, freshwater resources, climate change, and other risks have to be assessed.

From an ecological perspective end-of-pipe and closed-loop-sanitation systems may be compared through life-cycle analysis, which includes the resource efficiency during operation and maintenance (consumption of water, fossil fuels and other finite resources). As part of this comparison an energy balance should also be carried out. Aspects that must be considered would therefore include:

- Energy requirements for operation of sewer systems (e.g. pumping energy) and treatment plants versus recycling systems and their gain of energy (e.g. through biogas generation, or the recovery of heat energy from wastewater using heat exchangers) and irrigation water for saving water and other natural resources,
- Energy and resource requirements, for example for the production and transport of mineral versus ecosan fertiliser,
- The requirement of high-quality drinking water to transport excreta versus reduced water use, contributing to protection and conserving groundwater and other freshwater resources,
- The degradation of surface water bodies through sewage discharge versus improvement of regional ecological parameters through the application of reuse systems.

In general research should be looking at ways to assess the environmental impact of different sanitation systems on water, soil, air, climate and other natural resources, to enable a fair comparison of their ecological sustainability.

### **Material Flux Analysis**

An additional tool that can be used to analyse the resource use of sanitation systems is a Material Flux Analysis (MFA) (Baccini and Bader 1996, Brunner and Rechberger 2004). This can serve as a tool to protect finite resources and reduce energy consumption, applicable even on a global scale. MFA allows the quantification of different material flow streams, enabling comparisons to be made between different sanitation systems. Modelling material fluxes on a local or regional level can be used to support the optimisation of system design and decision making processes.

Analysis of material flows on a global scale can highlight the resources required for transport and related emissions, for example for phosphorous mined in Morocco, transported to Switzerland, where it is processed to mineral fertiliser, and used in agriculture in Germany, where it may very well end up to a large degree in surface waters and finally in the ocean.



In an MFA, the materials to be considered may include:

- finite and renewable natural resources (water, phosphorous, energy, ...)
- macro- and micro-nutrients, agricultural products
- pollutants (toxic substances, heavy metals, hormones, medical residues)
- substances with relevance for climate change (e.g. CO<sub>2</sub>, CH<sub>4</sub>, etc)
- construction materials

Current practice in industrialised nations is to remove or destroy the phosphorous and nitrogen in wastewater, using expensive, energy intensive technology, preventing it from entering surface water. This reduces the pollution in receiving waters, but increases the energy consumption and CO<sub>2</sub> emissions, and does not stop the depletion of finite resources. Recognising that phosphorus is a finite resource (EcosanRes 2005b, Rosemarin 2004), current research is focussing on its recovery by a range of different technical processes. A broader approach occurring at the legislative level is being adopted in Sweden, where a law is being proposed to parliament which sets a target of recovering 60% of the phosphorous in wastewater and recycling it to productive land by 2015 (Regeringens proposition 2004).

The material flow in many industrialised nations is also characterised by the import of large quantities of agricultural products. A considerable amount of e.g. fodder-maize imported from Southern countries is used for meat-production in the North. The manure from these and other animals combined with the use of artificial fertilisers, leads in several regions of central Europe to an accumulation of phosphorus in the top-soil and to problems of high nitrate concentrations in groundwater. An overall mass balance could show which areas in central Europe are the end destinations for large volumes of nutrients.

In developing countries however, negative nutrient mass balances can often be found. With farmers having not enough money to pay for artificial fertilisers, and with agricultural products often produced for export, not enough nutrient rich material is returned to the soil in many regions.

Material flux analysis enables the identification of problems and the quantification of the impact of potential measures.

Research is required to establish material flow analyses, taking into account the differences between the situation in the north and in the south. This research may be used to assess the effects of different sanitation concepts on the given material flow situation, and for the identification of the most ecological friendly solution serving best for the long term conservation of resources and the fertility of soils.

**Box 13: Example for MFA in Ghana**

“In developing countries, demographic and urban growth often results in severe environmental and social problems, including the lack of adequate water supply, environmental sanitation services and food security. Reusing waste products in peri-urban and urban agriculture can contribute to food security and reduce environmental pollution and sanitation costs. A comprehensive method is required to assess the potential and limitations of channelling urban waste products to peri-urban and urban agriculture. Material Flux Analysis is a helpful tool to assess material fluxes in a given system. It allows to identify problems and to quantify the impact of potential measures on resource recovery and environmental pollution. The present study analyses the material/nutrient fluxes of the city of Kumasi, Ghana. Import and export of products into or from the given system are recorded. Processes are identified and material fluxes between these processes are determined. The analysis revealed that households are the key process for material and nutrient fluxes. The groundwater and surface waters receive large amounts of waste products from the households. Reusing organic waste products in peri-urban and urban agriculture could significantly improve the organic matter and nutrient situation of agricultural soils and also protect the environment. However, a treatment process (e.g. co-composting) is required to reduce the health hazards related to the use of waste products.” (Forster, Schertenleib and Belevi 2003)

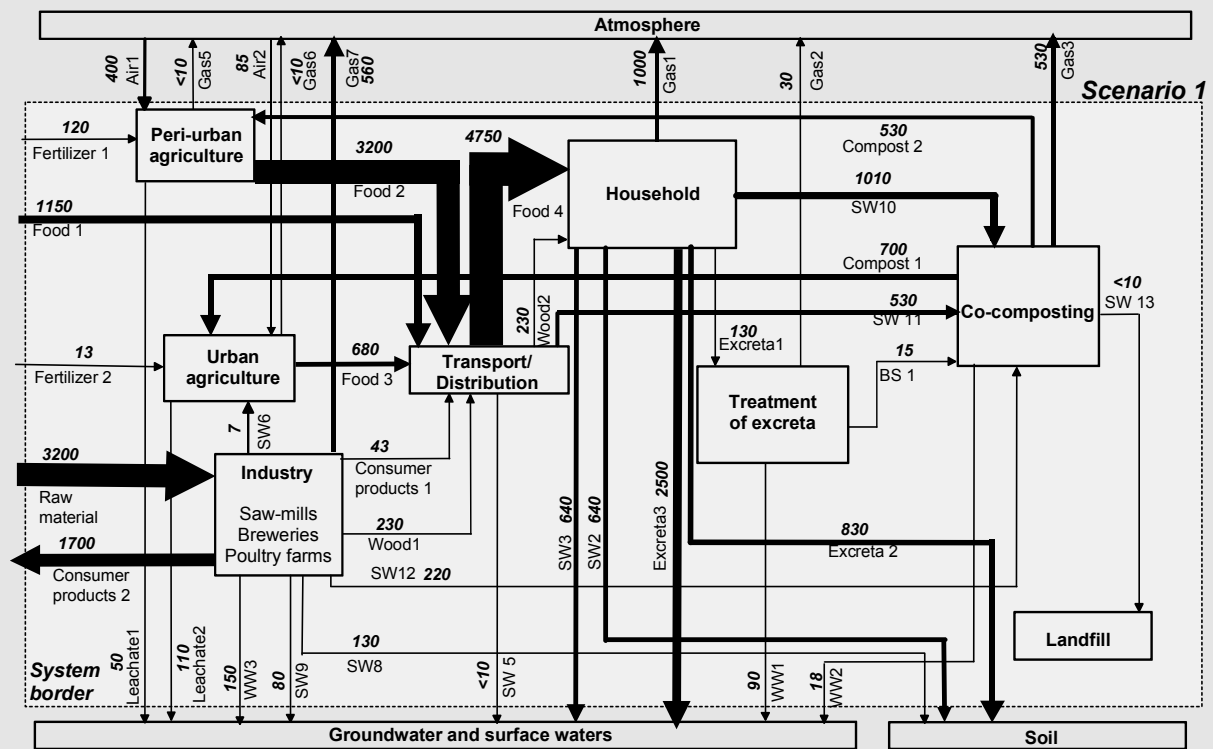

**Figure 26: Estimated annual nitrogen flows of Kumasi, Ghana in tons/year for the scenario “reuse of co-composted solid waste and faecal sludge” (Belevi 2002).**

## **Ecosan, urban agriculture, food security and quality of life in the city**

Most population growth is now occurring in urban areas. Consequently, the number of poor living in these areas has dramatically increased in recent years. To produce food and generate income many urban residents engage in urban and peri-urban agriculture using space that is available to grow crops or raise livestock. Wastewater or excreta is already often used in urban agriculture as it is readily available in urban areas. For example in Dakar Senegal, more than 60% of the vegetables consumed in the city are grown in urban areas using a mixture of groundwater and wastewater (untreated) (Faruqi, Niang, Redwood 2004). A proportion of vegetables sold in markets in Nairobi, Kenya and Kumasi, Ghana are also raised within the surrounding urban areas and irrigated with wastewater (Cornish and Kielen 2004). In Moscow, urban agricultural activity increased three-fold between 1970 and 1990. In Dar es Salaam it nearly quadrupled from 1968 to 1988, and in Romania it more than tripled (up 333%) from 1990 to 1996. In Argentina home gardening association members grew from 50,000 in 1990 to 550,000 in 1994. In metropolitan areas in the United States, food production increased from 30% in 1988 to 40% in 1996, and from 1994-1996 the number of farmer's markets selling locally-grown produce increased 40%. In great Bangkok 60% of the land is under cultivation. Urban agriculture facilitates the closing of the loop to food security. The demand for food by consumers and water and nutrients by producers reconnects resources and wastes in a safe, non-polluting and economic fashion (Esrey 2001).

FAO estimates that 800 million urban residents (up to two-thirds of all urban households) world-wide grow products for income or for their own consumption (FAO 1999). Urban agriculture can impact food security by increasing the amount, variety, nutritional value and freshness of food available to farming families (FAO, 1999) and provides additional income to purchase food. Some case studies have shown improvements in nutrition, especially in children, in poor urban families that produce their own food (Smit, Ratta and Nasr 1996).

Urban agriculture can be sustainable because it promotes the reuse of excreta, grey water organic wastes (Birley and Lock 1999). By closing nutrient loops and improving soil fertility and structure, yields should be higher per unit space, plants will be healthier and more nutritious, and lower levels of external inputs and less water will be required. Growing food closer to consumers also strengthens local communities. Food production and costs can be reduced by lowering the costs of inputs and producing food closer to where people live. Urban agriculture and home gardening can produce more food per unit space, as food can be grown on roofs, walls and in and around buildings. This in turn improves food security, and when food and non-food products are grown to generate income, food security and nutritional status can also improve. It is well known that women, who dominate the sphere of urban farming and gardening, are more likely to spend their extra income on food than men. Increasing national food availability will help to reduce child malnutrition. (Esrey 2001)

However, urban and peri-urban agriculture is often not adequately regulated to ensure that these activities do not negatively impact human health and the environment (Birley and Lock, 1999). In promoting urban agriculture, the following concerns need to be adequately researched and addressed to protect public health (Smit, Ratta and Nasr, 1996):

- Using best practices for the safe use of excreta and grey water;
- Restricting the use of industrial effluents for irrigation;
- Preventing contamination of crops with chemicals and or pathogens;
- Preventing contamination of drinking water sources;
- Promoting the safe use of pesticides; and
- Managing water and crops to prevent expansion of vector-borne diseases.

Ecosan systems can make considerable amounts of nutrients and irrigation water available, it allows constructed wetlands, urban agriculture and green belts to be systematically integrated into urban planning. The application of ecosan may thereby have clear impacts on nutrition, livelihood, local climate and on quality of life in the city. Research may therefore also need to concentrate on how to best make use of urban agriculture and ecological sanitation for the improvement of livelihood and the quality of living in urban areas. The cross sectoral characteristic of sustainable urban water and

nutrient management will require the development of instruments for the co-operation of different sectors institutions and allow for the participation of all relevant stakeholders.

**Project Box 9: ecosan within a natural resource management project in Botswana (GTZ - project-data sheets 2005-009)**

In Botswana the village of Paje is affected by strong winds, extreme erosion and soil degradation, whilst the Hanahais settlements are characterised by an extremely dry climate and sandy soil. Water consumption varies between 12 to 340 l/p/d depending on the access to a piped water connection and gardening activities, but mostly waster is used for gardening purposes.

To establish ecosan and other environmentally sound practices in the villages of Paje and east and west Hananhai in Botswana, the GTZ-supported IUCN natural resources management project placed a strong emphasis on participatory approaches and focused on 'learning by seeing'. Raising community and household awareness for the ecosan concept included tangible activities, which were undertaken in all households.



**Figure 27: Training workshop (left); traditional hut with ecosan toilet (middle); revised ground structure (right). (IUCN/GTZ)**

Following these activities, most of the families chose a urine diverting (UD) toilets to address their sanitation problem when given a choice of several options. In the first pre-pilot step, 20 ecosan single vault urine diverting (UD) dry toilets were implemented and adapted according to the needs of the users. Faeces were collected in 20 or 50 l containers, and 1-3 months later, they were put in a composting unit for further hygienisation. They were composted together with organic waste and animal refuse for 1-2 years to produce a safe soil conditioner.

The urine was collected in 20 l containers and used after about 3 weeks. Some users preferred the application of diluted urine for compost humidification rather than its direct use on the field.

From pilot trials, it was found that fertilisation with urine and compost led to a 40-50% higher production when compared to unfertilized plots.

## **Agricultural research**

As ecosan systems close the loop between sanitation and agriculture, agricultural research is as important as research into sanitary aspects.

A broad range of topics need to be addressed from an agricultural perspective – ranging from purely technical issues, to aspects of agricultural extension and the dissemination of research results for practical use. Topics to be addresses will include:

- Comparative risk benefit analysis of different types of fertilisers
- Fertiliser value and efficiencies of fertilisers
- Fertilisation strategies and application techniques when using excreta
- Impact of fertilisers quality of agricultural products and soil - and the development of related standards and guidelines
- Contribution of reuse to food security
- Effects of micro nutrients
- Degradation and effects of micro pollutants
- Assessing farmers needs regarding fertiliser
- Extension methodologies for the use of treated excreta

There are gaps in current knowledge concerning the use of urine and faeces as fertilisers. Lack of documented research in this area currently makes the development of standards and norms difficult. However, excreta and wastewater have been used in agriculture since ancient times, and there is a lot of undocumented knowledge based upon practice that needs to be researched and documented and may serve as a basis for modern, risk based standards. (Jönsson et al 2004)

In the urban context, home gardens, allotments and community gardens offer great potential for combined research on urban agriculture and ecosan in closed-loop systems, e.g. in the Philippines allotment gardens have recently been implemented, which use as fertiliser composted organic household wastes from integrated waste management (Universität Freiburg 2004; Holmer et al. 2003). These gardens are now combined with ecosan systems for the reuse of human excreta in the gardens (PUVeP 2005; GTZ-ecosan newsletter 2005-18). "Organoponics", a system similar to hydroponics has been promoted in Mexico (Sawyer, Arroyo and Delmaire 2003).

**Project Box 10: Constructed wetland treatment and wastewater reuse in Haran-AI-Awamied in Syria (GTZ -project-data sheets 2005-015)**

The village of Haran Al-Awamied is located south east of Damascus, Syria. The inhabitants are poor; with farming the main source of income. The use of untreated wastewater from the existing gravity sewers for irrigation was common. The specified purpose of the GTZ supported ecosan project in Haran Al-Awamied was therefore to make irrigation with wastewater hygienically safe and to use the fertilising effect of the nutrients contained in the waste water.

Therefore a new combined public sewer system was installed to collect and transport rain and wastewater to the new wastewater treatment plant. The plant consists of bar screens and a sedimentation tank as pre-treatment, two reed beds to treat the wastewater, and one reed bed for sludge soilification. The treated water is collected in a tank for storage, and is pumped from the collection tank to the fields near the plant when needed, with the distribution being organised by the farmers.



**Figure 28: Constructed wetland reed beds (left); sludge reed bed (middle); official inauguration of the pilot project (right). (Mohamed)**

The improved availability of irrigation water which contains valuable nutrients reduces the expenses of the farmers for commercial fertilisers. It contributes to higher yields in crop production, and increases the number of harvests from one to several per year. The reed plants of the constructed wetland are used for wicker and roof materials. The treated sludge is used as soil conditioner.

As the residents get these benefits from the constructed wetland, they provide a great deal of support to ensure its correct functioning.

Other convincing reasons why the reed bed systems were chosen, are its low costs, easy construction and simple operation and maintenance.

## Monitoring ecosan systems, quality control and environmental impact assessment

In Germany around 7.000 water works currently treat and discharge the wastewater of 80 Million people. If a closed loop strategy is pursued the number of treatment facilities will sharply increase (compare Thomas 2000), as local, decentralised sanitation systems will be recognised as a convenient, cost-efficient option. The development of systems to monitor this increased number of decentralised facilities will be necessary to minimise any possible adverse effects on human health and the environment. Research should also help develop systems to enable products emanating from eco-sanitation to be standardised, allowing quality control and the assessment of environmental impacts and guaranteeing that the products conform to legal and market requirements.

### Project Box 11: Biogas-ecosan-project Waldmichelbacherhof in Germany (GTZ -project-data sheets 2005-006)

For the last ten years, the family-owned farm and restaurant Waldmichelbacher Hof in rural Bavaria, Germany, uses a closed-loop biogas plant system for sanitation and waste management. All nutrients generated on-site are reused on the 200 ha of land. This agricultural land is mainly used for grazing, fodder production, cattle breeding and meat production (the meat is sold at the restaurant and farm shop).

The toilets used in this sanitation system are conventional low flush toilets, as neither dry toilets nor urine diversion toilets were seen to bring any additional benefit to this project, as the black water is digested together with animal manure in a heated anaerobic digester. The resulting product, liquid “digested manure”, is easy to apply to the pasture as fertiliser (with no need for dilution). A co-generation plant converts the biogas from the anaerobic digester to produce heat and electricity (excess electricity is sold back to the grid).



**Figure 29: Waldmichelbacherhof (left; Schultes); collection channel under the barn floor (right; Wang)**

The system is a good example of an on-site ecologically sustainable system in a European rural context. It is a closed-loop system, where only negligible amounts of nutrients are added or removed. Further benefits are that the farmer has observed better yields when using the digested manure as fertiliser compared to non-digested manure. There are also no odour problems when applying the digested manure to the fields.

The development and establishment of an Environmental Management Plan (EMP) will be necessary for ecosan systems. The plan should cover all aspects of the system, which pose a risk to the environment, human and livestock health, and provide a framework to assess its long-term sustainability. The EMP should address a number of issues such as product quality and quantity, storage, site controls, buffer distances if needed, warning signs, application rates and timing, irrigation methods, ground water quality monitoring, salinity controls, soil testing etc. Users of the system may consider the regular monitoring costs as an extra financial burden in addition to the initial cost of infrastructure, and research will be needed to establish how these costs can best be distributed between for example households, users of the products and the state.



#### **Box 14: Learning from organic waste management**

9 Million tons of organic wastes are currently recycled into compost in Europe and regarding logistics, system management, market orientation and regulations ecosan systems can profit from these experiences! Josef Barth (2004) provides an overview of the treatment of organic waste in Europe. Many of the points raised are equally valid for ecosan systems. Barth writes "Investigations in Europe indicate that quality and marketing of the end product are the most crucial composting issues. Both producers and users are of the opinion that sustainable recycling of organic wastes demands clear regulations with regard to what is suitable to be recycled and how it should be managed and controlled. Around 15% of the estimated total recoverable potential of 60 million tons of organic waste is presently treated biologically in Europe. The re-use has to meet environmental and market requirements. Therefore, the trend in Europe goes definitely towards source separation of the organic residues from gardens and households. Quality requirements for composts regarding heavy metals, organic pollutants and hygiene allow no other alternative. There is no longer a market for mixed-waste compost. The introduction of source separation and composting must go hand in hand with the introduction of a quality assurance system for compost plants. Assuring compost quality entails more than just fulfilling a number of heavy metal limits. ... " (Josef Barth 2004). Researchers and educators alike need to consider how the lessons of these systems can be transferred and applied to eco-sanitation.

### **5.4.3 Health related risks and benefits**

Generally speaking, water supply and sanitation systems can expose the public to two basic types of risk – the risk of infection from water-borne diseases caused by faecal contamination, and the risk of exposure to toxic or harmful substances present in the water or wastewater, for examples heavy metals, toxic organic compounds, medical residues, or hormones.

The prevailing economic, social, and environmental conditions do increase these risks in many countries. Increased temperatures or humidity may for example favour the spread of particular faecal pathogens, which in turn will result in an increased occurrence of diarrhoea; or, severe malnutrition may in turn increase the impact of diseases, so that the otherwise harmless diarrhoea increasingly has lethal consequences.

In many ways ecosan intends to better the situation, for example through a multi-barrier concept and through contributing to the nutrition status of the people.

It is however recognised, that with any sanitation system, there are associated risks, and systems should therefore be designed with the aim of minimising these whilst at the same time maximising the benefits the system can bring to all stakeholders. Such a risk based approach is proposed in the upcoming guidelines from the WHO for the safe use of wastewater in agriculture and aquaculture and the safe use of excreta and greywater. In fact the risks should be lowered to an extent that they do not differ from other everyday risks in a safe way of living.

A method which allows to make such a risk assessment and enables to compare different types of risks is the so called DALYs (Disability Adjusted Life Years) concept (Foege 1994). After accumulating in a first step all years lost to deaths and illnesses for a given population, it is possible to analyse in a second step which risks do contribute how much to this burden. The total burden of disease for the world in 1990 was calculated to be 1.4 billion DALYs lost, or 259 per 1000 population, or 0,26 DALYs per person. (See Box below for further information on the DALYs concept).

For drinking water WHO has set a high safety level and decided to recommend measures which reduce the risk below a level of  $10^{-6}$  DALYs (or 0,00001 DALYs) per person. The same high safety level is now set in the above mentioned forthcoming WHO publications for all risks related to sanitation and reuse systems and the WHO guidelines will describe the measures enabling to reach this safety level.

### **Box 15: Disability Adjusted Life Years (DALYs)**

#### **Disability Adjusted Life Years (DALYs)**

DALYs are a measure of the health of a population or burden of disease due to a specific disease or risk factor. DALYs attempt to measure the time lost because of disability or death from a disease compared with a long life free of disability in the absence of the disease. DALYs are calculated by adding the years of life lost to premature death (YLL) to the years lived with a disability (YLD). Years of life lost are calculated from age-specific mortality rates and the standard life expectancies of a given population. YLD are calculated from the number of cases multiplied by the average duration of the disease and a severity factor ranging from 1 (death) to 0 (perfect health) based on the disease (e.g., watery diarrhoea has a severity factor from 0.09 to 0.12 depending on the age group) (Prüss and Havelaar 2001; Murray and Lopez, 1996). DALYs are an important tool for comparing health outcomes because they account for not only acute health effects but also delayed and chronic effects – including morbidity and mortality (Fewtrell and Bartram 2001).

When risk is described in DALYs, different health outcomes (e.g., cancer vs. giardiasis) can be compared and risk management decisions can be prioritized.

Finally, it is possible to use the DALYs approach to allocate research funds. Representatives of three foundations (the Rockefeller Foundation, the John D. and Catherine T. MacArthur Foundation, and the Edna McConnell Clark Foundation) held a meeting in 1993 to determine research priorities in combating global microbial threats. They realized that some disease conditions responsible for major burdens of disease, such as malaria, require significant basic research if better interventions are to be developed. On the other hand, with other diseases (e.g. vaccine-preventable diseases, lower respiratory tract infections, watery diarrhoea), good interventions are available but are not reaching those in need. In such cases, applied research or behavioural research is needed to produce better outcomes (Foege 1994).

However, the reality today is that a high percentage of wastewater world-wide is discharged untreated into the environment. At the same time farmers around the world use untreated wastewater and excreta to secure their livelihoods, often being completely unaware of the related health risks. Ecosan systems do offer the possibility to greatly reduce risks during reuse, improve the efficiency of nutrient recovery, and avoid wastewater discharge.

It is in this context that the WHO is updating guidelines from 1989 (WHO 1989), and is devoting an entire set of books to “the safe use of wastewater in agriculture and aquaculture”, and to “the safe use of excreta and greywater”, using recent research findings and results from practice. A screening of existing epidemiological studies and research on treatment efficiencies has been made for the new edition, which will appear in 2006. Continuous research is required in this field to keep pace with rapid developments. Knowledge management is urgent to disseminate the latest results to the public in an appropriate form.

Health-related research fields should include:

- Sanitisation of excreta and grey water and wastewater
- Comparison of risks from different technologies and system approaches
- Epidemiological studies (given infection rate in a certain environment and social or regional group and its relation to water and sanitation)
- Comparative research on sanitisation effects of different technological components in different climate zones and local conditions (e.g. research on effects of constructed wetlands; on adding of ammonium for the sterilisation of faecal matter; on pH-change and its sterilising effects in urine)
- Health oriented multiple barrier concepts
- Social aspects of crop restriction and exposure control (the use of safety equipment such as boots or shoes, or the use of excreta on cash crops)
- Hygiene education
- Comparative research on toxic substances, and their pathways in the food chain, including metabolites etc. (e.g. comparing effects from heavy metals like cadmium in current artificial fertilisers, with those from hormones in fertiliser from animal manure and from ecosan-systems)
- Effects of the use of the eco-fertilisers on the nutrition and health status especially in poor communities



**Project Box 12: Use of reclaimed water in the Jordan Valley in Jordan (GTZ -project-data sheets 2005-013)**

The GTZ supported Reclaimed Water Project aims to encourage the use of treated wastewater (reclaimed water) in the Jordan Valley on about 10.000 ha of agricultural land as a substitute for freshwater and in accordance with environmental and public health regulations.

The project area is characterised by a low annual rainfall with a mild winter allowing the off-season production of vegetables under irrigation. As irrigated agriculture consumes about 70 % of the available fresh water resources, which are also urgently needed as drinking water, the use of marginal water resources, such as brackish and reclaimed water for irrigation, is highly desirable.

In the project region, the main source of reclaimed water for irrigation is the countries largest treatment plant with the effluent being distributed through wadis, reservoirs and canals to agricultural areas. Reclaimed water, diluted with surface and rain water is then used for agricultural irrigation. Drip irrigation is most commonly practiced, in combination with a black plastic covering.



**Figure 30: Demo plot (left); irrigation and mulching (middle); planting (right). (GTZ)**

The Reclaimed Water Project monitors and evaluates agronomic and irrigation practices on 20 selected farm units. Analysis of local practices and comparison with international experience will lead to appropriate and practical guidelines for the use of reclaimed water.

The implementation of crop quality monitoring is difficult because so far governmental agencies do not feel responsible for sampling and analysis of crops irrigated with reclaimed water. Providing guidelines in this field will help clarify and improve the situation. In the beginning, the majority of farmers in the project were not aware of the nutrient content of the reclaimed water but now they are starting to appreciate its quality.

To reduce health risks from handling urine and excreta in agriculture a guideline by Schönning and Stenström (2004) has recently been published. The guideline discusses as main physicochemical and biological factors that affect the survival of micro organisms in the environment: temperature, pH, ammonia, moisture, solar radiation, UV-light, nutrients, and presence of other micro organisms. For the comparatively harmless urine they state that in “small-scale family based systems, the urine may be used directly or after short periods of storage if the crops are intended for family use. The likelihood of transmission is larger between family members than through urine fertilised crops.”

As needs for further research Schönning and Stenström (2004) point out that for large-scale systems additional studies on appropriate handling and use systems are essential, including a systematic microbial risk assessment and epidemiological follow-up investigations. When secondary treatment is applied, different methods need to be considered, including pH elevation with lime and other alkaline chemicals, including urea. For lime, experience from large-scale treatment of sewage sludge exists, and laboratory scale studies with faeces are presently ongoing.

For future studies, it would be valuable to consider a harmonization of treatment methods under different local conditions and using the same type of analytical methods, so that the results easily could be compared. All methods need to be evaluated in a systematic analytical way regarding environmental effects.

#### 5.4.4 Technical and performance aspects of ecological sanitation

Obviously the technical reliability and performance of the system is key to its success and ultimately its sustainability.

Research on technical and performance aspects of ecological sanitation needs to assess system aspects like collection, treatment, transport and use of household wastes and wastewater, the management, maintenance, operation and logistics for large matter fluxes in large cities, or resource and energy efficiency during operation of conventional versus ecological sanitation systems. Researchers should also pay attention when analysing such systems to ensure that what is developed is actually appropriate to the needs and desires of the users. It will be easier to adapt technologies and systems to the needs of the users than to adapt the users to the needs of the system. Researchers also need to consider the robustness and flexibility, both within the system (to be able to receive varying loads) and externally (to be able to withstand varying extreme environmental conditions as well as user abuse).

Research has already begun to adapt and further develop existing innovative technologies, for their use in recycling oriented waste water management schemes.

For example, vacuum systems, commonplace on ships and aircraft, have been adapted, tested and standardised in the domestic context, and have proven successful. Other innovative technologies do not have such proven tracks and may require further development. Membrane technology is one example of this. Following their rapid development over the last decades, membranes are increasingly used in split stream systems and for wastewater treatment. New technologies are continuing to emerge for closed loop systems, for example from NASA and ESA who have developed closed loop sanitation systems for space flight that are designed to function over many years. (CNN 2005, GTZ – ecosan newsletter 2005-16).

Eventually an internationally acceptable set of standardised system components should be developed and established as the state of the art. As development in this area is continuing apace, databases and knowledge management system are of high importance to share new findings and discoveries. The available data should be of a high quality making it attractive to professional associations and ultimately to governments. A series of case studies and of research results emanating from them should allow qualified statements on components and combinations of components answering context specific questions such as:

- Which kind of treatment will result in which kind of fertiliser-quality?
- Which kind of treatment will guarantee which hygienic standard?
- What are the maintenance and operation costs of a certain component? What is the expected life-time of this component in the system?
- What is the best combination of components to solve a specific problem?
- What logistical and institutional arrangements are possible, and to which contexts are they most suitable?
- How suitable are existing standardised devices for their use in ecosan solutions?

However in a field developing as quickly as ecological sanitation a special conflict arises with respect to standardisation:

- On one hand standardisation of a set of modular system elements is urgently needed as planners, constructors and those financing the projects want this kind of “certificate” to insure that reliable and proven elements and systems are implemented.
- On the other hand this standardisation may hinder further development and standard technologies may simply be applied in situations where large-scale research and demonstration projects are still missing, and where new technologies may be needed to correctly address the context.

### 5.4.5 Socio-cultural aspects of sustainable sanitation

In recent years, there has been a growing realisation that access to sanitation does not increase unless there is demand from the user, and as most expenditure for sanitation is at the household level, where promotional efforts are most needed here. Previous attempts to market sanitation have relied on the promotion of the health benefits that sanitation and hygienic behaviour can bring. Whilst this is clearly the most important reason for promoting sanitation and hygiene from an institutional point of view, it often proves to be much less of a motivating factor for spending money on sanitation at the individual or household level. When households contemplate a shift, other factors may prove to be a greater motivation. Research by the World Bank Water and Sanitation Programme has identified several other factors that serve to motivate even very poor households to invest in sanitation (Cairncross 2004). These include (and see Box 16 for an example of drivers for sanitation from the Philippines):

- Convenience and comfort
- Privacy and safety
- For women and girls, avoidance of sexual harassment and assault
- Less embarrassment with visitors
- Dignity and social status

#### Box 16: Why people want toilets

The following responses concerning satisfaction with a new toilet were recorded in a survey of rural households conducted in the Philippines. The following reasons for having a toilet were listed in order of preference:

- Lack of flies,
- Cleaner surroundings,
- Privacy,
- Less embarrassment when friends visit, and
- Reduced gastrointestinal disease.

Similar results have been obtained from surveys conducted in other parts of the world, where health is often found to be a less important driver for obtaining sanitation for households than dignity, convenience and social status.

WHO 1997 in WHO/UNICEF JMP 2000.

User views are also related to how hygienically safe the design allows them to be. Hence introducing and operating ecosan installations in rural and urban areas requires a thoughtful combination of technical and managerial aspect fitting the prevailing socio-cultural context. Cordova and Knuth (2005) studied user satisfaction with Dry Toilets (DT's) in 5 urban and peri-urban sites in Mexico. They found high satisfaction rates with different combinations of program style and toilet models, as well as among populations with different motivations, income-levels and previous sanitation history. User satisfaction was influenced by the degree of choice users had in obtaining DT's and their understanding of the benefits of Dry Sanitation (DS), whereas user dissatisfaction was related to technical and programmatic factors. Cordova and Knuth (2005) also found that indoor, aesthetic toilets with a complementary greywater system for the household; maintenance and end-product collection services; and high water supply costs would be incentives for users to accept DS in the long-term. And they suggested that associating DT's with high social status might increase user acceptance of this technology.

**Project Box 13: Public toilet project in Rajendar Nagar Slum in Bangalore, India (GTZ-ecosan-newsletter 2005-18)**

To meet urgent community needs the Indian NGO ACTS and the Swiss Seecon GmbH established an eco-friendly public toilet centre in Rajendra Nagar Slum, Bangalore, and a co-composting site for faecal matter at the ACTS Rayasandra Campus, serving about 500 to 600 users per day. Although it has successfully been in operation for almost 4 years now, the originally designed logistic system, which was based on the collection of source-separated urine and faecal matter in plastic drums and the transportation of those drums to the processing side at Rayasandra Campus, was often discussed controversially. A socially and culturally more acceptable, sustainable and hygienically safe collection, transportation and processing scheme has therefore been developed and implemented with the support of GTZ.

For the improved system, storage tanks now replace the barrels for collection of urine and faeces. A suction truck, equipped with tanks and a pumping system, evacuates faeces and urine and manual handling is no longer necessary. Urine and faeces are then transported to the treatment site, where urine is stored in large storage tanks and faeces are treated in a biogas plant.



**Figure 31: Urine diverting public toilet in Bangalore (left; Heeb); biogas plant (right; Wafler)**

The stored urine and digested slurry are used as fertilisers and the biogas is being used for cooking. The biogas plant has a much higher capacity to treat faeces than the previous co-composting system. The higher treatment capacity will allow the extension of the project for further public toilet blocks.

Social marketing techniques are currently seen as an extremely useful tool in promoting sanitation amongst private households. They involve the application of commercial marketing techniques to advance social goals, in this case the safe use of excreta and greywater through appropriate sanitation solutions. Social marketing has been used successfully to increase sanitation coverage in rural India. The marketing side is based on the "four Ps" - Product, Price, Place, and Promotion.

**Product**

Toilet and sanitary system designs must respond to what people want, rather than what sanitary engineers believe they should have.

**Price**

Includes all costs (monetary and non-monetary) needs to be affordable, and therefore it is necessary to offer a range of products available at different prices. This is the hardest part of selling sanitation to those who lack it. The poor, who need it most, can least afford it. Hence the need to keep costs down and market a range of products with various price tags.

**Place**

The product must be delivered to the right place; in particular, a toilet must be installed in the customer's own home. This means that the supply chain has to reach every household.

### **Promotion**

Promotion is communication with consumers about the product or service. This includes advertising, mass media, word of mouth, and anything in between. It can also include many other means to get customers' attention and convince them to buy the product: demonstration toilets, time-limited special offers, coupons and vouchers, competitions and prizes, door-to-door sales, credit sponsored by local traders, and mutual help schemes to help the poorest with the cost and the elderly with the digging.

When designing social marketing campaigns to promote sanitation and the safe use of excreta and greywater, the possible barriers to the promotion and success of the campaign should be identified, explicitly addressed, and integrated into the campaign. With regard to sanitation Simpson-Hébert and Wood (1998) have identified 10 barriers to progress in sanitation, all of which are equally valid for the safe use of excreta and greywater:

- Lack of political will;
- Low prestige, priority and recognition;
- Poor policy at all levels;
- Weak institutional framework and unclear distribution of responsibilities;
- Inadequate and poorly used resources;
- Inappropriate approaches;
- Failure to recognise defects of current excreta management systems;
- Neglect of consumer preferences;
- Ineffective promotion and low public awareness; and
- Women and children last.

### **Research on sanitation, reuse knowledge and traditions**

As stated previously, many sanitation projects have failed due to a poor consideration of the socio-cultural sustainability of the system. For example, in India pit toilets installed during supply driven programmes of the 1980 ended up to a high percentage as being used as store rooms. In the programmes it was ignored that these toilets were culturally disliked as claustrophobic, that people wanted excreta to be deposited at a distance from their homes and not kept under the ground beneath their feet, and that, when the pit was full, it had to be emptied and the content handled – by someone (Black and Talbot 2005). Today several projects in India focus instead on awareness raising campaigns for “zero open defecation” and develop demand driven programmes e.g. with woman self help groups which have a clear interest in well maintained toilet facilities. In general sanitation projects in India should take into account aspects of the “old” history, e.g. the problematic concept of untouchability, as well as those of the “recent” history, during which e.g. Mahatma Gandhi was a ferocious advocate for more hygienic methods of sanitation, and campaigned against the degradation of humanity contained in the concept of untouchability. (Black and Talbot 2005)

Research on sanitation-related socio-cultural aspects and traditions can therefore greatly contribute to the socio-cultural sustainability of sanitation systems. Generally projects and related research have to realise that:

- Defecation is a highly private and intimate topic and related habits may largely differ between regions and cultures
- In some cultures handling of excreta is subject of strong taboos and may be related to aspects of human dignity
- Knowledge and perception of the reuse of excreta largely varies between cultures and regions
- Sanitation practices differ (wet versus dry hygiene, squatting versus sitting, etc.)

Problems to be addressed by research for socio-cultural sustainable sanitation systems include:

- Household motivations to invest in sanitation
- Household expectations from the system
- Lack of awareness of hygienic risks and practices
- Traditional practices which may be wise or may pose severe hygienic risks
- The need to modify existing practices as a result of increasing urbanisation in recent years

All these socio-cultural aspects have a large impact on the required design of sanitation systems, their operation, and the possible reuse of products from waste water and excreta. Therefore research is required in order to take into consideration these aspects during the preparation, implementation and operation of the sanitation systems.

Although social norms may at first complicate the introduction of innovative sanitation systems, research should concentrate on the flexibility of these systems, and determine in what way ecosan systems could most acceptably be introduced to society - for example after seeing the benefits through pilot/demo systems. Social acceptance is not just a simple yes or no, but a flexible parameter that changes with time.

Summarizing the above we can say that no technical sanitation solution can be successful unless it complies with the attitudes, norms and the cultural context. The term "cultural" covers a large spectrum ranging from contemporary habits and perceptions over historical heritage, religious norms, and the often unpronounceable "feelings" of the population. It is obvious that research on these viewpoints is still needed, both in general terms to allow methodologies to assess this to be developed, and in case specific studies, as each project and region has its own individual particularities, and not taking them into account may provide a false picture and lead to project failure. The aims of research are of course to gain knowledge, but also to deliver arguments, since habits may change, and viewpoints so far unknown to the population may meet with a positive interest. To allow an informed choice the decision should be based on a broad pre-selection of sanitation alternatives.

## **Participatory planning, knowledge management and decision making**

Ecosan projects are more complex than conventional systems, being trans-sectoral and including topics ranging from calculating diameters of pipes to the analysis of cultural habits. The stakeholders however should have a central role in these planning processes. Thus a stakeholder analysis, awareness raising, education and information is necessary, to allow an informed choice. Practitioners may therefore require a different set of tools and instruments to make ecosan baseline assessments, to prepare projects, plan, chose technologies, implement, monitor, and evaluate the system. So far mainly the material and social aspects have been addressed.

One of the key challenges in knowledge management and research is to develop or identify these tools, and test them in the sanitation context. A number of tools are available from related disciplines, and can be adapted. Some sanitation-specific planning tools, which are suitable for ecosan, and are based on the model of active participation and stakeholder involvement, have been recently developed and have to be field-tested now. Among others these include the "Household Centred Environmental Sanitation Approach" (HCES) of the WSSCC (Eawag 2005), the adaptation of the HCES for ecosan projects as described in the GTZ-ecosan source book (Werner et al. 2004), and Open planning of sanitation systems developed by EcosanRes (Sweden) by Kvarnström and Petersens (2004)

To date, most planning and implementing systems for conventional sanitation have tended to be highly centralised, hierarchical and bureaucratic, focusing on formal knowledge, and severely limiting opportunities for the participation of a range of stakeholders. Similarly, sanitation policy and legal frameworks are focused on regulating the government organisations or their private sector agents who deliver services, which themselves are often rigidly defined.

The practice of centralised sanitation planning, decision making and financing removes central planners from the daily experience and problems of the users. Steeped as it is in formal knowledge, it creates the illusion that it represents the ultimate in scientific truth, and blinds practitioners to the drawbacks and weaknesses of the system. Sanitation practice, for example, has not significantly changed since the early part of the 20th century, and so, other than the addition of tertiary treatment, it has not benefited from the insights and knowledge of modern environmental management.

In contrast, if planners were more open to and familiar with either environmental management, or traditional knowledge, they might understand that the processes of generation and management of faeces, urine, and are intricately related to social and cultural values and norms. The equipment and treatment used, the necessary maintenance, cultural and religious rules about who may handle excreta and when, the conditions under which these materials may be recycled, and customs and taboos, govern much of behaviour. Elizabeth Shove (2003) bundles these factors under the terms "comfort, cleanliness, and convenience." Sanitation systems, if they are to work for the users, have to take these things into account. In the 21st century, in an age when public utilities are under pressure to match the financial performance of the private sector, such systems also depend on user payments and compliance with rules. This means that they also have to be affordable to the user. If the user is not consulted, there is little likelihood that the resulting systems will meet their needs.

On the system side, sanitation systems have to allow the system provider, whether public, private, or hybrid, to design, build, and maintain (and in some cases dismantle) the system. System providers are dependent on information from users about rate and type of use of equipment and resources; about failure rate; and, more directly, they are dependent on users for paying for the systems themselves. Moreover, system providers depend on the goodwill and local knowledge of users and neighbours when they have to install or repair infrastructure, site facilities, or store equipment and materials. When decisions about infrastructure are made without consultation, the system providers are also operating with partial blinders, depriving themselves of key local knowledge that could make their work more effective.

Participation also adds to the knowledge available for planning. Open channels of communication between users and system providers are a key feature of modernised socio-technical systems, which build an element of user choice and discursive awareness into the planning process (Spaargaren and van Vliet 2000).

The paradigm shift in sanitation depends on the participation of users and other stakeholders, in order to arrive at a collectively acceptable informed choice, so that the sanitary systems are tailored to their needs and demands. Providing for an informed choice generally means inviting potential users and stakeholders to explore alternatives in terms of toilets, storage facilities, transformation of excreta into soil conditioners and fertilisers, and the like. It requires transparency as to the benefits and drawbacks of both conventional and alternative systems, including their financial and economic requirements and benefits. Only in the context of this transparency can users have the room to participate in the decision-making. Then there is still the question of whether the system providers will listen, and will give the users' non-formal knowledge the respect and legitimacy they deserve.

Almost all experience with a participatory approach to planning has given special attention to the differences in practices, preferences, status, and knowledge of women, men, and children. Whereas traditional sewerage sanitation is associated with the highly masculinised engineering culture that arose in the middle of the 19th century, alternatives both offer and require more participation of women and children in decision-making, management, and use. This in turn requires a more refined analysis and understanding of the role of the household, the unit of sanitation planning, than has normally been the case. Gender analysis offers both tools and guidelines for this added level of analysis.

#### **Box 17: What is "gender"?**

"In all societies men and women play different roles, have different needs, and face different constraints. Gender roles differ from the biological roles of men and women, although they may overlap in nearly all societies. Gender roles are socially constructed. They demarcate responsibilities between men and women, social and economic activities, access to resources, and decision making authority. Biological roles are fixed, but gender roles can and do change with social, economic, and technological change. Social factors underlie and support gender-based disparities." (Fong, Wakeman and Bhushan 1996)

The household is the basic unit of sanitation planning, but even within the household, there are deep differences between children, women and men in terms of behaviour, preferences, power, access to resources, time spent at home, information, and skills (Khabeer 1994).



Addressing gender issues in sanitation means having a closer look at social relationships, to see the different roles of community members and the complicated structure between women and men, girls and boys with regard to decision making, choice and manner of use of technology, hygiene, food security, financial security, crop production and health issues. Participation does not mean merely inviting the men from all types of households to come to a meeting and vote on toilet designs, it requires deliberate and skilled facilitation to elicit this same information from women, servants, and the social or ethnic classes who are given the “dirty work” in any particular society. The people charged with the dirty work have critical knowledge about the workings of the system, but they are frequently ignored as key stakeholders.

**Box 18: Who does the dirty work?**

In most societies, the dirty work is done by special castes, ethnic groups, or social or age classes. For example, emptying of pit toilets in East Africa is done by extremely poor youths, called “frogs”. In India, the Dalit (“untouchable”) caste had this and other functions. In Bulgaria and Romania, if there is a need to clean out a sewer or sweep a street or empty a toilet, the answer is ‘call a Gypsy’ (Roma). In Egypt Coptic Christians (the Zabbaleen) handle the waste; until recently, in North America (like in Victorian England) housecleaning was something only unmarried girls from poor families were called on to do.

Participation in ecosan projects also serves to include appropriately the different interests, needs, priorities, and framework conditions, as well as the economic and organisational potential and limits of the different stakeholders, in the decision making process, insofar as they do not contradict the needs of other participants. If at times in the process no consensus can be achieved, then mediation or other mechanisms to balance the different interests may be necessary, for example majority decisions or decisions made by legal representatives.

**Willingness to pay and degree of participation in the system operation and maintenance**

When adopting a demand responsive approach to sanitary provision on the basis of a freedom of choice and willingness to pay, the questions “whose demand?” and “whose willingness to pay?” may have to be answered to address equity concerns. “Payment” in this case may include all forms in which the users may contribute, i.e., in cash, in kind, and with time and energy for obtaining, operating, maintaining, and managing services.

Also inherent in this definition is the understanding that “choice” means a lot more than technology or cost options. It can also mean who participates in which choices, i.e., which groups within the communities and households make which of the several key decisions, such as:

- initiation of the projects;
- the type of technologies and service levels;
- the location of the facilities;
- the local management, maintenance, and financing systems; and
- the candidates for training.

The “capacity to pay” can be verified through the process of facilitating informed choice - an essential requirement of the demand-responsive approach. It is not possible to assess “willingness to pay” with any accuracy in the absence of choices and full information about choices being offered and discussed with potential consumers. Both willingness and capacity to pay can be surprisingly elastic, depending on what options are being offered, at what immediate and longer term costs, and how clearly this information is communicated to and discussed with women and men from wealthier, intermediate, and poor groups, who are all potential consumers of services. Gender-sensitive methods play an important role in assessing the overall demand for services.



In researching and establishing demand, researchers will need to investigate and control for incentives in the potential users' environment which may distort their willingness or capacity to pay. For example, if people believe that services might be provided free of charge, they may have an incentive to say that they are too poor to pay. In such cases it may not be possible to get an accurate assessment of demand until the initial stages of project implementation are under way. At this time potential consumers can begin to see the real terms under which the services are finally being provided.

Demands and meeting demands are not static issues. Continued maintenance and use of services and user payments depend on how well the improved facilities continue to match the expectations and resources of the different groups. Users also continually compare how benefits relate to the costs of obtaining them. A close monitoring and documentation of these processes in pilot projects by an accompanying research programme will provide valuable lessons for further implementation of ecosan systems (Mukherjee and van Wijk 2002).

### **Policy and institutional aspects, enabling environment**

In most countries the use of surface and ground water is subject to respective national water laws. Other laws concerning soil, transport of chemicals, utilisation of fertilisers etc. supplement these water laws. The laws which have to be consulted in ecosan-related projects therefore are potentially much wider reaching than for more conventional sanitation systems, for example emission laws, soil protection, groundwater protection, labour regulations, fertiliser regulations, impact of subsidies, and the broad application of health regulations.

As ecological sanitation is still a relatively new approach, these types of sanitation systems are usually not yet included in the respective legal national frameworks. However there are some guidelines available that do create opportunities for ecosan systems, for example the new edition of the 1989 WHO Guidelines on the "Safe Use of Wastewater and Excreta" which are currently under preparation, or the EcoSanRes guidelines (Jönsson et al. 2004), as well as national policies, for example in Sweden (Regeringens proposition 2004).

Irrigation with water from other than natural sources is subject to rigid regulations and here ecosan may encounter legal problems. For example in Germany urine from urine separating toilets is seen legally as wastewater (as long as it is mixed with water), or solid waste (as long as it is not mixed with water). As solid waste the existing legislation applies and urine can not be used as a fertiliser (as it is not included in the list of certified fertilisers). Even struvite - magnesium ammonium phosphate (a substance that contains both N and P with a high fertilising potential) that may be produced from urine by precipitation technologies - meets this problem.

In view of the legal uncertainty concerning ecosan systems they "should be codified into the local, national and international systems of technical standards and norms in order to provide reference for Best Practice and Best Available Technology. The regulatory framework should be verified or adjusted with the aim of authorising and promoting a closed loop with new innovative technologies and management concepts." Furthermore, "Ecosan strategies should be implemented in national and international action plans including the Implementation Plans for the MDGs (Millennium Development Goals), PRSPs (Poverty Reduction Strategy Papers) and the National Plans of Action within the UNEP GPA (Global Programme of Action for the Protection of the Marine Environment from Land-based Activities). The indicator system for safe and sustainable sanitation provision should be revised to reflect the real risks and dangers to the environment and public health posed by all forms of sanitation." (quoted from GTZ 2003)

A review of existing national and international regulations with respect of the requirements of ecological sanitation systems is needed. This has been started to some extent by a recently published report on sanitation regulatory frameworks (Johansson and Kvarnström 2005), which analysed and compared the frameworks in Mexico, South Africa, Sweden and Uganda. It has become evident, that the present regulatory and legislative set-up in many countries can hinder the introduction of eco-sanitation systems, and do not actively support recycling and sustainable resource management in the water and sanitation sector. Research needs to focus on providing a sound basis for developing legislation, regulation and technical standards that favour recycling oriented wastewater and excreta management, ensuring a high level of public health and environmental and performance standards.

**Project Box 14: Vocational training centre “Dalit Shakti Kendra” in India (GTZ-ecosan-newsletter 2005-18)**

The Navsarjan Trust was established in 1989 to help eliminate discrimination based on caste and gender and to assure equality of status and opportunities. In cooperation with GTZ and with support of the Swiss Agency for Development and Cooperation SDC, Navsarjan Trust has developed ecologically sound sanitation concepts based on various technological components on different sites.

A vocational training centre for Dalit youth called Dalit Shakti Kendra (DSK) was established in Gujarat in 1999. The DSK comprises an administration and kitchen building, a workshop building, a common toilet centre, a hostel and a community training centre. DSK is used by around 250 students, and a variable number of guests attending meetings and workshops. The sanitation concept comprises the following components: (1) A common toilet block with toilets for men and women, a biogas plant and subsequent treatment of the digested slurry in soilisation fields. The biogas plant also receives the manure of between 5 and 10 buffaloes. Source separated urine from the urinals and the squatting pans, is collected in tanks outside the toilet building. Urine storage and hygienisation tanks (black plastic tanks) are exposed to the sunlight to facilitate hygienisation. (2) Greywater from showers in the hostel and from the kitchen is treated in organic filters for solids removal and reused for surface irrigation; (3) Two double vault urine-separation vermi-toilets are installed. Earth worms facilitate the composting of faeces in the batch-chambers; (4) Urine is collected separately and directed together with water from hand washing to a greywater garden. Leachate from the composting chamber is treated and reused in a special leachate garden. The leachate is applied below surface to avoid public exposure to pathogens.

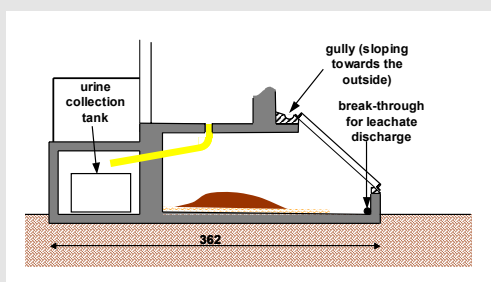

**Figure 32: Urine-separation vermi composting toilet (left) and new school toilet block with bio-gas treatment - under construction (right). (GTZ)**

(5) Mixed wastewater and blackwater from toilets in the community training centre is treated in organic filters, followed by evapotranspiration/infiltration beds. (6) Some greywater is being separately collected and directly treated and used in mulch trenches which allow a safe reuse of untreated greywater. As organic mulch material decomposes, the trenches have to be restored periodically

### **Awareness raising**

Ecosan systems have the overriding aim of improving public health and hygiene. However, the basic premise of ecosan, of closing the nutrient loop between sanitation and agriculture, means that designers of ecosan systems must consider a much wider range of factors than those of conventional systems. This also leads to the consideration of soil conservation, increased long-term food security, and the sustainable use of resources (in the form of nutrients, organics, water and energy). As ecosan aims to solve sanitation problems and ensure reuse at the lowest possible level, promoters of these systems also have to consider the active engagement of the local private sector, contributing to job creation and poverty reduction.

The phrases “awareness raising” and “public education” came into wide use in the political modernisation of a number of urban environmental and governance systems in the 1990s. Another term, “social advertising”, is slightly more accurate, in that all of these terms refer to a process of public relations or propaganda for stakeholders who are outside of – or peripherally related to – the

main decision-making processes. Awareness raising is often a strategy to bring these stakeholders into the process, sometimes as a counterweight to traditional or conventional institutions and experts.

Awareness raising focuses on “elevating the level of knowledge” that the users of a system have, so that they can participate in decision making at a more informed level. It is focused primarily on two kinds of communications: (1) instructions on how to use the system, comply with the rules, or change behaviour to match the needs of the system providers; and (2) information or justification about why this is necessary, desirable, morally appropriate, religiously approved, environmentally sound, or the like. There are a number of classic formulae for awareness raising, among them the “decision-makers guides”, “key sheets”, “decision trees”, SWOT analyses, and “advantages and disadvantages” tables.

The main reason for awareness raising with regard to ecological sanitation is that the ecosan approach and range of alternative technical, logistical, and institutional options are at the moment relatively unknown, not only to (potential) users, but also amongst engineers, planners, decision makers, agriculturists and even sanitation professionals. The role of awareness raising is therefore to spread this knowledge and to raise the profile of ecosan solutions among all stakeholders, with due attention to their power in the process, their tasks, their information needs, and the ways in which this information must be presented.

The strategy of most awareness raising is to de-construct and re-construct a particular discourse about alternatives, bringing in new information, criteria, or factors which weigh differently than those in the conventional approach. In sanitation, for example, the conventional criteria have to do with microbiology, (in-house) health, and hygiene, whereas ecosan shifts the debate to a discussion (among others) of health and hygiene risks from contaminated surface water and insufficiently treated effluents, on water-intensivity, resource use, poverty reduction, nutrient cycles, and cultural appropriateness. The result of bringing them into the sanitation discussion is to create a demand for comparing conventional with new solutions, and (sometimes) creates a space for decision makers to take different decisions and support alternatives.

Topics of the new discourse are e.g.:

- participation versus top-down approaches
- sanitation only for those who pay for it versus pro poor sanitation
- comparing the money invested in sanitation with the gains for the national economy
- capital cost versus labour cost and job creation
- centralised versus decentralised
- large infrastructure versus modest investment
- end-of-pipe versus closed loop systems
- waste as a resource versus waste as something to be disposed of

## **6 Conclusion: The role of educational institutions in stimulating and supporting the paradigm shift towards sustainable sanitation**

Education has a clear role to play, both in acknowledging the paradigm shift in sanitation and in incorporating the interdisciplinary theme of innovative sustainable sanitation systems into teaching curricula. Education on ecosan should enable the people to develop, plan and implement eco-sanitation systems that are hygienically safe, socially acceptable, economically feasible, environmentally sound and technically appropriate.

Educational institutions, universities, and technical schools can contribute to the mainstreaming of the new sanitation paradigm by fully integrating the discourse and criteria for sustainability into their curricula. They should make clear that defining criteria for sustainable sanitation is a political act and influences what is the accepted, legitimate form of sanitation, including the impacts from sanitation on other sectors. Sanitation capacity building should take the stakeholders in a sanitation project not as objects, but as partners for jointly developing sustainable sanitation solutions.

In response to satisfying especially the health needs of unserved, mostly poor population groups, education and research has to add resource conservation and waste reuse into taught sanitation paradigm, in order to improve economic conditions and the health of the population served, the quality of the environment and the long term availability of natural resources.

Sanitation engineers and practitioners, policymakers, managers, and operators get their ideas and information during their education. Therefore the curricula of universities, continuing education programmes, technical schools, research institutes and training centres have to include the ecosan philosophy. Thus several objectives, such as the improvement of human health, poverty reduction in developing countries, the conservation of natural resources and sustainable water and sanitation management systems in both, industrialised and developing countries may be addressed. Those responsible for the content of curricula should be informed about the new developments in this field.

The education system has to prepare students to think about urine and faeces and grey/black water as resources. Emphasis has to shift from the simple disposal to the hygienisation of contaminated flow streams, and to resource conservation and safe reuse. Teaching must make clear that health and a healthy environment is a prerequisite for human productivity, and productivity determines economic well being.

Many proven technical elements are available for ecological sanitation systems and the number of pilot demonstration and research projects, and of large scale applications, is continuously increasing. However, given the broad variety of local framework conditions and the large number of open questions in this complex interdisciplinary field, there is still a great need to further develop technical and operational solutions and to enlarge the knowledge base with respect to public health, risk management, economics, logistics, material-flow-streams, socio-cultural and many other aspects. Research in these disciplines will require trans-sectoral and interdisciplinary co-operation and inputs from a range of research fields.

Development and applied research should concentrate on a large series of pilot research and demonstration projects which can serve as laboratory for developing and field-testing a broad variety of technical and operational sanitation systems. The pilot research and demonstration projects should showcase innovative solutions in a variety of climatic, social, cultural, economic and geomorphological contexts, and should enable the development of a series of model solutions covering the whole range of sanitation needs.

Research should concentrate on comparative studies between a range of conventional and innovative solutions comparing them against a set of sustainability criteria. It should also help in developing field tested and proven sustainable sanitation components and systems, and contribute to forming a knowledge base for drawing up technical standards. Documentation and case studies for innovative

sanitation solutions should be easily made available in a uniform comprehensive format, and technical information for components of innovative sanitation solutions should be provided to accelerate their dissemination.

The achievement of the sanitation MDGs is one of the major challenges for sustainable development in the next decade. Putting emphasis on education and research for ecologically sustainable sanitation may largely contribute to reaching this goal.

## 7 Annex - Examples of workshop contents, curricula outlines and an awareness raising presentation

These examples are demonstrating the broad range of awareness raising, teaching, practical training, and professional networking activities, which may serve as a source for the reader to build his own materials and tools.

Presentations, workshops and curricula have to be strongly tailored to the target group they are meant for. Further more an awareness raising workshop will differ from a project-start-up workshop or a decision-making workshop. Not only the target group in general e.g. secondary school teachers, but as well e.g. the specific geographic and socio-cultural context has to be addressed. Teachers in sub-Saharan countries need different input than those in Sweden. Hence no two presentations, workshops, curricula will be alike, if such differences are well addressed.

The below given examples are not more than a stimulation or first input for those planning to work out their own ecosan teaching-framework, presentation-material, or workshops for their individual context.

The intention is, however, to show the wide range of topics to be covered and groups to be specifically addressed, with the set of examples given below.

More Examples and material are found on the “ecosan resource” CD that is either found at the end of this publication, or can be ordered from [ecosan@gtz.de](mailto:ecosan@gtz.de). Information on up-to-date online-versions of this “ecosan resource” CD are found at <http://www.unesco.org/water/ihp> [search in “publications”] and at [www.gtz.de/de/dokumente/en-ecosan-education-resources-2006.pdf](http://www.gtz.de/de/dokumente/en-ecosan-education-resources-2006.pdf).



### 7.1 Example: A three-minute awareness raising presentation at CSD12

The speech and presentation “ecosan - principles, urban applications and challenges” given by Christine Werner at the 12th session of the UN Commission on Sustainable Development (12 CSD) on ecological sanitation is given as an example for an awareness-raising presentation.

The speech had duration of 3 minutes, provoked a lively discussion at the CSD12 on the topic and was aimed at high ranking political decision makers.

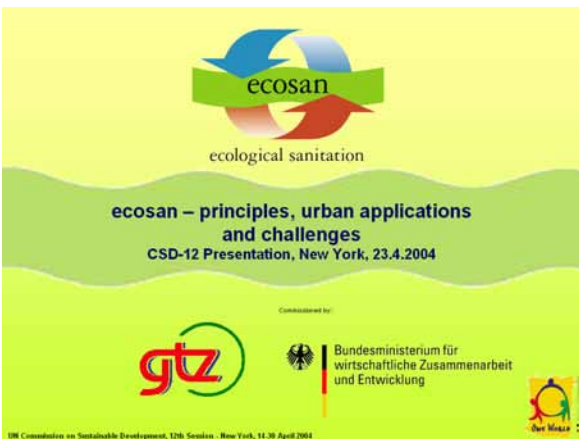
**Table 8: Example for a 3-minute awareness raising presentation**

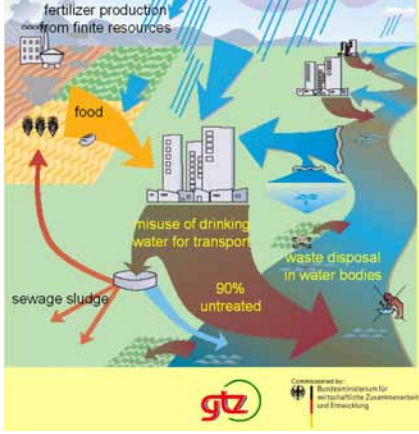

Text	Slide of presentation
<p><b>Ecosan - principles, urban application and challenges</b></p> <p>Occasion: UN Commission on sustainable development CSD 12th session – New York, 14th to 30th of April 2004</p>	

Text	Slide of presentation				
<p>The idea, that human excreta are wastes with no useful purpose is a modern misconception. It has led to the development of so-called “drop and store” or “flush and forget” sanitation solutions, where precious drinking water is used to transport excreta into the water cycle misusing our rivers, oceans and aquifers as a sink for untreated waste.</p>	 <p><b>misconception of current sanitation</b></p> <p>GTZ logo and text: <small>Commissariat für Bundesministerien für wirtschaftliche Zusammenarbeit und Entwicklung</small></p>				
<p>On the other hand, farmers around the world yearly require 135 Mio tons of mineral fertiliser for their crops, while at the same time conventional sanitation dumps 50 Mio tons of fertiliser equivalents flows into our water bodies - nutrients with a market value of around 15 Billion US dollars.</p>	 <p><b>excreta are a valuable resource</b></p> <p>million tons per year (as N + P<sub>2</sub>O<sub>5</sub> + K<sub>2</sub>O)</p> <table border="1"> <tr> <td>global mineral fertilizer consumption</td> <td>135</td> </tr> <tr> <td>global fertilizer equivalent in wastewater</td> <td>50</td> </tr> </table> <ul style="list-style-type: none"> <li>more than 1/3 of global mineral fertilizer consumption can be covered by the reuse of human excreta</li> <li>over 15 billion US\$ fertilizer equivalent are annually flushed down the toilet</li> </ul> <p>GTZ logo and text: <small>Commissariat für Bundesministerien für wirtschaftliche Zusammenarbeit und Entwicklung</small></p>	global mineral fertilizer consumption	135	global fertilizer equivalent in wastewater	50
global mineral fertilizer consumption	135				
global fertilizer equivalent in wastewater	50				
<p>In nature however, there is no waste. All products of living things are used as raw materials by others as part of a cycle. Considering the environmental damage, the health risks, and the worsening water crisis, a revolutionary rethink of our current sanitation practises is urgently needed. To solve our self made sanitation problems, ecosan applies the basic natural principal of closing the loop by using modern and safe sanitation and reuse technologies, thereby continuing the historic tradition of recycling human wastes once applied in most farming societies. Eco-sanitation opens up a wider range of sanitation options than those currently considered.</p>	 <p><b>Closing the loop between sanitation and agriculture</b></p> <p>GTZ logo and text: <small>Commissariat für Bundesministerien für wirtschaftliche Zusammenarbeit und Entwicklung</small></p>				
<p>Firstly, flow streams with different characteristics, such as faeces, urine and greywater, are often collected separately. Rainwater harvesting and the treatment of organic waste and animal manure can also be integrated into the concepts.</p>	<p>Secondly, unnecessary dilution of the flow streams is avoided, for example by using dry, low flush or vacuum transport systems. This minimises the consumption of valuable drinking water and produces high concentrations of recyclables.</p>				



Text	Slide of presentation
<p>Benefits of ecological sanitation comprise: the protection of human health through safe sanitation, the preservation of clean waters, and a safe and healthy environment</p>	<p><b>benefits of ecological sanitation</b></p> <ul style="list-style-type: none"> <li>• safe sanitation</li> <li>• healthy environment</li> </ul> <p>ecosan-toilets in Bangalore, India</p> <p>Commissariat für Bundesministerium für wirtschaftliche Zusammenarbeit und Entwicklung</p>
<p>Benefits of ecological sanitation comprise... the reuse of plant nutrients as valuable fertiliser restoring soil fertility and substituting expensive mineral fertilizers from limited natural resources the reuse of organic matter for improving soil quality, especially its water and nutrient retention capacity</p>	<p><b>benefits of ecological sanitation</b></p> <ul style="list-style-type: none"> <li>• restored soil fertility through nutrient reuse</li> <li>• improved soil quality through reuse of organics</li> </ul> <p>faeces &amp; urine urine none</p> <p>compost improved soil untreated soil</p> <p>after one week without water</p> <p>Commissariat für Bundesministerium für wirtschaftliche Zusammenarbeit und Entwicklung</p>
<p>Benefits of ecological sanitation comprise... the recovery of energy contained in excreta and wastewater for example through the production of biogas and the reuse of water for irrigation, service water or groundwater recharge</p>	<p><b>benefits of ecological sanitation</b></p> <ul style="list-style-type: none"> <li>• recovery of energy content (covering about 20% of cooking energy needs for a typical family in a developing country)</li> <li>• reuse of water</li> </ul> <p>energy savings in fertilizer production &amp; wastewater treatment</p> <p>Commissariat für Bundesministerium für wirtschaftliche Zusammenarbeit und Entwicklung</p>
<p>Examples of ecosan technologies Initially, when Scandinavian pioneers first began promoting the advantages of urine separation and nutrient recovery in the '80's, the focus was on dry sanitation systems for rural areas only. Since then however, many different technical options have been developed, ranging from low cost systems - such as composting toilets, urine diverting dehydration latrines and constructed wetlands - to high tech water-borne applications - such as vacuum sewers, anaerobic treatment, chemical processing or membrane technology, most suitable for use in densely populated urban areas all over the world.</p>	<p><b>examples of ecosan technologies</b></p> <p>urine-separating dehydration latrine</p> <p>constructed wetlands</p> <p>membrane technology</p> <p>biogas plant</p> <p>Commissariat für Bundesministerium für wirtschaftliche Zusammenarbeit und Entwicklung</p>



Text	Slide of presentation
<p>One of the most recent examples in Germany can be seen at the headquarters of the KfW banking group in Frankfurt, where vacuum technology, best known from trains and aircraft, is used to collect blackwater and greywater is being recycled to flush toilets, while at the GTZ main office, urine separation and agricultural use will be implemented in the course of the ongoing renovation of the building.</p>	 <p><b>examples of urban applications</b></p> <p><b>KfW headquarters, Germany</b> Vacuum blackwater collection and greywater recycling</p> <p><b>GTZ headquarters, Germany</b> Urine separation and nutrient recovery planned</p> <p>GTZ Commissariat für Bundesministerium für wirtschaftliche Zusammenarbeit und Entwicklung</p>
<p>However, there are still some challenges to be faced before ecological sanitation systems are widely adopted: Awareness of the alternatives offered by ecosan has to be increased Resource reuse needs to be integrated into sanitation planning processes from the very beginning Legal frameworks and technical standards need to be revised We need a full cost analysis and comparison of the environmental and health risks of all types of sanitation</p>	 <p><b>main challenges</b></p> <ul style="list-style-type: none"> <li>▪ increasing awareness</li> <li>▪ integration of reuse into planning</li> <li>▪ revision of legal frameworks &amp; technical standards</li> <li>▪ establishment of full cost analysis and risk comparisons</li> <li>▪ finding innovative investors and adapting financing instruments</li> <li>▪ implementation of large scale urban projects</li> </ul> <p>Greywater treatment in Norway</p> <p>GTZ Commissariat für Bundesministerium für wirtschaftliche Zusammenarbeit und Entwicklung</p>
<p>Innovation-friendly investors are required, as well as new financing instruments supporting private households investment</p>	<p>And, most important of all, we need large scale implementation of ecosan projects in urban areas for show casing the technical feasibility and the benefits of this new approach</p>
<p>We all recognise that a “business as usual” approach to provide sanitation will not allow us to meet the MDGs. Despite more than 100 years of experience and trillions of dollars of investment, conventional systems have failed. But we still continue to waste our non-renewable resources as if they were in infinite supply. Due to its huge potential, ecological sanitation must be recognised and introduced as the new promising holistic and sustainable approach to provide safe and decent sanitation, reduce poverty, contribute to food security, preserve our environment and maintain the natural basis of life on earth.</p>	 <p><b>Conclusion</b></p> <ul style="list-style-type: none"> <li>▪ “business as usual” will not allow us to meet the MGDs, as conventional systems have failed</li> <li>▪ we cannot continue to waste our non-renewable resources</li> <li>▪ ecological sanitation must be recognized and introduced as the new promising holistic and sustainable approach to provide safe and decent sanitation, reduce poverty, contribute to food security, preserve our environment and maintain our natural basis of life on earth</li> </ul> <p>GTZ Commissariat für Bundesministerium für wirtschaftliche Zusammenarbeit und Entwicklung</p>

## 7.2 Example: Advanced 3 plus 2 weeks ecosan training course in Sweden

This 3 plus 2 weeks advanced ecosan training course by Stockholm Environment Institute and funded by SIDA, Sweden, is designed for professionals (engaged in town planning, water supply, waste management, and socio-economic development), researchers and trainers (in the field of environmental sanitation), and key persons (e.g. engaged in NGOs with projects related to improved sanitation and water supply). It has the following overall objective and long term goal:

**Objective:** To acquire information and knowledge about new options in sanitation in order to support urban dwellers in reducing environmental health risks, improving their nutritional status and protecting their water sources.

**Goal:** Lead to better health and well being as well as the protection of the environment.

**Duration / Structure / Location:**

**Part 1:** The first 3-weeks introduction to the basics of ecosan takes place in Sweden.

**Part 2:** Back in their countries of origin, participants work on professional ecosan projects for several months, supported by the course supervisors.

**Part 3:** A two weeks course takes place in or near the participant's countries of origin. This part is based on the individual projects with discussions and seminars with professionals from the country where the course is given. This regional exchange and cooperation will support regional networking.

**Method:** A mix of lectures and work in groups. The first three weeks introduce the problem-based learning method.

**Table 9: Programme for part 1 (3 weeks, in Sweden) of the advanced Sida/EcosanRes course of ecological alternatives in sanitation**

Country	Sweden		
Type of activity (Name)	Advanced 3 plus 2 weeks ecosan training course		
Dates	14 August – 4 September, 2005		
Place	Stockholm		
Organizer	Stockholm Environment Institute		
Sponsor	SIDA		
No. participants	30		
Objective	To acquire information and knowledge about new options in sanitation in order to support urban dwellers in reducing environmental health risks, improving their nutritional status and protecting their water sources		
Sunday, 14 August			
Time	Content	Lecturer/ressources	Base group assignment
18:00	Course opening with joint dinner (+ info on Sweden)	All	-
Day 1: Monday, 15 August			
Time	Content	Lecturer/resources	Base group assignment
09:00	Welcome and course description	JOD	
09:30	Welcome by Sida/SEI	Andersson /AR	
10:45	Presentation of course programme	JOD+TAS+HJ	
14:00	Hygiene/food prod./management		
19:00	Intro. to Problem-Based Learning	JOD+CS+BV+HK	
	Introductory case		
	Pre-conceived ideas about ecosan	Individual task	
Day 2: Tuesday, 16 August			
Time	Content	Lecturer/resources	Base group assignment
08:30	<i>"Pathogens &amp; disease transmission"</i>	TAS+CS	
10:00	Base-group work	JOD+CS+BV+HK	Test case
13:00	Study tour to Skarpnäck (dry toilets)	CS+BV+HK	
16:30	Return to hotel (review in the bus)		
Day 3: Wednesday, 17 August			
Time	Content	Lecturer/resources	Base group assignment
08:30	Base-group work	-	Test case cont.
10:00	BG-meeting (present test case +new)	JOD+CS+BV+HK	Start Case I
13:45	<i>"Indicators and the risk concept"</i>	CS	-
15:30	Free for shopping & sightseeing		
Day 4: Thursday, 18 August			
Time	Content	Lecturer/resources	Base group assignment
08:30	<i>"Urban groundwater &amp; treatments"</i>	GJ	Case I cont.
11:30	Base-group work		
14:00	<i>"Hygienisation of excreta and WHO Guidelines"</i>	TAS	
15:30	Base-group work		
17:00	Bus to Skansen + ferry to Gamla stan	Guide tour	

Day 5: Friday, 19 August			
Time	Content	Lecturer/resources	Base group assignment
08:30	Base-group work	-	Case I cont.
10:30	"Greywater treatment and use"	HJ	
13:30	Report of Case I in plenum+comments	JOD+CS+Bv+PR	Report Case I
14:30	Greywater in Erdos and Bufallo City	PR	
15:30	BG-meeting	JOD+CS+Bv+HK	Start Case II
Saturday, 20 August			
Time	Content	Lecturer/ressources	Base group assignment
08:15	Study tour: Building exhibition centre/ Nacka NaturCentrum /Hammarby Sjöstad/Bornsjön Travel to Linköping		-
Sunday, 21 August, Free activities			
Day 6: Monday, 22 August			
Time	Content	Lecturer/resources	Base group assignment
08:30	"A holistic house"	RSh (Nepal)	Case II cont.
11:00	BG-work		
13:00	"How to produce interview protocols"	JOD	
14:30	Sanitation experiences from participants' countries (plenum)	All participants 10min/country	
Day 7: Tuesday, 23 August			
Time	Content	Lecturer/resources	Base group assignment
08:30	Study visit to Ekoporten		Case II cont.
13:00	"Wetland treatment of wastewater"	KS	
14:30	Sanitation experiences, cont.	Participants	
Day 8: Wednesday, 24 August			
Time	Content	Lecturer/resources	Base group assignment
08:15	1/2-group interview training, prep. of individual interview protocol	Video mirroring	Case II cont.
13:00	1/2-group interview training, prep. of individual interview protocol	Video mirroring	
Day 9: Thursday, 25 August			
Time	Content	Lecturer/resources	Base group assignment
08:15	Cont. base-group with Case II	-	Case II cont.
10:30	Individual interviews with <i>users and producers of ecosan</i>	-	
18:00	Multicultural dinner		
Day 10: Friday, 26 August			
Time	Content	Lecturer/resources	Base group assignment
08:30	Report of Case II in plenum+comment	JOD+CS+Bv+HK	Report Case II
10:30	BG-meeting	JOD+CS+Bv+HK	Start Case III
13:00	"Treatment of excreta"	BV	
15:30	Outstanding issues of Case II	CS	

	introduction to professional project	JOD+CS+BV+HK	
Saturday, 27 August			
Time	Content	Lecturer/resources	Base group assignment
08:30	Departure from Linköping Study visit to Enköping with ww irrigation. Travel to Uppsala. <i>"Small-scale options"</i> Visit to home garden in Uppsala Arrival at hotel	BV+JOD BV+Muller  HJ	
Sunday, 28 August, Free activities			
Day 11: Monday, 29 August			
Time	Content	Lecturer/resources	Base group assignment
08:30	<i>"Urine, faeces &amp; solid waste as fertilisers"</i>	HJ	Case III cont.
10:30	Reports of interviews in plenum	JOD+CS+BV+HK	
13:30	<i>"Residents' views and wants"</i>	RS	
15:00	Reports of interviews cont. + summary	JOD+CS+BV+HK	
17:00	<i>Production of simple ecosan-toilets</i>	BV+HJ	
Day 12: Tuesday, 30 August			
Time	Content	Lecturer/resources	Base group assignment
08:30	<i>"Fertilisers in urban farming and gardening"</i>	HJ	Case III cont.
10:00	Base-group work		
13:00	<i>"Ecosan in practice-technical issues"</i>	HJ+JOD	
15:15	Discussion of professional project	BV+CS+JOD	
15:45	Base-group work		
Day 13: Wednesday, 31 August			
Time	Content	Lecturer/resources	Base group assignment
08:30	<i>"Evolution of toilet systems (Gender)"</i>	JOD	Hand in draft of professional project
10:30	Base-group work	(KT)	
13:30	<i>"Institutional aspects of ecosan"</i>	JOD	
15:30	Film on dalits in India, Durban, etc.	JOD	
Day 14: Thursday, 1 September			
Time	Content	Lecturer/resources	Base group assignment
08:30	<i>"Systems perspectives incl. costs and returns of various arrangements"</i>	HJ+JOD	
10:30	Report on Case III in plenum	JOD+CS+BV+HK	Report on Case III
13:00	Evaluation of experience of PBL	JOD+CS+BV+HK	
15:30	General discussion on ecosan		
18:00	Preparation for departure	All	DHL
Day 15: Friday, 2 September			
Time	Content	Lecturer/resources	Base group assignment
08:30	Group discussion on planning & discussion of professional projects	All	
10:30	Ecosan in the future (MDG)		

13:00	Bengt Johansson, Sida-Natur	Sida, all	
13:30	Evaluation, summing up experiences		
19:00	Farewell dinner	All	
Saturday, 3 September, departure			
Sunday, 4 September, departure			

**Table 10: Programme for part 3 (2 weeks, regional) of the advanced Sida/EcosanRes course of ecological alternatives in sanitation in or near the participant's countries of origin**

Country	African participants meet in S. Africa, Asian participants in India		
Type of activity (Name)	Follow-up course to professional projects		
Dates	13 – 24 February, 2006 (Africa) and March 13 -24 2006 (India)		
Place	variable		
Organizer	Stockholm Environment Institute and a local organiser		
Sponsor	Sida		
No. participants	15 African participants in South Africa, and 15 in India		
Objective	To strengthen the ability to organise and improve ecosan projects		
Day 1: Monday, 13 February			
Time	Content	Lecturer/resources	Base group assignment
09:00	Welcome by local organiser	SM	
09:30	Presentation of course programme	JOD	
10:15	<b>Seminar:</b> "Sanitation norms & policy"	DWAF	
13:30	Presentation of participant projects	Each participants	
17:00	(20 min for each)		
19:00	Welcome dinner		
Day 2: Tuesday, 14 February			
Time	Content	Lecturer/resources	Base group assignment
08:30	Project presentations continue	Each participant	
11:00	Peri-urban sanitation projects	DG	
13:15	Base-group task: select 2 focus areas	JOD+SS	Case V
15:15	Base-group work	Participants	
Day 3: Wednesday, 15 February			
Time	Content	Lecturer/resources	Base group assignment
08:00	Study visit to periurban sanitation units	Schoman, Booyesen	
11:30	Follow-up of visit	JOD	
13:00	e.g. "An array of technical solutions"	Base group A	Report 1 of Case V
14:15	<b>Workshop A:</b> "Fit or misfit of technical systems in the urban context"	DG	Team 2

[... continued]			
Day 4: Thursday, 16 February			
Time	Content	Lecturer/resources	Base group assignment
08:30	e.g. "Monitoring activities"	Base group B	Report 2 of Case V
09:15	<i>"Work in communities. Promotion &amp; monitoring strategies for ecosan"</i>	SM	
13:15	Practical task: produce info material for toilet/greywater use and maintenance	Local professional & work in groups	
Day 5: Friday, 17 February			
Time	Content	Lecturer/resources	Base group assignment
08:30	Presentation of information material	Participants	Reports Case VI
10:00	Base-group task: "Sanitation matters"	JOD+SS	
13:30	Preparation of individual interviews	JOD	
14:15	Preparation continue in small groups	Participants	
Saturday, 18 February			
Time	Content	Lecturer/resources	Base group assignment
24:00	"Ghost" tour in town?		
Sunday, 19 February, Free activities			
Day 6: Monday, 20 February			
Time	Content	Lecturer/resources	Base group assignment
08:30	<b>Workshop B:</b> <i>"Reuse of greywater, urine and dried faecal matter"</i> <i>"Prevention is better than cure"</i>	CB, HJ	Case VI cont., Team 3
13:00		T-A Stenström	
14:30		Individual interview in town	
Day 7: Tuesday, 21 February			
Time	Content	Lecturer/resources	Base group assignment
08:00	Study visit to small ecosan projects	Henk	Case VI cont.
11:00	Follow-up of visit and lessons learnt	TAS	
11:30	<b>Workshop C:</b> <i>"A sanitary city"</i>	AA	
15:30	Preparation of presentations by groups	Participants	
Day 8: Wednesday, 22 February			
Time	Content	Lecturer/resources	Base group assignment
08:30	Presentation of interviews in groups with similar informants. Discussion.	JOD+SS	Case VI cont.
10:30	" "	Still open slot	
13:30	<i>Base-group work</i>	Participants	
14:30	<i>"Systems Analysis and an algorithm"</i>	JOD+ HJ	
Day 9: Thursday, 23 February			
Time	Content	Lecturer/resources	Base group assignment
08:30	Presentation of ideas for future work	Participants	Case VI cont.
10:30	Working groups on future work	Participants+some former	
13:15	Cont.		Report of Case VI
15:00	Presentation of Case VI	Participants	

[... continued]			
Day 10: Friday, 24 February			
Time	Content	Lecturer/resources	Base group assignment
08:30	Establishing local and country working groups. Plans for networking	Participants	
11:00	Oral evaluation of course	JOD	
13:30	Evaluation cont.		
14:30	Closure of the training programme	Invited guest	
18:00	Farewell dinner		
<i>Abbreviations for names used in this table are:</i>			
IA	<i>Ingvar Andersson, Sida</i>		
AR	<i>Arno Rosemarin, SEI, Stockholm</i>		
BV	<i>Björn Vinnerås, Swedish University of Agricultural Sciences, Uppsala</i>		
CS	<i>Carolina Schonning, Swedish Institute of Infectious Disease Control</i>		
HJ	<i>Hakan Jönsson, Swedish University of Agricultural Sciences, Uppsala</i>		
HK	<i>Helena Krantz, Linköping University</i>		
JOD	<i>Jan-Olof Drangert, Linköping University</i>		
KS	<i>Karin Sundblad, Linköping University</i>		
GJ	<i>Gunnar Jacks, KTH, Stockholm</i>		
PR	<i>P. Ridderstolpe, WRS, Uppsala</i>		
RSh	<i>R. Shrestha, UN-Habitat, Nepal</i>		
RS	<i>Ron Sawyers, Sarar, Mexico</i>		
TAS	<i>Thor-Axel Stenström, Swedish Institute of Infectious Disease Control</i>		
AA	<i>Aussie Austin, CSIR, South Africa</i>		
CB	<i>Chris Buckley, University of Kwa Zulu Natal, Durban</i>		
SM	<i>Shelly van der Molen, Consultant, Kimbreley</i>		
GD	<i>Duke Gumede, Cape Town City council, South Africa</i>		
SS	<i>Saskia Senekal, Homevale WWTP, Kimberley</i>		

### 7.3 Example: Schedule of a 5-day ecosan introduction course in Norway

The Agricultural University of Norway (NLH) offers different courses which include ecological sanitation in their curricula. The course schedule presented below refers to the course “Appropriate sanitation in the developing world” which is a 5-day course for both, professionals and students.

Focus: The focus of this course is to explore ecological solutions for developing countries. Specifically, recycling and natural waste treatment systems are examined. Case-studies are presented by sanitation specialists, followed by analysis of associated issues – both technical and social. The range of case studies covers Asia, Africa and Latin America. And the scope of analysis offered by engineers, scientists, and public officials is wide and timely.

Target group: The course is designed for both the professional and student. Its purpose is two-fold: (1) to illustrate how ecological sanitation is applied in developing countries, and (2) to explain, in-depth, the principles of ecological engineering. Participants are expected to include professionals from consulting firms (e.g. civil engineers), NGO personnel (field and administrative), public officials (e.g. health and foreign services), research scientists, and students from various disciplines.



**Table 11: Schedule of a 5-day ecosan introduction course in Norway**

Country	Norway	
Type of activity (Name)	5-day ecosan introduction course	
Dates	Every year; e.g. from 24 to 28 May, 2004	
Place	Agricultural University of Norway, Ås, (30 km from Oslo)	
Organizer	Agricultural University of Norway (NLH)	
Sponsor	Financed by fees, limited number of scholarships available	
No. participants	30	
Objective	Explore ecological solutions for developing countries	
Day 1: Monday, 24 May (Fundamentals of ecological sanitation)		
Time	Content	Presenter
09:30 – 09:40	Welcome	
09:40 – 10:20	Ecological sanitation an option for all	P. D. Jenssen
10:20 – 10:40	The UN goals for water and sanitation	M. Svelle
10:40 – 11:00	Coffee break	
11:00 – 11:10	Welcome to the University	O.J. Skjelhaugen
11:10 – 11:35	The wastewater resource	P. D. Jenssen
11:35 – 12:15	Ecological sanitation in developing countries	H.P. Mang
12:15 – 13:15	Lunch	
13:15 – 14:00	Composting and dry sanitation toilets	P.D. Jenssen
14:15 – 15:00	Vacuum toilets and vacuum transport	K. Haddal
15:15 – 16:00	From blackwater and organic waste to fertilizer	J. Morken
16:15 – 17:00	Demonstrations: toilet options for the future, greywater treatment and slurry injection	J. Morken, P.D. Jenssen
Day 2: Tuesday, 25 May (Sanitation under stress - Agricultural aspects)		
Time	Content	Presenter
08:30	Sanitation under stress: scenarios, challenges -experiences after Tsunami	A. Koestler
	Case study - input parameters: New settlements along tsunami affected coast lines	A. Koestler
	Case study exercise - group work A	Koestler/P.D. Jenssen/ H.P. Mang
12:15	Presentation and discussion of students work	A. Koestler/P.D. Jenssen/ H.P. Mang
12:15 – 13:15	Lunch	
13:15 – 14:00	Summary and formulation of future tasks and challenges - what is really needed in disasters!	A. Koestler/ P.D. Jenssen/ H.P. Mang
14:15 – 15:00	Urine diverting systems - an overview	E. Kvärnström
15:15 – 17:00	Agricultural aspects of ecological sanitation with practical demonstrations	E. Kvärnström
Day 3: Wednesday, 26 May (Natural systems – Health aspects)		
Time	Content	Presenter
08:30 – 10:00	Soil for groundwater protection and wastewater treatment	P.D. Jenssen/ S. Jonasson
	Coffee break	
10:15 – 11:00	Soil for groundwater protection and wastewater treatment	P.D. Jenssen/ S. Jonasson
11:15 – 12:15	Greywater treatment and reuse	P.D. Jenssen
12:15 – 13:15	Lunch	
13:15 – 14:00	Health aspects of ecological sanitation	T.A. Stenström
14:15 – 15:00	Health aspects of ecological sanitation	T.A. Stenström

15:15 – 16:00	WHO guidelines for excreta and greywater reuse	T.A. Stenström
16:15 – 17:00	Energy aspects and co-treatment of waste	P.H. Heyerdahl
19:00	Garden party	
Day 4: Thursday, 27 May (Energy – Wetlands, ponds and aquaculture for wastewater treatment – Participant presentations)		
Time	Content	Presenter
08:30 – 09:45	Biogas systems	H.P. Mang
09:45 – 10:00	Coffee break	
10:00 – 10:45	Wetlands and ponds an overview	P.D. Jenssen
10:45 – 11:30	From pit latrines to constructed wetlands- peri urban solutions near Colombo Sri Lanka	A. Heistad
11:30 – 12:15	Ecological Sanitation for Megacities: Calcutta Wetlands and other examples	B. Guterstam
12:30 – 13:15	Lunch	
13:15 – 13:45	Experience from an ecovillage in Denmark	D. Wulfson
13:45 – 14:30	Ecosan examples	H. P. Mang
14:30 – 14:45	Coffee break	
14:45 – 17:00	Participants presentations	
18:00	Excursion to the Klosterenga urban greywater treatment system in Oslo - dinner and sightseeing	
Day 5: Friday, 28 May (Social and economic issues related to sanitation)		
Time	Content	Presenter
08:30 – 09:15	Organizing decentralized systems – a GIS based tool	H. Borch
09:30 – 10:00	Socioeconomic issues related to ecological sanitation	O. Hanserud
10:00 – 10:15	Coffee/tea	
10:30 – 12:30	Case Bangalore: Eco-san public toilets Starting an economic spiral Generating employment Grassroot involvement for success Economy and gender aspects The influence of religion	K. Gnanakan, J. Heeb
12:30 – 13:15	Lunch	
13:15 – 14:00	Case Bangalore continued	
14:00 – 15:00	Discussions and summing up	J. Heeb/H.P. Mang/ P.D. Jenssen
15:00	Adjourn	

## 7.4 Example: Workshop in the frame of the large urban ecosan project in Erdos, China

Erdos represents a cluster of cities in a coal mining belt of Inner Mongolia. The ecosan project undertaken by EcosanRes and the Chinese Government takes place in a new eco-town which is being developed as a suburb a few kilometres from the city centre of Dongsheng.

The outline below refers to an awareness raising workshop, undertaken with government officials and various experts. Its aim was to introduce the ecosan concept and to identify an appropriate innovative solution for its local application in the eco-town.

**Table 12: Schedule of a 4-day ecosan training course in China**

Country	China	
Type of activity (Name)	4-day ecosan training course	
Dates	17-22 July 2003	
Place	Dongsheng, Inner Mongolia	
Organizer	China-Sweden Erdos Eco-town Project	
Sponsor	Swedish International Development Agency	
No. participants	n.a.	
Objective	Introduce ecosan concept and discuss future adaptation at local level	
Day 1: Thursday, 17 July		
Structure	Content	Presenter
Lecture 1	The current situation and the challenge of the UN Millennium Goals: globally and in China Issues: environment, costs, awareness and institutions Conventional solutions: pit toilets and flush toilets	Q. Zhu
Lecture 2	The vision: a systems approach to the management of human excreta; closing-the-loop vs. a linear approach Basic principles: diversion, containment, sanitization and recycling	U. Winblad
Groupwork 1	Read training material; discuss existing sanitation systems in Inner Mongolia, advantages, disadvantages, what people want. (For example 20 min group discussions, 5 min presentations/discussions - 5 groups.)	J. Xiao
Lecture 3	Excreta management and public health: - excreta related diseases - barriers - how pathogens die	J. Xiao
Lecture 4	Stepwise pathogen destruction: - divert urine - prevent dispersal of faeces - reduce volume and weight - kill pathogens - primary and secondary treatment	U. Winblad
Groupwork 2	Read training material; discuss public health aspects of existing sanitation systems in Erdos Municipality. Formulate questions to be answered / discussed by resource persons and participants.	J. Xiao
Lecture 5	Urine and faeces - amounts and properties Examples of urine diversion	J. Xiao U. Winblad

Day 2: Friday, 18 July		
Structure	Content	Presenter
Lecture 6	Check Peter Morgan's writings - reports and website; Stockholm Water report "Urine Separation -closing the nutrient cycle"; Esrey et.al. "Closing the Loop"; Reports by Hakan Johnsson/ Recycling: - waste or resource? - advantages of recycling - recycling of urine - recycling of faeces	Q. Zhu
Groupwork 3	Discuss recycling of human urine and sanitized faeces in Erdos Municipality	J. Xiao
Lecture 7	Examples of ecological toilets based on dehydration: south China "open toilet", Vietnam, Guangxi, Mexico, Sweden, solar heated, Yemen, Ladakh	U. Winblad
Lecture 8	Examples of ecological toilets based on decomposition: Clivus Multrum, Mexican solar heated, Norway, Kerala, Sweden (Kalmar University)	U. Winblad
Day 3: Monday, 21 July		
Structure	Content	Presenter
Groupwork continued 4	Build a mock-up model of the ecological toilet designed by the group.	Q. Zhu, J. Xiao, U. Winblad
Lecture 9	Design and management features: - urine diversion vs combined processing - dehydration vs decomposition - multiple vaults - anal cleaning material and absorbents - solar heater - ventilation	U. Winblad
Lecture 10	What can go wrong? - Troubleshooting: - lack of participation - lack of knowledge - poor design - defective materials and workmanship - improper maintenance	J. Xiao
Lecture 11	Greywater: - concept and terminology - controlling quantity and quality - processing - utilization	Q. Zhu
Groupwork 5	Discuss different possibilities of handling greywater in the HZK project.	Q. Zhu

Day 4: Tuesday, 22 July		
Sturcture	Content	Presenter
Lecture 12	Large-scale applications, ecostations: - when and where to apply ecological sanitation? - concept and role of ecostations - source separation and community participation - collection and processing	Q. Zhu U. Winblad
Groupwork 6	Discuss the application of the ecostation concept in Erdos.	Q. Zhu J. Xiao
Plenary discussion	Ecological urban development in Erdos Municipality	Q. Zhu J. Xiao U. Winblad
Closing remarks	The Sida-funded R&D project in Erdos Municipality	A. Rosemarin

## 7.5 Example: Schedule of a 2-day ecosan workshop in Eritrea

The following table shows the schedule of a 2-day ecosan workshop conducted by the GTZ in Eritrea in 2005, which may serve as an example for a 2-day awareness-raising workshop.

The workshop was aimed principally for representatives from the Water Resources Department under the Ministry of Land, Water and Environment (MoLWE), but was also attended by representatives from the Ministry of Agriculture, the Ministry of Health and other local authorities. The workshop was planned to be a forum for presenting the roles and responsibilities of the different authorities on national level in regard of sanitation, discussing the overlap of roles about sanitation issues. It addressed the existing sanitation situation in the country, and promoted the ecosan concept as a possible solution to improve the current situation, by the same time saving and protecting the scarce natural resources.

**Table 13: Schedule of a 2-day ecosan workshop in Eritrea**

Country	Eritrea	
Type of workshop (Name)	2 days in depth workshop on ecological sanitation program	
Dates	7-8 May, 2005	
Place	Asmara, Eritrea	
Organizer	Water Resource Department (WRD), GTZ	
Sponsor	GTZ	
No. participants	40	
Objective	The workshop was planned to be a forum for presenting the roles and responsibilities of WRD, MoH and MoA in the promotion of sanitation system on a national basis, presenting the existing sanitation situation in Eritrea, discussing the significant overlap of roles about sanitation issues amongst governmental organisations, and training in great detail the concept of ecosan, so that the participants can share and incorporate it in their sanitation planned activities.	
Day 1: Saturday, 7 May		
Time / Activity	Content	Presenter
8.30 – 8.45	Introduction of participants	
9.00 – 9.30	Participant expectations and key questions	
9.30 – 10.30	The role and activities of the Water Resources Department in sanitation	WRD
10.30 – 11.00	Assessment of the existing sanitation situation in Eritrea	Local Consultant, GTZ
11.00 – 13.00	Tea break	
13.00 – 13.30	An introduction to ecological sanitation – concept, technologies and case studies	GTZ, ecosan Program
13.30 – 14.15	The National sanitation framework (responsibility)	Participants
14.15 – 15.45	Who is involved in sanitation in Eritrea (ministries, departments etc.)? What co-operation exists between those responsible and what is needed?	
15.45 – 16.15	Lunch	
16.15 – 17.45	Agricultural aspects of ecological sanitation	GTZ, ecosan Program
	Health aspects of ecological sanitation	
	Tea break	
	Opportunities and obstacles for ecological sanitation – next steps in Eritrea:	
	What steps are now needed for adoption on a national and individual level?	
Day 2: Sunday, 8 May		
Time / Activity	Content	Presenter
9.00 – 9.20	Summary of day 1	
9.20 – 9.40	Urban agriculture in Eritrea	Min. of Agriculture
9.40 – 10.00	Public health and sanitation in Eritrea	Min. of Public Health
10.00 – 11.00	Planning for ecological sanitation	GTZ, ecosan Program
11.00 – 11.30	Tea break	
11.00 – 12.15	Refer back to expectations and questions and check if they have been achieved. Summing up.	
Closing session		

## 7.6 Example: Schedule of a 3-day ecosan symposium in Syria

The symposium on ecosan was organised by the Syrian order of engineers, the University of Damascus, and the GTZ for water professionals in 2005.

It gives a general introduction in ecosan, it draws on local experience, e.g. from wetlands designed to produce hygienic safe irrigation water from waste water, and includes a case study excursion.

The main objective of this symposium is the capacity building for ecological sanitation and the identification of further activities, which could be realized in order to implement ecosan projects in Syria and other countries of the region.

**Table 14: Schedule of a 3-day ecosan symposium in Syria**

Country	Syria	
Type of workshop (Name)	Ecological Sanitation Symposium	
Dates	11-13 December, 2005	
Place	Damascus, Syria	
Organizer	Order of Syrian Engineers and Architects (OSEA) and German Technical Cooperation (GTZ), University of Damascus	
Sponsor	GTZ- Water Programme and Order of Syrian Engineers and Architects (OSEA)	
No. participants	500	
Objective	Capacity building for ecological sanitation and identification of further activities for implementing ecosan projects in Syria and other Arab countries.	
Day 1 : Sunday, 11 December (Introduction and Syrian situation)		
Time / Activity	Content	Presenter
08:00 - 08:30	Registration	
08:30 – 09:00	Opening Ceremonies (Moderation Saad Ahmad, OSEA)	Mr. Hassan Majed Ali (OSEA ); Prof. Wael Mualla (President of Damascus University) Mr. Volkmar Wenzel (Ambassador Germany)
09:00 – 09.20 Presentation	Syrian-German cooperation in the water sector	Mr. Harald Heidtmann (GTZ Syria)
09:20 – 09:40 Presentation	Future vision for the drinking water supply and sewage sector within the 10th five year investment plan	Dr. Kamal Al-Sheikha (MoHC)
09:40 – 10:00 Presentation	Water pollution and environmental situation in Syria	Mrs. Reem Abdrabo (MLAE)
10:00 – 10:30	Discussion	Mr. Saad Ahmed (OSEA)
10:30 – 11:00	Tea / Coffee break	
11:00 – 11:45 Presentation	Introduction to ecological sanitation	Mrs. Christine Werner (GTZ, Germany)
11:45 – 12:30 Presentation	Overview of ecosan technologies	Prof. Dr. Petter Jenssen (Norwegian University of Life Sciences)
12:30 – 14:00	Tea / Coffee break	
14:00 – 14:45 Presentation	Experiences from a one-year training course for the management of sewage treatment plants in Germany	Mr. Jamal Jarad Mr. Hesham Al-Fandi
14:45 – 15:30 Presentation	International experiences in ecological sanitation / Project examples	Mrs. Christine Werner (GTZ, Germany)

[... continued]		
Day 2: Monday, 12 December (Experience Exchange)		
Time / Activity	Content	Presenter
08:30 - 08:45	Summary of the previous day and presentation of the present day	
08:45 - 09:30 Presentation	Present wastewater and reuse standard in Syria and practices	Mrs. Intesar Mardini (MoHC)
09:30 – 10:15 Presentation	International Guidelines WHO, FAO and Sweden: health and agriculture aspect	Mrs. Christine Werner (GTZ, Germany)
10:15 – 10:45	Tea / Coffee break	
10:45 – 11:30 Presentation	Anaerobic systems for biological treatment in ecological sanitation systems (ecosan) for biogas and fertilizer production	Mr. Michael Köttner (Int. Biogas and Bioenergy Centre of Competence)
11:30 – 12:15 Presentation	Demonstration of anaerobic technology for cost-effective municipal wastewater treatment and reuse - experience from Germany and Egypt	Dr. Walid Abdel-Halim (Housing and Building Nat. Res. Center, Inst. of Env. Eng., Cairo, Egypt)
12:15 – 13:00 Presentation	Constructed wetlands for the provision of irrigation water- and the production of regrowing raw products	Dr. Roland Müller (UFZ-Centre for Env. Research Leipzig/ Germany)
13:00 – 13:30	Tea / Coffee break	
13:30 – 14:15	Wastewater reuse experience in Jordan	Mr. Artur Vallentin (GTZ)
14:15 – 14:45 Presentation	Greywater treatment and reuse	Prof. Dr. Petter Jenssen (Norwegian Univ. LifeSc.)
14:45 – 15:30 Presentation	Reuse of greywater in the Kingdom of Saudi Arabia	Mr. Jäger (BIOCLEAN GmbH)
15:30 – 17:30	Lunch / or Dinner	
Day 3: Friday, 13 December		
Time / Activity	Content	Presenter
08:30 - 08:45	Summary of the previous day and presentation of the present day	
08:45 - 09:30 Presentation	German Association for Water, Wastewater and Waste (DWA)- standards, capacity building and networking	Mr. Roland Knitschky (DWA)
09:30 – 10:15 Presentation	Batch humification of sewage sludge in grass beds	Dr. Holger Pabsch (IPP, Hildesheim)
10:15 – 10:45 Presentation	Constructed wetlands – experiences from a pilot project in Syria	Dr. Abir Mohamed (MoHC, Syria)
10:45 – 11:15	Tea / Coffee break	
11:15 – 12:00 Presentation	Planning process of WWTP for small communities in Syria, overview of difficulties and solutions	Dr. George Zahr (Damascus University)
11:15 – 12:15 Discussion	Future developments	Mr. H. Heidtmann (GTZ); Dr. A. Mohamed (MoHC)
12:15 – 12:30	Closing remarks	Mr. Saad Ahmed
12:30 – 16:30 Excursion	Excursion to Haran Al-Awamied	Dr. Abir Mohamed (MoHC, Syria)

## 7.7 Example: Schedule of a 3-day ecosan workshop in Zambia

This 3-day workshop was meant as a first awareness raising and capacity building workshop for experts and decision-makers in water supply and sanitation in Zambia. At the same time, it served to support regional networking between ecosan initiatives and pilot projects in Southern African countries.



**Table 15: Schedule of a 3-day ecosan workshop in Zambia**

Country	Zambia	
Type of workshop (Name)	1st International Workshop on Ecological sanitation	
Dates	21-23 January, 2004	
Place	Lusaka, Zambia	
Organizer	GTZ-Lusaka and WASAZA	
Sponsor	GTZ-ecosan	
No. participants	n.a.	
Objective	To provide a forum for discussion on ecological sanitation among decision/policy makers, organisations and other donor agencies. The workshop will be the starting point for the promotion of ecological sanitation in Zambia.	
Day 1: Wednesday, 21 January (Introduction, official opening, pilot case studies, hygiene considerations)		
Time / Activity	Content	Presenter
08:00 – 09:00	Registration	
09:00 – 09:15	Introductions	Simataa Nakambo (GKW Consult, Zambia)
09:15 – 10:00 Presentation	Overview of the National Environmental Sanitation Strategy	C. Mulambo (MLGH/DISS, Zambia)
10:00 – 10:45 Presentation	Toilets and Urban Agriculture infrastructure / Ethiopia	Gunder Edström (SUDEA, Ethiopia)
10:45 – 11:30 Presentation	Water-borne ecological sanitation technologies/ closing the loop on-site – experience in Lesotho	Mantopi Lebofa (DED, Lesotho)
11:30 – 12:00	Tea / Coffee break	
12:00 – 12:25 Presentation	Ecological sanitation concept – an introduction	Heinz-Peter Mang (GTZ-ecosan, Germany)
12:30 – 13:00	Official Opening Address	Levi Zulu (WASAZA, Germany) Martina Bergschneider (GTZ Country Director) Sylvia Masebo (Minister of Local Government and Housing, Zambia)
13:00-13:15	Ecological sanitation concept – an introduction cont'd after the speeches	Heinz-Peter Mang (GTZ-ecosan, Germany)
13:15 - 14:15	Lunch	
14:15 – 15:00 Presentation	Experiences in piloting ecosan projects in Zambia	Ernest Hamalila (WaterAid, Zambia)
15:00 – 15:45 Presentation	“CBNRM-missing link”-piloting ecological sanitation in Botswana	Catherine Wirbelauer (IUCN, Botswana)
15:45 – 16:30 Presentation	Institutional and implementation aspects of ecosan in Ouagadougou, Burkina Faso	Patrick Bracken (GTZ-ecosan, Germany)
16:30 – 17:00	Tea / Coffee Break	
17:00 – 17:45 Presentation	Diseases linked to poor sanitation and their prevention	Dr. M. Mbewe (UTH, Zambia)
17:45 – 18:30 Presentation	Health aspect of ecological sanitation	Aussie Austin (CSIR, South Africa)
18:30 – 20:00	Cocktails, discussion and open market space for ecological sanitation components – with invited companies	

[... continued]		
Day 2: Thursday, 22 January (Overview of different aspects of ecosan)		
Time / Activity	Content	Presenter
08:30 – 08:45	Summary of the previous day and presentation of the present day	Simataa Nakambo (GKW Consult, Zambia)
08:45 – 09:30 Presentation	Urban ecological sanitation experiences in Uganda	Austin Ali Tushabe (Directorate of Water Development, Uganda)
09:30 – 10:15 Presentation	Effects of urban expansion on groundwater quality	H. Mpamba (Department of Water Affairs, Zambia)
10:15 – 10:45	Tea / Coffee break	
10:45 – 11:30 Presentation	Urban Integrated Sustainable Resource Management	Gert de Bruijne (WASTE –NL)
11:30 – 12:15 Presentation	Design of feasible ecological sanitation toilets	Aussie Austin (CSIR, South Africa)
12:15 – 13:00 Presentation	Selling the ideas and gender aspect of ecosan	Almaz Terrefe (SUDEA, Ethiopia)
13:00 – 14:00	Lunch	
14:00 – 14:30 Presentation	Agricultural aspects of ecological sanitation	Heinz-Peter Mang (GTZ-ecosan, Germany)
14:30 – 15:30 Presentation	Technical components for ecological sanitation systems - world-wide examples	Heinz-Peter Mang (GTZ-ecosan, Germany)
15:30 – 15:45 Group work	Introduction in group work	Simataa Nakambo (GWK Consult, Zambia), Patrick Bracken (GTZ-ecosan, Germany), Catherine Wirbelauer (IUCN, Botswana)
15:45 – 16:15	Tea / Coffee Break	
16:15 – 18:00 Group discussions	Three themes	
Day 3: Friday, 23 January (The way forward for ecosan in Zambia)		
Time / Activity	Content	Presenter
09:00 – 09:30	Summary of the previous day and presentation of the present day	Simataa Nakambo (GWK Consult)
09:30 – 10:15 Presentation	Ecological sanitation in peri-urban areas – main opportunities and constraints	Brian Hangoma (SWSC)
10:15 – 10:45	Tea / Coffee break	
10:45 – 11:30 Presentation	The Regulator and issues of ecological sanitation	O. M. Chanda (NWASCO)
11:30 – 12:15 Presentation	The general way forward for ecological sanitation in Zambia	Pamela Chisanga (WaterAid Zambia)
12:15 – 13:00 Presentation from participants	Group presentation and Recommendations from workshop participants on ecological sanitation development in Zambia	Participants
13:00 – 14:00	Closing remarks	Heinz-Peter Mang (GTZ-ecosan, Germany) Gert de Bruijne (WASTE – NL) T. C. Chanda stood in for P. Lubambo (MLGH/DISS) Simataa Nakambo (GKW Consult)

## 7.8 Example: Schedule of a 3-day ecosan workshop in Botswana

The Ecosan approach, tested by the IUCN-PTB “Missing Link” project (funded by GTZ) in Botswana consists of small-scale integrated natural resources management activities around the households and within the communities. The schedule presented below is from a workshop held in the frame of this project. It was held to present and discuss the results of the first phase of the project, and discussed options for up-scaling ecosan on to the national level.

**Table 16: Schedule of a 3-day ecosan workshop in Botswana**

Country	Botswana	
Type of workshop (Name)	Awareness Raising Workshop on Ecological Sanitation	
Dates	2nd – 4th September, 2003	
Place	Maharaja, Gaborone, Botswana	
Organizer	IUCN, GTZ, DSWM	
Sponsor	IUCN, GTZ	
No. participants	48	
Objective	Awareness raising for the ecosan concept; discussion of results from agricultural research and pilot activities and of potential for up-scaling	
Day 1: Tuesday, 2 September (Introduction and pilot case studies)		
Time / Activity	Content	Presenter
8:15 – 8:30	Registration	
8:30 – 8:45	Opening remarks/introductions	K.A. Selotlegeng (DSWM)
8:45 – 9:15 Presentation	Closed loop oriented wastewater and waste management	Heinz-Peter Mang (GTZ-ecosan, Germany)
9:15 – 10:00 Presentation	National Master Plan for Wastewater and Sanitation (“The Need for Integrated Sanitation Services”)	Neil Mudge (SMEC International)
10:00 – 10:30	Tea / Coffee break	
10:30 – 10:55 Presentation	Effects of urban expansion on groundwater quality in Francistown	Benjamin Mafa (Geological Survey)
10:55 – 11:20 Presentation	Effects of urban expansion on groundwater quality in Ramotswa	Dr. Horst Vogel (Geological Survey)
11:20 – 11:45 Presentation	The CBNRM Missing Link – Piloting Ecological Sanitation in Botswana	Cathrine Wirbelauer (IUCN/DED, Botswana)
11:45 – 12:10 Presentation	Vacuum sewer system in Shoshong	Michael Buxton-Tetteh (CPP, Gaborone)
12:10 – 12:35 Presentation	Health and safety aspects of ecosan and excreta handling	Aussie Austin (CSIR, South Africa)
12:35 – 14:00	Lunch	
14:00 – 14:30 Presentation	Experiences in piloting composting toilets in Botswana	Gaba Moanakwene (RIIC)
14:30 – 15:00 Presentation	Example on water-borne closed loop sanitation systems in Maseru	Alice Leuta (DED, Lesotho)
15:00 – 15:30	Tea Break	
15:30 – 16:00 Presentation	Decentralised Wastewater Treatment Systems/CBS	Christopher Kellner (FEDINA-BORDA)
16:00 – 16:30 Presentation	Water saving devices and low flush technology	Johannes Selke (Orbit pumps/Roediger, Germany)
16:30 – 17:00	Design of ecosan systems and the urine	Aussie Austin

Presentation	diversion component	(CSIR, South Africa)
17:00 – 19:00	Cocktail discussion	
<b>Day 2: Wednesday, 3 September (Experience Exchange)</b>		
Time / Activity	Content	Presenter
8:30 – 8:45 Presentation	Summary of the previous day and presentation of the present day	Cathrine Wirbelauer (IUCN/DED, Botswana)
8:45 – 9:15 Presentation	Acceptance and awareness for ecological sanitation	Elisabeth-Maria Huba (GTZ-ecosan/ FRUXOTIC, Germany)
9:15 – 9:45 Presentation	Gardening and agriculture with ecosan subproducts	Tobias Hanke (GTZ-ecosan, Germany)
9:45 – 10:15 Presentation	Multiple strategies for ecological sanitation	Heinz-Peter Mang (GTZ-ecosan, Germany)
10:15 – 10:45	Tea / Coffee break	
10:45 – 12:30 Group work	Working Groups	Two or three groups
12:30 – 13:30	Lunch	
13:30 – 16:30 Excursion	Site visits to ecosan facilities around Gaborone (Kgatleng District)	DSWM/KDC
16:30 – 18:00 Exposition	Open market space for ecosan component companies from Botswana, SA, Swaziland and Germany	
<b>Day 3: Thursday, 4 September (Introduction and pilot case studies)</b>		
Time / Activity	Content	Presenter
8:30 – 8:45	Summary of the previous day and presentation of the present day	Cathrine Wirbelauer (IUCN/DED, Botswana)
8:45 – 10:00 Group work	Report back from the groups, Recommendations	Groups
10:00 – 10:30	Tea / Coffee break	
10:30 – 11:30 Presentation	Overview on technical components and worldwide strategies and Planning procedures for an ecosan project	Heinz-Peter Mang (GTZ-ecosan, Germany)
11:30 – 12:00 Presentation	National Master Plan for Wastewater and Sanitation: “On-site Sanitation-The Way Forward”	Neil Mudge (SMEC International)
12:00 – 12:30 Presentation	General Way Forward for ecological sanitation in Botswana	Kentlafetse Mokokwe (DSWM/IUCN)
12:30 – 12:45	Closing remarks	Rapelang Mojaphoko (UNDP)
13:00 – 14:00	Lunch	

## 7.9 Example: Schedule of a 4-day ecosan workshop in El Salvador

This is an example of a 4-day ecosan workshop organized by Oikos and WASTE in co-operation with GTZ and others to consolidate the link between organisations, which have realized ecosan projects and activities in Latin-America.

The programme was designed to expose each day different components of an ecosan system so those, which are not familiarized with the topic, could get a clear idea about the principles of ecological sanitation and the problems of conventional systems. It combined expositions about experiences in ecosan and practical exercises.

**Table 17: Schedule of a 4-day ecosan workshop in El Salvador**

Country	El Salvador	
Type of workshop (Name)	Ecological Sanitation Workshop (Taller de Saneamiento Ecológico)	
Dates	27-31 October, 2003	
Place	El Tránsito, El Salvador	
Organizer	WASTE and Oikos	
Sponsor	WASTE, Cordaid, GTZ and UNDP	
No. participants	42	
Objective	Introduce formal knowledge about the importance of sustainable and ecological sanitation, the exchange of experiences and interests and the creation of alliances and compromises between the participants on developing specific actions in the region.	
Day 1: Monday, 27 October		
Time / Activity	Content	Presenter
Presentation	Participatory diagnosis on ecological sanitation	Alberto Isunza Ogazón (Mexico)
Presentation	Some principles and questions on ecological sanitation	Gert de Bruijne (WASTE)
Presentation	Ecological sanitation in intervention areas	Vicente Hernández (OIKOS)
Presentation	Situation of the environmental health in El Salvador	Herbert Aparicio (Ministry of Health of El Salvador)
Presentation	Presentation on the present situation of standards on latrines	Jorge Soto
Day 2: Tuesday, 28 October		
Time / Activity	Content	Presenter
Presentation	Environmental Sanitation and Health	Alberto Isunza Ogazón
Presentation	Evaluation of the fertilizing family solar latrines (LAFS) in El Salvador	Christine Moe/ R. Izurieta
Presentation	Latrinisation and parasite infections in rural areas in El Salvador	Lana Corrales
Day 3: Wednesday, 29 October		
Time / Activity	Content	Aim / Presenter
Presentation	Cultural and gender aspects in ecological sanitation	Silvia Diaz Urdanivia
Presentation	Improvement of the nutritional security and sanitation in peri-urban areas: City of Pachacutec Ventanilla - Peru	Oswaldo Cáceres L
Presentation	Nutrients recycling 1 & 2	Francisco Arroyo
Presentation	Holistic and Sustainable Management of Waste - Acepesa - UWEP	Victoria Rudin
Presentation	Implementation of approaches on ecological sanitation aspects in Cuba	Viviana Avendaño
Presentation	Experiences on the introduction of the ecological sanitation concept in Ecuador	Jenny Aragundi
Presentation	The integrated microsystem of alternative sanitation, Ecodess, an ecological sanitation instrument in Lima - Perú	Juan Carlos Calizaza (Peru)
Presentation	Experiences and projects of the GTZ	Heinz-Peter Mang (Germany)

Day 4:		
Time / Activity	Content	Aim / Presenter
Presentation	Tepoz-Eco- pilot project on urban ecological sanitation for the municipality of Tepoztlán	Ron Sawyer (Mexico)
Presentation	Feasibility study in the archipelago of San Andrés, Providencia and Santa Catalina	Patrick Newball
Other activities taking place during the four-day workshop		
Time / Activity	Content	Presenter
Exercise	Sanitation Ladder	Ron Sawyer and participants
Exercise	Groups to be interviewed and question guide	
Exercise	Guidelines for solar latrines with urine separation These guidelines are taken from the project developed in Palestina by the Palestinian Hydrology group (PHG)	
Exercise	Decision Tree This tree or decision diagram was developed by the Ministry of Health from El Salvador within the project of norms for latrines	
Exercise	Health Educational Model and Environmental Sanitation in the community and schools in El Salvador – Educational Methodology SARAR.	Ministry of Public Health and Social Security of El Salvador
Exercise	General Questionnaire for Sanitation Practical Questionnaire, which can be used to evaluate the current situation of the sanitation and water system in the population	
Contribution of participants	Aspects to consider or to use to generate public awareness	J.Carlos Calizaya/Patrick Newball
Contribution of participants	Aspects which should be included in a presentation on ecological sanitation	Oscar Murga
Contribution of participants	Presentation on Environmental Awareness	Patrick Newball
Discussion	Diagnosis on sanitation- field trip	Alberto Isunza (Mexico)
Discussion	Revision on the Ecological Sanitation Concept	Viviana Avendano and Jenny Aragundi/ Participants
Discussion	MISD (Holistic and Sustainable Management of waste)	Participants
Discussion	Regional Cooperation – Network Forum	
Discussion	Particular discussions (30-31 October)	
Discussion	Comments on presentations 1 and 2	
Drawing contest	The Environment and I	OIKOS and WASTE

## 7.10 Example: Schedule of a 2-day ecosan workshop in Turkey

This 2-day workshop took place in early 2004 in Turkey in the frame of an erosion control and desertification programme in collaboration between German and Turkish institutions.

The aim of this workshop was to introduce the assistants to decentralised sanitation and ecological sanitation, in order to analyse the possibilities of the sustainable use water, wastewater and nutrients. The programme included as well an introduction to constructed wetlands and biogas generated from agricultural residues.

**Table 18: Schedule of a 2-day ecosan workshop in Turkey**

Country	Turkey	
Type of workshop (Name)	Wastewater Management and Nutrients Recovery in rural areas in Turkey	
Dates	14-15 February, 2004	
Place	Ankara, Turkey	
Organizer	TEMA, GTZ	
Sponsor	GTZ	
No. participants	80	
Objective	Introducing ecological sanitation including the sustainable use of wastewater, nutrients and agricultural residues into the turkish-german programm of erosion control and disertification in Turkey.	
Day 1: morning, Saturday, 14 February (Overview Presentations)		
Time / Activity	Content	Presenter
09:00 – 09:45	Opening	Köy Hizmetleri TEMA GTZ
09:45 – 10:15 Presentation	Overview of the wastewater system in rural areas in Turkey	Prof. Dr. Celal Ferdi Gökçay (Middle East Technical University)
10:15 – 10:30	Discussion	
10:30 – 11:00	Break	
11:00 – 11:25 Presentation	Natural Wastewater Treatment Systems	
11:25 – 11:30	Questions – Answers	
11:30 – 11:55 Presentation	Wastewater Management and Nutrients cycle in rural areas	Michael Köttner (IBBK)
11:55 – 12:00	Questions – Answers	
12:00 – 12:25 Presentation	Nutrients' Close Cycle: The Ecosan Concept	Christine Werner (GTZ – ecosan, Germany)
12:25 – 12:45	Discussion	
12:45 – 14:00	Lunch Break	
Day 1: afternoon, Saturday, 14 February (Goals and legal framework)		
Time / Activity	Content	Presenter
14:00 – 14:20 Presentation	Legal Framework in Turkey: The actual situation and the necessary modifications	Fevzi İsbilir Çevre Yönetimi Genel Müdür Yardımcısı (Representative of the General directive for Environmental Management of the Ministry of the Environment and Forestry)
14:20 – 14:30	Discussion	

14:30 – 14:50 Presentation	The legal framework of Wastewater Management in Germany	Wolfgang Holleis (Regional Authority for Water Pollution Control of Bavaria, Germany)
14:50 – 15:00	Discussion	
15:00 – 15:20 Presentation	Qualification of municipal services in the wastewater field	Dieter Blome (GTZ- Project “Qualification of municipal services”)
15:20 – 15:30	Discussion	
15:30 – 16:00	Break	
16:00 – 16:20 Presentation	Conditions for a successful implementation of a decentralized wastewater system	Johannes Biener
16:20 – 16:30	Discussion	
16:30 – 16:50 Presentation	Canalisation system in rural areas	Istanbul Technical University, Turkey
16:50 – 17:00	Discussion	
Day 2: morning, Sunday, 15 February (Technical Solution Approaches)		
Time / Activity	Content	Presenter
09:00 – 09:20 Presentation	Low-cost solutions in Turkey: Proposals for the Bayburt-Project	Prof. Dr. Omer Saygin (Bosphorus University, Turkey)
09:20 – 09:30	Discussion	
09:30 – 09:50 Presentation	Adequate alternatives for the clarification of wastewater in rural areas	Vahap Balman Nava (ING, Turkey)
09:50 – 10:00	Discussion	
10:00 – 10:15		
10:15 – 10:30 Presentation	Wastewater clarification in wet areas	Dr. Kemal Günes (Marmara Research Center, TÜBITAK, Turkey)
10:30 – 10:45	Discussion	
10:45 – 11:15	Break	
11:15 – 11:30 Presentation	Anaerobic Systems and Biogas	Prof. Dr. Izzet Öztürk (Istanbul Technical University, Turkey)
11:30 – 11:40	Discussion	
11:40 – 11:55 Presentation	One-tank wastewater treatment plants: The Sequencing Batch Reactor	Ralf Weber (Fa. Biogest)
11:55 – 12:00	Discussion	
12:00 – 12:15 Presentation	Reuse of sludge as a fertilizer in agriculture	Nesteren Bilgrin (Research Institute of the Department of Provision of Rural Services, Turkey)
12:15 – 12:20	Discussion	
12:20 – 12:35		
12:35 – 12:40	Discussion	
Day 2: afternoon, Sunday, 15 February (Development of the project)		
Time / Activity	Content	Presenter
12:40 – 12:55	Total Village System	Jason Gondron (Global Water INC.)
12:55 – 13:00	Discussion	
13:00 – 14:00	Lunch Break	
14:00 – 14:20 Presentation	Possibilities of support of the Iller-Bank in rural areas in Turkey	Figen Ildir (Iller Bankasi, Turkey)
14:20 – 14:30	Discussion	
14:30 – 14:50	Break	



14:50 – 15:00 Presentation	The activities of the “Kreditanstalt für Wiederaufbau” (KfW) in the wastewater field in Turkey	Burghard Hinz (German Development Bank, KfW, Germany)
15:00 – 15:15	Discussion	
15:15 – 17:00 Discussion	Working Group Project Development (Wastewater Management, based on the approaches of the Bayburt-project)	Discussion coordination and moderator: Dr. Hartlieb Euler

## 7.11 Example: 2-day workshop held in the frame of an Indian ecosan network

A series of regional workshops has been organised by the Innovative Ecological Sanitation Project India (IESNI) with support from Norway, Sweden, the Netherlands, Switzerland and Germany aiming at introducing ecological sanitation, initialising pilot projects, and supporting capacity building and networking in ecological sanitation in India.

The following table shows the schedule of one of these workshops.

**Table 19: Schedule of a 2-day ecosan workshop in India**

Country	India	
Type of workshop (Name)	2nd Workshop on Ecological Sanitation	
Dates	1-2 March, 2005	
Place	Pune, India	
Organizer	Innovative Ecological Sanitation Network India (IESNI) in cooperation with GTZ	
Sponsor	GTZ	
No. participants	80	
Objective	Introducing ecological sanitation, initialising pilot projects and supporting capacity building and networking in ecological sanitation in India.	
Day 1: Tuesday, 1 March		
Time / Activity	Content	Presenter
10.00-12.00 Presentation	Introductory general overview about ecosan	H. Bartels/C. Werner and IESNI (Mr. Patankar)
13.30-16.00 Presentation	Status reports about ongoing IESNI projects - Bangalore project	K. Gnanakan (ACTS, India)
Presentation	- DSK/Navsarjan project	M. Mcwan (Navsarjan project, India)
Presentation	- Khopoli/Nagpur project	M. Wafler (GTZ, India)
16.30-18.30 Presentation	Information panel about other ongoing and upcoming activities	
Presentation	Gol Total Sanitation Campaign etc.	Gol-Representative
Presentation	Linking with Sulabh India	Sulabh-Representative
Presentation	Mumbai project idea	ACTS – Rotary Mumbai Rotary-member
Presentation	Chennai project idea	IIT-Representative
Presentation	Water for Billions	C. Werner (GTZ-ecosan, Germany)
Presentation	Reconstruction in South India	K. Gnanakan (ACTS, India)
Presentation	BMBF/Megacity	C. Werner (GTZ-ecosan, Germany)

Presentation	UNICEF School Projects	Unicef Representative
Presentation	Trivandrum Projects	P. Calvert
	Further	WB, EU, WASTE, BORDA, SIDA, Gramalya, etc.
Day 2:2nd of March, 2005		
Time / Activity	Content	Presenter
08.30-10.30	Presentation and Discussion of several Aspects of Relevance	
Presentation	Guideline for agricultural use of ecosan products	B. Vinneras (SLU, Sweden)
Presentation	Nitrogen based hygenization	B.Vinneras (SLU, Sweden)
Presentation	Vermicomposting	GoM Agri Dept.- Representative
Presentation	Vacuum technology	U. Mosel (GTZ)
Presentation	Development of Urine Separation Squatting Toilet	Moderator
	Further	
11.00-12.30	Communication and Information	
Presentation	Introduction to myNetWorks	J. Heeb (SEECON, Switzerland)
Presentation	E-Learning on ecosan with Bangladesh	H. Bartels (GTZ, India)
Presentation	ecosan courses and local networking aspects (website, etc)	J. Heeb (SEECON, Switzerland)
Presentation	Information/awareness campaign	Mr Patankar/ Sulabh- Representative
Presentation	SIDA funded ecosan course in India	SIDA-Representative
Presentation	Durban ecosan conference	C. Werner (GTZ ecosan, Germany)
14.00-16.00	Planning next Steps, "to do's"	

## 7.12 Example: Expert meetings held in the Netherlands on a shift in the sanitation paradigm

In January – March 2005, a total of four expert meetings were held to discuss the relationship between sustainable sanitation and integrated urban planning. During these meetings, Dutch participants from various professions were encouraged to look beyond the boundaries of their discipline and the borders of the Netherlands. Their observations lead to a critical evaluation of the sustainability of current sanitation systems and to a series of recommendations to ensure the implementation of sustainable and efficient approaches now and in the future.

“At the End of the pipe” aimed to accelerate the policy dialogue in the Netherlands towards the adoption of integrated urban sanitation planning, a strategic approach, which should enable a more effective response to the current environmental challenges facing decision-makers. The programme also sought to develop a number of concrete proposals for increasing the sustainability of sanitation provision to present to the 13<sup>th</sup> CSD meeting in New York in April 2005.

“At the End of the pipe” consisted of three closed informal discussion meetings and concluded with one public debate. The informal meetings each highlighted one element of sanitation systems. The first informal discussion meeting focussed on planning and demand, the second meeting on management, while the last meeting focussed on resource management of human excreta. The public

debate expanded upon the ideas and statements that were generated during the informal discussion meetings and prioritised the actions and measures identified.

The series of expert meetings and the public debate, offer an example of how to accelerate the policy dialogue to move towards an integrated approach to urban sanitation planning which responds to current environmental challenges.

Full documentation of the workshop and its results is available online ( [www.ecosan.nl](http://www.ecosan.nl) ). The proceedings and all presentations given during the meetings can be downloaded from this website as pdf-files. Below an overview is given on the programmes of the expert meetings and public debate.

**Table 20: programme expert meetings**

Country	The Netherlands
Type of workshop (Name)	“At the End of the Pipe” expert meetings held in the Netherlands on a shift in the sanitation paradigm
Dates	January – March , 2005
Place	The Hague
Organizer	WASTE
Contributions by	NCDO, Habitat Platform, Netherlands Water Partnership (NWP) and Partners for Water-
No.participants	65
Objective	<ul style="list-style-type: none"> <li>• To evaluate existing sanitation systems as part of urban environmental infrastructure in the Netherlands</li> <li>• To bring different sectors and stakeholders together and evaluate existing sanitation approaches as part of urban environmental infrastructure.</li> <li>• To exchange and compare experiences in the development and management of sanitation facilities between developing countries and the Netherlands.</li> <li>• To familiarise stakeholders with the social, environmental, institutional, legal, and financial aspects of sustainable sanitation approaches developed outside the Netherlands.</li> <li>• To accelerate the policy dialogue in the Netherlands and to move towards an integrated approach to urban sanitation planning which responds to current environmental challenges.</li> <li>• To discuss current sanitation problems from the point of view of worldwide sanitation demand, management and resource recovery in order to formulate concrete recommendations about required initiatives and stakeholders that need to participate in these initiatives. Programme recommendations include recommendations for policy makers at the 13<sup>th</sup> session of the Commission for Sustainable Development (CSD-13) and recommendations for actions needed for the implementation of the goals of the European Union Water Frame Directive (‘Europese Kaderrichtlijn Water’).</li> </ul>

[... continued]	
Thursday, 20 January	<b>Meeting 1: Problems with sanitation planning</b>
Time / Location	Content
9.30 - 12.00 VROM, The Hague	The problems, policy and developments with respect to sanitation in the Netherlands as well as in South Africa and Kenya (city of Nakuru) – will be presented. Special attention is given to the social aspects of the transformation towards sustainable sanitation planning
	<b>Participants</b>
	Host: Ton Boon von Ochssee invited – Dutch Ambassador for Sustainable Development, Ministry of Foreign Affairs
	Moderator: André Frijters – Board member of WASTE; Directorate-general for Public Works and Water Management from the Dutch Ministry of Transport and Public Works
	Speakers: Harm Baten – Water Control Board district Rijnland, the Netherlands Adriaan Mels – Lettinga Associates Foundation, the Netherlands Aussie Austin – CSIR Building and Construction Technology, South Africa Moses Ochola Otieno – WASTE-IHE, Nakuru
Thursday, 27 January	<b>Meeting 2: Municipal management of sanitation systems</b>
Time / Location	Content
9.30 - 12.00 Partners for Water, The Hague	Insight is given how cities in Germany, India and the Philippines are dealing with problems of current sanitation systems with respect to management of human excreta in the context of urban development
	<b>Participants</b>
	Host: Wouter J. Veening, Director Institute for Environmental Security
	Moderator: Ron Spreekmeester, Habitat Platform
	Speakers: Harald Hiessl – Fraunhofer ISI, Germany Anton Peter-Fröhlich – Berliner Wasserbetriebe, Germany Viju James - Pragmatix Research & Advisory Services Pvt. Ltd., India Dan Lapid – CAPS-Centre for Advanced Philippine Studies, the Philippines
Thursday, 3 February	<b>Meeting 3: Treatment and resource management</b>
Time / Location	Content
9.30 - 12.00 LNV, The Hague	What motivates Sweden and China (Guangxi) to search for sanitation options in which resource management is one of the key words? How to deal with safety issues and recycling issues in agriculture?
	<b>Participants</b>
	Host: René van Veenhuizen, ETC-UA (ETC-Foundation, Urban Agriculture Programme)
	Moderator: Jaap Warners – Amongst others former council of Environment from the city of Gouda, and chairman of the Task Force Wind Energy
	Speakers: Pascal Karlsson – Municipality of Göteborg, Sweden Lin Jiang – Guangxi Committee JiuSan Society, China Caroline Schönning – Swedisch Institute for Infections Disease Control, Sweden

**Table 21: programme public debate**

Country	The Netherlands	
Type of workshop (Name)	"At the End of the Pipe" Programme public debate "Are we connected?"	
Dates	3. March 2005	
Place	Habitat Platform – VNG, Nassaulaan 12, The Hague	
Organizer	WASTE	
Contributions by	NCDO, Habitat Platform, Netherlands Water Partnership (NWP) and Partners for Water	
No. participants	40	
Objective	<ul style="list-style-type: none"> <li>• Bringing different sectors and stakeholders together and evaluating the existing sanitation approaches as part of the urban environmental infrastructure.</li> <li>• To exchange experiences with sanitation options in developing countries and in the Netherlands.</li> <li>• To discuss the main sanitation problems from a point of view of sanitation demand, management and resource recovery worldwide in order to formulate concrete recommendations towards required initiatives and identified actors. The recommendations include among others recommendations for policy makers at the 13th session of the Commission for Sustainable Development in order to achieve the Millennium Development Goals (MDG's) and recommendations for actions needed for the implementation of the goals set in the Water policy in the European Union ('Europese Kaderrichtlijn Water').</li> </ul>	
Moderator: Ron Spreekmeester – Habitat Platform		
Time / Activity	Content	Presenter / Participants
14.00 Opening	Presentation of the background and the objectives of the debate	Gert de Bruijne, WASTE
14.10 Opening speech	Introduction on the subject from international and national perspective	Joep Bijlmer, DGIS, Dutch Ministry of Foreign Affairs
14.20 – 16.00 Presentations	Sharing of sanitation experiences between North – South	
14.20	Demand for improved sanitation: Insight in the sanitation demand in the Ukraine	Anna Tsvetkova, Mama 86, Ukraine
14.45	Management of sanitation systems: Case from Mexico which elaborates on decentralisation of management of sanitation in relation to decentralisation of the functioning of sanitation systems	Ron Sawyer, Sarar Transformación SC, Mexico
15.10	Management of resources in sanitation systems: Insight in the global nutrient balance focussing on the geopolitics of phosphorous	Arno Rosemarin, Stockholm Environment Institute, Sweden
15.35 Break		
16.00 Plenary discussion	Main obstacles and successes for a transition towards sustainable sanitation approaches	plenary
16.45 - 17.30	Recommended actions	
16.45 Working groups	Prioritisation of formulated concrete actions: Prioritisation of actions in order to come to up scaling of sustainable sanitation approaches	

	(recommendations for CSD 13 and implementation of European Water Policy)	
17.15	Break	
17.30 Judgement by the jury of the considered most relevant actions	Presenting the results of the prioritisation by the working groups and remark on this result by the jury	Jury: Ralf Otterpohl (Chair), Hamburg University of Technology, Germany Anna Tsvetkova, Mama 86, Ukraine Ron Sawyer, Sarar Transformación SC, Mexico Arno Rosemarin, Stockholm Environment Institute, Sweden
18.00 Closing	Closing and follow-up of the meeting	Joep Bijlmer, DGIS, Dutch Ministry of Foreign Affairs
18.15	Informal Reception	

### 7.13 Example: Schedule of an ecosan e-course

The internet has a high potential for capacity building and e-learning becomes more and more important for distributing innovative knowledge. Use of the internet allows reaching people all over the globe without costs for travelling. It allows pupils to do their individual tasks in their home environment and in their rhythm. In several of the courses presented in this Annex, distance learning is part of the preparatory phase, which is then followed by a face to face phase. However, the below given schedule is an example for a five day e-courses on ecosan.

**Table 22: Schedule of a 5-day e-course on ecosan**

Day 1: Monday, 6 December, 2004 (Ecosan - Concept)		
Day- Place/Tool	Activity/Material	Tutors
12:00 to 12:30 Classroom	Welcome chat Material: Manual of myNetWork	Johannes Heeb and Marieke Slob
12:30 to 13:30 Classroom	Chat on the concept of ecosan Material: Read course material for course 1	Johannes Heeb and Christine Werner
Discussion-forum ecosan-concept	Starting up discussion-forum ecosan-concept	
Day 2: Tuesday, 7 December, 2004 (Ecosan -Tools and Experiences)		
Day- Place/Tool	Activity/Material	Tutors
12:00 to 13:00 Classroom	Chat on the ecosan tools and experiences Material: Read course material for course 2	Johannes Heeb and Petter Jennsen
13:00to 13:30 Classroom Talk	Introduction to assignments Material: assignment.doc	Johannes Heeb and Marieke Slob
Discussion-forum tools and experiences	Starting up discussion-forum ecosan tools and experiences	
Day 3: Wednesday, 8 December 2004 (Ecosan - Health and Security, Agricultural and Social Aspects)		
Day- Place/Tool	Activity/Material	Tutors
12:00 to 13:30 Classroom Talk	Chat on the specific ecosan aspects Material: Read course material for course	Johannes Heeb and Ken Gnanakan
Discussion-forum health and security, agricultural and social	Starting up discussion-forum health and security, agricultural and social aspects	

aspects		
Day 4: Thursday, 9 December, 2004 (Aquaculture Day)		
Day- Place/Tool	Activity/Material	Tutors
12:00 to 13:00 Classroom Talk	Chat on the ecosan tools Material: Read course material for course 4	BB Jana and crew
Discussion-forum aquaculture	Starting up discussion-forums aquaculture	
Day 5: Friday, 10 December, 2004 (Ecosan - Summing up, Assignments)		
Day- Place/Tool	Activity/Material	Tutors
12:00 – 13:00 Classroom Talk	Summing up, discussion of open questions and assignments Material: Read course material for course 5	Johannes Heeb and Merieke Slob
13:00 – 13:30	Good bye chat	Johannes Heeb and Merieke Slob

## 7.14 Example: General set of interactive modules produced for teaching ecosan, including PowerPoint-presentations

A SDC (Swiss Agency for Development and Cooperation) funded project has been undertaken with the aim to process the available ecosan material, to present it in a professional way, and to structure the knowledge into modules.

Target groups of the resulting materials are:

- University and college teachers and students
- Planners, architects, engineers, investors
- Decision making bodies such as communities, public administration, NGOs, development cooperation etc.

Each module consists of:

- Power-Point Files which can be used as independent tutorials for students (e-learning courses, independent study etc.). They contain explanatory text, images, links, further reading material. The files themselves are linked to further reading material as well as other resource material (see below). Navigation inside the modules and inter-linkages are accessible with the help of buttons.
- Power-point Presentations which can be used as ready-made and adaptable lectures
- Further readings (state of the art literature)
- Videos (if available)
- Links to relevant institutions, programs, websites, etc.
- Exercises
- Assignments
- Furthermore, there is a comprehensive link list to ecosan relevant websites.

Knowledge Based on:

- Existing training experiences and training material of authors and other experts
- State of the art literature
- Existing expert knowledge
- Evaluated case study based experience
- Further material (Videos, product information, etc.)

The training material can be used for face to face courses and e-learning (2-3 credit points).

In the tables below is given a general overview on all modules and a more detailed example of the content of on sub-module.

**Table 23: Content of integrated ecosan training material - overview**

Module	Name	Goal
M1	Water and Sanitation in Regard to the Millennium Development Goals	Clarifying the relevance of sustainable sanitation options in relation to the Millennium Development Goals.
M2	Overview of Household and Community Based Sanitation and Wastewater Treatment Systems	Providing an overview about sanitation systems: toilet systems, collection systems, treatment systems and reuse systems are described to give readers an overview
M3	ecosan - an Approach to Human Dignity, Health and Food Security	Clarifying the role of ecosan in closing nutrient and water loops, improving community health and human dignity and thus acting as an essential promoter for development.
M4	ecosan Systems and Technology Components	Providing an overview about individual ecosan technology components and the referring technical, operational and biological processes. Clarifying advantages and disadvantages of each system depending on the enabling environment and context.
M5	Management: Planning, implementation and operation	Providing basic knowledge for a successful planning and implementation of ecosan projects; covering socio-cultural aspects; gender aspects; institutional aspects and options; economic aspects and options; health, hygiene and education; awareness building and monitoring; agricultural aspects and options.
M6	Case studies (India, Africa, Central America, China)	Providing a set of good practices examples reflecting the content of M1-5.



Table 24 below shows the structure of one of the sub-modules of M5 (Management, Planning, implementation and operation). In the second row, the subchapters of the modules are specified; the third row gives a selection of the resource materials used for this Module.

**Table 24: Content of integrated ecosan training material – example gender aspects**

Module 5-3	Subchapters:	Selection of Used Resource Material (not complete)
<b>Gender aspects</b>	Gender Perspectives on Ecological Sanitation Urban Agriculture and Women Gender Issues in Latrine Design Management Roles Involvement in Decision Making Processes Sanitation and Education	<ul style="list-style-type: none"> <li>• Bolt, E. (1994): Together for Water and Sanitation: Tools to Apply a Gender Approachc. IRC</li> <li>• Brikke, F. (2000): Operation and Maintenance of rural water supply and sanitation systems. WHO, IRC.</li> <li>• Gender and Water Alliance GWA: “Sidestream or Mainstream? Making all water uses the business of women and men”.</li> <li>• Gender and Water Alliance GWA: Advocacy manual for Gender &amp; Water Ambassadors.</li> <li>• Gender and Water Alliance GWA (2002): The Gender Approach to Water Management. Lessons Learnt Around the Globe. Findings of an electronic converence series convened by the Gender and Water Alliance. January – September 2002. Available at: <a href="http://www.genderandwateralliance.org/english/advocacy.asp">http://www.genderandwateralliance.org/english/advocacy.asp</a></li> <li>• Gender and Water Alliance GWA (2003): The Gender and Water Development Report 2003. Gender Perspectives on Policies in the Water Sector. Gender and Water Alliance, Delft, Netherlands.</li> <li>• Hannan, C. &amp; Andersson, I. (no year): Gender Perspectives on Ecological Sanitation. Available at: <a href="http://www.undp.org/water/docs/gen_eco_san_chi.doc">www.undp.org/water/docs/gen_eco_san_chi.doc</a></li> <li>• IRC: Gender in Water Resources Management, Water Supply and Sanitation</li> <li>• SDC (2004): GENDER &amp; TRAINING Mainstreaming gender equality and the planning, realisation and evaluation of training programmes. <a href="http://www.deza.admin.ch/ressources/deza_product_en_1519.pdf">http://www.deza.admin.ch/ressources/deza_product_en_1519.pdf</a></li> <li>• UN Water Policy Brief 2: Gender, Water and Sanitation. A Policy Brief.</li> <li>• United Nations Development Programme UNDP: Mainstreaming Gender in Water Management. A Practical Journey to Sustainability: A Resource Guide. Available at: <a href="http://www.undp.org/water/docs/resource_guide.pdf">http://www.undp.org/water/docs/resource_guide.pdf</a></li> </ul> <p><b>Internet links:</b></p> <ul style="list-style-type: none"> <li>• Gender and Water Alliance: <a href="http://www.genderandwateralliance.org/english/">http://www.genderandwateralliance.org/english/</a></li> <li>• UN Habitat Gender Analysis Tool <a href="http://www.unhabitat.org/cdrom/governance/html/yellop25.htm">http://www.unhabitat.org/cdrom/governance/html/yellop25.htm</a></li> <li>• IRC International Water and Sanitation Centre <a href="http://www.irc.nl/">http://www.irc.nl/</a></li> </ul>
	Gender Mainstreaming in Community Water & Sanitation Projects	
	Gender Mainstreaming in Community Water & Sanitation Projects	
	Making Gender Roles Visible	
	The way forward	

## 7.15 Example: ecosan as part of a M.Sc. curriculum for students of environmental science and engineering at the University of Science and Technology Beijing, China

Here an example of the ecosan part of a M.Sc. curriculum for Students of environmental science and engineering at the University of Science and Technology Beijing, China is given. The full program for master studies has a duration of five semesters. The ecosan part, as elective course, is given in the 2<sup>nd</sup> semester as weekly activity of 2 hours and has a total duration of 30 hours. Along with the course a related text book is being prepared for the students. The course includes an exam and runs for the first time in 2006.

**Table 25: ecosan curriculum description**

1.	History of sanitation and sewerage system development (1 hour)
2.	Conventional sanitation and sewerage system (2 hours)
2.1	Problems of conventional sewerage system (1 hour)
2.2	Possible solution (1 hour)
3.	Water and environmental problems in the world (2 hours)
4.	Alternative concept - ecosan (2 hours)
4.1	Principals and advantages of ecosan
4.2	Development and approaches for ecosan
4.3	ecosan for developing and emerging countries, countries in transition, and developed countries
5.	ecosan Technologies (8 hours)
5.1	Types of toilet
5.2	Collection system
5.3	Treatment system
5.4	Purposes for reuse
6.	Case study (4 hours)
6.1	Rural or underdeveloped areas
6.2	Suburban areas
6.3	Urban areas
6.4	Holiday spaces, public buildings
6.5	School & public toilets
7.	Financial and economic aspects (2 hours)
8.	Environmental and health risk assessment (4 hours)
9.	Socio-cultural aspects (2 hours)
10.	Policy and legal aspects of ecosan (2 hours)
11.	Discussions (1 hour)

## 7.16 Example: Description of a 1 week ecosan course in China for alumni

This course is an example provided by UNESCO-IHE Institute for Water Education for a training course that was funded by the Dutch fellowship programme Nuffic ([www.nuffic.nl](http://www.nuffic.nl)). The course was offered in September 2005 to alumni from UNESCO-IHE who live and work in Asia. These types of courses are called “refresher courses” by Nuffic because they are meant to refresh and bring up to date the knowledge that the participants gained while they completed their MSc degree at UNESCO-IHE with funding from the Dutch government (in Environmental Science and Technology, Water and Environmental Resources Management, Municipal Water Infrastructure, Sanitary Engineering). These alumni graduated several years ago (MEng or MSc degree) and have reached senior positions by now.

The course brochure describes the aims and objectives of the course as follows:

“The aim of this course is to provide active water managers from Asia with new views and insights of sustainable sanitation concepts and re-use of water and nutrients in a multi-disciplinary, multi-stakeholder setting. The general objective of this Refresher Course is to provide theoretical background and practical expertise in the field of ecosan, and to explain in some detail the closed-loop nature of this approach (including reuse and energy recovery aspects). The specific objectives of this course are to:

- Familiarise the participants with ecosan principles, which should be considered in all aspects of planning of sanitation systems;
- Enable the participant to make a first assessment of a given situation and to be familiar with the wide range of options that need to be considered;
- Provide tools to the participant so that he/she can make an in-depth assessment of the sanitation needs of a community or commercial facility and develop recommendations for appropriate technology and systems;
- Encourage longer-term collaboration among resource managers using internet-based knowledge platforms and the formation of a Community of Practice (CoP).”

The course consisted of one week of face-to-face teaching in Nanjing, China (the local counterpart was Hohai University), preceded by six weeks of preparation by the participants in a distance-learning mode. Details for the content of both phases are provided in Table 26 and 27.

**Table 26: Schedule for home country preparation for the ecosan alumni course in Nanjing China (Hohai University)**

Schedule for preparatory phase in home countries (6 weeks, using the internet)	
Week	Activity
1	Registration to the platform Instructions about the use of the platform
2	Participants introduce themselves by providing a short CV and information about employer and about their work responsibilities
3	Preparation of a short powerpoint presentation (10 slides) to describe current sanitation situation in home region (issues and challenges)
4	Continuation of preparation of powerpoint presentation
5	Continuation of preparation of powerpoint presentation (if possible: describe ecosan activities in the home region, if known)
6	Continuation and finalisation of the presentation Presentation will be published on the platform

**Table 27: Schedule for 6-day ecosan alumni course in Nanjing China (Hohai University)**

Schedule for 6-day course in Nanjing China (Hohai University)	
Day	Activity
1	Registration, opening, workshop introduction Overview of sanitation issues and options Introduction to relevant Millennium Development Goals Conventional sanitation versus ecosan Nutrient cycles Welcome reception: staff, participants, resource persons
2	Technologies that can form part of ecosan concept: • Toilet devices (dry/wet, urine diversion, no diversion) • Anaerobic digestion, energy recovery • Composting • Constructed wetlands • Others Time for preparations of country presentations
3	Reuse of greywater and of nutrients in agriculture Closing nutrient cycles Ecosan in urban, rural and per-urban settings Introduction to case study Country presentations Use of the internet, platform, alumni facilities etc.
4	Case study: field trip Eco-city in Changzhou (decentralised wastewater treatment) Country presentations
5	Discussions from field trip Social and legal aspects Health risks and hygiene education Exercise: application of ecosan concept to participant's home region Preparation for reporting on exercise
6	Reporting by participants about exercise outcomes, followed by group discussion Evaluation and closing, farewell dinner

### 7.17 Example: Introducing ecosan concepts into a M.Sc. programme

In the following, one example is provided from UNESCO-IHE (The Netherlands) a post-graduate educational institution, which operates with the following mandate:

- Strengthen and mobilise the global educational and knowledge base for integrated water resources management; and
- Contribute to meeting the water-related capacity building needs of the developing countries and countries in transition.

Within this mandate the mission is defined as follows:

The mission of the Institute is to contribute to the education and training of professionals and to build the capacity of sector organisations, knowledge centres and other institutions active in the fields of water, the environment and infrastructure, in developing countries and countries in transition.

To achieve this mission, the institute teaches mid-career professionals from developing countries and countries in transition in five different MSc programmes (all connection to the study field of "water"). As an example, we now look at the MSc programme called "Municipal Water Infrastructure". This is structured as 12 months of taught programme, followed by six months of research (the MSc thesis). Provided below is the current curriculum overview for the MWI programme, showing the four specialisations on offer. The figure also includes suggested changes to this curriculum to embed the ecological sanitation paradigm firmly into this curriculum. Hence, it presents the situation "before and after" the introduction of ecological sanitation content into the MSc programme.

**Table 28: MSc programme structure for MSc in Municipal Water and Infrastructure (with four specialisation options) for a 12-month taught programme, showing proposed inclusion of ecosan subjects within existing 3-week modules [see note below the figure for further explanation].**

Municipal Water and Infrastructure			
Water Supply Engineering	Sanitary Engineering	Integrated Urban Engineering	Water Services Management
Introduction [1]			
Integrated urban water management [2, 3, 5, 12]			
Project cycle and management [4, 6, 10]			
Christmas holiday			
Process technology [2]		Infrastructure finance and planning [6]	
Unit operations		Urban mobility planning	Water services management [9, 10]
Groundwater treatment & resources	Urban drainage and sewerage [2]		Water supply and sanitation systems [2, 12]
Surface water treatment	WWT process design & engineering [2, 10]	Road design and operations	Operations management
Easter holiday			
Water treatment processes & plants	Modelling and industrial WWT	Construction and maintenance	Financial management
Water transport and distribution I	Sustainable WWT and reuse [3]	Water transport and distribution I	Managing organisations and change
Choice of elective: 1) Water transport and distribution II 2) Solid waste engineering and management [2, 4] 3) Decentralised WS & S [2, 3, 5, 11] or 4) Public Private Partnerships [8, 9]			
International fieldtrip and fieldwork [2-14]			
Groupwork [4-12]			
Individual study / MSc research proposal [2-13]			
Final examinations			

The bold numbers **[in brackets]** refer to the ecological sanitation subjects listed below (for details see Table 4 in Section 4.5.2):

1. Introduction to ecological sanitation
2. Technologies applied in ecological sanitation
3. Resources recovery and agricultural reuse (nutrients, organics, water and energy)
4. Implementation, operation and maintenance management
5. Environmental and health aspects
6. Economic and financial aspects
7. Social and cultural aspects
8. Policy and Legal aspects
9. Institutional and organisational aspects
10. Case studies: successes and failures
11. Enabling search for up-to-date information on ecological sanitation (e.g. internet)
12. Interactions of ecological sanitation projects with existing infrastructure
13. Evaluation criteria for sanitation systems
14. Promotion and public awareness

## 8 References

### 8.1 Literature

(All URLs retrieved on 2005-12-15)

- Ali, Mansoor and Jonathan Rouse (2004): "Sustainable Composting". - Water, Engineering and Development Centre (WEDC), Loughborough University, Leicestershire, UK
- Anschütz, Justine, Jeroen Ijgosse and Anne Scheinberg (2004): "Putting Integrated Sustainable Waste Management to Practice - Using the ISWM Assessment Methodology - ISWM Methodology as Applied in the UWEP Plus Programme (2001-2003)". - WASTE, Gouda, The Netherlands, digitally available at:  
[http://www.waste.nl/redirect/content/download/561/4346/file/ISWM\\_ass\\_eng\\_screen.pdf](http://www.waste.nl/redirect/content/download/561/4346/file/ISWM_ass_eng_screen.pdf)
- Ashworth, John (2005): "Support for the dissent". - WATER 21, June 2005, International Water Association (IWA) Publishing, London, UK - part of the discussion on ecosan in WATER 21, complete discussion digitally available at:  
[http://www.tuhh.de/susan/downloads/water21ecosan\\_discussion.pdf](http://www.tuhh.de/susan/downloads/water21ecosan_discussion.pdf)
- Baccini, P. and H.P. Bader (1996): "Regionaler Stoffhaushalt – Erfassung, Bewertung, Steuerung". - Spektrum Akademischer Verlag GmbH, Heidelberg, Germany
- Barth, Joseph (2004): "Biological waste treatment in Europe – Technical and market developments". – online article at the European Compost Network (ECN), digitally available at:  
<http://www.compostnetwork.info/biowaste/>
- Belevi, Hasan (2002): "Material flow analysis as a strategic planning tool for regional waste water and solid waste management." - In: Proceedings of the workshop "Globale Zukunft: Kreislaufwirtschaftskonzepte im kommunalen Abwasser- und Fäkalienmanagement." GTZ /BMZ & ATV-DVWK Workshop during the IFAT, 13-15 May, Munich, Germany, digitally available at:  
[http://www.nccr-north-south.unibe.ch/publications/Infosystem/On-line%20Dokumente/Upload/Belevi\\_Material%20flow%20analysis\\_2002.pdf](http://www.nccr-north-south.unibe.ch/publications/Infosystem/On-line%20Dokumente/Upload/Belevi_Material%20flow%20analysis_2002.pdf)
- Birley, M.H. and K. Lock (1999): "The health impacts of peri-urban natural resource development." - Liverpool School of Tropical Medicine, Liverpool, UK <http://www.ihia.org.uk/document/periurbanhia.pdf>
- Black, Maggie and Rupert Talbot (2005): "Water, a matter of life and health – water supply and sanitation in village India." – Oxford University Press, Oxford, UK
- Bracken, Patrick; Kvarnström, Elisabeth; Ysunza Alberto, Kärman, Erik, Finsson, Anders and Saywell, Darren (2005): "Making sustainable choices – the development and use of sustainability oriented criteria in sanitary decision making". - In: "Proceedings of the Third International Conference on Ecological Sanitation (EcoSan), Durban, South Africa, 23-27 May 2005" - CSIR (Council for Scientific and Industrial Research), Pretoria, South Africa, digitally available at:  
<http://www.gtz.de/de/dokumente/en-criteria-for-decision-making-in-sanitation-sustainability-2005.pdf>
- Brunner, P.H. and H. Rechberger (2004): "Practical Handbook of Material Flow Analysis". - Lewis Publishers, USA
- Cairncross, Sandy (2004): "The Case for Marketing Sanitation." - WSP-AF (Water and Sanitation Program for Africa) Field Notes, Nairobi, Kenya, digitally available at:  
[http://www.wsp.org/publications/af\\_marketing.pdf](http://www.wsp.org/publications/af_marketing.pdf)
- Calvert, Paul (2004) "Ecological Solutions to Flush Toilet Failures." - EcoSolutions, Pickering, UK
- Cardone, R. and Fonseca, C. (2003): "Financing and Cost recovery." - Thematic Overview Paper, International Water and Sanitation Centre (IRC), Delft, The Netherlands, digitally available at:  
<http://www.irc.nl/redirect/content/download/13196/183128/file/costrecov.pdf>
- CNN (2005): "Space food for the future." - online article from CNN.com, digitally available at:  
<http://cnn.com/2005/TECH/space/11/23/thanksgiving.in.space.ap/index.html>
- Cordova, A. and Knuth, B. (2004): "Implementing Large-Scale and Urban Dry Sanitation." – Session I, p.849-857 - In: Werner et al. [eds.]. 2004: "ecosan - closing the loop - Proceedings of the 2nd international symposium on ecological sanitation (...), 7th – 11th April 2003, Lübeck, Germany", GTZ- ecosan program, Deutsche Gesellschaft für Technische Zusammenarbeit (GTZ), Eschborn, digitally available at:  
<http://www.gtz.de/de/dokumente/en-ecosan-symposium-luebeck-session-i-2004.pdf>
- Cordova, A. and Knuth, B. (2005): "User Satisfaction in Large-Scale, Urban Dry Sanitation Programs in Mexico." – in

- press (expected Dec 2005), Urban Water Journal, London, UK
- Cornish G.A. and Kielen N.C. (2004): "Wastewater Irrigation – Hazard or Lifeline? Empirical Results from Nairobi, Kenya and Kumasi, Ghana." - In: Scott, C.A.; Faruqui, N.I. and Raschid-Sally, L. (2004): "Wastewater Use in Irrigated Agriculture - Coordinating the Livelihood and Environmental Realities" – CABI (Wallingford, UK) / IWMI (International Water Management Institute, Pelawatte, Sri Lanka)/IDRC (International Development Research Centre, Ottawa, Canada) - Publishing, digitally available at:  
[http://www.idrc.ca/en/ev-31595-201-1-DO\\_TOPIC.html](http://www.idrc.ca/en/ev-31595-201-1-DO_TOPIC.html)
- del Porto, David and Steinfeld, Carol (1999): "The Composting Toilet System Book: A Practical Guide to Choosing, Planning and Maintaining Composting Toilets, a Water-Saving, Pollution-Preventing Wastewater Alternative." – Centre for Ecological Pollution Prevention (now called EcoWaters), Gene Logsdon Titles Series, Concord, USA
- Drescher, A.W. and Laquinta, D.L. (2002): "Food Security in Cities - A New Challenge to Development". - In: Brebbia, C.A., J.F. Matrin-Duque and L.C. Wadhwa(2002): "The Sustainable City II - Urban Regeneration and Sustainability. Advances in Architecture." - WIT Press, Wessex Institute of Technology, UK
- Eawag (Swiss Federal Institute of Aquatic Science and Technology) (2005): "Household-Centred Environmental Sanitation, Implementing the Bellagio Principles in Urban Environmental Sanitation – Provisional Guideline for Decision Makers" – by Kalbermatten, J.M.; Middleton, R. and Schertenleib, R., Eawag (Swiss Federal Institute of Aquatic Science and Technology), Sandec (Water and Sanitation in Developing Countries), Duebendorf, Switzerland; WSSCC (Water Supply and Sanitation Collaborative Council), Geneva, Switzerland, digitally available at:  
[http://www.wsscc.org/dataweb/internal/Media\\_and\\_communications/publications/hces.pdf](http://www.wsscc.org/dataweb/internal/Media_and_communications/publications/hces.pdf)
- EcoSanClub (2004): "Sacred Heart Sisters Kalungu Girls Secondary School: Improvement of Water & Sanitation Infrastructure, February 2003 – December 2003" - digitally available at:  
<http://www.gtz.de/ecosan/download/study-ecosanres-ugandaschool03.pdf>
- EcoSanRes (2005a): "The Sanitation Crisis." – EcosanRes Factsheet 1, EcoSanRes Programme, Stockholm Environment Institute (SEI), digitally available at:  
[http://www.ecosanres.org/PDF\\_files/Fact\\_sheets/ESR1lowres.pdf](http://www.ecosanres.org/PDF_files/Fact_sheets/ESR1lowres.pdf)  
(quoted from EU (European Union) (2001): "2nd Forum on Implementation and Enforcement of Community Environmental Law: Intensifying Our Efforts to Clean Urban Wastewater")
- EcoSanRes (2005b): "Closing the loop on phosphorous". – EcosanRes Factsheet 4, EcoSanRes Programme, Stockholm Environment Institute (SEI), Stockholm, Sweden, digitally available at:  
[http://www.ecosanres.org/PDF%20files/Fact\\_sheets/ESR4lowres.pdf](http://www.ecosanres.org/PDF%20files/Fact_sheets/ESR4lowres.pdf)
- EcoSanRes (2006): "EcoSanRes Programme Phase2 Project Document" EcoSanRes Programme, Stockholm Environment Institute (SEI), Stockholm, Sweden
- Élain, Christophe (2005): "Un petit coin pour soulager la planète - toilettes sèche et histoires d'eau." - Éditions Goutte Sable, Athée, France
- EMWater (2005): e-training course from the Institute of Municipal and Industrial Wastewater Management, Hamburg University of Technology  
[http://www.emwater.org/Training\\_courses/training1.htm](http://www.emwater.org/Training_courses/training1.htm)
- Esrey, Steven A. (2001): "Towards a Recycling Society - Ecological Sanitation - Closing the Loop to Food Security". Page 30 - 40 – In: Werner et al. (2001): "Proceedings of the international symposium - ecosan - closing the loop in wastewater management and sanitation, 2000, Bonn". - Deutsche Gesellschaft für Technische Zusammenarbeit (GTZ), Eschborn, Germany, digitally available at:  
<http://www.gtz.de/ecosan/download/ecosan-Symposium-Bonn-proceedings.pdf>
- Esrey, Steven A.; Andersson, Ingvar; Hillers, Astrid and Sawyer, Ron (2001): "Closing the loop - Ecological sanitation for food security." – UNDP/SIDA; Publications on Water Resources No. 18  
<http://www.ecosanres.org/PDF%20files/closing-the-loop.pdf>
- Evans, B. (2001): "Financing and cost recovery." - Sanitation Connection, WSP Water and Sanitation Program, Washington, USA, digitally available at:  
<http://www.sanicon.net/titles/topicintro.php3?topicId=13>
- FAO (Food and Agriculture Organization of the United Nations) (1999): "Issues in urban agriculture - Studies suggest that up to two-thirds of city and peri-urban households are involved in farming." – FAO, Agriculture21, Spotlight 1999, Rome, Italy, digitally available at:  
<http://www.fao.org/ag/magazine/9901sp2.htm>
- Faruqui, N.I.; Niang, S. and Redwood, M. (2004): "Chapter 10 - Untreated Wastewater Use in Market Gardens: A Case Study of Dakar, Senegal" – In: Scott, C.A.; Faruqui, N.I. and Raschid-Sally, L. (2004): "Wastewater Use in Irrigated Agriculture - Coordinating the Livelihood and Environmental Realities" – CABI (Wallingford, UK) / IWMI (International Water Management Institute, Pelawatte, Sri Lanka)/IDRC (International Development Research



- Centre, Ottawa, Canada) - Publishing, digitally available at:  
[http://www.idrc.ca/en/ev-31595-201-1-DO\\_TOPIC.html](http://www.idrc.ca/en/ev-31595-201-1-DO_TOPIC.html)
- Fewtrell, L. and Bartram, J. [eds] (2001): "Water Quality: Guidelines, Standards and Health; Assessment of Risk and Risk Management for Water-related Infectious Disease". - International Water Association (IWA), London, UK, on behalf of the World Health Organization (WHO), Geneva, Switzerland
- Foege, William H. (1994): "Preventive Medicine and Public Health - A discussion of the DALY (Disability Adjusted Life Years) approach to measuring the real impact of disease." - Journal of the American Medical Assoc. 271 (21). digitally available at:  
<http://www.ihpnet.org/preventtxt.htm>
- Fong, Monica S., Wakeman, Wendy and Bhushan, Anjana (1996): "Toolkit on Gender in Water and Sanitation." - Gender Toolkit Series No. 2, Gender Analysis and Policy, Poverty and Social Policy Department, UNDP- World Bank Water and Sanitation Program, TWUWS, The World Bank, Washington, D.C., digitally available at:  
<http://siteresources.worldbank.org/INTGENDER/Resources/toolkit.pdf>
- Forster, Dionys; Schertenleib, Roland and Belevi, Hasan (2004): "Linking Urban Agriculture and Environmental Sanitation." - Eawag (Swiss Federal Institute of Aquatic Science and Technology), Sandec (Water and Sanitation in Developing Countries), Duebendorf, Switzerland – Session H, p.795-798 - In: Werner et al. [eds.]. (2004): "ecosan - closing the loop - Proceedings of the 2nd international symposium on ecological sanitation (...), 7th – 11th April 2003, Lübeck, Germany", GTZ- ecosan program, Deutsche Gesellschaft für Technische Zusammenarbeit (GTZ), Eschborn, digitally available at:  
<http://www.gtz.de/de/dokumente/en-ecosan-symposium-luebeck-session-h-2004.pdf>
- GTZ (Deutsche Gesellschaft für Technische Zusammenarbeit) (2003): "10 Recommendations for Action from the Luebeck Symposium on ecological sanitation, April 2003" - 2nd international symposium on ecological sanitation (...), 7th – 11th April 2003, Lübeck, Germany", GTZ- ecosan program, Deutsche Gesellschaft für Technische Zusammenarbeit (GTZ), Eschborn, Germany, digitally available at:  
<http://www.gtz.de/de/dokumente/en-ecosan-recommendations-for-action-2003.pdf>
- GTZ (Deutsche Gesellschaft für Technische Zusammenarbeit) -ecosan newsletter (2004-12): "ecosan newsletter No 12." - GTZ- ecosan program, Deutsche Gesellschaft für Technische Zusammenarbeit (GTZ), Eschborn, Germany, digitally available at:  
<http://www.gtz.de/de/dokumente/en-ecosan-nl12-2004.pdf>
- GTZ (Deutsche Gesellschaft für Technische Zusammenarbeit) -ecosan newsletter (2005-16): "ecosan newsletter No 16." - GTZ- ecosan program, Deutsche Gesellschaft für Technische Zusammenarbeit (GTZ), Eschborn, Germany, digitally available at:  
<http://www.gtz.de/de/dokumente/en-ecosan-nl16-2005.pdf>
- GTZ (Deutsche Gesellschaft für Technische Zusammenarbeit) -ecosan newsletter (2005-18): "ecosan newsletter No 18." - GTZ- ecosan program, Deutsche Gesellschaft für Technische Zusammenarbeit (GTZ), Eschborn, Germany, digitally available at:  
<http://www.gtz.de/de/dokumente/en-ecosan-nl18-2005.pdf>
- GTZ (Deutsche Gesellschaft für Technische Zusammenarbeit) -project data sheets (2005): "Project data sheets for ecosan." - GTZ- ecosan program, Deutsche Gesellschaft für Technische Zusammenarbeit (GTZ), Eschborn, Germany, digitally available at:  
[GTZ themes > Environment and infrastructure > Water > ecosan > Further Information](http://www.gtz.de/en/themen/umwelt-infrastruktur/wasser/9399.htm)  
<http://www.gtz.de/en/themen/umwelt-infrastruktur/wasser/9399.htm>
- GTZ (Deutsche Gesellschaft für Technische Zusammenarbeit) -project data sheet (2005-001): "Vacuum sewerage and greywater recycling, office building "Ostarkade" of the KfW Bankengruppe Frankfurt am Main, Germany". – data sheets for ecosan projects 001 by the ecosan team, GTZ- ecosan program, Deutsche Gesellschaft für Technische Zusammenarbeit (GTZ), Eschborn, Germany , digitally available at:  
<http://www.gtz.de/de/dokumente/en-ecosan-pds-001-germany-frankfurt-kfW-2005.pdf>
- GTZ (Deutsche Gesellschaft für Technische Zusammenarbeit) -project data sheet (2005-005): "Urine diverting dry toilets dissemination programme Guanxi province, China." - data sheets for ecosan projects 005 by the GTZ ecosan team; GTZ- ecosan program, Deutsche Gesellschaft für Technische Zusammenarbeit (GTZ), Eschborn, Germany, digitally available at:  
<http://www.gtz.de/de/dokumente/en-ecosan-pds-005-china-guanxi-2005.pdf>
- GTZ (Deutsche Gesellschaft für Technische Zusammenarbeit) -project data sheet (2005-006): "Biogas-ecosan project, Waldmichelbacherhof, Bessenbach, Germany." – data sheets for ecosan projects 006 by the GTZ ecosan team, GTZ- ecosan program, Deutsche Gesellschaft für Technische Zusammenarbeit (GTZ), Eschborn, Germany , digitally available at:  
<http://www.gtz.de/de/dokumente/en-ecosan-pds-006-germany-waldmichelbacherhof-2005.pdf>
- GTZ (Deutsche Gesellschaft für Technische Zusammenarbeit) -project data sheet (2005-008): "Gebers collective

- housing project, Orhem, Sweden". – data sheets for ecosan projects 008 by the GTZ ecosan team, GTZ-ecosan program, Deutsche Gesellschaft für Technische Zusammenarbeit (GTZ), Eschborn, Germany , digitally available at:  
<http://www.gtz.de/de/dokumente/en-ecosan-pds-008-sweden-gebers-2005.pdf>
- GTZ (Deutsche Gesellschaft für Technische Zusammenarbeit) -project data sheet (2005-009): " ecosan within the community based natural resources management project, Hanahai and Paje, Botswana." – data sheets for ecosan projects 009 by Wirbelauer, C and the GTZ ecosan team, GTZ- ecosan program, Deutsche Gesellschaft für Technische Zusammenarbeit (GTZ), Eschborn, Germany , digitally available at:  
<http://www.gtz.de/de/dokumente/en-ecosan-pds-009-botswana-hanahai-paje-2005.pdf>
- GTZ (Deutsche Gesellschaft für Technische Zusammenarbeit) -project data sheets (2005-012): "TepozEco – urban ecosan pilot program, Tepoztlán, Mexico." – data sheets for ecosan projects 012 by Sawyer, R.and the GTZ ecosan team, GTZ- ecosan program, Deutsche Gesellschaft für Technische Zusammenarbeit (GTZ), Eschborn, Germany , digitally available at:  
<http://www.gtz.de/de/dokumente/en-ecosan-pds-012-mexico-tepoz-eco-2005.pdf>
- GTZ (Deutsche Gesellschaft für Technische Zusammenarbeit) -project data sheet (2005-013): " Use of reclaimed water in the Jordan Valley, Jordan". – data sheets for ecosan projects 013 by Vallentin, Artur and the GTZ ecosan team, GTZ- ecosan program, Deutsche Gesellschaft für Technische Zusammenarbeit (GTZ), Eschborn, Germany , digitally available at:  
<http://www.gtz.de/de/dokumente/en-ecosan-pds-013-jordan-valley-2005.pdf>
- GTZ (Deutsche Gesellschaft für Technische Zusammenarbeit) -project data sheet (2005-015): " Constructed wetland, Haran-Al-Awamied,Syria". – data sheets for ecosan projects 015 by the GTZ ecosan team, GTZ- ecosan program, Deutsche Gesellschaft für Technische Zusammenarbeit (GTZ), Eschborn, Germany , digitally available at:  
<http://www.gtz.de/de/dokumente/en-ecosan-pds-015-syria-haran-al-awamied-2005.pdf>
- GTZ (Deutsche Gesellschaft für Technische Zusammenarbeit) -project data sheet (2005-016): "Urine separation and reuse project at the main building of GTZ GmbH." – data sheets for ecosan projects 016 by the GTZ ecosan team, GTZ- ecosan program, Deutsche Gesellschaft für Technische Zusammenarbeit (GTZ), Eschborn, Germany , digitally available at:  
<http://www.gtz.de/de/dokumente/en-ecosan-pds-016-germany-gtz-eschborn-2005.pdf>
- GTZ (Deutsche Gesellschaft für Technische Zusammenarbeit) -technical data sheets (2005): "Technical data sheets for ecosan." – GTZ- ecosan program, Deutsche Gesellschaft für Technische Zusammenarbeit (GTZ), Eschborn, Germany, digitally available at:  
[GTZ themes > Environment and infrastructure > Water > ecosan > Further Information](http://www.gtz.de/en/themen/umwelt-infrastruktur/wasser/9397.htm)  
<http://www.gtz.de/en/themen/umwelt-infrastruktur/wasser/9397.htm>
- GTZ (Deutsche Gesellschaft für Technische Zusammenarbeit) -technical data sheet (2005-01.B2): "01.B2 Urine diversion - Waterless urinals." - Technical data sheets for ecosan 01.B2 by the GTZ ecosan team, GTZ- ecosan program, Deutsche Gesellschaft für Technische Zusammenarbeit (GTZ), Eschborn, Germany, digitally available at:  
<http://www.gtz.de/de/dokumente/en-ecosan-tds-01-b2-urine-diversion-waterless-urinals-2005.pdf>
- GTZ (Deutsche Gesellschaft für Technische Zusammenarbeit) (2006): "ecosan resource CD" - GTZ- ecosan program, Deutsche Gesellschaft für Technische Zusammenarbeit (GTZ), Eschborn, Germany, available on request from [ecosan@gtz.de](mailto:ecosan@gtz.de) Information on on-line-version at  
[www.gtz.de/de/dokumente/en-ecosan-education-resources-2006.pdf](http://www.gtz.de/de/dokumente/en-ecosan-education-resources-2006.pdf)
- Hellström D., Jeppsson U. and Kärrman E. (2000): "A framework for systems analysis of sustainable urban water management". - Environmental Impact Assessment Review, vol. 20, no. 3, pp. 311-322
- Hiesl, H., Toussaint, D., Becker, M., Dyrbusch, A., Geisler, S., Herbst, H., Prager, J.U. (2003): "Alternativen der kommunalen Wasserversorgung und Abwasserentsorgung - AKWA 2100." – Springer Verlag, Reihe: Technik, Wirtschaft und Politik, Band 53, Berlin, Germany
- Holden, R. (2004): "Factors which have influenced the acceptance of ecosan in South Africa and development of a marketing strategy". – p.167-174 - In: Werner et al. [eds.]. 2004: "ecosan - closing the loop. Proceedings of the 2nd international symposium on ecological sanitation (...), 7th – 11th April 2003, Lübeck, Germany", Deutsche Gesellschaft für Technische Zusammenarbeit (GTZ), Eschborn, Germany, digitally available at:  
<http://www.gtz.de/de/dokumente/en-ecosan-symposium-luebeck-session-b-2004.pdf>
- Holmer, Robert J.; Clavejo, M.T.; Dongus, S. and Drescher, A. (2003): "Allotment Gardens for Philippine Cities." - Urban Agriculture Magazine, 11, 29-31, Resource centre on urban agriculture and forestry (RUAF), Leusden, The Netherlands, digitally available at:  
[http://www.puvep.com/publications/29\\_phil.pdf](http://www.puvep.com/publications/29_phil.pdf)
- Hultman, B. and Levlin, E. (1999): "Sustainable water management in the Baltic Sea basin"– Part I, Chapter 2 – 6 -

- In: Lundin, Lars-Christer (1999): "Sustainable Water Management – 2. Water Use and Management", Uppsala University, Uppsala, Sweden
- IFS (International Foundation for Science) (2005): "Strengthening Capacity for Research on Sustainable Sanitation and Grey-Water Reuse in Developing Countries" – workshop announcement, digitally available at:  
[http://www.ifs.se/Programme/ifs\\_sida\\_specialcall.asp](http://www.ifs.se/Programme/ifs_sida_specialcall.asp)
- IGB (Fraunhofer-Institut für Grenzflächen- und Bioverfahrenstechnik) (2004): "Spatenstich in Knittlingen." - Press release of the Fraunhofer-Institut für Grenzflächen- und Bioverfahrenstechnik IGB, 02.06.2004, digitally available at:  
<http://idw-online.de/pages/de/news80984>  
[http://www.igb.fhg.de/WWW/Presse/Jahr/2004/dt/PI\\_Spatenstich-Knittlingen.html](http://www.igb.fhg.de/WWW/Presse/Jahr/2004/dt/PI_Spatenstich-Knittlingen.html)
- Illich, Ivan (1987): "H<sub>2</sub>O und die Wasser des Vergessens" – rororo aktuell 12131, Hamburg, Germany
- Jenssen, Petter D.; Heeb, Johannes; Huba-Mang, Elisabeth; Gnanakan, Ken; Warner, William S.; Refsgaard, Karen; Stenström, Thor-Axel; Guterstam, Björn and Alsén Knut Werner (2004): "Ecological Sanitation and Reuse of Wastewater - A Thinkpiece on ecological sanitation" – Agricultural University of Norway (UMB), Oslo, Norway, digitally available at:  
[http://www.dep.no/filarkiv/204575/ecosan\\_thinkpiece\\_final3.pdf](http://www.dep.no/filarkiv/204575/ecosan_thinkpiece_final3.pdf)
- Johansson, Mats and Kvarnström, Elisabeth (2005): "A Review of Sanitation Regulatory Frameworks". - EcoSanRes Publications Series, Report 2005-1, Stockholm Environment Institute (SEI), Stockholm, Sweden, digitally available at:  
[http://www.ecosanres.org/PDF%20files/ESR\\_publications\\_2005/ESR%202005-1.pdf](http://www.ecosanres.org/PDF%20files/ESR_publications_2005/ESR%202005-1.pdf)
- Johansson, Mats, Jönsson, Håkan; Höglund, Caroline; Richert Stintzing, Anna and Rodhe, Lena (2000): "Urine Separation – Closing the nutrient cycle" – Final report on the R&D Project "Source-separated human urine – a future fertilizer for the Stockholm region?", Stockholm, Sweden, digitally available at:  
[http://www.stockholmvatten.se/pdf\\_arkiv/english/Urinese\\_eng.pdf](http://www.stockholmvatten.se/pdf_arkiv/english/Urinese_eng.pdf)
- Jönsson, H., Richert Stintzing, A., Vinnerås, B. and Salomon, E. (2004): "Guidelines on use of urine and faeces in crop production". - EcoSanRes Publications Series, Report 2004-2, Stockholm Environment Institute (SEI), Stockholm, Sweden, digitally available at:  
<http://www.ecosanres.org/PDF%20files/ESR%20Publications%202004/ESR2%20web.pdf>
- Jönsson, Håkan; Werner, Christine; Otterpohl, Ralf, Rosmarin, Arno; Calvert, Paul and Vinnerås, Björn (2005): "Ecosan - both economic and eco-sane." - WATER 21 April 2005, IWA (International Water Association) Publishing, London, UK - part of the discussion on ecosan in WATER 21, complete discussion digitally available at:  
[http://www.tuhh.de/susan/downloads/water21ecosan\\_discussion.pdf](http://www.tuhh.de/susan/downloads/water21ecosan_discussion.pdf)
- Kalbermatten, J.M.; Middleton, R. and Schertenleib, R. (1999): "Household-Centred Environmental Sanitation" – Eawag (Swiss Federal Institute of Aquatic Science and Technology); Sandec (Water and Sanitation in Developing Countries), Duebendorf, Switzerland; WSSCC (Water Supply and Sanitation Collaborative Council), Geneva, Switzerland, digitally available at:  
[http://www.sandec.ch/EnvironmentalSanitation/Documents/Paper\\_Description\\_HCES\\_July99.pdf](http://www.sandec.ch/EnvironmentalSanitation/Documents/Paper_Description_HCES_July99.pdf)
- Kgomotso, P.; Makwati, D.; Molebatsi, L.; Ndaba, G.D.; Pelokgosi, M. and Wirbelauer, C. (2004): "Natural resources-based livelihood strategies in the villages of East Hanahai, Paje and West Hanahai." - International Union for the Conservation of Nature and Natural Resources or World Conservation Union (IUCN), Community Based Natural Resources Management (CBNRM) Missing Link project, Botswana, Printing and Publishing Company Botswana, Gaborone, Botswana, digitally available at:  
<http://www.gtz.de/ecosan/download/Botswana-CBNRM-Phase2Report.pdf>
- Khabeer, Naila (1994): "Reversed Realities, Gender Hierarchies in Development Thought". - Verso, London, UK and New York, USA
- Klutsé, Amah and Karin Ahlgren (2005): "Inter-disciplinary Research on Ecological Sanitation in Seven West African Countries." - pp.71-77 - In: "Proceedings of the Third International Conference on Ecological Sanitation (EcoSan), Durban, South Africa, 23-27 May 2005" - CSIR (Council for Scientific and Industrial Research), Pretoria, South Africa, digitally available at:  
<http://conference2005.ecosan.org/papers/klutse.pdf>
- Kvarnström, E. and E. Petersens (2004): "Open Planning of sanitation systems." - EcoSanRes Publications Series, Report 2004-3, Stockholm Environment Institute (SEI), Stockholm, Sweden, digitally available at:  
<http://www.ecosanres.org/PDF%20files/ESR%20Publications%202004/ESR3%20web.pdf>
- Lange, Jörg (2002): "Zur Geschichte des Gewässerschutzes am Ober- und Hochrhein". – PhD thesis, Albert-Ludwigs-Universität Freiburg, Germany, digitally available at:  
<http://www.freidok.uni-freiburg.de/volltexte/635/pdf/dissjoerglange.pdf>
- Lange, Jörg and Otterpohl, Ralf (2000): "Abwasser - Handbuch zu einer zukunftsfähigen Wasserwirtschaft" - Mallbeton

- Verlag, Reihe: Ökologie aktuell – Abwasser, Donaueschingen-Pföhren, Germany
- Larsen, T.A. and W. Gujer (1996): "Separate management of anthropogenic nutrient solutions (human urine)." - Water Science and Technology No. 34 (3-4): 87-94, IWA (International Water Association) Publishing Ltd, London, UK, free abstract digitally available at: <http://www.iwaponline.com/wst/03403/wst034030087.htm>
- Larsen, T.A. and W. Gujer (1997): "The concept of sustainable water management." - Water Science and Technology, No. 35 (9), pp 3-10, IWA (International Water Association) Publishing Ltd, London, UK, free abstract digitally available at: <http://www.iwaponline.com/wst/03509/wst035090003.htm>
- Larsen, Tove .A. and Judit Lienert (2003): "Societal Implications of Re-engineering the Toilet." - Water Intelligence Online March 2003, IWA (International Water Association) Publishing, London, UK , digitally available at: [http://www.novaquatis.eawag.ch/Downloads/Larsen\\_Lienert\\_2003\\_societal\\_implications\\_water\\_intell\\_online.pdf](http://www.novaquatis.eawag.ch/Downloads/Larsen_Lienert_2003_societal_implications_water_intell_online.pdf)
- Lennartsson, M. (2004): "Review of Alternative Sanitation Systems". - EcoSanRes working paper (draft version), Stockholm Environment Institute (SEI), Stockholm, Sweden, digitally available at: [http://www.ecosanres.org/alternative\\_sanitation\\_systems.htm](http://www.ecosanres.org/alternative_sanitation_systems.htm)
- Lens, P., Zeeman G. and Lettinga G. [eds.] (2001): "Decentralised sanitation and reuse - Concepts, systems and implementations." – IWA Publishing, London, UK
- Lettinga, G. (1996): "Sustainable integrated biological wastewater treatment." – Water Science and Technology 33(3), 85-98, IWA (International Water Association) Publishing Ltd, London, UK
- Lettinga, G. (2000): "Decentrale Sanitatie en Hergebruik op Gebouwniveau (DESAH)." - Eindverslag EET Kiemproject 98115, september 2000. Wageningen Universiteit, The Netherlands
- Liu, Jiayi and Mi, Hua (2003): "Sanitation: a Global Issue Sanitation: Ecosan Development Experience from China". - Guangxi Rural Water Supply and Sanitation Program Office/Harvard University and Ministry of Public Health, China – Presentation at the 12<sup>th</sup> session of the UN Commission on Sustainable Development (CSD), held on the 23<sup>rd</sup> of April 2004 in New York, USA, presentation digitally available at: <http://www2.gtz.de/ecosan/download/CSD12-ecosan-MiHua.pdf>
- Macleod, Neil A. (2005): "The provision of sustainable sanitation services to peri-urban and rural communities in the Ethekwini (Durban) municipality." - In: "Proceedings of the Third International Conference on Ecological Sanitation (EcoSan), Durban, South Africa, 23-27 May 2005" - CSIR (Council for Scientific and Industrial Research), Pretoria, South Africa, digitally available at: <http://conference2005.ecosan.org/papers/macleod.pdf>
- Mamit, James D., Peter Sawal, Ib Larsen and Tang Hung Huong. (2005): "Integrating Conventional and Ecological Sanitation in Urban Sanitation for the Future." - Manuscript from the Norwegian Ecocycle Conference April 26-27, 2005
- Mara, Duncan (2005a): "Ecological Sanitation - an unaffordable option?." - WATER 21, April 2005, International Water Association (IWA) Publishing, London, UK - part of the discussion on ecosan in WATER 21, complete discussion digitally available at: [http://www.tuhh.de/susan/downloads/water21ecosan\\_discussion.pdf](http://www.tuhh.de/susan/downloads/water21ecosan_discussion.pdf)
- Mara, Duncan (2005b): "Duncan Mara responds" - WATER 21, June 2005, International Water Association (IWA) Publishing, London, UK - part of the discussion on ecosan in WATER 21, complete discussion digitally available at: [http://www.tuhh.de/susan/downloads/water21ecosan\\_discussion.pdf](http://www.tuhh.de/susan/downloads/water21ecosan_discussion.pdf)
- McCann, Bill (2005): "The sanity of ecosan." - WATER 21, April 2005, International Water Association (IWA) Publishing, London, UK - part of the discussion on ecosan in WATER 21, complete discussion digitally available at: [http://www.tuhh.de/susan/downloads/water21ecosan\\_discussion.pdf](http://www.tuhh.de/susan/downloads/water21ecosan_discussion.pdf)
- Morel, Antoine; Zurbrügg, Chris and Schertenleib, Roland (2005): "National Centre of Competence in Research (NCCR) North-South: Partnerships for Mitigating Syndromes of Global Change." - Sandec News 6, April 2005, Eawag (Swiss Federal Institute of Aquatic Science and Technology); Sandec (Water and Sanitation in Developing Countries), Duebendorf, Switzerland, digitally available at: [http://www.sandec.ch/Publications/files/sandecnews\\_6.pdf](http://www.sandec.ch/Publications/files/sandecnews_6.pdf)
- Morgan, Peter (2005): "An Ecological Approach to Sanitation in Africa: A Compilation of Experiences." - Aquamor: Harare, Zimbabwe, digitally available at: [http://www.ecosanres.org/PM\\_Report.htm](http://www.ecosanres.org/PM_Report.htm)
- Mukherjee, Nilanjana and Christine van Wijk (2002): "Sustainability planning and monitoring in community water supply and sanitation - A Guide on the Methodology for Participatory Assessment (MPA) for Community-Driven Development Programs." - Water and Sanitation Program (WSP), Washington, D.C., USA, digitally available at: <http://www.wsp.org/publications/mpa%202003.pdf>
- Münch, Elisabeth von; Mang, Heinz Peter; Schultes, Georg and Panesar, Arne (2005): " Ten years of operational experiences with the ecosan-biogas plant at a family-owned farm and restaurant in Germany". - In: "Proceedings of the Third International Conference on Ecological Sanitation (EcoSan), Durban, South Africa,



- 23-27 May 2005" - CSIR (Council for Scientific and Industrial Research), Pretoria, South Africa, digitally available at:  
[http://conference2005.ecosan.org/papers/von\\_munch\\_et\\_al.pdf](http://conference2005.ecosan.org/papers/von_munch_et_al.pdf)
- Murray, Christopher J. L. and Lopez, Alan D.(1996): "Evidence-Based Health Policy - Lessons from the Global Burden of Disease Study." - Science 1 November 1996: 740-743, free abstract digitally available at:  
<http://www.sciencemag.org/cgi/content/summary/274/5288/740>
- Narain, Sunita (2004): "Why the flush toilet is ecologically mindless and why we need a paradigm shift in sewage technology." – Opening Session, p. 11-15 - In: Werner et al. [eds.]. 2004: "ecosan - closing the loop. Proceedings of the 2nd international symposium on ecological sanitation (...), 7th – 11th April 2003, Lübeck, Germany", Deutsche Gesellschaft für Technische Zusammenarbeit (GTZ), Eschborn, Germany, digitally available at:  
<http://www.gtz.de/de/dokumente/en-ecosan-symposium-luebeck-opening-session-2004.pdf>
- Nugent, R. and Drescher A. (2000): "Urban and Peri-Urban Agriculture (UPA) on the policy agenda: Virtual conference and information market". - A joint venture of the FAO Interdepartmental Working Group (IDWG) – Food for the Cities (FFC) and the Resource Center for Urban Agriculture and Forest (RUA/ETC), Leusden, The Netherlands
- Otterpohl, Ralf (2005): "A shift to resources management sanitation." - WATER 21, June 2005, IWA (International Water Association) Publishing, London, UK - part of the discussion on ecosan in WATER 21, complete discussion digitally available at: [http://www.tuhh.de/susan/downloads/water21ecosan\\_discussion.pdf](http://www.tuhh.de/susan/downloads/water21ecosan_discussion.pdf)
- Panesar, Arne and Lange, Jörg (2004): "Innovative sanitation concept shows way towards sustainable urban development. Experiences from the model project "Wohnen & Arbeiten" in Freiburg, Germany"- Session I, p.857-862 - In: Werner et al. [eds.]. (2004): "ecosan - closing the loop. Proceedings of the 2nd international symposium on ecological sanitation (...), 7th – 11th April 2003, Lübeck, Germany", Deutsche Gesellschaft für Technische Zusammenarbeit (GTZ), Eschborn, Germany, digitally available at:  
<http://www.gtz.de/de/dokumente/en-ecosan-symposium-luebeck-session-i-2004.pdf>
- Peter-Fröhlich, Anton; Kraume, Isabelle; Lesouëf, André; Gommery, Lionel; Phan, Laurent and Oldenburg, Martin (2004): "Sanitation concepts for separate treatment of urine, faeces and greywater." – Session G, p.675-683 - In: Werner et al. [eds.]. (2004): "ecosan - closing the loop. Proceedings of the 2nd international symposium on ecological sanitation (...), 7th – 11th April 2003, Lübeck, Germany", Deutsche Gesellschaft für Technische Zusammenarbeit (GTZ), Eschborn, Germany digitally available at:  
<http://www.gtz.de/de/dokumente/en-ecosan-symposium-luebeck-session-g-2004.pdf>
- Prüss, A. and Havelaar, A. (2001): "The global burden of disease study and applications in water, sanitation, and hygiene."- In: Fewtrell, L. and Bartram, J. [eds] (2001): "Water Quality: Guidelines, Standards and Health; Assessment of Risk and Risk Management for Water-related Infectious Disease". - International Water Association (IWA), London, UK on behalf of the World Health Organization (WHO), Geneva, Switzerland
- PUVeP (2005): "Allotment gardens."- Peri-urban Vegetable Project (PUVeP) of the Xavier University in Cagayan de Oro, Mindanao, Philippines, digitally available at:  
[http://www.puvep.com/allotment\\_garden.htm](http://www.puvep.com/allotment_garden.htm)
- Regeringens proposition 2004: "Swedish Governmental proposition 2004/05: 150 - Swedish Environmental Quality Objectives." –Swedish Government, page 193, digitally available at:  
<http://www.regeringen.se/sb/d/340/a/47646>
- Rosemarin, Arno (2004): "Phosphorous: scarce and dwindling." - Down to Earth, Science and Environment Fortnightly, Vol. June 30, 2004. Center for Science and Environment (CSE), Delhi, India
- Rosemarin, Arno, Jun, Xiao, Winblad, Uno, Han, Zhu, Guoyi Lixia, Sun, Jingrong, Li, Yunxiang, Han (2004): "China-Sweden Erdos Eco-town Project, Dong Sheng, Inner Mongolia, China". - EcoSanRes program, Stockholm Environment Institute (SEI), digitally available at:  
[http://www.ecosanres.org/PDF\\_files/SWS\\_poster\\_Dong\\_Sheng.pdf](http://www.ecosanres.org/PDF_files/SWS_poster_Dong_Sheng.pdf)
- Samwel, Margriet and Gabizon, Sascha (2005): "An example of ecological sanitation – Implemented in the scope of the pilot project Safe drinking water"– Woman for a common future (WECF), Munich, Germany, digitally available at:  
<http://www.wecf.de/cms/download/AQUA2004.doc>
- Sandec/WSSCC (Water and Sanitation in Developing Countries/ Water Supply and Sanitation Collaborative Council) (2000a): "Bellagio Statement: Clean, Healthy and Productive Living: A New Approach to Environmental Sanitation." - WSSCC (Water Supply and Sanitation Collaborative Council) Working Group Environmental Sanitation (Chair: Schertenleib R.), Geneva, Switzerland, Eawag (Swiss Federal Institute of Aquatic Science and Technology), Sandec (Water and Sanitation in Developing Countries), Duebendorf, Switzerland; WSSCC (Water Supply and Sanitation Collaborative Council), Geneva, Switzerland, digitally available at:

- [http://www.sandec.ch/EnvironmentalSanitation/Documents/Bellagio\\_Statement.pdf](http://www.sandec.ch/EnvironmentalSanitation/Documents/Bellagio_Statement.pdf)
- Sandec/WSSCC (Water and Sanitation in Developing Countries/ Water Supply and Sanitation Collaborative Council) (2000b): "Report of the Working Group on Environmental Sanitation to the 5th Global Forum of the WSSCC in Iguazu, 24 - 29 November 2000." - WSSCC (Water Supply and Sanitation Collaborative Council) Working Group Environmental Sanitation (Chair: Schertenleib R.), Eawag (Swiss Federal Institute of Aquatic Science and Technology), Sandec (Water and Sanitation in Developing Countries), Duebendorf, Switzerland; WSSCC (Water Supply and Sanitation Collaborative Council), Geneva, Switzerland, digitally available at: [http://www.sandec.ch/EnvironmentalSanitation/Documents/Report\\_Fifth\\_Global\\_Forum\\_Nov00.pdf](http://www.sandec.ch/EnvironmentalSanitation/Documents/Report_Fifth_Global_Forum_Nov00.pdf)
- Sawyer, Ron ; Arroyo, Francisco and Delmaire, Anne (2005): "Human Urine Harvesting in the Municipality of Tepoztlán, Morelos." – In: "Proceedings of the Third International Conference on Ecological Sanitation (EcoSan), Durban, South Africa, 23-27 May 2005 - CSIR (Council for Scientific and Industrial Research), Pretoria, South Africa, digitally available at: <http://conference2005.ecosan.org/papers/sawyer.pdf>
- Schönning, Caroline and Stenström, Thor Axel (2004): "Guidelines on the Safe Use of Urine and Faeces in Ecological Sanitation Systems", EcoSanRes Publications Series, Report 2004-1, SEI (Stockholm Environment Institute), Stockholm, Sweden, digitally available at: <http://www.ecosanres.org/PDF%20files/ESR%20Publications%202004/ESR1web.pdf>
- SDC/MyNetWork (2003): e-training course on ecological sanitation  
[http://www.iees.ch/pdf\\_files/ann\\_ecosan\\_1103a.pdf](http://www.iees.ch/pdf_files/ann_ecosan_1103a.pdf) (announcement), <http://www.mynetworks.org> (platform)
- SEI (Stockholm Environment Institute) (2005): "Sustainable Pathways to Attain the MDGs: Addressing the Key Role of Water, Energy and Sanitation". - Stockholm Environment Institute (SEI), Sweden, digitally available at: <http://www.ecosanres.org/PDF%20files/MDGRep/SustMDG31Auglowres.pdf>
- Shaeffer, J.R. and Stevens, L.A.(1983): "Future Water". - William Morrow and Co., New York, USA
- Shove, Elizabeth (2003): "Comfort, Cleanliness, Convenience, the social organisation of normality". - Berg, Oxford, UK
- Simpson-Hébert M. and Wood S. [eds] (1998): "Sanitation promotion." - WHO World Health Organization, Geneva, Switzerland (unpublished document WHO/EOS/98.5; available on request from Department of Protection of the Human Environment, World Health Organization, 1211 Geneva 27, Switzerland)
- Smit, J.; Ratta, A. and Nasr, J. (1996): "Urban agriculture: food, jobs, and sustainable cities." - United Nations Development Programme, Publication Series for Habitat II, Vol. 1., New York, USA.
- Spaargaren, Gert and van Vliet, Bas (2000): "Lifestyles, Consumption and the Environment: The Ecological Modernisation of Domestic Consumption." - Environmental Politics 9. v. 1 , pp 50-77
- Stadt Hamburg (2004): Press release of the Stadt Hamburg 29.06.2004, digitally available at: <http://fhh.hamburg.de/stadt/Aktuell/pressemeldungen/2004/juni/29/2004-06-29-bsu-grauwasser.html>
- Thomas, Percival (2000): "Wastewater Irrigation in the State of Victoria, Australia". –In: Werner et al. (2001): "Proceedings of the international symposium - ecosan - closing the loop in wastewater management and sanitation, 2000, Bonn". - GTZ- ecosan program, Deutsche Gesellschaft für Technische Zusammenarbeit (GTZ), Eschborn, Germany, digitally available at: <http://www.gtz.de/de/dokumente/en-proceedings-1st-international-ecosan-symposium-2000.pdf>
- Tischner, U., Schmidt-Bleek, F. (1993): "Designing Goods with MIPS." - Fresenius Envir. Bull., 2, pp.479-484
- UN - Habitat (United Nations Centre for Human Settlement) (2001): "Tools to Support Participatory Urban Decision Making". - Urban Governance Toolkit Series, the United Nations Centre for Human Settlement (UN-Habitat), New York, digitally available at: <http://www.unhabitat.org/cdrom/governance/html/cover.htm>
- UN (United Nations) (1992): "Agenda 21." – Report from the Conference on environment and development (Earth Summit) in Rio de Janeiro 3-14.6.1992 – Chapter 18 / 18.47, New York, USA, digitally available at: <http://www.un.org/esa/sustdev/documents/agenda21/english/agenda21toc.htm>
- UN (United Nations) (2000): "United Nations Millennium Declaration." – September 2000 - United Nations Department of public information, New York, USA, digitally available at: <http://www.un.org/millennium/declaration/ares552e.htm>
- UN (United Nations) (2002): "Key commitments, targets, and timetables from the Johannesburg plan of implementation" - United Nations Department of public information, New York, USA digitally available at: [http://www.johannesburgsummit.org/html/documents/summit\\_docs/2009\\_keyoutcomes\\_commitments.doc](http://www.johannesburgsummit.org/html/documents/summit_docs/2009_keyoutcomes_commitments.doc)
- UN (United Nations) (2005): "The Millennium Development Goals Report 2005." - United Nations Department of public information, New York, USA, digitally available at: <http://unstats.un.org/unsd/mi/pdf/MDG%20Book.pdf>
-

- UN (United Nations) Millenium Project (2005): "Health, Dignity, and Development: What Will it Take? Task Force on Water and Sanitation." - Earthscan, London and Sterling, UK, digitally available at: <http://www.unmillenniumproject.org/documents/WaterComplete-lowres.pdf>
- UNEP (United Nations Environmental Programm) (2004): "Financing Wastewater Collection and Treatment in Relation to the Millennium Development Goals and World Summit on Sustainable Development Targets on Water and Sanitation." (UNEP/GCSS.VIII/INF/4), digitally available at: <http://www.eldis.org/static/DOC14717.htm>
- Universität Freiburg (University of Freiburg) (2004): "Armengärten in den Phillippinen: Bundesministerium für wirtschaftliche Zusammenarbeit und Entwicklung zeichnet Projekt in Asien aus." – Press release (08.06.2004, in German) of the Albert-Ludwigs-Universität Freiburg, Germany, digitally available at: [http://www.pr.uni-freiburg.de/prmit\\_layout\\_alt/prmit.php?ind=805](http://www.pr.uni-freiburg.de/prmit_layout_alt/prmit.php?ind=805)
- Urban Water (2004): "MIKA – Methodologies for Integration of Knowledge Areas. Surahammar Case Study". - (unpublished, draft in Swedish), Urban Water, London, UK
- van der Vleuten-Balkema, Annelies J. (2003): "Sustainable Wastewater Treatment - developing a methodology and selecting promising systems." – PhD thesis, Technische Universiteit Eindhoven, The Netherlands
- van Zon, Henk (1986): "Een zeer onfrisse geschiedenis" ("A Very Dirty Affair"). - PhD thesis, Royal Groningen University, The Netherlands
- Werner, Christine; Panesar, Arne; Bracken, Patrick; Mang, Heinz Peter; Huba-Mang, Elisabeth and Gerold, Agnes M (2003a): „An ecosan source book for the preparation and implementation of ecological sanitation projects” – GTZ- ecosan program, Deutsche Gesellschaft für Technische Zusammenarbeit (GTZ), Eschborn, Germany, digitally available at: <http://www.gtz.de/de/dokumente/en-ecosan-source-book-2005.pdf>
- Werner, Christine; Kraus, Simone; Bracken, Patrick and Panesar, Arne (2003b): "ecosan-closing the loop. Bericht vom Zweiten Internationalen ecosan Symposium." – KA Zeitschrift für Abwasser-Abfall 8-2003, p994, ATV-DVWK, GFA Gesellschaft zur Förderung der Abwassertechnik, Hennef, Germany
- WHO (World Health Organization) (1989): "Guidelines for the use of wastewater and excreta in agriculture and aquaculture." – by Mara D.D. and Cairncross S., WHO (World Health Organization) Technical Reports 778, Geneva, Switzerland
- WHO (World Health Organization) (2002): "World Health Report 2002." - WHO World Health Organization, Geneva, Switzerland, digitally available at: <http://www.who.int/entity/whr/2002/en/index.html>
- WHO (World Health Organization) (2003): "Looking back, looking ahead. Five decades of challenges and achievements in environmental sanitation and health." - WHO World Health Organization, Geneva, Switzerland digitally available at: [http://www.who.int/entity/water\\_sanitation\\_health/hygiene/envsan/Lookingback.pdf](http://www.who.int/entity/water_sanitation_health/hygiene/envsan/Lookingback.pdf)
- WHO/UNICEF JMP (World Health Organization and United Nations Childrens Fund Joint Monitoring Programme for Water Supply and Sanitation) (2005): "Water for life: making it happen". - World Health Organisation, Geneva, Switzerland, digitally available at: [http://www.who.int/water\\_sanitation\\_health/monitoring/jmp2005/en/](http://www.who.int/water_sanitation_health/monitoring/jmp2005/en/)
- WHO/UNICEF JMP (World Health Organization and United Nations Childrens Fund Joint Monitoring Programme for Water Supply and Sanitation) (2000): "Global Water Supply and Sanitation Assessment 2000 Report." - World Health Organisation, Geneva, Switzerland, digitally available at: [http://www.who.int/docstore/water\\_sanitation\\_health/Globassessment/GlobalTOC.htm](http://www.who.int/docstore/water_sanitation_health/Globassessment/GlobalTOC.htm)  
- quoted from: WHO (1997, unpublished): "Health and environment in sustainable development: five years after the Earth summit". - Geneva, World Health Organization (unpublished document WHO/EHG/97.8; available on request from Department of Protection of the Human Environment, World Health Organization, 1211 Geneva 27, Switzerland)
- Wilderer P.A., Faulstich M., Schiegl, C., Kaukal, B. [eds] (1997): "Altlastensanierung in Bayern. Konzepte - Technologien – Erfolge." - Berichte aus Wassergüte- und Abfallwirtschaft, Technische Universität München Nr. 129, München, Germany
- Wilderer, P.A., Schroeder, E.D. and Kopp, H. [eds] (2004): "Global Sustainability - The Impact of Local Cultures. A New Perspective for Science and Engineering, Economics and Politics". - WILEY-VCH, Weinheim, Germany
- Winblad, Uno and Simpson-Hébert, Mayling (2004): " Ecological Sanitation – revised and enlarged edition". – EcoSanRes Program, SEI Stockholm Environment Institute, Stockholm ; digitally available at: [http://www.ecosanres.org/PDF\\_files/Ecological\\_Sanitation\\_2004.pdf](http://www.ecosanres.org/PDF_files/Ecological_Sanitation_2004.pdf)
- Zeeman G. and Lettinga G (1999): "The role of anaerobic digestion of domestic sewage in closing the water and nutrient cycle at community level." – Water Science and Technology 39(5), 187-194, IWA (International Water Association) Publishing Ltd, London, UK

Zhou, Liming; Dickinson, Robert E.; Tian, Yuhong; Fang, Jingyun; Li, Qingxian; Kaufmann, Robert K.; Tucker, Compton J. and Myneni, Ranga B. (2004): "Evidence for a significant urbanization effect on climate in China." - Proceedings of the National Academy of Sciences of the United States of America (PNAS), vol. 101, no. 26, June 29, 2004, Eashington, USA, digitally available at:  
<http://cybele.bu.edu/download/manuscripts/lmzhou05.pdf>

## 8.2 Selected links with information on ecosan research and education

Name or Abbreviation	Description and link
(All URLs retrieved on 2005-12-15)	
AGRICULTURE 21	FAO's Online Magazine <a href="http://www.fao.org/ag/default.htm">http://www.fao.org/ag/default.htm</a>
AKWA 2100	Alternativen der kommunalen Wasserversorgung und Abwasserentsorgung, AKWA 2100 research project, Germany <a href="http://www.akwa-2100.fhg.de/">http://www.akwa-2100.fhg.de/</a>
BMZ	German Ministry for economic collaboration and development <a href="http://www.bmz.de/">http://www.bmz.de/</a>
CREPA	Centre Régional pour l'eau potable et l'assainissement, Ouagadougou, Burkina Faso <a href="http://www.reseaucrepa.org/index.htm">http://www.reseaucrepa.org/index.htm</a>
CSD	UN Commission on Sustainable Development <a href="http://www.un.org/esa/sustdev/">http://www.un.org/esa/sustdev/</a>
CSE	Indian Centre for Science and environment, Delhi, India <a href="http://www.cseindia.org">www.cseindia.org</a>
CSIR	Council for Scientific and Industrial Research, Pretoria, South Africa <a href="http://www.csir.co.za">www.csir.co.za</a> <a href="http://www.csir.co.za/websource/ptl0002/docs/boutek/akani/print/2002/mar/print07.html">http://www.csir.co.za/websource/ptl0002/docs/boutek/akani/print/2002/mar/print07.html</a>
DWA	German Water Association (Deutsche Vereinigung für Wasserwirtschaft, Abwasser und Abfall, formerly ATV-DVWK) <a href="http://www.dwa.de">www.dwa.de</a>
Eawag - Novaquatis	Integrated aquatic research project at the Swiss Federal Institute for Environmental Science and Technology (Eawag), Research of urine source separation for improved wastewater management <a href="http://www.novaquatis.eawag.ch">www.novaquatis.eawag.ch</a>
Eawag - Sandec	Swiss Federal Institute for Environmental Science and Technology, Department of Water and Sanitation in Developing Countries <a href="http://www.sandec.ch">www.sandec.ch</a>
ECN	European Compost Network <a href="http://www.compostnetwork.info">http://www.compostnetwork.info</a>
Eco solutions	Eco solutions (NGO from India) <a href="http://www.eco-solutions.org/">http://www.eco-solutions.org/</a>
ecosan	ecosan program of the GTZ <a href="http://www.gtz.de/en/themen/umwelt-infrastruktur/wasser/8524.htm">http://www.gtz.de/en/themen/umwelt-infrastruktur/wasser/8524.htm</a>
EcoSanClub	Austrian NGO/consultancy group, homepage with information on many international ecosan activities, project information and publications <a href="http://www.ecosan.at/">http://www.ecosan.at/</a>
EcoSanRes	International ecosan program, sponsored by the Swedish International Development Agency (SIDA). Extensive ecosan information, publications, case studies, etc



---

	<a href="http://www.ecosanres.org/">http://www.ecosanres.org/</a>
FAO	Food and Agriculture Organization of the United Nations <a href="http://www.fao.org/">http://www.fao.org/</a>
Freiburg Vauban	Eco-Settlement in Freiburg, Germany <a href="http://www.passivhaus-vauban.de/idee.html">http://www.passivhaus-vauban.de/idee.html</a>
GTZ	German Technical Cooperation Association, Eschborn, Germany (implementing the GTZ – ecosan program) <a href="http://www.gtz.de/">http://www.gtz.de/</a>
GWA	Gender and Water Alliance (Open Network with over 300 organisations involved) <a href="http://www.genderandwateralliance.org/">http://www.genderandwateralliance.org/</a>
HCES	Household Centred Environmental Sanitation Approach (HCES) of the WSSCC <a href="http://www.wsscc.org/dataweb.cfm?code=593">http://www.wsscc.org/dataweb.cfm?code=593</a>
IDRC	International Development Research Centre, Canada <a href="http://www.idrc.ca/">http://www.idrc.ca/</a>
IEES	International Ecological Engineering Society, Wolhusen, Switzerland (with EcoEng-Newsletter) <a href="http://www.iees.ch/news.html">http://www.iees.ch/news.html</a>
IFS	International Foundation for Science, Stockholm, Sweden (funding program for scientists from developing countries) <a href="http://www.ifs.se/">http://www.ifs.se/</a>
InterWATER	Directory of organisations in the water and sanitation sector <a href="http://www.irc.nl/interwater/">http://www.irc.nl/interwater/</a>
IRC	International Water and Sanitation Centre, Delft, The Netherlands (news and information, advice, research and training, on low-cost water supply and sanitation in developing countries) <a href="http://www.irc.nl/">http://www.irc.nl/</a>
IUCN	International Union for the Conservation of Nature and Natural Resources (or World Conservation Union) <a href="http://www.iucn.org/">http://www.iucn.org/</a>
IWA	International Water Association, Specialist group on ecological sanitation <a href="http://www.ecosan.org/">http://www.ecosan.org/</a>
IWMI	International Water Management Institute, Sri Lanka <a href="http://www.iwmi.cgiar.org/">http://www.iwmi.cgiar.org/</a>
KfW	KfW banking group, Germany (Kreditanstalt für Wiederaufbau) <a href="http://www.kfw.de/">http://www.kfw.de/</a>
Knoten Weimar	Knoten Weimar, Germany (International Transfer Centre for Environmental Technologies) <a href="http://www.bionet.net/">http://www.bionet.net/</a>
NCCR	National Centre of Competence in Research (NCCR) North-South (Partnerships for Mitigating Syndromes of Global Change) <a href="http://www.nccr-north-south.unibe.ch">www.nccr-north-south.unibe.ch</a>
PUVeP	Peri-urban Vegetable Project (PUVeP) of the Xavier University in Cagayan de Oro, Mindanao, The Philippines <a href="http://www.puvep.com/">http://www.puvep.com/</a>
RUAF	Resource centre on urban agriculture and forestry Leusden, The Netherlands <a href="http://www.ruaf.org/news/gen_fr.html">http://www.ruaf.org/news/gen_fr.html</a>
RWTH Aachen, Germany	Technical University Aachen, Department of Environmental Engineering, Germany <a href="http://www.isa.rwth-aachen.de">www.isa.rwth-aachen.de</a>
Sanitation Connection	An Environmental Sanitation Network <a href="http://www.sanicon.net/titles/topicintro.php3?topicid=17">http://www.sanicon.net/titles/topicintro.php3?topicid=17</a>
SDC	Swiss Agency for Development and Cooperation (Direktion für Entwicklung und Zusammenarbeit DEZA)

---

---

	<a href="http://www.deza.ch/">http://www.deza.ch/</a>
SEI	The Stockholm Environment Institute, Sweden (SEI implements the EcoSanRes program) <a href="http://www.sei.se">www.sei.se</a>
SIDA	Swedish Agency for International Development Cooperation <a href="http://www.sida.gov.se/">http://www.sida.gov.se/</a>
Source news	Joint endeavour of IRC and WSSCC (with newsletter) <a href="http://www.irc.nl/source">http://www.irc.nl/source</a>
TepozEco	Urban ecological sanitation program, Tepoztlán, Mexico <a href="http://www.laneta.apc.org/sarar/tepozeco.htm">http://www.laneta.apc.org/sarar/tepozeco.htm</a>
TU Darmstadt, Germany	Institute of Water Supply and Groundwater Protection, Wastewater Technology, Waste Management, Industrial Material Cycles, Environmental and Spatial Planning at the TU Darmstadt, Germany <a href="http://www.iwar.bauing.tu-darmstadt.de">www.iwar.bauing.tu-darmstadt.de</a>
TUHH, Germany	Technical University of Hamburg Harburg, Institute of Municipal and Industrial Wastewater Management <a href="http://www.tu-harburg.de/aww/index.html">http://www.tu-harburg.de/aww/index.html</a>
UMB, Norway	Norwegian University of Life Sciences (Ecosan courses, projects and publications) <a href="http://www.umb.no/ecosan">www.umb.no/ecosan</a>
UN MDG homepage	UN MDG homepage_ <a href="http://www.un.org/millenniumgoals">http://www.un.org/millenniumgoals</a>
UNDP	United Nations Development Program <a href="http://www.undp.org">http://www.undp.org</a> United Nations Development Program, page on Ecological Sanitation <a href="http://www.undp.org/water/ecol.html/">http://www.undp.org/water/ecol.html/</a>
UNEP	United Nations Environmental Program <a href="http://www.unep.org/">http://www.unep.org/</a>
UNESCO	United Nations Educational Scientific and Cultural Organisation <a href="http://www.unesco.org/">http://www.unesco.org/</a>
UNESCO-IHE	Institute for Water Education, Delft, Netherlands <a href="http://www.unesco-ihe.org">www.unesco-ihe.org</a>
UNESCO-IHP	UNESCO-International Hydrological Programme <a href="http://www.unesco.org/water/ihp/index.shtml">http://www.unesco.org/water/ihp/index.shtml</a>
UN-Habitat	United Nations Centre for Human Settlement <a href="http://www.unhabitat.org/">http://www.unhabitat.org/</a>
UNICEF	United Nations Children's Fund <a href="http://www.unicef.org/">http://www.unicef.org/</a> United Nations Children's Fund, page on Water, Environment and Sanitation <a href="http://www.unicef.org/wes/index.html">http://www.unicef.org/wes/index.html</a>
University of Bonn, Germany	Institute of Plant Nutrition, Secondary Resources Management, University of Bonn, Germany <a href="http://www.rema.uni-bonn.de">www.rema.uni-bonn.de</a>
Urban Water	Swedish Water and Sanitation Research Group <a href="http://www.urbanwater.org/default_eng.htm">http://www.urbanwater.org/default_eng.htm</a>
WASH	Water, Sanitation and Hygiene for All – an Initiative of the WSSCC <a href="http://www.wsscc.org/dataweb.cfm?code=57">http://www.wsscc.org/dataweb.cfm?code=57</a>
WASTE	Advisors on Urban Environment and Development, NGO, The Netherlands <a href="http://www.ecosan.nl/">http://www.ecosan.nl/</a>
Water Page	The Water Page (Africa) <a href="http://www.thewaterpage.com/ecosan_main.htm">http://www.thewaterpage.com/ecosan_main.htm</a>
WATER21	International Water Magazine <a href="http://www.iwapublishing.com/template.cfm?name=iwapwater21">http://www.iwapublishing.com/template.cfm?name=iwapwater21</a>

---

WECF	Women in Europe for a Common Future <a href="http://www.wecf.org/">http://www.wecf.org/</a>
WEDC	Water, Engineering and Development Centre <a href="http://wedc.lboro.ac.uk/index.php">http://wedc.lboro.ac.uk/index.php</a>
WELL	Resource Centre Network for Water, Sanitation and Environmental Health (includes an extensive link list) <a href="http://www.lboro.ac.uk/well/index.htm">http://www.lboro.ac.uk/well/index.htm</a>
WHO	World Health Organisation <a href="http://www.who.int/en/">http://www.who.int/en/</a>
WB	World Bank <a href="http://www.worldbank.org/">http://www.worldbank.org/</a> World Bank Water Supply and Sanitation (WSS) Program <a href="http://web.worldbank.org/WBSITE/EXTERNAL/TOPICS/EXTWSS/0,,menuPK:337308-pagePK:149018-piPK:149093-theSitePK:337302,00.html">http://web.worldbank.org/WBSITE/EXTERNAL/TOPICS/EXTWSS/0,,menuPK:337308-pagePK:149018-piPK:149093-theSitePK:337302,00.html</a>
WSP	Water and Sanitation Programme, Washington, D.C., USA <a href="http://www.wsp.org/">http://www.wsp.org/</a>
WSSCC	Water Supply and Sanitation Collaborative Council, Geneva, Switzerland <a href="http://www.wsscc.org/">http://www.wsscc.org/</a>
WTO	World Toilet Organisation, Singapore <a href="http://www.worldtoilet.org/hp/wto_hp.htm">http://www.worldtoilet.org/hp/wto_hp.htm</a>

## 9 Glossary and Abbreviations

### 9.1 Glossary

Agricultural use in relation to sanitation	Use of recyclates produced from liquid and solid household waste. Includes other forms of use - e.g. in horticulture, aquaculture, forestry, ...
Aquifer	An underground water source. Porous water bearing layers of sand, gravel and rock below the earth surface,
Black water	Water that contains excreta from humans and/or animals
Capacity building	Strengthening of skills
Curriculum	The subjects that are studied or prescribed for study in a school, university
DALYs	Disability Adjusted Life Years; a method to quantify risks, by translating them into years, lost or spend ill, by the people of a given target group
Digestion	The breaking down of organic substances under aerobic or anaerobic conditions
Diversion, diversion systems	The process of separating materials at their source, or point of generation. Diversion systems are systems, like urine-diverting toilets (or recycling separation containers) that stimulate users to separate waste streams at source.
Ecosan	Abbreviation for ecological sanitation.
Effluent	Liquids discharged out of a tank or sewage works
Excreta	Emitted human and animal wastes: faeces and urine
Faeces	Human and animal waste matter discharged from the bowels, containing undigested foods, bacteria, mucus, and dead cells.
Gender sensitive planning	Planning that includes the fact, that in all societies community members (e.g. men and women, young and old, rich and poor) play different roles, have different needs, and face different constraints. Gender roles differ from the biological roles of men and women, as they are socially constructed. They demarcate responsibilities between men and women, social and economic activities, access to resources, and decision-making authority. Biological roles are fixed, but gender roles can and do change with social, economic, and technological change. Social factors underlie and support gender-based disparities. (Adapted from: Fong, M. S., Wakeman, W. and Bhushan, A. (1996). Toolkit on Gender in Water and Sanitation. The World Bank)
Grey water	Household wastewater without input of human and /or animal excreta, including sources from baths, showers, hand basins, washing machines, dishwashers, laundries and kitchen sinks (also called 'sullage'). Eventually kitchen waste water may also be treated separately, or together with black water, as it may contain larger concentrations of organic matter, oil, etc.
Hormone	Chemical substances produced by the body that has specific effects on the activity or function of a certain organ.
Leachate	Liquids draining from sewers, pits or waste collection chambers.
Nightsoil	Fresh human excreta with or without anal cleaning material, which are deposited in

---

	a bucket or other receptacle for manual removal (often taking place at night).
Nutrients	In this document used as: Essential chemical elements and minerals, assimilated by plants and micro-organisms that stimulate growth and remain, through decomposition and other biochemical processes in the ecosystem
Pathogens	Organisms that create diseases in host organisms
Pharmaceutical residues	Residues consisting of/ or containing pharmaceuticals
PRA	Participatory Rapid Assessment, an assessment methodology that includes sets of participatory techniques, includes integrated approaches and aims at facilitating poor, uneducated, or disempowered groups to take charge of their own development processes, and become subjects, rather than objects, of development and urban planning interventions.
Poudrette	French word for dried natural fertiliser from human excreta, manure or compost.
Rainwater harvesting	The capture and use of runoff from rainfall.
Recovery	The process of separation and collection of recyclable material from a waste stream
Recyclates	Recovered materials. In the sanitation sector this specific term is usually limited to products made from urine, faeces, and grey water.
Recycling	The reuse of materials, not necessarily in their original forms
Sanitation	Interventions to reduce people's exposure to diseases by providing a clean environment in which to live; measures to break down the cycle of disease. Sanitation involves both behaviours and facilities, which work together to form a hygienic environment.
Sanitation management system	The sum of several stages in the management of the flow of human waste and grey water within the city and the region
Sanitation, conventional	Sanitation systems based on collection, end-of-pipe treatment and disposal of excreta and wastewater, not considering reuse of water and nutrients
Sanitation, ecological	Holistic eco-system oriented approach towards hygienic safe, ecologically and economically sound sanitation; a concept where human waste is considered a resource and its management forms part of an integrated water resources, nutrient flows and waste management processes. Usually ecological sanitation systems are summarized under the term "ecosan". Other terms, which partly or fully comply with ecosan principles, include "wastewater reclamation and reuse", DESAR (Decentralised Sanitation and Reuse) or DEWATS (Decentralised Wastewater Systems).
Sanitation, environmental	Interventions to reduce peoples' exposure to disease by providing a clean environment in which to live, with measures to break the cycle of disease. This usually includes hygienic management of human and animal excreta, refuse, wastewater, storm water, the control of disease vectors, and the provision of washing facilities for personal and domestic hygiene. Environmental Sanitation involves both behaviours and facilities which work together to form a hygienic environment
Sewage	The spent or used water from a community that contains dissolved or suspended matter.
Sewage sludge	Sludge resulting from the treatment of raw wastewater.

---

Stakeholders	A person or an organisation that has a stake, an interest in a certain case
Strategic planning	A process of involving stakeholders in the articulation of problems, the setting of priorities, and the designating of desired actions and interventions to change the situation in relation to urban infrastructure, specifically sanitation, in the short-, medium- and long term.
Toilet	Place for defecation and urination
Urine	A pale-yellow fluid secreted as waste from the blood by the kidney, stored in the bladder, and discharged through the urethra
Waste	'Unwanted' for the person who discards it; a product or material that does not have a value for the first user and is therefore thrown away.
Wastewater	All types of domestic wastewater, commercial and industrial effluent as well as storm water runoff

## 9.2 Abbreviations

AKWA 2100	Alternativen der kommunalen Wasserversorgung und Abwasserentsorgung, AKWA 2100 Research Project
BCEB	Bahrain Convention & Exhibition Bureau, Manama, Kingdom of Bahrain
BMZ	German Ministry for economic collaboration and development
CBNRM	Community Based Natural Resources Management
CBO	Community-Based Organisation
CREPA	Centre Régional pour l'eau potable et l'assainissement, Ouagadougou, Burkina Faso
CSD	UN Commission on Sustainable Development
CSE	Indian Centre for Science and Environment
CSIR	Council for Scientific and Industrial Research, Pretoria, South Africa
DALYs	Disability Adjusted Life Years
DEZA	Direktion für Entwicklung und Zusammenarbeit (German for Swiss Agency for Development and Cooperation (SDC))
DS	Dry Sanitation
DT	Dry Toilets
DWA	Deutsche Vereinigung für Wasserwirtschaft, Abwasser und Abfall, German Water Association (formerly ATV-DVWK)
Eawag	Swiss Federal Institute for Environmental Science and Technology
Eawag - Sandec	Department of Water and Sanitation in Developing Countries at the Swiss Federal Institute for Environmental Science and Technology (Eawag)
Eawag Novaquatis	- Integrated aquatic research project at the Swiss Federal Institute for Environmental Science and Technology (Eawag)
ECN	European Compost Network
EcoSanRes	Ecological sanitation research – Swedish ecosan programme from SEI

EMP	Environmental Management Plan
ESA	European Space Agency
EUR	Euro
FAO	Food and Agriculture Organisation of the United Nations
GTZ	German Technical Cooperation Association
GWA	Gender and Water Alliance
HCES	Household Centred Environmental Sanitation Approach (HCES) of the WSSCC
IDRC	International Development Research Centre
IFAT	Internationale Fachmesse für Wasser-Abwasser-Abfall-Recycling
IFS	International Foundation for Science
IGB	Fraunhofer Institute for Interfacial Engineering and Biotechnology, Stuttgart
IMWI	International Water Management Institute
IPN	Inter-institutional professional network on ecosan
IRC	International Water and Sanitation Centre
IRTCID/CUW network	UNESCO endorsed network of centres for urban drainage / urban water
ISWM	Integrated Sustainable Waste Management
IUCN	International Union for the Conservation of Nature and Natural Resources or World Conservation Union
IWA	International Water Association
IWMI	International Water Management Institute
IWWA	Indian Water Works Association
KfW	Kreditanstalt für Wiederaufbau, KfW banking group
kg/cap/a	Kilogramme per capita and year
MDG	Millennium development goals
MFA	Material Flux Analysis
MIKA	Methodologies for Integration of Knowledge Areas
MPA	Methodology for Participatory Assessment
MSE	Micro- and Small-scale Enterprise
NASA	National Aeronautics and Space Administration
NCCR North- South	National Centre of Competence in Research (NCCR) North-South
NGO	Non Governmental Organisation
O&M	Operation and maintenance
OSEA	Order of Syrian Engineers and Architects
PNAS	Proceedings of the National Academy of Sciences of the United States of America
PRA	Participatory Rapid Assessment
PRSP	Poverty Reduction Strategy Papers

---

R&D Project	Research and Development Project
RUAF	Resource centre on urban agriculture and forestry, Leusden, Netherlands
SDC	Swiss Agency for Development and Cooperation
SEI	Stockholm Environment Institute
SIDA	Swedish Agency for International Development Cooperation
SWOT - Analyses	Strengths-Weaknesses-Opportunity / Opportunities-Threats - Analyses
TUHH	Technical University Hamburg Harburg
UN	United Nations
UNDP	United Nations Development Program
UNEP	United Nations Environmental Program
UNEP GPA	United Nations Environmental Program - Global Programme of Action
UNESCO	United Nations Educational scientific and Cultural Organisation
UNESCO-IHE	UNESCO-Institute for Water Education, Delft, the Netherlands
UNESCO-IHP	UNESCO-International Hydrological Programme
UN-Habitat	United Nations Centre for Human Settlement
UNICEF	United Nations Children's Fund
UWETTT	Urban Water Education, Training and Technology Transfer projects, UNESCO training material (UWETTT)
VIP latrines	Improved ventilated pit (VIP) latrines
WASH	Water, Sanitation and Hygiene for All – an Initiative of the WSSCC
WASTE	Advisors on Urban Environment and Development, NGO, The Netherlands
WATER21	International Water Magazine
WECF	Women in Europe for a Common Future
WEDC	Water, Engineering and Development Centre
WHO	World Health Organisation
WSP	Water and Sanitation Programme, Washington, D.C., USA
WSP-AF	Water and Sanitation Program for Africa
WSSCC	Water Supply and Sanitation Collaborative Council
WTO	World Toilet Organisation
YLD	Years lived with a disability
YLL	Years of life lost to premature death

---



## 10 Lists of Figures, Tabelles and Boxes

### List of Figures

Figure 1:	Emptying conventional pit toilets required special equipment (left picture) and turned out to be extremely costly - often exceeding 1000 Rand per pit. The urine diversion dehydration toilet (right picture) was selected by the communities as preferred solution after extensive awareness raising measures (Macleod 2005).....	7
Figure 2:	Schematic illustration of the main limitations of conventional wastewater management systems (GTZ).....	8
Figure 3:	Schematic illustration of the main advantages of ecological sanitation systems (GTZ).....	13
Figure 4:	Separation of substances and examples of possible ecosan elements (GTZ).....	15
Figure 5:	Essential technological components used in ecosan (GTZ).....	17
Figure 6:	Decision making in the past and in the future according to the HCES (Eawag 2005).....	19
Figure 7:	The “ecosan project steps” – key moments, necessary activities and expected results (GTZ).....	20
Figure 8:	ecosan urine diversion squatting pan (left); ecosan in-house toilets (middle and right) (SIDA).....	21
Figure 9:	Dehydrating chamber with 2 containers and urine collection (left); organoponics (right) (TepozEco).....	22
Figure 10:	Gebers apartment building (left); composting of faeces and organic waste (middle); urine application on a barley field (right) (VERNA).....	24
Figure 11:	The characteristics of the 4 basic types of ecosan projects (GTZ).....	25
Figure 12:	Principal stakeholders in participatory ecosan projects (GTZ).....	27
Figure 13:	Ecological sanitation is an inter-disciplinary field and is related to many aspects of modern societies in both developed and developing world (GTZ).....	33
Figure 14:	Modus operandi in Nodal Development. (EcoSanRes 2006).....	44
Figure 15:	The organisational structure of the “nodal concept for capacity building”, as suggested for the EcoSanRes Programme Projectphase 2. (EcoSanRes 2006).....	47
Figure 16:	Swedish research on urine separation and reuse in the end of the 20th century (Johansson et al. 2000).....	51
Figure 17:	Siphon for waterless urinals invented by Beets, 1885: Oil forms a layer on top of the urine and stops smells (left) (Lange 2002). Modern waterless urinal (right). (GTZ–technical data sheets 2005-01.B2)......	52
Figure 18:	In Amsterdam in 1906 more than 4.500 vacuum toilets were connected to a vacuum based Lienur-system (Lange 2002). (Foto Roediger).....	53
Figure 19:	KfW office building “Ostarkade” (left); Vacuum toilet and pumping unit (right) (KfW).....	54
Figure 20:	The main building of the GTZ headquarters (left - tsp-HWP-Seidel); urine diversion toilet (middle - ROEDIGER) and waterless urinal (right; Keramag).....	55
Figure 21:	Front view of the apartment buildings (left); straight drop urine diversion toilet design (middle); collection of faeces in cellar containers (right). (EcoSanRes).....	62
Figure 22:	Training of students (left); dry toilets with wooden containers for collecting the separated faecal material (middle - view from the back) and demonstration toilet (right). (EcoSan Club).....	66
Figure 23:	Cost comparison for the installation, operation and maintenance of the two systems for the school (EcoSanClub 2004).....	67
Figure 24:	Cost comparison for the installation, operation and maintenance of the three systems for a population of 5000 (Peter-Fröhlich et al. 2003).....	68
Figure 25:	The cost structures of conventional and safe use oriented sanitation systems (GTZ).....	70
Figure 26:	Estimated annual nitrogen flows of Kumasi, Ghana in tons/year for the scenario “reuse of co-composted solid waste and faecal sludge” (Belevi 2002)......	75
Figure 27:	Training workshop (left); traditional hut with ecosan toilet (middle); revised ground structure (right). (IUCN/GTZ).....	77
Figure 28:	Constructed wetland reed beds (left); sludge reed bed (middle); official inauguration of the pilot project (right). (Mohamed).....	78
Figure 29:	Waldmichelbacherhof (left; Schultes); collection channel under the barn floor (right; Wang).....	79

Figure 30: Demo plot (left); irrigation and mulching (middle); planting (right). (GTZ) .....	82
Figure 31: Urine diverting public toilet in Bangalore (left; Heeb); biogas plant (right; Wafler) .....	85
Figure 32: Urine-separation vermin composting toilet (left) and new school toilet block with bio-gas treatment - under construction (right). (GTZ) .....	91

## List of Tables

Table 1: Characteristics of flow streams .....	16
Table 2: Factors motivating and constraining stakeholders to participate in an ecosan programme .....	29
Table 3: Target groups for education and training in ecological sanitation .....	37
Table 4: Range of subjects to be taught in ecological sanitation training and education .....	41
Table 5: Matrix of relevance of subjects for different target groups .....	42
Table 6: Examples of general sustainability criteria for the evaluation of sanitation systems (modified from Bracken et al. 2005). The contents of this table is intended to assist planners, decision makers and other stakeholders to identify their own context specific sustainability indicators, and not to serve directly as a general checklist for sustainability .....	58
Table 7: Sanitation cost ladder for conventional and ecological sanitation methods (including initial capital cost and O&M for the first year of operation) (SEI 2005) .....	71
Table 8: Example for a 3-minute awareness raising presentation .....	95
Table 9: Programme for part 1 (3 weeks, in Sweden) of the advanced Sida/EcosanRes course of ecological alternatives in sanitation .....	100
Table 10: Programme for part 3 (2 weeks, regional) of the advanced Sida/EcosanRes course of ecological alternatives in sanitation in or near the participant's countries of origin .....	103
Table 11: Schedule of a 5-day ecosan introduction course in Norway .....	106
Table 12: Schedule of a 4-day ecosan training course in China .....	108
Table 13: Schedule of a 2-day ecosan workshop in Eritrea .....	111
Table 14: Schedule of a 3-day ecosan symposium in Syria .....	112
Table 15: Schedule of a 3-day ecosan workshop in Zambia .....	114
Table 16: Schedule of a 3-day ecosan workshop in Botswana .....	116
Table 17: Schedule of a 4-day ecosan workshop in El Salvador .....	118
Table 18: Schedule of a 2-day ecosan workshop in Turkey .....	120
Table 19: Schedule of a 2-day ecosan workshop in India .....	122
Table 20: programme expert meetings .....	124
Table 21: programme public debate .....	126
Table 22: Schedule of a 5-day e-course on ecosan .....	127
Table 23: Content of integrated ecosan training material - overview .....	129
Table 24: Content of integrated ecosan training material – example gender aspects .....	130
Table 25: ecosan curriculum description .....	131
Table 26: Schedule for home country preparation for the ecosan alumni course in Nanjing China (Hohai University) .....	132
Table 27: Schedule for 6-day ecosan alumni course in Nanjing China (Hohai University) .....	133
Table 28: MSc programme structure for MSc in Municipal Water and Infrastructure (with four specialisation options) for a 12-month taught programme, showing proposed inclusion of ecosan subjects within existing 3-week modules [see note below the figure for further explanation !]. .....	134

## List of Boxes

Box 1:	Millennium Development Goals and the Johannesburg Plan .....	1
Box 2:	The Bellagio Principles.....	11
Box 3:	What is “agricultural reuse” in ecologically sustainable sanitation?.....	12
Box 4:	The two main components of the HCES.....	18
Box 5:	Example for a funding programme to strengthen ecosan research capacity .....	45
Box 6:	Urine separation and reuse technology in the 19th century .....	52
Box 7 :	Vacuum technology in the 19th century.....	53
Box 8:	Conventional sewerage leaves the poor unserved .....	56
Box 9:	Grey becomes clear: Hamburg, Germany, promotes greywater recycling.....	63
Box 10:	Urban ecosan pilot project for 100 new urban houses in southern Germany.....	64
Box 11:	Examples of cost comparisons - Uganda .....	67
Box 12:	Examples of cost comparisons – Berlin Brandenburg .....	68
Box 13:	Example for MFA in Ghana.....	75
Box 14:	Learning from organic waste management.....	80
Box 15:	Disability Adjusted Life Years (DALYs).....	81
Box 16:	Why people want toilets .....	84
Box 17:	What is "gender"?.....	88
Box 18:	Who does the dirty work?.....	89

## List of Project Boxes

Project Box 1:	The Durban experience, South Africa (Macleod 2005).....	7
Project Box 2:	Urine diverting dehydration toilets in China (GTZ –project data sheets 2005-005).....	21
Project Box 3:	TepozEco urban ecosan pilot programme, Mexico (GTZ –project data sheets 2005-012) .....	22
Project Box 4:	Gebers collective housing project Sweden (GTZ -project-data sheets 2005-008) .....	24
Project Box 5:	Vacuum sewerage and greywater recycling at the KfW office building, Germany (GTZ-project data sheets 2005-001).....	54
Project Box 6:	Urine separation and reuse at the GTZ-Headquarters inGermany (GTZ -project-data sheets 2005-016) .....	55
Project Box 7:	China-Sweden project of Erdos eco-town in China (Rosemarin et al. 2004).....	62
Project Box 8:	Sanitation for a rural school in Uganda (EcoSan Club, www.ecosan.at).....	66
Project Box 9:	ecosan within a natural resource management project in Botswana (GTZ - project-data sheets 2005-009) .....	77
Project Box 10:	Constructed wetland treatment and wastewater reuse in Haran-Al-Awamied in Syria (GTZ -project-data sheets 2005-015) .....	78
Project Box 11:	Biogas-ecosan-project Waldmichelbacherhof in Germany (GTZ -project-data sheets 2005-006).....	79
Project Box 12:	Use of reclaimed water in the Jordan Valley in Jordan (GTZ -project-data sheets 2005-013) .....	82
Project Box 13:	Public toilet project in Rajendar Nagar Slum in Bangalore, India (GTZ-ecosan-newsletter 2005-18).....	85
Project Box 14:	Vocational training centre “Dalit Shakti Kendra” in India (GTZ-ecosan-newsletter 2005-18) .....	91