

AT MICROFICHE
REFERENCE
LIBRARY

A project of Volunteers in Asia

The Fuel Savers: A Kit of Solar Ideas for
Existing Homes

by: Dan Scully, Don Prowler and Bruce Anderson

Published by:
Total Environmental Action, Inc.
7 Church Hill
Harrisville, NH 03450 USA

Paper copies are \$ 2.75.

Available from:
Total Environmental Action, Inc.
7 Church Hill
Harrisville, NH 03450 USA

Reproduced by permission of Total Environmental
Action, Inc.

Reproduction of this microfiche document in any
form is subject to the same restrictions as those
of the original document.

THE FUEL SAVERS

**A KIT OF SOLAR IDEAS
FOR EXISTING HOMES**

DAN SCULLY
DON PROWLER
BRUCE ANDERSON
WITH DOUGLAS MAHONE

Dan Scully, Bruce Anderson, and Doug Mahone are on the staff of TEA, Inc, a research, design, consulting, and education firm in Harrisville, New Hampshire. Don Prowler, a designer, lectures at the University of Pennsylvania Graduate School of Architecture in Philadelphia.

Prepared for NORWESCAP
Northwest New Jersey Community Action Program, Inc.
Under a grant from the Community Services Administration

by Total Environmental Action, Inc.

Special thanks to Charles Corcoran, Director,
Housing and Community Development for NORWESCAP,
who conceived and made possible this book,
and to Karen Tolman, for the hard work of typing
the manuscript.

Additional copies may be obtained from:

Total Environmental Action, Inc., Church Hill, Harrisville, NH 03450
or
NORWESCAP, Inc., Old Firth School, Prospect St., Phillipsburg, NJ 08865

Copyright ©1976 by Total Environmental Action, Inc.

TABLE OF CONTENTS

	PAGE
NORWESCAP AND SOLAR ENERGY	1
WINTERIZATION, AN OVERVIEW	3
SOLAR ENERGY: THE SCOPE OF THIS STUDY	5
SITE CONDITIONS	
ORIENTATION	6
TILT	7
A KIT OF IDEAS	8
INSIDE STRUCTURES	
FLEXIBLE INSULATING CURTAIN	10
RIGID INSULATING SHUTTERS	12
THERMAL MASS	14
INTEGRAL STRUCTURES	
ADDITIONAL GLAZING	16
EXISTING STONE-MASONRY WALLS TRANSFORMED INTO SOLAR COLLECTORS	18
ROOF AIR COLLECTOR OVER EXISTING SLATE OR METAL ROOF	20
ADD A NEW WINDOW	22
ATTACHED STRUCTURES	
OUTSIDE SHUTTERS	24
WINDOW BOX	26
GREENHOUSES	28
LEAN-TO COLLECTOR WITH STORAGE	30
ROOF TRICKLE COLLECTOR	32
A SOLAR HEATING SYSTEM USING A CONVENTIONAL HOT WATER HEATER ..	34
FREE-STANDING STRUCTURES	
SOLAR WATER HEATER AND GARDEN SHED WITH HEAT STORAGE	36
WARM AIR COLLECTOR WITHOUT STORAGE	38
NEW LIVING STRUCTURES	
GARAGE	40
GLASSED-IN PORCH	42
SOLAR HOT WATER HEATERS	
INTRODUCTION	45
TROUGH TYPE	47
THERMOSIPHONING COLLECTOR	48
PUMPED WATER SYSTEM	49
EXAMPLES: THE IDEAS APPLIED TO EIGHT HOUSES	50
BIBLIOGRAPHY	59

The Northwest New Jersey Community Action Program, Inc. (NORWESCAP) is a private non-profit organization primarily funded from state and federal agencies to provide needed social services to the residents of Sussex, Warren and Hunterdon counties in New Jersey. As part of this mandate NORWESCAP operates a Housing and Community Development program responsive to the housing needs of the tri-county area.

Within this program NORWESCAP has undertaken a home winterization plan aimed at providing repairs and replacement parts to homes of residents of the area who are unable to undertake this work themselves. Winterization, under this program, includes installation of storm windows and doors, insulation, weatherstripping and other repairs to cut down on heat loss and save on home heating fuel bills. Frequently, the beneficiaries of NORWESCAP's winterization program are elderly citizens and others who are unable to meet the financial burden of the rapidly escalating cost of staying warm.

Because the pressing need continues for well-insulated, energy efficient housing, NORWESCAP is extending its winterization program to include solar energy utilization. Solar energy shines on all, old and young, rich and poor, and provides a means, not only of reducing fuel bills, but of helping to solve our societal energy problems. In addition, a solar heat system provides a personal, inflation-proof supply of energy to the individual home.

NORWESCAP's solar energy project is concentrating on solar heating demonstrations, and on the dissemination of information useful to you, the person paying the heat bill. The emphasis here is on lower-cost, easily installed applications of solar energy in existing residences. NORWESCAP has been engaged in altering or "retrofitting" homes to more efficient use of precious energy resources. The term "retrofit" is used to describe any modification made to existing residences to allow for solar energy utilization. While the principles involved in solar energy are identical for new and old construction, the specific solutions can be quite different.

This pamphlet will give some examples of potentially workable retrofit solutions for buildings within the NORWESCAP area, and provide a basis for individuals of all economic levels to branch out on their own and seek additional solutions of their own design. The use of solar energy is, in fact, relatively simple and can be readily applied to homes as do-it-yourself projects. While one frequently hears that the cost of using solar energy is still prohibitively high, this cost comes down substantially when labor costs are eliminated and simple methods and techniques are used. In fact, the sun's energy beating down on our houses is already contributing to our winter time comfort by penetrating through the roofs, walls, and windows.

The national program for solar energy utilization, released recently by ERDA (the federal Energy Research and Development Administration), calls for the installation of retrofit systems on 2,500 residences annually by 1980; by 1985 this number is expected to jump to 25,000 residences annually. In the same year (1985) ERDA hopes 10 percent of annual residential starts will utilize solar energy systems. If these figures are to be anywhere near correct, agencies such as NORWESCAP must take a lead in encouraging and demonstrating solar feasibility in locations throughout the country. As part of its winterization program NORWESCAP is committed to do just that. Out of this survey of some of the retrofit possibilities for residences within the NORWESCAP region we hope many will be stimulated to use solar energy in the near future.

The first step will be to examine the role of winterization.

WINTERIZATION, AN OVERVIEW

It is very important to realize that, before any thought of solar energy utilization is considered, the homeowner must first undertake a comprehensive program of winterization and energy conservation. Under today's economic conditions, and under the economic conditions of the foreseeable future, the most cost-effective and sensible approach to the energy shortage is still energy conservation. Only after some common-sense conservation measures have been instituted in your home can solar devices be successfully used as a long-term non-inflationary source of heat.

The first and most direct method of energy conservation is simply to use less. You control the rate of usage with the thermostat. Lower temperatures in the house mean less fuel consumed, it's that simple. The suggestion by President Ford and others that we keep our homes no warmer than 68 degrees is a sound one that will save energy for you. If you're uncomfortable at those temperatures, insulate your body with a sweater rather than raising the thermostat. Many people (the British are famous for it) can be quite comfortable at temperatures below 68 degrees, and they save both money and energy because of it. It also makes good sense to lower the temperature at least 5 degrees at night. It's not true that you burn more fuel reheating the house in the morning than you saved overnight. These measures do work at saving energy.

In this pamphlet it is not possible to present a complete discussion of the winterization of residences. It is important, however, to familiarize yourself with some of the most important measures which can be taken to winterize your home, so a brief approach to winterization is outlined below and may be supplemented by other sources (see Bibliography).

A general breakdown by percentage in the location of heat loss from three houses of the same size and shape, but of different qualities of winterization, is given below. As you can see, in all the houses a significant share of the heat loss is due to the large quantities of cold air that finds its way into the house through cracks and openings and replaces the expensive heated air in the house. This type of heat loss is called "infiltration."

To combat infiltration, any large, obvious holes in windows, foundations, roofs, etc., must first be located and sealed. Next, smaller cracks around windows and door frames should be recaulked to further seal your home. Sometimes it is helpful to blow cigarette smoke at your window to locate leaks. An assistant on the other side can pinpoint the problem spot. The next step in this process is to weatherstrip your windows and doors. This will seal the small openings that occur at the bottom, top and sides of doors and windows that open. These small openings can let a great amount of heat escape; be sure to take care of them! You can use pieces of cloth to do this or purchase from your hardware store special felt or plastic weatherstripping that is produced for this job. After your windows and doors are caulked and weatherstripped, the most productive step to take is to add storm windows. This can save from 1/3 - 1/2 of the amount of heat lost by infiltration through your window. You can find out more about adding another layer of glazing material in the text that follows.

Comparing losses in the three houses, the greatest loss is conduction in the uninsulated house. In the best house, conduction losses are dramatically reduced. Conduction occurs when heat is lost to the cold outside by passing through building materials such as wood, plasterboard or glass. The best way to deal with heat loss due to conduction is to use insulating materials. Insulating materials slow the passage of heat through walls, ceilings or other surfaces. Attics, which are often easily accessible and are one of the greatest sources of conductive heat loss,

should be insulated with at least 6 inches of mineral wool insulation or its thermal equivalent. When possible, steps should be taken to insulate exterior walls if they are not already well-insulated. Sometimes rigid board insulations can be used on interior surfaces or applied to exterior surfaces if new siding is required at the same time. Other times, insulation is blown into walls through small holes cut in the siding and resealed. These insulations can be fire hazards if flammable insulation is improperly used, so be careful! Some insulations, such as polyurethane foam, are more dangerous than others like fiberglass, cellulose fiber, or urea-formaldehyde foam. Check with local fire officials if you have a question.

While you are working to cut down on infiltration and adding insulation, you should be making sure that your furnace is working properly and is periodically cleaned so that you are getting the most energy from your fuel. Also, to further save energy, you might consider heating only the areas of your home which you most use in the winter time.

Insulation is usually thought of as an important part of walls, floors and ceilings, but people are beginning to realize that insulation over window areas is also very important. You can see from the bar graphs that conductive heat loss through windows is an important source of heat loss, despite the fact that windows open only a small percentage of the building surface. In the text you will find a number of ways of dealing with this problem because when dealing with windows you are also working with one of the most important types of solar collectors.

You will notice that, for the "ideal" house, the overall heat loss has been considerably reduced by using all of these measures. At this point, infiltration losses are proportionally the largest. This is because fresh air can't, and shouldn't be eliminated entirely. It's entrance can be limited by intelligent design, but if it were eliminated entirely the inside air would always be stale and musty. For most houses, this is far from being a problem and you should do everything you can to keep out cold air.

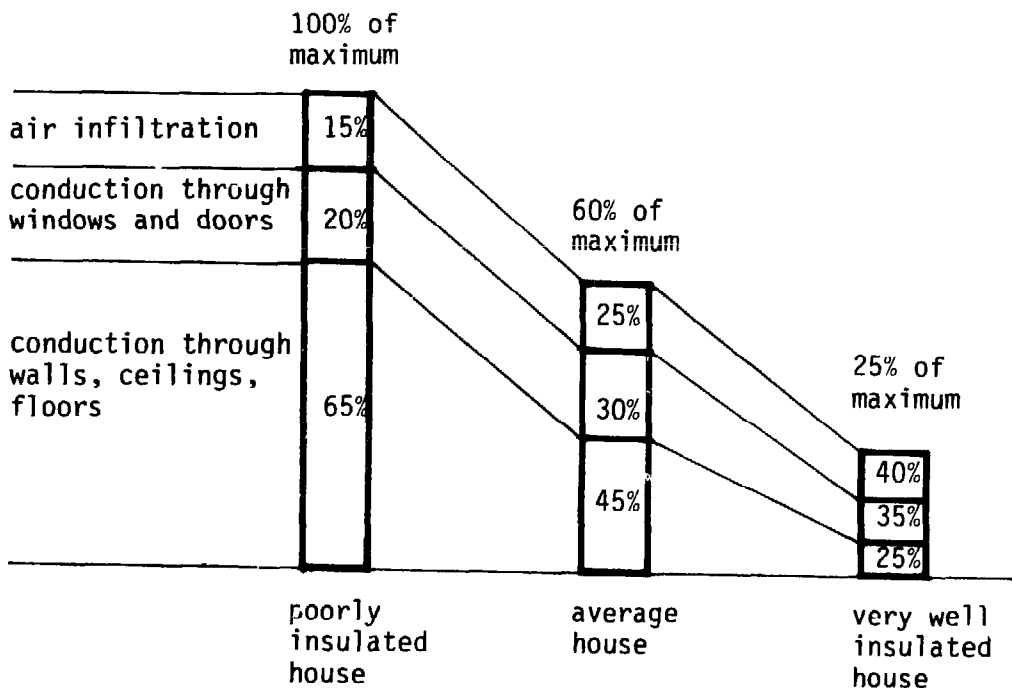
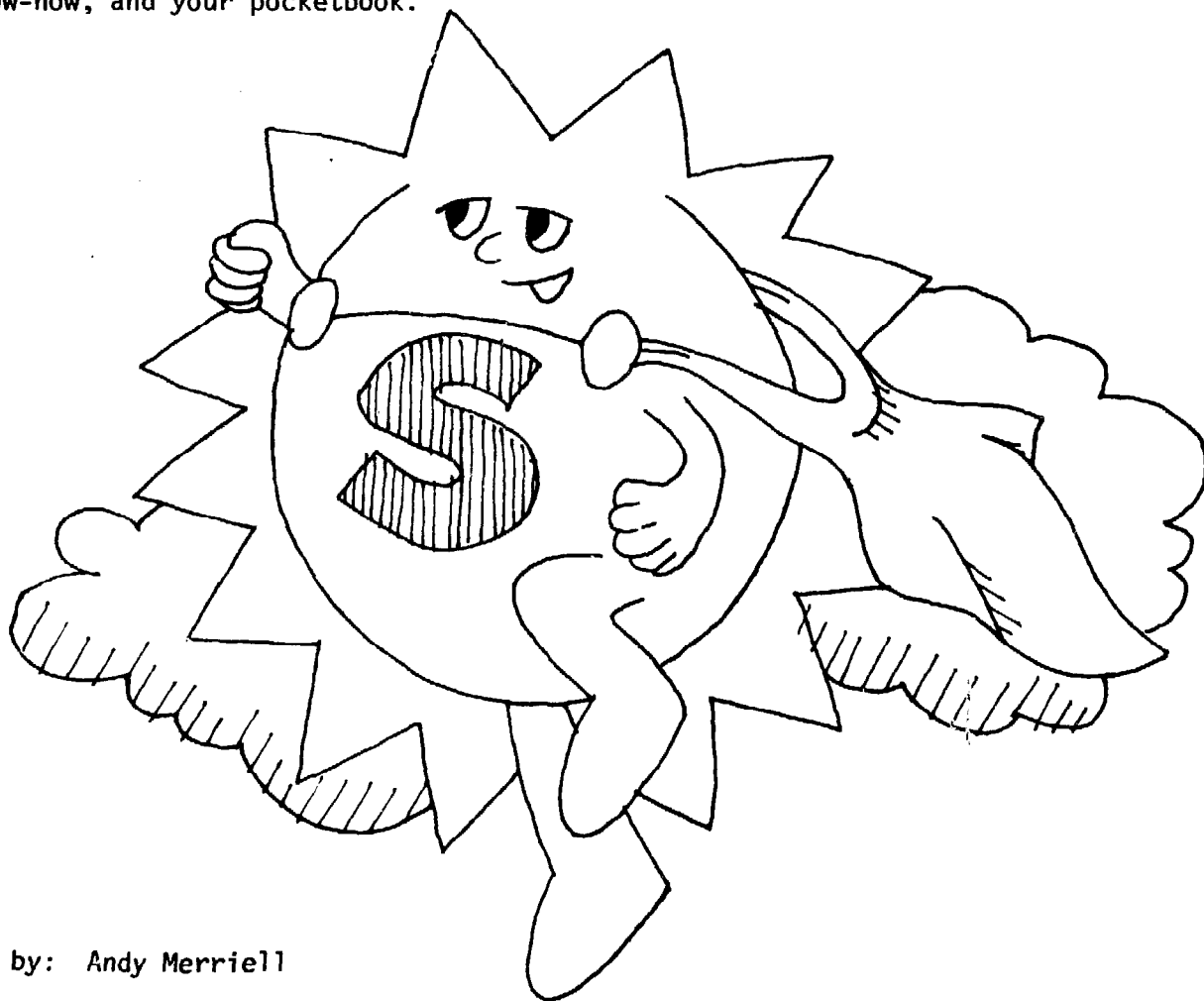

Figure 1. Comparison of heat loss due to various causes in three houses.

In preparing this pamphlet an effort was made to provide information about solar energy systems that can be constructed at moderate costs and as do-it-yourself projects. To provide good performance over extended periods of time, these systems are simply constructed, durable, and straightforward in their operation. Furthermore, many of these systems imply that the homeowner directly involve him/herself in their day to day operation and not rely on complex and expensive control devices. These systems can be applied to a wide range of existing buildings.

These concerns of cost and simplicity mean that pre-engineered and manufactured components will not be discussed, nor will we discuss solar system components which utilize expensive parts or fabrication techniques. This restriction eliminates from discussion most such devices as heat pumps, metal tube-in-plate absorber plates, heat exchangers of the sophisticated variety used by engineers, and other "store bought" solar heating components. High initial cost places them out of the range of options we have established. Many of these items have cheaply constructed functional equivalents. In order to simplify fabrication of your solar energy system, most of the devices suggested will be self-contained and will not tie into the existing heating system of your house. However, these restrictions on the equipment and operation of your system only partially limit the variety of devices and systems available to you. You will find outlined in the text opportunities for using solar energy that range from very simple devices to fairly complex systems. You must decide which option best suits your site location, your house configuration, your know-how, and your pocketbook.



drawing by: Andy Merriell

SITE CONDITIONS

ORIENTATION

When preparing to undertake any retrofit project that makes use of the properties of solar radiation, such as the use of window surfaces on buildings or collectors, it is important to understand the extent of the penalty being paid for any orientation off of due south.

Many people think that it is necessary to orient any solar energy collecting surface directly to the south to get any real benefit, but this is not so! From the diagram below, we can see, for vertical wall surfaces located at the latitudes covered by NORWESCAP, the extent of lost sunshine opportunities for orientations other than south. We can see that, for vertical wall surfaces as much as 30 degrees east or west of due south, we will receive fully 90 percent of the maximum solar radiation striking a south-facing wall. Even with a deviation from south by as much as 45 degrees, we are able to intercept about 72 percent of the maximum possible radiation striking a south facing wall. These figures are true for the winter heating season when we are most concerned about collecting sunshine. Even walls facing as far as 60 degrees from due south are about to collect substantial amounts of solar energy.

From a practical viewpoint the important thing to remember is that this analysis suggests a substantial leeway in the design and disposition of retrofit devices. We must just remember to compensate for any drop in solar radiation collected due to an orientation that is not optimal with an increase in intercepting area. Of course, it is still best to be as close to south as possible if there is a choice. It then is not necessary to pay extra for materials to construct more of whatever device you are using.

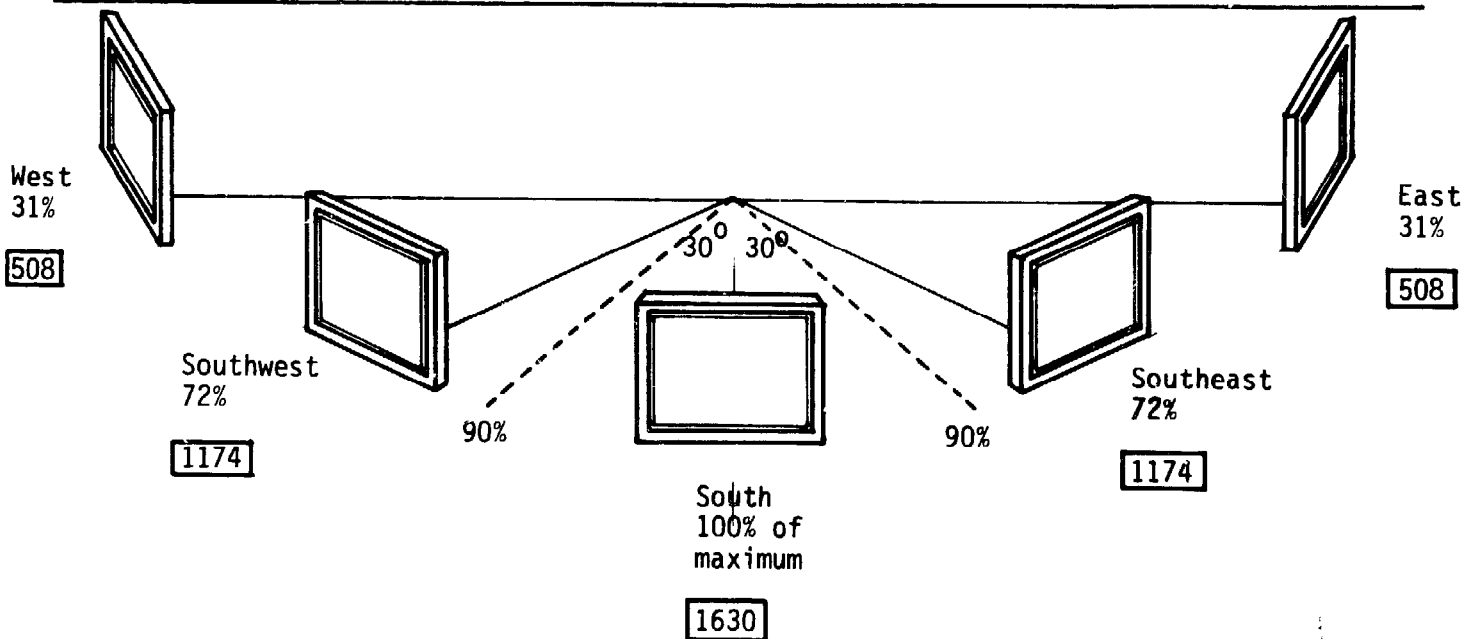

Figure 1. Solar radiation striking vertical wall relative to maximum southerly exposure (100 percent), winter condition, for the NORWESCAP latitude. Numbers in boxes represent average Btu per square foot per day solar energy striking the vertical wall in January.

TILT

Just as it is important to understand the penalty on solar radiation gains for orientations off of due south, it is important to understand the influence of tilt on optimum values.

On the basis of 10 degree increments, readings taken per unit area on clear, sunny days in the heating season indicate that the maximum solar energy collection is achieved at a tilt angle of 60 degrees from the horizontal. While these figures are for a location at 40° 00" north latitude, Flemington at 40° 30", would differ only slightly.

Less than optimum tilts receive less than 100 percent of available energy. The penalties incurred for tilts other than 60 degrees are indicated in the diagrams at the right. For vertical walls, reflections from snow or other surfaces can substantially increase performance.

From these figures it is important to realize that tilts as much as 20 degrees to 30 degrees from optimum can still intercept over 90 percent of the available daily insolation per unit area. From a practical viewpoint, this suggests a considerable leeway in the design and disposition of retrofit devices.

There are many reasons why you might build or use a surface with less than optimum tilt or orientation. If the device is attached to or part of an existing building, you will have to make-do with the surfaces you've got. A free-standing device can be more flexibly placed, but other things may interfere. There may be trees, neighbors' houses, even hills blocking the ideal orientation. Or it may look too obtrusive having a large solar device sitting at an odd angle to house or property lines. As our figures demonstrate, the penalties you pay for not orienting or tilting to the optimum are not, within limits, excessive. Your own good judgment will guide you in choosing the best angles for your particular situation.

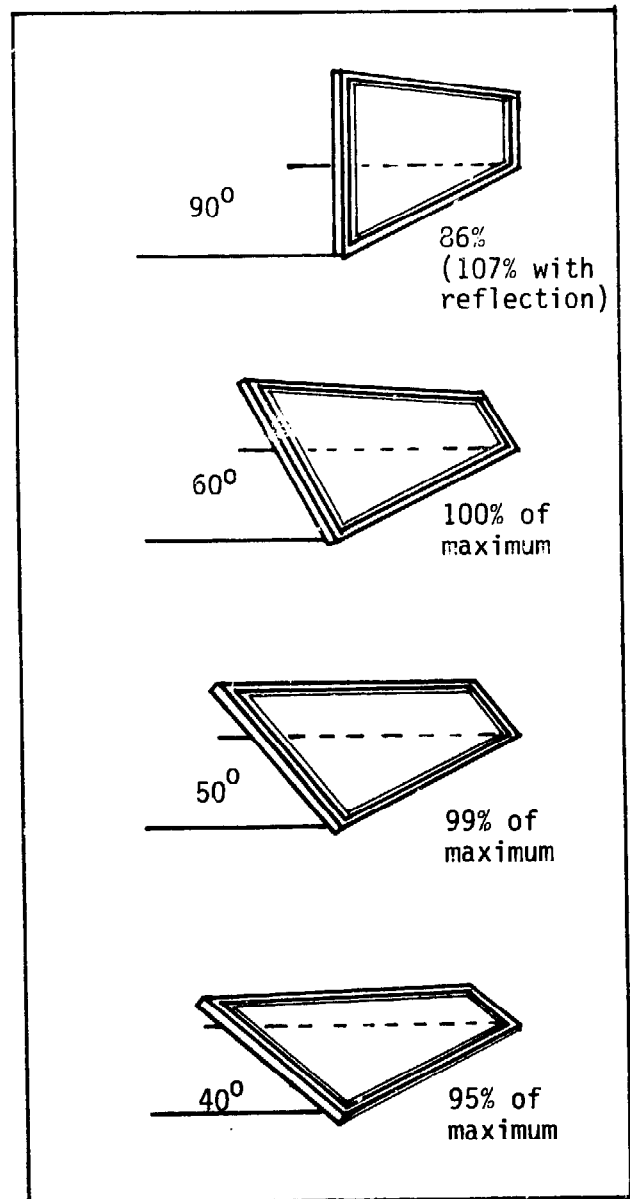

Figure 2. Solar radiation striking tilted surfaces relative to maximum (100%) 60 degree tilt angle, for the NORWESCAP latitude during the winter heating season.

A KIT OF IDEAS

Due in part to the vast diversity of house designs, it is relatively difficult to logically organize and categorize the large number of ideas for using solar energy to assist in the heating of existing buildings. Somewhat by coincidence, the categorization of projects used in this booklet, called "A Kit of Ideas," follows any of three relatively logical progressions.

The first has to do with the location of the solar device. Those on the inside of the home are discussed first. Those which are integral with the walls and roof are discussed next. Then come those attached to the house; then those which are not attached; and finally these which are part of new structures.

The second relatively logical progression has to do with simplicity and complexity. In general, the simplest methods are discussed first, and the more complex are discussed last.

The third progression has to do with cost effectiveness. That is, "how much energy can I save for each dollar I spend?" The first methods tend to be most cost effective; the last methods tend to require a greater expenditure of money to achieve the same amount of energy savings.

In order to give you an idea of the relative merits of each idea from the point of view of energy saved per dollar spent, the last items in the discussion of each idea are "Fuel Reduction," "Materials Costs," and "Cost-Effectiveness." The fuel reduction is given in terms of oil. The costs are those for the necessary materials, assuming you have to buy most of them. No cost for labor is taken into account, as most of the projects are feasible for the do-it-yourselfer.

Your actual saving in fuel cost will vary with the fuel and over time. If you use electricity, figure 30 kilowatt-hours (kwh) of electric resistance heating to be equivalent to 1 gallon of oil heat. Thus, if your electric company charges \$.01/kwh, the equivalent of 1 gallon of oil would cost you \$.30. In reality, electric costs are higher than that in most cases. To find your local equivalent price of electricity, multiply the rate per kilowatt-hour by 30. If you use natural gas, figure 1.25 cubic feet of gas to be equivalent to 1 gallon of oil. To get the equivalent cost of the natural gas, multiply the charge for 100 cubic feet (1 ccf) by 1.25. If you use bottled gas which sells by the gallon, figure 1.3 gallons of gas to be equivalent to 1 gallon of oil. The equivalent cost of the bottled gas can be figured if you multiply the price per pound by 1.3

All fuels are expected to continue rising in cost, although estimates vary as to how much. You may want to include some estimate of such price inflation in your calculations of energy saving over the years.

At the end of each discussion is a vertical bar diagram. It shows the relative cost effectiveness of each idea presented. The bottom of the bar indicates that not much energy is saved for the amount of money spent. The top of the bar indicates that not much money need be spent to save a lot of energy. It usually makes sense, therefore, to first use those ideas which rate highest on the vertical bar. Obviously though, many of the ideas will be inappropriate to your situation. In such cases, cost-effectiveness may become less important than other factors that determine the practicality of an idea.

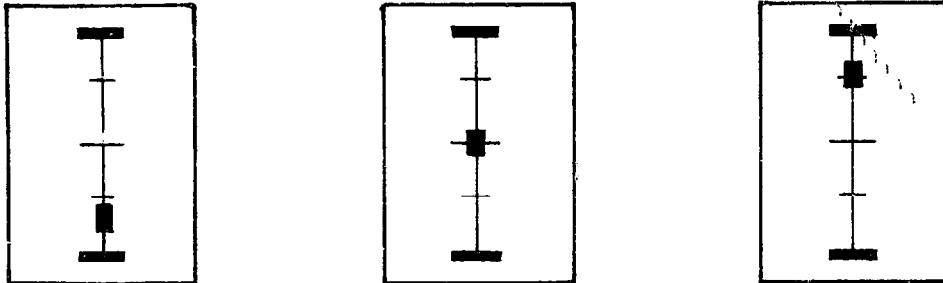

The ideas are presented rather schematically, with a discussion of advantages, disadvantages, and variations rather than a lot of construction detail. This is partly due to space limitations and partly because there are so few "typical" situations in retrofitting. The Bibliography at the end of the pamphlet is included to lead you to information more detailed than was possible to include here. It is recommended that you seek out this additional information, particularly for the more complex and expensive projects, before you invest a great deal in getting started.

INSIDE STRUCTURES

FLEXIBLE INSULATING CURTAIN

ONCE SUNLIGHT (SOLAR ENERGY) HAS BEEN ADMITTED INTO A ROOM BY A WINDOW, THE BEST AND MOST EFFICIENT SOLAR COLLECTOR OF THEM ALL, WE WANT TO MAKE THE BEST USE OF IT WE CAN. UNFORTUNATELY, THE SOLAR ENERGY WHICH HAS BEEN TRANSFORMED INTO HEAT CAN READILY BE LOST TO THE COLD OUTSIDE THROUGH THE SAME WINDOWS THAT ALLOWED IT TO ENTER IN THE FIRST PLACE. ONE WAY TO IMPROVE THIS SITUATION IS TO COVER ALL WINDOWS WITH INSULATING CURTAINS WHEN THE SUN HAS STOPPED SHINING. IT IS IMPORTANT TO MAKE THE CURTAINS FIT TIGHTLY SO AS TO ELIMINATE THE MOVEMENT OF WARM ROOM AIR BETWEEN THE COLD WINDOW SURFACE AND THE CLOSED CURTAIN. NOW ALL THE HEAT IS INSIDE AND CANNOT ESCAPE AS EASILY!

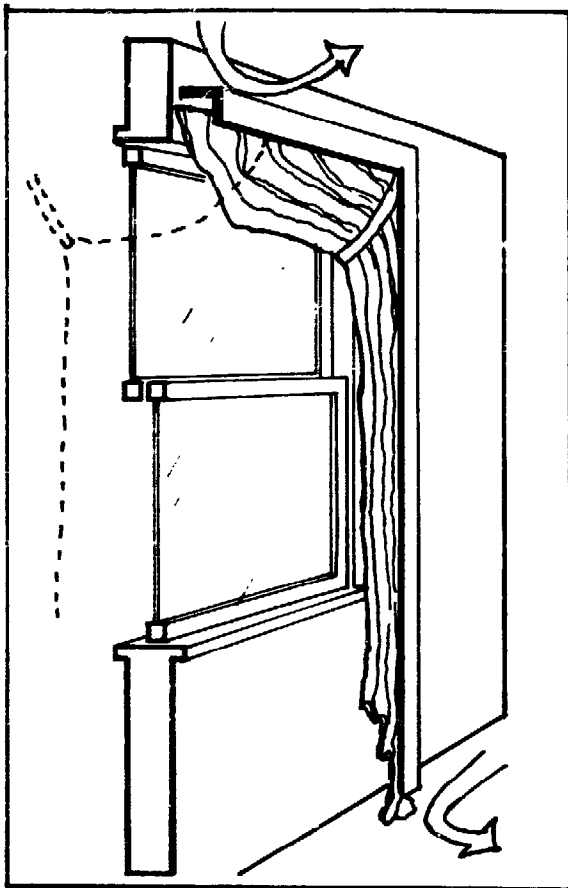

AT THE TOP OF THE CURTAIN IT IS BEST TO HAVE A FIXED VALENCE TO KEEP COLD DRAFTS FROM MOVING ACROSS THE WINDOW

MAKE SURE THE CURTAIN IS WEIGHTED AT THE BOTTOM OR IN SOME OTHER WAY MAKE AS FULL AND AS AIR-TIGHT A CONTACT WITH THE FLOOR AS POSSIBLE.

MAKE THE CURTAINS TIGHT AT THE SIDES OF THE WINDOW, TOO, NOT JUST AT THE TOP AND BOTTOM. A VERTICAL VALENCE (LIKE THE HORIZONTAL ONE ABOVE THE WINDOW) IS ONE SOLUTION.

VARIATIONS:

- + CURTAINS CAN BE CONSTRUCTED TO ROLL UP AND BE SECURED AT THE TOP OF THE WINDOW DURING THE DAYTIME SUNSHINE HOURS. VELCRO STRIPS CAN BE USED TO PROVIDE DRAFT-FREE VERTICAL JOINTS.
- + THE CURTAINS THEMSELVES CAN BE CONSTRUCTED OF HEAVY QUILTS, MULTI-LAYERED FABRICS, QUARTER INCH FLEXIBLE FOAM INSULATION COVERED WITH YOUR CHOICE OF FABRIC OR ANY OTHER MATERIAL THAT MAKES IT DIFFICULT FOR HEAT TO PASS THROUGH.
- + ONE OF THE BEST WAYS TO MAKE A GOOD CURTAIN FOR INSULATING PURPOSES IS TO MAKE IT OUT OF A NUMBER OF LAYERS OF MATERIAL TO TRAP AIR BETWEEN EACH LAYER.

WHERE THIS WORKS:

ONE OF THE NICE THINGS ABOUT THIS DEVICE IS THE WIDE RANGE OF SITUATIONS WHERE IT CAN BE USED. IT CAN BE ADAPTED TO ANY WINDOW WHERE THERE IS SOME ROOM AROUND THE EDGE. IT IS IMPORTANT TO MAKE SURE THAT ANY CRACKS OR LEAKS IN THE EXISTING WINDOW AND ITS FRAME ARE SEALED FIRST TO GET THE MAXIMUM BENEFIT FROM YOUR CURTAIN.

ADVANTAGES:

- + IT IS THE EASIEST WAY TO CHANGE AN ENERGY COLLECTING DAYTIME WINDOW INTO AN ENERGY CONSERVING NIGHTTIME WINDOW.
- + BECAUSE OF ITS SIMPLICITY AND LOW COST THE INSULATING CURTAIN CAN BE USED BY ALMOST ANYONE WILLING TO PUT IN A LITTLE OF THEIR OWN WORK IN RETURN FOR SIGNIFICANT BENEFITS.
- + BECAUSE OF ITS LOCATION INSIDE AND ITS UNCOMPLICATED NATURE, YOUR INSULATING SHUTTER CAN BE EXPECTED TO HAVE A LONG LIFETIME. THIS ALLOWS YOU TO SAVE ENERGY OVER A LONG PERIOD OF TIME.

DISADVANTAGES:

- + YOU MUST BE WILLING TO CONSISTENTLY OPEN AND CLOSE YOUR CURTAINS EVERY DAY TO GET THE MAXIMUM BENEFITS. IF YOU GET LAZY YOU DON'T SAVE NEARLY AS MUCH ENERGY AS YOU COULD.
- + THE SHUTTER WHEN OPEN TAKES UP WALL SPACE. IN SOME CASES IT MIGHT BE IMPOSSIBLE TO FIND A SUFFICIENT AMOUNT OF ROOM AROUND YOUR WINDOW TO HANG YOUR CURTAIN.
- + A FLEXIBLE SHUTTER WILL NOT BE AS TIGHT OR AS INSULATIVE AS A RIGID SHUTTER, YET COULD COST AS MUCH OR MORE.

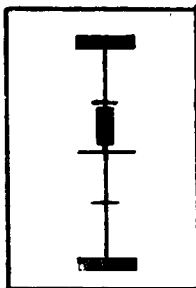
ECONOMICS/COST:

MATERIALS COSTS: THE MATERIALS THAT GO INTO MAKING YOUR CURTAIN CAN COST FROM \$.50 - \$1.25 FOR EACH SQUARE FOOT OF YOUR CURTAIN, SO IT'S GOING TO COST YOU FROM \$5 - \$12.50 FOR THAT 10 SQUARE FOOT WINDOW. BY USING FANCY MATERIALS FOR YOUR CURTAIN THIS FIGURE CAN GET HIGHER.

FUEL REDUCTION: FOR EACH SQUARE FOOT OF WINDOW SURFACE COVERED EACH NIGHT WITH A FLEXIBLE INSULATING SHUTTER, YOU CAN SAVE FROM 1/8 - 1/2 GALLON OF FUEL OIL EACH HEATING SEASON. A 10 SQ. FT. SHUTTER, THEN, WOULD SAVE FROM 1 - 5 GALLONS A YEAR.

COST-EFFECTIVENESS: ON OUR SCALE OF 1 - 20, THIS SUGGESTION EARNS A COST-EFFECTIVENESS RATING OF 11 - 14.

INSIDE STRUCTURES

RIGID INSULATING SHUTTERS

AN INSULATING PANEL CAN BE PLACED OVER A WINDOW IN THE EVENING AND GREATLY RETARDS THE LOSS OF HEAT OUT THROUGH THE WINDOW. THIS HEAT IS EITHER GAINED THROUGH THE WINDOW DURING THE DAY OR PRODUCED EXPENSIVELY WITH YOUR OIL BURNER. IT IS TOO PRECIOUS TO THROW AWAY, SO KEEP IT IN WITH AN INSULATING SHUTTER. THIS SHUTTER MUST BE OPENABLE FOR THE DAY, AND CLOSABLE FOR THE EVENING. MOST OFTEN THIS SHUTTER IS 2 INCHES OF STYROFOAM SURROUNDED BY A WOODEN FRAME AND MOUNTED TO THE WALL WITH HINGES. THE MOST VALUABLE SHUTTER WOULD HAVE AN INSULATING VALUE EQUIVALENT TO THE WALL NEXT TO THE WINDOW. BESIDES INSULATING A WINDOW AT NIGHT, A TIGHT FITTING SHUTTER WILL ALSO CUT DOWN ON THE LEAKAGE OF COLD OUTDOOR AIR IN AND AROUND WINDOWS INTO THE HOUSE. FOR THE MONEY, THIS IS A MOST WORTHWHILE ENERGY SAVER.

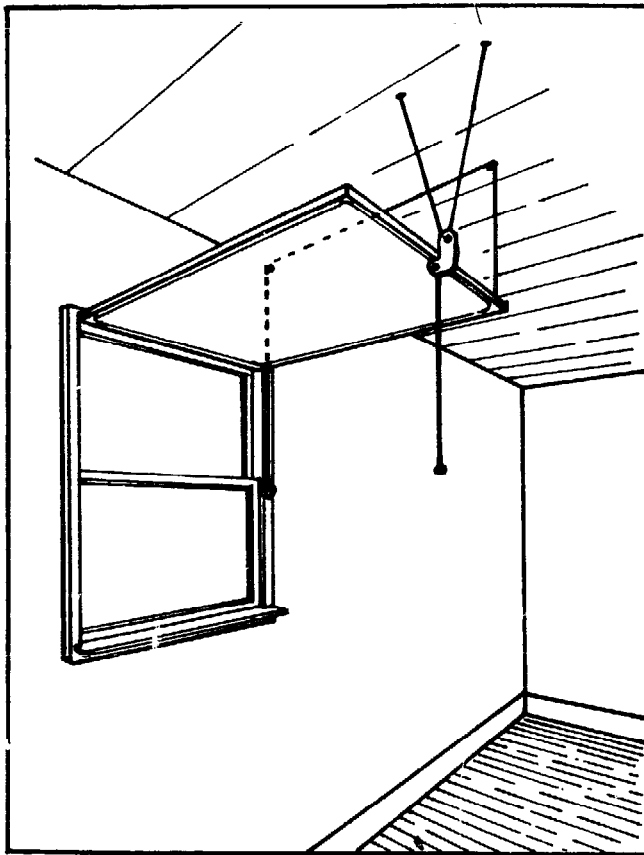

WEATHERSTRIPPING ALONG THE EDGE WILL HELP MAKE IT TIGHTER.

MOST SHUTTER DESIGNS WILL REQUIRE A WOOD FRAME PERIMETER FOR STRENGTH AND MOUNTING PURPOSES.

BIGGEST DESIGN ISSUE IS WHERE SHUTTER IS MOVED WHEN IT'S NOT COVERING THE WINDOW. THIS MIGHT VARY FROM ROOM TO ROOM.

VARIATIONS: MANY VARIATIONS OF INSIDE MOUNTED INSULATING SHUTTERS ARE POSSIBLE:

- + **INSULATING MATERIALS AND THICKNESS:** EASIEST ARE 1 AND 2 INCH THICK BOARDS OF RIGID STYROFOAM, THE GREATER THE THICKNESS, THE GREATER THE ENERGY SAVINGS. INSTEAD OF RIGID FOAM PLASTICS, FIBERGLASS OR OTHER INSULATING MATERIALS USED, SUCH AS UREA-FORMALDEHYDE FOAMS.
- + **MOUNTINGS:** SUCH SHUTTERS CAN BE ON SLIDING RACKS ACROSS WINDOWS, HINGED UP OR DOWN, SIDEWAYS, OR ANYWAY YOU LIKE IT. OR MAYBE THE SHUTTER IS HINGED ALONG THE BOTTOM EDGE AND FOLDS DOWN DURING THE DAY TO MAKE A TABLE.
- + **HARDWARE:** THE HARDWARE USED TO SUPPORT THE SHUTTERS CAN RANGE FROM CONTINUOUS CLOTH HINGES UP TO FANCY MOLDED HARDWOOD FRAMES WITH PIANO HINGES, WEATHER STRIPPING ALONG THE EDGES, AND LATCHES AT TOP AND BOTTOM TO PULL THE SHUTTER SNUG WITH THE WINDOW FRAME.

WHERE THIS WORKS:

INSULATING SHUTTERS WHICH OPERATE INSIDE THE HOUSE ARE MOST APPROPRIATE IN COLD FREEZING CLIMATES WHERE SNOW AND ICE COULD BUILD UP IN THE MOVING PARTS OF ANY OUTSIDE MOUNTED SHUTTERS AND HINDER THEIR USE. THERE MUST BE ROOM BY THE WINDOW TO STORE THE SHUTTER WHEN IT'S NOT COVERING THE WINDOW.

ADVANTAGES:

- + A GOOD SHUTTER PUTS EFFECTIVE INSULATION AT THE WINDOWS WHERE IT'S NEEDED MOST.
- + SHUTTERS ARE EASY TO MAKE AND OPERATE, REQUIRING NO FANCY TOOLS OR MECHANISMS.
- + A TIGHT FITTING SHUTTER WILL GREATLY REDUCE THE COLD AIR DRAFTS AROUND WINDOWS, MAKING THE HOUSE CONSIDERABLY MORE COMFORTABLE.

DISADVANTAGES:

- + CONDENSATION: BECAUSE THE GLASS IS ON THE COLD SIDE OF AN IN-DOOR SHUTTER, WATER VAPOR WHICH WORKS ITS WAY FROM THE INSIDE OF THE HOUSE OUT THROUGH THE SHUTTERS WILL CONDENSE ON THE GLASS AND WET THE FRAMING AROUND THE WINDOW. BECAUSE OF THE TIGHT SEAL AROUND THE SHUTTER THE PROBLEM IS SOMEWHAT MORE SEVERE THAN WITH CURTAINS.
- + FIRE: SOME PLASTIC FOAM BOARDS DO POSE SOME FIRE HAZARDS, AS THEY PRODUCE TOXIC GASSES WHEN IGNITED. THEREFORE, THEY ARE SAFEST WHEN COVERED WITH A FIRE-PROOF MATERIAL. CHECK WITH LOCAL CODE OFFICIALS FOR THEIR RECOMMENDATIONS.
- + WALL SPACE: IN THE OPEN POSITION, OR WHEN REMOVED ENTIRELY, THE SHUTTER CONSUMES SPACE INSIDE THE HOUSE.

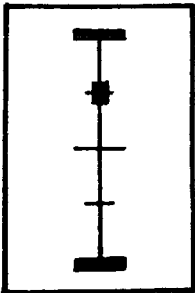
ECONOMICS/COST:

MATERIALS COSTS: THERE ARE A VARIETY OF WAYS TO BUILD A SHUTTER, BUT COSTS SHOULD RANGE FROM \$.40 - \$1.25 PER SQUARE FOOT. A 10 SQUARE FOOT SHUTTER, THEN WOULD COST BETWEEN \$4.00 AND \$12.50.

FUEL REDUCTION: IF USED EVERY NIGHT, AN INSULATING SHUTTER OF ABOUT 10 SQUARE FEET (AN AVERAGE WINDOW SIZE) MADE OF SOMETHING LIKE 2 INCH STYROFOAM WILL SAVE YOU ABOUT 10 GALLONS WORTH OF OIL HEAT EVERY WINTER, IN THE FORM OF HEAT NOT LOST OUT THROUGH THE WINDOW.

COST-EFFECTIVENESS: ON OUR SCALE OF 1 - 20, THIS SUGGESTION EARNS A COST-EFFECTIVENESS RATING OF 15 - 16.

INSIDE STRUCTURES

THERMAL MASS

THE IDEAS DISCUSSED SO FAR HAVE DEALT WITH WAYS TO MAKE HOUSES BETTER COLLECTORS AND CONSERVERS OF SOLAR ENERGY. IT IS ALSO POSSIBLE FOR A HOUSE TO STORE HEAT FOR USE LATER ON. THE IDEA IS TO LOCATE SUBSTANTIAL AMOUNTS OF HEAT HOLDING MATERIAL, SUCH AS MASONRY, CONCRETE, OR CONTAINERS OF WATER, IN THE BUILDING WHERE THE SUN CAN SHINE ON THEM. BESIDES STORING HEAT, THE THERMAL MASS HELPS PREVENT OVERHEATING OF THE SUNNY ROOM, REDUCING THE NEED TO OPEN WINDOWS OR SHADE OUT THE SUN'S FREE ENERGY JUST TO MAINTAIN COMFORT. THE MASS WHICH WAS WARMED DURING THE DAY WILL SLOWLY RETURN THAT HEAT TO THE SPACE AT NIGHT AND REDUCE THE NEED FOR CONVENTIONAL HEAT.

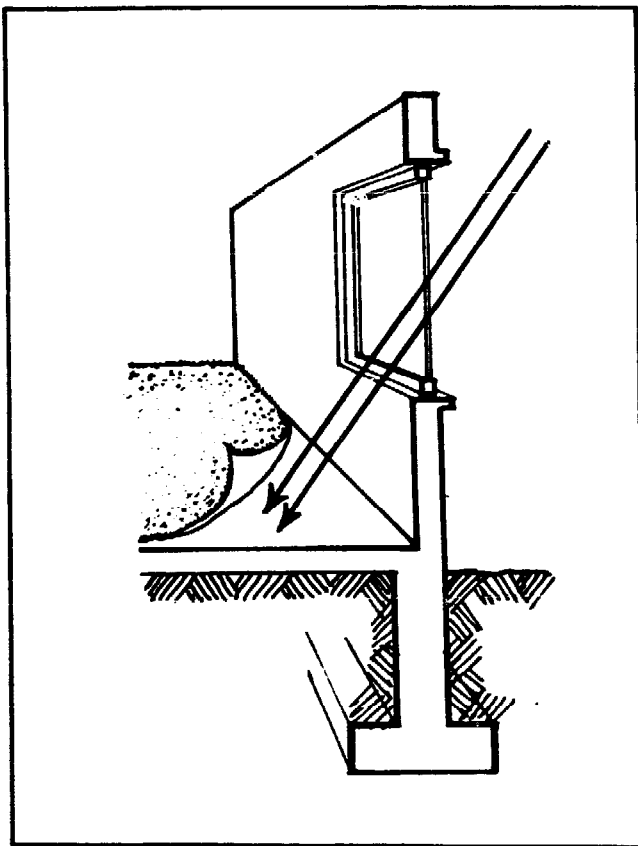

THERE ARE MANY WAYS TO PROVIDE THERMAL MASS TO A ROOM. THE TRICK IS TO GET ENOUGH. TRY TO PROVIDE 2 - 4 GALLONS (1/4 - 1/2 CUBIC FEET) OF WATER PER SQUARE FOOT OF SOUTH WINDOW, OR 1/2 - 1 CUBIC FOOT (75 - 150 LBS) OF CONCRETE OR MASONRY PER SQUARE FOOT. IF THE MASS IS OUT OF THE SUN, DOUBLE OR TRIPLE THESE AMOUNTS.

THE MASS SHOULD BE DARK COLORED TO ABSORB RADIATION, AND SHOULD GET SUNSHINE ALL DAY LONG. THUS IT SHOULD BE AS CLOSE AS POSSIBLE TO THE WINDOW.

IF YOU HAVE A CONCRETE SLAB, YOU HAVE THERMAL MASS ALREADY. JUST ALLOW THE SUN TO REACH IT.

VARIATIONS:

- + IF YOU HAVE A SUBSTANTIAL FLOOR STRUCTURE, YOU COULD POUR A THIN (2 INCH - 4 INCH) CONCRETE SLAB OVER IT, OR LAY DOWN BRICK OR HEAVY TILE.
- + STEEL DRUMS OR RACKS OF CONTAINERS FILLED WITH WATER ARE MORE COMPACT AND COULD ACT AS PARTITIONS OR FURNITURE.
- + AN INTERIOR WALL THAT RECEIVES SUNLIGHT COULD BE VENEERED IN STONE OR BRICK.
- + THERMAL MASS IN NON-SUNNY AREAS WILL ALSO HELP OUT BY MODERATING TEMPERATURES. WHEN YOU TURN DOWN THE THERMOSTAT AT NIGHT, IT WILL TAKE SEVERAL HOURS FOR THE MASS TO COOL DOWN, AND THE SPACE WILL REMAIN WARMER LONGER.

WHERE THIS WORKS:

THE ADDITION OF THERMAL STORAGE CAPACITY IS BOTH APPROPRIATE AND IMPORTANT IN ROOMS WHICH GET SUBSTANTIAL SOUTH SUNSHINE. THIS IS ESPECIALLY TRUE WHERE OVERHEATING IS A PROBLEM. THE ROOM MUST BE ARRANGED TO HAVE THE THERMAL MASS IN UNOBSTRUCTED SUNLIGHT FOR AS MANY HOURS A DAY AS POSSIBLE.

ADVANTAGES:

- + THE ADDITION OF THERMAL MASS DOES NOT INCREASE THE AMOUNT OF SOLAR ENERGY AVAILABLE TO A SPACE, BUT IT DOES SPREAD OUT THE TIMES OVER WHICH YOU FEEL THIS HEAT IN THE ROOM.
- + INSTEAD OF HOT DAY TEMPERATURES AND COOL NIGHTTIMES, THE THERMAL MASS WILL MODERATE THE TEMPERATURE SWINGS AND KEEP THE SPACE MORE COMFORTABLE.
- + EXCESS HEAT THAT MIGHT OTHERWISE BE THROWN AWAY IS SAVED AND MADE USEFUL LATER.
- + THERMAL MASS HAS NO MOVING PARTS OR COMPLEX PROCESSES. IT JUST SITS THERE AND DOES ITS JOB WITHOUT ATTENTION FROM YOU.

DISADVANTAGES:

- + THE NECESSARY VOLUMES OF MATERIAL WILL TAKE UP QUITE A LOT OF SPACE IN MANY SITUATIONS.
- + THE STRUCTURE OF YOUR HOUSE MAY NEED BEEFING UP BEFORE IT CAN SUPPORT THE CONSIDERABLE WEIGHT OF THERMAL MASS. TO BE SURE, HAVE YOUR HOUSE CHECKED BEFORE YOU LOAD IN THE MASS.

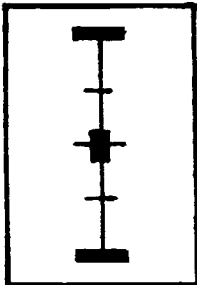
ECONOMICS/COST:

MATERIALS COSTS: THERMAL MASS MATERIALS ARE COMMON AND INEXPENSIVE. CONCRETE RUNS \$27 - \$30 PER CUBIC YARD (27 CUBIC FEET). WATER IS ALMOST FREE. CONTAINERS, SUCH AS STEEL DRUMS OR PLASTIC JUGS CAN BE SCROUNGED OR BOUGHT SECOND-HAND. FOR SAKE OF COMPARISON, YOU CAN FIGURE ON \$.40 - \$1.00 PER SQUARE FOOT OF WINDOW AREA.

FUEL REDUCTION: THERMAL MASS REDUCES FUEL CONSUMPTION ONLY IN THE SENSE THAT IT MAKES AVAILABLE SOLAR ENERGY (THROUGH YOUR WINDOWS) MORE USEABLE. IF THE WINDOWS DON'T OVERHEAT THE SPACE, THE MASS WON'T HELP EXCEPT AS FAR AS IT MODERATES UNCOMFORTABLE TEMPERATURE CHANGE. UNDER GOOD CONDITIONS, HOWEVER, THERMAL MASS WILL SAVE FROM .1 - .2 GALLONS OF OIL WORTH OF OTHERWISE WASTED HEAT PER SQUARE FOOT OF SOUTH WINDOW PER HEATING SEASON.

COST-EFFECTIVENESS: ON OUR SCALE OF 1 - 20, THIS SUGGESTION EARNS A COST-EFFECTIVENESS RATING OF 9 - 11.

INTEGRAL STRUCTURES

ADDITIONAL GLAZING

A SECOND, OR EVEN A THIRD, LAYER OF GLASS OR PLASTIC ADDED TO A WINDOW IS USUALLY CALLED A STORM WINDOW. WINDOWS ACT TO SAVE ENERGY IN TWO WAYS. THEY ADMIT SOLAR ENERGY INTO THE LIVING SPACE BECAUSE THEY ARE TRANSPARENT, AND THEY REDUCE THE FLOW OF HEAT OUT BY ACTING AS A BARRIER TO THE MOVEMENT OF HEAT. WHEN YOU ADD A SECOND OR THIRD LAYER OF GLAZING, YOU REDUCE THE TRANSPARENCY OF THE WINDOW, BUT MORE SIGNIFICANTLY YOU INCREASE THE INSULATING VALUE OF THE WINDOW BY CREATING DEAD AIR SPACES. A THIRD LAYER WILL SAVE ALMOST TWICE AS MUCH ENERGY AS ADDING ONLY A SECOND LAYER. IT CAN BE AS INEXPENSIVE AS POSSIBLE, AS LONG AS IT IS INSTALLED TIGHTLY TO KEEP OUT DRAFTS.

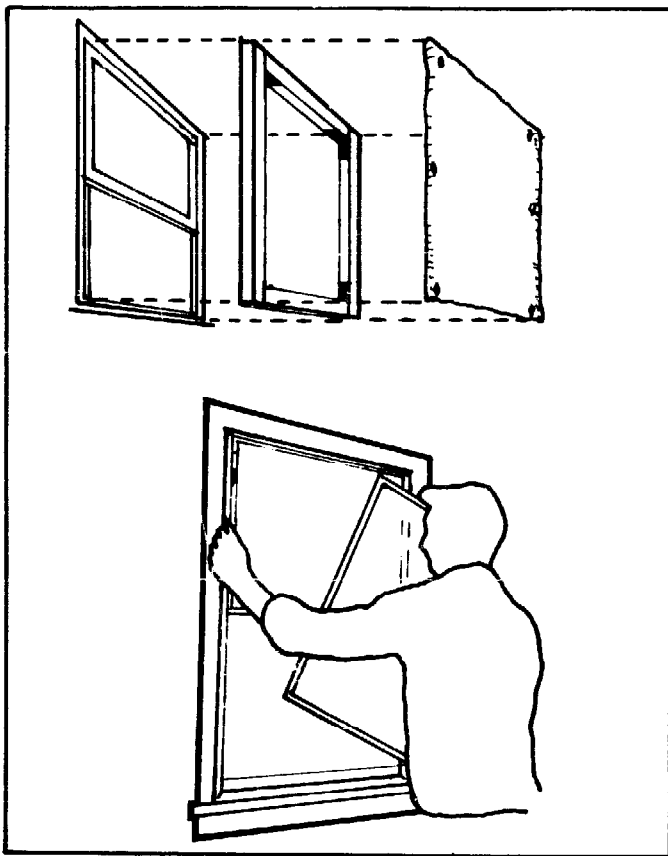

THESE SECOND AND THIRD LAYERS OF TRANSPARENT MATERIALS CAN BE EASILY MADE BY STRETCHING PLASTIC OVER A LIGHT FRAME.

THEY SHOULD BE INSTALLED SNUGLY, AND IDEALLY WOULD BE WEATHERSTRIPPED OR CAULKED FOR AIR-TIGHTNESS. BUT BE SURE TO LEAVE SMALL WEEP HOLES AT THE BOTTOM SO ANY INSIDE CONDENSATION CAN DRAIN AWAY.

YOU MAY WANT TO PROVIDE LARGER HOLES THAT CAN BE UNCOVERED TO LET FRESH AIR IN SOMETIMES FOR VENTILATION.

VARIATIONS:

- + AN EVEN CHEAPER METHOD IS TO TACK OR STAPLE PLASTIC FILM DIRECTLY TO THE WINDOW FRAME. THIS, HOWEVER, IS NOT VERY DURABLE OR ATTRACTIVE.
- + THE MOST PERMANENT SOLUTION IS TO USE GLASS IN WOODEN OR METAL FRAMES WHICH CAN BE STORED AND REUSED FOR YEARS. YOU MAY BE ABLE TO BUY OR SCROUNGE SECOND-HAND STORM-WINDOWS THAT FIT. OR, IF YOU CAN'T MAKE THEM YOURSELF, YOU COULD HAVE NEW STORM WINDOWS MADE FOR YOUR HOUSE. THEY'RE A GOOD INVESTMENT.

WHERE THIS WORKS:

THIS SOLUTION CAN (AND SHOULD) BE APPLIED TO ALL WINDOWS. IF YOU CAN'T DO THEM ALL AT ONCE, DO THE NORTH WINDOWS FIRST, AND WORK YOUR WAY AROUND THE WEST AND EAST SIDES TO THE SOUTH SIDE.

ADVANTAGES:

- + CHEAP AND SAVES LOTS OF ENERGY.
- + IT'S EASY TO INSTALL; IT'S APPLICABLE TO ALL WINDOW TYPES, ORIENTATIONS, LOCATIONS.
- + IT INSULATES THE BIGGEST HEAT LOSS AREA IN YOUR HOUSE, AND DOESN'T SHUT OUT NEEDED SUNLIGHT.

DISADVANTAGES:

- + IT MAY REQUIRE ATTENTION IN THE SPRING AND FALL TO INSTALL AND REMOVE.
- + IT MAY INTERFERE WITH THE OPENING OF THE WINDOW FOR VENTILATION OR VIEW.
- + IF IT'S MADE OF PLASTIC, IT WILL BLUR THE VIEW OUT THE WINDOW.
- + STORAGE OF THE STORMS OVER THE SUMMER WILL REQUIRE SPACE.

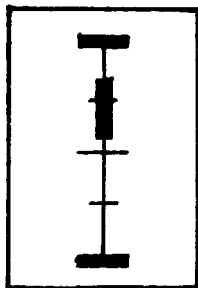
ECONOMICS/COST:

MATERIALS COSTS: THE MATERIALS FOR ADDING ON A SECOND OR THIRD LAYER CAN COST FROM \$0 IF YOU SCRUNGE, UP TO \$3 PER SQUARE FOOT FOR CUSTOM MADE, STORE-BOUGHT UNITS. IF YOU MAKE THEM YOURSELF, THE MAXIMUM COST WILL BE MORE LIKE \$1 PER SQUARE FOOT. FOR A 10 SQUARE FOOT WINDOW, THEN, THE COST WILL BE \$0 - \$10.

FUEL REDUCTION: PUTTING A SECOND LAYER OVER A SQUARE FOOT OF WINDOW CAN SAVE BETWEEN 1/3 - 1 1/3 GALLONS OF FUEL OIL PER HEATING SEASON. A 10 SQUARE FOOT WINDOW, THEN, WILL SAVE FROM 3 - 14 GALLONS PER WINTER. A THIRD LAYER WILL SAVE SOMEWHAT LESS THAN TWICE THAT AMOUNT.

COST-EFFECTIVENESS: ON OUR SCALE OF 1 - 20, THIS SUGGESTION EARNS A COST-EFFECTIVENESS RATING OF 12 - 17.

INTEGRAL STRUCTURES

EXISTING STONE-MASONRY WALLS TRANSFORMED INTO SOLAR COLLECTORS

THIS SCHEME CONVERTS AN EXISTING STONE, BRICK, OR CONCRETE SOUTH-FACING WALL INTO A COMBINATION SOLAR COLLECTOR AND SOLAR HEAT STORAGE. FIRST PAINT THE WALL A DARK COLOR, THEN MAKE OPENINGS THROUGH THE WALL AT FLOOR AND CEILING LEVEL. COVER THE OUTSIDE OF THE WALL WITH GLASS, OR DURABLE CLEAR PLASTIC, LEAVING A SPACE BETWEEN THE WALL AND THE GLASS, AND THAT'S ABOUT IT! THE SUN SHINES THROUGH THE GLASS AND HEATS UP THE WALL. THE WALL CONDUCTS SOME OF THE HEAT INTO THE HOUSE. IT ALSO HEATS UP THE AIR IN THE SPACE BETWEEN THE WALL AND THE GLASS. THE AIR RISES THROUGH THE CEILING OPENING AND INTO THE ROOM. THIS PROCESS DRAWS COOL AIR IN BEHIND IT AT FLOOR LEVEL. THE WALL ALSO STORES SOME OF THE HEAT FOR USE AT NIGHT.

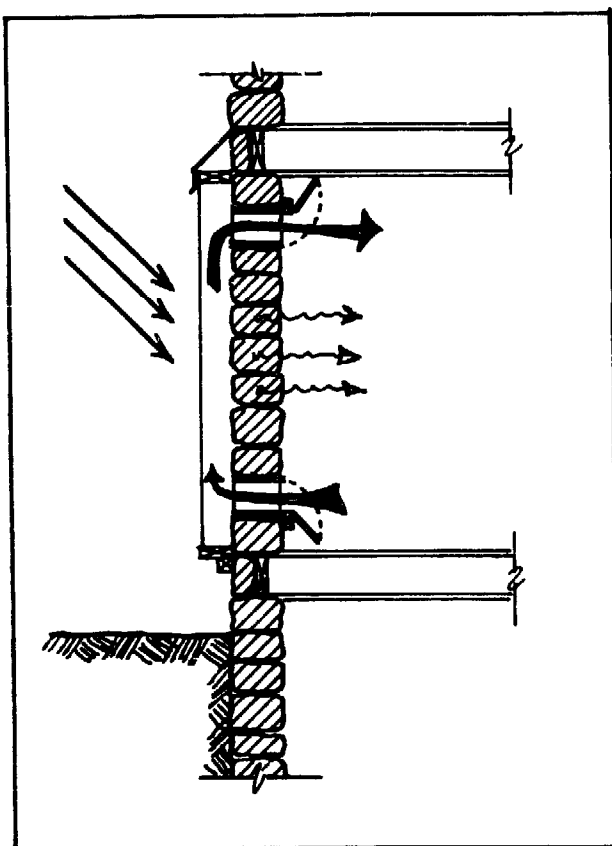

MAKE OPENINGS, FLOOR AND CEILING, EVERY 2 OR 3 FEET. EACH SHOULD BE AROUND 8 INCHES IN DIAMETER. THEY ALSO CAN BE RECTANGULAR.

INCLUDE DAMPERS OR LITTLE DOORS ON THE OPENINGS. CLOSE THE BOTTOM ONES AT NIGHT DURING THE WINTER TO PREVENT COLD DOWN DRAFTS. CLOSE THE TOP ONES DURING THE SUMMER TO KEEP OUT THE HEAT.

PROVIDE A VENT AT THE TOP WHICH CAN BE OPENED DURING THE SUMMER TO LET HOT AIR ESCAPE TO THE OUTSIDE INSTEAD OF OVERHEATING THE COLLECTOR.

VARIATIONS:

- + COVER THE GLASS AT NIGHT WITH INSULATING PANELS TO GREATLY REDUCE NIGHTTIME LOSS OF HEAT FROM THE WALL BACK TO THE OUTSIDE. THESE COULD SLIDE ON TRACKS, OR HINGE LIKE BIG DOORS.
- + BUILD THE WHOLE SYSTEM, BUT WITHOUT THE OPENINGS THROUGH THE WALL. FOR AN UNINSULATED CONCRETE, BRICK OR STONE WALL YOU'D SAVE LESS THAN HALF THE ENERGY COMPARED WITH THE WALL THAT HAS OPENINGS FOR AIR FLOW, BECAUSE THE HEAT WOULD HAVE TO SOAK THROUGH THE WALL IN ORDER TO HEAT THE ROOM. IF THE WALL IS INSULATED, THE OPENINGS ARE NECESSARY AND WILL HAVE TO BE CUT THROUGH.

WHERE THIS WORKS:

THIS TYPE OF SOLAR COLLECTOR IS APPROPRIATE OVER SOUTH-FACING STONE, BRICK, BLOCK AND CONCRETE WALLS THAT ARE UNINSULATED AND WHICH HAVE A LIVING SPACE DIRECTLY BEHIND THEM. THEY ARE ESPECIALLY APPROPRIATE FOR USE OVER FULLY EXPOSED CONCRETE BASEMENT WALLS OR ON EXISTING STONE HOUSES.

ADVANTAGES:

- + THIS SYSTEM CONVERTS WALLS WHICH LOSE HEAT INTO WALLS WHICH PRODUCE HEAT. COLLECTOR STORAGE AND HEAT DELIVERY ARE COMBINED INTO A SIMPLE UNIT.
- + IT ALSO EFFECTIVELY INSULATES HARD TO INSULATE WALLS, WHILE NOT ALTERING THE INTERIOR APPEARANCE OF THE WALL.
- + THE SYSTEM HAS NO MECHANICAL PARTS AND IS EASILY CONTROLLED BY THE OCCUPANTS.

DISADVANTAGES:

- + THIS WALL-TYPE SOLAR COLLECTOR IS LESS EFFECTIVE AT PRODUCING HEAT WHEN PLACED OVER AN INSULATED WALL.
- + IT MAY BE DIFFICULT TO FIND WALL SPACE WHERE THE NEEDED OPENINGS CAN BE EASILY OR CONVENIENTLY CUT.
- + THE COLLECTOR MAY NOT LOOK AS NICE AS THE STONE-MASONRY WALL IT COVERS.
- + IF THE WALL WAS NOT WELL-MADE, THE COLLECTOR HEAT MAY DAMAGE IT SOMEWHAT.

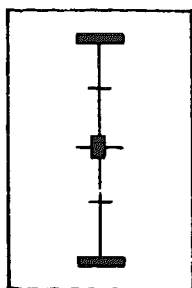
ECONOMICS/COST:

MATERIALS COSTS: MATERIALS TO GO OVER AN EXISTING WALL WILL COST APPROXIMATELY \$2 - \$3 PER SQUARE FOOT FOR GLASS, FRAMING MATERIALS, CAULKING, AND DAMPERS FOR THE OPENINGS. ADD ANOTHER \$.50 - \$1.50 PER SQUARE FOOT FOR AN INSULATING COVER.

FUEL REDUCTION: EACH SQUARE FOOT OF SOLAR WALL WILL SAVE BETWEEN 1/2 AND 1 GALLON OF OIL EACH WINTER. YOU WILL SAVE ALMOST DOUBLE THIS FOR A WALL WITH INSULATING PANELS OVER THE GLASS AT NIGHT.

COST-EFFECTIVENESS: ON OUR SCALE OF 1 - 20, THIS SUGGESTION EARNS A COST-EFFECTIVENESS RATING OF 11 - 12.

INTEGRAL STRUCTURES

ROOF AIR COLLECTOR OVER EXISTING SLATE OR METAL ROOF

THIS IS A DESIGN FOR AN AIR-HEATING SOLAR ENERGY COLLECTOR THAT CAN BE BUILT OVER AN EXISTING, SOUTH-FACING, ROOF. IF YOUR ROOF IS LEAKY AND YOU HAVE TO FIX IT ANYWAY, THIS IS ONE IDEA THAT WOULD ALLOW YOU TO WATERPROOF YOUR ROOF AND GET HEAT INTO YOUR HOUSE AT THE SAME TIME. SIMPLY INSTALL STRIPS TO SUPPORT ONE OR TWO LAYERS OF GLASS OR RIGID PLASTIC OVER THE ROOF. BASICALLY, COOL AIR IS TAKEN FROM A COLD PART OF YOUR HOUSE AND BROUGHT TO THE BOTTOM OF YOUR ROOF THROUGH A DUCT. THE AIR GETS HOTTER AS IT COMES IN CONTACT WITH THE ROOF WHICH IS ABSORBING THE SUN'S ENERGY. AT THE TOP OF THE ROOF, A LARGE DUCT COLLECTS THE WARM AIR WHICH IS THEN BLOWN BY A FAN BACK DOWN TO YOUR HOUSE. IF YOU WANT TO GET Fancier, SOME OF THIS HEAT CAN BE STORED FOR USE WHEN THE SUN IS NOT SHINING BY RAISING THE TEMPERATURE OF A BIN OF ROCKS OR SMALL CONTAINERS OF WATER.

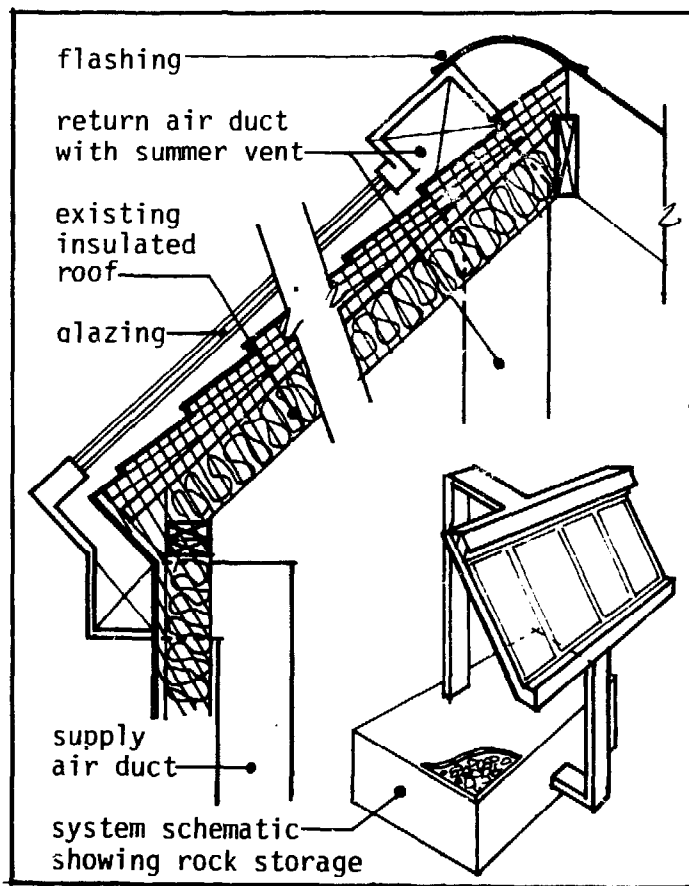

BE SURE TO PROVIDE A VENT FOR THE VERY HOT AIR TO GET OUT OF YOUR COLLECTOR IN THE SUMMER!

TWO COVER LAYERS WILL HELP REDUCE HEAT LOSSES, BUT WILL BE MORE COMPLICATED TO INSTALL THAN ONE LAYER WOULD BE.

CLEAR FIBERGLASS PLASTIC SHEETS CAN BE USED INSTEAD OF GLASS AS A COVERING. FRAMING FOR THE FIBERGLASS CAN BE SPACED 2 FEET APART ON YOUR ROOF.

IT TAKES LARGE DUCTS TO CARRY ALL THE SLOW MOVING AIR OFF THE ROOF. FOR 500 SQUARE FEET OF ROOF, THE DUCT WILL HAVE TO BE ABOUT 1 FOOT BY 2 FEET IN CROSS-SECTION.

ALLOW ABOUT 2 - 3 INCHES OF AIR BETWEEN YOUR ROOF AND THE GLASS OR PLASTIC COVER OF YOUR COLLECTOR.

VARIATIONS:

- + THE CONSTRUCTION OF YOUR HOUSE WILL GREATLY INFLUENCE HOW YOU DUCT AIR TO AND FROM THE COLLECTORS AND HOW YOU VENT THE COLLECTOR IN THE SUMMERTIME - WHETHER IT BE OUT THE TOP, OR OUT THE SIDES.
- + IN CERTAIN CIRCUMSTANCES WHERE THE ROOM OR ROOMS TO BE HEATED ARE ABOVE THE ROOF SURFACE WHERE YOU ARE COLLECTING THE HEAT, IT MIGHT BE POSSIBLE TO HAVE THE HOT AIR RISE NATURALLY TO THE SPACE WITHOUT THE USE OF A FAN. THIS IS CALLED NATURAL THERMOSIPHONING AND IT WOULD SAVE YOU THE ENERGY IT TAKES TO OPERATE A FAN.

WHERE THIS WORKS:

ON MOST ROOFS, SUCH AS ASPHALT SHINGLE ROOFS, THE SURFACE WOULD NOT BE ABLE TO WITHSTAND THE HIGH TEMPERATURES THAT BUILD UP IN THE COLLECTOR. MAKE SURE THAT YOU HAVE A ROOF THAT CAN TAKE TEMPERATURES IN THE 150 - 200 DEGREE RANGE. THIS PROBABLY LIMITS THE IDEA TO SLATE OR METAL ROOFS. AS WE HAVE SEEN IN THE SITE CONDITIONS SECTION, A ROOF CAN HAVE A SOUTH-FACING TILT AS SHALLOW AS 40 - 30 DEGREES FROM THE HORIZONTAL AND STILL COLLECT A LARGE PERCENTAGE OF THE SOLAR ENERGY AVAILABLE. ON ROOFS SHALLOWER THAN THIS, IT IS NOT WORTH GOING TO THE TROUBLE TO USE THIS TYPE OF COLLECTOR.

ADVANTAGES:

- + UNDER CERTAIN SPECIAL CIRCUMSTANCES, SUCH AS THE LEAKY ROOF MENTIONED EARLIER, THIS CAN BE A VERY EXCITING WAY OF DOING TWO CHORES AT ONCE.
- + ALSO BY USING THE EXISTING ROOF SURFACE YOU CAN SAVE MONEY BY NOT HAVING TO PROVIDE PARTS OF THE COLLECTOR OTHER THAN THE COVER AND THE CONNECTING DUCTS.

DISADVANTAGES:

- + POTENTIAL PROBLEMS DO EXIST WITH THE EXCESSIVE EXPANSION DUE TO HIGH TEMPERATURES AND POTENTIAL DAMAGE TO THE SLATES OR METAL.
- + IF YOU ARE THE OWNER OF AN EXCESSIVELY LEAKY ROOF THERE MIGHT BE A GREAT DEAL OF AIR LEAKAGE THROUGH THE ROOF, WHICH COULD THEN BE WASTED IN AN UN-HEATED ATTIC SPACE.
- + LASTLY, REMEMBER THAT THIS TYPE OF SOLAR COLLECTOR LOSES A LARGE AMOUNT OF THE SOLAR ENERGY AVAILABLE TO IT BECAUSE IT DOES NOT TAKE THE HEAT AWAY IN A VERY EFFICIENT MANNER. HOWEVER, THIS HEAT WOULD OTHERWISE BE LOST ENTIRELY.

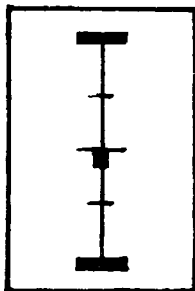
ECONOMICS/COST:

MATERIALS COSTS: THE COST WILL VARY, DEPENDING ON THE QUALITY OF MATERIALS USED AND ON HOW MUCH ALTERNATION YOUR HOUSE REQUIRES. IN GENERAL, THOUGH, YOU CAN EXPECT TO PAY \$4 - \$5 PER SQUARE FOOT OF COLLECTOR BUILT. A 100 SQUARE FOOT COLLECTOR, THEN, WOULD COST \$400 - \$500. IF YOU ADD A ROCK STORAGE BIN THIS WILL NATURALLY INCREASE, PERHAPS AS MUCH AS 100 PERCENT. IF THE SYSTEM IS LARGER THAN 100 SQUARE FEET, THIS WILL PROBABLY BE NECESSARY.

FUEL REDUCTION: EACH SQUARE FOOT OF SOLAR ROOF AIR COLLECTOR WILL SAVE BETWEEN .4 AND .8 GALLONS OF OIL PER SEASON. A 100 SQUARE FOOT COLLECTOR, THEN, WILL SAVE FROM 40 - 80 GALLONS PER YEAR.

COST-EFFECTIVENESS: ON OUR SCALE OF 1 - 20, THIS SUGGESTION EARNS A COST-EFFECTIVENESS RATING OF 9 - 10.

INTEGRAL STRUCTURES

ADD A NEW WINDOW

ONE OF THE OPPORTUNITIES EVERYONE SHOULD CONSIDER FOR USING SOLAR ENERGY IN THEIR HOUSE IS TO ADD A WINDOW TO THE SOUTH WALL OF THEIR HOUSE. A WINDOW ON THE SOUTH WILL GAIN MORE HEAT ENERGY FROM THE SUN THAN IT WILL LOSE BACK TO THE COLD OUTSIDE. IF YOU CAN AFFORD IT, IT IS BEST TO ADD A STORM WINDOW OR TO USE DOUBLE GLASS SUCH AS THERMOPANE. MAKE SURE YOU HAVE DONE A GOOD INSTALLATION JOB AND THAT THERE IS NO AIR LEAKING INTO YOUR HOUSE FROM SPACE AROUND THE NEW WINDOW FRAME. NOW INSULATE YOUR WINDOW AT NIGHT WITH AN INSULATING CURTAIN OR MOVABLE INSULATION SUCH AS A SHUTTER AND YOU HAVE ONE OF THE BEST SOLAR COLLECTORS THERE IS!

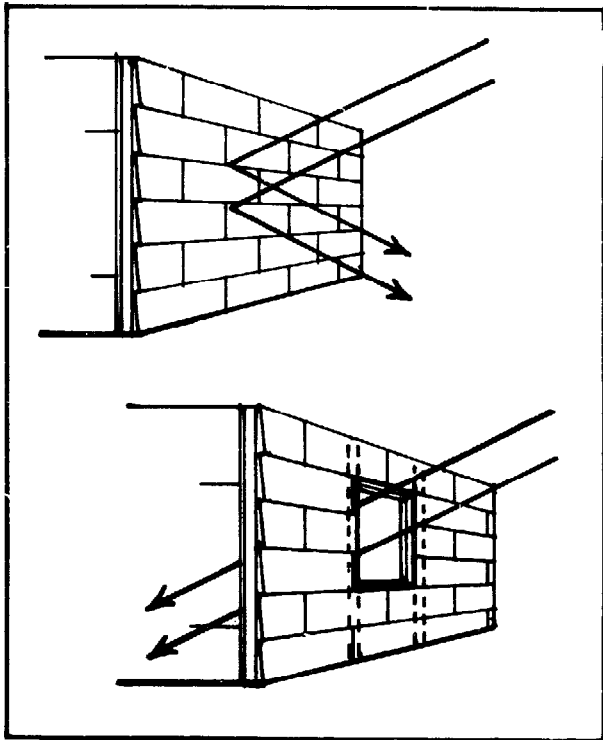

BE CAREFUL WHEN CUTTING THROUGH THE WOOD FRAME THAT HOLDS UP YOUR HOUSE. CONSULT WITH A CONTRACTOR OR ARCHITECT FIRST TO AVOID DAMAGING THE STRUCTURE.

MANY PEOPLE LEAVE THEIR LIGHT-COLORED CURTAINS OR VENETIAN BLINDS COVERING THE WINDOW DURING THE DAY. THIS IS A WASTE OF SOLAR ENERGY BECAUSE A LIGHT COLOR REFLECTS THE SOLAR ENERGY BACK OUT OF YOUR HOUSE BEFORE IT CAN CHANGE TO HEAT. IF YOU WANT TO KEEP YOUR DRAPES CLOSED BECAUSE YOU DON'T WANT TO FADE YOUR UPHOLSTERY, THEN MOVE YOUR FURNITURE AND OPEN THE DRAPES. LET THE SUN SHINE IN!

VARIATIONS:

- + YOUR NEW WINDOW CAN BE OPERABLE OR FIXED GLASS. FIXED GLASS WILL LET LESS COLD AIR SNEAK IN, BUT CAN'T BE USED FOR VENTILATION.
- + WINDOWS COME IN LOTS OF SIZES AND TYPES, FROM COLONIAL DOUBLE-HUNG TO BAY WINDOWS AND SLIDING GLASS DOORS.
- + SKYLIGHTS ARE WINDOWS, TOO. BECAUSE HEATED AIR RISES, IT'S ESPECIALLY IMPORTANT TO HAVE INSULATING SHUTTERS FOR SKYLIGHTS.

WHERE THIS WORKS:

THIS CAN WORK ALMOST ANYWHERE ON THE SOUTH OF YOUR BUILDING. JUST MAKE SURE YOU DON'T CUT OUT SOMETHING THAT'S HOLDING YOUR BUILDING UP, OR CUT INTO ELECTRICAL WIRING OR PLUMBING.

ADVANTAGES:

- + WINDOWS ARE GREAT THINGS ANYWAY. YOU CAN LOOK OUT AND SEE THINGS OR HAVE PEOPLE WAVE TO YOU IN YOUR WINDOW FROM THE STREET. A WINDOW IS YOUR EYE ON THE WORLD.
- + THERE ARE MANY PEOPLE WHO HAVE EXPERIENCE PUTTING UP WINDOWS AND IF YOU CAN'T DO IT, MAYBE YOUR NEIGHBORS CAN HELP AND YOU CAN MAKE THEM SOME INSULATING CURTAINS FOR THEIR WINDOWS.

DISADVANTAGES:

- + IT IS POSSIBLE TO GET "TOO MUCH HEAT" INTO THE SPACE, ESPECIALLY IN THE SUMMER, IF TOO MUCH OF THE SOUTH WALL IS GLASS. YOU MAY HAVE TO ADD MATERIALS INSIDE TO ABSORB THIS EXCESS HEAT.
- + REDUCES WALL AREA INSIDE.
- + MAY RUIN APPEARANCE OF HOUSE.
- + CAUSES CONSIDERABLE DISRUPTION DURING CONSTRUCTION PERIOD.

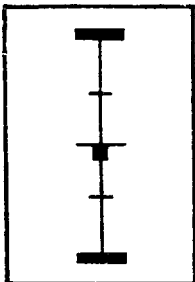
ECONOMICS/COST:

MATERIALS COSTS: A WINDOW OF REGULAR SIZE (10 SQUARE FEET) WILL COST ABOUT \$50, PLUS THE TRIM MATERIALS, REFRAMING, AND LABOR. THE BIGGER THEY GET, THE MORE THEY COST. COST ALSO RISES WHEN YOU GET INTO TIGHT, WELL WEATHER STRIPPED WINDOWS, BUT IT'S WORTH THE EXTRA EXPENSE TO KEEP OUT COLD AIR INFILTRATION.

FUEL REDUCTION: EACH SQUARE FOOT OF WINDOW AREA CAN SAVE YOU FROM 1/2 - 1.2 GALLONS OF OIL PER HEATING SEASON. A 10 SQ. FT. WINDOW, THEN WOULD SAVE FROM 5 - 12 GALLONS A WINTER.

COST-EFFECTIVENESS: ON OUR SCALE OF 1 - 20, THIS SUGGESTION EARNS A COST-EFFECTIVENESS RATING OF 9 - 10.

ATTACHED STRUCTURES

OUTSIDE SHUTTERS

AN INSULATING SHUTTER COULD HINGE FROM THE OUTSIDE OF YOUR HOUSE AND SWING OPEN DURING THE DAY TO ALLOW SUNLIGHT TO ENTER THROUGH THE WINDOW. DURING THE NIGHT WHEN THE SUN IS NO LONGER SHINING, THE SHUTTER WOULD BE CLOSED OVER THE WINDOW TO TRAP THE HEAT INSIDE THE HOUSE. DURING THE SUMMER MONTHS WHEN TOO MUCH HEAT IS A PROBLEM, IT MIGHT SOMETIMES BE HELPFUL TO HAVE THE SHUTTERS CLOSED DURING THE DAY, OR PARTIALLY CLOSED, TO KEEP SUNLIGHT OUT. IF THE SHUTTERS ARE LINED WITH A REFLECTIVE MATERIAL ON THE INSIDE SURFACE THEY CAN BE USED AS REFLECTORS WHEN THEY ARE OPENED TO DIRECT MORE HEAT-PRODUCING SUNSHINE INTO THE HOUSE.

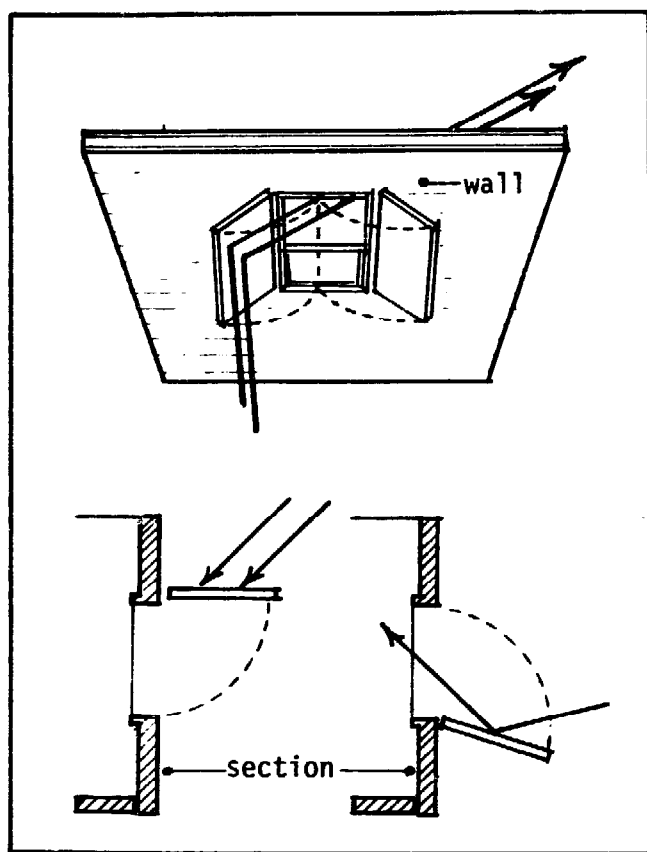

SHUTTER SHOULD FIT SNUGLY WHEN IT IS CLOSED TO HAVE MAXIMUM INSULATING VALUE.

BE SURE TO DESIGN A SHUTTER THAT CAN STAND UP TO POOR WEATHER CONDITIONS SUCH AS WINDY DAYS OR SNOW FALLING FROM THE ROOF!

YOU SHOULDN'T HAVE TO OPEN EVERY WINDOW TO CLOSE THE SHUTTERS. EITHER GO OUTSIDE TO DO IT, OR DEVISE A REMOTE-CONTROL METHOD OF CLOSING.

A REFLECTIVE FOIL FACE ALSO REFLECTS HEAT BACK INTO YOUR HOUSE WHEN THE SHUTTERS ARE CLOSED.

ON EAST- AND WEST-FACING WALLS, A SHUTTER WHICH IS BOTH REFLECTING AND INSULATING CAN BOUNCE SOUTHERN LIGHT DIRECTLY INTO THE ROOM AT TIMES WHEN DIRECT SUNSHINE WOULD NORMALLY NOT BE AVAILABLE.

VARIATIONS:

- + YOUR OUTSIDE INSULATING SHUTTERS CAN HINGE FROM THE SIDES AS SHOWN OR FROM THE TOP AND/OR BOTTOM OF THE WINDOW. IF THEY ARE TO BE USED AS REFLECTORS AS WELL AS SHUTTERS, THE KIND HINGED ON TOP AND BOTTOM ARE MOST EFFECTIVE ON THE SOUTH SIDE OF YOUR HOUSE.
- + TOP HINGING SHUTTERS CAN BE USED AS SUMMER AWNINGS.
- + INSTEAD OF WORKING ON A HINGE, YOUR SHUTTER MIGHT SLIDE ON A TRACK OR BE ENTIRELY REMOVABLE AND STORED DURING THE DAY.

WHERE THIS WORKS:

THIS SHUTTER WILL BE EFFECTIVE ON ANY WINDOW. WHENEVER A WINDOW IS NOT COLLECTING SOLAR HEAT AND IS NOT NEEDED FOR DAYLIGHTING, IT SHOULD BE SHUTTERED. SHUTTERS ARE ESPECIALLY IMPORTANT ON SUNLESS OR SHADED WINDOWS WHICH NEVER COLLECT HEAT. THEY ONLY LOSE IT.

ADVANTAGES:

- + INTERIOR SHUTTERS SOMETIMES HAVE CONDENSATION PROBLEMS THAT AN EXTERIOR SHUTTER CAN ELIMINATE.
- + MOST IMPORTANTLY THIS IS A SIMPLE DEVICE WHICH IS VERY EFFECTIVE AND CAN BE VERY EASILY CONSTRUCTED BY THE AVERAGE WEEKEND CARPENTER.

DISADVANTAGES:

- + THE MAJOR DIFFICULTY IS THE NECESSITY OF OPERATING THE SHUTTERS EVEN DURING THE COLDEST AND SNOWIEST DAYS. IT IS DURING JUST THESE DAYS, WHEN YOU WOULD LIKE TO AVOID GOING OUTSIDE TO CLOSE YOUR SHUTTERS, THAT THEY ARE DOING THE MOST GOOD - YOU HAVE TO DO IT!
- + OUTDOOR EXPOSURE TO THE ELEMENTS INCREASES WEAR AND TEAR ON THE MATERIALS, PAINT, HARDWARE.
- + SHUTTERS MAY BE VULNERABLE TO ICING WHICH WOULD IMPAIR THEIR OPERATION.

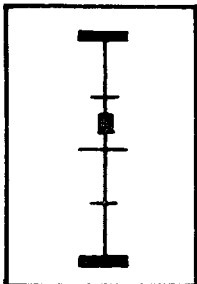
ECONOMICS/COST:

MATERIALS COSTS: THE MATERIALS THAT GO INTO MAKING YOUR OUTSIDE INSULATING SHUTTER CAN COST FROM \$1 - \$2 FOR EACH SQUARE FOOT OF YOUR SHUTTER. A 10 SQUARE FOOT SECTION OF SHUTTER WOULD THUS COST FROM \$10 - \$20. ADD UP TO \$.25 FOR A REFLECTING SURFACE.

FUEL REDUCTION: FOR EACH 10 SQUARE FEET OF WINDOW SURFACE COVERED EACH NIGHT WITH AN OUTSIDE INSULATING SHUTTER DURING THE HEATING SEASON, YOU SHOULD BE ABLE TO SAVE FROM 4 - 10 GALLONS A WINTER OR 1/4 - 1 GALLON PER SQ. FT. IF YOUR SHUTTER ACTS AS A REFLECTOR AS WELL, YOU CAN INCREASE YOUR SAVINGS BY AS MUCH AS 20%

COST-EFFECTIVENESS: ON OUR SCALE OF 1 - 20, THIS SUGGESTION EARNS A COST-EFFECTIVENESS RATING OF 12 - 13.

ATTACHED STRUCTURES

WINDOW BOX

IT CAN'T BE SAID TOO OFTEN: THE BEST SOLAR COLLECTOR IS A SIMPLE WINDOW THAT IS INSULATED AT NIGHT. ONE WAY TO EXTEND THE AREA OF YOUR WINDOWS SO THAT THEY CAN COLLECT MORE SOLAR ENERGY WITHOUT HAVING TO BREAK THROUGH A WALL AND ADD A NEW WINDOW IS TO USE A WINDOW BOX. BASICALLY A WINDOW BOX IS A GLAZED PLYWOOD BOX THAT ATTACHES TO YOUR WINDOW SILL, BUT STILL ALLOWS YOU TO GET LIGHT INTO YOUR HOUSE THROUGH THE WINDOW. THE SUN'S ENERGY STRIKES A BLACKENED SURFACE IN THE WINDOW BOX AND CHANGES TO HEAT. COOL AIR IN THE BOX COMES INTO CONTACT WITH THE HOT BLACK SURFACE AND THE AIR IS WARMED. WARM AIR RISES SO THE AIR IS DRAWN NATURALLY INTO THE HOUSE. AT THE SAME TIME COOL AIR FROM NEAR THE FLOOR OF YOUR ROOM ENTERS THE WINDOW BOX TO BE HEATED UP. WHILE THE SUN IS OUT, YOU CAN GAIN EXTRA HEAT FOR YOUR HOUSE!

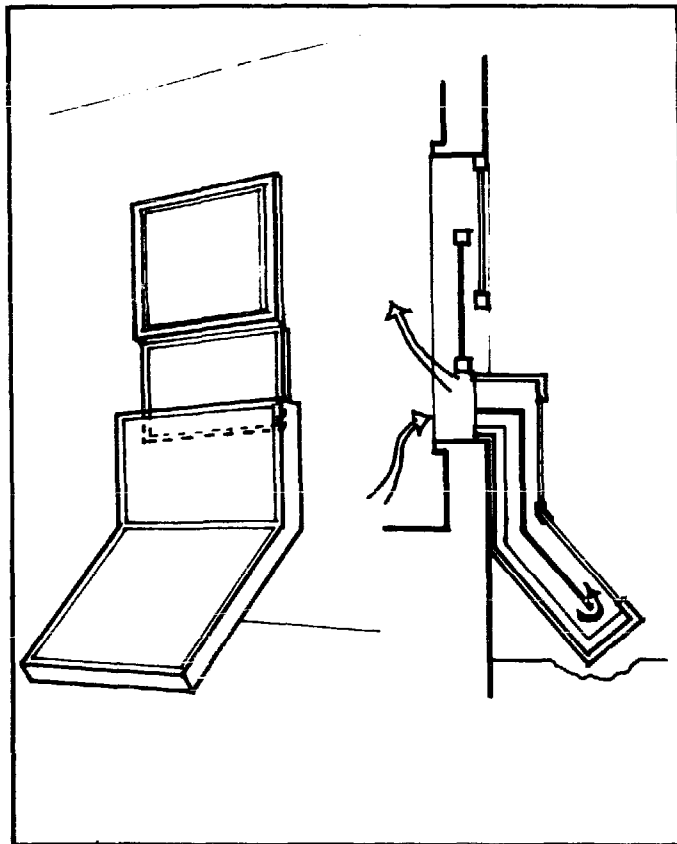

YOUR EXISTING WINDOW REMAINS ENTIRELY IN PLACE. THE LOWER SASH OF YOUR WINDOW ACTS AS A DAMPER; WHEN IT IS UP, HEAT IS ALLOWED IN, AND WHEN IT IS CLOSED, IT PREVENTS HEAT FROM LEAVING THE ROOM.

MAKE SURE TO PAINT THE ABSORBING SURFACE OF YOUR BOX, WHICH CAN BE METAL OR PLYWOOD, WITH FLAT BLACK PAINT.

ALLOW A 2 INCH AIR SPACE ON BOTH SIDES OF YOUR ABSORBING SURFACE AND MAKE SURE YOU INSULATE THE BACK OF YOUR BOX TO KEEP HEAT FROM ESCAPING. ALSO INSULATE THE SIDES.

THE TRANSPARENT COVER CAN BE PLASTIC OR GLASS. AN OLD WINDOW SASH WORKS WELL.

BE SURE TO STUFF INSULATION IN THE GAP BETWEEN THE SASH SO COLD AIR DOESN'T FLOW IN ALONG WITH THE WARM.

VARIATIONS:

- + A LARGE NUMBER OF CONFIGURATIONS ARE POSSIBLE WITH THESE WINDOW BOX COLLECTORS, SUCH AS CONNECTING UP TWO WINDOWS WITH ONE LARGE BOX OR HAVING THE WINDOW BOX FOR A SECOND STORY WINDOW ACT AS AN ENTRANCE CANOPY OR SHADING DEVICE FOR THE FIRST FLOOR.
- + YOU MIGHT FIND THAT YOU CAN SALVAGE MANY OF THE MATERIALS TO MAKE YOUR WINDOW BOX COLLECTOR. YOU CAN EXPERIMENT WITH DIFFERENT DESIGNS AT LITTLE COST UNTIL YOU DEVELOP THE ONE THAT SUITS YOU AND YOUR HOUSE BEST. HAVE FUN AND LEARN WHILE YOU SAVE.

WHERE THIS WORKS:

THE FIRST PLACE TO USE THIS TYPE OF SYSTEM WOULD BE ON HOUSES WITH SMALL SOUTH-FACING WINDOWS WHERE YOU ARE NOT ABLE TO CUT OPENINGS THROUGH THE WALL FOR NEW WINDOWS. OF COURSE, THIS DEVICE CAN BE MOST EASILY INSTALLED IN FIRST FLOOR LOCATIONS, ALTHOUGH EXISTING PORCHES OR ENTRYWAYS MIGHT PROVIDE OPPORTUNITIES TO SUPPORT WINDOW BOXES ABOVE GROUND. IN SITUATIONS WHERE NEW EXTERIOR SIDING IS NECESSARY THE CONSTRUCTION OF THE BOX COULD BE COMBINED WITH THE CONSTRUCTION OF THE NEW SIDING.

ADVANTAGES:

- + THE WINDOW BOX IS ONE OF THE SIMPLEST DEVICES YOU CAN BUILD TO COLLECT SOLAR ENERGY. IT CAN BE BUILT WITH RELATIVELY INEXPENSIVE MATERIALS THAT YOU MIGHT HAVE AVAILABLE ALREADY!
- + THE WINDOW BOX DOES NOT INVOLVE THE USE OF EXPENSIVE CONTROLS OR MECHANICAL PARTS.
- + YOU, IN EFFECT, INCREASE THE HEAT ABSORBING AREA OF YOUR WINDOW WITHOUT ALTERING IT SIGNIFICANTLY.
- + THE BOX CAN BE MOVED AND STORED FOR THE SUMMER.

DISADVANTAGES:

- + WITH THIS DEVICE THERE IS NO WAY OF STORING THE HEAT FOR TIMES WHEN THE SUN IS NOT SHINING AND IT IS COLD. IN FACT, AT NIGHT WHEN YOU REQUIRE THE HEAT MOST IT PRODUCES NO HEAT AT ALL.
- + BECAUSE THE HEAT IS COLLECTED OUTSIDE AND MOVED IN, MORE IS LOST THAN WOULD BE IF THE SUN WERE SHINING DIRECTLY INTO A LARGER WINDOW AREA.
- + HAVING THE BOXES BESIDE YOUR HOUSE MAY UNDESIREABLY AFFECT THE APPEARANCE OF YOUR HOUSE.
- + UNLESS THERE IS AN AIRTIGHT SEAL BETWEEN THE BOX AND YOUR WINDOW, THE HEAT GAINED MAY BE CANCELLED OUT BY COLD AIR LEAKAGE.

ECONOMICS/COST:

MATERIALS COSTS: THE COST OF THE MATERIALS TO BUILD YOUR BOX INCLUDING WOOD, INSULATION, GLASS OR PLASTIC, PAINT, ETC., WILL BE FROM \$1 - \$2 PER SQUARE FOOT OF WINDOW BOX AREA.

FUEL REDUCTION: EACH SQUARE FOOT OF YOUR WINDOW BOX HEATER CAN BE EXPECTED TO SAVE YOU FROM 1/3 - 1 GALLON OF FUEL OIL EACH WINTER.

COST-EFFECTIVENESS: ON OUR SCALE OF 1 - 20, THIS SUGGESTION EARNS A COST-EFFECTIVENESS RATING OF 12 - 13.

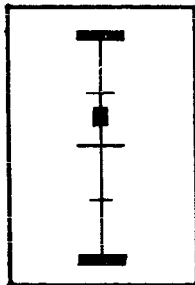

ATTACHED STRUCTURES

GREENHOUSES

BY ATTACHING A GREENHOUSE TO A SOUTH FACING WINDOW IT IS POSSIBLE TO GAIN EXTRA HEAT FOR YOUR HOUSE, AS WELL AS TO PROVIDE A PLACE TO GROW PLANTS. THIS IS AN IDEA FOR A UNIT THAT WILL ATTACH TO ANY WINDOW FRAME AND BE SUPPORTED BY THE WALL OF THE HOUSE. THE EXTRA LAYER OF GLASS IN THE GREENHOUSE, OVER AND ABOVE THAT ALREADY ON THE HOUSE, ALSO REDUCES THE LOSS OF HEAT WHEN THE SUN IS NOT SHINING. THIS GREENHOUSE IS 12 INCHES DEEP, THE SAME SIZE AS THE WINDOW AND HAS TWO MESH SHELVES TO ALLOW THE FREE FLOW OF WARMED AIR. REMEMBER, AS AIR IS WARMED IT RISES NATURALLY! WHEN THE STRUCTURE GETS TOO WARM, A MOVABLE, HINGED TOP CAN BE FLIPPED UP TO VENTILATE THE GREENHOUSE. THE WINDOW OF THE HOUSE CAN BE RAISED OR LOWERED TO ACT AS A DAMPER TO REGULATE THE AMOUNT OF HEAT ENTERING THE HOUSE FROM THE GREENHOUSE.

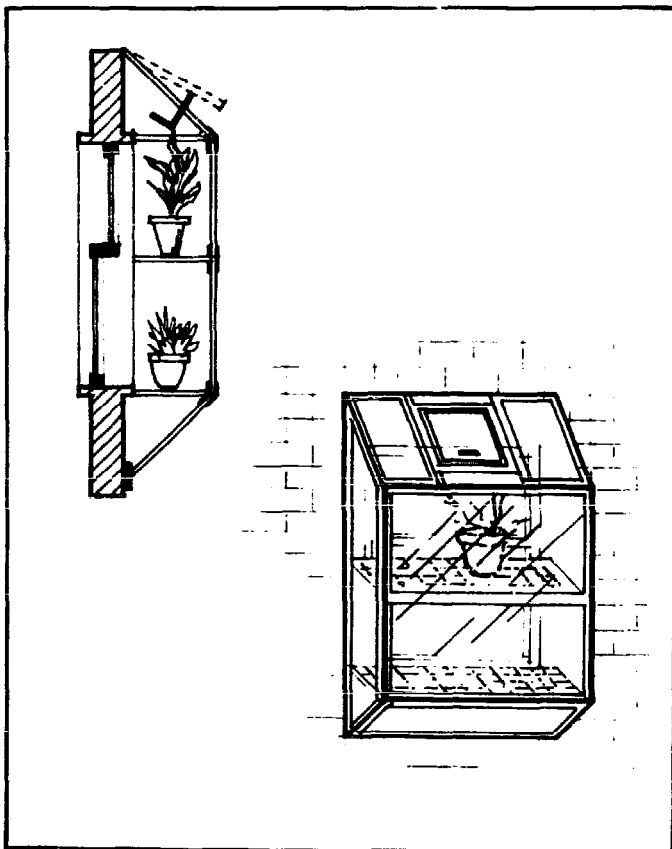

THE FRAME CAN BE MADE OF SOFT WOOD COATED WITH PRESERVATIVE AND COVERED WITH GLASS.

TRY TO MAKE SURE THAT THE WOOD OR OTHER MATERIAL THAT YOU USE TO BUILD YOUR GREENHOUSE DOES NOT GET TOO LARGE AND BLOCK A LOT OF SOLAR ENERGY FROM ENTERING YOUR GREENHOUSE.

YOU MUST BE CAREFUL NOT TO PLACE YOUR GREENHOUSE IN THE WAY OF ICE OR SNOW FALLING OFF YOUR ROOF WHICH MIGHT DAMAGE YOUR UNIT.

IF YOUR BUDGET DOES NOT ALLOW THE USE OF GLASS YOU MIGHT USE PLASTIC SUCH AS POLYETHYLENE, ALTHOUGH IT HAS A SHORT LIFE SPAN.

VARIATIONS:

- + IT IS ALSO POSSIBLE TO CONSTRUCT A LARGER GREENHOUSE UNIT THAT SURROUNDS A WINDOW, SEVERAL WINDOWS, OR A DOOR ON THE SIDE OF A HOUSE. VENTILATION TO THE OUTSIDE IS AGAIN PROVIDED BY A MOVABLE CENTER PANEL ON THE TOP. THE FRAME IS COVERED BY TWO LAYERS OF POLYETHYLENE AND HAS A DARK GRAVEL FLOOR. IN LARGER UNITS, ADD SOME HEAT ABSORBING MASONRY OR CONTAINERS OF WATER.

WHERE THIS WORKS:

ALMOST ANY SOUTH FACING WINDOW CAN WORK FINE. AS INDICATED IN THE SECTION ON SITE CONSIDERATIONS WINDOWS THAT DO NOT FACE DIRECTLY SOUTH ARE ALSO USEFUL. EVEN GREENHOUSES FACING EAST OR WEST CAN WORK IF REFLECTORS ARE MOUNTED ON THE NORTH SIDE OF THE UNIT. AS ALWAYS, BE SURE THERE ARE NO LARGE BUILDINGS IN THE WAY OF THE SUN IN THE WINTERTIME WHEN THE SUN IS LOW ON THE HORIZON, WHICH WILL SHADE YOUR GREENHOUSE.

ADVANTAGES:

- + BESIDES THE BENEFICIAL HEATING EFFECTS, THE GREENHOUSE WILL PROVIDE PLANTS FOR THE HOUSE WHICH WILL INCREASE THE MOISTURE LEVEL IN THE DRY WINTER MONTHS.
- + LARGER GREENHOUSES CAN PROVIDE FOOD AS WELL. ANY GREENHOUSE CAN ALSO ALLOW AN EARLY START FOR GARDEN SEEDLINGS.
- + THERE ARE MANY WHO FEEL THAT PLANTS ARE AN EXCITING DECORATING TOOL THAT ADDS SUBSTANTIALLY TO THE OVERALL "FEEL" OF A HOME.

DISADVANTAGES:

- + FOR SOME PEOPLE, THE ONE TO FIVE HOURS A WEEK NECESSARY TO MAINTAIN THE PLANTS IN YOUR GREENHOUSE MAY BE TOO MUCH OF A BOTHER. THERE ARE DIFFICULTIES WITH LARGER GREENHOUSES AS WELL.
- + WITH UNITS THAT ABUT ORDINARY WOOD FRAME WALLS, THERE MIGHT BE PROBLEMS WITH MOISTURE BUILD-UP IN THE WINTER TIME.
- + IF PLANTS ARE TO BE KEPT FROM FREEZING ALL WINTER, IT MAY BE NECESSARY TO OPEN THE WINDOW AND USE SOME INTERIOR HEAT TO KEEP THE GREENHOUSE WARM ON COLD WINTER NIGHTS.

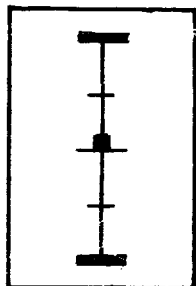
ECONOMICS/COST:

MATERIALS COSTS: THE MATERIALS TO BUILD THIS WINDOW GREENHOUSE SHOULD COST IN THE RANGE OF \$2 - \$8 PER SQUARE FOOT WINDOW AREA COVERED, DEPENDING ON THE QUALITY AND DURABILITY OF MATERIALS USED. THUS, A GREENHOUSE FOR A 10 SQUARE FOOT WINDOW WOULD COST BETWEEN \$20 AND \$80.

FUEL REDUCTION: EACH HEATING SEASON YOUR GREENHOUSE CAN SAVE YOU FROM $\frac{1}{3}$ - $\frac{2}{3}$ GALLON OF FUEL OIL PER SQUARE FOOT. FOR AN AVERAGE WINDOW, THEN, SAVINGS WOULD RANGE FROM $3 \frac{1}{3}$ - $6 \frac{2}{3}$ GALLONS PER WINDOW PER SEASON

COST-EFFECTIVENESS: ON OUR SCALE OF 1 - 20, THIS SUGGESTION EARNS A COST-EFFECTIVENESS RATING OF 10 - 11.

ATTACHED STRUCTURES

LEAN-TO COLLECTOR WITH STORAGE

THIS IDEA IS FOR A SOUTH-FACING LEAN-TO WHICH IS USED AS A SOLAR HEAT COLLECTOR. WHAT MAKES THIS SCHEME VERY DIFFERENT FROM THE OTHER IDEAS FOR ATTACHED STRUCTURES IS THE ABILITY THIS DEVICE HAS TO STORE THE HEAT IT GATHERS IN THE ROCKS THAT ARE LOCATED IN THE LEAN-TO. HEAT THAT IS COLLECTED BUT NOT IMMEDIATELY NEEDED TO KEEP YOUR HOUSE WARM ENOUGH CAN BE SAVED FOR LATER USE BY HEATING THE ROCKS IN THE LEAN-TO. THIS COLLECTOR IS AN AIR HEATING COLLECTOR. THIS MEANS THAT THE HEAT THAT BUILDS UP ON THE FLAT-BLACK PAINTED SURFACE BEHIND THE GLASS OR PLASTIC THAT COVERS YOUR COLLECTOR IS CARRIED AWAY BY A BLOWER DRAWING AIR EITHER TO YOUR HOUSE OR DOWN TO THE MASS OF ROCK, BRICK OR OTHER HEAT ABSORBING MATERIAL THAT IS IN THE LEAN-TO. USE ABOUT ONE CUBIC FOOT OF ROCK FOR EACH SQUARE FOOT OF COLLECTOR AREA YOU HAVE IN YOUR LEAN-TO.

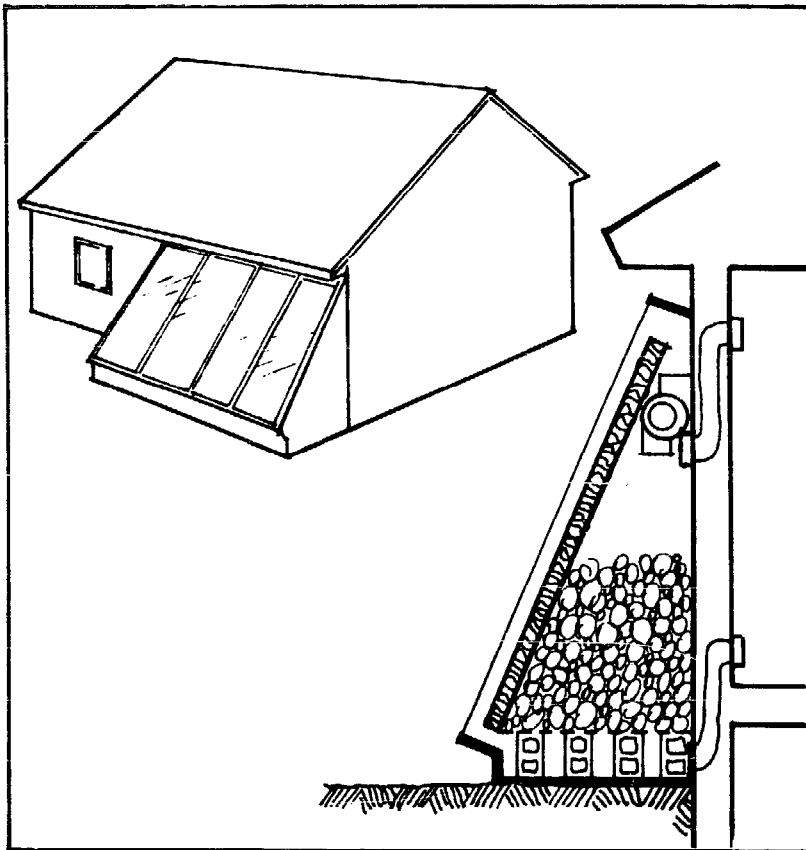

MAKE SURE THAT THE BACK OF YOUR SOLAR ABSORBING SURFACE IS WELL INSULATED SO THAT HEAT STORED IN YOUR ROCK THERMAL STORAGE DOES NOT ESCAPE.

MAKE SURE THAT THE BOTTOM, TOP AND SIDES OF YOUR ROCK BIN ARE INSULATED, AND THAT IT IS AIR-TIGHT.

COOL ROOM AIR IS DRAWN THROUGH A PLENUM FORMED BY CONCRETE BLOCKS TURNED ON THEIR ENDS. THE HOLES IN THE BLOCKS ALLOW AIR PASSAGE TO THE BOTTOM OF THE COLLECTOR TO BE HEATED AS IT MOVES BY THE ABSORBING SURFACE.

WHEN WARM AIR IS NEEDED FOR THE HOUSE, AIR CAN BE BLOWN FROM THE HOUSE, THROUGH THE WARM ROCK, AND BACK TO THE HOUSE. MAKE SURE ALL DUCTS ARE AIRTIGHT.

DESIGN YOUR LEAN-TO TO BE VENTED TO THE OUTSIDE IN THE SUMMER-TIME TO ALLOW THE EXCESS HEAT TO ESCAPE.

VARIATIONS:

- + THIS STRUCTURE NEED NOT BE MOUNTED FLAT AGAINST A WALL. IT COULD BE FREE STANDING AND THEN DUCTED TO THE ROOM NEEDING HEAT. YOU ALSO HAVE SOME LEEWAY WITH THE TILT YOU CHOOSE, AS WE'VE SEEN IN OUR SITE CONDITIONS SECTION. STEEPLY PITCHED LEAN-TOS CAN BENEFIT FROM THE USE OF REFLECTING SURFACES PLACED ON THE GROUND IN FRONT OF THE LEAN-TO.

WHERE THIS WORKS:

THE MOST APPROPRIATE PLACE TO USE THIS LEAN-TO SOLAR COLLECTOR AND ROCK STORAGE COMBINATION IS ON THE SOUTH SIDE OF A HOUSE THAT HAS LITTLE IN THE WAY OF WINDOWS. IF FOR SOME REASON YOU DO NOT WANT WINDOWS, OR CANNOT HAVE WINDOWS IN THIS WALL, THIS SCHEME IS PARTICULARLY SENSIBLE. ALSO, IF YOUR HOUSE ALREADY GETS ENOUGH HEAT THROUGH ITS WINDOWS DURING A WINTER DAY THE ABILITY THIS DEVICE HAS TO STORE EXTRA HEAT FOR THE NIGHTTIME WILL BE APPRECIATED.

ADVANTAGES:

- + ONE OF THE MAJOR ADVANTAGES OF THIS DEVICE IS THAT IT DOES NOT REQUIRE MAJOR CHANGES TO THE INTERIOR OF THE HOUSE AGAINST WHICH IT IS LOCATED. THE ONLY CHANGES REQUIRED ARE TWO AIR DUCTS THROUGH THE WALL AND A FAN CONTROL SWITCH MOUNTED ON THE WALL.
- + BECAUSE THIS STRUCTURE IS BOTH INSULATED AND IS ITSELF WARM, IT WILL FURTHER INSULATE THE EXISTING WALL AGAINST WHICH IT IS PLACED.
- + THE STORAGE BIN ALLOWS YOU TO SAVE DAYTIME HEAT FOR USE LATER WHEN IT IS MOST NEEDED.
- + AS IN MANY OF THESE DEVICES IT MIGHT BE POSSIBLE TO SCAVENGE MANY OF THE CONSTRUCTION MATERIALS.

DISADVANTAGES:

- + IF YOU USE TOO MUCH ELECTRICITY TO DRIVE THE FAN THAT IS BLOWING THE AIR IN YOUR COLLECTOR YOU WILL WIND UP WITH LITTLE NET ENERGY SAVINGS. IT IS IMPORTANT TO ACHIEVE THE PROPER FAN SIZE.
- + IN SOME CASES IT WILL BE NECESSARY TO BUILD A FOUNDATION UNDER YOUR LEAN-TO AND THIS WILL OBVIOUSLY ADD TO THE COST OF YOUR DEVICE.
- + THIS DEVICE IS CONSIDERABLY MORE COMPLEX THAN OTHERS WE'VE DISCUSSED. THIS INCREASES COST AND MAINTENANCE, AND LOWERS COST-EFFECTIVENESS.

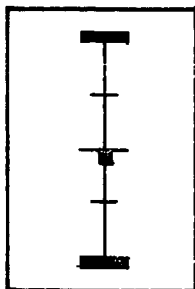
ECONOMICS/COST:

MATERIALS COSTS: THE COST OF THE MATERIALS TO BUILD YOUR LEAN-TO, INCLUDING PLYWOOD, PAINT, GLASS OR OTHER GLAZING, INSULATION, CONCRETE BLOCKS, ROCKS, DUCTWORK, FAN AND MISCELLANEOUS VENTS, CONTROLS AND FINISHES SHOULD RUN FROM \$5 - \$7 PER SQUARE FOOT OF COLLECTING SURFACE. THIS IS TRUE FOR A UNIT OF MEDIUM SIZE (100 - 200 SQUARE FEET).

FUEL REDUCTION: WITH THIS MEDIUM SIZE UNIT, 100 SQUARE FEET OF COLLECTOR CAN BE EXPECTED TO SAVE ABOUT 40 - 90 GALLONS OF OIL PER HEATING SEASON, OR .4 - .9 GALLONS PER SQUARE FEET. REMEMBER, HOWEVER, THAT THIS SAVINGS CAN BE DELIVERED WHEN IT IS MOST NEEDED.

COST-EFFECTIVENESS: ON OUR SCALE OF 1 - 20, THIS SUGGESTION EARNS A COST-EFFECTIVENESS RATING OF 9 - 10.

ATTACHED STRUCTURES

ROOF TRICKLE COLLECTOR

IF YOU HAVE A SOUTH-SLOPING ROOF IN NEED OF REPAIR, CONSIDER CONVERTING IT INTO A WATER HEATING SOLAR COLLECTOR. COVER YOUR ROOF WITH BLACK-PAINTED SHEET METAL, SUCH AS CORRUGATED ALUMINUM, OVER WHICH WATER SLOWLY TRICKLES TO ABSORB THE HEAT FROM THE METAL. THE WHOLE ASSEMBLY IS COVERED WITH GLASS AND IS AIR- AND WATER-TIGHT. THE HEATED WATER IS COLLECTED AT THE BOTTOM OF THE COLLECTOR AND DRAINS TO AN INSULATED STORAGE TANK. LEAVE THE TANK UNINSULATED BUT PLACE IT IN AN INSULATED CLOSET-LIKE SPACE. BLOW HOUSE AIR THROUGH THE CLOSET IN ORDER TO HEAT THE HOUSE. MAKE SURE YOUR WATER COLLECTOR IS SELF DRAINING WHEN THE SUN IS NOT SHINING, OTHERWISE THE WATER MIGHT FREEZE IN THE PIPES AND BURST THEM.

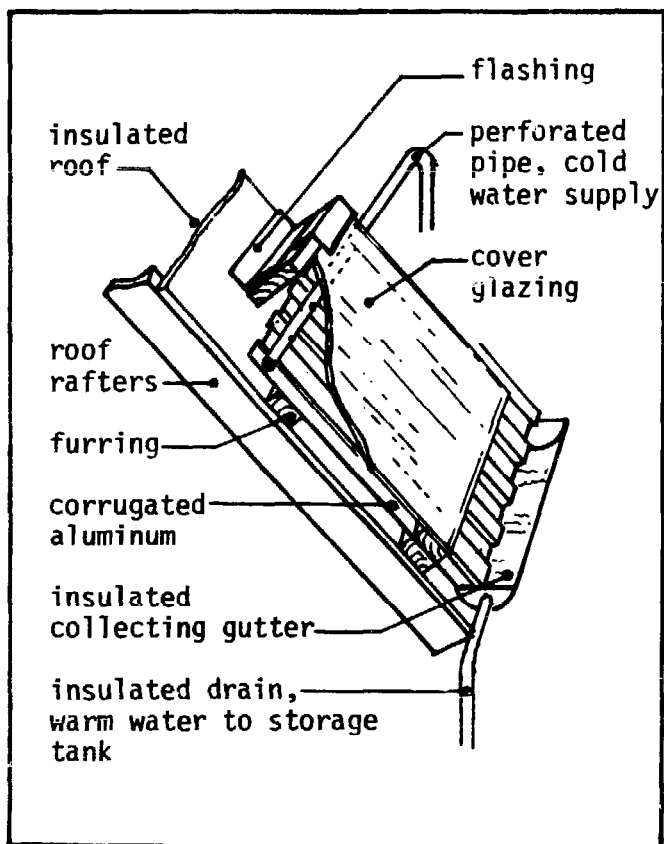

A 1/2 - 3/4 INCH DIAMETER PIPE IS USED TO DELIVER THE WATER TO THE PEAK OF THE ROOF. IT IS PERFORATED WITH TINY HOLES WHICH SQUIRT WATER DOWN EACH OF THE TROUGHS IN THE CORRUGATED METAL. A PUMP MOVES THE WATER UP FROM THE STORAGE TANK.

MAKE SURE THAT THE METAL SHEET THAT YOU ARE USING FOR AN ABSORBING SURFACE, WHICH CAN GET VERY HOT WHEN WATER IS NOT FLOWING OVER IT, IS NOT TOUCHING A PART OF YOUR OLD ROOF THAT CANNOT STAND UP TO THE HIGH TEMPERATURES, SUCH AS TARPAPER OR ASPHALT SHINGLES.

ONE COVER SHEET OF GLASS OR PLASTIC WILL PROBABLY BE ENOUGH IN THIS CLIMATE, ALTHOUGH TWO SHEETS WILL IMPROVE COLD WEATHER OPERATION. MAKE SURE THAT YOU ARE NOT LOSING TOO MUCH HEAT OUT FROM THE SUPPORTS THAT ARE HOLDING UP YOUR GLASS!

VARIATIONS:

- + IN SOME SPECIAL CASES AN EXISTING METAL ROOF OF ALUMINUM OR COPPER CAN BE ADAPTED TO A WATER TRICKLE SYSTEM.
- + THERE ARE SEVERAL OTHER WAYS TO GET THE HEAT FROM THE STORAGE TANK TO THE HOUSE. THE WARM WATER COULD BE CIRCULATED THROUGH PIPES BURIED IN FLOORS OR CEILINGS. THE TANK COULD BE BURIED IN A ROCK BIN AND AIR BLOWN THROUGH THE BIN AND INTO THE HOUSE. THE METHOD CHOSEN DEPENDS ON YOUR PARTICULAR SITUATION.

WHERE THIS WORKS:

THIS DEVICE MAKES THE MOST SENSE WHEN USED WITH SUNNY SOUTH-FACING ROOFS THAT NEED REPAIR. THEN PART OF THE COSTS OF THE SYSTEM CAN BE SUBTRACTED DUE TO THE NEED TO FIX THE ROOF ANYWAY. THIS SYSTEM SHOULD NOT BE UTILIZED IN BUILDINGS WITH ROOF PITCHES LOWER THAN 40 DEGREES BECAUSE OF THE DIFFICULTY OF GETTING THE WATER TO TRICKLE PROPERLY. BEST RESULTS ARE WITH ROOFS HAVING STEEPER PITCHES.

ADVANTAGES:

- + WITH THIS METHOD, LARGE ROOF AREAS ARE MADE AVAILABLE FOR SOLAR COLLECTION, MAKING THIS SYSTEM CAPABLE OF SATISFYING A RELATIVELY LARGE PERCENTAGE OF YOUR HEATING NEEDS. THIS SYSTEM WILL ALSO HELP YOU SAVE HEAT BY CUTTING DOWN ON THE AMOUNT OF HEAT THAT IS ESCAPING THROUGH YOUR ROOF.
- + IT CAN BE USED ALL YEAR ROUND BECAUSE IT CAN PREHEAT YOUR DOMESTIC HOT WATER.
- + THIS IS ONE OF THE SIMPLEST TYPES OF WATER HEATING SOLAR COLLECTORS YOU CAN MAKE. THE WATER HEAT STORAGE REQUIRES LESS SPACE THAN ROCK STORAGE.

DISADVANTAGES:

- + THE HEAT COLLECTION IS MUCH LESS DIRECT THAN SIMPLER METHODS DESCRIBED EARLIER. THERE IS MORE OPPORTUNITY FOR HEAT LOSS AND INEFFICIENCY. THE OPEN WATER PATH ALLOWS EVAPORATION OF WATER WHICH TAKES HEAT AND LOWERS COLLECTOR EFFICIENCY.
- + THE STORAGE TANK REQUIRES SPACE IN CELLAR OR HOUSE, SOMETIMES AS MUCH AS A SMALL ROOM.
- + THE SYSTEM REQUIRES PIPING RUNNING THROUGH THE HOUSE, A PUMP, FAN, OR BOTH, AUTOMATIC CONTROLS TO REGULATE THE COLLECTOR. THESE INCREASE COMPLEXITY AND POTENTIAL FOR BREAKDOWNS.

ECONOMICS/COST:

MATERIALS COSTS: THE MATERIALS TO BUILD THIS COLLECTOR INCLUDING THE COST OF SHEET METAL, GLAZING, PIPING, MULLIONS, STRUCTURE, WATER PUMP AND SOME METHOD OF STORING THE HEAT WILL COST ABOUT \$4 - \$6 PER SQUARE FOOT OF COLLECTOR AREA. THIS WOULD BE FOR SYSTEMS IN THE 200 - 400 SQUARE FOOT RANGE.

FUEL REDUCTION: EACH SQUARE FOOT OF THIS SOLAR COLLECTOR CAN BE EXPECTED TO SAVE FROM .4 - .9 GALLONS OF FUEL OIL EACH WINTER. FOR 100 SQUARE FEET OF COLLECTOR, AT \$.40/GALLON OIL PRICES, YEARLY SAVINGS WOULD RANGE FROM \$16 - \$36.

COST-EFFECTIVENESS: ON OUR SCALE OF 1 - 20, THIS SUGGESTION EARNS A COST-EFFECTIVENESS RATING OF 9 - 10.

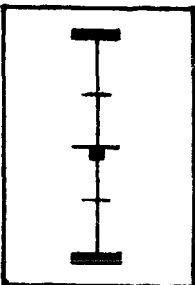

ATTACHED STRUCTURES

A SOLAR HEATING SYSTEM USING A CONVENTIONAL HOT WATER HEATER

IF YOU ARE CONSIDERING A SMALL (200 SQUARE FEET OR LESS) ADDITION TO YOUR HOUSE, HERE IS A SYSTEM WHICH WOULD PROVIDE HEAT FOR THE ADDITION. THE SYSTEM USES AN OVERSIZED CONVENTIONAL HOT WATER HEATER TO STORE HEAT COLLECTED WITH SOLAR COLLECTORS, AND USES THE STANDARD HEATING ELEMENT TO PROVIDE THE BACK-UP HEATING. BEFORE TRYING THIS SCHEME, DESIGN THE ADDITION TO MAKE BEST USE OF WINDOWS TO THE SOUTH, AND INSULATION THROUGHOUT THE BUILDING. ALSO, FACE THE ROOF TOWARD THE SUN TO PROVIDE A LOCATION FOR THE SOLAR COLLECTORS.

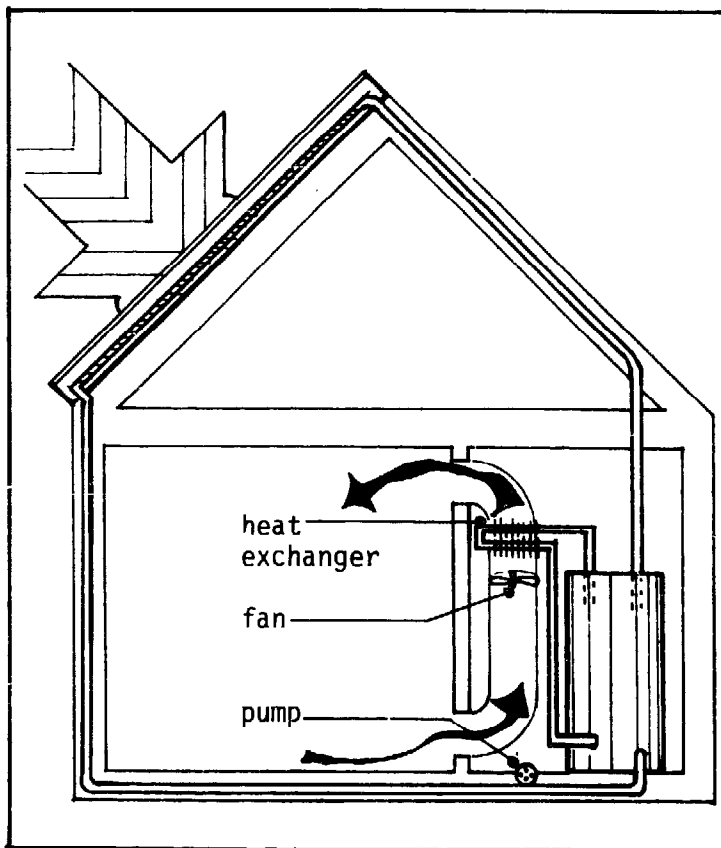

THIS SOLAR SYSTEM REQUIRES A WATER COLLECTOR MOUNTED IN A POSITION FACING THE WINTER SUN. WATER IS PUMPED THROUGH THE COLLECTORS TO A CONVENTIONAL HOT WATER TANK WHICH IS WELL INSULATED (ADD MORE THAN THE UNIT COMES WITH) AND HAS A WATER-TO-AIR HEAT EXCHANGER COIL ATTACHED TO IT. THIS HEAT EXCHANGER CAN BE MADE OUT OF STANDARD 1/2 INCH FINNED COPPER BASEBOARD HEATING PIPES. WHEN HEAT IS NEEDED, AIR FROM THE ROOM IS BLOWN OVER THESE COILS BY A FAN AND OUT INTO THE ROOM AS WARMED AIR.

THIS SYSTEM CAN BE USED TO FIRST WARM WATER WITH THE SUN'S INPUT, AND THEN THE CONVENTIONAL HEATING ELEMENT IN THE HOT WATER TANK WILL HAVE ABOUT 1/2 ITS USUAL JOB OF HEATING THE WATER THE REST OF THE WAY UP TO THE REQUIRED OPERATING TEMPERATURES.

AS A RULE OF THUMB, USE UP TO 100 SQUARE FEET OF SOLAR COLLECTOR FOR A 200 SQUARE FOOT ADDITION. PROVIDE UP TO 3 GALLONS OF WATER STORAGE FOR EACH SQUARE FOOT OF SOLAR COLLECTOR.

VARIATIONS:

- + INSTEAD OF AN INSULATED TANK, AN UNINSULATED TANK COULD BE PUT IN AN INSULATED CLOSET. WHEN HEAT IS REQUIRED IN THE LIVING SPACES, OPEN THE CLOSET DOORS WIDE AND LET THE HOT TANK RADIATE HEAT INTO THE ROOM.
- + HEAT COULD BE DISTRIBUTED AS HOT WATER DRAWN OUT OF THE STORAGE TANK AND PUMPED THROUGH FINNED BASEBOARD HEATERS PLACED THROUGHOUT THE ROOMS.

WHERE THIS WORKS:

IN A WELL-INSULATED, LOW HEAT REQUIREMENT, BUILDING DESIGN IN WHICH A HEAT STORAGE CLOSET CAN BE CENTRALLY LOCATED TO ALLOW EASY DISTRIBUTION OF WARM AIR TO HEATED SPACES. THE SOLAR COLLECTORS MUST BE MOUNTABLE ON A SOUTHERN EXPOSURE. SINCE THE STORAGE CAPACITY OF AN 80 GALLON DOMESTIC HOT WATER TANK IS NOT VERY GREAT, THIS SYSTEM IS ONLY APPROPRIATE FOR A SMALL BUILDING SPACE. LARGER COMPONENTS WOULD BE REQUIRED FOR A BUILDING SPACE OF GREATER THAN 250 SQUARE FEET.

ADVANTAGES:

- + THIS SYSTEM ALLOWS THE USE OF READILY AVAILABLE FAMILIAR EQUIPMENT, WHILE BUILDING UP A SOLAR SYSTEM. AS THE SYSTEM CAN USE AN EXISTING HOT WATER HEATER TANK, THE AUXILIARY HEATING ELEMENT IS ALREADY BUILT IN.
- + BECAUSE HEAT IS MOVED MECHANICALLY BY PUMPS AND BLOWERS, SYSTEM COMPONENTS CAN BE FLEXIBLY LOCATED.
- + BECAUSE OF THE SMALL NATURE OF THE SYSTEM, TWO OR MORE SYSTEMS COULD BE USED IN THE SAME HOUSE TO HEAT DIFFERENT ZONES.

DISADVANTAGES:

- + INEVITABLY, THIS USE OF SOLAR WHICH REQUIRES A WATER CIRCULATING COLLECTOR, PUMPS, HEAT STORAGE TANK, ELECTRONIC CONTROLS TO TELL THE PUMP AND FAN WHEN TO TURN ON AND OFF, AND THE INSTALLATION OF DUCT WORK, FANS AND HEAT-EXCHANGERS TO DISTRIBUTE THE HEAT INTO THE SPACE, IS A MOST EXPENSIVE WAY TO MAKE USE OF THE SUN'S ABILITY TO HEAT YOUR ROOMS.
- + SPACE MUST BE PROVIDED FOR THE STORAGE TANK AND DUCTWORK. IN A SMALL BUILDING, THIS COULD BE A PROBLEM.
- + DUE TO THE INDIRECTNESS OF HEAT TRANSFER FROM COLLECTOR TO ROOM, MUCH OF THE CAREFULLY COLLECTED HEAT IS LOST BEFORE IT EVER DOES ANY GOOD.

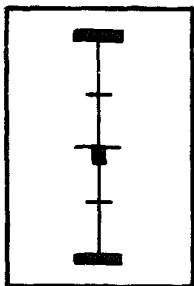
ECONOMICS/COST:

MATERIALS/COSTS: A SYSTEM LIKE THIS REQUIRES A LOT OF PLUMBING, SOME OF WHICH CAN PROBABLY BE SCROUNGED. YOU CAN PROBABLY FIGURE COSTS IN THE NEIGHBORHOOD OF \$5 - \$7 PER SQUARE FOOT OF COLLECTOR, OR \$500 - \$700 FOR A 100 SQUARE FOOT SYSTEM.

FUEL REDUCTION: BECAUSE THIS SYSTEM HAS STORAGE, THE HEAT IT DELIVERS TO THE SPACE CAN BE RATIONED TO DO THE MOST GOOD. YOU CAN FIGURE SAVINGS OF .6 - 1.2 GALLONS OF OIL PER SQUARE FOOT PER SEASON, OR 60 - 120 GALLONS FOR A 100 SQUARE FOOT SYSTEM.

COST-EFFECTIVENESS: ON OUR SCALE OF 1 - 20, THIS SUGGESTION EARNS A COST-EFFECTIVENESS RATING OF 9 - 10.

FREE-STANDING STRUCTURES

SOLAR WATER HEATER AND GARDEN SHED WITH HEAT STORAGE

THIS STORAGE SHED CAN SIT IN YOUR YARD. ON ITS SOUTH-FACING SURFACE IS A SOLAR WATER HEATER AND INSIDE IT AT A LEVEL ABOUT 18 INCHES HIGHER THAN THE TOP OF THE COLLECTORS IS THE INSULATED HOT WATER TANK. A REFLECTOR ABOVE THE COLLECTOR SURFACE INCREASES THE SOLAR INPUT ON THE COLLECTORS. SINCE THE WATER STORAGE IS ABOVE THE TOP OF THE COLLECTORS, WATER FLOWS BETWEEN THE COLLECTORS AND STORAGE BY THE "THERMOSIPHONING" PRINCIPLE, WHERE HOT WATER RISES TO THE TOP OF THE TANK AND COLD WATER LOCATED ON THE BOTTOM OF THE TANK IS DRAWN TO THE BOTTOM OF YOUR WATER COLLECTOR TO BE HEATED BY THE SUN'S ENERGY. HOT WATER IS PUMPED TO THE HOUSE AS NEEDED AND IS THEN DISTRIBUTED IN WHATEVER WAY IS MOST COMPATIBLE WITH THE EXISTING HEATING SYSTEM IN THE HOUSE. THE BACK SIDE OF THE STRUCTURE IS A GARDEN SHED WITH DOORS.

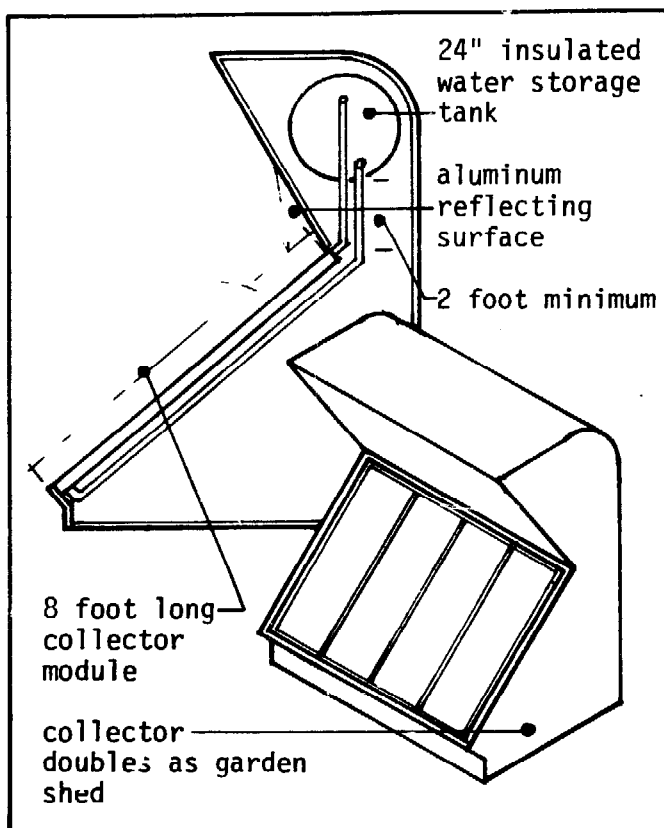

YOUR WATER COLLECTOR CAN BE MADE IN 8-FOOT LONG SECTIONS OUT OF STANDARD DIMENSION BUILDING MATERIAL.

FOR THIS LENGTH COLLECTOR YOUR WATER STORAGE TANK SHOULD BE 24 INCHES IN DIAMETER TO CARRY ENOUGH WATER VOLUME FOR THE BEST OPERATION.

YOU WILL HAVE TO LOOK ELSEWHERE FOR THE SPECIFIC DETAILS OF YOUR WATER COLLECTOR, BUT BASICALLY YOU WILL WANT TO BUILD A GLAZED BOX THAT CONTAINS A BLACKENED, METAL, HEAT-CONDUCTING SURFACE AGAINST WHICH PIPES (FOR BEST RESULTS USE COPPER) ARE CONNECTED. THE SUN'S HEAT THAT IS CAUGHT BY THE ABSORBING SURFACE FLOWS TO THE WATER IN THE PIPES WHICH CARRIES THE HEAT TO YOUR HOUSE OR TO STORAGE.

BE SURE TO INSULATE THE BACK OF YOUR COLLECTOR ASSEMBLY TO KEEP THE HEAT FROM GOING ANYWHERE. ALSO BE SURE TO MAKE PROVISIONS TO AVOID THE FREEZING OF PIPES IN THE WINTERTIME!

VARIATIONS:

- + THE SIZE OF THE SHED CAN BE EASILY CHANGED, BOTH IN HEIGHT (AS LONG AS THE PROPORTIONS ARE KEPT ABOUT THE SAME) AND LENGTH. IN FACT, EVEN AFTER COMPLETION IT CAN BE EASILY ADDED TO. TO INCREASE THE COLLECTOR'S HEAT OUTPUT EVEN MORE, ADD A REFLECTOR ON THE GROUND IN FRONT OF THE COLLECTOR.

WHERE THIS WORKS:

ANY FREE-STANDING DEVICE IS BEST CONSIDERED FOR LOCATIONS WHERE IT IS IMPOSSIBLE TO RECEIVE ENOUGH SUNLIGHT AGAINST THE BUILDING SURFACE ITSELF. THE TYPE OF EXISTING HEATING SYSTEM IS ALSO OF CONCERN. A SOLAR SYSTEM SUCH AS THIS CAN BE COMBINED WITH A WATER-TO-AIR HEAT EXCHANGE COIL TO PRODUCE HOT AIR FOR HOUSE HEATING OR, WITH GREATER DIFFICULTY AND EXPENSE, IT CAN BE COMBINED WITH AN EXISTING HOT WATER BASEBOARD HEATING SYSTEM. IN THIS CASE THE BASEBOARD SYSTEM WOULD HAVE TO BE INCREASED IN SIZE TO DEAL WITH THE LOWER TEMPERATURE HEAT DERIVED FROM THE SUN THROUGH YOUR COLLECTOR. OTHER OPTIONS, SUCH AS RADIANT PANEL HEATING, ARE POSSIBLE.

ADVANTAGES:

- + WATER IS A VERY EFFICIENT HEAT TRANSFER AND STORAGE MEDIUM. AS A RESULT, COLLECTOR, STORAGE, AND PIPING ARE ALL MUCH MORE COMPACT IN A WATER SYSTEM THAN IN AN AIR SYSTEM.
- + BY COMBINING THE COLLECTOR WITH A SHED, SOME OF THE COSTS OF THE SOLAR SYSTEM (SUCH AS STRUCTURAL FRAMING AND FOUNDATIONS) CAN BE SHARED WITH THE SHED COSTS. THIS HELPS MAKE THE SOLAR INVESTMENT MORE COST-EFFECTIVE THAN IF A SPECIAL COLLECTOR SUPPORT WERE TO BE REQUIRED.
- + THE THERMOSIPHONING DESIGN MINIMIZES THE MECHANICAL COMPLEXITY OF THE SYSTEM.

DISADVANTAGES:

- + IN FREEZING CLIMATES THE SYSTEM NEEDS EITHER TO BE DRAINED ON FREEZING NIGHTS OR TO HAVE AN ANTI-FREEZE SOLUTION CIRCULATED THROUGH THE COLLECTOR AND THEN THROUGH A HEAT EXCHANGER IN THE WATER STORAGE TANK.
- + A SEPARATED COLLECTOR LOSES MORE HEAT TO THE OUTSIDE THAN ONE BUILT RIGHT ONTO THE BUILDING.
- + IT TAKES MORE SKILL TO DESIGN AND BUILD AN EFFICIENT WATER SYSTEM THAN IT DOES FOR MANY OF THE SIMPLER DESIGNS. SEE BIBLIOGRAPHY FOR HELP.

ECONOMICS/COST:

MATERIALS COSTS: THE MATERIALS FOR 100 SQUARE FEET OF COLLECTOR WILL COST \$600 - \$800, OR \$6 - \$8 PER SQUARE FOOT. THIS INCLUDES THE SHED AND THE INSULATED PIPE TO THE HOUSE, BUT NO EXTRA AMOUNT FOR NEW HEATING SYSTEMS, IF REQUIRED.

FUEL REDUCTION: EACH HEATING SEASON YOU CAN SAVE FROM 1/2 - 1.2 GALLONS OF FUEL OIL PER SQUARE FOOT OF COLLECTOR, OR 50 - 120 GALLONS FOR 100 SQUARE FOOT MODEL.

COST-EFFECTIVENESS: ON OUR SCALE OF 1 - 20, THIS SUGGESTION EARNS A COST-EFFECTIVENESS RATING OF 9 - 10.

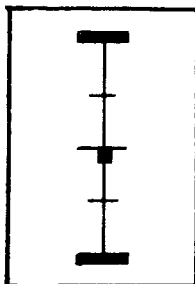

FREE-STANDING STRUCTURES

WARM AIR COLLECTOR WITHOUT STORAGE

SOMETIMES IT IS IMPOSSIBLE TO ATTACH ANY DEVICE TO YOUR HOUSE THAT WILL BE ABLE TO COLLECT SUNLIGHT AND IT IS NECESSARY TO BUILD A SEPARATE STRUCTURE THAT WILL BE YOUR SOLAR COLLECTOR. IN THIS CASE THE IDEA IS FOR AN AIR SOLAR COLLECTOR WHICH DOES NOT HAVE THE ABILITY TO STORE ANY EXTRA HEAT FOR LATER USE. AN AIR COLLECTOR IS A GOOD CHOICE FOR THIS TYPE OF SYSTEM FOR YOU DO NOT HAVE TO WORRY ABOUT FREEZING WHICH MIGHT OCCUR IN WATER OR OTHER LIQUID SYSTEMS. HERE, COOL ROOM AIR IS DELIVERED THROUGH INSULATED DUCTS TO THE BOTTOM OF YOUR COLLECTOR AND HEATED AS IT RISES OVER THE WARM COLLECTING SURFACE OF YOUR SOLAR COLLECTOR. THE WARMED AIR IS THEN RETURNED TO YOUR ROOMS THROUGH ANOTHER INSULATED DUCT AT THE TOP OF THE COLLECTOR. THUS, WHEN THE SUN IS SHINING YOU CAN COLLECT EXTRA HEAT FOR YOUR HOUSE. WHEN THE SUN STOPS SHINING YOU MUST BE SURE TO CLOSE A VENT TO YOUR COLLECTOR TO AVOID LOSING WARMED ROOM AIR BACK TO THE OUTSIDE.

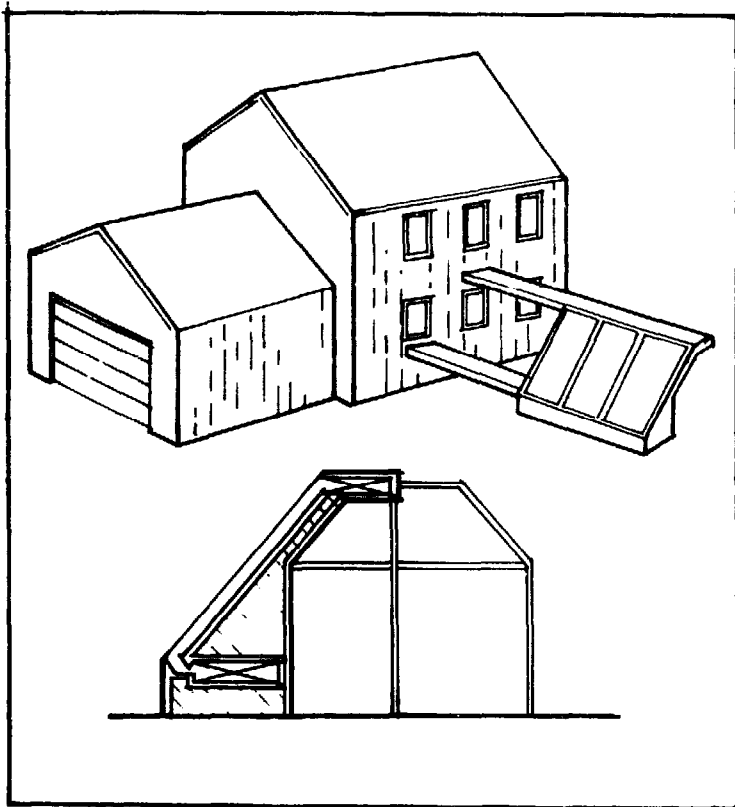

IN SOME CASES IT MIGHT BE POSSIBLE TO ALLOW THE AIR TO RISE NATURALLY THROUGH YOUR COLLECTOR AND BACK TO YOUR HOUSE. IN MOST CASES, HOWEVER, IT WILL BE NECESSARY TO PROVIDE A FAN TO BLOW THE AIR.

FOR EACH SQUARE FOOT OF GLAZING IN YOUR COLLECTOR IT WILL REQUIRE BLOWING ROUGHLY 2 - 3 CUBIC FEET PER MINUTE THROUGH YOUR COLLECTOR.

TO CONSTRUCT YOUR OWN AIR SOLAR COLLECTOR CAN BE TRICKY, BUT IT CAN BE DONE IF YOU LEARN HOW! CHECK THE APPENDIX FOR SOME SOURCES THAT WILL GIVE YOU SOME MORE DETAILS.

VARIATIONS:

- + YOU MIGHT PREFER THE APPEARANCE OF YOUR COLLECTOR IF BOTH THE WARM AND COOL AIR DUCTS CAN BE BUILT INTO ONE STRUCTURE AND RUN UNDERGROUND.
- + THE APPEARANCE AND USEFULNESS OF YOUR COLLECTOR CAN ALSO BE IMPROVED IF THE BACK OF YOUR COLLECTOR IS HALF OF ANOTHER BUILT THING, SUCH AS A PORCH, A SHADED SEAT NEAR A POOL, OR A STORAGE AREA. THIS WILL ALSO CUT DOWN ON THE COST ATTRIBUTED SOLELY TO YOUR SOLAR COLLECTOR.
- + THE ADDITION OF A LARGE REFLECTOR ON THE GROUND NEXT TO YOUR UNIT WOULD GREATLY INCREASE THE HEAT OUTPUT.

WHERE THIS WORKS:

IN DENSELY POPULATED AREAS OR IN RESIDENCES THAT SHARE PARTY WALLS WITH OTHER BUILDINGS, A FREE-STANDING COLLECTOR IS OFTEN THE ONLY DEVICE THAT CAN BE PUT IN A POSITION TO COLLECT SOLAR ENERGY. IF THE SOLAR COLLECTOR CAN BE PLACED ON YOUR SITE AT AN ELEVATION LOWER BY A COUPLE OF FEET FROM THE ROOM OR ROOMS WHICH YOU HOPE TO HEAT, THEN YOU CAN TAKE ADVANTAGE OF THE NATURAL ACTION OF HEAT "THERMOSIPHONING" FROM THE COLLECTOR TO THE ROOM.

ADVANTAGES:

- + BECAUSE THIS COLLECTOR IS FREE-STANDING IT CAN BE ORIENTED DIRECTLY TOWARD THE SUN TO GET OPTIMAL AMOUNTS OF SOLAR ENERGY ON YOUR COLLECTING SURFACE. THIS ALSO HOLDS TRUE FOR SELECTING TILT ANGLES.
- + A SEPARATE COLLECTOR DOES NOT REQUIRE THAT THE EXISTING BUILDING BE ALTERED IN ANY MAJOR WAY, EITHER STRUCTURALLY OR IN ITS APPEARANCE.
- + THE SEPARATE NATURE OF THE DEVICE ALLOWS YOU TO EASILY DETACH THE UNIT DURING THE SUMMERTIME TO AVOID OVERHEATING.

DISADVANTAGES:

- + FOR THE ENERGY PROVIDED, A FREE-STANDING COLLECTOR IS OFTEN MORE EXPENSIVE THAN AN INTEGRAL OR ATTACHED ONE DUE TO THE SUPPORT STRUCTURE REQUIRED AND THE NECESSITY OF DUCTWORK FROM THE COLLECTOR TO THE HOUSE.
- + THE HEAT LOSS FROM THE DUCTWORK IS ALSO A PROBLEM. FOR THIS REASON, IT SHOULD BE WELL INSULATED WITH THE EQUIVALENT OF AT LEAST 6 INCHES OF FIBERGLASS INSULATION.
- + IN DENSE AREAS WHERE FREE-STANDING COLLECTORS MIGHT FREQUENTLY BE REQUIRED, THERE IS THE PROBLEM OF ESTABLISHING "SUN RIGHTS", THE RIGHTS TO UNOBSTRUCTED SUNSHINE.

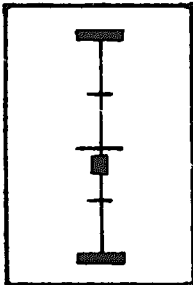
ECONOMICS/COST:

MATERIALS COSTS: THE MATERIALS, SUCH AS GLASS OR PLASTIC, WOOD, PAINT, ABSORBING SURFACE AND DUCTWORK TO THE HOUSE FOR A SOLAR COLLECTOR AND STRUCTURE OF 100 SQUARE FEET MIGHT COST FROM \$400 - \$600, OR \$4 - \$6 PER SQUARE FOOT. THIS FIGURE CAN VARY SUBSTANTIALLY WITH THE QUALITY OF THE COLLECTOR YOU BUILD.

FUEL REDUCTION: WITH THIS MEDIUM-SIZE UNIT, YOU CAN EXPECT SAVINGS OF .3 - .7 GALLONS OF FUEL OIL FOR EACH SQUARE FOOT OF COLLECTOR, OR 30 - 70 GALLONS FOR THE UNIT.

COST-EFFECTIVENESS: ON OUR SCALE OF 1 - 20, THIS SUGGESTION EARNS A COST-EFFECTIVENESS RATING OF 8 - 9.

GARAGE

A NEW BUILDING PROVIDES THE CHANCE TO PLAN AND BUILD WITH SOLAR IN MIND FROM THE BEGINNING. EVEN IF THE NEW BUILDING DOES NOT ITSELF NEED TO BE HEATED, AS WITH A GARAGE, IT CAN PROVIDE A LOCATION FOR MOUNTING COLLECTORS AND FOR LOCATING HEAT STORAGE. FOR THE EASIEST DISTRIBUTION OF THE COLLECTED SOLAR HEAT TO AN EXISTING BUILDING, THE NEW STRUCTURE SHOULD BE NEXT TO THE ROOMS REQUIRING HEAT. BE CAREFUL, HOWEVER, TO MAKE SURE THAT THE EXISTING BUILDING DOES NOT SHADOW THE NEW ONE, NOT ONLY AT NOON BUT ALSO IN THE MORNING AND THE AFTERNOON. SINCE SOME HEAT WILL INEVITABLY BE LOST FROM THE STORAGE AREA EVEN WHEN IT IS HEAVILY INSULATED, IT IS DESIRABLE, WHEN POSSIBLE, TO PLACE THE STORAGE INSIDE THE BUILDING TO BE HEATED. THEN, THE HEAT IS GIVEN OFF TO LIVING SPACES WHICH NEED IT ANYWAY.

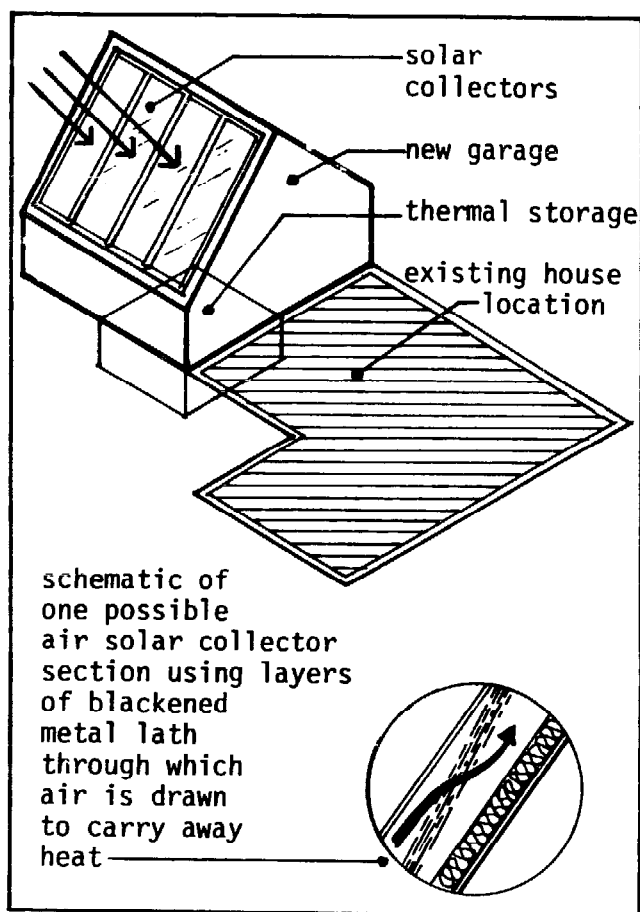

IF YOU WILL BE USING AN AIR SOLAR COLLECTOR YOU WILL BE STORING YOUR HEAT IN A ROCK BIN. THIS BIN SHOULD CONTAIN ROCKS, OF UNIFORM SIZE, WITH DIAMETERS OF 1 1/2 - 2 1/2 INCHES.

YOU SHOULD BE DELIVERING THE WARMED AIR FROM YOUR COLLECTOR TO AN AIR PLENUM AT THE TOP END OF YOUR STORAGE. WHEN YOU WANT TO RETRIEVE THE HEAT, YOU SHOULD DRAW IT FROM THE TOP OF YOUR STORAGE BIN, THE AIR MOVING IN A DIRECTION OPPOSITE TO THE ONE FROM WHICH IT WAS DELIVERED.

OTHER GUIDELINES THAT ARE HELPFUL IN DETERMINING THE DESIGN OF YOUR COLLECTOR AND STORAGE CAN BE FOUND IN SOME OF THE OTHER SCHEMES OUTLINED HERE. IN MOST CASES, HOWEVER, IT WILL BE NECESSARY FOR THE HOMEOWNER TO DO SOME ADDITIONAL RESEARCH OF HIS OR HER OWN BEFORE WORK CAN BEGIN.

VARIATIONS:

- + THERE IS AN ENDLESS VARIETY TO THE KIND OF NEW STRUCTURES THAT COULD BE CONVERTED INTO PARTIAL SOLAR COLLECTORS. A NEW BARN, TRASH SHED, BILLBOARD OR PICNIC SHED COULD EASILY BECOME SOLAR COLLECTORS, FOR INSTANCE. AT THE SAME TIME THERE ARE ALMOST AS MANY PLACES WHERE YOUR HEAT STORAGE CAN GO. THERE IS EVEN ONE WELL-KNOWN SOLAR PIONEER WHO PLACED 16 FOOT HIGH ROCK STORAGE TUBES IN THE ENTRANCE FOYER OF HIS HOUSE! WHAT CAN YOU COME UP WITH?

WHERE THIS WORKS:

OBVIOUSLY, THERE ARE A GREAT NUMBER OF SITUATIONS THAT LEND THEMSELVES TO THIS IDEA. THE MAJOR POINT TO BE GOTTEN FROM THIS SUGGESTION IS THE IDEA THAT SOLAR COLLECTION CAN BE INTEGRATED WITH MANY OTHER NEW CONSTRUCTIONS TO HELP DROP THE INITIAL COST OF THE SOLAR PART OF THE CONSTRUCTION. TRULY, ANY OF THE OTHER SCHEMES OUTLINED IN THIS PAMPHLET CAN BE APPLIED TO A NEW LIVING STRUCTURE, BUT THE ADDITIONAL IDEA HERE IS THAT THE NEW STRUCTURE CAN SUPPLY HEAT FOR THE EXISTING BUILDING. THIS IDEA IS PARTICULARLY SUITABLE IF, BY ADDING A NEW STRUCTURE, YOU ARE ABLE TO ATTAIN A BETTER SOLAR ORIENTATION.

ADVANTAGES:

- + IN MANY CASES, BY ADDING A NEW PIECE THAT DOES NOT REQUIRE HEATING, TO AN EXISTING BUILDING THAT DOES, YOU HELP CUT DOWN THE LOSS OF HEAT FROM THE OLD BUILDING.
- + WHEN BUILDING FROM SCRATCH, IT IS MUCH EASIER TO INTEGRATE SOLAR HEATING WITH THE DESIGN. AS WE'VE DEMONSTRATED, AN EXISTING BUILDING IS OFTEN ILL-SUITED TO EFFICIENT SOLAR UTILIZATION, SO YOU DO THE BEST YOU CAN. IN NEW BUILDING, YOU CAN MAKE SURE EVERYTHING WORKS RIGHT FROM THE START.
- + IF HEAT IS TO BE STORED FOR MORE THAN ONE DAY, A GOOD COLLECTOR AND STORAGE SYSTEM IS THE MOST EFFICIENT WAY TO DO IT.

DISADVANTAGES:

- + PERHAPS THE GREATEST DISADVANTAGE ENCOUNTERED HERE IS THAT, WITH EACH INSTALLATION BEING DIFFERENT, A CERTAIN ENGINEERING SOPHISTICATION IS REQUIRED TO GET THE BEST OUT OF YOUR SYSTEM. THIS IS BEYOND THE GRASP OF MANY HOMEOWNERS. DO NOT LET THIS DISCOURAGE YOU TOO MUCH, HOWEVER; THE MORE YOU WORK WITH IT THE BETTER YOU WILL GET!
- + ANOTHER OBVIOUS DISADVANTAGE IS THAT ONLY THOSE WITH SUBSTANTIAL FINANCIAL RESOURCES WILL BE ABLE TO FOOT THE BILL OF NEW CONSTRUCTION AT THE SAME TIME THEY ARE IMPLEMENTING A SOLAR HEATING SYSTEM. IT MAY BE POSSIBLE, HOWEVER, TO DESIGN WITH SOLAR IN MIND AND INSTALL THE SYSTEM LATER.
- + A SYSTEM SUCH AS THIS, DUE TO ITS HIGH COST, IS NOT AS COST-EFFECTIVE AS SIMPLER, MORE DIRECT WAYS OF USING THE SUN'S ENERGY.

ECONOMICS/COST:

MATERIALS COSTS: IT IS ALMOST IMPOSSIBLE TO MAKE A MEANINGFUL ESTIMATE OF THE COST OF AN UNDEFINED SYSTEM. HOWEVER, IT WOULD CERTAINLY BE ONE OF THE MOST EXPENSIVE. A GOOD GUESS WOULD BE BETWEEN \$6 - \$8 PER SQUARE FOOT FOR MATERIALS.

FUEL REDUCTION: A WELL-MADE COLLECTOR AND STORAGE SYSTEM CAN BE EXPECTED TO SAVE FROM 1/2 - 1.2 GALLONS OF FUEL OIL PER SQUARE FOOT EACH HEATING SEASON.

COST-EFFECTIVENESS: ON OUR SCALE OF 1 - 20, THIS SUGGESTION EARNS A COST-EFFECTIVENESS RATING OF 9 - 10.

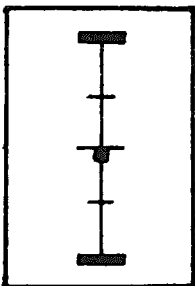

NEW LIVING STRUCTURES

GLASSED-IN PORCH

ANOTHER FORM OF NEW CONSTRUCTION THAT CAN HELP YOU SAVE MONEY TO HEAT YOUR HOME IS A GLASSED-IN SOUTH PORCH. JUST AS A WINDOW GREENHOUSE CAN TRAP HEAT WHEN THE SUN IS SHINING, SO CAN A PORCH. THE HOT AIR IN THE PORCH ENTERS THE HOUSE THROUGH AN EXISTING WINDOW OR A NEW DUCT OPENING, THAT CAN BE CLOSED AT NIGHT. WHEN THE SUN IS NOT SHINING THE ADDED LAYER OF GLASS IN THE PORCH HELPS KEEP THE WARM AIR IN THE HOUSE FROM LOSING ITS HEAT TO THE COLDER OUTSIDE. THE PORCH ALSO HELPS YOU SAVE MONEY ON FUEL BY ALLOWING LESS WARM AIR IN THE HOUSE TO ESCAPE TO THE OUTSIDE THROUGH CRACKS AND AROUND WINDOWS BETWEEN THE HOUSE AND THE PORCH. IF INSULATING SHUTTERS ARE ADDED TO THE PORCH AT NIGHTTIME, ITS PERFORMANCE WILL BE IMPROVED.

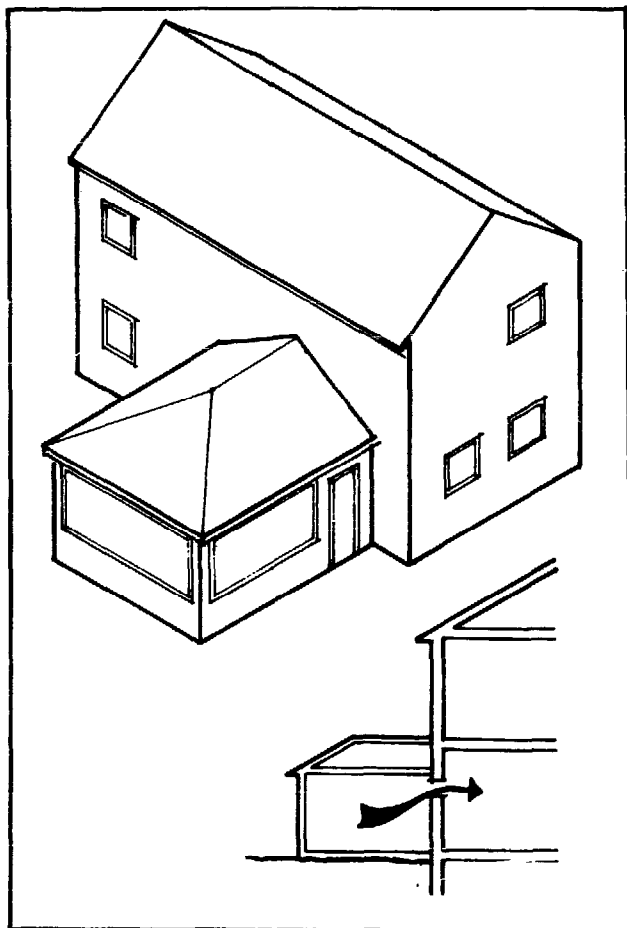

SINCE YOU LOSE A GREAT DEAL OF HEAT EACH TIME YOU OPEN THE FRONT DOOR, OR REAR DOOR, OF YOUR HOUSE, THE PORCH CAN BE USED AS A NEW ENTRANCE TO YOUR HOME AND YOU WILL SAVE FUEL. IT DOES THIS BY ALLOWING THE LESS EXPENSIVE WARM PORCH AIR WHICH IS SUN HEATED TO ESCAPE FROM THE OPEN DOOR, RATHER THAN THE RELATIVELY EXPENSIVE HOUSE AIR.

THE AIR IN YOUR PORCH WILL USUALLY BE AT A TEMPERATURE BETWEEN THAT OF THE OUTSIDE AND THAT OF THE HOUSE INTERIOR, SO IT ACTS AS A THERMAL BUFFER ZONE.

EVEN IF YOUR PORCH CANNOT BE ON THE SOUTH SIDE OF YOUR HOUSE TO GAIN EXTRA SOLAR ENERGY, IT CAN STILL BE WORKING LIKE A STORM WINDOW TO KEEP HEAT IN ON OTHER SIDES OF YOUR HOME.

VARIATIONS:

- + IF YOU CANNOT AFFORD GLASS TO COVER THE FULL AREA OF YOUR PORCH, AND IF YOU ARE NOT TOO CONCERNED WITH APPEARANCE OR LONG LIFETIMES FOR THE MATERIAL, YOU CAN USE A PLASTIC SUCH AS POLYETHYLENE. AN ENCLOSED PORCH CAN BE MADE FROM AN EXISTING OPEN PORCH OR PATIO WITH A CANOPY THAT MIGHT ALREADY BE SHIELDING THE DOORS TO YOUR HOME FROM THE ELEMENTS.

WHERE THIS WORKS:

WHEN MORE LIVING SPACE IS NEEDED IN YOUR HOUSE, A PORCH WHICH RECEIVES PLENTY OF SOLAR ENERGY BECAUSE OF ITS LARGE GLASS AREA CAN BE A GREAT SOLUTION. WHEN OTHER SOLAR ENERGY DEVICES ARE ALSO USED, SUCH AS MOVABLE INSULATION AND HEAT STORAGE MASS, THE EFFECTIVENESS OF THE PORCH IS GREATLY INCREASED. REMEMBER THAT, ALTHOUGH YOUR PORCH WILL NO LONGER BE ACTING AS A SOLAR COLLECTOR ON THE NORTH SIDE ON YOUR HOME, THERE ARE STILL SUBSTANTIAL BENEFITS TO BE GAINED BY PLACING A PORCH THERE.

ADVANTAGES:

- + THE PRINCIPLE ADVANTAGE OF THIS SCHEME IS THAT IT IS POSSIBLE TO ACHIEVE GREAT ENERGY SAVINGS FOR VERY LITTLE MONEY IF YOU CONSIDER THAT YOU WOULD HAVE HAD TO GO TO THE EXPENSE OF BUILDING NEW LIVING SPACE IN ANY CASE.
- + REMEMBER, HOWEVER, THAT THIS GLASSED-IN PORCH WILL GET VERY WARM ON SUNNY DAYS, AND VERY COOL ON COLD NIGHTS IF THERE IS NO OTHER HEATING SYSTEM BEING USED.
- + THERE ARE WONDERFUL OPPORTUNITIES TO AFFECT THE WAY YOUR HOUSE LOOKS AND FUNCTIONS WITH THE ADDITION OF YOUR PORCH.

DISADVANTAGES:

- + THE ADDED HEAT FROM THE PORCH IS MOST EASILY SHARED WITH THE ROOMS WHICH ARE DIRECTLY ADJACENT TO THE PORCH. IF A ROOM IS NOT NEXT TO THE PORCH AND HEAT IS NEEDED THERE, ADDITIONAL DUCTING AND, POSSIBLY, A FAN WOULD BECOME NECESSARY. OF COURSE, THIS WOULD REPRESENT ADDITIONAL COST AND COMPLICATIONS.
- + IF THERE IS A GREAT DEAL OF GLASS AND THERE IS NO PLACE FOR THE HEAT TO BE "STORED" THAT IS BEING TRANSMITTED BY SUNLIGHT INTO THE ROOM, THE PORCH CAN EASILY OVERHEAT AND BECOME UNCOMFORTABLE.
- + ROOMS THAT FORMERLY HAD DIRECT SUNSHINE WILL BE MADE DARKER BY THE PORCH ADDITION.

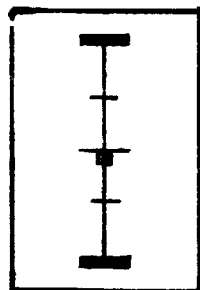
ECONOMICS/COST:

MATERIALS COSTS: THE DESIGN OF A PORCH VARIES SO MUCH IN VARIOUS SITUATIONS, THAT IT IS IMPOSSIBLE FOR US TO GIVE MEANINGFUL ESTIMATES HERE. YOUR LOCAL BUILDING CONTRACTOR CAN BE MORE HELPFUL.

FUEL REDUCTION: SAVINGS ARE DUE AS MUCH TO THE REDUCTION OF BUILDING AIR INFILTRATION AND THE INSULATING ROLE OF THE PORCH SPACE AS THEY ARE TO SOLAR GAIN THROUGH THE WINDOWS. AS A ROUGH GUIDE, THOUGH, YOU CAN FIGURE A FUEL SAVINGS OF .3 - .5 GALLONS OF OIL PER SQUARE FOOT OF SOUTH GLASS FOR A HEATING SEASON.

COST-EFFECTIVENESS: ON OUR SCALE OF 1 - 20, THIS SUGGESTION EARNS A COST-EFFECTIVENESS RATING OF 9 - 10.

SOLAR HOT WATER HEATERS

INTRODUCTION

Up to this point, we have discussed home energy efficiency in terms of heating and energy conservation. There is one other area, however, which is worth discussing here. That is the area of domestic hot water for washing and bathing. Fully 20% of the energy used in our houses goes for heating water, and the sun can help do the job.

Before discussing how to heat water, however, some attention should be given to cutting down the need for hot water. In a typical American household, the total hot water usage averages 20 gallons per person per day. This is dramatically more hot water than is used by most of the world, and it's even more than is used in countries like Australia (where the average is more like 10 gallons/person/day). By cutting down on your own use of hot water, you wouldn't have to make inordinate sacrifices, and you'd be making a real savings. There are several ways this can be done.

About 50% of the hot water we use is for bathing, about 25% is for laundry, and the rest is for cooking, lavatory, and miscellaneous cleaning. It is well known that you use less water taking a shower than taking a bath. You can save even more by getting a water-conserving shower head that gives off a spray instead of a hard, steady stream of water. If you cut back hot water used for bathing by 50%, you cut your hot water heating bill by 25%. You can save on laundry hot water by only washing full loads and by using cooler water temperatures. You can even save hot water in the kitchen by rinsing dishes in a basin of hot water, rather than under a constantly running stream of tap water. Once you have done what you can to reduce hot water consumption, you can look for cheaper ways to provide the hot water you do need.

Your present hot water heater is given water from a well or water main at temperatures around 50 degrees F. Its task is to warm that water to 125 degrees F. or more, and then store enough of that water so you don't run low too quickly. The actual heating of water can be easily done with solar energy. A garden hose sitting in the sun is perhaps the simplest solar water heater. There are obviously more efficient heater designs possible, but they are only improvements on the basic scheme. What really complicates matters, as far as solar hot water is concerned, is the requirement for storage.

If you were willing to forego hot showers on cloudy days or in the morning, you could make a very simple and inexpensive solar hot water heater. But it gets a bit more complex when you want to be able to keep the day's hot water overnight, or store it for a day or longer. If you want your hot water supply to be unfailing, you would even put in an auxiliary heater for times when the sun isn't as available as you'd like. The simple solar heater becomes not-so-simple. Despite all this, it is not unduly difficult to make your own solar water heater, and there are good reasons why you should.

For one, simple hot water heaters have been used in places like Florida, Israel, Japan, and Australia for over twenty years, so we aren't talking about fancy new technology. Also, a solar hot water heater is not as big an undertaking as a solar house heating system. It's physically much smaller, it's simpler, and it's cheaper to build. It's also a good way to experiment and gain personal experience with solar heating before moving on to bigger projects.

Besides these general advantages, solar hot water heaters have an important economic

advantage. Unlike solar house heaters, which sit idle during the warm months, solar water heaters meet a constant year-round demand for hot water. They save you money every time the sun is shining, and, as we've seen, water heating is a big chunk of your total energy bill.

Solar hot water heating collectors are similar to other collectors in almost all respects. The major construction difference, besides their smaller size, is that hot water heaters, because they operate all year-round, should be tilted to make good use of both winter and summer sun. For the NORWESCAP area, tilt these collectors about 40 degrees from horizontal.

The biggest technical problem, common to all solar hot water heaters in northern climates, is the danger of freeze-up in the pipes and water channels. We present three types of heaters here, from simple to complex. The simplest avoids the freezing problem entirely. It is drained and empty all the time except on sunny days or when it's closed up tight and full of hot water. The second system, the type most common worldwide, has been modified by the addition of a heat exchanger and anti-freeze so that the liquid in the collector can't freeze. The third system can either use the same solution, or be designed to drain down when the pump is off. Thus, the more complex the system, the more complex the freeze control mechanism.

The other big problem with a water heater is corrosion of the components. Our simple system uses conventional plumbing and a non-metallic plastic collector. The other two would probably require copper in the collector and piping. Other metals such as aluminum and iron can be used, but corrosion inhibitors would be required. There are numerous other minor problems that can show up which you should know about before you get very far. The Bibliography lists references and plans which are quite helpful.

The main point here is that you can build a solar hot water heater, it can be simple and cheap, and it's worth doing. You'll save money and learn a lot.

TROUGH TYPE

THE SIMPLEST SOLAR WATER HEATER IS A TROUGH OF WATER SITTING QUIETLY IN THE SUN, SOAKING UP HEAT. YOU CAN MAKE IMPROVEMENTS TO THE BASIC TROUGH BY ADDING A TRANSPARENT COVER, INSULATION, AND PLUMBING FOR FILLING AND DRAINING. OPERATION INVOLVES FILLING THE TROUGH IN THE MORNING AND USING THE HOT WATER IN THE AFTERNOON. IF YOU WANT TO STORE HOT WATER OVERNIGHT, EITHER DRAIN THE TROUGH TO AN INSULATED TANK OR SEE THAT THERE IS ENOUGH INSULATION AROUND AND OVER THE TANK (6 INCHES ISN'T TOO MUCH) SO THAT THE HEAT ISN'T LOST.

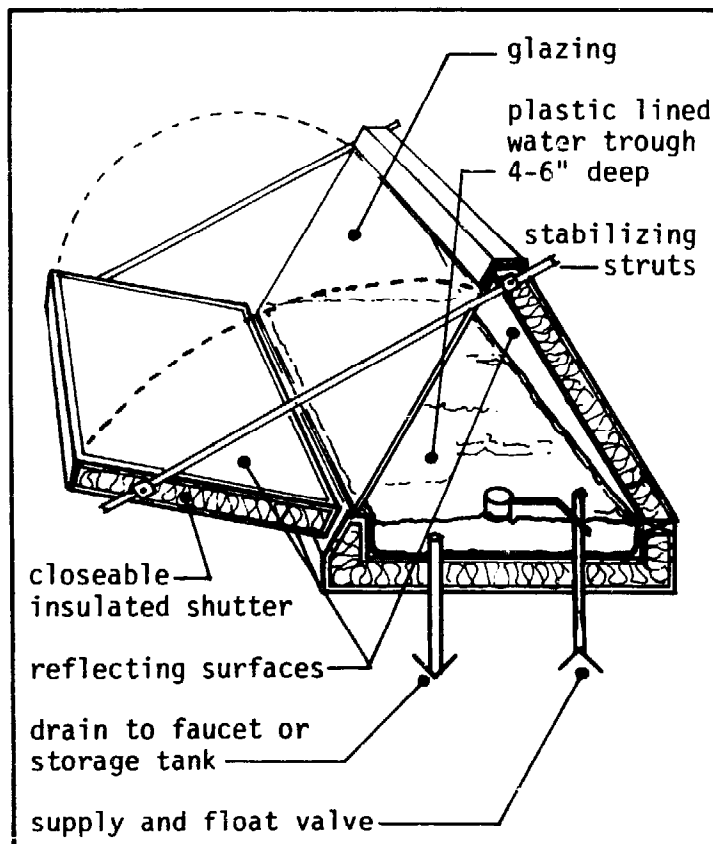

THIS DESIGN CAN STORE HEATED WATER FOR SEVERAL HOURS. THE FILLING AND DRAINING OPERATIONS ARE STRAIGHTFORWARD. OPEN THE SUPPLY VALVE TO FILL IT IN THE MORNING. OPEN THE DRAIN VALVE TO EMPTY IT.

MOUNT THE UNIT ON THE ROOF OR BUILD A TALL SUPPORT STRUCTURE SO THAT HOT WATER GRAVITY-FEEDS TO YOUR SINK OR SHOWER.

THE UNIT WILL HEAT ROUGHLY 1 GALLON OF WATER PER SQUARE FOOT OF GLASS ON AN AVERAGE SUNNY DAY. AVERAGE HOT WATER CONSUMPTION IN THE U.S. IS 20 GALLONS PER PERSON PER DAY. IF YOU'RE CONSERVATIVE, THIS CAN BE MORE REALISTIC 10 GALLONS PER PERSON PER DAY. FOR A FAMILY OF 4, WITH 4 INCHES OF WATER, THE TROUGH SHOULD BE ABOUT 60 SQUARE FEET OR 6 FEET BY 10 FEET.

ECONOMICS/COST:

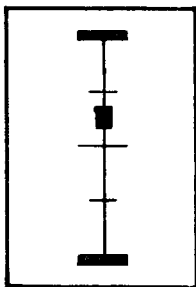

MATERIALS COSTS: A SMALL, SIMPLE UNIT LIKE THIS CAN BE BUILT FROM SCROUNGED MATERIALS OR INEXPENSIVE STORE-BOUGHT PARTS. COSTS WILL RANGE FROM \$0 - \$3 PER SQUARE FOOT. YOU CAN START SIMPLE AND IMPROVE IT AS YOU GO.

FUEL REDUCTION: THIS HEATER IS NOT PARTICULARLY EFFICIENT, BUT BECAUSE OF ITS YEAR-ROUND OPERATION THE SAVINGS ADD UP. YOU CAN FIGURE SAVINGS OF .7 - .9 GALLONS OF OIL PER SQUARE FOOT OF COLLECTOR PER YEAR OR, SINCE MANY WATER HEATERS ARE ELECTRIC, 21 - 27 KWH PER SQUARE FOOT PER YEAR.

COST-EFFECTIVENESS: ON OUR SCALE OF 1 - 20, THIS SUGGESTION EARNS A COST-EFFECTIVENESS RATING OF 12 - 13.

SOLAR HOT WATER HEATERS

THERMOSIPHONING COLLECTOR

THIS IS A MORE EFFICIENT, BUT ALSO MORE EXPENSIVE SOLAR HOT WATER HEATER THAN THE TROUGH TYPE. BECAUSE OF ITS GREATER EFFICIENCY, IT CAN HEAT MORE WATER HOTTER PER SQUARE FOOT, AND CAN STORE IT LONGER. THE COLLECTOR ITSELF CAN BE ANY OF A NUMBER OF TYPES OF CONVENTIONAL WATER HEATING COLLECTORS. THE EASIEST FOR YOU TO BUILD WILL PROBABLY BE MADE OF 1/2 INCH COPPER TUBES SOLDERED 6 INCH O.C. TO A THIN COPPER SHEET, PAINTED BLACK, AND MOUNTED IN AN INSULATED BOX WITH TWO LAYERS OF GLASS ON TOP. THE STORAGE TANK IS MOUNTED RIGHT ABOVE THE COLLECTOR TO MINIMIZE PIPING. THE WATER CIRCULATES BY NATURAL CIRCULATION, OR THERMOSIPHONING. NO PUMPING IS NEEDED. WARM LIQUID FROM THE COLLECTOR RISES AND COOLER LIQUID FROM THE TANK SETTLES DOWN IN A SLOW, CONTINUOUS FLOW FROM COLLECTOR TO TANK TO COLLECTOR. TO POSE MINIMUM RESISTANCE TO THIS FLOW, LARGE PIPING (3/4 INCH - 1 INCH DIAMETER) IS USED BETWEEN COLLECTOR AND TANK, AND BENDS AND ELBOWS ARE KEPT TO A MINIMUM. THE TANK IS MOUNTED 2 FEET HIGHER THAN

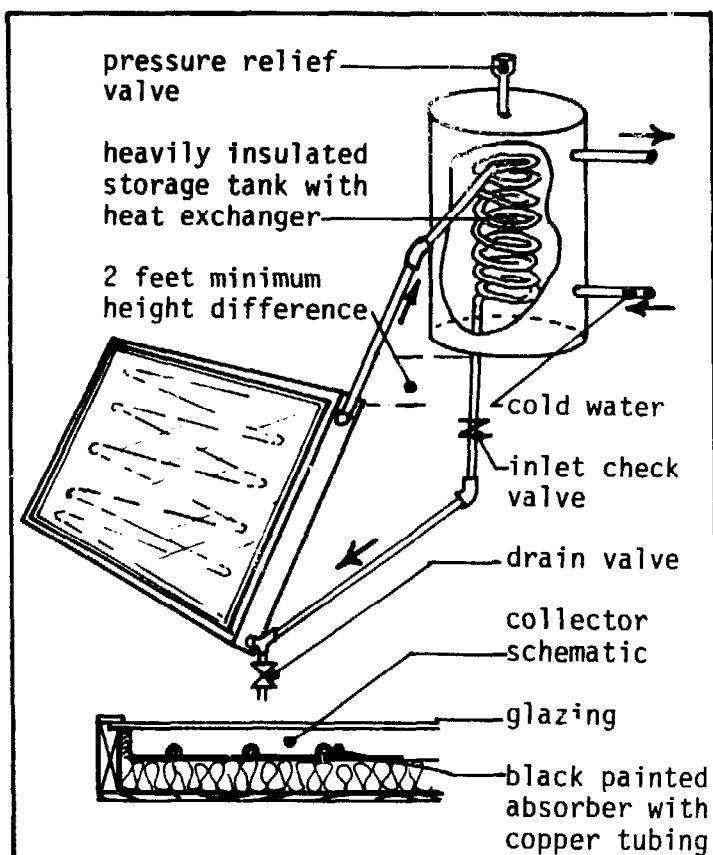

THE TOP OF THE COLLECTOR TO PREVENT REVERSE FLOW AT NIGHT. TO PREVENT FREEZING, THE FLUID CIRCULATING IS ANTI-FREEZE AND, INSTEAD OF FLOWING DIRECTLY INTO THE TANK, THE FLUID MOVES THROUGH A HEAT EXCHANGER WHICH TRANSFERS HEAT TO THE WATER IN THE TANK. IT IS HIGHLY RECOMMENDED THAT YOU USE A NONTOXIC ANTI-FREEZE SUCH AS PROPYLENE GLYCOL, IN CASE A LEAK EVER DEVELOPS. THE TANK SHOULD BE WELL INSULATED TO MINIMIZE HEAT LOSS (8 INCHES - 10 INCHES). BECAUSE THE TANK MUST BE ABOVE THE COLLECTOR, IT OFTEN ENDS UP ON THE ROOF. BE SURE YOUR BUILDING CAN SUPPORT THE WEIGHT OF THE NECESSARY STORAGE TANK. ONE SOLUTION TO THE APPEARANCE PROBLEM IS TO DISGUISE THE TANK ENCLOSURE AS A CHIMNEY. IF YOU DO ONE OF THESE SYSTEMS, GET ONE OF THE REFERENCES LISTED IN THE BIBLIOGRAPHY FOR MORE DETAILED DISCUSSION OF THE VARIOUS PROVEN DESIGNS FOR THIS TYPE OF SOLAR HOT WATER HEATER.

ECONOMICS/COST:

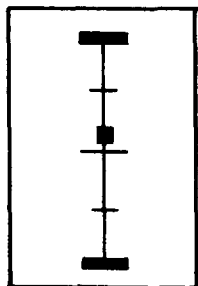

MATERIALS/COSTS: THERE ARE NUMEROUS WAYS TO MAKE ONE OF THESE HEATERS, BUT AVERAGE COSTS FOR MATERIALS FALL IN THE \$5 - \$7 PER SQUARE FOOT RANGE.

FUEL REDUCTION: A WELL-MADE UNIT, WITH 15 - 20 SQUARE FEET OF COLLECTOR PER PERSON IN THE HOUSE, WILL SAVE FROM 1.5 - 1.8 GALLONS OF OIL PER SQUARE FOOT PER YEAR, OR 45 - 55 KWH PER SQUARE FOOT PER YEAR ELECTRICITY.

COST-EFFECTIVENESS: ON OUR SCALE OF 1 - 20, THIS SUGGESTION EARNS A COST-EFFECTIVENESS RATING OF 11 - 12.

SOLAR HOT WATER HEATERS

PUMPED WATER SYSTEM

THIS SYSTEM IS SOMEWHAT MORE EFFICIENT AND MUCH MORE FLEXIBLE IN LAYOUT THAN THE THERMOSIPHONING COLLECTOR. INSTEAD OF RELYING ON NATURAL CIRCULATION, A SMALL PUMP IS USED TO CIRCULATE WATER THROUGH THE COLLECTOR WHENEVER THE SUN IS SHINING. THIS ALLOWS YOU TO HAVE THE STORAGE TANK ANYWHERE IN THE HOUSE INSTEAD OF CLOSE TO THE COLLECTOR. IT ALSO ALLOWS YOU TO USE 1/2 INCH PIPING THROUGHOUT. THE PUMP WILL MOVE LESS THAN 50 GALLONS PER HOUR, SO COST AND POWER CONSUMPTION ARE LOW. FREEZING IS PREVENTED EITHER WITH ANTI-FREEZE THROUGH A HEAT EXCHANGER, OR A MECHANISM FOR DRAINING WATER OUT OF THE COLLECTOR IS DESIGNED. THE COLLECTOR ITSELF IS SIMILAR TO THAT USED IN THE THERMOSIPHONING DESIGN.

ALSO SIMILAR, BUT NOT MENTIONED EARLIER, IS THE AUXILIARY HEATING ARRANGEMENT. IF YOU WANT AN ASSURED, CONSTANT SUPPLY OF HOT WATER, YOU TREAT THE COLLECTOR AS A PRE-HEATER FOR YOUR CONVENTIONAL WATER HEATER ON SUNNY DAYS, THE AUXILIARY HEAT WON'T TURN ON, BUT IN CLOUDY WEATHER IT WILL AUTOMATICALLY "TOP OFF" THE TEMPERATURE. THE SOLAR STORAGE TANK COULD BE A SEPARATE TANK, OR BETTER, THE CONVENTIONAL TANK ADAPTED TO THE DOUBLE PURPOSE. THE TANK WOULD BE SIZED TO FAMILY USE REQUIREMENTS -- 10 - 20 GALLONS PER PERSON.

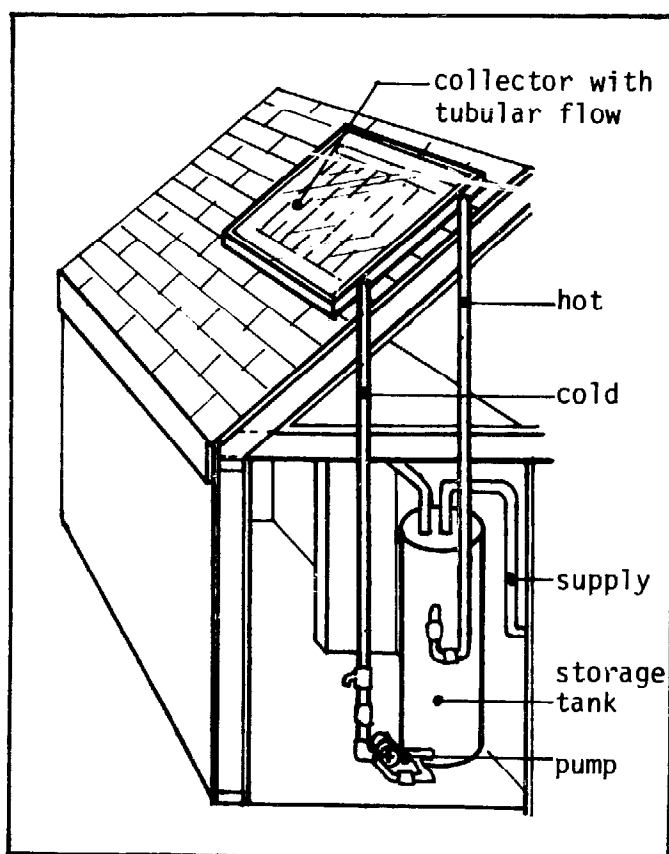

ECONOMICS/COST:

MATERIALS COSTS: THIS TYPE OF SYSTEM WOULD BE ONLY SLIGHTLY MORE EXPENSIVE TO BUILD THAN A THERMOSIPHONING SYSTEM. THE BIGGEST DIFFERENCE WOULD BE THE PUMP, A CONTROL DEVICE, AND SOME ADDITIONAL PLUMBING. FIGURE ON \$5 - \$8 PER SQUARE FOOT OF COLLECTOR, WITH 15 - 20 SQUARE FOOT PER PERSON.

FUEL REDUCTION: A GOOD UNIT CAN SAVE FROM 1.5 - 2 GALLONS OF OIL PER SQUARE FOOT PER YEAR, OR 45 - 60 KWH PER SQUARE FOOT PER YEAR.

COST-EFFECTIVENESS: ON OUR SCALE OF 1 - 20, THIS SUGGESTION EARNS A COST-EFFECTIVENESS RATING OF 11 - 12.

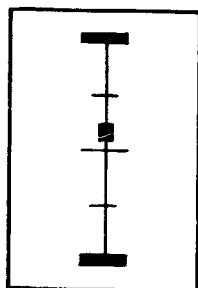

EXAMPLES: THE IDEAS APPLIED TO EIGHT HOUSES

The cost-effectiveness rating is presented as a guide to making decisions about which systems to use. But that is only one criteria by which to decide how to spend your money. Of equal importance to the cost-effectiveness rating is the appropriateness of the scheme for your house. What does your house suggest for a method of collecting and storing solar energy? The first job is to analyze your house and to evaluate it in terms of the various ideas available. What is the construction of the house? What is its orientation? the windows? Does the house already overheat with its windows, or never get any sun? How can you combine the solar heating system with the existing heating system, and distribution system? Is there space available on the roof, the walls, or out in the yard? How hard would it be to alter the existing structure. Are some of the roof slopes appropriate for year-round domestic hot water heating, or steep and most appropriate for winter house heating? Structurally, can additional thermal mass be added anywhere to the house? or should it be separate?

In the evaluation of the effectiveness of various solar systems and the possibilities for your house, keep in mind that these kits show ideas that are flexible -- they can be adjusted to fit the existing situation. The ideas are presented in an approximate progression of the simplest to the more complex methods of making use of the energy available from the sun. Often, the cost-effectiveness ratio reflects this progression. Reasonably, you might go down the list of ideas and evaluate each for your house, taking each design and evaluating how well it applies to your house.

Here, eight representative houses have been selected to show how this idea we have discussed might be adapted. Often, several ideas can be simultaneously and effectively applied.



The roof-mounted domestic hot water heater must be at a fairly shallow angle for annual use so they are here appropriately mounted on the roof. They are located in a position to look like a continuation of the porch, and have a gable end to complete this look. The window box solution is appropriate here as the openings into the house for air movement already exist, using the windows as the duct openings.

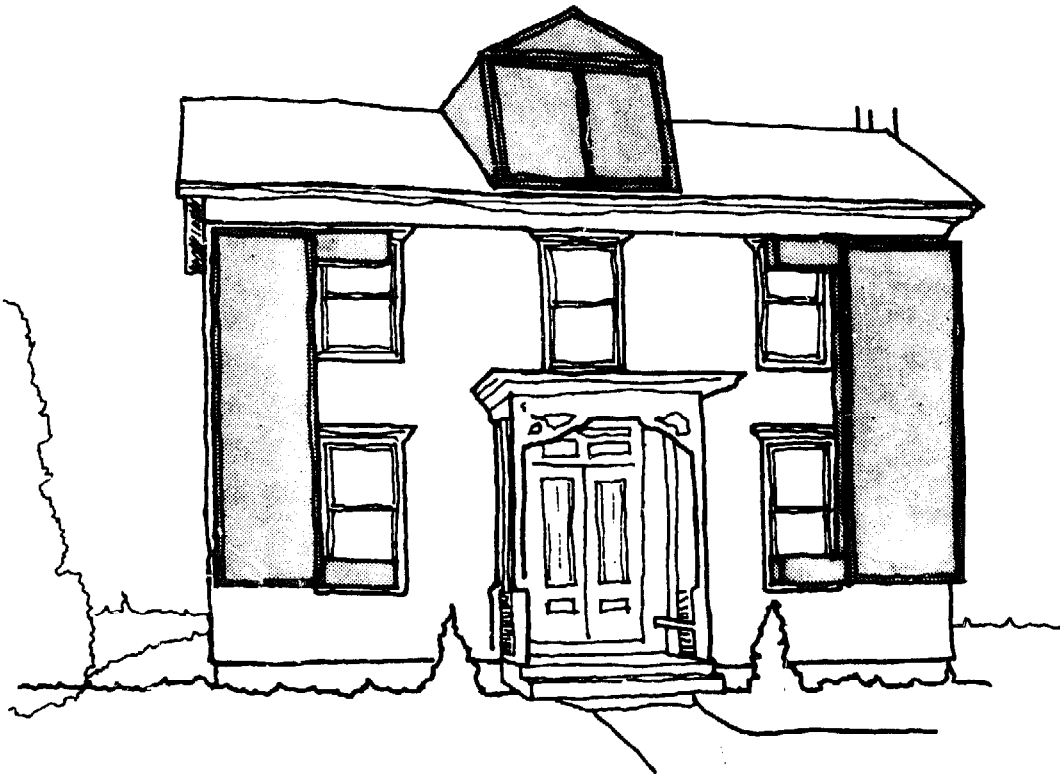

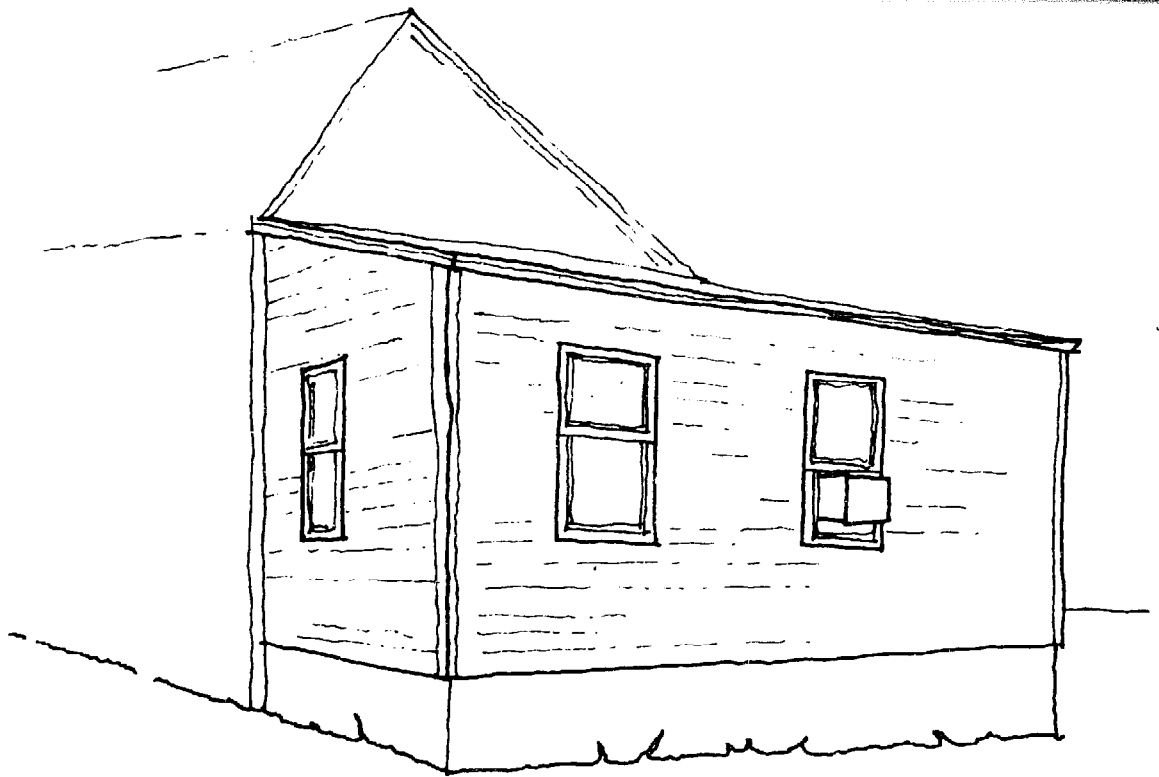

The window box idea here becomes a very large double window box joining two windows. The outside mounted insulating shutters can be used to reflect sunlight into the western facing windows. Both ideas effectively increase the amount of solar energy that enters each window. In the summer the window box could be taken off to keep the heat out and to allow other devices for summer cooling.



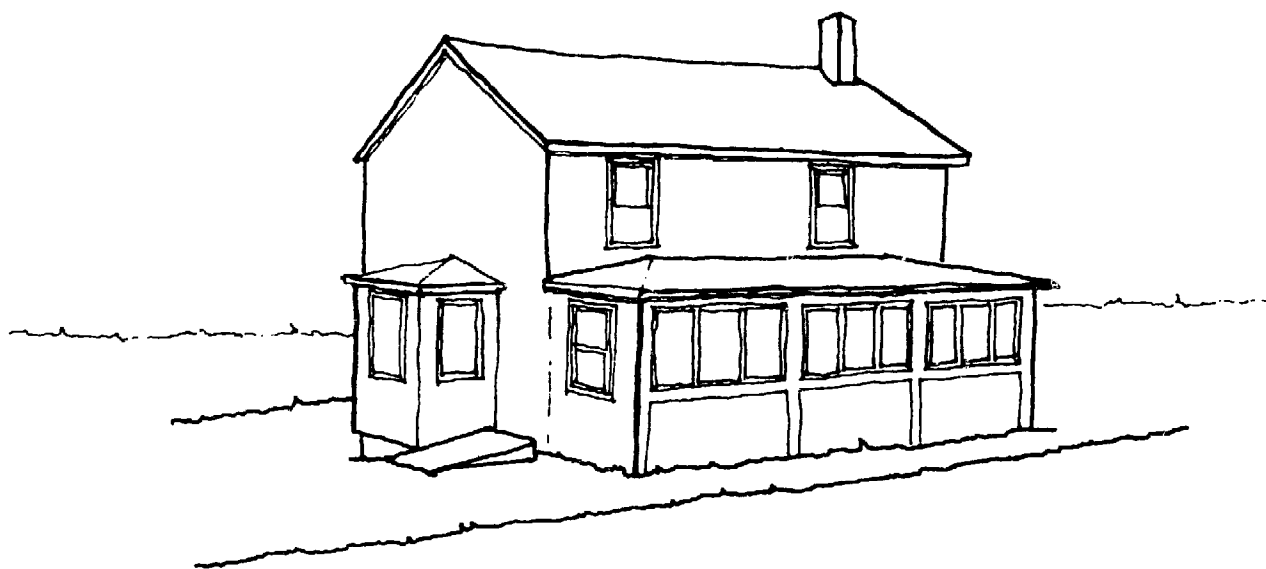

This house is off to a good start as it already has a large glassed-in porch. Outside mounted insulating shutters, with reflective foil faces, would be used to increase the daily input into the porch and then at night be closed to hold that heat in. The slope of the porch roof could also be an effective reflector for a wall-mounted solar collector. Also added is a domestic hot water collector, and more windows.





This house looks like a natural for solar energy. It already has a big south sloping roof, large windows to the south. The entrance porch also offers several possibilities. The house would be an even more appropriate house to apply solar to if that roof were a leaky slate roof in need of repair. Instead of spending money to repair the roof, it could be converted into a collector. If air ducts could not be easily run between the roof and basement storage, a liquid system might then be appropriate. The decision would also be made with regard to the method most reasonable for distributing the heat around the particular house. The porch also offers the possibility of an entrance enclosure of glass.



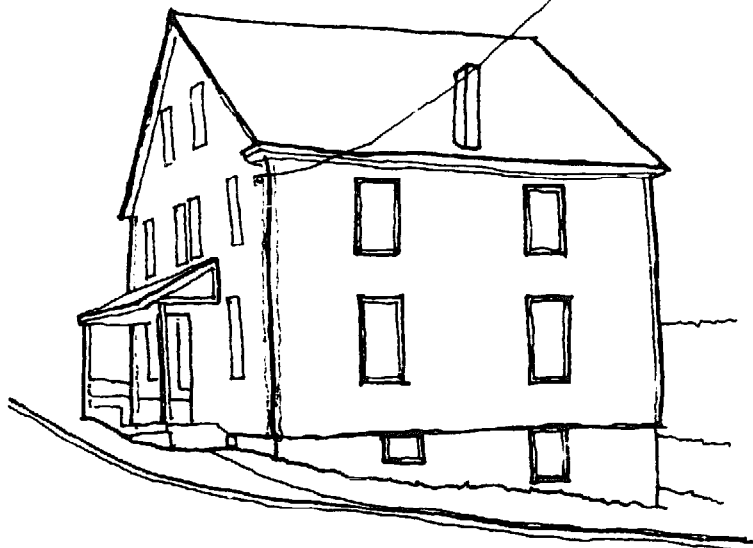

With both yard space and wall space available for solar collection, a lean-to collector/rock storage combination was used entirely across the south face of the building as it did not block the windows. If the building is masonry, it can be partially converted into collectors running vertically up between the windows. The roof angle is good for a pumped domestic hot water heater and the porch could reasonably be enclosed for an entry foyer.

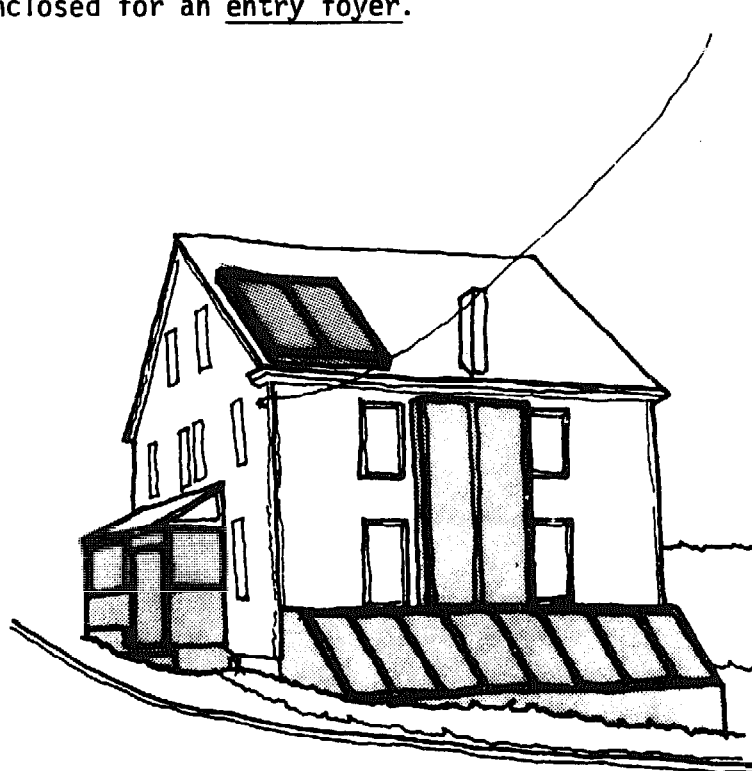

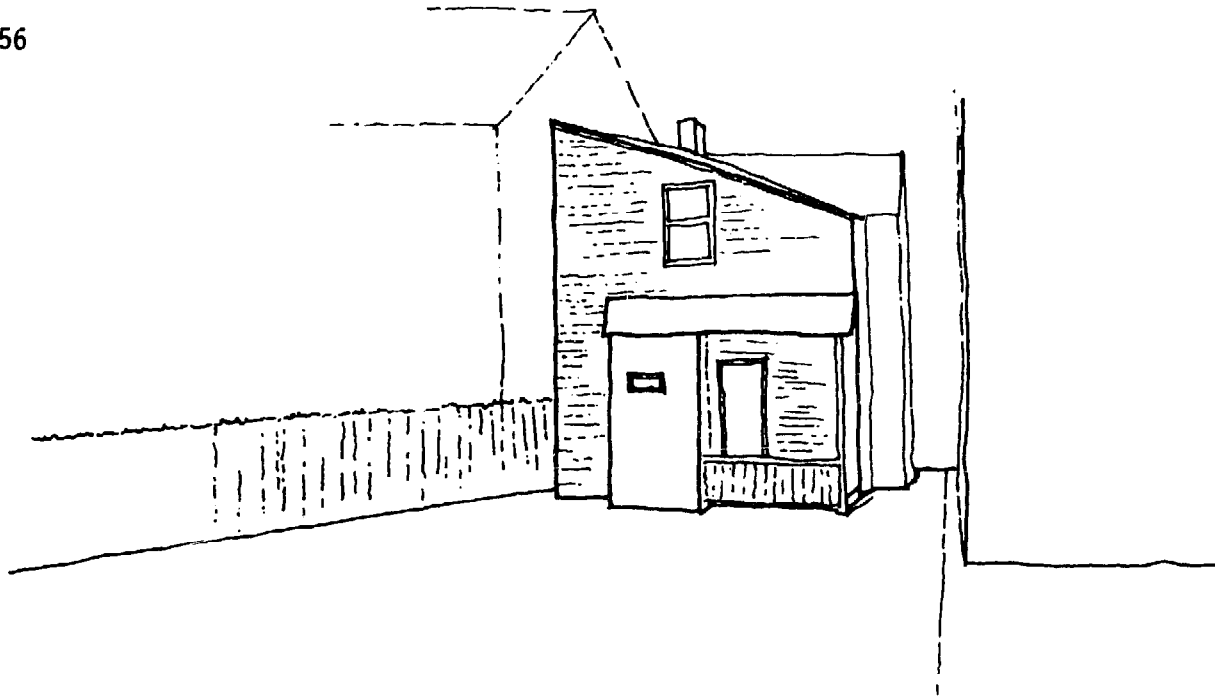

A separate solar collector/heat storage system is used here as the house is blocked from the sun by the higher building to the south. As the house is small, the heat storage must also be outside of it. A window is also added to the western side, as there is valuable heat there too.

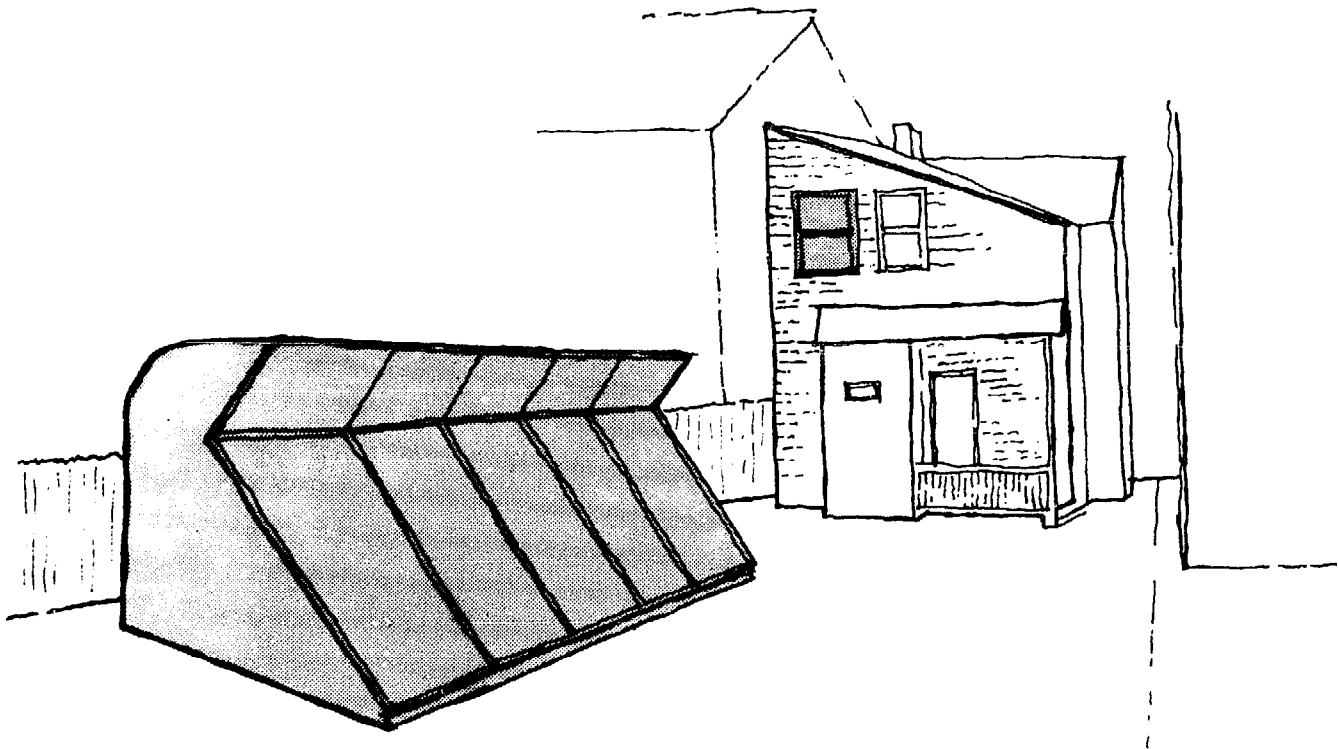

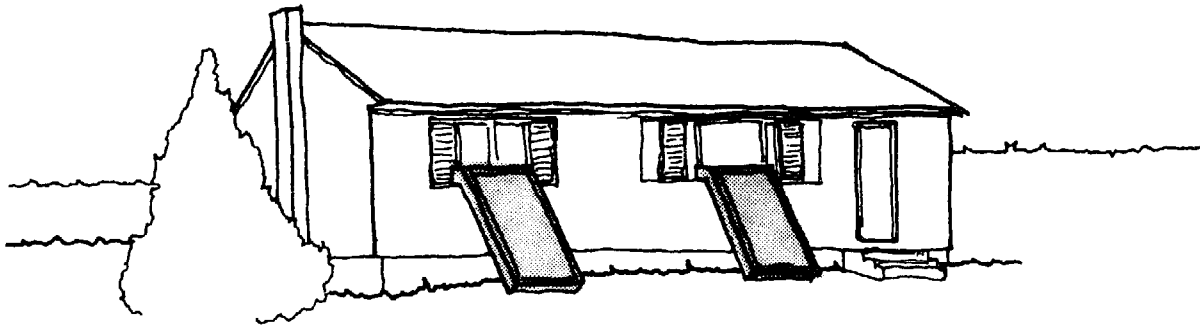
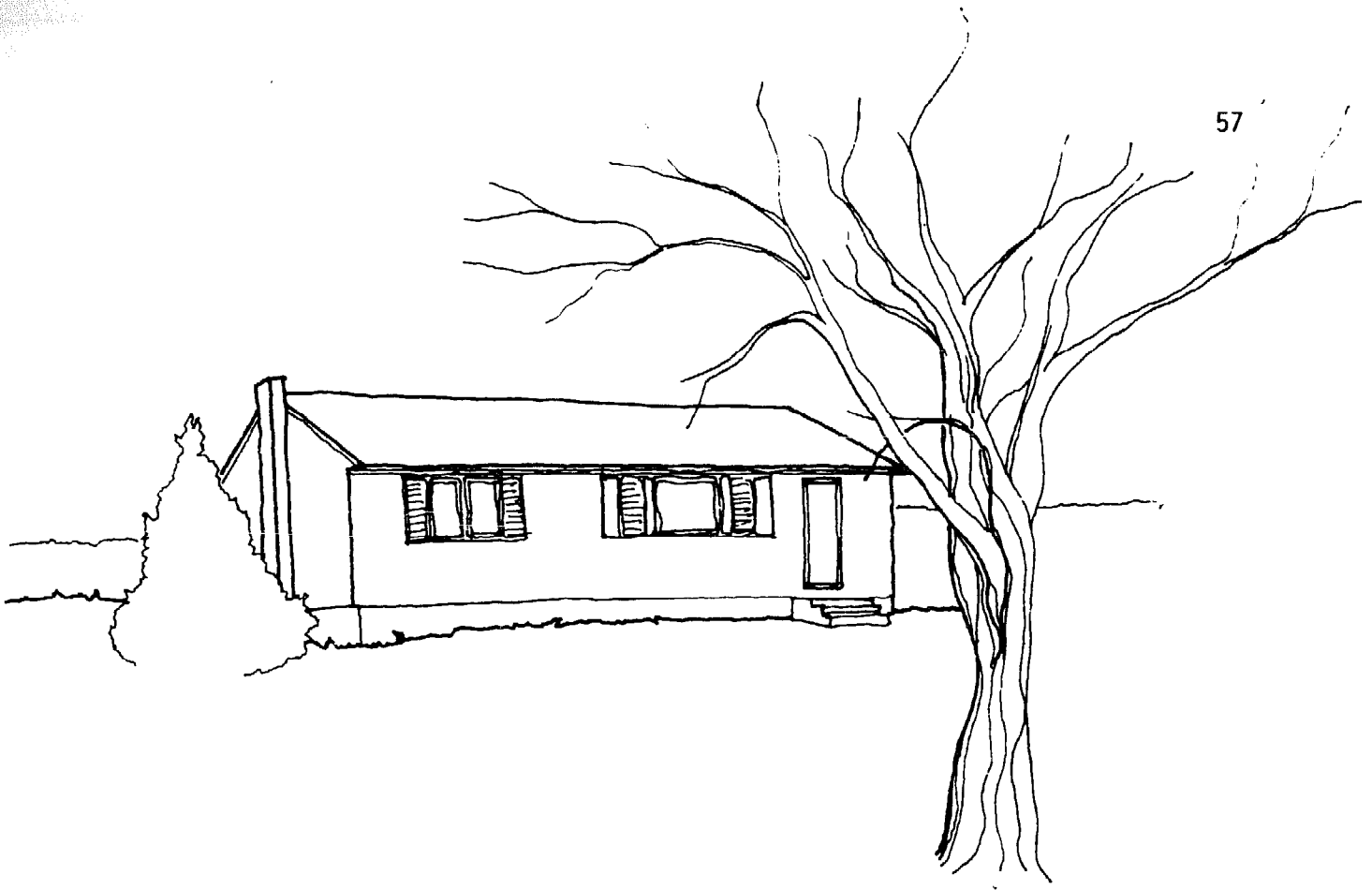

In the simplest improvement, these window boxes increase the solar collection area of these windows. The more complex scheme combines greenhouse frames around each window and a new entry foyer, and solar domestic hot water structure.

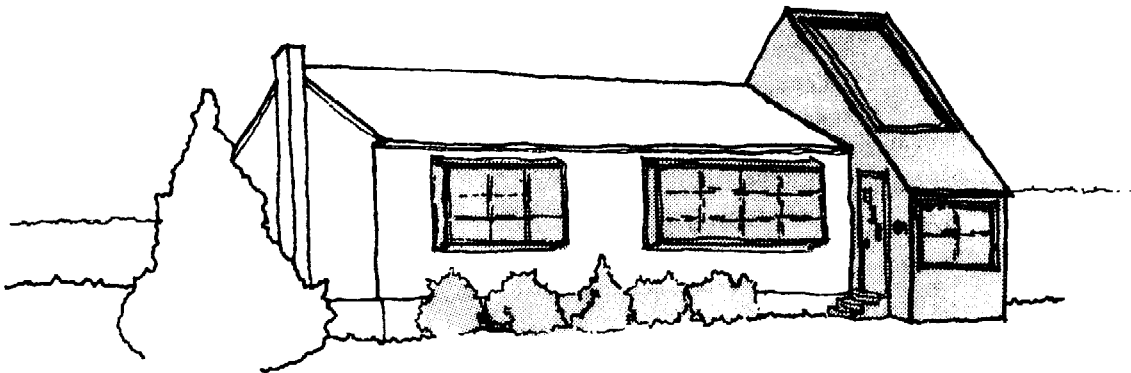



In the view of a typical city street comprised of town houses, a wide variety of different alterations are possible. It is not necessary that all the homes have solutions that look the same. Different living patterns, different budgets, different families will find different ideas most appropriate.



General Solar and Energy Conservation:

Anderson, Bruce. Michael Riordan, editor. The Solar Home Book- Heating, Cooling, and Designing with the Sun. Harrisville, N.H.: Cheshire Books, 1976, 304 pp.
"Complete, up-to-date, amply illustrated. Treats the entire subject quite well"

Clegg, Peter. Energy for the Home, (New, Low-Cost Sources of). Charlotte, Vermont: Garden Way Publishing, 1975, 252 pp.
"Treats not only solar, but wind, wood, water, and waste. Includes catalog references"

Duffie, John A., and William Beckman. Solar Energy Thermal Processes. New York: John Wiley & Sons, 1974, 386 pp.
"The best engineering treatment of solar available. Highly technical"

Eccli, Eugene, editor. Low-Cost, Energy Efficient Shelter for the Owner and Builder. Emmaus, Pa.: Rodale Press, Inc., 1976, 408 pp.
"Excellent treatment of a broad range of energy conserving ideas for the home"

Kern, Ken. The Owner-Built Home. 1961, 300 pp. \$5.00 from Owner Builder Publications, Sierra Route, Oakhurst, California.
"Innovative approach to home construction and design. Good, sensible ideas"

Leckie, Jim, Gill Masters, Harry Whitehouse, and Lily Young. Other Homes and Garbage. San Francisco: Sierra Club Books, 1975, 302 pp.
"Covers solar, wind, water, methane, etc. Good diagrams and technical data included"

Lewand, T.A. Preliminary Report on Solar Air Heater Tests. Technical Report No. T-3, March, 1963. From: Brace Research Institute, P.O. Box 221, MacDonald Campus of McGill University, Ste. Anne de Bellevue, Quebec, Canada.
"Practical report on their experimental program with an owner-builder emphasis"

Mother Earth News. Handbook of Homemade Power. New York: Bantam Books, Inc., 1974.
"A smorgasbord of good ideas on all aspects of homemade power. Nicely illustrated"

Portola Institute. Energy Primer. 1974, 200 pp. Portola Institute, 540 Santa Cruz Avenue, Menlo Park, CA 94025.
"A solid introduction to solar and other energy sources. Includes catalog data"

Roberts, Rex. Your Engineered House. New York: M. Evans & Co., 1964, 237 pp. \$8.95 from J.P. Lippincott Co., E. Washington St., Philadelphia, Pa. 19105.
"Written in clear, non-technical language. Common-sense approach to house design"

Stoner, Carol Hopping, editor. Producing Your Own Power: How to Make Nature's Energy Sources Work for You. Emmaus, Pa.: Rodale Press Inc., 1974, 332 pp.
"Combines a good, general overview of solar, water, wind, etc., with how-to detail"

Solar Water Heaters- How-to-do-it Plans from various sources:

Brace Research Institute. How to Build a Solar Water Heater. (Do-it-Yourself Leaflet No. L-4). McGill University, February, 1965. Revised February, 1973.

de Winter, Francis. How to Design and Build a Solar Swimming Pool Heater. 1974. free from: Copper Development Association, Inc., 405 Lexington Ave. N.Y. 10017.

Environmental Information Center of the Florida Conservation Foundation, Inc.
Build Your Own Solar Water Heater. 1976, 23 pp. From the authors, 935 Orange
Avenue, Suite E, Winter Park, Fla. 32789.

Paige, Steven. Solar Water Heating for the Handyman. Edmund Scientific Co.
Barrington, N.J. 08007, 1974, 32 pp.

Zomeworks Corporation. Solar Water Heater Plans. 1974. and Bread Box Water
Heater Plans. 1975. From the authors, P.O. Box 712, Albuquerque, NM 87103.

Periodicals:

Alternative Sources of Energy. Route 2, Box 90A, Milaca, Minn. 56353.

Solar Age. SolarVision, Inc., Route 515, Box 288, Vernon. N.J. 07462.

