

**AT** MICROFICHE  
REFERENCE  
LIBRARY

A project of Volunteers in Asia

The Design of Small Bore Sewer Systems

by Richard Otis et. al.

Published by:

Technology Advisory Group  
World Bank  
1818 H St. N.W.  
Washington D.C. 20433  
USA

Available from:

same as above

Reproduced by permission.

Reproduction of this microfiche document in any form is subject to the same restrictions as those of the original document.

United Nations Development Programme  
Interregional Project INT/81/047  
Executing Agency: World Bank

# The Design of Small Bore Sewer Systems

by Richard J. Otis and  
D. Duncan Mara,  
Technology Advisory Group (TAG)



A joint United Nations Development Programme  
and World Bank Contribution to the International  
Drinking Water Supply and Sanitation Decade

LIST OF PUBLICATIONS BY  
THE TECHNOLOGY ADVISORY GROUP (TAG)  
UNDP INTERREGIONAL PROJECT INT/81/047

- WP/01 A Model for the Development of a Self-help Water Supply Program;  
by Colin Glennie.
- WP/02 Ventilated Improved Pit Latrines: Recent Developments in Zimbabwe;  
by Peter Morgan and D. Duncan Mara.
- TN/01 Methods for Gathering Socio-cultural Data for Water Supply and  
Sanitation Projects; by Mayling Simpson-Hebert.
- TN/02 Planning of Communication Support (Information, Motivation and  
Education) in Sanitation Projects and Programs; by Heli Perrett.
- TN/03 The Ventilated Improved Double-Pit Latrine: A Construction Manual  
for Botswana; by John van Nostrand and James G. Wilson.
- TN/04 Pit Latrine Ventilation: Field Investigation Methodology;  
by Beverley Ryan and D. Duncan Mara.
- TN/05 Social Feasibility Analysis of Low-cost Sanitation Projects;  
by Heli Perrett.
- TN/06 Ventilated Improved Pit Latrines: Vent Pipe Design Guidelines;  
by Beverley Ryan and D. Duncan Mara.
- TN/07 Community-based Workshops for Evaluating and Planning Sanitation  
Programs: A Case Study of Primary Schools Sanitation  
in Lesotho; by Piers Cross.
- TN/08 Rural Ventilated Improved Pit Latrines: A Field Manual for Botswana;  
by John van Nostrand and James G. Wilson.
- TN/09 Handbook for District Sanitation Coordinators; by Keadire Basaako,  
Ronald D. Parker, Robert B. Waller and James G. Wilson.
- TN/10 Manual on the Design, Construction and Maintenance of Low-cost  
Pour-flush Waterseal Latrines in India; by A.K. Roy.
- TN/11 Monitoring and Evaluation of Communication Support Activities in  
Low-cost Sanitation Projects; by Heli E. Perrett.
- TN/12 A Monitoring and Evaluation Manual for Low-cost Sanitation Programs  
in India; by Ronald Parlato.
- TN/13 The Design of Ventilated Improved Pit Latrines; by D. Duncan Mara.
- TN/14 The Design of Small Bore Sewers; by Richard Otis and D. Duncan Mara.
- DP/01 Ventilated Improved Pit Latrines: Zimbabwean Brick Designs;  
by Peter R. Morgan and D. Duncan Mara.
- DP/02 A Construction Manual for Urban Ventilated Improved Pit Latrines:  
Examples from Tanzania; by John van Nostrand, Daniel Makerere  
and Robert Boydell.

**TAG Technical Note No. 14**

# **The Design of Small Bore Sewer Systems**

**by Richard J. Otis and  
D. Duncan Mara,  
Technology Advisory Group (TAG)**



**A joint United Nations Development Programme  
and World Bank Contribution to the International  
Drinking Water Supply and Sanitation Decade**

Copyright © 1985  
The International Bank for Reconstruction  
and Development/THE WORLD BANK  
1818 H Street, NW  
Washington, DC 20433, U.S.A.

All rights reserved  
Manufactured in the United States of America

First printing May 1985

**PREFACE**

This Technical Note by Richard J. Otis and D. Duncan Mara is one of a series of informal Technical Notes prepared by TAG\*/ on various aspects of water supply and sanitation programs in developing countries. The initial emphasis of TAG was on the promotion of policy shifts from high-cost to low-cost on-site sanitation technologies. This emphasis is now being directed progressively to a focus on institutional development for on-site low-cost sanitation program delivery.

The present note sets out provisional guidelines for the design of small bore sewers receiving pre-settled domestic wastewater. These guidelines are based on recent experience with small bore sewerage in Australia, Nigeria, the United States of America and Zambia; they have been written particularly for use in developing countries. Consequently, emphasis has been placed upon achieving simplicity of design consistent with reliability of operation.

The note was originally prepared as an internal discussion document. Its wide distribution does not imply endorsement by the sector agencies, government, or donor agencies concerned with programs, nor by the World Bank or the United Nations Development Programme.

TAG will be interested in receiving comments and suggestions on the paper, and, in particular, information on costs of technology, delivery and support systems, and generally, information on experience in program implementation. All communications should be addressed to the Project Manager, UNDP Project INT/81/047, Water Supply and Urban Development Department, The World Bank, 1818 H Street, NW. Washington, DC 20433.

Richard N. Middleton  
Project Manager

**Acknowledgements**

The authors would like to express their gratitude to Mr. Cecil W. Rose (formerly of the Farmers Home Administration, United States Department of Agriculture) and Dr. M.G. McGarry (COWATER International, Ottawa, Canada) for their helpful comments on early drafts of this Technical Note.

---

\*/ TAG: Technology Advisory Group established under the United Nations Development Programme, UNDP Interregional Project INT/81/047: Development and Implementation of Low-cost Sanitation Investment Projects (formerly Global Project GLO/78/006), executed by the World Bank.

## TABLE OF CONTENTS

	Page
Preface . . . . .	(i)
I. INTRODUCTION . . . . .	1
System description . . . . .	1
Component parts . . . . .	2
Applicability in developing countries . . . . .	4
II. DESIGN CRITERIA . . . . .	7
Interceptor tank . . . . .	7
Small bore sewers and appurtenances . . . . .	11
Wastewater treatment options . . . . .	17
III. CONSTRUCTION AND MAINTENANCE . . . . .	17
Materials . . . . .	17
Construction . . . . .	19
Maintenance . . . . .	22
IV. CASE STUDIES . . . . .	23
Zambian sewerred aqua-privies . . . . .	25
Australaian sewerred septic tanks . . . . .	27
Nigerian sewerred aqua-privies . . . . .	28
American sewerred septic tanks . . . . .	29
V. COSTS . . . . .	39
 ANNEXES	
I. Interceptor tank design . . . . .	43
II. Small bore sewer design examples . . . . .	47

	Title	Page
<b>Table 1</b>	: Unit Cost for Small Bore Sewers. Conventional Sewers. Conventional Sewer and Water Main Installation from Selected Projects in the United States of America .....	38
<b>Table 2</b>	: Share of Total Project Cost by Component from 10 Uniform Grade Small Bore Sewer projects in the United States of America .....	40
<b>Figure 1</b>	: Schematic diagram of a small bore sewer system.....	(iv)
<b>Figure 2</b>	: Typical solids interceptor tank. [The tank may be buried by 300 mm or more to prevent unauthorized access by children or for garbage disposal].....	6
<b>Figure 3</b>	: A typical small bore sewer cleanout.....	14
<b>Figure 4</b>	: Individual service connection lift station.....	15
<b>Figure 5</b>	: Main in-line lift station with drop inlet.....	18
<b>Figure 6</b>	: Sewered aqua-privy blocks in the Chipanda area of Matero, Lusaka, Zambia.....	24
<b>Figure 7</b>	: Sewered aqua-privy block in the Chipanda area of Matero, Lusaka, Zambia.....	26
<b>Figure 8</b>	: Sanitation block in New Bussa.....	30
<b>Figure 9</b>	: Sanitation block in New Bussa.....	31
<b>Figure 10</b>	: External view of sanitation block in New Bussa, showing exposed connector sewer and junction boxes.....	32
<b>Figure 11</b>	: Site plan of the Mt. Andrew small bore sewer system.....	33
<b>Figure 12</b>	: Profile of the 50 mm diameter inflective gradient small bore sewer system at Mt. Andrew, Alabama.....	34
<b>Figure 13</b>	: Site plan of the Westboro small bore sewerage systems.....	36



(iv)

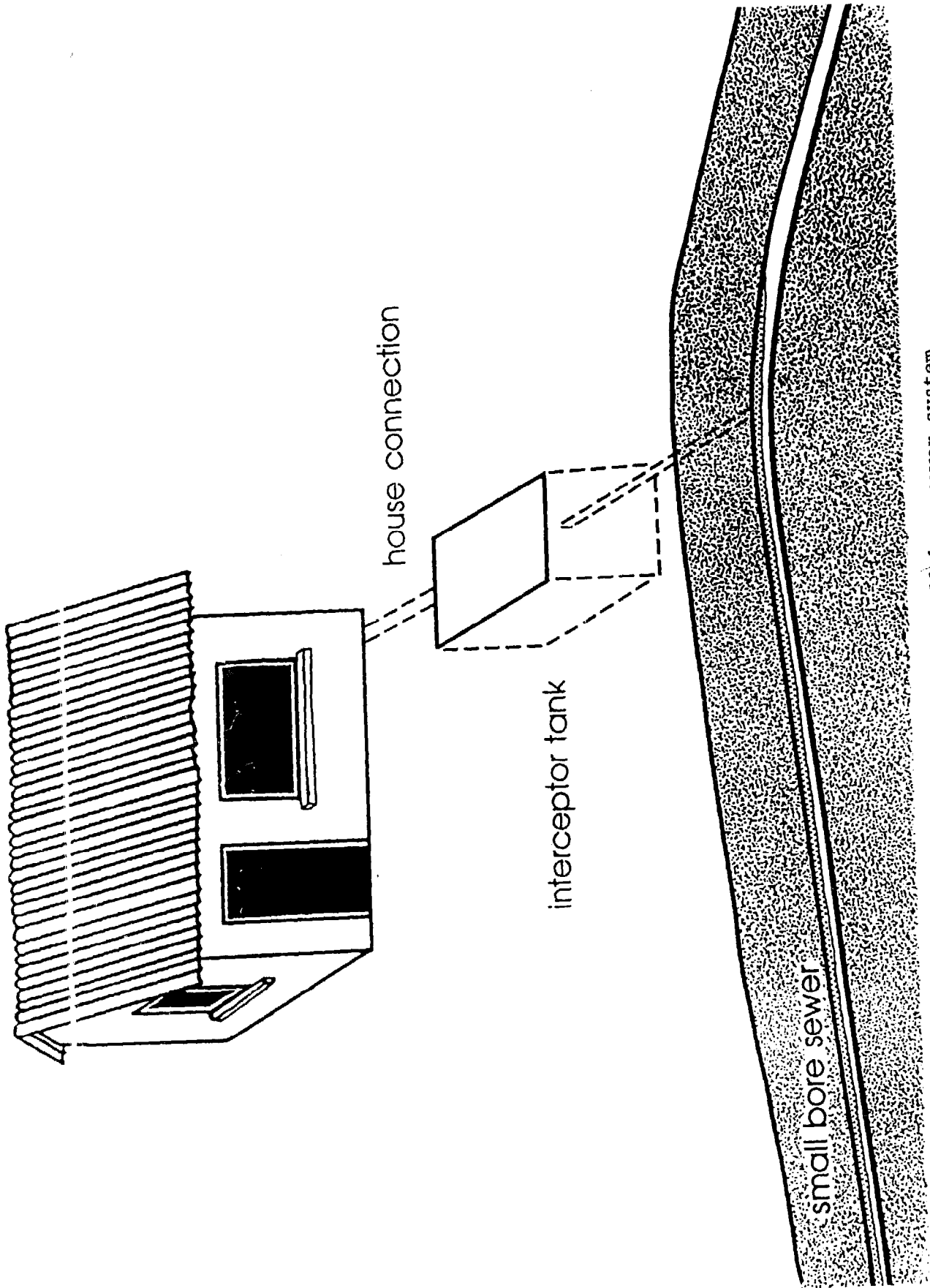

Figure 1. Schematic diagram of a small bore sewer system

## I. INTRODUCTION

### System description

1.1 Small bore sewer systems (Figure 1) are designed to receive only the liquid portion of household wastewater for off-site treatment and disposal. Grit, grease and other troublesome solids which might cause obstruction in the sewers are separated from the waste flow in interceptor tanks installed upstream of every connection to the sewers; the solids which accumulate in the tanks are removed periodically for safe disposal.

1.2 Collecting only settled wastewater in this manner has four principal advantages:

- (a) **Reduced water requirements.** Since the sewers are not required to carry solids, large quantities of water are not needed for solids transport. Thus, unlike conventional sewers, small bore sewers can be employed without fear of blockages where domestic water consumption is low, where water-saving plumbing fixtures and appliances are widely used, or where long flat runs with few connections are necessary.
- (b) **Reduced excavation costs.** With the troublesome solids removed, the sewers do not need to be designed to maintain a minimum flow velocity for self-cleansing. Therefore, rather than being installed on a straight path with a uniform gradient, they may be laid with curvilinear alignment with a variable or inflective gradient. This reduces excavation costs, since the sewer can follow the natural topography more closely than conventional sewers and avoid most obstructions within its path.
- (c) **Reduced materials costs.** Peak flows which the small bore sewers must be designed to handle are lower than those experienced with conventional sewers because the interceptor tanks provide some surge storage which attenuates peak flows. Therefore, the sewer and any pumping equipment can be reduced in size (and pumps handling only liquids are simpler). In addition, expensive manholes can be replaced with much less costly cleanouts or flushing points, since mechanical cleaning equipment is not necessary to maintain the sewers in a free-flowing condition.
- (d) **Reduced treatment requirements.** Screening, grit removal and primary sedimentation or treatment in anaerobic ponds are not needed at the treatment works, since these unit processes are performed in the interceptor tanks.

1.3 Thus, small bore sewer systems provide an economical way to upgrade existing sanitation facilities to a level of service comparable to conventional sewers. Because of the lower costs of construction and maintenance and the ability to function with little water, small bore sewers can be used where conventional sewerage would be inappropriate. Small bore sewers therefore offer an opportunity of improving sanitation in areas which otherwise might not be upgraded.

1.4 The principal disadvantage of the small bore sewer system is the need for periodic evacuation and disposal of solids from each interceptor tank in the system. Experience with the system is limited and mixed. Consequently, in spite of its obvious advantages it must be used judiciously and adopted only in situations where there is sufficient provision to ensure a strong organization for maintenance. This organization must also be able to exercise effective control over connections to the system. Special precautions should be taken to prevent illegal connections, since it is likely that interceptor tanks would not be installed in such connections, thereby introducing solids into a system which is not designed to handle solids. This could create serious operational problems.

#### **Component parts**

1.5 Small bore sewer systems consist of: (a) house connections; (b) interceptor tanks; (c) the sewers and their appurtenances; and (d) a sewage treatment plant. Occasionally, individual pumping stations may be required to lift the effluent from the interceptor tank into the sewer to overcome adverse elevation differences; additionally, pumping stations may be required in the sewer system itself in very flat areas.

- (a) **House connection.** The house connection is made at the inlet to the interceptor tank. All household wastes, except for garbage and trash which must be removed for disposal elsewhere, enter the system at this point. Storm water must be excluded.
- (b) **Interceptor tank.** The interceptor tank is a buried water-tight tank with baffled inlet and outlet. It is designed to detain the liquid flow for 12 to 24 hours and to remove both floating and settleable solids from the liquid stream. Ample volume is also provided for storage of the solids, which are periodically removed through an access port. Typically, a single-chamber septic tank is used as an interceptor tank.
- (c) **Sewers.** The sewers are small bore plastic pipe (minimum diameter of 100 mm) which are trenched into the ground at a depth sufficient to collect the settled wastewater from most connections by gravity. Unlike conventional sewers, small bore sewers are not necessarily laid on a uniform gradient with straight alignment between manholes or cleanouts. The sewer may have an inflective gradient; that is to say, the sewer may have dips so that sections of it remain full under static conditions. Also, the alignment may curve to avoid natural or manmade obstacles. The objective in the design and construction of small bore sewers is to utilize to the maximum extent the energy resulting from the difference in elevation between the upstream and downstream ends.

- (d) **Cleanouts and manholes.** Cleanouts and manholes provide access to the sewers for inspection and maintenance. In most circumstances, cleanouts are preferable to manholes because they cost less and can be more tightly sealed to eliminate most infiltration and grit which commonly enter through the lids and walls of manholes. Also, they can be easily concealed to prevent tampering. They function as flushing points during sewer cleaning operations.
- (e) **Vents.** The sewers must be ventilated to maintain free-flowing conditions. Vents within the household plumbing are sufficient, except where inflective gradient sewers are installed. In such cases, the high points of the sewer should be ventilated either by locating the high points at connections or by installing a cleanout with a ventilated cap.
- (f) **Lift stations.** Lift stations are necessary where elevation differences do not permit gravity flow. Either residential or major lift stations may be used. Residential lift stations are small lift stations pumping wastes from the interceptor tank of one home or of a small cluster of homes to the sewer, while major lift stations are located in the sewer line and service all connections within a larger drainage basin. Whenever pumping becomes necessary, the difference in total annuitized costs between a small bore sewer system and conventional sewerage may be greatly reduced. Consequently, a close cost comparison would be required between the two before selection between them.

Detailed design criteria for interceptor tanks and the hydraulic design of small bore sewers and sewer appurtenances are discussed in Section 2 below. Design examples are given in Annex II.

1.6 As will be seen from the system description above, the most important characteristic of small bore sewers is that they are designed to handle only the liquid portion of domestic wastes. Although the term "small bore sewers" has become commonly accepted, it is not in fact a very accurate description of the system, since the pipes need not be small diameter (the size being determined by hydraulic considerations and not constrained by other conditions), and the pipe system is not designed according to sanitary sewer practice. A more accurate description would be "solids-free sewers", but the best term is probably "effluent drains", as is used in the systems widely employed in Australia; this emphasizes the essential purpose of the sewers - to remove liquid effluents (from interceptor tanks) that cannot otherwise be disposed of on site - and so forms a natural link to the most likely application of small bore sewers in developing countries: to upgrade on-site disposal systems such as pour-flush latrines when changes in water use, housing densities or other conditions lead to difficulties in on-site effluent disposal. However, for consistency with other recent publications on this subject, in this note we have retained the term "small bore sewers".

## Applicability in developing countries

1.7 Although on-site excreta and sullage<sup>1/</sup> disposal systems are usually much less expensive in developing countries than off-site systems<sup>2/</sup>, there are situations when, due to adverse ground conditions (such as low soil permeability, shallow rock), on-site systems are technically infeasible. In such circumstances, off-site disposal is required and the full range of off-site disposal technologies has to be evaluated in technical, financial and economic terms. The available off-site disposal technologies are:

- (a) vault toilets and cartage;
- (b) conventional sewerage; and
- (c) small bore sewerage.

1.8 Vault toilets and cartage systems require a high degree of organizational capability within the institution (usually a municipality) responsible for operating the system: the vault-emptying equipment (commonly a vacuum tanker) has to arrive at each vault very close to the chosen emptying frequency (two to four weeks), otherwise the system fails; and the emptying equipment must be properly maintained. In many developing countries such a level of institutional competence is lacking and very often the system cannot be considered feasible for this reason.

1.9 Conventional sewer systems are so expensive that they are economically inappropriate in low-income communities. For example, studies by the World Bank (see footnote 2) showed that investment costs for conventional sewerage in eight major cities in developing countries ranged from US\$600 to US\$4,000 (at 1978 prices) per household, with corresponding annual economic costs<sup>3/</sup> between US\$150 and US\$650 per household. Such costs are clearly unaffordable when it is remembered that total annual household incomes are frequently less than US\$500 and often below US\$200.

1.10 Small bore sewer systems are especially suitable in developing countries in the following situations<sup>4/</sup>:

- (a) **Sewered pour-flush toilet systems.** When the effluent from pour-flush toilets and household sullage cannot be disposed of on-site, small bore sewerage is almost always the best

---

1/ Sullage (or "grey water") is all household wastewater other than the wastewater from toilets.

2/ J.M. Kalbermatten, D.S. Julius and C.G. Gunnerson, **Appropriate Sanitation Alternatives: A Technical and Economic Appraisal**, Johns Hopkins University Press, 1982.

3/ These include annuitized investment costs and all operation and maintenance costs, including the cost of the water used for flushing the toilet.

4/ The use of small bore sewers is not restricted to developing countries. As noted in Section IV, they have been successfully used in Australia and the United States, where they have shown considerable cost savings over conventional systems.

solution<sup>5/</sup>; it may be installed in new schemes, or it may represent the last stage in a planned sequence of incremental sanitation improvements<sup>6/</sup>.

- (b) **Sewered septic tank systems.** When existing septic tank systems have failed, commonly due to the soil becoming unable to absorb increased wastewater flows resulting from improvements in the water supply distribution system or from increased housing densities, the septic tank effluent is best discharged into small bore sewers; this is almost always less expensive than abandoning the septic tanks and installing a conventional sewer network. In certain circumstances, especially in very flat terrain, it may be economically advantageous to install sewered septic tank systems - in conjunction with low-volume cistern-flush toilets - in new housing schemes as well.

From the perspective of the householder there is little difference between small bore and conventional sewer systems, provided the interceptor tank is desludged regularly<sup>7/</sup>.

1.11 In new schemes small bore sewerage often appears to have little advantage over conventional sewerage when compared to the latter in present worth terms. Yet the distribution of its costs between capital investment and operation and maintenance is quite different to those of conventional systems and is generally more appropriate to developing country conditions: capital costs - with their commonly high foreign exchange requirements - are lower; less skill is required in its construction; and its operation and maintenance are quite different to those of conventional systems and

---

<sup>5/</sup> Sewered pour-flush toilet systems are best used in conjunction with at least a yard-tap level of water supply service. They may also be appropriate for use with a water supply system based on public standpipes; however, this depends on the standpipe density and the willingness and ability of the householders to carry sufficient water home. With sewered pour-flush toilets the total wastewater flow will normally be low, in the region of 30-80 litres per capita per day.

<sup>6/</sup> See J.M. Kalbermatten, D.S. Julius, C.G. Gunnerson and D.D. Mara, **Appropriate Sanitation Alternatives: A Planning and Design Manual**, Johns Hopkins University Press, 1982. A final in-house improvement might be the upgrading of the pour-flush toilet to a low-volume (three to five litres) cistern-flush toilet.

<sup>7/</sup> Ideally, this should be the responsibility of the local water supply and sewerage agency, enabling the cost of desludging to be included as a normal part of the sewerage tariff, and so covered by regular small monthly payments rather than forming a large lump sum cost which householders may be unable or unwilling to afford.

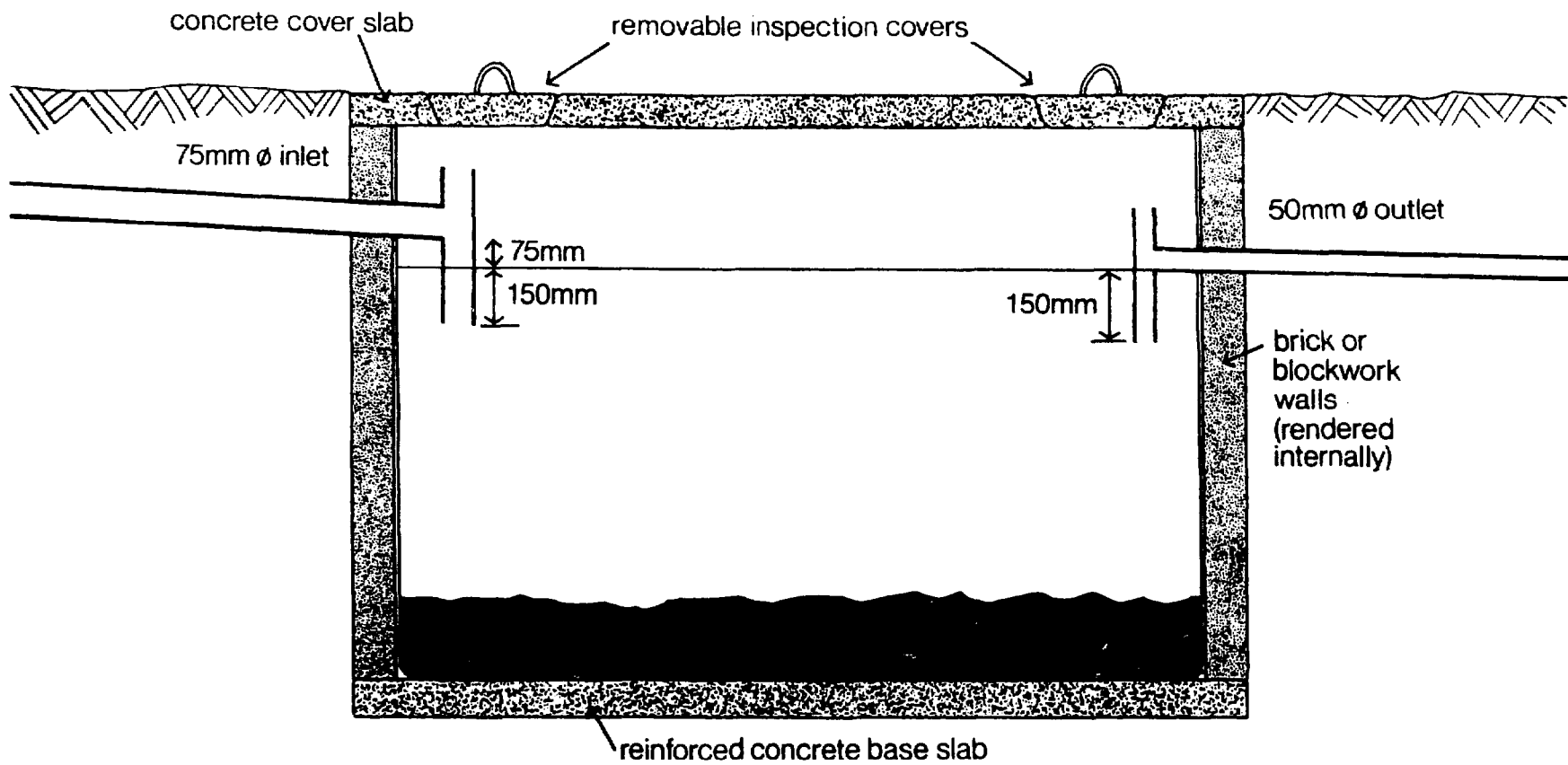

Figure 2. Typical solids interceptor tank. [The tank may be buried by 300 mm or more to prevent unauthorized access by children or for garbage disposal.]

are more labor-intensive, and these costs (which are generally lower than those for conventional systems) can be mainly paid for in local currency out of revenue. Small bore sewerage is inherently a much more flexible system than conventional sewerage and its feasibility should always be evaluated during the technology selection stage of a feasibility study since it can offer a viable solution in many situations where conventional systems are technically or economically infeasible.

## II. DESIGN CRITERIA

### Interceptor tank

2.1 **Functions.** The interceptor tank (Figure 2) is designed to perform four primary functions:

- (a) **Sedimentation:** The foremost function of the interceptor tank is to remove solids suspended in the wastewater. It is designed to provide quiescent conditions for a period of time sufficient to allow the settleable solids to fall to the bottom, and the floatable solids to rise to the top. Inlet and outlet baffles prevent short-circuiting of wastewater through the tank and retain the sludge and scum blankets that form.
- (b) **Storage:** To avoid too frequent removal of the accumulated solids, the tank is designed with sufficient volume to store sludge and scum for three years or more without disturbing the sedimentation function.
- (c) **Digestion:** Anaerobic biological digestion of the sludge is a beneficial result of prolonged storage of the solids in the tank. The bacteria in the tank deplete any oxygen that may be dissolved in the waste while feeding on the concentrated organics. Anaerobic bacteria attack the complex organic compounds reducing them to soluble compounds and gases including  $H_2$ ,  $CO_2$ ,  $NH_3$ ,  $H_2S$  and  $CH_4$ . This digestion has several effects on tank performance:

- (i) **Sludge volume reduction**

- The sludge volume may be reduced by up to 50-80% (depending on temperature), so reducing sludge pumping frequency.

- (ii) **Mixing**

- The rising gas bubbles from the sludge blanket may carry active organisms with them seeding the liquid clear space providing anaerobic decomposition of the colloidal and soluble organic solids remaining in the liquid phase.



(iii) **Turbulence**

The rising bubbles may re-suspend settled solids so that they are carried out of the tank.

(iv) **Hazardous atmosphere**

Toxic, anoxic or explosive atmospheres may result from the accumulation of the gases produced in the tank. This atmosphere can be hazardous to septage pumpers.

- (d) **Flow attenuation:** Interceptor tanks reduce peak flow substantially by providing limited surge storage. Reductions from 11 litre/hour to less than 4 litre/hour have been reported<sup>8/</sup>. The attenuation increases as the liquid surface area of the tank increases.

2.2 **Number of households served.** In the small bore sewerage schemes which have been installed so far in industrialized and developing countries (see Section IV) each household is usually served by its own solids interceptor tank. In many instances this may be the optimal solution, but consideration should be given to the feasibility of connecting more than one household to each interceptor tank. This is likely to be a lower-cost solution in many situations, especially in high-density, low-income urban areas.

2.3 **Design flows.** Estimates of household wastewater flows are commonly based on the household water consumption. Thus wastewater flows are a function of the level of water supply service (yard taps, multiple tap in-house connections), the adequacy of the supply (high or low mains pressure, intermittent supplies), the presence or absence of water-saving plumbing fixtures, and socio-economic status (the proportion of water consumption used for such purposes as animal or garden watering, car washing and other non-in-house uses resulting in wastewater not discharged into a sanitary drain). Considerable care has therefore to be exercised by the design engineer in estimating the design flow, as often the factors are difficult to evaluate precisely; over-estimation of the flow usually results in the interceptor tank and small bore sewers being overdesigned, and under-estimation results in a system prone to failure. Very approximate guidelines for wastewater flows are as follows:

Yard tap supplies:	40 - 80 lcd (litres per caput per day)
Multiple tap in-house supplies:	80 - 120 lcd

---

<sup>8/</sup> University of Wisconsin, **Management of Small Waste Water Flows**, Publication No. EPA-600/2-78-173, United States Environmental Protection Agency, Cincinnati, Ohio, 1978.

Flows in excess of 120 lcd should not be considered feasible in low-income communities (or indeed middle-income communities) as they indicate a severe wastage of water; water-saving plumbing fixtures should be used to restrict water consumption to the level at which resulting wastewater flows are less than 120 lcd. It is all too common, however, for design engineers to assume wastewater flows of 200 lcd or more; in developing countries this is normally unjustified (especially in low-income communities) and results in excessively expensive, and hence unaffordable, solutions.

2.4 Conventional sewer systems are typically designed for an economic life of about 30 years. Because of their high initial cost and relative inflexibility once installed, it is natural for their designers to think in terms of a long economic life and to plan accordingly. (Even where it might appear advantageous to lay a smaller system initially, and to duplicate it when needed, the disruption caused in high-density areas by the installation of duplicate mains is such that many city authorities prefer to lay the larger-capacity mains in the first instance.) Small bore sewer systems, in contrast, appear much more suitable for upgrading in stages, either by duplication of the mains or by installing relatively simple pumping equipment; so the design should examine the relative economic costs of laying systems with initial capacities sufficient to carry the flows expected to arise in, say, 10, 20, or 30 years, with appropriate upgrading at the end of each stage. (The discounting techniques used in comparing these alternative development sequences are not covered in this Technical Note, but appear in standard works on engineering economics.) Careful analysis of alternative development sequences is especially important in the case of small bore sewers, since they are likely to be installed in low- to middle-income areas on the peripheries of towns in developing countries, where very high rates of urban population growth will probably result in considerable changes in settlement patterns and in provision of water supply service during the design period.

2.5 **Volume.** The interceptor tank must have sufficient volume to provide an adequate hydraulic detention time for good settling at the estimated daily flow, while reserving a portion of the total volume for sludge and scum storage. Hydraulic detention times typically range from 12 to 24 hours. The volume reserved for sludge and scum storage depends on several factors, including the total solids which reach the tank daily, the ambient temperature and the frequency of solids removal. Guidelines (generally based on septic tank design procedures) have been developed to determine the necessary volume of the interceptor tank for a given application. Design guidelines are reviewed in Annex I.

2.6 **Geometry.** The preferred shape of interceptor tank is rectangular with a length to breadth ratio of 2 to 1, or higher, in order to reduce short-circuiting of the raw wastewater across the tank, and so improve suspended solids removal.

2.7 For equal volumes, shallow tanks are preferred to deep tanks, since they provide more hydraulic surge storage capacity and greater reduction of the velocity of the outflow, and so improve solids retention. Also, the depth of excavation is reduced, thus lowering costs and lessening problems with groundwater infiltration. However, to ensure good removal of settleable solids, the liquid depth of the tank should be at least 0.9 m but not more than 2 m.

2.8 Single-compartment interceptor tanks are sufficient to remove settleable solids, since the suspended solids carried out in the effluent are not likely to settle in the sewer.

2.9 **Inlets and outlets.** The inlet to the tank should be equal in size or larger than the incoming building sewer to prevent blockages at the inlet. To prevent blockages in the small bore sewers, the tank outlet should be smaller than or equal to the diameter of the sewer. Both inlet and outlet connections should be watertight.

2.10 Baffles should be provided at both inlet and outlet. Inlet baffles are designed to dissipate the energy of the influent and deflect it downward into the tank. This prevents short-circuiting of the liquid across the top of the tank to the outlet and mixes the fresh waste with the biologically active liquid and sludge in the tank. The outlet baffle is designed to retain the scum layer within the tank. Sanitary tees are commonly used but semi-circular baffles are equally effective. The baffle should extend 150 mm above the liquid level to rise above the scum layer, and down to approximately 30 to 40% of the liquid depth. A curtain, or hanging, baffle is not recommended on the inlet because scum is able to build up behind it and so plug the inlet.

2.11 The outlet invert should be at a sufficient level below that of the inlet to provide some surge storage and prevent stranding of solids in the building sewer during momentary rises in the liquid level when wastewater enters the tank. A drop of 75 mm is recommended. A minimum free-board or space above the liquid level of 300 mm should be provided for scum storage and ventilation.

2.12 **Ventilation.** A free flow of air must be provided between the house plumbing and the small bore sewer. Therefore, the inlet and outlet baffles should be open above the scum layer.

2.13 **Access.** Manholes must be provided in each interceptor tank for removal of the accumulated sludge and scum. A hole 300 to 600 mm across is common. In large tanks, more than one manhole may be necessary. The manholes are often buried to prevent accidental entry or odor problems. An inspection port above the inlet and outlet must also be provided. This allows inspection of sludge and scum levels to determine when desludging is necessary and to allow cleaning of the baffle if it should become fouled.

2.14 **Structural design.** Structural considerations should include soil loading, hydrostatic loading and vehicular loading. Soil loadings must always be considered for the tank walls, floor and cover. In areas of

shallow water tables, hydrostatic loads on the empty tank must also be included. Under most circumstances, the interceptor tanks should not be located in areas subject to vehicular traffic; but, if they have to be, the tank cover must be of sufficient strength to resist collapse.

#### **Small bore sewers and appurtenances**

2.15 **Design considerations.** A small bore sewer system is a method of conveying settled wastewater from all users to a selected outlet utilizing the energy resulting from the difference in elevation of its upstream and downstream ends. It must be set deep enough to receive flows from each user and it must have sufficient size and gradient to carry these flows. Therefore, design decisions regarding its location, depth, size and gradient must be carefully made to hold hydraulic losses within the limits of available energy. Where the differences in elevation are insufficient to permit gravity flow, energy must be added to the system by lift pumps. The number and location of lift stations generally is determined from comparisons of their costs of construction, operation and maintenance with the cost of construction and maintenance of deeper and/or larger diameter sewers. The consequences of mechanical or electrical breakdown of the lift station to the health, safety and aesthetics of the community must be taken into account.

2.16 In addition to these energy considerations, maintenance operations, safety and public convenience must be evaluated. Pipe materials with sufficient structural strength to withstand backfill, impact and live loads must be selected. The type and number of appurtenances used must facilitate cleaning of the sewers with the kinds of cleaning equipment likely to be used. Public inconvenience and safety during construction is an additional important factor.

2.17 **System layout.** A system layout can be made largely from maps of the area to be served if these show elevations, existing roads, buildings, property boundaries and other pertinent information. The layout begins by selecting an outlet and service district and sub-district boundaries. The district and sub-district boundaries usually are made to conform to natural drainage basins. Within these boundaries, the branch and main sewer routes are selected. Selection of sewer routes must consider the following:

- (a) interceptor tank location and elevation;
- (b) rights-of-ways and easements;
- (c) vertical and horizontal alignment;
- (d) lift stations;
- (e) future development;
- (f) site restoration; and
- (g) resident and traffic disruption.

The location and outlet elevation of the interceptor tanks together with the local topography will establish the routes and necessary depths of the sewers in most cases. Use of existing rights-of-way and easements should be assessed but if excavation costs can be reduced significantly by some other route special easements may be necessary. While it is desirable to serve every connection by gravity, the local terrain or cost of excavation may require that lift stations be used. Groups of homes can be served by a single lift station or each home can be served individually. Cost considerations may dictate which alternative to use, but thought must be given to the consequences of pump failure; for example, failure of individual lift stations disrupt fewer families but many pumps may be more difficult to maintain. Problems created by overflows should also be considered in site selection. The cost of reinstating pavements, curbs and gutters and other structures which may be torn up during construction will be an important consideration in locating routes. Curvilinear alignment will allow some structures to be avoided but this must be carefully planned so that joint deflections do not exceed those permitted by the pipe manufacturer. Also, if homes are on either side of a roadway, consideration should be given to laying sewers on both sides to avoid expensive road crossings.

2.18 **Peak flow estimation.** The wastewater flows which reach the small bore sewers are attenuated markedly in the interceptor tank from the rate at which they are discharged by the user. The extent of attenuation is a function of the tank liquid surface area and the length of time over which the wastewater is discharged to the tank. For example, a 100 litre bath discharging for a period of 2 minutes to an interceptor tank with a liquid surface area of 4.2 m<sup>2</sup> resulted in an instantaneous peak flow from the tank of approximately 16 litres/minute, but within 15 minutes the rate was less than 2 litres/minute (see footnote 8, page 8). Outflow will equal inflow only with prolonged discharges of approximately 15 minutes or more<sup>9/</sup>; however flows of this duration rarely occur, except occasionally from industrial or institutional sources.

2.19 There are very few data on the magnitude of peak flows in small bore sewers. In the system serving 200 people at Westboro, Wisconsin (Section 4.17), peak factors of 1.2 to 1.3 have been observed. Until more field data are available it seems prudent to adopt a design flow peak factor of 2.

2.20 Where gravity connections are not possible or economic over the full design life, pumped discharges are necessary. The discharge rate and

---

9/ E.E. Jones, **Domestic water use in individual homes and hydraulic loading of and discharge from septic tanks**, in: Home Sewage Disposal (Publication No. PROC-175), American Society of Agricultural Engineers, St. Joseph, Michigan, 1975.

duration of each pumping cycle become the important factors in establishing peak flow rates for these connections. The peak flow rate will equal the pump discharge rate, unless the pumping cycle is less than five minutes. Long pumping should be avoided to prevent excessively surcharged conditions in the small bore sewers.

2.21 In addition to wastewater flows, estimates of groundwater infiltration and surface water inflow must be made. Ideally, the addition of any such "clear" water should be zero, but in practice some imperfectly sealed pipe joints must be expected; these are less common with polyvinyl chloride (PVC) pipes, as the joints are easier to make and pipe lengths are longer than with vitrified clay pipes. If the prevention of clear water entry cannot be ensured, conservative estimates of clear water inflow would be 20 m<sup>3</sup>/ha/day for vitrified clay pipes and 10 m<sup>3</sup>/ha/day for PVC pipes.

2.22 **Hydraulic design.** Unlike conventional gravity sewers which are designed for open channel flow, small bore sewers may be installed with sections depressed below the hydraulic grade line. Thus, flow within a small bore sewer may alternate between open channel and pressure flow. In making design calculations, separate analysis must be made for each sewer section in which the type of flow does not vary and the slope of the grade line is reasonably uniform. Manning's equation may be used in this analysis:

$$v = (1/n) R^{2/3} S^{1/2}$$

where v = velocity of flow, m/s  
n = pipe roughness coefficient  
R = hydraulic radius, m  
S = slope of the hydraulic grade line, m/m

To simplify the computations, a nomograph can be used for this equation under pressure conduit conditions; a hydraulic elements chart is then used to relate velocity and flow under full conditions to those under partially full conditions.

2.23 The coefficient of pipe roughness is related to the pipe material, variations in inside dimensions, fitting, alignment and workmanship. With time, deposits and biological growths will increase the pipe wall roughness; therefore the coefficients selected for design should reflect the ultimate roughness expected. Values of n range from 0.011 to 0.015 but for most pipe materials a value of 0.013 is suitable.

2.24 Minimum pipe diameters of 50 and 100 mm have been used successfully in experimental small bore sewers in the United States of America (see Section IV). Selection of the minimum permissible size should be based primarily on maintenance considerations and costs. At present, in order to facilitate cleaning of the sewer, a minimum diameter of 100 mm is recommended in developing countries where the specialized equipment for cleaning smaller pipes is not generally available.

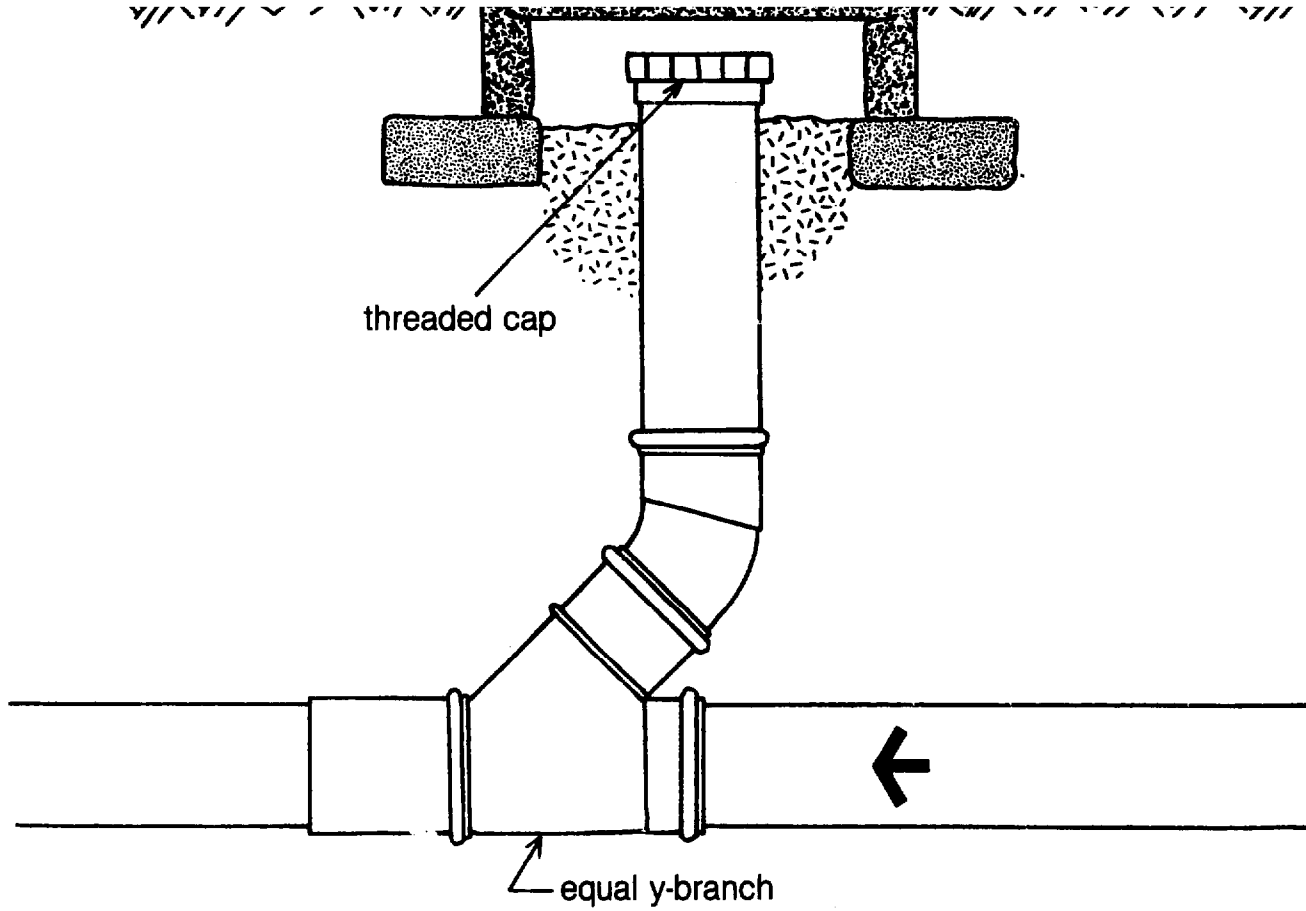
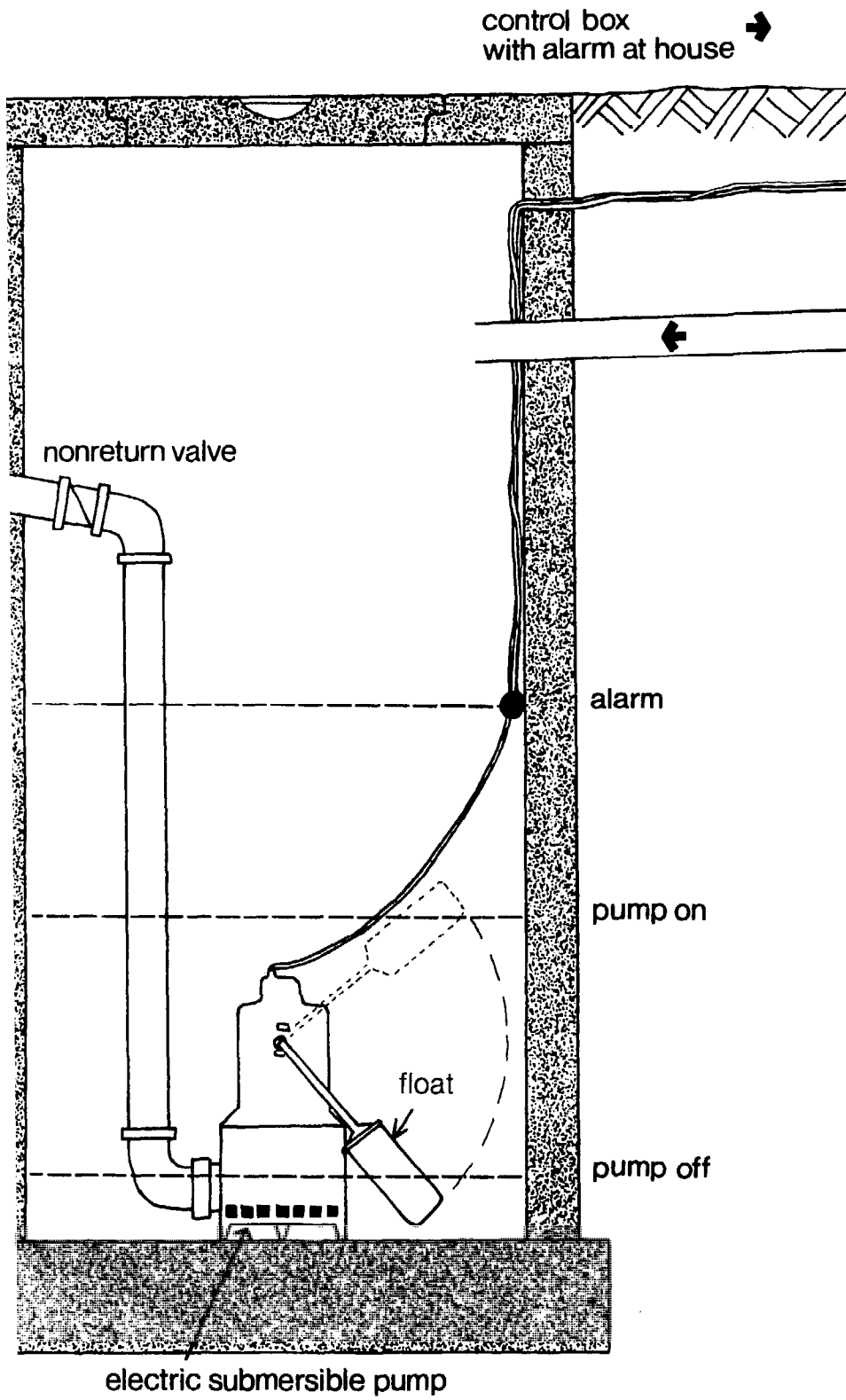

Figure 3. A typical small bore sewer cleanout.



Individual service connection lift station.



2.25 Maintenance of strict sewer gradients to ensure that minimum self-cleansing velocities are achieved daily is not necessary, since small bore sewers are designed to collect only the liquid portion of the wastewater. However, the design must ensure that an overall fall does exist across the system and that the hydraulic grade line during estimated peak flows does not rise above the outlet invert of any interceptor tank. High points where the flow changes from pressure flow to open channel flow and points at the end of long flat sections are critical locations where the maximum elevation must be established above which the sewer pipe cannot rise. Between these critical points, the sewer may be constructed with any profile as long as the hydraulic gradient remains below all interceptor tank outlet inverts and no additional high points are created (see the design examples in Annex II).

2.26 Ventilation is not necessary for satisfactory operation of small bore sewers if the sewers are laid on a continuous negative gradient. However, if inflections in the gradient exist creating sections where the sewer is depressed below the hydraulic grade line, portions of the line will remain full and air will accumulate at high points. To prevent a loss of capacity due to air accumulation, a service connection or ventilated cleanout located at the high point will provide air release.

2.27 **Appurtenances.** Cleanouts and manholes provide points of access for cleaning and maintaining the sewers. Since hydraulic flushing is sufficient to cleanse the lines of accumulated organic solids, cleanouts are recommended in lieu of manholes, except at major junctions, because the latter are more costly and are a source of infiltration, inflow and grit. Cleanouts should be located at all upstream termini, intersections of sewer lines, major changes in direction, high points, and at intervals of 150 to 200 m in long flat sections. A typical cleanout design is shown in Figure 3.

2.28 Lift stations are used to overcome adverse elevation conditions either at individual service connections or to raise collected wastewater from one drainage basin to another. Lift stations at individual connections are simple in design with low-head, low-capacity corrosion-resistant pumps designed to handle water rather than sewage (since solids have been settled out). The pumps are controlled by mercury float switches (Figure 4; cf. paras. 3.14-3.17), set for small pumping volumes to prevent surcharging of the sewers. A high-water alarm switch operated off a separate circuit should be set approximately 15 cm above the 'pump on' switch to alert the user of any pump malfunction by a visual and audible alarm. A sufficient volume between the high-water alarm and the influent sewer invert should be provided to allow storage of wastewater while the malfunction is corrected.

2.29 Major lift stations serving a drainage basin are conventional in design except that large-capacity solids-handling pumps are not necessary. So small-capacity pumps typically used for clean water can be used, rather than more costly sewage pumps, since large solids and debris do not gain entry to the sewers and peak flows are attenuated significantly. However, because of the septic nature of the wastewater in small bore sewers, corrosion and odors are major problems. All equipment should be of

nonferrous construction, although ferrous metal pumps can be used if they remain below the low water level. Concrete should be coated with a chemically resistant material. To control odors, drop inlets extended below the low water level to minimize agitation of the liquid are effective (Figure 5); a fresh air vent to the sump should be provided. In the event of power failure, emergency storage is provided in the lift station itself; a truck-mounted self-priming pump is then used to pump the lift station contents directly into the force main through the hose connection shown in Figure 5.

### **Wastewater treatment options**

2.30 **Waste stabilization ponds** are generally the wastewater treatment option of choice in developing countries. Pond design guidelines are available in a number of publications<sup>10/</sup>. To design a series of ponds to treat small bore sewerage effluent, one can conservatively assume BOD<sub>5</sub> and fecal coliform reductions of 60% and 90% respectively in interceptor tanks in warm climates. The wastewater should be discharged into a facultative pond<sup>11/</sup> and thence into maturation ponds, the size and number of which are determined in the normal way by the required quality of the final effluent.

2.31 **Land treatment** is an alternative option which has been used in the United States<sup>12/</sup>. The presettled sewage first enters a storage pond, the retention time of which is equal to the maximum number of consecutive days that the wastewater is not used for irrigation (e.g., during winter frosts in the United States). The pond effluent is directed in turn to one of several (usually two to six) grass plots which are designed for an application rate of 13-100 mm per week depending on soil type and taking into account seepage and evapotranspiration losses. The effluent from the grass plots is collected and discharged into a local stream.

2.32 Alternatively, under certain circumstances, it may be possible to discharge the effluent from small bore sewers into a conventional sewer and thus be able to treat it at the works receiving the unsettled sewage.

## **III. CONSTRUCTION AND MAINTENANCE**

### **Materials**

3.1 **Interceptor tanks.** Most commonly in developing countries interceptor tanks are constructed in brick or blockwork on a concrete base, and

---

<sup>10/</sup> For example: J.A. Arthur, **Notes on the Design and Operation of Waste Stabilization Ponds in Warm Climates of Developing Countries**, World Bank Technical Paper No. 7, The World Bank, Washington D.C., 1983; and D.D. Mara, **Sewage Treatment in Hot Climates**, John Wiley, London, 1976.

<sup>11/</sup> An anaerobic pond is not required as the interceptor tanks fulfill this function.

<sup>12/</sup> U.S. Environmental Protection Agency, **Process Design Manual for Land Treatment of Municipal Water**, Cincinnati, Ohio, October 1981.

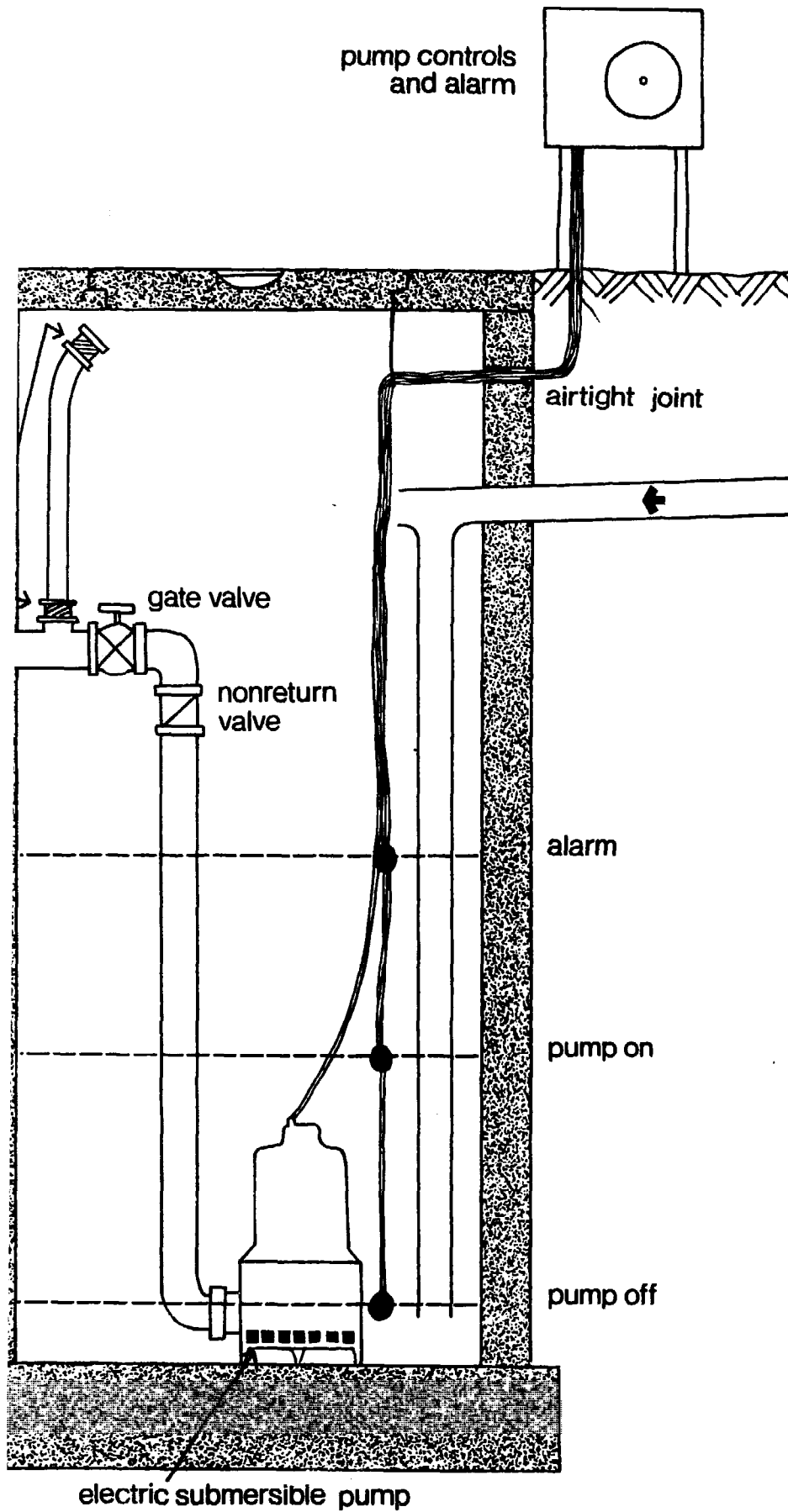

e 5. Main in-line lift station with drop inlet.

rendered with cement mortar internally. The concrete base should be at least 100 mm thick and should have light reinforcement to prevent surface cracking (for example, 6 mm diameter mild steel bars at 150 mm centers in both directions).

3.2 If available, prefabricated tanks of precast concrete, glass-fiber-reinforced plastic or thermoplastics may be used. Precast concrete tanks can be readily made at a central casting yard, and are usually made in flat or cylindrical sections for ease of transport and subsequent erection on site.

3.3 **Sewers.** Thermoplastic pipes, most commonly PVC but also low density polyethylene, are used for small bore sewers. Their advantages include light weight, long laying lengths, high impact strength, corrosion resistance, flexibility and ease of cutting in the field. Elastomeric seal gasket (rubber ring) or solvent weld joints are used. Both pressure and non-pressure PVC pipe and fittings are available. Where appropriate, locally available pipes, such as vitrified clay pipes, may be used.

3.4 **Cleanouts and manholes.** Cleanouts can be easily made up from standard PVC pipe fittings (Figure 3) (page 14), or they can be made as small inspection boxes in cement-rendered brick or blockwork with suitable benching and airtight covers. Manholes are best made in concrete or cement-rendered brick or blockwork; standard manhole designs (for conventional sewer networks) should be used. Covers of manholes should be sealed to prevent ingress of water into the sewer system.

## **Construction**

### **(a) Interceptor tanks**

3.5 **Location.** The tanks should be located where they can be reached easily for routine removal of solids. The tanks should be clear of vehicular traffic areas unless the cover is adequately reinforced to withstand live traffic loads.

3.6 **Testing.** Leakage can be detrimental to the performance of small bore sewers. Infiltration can add significantly to the volume of liquid the sewers must carry and reduce the solids retention capacity of the interceptor tanks. Exfiltration can cause the liquid level in the tank to fall, permitting the scum layer to enter the outlet tee. To ensure watertightness, the tanks should be tested prior to installation by filling with water. After standing for several hours, the tank should be examined for leakage and repaired as necessary.

3.7 **Inlet and outlet piping.** All joints at the tank should use rubber gaskets or be sealed with a durable, water-tight, flexible material.

3.8 **Bedding and backfilling.** The tank must be set level on undisturbed soil at an elevation that allows at least a 2.5% slope in the building sewer. If over-excavation occurs or the natural soil is soft or yielding, crushed rock should be used as bedding material. Backfill should be free of large stones, rubbish, waterlogged or other unsuitable materials. In the vicinity of the inlet and outlet piping, the backfill should be placed manually and tamped.

**3.9 Flotation collars.** If the tanks have to be set in soil that may be saturated at any time, flotation collars should be used to prevent flotation when the tank is desludged.

**3.10 Depth of cover.** Tanks should be kept shallow to allow easy access for pumping. However, a minimum depth of cover of 300 mm is recommended. If deep tanks must be installed, risers should be placed on all access and inspection ports to bring them up to just below ground level. Access and inspection ports may be brought above ground level, but only if they can be securely sealed.

**3.11 Existing tanks.** Existing tanks may be used to reduce construction costs if they are in good repair. A careful inspection of each tank is required. The tanks should be emptied completely and well ventilated before inspection. The inlet and outlet baffles should be inspected and the extent of any corrosion determined. Leaks can be detected by smoke tests. Any tanks failing the inspection test must be repaired or replaced.

**3.12 Building sewer.** The building sewer should be a 75 - 100 mm diameter pipe installed at a uniform negative gradient sufficient to transport fecal solids but not so great as to strand solids in the line. Recommended gradients are 1 in 30 (75 mm pipe) and 1 in 40 (100 mm pipe). Bends greater than 45° should be provided with a cleanout. Great care must be exercised to ensure that all joints are watertight.

**3.13 Service connection.** Service connections from the interceptor tank to the sewer main should be the same or preferably smaller in diameter than the sewer main. Connections to the main are usually made with wye or tee fittings. If a high point in the main exists near where the connection is to be made, an effort should be made to provide the connection at that point to act as an air release.

#### **(b) Lift stations**

**3.14 Effluent pumps.** Centrifugal submersible effluent pumps are most commonly used with small bore sewer systems. Pumps used at individual connections should be low-capacity pumps to prevent surcharging of the sewers downstream. All pumps should be of cast iron, bronze and/or plastic construction and mounted on three integral support feet or a base.

**3.15 Discharge piping.** Because of the corrosive nature of the wastewater, only plastic pipe should be used. Quick-disconnect couplings should be provided to allow easy removal of the pump for repairs.

**3.16 Level sensors.** Mercury level control switches have been found to be the most trouble-free of the several types of switches readily available. They are mercury contact switches encased in floating polyurethane balls. Two switches are necessary for single pump applications, one for 'pump on' and the other for 'pump off'. A third is recommended as a high water alarm to signal malfunctions.

3.17 **Wiring.** The wiring used to connect the pump to the power source should be suitable for direct burial. The pump and high-water alarm must be on separate circuits.

**(c) Sewer installation**

3.18 Techniques used for the installation of small bore sewers are the same as those used in conventional sewer construction except that horizontal and vertical controls need not be maintained as carefully. Usually, construction begins at the treatment and disposal facility with the pipe being laid in the upstream direction.

3.19 **Preliminary layout.** Prior to the start of any work, rights-of-way, work areas, clearing limits and pavement cuts should be laid out to protect adjacent properties. Access roads, detours and protective barricades should be laid out and constructed as required in advance of construction.

3.20 **Setting line and grade.** The line of the sewer should be set by the designer to avoid unnecessary construction problems or costs. Stakes set at the surface on an offset from the sewer centerline are sufficient. The maximum elevation of each critical highpoint should be specified. The profile of the sewer between highpoints is not critical except that the sewer should not rise above the elevation of the last downstream highpoint. A minimum depth of cover of 50 cm should be maintained.

3.21 **Excavation.** Extreme care is necessary to locate and protect existing utilities. The owners of any utilities should be contacted before excavation commences. In general, over-excavation is not a critical concern and should not be backfilled since uniform negative gradients are not followed. However, to minimize headlosses and potential solids or gas collection points, the pipe should be laid as uniformly as is reasonable. If it is necessary to fill a trench that has been over-excavated, only suitable bedding materials should be used and properly tamped. In many instances, the pipe may be joined above ground and laid in the trench. Where assembly must be done in the trench all safety precautions should be taken to protect workers.

3.22 **Bedding and backfilling.** The sewer pipe must be embedded in well graded, compacted bedding material. If the original soil is unsuitable, suitable bedding materials should extend at least 100 mm below the bottom of the pipe to 300 mm above the top of the pipe and across the full width of the trench<sup>13/</sup>. Backfill materials should be free from waste, objectionable organic matter, rubbish, boggy or other unsuitable materials.

---

<sup>13/</sup> Bedding requirements are detailed in, for example, **Gravity Sanitary Sewer Design and Construction**, Manual of Practice No. FD-5, Water Pollution Control Federation, Washington DC, 1982.

3.23 **Marking pipe locations.** Care must be taken to ensure that the exact location of the pipe is known. This can be done by pipeline markers which relate the pipe to existing permanent above-ground structures, or by using special color-coded pipe location marking tape, if this is available, buried 100 to 200 mm below ground level and directly over the sewer. In countries where electronic instruments are available for tracing metal utilities below ground, a tracer wire should be buried with the PVC sewer (since the PVC sewer pipe by itself will not be detected by the instruments).

### **Maintenance**

3.24 Small bore sewers require very little maintenance. The only routine maintenance which must be performed is the removal of sludge from each of the interceptor tanks. Routine flushing of the sewer mains has not been necessary in any of the systems currently in use. However, periodic flushing is recommended to insure against blockages.

3.25 **Administration.** Small bore sewer systems should be operated and maintained by the local agency (e.g., municipality, local water and sewerage company) responsible for waterborne sanitation. Its responsibilities should include all sewer appurtenances located on private property as well as those in the public right-of-way. Easements to any appurtenances should be obtained from each property owner to allow free access.

3.26 **Interceptor tanks.** Scheduled maintenance for the tanks is generally limited to yearly inspection and solids removal when necessary. If the sludge layer is within 300 mm of the bottom of either the inlet or outlet baffles, or if the bottom of the scum layer is within 75 mm of the bottom of the outlet baffle, the tank should be desludged. The sludge layer can be determined by wrapping a cloth (preferably towelling) on a stick long enough to reach the bottom of the tank. The stick is pushed to the bottom of the tank, twirled between the hands and held in the tank for about a minute. When the stick is withdrawn, a distinct black mark is left on the cloth recording the sludge depth. The scum layer can be checked by nailing a 75 mm square piece of wood on the bottom of the stick. This is pushed through the scum layer and slowly moved up and down to locate the bottom of the scum by feeling the change in resistance. The stick is marked using a convenient point for reference. With the same stick, the bottom of the outlet baffle is located and the stick marked again. The distance between the two marks is the distance between the bottom of the scum layer and outlet baffle.

3.27 Interceptor tanks are cleaned by pumping the contents to a truck-mounted tank for hauling to a suitable disposal site. All solids should be removed, although a small quantity may be left in the tank to act as a seed for the new sludge. At no time should the tank be entered because of the danger of toxic gases. Land spreading or discharge to a treatment plant are the most common methods for sludge disposal.

3.28 **Sewer mains.** Occasional hydraulic flushing of the sewer mains is required. This is usually sufficient to remove most solids accumulations.

Flushing should begin at the upstream terminal ends of the sewers, and each section between cleanouts or manholes should be flushed successively downstream. Each cleanout or manhole is flooded with water from a tank truck to a depth sufficient to create a flow velocity of at least 0.5 m/s in the section. During flushing care must be taken not to surcharge the system excessively, so creating sewage backups at individual connections. The connections with the lowest elevation in each station should be noted to determine whether the flushing will create backup. Flushing rates and volumes should be adjusted accordingly.

3.29 If blockages occur, the connection at the lowest elevation upstream of the blockage should be located, the interceptor tank opened and a pump truck stationed there to remove all incoming sewage. The blockage can then be removed using hydraulic cutting tools snaked down the main through the cleanouts or by breaking into the pipe. If the pipe is broken into, a cleanout should be installed at that point for future emergencies.

3.30 Flow monitoring at the wastewater treatment plant headworks is recommended to identify problems with inflow or infiltration. Both are detrimental to the system because of the grit which usually enters with the flow. If flows increase substantially during the wet season, the building sewers, interceptor tanks, sewer mains and appurtenances should be inspected for leaks.

#### IV. CASE STUDIES

4.1 This section describes five small bore sewer systems, one in each of Zambia, Australia and Nigeria, and two in the United States. They are presented in this order as this is the chronological sequence of construction<sup>14/</sup>, although the design approach advocated in Section II - the permissible inclusion of surcharged flow - was followed only in one of the American examples; in all the other cases the sewers were designed to flow under partially full conditions only. The Zambian and Nigerian small bore sewer systems were designed to accept aqua-privy effluents<sup>15/</sup>, whereas the Australian and American systems receive the effluent from septic tanks.

4.2 The feasibility of small bore sewers was mentioned in the literature as early as 1935<sup>16/</sup>:

---

<sup>14/</sup> The first small bore sewer system in Zambia was installed in 1960; in Australia in 1962; in Nigeria in 1964; and in the United States in 1975.

<sup>15/</sup> Aqua-privies are not, in most circumstances, a good sanitation technology; pour-flush toilets are generally superior and usually less expensive. This is discussed in detail in J.M. Kalbermatten, D.S. Julius, C.G. Gunnerson and D.D. Mara, **Appropriate Sanitation Alternatives: A Planning and Design Manual**, pp. 94-100, Johns Hopkins University Press, 1982.

<sup>16/</sup> A.J. Martin, **The Work of the Sanitary Engineer**, Macdonald and Evans, London, 1935.



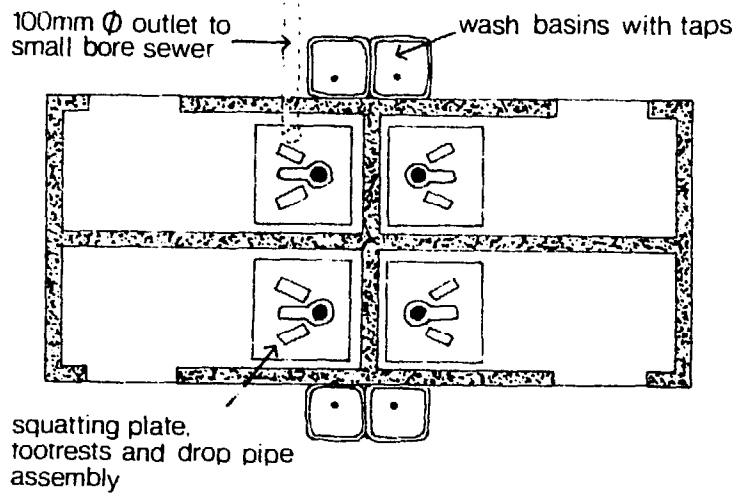

PLAN

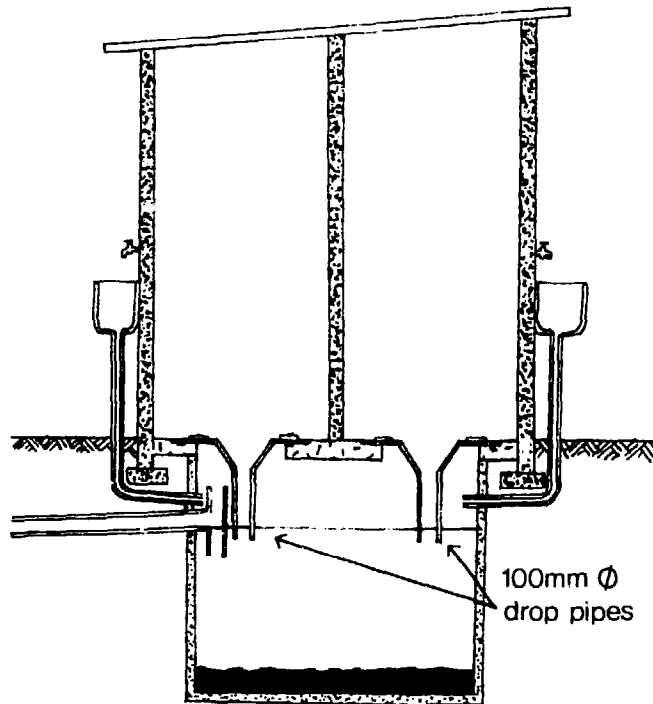

SECTION

Figure 6. Sewered aqua-privy blocks in the Chipanda area of Matero, Lusaka, Zambia.

"If there is not enough fall to give a self-cleansing velocity in the main drain, it will sometimes be possible to put in a septic tank at the head of it. The effluent from a septic tank, being free from any solids capable of choking a drain, may safely be laid with a merely nominal fall."

There are, however, no reports of small bore sewers until the Zambian system was described in 1961.

#### **Zambian sewered aqua-privies**

4.3 The small bore sewer system was originally developed in the late 1950s by design and research engineers working in the then African Housing Board of Northern Rhodesia (now the Zambian National Housing Authority) <sup>17a/</sup>. Conventional and sullage aqua-privies did not work well in Northern Rhodesia and so small bore sewers were installed to remove the settled wastewater (toilet wastes and sullage) from the aqua-privy tanks. They were originally designed for a minimum daily peak velocity of 0.3 m/s, and the pipes were 100 mm minimum bore and laid at a minimum gradient of 1 in 200. They were designed only to flow partially full and not, unlike the more recent North American systems described below, for surcharged flow. One Zambian system - that at Chipanda in Matero Township, Lusaka - is described below, but several others exist and are described elsewhere<sup>17b, c/</sup>.

4.4 In 1978 there were 532 one- or two-bedroom houses served by the sewered aqua-privy system in the Chipanda low-income housing area, which was installed in 1960. Each aqua-privy block serves four contiguous households, and immediately outside its toilet compartment each household has a water tap and a sink which discharges its sullage into the aqua-privy tank (Figures 6 and 7). The tank effluent discharges, via a 100 mm asbestos cement (AC) connector pipe, into a 150 mm AC lateral sewer which runs between most of the compounds. This in turn discharges into a 225 mm main

---

<sup>17/</sup> (a) L.J. Vincent, W.E. Algie and G.v.R. Marais, **A system of sanitation for low-cost high-density housing**, in: Proceedings of a Symposium on Hygiene and Sanitation in Relation to Housing, Niamey, 1961, pp. 135-172, Commission for Technical Cooperation in Africa South of the Sahara, London, 1962.

(b) G-J. W. de Kruijff, **Aqua Privy Sewerage Systems: A Survey of Some Schemes in Zambia**, Housing Research and Development Unit, University of Nairobi, 1978.

(c) R.G. Feachem, D.D. Mara and K.O. Iwugo, **Appropriate Sanitation Technologies for Urban Areas in Africa**, Public Utilities Report No. RES 22, The World Bank, 1979. More detailed information is given in "Sanitation Site Report No. 4: Zambia (Lusaka and Ndola)", by the same authors (unpublished World Bank document, May 1978).



Figure 7. Sewered aqua-privy block in the Chipanda area of Matero, Lusaka, Zambia. (Photograph: Dr. K.O. Iwugo).

sewer, and thence into a 600 mm trunk sewer which transverses the city from north-west to south-east. The 225 and 600 mm sewers were designed as part of the conventional sewer system of Lusaka and so receive unsettled sewage. Some conventional flush-toilets discharge directly into the 150 mm lateral sewers without settlement. Treatment was originally in a series of waste stabilization ponds, but these were abandoned when the small bore sewers were connected to the city's expanded conventional sewerage system.

#### **Australian sewered septic tanks 18/**

4.5 The State of South Australia has the largest number of small bore sewer systems receiving septic tank effluent. In South Australia they are called "common effluent drainage systems" and by mid-1982 65 townships were served by small bore sewers and 55 extensions to existing schemes had been added; the total length of small bore sewers was then some 750 km. Demand for small bore sewerage is high, with 56 townships requiring service over the next few years. The first small bore sewer scheme, serving 40 properties in Pinnaroo, was installed in 1962. The first township to provide a scheme for all properties was Barmera; this scheme was commissioned in 1964 and provided for 493 connections at an average cost of A\$116 (US\$129) (1964 prices) per connection. It has five pumping stations and treatment of the collected wastewater is in a facultative waste stabilization pond. The design details are as described in paragraph 4.6.

4.6 **Design criteria.** Small bore sewer schemes are subject to Section 530c of the South Australian Local Government Act 1934-1972 as amended. In practice schemes have to conform to the specifications laid down by the South Australian Health Commission (Health Surveying Services division). The principal design criteria are as follows:

- (a) **Design velocity and flows:** minimum design velocity of 0.46 m/s (1.5 ft/s) at half-full pipe; average wastewater flow of 136 lcd (30 imp. gallon or 36 US gallon per person per day); peak flow of 0.283 litres/minute per person, which allows for three times the average dry weather flow.
- (b) **Pipe diameters and gradients:** PVC pipes with diameters of 100, 150 and 200 mm are used; they should not flow more than half full at any time; and they should be laid at gradients not flatter than:

---

18/ Detailed information on Australian small bore sewer systems can be found in: **Common Effluent Drainage Systems**, South Australian Health Commission, Adelaide, 1982. [This publication is a collection under one cover of various records, directions and legislation on small bore sewers compiled by the Health Surveying Services office of the South Australian Health Commission.]

100 mm	.....	0.67%	(1 in 150)
150 mm	.....	0.40%	(1 in 250)
200 mm	.....	0.33%	(1 in 300)

- (c) **Manholes and flushing and inspection points:** manholes (minimum diameter 1.066 m, 3.5 ft) should be located at intersections of four sewers (or of two or three sewers if the sewer depth exceeds 2.5 m) and every 245 m where minimum gradients are used. Flushing and inspection points should be installed at all changes in direction; at the junction of two sewers where the sewer depth is less than 2.5 m; every 120 m; at the upstream termini of the scheme; and at each household connection point. Flushing of the sewers with clean water once a year is recommended.
- (d) **Cover:** the minimum cover is 1 m, unless special arrangements are made to prevent damage to the pipe. Recommendations are also made for the design of pumping stations and waste stabilization ponds (see footnote 18, page 27).

4.7 Nonetheless, the South Australian experience with small bore sewers has been excellent and systems installed in the early 1960s are working very well today, some twenty years later. However, several of the above design criteria appear too conservative. Smaller pipe diameters, a lower peak factor and flatter gradients can be used satisfactorily, especially if the inflective gradient design approach (Section 2.23) is used.

**Nigerian sewered aqua-privies 19/**

4.8 The only small bore sewerage scheme in Nigeria is the sewered aqua-privy system in the resettlement town of New Bussa near the Kainji Dam in Kwara State. This system, which was constructed in 1964, serves 256 enclosed family compounds, each housing 15-40 people. A sanitation block, comprising a laundry, shower room and an aqua-privy compartment, is

---

19/ This case study is taken from R.G. Feachem, D.D. Mara and K.O. Iwugo, **Appropriate Sanitation Technologies for Urban Areas in Africa**, Public Utilities Report RES 22, The World Bank, 1979. More detailed information is given in **Sanitation Site Report No. 2: New Bussa, Nigeria**, by the same authors (unpublished World Bank document, May 1978). An early report of the system is given by B.B. Waddy, **The Siting and Sewage System of New Bussa**, Journal of the Society of Health of Nigeria, 6, pp. 16-19, 1971.

provided in each compound (Figures 8 and 9); a water tap is located in the laundry area. Sullage is discharged into the aqua-privy tank, which in turn discharges into a short length of 100 mm diameter asbestos cement pipe which is connected, via a street junction box, to a 100 mm or 150 mm diameter collector sewer which runs in the lane or street outside the compound (Figure 10). The wastewater is treated in one of two single facultative waste stabilization ponds serving the east and west sides of the town.

4.9 No information on the hydraulic design of the small bore sewers is available, but it can be reasonably assumed that it was based on the Zambian schemes described above, as these were the only other schemes in existence at that time. Some design details differ, however. For example, the short connector sewers were commonly exposed, some being protected by a thin layer of concrete (Figure 10); they were thus liable to damage. Many of the precast concrete junction box covers were broken and it was common to see excreta and paper lying in the sewers; some of the junction boxes were completely blocked and overflowing. This suggests that the aqua-privy tanks were not being desludged regularly, so permitting solids to enter the small bore sewers; desludging was expected to be done manually by the householders, with burial of the removed sludge in the compound itself. The situation was further aggravated by poor tank outlet design: many outlets were broken, so permitting the escape of floating solids.

4.10 In spite of these problems, user satisfaction was generally high, the main complaints being the intermittence of the water supply and the need for manual desludging. There were also design faults with the small bore sewer network, principally the shallow (often zero) depth of the connector and collector sewers and their junction boxes.

4.11 Total construction costs (household sanitation block, small bore sewers, ponds) were N£ 33.3 (1964 Nigerian pounds) per household, equivalent to US\$408 (1978 dollars).

#### **American sewered septic tanks**

4.12 There are more than 20 small bore sewer systems in the United States. The first to be constructed was at Mt. Andrew in Alabama, in 1975. This system and another at Westboro in Wisconsin, which was constructed in 1977, are described below.

##### **(a) Mt. Andrew, Alabama 20/**

4.13 This experimental small bore sewer system serves the Grady W. Taylor subdivision, a self-help housing project for 31 low-income families.

---

20/ A detailed description of this system can be found in J.D. Simmons, J.O. Newman, C.W. Rose and E.E. Jones, **Small-Diameter, Variable Grade, Gravity Sewers for Septic Tank Effluent**, In: **On-Site Sewage Treatment**, (Publication 1-82), American Society of Agricultural Engineers, St. Joseph, Michigan, 1982.



Figure 8. Sanitation block in New Bussa

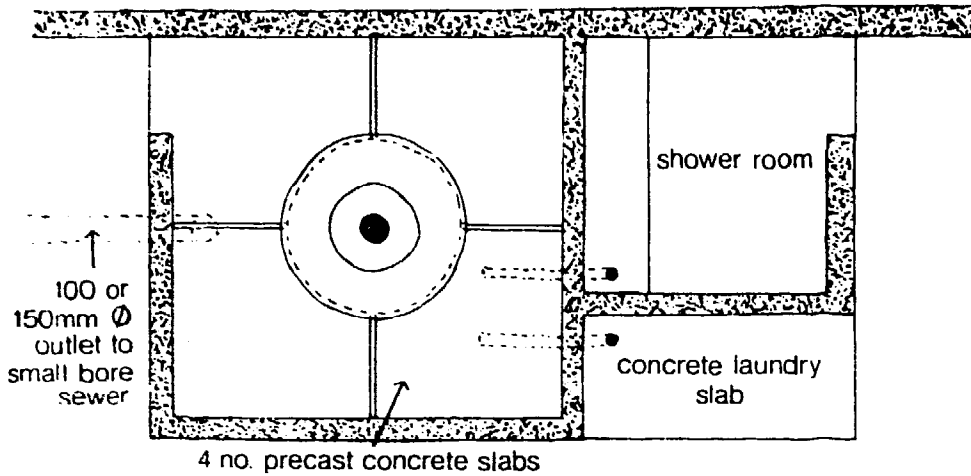

PLAN

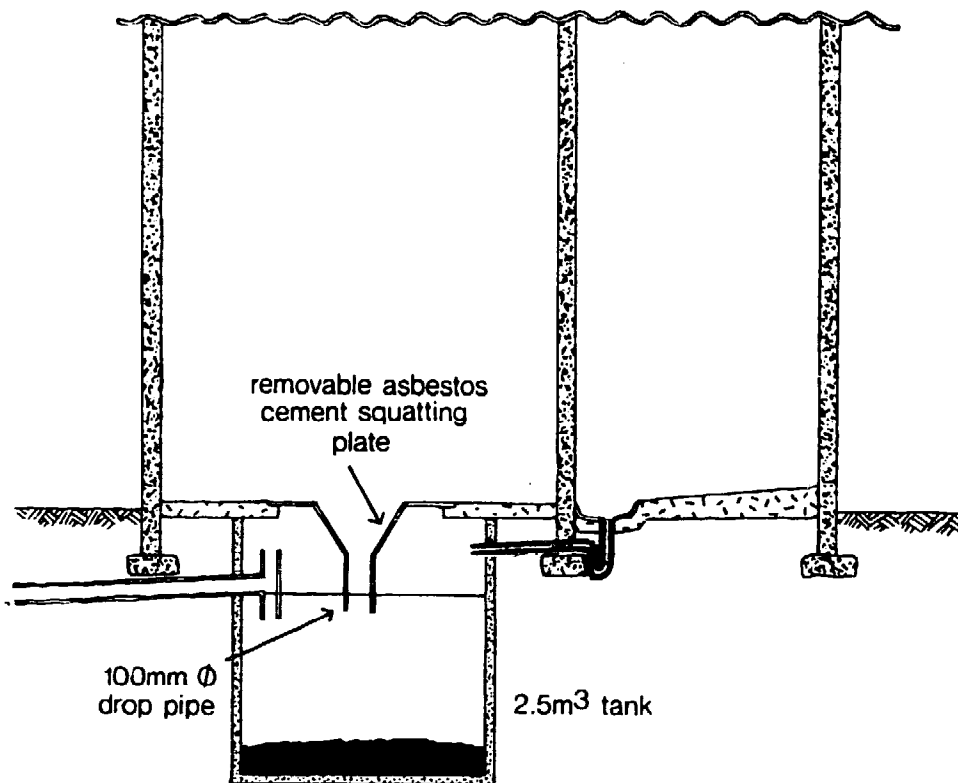

SECTION

Figure 9. Sanitation block in New Bussa.



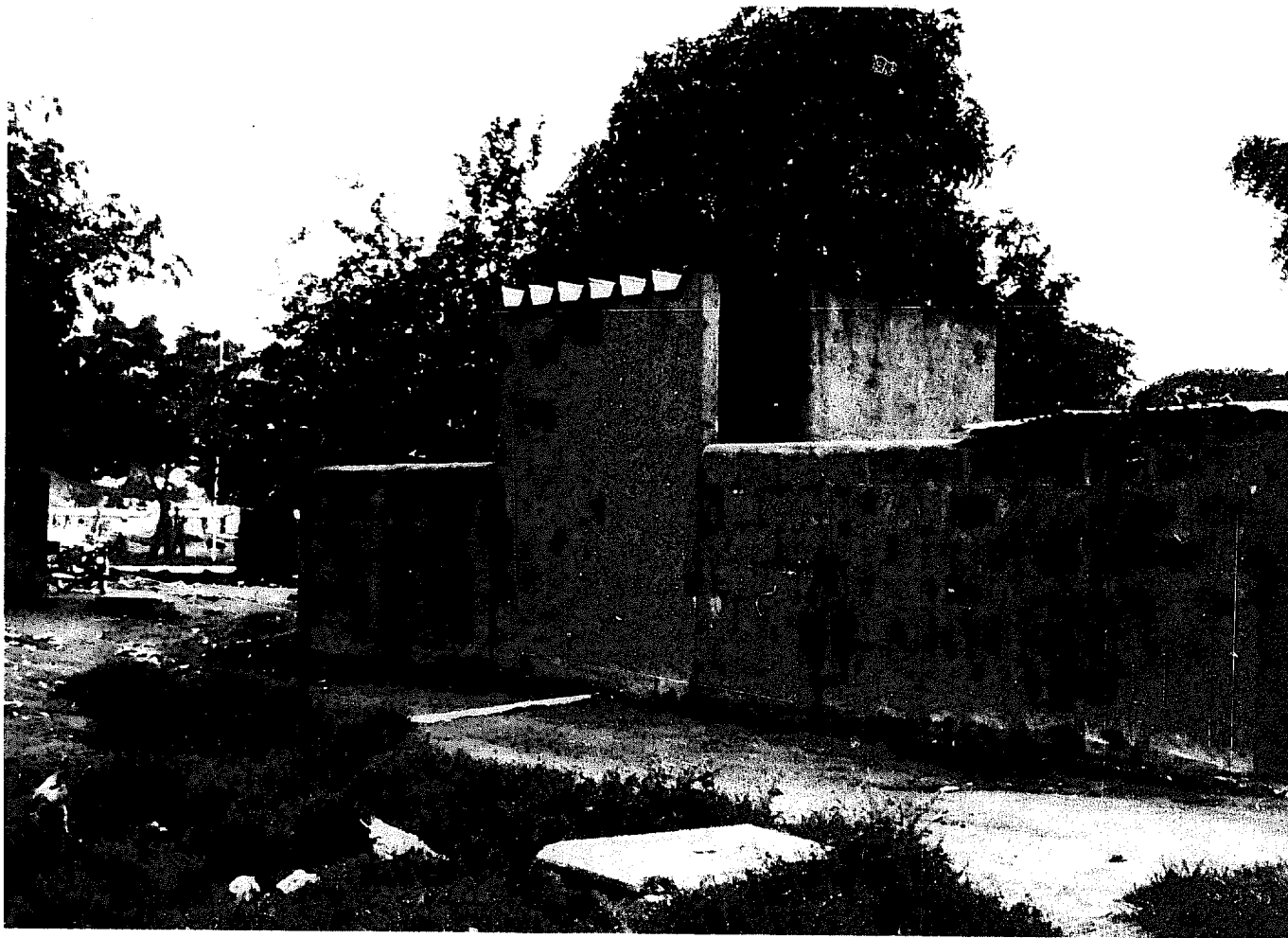
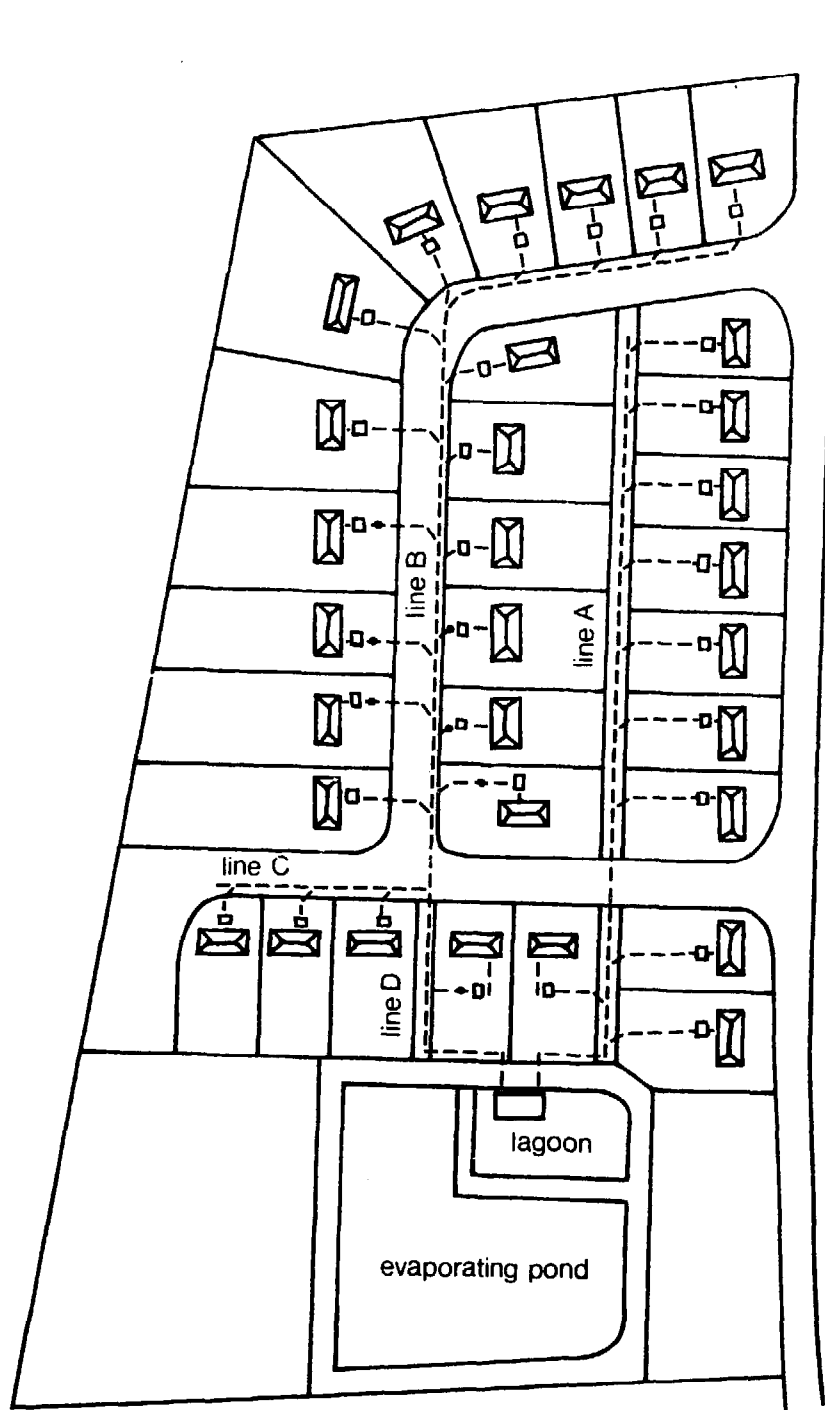

Figure 10. External view of sanitation block in New Bussa, showing exposed connector sewer and junction boxes.



- interceptor tank with gravity flow
- interceptor tank with individual lift station

Figure 11. Site plan of the Mt. Andrew small bore sewer system.

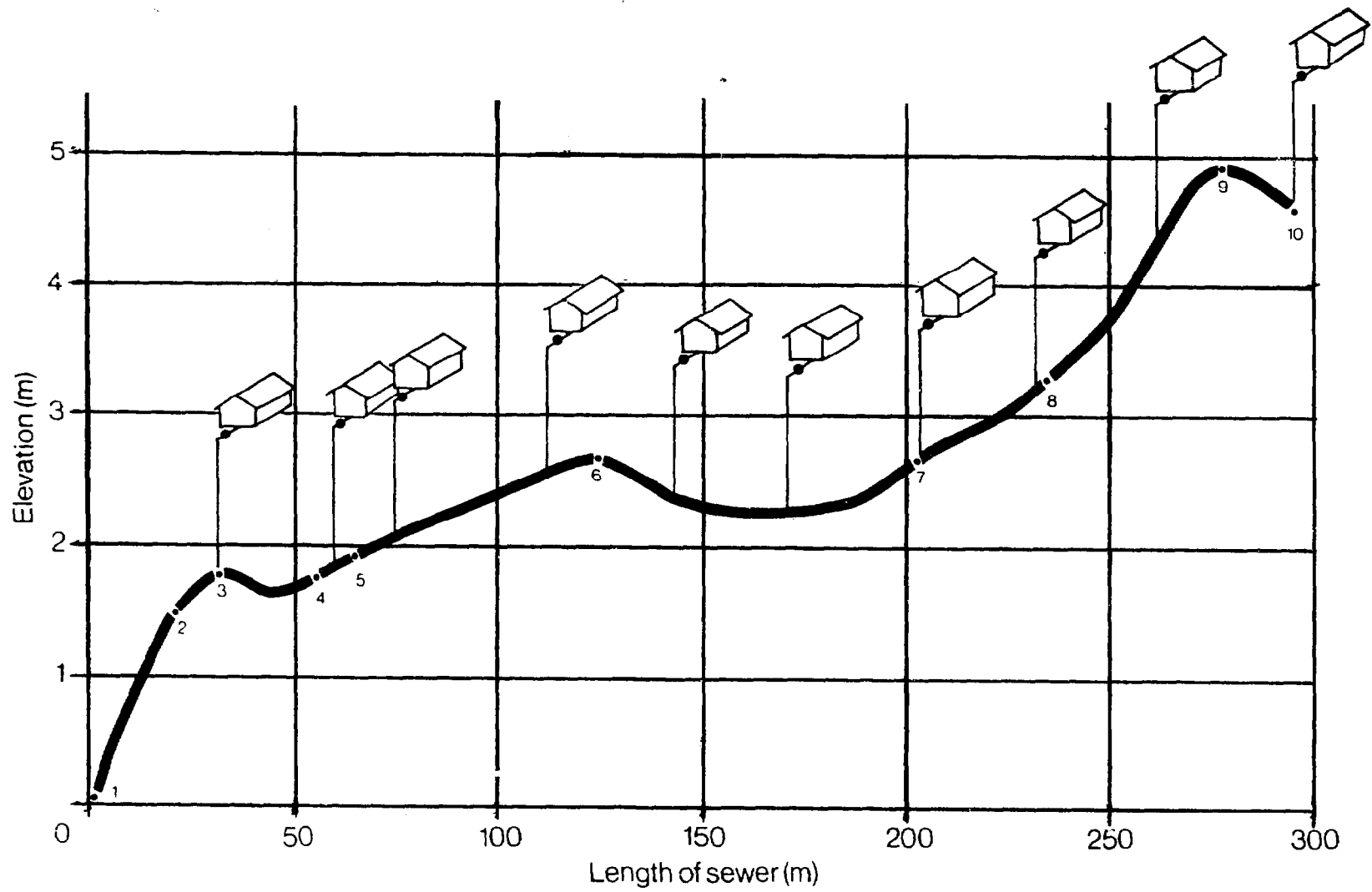

Figure 12. Profile of the 50 mm diameter inflective gradient small bore sewer system at Mt Andrew, Alabama

The system was designed to test three low-cost septic tank effluent collection systems: (a) a small bore sewer with continuous but not uniform slope; (b) force main connections to a small bore sewer with continuous slope; and (c) a small bore sewer with variable gradient. Final treatment and disposal were provided by a stabilization pond. The collection lines were laid out in a conventional manner (Figure 11). Line B and its continuation, Line D, both 75 mm diameter PVC pipe, have nearly continuous slope but precise grade control was not maintained. The grade was controlled only to the extent that adequate fall exists from the septic tanks to the collection line and thence to the pond. Of the 18 homes served by these two lines, 8 required lift pumps to enter the collection main. Line C was constructed with continuous slope to its junction with Line D, but without precise grade control; it is a 50 mm PVC pipe serving three homes. Line A, a 295 m long 50 mm PVC pipe with 10 connections, was constructed with an average fall of 2% but at a constant depth rather than to grade. As a result, there are five inflections between positive and negative gradients (Figure 12). No manholes or cleanouts were installed in any of the lines.

4.14 Modified septic tanks installed upstream of each connection served as interceptor tanks. Each has two compartments; the first is a 1920 litre settling tank, and the second is a liquid storage compartment of 195 litre capacity. The two compartments are hydraulically connected with six 50 mm diameter PVC "lamella settling tubes" set at 60° from the horizontal and with their opening 600 mm above the bottom of the first compartment. The tubes are intended to remove any solids passing through the settling compartment and to prevent scum from entering the storage compartment. The outlet from the storage compartment is a 50 mm PVC vertical standpipe with its opening 300 mm above the floor. This allows for surge storage above the outlet and a vent for the drain.

4.15 The residents installed the sewers themselves with technical assistance. The cost of installation in 1975 was about US\$ 6.50 per linear metre. This system has required very little maintenance during its eight years of operation. Pumping of the interceptor tanks, the only maintenance performed on the system, has been more frequent than originally anticipated due to the small settling compartment volume. Inspection and sampling of the tanks and lines were performed after 18 months of operation. Samples of effluents from the interceptor tanks indicated that the solids removal is no better and is sometimes worse than conventional septic tanks, but that sludge, scum and large suspended solids are removed effectively. To inspect the lines, sections of the 50 mm inflective gradient sewer were removed. Only a thin grey residue was found coating the inside walls of the pipe. No accumulations of heavy solids were observed.

**(b) Westboro, Wisconsin <sup>21/</sup>**

4.16 This system serves a small rural community of approximately 200 persons. It has 85 house connections, and so is a much larger system than

---

<sup>21/</sup> R.J. Otis, **An Alternative Public Wastewater Facility for a Small Rural Community**, Small Scale Waste Management Project, University of Wisconsin, Madison, Wisconsin, 1978.

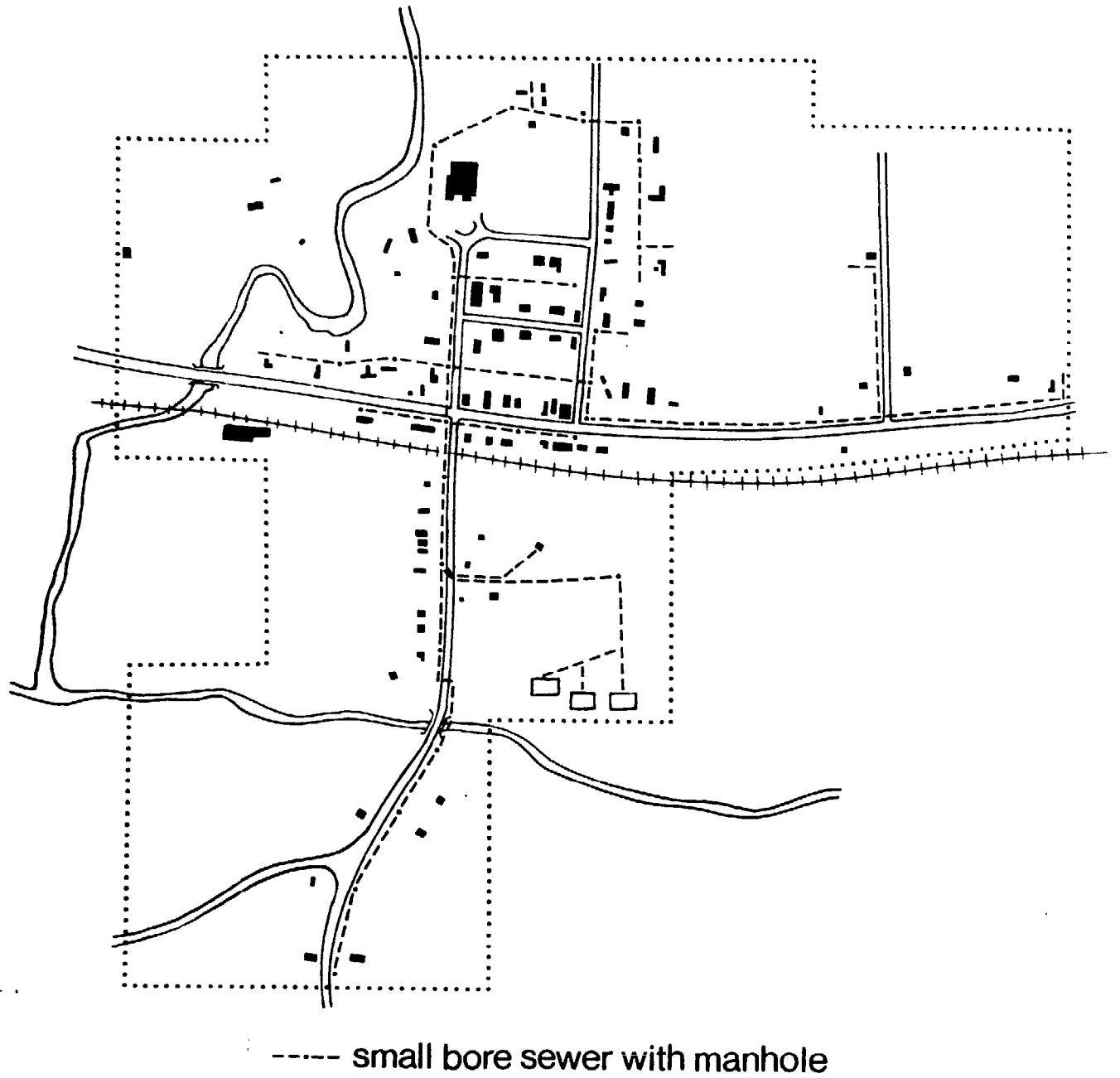

Figure 13. Site plan of the Westboro small bore sewerage systems.

that at Mt. Andrew. The small bore sewers, designed following the South Australian guidelines (para. 4.6), are used to collect effluent from interceptor tanks for direct discharge into a common subsurface soil absorption field without additional treatment (Figure 13)<sup>22/</sup>. The sewers are 100 mm diameter PVC pipes laid at a minimum gradient of 0.67%. Curvilinear alignments in both the horizontal and vertical planes between adjacent manholes were allowed. Manholes were installed at the upstream end of each line, at all junctions and at intervals not exceeding 185 m (spacings greater than the 122 m typically required for conventional sewers were permitted because of the availability of hydraulic jetting equipment able to reach more than 60 m). The few homes with basement drains below the invert elevation of the collector sewers were provided with small residential lift stations. In addition, three community lift stations were necessary.

4.17 Each household has an interceptor tank. Existing septic tanks were used if they were found to be in good condition; if they were not, new prefabricated 3,785 litre (1,000 US gallon) single-compartment tanks were installed regardless of home size. The tanks, whether new or existing, and all other appurtenances, such as the residential lift stations, were purchased by the Westboro Sanitary District, which retained ownership and responsibility for their maintenance. The costs of power to run the residential lift stations are paid by those households requiring them.

4.18 Construction costs of the Westboro system were significantly greater than the Mt. Andrew system, because it is a more conservative design and self-help labor could not be used. In particular, problems involving frost damage to sewer lines in past winters led to specifications requiring that the small bore sewers be buried much deeper than would be required simply on hydraulic grounds, significantly increasing cost; this would not be an issue in the great majority of developing countries. The total cost was US\$245,635 in 1977, representing a cost of US\$2,890 per connection and US\$42.60 per linear metre.

4.19 The small bore sewers have performed well over the six years since the system became operational. The only regular maintenance performed has been pumping of the interceptor tanks. The tanks are desludged on a staggered three-year cycle, except for those located at the larger commercial establishments which are desludged annually. No sewer cleaning has been necessary. Observation of the sewers indicates that they rarely flow more than one-eighth to one-quarter full. Solids accumulation in the sewers is primarily due to slime growths which commonly slough from the pipe wall. However, minor problems have occurred with the system. Infiltration and inflow have become a severe problem during heavy rains or snow melt. The sources have not been positively identified but the individual interceptor tanks are suspected. Covers of two of the 75 new tanks installed have collapsed because of insufficient reinforcement. There is a possibility that others are cracked and so allow groundwater to seep in. Also, the manholes have been found to be a source of grit, stones and other debris, as well as of clear water inflow; fortunately, these

---

<sup>22/</sup> For design criteria for soil absorption field systems, see U.S. Environmental Protection Agency, *Process Design Manual for Land Treatment of Municipal Water*, October, 1981.

Table 1: Unit Costs for Small Bore Sewers. Conventional Sewer and Water Main Installation from Selected Projects in the United States of America

United States Community	INSTALLED PIPE COST PER METRE (1982 \$/M)											
	DEPTH OF COLLECTOR INSTALLATION									WATER MAIN INSTALLATION		
	0 - 2 M			2 - 4 M			4 - 6 M					
	Pipe Dia.		Per- cent Savings	Pipe Dia.		Per- cent Savings	Pipe Dia.		Per- cent Savings	Pipe Diameter		
	100 mm	200 mm		100 mm	200 mm		100 mm	200 mm		100 mm	150 mm	200 mm
West Boro, Wisconsin	\$24.90	-	-	\$29.90	\$37.40	20%	-	-	-	-	-	-
Badgek, South Dakota	-	-	-	\$15.30	\$37.20	40%	-	-	-	-	-	-
South Corning, New York	\$38.50	\$46.80	18%	\$52.90	\$75.60	31%	-	-	-	-	-	-
New Castle, Virginia	\$28.80	\$50.40	43%	\$36.00	\$54.00	33%	-	-	-	\$25.20	\$27.00	\$45.00
Gardner, New York	\$13.90	-	-	\$48.70	\$86.90	44%	\$69.60	\$86.90	20%	-	-	-

materials have been retained largely within the manholes where they can be removed easily. Part of the problem with the manholes is damage to the covers in the course of snow-clearing operations using heavy equipment; this gain would not arise in most developing country applications. Corrosion is becoming severe in the three in-line lift stations where ferrous materials were used. Pump rails, chains and supports for the float switches will soon require replacement with non-corrosive materials. Odors have not been a problem.

## V. COSTS

5.1 Compared to conventional sewerage, small bore sewers can be significantly less costly to construct and operate, and yet provide a similar level of service. With primary sedimentation provided upstream of each connection to remove troublesome solids before the wastes enter the collectors, blockages rarely occur. In addition, flows are attenuated, markedly reducing peak to average flow ratios. As a result, design, construction and maintenance standards established for conventional sewers can be relaxed. For example, without the solids load, small bore sewers need not be designed for self-cleansing. Pipe gradients can be reduced and sections depressed below the hydraulic grade line. This reduces the depth of excavation necessary, but more importantly allows greater construction tolerances, reducing the level of skill required by the contractor and the extent of site supervision by the client agency. Also, access for mechanical cleaning equipment is not necessary since hydraulic flushing, if needed, is sufficient to keep the drains free-flowing. Therefore, curvilinear alignment is permitted and manholes can be replaced by simple cleanouts. Material costs are also reduced because attenuated peak flows allow smaller minimum permissible pipe diameters and smaller lift stations; moreover, pumping equipment, which handles liquids and not solids, can be simpler.

5.2 In Australia, "effluent drains" are required to be laid in the same way as conventional sewers with uniform gradients so as to achieve a minimum of 0.5 m/sec flow velocity. Despite this requirement, construction costs are reported to be 25 to 35% less than conventional sewers. The costs of interceptor tanks and drain connections are borne by the users. If the privately borne costs were to be included in the total costs, however, few savings, if any, would result. Practice in the United States of America is similar to that in Australia. Uniform gradients have been required but in many cases minimum flow velocities have been reduced to 0.3 m/sec. Reported savings in construction costs over conventional sewers range from 0% to 50%. In projects where the reported savings were low, the higher costs were attributed to a high percentage of interceptor tank replacement. Only recently have projects been constructed in the United States where inflective gradients were allowed. Cost savings in these projects are expected to be greater, but as-constructed data are not yet available.

5.3 Table 1 presents unit costs from several projects in the United States<sup>23/</sup>. These costs are presented as dollars (1982) per metre for

---

<sup>23/</sup> Otis, R.J., **Small Diameter Gravity Sewers: An Alternative Wastewater Collection Method for Unsewered Communities.** U.S. Environmental Protection Agency, Cincinnati, Ohio, 1985.



**Table 2: Share of Total Project Cost by Component  
from 10 Uniform Grade Small Bore Sewer projects  
in the United States of America**

<b>COMPONENT</b>	<b>PERCENT OF TOTAL PROJECT COST</b>
<b>In place pipe</b>	<b>29%</b>
<b>Interceptor Tanks</b>	<b>17%</b>
<b>Lift Stations</b>	<b>13%</b>
<b>Service Connections</b>	<b>13%</b>
<b>Street Repair</b>	<b>7%</b>
<b>Street &amp; R.R. Crossings</b>	<b>6%</b>
<b>Residential Lift Stations</b>	<b>3%</b>
<b>Force Main</b>	<b>3%</b>
<b>Site Restoration</b>	<b>3%</b>
<b>Manholes</b>	<b>3%</b>
<b>Cleanouts</b>	<b>1%</b>
<b>Miscellaneous</b>	<b><u>2%</u></b>
	<b>100%</b>

installing collector mains laid with a uniform gradient at various depths. Comparisons between 100 mm pipe and 200 mm pipe laid at the same depth and gradient show 20% to 44% savings. Total projects savings would be greater because with flatter or inflective gradients, small bore sewers would avoid deeper placement. If laid similarly to water mains, costs from the project in New Castle, (Virginia) suggest the savings would exceed 50% over conventional sewers.

5.4 Table 2 summarizes the construction costs by component of the 10 United States uniform grade small bore sewers reviewed. The costs are expressed as a percentage of the total construction costs. This shows that interceptor tanks and service connections account for approximately 30% of the total construction costs. In-place pipe costs also account for approximately 30% of the costs. Thus, even greater savings would result than those experienced in the United States in cases where interceptor tanks already exist and where inflective gradient systems are installed.

5.5 Few operation and maintenance costs data are available. In Australia, where there is nearly 25 years of experience, maintenance has been shown to be required infrequently, simple to perform and relatively inexpensive when compared to conventional sewerage<sup>24/</sup>. Maintenance personnel need not be highly skilled to perform the general maintenance duties. Reasons for the lower costs are that the system needs little water to function because the interceptor tanks remove solids which may cause blockages, the collectors can be laid at shallow depths, making any necessary repairs quick and simple to perform, and the pre-treatment provided by the interceptor tanks can reduce final treatment costs. The most significant maintenance operation is the regular desludging of the interceptor tanks. Frequency of desludging will depend on tank size and user habits, varying between 1 to 10 years.

5.6 In developing countries, the most economical application for small bore sewers is likely to be for the upgrading of areas where existing installations (septic tanks or pour-flush latrines with leach pits) are failing or are not functioning properly because of increased water use or urban expansion, rendering inadequate the area available for septic tank drain fields or on-site disposal of pour-flush effluents and sillage. In these circumstances, the septic tanks can be used as interceptor tanks to reduce the costs of installing the small bore sewers. Upgrading existing sanitation facilities in this manner is far more economical than constructing conventional sewers, not only because of the reduced construction costs but also because small bore sewers are not dependent on a good and reliable water supply to function properly.

---

24/ Environmental Protection Authority. **Comparison of Sewerage and Common Effluent Drainage for Country Townships.** Report No. 65/79 East Melbourne, Australia, 1979.

**INTERCEPTOR TANK VOLUME CALCULATIONS**

1. Interceptor tanks are usually designed as septic tanks, and a recent review of septic tank design has highlighted the wide variety of recommendations made in national codes of practice<sup>1/</sup>. In this Annex a rational design procedure for interceptor tanks is presented, based on the Brazilian septic tank code<sup>2/</sup>.
2. Interceptor tanks are designed to provide space for four separate functions:
  - (a) solids interception;
  - (b) digestion of settled solids;
  - (c) storage of digested solids; and
  - (d) storage of scum.

These functions and their tank volume requirements are discussed in turn.

**Solids interception**

3. The intercepted solids comprise two fractions: those in the tank influent and those which rise up from the sludge layers through flotation by the gases produced therein. Theoretically temperature affects the rate of sedimentation by changing the viscosity of the liquid phase, but in practice its influence is small and usually ignored. However temperature markedly affects the rate of anaerobic digestion and hence gas production; thus with increasing temperatures more solids will rise through flotation. Hydraulic surges which occur as a result of high peak flows over a short period of time also cause some of the settled solids to be resuspended. It is because of these two factors - solids flotation and hydraulic resuspension - that retention times in septic tanks are longer than those normally employed in raw sewage sedimentation tanks. Often a minimum mean hydraulic retention time of one day is used (rather than six hours at dry weather flow in sedimentation tanks), but there is a formula which relates the retention time to the contributing population and the per capita wastewater flow<sup>3/</sup>:

- 
- 1/ J. Pickford, **The Design of Septic Tanks and Aqua-Privies**, Overseas Building Note No. 187, Building Research Establishment, Garston, England, 1980.
  - 2/ **Construção e Instalação de Fossas Septicas e Disposição dos Efluentes Finais**, Norma Brasileira Registrada 7229, Associação Brasileira de Normas Tecnicas, Rio de Janeiro, 1982.
  - 3/ C.M. Fair and J.C. Geyer, **Water Supply and Waste Engineering**, p. 901, John Wiley, New York, 1954. The formula quoted has been changed from US gallons to litres.

$$t_h = 1.5 - 0.3 \log (Pq) \quad (1)$$

where  $t_h$  = minimum mean hydraulic retention time, days  
 $P$  = contributing population  
 $q$  = wastewater flow, lcd

This equation indicates that the required minimum retention time decreases as the population served or per capita wastewater flow increases; it thus makes inherent allowance for the fact that the magnitude of peak flows decreases with increasing flow rates. However, the minimum recommended retention is six hours.

4. The volume required for sedimentation ( $V_h, m^3$ ) is therefore given by the equation:

$$V_h = 10^{-3}(Pq)t_h \quad (2)$$

### Solids digestion and storage

5. Although the digestion of intercepted solids and the storage of digested solids are two separate functions of an interceptor tank, it is necessary to consider them together since currently available field data do not distinguish between them<sup>4/</sup>. The literature on septic tanks is full of references to sludge accumulation rates; reported values vary from 25 litres per capita per annum (lca) to greater than 100 lca. A reasonable estimate of sludge accumulation, based on the average sludge accumulation in 205 American septic tanks, is 0.19 lcd<sup>5/</sup>, equivalent to an annual storage requirement of 70 litres per capita. Thus the combined sludge digestion and storage volume ( $V_s, m^3$ ) is given by:

$$V_s = 70 \times 10^{-3} PN \quad (3)$$

Where  $N$  equals desired interval between successive desludging operations, years.

### Storage of Scum

6. Scum storage requirements are often implicitly included in the solids storage volume, but this is not strictly correct. Scum results from fats and grease in sullage and from toilet paper. A study of 268 septic tanks in the USA indicated that the submerged scum volume (i.e., the volume

---

<sup>4/</sup> Solids digestion is a very temperature-dependent process, and so clearly less volume is required for digestion at higher temperatures. However, more field results are required before a reliable design relationship can be formulated between the digestion rate in interceptor tanks and temperature.

<sup>5/</sup> S.R. Weibel and others, **Studies on Household Sewage Disposal Systems**, Part I, Public Health Service, Environmental Health Center, Cincinnati Ohio, 1949.

below the invert of the outlet pipe) rarely exceeds 0.7 cubic metres<sup>6/</sup>. Thus the maximum submerged scum depth ( $d_{SS}$ , m) is a function of the tank surface area ( $A$ , m<sup>2</sup>);

$$d_{SS} = 0.7/A \quad (4)$$

#### Clear space depth

7. The clear space depth, which is the minimum acceptable depth of the solids settling zone just prior to desludging, comprises the submerged scum clear depth and the sludge clear depth. The submerged scum clear depth is the distance between the underside of the scum layer and the bottom of the outlet "tee", and should be at least 75 mm<sup>7/</sup>. The sludge clear depth is the distance between the top of the sludge layer and the bottom of the outlet "tee"; its minimum value ( $d_{SC}$ , m) is related to the tank surface area as follows<sup>8/</sup>:

$$d_{SC} = 0.82 - 0.26A \quad (5)$$

subject to a minimum value of 0.3 m<sup>7/</sup>. Thus the minimum total clear space calculated as  $(0.075 + d_{SC})$  must be compared with the depth required for sedimentation ( $= V_h/A$ ), and the greater depth chosen.

#### Design example

8. Design an interceptor tank to pretreat the wastewater from a household of 8 persons who produce 70 lcd of wastewater; the tank is to be desludged every three years<sup>9/</sup>. The solution is as follows:

(a) Calculate the minimum mean hydraulic retention time for settleable solids sedimentation from equation [1]:

$$\begin{aligned} t_h &= 1.5 - 0.3 \log(Pq) \\ &= 1.5 - 0.3 \log(8 \times 70) = 0.68 \text{ day} \end{aligned}$$

<sup>6/</sup> T.W. Bendixen, R.E. Thomas, A.A. McMahan and J.B. Coulter, **Effect of Food Waste Grinders on Septic Tanks**, Public Health Service, Robert A. Taft Sanitary Engineering Center, Cincinnati, Ohio, 1961.

<sup>7/</sup> J.A. Cotteral and D.M. Norris, "Septic Tank Systems", **Journal of the Sanitary Engineering Division**, American Society of Civil Engineers, (95 9SA4), 715, 1969.

<sup>8/</sup> R. Laak, "Multi-chamber septic tanks", **Journal of the Environmental Engineering Division**, American Society of Civil Engineers, 106 (EE3), 539, 1980.

<sup>9/</sup> In practice, of course, designers would seek to optimize the combination of tank volume and desludging frequency, so as to produce a least-cost solution. Thus several desludging intervals would normally be considered.

Thus the volume required for sedimentation is given by equation [2] as:

$$\begin{aligned} V_h &= 10^{-3}(Pq)t_h \\ &= 10^{-3}(8 \times 70)0.68 = 0.39 \text{ m}^3 \end{aligned}$$

(b) Calculate the solids digestion and storage volume from equation [3]:

$$\begin{aligned} V_s &= 70 \times 10^{-3}PN \\ &= 70 \times 10^{-3}(8 \times 3) = 1.68 \text{ m}^3 \end{aligned}$$

(c) Assume a cross-sectional area (A) of 3 m<sup>2</sup>. Then:

(i) the maximum depth of sludge ( $V_s/A$ ) is  $(1.68/3)$ , = 0.56 m;

(ii) the maximum submerged scum depth ( $d_{ss}$ ) is given by equation [4] as  $(0.7/3)$ , = 0.23 m;

(iii) the minimum sludge clear space is given by equation [5] as  $[0.82 - (0.26 \times 3)]$ , = 0.04 m; this is less than the minimum of 0.3 m which is therefore adopted;

(iv) the total clear space depth is therefore  $(0.075 + 0.3)$  m, = 0.375 m; this is greater than  $(V_h/A)$ , =  $(0.39/3) = 0.13$  m, so the total clear space is the controlling factor in the design.

(d) The total effective depth is therefore the sum of the sludge depth (0.56 m), the clear space depth (0.375) and the maximum submerged scum depth (0.23 m), i.e. 1165 mm.

(e) Thus suitable overall internal dimensions of the tank would be 1 m x 3 m x 1.5 m, as shown in Figure I.1.

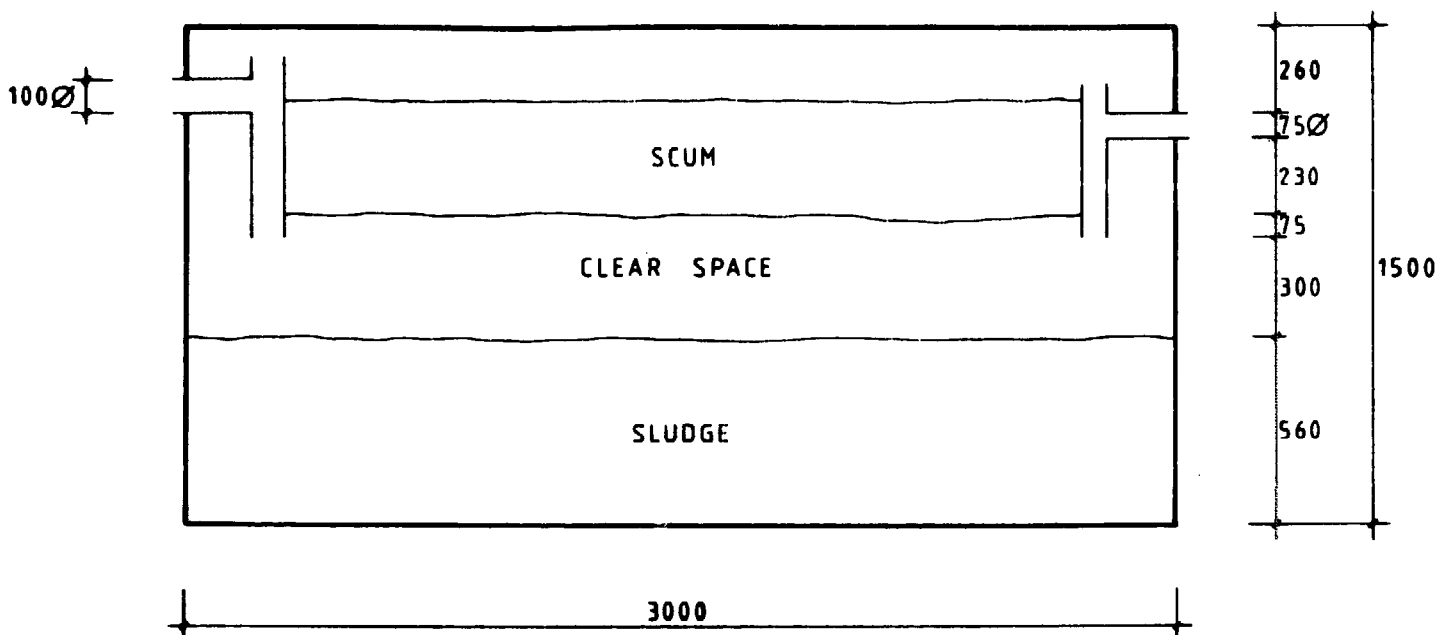

Figure I.1. Dimensions of design example interceptor tank.

**SMALL BORE SEWER DESIGN EXAMPLES****Example #1**

1. A single small bore sewer is to be constructed to serve 20 lots, of which only 10 have been built to date (Figure II.1). Each existing house has a multiple tap in-house level of water supply service. Provision must be made for the future connection of 10 lots located above the present upstream terminus of the sewer. The design (peak) flow is 0.025 litre/second per connection.

2. **Solution.** Firstly, individual sections of the sewer are selected for hydraulic analysis on the basis of isolating sections with relatively uniform gradients or flows. In this case nine sections were chosen, as shown in Figure II.1.

3. The hydraulic calculations are presented in Table II.1 and described, column by column, below:

**Column 1: Station number**

Numbers relating to the commencement of each sewer section and starting from the downstream terminus of the sewer.

**Column 2: Station elevations**

The elevation in metres, of each station above a datum (which in this case is the elevation of Station 1).

**Column 3: Distance**

The distance, in metres, of each station from Station 1.

**Column 4: Elevation difference over section**

The difference, in metres, between the elevations (column 2) of adjacent stations.

**Column 5: Length of section**

The difference, in metres, between the station distances (column 3) of adjacent stations.

**Column 6: Average slope of section**

Column 4 divided by column 5 gives the average slope of the section in m/m.

**Column 7: Number of connections served**

The number of lots connected upstream of the downstream station of the section.

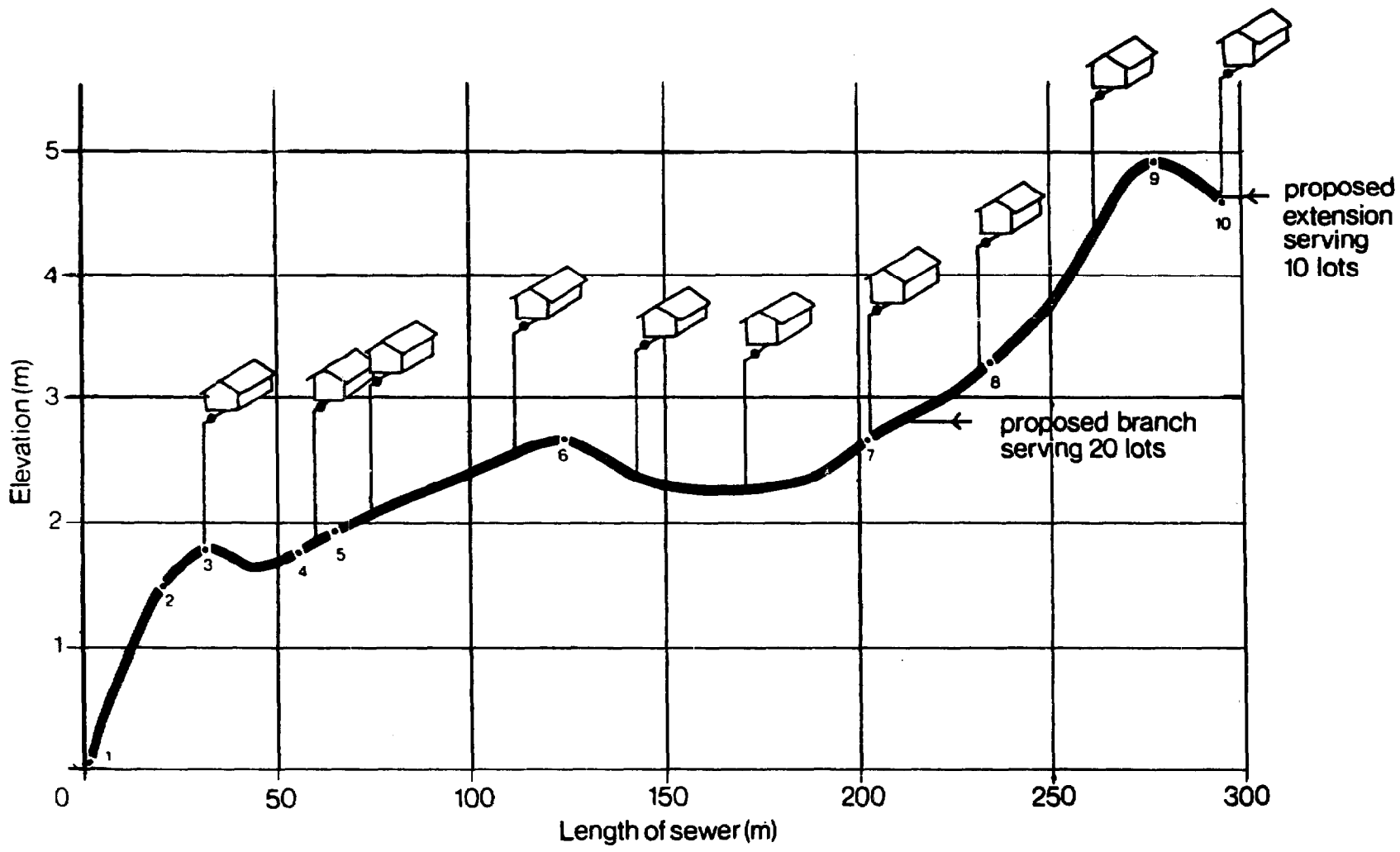

Figure II.1. Sewer profile for design examples



**Column 8: Design flow**

Column 7 multiplied by 0.025 (the design flow in litre/second per lot) gives the flow in the section in litres/second.

**Column 9: Pipe diameter**

The pipe diameter, in mm, selected by the designer for each section. Initial choices may prove inadequate and the pipe size may have to be increased (see column 10).

**Column 10: Flow at full pipe**

The capacity of the selected pipe diameter is calculated for the slope computed in column 9. Manning's equation was used in this example with a roughness factor (n) of 0.013 for plastic pipe. The flow at full pipe must be greater than the design flow (column 8). If it is not, a larger size pipe must be used or the slope increased.

4. The critical sections in small bore sewer designs are: (a) those that are continuously flooded; and (b) those laid level. In this example, three sections of the sewer will remain full at all times: the sections between stations 3 and 4; 6 and 7; and 9 and 10. These sections must be carefully analysed hydraulically to ensure that they do not become excessively surcharged during peak flow periods and back up into any connections. To check this, the maximum elevation to which the hydraulic gradient rises must be determined. The elevation difference between this elevation and the downstream outlet from the flooded section establishes the maximum permissible slope of the hydraulic gradient over the surcharged section. In the above example, for the section between stations 3 and 4, Manning's equation is used to calculate the hydraulic gradient for the 50 mm pipe flowing full: this is 0.0035 m/m and this is equivalent to the hydraulic grade line rising (0.0035 x 24, the latter figure being the section length), i.e. 0.08 m above the upstream station. The invert of the outlet of any interceptor tank discharging into the sewer along this section must be above the hydraulic grade line in order to avoid backflow into the tank during periods of peak flow. If this is not possible, then a larger pipe diameter must be chosen, or an individual lift station provided, or the sewer elevation at the downstream station lowered; the choice between these options is essentially economic, although (especially in developing countries) the consequence of pump failure in the lift station must be taken into account.

**Example #2**

5. This design example is the same as the first example, except that a branch sewer line serving 20 additional lots discharges into the sewer just upstream of station 8.

6. Solution. The hydraulic calculations are shown in Table II.2. They are essentially the same as those in Table II.1, except that in two sections 75 mm diameter pipe is needed as a result of the higher flow.

Table II.1. Hydraulic calculations for design example #1.

(1) Station number	(2) Station elevation  (m)	(3) Distance  (m)	(4) Elevation Difference over section  (m)	(5) Length of section  (m)	(6) Average slope of section  (m/m)	(7) Number of connec- tions served	(8) Design flow  (L/S)	(9) Pipe Diameter  (mm)	(10) Flow at full pipe  (L/S)	(11) Comments
1	0.00	0	1.65	21	0.079	20	0.50	50	2.27	
2	1.65	21	0.12	9	0.013	20	0.50	50	0.92	
3	1.77	30	0.00	24	0.00 0.0035 <u>a/</u>	19	0.48	50	- 0.48	Hydraulic gradeline 0.08 m above station 4
4	1.77	54	0.18	9	0.02	19	0.48	50	1.14	
5	1.95	63	0.67	64	0.01	18	0.45	50	0.81	
6	2.62	127	0.00	74	0.00 0.0024 <u>a/</u>	16	0.40	50	- 0.40	Hydraulic gradeline 0.18 m above station 7
7	2.62	201	0.61	34	0.018	14	0.35	50	1.08	
8	3.23	235	1.71	43	0.04	13	0.33	50	1.62	
9	4.94	278	-0.28	17	-0.017 0.0012 <u>a/</u>	11	0.28	50 50	- 0.28	Hydraulic gradeline 0.02 m + 0.28, i.e. 0.30 m above station 10
10	4.66	295								

a/ Slope of hydraulic gradeline.

Table II.2. Hydraulic calculations for design example #2.

(1) Station number	(2) Station elevation  (m)	(3) Distance  (m)	(4) Elevation Difference over section  (m)	(5) Length of section  (m)	(6) Average slope of section  (m/m)	(7) Number of connec- tions served	(8) Design flow  (L/S)	(9) Pipe Diameter  (mm)	(10) Flow at full pipe  (L/S)	(11) Comments
1	0.00	0	1.65	21	0.079	40	1.0	50	2.27	
2	1.65	21	0.12	9	0.013	40	1.0	50	0.92 <sub>a/</sub>	
3	1.77	30	0.00	24	0.00 0.015 <sub>a/</sub>	39	0.98	50 50	- 0.98	Hydraulic gradeline 0.35 m above station 4
4	1.77	54	0.18	9	0.02	39	0.98	50	1.14	
5	1.95	63	0.67	64	0.01	38	0.95	50 76	0.81 2.38	
6	2.62	127	0.00	74	0.00 0.012 <sub>a/</sub>	36	0.90	50	- 0.90	Hydraulic gradeline 0.92 m above station 7
7	2.62	201	0.61	34	0.018	34	0.85	50	1.08	
8	3.23	235	1.71	43	0.04	13	0.33	50	1.62	
9	4.94	278	-0.28	17	-0.017 0.0012 <sub>a/</sub>	11	0.28	50 50	- 0.28	Hydraulic gradeline 0.30 m above station 10
10	4.66	295								

a/ Slope of hydraulic gradeline.

7. It is worth noting that the two sections of 75 mm diameter pipe both discharge into sections of 50 mm diameter pipe. This is one of the major differences between small bore sewers and conventional sewers (in which pipe diameters of downstream sections are always equal to or greater than that of upstream sections), and is only possible because all large solids are removed in the interceptor tanks.

#### **Sewer diameter**

8. In both design examples the hydraulic analysis indicates that 50 mm diameter pipe is suitable for all or many of the sections. Since this is less than the recommended minimum of 100 mm (see section 2.24), in practice the sewer would be 100 mm diameter throughout its length.