

UC-NRLF



\$B 32 946

AEROPLANE CONSTRUCTION

SYDNEY CAMM

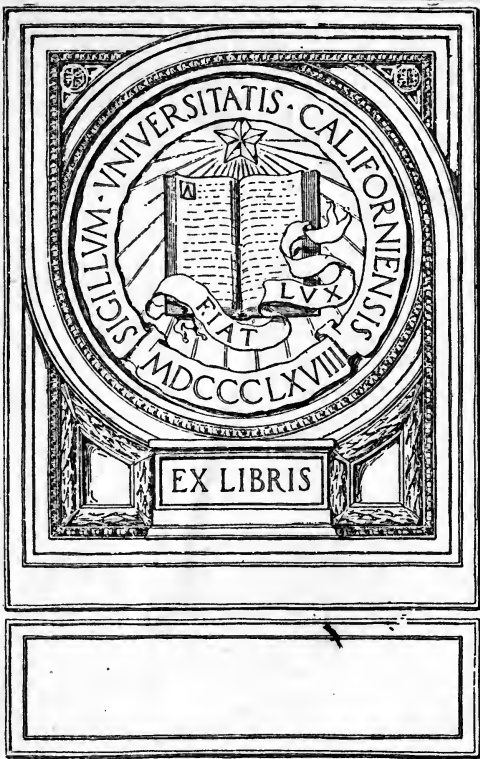

EX LIBRIS

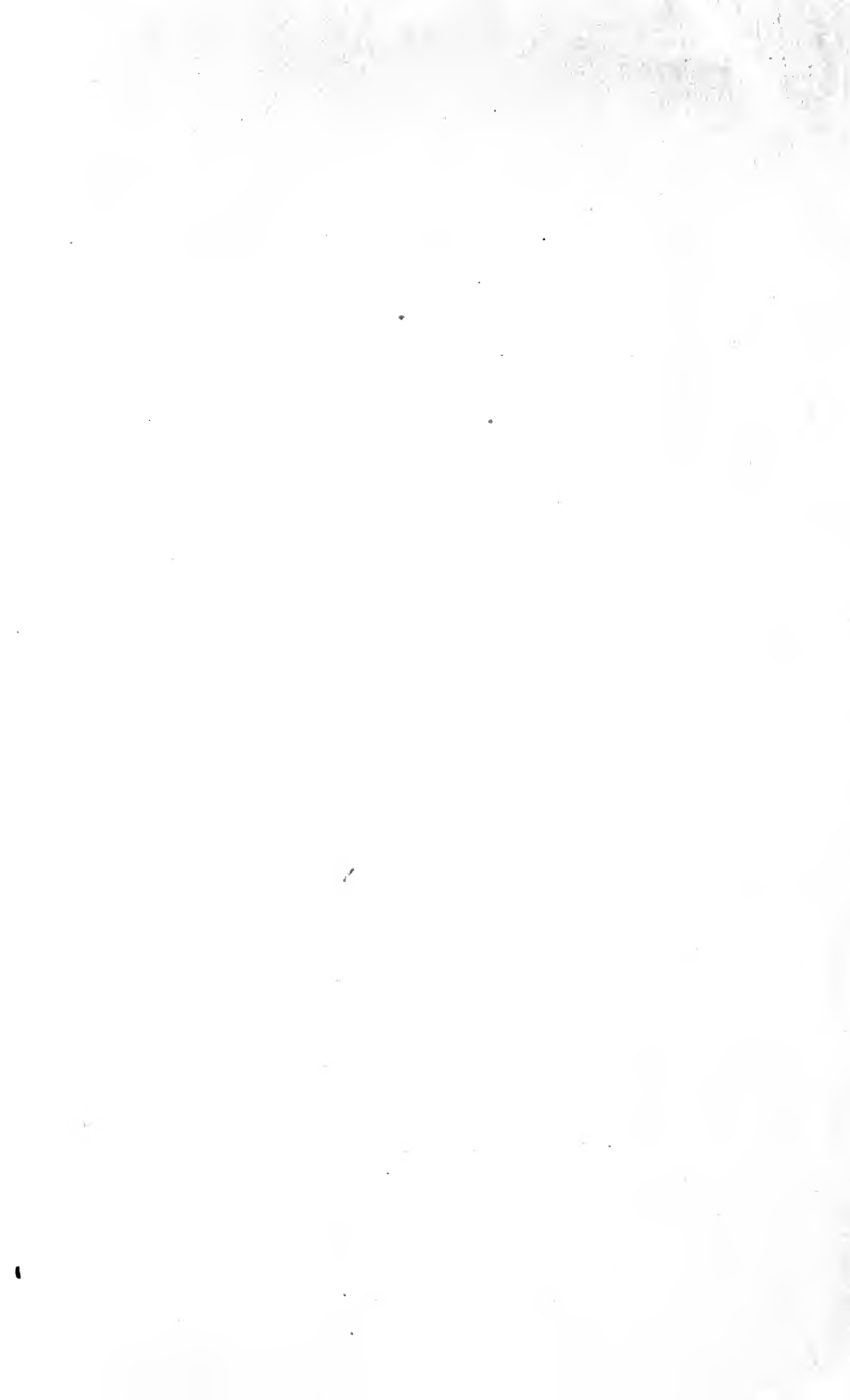

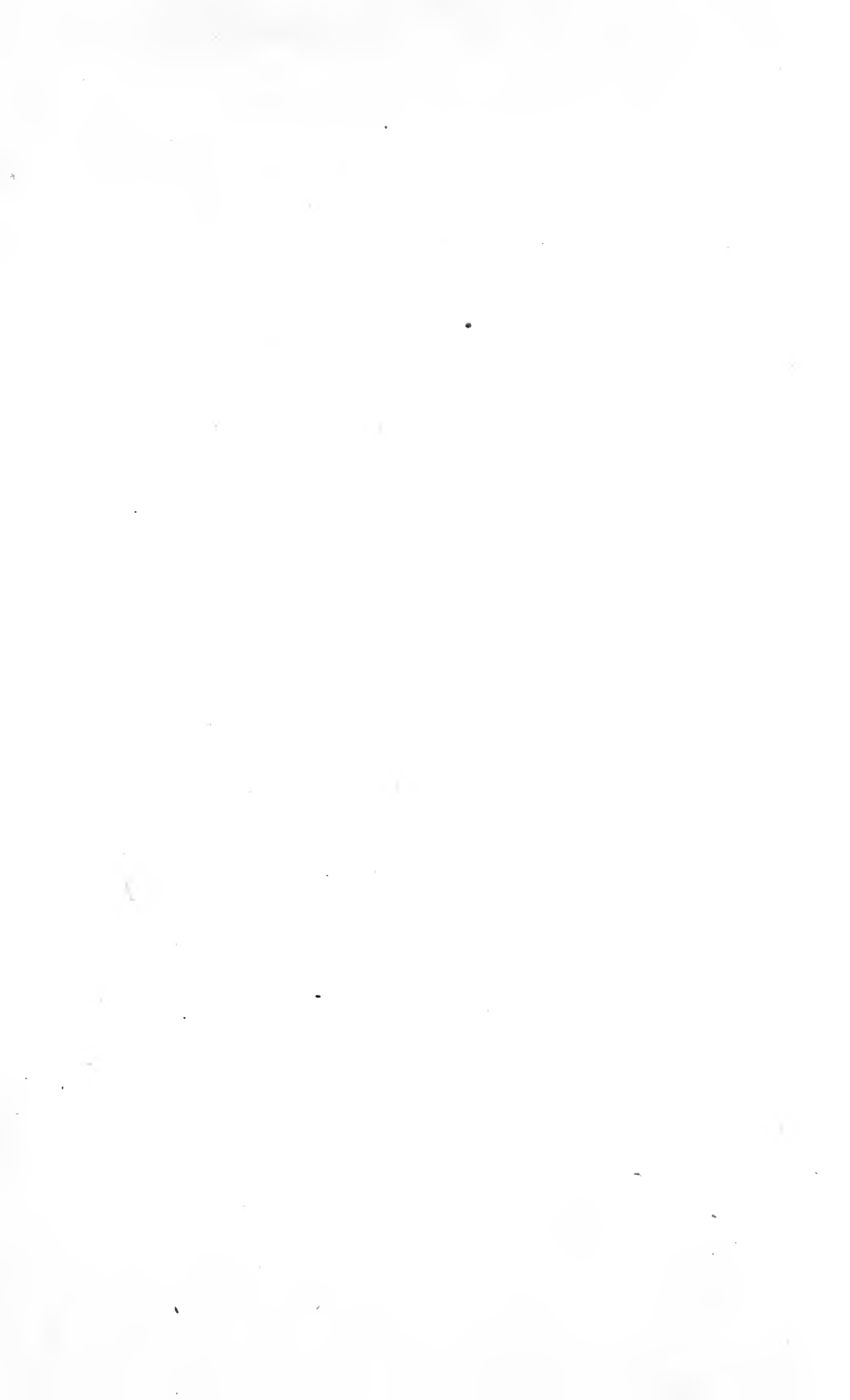

AEROPLANE CONSTRUCTION

*A Handbook on the various Methods and
Details of Construction employed in
the Building of Aeroplanes*

BY

SYDNEY CAMM

ASSOCIATE FELLOW ROYAL AERONAUTICAL SOCIETY



LONDON
CROSBY LOCKWOOD AND SON
7, STATIONERS' HALL COURT, LUDGATE HILL

1919

T2671

12

C3

PRINTED BY
WILLIAM CLOWES AND SONS, LIMITED,
LONDON AND BECCLES.

PREFACE

THE articles embodied with other matter in this book, were intended as a broad survey of the principles and details of modern aeroplane construction, concerning which there is a noticeable deficit amongst existing aeronautical literature.

They were written at a time when specific references to modern British aircraft were forbidden, and although from a comparative point of view this is to be regretted, the details and methods dealt with are, in the author's opinion, representative of those most generally used in machines of present-day design. It is hoped that the book will appeal not only to those engaged on the manufacture, but also to those concerned with the uses of aircraft.

S. C.



TABLE OF CONTENTS

	PAGE
CHAPTER I.	
INTRODUCTION	1
CHAPTER II.	
MATERIALS	6
CHAPTER III.	
SPARS AND STRUTS	18
CHAPTER IV.	
PLANE CONSTRUCTION	30
CHAPTER V.	
DETAILS OF PLANE CONSTRUCTION	40
CHAPTER VI.	
INTERPLANE STRUT CONNECTIONS	51
CHAPTER VII.	
WING-TRUSSING SYSTEMS	59
CHAPTER VIII.	
FUSELAGE CONSTRUCTION	67
CHAPTER IX.	
FUSELAGE FITTINGS	77

CONTENTS

	PAGE
CHAPTER X.	
UNDERCARRIAGE TYPES	86
CHAPTER XI.	
UNDERCARRIAGE DETAILS	93
CHAPTER XII.	
CONTROL SYSTEMS	101
CHAPTER XIII.	
WIRES AND CONNECTIONS	108
CHAPTER XIV.	
ENGINE MOUNTINGS	116
CHAPTER XV.	
ERECTION AND ALIGNMENT	123
INDEX	135

AEROPLANE CONSTRUCTION

CHAPTER I.

INTRODUCTION.

THE purpose of this book is to give some indication of the principles and methods of construction of modern aeroplanes, as distinct from those considerations pertaining purely to design, although occasional references to various elementary principles of aerodynamics have been found necessary to illustrate the why and wherefore of certain constructional details.

To many the aeroplane is a structure of appalling flimsiness, yet the principle which it exemplifies, that of obtaining the maximum strength for a minimum of weight, constitutes a problem of which the solving is not only an unceasing labour, but one demanding the observance of the best engineering procedure. The whole future of aviation, commercially or otherwise, may be said to be indissolubly bound up with the development of efficiency; and whether this is to be attained in improvements in aerodynamical qualities, by the discovery of a material giving a greatly enhanced strength to weight ratio, or by progress in the arrangement of the various members of the complete structure of the aeroplane, is a matter upon which some diversity of opinion exists. However, it is certain that the very great developments of the last few years are due more to refinements in design rather than construction; and it is questionable whether the constructional work of the modern aeroplane has developed equally with design, so that, even taking for granted the oft-repeated,

but very doubtful, statement that we are approaching the limitations of design, there is certainly plenty of scope for experiment and improvement in the constructional principles of the modern aeroplane.

Standardization of Details.

Whatever may be said for the standardization of aeroplane types, a scheme which should effect a considerable saving in labour and material, and which offers chances of success, would consist in the standardization of metal fittings and wood components generally, for in this direction there is certainly great need for improvement. Taking as a hypothesis the various makes of scouting machines, we find hardly any two details the same. This means that if in this country there are six firms producing machines of their own design (these figures, of course, being purely suppositionary), there will be six sets of detail drawings, six sets of jigs, templates, and press tools, and sundry special machine tools. There seems no valid reason why many of the fittings for all machines within certain dimensions should not be of standard design, and a brief review of the various details which could be standardized without detracting in the least from aerodynamical efficiency will indicate the extent to which the conserving of labour could be carried. In the construction of the fuselage, the clips fastening the longerons and cross struts could easily be of one design, whatever the make of the machine. At present we find some clips are bent up from a stamping and attached to the longeron without the drilling of the latter; some built up from various parts, such as washer-plates, duralumin pressings, and bolted through the longeron; while some combine advantages and others the disadvantages of both. In some cases the longerons of spruce are spindled out for lightening; in others no spindling occurs; while in a few instances hickory or ash, with or without channelling, is used. There are the interplane strut attachments, stern-post fittings, control-surface hinges, and under-carriage attachments, all showing great variations, and in all of which the design could be brought within reasonable limits.

As indicating how unnecessary a good deal of the variation is, one may instance the fact that for the swaged streamline, or R.A.F. wires, there are at least three different terminals in use. Although more difficult of achievement, there is scope for improvement in the different arrangements for the fixed gun mounting, while a standard instrument board would benefit the pilot.

Methods of Manufacture.

It is fairly well known that the output of some firms is considerably better than others, although the machines are of the same design. Although a good many factors may contribute to this result, it seems fairly certain that in some cases the methods of manufacture must be superior, which calls for some system of standardizing the broad principles pertaining to manufacturing procedure. Under this arrangement a much better estimate of probable output could be made. It is also necessary by the fact that some firms have been developed through the exigencies of war, and not as a result of any great manufacturing ability, whereas in peace time the spur of competition would force the adoption of the most rapid methods of production. The creation of a central or universal office for the design of the various jigs used in the manufacture of aircraft, with power to decide the process of manufacture, although a somewhat far-reaching reform, would certainly eliminate a number of useless experiments made by the individual constructors, and would also greatly improve the interchangeability of the various components. In addition, fresh firms to the aviation industry would be at once acquainted with the general methods of manufacture, which should be of considerable assistance in expediting initial output. Of course, this system would tend rather to destroy individual initiative, in that much that is now left to the skill and experience of the workman would be predetermined, although this would be more than compensated for by the increased benefits accruing to the State. Jigs designed to produce the same work in different works often differ in detail considerably, and this, of course, often influences the

rate of production. As an instance, in some works elaborate benches are considered necessary for the erection of fuselages, while in others a pair of trestles suffices. With this system of unified manufacturing procedure extreme regard would have to be paid, in the design of various jigs and fixtures, to adaptability for modifications in design. Otherwise the various alterations which are bound to occur would result in an unnecessary expenditure on fresh jigs. It is somewhat unfortunate that in the general design of an aeroplane, in numerous cases, far too little regard is paid to considerations of ease of manufacture, and this is frequently responsible for the many changes in design after a contract has been started. Under an ideal system of standardization, the requirements of manufacture would necessitate consideration in the design of the constructional details.

Metal Construction.

The question of the aircraft materials of the future is not so much a problem as a matter of gradual evolution. In view of the dwindling supplies of suitable timber, it certainly seems more than probable that some form of metal construction will one day constitute the structure of the aeroplane. The manufacture of the various components in wood does not necessitate an extensive plant, the labour necessary is comparatively cheap and easily available, and moreover the transitory nature of the whole business, and the ease with which essential changes in type can be made without the wholesale scrapping of the expensive jigs associated with the use of steel, all strengthen the case in favour of wood. The conclusion of hostilities would introduce another state of affairs, and it is conceivable that the various types will then be standardized for different purposes, which may necessitate the greater use of steel. Certainly the advantage of steel would be better realized under some system of standardized design, but this unfortunately is not possible while present conditions obtain. The advantages of metal as a material considered briefly, are that it permits of design to close limits without the allowance of so-called factors of safety, which are now necessary through

the great variation in the strengths of wood, manufacturing procedure would be expedited, while one can reasonably expect a greater degree of precision in the finished machine, due largely to the increased facilities for accurate manufacture of components which metal affords. It is quite possible, of course, given a uniform grade of steel, to design to extremely close limits without fear of collapse; but the human factor in the shape of fitter, welder, or operator introduces the unknown element, and one for which some allowance must always be made. One cannot assert that any very decided indication exists of a trend in modern design towards metal construction, and it is quite possible that this will not arrive until it is rendered imperative by reason of the scarcity of timber. The precise composition of the metal is rather a controversial matter, some authorities favouring steel, and others some alloy of aluminium, such as, for instance, "duralumin." The production of a suitable alloy constitutes a real problem and one upon which the Advisory Committee for Aeronautics have already made investigations and experiments. A disadvantage with steel is that, although it is quite possible to produce, say, a fuselage entirely of this material to withstand easily the greatest stress encountered in flying, such a structure, owing to the thin nature of the various components, would suffer damage through shocks induced by rolling over rough ground, and also by handling. In addition the effects of crystallization would require some considerable study. These and other reasons indicate that an alloy of aluminium, which for a given weight would be considerably more rigid than steel, offers possibilities as a material. It might prove advantageous to combine both metals, using steel for the more highly stressed parts, such as, for instance, wing spar attachments, inter-plane bracing lugs, and indeed any part where the load to be carried is one induced by tension.

The foregoing is indicative of some of the more important directions in which improvement and development are possible, and certainly ample scope yet exists for the attention of the student, or indeed any one interested in the future of the aviation industry.

CHAPTER II.

MATERIALS.

SEEING that wood constitutes the material for the greater part of the structure of the aeroplane, that is with very few exceptions, some notes on the characteristics and qualities of those woods most commonly used may prove of interest. The choice of a suitable wood for aircraft construction is a matter of some difficulty, engendered by the variety of considerations of which at least some observance is essential. The fundamental principle of aircraft construction, that of obtaining the maximum strength for a minimum of weight, affords one standpoint from which a particular wood may be regarded, but this does not constitute in itself a sufficient reason for its choice. Of almost equal importance are such considerations as the length and size of the balks obtainable from the log, the total stock available, the relative straightness of grain and freedom from knots as well as the durability of the wood.

Variable Qualities of Wood.

The choice is additionally complicated by the very great variation found in the strength and characteristics of trees of exactly the same species, and also of different portions cut from the same tree. The nature of the site upon which a tree is grown exercises a marked influence upon its properties, while as a general rule, it may be taken that the greater number of annual growth rings per inch, the greater the strength. It is also a general rule that up to certain diameters, the timber contained in that part of the tree the greatest distance from the pith, or centre, is the stronger.

The wood obtained from the base of a tree is heavier than that at the top, and one finds the influence of this in the necessity for balancing and alternating the different laminae of air-screws before gluing.

Shrinkage.

Another point, and one which is intimately concerned with the proper seasoning of timber, is the amount of moisture contained in a specimen, and this latter point is of some considerable importance, as not only is a large amount of moisture detrimental to the strength values of the timber, but it also renders useless any attempt at precision of workmanship. It is this very point of shrinkage, which constitutes the greatest bar to the achievement of a measure of component standardization, and it is also one of the most serious disabilities of wood as a material for aircraft construction. It is now necessary in the production of finished parts to make some allowance for resultant shrinkage, which is a matter of guesswork, and only practicable where some time will elapse between the finishing of the part and its erection in the complete machine. Under present conditions, more often than not the parts are assembled almost immediately they are made, which means that no allowance over the actual size is possible, this being due to the various fittings which in the majority of machines are of set dimensions and clip or surround the material.

As a natural sequence shrinkage occurs subsequent to the attachment of the fitting, followed by looseness and loss of alignment in the structure. Until the proper period for seasoning can elapse, between the cutting of the tree and its conversion into aeroplane parts, it is difficult to see how this disability can be obviated, although latterly some considerable advances have been made with artificial methods of seasoning. The prejudice against kiln drying is founded on the belief that the strength of the timber is reduced, and that extraneous defects are induced. A method which is a distinct improvement on those systems, using superheated steam and hot air, is now being used with apparently good results. In this

system, steam under very low compression is constantly circulated through the timber, drying being effected by a gradual reduction in the humidity of the atmosphere.

Unreliability of Tabulated Tests.

The various tables which exist indicating the strength, weight, and characteristics of various woods are of very doubtful utility, in some cases fallacious, and in nearly all cases far too specific. The foregoing enumeration of some of the variations existing with wood will indicate the enormous difficulty of obtaining with any exactitude a result representative of the species of wood tested, and which could be regarded as reliable data for the calculation of stresses, or for general design. The moisture content of timber, an extremely variable quantity, greatly affects the figures relating to the strength and weight of timber, so that tables indicating the properties of woods should include the percentage of moisture contained in the examples tested. Again, certain woods possessing relatively high strength values, are frequently short-grained and brittle, and therefore not so suitable as other woods of lower strength values, but of greater elasticity and resiliency.

WOODS IN USE.

Silver Spruce.

The wood most extensively used for the main items of construction is silver spruce, or Sitka spruce, found in great quantities in British Columbia. Experience has proved this wood pre-eminently suitable for aeroplane construction, its strength-weight ratio is particularly good, it can be (at least until recently) obtained in long lengths up to 30 ft., and, moreover, is particularly straight grained and free from knots and other defects. There are other woods possessing higher strength qualities, but in most cases their value is greatly diminished by reason of the greater weight, and that only a limited portion straight of grain and free from knots is obtainable. The weight of Sitka spruce varies from 26 to 33 lbs. per cubic foot, and although it is difficult to give a precise

figure, a good average specimen fairly dry would weigh about 28 lbs. per cubic foot. Some impression of the extent to which it enters into the construction of the aeroplane will be gathered if the components usually of spruce are detailed. For the main spars of the planes spruce is almost universally used, as here great strength for the least weight is of extreme importance, while a consideration almost as important is the necessity of a good average length, straight grained and free from defects. It is also used for the webs and flanges of the wing ribs, the leading and trailing edges and wing structure generally. The longerons or rails of the fuselage of many machines are spruce, although in this instance ash and hickory are used to a moderate extent. The growing practice is to make the front portion of the fuselage of ash, as this is subject to the greater stress, while the tail portion is of spruce; but in a number of cases the latter material is used throughout. The cross struts of the fuselage are invariably of spruce, as well as such items as inter-plane and under-carriage struts and streamline fairings.

Virginia Spruce.

This is of a lower weight per cubic foot than Sitka spruce, but does not possess such a good strength value, cannot be obtained in such large pieces, and is generally subject to small knots, which limit the straight-grained lengths procurable.

It is distinguishable from Sitka spruce by its whiteness of colour and general closeness of grain.

Norwegian Spruce.

This wood is also known as spruce fir and white deal, and is grown principally in North Europe. Selected balks can be obtained to weigh no more than 30 lbs. per cubic foot, which compares very favourably with silver spruce. It can be obtained in average lengths, but it is subject to the presence of small hard knots and streaks of resin, although the writer has seen consignments with very few knots. A material known as Baltic yellow deal and Northern pine is procured

from the same source, and is more durable than Norwegian spruce. It is inclined to brittleness when dry, and is heavier than white deal, weighing about 36 lbs. per cubic foot. The recent shortage of silver spruce has led to the employment of Norwegian spruce for items such as fuselage struts, hollow fairings to tubular struts, the webs and flanges of the plane ribs, and generally for those components for which long straight-grained lengths are not absolutely essential.

For fuselage struts, where the chief consideration is stiffness, to resist the bending strain produced by inequalities of wiring, fittings, etc., it may actually give better results, being slightly more rigid than silver spruce—at least that is the writer's experience of it. In addition, very little increase in weight would result, as this wood can be obtained of almost the same weight per cubic foot as silver spruce. The defect usually met with in this wood, of knots occurring at intervals, would be of no great detriment, the lengths needed for the fuselage struts being approximately 3 feet and less, and it would therefore be easily possible to procure wood of this length free from knots. The other items enumerated are of varying lengths, which, with care in selection and conversion, could be arranged for. The practical application of this would be the increased amount of silver spruce available for such highly stressed items as wing spars, interplane struts, and longerons.

Ash.

This wood is one of the most valuable of those employed, being extremely tough and resilient. There are two varieties in use, English and American, the former being considered the better material. It is used mainly for longerons, undercarriage struts, and for all kinds of bent work. It possesses the quality of being readily steamed to comparatively sharp curves, and will retain the bend for a considerable period. The strength and characteristics of ash vary greatly with the climate under which it is grown, and it is also much heavier than spruce, the weight per cubic foot ranging between 40 and 50 lbs. Difficulty is also experienced in obtaining lengths

greater than 20 ft., and even in lengths up to that figure, continuity of grain is somewhat rare. It is notable that on various German machines, ash in conjunction with a species of mahogany is used for the laminæ of the air-screw.

Hickory.

Hickory, a species of walnut, is imported from New Zealand and America, and possesses characteristics similar to those of ash. It is obtainable in about the same lengths as ash, but in the writer's experience is of greater weight. Its chief property is extreme resiliency, which makes it especially suitable for skids, and it has also been used to a limited extent for longerons. It is subject to excessive warping in drying, is not so durable as ash, and the great difficulty experienced in obtaining straight-grained lengths is responsible for its waning popularity.

Walnut.

This wood is almost entirely devoted to the making of air-screws, although the dwindling supplies and the very short lengths obtainable has practically enforced the employment of other woods for this purpose.

Mahogany.

The term "mahogany" covers an infinite variety of woods, possessing widely different characteristics, many of the species being quite unsuitable for the requirements of aircraft work. That known as Honduras mahogany possesses the best strength values, is of medium weight, about 35 lbs. per cubic foot, and is in general use for airscrews and seaplane floats. It has been used on some German machines for such parts as rib webs, but is not really suitable for parts of comparatively small section, such as longerons, as it is inclined to brittleness. It is of particular value for seaplane floats and the hulls of the flying-boat type of machine, as it is not affected by water. A defect peculiar to Honduras mahogany is the occurrence of irregular fractures across the grain known as thunder shakes. Although other so-called mahoganies are

similar in appearance to the Honduras variety, a species quite distinct in appearance is that known as Cuban or Spanish mahogany, which is of darker colour, and much heavier in weight, averaging about 50 lbs. per cubic foot, which latter factor almost precludes its use for aeroplane construction.

Birch.

One finds very few instances of the use of this wood for aeroplane details, although it is used fairly extensively in America for air-screw construction, for which it is only moderately suited. It possesses a high value of compressive strength across the grain, but is much affected by climatic changes, and does not take glue well. It is useful for bent work, and might conceivably be used instead of ash for small bent work details. Its weight is about 44 lbs. per cubic foot.

Poplar.

Under this name is included such woods as American whitewood, cotton wood, bass wood, etc. The wood sold under one or other of these names is generally very soft and brittle, and although of a light nature, weighing about 30 lbs. per cubic foot and less, it is of very little utility for the work under discussion. It has been used for minor parts such as rib webs, and fairings to tubular struts.

Oregon Pine.

The scarcity of silver spruce has led to the adoption of the wood known as Oregon pine for most of the components for which the former wood has hitherto been used. The term "Oregon pine" is applied to the Douglas fir, one of the largest of the fir species, a length of 200 ft. being an average. It is altogether heavier than silver spruce, weighing about 34 lbs. per cubic foot, and also differs greatly in appearance, possessing a reddish-brown grain, with very distinct annual rings. Its strength to weight ratios are practically equal to those of silver spruce, although in the writer's experience it has a tendency towards brittleness, and is not so suitable as Sitka spruce for components of small scantling. With some specimens of this

wood it is noticeable that the effect of drying on freshly sawn lengths for longerons, etc., is the appearance of "shakes" or cracks, not previously discernible. Its appearance generally is reminiscent of pitch pine, for which wood it is sometimes substituted in connection with building.

Other Woods.

The foregoing constitute woods which are in fairly general use for one purpose or another, there being, of course, very many other varieties, some of which may be called into use with the progress of the industry. Of the conifer species, silver spruce is easily the most suitable timber for aeroplane construction, and one realizes this more as the various substitutes are tried. As an instance, cypress is straight of grain with no very great increase over the weight of spruce, being also well up the table of strengths. It is, however, much too brittle for the various members of small section of which an aeroplane is composed, and does not seem to have any extensive future for aircraft work. Another, at one time much-advertised wood, is Parang, a species of mahogany. It has been reputed to bend well, but it certainly does not enter into the construction of modern aeroplanes. A consignment handled by the writer some years ago and intended for bending, was found to be exceedingly brittle, and although standing a good load, fractured almost square across the grain, in a manner known colloquially in the workshop as "carrot-like." The latter term is indicative of a characteristic which precludes the use of many woods possessing other physical properties especially suitable for aircraft work.

Multi-ply Wood.

This term is applied to the sheets of wood composed of a number of thin layers glued together with the grain reversed. As the layers are obtained by rotating the tree against cutters in such a manner that a continuous cut is taken from the outside almost to the centre, it is possible to get very great widths, which makes it particularly suitable for aircraft work. It is made in varying widths up to 4 ft., and in thickness

from $\frac{1}{20}$ in. up to $\frac{1}{2}$ in., consisting of three, five, and seven layers, although the three-ply variety in thicknesses up to $\frac{3}{16}$ in. is more commonly used. It is made up in nearly all woods, but those mostly utilized in the aeroplane industry are birch, ash, poplar, and satin-walnut, birch being superior by reason of its closeness of grain. Ash ply-wood in some instances tends towards brittleness, while poplar, although exceptionally light, is very soft and only used for minor parts. Satin-walnut is very even in quality but is apt to warp.

Defects in Timber.

Perhaps the most common and prolific defect encountered with the use of timber is the presence of cracks or shakes of different character, which are due to different causes. Fig. 1 indicates a very common form, known as a "heart shake,"



FIG. 1.—Heart shake.

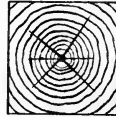

FIG. 2.—Star shake.

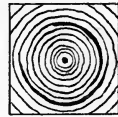

FIG. 3.—Cup shake.

dividing the timber at the centre; while Fig. 2, a "star shake," is really a number of heart shakes diverging from the centre. The process of seasoning sometimes results in the separation of the annual rings, forming cup shakes, as shown in Fig. 3. It should be understood that the presence of

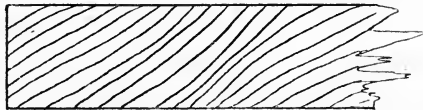

FIG. 4.—Twisted grain.

shakes may render useless an otherwise perfect specimen of timber, as it frequently happens that in the conversion of timber so affected the usable portions do not permit of the sizes necessary for such items as wing spars and struts. The defect of twisted grain (Fig. 4) is often found in ash, and is caused by the action of the wind when the tree is growing,

and renders such wood of limited utility. Shrinkage affects all timber in varying degrees, and its effect on boards due to their position in the log is shown by Fig. 5, while Fig. 6 indicates the effect of drying on a squared-up section. Incidentally one may point out that the annual rings, viewed from the end of the section, should be as straight as possible, which would obviate to an extent the distortion due to drying in a component subsequent to its finishing. Another defect, and one somewhat difficult to detect, is the presence of a brownish speckled tint in the grain. Any evidence of this in

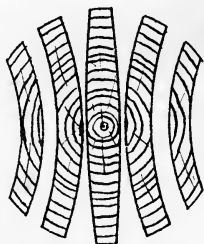

FIG. 5.—Shrinkage of boards due to position in log.

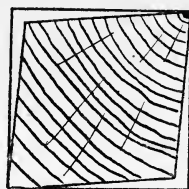

FIG. 6.—Effect of drying on a squared-up section.

a specimen indicates the beginning of decay, and is caused by insufficient seasoning and lengthy exposure in a stagnant situation.

Steel.

The greater proportion of the various fittings employed in the construction of the aeroplane are built up from sheet nickel steel, usually of a low tensile strength, to permit of working in a cold state, as, with a higher grade steel, the process of bending to template by hand, in many cases a none too careful procedure, would result in a considerable weakening of the material at the bend. In addition, the operation of welding, which now enters into the construction of a number of fittings, also necessitates a moderate grade of steel. A higher class of sheet steel, from 35 to 50 tons tensile, is used for parts subject to stress, such as interplane strut-fittings, wiring-lugs, etc. As a higher grade of steel is better from a strength-for-weight point of view, its employment for bent-up

clips is desirable, although where such a steel is used it is almost necessary, if the original strength of the material is to be retained in the finished fitting, to effect the various bends in a machine, in conjunction with bending jigs. Careful heat-treatment after bending to shape is an important factor in removing the stresses set up by working, and in rendering the structure of the material more uniform.

Steel Tube.

Steel, in the form of tubing of various sections, enters largely into aeroplane construction, and may be said to contribute largely to the efficiency of the structure. It is now being used for the different items of the undercarriage, for struts in the fuselage, interplane struts, and in many cases control surfaces, such as the ailerons, elevators, and rudder, are being built of this material entirely. In the early days of aviation steel tubing attained some considerable popularity, many machines being built almost entirely of tubing; but difficulties in its manipulation, and the fact that very often the methods of attachment reduced its strength considerably, gradually led to the general employment of wood. The great advances lately made in the production of a high-grade nickel-chrome steel, with a high ultimate tensile stress, are responsible for its present increasing use.

Aluminium.

The present use of aluminium is restricted to the cowling of the engine, and occasionally as a body covering. Although it is light in weight, its extremely low strength values render it of very little use for other purposes. It attained some measure of popularity in the early days of aviation, particularly for the manufacture of different strut-sockets, which were cast from aluminium; but the general bulkiness of the fittings, in addition to the fact that it was generally necessary to incorporate a steel lug to form the wire anchorage, caused it to gradually fall into disuse. The tendency of aluminium to flake and corrode, which is intensified by the action of salt water, also limits its use for seaplane construction. Many

attempts have been made through various alloys to impart greater strength to the material, and although progress has resulted, the characteristics of most of the products are unreliable.

Duralumin.

Of the different alloys, duralumin is probably the best, although one believes that its qualities are principally the result of special heat treatment. Its use is at present restricted to those parts not subjected to any great tensile strain. It is considerably less than half the weight of steel, bulk for bulk, and, properly used, may effect a considerable saving in weight. The fact that it has not achieved the popularity it deserves may be ascribed to the difficulties experienced in working it, especially for such parts as body clips, where several bends are necessary, and to the rather arbitrary methods in use. If properly annealed, no difficulty should occur in obtaining a reasonably sharp bend. The process recommended by the makers consists in heating the metal in a muffled furnace to a temperature of approximately 350° C., and the necessary work done as soon as possible after cooling. The importance of this is due to the fact that the process of annealing imparts to the metal a tendency to become brittle with time. The writer has often contended that, where duralumin is used, it should be with a real desire to reduce weight. Too often one sees a fitting of such lavish dimensions as to entirely nullify the advantage of the lighter metal.

CHAPTER III.

SPARS AND STRUTS.

HAVING thus considered generally the chief materials of aircraft construction, we will proceed to examine the various types of spars and struts in present use. The main spars of the wings are by far the most important items of the complete structure, and very great care is always taken to ensure that only the best of materials and workmanship are concerned with their manufacture. Looking back at the days one usually associates with the aero shows at Olympia, multitudinous methods of building wing spars can be recalled. Some composed of three-ply and ash; others, less common, of channel steel; and a few of steel tubing, either plain or wood filled. Various reasons and causes have combined to eliminate these methods of construction. For instance, the spar of channel steel proved much too flexible, although this characteristic was no great disadvantage in those machines employing wing-warping for lateral control, for with this arrangement a certain amount of flexibility in the wing structure is essential. While steel tubing is excellent for many details it can hardly be said to be really suitable for wing spars, which are stressed essentially as beams. Now, the strength of a beam varies as the square of the depth of the beam, and it is obvious that in the case of a circular steel tube the material is evenly distributed about the neutral axis, and therefore its strength in both horizontal and vertical directions is equal; although employed as a strut, this feature becomes of real value. One, however, still encounters its use on modern machines; indeed, it must not be supposed that the progress

made in construction generally since 1914 has tended greatly towards a reduction in the number of different methods employed, and this will be realized from a consideration of the accompanying spar sections which are in use to-day on one make of machine or another.

Spar Sections.

The I section form of wing spar, shown by Fig. 7, is in general use, being spindled from the solid. It is comparatively easy to produce, which in a measure explains its

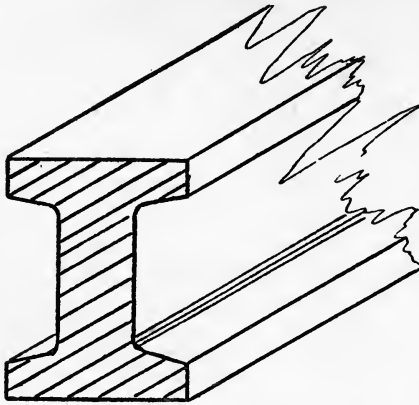

FIG. 7.—Solid spar.

popularity, and it also disposes the material in probably the best manner for the stresses involved. The laminated spar, Fig. 8, is an improvement on the solid channelled spar; it is stronger, will withstand distortion to a greater degree without injury, and the strength is also more uniform than with the solid spar. An additional point in its favour is that it is much easier to procure three pieces of small section timber free from defects than one large piece, which, in view of the increasing scarcity of perfect timber, is an important consideration. In order to minimize the risk of the glue between the laminations failing, the usual practice is to copper rivet or bolt the flange portion, while both spars are left solid at the point of attachment of the interplane strut fittings and wire

anchorages. The spar shown by Fig. 9 is of the hollow box variety, chiefly used for machines of large wing surface, where

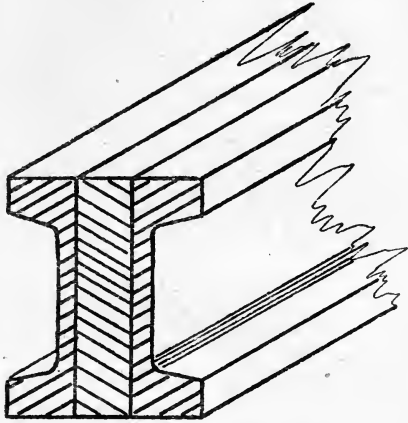

FIG. 8.—Laminated spar.

weight reduction is an important factor. The two halves of channel section are spindled from the solid and glued to-

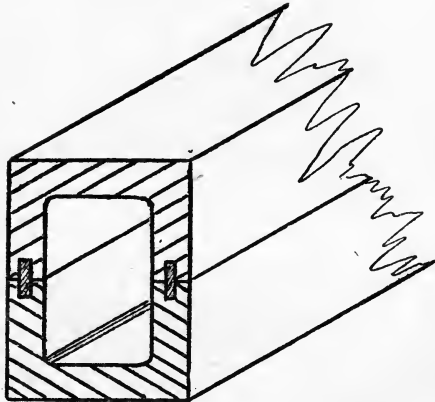

FIG. 9.—Hollow box-spar.

gether. The joint is strengthened by the provision of small fillets or tongues of hard wood, and in some instances the complete spar is bound with glued fabric. Comparing the

hollow spar with the solid, and neglecting the cost factor, the writer contends that the advantage is indisputably with the former. The tendency of the I-section spar to buckle laterally is of much lesser moment in a hollow spar of the type shown by Fig. 9, while for a given weight it shows an increase in strength, and for equal strength it is much lighter. A different version of the hollow spar system is that indicated by Fig. 10, consisting of two channelled sections, tongued together at the joint, the sides being stiffened with three-ply. The disposition of the joint in a vertical plane is a distinct improvement on the hollow spar previously considered, mainly in that better resistance to a shearing stress is afforded.

The principle underlying the construction of the spar

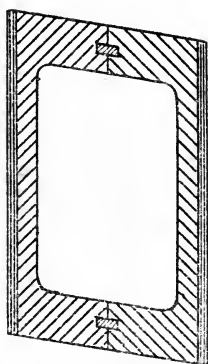

FIG. 10.—Hollow spar with stiffened sides.

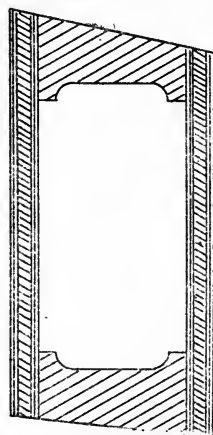

FIG. 11.—Hollow spar with multi-ply sides.

shown by Fig. 11, is that in its manufacture the lengths of wood necessary are of small section. The sides of this spar are built up with a centre of spruce about $\frac{1}{8}$ in. thick, to each side of which is glued thin three-ply, these being glued, screwed, and bradded to the flanges. The wing spar shown in section by Fig. 12 is unique in that it really constitutes two spars placed closed together, the connection being formed by the top and bottom flanges of three-ply. This spar was used in a machine with planes of small chord, but of very deep

section, and in which no interplane wiring occurred, the wings functioning as cantilevers. Its chief advantage is great rigidity for a low weight, but such a spar necessitates a deep wing section, and is not in general use.

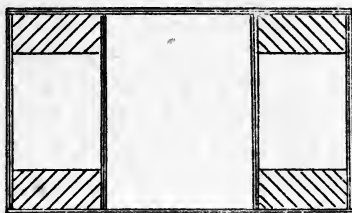

FIG. 12.—Twin box spar.

Hollow Spar Construction.

The advantages of the hollow type of spar summarized are (1) greater strength for a given weight; (2) it can be produced from wood of small section, and is therefore a better manufacturing proposition. On the other hand, the strength of a hollow spar is greatly and almost entirely dependent on the glue used. Now, however well the joint may be made, the glue is susceptible to a damp atmosphere, and if so affected is of greatly reduced strength, while possible depreciation in the glue due to age renders the life of the spar a problematic quantity. Where the various fittings occur it is also necessary to place blocks before the spar is glued up, which is rather an unmechanical job. The practice of forming vertical sides of a hollow spar from three-ply is not to be commended, by reason of the doubtful character of the glue used in its manufacture. However, in spite of these disabilities, there is a future for hollow spar construction in the manufacture of the big commercial machines of the future, for with these the question of maximum strength for minimum weight, to permit the carrying of the greatest possible useful load, will be a primary consideration. This, of course, assuming that the era of the all-steel machine has not arrived.

Strut Sections.

In the construction of the interplane and undercarriage struts, one does not find a very decided preference for any one particular method, although the interplane strut spindled from the solid to a streamline section is common to many types of modern aircraft. The strut shown in section by Fig. 13 is in use for both interplane and undercarriage struts. This consists of ordinary round section steel tubing, to which is attached a tail piece or fairing of wood, this being bound to

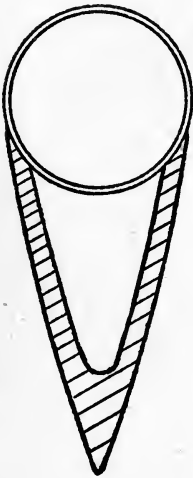
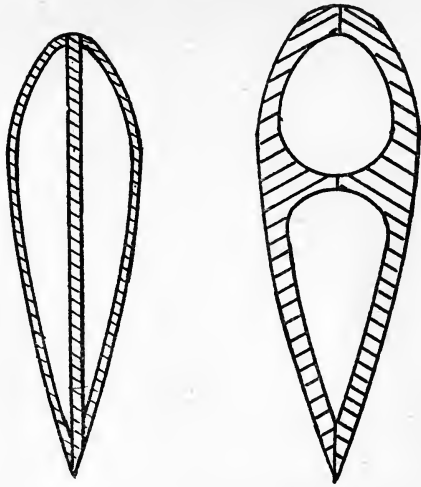

FIG. 13.—Steel tube strut with fairing bound on.



FIGS. 14, 15.—Inter-plane struts spindled from the solid.

the tube by linen tape or fabric, doped and varnished. This strut is of practically equal strength in both lateral and longitudinal directions, and from this point of view is superior to the solid spindled strut, which is usually of great strength in the fore and aft direction, but always possesses a tendency to buckle laterally. Fig. 14 indicates a hollow plane strut, in which the sides of spruce are spindled from the solid, and glued to a central stiffening piece of ash; while Fig. 15 is arranged so that a stiffening web is formed in the spindling process. Owing to the rather extensive nature of the latter

operation, one does not find many instances of its use. Where the hollow wood struts used are not completely bound with tape or fabric, they should at least be bound at intervals with tape or fine twine, as there is always the possibility of the glued joint failing under the combined attentions of rain and heat.

A type of strut which is now being widely used is that of streamline section steel tubing, drawn or rolled from the round section. It is employed for both the inter-plane and undercarriage struts, but for the latter has not given entirely

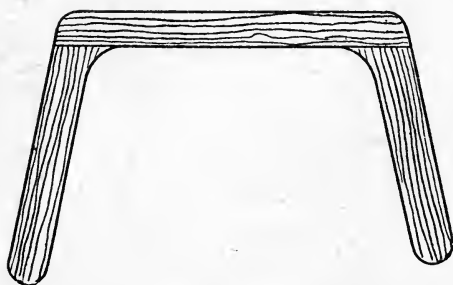

FIG. 16.—Inter-plane support from body.

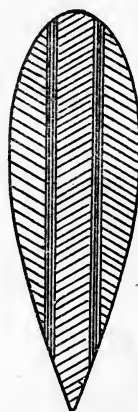

FIG. 17.—Section of built-up strut.

satisfactory results, owing to the tendency to buckle under extra heavy landing shocks. This would be more pronounced with a tube of fine section than with one possessing a bluff contour; but in any case, a strut of parallel section, whatever the material, is not well suited to withstand sudden shocks. This point is referred to later. Seeing that progress is being made with the production of a seamless streamline tapered strut this defect should soon disappear.

In some machines the top plane is supported from the fuselage by struts which are formed integrally with a horizontal compression member, as in Fig. 16; the section of the vertical struts being shown by Fig. 17. The ply-wood is

cut to the shape of the complete component, and forms a tie for the spruce layers, which are jointed at the junction of the vertical and horizontal members.

Strut Materials.

Referring again to the material generally employed for struts, *i.e.* silver spruce, it is perhaps necessary to explain further the reasons for its predominance over ash, as on a strength-for-weight ratio the latter wood is slightly the better material. The points already detailed, indicate that an interplane strut is stressed essentially in compression, and therefore the chief characteristic of ash, great tensile strength, is of but secondary importance. There is also the fact that, for the same weight, spruce would be thicker, and correspondingly more able to resist collapse. However, in machines of the flying-boat class, where the engine is invariably mounted between the four central plane struts, and consequently subjected to an amount of vibration varying with the type of engine used, ash forms the material.

Tapering of Interplane Struts.

The correct shaping of struts longitudinally, particularly those for interplane use, is apparently a rather controversial subject. Taking the case of an untapered strut, it is evident that the greatest stress will be located at or near the centre, so that if at this point the section is strong enough, clearly there must be an amount of superfluous material at the ends. By suitably reducing or tapering the strut from the centre one can obtain the same degree of strength for less weight. Conversely, for the same weight a much stronger strut is possible. So it has always appeared to the writer. It is, however, admittedly possible that unless carefully done, the operation of tapering a strut may actually diminish the strength. One method of tapering, that of making the maximum cross-section at the centre, and from this point diminishing in a straight line to the ends, is undoubtedly open to criticism, and a way more nearly approximating to the correct method of shaping is to reduce the cross-section at various points so

that the finished contour is curvilinear, as in Fig. 18. In this connection it is pertinent to emphasize the importance of ensuring that all strut ends are cut to the correct bevels, and this is particularly applicable to those struts which seat directly in a socket. The slightest irregularity will cause considerable distortion when assembled under the tension of the bracing wires, and frequently the writer has seen an ostensibly perfect

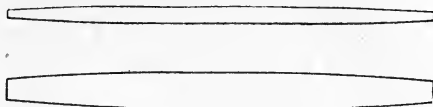

FIG. 18.—Tapering of inter-plane struts.

strut assume the most hopeless lines directly the operation of truing up is commenced.

Design of Strut Sections.

Although, strictly speaking, the design of strut shapes is outside the scope of this book, a few remarks anent the development of streamline may emphasize the advances made, and also the need for careful construction. The resistance of a body is generally considered to increase as the square of the speed, *i.e.* double the speed and head resistance is doubled, and while this is true for a moderate range of speeds, experiment has proved that for high speeds, exceeding say 100 miles per hour, resistance increases at rather less than as the square of the speed. However, it is certain that the correct shaping or otherwise of the struts and other exposed members, affects generally the performance in flight of the aeroplane. The accepted feature of all streamline forms is an easy curve, having a fairly bluff entrance and gradually tapering to a fine edge. The ratio of length to diameter, called the fineness ratio, varies in modern machines, being in some instances 3 to 1 and in others 5 to 1, a good average being 4 to 1. Considering only the point of head resistance, it would be better to choose a section of high fineness ratio, but constructionally such a strut would buckle sideways under a moderate load, and therefore the cross section must be sufficient

to resist this. The strut section used on the earliest aeroplanes, such as the Wright biplane, shown by Fig. 19, is

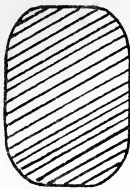

FIG. 19.

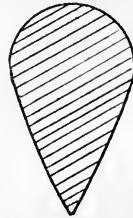

FIG. 20.

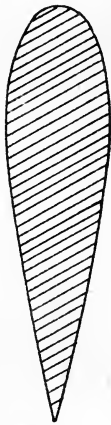

FIG. 21.

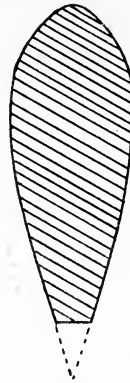

FIG. 22.

FIGS. 19 22.—Strut sections.

nothing more than a rectangle with the corners rounded off. Fig. 20 shows a development of Fig. 19 consisting of a semi-circular head with a cone-shaped tail, which by gradual

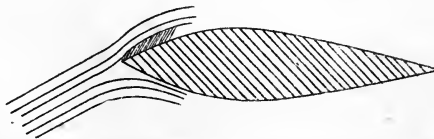

FIG. 23.—Showing inefficiency of pointed section in a side wind.

evolution has resulted in the section Fig. 21. Some experiments carried out a considerable time ago by Lieut.-Col. Alec

Ogilvy, revealed the rather interesting point that a strut shaped as in Fig. 22 gave the same results as a similar strut taken to a fine edge. The reasons for the non-suitability of a sharp-pointed section are apparent from a consideration of Fig. 23, showing the action of a side wind with the resultant dead air region.

Fuselage Struts.

In the general features of those struts associated with the construction of the fuselage and nacelle, there is very little



FIG. 24.—Channel-section fuselage strut.

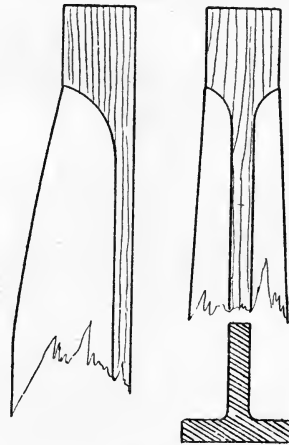

FIG. 25.—T section fuselage strut.

diversity of practice, the majority of constructors favouring a square spruce strut, Fig. 24, channelled out for lightness. A defect with this type of strut is the tendency, engendered by irregularities in the fittings and wiring, to buckle laterally, although this can be obviated by the provision of a strut of larger section at the centre and diminishing in width to the ends. A strut not nearly so popular but nevertheless in use is that indicated by Fig. 25, consisting of spruce spindled to a T section the web being of considerable width at the centre. It would seem that the piece of wood necessary to obtain such a strut is out of proportion to its actual finished dimensions,

and from the standpoint of economy in both labour and material is not justified. The circular turned and tapered strut noticeable on a number of machines disposes the material in probably the best manner for the conditions applicable to this component, although it necessitates the provision of tubular ferrules in the fuselage clip. On one modern machine the fuselage struts are circular, but of hollow section, built up of two pieces glued together. An obsolescent method is that in which the strut is shaped to something approaching a streamline section, as the fact that all aeroplane bodies are now fabric covered renders it unnecessary.

CHAPTER IV.

PLANE CONSTRUCTION.

OF the various components which comprise the complete machine, the wings, aerofoils, or planes, as these items are variously designated, may be said to contribute the greater part of the ultimate success of the complete machine. The aerodynamical properties of a wing are now fairly well determined, and have been the subject of a great number of experiments, resulting in the clearing away of many hazy ideas and notions, so that the actual design of the wing section for machines of given purpose is almost standardized. From this it might be deduced that the methods of construction were equally well determined, and although absolute uniformity of practice does not exist, the wing construction of most machines is similar, as far as the main assembly is concerned.

Effects of Standardization.

Incidentally, one may point out the detrimental effects of undue standardization as applied to an industry in its preliminary stages. These effects are well exemplified by certain machines, in which standardization has been studied to an almost meticulous extent, with the logical result that their performance is considerably inferior to that of other machines of contemporary design, but in which desirable improvements are incorporated as they occur. Although at present one cannot give actual figures, the average performance of modern British aircraft in range of speeds, rate and extent of climb is

superior to the products of any other country, and one certainly cannot cite the construction of the average British machine as an example of standardization. Seeing that, as a typical instance, wing sections are frequently altered in minor detail, the impracticability of standardization is apparent, for this would entail, to a firm wishing to keep pace with developments, a considerable loss, through scrapping of jigs, etc., consequent upon the new design. When the principles of aeroplane design are as well defined as those pertaining to internal combustion engines, one may expect the various manufacturers to produce one type of machine per year, and

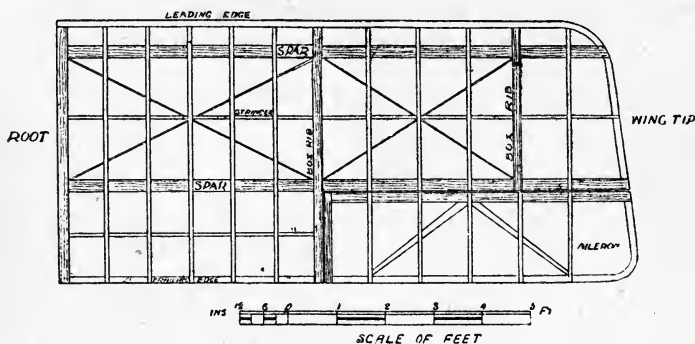

FIG. 26.—Plan view of wing assembly.

the various improvements adduced from the year's experience would be incorporated in the type of the succeeding year.

However, leaving the realms of vaticination for the more prosaic subject of wing construction, it will be realized that the process of producing the full-sized wing, accurately conforming to the measurements, etc., deduced from experiment, and so constructed that the chief characteristic of the section will permanently remain, is of importance. As one or two of the spar sections in use were dealt with in the first chapter, it will be unnecessary again to consider them in detail.

Fig. 26 shows diagrammatically the plan view of a wing assembly typical of modern practice, so far as the disposition of the various components is concerned.

Shaping of Main Spars.

Taking in greater detail the different parts, it is apparent that the spars form the nucleus of the general arrangement. There are two methods of shaping the spar longitudinally, and, as shown by Fig. 27, the one consists of leaving it parallel for the greater part of its length, while the end forming the tip of the wing is gradually tapered to a comparatively fine edge. This may be said to constitute prevailing practice. The other method which is illustrative of monoplane practice is not used to anything like the same extent, and differs in that it is constantly tapering from root to tip. The advantage of this spar construction is the improved distribution of the

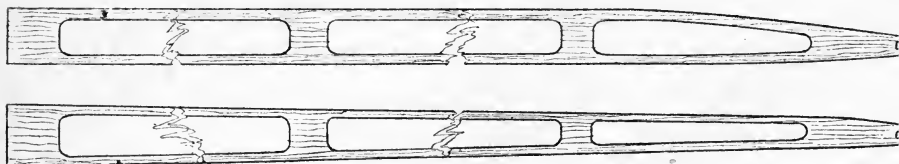

FIG. 27.—Shaping of main spars.

material for the stresses involved, and also that a wing built with this spar may possibly possess a greater degree of lateral stability owing to the weight of the complete wing being located nearer the centre of gravity. Against this one must balance the fact that each rib must necessarily be different in contour, entailing a greater number of jigs, an increase in the time taken in building, with a consequent increase in cost. In addition, all strut fittings would differ in size, so that, taking all things into consideration, this construction is hardly justified. It will be noted that at the point of attachment of the interplane strut fittings, or, in the case of the monoplane wing, the anchorage for the wires, the spar is left solid. It is possible to channel the spar right through, from root to tip, and to glue blocks where fittings occur; and although there is a possible saving of labour thereby, it hardly conforms to the standards of modern workshop practice.

Defects of Glue in Wing Spars.

Although gluing is a most necessary operation in modern wing construction, it is not what one would call an engineering proposition. It has a tendency to deteriorate with time, especially if exposed to a humid atmosphere. A great deal depends on the method of making the joint, and an operation such as gluing a laminated wing spar is usually carried out in a special room of certain temperature. Such spars are generally additionally fixed by rivets, bolts, or screws through the flanges. The material should always be dry, and as straight and close-grained as can be procured. The straightness and closeness of grain affect the strength to a remarkable degree; and here it may be remarked that the use of the best material is a most important factor for ensuring sound construction, and one that in the end pays. If a spar should happen to be cut from a wet log, it may in the interval between its finishing as a part and subsequent assembly in the wing cast or warp, which may cause trouble in assembling, and is more likely to result in eventually being sawn up as scrap. The resultant section of any wing is really dependent upon the spar being of correct section, and should the spar be out of "truth," the section will vary at different points. This may not be eradicated even in the erection of the machine, so that finally the actual flying properties of the machine will be affected—another illustration of the importance of thorough construction in ensuring a good and lasting performance. To secure uniformity and interchangeability the wing spars are set out for the wing positions, and the necessary holes for the fittings drilled to jig, before being handed over to the wing erectors.

Arrangement of Planes.

The usual arrangement on machines of the scout type is for the lower plane to butt against the lower members of the fuselage, and the top planes being the same span, the width of the body is made up by a centre plane. Another method is to make the top plane in two portions only, thus obviating the centre plane; and occasionally the spars of the top plane

run through, from wing-tip to wing-tip, although this is only possible in machines of small span. Apart from the fact that such a wing requires extra room, it is difficult to procure timber of length exceeding 20 ft. sufficiently straight in the grain; and a minor detail would be the difficulty of repair, as a damaged wing-tip would practically entail a new spar, as splicing, although permissible in some parts of the machine, should not be tolerated as a means of repairing wing spars.

The difficulty of obtaining timber will necessitate the wings of large machines being made in sections; and there are several instances where this form of construction has been adopted, in one case the sections being only five feet in length. This construction seems eminently suited to the post-war sporting machine, as chance damage would be confined to a smaller area, transport simplified, and, providing the joints are well made, no appreciable loss in efficiency should ensue.

Types of Wing Ribs in Use.

From a survey of the plane diagram, Fig. 26, it will be noticed that the chief components, in addition to the main

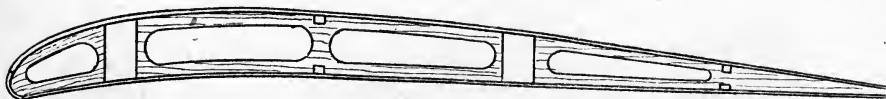

FIG. 28.—Construction of ribs.

spars, are the ribs, box-ribs, stringers, and leading and trailing edges.

The ribs, which is the term applied to the very light framework built over the spars to maintain the correct curvature, are variously constructed; one of the most popular methods in vogue is that shown by Fig. 28. The central portion, or web, which includes the nose and trailing edge formers, may be cut from either spruce, whitewood, cotton wood, which can be bent to a surprising degree without fracture, and three-ply. Three-ply, while excellent for some items, is hardly suited for this purpose, as the laminations have a tendency to come apart, especially in the lower grades,

which is aggravated by the screws or brads necessary for the attachment of the flange. A rib, fretted out as in Fig. 28, with the web of cotton wood and a spruce flange, can be made extremely light. A rib for a chord of from 4 ft. 6 in. to 5 ft. would weigh about $5\frac{1}{2}$ oz. As it is very necessary that every rib should correspond, these parts should be made to a metal jig, which is about the only way to ensure exactitude. This should be made from mild sheet steel, about 16 B.W.G., and need only be shaped to the outer curve, as the lightening holes are of but secondary importance, these being usually marked out in the saw mill, and cut to the line with a fine jig saw. For production in quantity a box jig, between which a dozen ribs might be clamped and shaped, is preferable. Templates of wood are of doubtful accuracy, for not only do corners wear, but gradual shrinkage soon renders them useless. The incorrect shaping of the most insignificant piece of wood may have far-reaching effects when assembled, and any extra trouble taken in the preparation of parts is more than repaid by the subsequent ease and precision of erection.

While the method of rib building previously described constitutes general practice, there are, of course, other arrangements in vogue. Fig. 29 illustrates a system in which the front spar forms the leading edge, a procedure which is somewhat rare now, owing to the features of modern wing sections, but at one time quite common. In this case the web is of three-ply lightened with a series of graduated holes, according to the width of the web, and the flanges of spruce.

The rib assembly, Fig. 30, is extremely simple and light, as in this case the web proper is superseded by thin strips of three-ply, glued and bradded each side of the spruce flange. The amount of woodwork between the spars is reduced to a minimum, although one can hardly imagine such a system answering for a chord over five feet. Even then the wing curvature would require to be fairly simple, as a pronounced curve would flatten out. As a point of fact, this assembly is rarely used for chords exceeding 4 ft. 6 in. In another arrangement as shown in Fig. 31, the connection between the top and

bottom flanges is formed by blocks, a method which is certainly economical of material.

An interesting form of rib design is that shown by Fig. 32, and in this instance the fretting is specially designed to prevent any flattening out of the camber. The rib section is

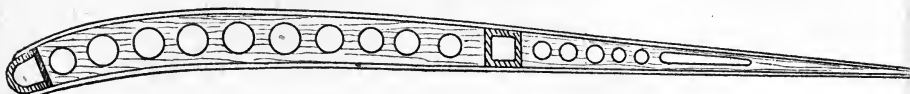

FIG. 29.

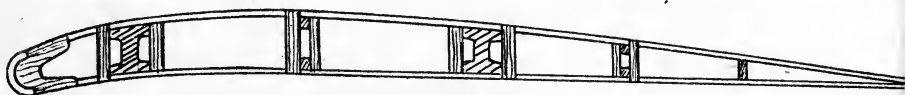

FIG. 30.

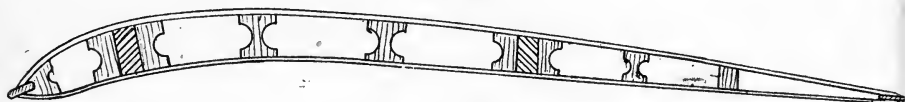

FIG. 31.

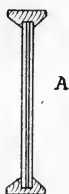
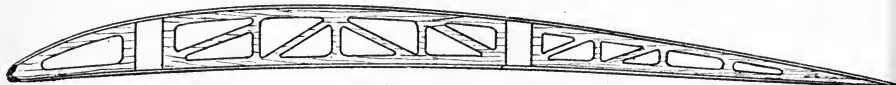

FIG. 32.

FIGS. 29-32.—Construction of ribs.

shown at A, Fig. 32, and it will be noticed that the flange of chamfered section is grooved to take the three-ply web. The vertical parts of the web are stiffened by small semicircular fillets.

Ribs under Compression.

For those ribs contiguous to the inter-strut joints, a different construction is necessary to withstand the tension of

the cross-bracing of the planes and, to a lesser degree, the internal plane wiring, so that at this point the rib performs two functions, that of maintaining the wing curve, and also taking the strains due to compression. Where such provision is not made, the tension of the wiring will result in either or possibly both of the following: (1) the rib will buckle laterally; (2) the camber will increase to an extent varying with the pressure on the wires, both results being extremely detrimental to efficiency. In this respect the old box-kites of varying origin used to offer some interesting studies in variable camber, and when it is remembered that the wing ribs were commonly composed of a single ash lath, steamed to shape, and the fabric

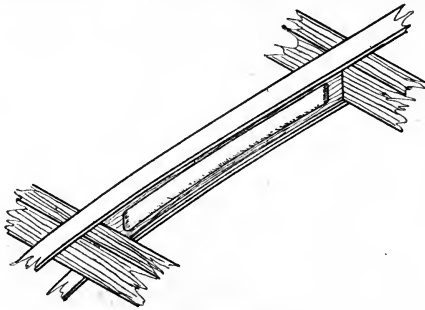

FIG. 33.—Compression rib.

attached on the top side only, the wonder is that extended flying was possible at all. For all that, some comparatively classic cross-country flights were accomplished. One popular system is to incorporate a box-rib at these points, sometimes made by placing two ordinary ribs close together and connecting them with three-ply or thin spruce, so that, although the overall width of the finished box-rib would be approximately 2 in., it is exceptionally rigid and withal light.

Another solution is to use a solid web, lightly channelled out, as in Fig. 33.

In some wing structures the ribs are uniform throughout, a strut of either steel tube or wood being inserted and to which the internal wiring is attached. This latter method is possibly more desirable, that is, if the joint between the compression

strut and spar can be combined with the inter-strut fitting. This may necessitate a little extra work in the latter, but this is preferable to the use of a separate fitting, involving additional piercing of the spar.

Importance of Even Contour.

Whilst on the subject of rib building, one cannot over-emphasize the desirability of even contour, and the template, illustrated by Fig. 34, serves as an admirable check. It is cut from very dry material to the outside curve of the section, and if this is tried on as each rib is fixed, one may be sure of comparative uniformity. The root rib is generally of stouter construction, and usually follows the same lines as the compression ribs. At this point the pull of the fabric has to be

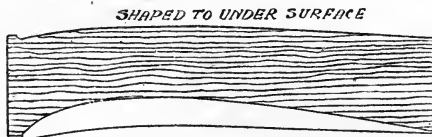

FIG. 34.—Template for testing rib contours.

contended with, which is not infrequently a considerable strain. The same conditions prevail at the wing tip, which is one reason against excessive reduction of material at this point. Instances occur where the tension of the fabric after doping has considerably deformed the tip curve, which is at least unsightly, and may entail reconstruction.

Wing Tip Details.

The actual shape of the wing tip varies with the make of machine, and forms one of the distinctive features of the complete assembly. There is a general tendency to rake the ends, making the back spar longer than the front, on the score that increased efficiency due to reduction of end losses is attained. While this is somewhat problematic, seeing that several notable machines have square tips, and some actually constructed with the longest edge leading, it undoubtedly imparts a pleasing and distinctive appearance.

The actual construction is largely a matter for individual preference, as there are several ways of forming it. For instance, a single piece of ash may be bent to shape, or it may be cut out in sections from spruce boards and glued together with a long splice, while in another instance oval steel tube is the material. This small section steel tubing seems admirably suited for such items as wing tips, trailing edges, and the various components of the empennage, such as the fixed stabilizer, elevators, fin, and rudder.

Another method of construction used for the wing tips of some machines consists of a number of strips, about six for a wing tip 1 in. wide by $\frac{1}{4}$ in. thick, the joints between which are disposed vertically, forming a laminated wing tip. In manufacture, each piece is bent round bending jigs or blocks of the required shape, the edges of the strips having previously been glued. It is apparent that the smaller the section of strip used, the easier it can be bent, and with this arrangement quite sharp bends can be successfully formed in spruce. The alternative method of steaming a solid piece is often wasteful, apart from the fact that it enforces the use of ash.

CHAPTER V.

DETAILS OF PLANE CONSTRUCTION.

THE tendency to lose lift, pronounced in some machines, hardly noticeable in others, may be directly traced and attributed to the manner in which the wings are built, which is largely dependent upon the design. In the preliminary stages of design it is usual to take as a basis the figures for lift and drift of a known tested section, that is if facilities are not available for testing an exact scale model of the section it is intended to use. Anyway, the whole design is dependent upon these figures, in respect of both the maximum and minimum speeds, and also the rate of climb, and the extent to which the actual performance of the machine complies with these calculations is determined solely by the exactitude and precision with which the full-size wing conforms to the scale model. By this means only is it possible to design with any degree of accuracy.

The Sagging of Fabric.

The sagging of the fabric between the ribs is one of the principal reasons for the failure of the finished machine to satisfy expectation and also of the tendency to lose lift. One or two causes contribute to this result. One is the spacing of the ribs, which in some cases is not nearly close enough. A rough average spacing is from 10 ins. to 1 ft., but in modern high-speed machines, loaded to anything from 5 lbs. to 8 lbs. per square foot, the spacing should be much closer. In addition, the ribs near the wing root should be closer

than those at the tip, for at this point the stresses are greater, a certain amount of vibration from the engine having to be contended with, in addition to the effects of the slip-stream of the air-screw. Particularly noticeable is the tendency for the fabric to sag down on the top surface of the leading edge, a feature which imparts to the machine, especially when viewed from the front, a not unpleasing corrugated appearance. At this part of the section the curve is somewhat sharp, and naturally the fabric tends to conform to the definition of the shortest distance between two points, a straight line. This, of course, is aggravated in flight, when the planes are under load, and by far the greatest amount of pressure is located at the front portion, or leading edge, of the wing.

False Ribs.

In some wing constructions the forces are minimized by the provision of subsidiary or false nose-ribs, Fig. 35, which

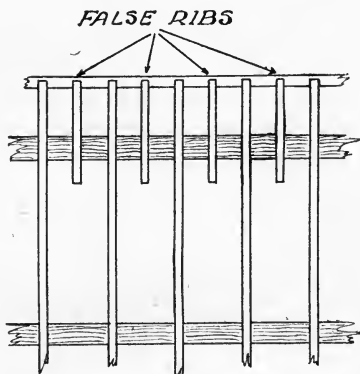

FIG. 35.—Arrangement of ribs at leading edge.

extend usually from the leading edge as far back as the front spar and occasionally to the longitudinal stringer. While this prevents, to a certain extent, the sagging in of the fabric, it does not entirely eradicate it. The only successful way in which the characteristics of the wing contour may be preserved is by covering the leading edge with thin veneer, spruce, or,

still better, three-ply, as Fig. 36. Despite the great advantages attending this constructional feature, its use cannot be said to be really extended.

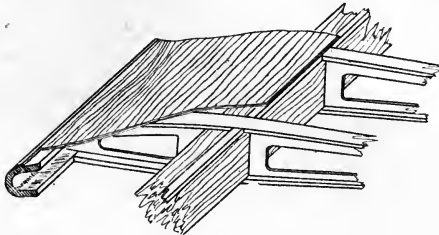

FIG. 36.—Three-ply covering for leading edge.

Pressure at Leading Edge.

The pressure at the leading edge produced by the enormous speed at which the modern machines fly (and the maximum diving speed of which, owing to the reduction of resistance, is correspondingly increased) must be abnormal, and calls for different methods of construction from those which at present obtain. There is at least one case on record where the fabric has burst at this point with fatal results. It is interesting to note that in the report of the N.P.L. for the year 1916-17 mention is made of the deformation of the wing form, due to the sagging of the fabric, which has been reproduced in model form, so that the allowances to be made and the resultant effects have been determined.

Effect of Lateral Control.

The system adopted for the lateral control is a decisive factor in deciding the general lines of construction. The arrangement of plane warping, whereby the wing was twisted or warped from root to tip, or the outer section only, has given place to the almost universal use of aileron control. With the old warping system the ribs, spars, and the whole wing collectively was subjected to a torsional strain, which could only have had a deleterious effect upon it. This fact was almost entirely responsible for the practice of using steel tube for wing spars, for by its use it was a fairly easy matter

to arrange the ribs to slide or hinge upon the tube, which, at least, relieved some of the torsional stress.

Leading and Trailing Edges.

The average practice concerning the formation of the leading and trailing edges is shown by Figs. 37 and 38. Where the section in use requires a bluff entry the spindled-

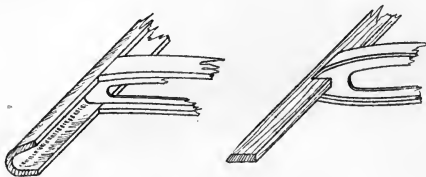

FIG. 37.—Leading edges.

out nose-piece is applicable, while for a sharp entry a fillet let into the nose-formers suffices. As previously mentioned, steel tubing makes a satisfactory trailing edge, although somewhat heavier than the spruce strip, while an extremely fine



FIG. 38.—Trailing edges.

leading edge can be formed by steel wire. The edge, under pressure of the fabric, assumes a variegated shape, a distinctive feature of some types, but, nevertheless, a wire trailing edge is somewhat flabby and undulating, and as a method is obsolescent. Longitudinal stringers are employed to preserve the wing contour and also for a stiffening medium for the ribs in a lateral direction. About the only variation of the small spruce strip for the purpose is linen tape, crossed alternately.

Efficiency of the Raked Wing Tip.

In the previous chapter mention was made of the probable gain in efficiency resulting from the raked wing tip, and that.

this has some foundation in fact will be apparent from a consideration of Fig. 39, which illustrates the flow of air across a plane, as generally accepted. Where the plane surface is continuous from wing tip to wing tip, the provision of the shaped tip would appear to compensate for any slight loss, but

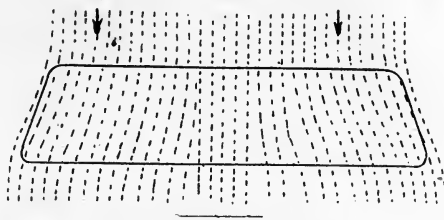

FIG. 39.—Diagram showing flow of air across plane.

there are instances where the extent of the pilot's range of view is of the utmost importance, and this may necessitate the cutting away of a portion of the centre section (which sometimes affords the only means of ingress and egress), or the root of the lower plane, as in Fig. 40.

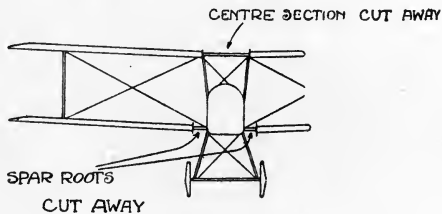

FIG. 40.

Wing Baffles.

An attempt to prevent air leakage caused by this is occasionally observed in the employment of vertical vanes, or wing baffles. In the case of a machine with the lower plane abutting against the side of the fuselage, these would not be necessary, the fuselage acting in the same manner. The baffles are usually of three-ply or spruce, and shaped to project above the top and bottom surfaces, this projection rarely exceeding six inches. A typical arrangement is illustrated by

Fig. 41, which also shows the exposed spars streamlined with a fairing of three-ply. It is typical of the varied opinions which still exist, that on some machines the wing roots are merely washed out somewhat abruptly. If this air leakage is of any moment, it is apparent that it must detrimentally affect the lift-drift ratio. As a proof of the existence of pressure at the openings in the wing, the writer remembers the case of a well-known seaplane, where the wing baffles on the centre section were made of somewhat thin three-ply. In flight it was noticed by the pilot that these were being forced away

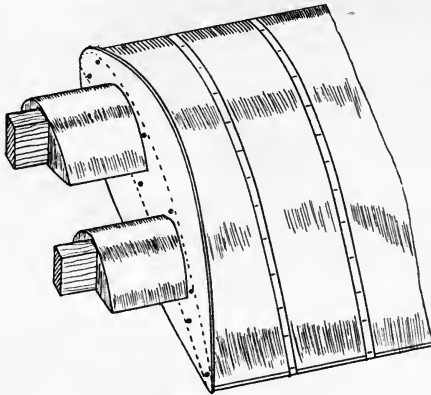

FIG. 41.—Wing baffle.

from the wing, and subsequently these were replaced by baffles of stouter construction.

Metal Wing Construction.

Of two machines, equal in air performance, the one which can be most easily produced has an obvious and, especially at the present time, a very important superiority. Rapidity of production is a most cogent argument in favour of metal construction, for once the necessary machines are set up, and the jigs and dies made, and given a constant supply of material, output is only limited by the speed of the machine. In addition, there are the very exacting demands of interchangeability. Now, it is infinitely more easy to obtain exactitude in metal than in wood, and, moreover, assuming

that it is possible to produce woodwork to the nearest $\cdot 01$ of an inch, what preventive is there against shrinkage, which occurs even when using the dryest of timber. By the more extensive use of metal there should be a considerably reduced proportion of scrapped parts, and erection would be accelerated. It is significant that the planes of some of the most recent German machines are constructed largely of steel tubing, which is at present the most practicable form in which steel can be used. Of course, steel tube spars are quite an old detail, although the more general English practice is to core them with spruce or ash, as in Fig. 42. One remembers a

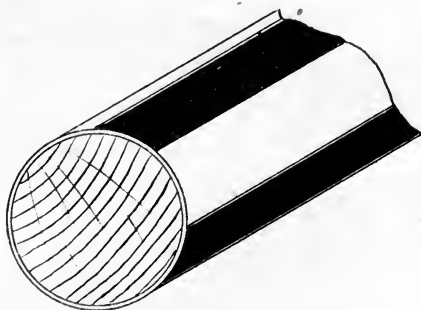

FIG. 42.—Steel tube spar with wood filling.

monoplane, built some time before the war, in which the spars and ribs were of steel and the covering of thin aluminium sheet. In flight this machine was particularly fast, which may be accounted for by the reduction of skin friction, which a smooth surface such as aluminium would afford. In addition, the tendency of a fabric covering to sag was also obviated. Another example of metal construction is afforded by the Clement-Bayard monoplane, exhibited at Olympia in 1914. The plane construction of this machine, as shown by Fig. 43, consisted of channel steel spars, steel leading and trailing edges, and thin steel strips replacing the usual wooden stringers. However, steel construction in modern English machines is restricted to the various organs of the empennage, and occasionally one finds ailerons so built. There seems no valid reason for the continued use of wood as the material for the

construction of such items as the fin, rudder, and elevators, as a considerable saving of labour and time can be effected by using the various forms of steel tubing; moreover, the tendency which most controlling organs built of wood have to warp and twist with variations in temperature is prevented by the steel frame. One frequently sees such items as the ailerons and elevators distorted, which must result in excessive drift, if not erratic flying. At the present time it is difficult to obtain aluminium alloy in any large quantity, and this, in conjunction with the present high prices, precludes its extensive use. When this material is procurable in quantity, and

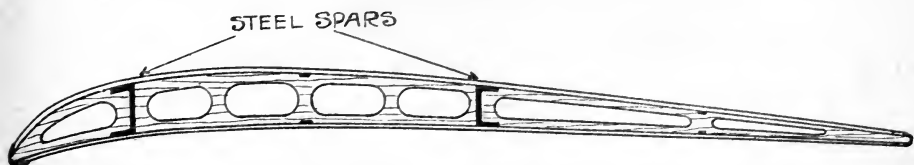

FIG. 43.—Rib construction with metal spars.

when design is reasonably standardized, rolled or lattice spars and stamped ribs may come into vogue.

Fabric Attachment.

Fabric and its attachment is a matter requiring considerable attention, with the great pressure to which modern wings are subjected. In the old days any fabric which was light with a moderate degree of strength was utilized. Nowadays, it is required to stand a certain strain in warp and weft, and rightly so, since the bursting of fabric in flight can only have one result. It is interesting to note that the fabric used on the Deperdussin hydro-monoplane was specially woven with threads running at right angles, forming innumerable squares. The purpose of this was that, should a bullet or any object pierce any one of the squares, damage would be confined to that square, and thereby prevented from developing; but the writer cannot recall any instance of its use to-day.

In covering, the fabric should be tightly and evenly stretched from end to end of the wing, and only comparatively

lightly pulled from leading to trailing edge. If too much strain is applied to the fabric crosswise it will result in undulations between each rib. The tendency of fabric to sag between the ribs is accentuated by this, and, of course, matters are not improved upon the application of the dope. It should be remembered that the efficiency of any machine is greatly dependent upon the tautness of the fabric. It should not be stretched too tightly, as the application of the specified coats

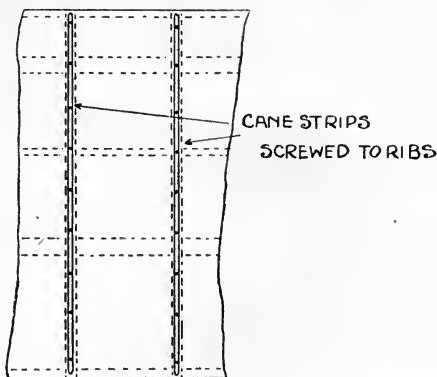

FIG. 44 — Attachment of fabric to ribs by cane strips.

of dope may result in the fibres or threads of the material being overstrained.

With regard to the actual attachment of the covering to the wing framework modern practice is restricted to two methods. The older method is illustrated by Fig. 44, and consists of strips of spruce, or more usually cane, tacked or screwed to the ribs. It is usual, and certainly preferable, to affix this beading to every rib of those sections of the planes adjacent to the fuselage, as the fabric on these portions is subjected to the slip stream of the propeller, which meets it in a succession of small blows. The fabric in the outer sections need only be affixed to alternate ribs. The alternate method is shown by Fig. 45. In this case the fabric is sewn to the ribs with twine or cord, the stitches occurring about every three inches. It will be noted that every loop or stitch is locked with a species of half-hitch knot. This stitching is then

covered with bands of fabric, the edges being frayed to ensure perfect adhesion and doped to the main cover. It is largely a matter of opinion which system ensures the most even wing contour, although it would seem that the drift or resistance is slightly lessened by the sewing method. An obsolete method

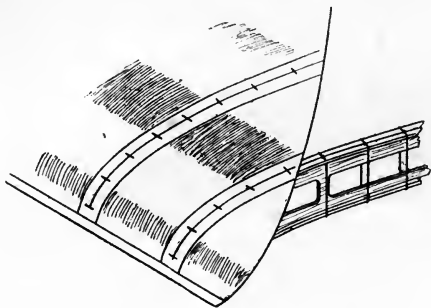

FIG. 45.—Fabric sewn to ribs.

is that in which the fabric was tacked to the ribs with brass pins and taped with linen tape. All sewn joints in wing covers should be, and generally are, of the double lapped variety (Fig. 46), and arranged to run diagonally across the wing.

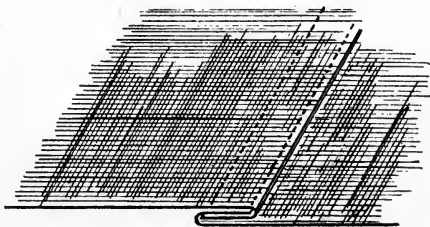

FIG. 46.—Double-lapped joint in fabric.

covering is the provision of small eyelet holes in the under surface of the trailing edge, allowing water accumulated through condensation to drain away, and although not general practice, would appear to be necessary. A refinement which may be necessary on the post-war sporting machine is the attachment of small blocks, or "domes of silence," to the

leading edge, as a protection for the fabric against wear. When planes are disassembled more often than not they are stacked leading edge downwards on a concrete floor, and any movement or friction is likely to result in the rubbing away of the fabric, which, if unnoticed, may result in the bursting of the covering. Such fittings would hardly constitute an innovation, as the writer has distinct recollections of seeing such fittings on the D.F.W. biplane at Brooklands just prior to the outbreak of war. These consisted of brass balls, free to rotate in a socket, screwed to the leading edge. A narrow strip of aluminium screwed along the entering edge would be quite sufficient, and would not add appreciably to the weight.

CHAPTER VI.

INTERPLANE STRUT CONNECTIONS.

It may be taken as fairly conclusive that for war purposes the biplane has proved its superiority, and it appears also that for the commercial requirements of the future it is suited still better, and therefore, in view of the huge possibilities thus opened up, is likely to maintain this predominance.

As the arrangement of planes in a biplane forms the extremely simple yet enormously efficient box-girder, it is generally considered superior in strength to weight requirements, although for monoplanes of small span it is doubtful if this is so, which affords some indication of the possibilities of the small monoplane as the sporting machine of the days to come. Seeing that the principal difference between the biplane and monoplane consists essentially in the type of truss employed, the arrangement and attachment of the various members peculiar to the biplane truss becomes of interest, certainly of importance. It is intended to deal with the various trusses in a later chapter, confining the present remarks to the interplane strut fittings in use, and commencing by detailing the chief requirements and desirable features. The most desirable requirement is that the attachment of the fitting to the wing spars does not involve the drilling of the spar. In practice this is most difficult of accomplishment, for while no great trouble would be experienced in making a fitting fulfilling this requirement, it would be quite another matter to keep it in place under the tension of the bracing wires, and in the case of the outer strut

fitting, to which any strain is ultimately transmitted, practically impossible. In spite of this, it must be remembered that the machine may occasionally, when landing or getting off, pitch over on to the wing-tip skid, and if severe, the shock transmitted to the spar may cause a fracture to develop which, starting at the hole due to the strut fitting, and owing to the fabric covering, would be difficult to detect. One or two similar mishaps, with a consequent increase in the extent of the fracture, give distinct possibilities of collapse in the air. Although one cannot give specific instances, it is a feasible contingency, and one that should be eliminated from the region of possibility.

Additional important features are the provision for rapid assembly and detachment, ease of manufacture, and the absence of brazing, welding and soldering as mediums for forming connections, at least for those parts subject to any stress.

The qualities of strong construction and good design are paramount considerations in the manufacture of these fittings, as the purpose of an interstrut joint is not merely to form a connection between the upper and lower planes, but also to distribute the intricate stresses encountered in flight.

Brazing and Welding.

It is somewhat amazing that brazing as an essential operation in the making of a joint should still be employed, as it is difficult to imagine anything less suited to the conditions under which aircraft operate. The advantages of a uniform high-grade steel possessing a high ultimate tensile strength are dissipated by the intense heat necessary for the action of brazing, resulting in the strength of the finished joint becoming an extremely problematic quantity, indeed this is rendered the more so by the individuality of the workmen.

Welding properly performed is less objectionable, indeed, its use may be said to be constantly increasing, although it is well to recognize its limitations. It should not be used for parts subject to any great tensile stress, such as the fittings forming the subject of this chapter. The efficiency of any

welded joint is hard to determine, as apparent soundness on the surface is no indication of the internal nature of the weld. Regarded from the aphoristic "maximum strength for minimum weight" view point, and taking into account the advantages in this direction which can be obtained by the use of a high-grade steel, brazing and welding are not to be commended.

The operation of soft soldering, requiring only a moderate heat, does not weaken the material to any great extent, and for some items a properly pegged and soldered joint is superior to the two methods of jointing previously described.

Connections in Use.

The illustrations given indicate the varying degrees of practice, taking as the standard for comparison the early Wright socket, Fig. 47. Although somewhat crude it was

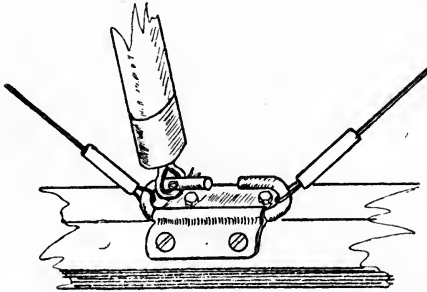

Fig. 47.—Interplane strut attachment.

quite suitable for the purpose, especially as the wing warping system in the Wright machines necessitated a fair amount of flexibility in the joints. It serves also to illustrate that some advancement has been made in constructional work. The advantages of rapid erection and dismantling have been realized and provided for in most machines since the early days of the industry, and it is not surprising, therefore, that the salient characteristic of the joint (Fig. 48) used by S. F. Cody on his famous biplane was portability. The interstrut terminates in a kind of fork, which in turn is pinned to the

head of a special bolt slotted to receive it. The fact that the wiring lugs were improvised from chain links is interesting.

The method of packing the wings for transport consisted in detaching the two outer cellules from the central structure,

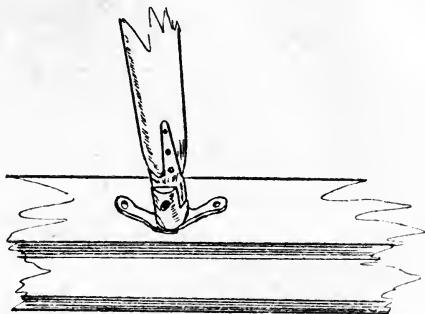

FIG. 48.—Interplane strut attachment.

when the removal of one set of wires enabled the planes to be folded one against the other. It is possibly of interest to record the fact that in the military trials of 1912 this machine was taken down and re-erected in 51 minutes, quite a good

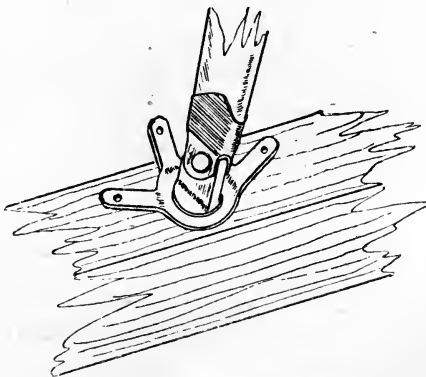

FIG. 49.—Interplane strut attachment.

performance, taking into account its large dimensions. Although this attribute is scarcely necessary at the present time, it will be undoubtedly required by the sporting owner of the future with limited storage facilities. The fitting shown

by Fig. 49 is only suitable for machines with light wing loading. The plate forming the anchorage for the wires is pressed out, the lugs bent to the different angles, and then attached to the spar by an eyebolt, to which is fixed the plane

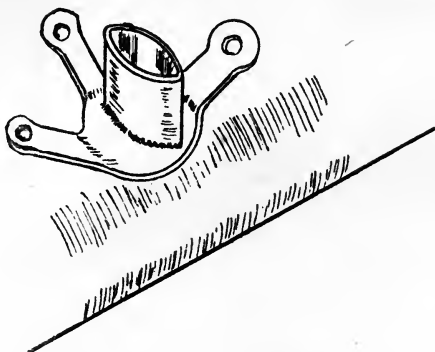

FIG. 50.—Interplane strut attachment.

strut, the ends of the latter being capped with steel tube of streamline section. A similar arrangement is that shown by Fig. 50, the lug plate being pressed out and bent, but in this example the strut terminates in a socket of oval steel tube

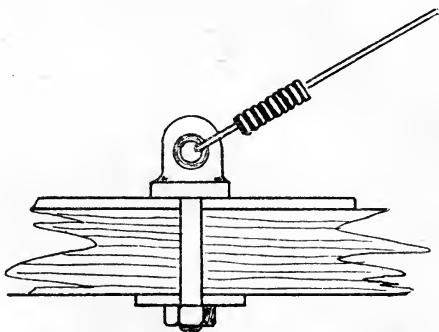

FIG. 51.—Interplane strut attachment.

welded to the plate. It is connected to the spar by a bolt passing through the centre of the socket, the strut end fitting over this.

The practice of anchoring wires to eyebolts, as in Fig. 51,

forms the nucleus of many strut connections, but as a method cannot be recommended. Continual strain on the wire has a resultant in the bending over of the head of the eyebolt as in Fig. 52. As a point of fact the use of the eyebolt is distinctly

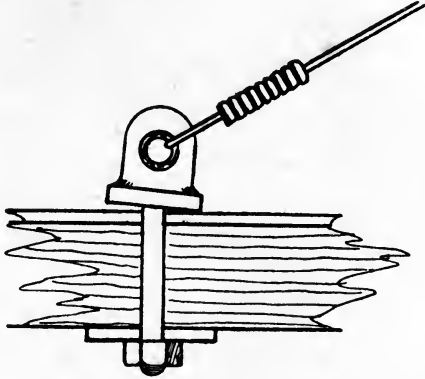

FIG. 52.—Interplane strut attachment.

elementary, and gives the impression of a makeshift. The fitting illustrated by Fig. 53 constitutes an advance on the

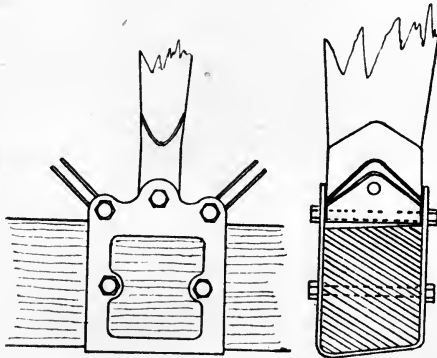

FIG. 53.—Interplane strut attachment.

previous arrangements dealt with, and is also indicative of modern practice.

The main body of this clip is a stamping from heavy sheet-steel, bent up to the section of the spar, the bolts, it

will be noticed, passing horizontally through it. The anchorage for the wires is formed by lugs, which have a direct pull on the bolts, and is so arranged that a slight clearance exists between lug and spar.

The plane-strut is shod with steel tubing, and connected to the fitting by a bolt, as shown. Of the strut connections described so far, hardly one can be said to conform to the leading principle of the ideal fitting, *i.e.* the secure attachment to the spar without piercing the latter for bolts. Fig. 54 gives a fitting which is as good a solution of the problem as is constructionally possible. The basis of this connection is the lug-plate, to which is welded the strut-socket, the whole being fastened to the spar by four bolts, which are let in the flange

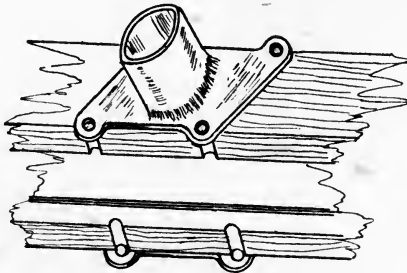

FIG. 54.—Plane strut attachment.

of the spar just half their diameter, and tighten on a washer-plate on the opposite side. Lateral movement along the spars is thus adequately prevented, although the outer strut-socket might conveniently be bolted right through the spar, without materially reducing the strength thereof. This is made possible by the fact that the wing spars, disregarding the small wash-out at the extreme tip, are generally parallel in depth from root to tip, the amount of material at the point of intersection of the plane-strut being in excess of that necessary for the stresses concerned. Another attachment achieving similar results is shown in the diagram (Fig. 55), forming an example of the fitting employed on the pre-war Avro biplane. It will be noticed that in this case two bolts only are used for the connection, the pull of the flying or lift-wires being counter-

acted by the duplicated wires taken from the washer-plate to a fitting located on the single central skid of the under-carriage.

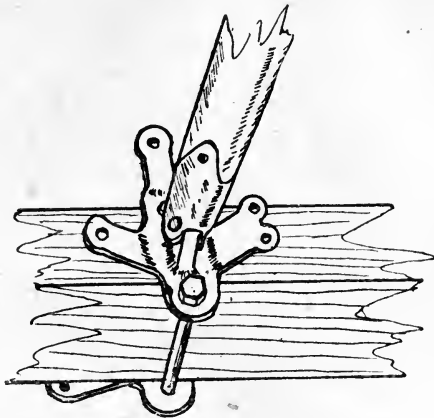

FIG. 55.—Interplane strut attachment.

Head Resistance of Strut Sockets.

A point calling for comment is the apparent oversight or neglect of the amount of head resistance offered by the average strut fitting, although great care is taken to ensure the strut and wing sections being of correct form. It seems probable that some difference must occur, especially at the high speeds now prevalent, between the air flow across the plane and that which meets the strut terminal. Anyway, some discontinuity of flow exists, and whether or no the aggregate resistance of all the fittings is of any great moment provides matter for discussion. It is quite possible to fair off any irregularities in air-flow due to the strut connections by the attachment of sheet-aluminium fairings, which could be beaten, pressed, or spun with little difficulty. Although examples of this practice are very little in evidence, the writer inclines to the belief that the additional weight would be negligible compared with the ensuing reduction in head resistance.

The foregoing examples cannot be said to constitute the latest practice, nor is it possible under present conditions to give such details, but sufficient has been said to indicate the progress and trend of design.

CHAPTER VII.

WING-TRUSSING SYSTEMS.

ALTHOUGH the trussing of aeroplanes is carried out along certain well-defined lines, there are occasional divergences from the orthodox. The differences now existing are not nearly so great as those of former days, this being explained by the fact that the progress of any science or industry tends towards uniformity of method, while practical experience eliminates the undesirable systems. This does not necessarily mean that the present methods in vogue are incapable of improvement, but merely denotes their suitability for present requirements.

The Pratt Truss.

The basis of all modern trussing systems, with modifications, is the Pratt truss (Fig. 56), familiar in bridge-building



FIG. 56.—The Pratt truss.

circles, the basic principle of which is that the compression members are disposed vertically, and while of minimum length are most favourably placed for obtaining the maximum efficiency. There are other types of trusses used in structural engineering, as, for instance, the Howe truss, in which the compression members are arranged diagonally, and the Warren lattice-type girder; but for various reasons these are

not applicable to the needs of aeronautical engineering. But a brief consideration of the chief features of the Pratt or box-girder system of trussing will suffice to illustrate its great advantages for air-craft work, particularly for machines exceeding a certain span; and it is this limiting span to which a monoplane can safely and efficiently be built which is largely responsible for its present spell of unpopularity.

Monoplane Trussing.

From the standpoint of simplicity, the monoplane equals the biplane. As each wing of the former may be considered as a cantilever, it is the difficulty of adequately staying the wings above a certain span which forms the deterrent feature, for it is obvious that, as the span increases, in order to obtain a reasonable angle for the wires, the king post, or cabane,

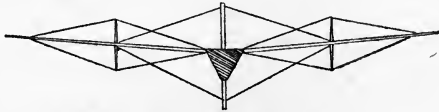

FIG. 57.—Monoplane wing bracing.

must be increased in height. This would necessitate an ungainly undercarriage, less able to withstand rough landings, with a consequent increase in both weight and head resistance. However, it seems that the monoplane will have a future for sporting purposes, where the span will not exceed 30 ft., and will probably be nearer 20 ft.

Various attempts have been made to obviate this inherent defect of the monoplane system of trussing, the first and most popular being the king-post system (Fig. 57), in which short masts are incorporated in the wing structure and wire-braced to the spars. . From the points formed by the crossing of the mast and spar the main bracing-wires are taken. That this system is of real use is demonstrated by the fact that, amongst others, the Antoinette, Flanders, and Martinsyde monoplanes incorporated this system. It is worthy of note that this system also characterized the huge Martinsyde trans-Atlantic 'bus, the wing-spread being in the neighbourhood of 70 ft.

Another original attempt at improvement, the wing-bracing of the Deperdussin hydro-monoplane, is of interest (Fig. 58). As regards the bracing, the machine was virtually a biplane, the wings being stayed by a steel tube running parallel with the wings, and connected to it at intervals by steel tubular struts, with cross-bracing between, as in a biplane. The abolition of the top wires rendered the machine of greater value for war purposes than other tractor machines of that period. The logical conclusion of this system is exemplified by the Nieuport



FIG. 58.—Deperdussin monoplane bracing.

scouting biplane, the lower plane of which corresponds to the streamlined steel boom of the Dep.

Wireless Wing Structure.

Superficially, it would appear that the abolition of external trussing and wiring would make for greater aerodynamical efficiency; and, constructionally, it would be quite possible to build wings devoid of external staying, and at the same time of sufficient strength. But when it is considered that this would entail an excessive depth of spar at the root of the wing, with a resultant increase of head resistance, it is doubtful whether any appreciable advantage would accrue. In the event of the wing becoming deformed or out of alignment, retruing up would be almost impossible, and would certainly require the uncovering of the wing and partial reconstruction. Contrast this with the orthodox wire bracing. It is simple of attachment, of relatively low cost, and offers the utmost facility for truing up. A monoplane of note, built without external trussing, was the special Antoinette, produced for the French military trials of 1911. This had a span of approximately 46 ft., and the depth of spar at the root was about 2 ft. 3 ins., and at the tip 9 ins., the consequent weight alone being abnormal.

Anchorage of Lift Wires.

The one-time practice of anchoring lift wires to various parts of the undercarriage is bad in principle, as there is a distinct possibility that a rough landing may damage the wire or its attachment, and ultimately cause failure in flight. This practice undoubtedly arose from a desire to obtain a good angle for the lift wires, a subsequent improvement being the addition of a separate pylon or cabane.

Biplane Trussing.

The most common form of biplane truss is shown by the diagram (Fig. 59), sometimes, as in the case of various pusher



FIG. 59.—Biplane Truss.

types, or those for long-distance work where a large wing area is necessary, extended to three bays each side, which probably explains the partiality of German designers for multiplicity of interplane struts, as, prior to the outbreak of the war, the majority of German machines were designed and built entirely for long distance and duration flying. By this means light wing loading, which entails large wing area, was possible without prohibitive weight, for by the addition of a pair of struts to the two-bay type, a lighter wing spar for the same



FIG. 60.—Farman wing structure.

strength is possible. In this type of truss the bays adjacent to the fuselage are varied in width, in order more easily to apportion the stresses, which are greater at the centre of the wing structure. A modification of Fig. 59 is indicated by Fig. 60, which illustrates diagrammatically the arrangement of

the Maurice Farman biplane, the improvement consisting of the method of strengthening the interplane struts. The outer strut is braced with a small king-post, and from this a wire is taken through each side of the strut. On this machine the struts are of the light, hollow-spar type, and this arrangement must therefore materially reduce their tendency to buckling.

Another version of this system is that in which the top plane is of greater span than the bottom, the extension thus formed being stayed with lift and counter-lift wiring, or by means of a strut acting in tension and compression.

Single Strut Systems.

The almost universal arrangement for the small single-seater scout is the single bay, and from this method the progress of design has inclined towards the elimination of as many struts and wires as possible, which has its culminant in the type of truss embodying one strut and one pair of wires, lift and counter-lift, each side of the body. Quite a number of machines have incorporated the single strut assembly, the earliest perhaps being the Brequet, and one also remembers a small Avro scout, the strut in this case being built up with spars and stringers, covered with fabric. The single-lift truss is particularly suited to multiplane construction, where the chord of the wings is narrow, and the bending moment, due to the movement of the centre of pressure, is correspondingly reduced. A disadvantage exists with this form of truss similar to that experienced with the wireless monoplane truss, *i.e.* the difficulty of maintaining the correct incidence from root to tip. However, some extraordinary machines of recent construction embodying this feature, stand up to active service demands, so that this defect can be of no great moment. A minor detail consists in the circumstance of, for example, a lift wire coming adrift or perhaps being shot away. With the single-lift truss total collapse would ensue, but it is conceivable that the ordinary double-lift truss offers more chances of escape.

Another system which obviates the need for wires is illustrated by Fig. 61, which was the particular system used on the Albatross "Arrow biplane" of 1912. A drawback is

the difficulty of readjustment, which is the probable explanation of its failure to come into extensive use. The direct



FIG. 61.—Wireless wing structure.

antithesis of this arrangement, the elimination of struts, is indicated by Fig. 62; but as this embodies all the defects of the monoplane system of trussing, even of the attachment

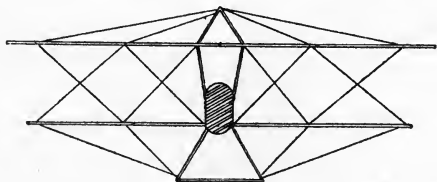

FIG. 62.—Biplane truss without interplane struts.

of wires to the undercarriage, it must be considered of no practical utility.

1½ Strut Machines.

The arrangement shown by Fig. 63 is responsible for the designation of machines so built as “1½ strutters.” A later development of this system consists of but four centre plane

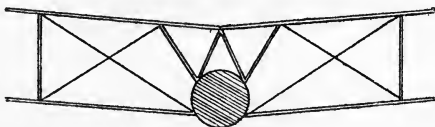

FIG. 63.—1½ strut wing structure.

struts, the two struts forming an inverted V between the fuselage longerons and centre being dispensed with.

The system (Fig. 64) is illustrative of the form of staying in use on a modern high-speed scout, and in respect of which a patent is held. As this machine is designed with a very small gap, the lift wires are consequently at a somewhat flat

angle. The strut, about halfway along each wing, is hinged at the point of intersection of the wires, which, incidentally, do not run through from corner to corner, but are attached in the centre to a fitting which also forms the anchorage for the struts. By this method there is an apparent reduction



FIG. 64.—A patented wing bracing.

in the tendency of the wing spars to buckle under load between the points of support.

Drift Bracing.

So far the methods dealt with denote the methods of staying in a vertical dimension, and it remains to consider the provision for trussing in the fore-and-aft direction. There are two methods in use, one being to brace the wings internally, which is the more general practice, as by this arrangement the resistance of exposed wiring is obviated, while the alternative method consists in taking wires from various points along the wing to the nose and rear part of the fuselage.

Properties of the Various Types.

The necessity for increased size, with its inevitable sequence, increased weight, must be realized without a very great addition to the landing speed, the figure for the latter standing at approximately 45-50 m.p.h. This factor greatly influences the maximum wing loading possible, without detrimentally affecting this, so that in the design of the large machine a considerable increase in wing area is unavoidable. This fact practically rules out the monoplane system for the large aeroplane, as, although this arrangement possesses a superior ratio of lift to drag to that of the biplane or multiplane, the great span necessary to obtain the wing area is impracticable. It is quite obvious that to brace adequately a monoplane structure of 100 ft. span or so, a very complex system would be required, in addition to which the spars would essentially

be of larger and heavier section. The biplane arrangement can be used successfully for spans up to 100 ft., and, assuming that the future commercial machine will necessitate still greater wing area, it is a feasible supposition that the triplane, or even quadruplane systems will be used. Certain modern triplanes have a reputed excellent performance, the carrying capacity and engine power being colossal. Against this we have the fact that the advantage of the triplane system is purely structural, as aerodynamically it is not nearly so efficient as the biplane, and it is at this stage that the question of the limiting size of aeroplanes is encountered. Various tests, both in model form and full size, have shown that the lift of the middle plane of the triplane system is greatly inferior to that of the top or bottom planes, this being due to the interference of the free air flow by the upper and lower planes. This circumstance is an indication that the biplane arrangement, viewed from the standpoints of modern design, is the most economical form for future commercial use.

CHAPTER VIII.

FUSELAGE CONSTRUCTION.

THE body, or fuselage as it is generally described, constitutes the nucleus of the completed machine, and at the same time offers the most interesting examples of constructional detail. It may be as well to point out that the term "fuselage" is ordinarily applicable to a body of a machine of the tractor type; the short body of the average "pusher" or propeller aeroplane is termed the "nacelle."

The material chiefly used in the construction of this component is wood, and there are but very few instances where metal is used.

Fuselage Types.

The different types or methods of construction may be classified in the following order:—

1. Box-girder of four longerons or rails, with cross-struts and wire bracing (Fig. 65).

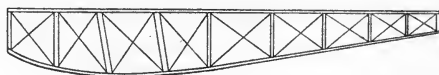

FIG. 65.—Arrangement of fuselage members.

2. Tail portion of longerons, struts and wiring; in the front portion the wire bracing is dispensed with, being replaced by diagonal wood bracing, to which is screwed either three-ply or sheet aluminium alloy (Fig. 66).

3. In this case wire bracing is entirely dispensed with, the

four, and occasionally six, longitudinals being connected together by cross struts or formers cut to the required shape, the whole body being covered with three-ply.

4. Laminated or monocoque type, formed by layers of wood and fabric, crossed alternately and glued together.

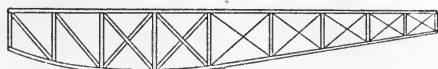

FIG. 66.—Arrangement of fuselage members.

Box-Girder Type.

Dealing with each type in greater detail, and in order of classification, the details and methods of manufacture of type 1 may be considered. The longerons are usually of ash or hickory, although latterly silver spruce has come into use for this purpose, this being due to the desire to reduce weight to the absolute minimum.

In the opinion of the writer, a spruce longeron should be of larger section than one of hard wood, for one or two reasons. Spruce is a soft wood, and the outside fibres are far more apt to get damaged by a fitting which has been bolted home with too much pressure, also the corners may get rubbed or knocked off, which all means a reduction in strength. The use of a spruce longeron precludes any sharp bends in the contour of the fuselage, as this wood does not lend itself to bending, although it may be sprung to an easy curve. By disposing joints in the longerons, it is possible to arrange the lengths so that the bend is contained in one portion. This portion can then be of laminated construction, *i.e.* it can be built up of a number of layers glued together, and clamped to a block of the required shape until the glue has set. In some cases the longerons from the engine mounting to the rear cockpit, where additional strength is necessary, are of ash, while aft of that, to the stern post, spruce is the material.

It is usual, in this country at least, to spindle the rails to one of the sections illustrated by Fig. 67, this spindling or channelling running through from nose to stern post, or the

front portion, extending as far as the rear cockpit, is left solid, the tail part only being spindled. This channelling is always stopped at the intersection of the cross-struts with the rails, to provide the abutment for the struts, and the extra material to compensate for any holes necessary for the attachment of the fitting. In the shaping of the rails longitudinally, two methods are available: they may be tapered or gradually diminished from the front to the stern post, or the overall section may be parallel to a point somewhere in the neighbourhood of the pilot's seat, and from that point diminished

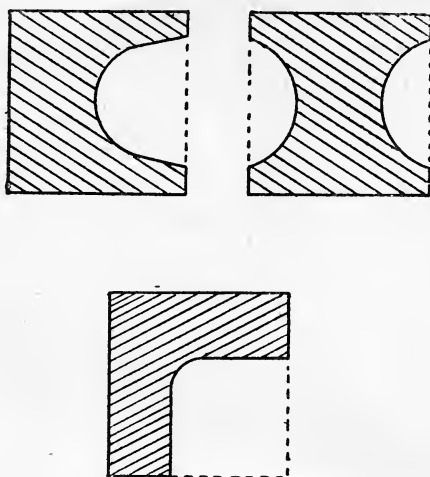

FIG. 67.—Longeron sections.

to the stern post. The first method is obsolete, as all the fittings vary in size, which makes for undue complication as well as increasing the number of jigs and dies necessary to produce the stampings. The second method only partly obviates this, and the only system which permits of the same size fitting being used right through is that in which the rails are of the same overall section throughout, but this is very rarely used.

Another arrangement consists of keeping the rail of equal thickness for approximately 10 ft. from the engine bearers, and then diminishing in a series of steps to the stern post.

By this method only three or four sizes of fittings are necessary. Some fittings are not affected by the taper of the rails, and are made the same size throughout, but in nearly every case the attachment to the rails is accomplished either by bolts or screws. The piercing of the longeron, particularly when this is of spruce, is hardly commendable practice, and certainly in view of the many forms of clip fittings in use appears to be unnecessary. A point which apparently escapes the notice of some designers, is the necessity of some allowance being made for unfair stresses induced by landing shocks and rough handling. There is a tendency to make the tail portion separate from the front, the joint occurring just aft of the rear cockpit, so that in the event of damage due to strains transmitted by the tail skid, this portion can be detached and a new portion substituted, which seems infinitely better than dismantling the whole machine and returning the whole body to the works or dépôt. In the design of the body under consideration due regard should be given to the necessity of occasional replacement of a damaged rail. Some fittings afford the utmost facility for this, while others render this procedure a lengthy and difficult operation.

Jointing of Longerons.

A popular method of jointing longerons consists usually of a plain butt joint, clipped with some form of steel tube socket, or by fish-plates flanged to clip the edges of the longerons and bolted through. A spliced joint is sometimes used when timber is not procurable in any great length, this consisting of an ordinary splice from 12 to 18 ins. long, glued and riveted, and afterwards, when the joint is thoroughly set, bound with tape soaked in glue and subsequently doped and varnished. As this is a somewhat lengthy operation the socket method predominates. In modern aeroplanes the size of a longeron rarely exceeds $1\frac{1}{2}$ ins. square, and it will therefore be realized that this construction is all that is possible, as, owing to the slightness of material, no advantage would accrue from the employment of a joint of the halved or scarfed variety.

Diagonal Wood Bracing.

A great deal of the foregoing applies to the second type, so far as the longerons and tail portion are concerned. The diagonal wood bracing is usually of spruce, and is, of course, heavier than wiring. The aluminium or duralumin sheeting has latterly given place to three-ply for the outside covering, which may be ascribed to the saving in weight effected by its use, as a square foot of 20 B.W.G. aluminium, which is the general thickness for this purpose, weighs 8 ozs., while a square foot of $\frac{3}{32}$ in. birch three-ply weighs approximately 5 ozs. This gives a saving of 3 ozs. for every square foot of surface covered, and moreover three-ply, properly glued and screwed or copper, nailed to the framework, constitutes by far the better stiffening medium. The disadvantages of this method of construction are: (1) the difficulty of re-truing the front portion should distortion occur; (2) erection is somewhat involved; and (3) it is heavier than the first type, although it affords a more solid mounting for the engine, with a consequent reduction of vibration.

Three-ply Fuselage.

The third system is typical of the method adopted for the series of German Albatross machines. There are few, if any, examples of its use in this country, although prior to the war a few constructors favoured its use, and one successful monoplane of note was so built. The writer is acquainted with one pioneer designer who very strongly believes in this form of construction, and certain later developments in the use of three-ply confirm this view. The advantages of this form of construction are: (1) quickness of production; (2) great strength in a vertical and horizontal direction; (3) the result of the longeron being shot through would not endanger the structure to the same extent as with a wire-braced system. Against this must be balanced the fact that: (1) it entails a considerable increase in weight; (2) is weak under a torsional strain, such as that produced by the combined actions of elevator and rudder; and (3) cannot be trued up in the event

of distortion. Examples of this system in pre-war machines are afforded by the Martinsyde and Blackburn monoplanes, although the framework in both cases was so formed as to constitute a lattice girder. The tail portion of the Martinsyde was lightened by cutting away diamond-shaped pieces from each bay.

The formers of the Albatross are extremely simple. In the fore part they are cut from three-ply, while at the rear they are just simple frames composed of laths, reinforced where the longerons occur by three-ply stiffeners. There are six longerons, the two middle ones being fixed slightly more than halfway up each side, which are really longitudinal stringers to prevent the three-ply buckling between the points of attachment.

The Monocoque Type.

The monocoque system originated in France, several constructors having produced machines incorporating this feature. The most successful machine produced on these lines was the Deperdussin, and many will recall the excellent streamline form of the machine exhibited at the 1913 Aero Show. These bodies were built over formers of various sections, which were removed when the glue joining the different layers had set. The resultant shell, which was about four millimetres thick, was then covered with fabric and varnished. Several factors militate against its extensive adoption as a method. It is rather costly, and does not seem to be suited to rapid production. In addition, the attachment of such members as the chassis, wings, and interplane struts, is more complicated. It should be noted, however, that various modern machines are similarly built. The Borel firm produced a machine with monocoque body, this being composed of three-ply covering on ribs running diagonally the length of the body, and although this is not such a lengthy operation as the Dep. system, it has not survived, unless one considers flying-boat construction as its modern version. A slight variation of the monocoque system is used for the bodies of some modern aeroplanes. The framework consists of very small stringers

arranged at various points on light formers cut to the fuselage section. To this structure is applied two thicknesses of three-ply in the form of strips about $3\frac{1}{4}$ ins. wide, each thickness being disposed diagonally in opposite directions, as shown by Fig. 68. This is covered with fabric, the total thickness being no more than $1\frac{1}{2}$ mm., and as this is made up of six layers of wood and one of fabric, the fineness of the ply-wood will be realized.

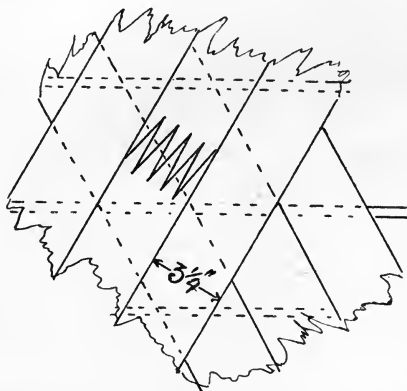

FIG. 68.—Arrangement of three-ply bands in monocoque fuselage.

It should be noted that the ply-wood strips do not completely encircle the formers, but are jointed at the top and bottom, a light longeron being arranged at these points.

A detail which would appear to be of great utility at the present time is the arrangement wherein the nose of the body containing the engine and accessories is a separate unit, and in the event of engine breakdown can be detached and another substituted.

Fuselage Contours.

In the design of the contour of the fuselage the type of the motor used is the determining influence. With the vertical "in line" engine, it is possible to design a slim narrow body, while a rotary or radial engine necessitates an increase in width, which also means increased air resistance. With the Vee type engine, the popular practice is to allow the tops of

the cylinders to project through the cowling, which permits of a narrower body than if the width of the body equalled the overall width of the engine. Where a rotary engine is employed and the mounting is of the overhung type, the width of the fuselage may be reduced by allowing the engine to project over the sides, and the cowling carried on an arrangement of formers and stringers, which gradually merges into the main structure, as in Fig. 69. It is apparent that the line

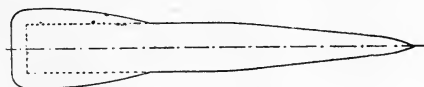

FIG. 69.—Fuselage outline.

of the body and that of the fairing should converge as gradually as possible, as, should this be at all abrupt, there is a distinct possibility that the air flow will take the course indicated in Fig. 70, resulting in a dead air region and inefficiency.



FIG. 70.—Fuselage outline.

It may be taken generally that the wider the body the greater the weight, for the struts have not only to be made longer but also of greater overall section. The practice in this country is to keep the longerons parallel to the centre line

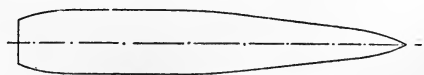

FIG. 71.—Fuselage outline.

on plan, as far as the rear cockpit, tapering from that point to the stern post in a straight or slightly curved line, as Fig. 71.

This simplifies the fittings, the sockets for the centre plane

struts are in line, and the different lengths of fuselage struts necessary reduced to a minimum.

The plan outline of several German machines is shown diagrammatically by Fig. 72. It will be seen that from the

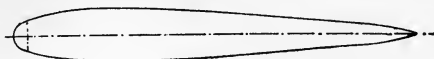

FIG. 72.—Fuselage outline.

nose the body gradually widens out until the maximum width, generally in the vicinity of the front seat, is reached, from where it tapers to the tail. This shape appears to satisfy aero-dynamic requirements more closely than either of the

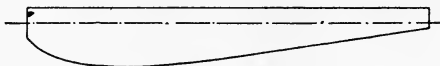

FIG. 73.—Fuselage outline.

foregoing examples; but in practice the difference is not appreciable, and in any case the reduction of head resistance does not compensate for the additional work.

In side elevation the general practice, with exceptions, is

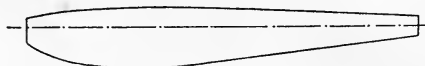

FIG. 74.—Fuselage outline.

to arrange the top longerons parallel to the line of thrust, *i.e.* the axis of the motor, as in Fig. 73. This simplifies erection and affords a convenient datum line for truing up.

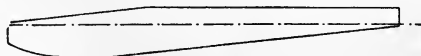

FIG. 75.—Fuselage outline.

On the German Rumpler and early Albatross biplanes, the upper longerons are curved, as in Fig. 74, but in the most recent versions of the Albatross they are level with the line of thrust. Fig. 75 illustrates an arrangement where the top rails,

from a point some distance along, slope down to the nose. By this method the body weight is kept as low as possible and the engine and accessories rendered more accessible. Although it is usual to terminate the body in a vertical knife-edge, formed generally by the rudder post, another arrangement, typical of the Morane monoplane, finishes in a horizontal edge. The German Fokker, obviously inspired by the French Morane, and the Albatross DI, are similarly terminated. This system of tapering to a horizontal knife-edge is not considered the best arrangement from a strength point of view, the flat angle of the bracing wires permitting a certain amount of movement, eventually resulting in slackness and loss of alignment.

CHAPTER IX.

FUSELAGE FITTINGS.

THE design and type of fitting employed for connecting the longerons, cross and vertical struts of the fuselage, varies greatly, being usually one of the distinctive constructional details of a machine. This position renders uniformity of practice a comparatively unattainable quantity, which, in view of present requirements, and the absolute need of rapidity of output (which must commence as soon as possible after a successful design is produced), can only be considered as regrettable. This diversity of design is mainly the result of the desire for originality of each individual designer, and however commendable from this standpoint, is a position which is almost certain to disappear with the progress of the industry. Take as a hypothesis the case of, say, ten makes of scouting biplanes in use, each with approximately the same arrangement of longerons and struts, and with a similar overall size of fuselage. Each of these machines will incorporate a different fuselage clip, which means that somewhere highly skilled labour is being unnecessarily expended in the making of jigs and press tools, whereas a suitably standardized clip for all scout machines of certain dimensions would involve the making of one set of press and bending tools only for the machines of the one type built. Another aspect, quite as important, is the simplification of the supply of spares. Acceleration of aircraft output, if achieved only through the medium of small part production, is one of the most important contributory factors towards ultimate success in the field.

Types in Use.

The sketches, explained in detail hereafter, are illustrative of some of the many systems in use, and taken collectively fall under two categories: (1) those in which attachment to the longeron involves drilling, and (2) those in which the fitting clips or encircles the longeron, friction only keeping it in position. The first method permits of a clip of comparatively simple design, but it has the serious disadvantage of weakening the material, and assuming the longeron section is sufficient to account for this, then clearly a fitting which is attached without the use of bolts would allow a reduction in the size of a longeron (which means a saving in weight) without depreciating the factor of safety. In the second method the attachment is usually accomplished by the pressure of bolts, with practically no weakening effect; but in this case the disadvantage lies in the fact that at each point of attachment a differently dimensioned clip will be necessary, this being due, as explained in the previous chapter, to the longeron tapering towards the stern post. (A method of reducing the number of different clips by suitably shaping the longeron was also dealt with.) It is evident that most fittings must inevitably form a compromise between the demands of production and design, although it must be admitted that in some cases the fittings collectively very successfully evade the requirements of both.

The clip indicated by Fig. 76 is the particular form of construction associated with the various versions of the Bleriot monoplane, and favoured by the early pioneers generally. It was retained in the Bleriot construction until some time after the outbreak of the war—as a matter of fact, until the type was deleted for war purposes.

It is composed, as will be seen from the sketch, of simply two U-bolts, the attachment to the longeron involving the drilling of four holes, which constitutes the chief objection to this particular form of clip, and has been the subject of criticism from the time of its first appearance as an aircraft detail. The struts are slotted over the bolt, and although this

does not conform to the best principles, it is simple, and may have been sufficient for a lightly loaded machine. A point about this clip, which undoubtedly was the cause of its

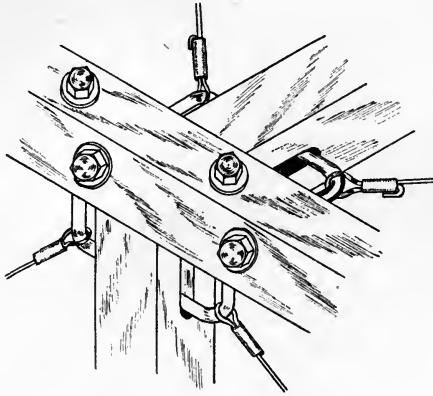

FIG. 76.—Fuselage fitting.

popularity amongst the pioneers, with whom economy was an evil necessity, is that the wires can be strained or tensioned by an adjustment of the nuts on the longerons, thus rendering

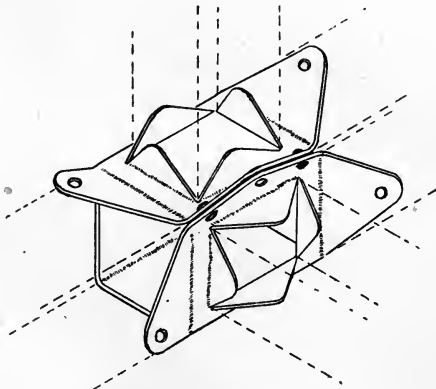

FIG. 77.—Fuselage fitting.

turnbuckles unnecessary. Fig. 77 shows the form of clip used on the Hanriot monoplanes, and is a good example of the class of fitting bent up from sheet metal. This is usually made to

be slightly smaller than the longeron, the pressure resulting from the tightening of the bolts on the ends forming the cross-bracing lug, keeping it in place. The defect of this arrangement is that any slight shrinkage of the longeron will permit movement, and for this reason provision should be made for the subsequent adjustment of the bolts. The struts are taken by the lugs punched up from the body of the clip. This leaves very little material to resist the tension of the bracing wires or tierods, but a modification of this clip surmounts this difficulty.

A similar clip is used by the German Aviatik firm, but it is certainly inferior owing to the very poor connection of the struts. Instead of the four lugs gripping the sides of the

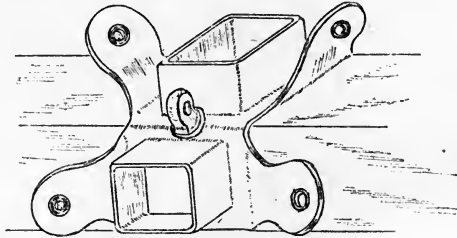

FIG. 78.—Fuselage fitting.

struts, they are punched up to form a square or tenon, over which the cross-struts are mortised. In any case it would not satisfy the standards maintained by our leading constructors, and certainly not the technical advisers to the Air Board. The clip indicated in Fig. 78 does not encircle the longeron, but abuts against the two inner sides of the longeron only. The body of this clip is a stamping, bent to a right angle, to which the square sockets for the struts are welded. Attachment to the longeron is effected by an eyebolt, which passes diagonally through it, this also providing the anchorage for the cross-bracing wire. A form of this clip has been used on a certain make of machine for a considerable period, so that it has advantages that are not readily apparent. One outstanding defect is existent in that the pull of the wires would tend to lift the socket on the side opposite to the eye bolt, and

this in turn would cause distortion of the struts. A connection favoured by an American firm is shown by Fig. 79, and possesses the merit of extreme simplicity. The longerons are not drilled, the attachment being through the agency of an

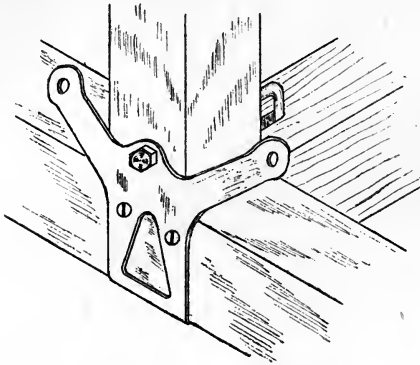

FIG. 79.—Fuselage fitting.

L bolt, which also provides the anchorage for the cross-bracing wire. To prevent movement the clip is additionally fixed to the longeron by wood screws.

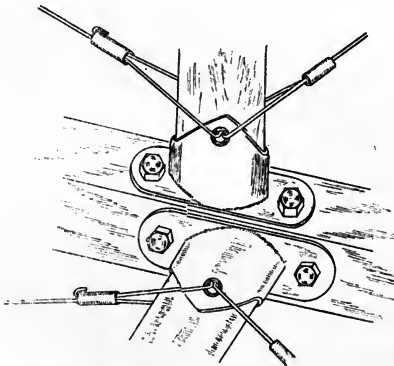

FIG. 80.—Fuselage fitting.

The method shown by Fig. 80 is that used on the Deperdussin monoplanes, being patented by that firm as far back as 1912, and consists of two cast aluminium sockets, bolted to the longeron. The struts, in this case oval in section, are

fastened in place by steel bushes, which are driven through in the form of steel tube, and expanded and burred round the socket, at the same time forming the anchorage for the wires. This system has been used in the construction of a fast scout of comparatively recent origin, but it embodies the same defects as the Bleriot clip, *i.e.* four holes are needed in the longeron for every joint; but it has the advantage over the latter in that a better terminal is provided for the struts.

Fig. 81 indicates the arrangement on the German L.V.G.

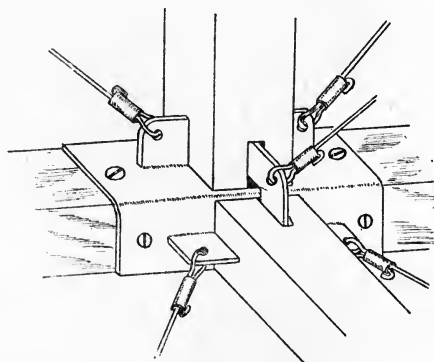

FIG. 81.—Fuselage fitting.

(Luft-Verkehrs-Gesellschaft) fighting biplane. This is an aluminium alloy casting, fastened to the longeron by screws, and as it is not affected by the taper of the longeron, all the fittings, or at any rate, those in the tail portion, can be of the same dimensions. A point which is often overlooked when using a fitting of this type is that any strain on the wires is transmitted to the longeron by the fastening screws only, or, in other words, the tendency of the wires when tensioned to pull the fitting from the longeron is resisted by the screws only. This does not impress one as being well suited to perform the functions demanded of the average joint, and about the only detail upon which its existence is justified is its ease of production. In the writer's opinion the clip, Fig. 82, is by far the finest connection yet devised, and one that should be standardized. Its attachment is accomplished with-

out objectionable drilling; it provides an excellent housing for the cross-struts; can be tightened up should shrinkage occur in the longerons; and can be produced at an absurdly low figure. This clip has been used on machines which have

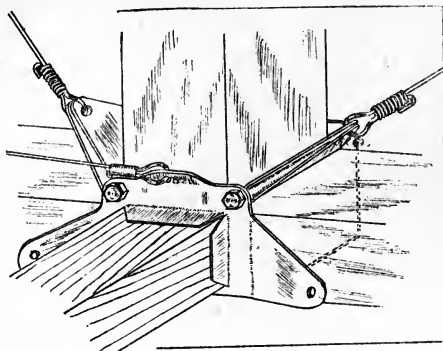

FIG. 82.—Fuselage fitting.

accomplished some meteoric performances during the war, and, moreover, was designed and in use a considerable period before the war.

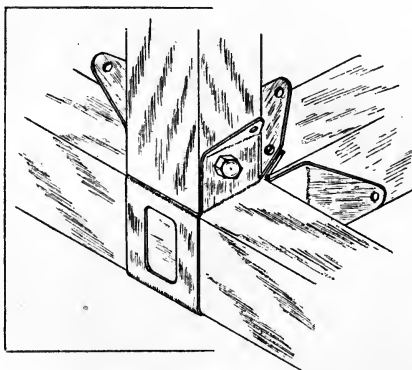

FIG. 83.—Fuselage fitting.

The clip, Fig. 83, is simple and quite easily manufactured, being stamped out of sheet metal, and bent up to shape. The lugs forming the anchorage for the wires would have a tendency to straighten out at the bends; but the amount of this,

whether serious or otherwise, in the absence of actual experience, is largely conjectural. However, a fitting of this kind was used in the construction of the nacelle of a seaplane exhibited at Olympia in 1914.

Steel Tube Fuselage Construction.

In certain isolated instances, the fuselage is built up of steel tubing, and on one machine of recent design the joints throughout are effected by welding: a detail of the attachment of the vertical and cross struts to the longerons is shown by Fig. 84. It will be noticed that a small quadrant-shaped piece

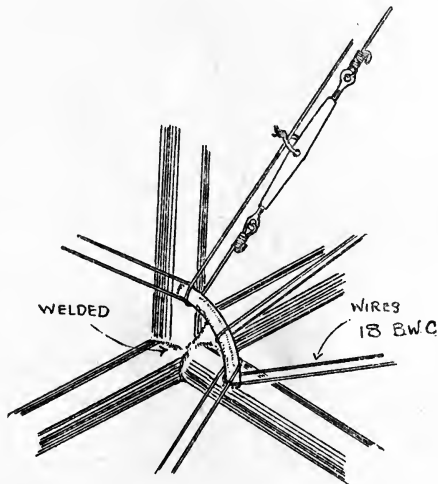

FIG. 84.—Welded joint in steel tube fuselage.

of tube or rod is welded to the struts, and from this are taken the bracing wires. As the welded joints impart a certain rigidity to the structure, the fact that the wires are exerting a side pull on the struts may be of little consequence, although this method could hardly be used in conjunction with the fuselage construction of average English machines. A rather unusual feature may be noticed in the attachment of the bracing wires, which are not finished off with the orthodox wire ferrule, but are arranged as a loop, the turnbuckle

forming the anchorage for the two ends. The trend of design in this country seems to incline towards the clip, stamped out from sheet steel and bent up. This class of fitting can be produced accurately and quickly, and, in the writer's opinion, is by far the best manufacturing proposition. Aluminium castings are quite obsolete, and the built-up fitting, involving welding or brazing, does not seem greatly in vogue.

CHAPTER X.

UNDERCARRIAGE TYPES.

THE present chapter deals with the general arrangement of the different types of undercarriages, as distinct from the details of construction. The principles of design embodied in the undercarriage are necessarily a compromise, this position being due to the fact that its construction has to be considered from two distinctly opposed view-points, and undue attention to the requirements of either does not produce the best results. Thus, on the one hand, we have the desirability of great strength to withstand landings on very rough ground, ploughed fields, and the like; and on the other hand, we have the considerations of aero-dynamical efficiency in flight, which, taken to one extreme, would be best satisfied if the undercarriage did not exist, and at most calls for a system in which the head resistance is brought to an irreducible minimum. By the ordinary process of evolution the agglomeration of ideas existing in the early days of flying with regard to the most suitable form of landing gear, have given place to something which, for machines of modern attainments, approaches finality. This has resulted from improvements along the line of (1) simplification of general design, (2) the reduction of head resistance and weight without a consequent diminution in its powers as an alighting gear. A better impression of the distinguishing points of the various types will be gathered if we consider the desiderata of an ideal undercarriage.

Principles of Design.

One of the most important points is that rolling shocks should be completely absorbed, and the least possible strain

transmitted to the fuselage or main structure, this calling for a good system of wheel suspension. It must be capable of standing the considerable strains sustained in alighting, not the least of which are those attendant upon landing in a side wind; should offer the least possible head resistance, while the weight must be reduced to a minimum. Cross-country flying, which more often than not means "getting off" in a restricted space, requires that the machine shall attain flying speed in the shortest time, and conversely in alighting the machine should come to rest in the quickest time. Innumerable smashes have been caused after a perfectly good landing by failure to pull up before a hedge, fence, or ditch. These are the main principles involved, and at least they indicate how and why the undercarriage is necessarily a compromise.

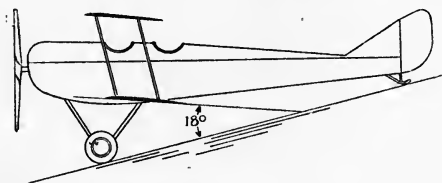

FIG. 85.

It is clear that in landing the speed of the machine relative to the ground should be as low as possible, without developing into the operation generally known as "pancaking," or stalling, and the usual method of accomplishing this is to bring the machine into the wind, which, if of a moderate velocity, materially reduces the speed relative to the earth. In ordinary circumstances, landing would be accomplished by gradually increasing the angle of incidence until the maximum, or angle of no lift, is reached, which is practically stalling point. To satisfy this consideration, the heights of the main rolling wheels and tail skid should be arranged to allow the wings to lie at an angle a little in excess of this. With modern wing sections the angle of maximum lift is between 14° and 16° , so that the angle of 18° , as shown in Fig. 85, is usually sufficient. This has additional value in restricting the length of run after

contact with the ground, the wings acting as air-brakes. It will be realized that reduction in height of the undercarriage, desirable as it is from the aspect of head resistance, cannot be carried beyond a certain point without the sacrifice to some extent of the foregoing qualities. So far we have taken the principles of design as affecting the disposition of the undercarriage members in a longitudinal direction, but, of course, there are several details to be considered in its arrangement laterally. A fundamental point is that the track of the wheels, *i.e.* the distance, centre to centre, should be of ample width, but several constructional difficulties tend to restrict this to certain limits. Where the undercarriage is of the type in which the main rolling wheels are mounted on a single axle, it is clear that the wheel base is limited to the greatest length the steel or duralumin tube can be used without buckling under landing shocks. If this is to be exceeded a bigger diameter tube of thicker gauge will be necessary, and this means additional weight. Again, the fuselage width for the tractor machines now in vogue does not greatly exceed 3 ft., being more usually under that figure, so that a very wide base would mean raking the struts at a flat angle, which would therefore require to be made of larger section than would be the case if the wheel base was narrower; or, if the same section strut is used, the strength is reduced. A wide wheel base therefore means an undesirable increase in weight and resistance. To make up for the deficiencies of the almost unavoidable narrow wheel base, it is usual to make use of the wing tips by fitting skids of malacca cane or laminated ash, which are brought into action when the machine is excessively canted over sideways. At one time the wing tips were almost invariably used to assist the undercarriage, the wing tips of the Nieuport monoplane being specially constructed for the purpose, and no skids were fitted. Earlier still the R.E.P. monoplane had only one central rolling wheel, a smaller wheel being attached to each wing tip. The wing tip wheels of the Cody biplane performed similar functions, although these were used in conjunction with two main wheels.

Undercarriage Types.

The type of landing gear in use to-day does not vary in principle to any great extent, the differences usually occurring in the choice of material, the system being that usually known as the Vee type, from the fact that viewed in side elevation, the struts form a V. While this type has much to commend it from the points of low head resistance and great strength for weight, there are other systems, some of which have been tried-out, while others still exist, incorporating features designed for some specific purpose. Of these the Farman type is an example of a landing gear designed for the requirements of school work, consisting of two long ash skids, which, extended from the rear end of the nacelle, being gradually bent upwards to carry the front elevator. This was the arrangement on the

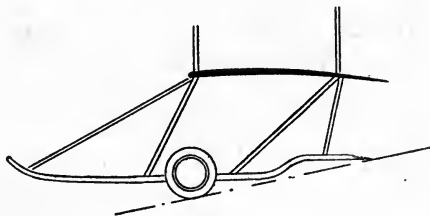

FIG. 86.—Side view of Farman landing gear.

“Longhorn” machine, but on the “Shorthorn,” produced at a later date, the skids, as shown by Fig. 86, terminated in short bends. Each skid carried a pair of rolling wheels, attached to a short axle, this being bound to the skids by rubber bands. The wheel base being almost 9 ft., this type gave excellent results. In the case of big machines, where it is desired to keep the load on the tail skid as light as possible, three wheels are sometimes used, two main rolling wheels and a light pilot wheel in the front. This enables the main rolling wheels to be placed under the centre of gravity, the pilot wheel preventing the consequent tendency to pitch forward when rolling. A further development of this system dispenses with the tail skid, two main wheels being placed under the centre of gravity, and two smaller wheels a little forward of the propeller, as in Fig. 87. The skids were sometimes

continued back behind the rear struts, and saw-kerfed to increase the resiliency. The base of support was formed by the rear wheels and the ends of the skids, the machine being pulled on to the front wheels by the thrust of the propeller. The short wheel base is bad for rolling on bumpy ground, and frequent skid replacements are necessary with this system. A similar

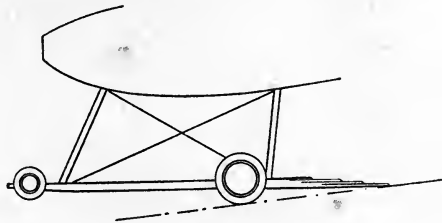

FIG. 87.—Side view of four-wheeled landing gear.

type with no tail skid has the wheels disposed forward of the C.G., while a single central skid, connected to the fuselage by a series of V struts, replaced the double skids, as in Fig. 88. This type was used on the original Nieuport monoplane, and with minor modifications on the Avro 80 h.p. Gnome tractor biplane. Its chief advantage is low head resistance, but un-

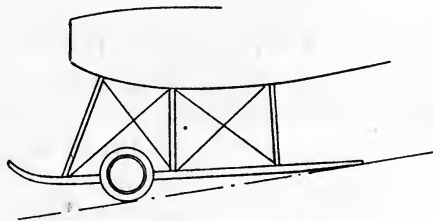

FIG. 88.—Side view of Nieuport undercarriage.

fortunately with this system a narrow wheel base, with the attendant defects, is inevitable. A very distinctive system was that favoured by Bleriot, and used with minor alterations on all the Bleriot monoplanes. This is shown, diagrammatically, in side elevation, by Fig. 89, and was unusual in that the wheels were arranged to swivel, this being an attempt to counteract the side strains set up when landing in a side

wind. Although in the hands of some of our most famous exhibition pilots this has functioned excellently, it is complicated and somewhat heavy.

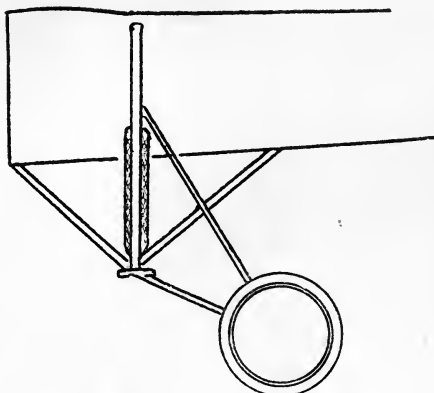

FIG. 89.—Bleriot undercarriage.

Recent Developments.

During the last three years the vital necessity of speed and climb, and more speed and climb, has resulted in the gradual elimination of skids, struts, and wires, until to-day the chassis

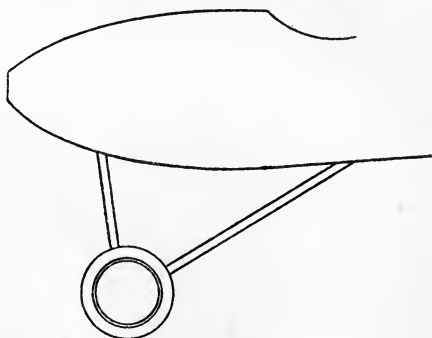

FIG. 90.—Vee type undercarriage.

for machines of average dimensions is almost invariably the V type (Fig. 90). The wheels are placed about a foot in front of the C.G., as, owing to the absence of any forward skid, no

other provision exists to counteract the tendency to pitch over. In the actual construction of the Vee undercarriage, some diversity of practice exists with regard to the material chosen. In some cases the struts forming the Vees are constructed of a streamline section steel tubing, in others round tubing, the streamline section being obtained by a wooden fairing bound on, while a number of constructors use wood for the struts.

CHAPTER XI

UNDERCARRIAGE DETAILS

THE details of construction associated with the undercarriage are those concerned with the forming of the struts and main members, and the suspension of the axle. As noted in the previous chapter the Vee undercarriage is greatly in favour at present, but the fact that with this type no forward support exists to prevent pitching over when obstructions are met in rolling, will almost certainly result in some arrangement of wheels and skids for the touring machines of the post-war period. Machines are now designed for air performance pure and simple, so that an undercarriage of the simple Vee type is all that is permissible; but in the post-war machine general utility will be the desideratum sought for by designers. At one time the majority of the undercarriage arrangements incorporated one or more skids. The material most suited for this purpose is hickory, although some designers prefer ash, steamed to the desired curve, and generally channelled out between the points of intersection of the struts, fittings, etc., in a similar manner to longerons and wing spars.

Where the bend is sharp, and therefore difficult to obtain by steaming, it is usual to form the skid from a number of strips, or laminations, glued together. Quite a good method of stream-lining the curved toe of the skid is shown by Fig. 91, consisting of a spruce block attached to the skid by screws, and it has additional value in ensuring permanency of curve. Where the design is such that the rear end of the skid performs the functions of a tail skid it is saw-kerfed, as in Fig. 92, the laminations so formed being stepped back, and the bottom

layer shod with a plate, or claw fitting, acting as a brake, and also preventing wear produced by contact with the ground.



FIG. 91.—Streamlining curved toe of skid.

At one time this constituted popular practice, but it is a matter of some difficulty to prevent the saw-cuts from developing into fractures. As a matter of fact, on one type of machine



FIG. 92.—Laminated skid end.

replacements were so frequent that eventually the skid end was left solid.

Methods of Suspension.

In the preliminaries of design referred to in the last chapter, it was observed that the action of rolling and alighting called for a good system of suspension and shock absorption, and this is accomplished on modern machines by binding the axle to the main members of the structure with either rubber cord (this being a number of strands of rubber about $\frac{1}{16}$ in. square, compressed and bound together with a woven twine casing) or plain rubber rings. The latter are more or less obsolescent, at least in this country, the reason being found in the better lasting qualities of the cord, which will also withstand a much higher ultimate stress, the fabric covering contributing largely to this. In a number of cases, and generally for heavy machines, steel helical springs are fitted. Various attempts right from the beginning of successful flight have been made to utilize steel springs for suspension, but hitherto

very few machines have successfully incorporated them, and but a brief examination will show that their use on machines of the average modern type is attended with some unsatisfactory features. Firstly, they are much heavier than rubber, but this in itself is no great disadvantage, as ease of attachment probably compensates for this; but what is of moment is the fact that steel springs are not nearly so efficient *shock-absorbers* as the rubber variety, while even the efficiency of the latter is capable of considerable improvement. If we take the case of a machine rolling over bumpy ground, all that is required of the suspension is that the wheel movement over the inequalities shall not be transmitted to the whole machine. So far both steel springs and rubber cord satisfy these conditions, but in the operation of alighting the machine not infrequently strikes the ground with some force, sometimes the result of gusts or pancaking. With steel springs, and to a lesser degree those of rubber, the energy of landing is not absorbed, but is stored up, being given out again in the form of a rebound. With rubber, elongation and its consequent depreciation of ultimate tensile strength prevents any energy of moment being returned to the aeroplane, which is why, for light machines of modern design, say, up to 2500 lbs. total weight, rubber is the better material. Steel springs being deficient in the power to damp out shocks, it becomes necessary to use these in conjunction with some other medium possessing this quality, and one of the most suitable arrangements extant is that known as the oleo-pneumatic gear, consisting of a combination of helical coil spring and oil plunger. It is usual to arrange the main compression members in two halves, the upper half forming a piston, and the lower, attached to the wheels, constituting the cylinder, is filled with oil. The weight of the machine is taken normally during rolling by the helical spring, wound round the upper half of the telescopic tube. Excessive shocks cause the oil to be forced through a spring valve, adjusted to open at a certain pressure, into the upper half, a back-pressure valve enabling the oil to gradually return to the cylinder. The Breguet biplane, a pre-war machine of original design,

embodied in the undercarriage arrangement a system analogous to the foregoing.

Shock Absorbing Effect of Tyres.

The assistance rendered by tyres of large diameter must not be overlooked. The merits of the large tread are quite well known in the sphere of the motor-car, and they are no less beneficial to the aeroplane. It is of interest to record that a pre-war racing machine had no other suspension and shock-absorbing medium than that provided by the very large tyres fitted to the wheels, the axle being fixed rigidly to the undercarriage struts. A similar arrangement existed on a machine of much more recent date. One does not advocate this system, as it can be of very little use for rough ground, the instance being cited to emphasize the assistance so rendered to the ordinary type of suspension.

Connections.

Various methods exist for connecting the rubber to the main members, a typical arrangement with the Vee under-

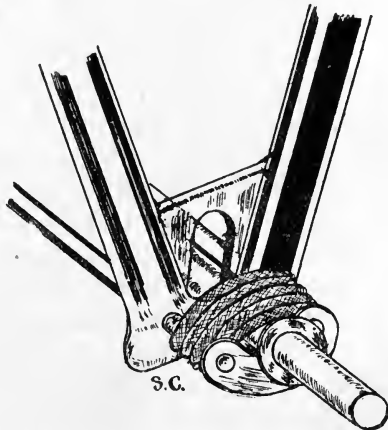

FIG. 93.—Arrangement of suspension on steel tube undercarriage.

carriage of steel being shown by Fig. 93, and a variation of this, when wood is the material, is indicated by Fig. 94. The

web plate in Fig. 93 forms a means for guiding the axle in its upward travel, and is another version of the one-time popular

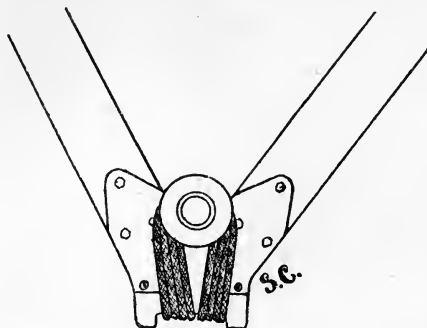

FIG. 94.—Arrangement of suspension on wood undercarriage.

radius rod. It is not considered necessary, in many instances, to fit either web plate or radius rod, the movement of the axle

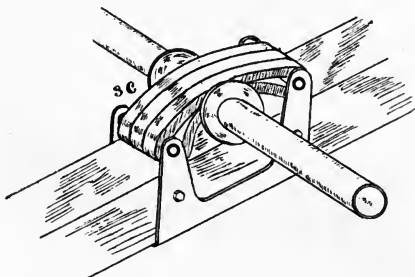

FIG. 95.—Farman type axle suspension.

being of no great extent. Another system is shown by Fig. 95, this being the method of suspension adopted for the Farman

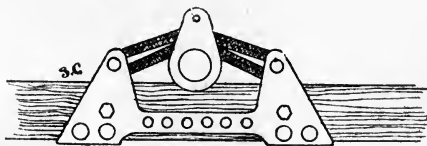

FIG. 96.—Rubber cord suspension.

machines. In this case rubber bands are attached to the main skids, the short axle passing between the two. A similar

arrangement in general outline is shown by Fig. 96, although in this case the rubber takes the form of cord.

A method greatly in vogue in America is that indicated by Fig. 97, known as the bridge type, and a characteristic Wright

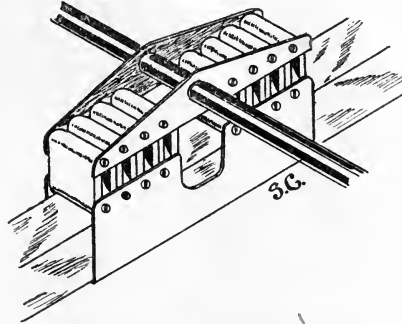

FIG. 97.—Bridge type suspension.

detail, the rings being approximately two inches wide by two inches long. The fact that very few examples of this system exist in this country may be ascribed to the inferiority of rubber bands compared with the rubber cable.

Axle Fairings.

It is now the practice to streamline the compression tubes between the vees of the undercarriage with a fairing of aluminium or three-ply. This is so arranged that in flight the

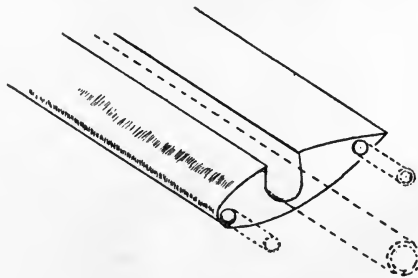

FIG. 98.—Axle fairing.

axle lies in a slot formed in the fairing, which appreciably reduces head resistance. A typical arrangement is indicated

by Fig. 98. The axle is usually formed of steel or duralumin tube, and in the majority of undercarriage arrangements is divided and hinged in the centre, a wire or wires from this point to the fuselage accounting for any strain. Duralumin tube is especially suited for this item, as a much stiffer axle is possible for a given weight, although, unfortunately, this is slightly discounted by the fact that duralumin does not form a good bearing surface for the wheel hubs, and it therefore becomes necessary to fit either sleeves or stub-axles of steel.

Undercarriage Brakes.

Additional means for restricting the length of travel after contact with the ground is sometimes found in the employment of brakes of various types. A very simple and widely used arrangement is to terminate the tail skid in a claw fitting, as Fig. 99, so that in alighting the tail is shoved hard

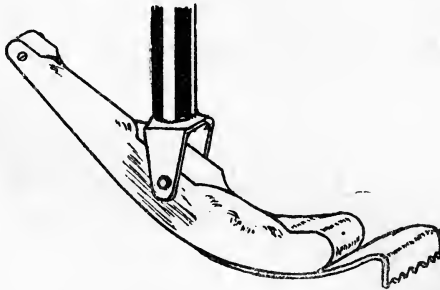

FIG. 99.—Tail skid with claw fitting.

down, bringing the skid into contact with the ground. The disadvantage is that undesirable strains may be carried to the fuselage members.

Another version recently patented is to construct small planes to conform to the wing curve, and hinged so that by a system of wires and pulleys, actuated from the pilot's seat, they could be adjusted to offer a normal surface to the direction of flight. The efficiency of this arrangement at low speeds is not very great, moreover a landing with the wind renders them quite useless. The best form of brake is

undoubtedly one acting direct on the main wheels, either of the rim or band type, a good example of the latter being the system used on the 70 h.p. Bristol biplane. Closely allied to the question of brakes is that of steering, and the requirements of this latter item are fairly well satisfied by pivoting the tail skid and working it in conjunction with the rudder from the foot-bar or wheel.

Housing of Undercarriage during Flight.

Numerous suggestions, ideas, and patents exist, having as their object the housing of the undercarriage in the fuselage during flight, with a resultant reduction in resistance; and excellent as the principle is, its practical application is difficult of achievement—at least, for machines of the present. In flight the undercarriage is a useless encumbrance, adding weight and head resistance, so that an arrangement whereby this component could be folded into the main structure would apparently effect a saving in resistance. This would mean that the fuselage would be of larger cross-sectional area, the natural sequence being extra weight and resistance. It does not appear that the saving effected in resistance, when the undercarriage is folded during flight, would account for the additional weight of the operating mechanism and the increased head resistance of the fuselage, so that altogether the advantages of any so-called disappearing landing gear are very much more apparent than real. There is also the very great possibility of the undercarriage folding up or disappearing when it would be least required to do so. In the construction of the problematic air-liners of the future it may be possible to economically effect the housing of the undercarriage.

CHAPTER XII.

CONTROL SYSTEMS.

THE mechanism by which the aeroplane is controlled in flight forms the connecting link between the pilot and machine, and constitutes a vitally important and somewhat vulnerable item of the complete structure.

Main Principles.

The control of all modern aeroplanes is effected in a lateral direction by small planes hinged to the rear spar of the outer ends of the wings, and known as "ailerons"; in a longitudinal or "fore-and-aft" direction by the elevator planes; and for steering by the rudder. Although these functions are alluded to separately, they are more often than not combined in their actions. The correct proportion of the controlling surfaces is an important factor in determining the ease or otherwise with which a machine can be handled in flight, and faults in this direction are responsible for the terms "heavy" or "stiff" on the controls being applied to a machine. The use of subsidiary flaps or ailerons for lateral control is a comparatively modern innovation. At one time it was usual to warp the entire plane, or in some cases the outer section only, and although the principle is the same—that of forming a negative or positive surface to the line of flight—structural considerations are wholly in favour of ailerons. With warping, the whole plane is subjected to continuous torsional movement, and to obtain this some of the trussing wires have necessarily to be arranged as control wires, the result being that the plane curvature loses its uniformity, and the whole

girder system of the planes is less efficient under load than if the wires were permanently fixed ; and the latter item is only possible with aileron control. Although it is usual to attach ailerons to both top and bottom planes of a biplane, there are occasions when sufficient control can be obtained with ailerons to the upper plane only, usually when the span of this plane is greater than that of the bottom.

Control by Inherent Stability.

With machines of the inherent stability class the lateral control is effected by additional means, the planes being designed to automatically right the effects of gusts. This element of inherent stability is obtained by suitably grading the camber and incidence of the wings, until at the wing tips the chord of the plane section forms a negative angle to the line of flight. Although this arrangement is undoubtedly of value, especially for the touring machine of moderate power, its chief fault lies in the relatively slow righting movements, which, although of no great consequence at a reasonable altitude, becomes a source of danger when alighting, and certainly entail the use of ailerons, or warp, to counteract it. The type was well exemplified in this country by the Handley-Page monoplane and biplane, while in Germany it achieved great popularity, surviving in some makes until the latter part of 1916. In the matter of control-surface design it is interesting to note the contrast between the preferences of English and German designers. In almost all German machines the ailerons, elevators, and rudder are balanced, *i.e.* surface is disposed each side of the hinge-axis, this applying to the small Albatross scouts and to the large machines of the Gotha class ; while in this country few examples of this practice occur. The reason for the balancing of controls lies in the desire to reduce the manual strain on the pilot to a minimum ; and it appears that with large machines balanced surfaces will be imperative. Several automatic controls have been produced, the most notable perhaps being the Sperry gyroscopic, this being a combination of servo-motor and gyroscope. This apparatus has been well tried.

So far as the arrangement of the control surfaces is concerned, little variation occurs, which condition has obtained from the early days of aviation, but the mechanism governing or directing these movements varied at one time considerably, and although in this country one type of control is used, there are still instances of the use of widely different systems. In former days the practice of individual makers fitting different controls resulted in some arrangements being in exact contradistinction to others, which not infrequently meant, to a pilot taking on a new type, the unlearning of a great deal which practice had rendered instinctive.

The Instinctive Principle.

All modern controls are based on the instinctive principle, *i.e.* the movements of the control lever coincide in direction with the promptings of natural instinct. Thus, to change the course of a machine flying level into an upward one, the column is pulled towards the pilot, and for descent, the reverse, while to correct a bank, the column is moved in a direction opposed to that of the bank. For steering, a foot-bar is employed, so arranged that for a turn to the left the left foot is pushed forward, and the reverse for a right turn. On one well known machine of former days, the foot-bar actuated the lateral control, which is sufficient indication of the great diversity of opinion then existing.

Vertical Column Control.

A typical control of the immensely popular "joy-stick" type is shown by Fig. 100. This consists of a vertical column pivoted through the medium of a fork-joint to a rocking shaft. The elevator wires are taken round pulleys mounted under the seat, and the aileron wires from a form of bell-crank, flanged and welded to the steel tube. A disadvantage with this system, in addition to the complication of the wires, is that lateral movement also affects the elevator, although the extent of this is of no great moment. It is obvious, although somewhat paradoxical, that if the elevator is to be depressed by a forward movement of the column, the control wires will

required to be crossed, *i.e.* the wire running from the base of the tube to the pulleys will be attached to the arm on the top side of the elevator, and *vice versa*. On single-seater machines it is sometimes necessary for the pilot to have both hands free of the controls, so that it becomes necessary to install some form of locking device for the elevator control, there being many simple ways of accomplishing this. The locking of the control lever fixes the flight path of the machine, but, of

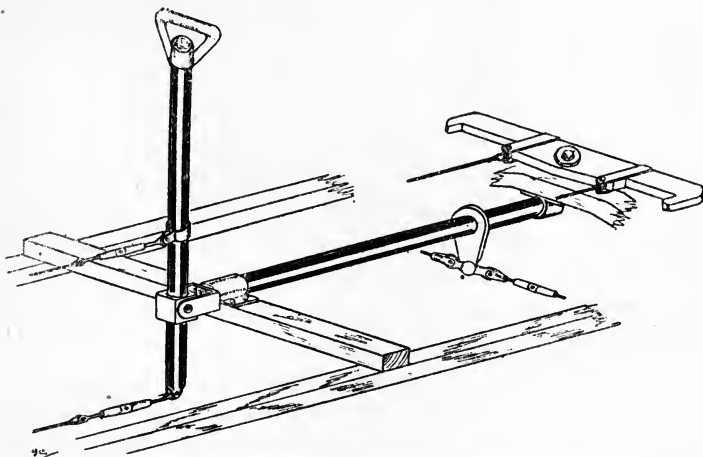

FIG. 100.—Arrangement of vertical column control.

course, lateral equilibrium can be maintained by movements of the lever sideways, and steering by the rudder bar. The German machines of the Fokker and Albatross types are both fitted with the single lever control with a locking arrangement. Another method which achieves the same purpose consists of bracing the lever in a normal flying position, with rubber cable or coil springs anchored to various parts of the fuselage, and although this permits of movement, the control column always tends to return to the normal position.

Wheel Controls.

While the "joy-stick" type of control is greatly in favour, there are various forms of wheel control in use. American machines are almost entirely fitted with wheel controls, and

all things considered, it appears that modern practice is evenly divided between the two types. The sequence of movements of the wheel type may be varied in a number of ways, the general arrangement shown by Fig. 101 being typical of an average system. In this case the hand-wheel is mounted on a central column, which in turn is rigidly fixed by some form of Tee joint to a transverse rocking shaft. A sprocket attached

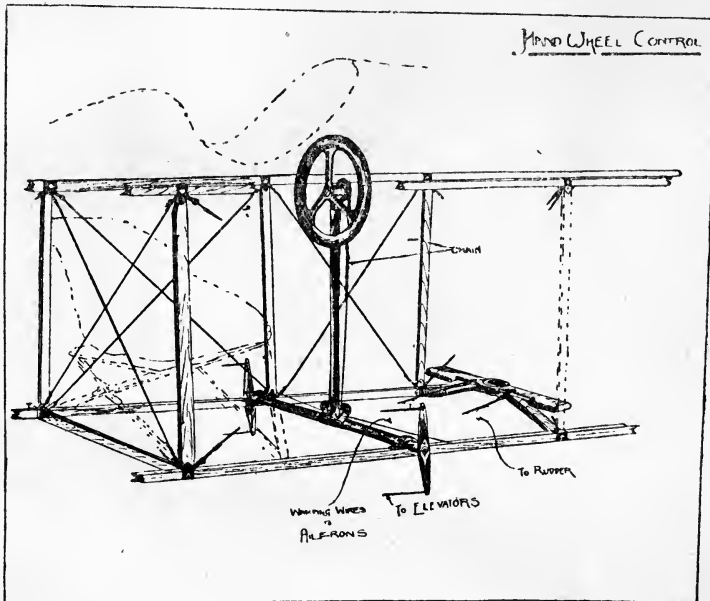

FIG. 101.—Arrangement of wheel control.

to the wheel centre engages with a short length of chain, which connects to the aileron control, while the elevator wires are connected to short tillers, arranged to work on the outer side of the fuselage. With this system the hand-wheel is rotated for the aileron movements, a fore-and-aft rocking motion for the elevation, and the rudder is actuated by an outward movement, with either foot on the rudder bar. A development designated "three in one" embodies all these movements in the wheel column, which in this case is pivoted at its base: a to-and-fro motion in the column for the elevators,

sideways for the ailerons, while the rudder control is effected by the rotation of the wheel. This system is fitted to a number of American machines, but it is a moot point whether the rotation of the wheel for warping or steering is quite such an instinctive action, as the sideways movement of the lever combined with the movements of the foot on the rudder-bar; in any case, there is just a suspicion of complication in its working which is undesirable, that is, for machines intended for popular use.

The "Dep" Control.

The type of control used on the Deperdussin monoplanes of 1910 and onwards has survived until the present day, and forms a distinctive arrangement. Its chief attribute is that,

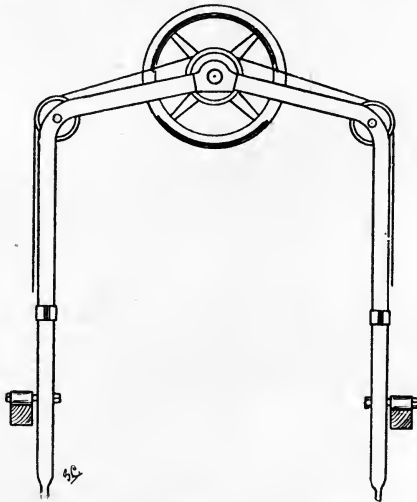

FIG. 102.—"Dep" type control.

compared with other systems, much greater room and freedom is afforded the pilot, which is evident by a consideration of the diagrammatic sketch, Fig. 102. The inverted U-shaped lever is composed of either ash, bent to shape, or steel, or duralumin tube, the general system of its working being the same as the wheel control shown by Fig. 101. Incidentally, passing

reference may be made to the fact that the usual close proximity of the compass to the controls precludes the use of steel in any great quantity for the construction of the lever, as the various movements adversely affect the compass readings.

The Wright System.

Another variant of the wheel control is instanced by the Wright system, this consisting of a general lay out similar to that shown by Fig. 101, but no rudder-bar is fitted. The rudder control is provided by a small lever, mounted concentric with the wheel, the latter carrying a rigidly attached sprocket. The hand-lever is also connected to a sprocket, this running free on the wheel shaft, so that by gripping both hand-lever and wheel it is possible to operate the ailerons and rudder simultaneously, this action being a characteristic feature of all the Wright productions. Although there are many types of control in use, those described in the foregoing chapter are illustrative of general practice.

CHAPTER XIII.

WIRES AND CONNECTIONS.

IN all aeroplanes the question of wires and the terminal connections associated therewith is a matter of some importance, and while this may vary in degree, there is little doubt that the efficiency of modern wiring systems is largely responsible for the structural efficiency of the aeroplane as a whole.

Aeroplane construction consists almost exclusively of a framework of wood braced by wires, a condition of things which has obtained since the inception of flight; as may be judged by the various engravings of Henson's projected monoplane of 1842. This machine incorporated an arrangement of king-posts and wires approximating very closely to modern practice, and the natural sequence of improvements have tended towards the gradual elimination of exposed wiring.

Various Wires used.

The various wires used in construction may be classified into four distinct types: the solid wire stay, the straining cord or cable used for stay wires, the extra flexible cable used for controls, and the swaged tie rods in plain or streamline form. The earliest form of bracing was of the solid piano wire variety, this having been used on most aeroplanes from the days of the Wrights onward. From the view-point of the early pioneers, this wire was eminently satisfactory, being cheap (a vital consideration) and simple to attach and replace. Although the tensile strength of this wire cannot probably be excelled, its hardness renders somewhat difficult the forming of the end

loop without fracture of the wire. For this reason piano wire gradually gave place to a softer grade of wire which, while being strong, was tough and ductile, enabling bends to be made with a lesser danger of fracture. The original connection used for the piano wire stay is shown by Fig. 103, this consisting of a loop or eye, the free end being turned round a ferrule of soft copper tube, this being sometimes varied by the use of a flat strip of tinned iron, wrapped round and soldered. While this was fairly satisfactory for short stays, it was hardly suitable for the main lift wires of the interplane bracing, owing to the comparative ease with which, under load, the free end pulled or cut through the ferrule, so that after a while the oval spring-wire ferrule, Fig. 104, came into use. This is made of the same gauge wire as the stay, and is from seven to nine convolutions in length. The eye should be formed as an easy bend, and not kinked, the ferrule being pushed tight against the shoulders, and the free end turned back.

Result of Tests.

Tests undertaken at the instance of the American Advisory Committee for Aeronautics showed that 80 per cent. of the wires tested failed by the free end pulling through the ferrule, the remaining 20 per cent. failing by fracture, the stays possessing an average efficiency of 68 per cent. of the maximum strength of the wire. Although various modifications, such as tying the free end to the ferrule with fine wire, as in Fig. 105, resulted in an increase in total efficiency, average European practice consists of that shown by Fig. 104. At the present time the solid wire stay of the form dealt with is used mainly for the bracing of the fuselage frame, and the internal wiring of the tail planes.

Stranded Cable.

The gradual increase in engine power and total weight of aeroplanes led to the adoption of stranded cable for all important loaded wires, this being made in two distinct ways.

The cable employed for interplane bracing is composed of

a number of fine wires, varying from nineteen to thirty-seven according to the different diameters, the end section being indicated by Fig. 106.

Where extra flexibility is required, such as for control wires running round pulleys, the cable is composed of a number of strands, generally seven, which in turn consists of a number of fine wires, usually nineteen, the end section being shown by Fig. 107. English practice designates this form of cable as extra flexible, and the single rope of nineteen wires

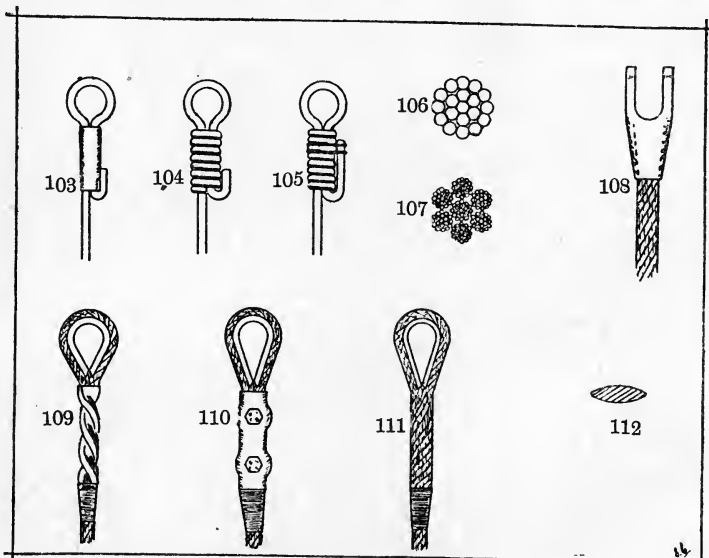

FIGS. 103-112.—Methods of forming wire connections.

as straining cord. American classification is practically the reverse, in that the single rope is known as stranded cable, and the multi-strand as cord. Although the factor of strength is an important one it does not entirely govern the selection of a wire, as other considerations, such as flexibility and fatigue strain, influence greatly the efficiency of a stay under active service conditions. Under test the solid wire possesses the greatest ultimate breaking weight, the next best being the single rope. It must be understood that in flight a wire is subjected to constant and intensive vibration, which must

have a deleterious effect on the material, and for this reason a flaw or slight fracture in a solid wire may escape notice until complete failure in the air; whereas the cable, by the unstranding of the damaged wires, would give warning of wear. Chiefly owing to the difficulty of forming a satisfactory splice in the single-strand cable, modern practice inclines toward the use of the multi-strand cable for all purposes, as the construction of this wire lends itself to the forming of a successful splice.

Cable Connections.

The earliest form of terminal connection for stranded cable consisted of a loop, the free end being bound to the main part of the wire and soldered. With the addition of a binding or serving of wire round the loop to prevent injury, due to contact with the wiring lug, or strainer eye, this wire, in a recent test, gave an efficiency of 100 per cent. for all diameters up to $\frac{1}{4}$ in.

This result, considering the elementary nature of the joint, is surprising. Unfortunately the effect of corrosion due to acid and solder is a somewhat doubtful quantity; moreover, the appearance of the joint is far from neat. An attachment which at one time achieved some popularity is shown by Fig. 108, and is especially suitable for the single-strand wire. This consists of a cone-shaped forked end with a taper hole, into which the cable is inserted, the free end being unstranded, spread out and soldered. The attachment has been used on what was at one time one of our best products. The efficiency obtained with this fitting is in the neighbourhood of 100 per cent.

In the method indicated by Fig. 109 a piece of flat copper tube is passed over the wire, the free end of the latter being bent round a brass thimble, and then passed through the copper tube, in a similar manner to the connection for the solid wire in Fig. 102. The tube is then given several turns, and the complete joint well soldered. This system is reliable, and has given good results.

A distinctive terminal is indicated by Fig. 110, consisting

of a brass ferrule just sufficiently wide to accommodate the two thicknesses of wire. The bolts are of the counter-sunk head variety, so that the operation of screwing a bolt home also forces the wires into the protuberances in the sides of the ferrule. Although the foregoing methods have all been extensively used, they have now given place to the thimble splice, Fig. 111, which, as a general proposition, is undoubtedly the better terminal connection. The brass thimble protects the strands from the wearing effect produced by contact with the turnbuckle or wiring lug. It is the usual practice to wrap the splice with a binding or serving of fine copper wire, or waxed twine. The efficiency of this joint with a properly made splice may be safely taken as 85 per cent. of the total strength of the wire. With this joint the point of failure, as evidenced by numerous tests, always occurs at, or near, the last tuck in the splice, at which point the extra thickness of the splice is just merging into the normal thickness of the wire. The disadvantage with all terminal connections which necessitate the use of solder is the impossibility of determining just how much the heating operation affects the strength of the wire, and also the effects of corrosion, set up by the various species of flux used in the process of soldering.

Relative Strengths.

For a given diameter the solid-wire stay possesses the greatest strength, the next best being the single-stranded cable, as the following comparison of stay strength, taken from the Report of the National Advisory Committee for Aeronautics, 1915, of America, will show:—

Material.	Diameter.	Strength of material.	Strength of stay.
Wire, solid	inch. $\frac{3}{16}$	lbs. 5500	lbs. 5100
Strand, single	$\frac{3}{16}$	4600	4100
7 × 19 multi-strand... ..	$\frac{3}{16}$	4200	3500

Streamline Wires.

Although in the quest for increased speed the number of exposed wires were reduced to a minimum, the aggregate resistance still remained considerable, this leading to the development of the swaged streamline wire, the introduction of which is generally ascribed to the Royal Aircraft Factory ;

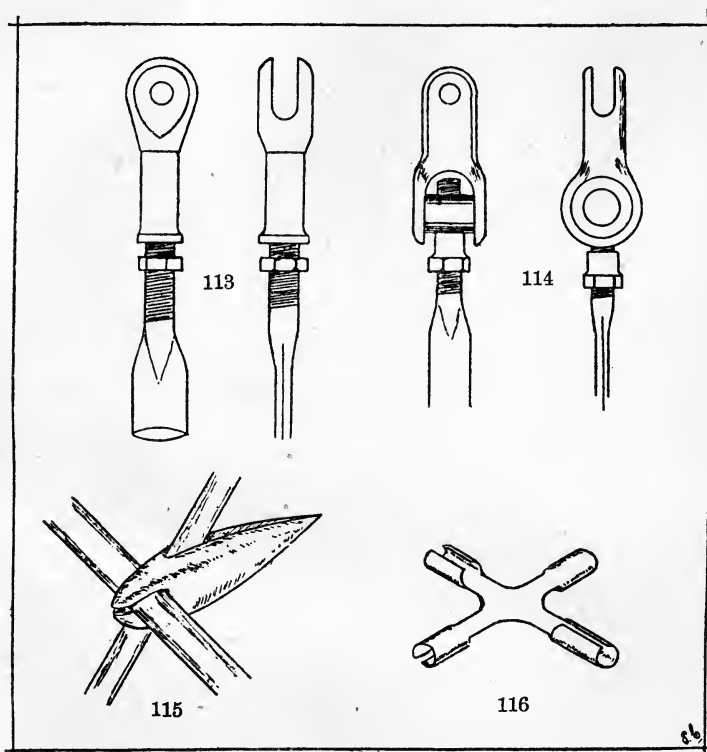

Figs. 113—116.—Methods of forming wire connections.

and these wires are now generally used for all exposed wiring. The points in favour of them are that, properly fitted, a considerable reduction in resistance is obtained, there is a lessened liability to slacken after some use, this rendering rigging a more certain operation, and the nature of its connection obviates the use of turnbuckles.

They have been variously criticized as being expensive to produce, that the resistance may be increased if improperly aligned in the machine, and also that any fracture or flaw is less liable to be detected before complete failure during flight. In manufacture the solid rod is rolled to the section shown by Fig. 112, a certain length each end being left for the right- and left-hand thread. Two of the connections mostly used are shown by Figs. 113 and 114, the latter being preferable, as the universal joint permits of movement in two directions, which reduces the tendency of the wire to crystallize as a result of excessive vibration. To prevent wear at the points of intersection it is usual to fit acorns of fibre or aluminium, a popular form being shown by Fig. 115. Some designers still prefer to use the wire cable for interplane bracing, a fairing of wood being bound to the cables by tape at intervals, this also preventing excessive vibration.

Some years ago various attempts were made, mostly on French monoplanes, to utilize flat steel ribbon for exposed wiring, but, owing to the difficulty of successfully forming a terminal, its use never became extensive, although it may possibly be regarded as the precursor of the modern streamline wire.

It is notable that, so far, the wiring of all German aeroplanes is effected by cable, so that apparently the merits of the streamline wire are not recognized. It is also surprising that no attempt has been made to streamline the cable. A device for tying the wires and preventing friction at the point of intersection, found on nearly all enemy aeroplanes, is indicated by Fig. 116, and there are also instances of quick release devices, these being popular in this country about 1912, and now obsolete.

Although determined attempts have been made of late to entirely eliminate exposed wiring, examples of this occurring in the recent German Fokker triplane, it appears that the various alterations engendered by this procedure in the structure of the machine more than counteract the saving in head resistance.

Moreover, with modern methods of construction the ulti-

mate strength of a wireless wing structure leaves considerable room for improvement, and the price paid for the saving is too great.

The arrival of the all-steel aeroplane would entirely alter the condition of things, as with this construction much better chances exist for the production of a reasonably strong wing structure without exposed wing bracing.

CHAPTER XIV.

ENGINE MOUNTINGS.

THE mounting of the engine and the general arrangement constitute one of the most important and interesting sections of aeroplane construction, and perhaps a brief outline of the various engines in use will suitably preface a consideration of the mountings of the different types. Although there are signs that certain revolutionary engines may eventually come into use, the types in use on modern aircraft are the stationary air- and water-cooled, the radial air- and water-cooled, and the air-cooled rotary. The greater variety occurs with the stationary type of engine, which may be sub-divided into those in which the cylinders are arranged vertically in line, and those where the cylinders viewed from the front form a **V**. Engines typical of the former class are the Beardmore, Green, Mercedes, and Benz, all of which are water-cooled; and of the latter class, Rolls-Royce, Sunbeam, Hispano-Suiza water-cooled, and the Renault and R.A.F. air-cooled. The types of radial engines which have been extensively used are confined to two, these being the air-cooled Anzani and the water-cooled Salmson. There is another radial engine of comparatively recent production; but mention of this while present conditions obtain is not permissible. Rotary engines of note are the Gnome, Le Rhone, and Clerget, all of which are necessarily air-cooled.

Essential Requirements of an Engine Mounting.

The essential features of any mounting are absolute rigidity, accessibility to permit ease of erection and dismount-

ing; and it should also be of a moderately low weight. Moreover, the general arrangement must offer a minimum of head resistance, although in this direction the type of engine used is a determining factor. Rigidity is a paramount consideration, for the slightest tendency to slackness or "play," under the effect of engine vibration, speedily develops, until either serious stresses are induced in the fore part of the fuselage or the engine loses its correct alignment, with a consequent detrimental effect on the flying qualities of the aeroplane. This, of course, should be provided against in the general design; but it is also a contingency which should be kept in mind during the actual construction of the various components of the complete mounting.

A detail which does not always receive sufficient attention is the provision of adequate bracing against the thrust of the engine. Where the construction is such that the engine-bearers form an integral part of the fuselage structure, there is generally little fault to find, but with some sheet steel mountings, particularly those employed for the rotary type of engine, the only bracing in a fore-and-aft direction is that provided by the flanged edges of the plate, which are usually much too narrow to be of real use. Further, the construction of both the engine mounting and the fore part of the fuselage should be of the necessary strength to ensure that the bearers supporting the engine are always correctly in alignment and dead level. With some methods of construction the weight of the engine and various landing shocks, result after a time in the lowering of the bearers at the front, which means that the angle of thrust is not in its correct position relative to the centre of gravity and the incidence of the wings, this being extremely detrimental to the flying properties of the machine.

Materials.

Wood, on account of its property of absorbing vibration, is particularly well suited for the construction of the engine mounting, and one finds examples of its use in a variety of ways. Perhaps the most common form is that in which a bearer of ash or spruce, channelled out between the fastening-

down bolt holes for lightness, is attached to steel brackets which in turn are bolted to the various fuselage members. A development of this method consists of mounting the bearers on either multi-ply formers of wood, or built-up wood brackets stiffened with a three-ply covering on each side, and both of these arrangements are being extensively used. Sheet steel is used for the mountings of various machines, but it does not possess the characteristic of absorbing vibration. In some instances one finds that the engine has been specifically designed to be supported on bearers of the tubular variety, in either steel or duralumin; but here again rigidity is difficult of attainment. Although the use of welding, that is to any extent, is not advisable in the construction of the engine mounting, one finds this process very extensively used for the mountings of some modern machines. In one particular instance, the tubular bearers are supported from the steel tube fuselage by various tubes, the whole structure being welded, and although every joint successfully survived a smash which resulted in a considerable bending and distortion of the fuselage, its use does not engender a sense of security or reliability.

Rotary Engine Mountings.

The mountings associated with the rotary type of engine fall under two categories: those where the motor is supported

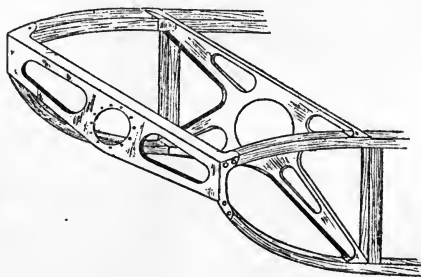

FIG. 117.—Rotary engine mounting, in which engine is supported between two plates.

between two or more plates, and those in which the motor itself is overhung. The method of mounting adopted for the

first case is generally the type shown by Fig. 117. The plates are pressed or bent up from sheet steel, and all edges flanged to prevent buckling. The front plate embodies a ball race, through which the propeller shaft runs, while to the rear bearer is bolted the back plate of the engine. This arrangement with minor variations has been extensively used for the different makes of small scouting biplanes engined with the 80 h.p. and 100 h.p. Gnome motors.

Where the weight of the rotary engine used is excessive, as in the case of the 160 h.p. Gnome with 20 cylinders, which is now out of date, a mounting incorporating three bearers is used. The arrangement would be similar to that indicated by Fig. 117, with the addition of an extra bearer for the support of the crank-shaft extension.

Overhung Mounting.

The overhung type of engine mounting which is used for both propeller and tractor aeroplanes, is shown by Fig. 118.

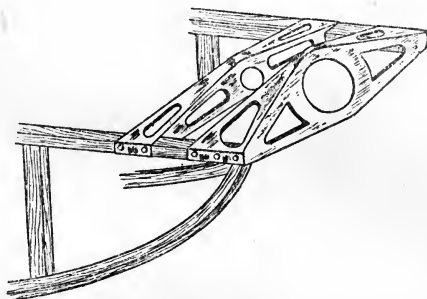

FIG. 118.—Overhung rotary engine mounting.

In this case the back plate of the motor is bolted to the capping plate, while an extension of the hollow crank shaft is supported by a smaller rear plate. This system has been very widely used, chiefly by reason of its extreme lightness, and the great facility afforded for the operation of dismantling the engine; indeed, it would be difficult to find an arrangement in which the demands of accessibility are so well satisfied. Another form of overhung mounting, which has been used for a radial

Anzani motor, is shown by Fig. 119. In this case the four longerons of the fuselage are capped by a single flanged steel plate, to which the engine is attached by long bolts through

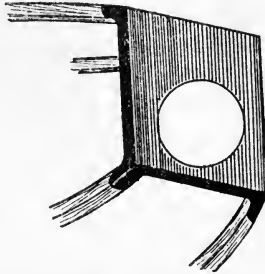
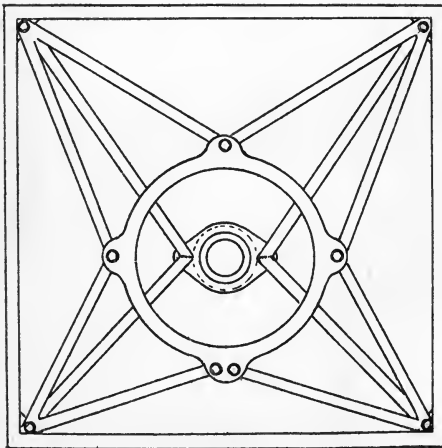

FIG. 119.—Anzani type engine mounting.

the crank case. Additional support is provided by light steel tube stays, which are taken from various points on the front

FRONT ELEVATION



SIDE ELEVATION

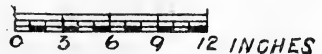
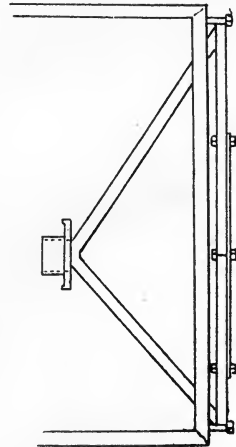

FIG. 120.—An overhung mounting built up of steel tubes.

of the crank case to the centre section of the upper plane, or other parts of the machine.

A distinctly original type of overhung mounting is shown

by Fig. 120 in front and side elevation, this being used on a machine incorporating an all-steel fuselage. The ring to which the back plate of the engine is bolted, is supported from the four corners of the fuselage by steel tubing, while the bearing for the crank-shaft extension is formed by a pyramid of tubes welded to a pressing of sheet steel, to which in turn is bolted a ball-race housing. At each corner the three converging tubes are welded together, and bolted to small angle plates, which are also welded to the framework of the fuselage. It will be seen that the strength of this mounting is entirely dependent upon the welding; but such reliance, in view of the generally uncertain nature of this latter process, is not to be recommended.

A Stationary Engine Mounting.

A mounting used for a 70 h.p. air-cooled Renault, which is designed to be supported by short lengths of steel tube projecting from the crank case, is shown by Fig. 121, this

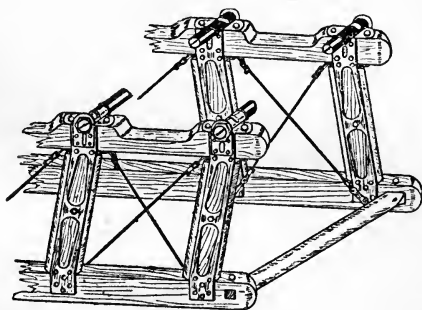

FIG. 121.—Stationary engine mounting.

particular arrangement being used on a propeller biplane. The four ash longerons of the nacelle are built up in the form of a box girder, the struts immediately under the engine bearers being reinforced with steel plates. The steel tubes from the crank case embedded in a steel bearing, composed of two semi-circular clips, which are let into the upper longerons, and are prevented from moving sideways by steel collars sweated to the tubes and abutting against the fixing clips.

In this case, by the removal of the four fixing clips and the necessary pipe connections, the engine can be lifted bodily out.

Multi-Engine Mountings.

Several versions of the type of machine employing two or more engines, and which, by the way, is regarded as being the type most suitable for the commercial purposes of the future, are existent. The usual arrangement with the twin-engined machine is to support the engines between the planes on either side of the body, the bearers being mounted on a structure of struts, which also serve as inter-plane supports.

With regard to the flying-boat type of machine, a favourite practice is to mount the motor on the four struts supporting the centre section of the upper plane, which is braced by struts and wires from different points on the hull or body.

Although the modern aircraft engine is of greatly increased power, compared with the engine of the period 1912-1914, one does not find any great difference in the structural features of the mounting employed, and in view of the very diverse arrangements for mounting the same type of engine which now exist, there is need for greater uniformity. With regard to the materials employed, there is a very pronounced trend towards the greater use of wood, which circumstance is certainly at variance with the oft-ported approaching era of steel. As indicated in previous chapters, wood possesses remarkable powers of resistance to sudden shock, which, combined with its quality of absorbing vibration, renders it peculiarly suitable for the structure of the aeroplane, and despite its numerous defects, will undoubtedly continue in use until either the available supplies of suitable timber are exhausted, or until the production of a remarkably light alloy possessing high strength values.

CHAPTER XV.

ERECTION AND ALIGNMENT.

THE accurate erection and alignment or truing up of the aeroplane, is a cogent factor in ensuring that the best performance is obtained, and it is almost platitudinous to emphasize the fact that a machine incorrectly aligned gives inferior results in flight, entails greater attention on the part of the pilot, and may possibly seriously interfere with the general stability of the aeroplane. The degree of precision attained in the manufacture of the various components is reflected in the ease or otherwise with which the complete assembly is aligned ; indeed, accuracy of erection is impossible without the close observance of limits and general trueness in the production of the different parts. For this reason the erection of the principal components is surveyed as a necessary preliminary to a consideration of their assembly in the complete structure.

Accurate Part Production.

In the production of the various struts, longerons and fittings of the fuselage, the wing spars, compression and interplane struts of the planes, the utmost accuracy must be observed. Although tolerances are permissible with regard to the overall dimensions of the struts, spars, longerons, etc., the lengths particularly of the fuselage struts should be absolutely correct to drawing. The bad effects of a strut, say 1 millimetre short, are not restricted to the particular component of which it forms a part, but are noticeable in one way or another in the complete structure. Similarly the ends of struts which are required to be square should be dead square, and those

which are cut to a bevel should correspond with the correct angle. The result of the slightest discrepancy in this respect becomes speedily apparent when the defective struts are assembled, as the tension of the bracing wires will result in the strut becoming bowed or bent, this being due to the bedding down of the strut end in the socket or clip. It is also advisable to trim the ends in a machine after being sawn to something approaching the correct length, and the practice of sawing to dead length should not be permitted. The surface of a sawn strut end is formed of a number of more or less ragged fibres, which in position in the machine and under pressure of the bracing wires tend to gradually flatten down, this resulting in slack wires and loss of alignment. Absolute accuracy and uniformity of part production can only be obtained by the use of jigs, preferably of metal, and some form of jig should certainly be used for cutting the various struts to length. Referring again to the necessity of the strut ends being of the correct angle, it is surprising to note the effect of the smallest inaccuracy. The writer has frequently noticed fuselage struts considerably out of straight, the grain of the timber being sometimes advanced as the reason. However, the removal of the defective strut always resulted in its return to a straight condition. It should be realized that the effect of an initially bent strut is a reduction of strength, and as this may prove a source of danger, it is in itself sufficient reason for the rigid observance of length limits.

Drilling of Bolt Holes.

Of equal importance is the drilling of the various bolt holes for the attachment of the fittings. It is not always advisable to drill the holes in the spars and longerons before the fittings are applied, but in numerous instances this is possible, and where interchangeability is an important consideration it is imperative. The practice of setting out the positions of the various holes from a drawing and then drilling with a hand brace, is a procedure only justified when a small number of machines of a certain type are to be produced, and ought by now to be obsolete. Under such a system no two spars would

be exactly the same, as owing to the influence of grain in the wood, the drill or bit always tends to "run" from the correct angle. Viewed from the aspect of quantity production such a practice is very deficient. It is only by the use of metal drilling jigs of suitable design that anything approaching absolute accuracy is possible. Such jigs should not only locate the hole, but should also form a guide for the drill. In the attachment of the fittings to a properly jig-drilled spar, it should not be necessary to again drill through, although this often occurs. Where this is done, there is a distinct possibility of the brace not being held true, which means that the hole becomes larger than necessary and not infrequently oval in shape. An additional bad point is the impossibility of detecting such a fault after the fitting is bolted on, and it may not be realized until a noticeably slack wire in the complete machine indicates the movement of the fitting. In the foregoing, absolute accuracy in the various fittings has been assumed, but unfortunately in practice almost the reverse is true. Variation generally occurs in built- or bent- up fittings, and is usually the result of jigs of either incorrect or bad design. Where the variation includes a hole out of position, the use of this fitting on a previously drilled wood part is only possible by the bad practice of drilling through with the results explained above. It will thus be realized that the uniformity and accuracy of component production is only attainable by the utmost precision in the manufacture of both wood and metal parts.

Locking of Bolts.

Throughout the complete machine it is necessary to lock the nuts of the bolts, to prevent their gradual loosening under the vibration of the engine, and different methods of accomplishing this are in use. Undoubtedly the best form of lock is by the use of a castellated nut and split pin. By this method one can readily ascertain whether or no a bolt is locked, while by the withdrawal of the split pin the bolt may be taken out. A disadvantage is that its use entails considerable drilling, so that a modification consists of fitting castellated nuts to all

bolts liable to removal for minor adjustments; while elsewhere the threaded portion of the bolt is left a little longer than the nut, and then riveted over. Although this reduces labour, it is a somewhat destructive method; and it is also difficult to determine the adequacy of the riveting. Another method consists of filing the bolt end flush with the nut, and then centre punching three or four dots in the joint between nut and bolt.

This method is neat, the removal of a bolt is easily effected, and the fact that it has been used in the construction of some fast scouting biplanes is proof of its effectiveness.

Other systems include the use of two nuts, of a single nut soldered to the bolt end, and the various patent lock-washers, which in this country are not greatly in vogue. The practice of re-running down the threads of bolts to ensure ease in the application of the nut is not to be recommended—that is, indiscriminately done. Unless the die is properly adjusted there is a possibility of too much thread being taken off; the result, an extremely slack nut, being detrimental to general reliability. The durability of an aeroplane in service is dependent upon the good workmanship effected in the smallest and most insignificant detail. Moreover, it should be remembered that the absence of a split pin may eventually result in disaster.

Truing of Main Planes.

The planes or sections of a machine of the straight-wing type, as distinct from a machine possessing arrow-shaped or retreating wings, should, when erected on the fuselage, form a straight line from tip to tip. This feature is dependent upon (1) the trueness of the planes, and (2) the alignment of the attachments on the fuselage, the latter being considered under the fuselage heading. To ensure that the plane is quite square, it should be checked previous to covering by diagonal measurements on the wing spars, these being taken from accurate set positions such as are provided by the wing-root attachments and the interplane strut fittings. Should a difference in the diagonals exist, this can easily be rectified by a

slight adjustment of the turnbuckles incorporated in the internal plane wiring. As the ribs of the plane are built up beforehand, and checked for correct contour by pattern, little variation should occur in the camber. A point where differences may occur is between the front spar and the leading edge, as the nose formers are generally inserted during the assembling of the plane. For the detection of faults in this direction the template illustrated by Fig. 84 in Chapter IV. is of great utility.

Fabric Covering of Planes.

The evenness and correct tautness of the fabric covering contributes largely to the trueness of the plane. Should the covering be stretched unevenly or too tightly, the application of the dope will cause distortion of the framework, which can only be obviated by re-covering. The bad effects of this is more noticeable with regard to the ailerons, elevators and rudder, which, being of very slender construction, are more liable to deformation. Twisted or warped control surfaces should never be used, as such surfaces not only offer increased resistance, but also interfere with the balance of the machine in flight.

Fuselage Erection.

As the fuselage constitutes the nucleus of the aeroplane, accuracy of alignment in this component is essential, and the degree of accuracy obtained in the complete erection depends largely on the correctness or otherwise of the fuselage. In different individual designs the methods employed for the construction of the body will be found to vary considerably. The process of erection adopted in many instances is to assemble the sides first, upon a table or bench upon which the correct disposition of the various parts have previously been set out. The wires are adjusted until the sides conform to the setting out, which are then packed up on a pair of trestles and the cross-struts attached. It now remains to align the body so that it is perfectly symmetrical in plan; and this is accomplished by marking the centre of each cross-strut, preferably

before insertion in the fuselage, and then adjusting the plan-wires until a cord stretched from the stern-post to the nose covers each centre line. The cross or sectional bracing-wires are then tensioned until each diagonal coincides absolutely in length. This procedure answers very well for a small fuselage of simple construction, and of the wire-braced fabric-covered type; but where the forward portion is covered with ply-wood, and the top rails of the body are horizontal, viewed in side elevation, it is usual to true up on a bench. This consists of a wooden structure built up of strong sides, with legs at short intervals, the whole being well braced. The top surface, on which the body lays, is composed of boards placed wherever a plan-strut occurs. The bench should be rigidly fixed to a concrete floor, the top planed until it is level both longitudinally and transversely, and a centre line marked on each board, while these lines, checked with a fine steel wire stretched from end to end, should be in exact agreement with it. The fuselage, having been previously assembled, with the wires inserted and the plan struts accurately centred, is placed on it in an inverted position. All wires should be then slacked off, and the top, which is now underneath, should be wired until the centre on each strut coincides with the centres on the bench. The side wires are then tensioned until the stern post is vertical, or until various fixed points, such as wing-spar attachments, are in agreement with points marked on the bench and squared or lined up, and also until the longerons are touching every board. The sectional wires are then tightened and adjusted so that each diagonal is of the same length; and this will ensure the centre lines on the cross-struts connecting the bottom rails being plumb or vertical over the centre lines of the cross-struts connecting the top rails. Where the top rails of the fuselage are not parallel to the line of flight, but slope down towards the tail, it would be necessary, if the bench method is used, to construct it so that the boards conform to the slope. With the wire-braced fuselage minor adjustments to the wing-spar attachments, which predetermine the angle of incidence of the main planes, can be subsequently made. A type of fuselage which precludes

this operation, and which demands extreme accuracy in construction, is that in which the bracing of the forward portion is effected by three-ply, all wiring in a vertical dimension being eliminated, this system being described in Chapter VIII. and illustrated by Fig. 66.

With this construction points such as the wing spar attachments are fixed, and cannot be altered after the fuselage is built, so that meticulous care must be taken in the setting of the short wing spars across the body, or the fittings to which the wing roots are anchored.

Where a joint occurs in the fuselage it is usual to build the tail separate from the front portion, and occasionally the two sections are trued up independently. This does not give such good results as when the two portions, although separately built, are joined together and trued up complete.

Checking of Fuselage.

To check the fuselage for alignment it should be placed on a pair of trestles, one underneath the forward undercarriage strut fixing and the other under a vertical strut a short distance from the stern post. The body should then be levelled up longitudinally by a straightedge placed on two short straightedges of exactly similar widths, one being placed at the front and the other towards the tail. It should then be packed up on the trestles until the top longerons are dead level across. At this point, if the body is in correct alignment, the engine-bearers would be level both longitudinally and transversely, the incidence of the main spar attachments should be correct and the stern post perfectly vertical in all directions. Other tests should include the placing of a straight-edge at the nose, and another placed at the points where struts occur, should, when sighted across the top edges, be "out of wind," that is in agreement. A point which should be carefully levelled is that portion of the fuselage towards the stern post to which is attached the fixed tail plane. Any inaccuracy here will result in the tail being twisted in relation to the main planes. Each fitting or attachment should also be equidistant from the stern post, and the effect of variation here

will be evidenced by the tail plane being out of square with the centre line of the fuselage. Where the type of machine is such that the engine is supported on bearers of wood, it is usual to drill the holes for the accommodation of the holding-down bolts to jig before the bearer is built in the structure. In this case care should be taken to ensure that the corresponding bolt holes in each bearer are square with the centre line. Any deviation will result in the axis of the engine forming an angle with the centre line.

Alignment of Complete Machine.

In this connection it will be better to consider the alignment of a type of machine in common use: a tractor-biplane in which the upper plane is composed of two outer planes and a centre section, and the lower plane in two sections, each abutting against the side of the fuselage, this arrangement being shown in front elevation by Fig. 122. The first operation is the levelling of the fuselage transversely by placing the level across the engine bearers, and the attachment of the centre section, which is mounted upon four struts which have been previously cut to dead length and tested by jig. This, considered in front elevation, should be centrally placed over the body, and this is assured by adjustments in the wires A—A1. This can be checked by dropping a plumb-line from the centre plane spar ends and measuring the distance from the line to the side of the body, the distances on either side should, of course, coincide. The next point is to brace the outer sections to the correct dihedral. One method of accomplishing this, as shown by Fig. 122, is by the use of a dihedral board, this being prepared perfectly straight on one edge, the other being tapered to the desired angle. The wires are then adjusted until the straightedge is level. Another method is to use an ordinary straightedge placed along the top surface of the plane, the angle being measured with a protractor or clinometer, the latter instrument being most accurate. To check the dihedral a line can be stretched between points immediately above the top interplane struts on each side and then measuring to the centre section, but it would be difficult

to detect differences in the angles of each wing. With regard to the undercarriage, the distances between lines dropped from the fuselage sides and the wheel centres should coincide.

Alignment of Machine in Side Elevation.

Considering the side elevation, Fig. 123, alignment here is concerned with the incidence of the main planes, the distance forward of the top plane from the lower plane or stagger, and

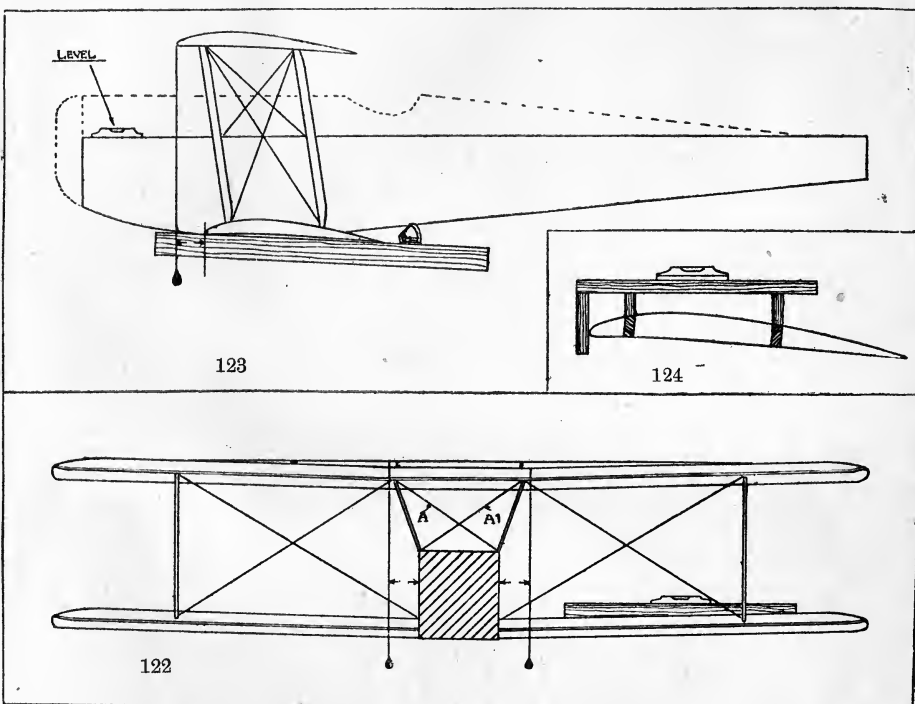

FIG. 122.—Showing use of dihedral board and spirit-level.

FIG. 123.—Checking of main-plane incidence and stagger.

FIG. 124.—Template for checking incidence.

the level of the engine bearers in relation to the top longerons of the fuselage.

The fuselage should be levelled longitudinally by placing the level on the engine bearers, assuming the engine is not in place. When the bearers are level, the top longeron should

also be level, in any case the incidence of the plane should only be adjusted in relation to the engine bearers. To check the stagger, a plumb line should be dropped from the leading edge of the centre plane, and adjustments made with the incidence wires from the fuselage to the centre-plane struts, until the required distance forward from the leading edge of the lower plane is obtained. The incidence can be tested by a straightedge placed under the plane and a clinometer, as in Fig. 123, and another device sometimes used is shown by Fig. 124. This is made of dry wood, the lengths of the legs to the tops of the spars being obtained from a drawing of the wing section, and its incidence.

Plan Alignment of Machine.

In the plan view, Fig. 125, the distances AB and AC must be equal, the same applying to CD and BD. With modern

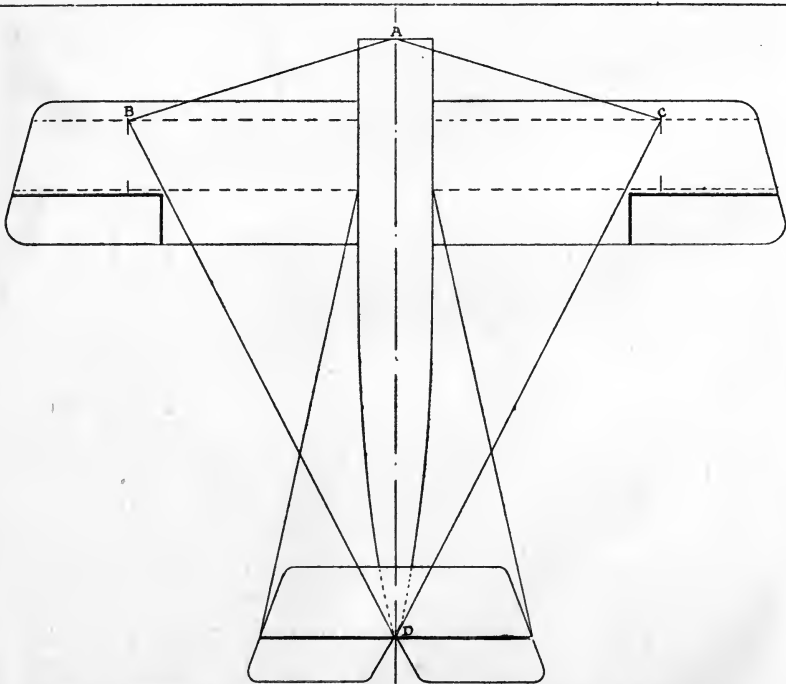

FIG. 125.—Showing points to check for correct alignment on plan.

machines external drift wiring is obsolete, so that discrepancies in these measurements must be rectified by alterations in the wiring of the fuselage, as it is inaccuracy at some point in the latter component to which the trouble may be ascribed. It is at this point that one realizes the need for precision in the construction of the fuselage. In Fig. 126 is shown a plan view in which the main plane is very obviously out of square with the centre line of the body, the amount is not likely to occur in actual practice, but it has been exaggerated in the

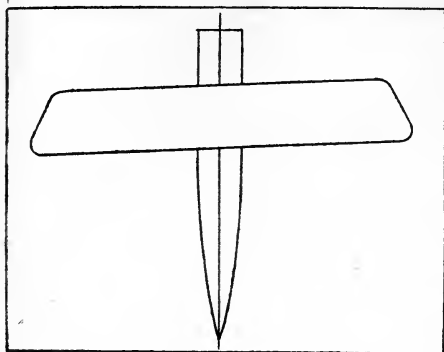

FIG. 126.

drawing. The cause of this trouble can be traced to the short wing spars in the fuselage, to which the lower plane is attached, or in other cases to the fittings, to which the lower plane is anchored, being out of centre, possibly only an insignificant amount. The lengths of the fuselage wing spars are also possible causes of trouble. Assuming that the rear spar is the correct length, and the front spar is over the length, this would result, when the outer sections were attached, in the latter sloping backwards, which again emphasizes the need for accurate part production.

With regard to the tail plane, measurements taken from the extremities of the back spar to some fixed point forward on the fuselage, to the strut sockets on the planes, or to the rear wing spar anchorage, as in Fig. 125, should be equal.

The primary consideration with regard to the rudder and fin is that, viewed from the rear, they should be perpendicular,

which can be verified by a plumb-line dropped from the top of the rudder-post. In plan view the fixed fin should correspond with the centre line of the fuselage although there are exceptions to this rule, notably where the fin is set over, to neutralize propeller torque, and in this case the measurements given in the general drawings must be adhered to.

Tension of Wires.

The correct tensioning of wires is a matter upon which some variation of opinion occurs. Although wires should not be left slack, conversely they should not be over-tensioned, as this results in the spars, wires, and struts, being initially stressed before any load due to flight is applied. In this connection the importance of even or uniform tension in the wires may be emphasized. The wires in one bay being of greater tension than those in an adjacent bay, is the frequent cause of bent or deformed struts. The more extended use of a tautness meter for the inter-plane wiring would result in greater uniformity and the more equal distribution of stresses.

INDEX

- Aileron and warp control, 101
 Aluminium, 16
 Anchorage of wires to eye-bolts, 55
 Ash, 10
 Ash, weight of, 10
 Axle fairings, 98

 Biplane trussing, 62
 Birch, 12
 Birch, weight of, 12
 Brazing and welding, 52
 Bridge-type undercarriage suspension, 98

 Control systems, 101
 Control by inherent stability, 102
 Control, vertical column, 103
 Control, wheel type, 104
 Control, the "Dep," 106
 Control, the "Wright" 107
 Control surfaces, balancing of, 102
 Cypress, 13

 Drift bracing, 65
 Drilling of bolt-holes, 124
 Duralumin, 17

 Engine mountings, 116
 Engine mountings, rotary, 118
 Engine mountings, overhung, 119
 Engine mountings, stationary, 121
 Engine mounting materials, 117
 Erection and alignment, 123

 Fabric, attachment of, 47

- Fabric, sagging of, 40
 Fabric, tension of, 48
 Fabric, friction blocks, 49
 False ribs, 41
 Fineness ratio, 26
 Fuselage construction, 67
 Fuselage covering, 71
 Fuselage contours, 75
 Fuselage erection, 127
 Fuselage fittings, 77
 Fuselage struts, 28
 Fuselage types, 67

 Glue, defects of, in wing
 spars, 33

 Hickory, 11

 Interplane struts, tapering
 of, 26
 Interplane strut connec-
 tions, 51

 Leading and trailing edges,
 43
 Lift wires, anchorage of, 62
 Locking of bolts, 125
 Longerons, 68
 Longerons sections, 69
 Longerons, jointing of, 70
 Longerons, shaping of, 69

 Mahogany, Honduras, 11
 Mahogany, Honduras,
 weight of, 11
 Mahogany, Cuban, weight
 of, 12
 Main planes, truing of,
 126
 Main spars, shaping of, 32
 Materials, 6
 Maurice Farman strut
 arrangement, 62
 Metal construction, gene-
 ral, 4
 Metal wing construction,
 45
 Methods of manufacture,
 general, 3
 Moisture content of tim-
 ber, 8
 Monoplane bracing, 60
 Monocoque fuselage con-
 struction, 72
 Multi-ply wood, 13

 Oleo-pneumatic gear, 95
 Oregon pine, 12

 Parang, 13
 Piano wire bracing, 108
 Piano wire connections,
 109

- Plane construction, 30
Plane construction, details
 of, 40
Planes, arrangement of, 33
Poplar, 12
Pratt truss, 59
- Raked wing tip, efficiency
 of, 43
Ribs, spacing of, 40
Ribs, types in use, 34
Ribs under compression, 36
- Shakes, 14
Shrinkage, 7
Silver spruce, 8
Silver spruce, weight of, 8
Single-strut truss, 63
Spar construction, hollow,
 20-22
Spar, laminated, 19
Spar sections, 19
Spars and struts, 18
Spruce fir, 9
Standardization of details,
 general, 2
Steel, 15
Steel tube, 16
Steel-tube fuselage con-
 struction, 84
Stranded cable, 109
- Stranded-cable connections,
 111
Streamline wires, 113
Streamline wires, attach-
 ments, 113
Strut sections, 23
Strut sections, design of, 26
Strut materials, 25
Strut socket, "Wright," 53
Strut socket, "Cody," 53
Strut-socket fairings, 58
Suspension springs, steel,
 95
Suspension springs, rubber,
 97
- Tabulated tests, unrelia-
 bility of, 8
Three-ply fuselage con-
 struction, 71
Thunder shakes, 11
Timber, defects in, 14
Trailing edge, wire, 43
Twisted grain, 14
- Undercarriage brakes, 99
Undercarriage details, 93
Undercarriage, principles
 of design, 86
Undercarriage skids, 93
Undercarriage types, 89

- Walnut, 11
White deal, 9
Wing baffles, 44
Wing fittings, attachment
to spars, 51
Wing-tip construction, 39
Wing-tip details, 38
Wing-trussing systems, 59
Wireless wing structures,
61
- Wires and connections, 108
Wires, results of tests on,
109
Wires, relative strengths
of, 112
Wires, tension of, 134
Wood, choice of a suit-
able, 6
Wood, variable qualities
of, 6

**Just Published. Over 100 pages. With numerous Diagrams.
Fcap 8vo. Paper wrapper, Price 3s. 6d. net.**

The Aircraft Identification Book

**A CONCISE GUIDE TO THE RECOGNITION OF
DIFFERENT TYPES AND MAKES OF ALL KINDS
OF AEROPLANES AND AIRSHIPS**

BY

R. BORLASE MATTHEWS

Associate Member of the Institution of Civil Engineers, Member of the
Institution of Electrical Engineers, Fellow of the Royal
Aeronautical Society, Whitworth Exhibitioner,
Author of the "Aviation Pocket-Book," etc.

AND

G. T. CLARKSON

EXTRACT FROM PREFACE

JUST as one make of motor car can be distinguished from another by noting some characteristic detail, such as the radiator, the trade mark, the hubs, etc., so can the main types of aeroplanes and airships be readily differentiated by the recognition of the outstanding features of each machine. It must be admitted, nevertheless, that it needs considerable experience to be able definitely to classify detail modifications of a particular type of aircraft, for the difference is often very slight. Besides, the machines are frequently only visible at a great distance, and for but short periods (their speed being so high—60 to 150 miles per hour). There are, moreover, physical difficulties to contend with, in the form of clouds, effects of winds, position of the sun, etc.

It is claimed, however, that this book will enable the reader to identify any aircraft, provided it can be seen for sufficient time to observe its main features.

LONDON

CROSBY LOCKWOOD AND SON,

7 STATIONERS' HALL COURT, LUDGATE HILL, E.C. 4, AND
5 BROADWAY, WESTMINSTER, S.W. 1

LIST OF BOOKS ON AVIATION.

THE AVIATION POCKET BOOK.

A Compendium of Modern Practice and a collection of useful Notes, Formulæ, Rules and Tables relating to Aeronautics. By R. BORLASE MATTHEWS, Wh. Ex., A.M.Inst.C.E., M.I.E.E., F.R.Ae.S., etc. Assisted by Specialists. New Edition, revised and enlarged. Fully illustrated. Fcap 8vo. 1918 Edition. Price 6s. net.

THE A.B.C. OF AVIATION.

A Complete Practical Treatise outlining clearly the elements of Aeronautical Engineering, with special reference to simplified explanations of the Theory of Flight, Aerodynamics, and Basic Principles underlying the Action of Balloons and Airplanes of all types. By Captain VICTOR W. PAGÉ, of the U.S. Air Service. Demy 8vo. 274 pages, with very numerous illustrations and 4 folding plates. Price 12s. 6d. net.

This Work contains valuable instructions for all Aviation Students, Airplane Mechanics, Squadron Engineering Officers, and every one interested in Construction and Up-keep of Airplanes.

AVIATION ENGINES.

Their Design, Construction, Operation, and Repair. A Book for the Student, Engineer, and all interested in Aviation. Giving practical instruction on repair and maintenance. By Captain VICTOR W. PAGÉ, of the U.S. Air Service. 580 pages, with over 240 illustrations. Medium 8vo, 16s. net.

GLOSSARY OF AVIATION TERMS.

English-French, French-English. Cr. 8vo, 100 pages, with plates and illustrations. By Captain VICTOR W. PAGÉ and Lieut. PAUL MONTARIOL. Price 5s. net.

AVIATION CHART.

A large Wall Chart, showing a typical Aeroplane Power Plant in Part Section with all important components. Folding to pocket size. Price 2s. 6d. net.

OBSERVATION BALLOONS.

By EMIL J. WIDMER. 150 pages, with 3 plates and 38 illustrations. Crown 8vo. 16s. net.

CROSBY LOCKWOOD AND SON,

7 STATIONERS' HALL COURT, E.C. 4.



RETURN CIRCULATION DEPARTMENT
TO → 202 Main Library

LOAN PERIOD 1	2	3
HOME USE		
4	5	6

ALL BOOKS MAY BE RECALLED AFTER 7 DAYS

1-month loans may be renewed by calling 642-3405

6-month loans may be recharged by bringing books to Circulation Desk
 Renewals and recharges may be made 4 days prior to due date

DUE AS STAMPED BELOW

NOV 13 1980		
REC CIR MAR 13 '81		
MAR 22 1984		
rec'd circ. FEB 22 1984		

UNIVERSITY OF CALIFORNIA, BERKELEY

FORM NO. DD6, 60m, 3/80

BERKELEY, CA 94720

©s

94720

©s

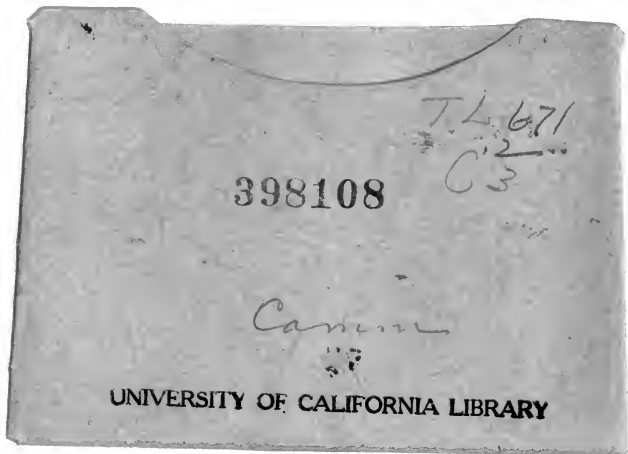

TL 671
C2
C3

398108

Cameron

UNIVERSITY OF CALIFORNIA LIBRARY

YC 19313