

ARCHITECT AND ENGINEER

ADOBE HOUSE, BAKERSFIELD, CALIFORNIA

PUBLISHED
FEB 2 - 1947
PERIODICAL DEPT.



NEW-ADOBE HOUSES

Clarence Cellimore, Architect, F.A.I.A.

JANUARY

1948

DEWEY AND ALMY CHEMICAL CO.

Metal Doors



Illustrated: Stainless Steel Entrance
HENRY L. KENNEDY, Architect
CHRISTENSEN & LYONS, General Contractors

DOORS in Aluminum, Bronze and
Stainless Steel. Write or telephone
today for complete information . . .

Michel & Pfeffer Iron Works, Inc.

KENNETH OPIE, *Manager Misc. and Ornamental Division*
Tenth and Harrison Streets, San Francisco 3, California
Telephone MARKET 1-5966

ARCHITECT

Vol. 172 No. 1

AND ENGINEER

ARCHITECTS' REPORTS—Published Daily

FEB 8 - 1949

720.5
A v 24 172
693518

Contents for

JANUARY

E. H. WILDER
Editor

MARK DANIELS, A.I.A.
Associate Editor

PROF. LELAND VAUGHAN
Landscape Architecture

MICHAEL GOODMAN
Planning

JOHN S. BOLLES, A.I.A.
Book Reviews



COVER PICTURE:

NEW ADOBE
RESIDENCE
Bakersfield
California

Clarence Cullimore
Architect F. A. I. A.

(See Story on Page 18)

EDITORIAL NOTES	4
NEWS & COMMENT ON ART	10
URBAN REDEVELOPMENT FOR SAN FRANCISCO	11
A Report of the Planning Commission	
SHOPPING CENTER, Corte Madera, California. C. E. Leonard	12
KATY AND PAUL STEINMETZ, Site Planners	
AH FONG FLORIST, San Mateo	14
OSCAR R. THAYER, Architect, A.I.A.	
BOB'S ON BROADWAY, Burlingame, California	15
OSCAR R. THAYER, Architect, A.I.A.	
PENINSULA FURNITURE COMPANY, Millbrae, California	16
OSCAR R. THAYER, Architect, A.I.A.	
WEST COAST'S MOST MODERN FISH PROCESSING PLANT, Oakland, Calif.	17
THE NEW-ABODE HOUSE	18
By CLARENCE CULLIMORE, Architect, F.A.I.A.	
IN THE NEWS	26, 37, 43, 44, 46, 47
ART DEPARTMENT	
A.I.A. ACTIVITIES	31
WITH THE ENGINEERS	32
HEADLINE NEWS & VIEWS	36
LANDSCAPE ARCHITECTURE	38
ESTIMATOR'S GUIDE, Building & Construction Materials	41
BUILDING TRADES WAGES, Northern & Central California	43
CLASSIFIED ADVERTISING	43
BOOK REVIEWS, Pamphlets & Catalogs	45
INDEX TO ADVERTISERS	48

ARCHITECT AND ENGINEER (Established 1905) is published on the 15th of the month by The Architect and Engineer, Inc., 68 Post St., San Francisco 4; Telephone EXbrook 2-7182. President, K. P. Kierulff; Vice-President and Manager, L. B. Penhorwood; Treasurer, E. N. Kierulff.

Los Angeles Office: Wentworth F. Green, 5605 Hollywood Blvd., Los Angeles 28. Telephone HEmpstead 3171.

Entered as second class matter, November 2, 1905, at the Post Office in San Francisco, California, under the Act of March 3, 1879. Subscriptions United States and Pan America, \$3.00 a year; \$5.00 two years; foreign countries \$5.00 a year; single copy 50c. ARCHITECTS' REPORTS are published daily from this office, Vernon S. Yallop, Manager, Telephone DOuglas 2-8311.



EDITORIAL NOTES

January is the month when we look ahead in hopeful anticipation that the year before us will be bigger and better than any of its predecessors. It is the month when our determination to side-step the well-known pitfalls of personal and professional inertia is keyed to a feverish pitch.

Whether the year 1948 unfolds with a multitude of accomplishments and develops into a "bigger and better" year than any heretofore is a matter for individual determination, as in the final analysis it's up to you.

It's one thing to set a goal to be reached in 1948 (in January), and it's another thing to reach your destination (in December) . . . Wonder how we'll come out?

Vastly expanded industrial and commercial activities throughout the entire Pacific Coast area has brought a new market of consumer goods, a greater need for housing, and an enlarged scope of civilian employment—all of which must be successfully coordinated if continued expansion and development of the West is to be expected.

Our attention was attracted to a "press release" recently which has stimulated a considerable amount of debate in our mind as to the proper approach to the problem of securing publicity for a professional member where the ethics of the profession shun the spotlight of paid advertising.

A recent issue of "Time" magazine prints an article on David Alfaro Siqueiros, artist, which says in part, and we quote: "Siqueiros was a hellor-leather Communist of the old fashioned sort, and could never keep his eagle beak out of trouble."

The "press release" further stated that when interviewed in connection with the successful exhibition of paintings in Mexico City, Senor Siqueiros said, and we again quote: "I've been taken to jail nearly seventy times."

Now the \$64 question in our rather confused mind is whether we should advise young aspiring professionals that the sure way to fame and fortune is to extend an "eagle beak" into trouble at every opportunity, and to get tossed into the clink at least seventy-five times (five times for good measure), or just join the Commies?

The San Francisco Bay Area by mid-1948 will have absorbed more than one million new resi-

dents since 1940, and as the population of this area represents approximately twenty-seven per cent of the total population of California the urgent need for housing has probably passed the stage of being needed for "veterans" only.

The National Association of Home Builders will hold their Annual Convention in Chicago the latter part of February, with members in attendance representing all parts of the nation.

The importance of the gathering is indicated when one realizes that more than 80 per cent of the successful home builders in the United States belong to the organization and that the building of homes remains as one of the major problems of today.

Shackled with government regulations immediately following the close of World War II, the Construction Industry is just getting to the point where a solution of the nation's housing problem is possible.

The important factor of this Convention in Chicago should be: more homes in '48.

Dr. Edwin G. Nourse of President Truman's Council of Economic Advisors regards 1948 production throughout the nation through rose-tinted glasses.

According to the Chamber of Commerce of the United States, Dr. Nourse is quoted as thinking there is a "distinct possibility" that inflation will slow down and production rise to new peaks this year.

He cautions, however, that "we are not yet at a point where we can see we are arriving at a stable level of prices. If there should be a short crop season, we would really have something to worry about. But, aside from the weather consideration, I am inclined to be optimistic."

In addition to the belief that the weather may have something to do with the nation's prosperity in 1948, Dr. Nourse is of the opinion that "a new wave of strikes curtailing production, or a third round of sizable wage increases, could add inflationary pressures."

The final extent to which he ventures is that "Heavy exports could render more critical the scarcity of such products as steel and grain, thus adding to inflation."

Architects, Engineers, Contractors and official Planning Commissions can easily figure from Dr. Nourse's predictions what to expect during 1948.

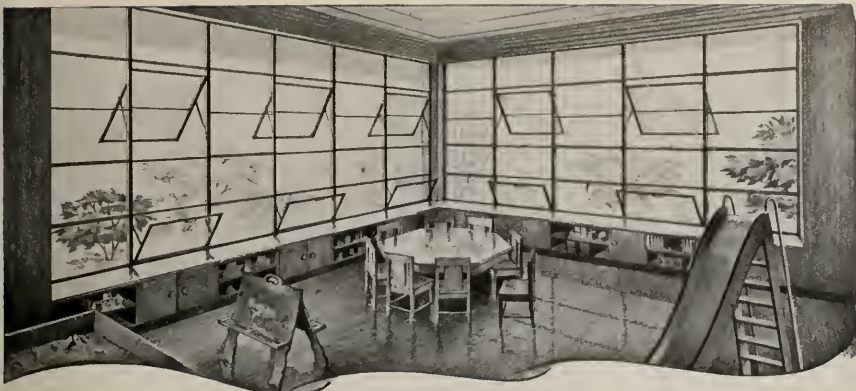

More Daylight—

WITH BETTER VENTILATION AS A BONUS!

When you plan larger daylighting areas, why not take advantage of the opportunity the larger wall opening affords for better ventilation?

With Fenecraft Projected Windows, large steel-strengthened areas of glass flood the room with daylight. All-weather ventilation is provided by two vents in each window unit. One opens out to form a canopy over the opening—to shed rain and snow. A sill vent opens in—deflecting incoming air upwards to prevent direct drafts. This vent likewise sheds rain and snow to the outside.

They're economical windows, too. Lower cost—in both manufacturing and installation—has been accomplished by standardization. Fenecraft Window units conform with modular dimensions of modern construction practice. Yet the variety that is achieved in making these windows of standard sections enables you to have all the design flexibility you wish, without the cost of "specials". There's a great range of types and sizes—in Projected, Combination and Casement Windows. That means a *right* window for every use—designed right... made right. See your Sweet's Architectural File for full information. Or mail the coupon.



FENCERAFT COMBINATION WINDOW

Generous fresh-air ventilation. Swing leaves deflect breezes into the room. In-tilting sill vent protects against drafts. Both sides easily and safely washed from inside.



FENCERAFT CASEMENT WINDOW

Safe washing an outside, from inside. Easy to operate. Interchangeable inside screens, protected from outside dirt.

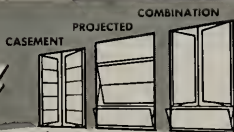

Fenestra

FENCERAFT INTERMEDIATE STEEL WINDOWS

Detroit Steel Products Company,
Dept. AE-1,
2262 East Grand Blvd.,
Detroit 11, Michigan

Please send me data on types and sizes of the new Fenecraft family of Fenestra Windows:

Name _____

Company _____

Address _____

**LARGER STOCKS
ARE BECOMING
AVAILABLE**

Simpson's Entire Production of Insulating Building Board Is Allocated To Western Dealers

ONE of the Simpson Dealers gave us the idea for this advertisement. "Since the war and up to about a year ago", he said, "I was not getting any insulating building board. Then Simpson built a plant at Shelton and allocated all the production to us western dealers. You made it possible to supply my customers, architects, builders and home owners with a high grade insul-

ating building board. They appreciate it . . . and so do I from a service standpoint. In '48 I'm sure to get still more Simpson Insulating Board Products. I really appreciate what you've done and plan to do. From here on out", he declared, "I'm a one hundred per cent Simpson dealer . . . just send me more of those good Simpson products!"

WOODFIBER DIVISION, SIMPSON LOGGING CO. • PLANT AT SHELTON, WASHINGTON
SALES DIVISION, SIMPSON INDUSTRIES, 1010 WHITE BUILDING, SEATTLE, WASHINGTON

Simpson

QUALITY SINCE 1895



ARIZONA SASH, DOOR & GLASS CO.
521 S. 9th Ave.
Phoenix, Arizona Phone: 3-3151

ARIZONA SASH, DOOR & GLASS CO.
567 West St. Mary's Road
Tucson, Arizona Phone: 1699

CALIFORNIA BUILDERS SUPPLY CO.
700 Sixth Avenue, Oakland 4, Calif.
Phone: Templebar 4-8383

CALIFORNIA BUILDERS SUPPLY CO.
19th & 5 Sts., Sacramento 14, Calif.
Phone: 2-0788

CALIFORNIA BUILDERS SUPPLY CO.
3180 Hamilton Ave., Fresno, Calif.
Phone: 2-9470

CALIFORNIA PANEL & VENEER CO.
955-967 Alameda St., Los Angeles,
Calif. Phone: Trinity 0057

CONTINENTAL LUMBER CO.
P. O. Box 2042
Boise, Idaho Phone: 450

ELLIOTT BAY LUMBER CO.
400 W. Spokane St.
Seattle, Wash. Phone: Elliott 8080

ELLIOTT BAY LUMBER CO.
2712 McDougall St.
Everett, Wash. Phone: Main 150

ELLIOTT BAY LUMBER CO.
Box 188—Union Gap Station
Yakima, Wash. Phone: 24627

EXCHANGE LUMBER & MFG. CO.
P. O. Box 1514, Spokane, Wash.
Phone: Greenwood 1621

FROST HARDWOOD LUMBER CO.
Market of State St., San Diego, Calif.
Phone: F-7224

LUMBER DEALERS, INC.
7 A. Box 2222, Denver 17, Colo.
Phone: Tabor 6141

LUMBER DEALERS, INC.
103 South Main St., Pueblo, Colo.
Phone: 4681

LUMBER DEALERS, INC.
423 N. 33rd, Billings, Mont.
Phone: 3911

MORRISON-MERRILL & CO.
353 No. Park St.
Reno, Nevada Phone: 2-2196

CHAS. E. SAND PLYWOOD CO.
1106 N. W. 16th Ave.
Portland, Oregon
Phone: Atwater 6421

SIMPSON INDUSTRIES
1610 E. Washington Blvd.
Los Angeles, Calif.
Phone: Prospect 6183

SIMPSON INDUSTRIES
Shelton, Wash. Phone: Shelton 611

UTAH LUMBER CO.
333 W. 1st St.
Salt Lake City 9, Utah
Phone: 4-4318

WESTERN DOOR & SASH CO.
5th & Cypress St., Oakland 7, Calif.
Phone: Templebar 2-8400

WESTERN DOOR & SASH CO.
9th & Parker St., Berkeley, Calif.
Phone: Ashbery 3-6472

You don't urge "Spanish"



when "Modern Ranch" is in vogue

Forward-looking architects and builders not only sense public acceptance but actually *create trends* in home design. Thus, through your leadership, the conventional influence is giving way to contemporary ("modern") ideas.



**The same reasoning
applies to Kitchen Planning**

So, too, having sensed the need for better kitchens, you have led the way with step-saving arrangement, colorful decoration and recommendation of modern gas appliances. Today, the gas-equipped kitchen is so overwhelmingly in vogue that 92.8 per cent of all California city and suburban homes cook with gas!

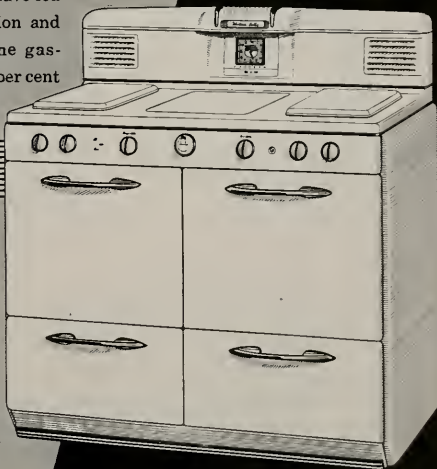

"Contemporary cooking" demands gas fuel

And now, more than ever, the trend is towards gas fuel... led by the brilliant new automatic ranges, built to CP standards. Still the most dependable, flexible and economical, they are also the most *modern*... in design, in performance. You're sure to please your clients by specifying *gas* cooking, as well as *gas* water heating and refrigeration.

The West Prefers
GAS
Better • Quicker • Cheaper

THE PACIFIC COAST GAS ASSOCIATION

DEPENDABLE



A
"PACIFIC
PRODUCT"

Produced by

**PACIFIC PORTLAND
CEMENT COMPANY**

San Francisco • Los Angeles
Portland

Sold by

**YOUR BUILDING
MATERIALS DEALER**

UNIFORM - TIME TESTED



When does a man start slipping?

The moment comes to every man.

The moment when he realizes that he isn't the man he used to be . . .

That the days of his peak earning power are over . . .

That some day not so very far away some younger man will step into his shoes.

When does this time come?

It varies with many things.

But of one thing you can be sure. It will come to you as surely as green apples get ripe— and fall off the tree.

Is this something to worry about? Well, yes. But . . . constructively. For that kind of worrying can lead you to save money systematically.

What's the best way to do this? By buying U. S. Savings Bonds . . . *automatically*. Through the Payroll Savings Plan. Or through the Bond-A-Month Plan at your checking account bank.

Either method is an almost foolproof system of saving. It's automatic. You don't put it off. There's no "I'll start saving next month"—no "Let's bust the piggy bank."

And you get back four dollars, at maturity, for every three invested.

So why not take this one step now that will make your future so much brighter?

Get on the Payroll Savings Plan—or the Bond-A-Month Plan—today.

Sure saving because it's automatic—U. S. Savings Bonds

Contributed by this magazine in co-operation with the Magazine Publishers of America as a public service.



NEWS AND COMMENT ON ART

MILLS COLLEGE ART GALLERY

Exhibitions of Mexican Student Work from the Escuela de Pintura y Escultura in Mexico City, and Photographs of Mexican art and life by Mary Saint Albans, and The Incas (Life photographic exhibition) are being shown at the Mills College Art Gallery until February 8th.

SAN FRANCISCO ART ASSOCIATION

Announcement of the winners of the 1947-48 Albert M. Bender Grants-In-Aid have been made by trustees of the Bender Memorial Trust.

John Grillo, a native of Lawrence, Massachusetts, and a World War II Navy veteran, was given the award in the field of painting. He plans to study problems of abstract art in New York.

Edith Henrich, recently from Montclair, New Jersey, was awarded the grant in literature. Her book "Quiet Hour" was hailed as a literary event and she plans another volume of poetry during this year. Mrs. Henrich is at present a Lecturer at the University of California and an instructor in creative writing at the University Extension classes in Berkeley and San Francisco.

SAN FRANCISCO MUSEUM OF ART

Due to unforeseen difficulties the Museum will not be closed for renovation until March 1. The schedule of Exhibitions and Activities announced for January include:

EXHIBITIONS: Paintings by Keith Martin, through January; Picasso in the Museum Collections, through January; Matisse in the Museum Collections, through January; Orozco in the Museum Collections, through January; Selections from the Albert M. Bender Collection and from the Permanent and Loan Collections of the Museum, through January; Photographs by Clarence John Laughlin.

FILMS: There will be regular Saturday and Sunday film showings on the KNOW YOUR WORLD SERIES through January and February.

A special FAMOUS FILM SERIES will begin January 27 with "AFRICA SPEAKS," the first actual natural sound movies ever filmed in Africa.

The Museum Reading Room will be open in the afternoon from 2:00 to 5:00 p.m. Monday through Thursday during January and February.

CALIFORNIA PALACE OF THE LEGION OF HONOR

Thomas Carr Howe, Jr., Director of the California Palace of the Legion of Honor, Lincoln Park, San

Francisco, has announced the following schedule of exhibitions and special events for January:

EXHIBITIONS: Ceramics by Dan Rhodes, opening January 9; Photographs by Cartier-Bresson, opening January 12; Oils by Fred Sexton, opening January 14.

The Alma de Bretteville Spreckels Collection of Sculpture by Auguste Rodin.

The Mildred Anna Williams Collection of Paintings, Sculpture, Tapestries and Furniture.

The Collis Potter Huntington Memorial Collection of 18th Century French Paintings, Sculpture, Tapestries, Furniture and Porcelain.

EDUCATIONAL ACTIVITIES: Regular Saturday art classes for children, ages four through fifteen will begin January 10 at 10:00 a.m. Instruction in the use of a variety of media will be given by Katharine L. Parker, Milly Weil Jaffe, and William T. Getman. Admission free.

The painting class for adults, under the direction of William T. Getman, will be resumed on Saturday afternoon, January 10, at 2:00 p.m. Admission free.

Gallery tours of the permanent collection and current exhibitions will be given by Katharine L. Parker each Wednesday and Friday at 2:30 p.m. through the month of January.

ART IN ACTION CITY OF PARIS

During the month of January a special exhibit of oils and watercolors from the Northwest will be shown. The exhibit will feature the work of Guy Anderson, Kenneth Callahan, Morris Graves, C. S. Price, and Mark Tobey. It will be shown on the 4th floor.

The Pictures of the Month in the Art In Action Shop, 5th floor, will feature the work of Irma Engel.

A display of pure silk scarfs by Ascher of London, which have been designed by Derain, Henry Moore, Jean Hugo, and others, will be shown. There will also be a Weav-rite Loom demonstration.

UNIVERSITY OF OREGON SCHOOL OF ARCHITECTURE

The School of Architecture and Allied Arts at the University of Oregon, through its chairman of exhibitions Mark R. Sponenburgh, has announced the following exhibit for February:

An unusual group of French Prints from Corot to Picasso.

The work includes drawings, etchings, and lithography. It will be on display from February 7 to 26.

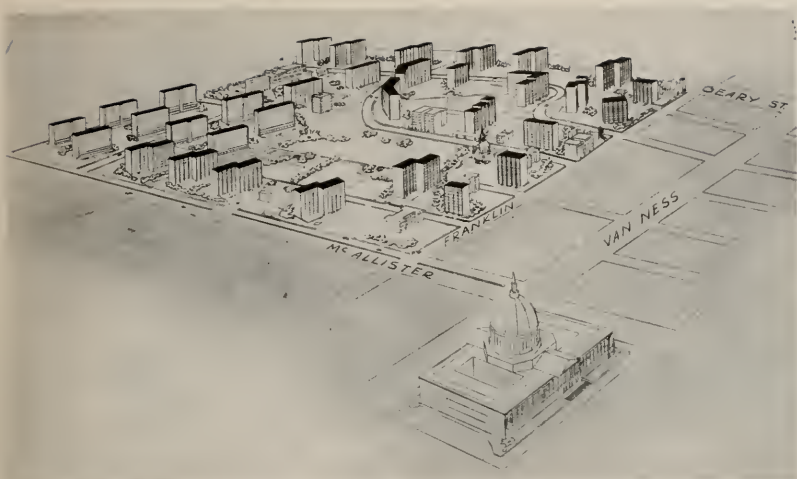

URBAN REDEVELOPMENT FOR SAN FRANCISCO

Summarized Report of the Planning Commission

The San Francisco City Planning Commission has submitted a proposal that decayed and overcrowded dwellings in the city's Jefferson Square area in the blighted Western Addition district be replaced by a \$53,000,000 redevelopment project which will house approximately 10,000 persons.

Details of the proposal are contained in a report prepared for the Commission by Mel Scott, Consultant, under the general direction of T. J. Kent, Jr., Director of Planning.

The Commission submitted its report to the Board of Supervisors in accordance with the Board's request made last May for a study recommending tentative general plan for the Western Addition district and a proposal for a first project area.

The Commission recommended to the Supervisors the immediate launching of the redevelopment program by formally designating the entire Western Addition district as a "redevelopment area" as defined in the California Community Re-

development Act of 1945, and by establishing a redevelopment agency to seek to interest private groups in submitting economically feasible proposals for rebuilding the project area indicated in the Report.

The "redevelopment area" proposed by the Commission is bounded by Van Ness Avenue on the East, Market and Duboce Streets on the South, Masonic and Presidio Avenue on the West, and California Street on the North. It includes approximately two and a quarter square miles.

Jefferson Square First Project

The Jefferson Square area suggested by the Commission for the initial undertaking in the elimination of blight is one of eleven neighborhoods into which the tentative general plan divides the Western Addition district.

The proposed first project area embraces 36 blocks bounded by Van Ness Avenue, McAllister

(See Page 39)

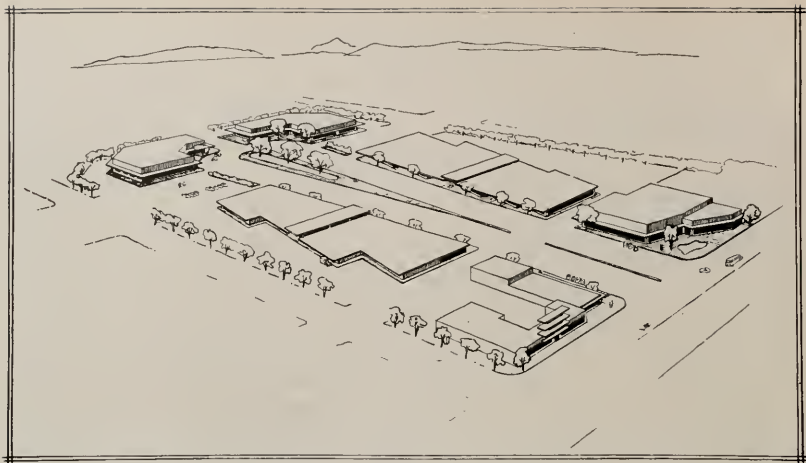

SHOPPING CENTER

C. E. LEONARD

CORTE MADERA, CALIFORNIA

KATY AND PAUL STEINMETZ

Site Planners

Research has been done and a preliminary plot plan has been prepared by the landscape architect for an extensive shopping center in Corte Madera, Marin County, California. The design of the buildings has been considered only in their relation to the general development of the entire property. This study has been approved and architect, engineer and landscape architect will collaborate in the final development of the plant.

It will be built on property located $\frac{1}{4}$ mile from the San Francisco highway. The property has a

frontage of 375' on the main street into Corte Madera and a depth of about 1400'. On the west, Corte Madera proposes to develop a city park and on the east a subdivision of 660 homesites has been approved.

The entire property will not be developed at this time, but to retain the value of the rear half it is important that it be considered along with the front and not cut off from access to the road. It has been proposed that this piece could be given to the city as part of the park, thus providing a per-

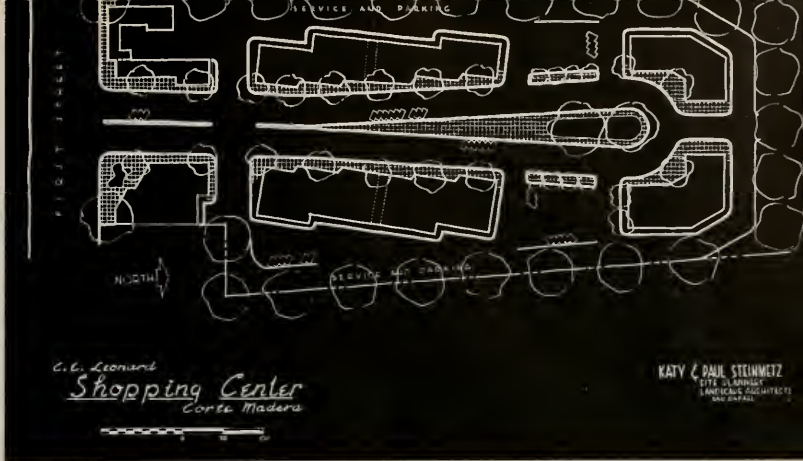

fectly comfortable setting for the shopping center and an addition to the city's recreation area.

The shopping center on the front will in itself be particularly attractive and park-like with pleasant openness, broad streets and walks, and numerous shade trees and flowering shrubs. There will be 17' parking lanes, 10' one way travel lanes, 10' maneuvering lanes and a 2' planted center strip. Additional parking space behind the buildings will provide a ratio of shop space to parking area of 2 to 1. The total shopping area for the 9800 people of Corte Madera and Larkspur is 33,690 square feet, with a shop frontage of 795' or $4\frac{1}{2}'$ per fifty population. Marin County is becoming amply

equipped with "super markets" so this center will provide more unusual shops such as custom built furniture, a modern gift shop, hand wrought iron work, etc.

The owner, Mr. C. E. Leonard, is unable to handle the whole project at once so he will construct the buildings adjacent to the road first. He will sell these buildings to business men desiring to participate in the program of the center. He will then continue with the interior roads and planting and eventually the rest of the buildings. In this way the architecture and complete project will retain its harmonious aspect as planned, and be a pleasant and attractive place for the people of Marin County to gather and shop.

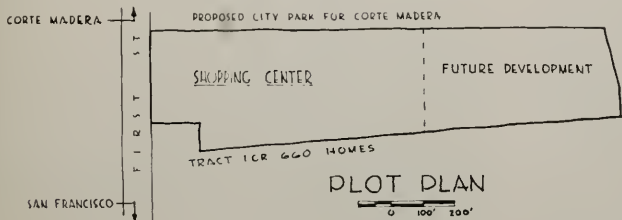



AH FONG FLORIST

San Mateo
California

Oscar R. Thayer
Architect, A.I.A.

To be constructed on El Camino Real. First floor reinforced concrete. Stairs from lobby lead to two 5-room apartments on second floor of wood frame construction, to be occupied by owners.

Cost of Construction,
\$37,500.

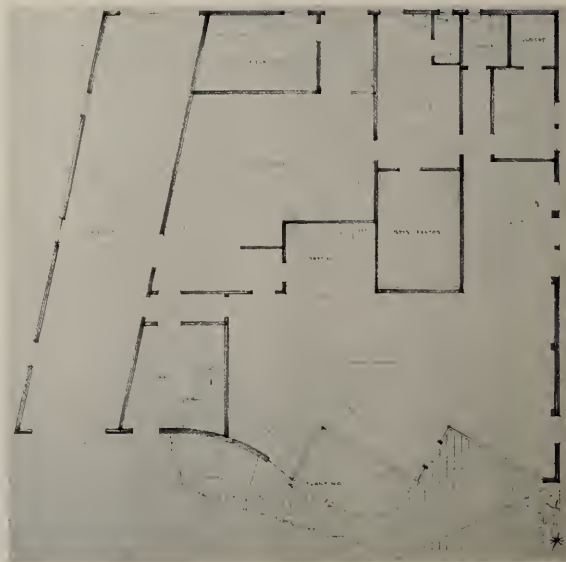



BOB's on Broadway, Burlingame, California: Oscar R. Thayer, A.I.A., Architect. Cocktaail and dining room, room for general storage and refrigerator added to original building. Ceiling in fiber glass, booths mohair, walls paneled in walnut. Cost of construction, \$65,000.





PENINSULA FURNITURE COMPANY

Millbrae, California

Oscar R. Thayer, Architect, A.I.A.

Located on El Camino Real, this is a two story and mezzanine building of wood frame. Show-rooms on the first floor. Offices and work rooms on the mezzanine.

Cost of construction, \$40,000

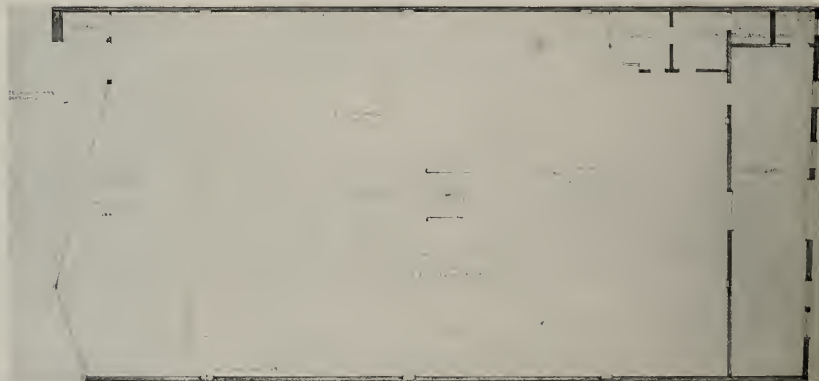



WEST COAST'S MOST MODERN FISH PROCESSING PLANT OPENS

Oakland, California



One of the West Coast's most modern fish freezing and storing plants has just been completed in Oakland for Western California Fish Co., pioneer California fish firm. According to Thomas Caito, partner of the company, the new plant incorporates the latest in materials, design, and construction to safeguard against spoilage the tons of fish which are processed in the new plant before being sent to markets throughout the United States and overseas. Geo. J. Maurer of Piedmont was general contractor for the job.

"Western's" new plant has three separate cold storage rooms. First is a 15'x20' fresh fish room for storing 40 to 50 thousand pounds of fish at 33 degrees for short periods before retail delivery or long term storage. Second, another room of the same size sharp freezes the fish at 20 degrees

below zero. Third is a 30'x20' "zero" room with capacity for 100,000 pounds of fish for long term storage.

All three storage rooms have been insulated with fireproof, verminproof, Fiberglas AE Board. Construction was done by Western Fiberglas Supply's Oakland office with Walter J. Paul, 43 year veteran of the insulation field, in charge. The York refrigeration plant—designed and installed by Scatena York Co. of San Francisco—includes nearly a mile of refrigeration piping and has been especially laid out so as to minimize dehydration. The plant equipment also includes a York ice making machine no larger than a console radio which turns out 2000 pounds of flaked ice daily for packing fish for shipment.

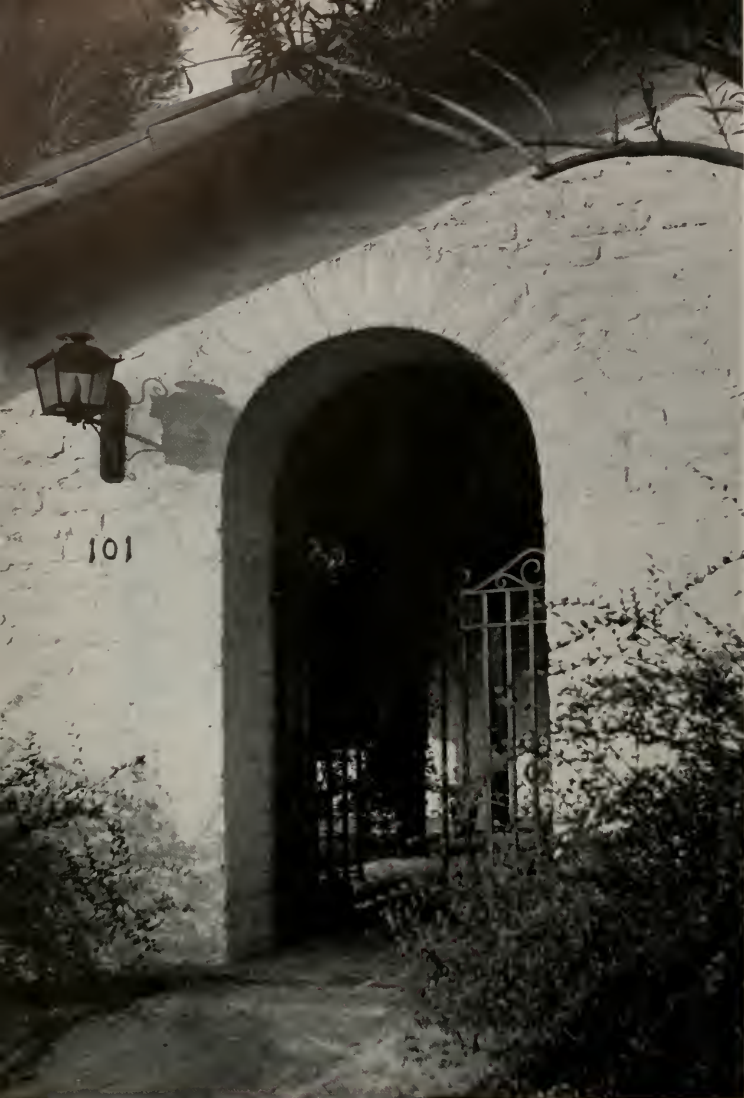

THE ADOBE

The exposed adobe bricks emphasize the honesty
inherent in modern adobe construction.

CLARENCE CULLIMORE, Architect, F.A.I.A.

The New ADOBE Houses

By **CLARENCE CULLIMORE**
Architect, F.A.I.A.

Today, when nature and science have con-
trived to provide an unusual variety of new ma-
terials applicable to building purposes, the old-
fashioned adobe, too, has had its transformation
into the new-adobe. The age-old stigma of "being
soluble in water" has been removed, since the
new-adobe is now manufactured with the inclus-

ion of a small quantity of emulsified asphalt in
the adobe mix. This asphalt forms a film sur-
rounding the particles of clay and waterproofs
and stabilizes the bricks.

Shortly before the second World War, in many
western states, adobe bricks, made by this new-
adobe formula, were being fabricated into modern

CLARENCE CULLIMORE, F. A. I. A.
ARCHITECT

Bakersfield, California





The New-ADOBE lends itself to ultra-modern trends

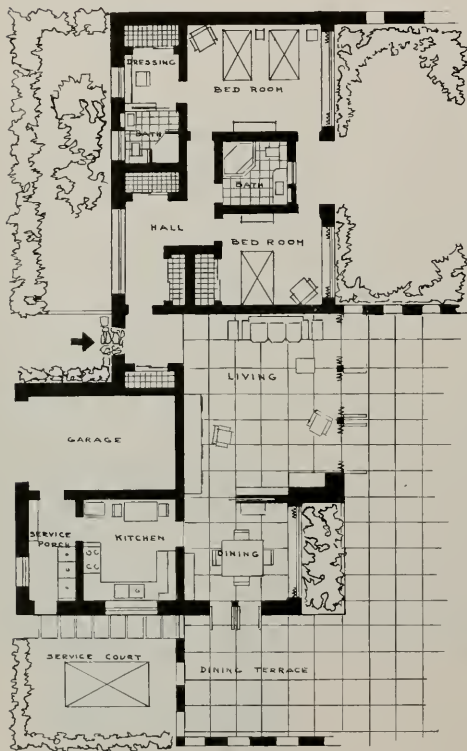

FLOOR PLAN

buildings, Churches were being built of it, warehouses, county buildings, municipal buildings, schoolhouses, and homes, many hundreds of them, some small and compact and others of the rambling ranch-house type, but all basically of the good earth from under foot. It is not necessary to emphasize the fact that such a material is plentiful, but perhaps there are those who do not know that there is a long list of adobe attributes in its favor.

Among them, insulation against heat and cold plays a major part. Sound also is not readily transmitted through adobe walls. They are fireproof, and now that this material may be scientifically stabilized and made impervious to moisture, it possesses the features most prized in building

(See Page 22)

TAOS
NEW
MEXICO



An artist's studio of the Old Fashioned Adobe

Constructing a New-ADOBE





New-ADOBE

Demonstrates its superiority over the old-fashioned adobe under a water test.

(From Page 20)

materials. In sections where earthquakes occur, this is not enough. There, a building must be capable of withstanding seismic disturbances; and so, to the knowledge of the research worker and the laboratory technician and the skill of the builder, has been added the science of the structural engineer. This technical collaboration has resulted in the formulation of building codes that are applicable to the use of the new-adobe, which may withstand not only fire and flood but temblors as well.

The days of the mud-hovel have long since passed, but it appears that new-adobe days lie ahead. Adobe days that will not limit this type of construction to the hot and arid sections alone, but will broaden its service-ability throughout the entire land and other lands.

The present interest in adobe construction on the part of architects and builders is largely a result of recent advances in this science of waterproofing it. The progressive architects, who desire to use new and improved materials in an ultra-modern manner, may focus their attention on this simple, undated, new-adobe. Its use is not at all out-of-line with the principles that underlie the best practices in any sound and logical development. It needs no apology.

The new-adobe is true to the roots of its heritage, yet it possesses in addition an architectural integrity all its own. It is something more than the expression, in a practical way, of the best in building skills today. It is a combination of modern planning with inherent warmth and beauty.

The actual manufacture of waterproof adobe

(See Page 25)

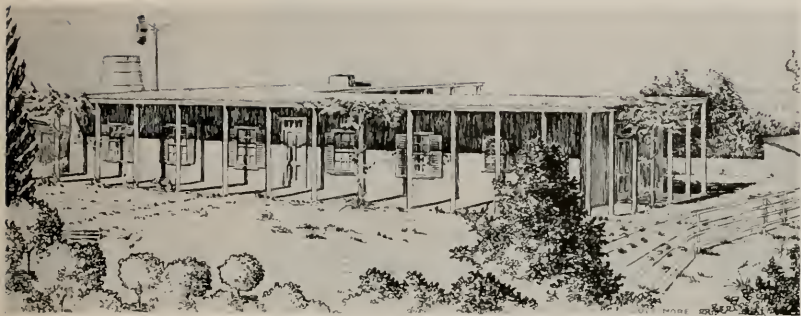

The Manuel Dominguez Adobe at Compton, California, as it appeared in 1854 showing that the flat projecting roof is not new to adobe.

Below is an adobe floor plan devised in the "Days of the Dons"—
was functional for that period

(Santa Barbara, about 1823)

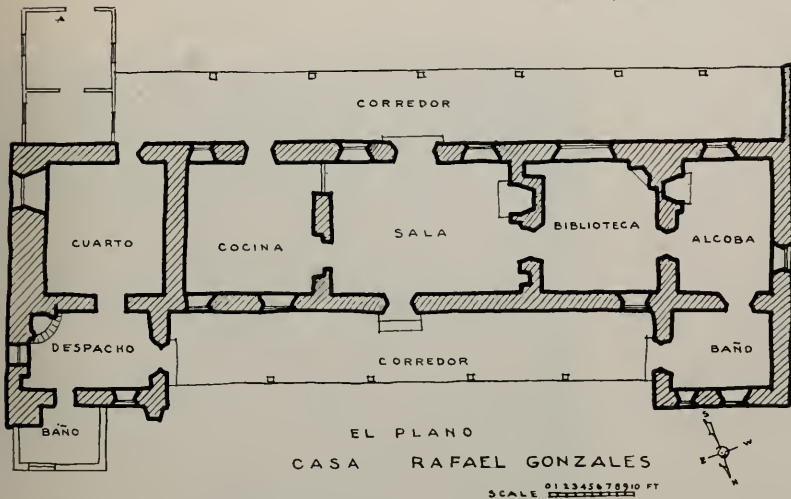



Photo
Geo. J. Seideneck

Patio view of a Carmel Valley, California, ranch adobe

Guest cottage of the above Carmel Valley ranch home



Builders

Hugh W. Comstock

John H. Neikirk

(From Page 22)

bricks and the fabrication of them into buildings has come as a result of years of research, extensive laboratory tests, and the development of practical constructional processes.

Architects have shared in providing interest in this constructional development. They have given it an esthetic quality of design, that, while retaining a definite identity emanating from a romantic

past, has allowed the new-adobe to stand on its own merits.

The very nature of this adobe material presupposes a quality of design that is intrinsic but not insistent in its architectural presentation. Limitations of types, as such, are at best transient fads, while a genuine and logical expression of a building material used in conformity to the times may have an architectural quality which is more permanent because it is truly its own.

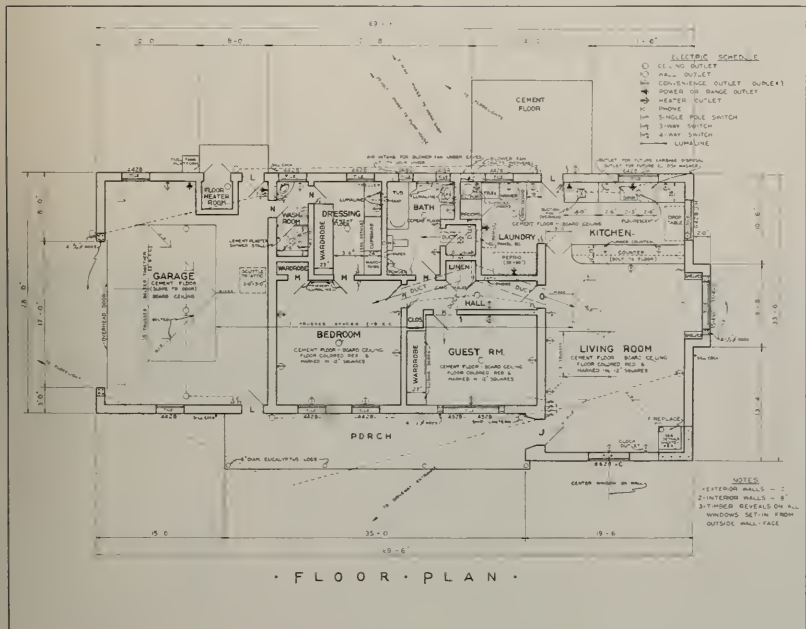



Patio view of the Kirk B. Johnson adobe house on Rancho Tajigus, about 18 miles north of Santa Barbara. The house is built mainly of adobe bricks that formerly stood on the spot.

RANCHO TAJIGUS - - Santa Barbara

Living room of the Rancho Tajigus . . . shown below

(The house was designed by the late George Washington Smith, Architect, Santa Barbara)

Photo
Lawrence Westburry



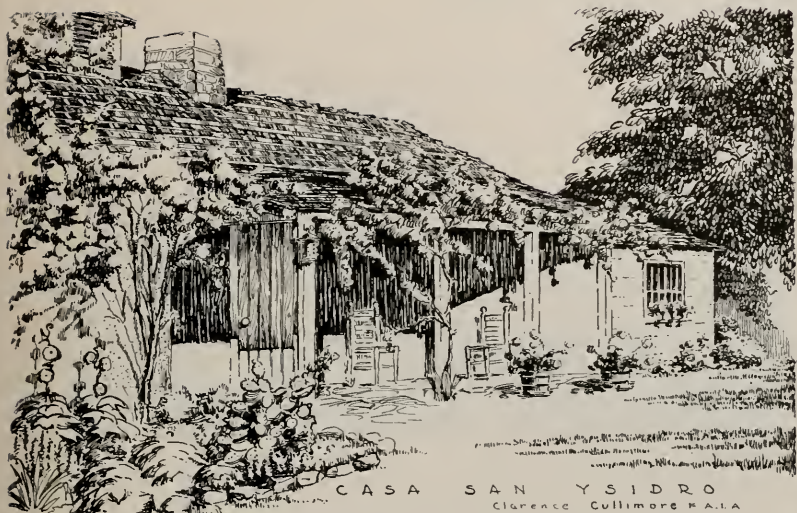

The New-ADOBE has inherited the quaint charm of early California. The San Ysidro Adobe, Montecito, Santa Barbara, Calif., is more than a century old.

Bedroom of the Bonalanza New-ADOBE at Bakersfield, Calif.

Clarence Cullimore, F.A.I.A.
Architect





DESTINED FOR ARABIA, these export-packaged Stran-Steel "Quonset" buildings start the long journey from Kraftfile Company's Niles, California, warehouse. "Quonsets" totaling more than 100,000 square feet of floor space have been purchased for use in Arabian construction operation. (Kraftfile Co. Photo)

CALIFORNIA STATE DIVISION OF ARCHITECTURE EXPANDS

A branch office of the California State division of Architecture was opened in San Francisco on January 1st, "to speed checking of proposed school construction plans" according to state officials.

KALMAN FLOOR COMPANY have announced the transfer of F. W. Hill from Cleveland to Los Angeles where he will become District Manager of the West Coast District. George H. Wray will continue to represent the company in San Francisco, and W. J. Burke & Co. will continue to represent the company in the Northwest with headquarters in Seattle.

TIMBER STRUCTURES INC. announce the appointment of Theodore C. Combs of Portland, Oregon, as the manager of the company's southwest and Mexican activities. Headquarters are in San Francisco.

ARTHUR P. CRAMER, former manager of the Timber Structures Inc., San Francisco office, has resigned to enter the contracting business.

CALIFORNIA FUNDS have been allocated for the construction of additions to the Agnews State Hospital amounting to some \$1,620,500.

HOBBS RE-ELECTED

Leonard A. Hobbs of Smoot-Holman Company, Inglewood, California, has been re-elected Secretary of the RLM Standards Institute, at recent meeting of the organization in Chicago.

He is the only representative from a western concern to ever hold an office in the nationally recognized RLM Institute.

ARCHITECT MOVES

Gifford E. Sobey, Architect, has moved his offices in San Jose, California, from 69 South 1st, to 9 Post Street at First.

CHURCH CONTRACT of \$40,000 has been awarded to Howard J. Miller, Modesto, contractor for addition to the First United Brethren Church of Modesto. G. N. Hilburn is the architect.

FIRE HOUSE BONDS VOTED. Lawrence W. Gentry, Architect, of Los Altos, California, reports the City of Los Altos will construct a new fire house.

B. W. MITCHELL has been appointed Manager of Sales for the Oregon division of Columbia Steel Company with headquarters in Portland, Oregon.

U. C. EXTENSION ENLARGES ARCHITECTURE COURSES AT L. A.

When University of California Extension opens its spring program of evening courses in mid-February, an enlarged program of architecture and related courses will be included, according to Dean L. M. K. Boelter, of the UCLA College of Engineering who will supervise the Extension Engineering work.

Courses available starting during the week of February 16 will include architectural design, architectural drawing, mechanical drawing, structural analysis, stress analysis and construction costs and estimating. Classes will meet at 813 South Hill Street and on the UCLA campus. Bulletins listing spring classes are available on request.

BRICKLAYER APPRENTICES INCREASE

Indicating the progress made by the Joint Apprenticeship Committee for the Masonry Industry of Alameda and Contra Costa Counties, and similar efforts throughout California, latest recapitulations show that there are 463 bricklayer apprentices holding membership in local unions of the state. Previously reported total was 280 apprentices.

The Joint Apprenticeship Committee is represented on the employers' side by the Mason Builders of California, Inc., with Harold Peterson as chairman and P. C. Knudsen and Clarence Merrill as committee members. On the employees' side is the bricklayers' local, with Soren Sorensen and Harry A. Boyter being committee members in addition to Thomas W. Cole. Loren Stevens is school representative on the joint committee.

ANDREW CARRIGAN has recently been appointed Manager of Sales for the Central division of the Columbia Steel Company with offices in San Francisco.

INSECTICIDE LABORATORY to cost some \$452,000 has been contracted for by the University of California, Riverside campus.

NEW VENETIAN BLINDS ARE DEMONSTRATED

Something new in Venetian blinds has been perfected recently by the Ambassador Venetian Blind Company of Berkeley, California, and according to officials of the Gunn, Carle & Company of San Francisco who have been appointed general sales representative for this area, public approval of the product has resulted in an immediate demand for the new Venetian blinds.

Ambassador Venetian blinds are revolutionary in that they are built with removable slats. As shown in the accompanying illustration, you just unsnap the fasteners, one to each slat, and slip the slats out to clean them.

The blinds are suitable for offices, apartments, hotels, hospitals, public buildings and factories.

SUTTER'S MILL DESCRIBED BY U. C. HISTORIAN

Sutter's Mill, where gold was discovered January 24, 1848, was a complicated thing to be built by primitive tools and materials, but such pioneer engineering was carried out time and time again in the Old West.

So says Dr. John W. Caughey, professor of history at the University of California at Los Angeles and an authority on early California.

Describing the historic site on the American River, 45 miles above Fort Sutter, Dr. Caughey says:

"A log and brush dam had been thrown across the river where it swung wide around a bar. A headgate opened into a race cut across the bottom of this bar. Astraddle the upper end of the race the mill itself was rising, a rough shed about 60 by 20 feet, made of hewn and hand-sawed timber.

"Its vertical saw would be powered with a wooden flutter wheel, 12 feet in diameter and in width. The wheel had been made on the spot, though the axle, crank and pitman irons were forged by a blacksmith at Sutter's Fort."

It was in the tail race of this mill that James Marshall, a moody, eccentric carpenter who worked for Sutter, found on January 24, 1848, the glittering yellow particles that started the California Gold Rush.

PAROCHIAL SCHOOL. The Pacific Coast Builders, San Francisco, have been awarded a \$300,000 contract for construction of the St. Stanislaus Parochial School at Modesto, California.



PRODUCERS' COUNCIL ELECTS 1948 SLATE

E. P. Larson of the Celotex Corporation was elected president of the Northern California Chapter of Producers' Council, Inc., a national organization of manufacturers of building materials and equipment, at the January meeting in San Francisco. New vice-president is J. A. Carlson of the Kraftite Company, Niles, Calif.; secretary, D. W. Lyon of Libbey-Owens-Ford Glass Co., and treasurer, W. J. Rawlings of Harbor Plywood Corporation of California.

Retiring president C. J. Nicholas of the Bastian-Morley Co. inducted the 1948 officers into office. Highlights of the meeting were reports from retiring officers and committeemen and a get-together with prominent architects of the area, headed by Lester Hurd, vice-president of the Northern California Chapter of American Institute of Architects, and Lewis Kune of the East Bay Chapter of A.I.A.

Producers' Council is affiliated with A.I.A. for the purpose of improving data and technical services furnished by manufacturers to architects and engineers.



FAST RECOVERY WITH SPARTAN

Gas is faster and costs less, but in the SPARTAN, gas reaches its peak of efficiency. A double extra heavy boiler with three flues each running its entire length assures fast recovery of approximately one gallon a minute. So — where fast recovery is an **added** requirement — Spartan is the answer.

 **Continental**
Water Heater Company Ltd.

LOS ANGELES • SAN FRANCISCO

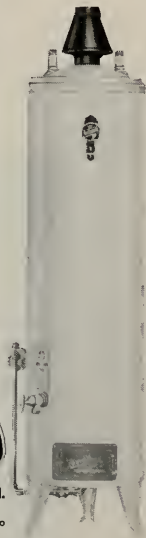

ASSOCIATED GENERAL CONTRACTORS OF AMERICA—ANNUAL CONVENTION

The problems to be encountered in a construction volume during 1948 exceeding \$22,000,000,000 will be considered by the 29th annual convention of The Associated General Contractors of America.

Approximately 1,200 delegates from the more than 4,500 contracting firms throughout the country which comprise its membership will meet in Dallas, Texas, February 9 through 12.

In announcing details of the program, Managing Director H. E. Foreman pointed out that a large volume of construction was completed during 1947 in spite of shortages of materials and skilled workmen, increasing costs, governmental regulations during the early part of the year, delays which caused interruptions to schedules, and many business uncertainties. He stated:

"We hope that during 1948 many of the uncertainties can be resolved so that construction can be undertaken with greater speed, efficiency and economy.

"Studies have shown that construction costs are in line with the prices of other services and commodities, and that a dollar invested in construction completed to specifications of the owner has brought full value in today's markets.

"The indications are that through concerted efforts, improvements can be made which will lead to increased speed, efficiency and economy in construction operations during the current year."



Arizona Chapter:
James Macmillan, President; Arthur T. Brown, Secretary,
740 N. Country Club Road, Tucson, Arizona.

Central Valley of California:
Herbert E. Goodpaster, President; Frank V. Mayo, Secretary,
307 Exchange Building, Stockton 2, California.

Colorado Chapter:
Raymond H. Ervin, President; James M. Hunter, Secretary,
2949 Broadway, Boulder, Colorado.

East Bay Chapter:
A. Lewis Koue, President; James H. Anderson, Vice-President;
Loy Chamberlain, Secretary; Chester H. Treichel,
Treasurer, Office, 3533 Piedmont Ave., Berkeley, California.

Montana Chapter:
Ralph H. Cushing, President; H. C. Cheever, Secretary,
Montana State College, Bozeman, Montana.

Northern California Chapter:
Hervey F. Clark, President; Lester Hurd, Vice-President;
Ralph Pollack, Secretary; William C. Ambrose, Treasurer;
605 Market Street, San Francisco.

Oregon Chapter:
Walter E. Church, President; Frank Roehr, Secretary;
Office 619 Builders Exchange Bldg., Portland 4, Oregon.

San Diego Chapter:
H. Louis Bauer, President; Louis J. Gill, Secretary, 203
Granger Building, San Diego, California.

Santa Barbara Chapter (California):
Chester L. Carjala, President; Robert I. Hoyt, Secretary,
116 E. Sala St., Santa Barbara, California.

CALIFORNIA COUNCIL OF ARCHITECTS
Vincent Palmer, President; Andrew Haas, Vice-President;
A. C. Martin, Jr., Secretary-Treasurer; 359 Pine
St., San Francisco 4.

Southern California Chapter:
Adrian Wilson, President; A. C. Martin, Jr., Vice-President;
Walter L. Reichardt, Secretary; George E. Gable, Treasurer;
Chapter Headquarters, 3757 Wilshire Blvd., Los Angeles 5,
California.

Spokane Chapter (Washington):
Noel E. Thomson, President; Kenneth D. Starnett, Secretary,
Hutton Building, Spokane, Washington.

Utah Chapter:
Gordon Cannon Young, President; Theodore R. Pope, Secretary,
29 South State Street, Salt Lake City 1, Utah.

Washington State Chapter:
Clifton J. Brady, President; Arrigo M. Young, Vice-President;
John Richards, 2nd Vice-President; Raul E. Decker,
Sec.; Waldo B. Christensen, Treasurer, Office 1411 Fourth
Avenue Building, Seattle 1, Washington.

Hawaii Chapter:
Kenneth W. Roehrig, President; James Morrison, Secretary,
334 Federal Bldg., Honolulu, T. H.

EAST BAY CHAPTER (OAKLAND)

A. Lewis Koue was re-elected president of the East Bay Chapter, A.I.A., at the annual meeting of the Chapter held in Berkeley early in January. James H. Anderson was renamed vice-president; Loy Chamberlain, secretary, and Chester Treichel was re-elected treasurer.

The board of directors include Oscar M. Price, Albert Hunter, and John C. Warecke.

Chartered by the American Institute of Architects last year, this will be the first full year of operation of the Chapter.

* * *

MEMBERS of the East Bay Chapter, A.I.A., visited the cyclotron installations of the Radiation Laboratory, University of California, recently, being conducted through the various buildings by Dr. Robert Thornton, Dr. Donald Cooksey, and Marvin Martin of the Radiation Laboratory. The work being done and different equipment was explained and many interesting phenomena in the proximity of the huge cyclotron were observed. Following the tour of inspection the regular meeting of the Chapter was held.

WASHINGTON STATE CHAPTER

NEW MEMBERS—Kenneth C. Helms, Wallace W. Macdonald, John M. Morse, Marshall W. Perrow and Rolland G. Pray, have been assigned Corporate memberships in the Institute with assignment to the Washington State Chapter.

REPORTS are still coming in indicating the Vic-

toric meeting was a tremendous success. Plans for formation of the Northwest Chapter were given support and it is expected those supporting the project will report further progress in the near future.

* * *

SEATTLE PLANNING COMMISSION has announced it will make a study of the city's needs and revise the zoning laws where necessary. Work will start on January 1, 1948.

WILLIAM B. FAVILLE, A.I.A.

William B. Faville, distinguished architect, civic leader, and designer, died at his home in Sausalito, California, recently.

Born November 13, 1866 in San Andreas, California, he graduated from the Massachusetts Institute of Technology; served as president of the American Institute of Architecture, the San Francisco Chapter A.I.A.; and was a member of the State Association of California Architects and many civic organizations.

Among the major buildings designed by Mr. Faville are the St. Francis Hotel, Bank of California, American Trust Company, State building in the Civic Center, Southern Pacific Building, Masonic Temple, Children's Hospital, Presbyterian Orphanage, Geary Theater, Liverpool London and Globe Insurance Company, Eastman Kodak, Moore Office building, Oakland Public Library, Hotel Oakland and the James Flood residence.

WITH THE ENGINEERS

Structural Engineers Association of Northern California

John A. Blume, President; Jesse Rosenwald, Vice President; Franklin P. Ulrich, Treas.; Geo. E. Solnar, Jr., Sec.; Wm. H. Popert, Consultant; Office, Room 713, 57 Post St., San Francisco 4. Phone SÜtter 1-5474. DIRECTORS, A. W. Anderson, Henry J. Degenkolb, John E. Rinne, Robert D. Dewell, and Wm. W. Moore.

San Francisco Section

L. A. Elsner, President; A. W. Earl and G. B. Woodruff, Vice-Presidents; John E. Rinne, Secretary-Treasurer; 225 Bush Street, San Francisco 20.

Structural Engineers Association of Southern California

Steve Barnes, President; Harry W. Bolin, Vice President; Lewis K. Osborn, Sec-Treas. DIRECTORS, Richard W. Ware, Geo. E. Brandow, L. T. Evans, Harold P. King, and Donald F. Shugart. Office: 202 Architects Bldg., Los Angeles 13, Calif.

Puget Sound Engineering Council (Washington)

R. E. Kister, A. I. E. E., Chairman; E. R. McMillan, A. S. C. E., Vice Chairman; L. B. Cooper, A. S. M. E., Secretary; A. E. Nicholson, I. E. S., Treasurer; Offices, L. B. Cooper, c/o University of Washington, Seattle 5, Washington.

STRUCTURAL ENGINEERS ASSOCIATION OF SOUTHERN CALIFORNIA

Steve Barnes was elected President of the Structural Engineers Association of Southern California for the year 1948 at the Association's annual meeting held early in December. He succeeds Richard W. Ware, Structural Engineer of Pasadena.



STEVE BARNES
President

Barnes was graduated from Purdue University in 1921 with the degree of Bachelor of Science in Civil Engineering. Since 1934 he has practiced his chosen profession of Structural Engineering from his own office in Los Angeles. He is a member of the American Society of Civil Engineers, member of the Los Angeles Coun-

ty Board of Appeal, and Chairman of the Building and Safety Committee of the Construction Industries of the Los Angeles Chamber of Commerce.

Harry W. Bolin, principal Structural Engineer of the State Division of Architecture was elected vice-president, and Lewis K. Osborn, designing Structural Engineer of Kistner, Curtis and Wright, was elected secretary-treasurer.

Members of the Board of Directors for 1948 will be Richard W. Ware, retiring president; George E. Brandow; L. T. Evans; Harold P. King, and Donald F. Shugart, all practicing Engineers in southern California.

Dr. C. Y. Hsiao of China, graduate of the California Institute of Technology, was the guest speaker. He was formerly director of highways for Free China during the war and immediately thereafter and at present is representing the Minister of Communications with the Chinese Government Supply Agencies.

Dr. Hsiao spoke of the vast amount of highway

OFFICIALS OF THE STRUCTURAL ENGINEERS ASSOCIATION OF CALIFORNIA—

John A. Blume, President of the Northern Section; William W. Moore, Past-President of the Northern Section; Richard W. Ware, Past-President of the Southern Association, and Steve Barnes, President of the Southern Association. (Reading left to right.)



work performed by the Chinese by ancient hand methods in opening up new roads to the west and south after the Japanese closed the Eastern ports. He stated that China's great problem today is transportation, with approximately fifty per cent of their highway and railroad transportation reconstruction work completed.

STRUCTURAL ENGINEERS ASSOCIATION OF NORTHERN CALIFORNIA

John A. Blume, Consulting Structural Engineer, was elected president of the Structural Engineers Association of Northern California at the Annual meeting held in San Francisco recently.

A native of California, Blume attended grammar and high school in San Francisco, and prior to entering Stanford University where he graduated with the Bachelor of Arts Degree in Civil Engineering in 1932, he lived in the Hawaiian Islands.



JOHN A. BLUME
President

Following two years of graduate study at Stanford, he was given the degree "Engineer" in Civil Engineering, Structural Branch. He is a member of Sigma Xi and Tau Beta Pi honorary scientific and technical societies and held the American Society of Civil Engineers and University Graduate scholarships.

Blume approaches structural design problems with the perspective of the man in the field as at various times he has worked as construction laborer, carpenter, structural ironworker, truck driver, surveyor, inspector, superintendent and field engineer. He worked for some time in engineering seismology with Professor Lydik S. Jacobsen, Stanford University, and with Franklin Ulrich in the U. S. Coast and Geodetic Survey, and was associated with the development of the dynamic model of an office building for research on the shaking table and with the building vibration machine used in earthquake research.

He is now engaged in the private practice of Structural Engineering in San Francisco, is married and hobby is work.

* * *

The regular January meeting saw the installation of officers for 1948, plus an interesting program on the "Recent Developments in Timber Construction." Speakers included T. K. May, representing the Forest Products Laboratory; Jack Horner, rep-

*For convenience in the future...
put telephone facilities in
your plans*



The blue-print stage is the time to include built-in telephone conduit and outlets. During construction, the cost is trifling. Just a few pieces of pipe or other conduit material leading to convenient outlet locations will provide raceways for telephone wires. Later on telephones can be added—or moved to other locations—without drilling holes or running wire along baseboards.

Your clients will appreciate your thoughtfulness. For free help in planning modern, built-in telephone wiring, call your local telephone company number and ask for free "Architects and Builders Service."

**The Pacific Telephone
and Telegraph Company**





MODERN DEPENDABILITY

YOU assure modern dependability in drinking water facilities when you specify HAWS Fountains. Simple maintenance, lasting durability and complete sanitation means real client-satisfaction. And your recommendations are backed by the reputation of a company which has built superior drinking fountains since 1909. Write for complete information, today.

HAWS DRINKING FOUNTAINS

HAWS DRINKING FAUCET CO.
FOURTH and PAGE STREETS (Since 1909) BERKELEY 2, CALIFORNIA
Agents and Sales Representatives in All Principal Cities



representing the National Lumber Manufacturers Association, and Theodore Combs, manager of Timber Structures Inc.

AMERICAN SOCIETY OF CIVIL ENGINEERS—San Francisco

"Engineering in China" was the subject of a talk before members by Ralph A. Tudor, MASCE, at the December meeting.

Tudor illustrated his talk with slides, and spoke on his engineering experiences while in China for the firm of Morrison-Knudsen International.

Members participated in a joint excursion with the Sacramento Section to the U. S. Navy installations at Mare Island on December 13th. The inspection included the shops, power plant, wharves, dry docks, a submarine, and ship repairs.

The subscribing membership of the Section on December 1, 1947, was 873.

MEMBERSHIP—following are new subscribing members, William C. Cassidy, Frederic L. Copeland, R. F. Kelker, Jr. **ASSOCIATE MEMBERS**, David H. Caldwell, Charles B. Wilkie, Felix A. Wallace; and **JUNIORS**, S. D. Bechtel, Jr., Conroy Betts, George A. Malony, Richard R. Schindler, and Thomas Sommerville.

NEW ANNUAL AWARD—RICKEY MEDAL. In honor of the late James W. Rickey, former hydro-electric engineer with the Aluminum Company of America, the ASCE has accepted an offer of Mrs. Lucy M. Rickey, Washington, D. C., to establish a sum of \$16,500 to perpetuate the memory of her late husband.

The award to be known as the **RICKEY MEDAL**, will be a gold medal and an engraved certificate. It will be made for papers in the general field of hydro-electric engineering, including any of its branches, deemed to constitute an outstanding contribution to the art, with consideration both for the usefulness of the subject matter and the form of presentation.

AMERICAN SOCIETY OF MECHANICAL ENGINEERS

The 68th Annual meeting of the Association, recently held in New York, was devoted to the theme of "Production for Peace."

Outstanding speakers appearing before more than 6000 engineers included E. O. Schreve, of New York and Washington and President of the United States Chamber of Commerce; David E. Lilienthal, Chairman of the U. S. Atomic Energy Commission; Fred S. McConnell, President National Coal Association; W. C. Schroeder of the U. S. Bureau of Mines; Paul W. Kiefer, Chief En-

...ngineer, New York Central R. R.; and Alvin E. Dodd, President of the American Management Association.

Officials of the organization reported that enrollment in the ASME had now reached a total of 23,000 members.

UNIVERSITY OF CALIFORNIA EXTENSION ENGINEERING

Addition of nine new members to the teaching staff of the University of California Extension Engineering has been announced by L. M. K. Boelter, Dean of the College of Engineering on the UCLA campus and Extension representative in engineering.

Clyde C. Carpenter, General Petroleum Corp'n; Robert Arno Eldridge, stress analyst; Albert F. Bush, State Department of Public Health industrial hygiene engineer; Dr. Hugh Dierker; Ted L. Bear, consulting geologist; William H. Shutts, aircraft aerodynamicist; Theron N. Lambert, U. S. Navy Electronics Laboratory physicist; Harvey F. Ludwig, Consulting Engineer, and Albert Zimmerman, air conditioning engineer will lecture at the evening classes which will open for public enrollment.

Courses will open February 16, on the UCLA campus and the Extension classroom center at 813 S. Hill Street.

WEIR MADE LIFE MEMBER OF CIVIL ENGINEERS

Walter Weir, University of California College of Agriculture drainage engineer since 1913, has been made a life member of the American Society of Civil Engineers.

The award was made at a meeting of the San Francisco Section of the ASCE. Weir has been a member of the organization for more than 35 years.

ENGINEERING FIRM

George Washington and Felix H. Spitzer have announced the formation of their association in the practice of Structural Engineering to be known as Consulting Structural Engineers Associated.

Offices will be maintained at 204 Sacramento Street, San Francisco, California.

GOODRICH MFG. COMPANY are erecting new buildings at their South San Francisco plant amounting to more than \$100,000, according to Myron Gould & Associates, Engineers, of San Francisco.

ELECTRIC CONTRACT for the Oakland Tribune press-room building, Oakland, California, has been awarded to Chas. A. Langlois, San Francisco, for \$94,674, according to Edw. T. Foulkes, Architect.

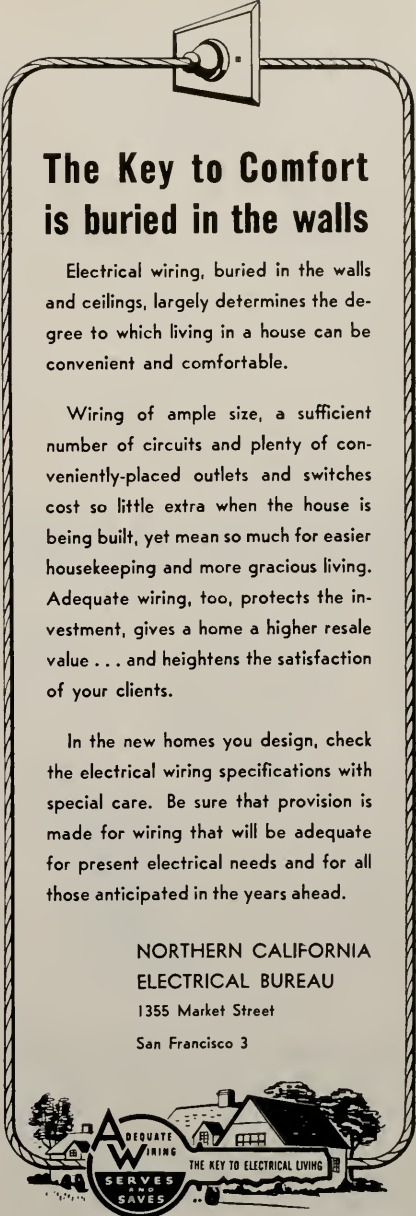

The Key to Comfort is buried in the walls

Electrical wiring, buried in the walls and ceilings, largely determines the degree to which living in a house can be convenient and comfortable.

Wiring of ample size, a sufficient number of circuits and plenty of conveniently-placed outlets and switches cost so little extra when the house is being built, yet mean so much for easier housekeeping and more gracious living. Adequate wiring, too, protects the investment, gives a home a higher resale value . . . and heightens the satisfaction of your clients.

In the new homes you design, check the electrical wiring specifications with special care. Be sure that provision is made for wiring that will be adequate for present electrical needs and for all those anticipated in the years ahead.

NORTHERN CALIFORNIA ELECTRICAL BUREAU

1355 Market Street
San Francisco 3

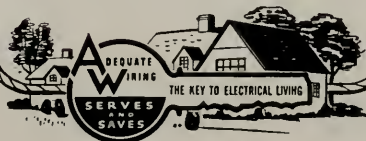

BAXCO
CHROMATED ZINC CHLORIDE

CZC

PRESSURE TREATED LUMBER
● **PROTECTS AGAINST DECAY
AND TERMITE ATTACK**

*Specify it in your home
Available through Lumber Dealers*

<p>LOS ANGELES 601 W. 5th Street Phone Michigan 6294</p>	<p>SAN FRANCISCO 333 Montgomery Street Phone DOuglas 2-3883</p>
--	---

J. H. Baxter & Co.

AGENTS FOR WEST COAST WOOD PRESERVING CO., SEATTLE, WASH.

HEADLINE NEWS AND VIEWS

By E. H. W.

The Jury Of Award of The James F. Lincoln Arc Welding Foundation has announced winners in this year's \$200,000 Design-For-Progress Award Program. Winners represent practically every part of the World.

ACCORDING TO THE FEDERAL WORKS AGENCY—"new construction activity averaged about 10½ per cent of national income during the 20-year period from 1920 to 1939. It is now running but little more than half that rate even in terms of current dollars. Construction volume today is about the same as it was in 1939."—What the report failed to point out was that in 1939 there were few if any Federal regulations imposed upon the Construction Industry, neither were the so-called Aid-To-Europe commitments of building materials as severe as they are at the present time. Give the Construction Industry a chance and they will deliver the goods.

A new germicidal unit has been announced by the Duro Test Corporation of North Bergen, N. J., which will destroy airborne bacteria in as little as eight seconds.

TAX RATES have a definite bearing on new construction—residential, industrial, and commercial—and while all TAX SPENDING AGENCIES cannot be charged with "squandering the taxpayer's money," a metropolitan city recently spent \$12,000 for a flagpole to be erected at the municipal airport.

We agree "Old Glory" deserves the very best—but, 12 thousand plus smackeroos is a lot of tax cabbage.

The Russell Sage Foundation, 130 E. 22nd Street, New York, has published a report by James Dahir on "Neighborhood Unit Plan: Its Spread and Acceptance". The report is a comprehensive study of many localities throughout the nation.

HIGH SCHOOL BUILDING comprising classrooms, assembly, science rooms, office, library, and heating plant will be built at Winters, California, as the result of a recent \$165,000 bond issue being approved by the voters of the city.

SOUTH SAN FRANCISCO voters approved \$1,500,000 at the November election for construction of new high school buildings, elementary schools, and primary schools. Bamberger & Reid, San Francisco are the architects.



E. K. WOOD LUMBER CO.

SAN FRANCISCO General Offices: No. 1 Orum Street
LOS ANGELES Office and Yards: 4710 S. Alameda St. — JE 3111
OAKLAND Yards and Wharves: 2111 Frederick St. — KE 24277
PORTLAND Mill Sales Office: 827 Terminal Sales Bldg
SAW MILLS: Roseburg, Oregon • Reedsport, Oregon
RETAIL YARDS: LOS ANGELES • OAKLAND • ONTARIO • HOLLYWOOD
 LONG BEACH • RIVERSIDE • TEMPLE CITY • SIERRA MADRE • INDIAN • THERMAL
 LA VERNE • WHITTIER • PASADENA • SAN PEDRO

IN THE NEWS

HOSPITAL BIDS REJECTED. Architects DeLongchamps & Brien of Reno, Nevada, have announced rejection of a \$175,000 bid for construction work at the County General Hospital, Fallon, Nevada.

APPROVED. Plans for a shop building and music building at the Burlingame High School to cost \$75,000 have been approved by the San Mateo Union High School District. James H. Mitchell, San Francisco, is the architect.

HIGH SCHOOL ADDITION. A contract has been awarded Monahan Bros., San Francisco, for the construction of 2-shop buildings at the Daly City High School, at an estimated cost of \$103,730. Richard J. Bates, Jr., is the Architect.

BOND ELECTION. Voters of the Alhambra (California) Elementary School District will vote on a \$100,000 grammar school bond proposal February 27, 1948.

FACTORY ADDITION to the Western Paper Box Company, Oakland, California, will be by Christensen & Lyons, Contractors. Estimated cost \$70,000.

HOSPITAL BONDS have been voted for a \$1,500,000 (90 bed) Hospital at Redwood City, California. D. Stone & Lou Mulloy are the architects.

OPENS OFFICE. Cecil S. Moyer, architect, has opened new offices at 339 15th Street, Oakland, California.

FACTORY ADDITION and office building for the American Thread Company will be built at Apparel City, San Francisco, California at an estimated cost of \$250,000. Barrett & Hilp have been awarded the contract. J. Francis Ward & John S. Colles are the Architects.

BONDS have been voted for a new fire station and addition to the Central Fire House, Palo Alto, California. Cost \$125,000.

ARCHITECTS MOVE. Clarence O. Peterson and Wendell R. Spackman, Architects have moved their offices to 45 Second Street, San Francisco, California.

Planned Lighting with ZENITH



OFFICES . . . STORES

Here's a commercial fluorescent luminaire that's engineered for superlative lighting performance — yet costs only a very little more than conventional equipment. Precision formed on precision tools, the Zenith installs easily, services quickly. Polystyrene plastic side panels are light, strong and shatterproof. The shielding unit controls the light for greatest effectiveness, with a minimum of surface brightness. The Zenith may be installed individually as shown, or in continuous mounting.

Write for the new Zenith catalog sheet



FOR THE BEST IN INDOOR AND OUTDOOR LIGHTING IT'S SMOOT-HOLMAN

LANDSCAPE ARCHITECTURE

Notes of The Profession

ASSOCIATION OF LANDSCAPE ARCHITECTS, SAN FRANCISCO REGION

Vernon Dean, President; Robert Royston, Vice-President; Ned Rucker, Treasurer;
E. L. Anderson, Secretary, 1736 Franklin, Oakland, California.

A.L.A. CHRISTMAS PARTY was held at the Claremont Hotel, Berkeley, with many old and new friends meeting to enjoy a pleasant evening. Among the guests were Mr. and Mrs. Lewis A. Koue (President East Bay Chapter, A.I.A.), Mr. and Mrs. Duncan McDuffie, Colonel and Mrs. James Cobbledeck, and Mr. and Mrs. Langdon Post.

WILLIAM MOTT AND LYNN HARRIS, A.L.A., Oakland Park Department, announced that the Business Men's Garden Club of Oakland has completed the first unit of its tree planting program in Oakland. *Cercis occidentalis* has been planted along Mountain Boulevard. Complete planting of trees will be approximately five miles long, with a bridle trail parallel to the planting.

THE OAKLAND PARK DEPARTMENT has a collection of Wild specie Tulips from Holland, which is thought to be the largest collection of wild specie Tulip in this country. It will be planted in Central Plaza, Oakland, early in the Spring.

GARRET ECKBO of the firm of ECKBO, ROYSTON & WILLIAMS has the landscaping job on the Mutual Housing Association Cooperative Community in Los Angeles. He is cooperating with the Architects on the site plan, public and private landscaping for a community of over 500 houses.

WILLA CLOYS CARMACK, A.L.A., is doing the landscaping on several residences down the Peninsula. The Miss M. Hall estate, Mrs. H. H. Hall ranch at Milpitas, Paul Kent estate at San Carlos, the Chas. Randlett residence at Redwood City, J. Mathes residence at San Carlos, and the Julian Meyer residence at Atherton. Se is also revamping the old rundown cemetery called The Lafayette-Alamo Cemetery.

A.L.A.-A.I.A. JOINT EXHIBIT

Plans are being considered for the proposed joint exhibit of the A.L.A., San Francisco Region and the East Bay Chapter, A.I.A., at the Oakland Spring Garden Show which has been scheduled this year from April 27th to May 2nd.

NED RUCKER, A.L.A., has just completed the landscape plans for the Jefferson Square and Lincoln Square Playgrounds in Oakland. Construction has been started on the Jefferson Square.

KENNETH F. JONES, A.L.A., has plans under way for a Garden Apartment House Project in Reno, Nevada. It is to consist of 96 apartments and construction will start about March 1, 1948. He has also prepared sketch plans for the Westfield Village Shopping Center in Reno, and Subdivision Plan for the Sun Acres Subdivision in Reno has been completed. In the San Francisco Bay Area he has completed the site and grading plans for a Shopping Center in Oakland, Calif.

BERNARD WISELTIER AND WAYNE GRAY, A.L.A., were the Association of Landscape Architects, San Francisco Region delegates attending the State Meeting of the California Planning Institute held in Yosemite early in December.

HEADLINE NEWS & VIEWS

Applications for Title VI insurance for rental and sale housing for veterans were reported to be \$50 million per week early in November. The authorization of \$4,200,000,000 has been exhausted, therefore the current special session of Congress will have to appropriate additional funds to keep the project in operation.

Utah's paved road mileage has increased over 900 per cent during the past 20 years.—Report of the Utah State Road Commission.

BEN WADE, California Redwood Association, San Francisco, recently addressed members of the Northern California Chapter, Producers' Council on the subject "The Features of Redwood Lumber."

COUNTY FAIR BUILDINGS to be built at King City, California, will cost an estimated \$44,452, according to Chas. E. Butner, Architect of Salinas. Contract for construction has been awarded to Geo. L. Fisk, Salinas.

URBAN DEVELOPMENT FOR SAN FRANCISCO

(From Page 11)

Street, Webster Street, and Geary Street. Central features are the Margaret Haywood Playground and Jefferson Square, which together include four blocks.

Among important institutions in the project area that would be incorporated into the proposed redevelopment are St. Mary's Cathedral, St. Paul's Lutheran Church, the Family and Children's Agency, Sacred Heart College, St. Vincent's High and Commercial School, the interracial YWCA-YMCA on Buchanan Street, the Salvation Army Officers Training College, the Raphael Weill Elementary School, and the John Swett Junior High School.

The Commission gives several reasons for selecting the Jefferson Square neighborhood as the first project area.

Its future is relatively certain from an overall city planning standpoint: contemplated major changes in traffic and transit routes will not materially affect the area. It is near a permanent good development, the Civic Center.

There is a possibility of substantially reducing the present excessive cost of municipal services in the area through redevelopment. Re-building would eliminate some of the worst blocks in the entire Western Addition District. From a financial standpoint, the close-in location of the area promises success to any project built there.

10-Story Buildings Proposed

The Commission's proposal envisages construction of 33 apartment buildings, all 10 stories high, three specially designed hotels for single persons, a modern shopping center, a nursery school, and a small auxiliary shopping area. The plan provides for enlargement of the grounds of the Raphael Weill Elementary School and private schools in the project area. It also indicates creation of a new recreation area to serve apartments on the hill that rises north of Jefferson Square.

Several large apartment houses now existing in the area are shown on the plan as being part of the redevelopment scheme. The Commission points out that the California Community Redevelopment Act, under which the project would be carried out, provides for continuation in their present use of structures that are in good condition and would fit into the proposed redevelopment.

New apartments that would be built by a private group in accordance with standards determined by the City Planning Commission would cover not more than 25 per cent of the land devoted to residential use. The buildings shown on the Commission's tentative plan for the project area cover

only 21 per cent of the residential acreage, in contrast to a 75 per cent coverage in some blocks of the area today. Residents in the new development would be assured ample open space, light, and air.

Although the apartment buildings suggested for the project area would be 10 stories high, every family with young children would live in a unit having direct access to the ground. Nine of the 10-story buildings would contain eight two-story apartments designed like row-house units. Each of these apartments would have its private main entrance and kitchen entrance on one side of the building and a private terrace and garden on the other. Floors three through ten would contain two-room or efficiency-type apartments for single persons and couples.

Other building types would provide two-bedroom and three-bedroom units for families with children on the ground floor.

The efficiency-type apartments suggested by the Commission include a general living-sleeping room, a dining alcove, kitchen, bath, and dressing room with large closets and dressing table. Some units of this type would have balconies.

Rents in the project would be between \$25 and

**No More Worry
on this Job...
THREE HINGES.**

STANLEY

VISIBLE
Mark of Good
Construction

STANLEY
Reg. U.S. Pat. Off.

HARDWARE · HAND TOOLS · ELECTRIC TOOLS

THE STANLEY WORKS, NEW BRITAIN, CONNECTICUT

REMEMBER... THREE HINGES TO A DOOR.

The advertisement features a cartoon illustration of a smiling carpenter wearing a hat with the Stanley logo, working on a door. A large speech bubble above him contains the slogan. To the left of the door, three Stanley hinges are shown in a vertical line, with an arrow pointing to them from the text 'VISIBLE Mark of Good Construction'. Below the hinges is the Stanley logo and the text 'Reg. U.S. Pat. Off.'. At the bottom, the company name 'STANLEY' is in a box, followed by 'HARDWARE · HAND TOOLS · ELECTRIC TOOLS' and 'THE STANLEY WORKS, NEW BRITAIN, CONNECTICUT'. A banner at the very bottom reads 'REMEMBER... THREE HINGES TO A DOOR.'

FORDERER CORNICE WORKS

Manufacturers of

Hollow Metal Products • Interior Metal Trim
Elevator Fronts and Cabs
Metal Plaster Accessories • Sanitary Metal Base
Flat and Roll Metal Screens
Metal Cabinets • Commercial Refrigerators

269 POTRERO AVE.

SAN FRANCISCO, CALIF.

HEMLOCK 4100

STRUCTURAL STEEL

For Class A Buildings,
Bridges, etc.

JUDSON PACIFIC - MURPHY CORP.

4300 EASTSHORE HIGHWAY
EMERYVILLE, CALIF.

VALUABLE NEWS SERVICE

- BUILDING MATERIAL DEALERS
- CONTRACTORS
- ENGINEERS
- FINANCIAL INSTITUTIONS

ARCHITECTS REPORTS gives advance news on construction projects in Northern California, lists: name of projects, location, architect, proposed cost and other pertinent information.

HANDY individual slip-reports, issued daily at a total cost of only

\$10 a month

ARCHITECT'S REPORTS

Published Daily

The ARCHITECT and ENGINEER, Inc.

68 Post Street, San Francisco - DO 8311

\$30 per room per month, the Commission estimates.

Financial Problems Discussed

The report discusses various types of financial aid that might be employed to enable private enterprise to establish rents at this level. These include the minimum 10 per cent write-off on the cost of the land authorized by the Community Redevelopment Act, loans at low interest rates, and Federal or State contributions to absorb the difference between what it will cost to buy blighted properties and what private enterprise can afford to pay for the land after it has been cleared. Tax "freezing," or computing of taxes on the basis of present assessed valuations for a period of 25 years, is not permitted in California. The State Constitution would have to be amended before this type of financial assistance could be made available to redevelopment projects.

The report concludes with recommendations that the Board of Supervisors recognize the necessity of having Congress appropriate funds for urban redevelopment and authorize yield insurance to protect the investment of private groups in urban redevelopment projects. It also points out to the Board that the State Legislature should establish a permanent urban redevelopment agency adequately supplied with funds to assist cities in eradicating blighted areas.

Ladislav Segoe, Principal Planning Consultant, and staff of the Commission aided in the community redevelopment study.

The Commission, consultants, and staff were assisted by a citizens' advisory committee composed of Harry B. Allen, E. N. Ayer, Jefferson Beaver, John Cahill, Morse Erskine, John L. Hogg, Leland M. Kaiser, William G. Merchant, and Harold E. Winey.

KRAFTILE APPOINTS

L. R. "Les" Alt, plant superintendent of the Kraftile Company, Niles, California, manufacturers of structural clay products, has been appointed a vice-president of the organization of production, according to an announcement by Chas. W. Kraft, President.

Action of the Kraftile Board of Directors was a result of Alt's leadership in building up production during the past three years, and gives the Kraftile production department direct representation in company policy matters.

VETERAN HOUSING

The Housing Authority of Butte County has awarded a contract to J. A. Bryant, contractor of Sacramento, for the construction of 48 units in Chico, 1n units in Gridley, 8 units in Oroville, and 8 units in Biggs.

Estimated cost of the housing units is \$169,113.

ESTIMATOR'S GUIDE

BUILDING AND CONSTRUCTION MATERIALS

PRICES GIVEN ARE FIGURING PRICES AND ARE MADE UP FROM AVERAGE QUOTATIONS FURNISHED BY MATERIAL HOUSES TO SAN FRANCISCO CONTRACTORS. 2½% SALES TAX ON ALL MATERIALS BUT NOT LABOR

All prices and wages quoted are for San Francisco and the Bay District. There may be slight fluctuation of prices in the interior and southern part of the state. Freight cartage, at least, must be added in figuring country work.

BONDS—Performance—\$10 per \$1000 of contract. Labor and materials, \$10 per \$1000 of contract.

BRICKWORK—

Common Brick—Per 1M laid—\$100.00 to \$120.00 (according to class of work).
 Face Brick—Per 1M laid—\$215 to \$250 (according to class of work).
 Brick Steps—\$3.50 per lin. ft.
 Brick Veneer on Frame Bldg.—Approx. \$2.25 per sq. ft.
 Common Brick—\$28.50 per M, truckload lots, f.o.b. job.
 Face Brick—\$75 to \$90 per M, truckload lots, delivered.
 Cartage—Approx. \$9.00 per M.

BUILDING PAPER—

1 ply per 1000 ft. roll.....	\$5.30
2 ply per 1000 ft. roll.....	7.80
3 ply per 1000 ft. roll.....	9.70
Brownish, Standard, 500 ft. roll.....	8.00

BUILDING HARDWARE—

Sash cord com. No. 7.....	\$2.65 per 100 ft.
Sash cord com. No. 8.....	3.00 per 100 ft.
Sash cord spot No. 7.....	3.65 per 100 ft.
Sash cord spot No. 8.....	4.00 per 100 ft.
Sash weights, cast iron, \$100.00 ton.	
Nails, \$5.50 base.	

CONCRETE AGGREGATES—

The following prices net to Contractors unless otherwise shown. Carload lots only.

	Bunker per ton	Del'd per ton
Gravel, all sizes.....	\$2.44	\$2.75
Top Sand.....	2.38	3.13
Concrete Mix.....	2.38	3.06
Crushed Rock, ¾" to ¾".....	2.38	2.94

	Bunker per ton	Del'd per ton
Crushed Rock, ¾" to 1½".....	\$2.38	\$3.13
Roofing Gravel.....	2.81	3.50
River Sand.....	2.50	3.06

Sand—
 Lepis (Nos. 2 & 4)..... 3.56 3.94
 Olympia (Nos. 1 & 2)..... 3.56 3.88

Cement—

Common (all brands, paper sacks), carload lots, \$3.02 per bbl. f.o.b. car; delivered \$3.60.
 Cash discount on carload lots, 10c a bbl., 10th Proc., less than carload lots \$4.00 per bbl. f.o.b. warehouse or delivered.
 Cash discount 2% on L.C.L.

Trinity White	{ 1 to 100 sacks, \$3.13 sack warehouse or del.; \$9.56 bbl. carload lots.
Medusa White	

DAMP-PROOFING and Waterproofing—

Two-coat work, \$8.00 per square.
 Membrane waterproofing—4 layers of saturated felt, \$9.00 per square.
 Hot coating work, \$5.00 per square.
 Medusa Waterproofing, \$3.50 per lb. San Francisco Warehouse.
 Tricoel waterproofing.
 (See representative.)

ELECTRIC WIRING—\$15 to \$20 per outlet for conduit work (including switches).

Knob and tube average \$6.00 per outlet. (Available only for priority work.)

ELEVATORS—

Prices vary according to capacity, speed and type. Consult elevator companies. Average cost of installing a slow speed automatic passenger elevator in small four story apartment building, including entrance doors, about \$8000.00.

EXCAVATION—

Sand, \$1.00; clay or shale, \$1.50 per yard. Trucks, \$30 to \$45 per day.
 Above figures are an average without water. Steam shovel work in large quantities, less; hard material, such as rock, will run considerably more.

FIRE ESCAPES—

Ten-foot galvanized iron balcony, with stairs, \$250 installed on new buildings; \$300 on old buildings.

FLOORS—

Composition Floors, such as Magnesite, 50c per square foot.
 Linoflor—2 gages—\$3.00 per sq. yd.
 Mastipave—\$1.50 per sq. yd.
 Battleship Linoleum—available to Army and Navy only—½" —\$3.50 sq. yd.
 ¾" —\$3.50 sq. yd.
 Terazzo Floors—\$1.50 per sq. ft.
 Terazzo Steps—\$2.50 per lin. ft.
 Mastic Weer Coat—according to type—20c to 35c.

Hardwood Flooring—

Standard Mill grades not available.
 Victory Oak—T & G
 ¾" x 2¼"..... \$252.00 per M, plus Cartage
 ½" x 2"..... \$210.00
 ½" x 1½"..... 200.00
 Prefinished Standard & Better Oak Flooring
 ¾" x 3¼"..... \$265.00 per M, plus Cartage
 ½" x 2½"..... 237.00 per M, plus Cartage
 Maple Flooring
 ¾" T & G Clear \$330.00 per M, plus Ctg.
 2nd 305.00 per M, plus Ctg.
 3rd 255.00 per M, plus Ctg.
 Floor Layers' Wage, \$2.12½ per hr. (Legal as of July 1, 1947. Given us by Inlaid Floor Co.)

GLASS—

Single Strength Window Glass.....	\$.40 per □ ft.
Double Strength Window Glass.....	.60 per □ ft.
Plate Glass, under 75 sq. ft.....	1.50 per □ ft.
Polished Wire Plate Glass.....	2.25 per □ ft.
Rgh. Wire Glass.....	.60 per □ ft.
Obscure Glass.....	.40 per □ ft.
Glazing of above is additional.	
Glass Blocks.....	\$2.75 per □ ft. set in place

HEATING—

Average, \$2.50 to \$3.00 per sq. ft. of radiation, according to conditions.
 Warm air (gravity) average \$64 per register.
 Forced air average \$91 per register.

INSULATION AND WALLBOARD—

Rockwool Insulation— [2"]\$45.00 per M sq. ft.
Cotton Insulation—Full thickness [3 1/2"]\$95.50 per M sq. ft.
Aluminum Insulation—Foam-mounted on both sides\$33.50 per M sq. ft.
Tileboard—4 1/2" panel\$55.00 per M sq. ft.
Wallboard—1/2" thickness\$55.00 per M sq. ft.
Finished Plank\$49.00 per M sq. ft.
Ceiling Tileboard\$49.00 per M sq. ft.

IRON—Cost of ornamental iron, cast iron, etc., depends on designs.

LUMBER—

No. 1 Common\$90.00 per M
No. 2 Common88.00 per M
Select O. P. Common94.00 per M

Flooring—

	Per M Delvd.
V.G.-D.F. B & Btr. 1 x 4 T & G Flooring\$170.00
"C" and better—all170.00
"D" and better—all170.00
Rwd. Rustic—"A" grade, medium dry150.00
8 to 24 ft.	
"B" grade, medium dry150.00

Plowwood15c to 18c per ft.
Plyscord9 1/2c per ft.
Plywall7c per ft.
Plyform15c per ft.

Shingles (Rwd., not available)—

Red Cedar No. 1—	\$13.00 per square; No. 2, \$10.50; No. 3, \$9.00.
Average cost to lay shingles,	\$6.00 per square.
Cedar Shakes—Tapered: 1/2" to 3/4" x 25"\$17.00 per square.
Resawn: 3/4" to 1 1/4" x 25"\$22.00 per square
Average cost to lay shakes—	8.00 per square

MILLWORK—Standard.

D. F. \$150 per 1000. R. W. Rustic \$175 per 1000 (delivered).
Double hung box window frames, average with trim, \$12.50 and up, each.
Complete door unit, \$15 to \$25.
Screen doors, \$6.00 to \$8.00 each.
Patent screen windows, \$1.25 a sq. ft.
Cases for kitchen pantries seven ft. high, per lineal ft., \$12.00 each.
Dining room cases, \$15.00 per lineal foot. Rough and finish about \$1.00 per sq. ft.
Labor—Rough carpentry, warehouse heavy framing (average), \$65.00 per M.
For smaller work average, \$75.00 to \$85.00 per 1000.

MARBLE—(See Dealers)

PAINTING—

Two-coat workper yard 75c
Three-coat workper yard \$1.00
Cold water paintingper yard 25c
Whitewashingper yard 15c
Turpentine.....	\$1.85 per gal. in 5-gal. cont.
Raw Linseed Oil.....	\$3.33 per gal. in 5-gal. cont.

Boiled Linseed Oil.....	\$3.23 per gal. in drums.
Boiled Linseed Oil—	\$3.33 per gal. in 5-gal. containers.
Replacement Oil—	\$2.75 per gal. in drums, \$2.75 per gal. in 5-gal. containers.
Use Replacement Oil.....	\$3.00 per gal. in 1 gal. cont.
A deposit of \$7.50 required on all drums.	

PATENT CHIMNEYS—

6-inch\$2.00 lineal foot
8-inch2.50 lineal foot
10-inch3.50 lineal foot
12-inch4.50 lineal foot

PLASTER—

Neat wall, per ton delivered in S. F. in paper bags, \$17.60.

PLASTERING (Interior)—

3 Coats, metal lath and plasterYard \$3.00
Keene cement on metal lath3.50
Ceilings with 3/4" hot roll channels metal lath (lathed only)3.00
Sellings with 3/4" hot roll channels metal lath plastered4.50
Single partition 3/4" channel lath 1 side (lath only)3.00
Single partition 3/4" channel lath 2 inches thick plastered8.00
4-inch double partition 3/4" channel lath 2 sides (lath only)5.75
4-inch double partition 3/4" channel lath 2 sides plastered8.75
Thermax single partition: 1" channels; 2 1/4" overall partition width. Plastered both sides7.50
Thermax double partition: 1" channels; 4 1/2" sides11.00
3 Coats over 1" Thermax nailed to one side wood studs or joists4.50
3 Coats over 1" Thermax suspended to one side wood studs with spring sound isolation clip5.00
Note—Channel lath controlled by limitation orders.	

PLASTERING (Exterior)—

2 coats cement finish, brick or concrete wallYard \$2.50
3 coats cement finish, No. 18 gauge wire mesh3.50
Lime—\$4.00 per bbl. at yard.	
Processed L.Lime—\$4.15 per bbl. at yard.	
Rock or Grip Lath—3/4"—30c per sq. yd.	
3/4"—29c per sq. yd.	
Composition Stucco—\$4.00 sq. yard (applied).	

PLUMBING—

From \$150.00 per fixture up, according to grade, quality and runs.

ROOFING—

"Standard" tar and gravel, 4 ply—	\$11.00 per sq. for 30 sqs. or over.
Less than 30 sqs.	\$14.00 per sq.
Tile	\$40.00 to \$50.00 per square.
Redwood Shingles, \$15.00 per square in place.	
5/2 #1-16" Cedar Shingles, 4 1/2" Exposure\$16.50 square

5/8 x 16"—#1 Cedar Shingles, 5" Exposure\$17.00 square
4/2 #1-24" Royal Shingles, 7 1/2" Exposure\$18.25 square
Re-coat with Gravel	\$5.50 per sq.
Asbestos Shingles \$30 to \$60 per sq. laid.	
1/2 x 25" Resawn Cedar Shakes, 10" Exposure\$18.50
3/4 x 25" Resawn Cedar Shakes, 10" Exposure21.00
1 x 25" Resawn Cedar Shakes, 10" Exposure22.00

Above prices are for shakes in place.

SHEET METAL—

Windows—Metal, \$2.50 a sq. ft.
Fire doors (average), including hardware \$2.80 per sq. ft.

SKYLIGHTS—(not glazed)

Copper, \$1.25 sq. ft. (flat).
Galvanized iron, 65c sq. ft. (flat).
Vented hip skylights 90c sq. ft.

STEEL—STRUCTURAL—

\$220 per ton erected, when out of mill.
\$270 per ton erected, when out of stock.

STEEL REINFORCING—

\$200.00 per ton, in place.

STORE FRONTS (None available).

TILE—

Ceramic Tile Floors—\$1.70 per sq. ft.
Cove Base—\$1.35 per lin. ft.
Glazed Tile Wainscot—\$1.85 per sq. ft.
Asphalt Tile Floor 1/2" x 3/4"—\$.40 per sq. ft.
Light shades slightly higher.
Cork Tile—\$1.00 per sq. ft.
Mosaic Floors—See dealers.
Lino-Tile—\$1.00 per sq. ft.

Wall Tile—

Glazed Terra Cotta Wall Units (single faced laid in place—approximate prices:	
2 x 6 x 12\$1.25 sq. ft.
4 x 6 x 121.50 sq. ft.
2 x 8 x 161.45 sq. ft.
4 x 8 x 161.75 sq. ft.

VENETIAN BLINDS—

75c per square foot and up. Installation extra.

WINDOWS—STEEL—

60c per square foot, \$5 for ventilators.

ARCHITECT AND ENGINEER

IN THE NEWS

AMERICAN CONCRETE PIPE ASS'N ANNUAL CONVENTION PLANS SET

Initial plans for the 40th Annual Convention of the American Concrete Pipe Association call for a three day session in March at New Orleans, according to Association officials.

Registration and preliminary meetings have been scheduled for March 11, and the grand opening reception will be held at 5:00 o'clock. Formal meetings and the annual banquet will be held on March 12 and 13.

Special social program has been planned for the ladies.

SIMPLIFIED PRACTICE RECOMMENDATION COPPER AND ALLOY SEAMLESS TUBE

A proposed Simplified Practice Recommendation for Copper and Copper-Alloy Round Seamless Tube has been submitted to producers, distributors, and users for approval or comment, according to the Commodity Standards Division of the National

Bureau of Standards.

Proposed by the Copper and Brass Research Association, the recommendation lists preferred outside diameters and wall thicknesses for copper and copper-alloy round seamless tube.

RALPH WINSHIP of Seattle has been named Manager of Sales for the Washington division of the Columbia Steel Company, according to a recent company announcement. Offices are maintained in Seattle, Washington.

LINOLEUM

Armstrong, Nairne, Pabco, Sloane-Blabon

Linoleum, Asphalt and Rubber Tile
for any installation



FOX TILE CO.

3247 E. 14th Street, Oakland
Phone: ANdover 1-0431

BUILDING TRADES WAGE (JOB SITES) NORTHERN AND CENTRAL CALIFORNIA

ATTENTION: The following are the PREVAILING hourly rates of compensation being paid and in effect by employers by agreement between employers and their union; or as recognized and determined by the U. S. Department of Labor. (Revised to January 1, 1948.)

CRAFT	San Francisco	Alameda Contra Costa	Marin	Vallejo	San Mateo	San Jose	Stockton	Sacramento	Fresno
	ASBESTOS WORKERS	1.90	1.90	1.90	1.90	1.90	1.90	1.90	1.90
BRICKLAYERS	2.25	2.25	2.25	2.25	2.25	2.25	2.25	2.50	2.25
BRICKLAYERS, HODCARRIERS	1.75	1.75	1.75	1.75	1.75	1.87 1/2	1.87 1/2	1.87 1/2	1.75
CARPENTERS	2.00	2.00	2.00	2.00	2.00	2.00	2.00	2.00	2.00
CEMENT FINISHERS	2.02 1/2	2.02 1/2	2.02 1/2	2.02 1/2	2.02 1/2	2.02 1/2	2.02 1/2	2.02 1/2	2.02 1/2
ELECTRICIANS	2.25	2.25	2.25	2.25	2.25	2.25	2.25	2.25	2.25
ENGINEERS: MATERIAL HOIST	2.00	2.00	2.00	2.00	2.00	2.00	2.00	2.00	2.00
PILE DRIVER	2.25	2.25	2.25	2.25	2.25	2.25	2.25	2.25	2.25
STRUCTURAL STEEL	2.25	2.25	2.25	2.25	2.25	2.25	2.25	2.25	2.25
GLASS WORKERS	1.87 1/2	1.87 1/2	1.87 1/2	1.87 1/2	1.87 1/2	1.87 1/2	1.87 1/2	1.87 1/2	1.87 1/2
IRON WORKERS: ORNAMENTAL	2.10	2.10	2.10	2.10	2.10	2.10	2.10	2.10	2.10
REINF. ROOMEN	2.00	2.00	2.00	2.00	2.00	2.00	2.00	2.00	2.00
STRUCTURAL	2.25	2.25	2.25	2.25	2.25	2.25	2.25	2.25	2.25
LABORERS: BUILDING & CONCRETE	1.40	1.40	1.40	1.40	1.40	1.30	1.40	1.40	1.30
LATHERS	2.25	2.25	2.25	2.25	2.25	2.25	2.25	2.25	2.25
MARBLE SETTERS	2.00	2.00	2.00	2.00	2.00	2.00	2.00	2.00	2.00
MOSAIC & TERRAZZO	2.00	2.00	2.00	2.00	2.00	2.00	1.75	1.75	1.75
PAINTERS	2.00	2.00	2.00	2.00	2.00	2.00	2.00	2.00	2.00
PILEDRIVERS	2.12 1/2	2.12 1/2	2.12 1/2	2.12 1/2	2.12 1/2	2.12 1/2	2.12 1/2	2.12 1/2	2.12 1/2
PLASTERERS	2.25	2.25	2.25	2.25	2.25	2.25	2.05	2.05	2.05
PLASTERERS' HODCARRIERS	2.00	2.00	2.00	2.00	2.00	2.00	1.87 1/2	1.87 1/2	1.87 1/2
PLUMBERS	2.25	2.25	2.25	2.25	2.25	2.25	2.25	2.25	2.25
ROOFERS	2.00	2.00	2.00	2.00	2.00	2.00	2.00	2.00	2.00
SHEET METAL WORKERS	2.00	2.00	2.00	2.00	2.00	2.00	2.00	2.00	2.00
SPRINKLER FITTERS	2.00	2.00	2.00	2.00	2.00	2.00	2.00	2.00	2.00
STEAMFITTERS	2.25	2.25	2.25	2.25	2.25	2.25	2.25	2.25	2.25
STONESETTERS (MASON'S)	2.25	2.25	2.25	2.25	2.25	2.25	2.25	2.25	2.25
TILESETTERS	2.15	2.15	2.15	1.90	2.15	1.90	1.90	1.90	1.90

Prepared and compiled by

CENTRAL CALIFORNIA CHAPTER, ASSOCIATED GENERAL CONTRACTORS OF AMERICA

with the assistance and cooperation of secretaries of Building Trades Unions, General Contractors Associations and Builders Exchanges of Northern California

CLASSIFIED ADVERTISING

RATE: 10c PER WORD . . . CASH WITH ORDER

MINIMUM \$2.50

HELP WANTED: Bldg. Specif. Writers for arch. work—perm. Civil Service \$395 & \$440 month. Annual increases, sick leave, retirement, L. A. County Civil Service, Rm. 102, Hall of Records, Los Angeles 12, Calif.

ARCHITECT'S REPORTS—A valuable advance news service giving building and construction information daily on projects in Northern California. Name, location, architect, proposed cost, etc., on individual slips. Ideal for securing new business leads. Hun-

drads of items, total monthly cost only \$10. Don't delay, subscribe today. ARCHITECT & ENGINEER, Room 618, 68 Post Street, San Francisco, California. Phone DOUGLAS 2-8311.

PHOTOGRAPHS: Specializing in building and construction photographs for publication, or historic records. For Industrial-Aerial. Publicity photography use the INDUSTRIAL San Francisco. PHOTO'S, Room 722, Hearst Bldg., San Francisco, Phone SUTTER 1-6953.

WANTED experienced Architectural Designer/Draftsman small San Francisco office. Exceptional pay for exceptional man. Furnish detailed outline of previous experience. All replies confidential, Box 210, Architect & Engineer, 68 Post Street, San Francisco, California.

ENGRAVING—Good engravings are essential to a satisfactory job of printing reproduction. For the best, see Poor Richard Photo Engraving Co., 324 Commercial St.

CLINTON CONSTRUCTION CO.

OF CALIFORNIA

General Contractors

923 FOLSOM STREET • SAN FRANCISCO

Utter 1-3440

HOGAN LUMBER CO.

Wholesale and Retail

LUMBER

MILL WORK • SASH & DOORS

Office, Mill, Yard and Docks
SECOND AND ALICE STREETS • OAKLAND, CALIF.

Telephone GLencourt 1-6861

SISALKRAFT

REG. U. S. PAT. OFF.

"More than a building paper"

THE SISALKRAFT CO.

205 West Wacker Drive
Chicago, Ill.

55 New Montgomery Street
San Francisco, Calif.

SANTA MARIA INN

SANTA MARIA, CALIFORNIA

FRANK J. McCOY, General Manager

FERNAND E. PIMENTEL, Manager

On the
Coast
Highway
between
San
Francisco
and
Los
Angeles



American
or
European
Plan
•
Old
English
Tap
Room

NEW TWIN PARKING METER GIVES MOTORIST A BREAK

The American-LaFrance-Foamite Corporation of Elmira, N. Y., have just announced the acquisition of controlling interest in International Meters, Inc.

International Meters, Inc., will serve as a separate sales company for the distribution of the newly invented Allico Twin Automatic Parking Meter, an ingeniously engineered unit which parks 2 cars independently of each other with but 1 meter, 1 clock, 1 housing, 1 pedestal and 1 coin box.

The new Allico Twin Meter now being manufactured in Elmira, N. Y. is scheduled for completion on December 15th.

According to claims made by the manufacturers, the Allico Twin Automatic Parking Meter is the greatest innovation in the history of metered parking control.

It revolutionizes the former method of crowding each single car into a cramped space at a single meter, by parking two cars bumper to bumper, leaving all the parking area thus saved for easy entry or exit to and from the parking space. It does not reduce the number of parking stations.

It does, however, nearly cut in half the original cost of Meters, as well as the expense of installation, maintenance, winding and collections because one Meter does the work of two single meters. It simplifies policing, as one Twin Meter clocks two cars at a time.

Plus these savings to cities, it is also claimed the new roomy way of easy parking at the Meter will help to lessen parking mishaps.

Even though it does not reduce the number of parking stations, it does provide more space for the motorist in which to park. It gives clearer vision of traffic lanes, thus helping to speed up parking action. It helps to eliminate traffic blocks with their turmoil of confusion and nervous tension to impatient drivers. It means fewer locked bumpers and fewer dented fenders.

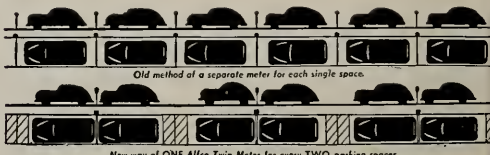
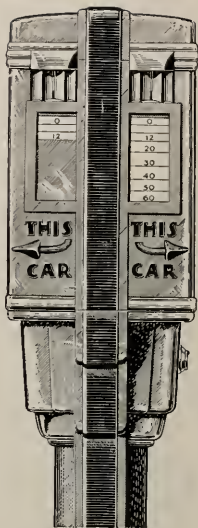

BOOK REVIEWS PAMPHLETS AND CATALOGUES

THE NEIGHBORHOOD UNIT PLAN. Its Spread and Acceptance. Compiled by James Dahir. Russell Sage Foundation, N. Y. Price \$1.00.

Represents a selected bibliography with interpretive comments by James Dahir and was compiled for the Social Work Year Book Department of the Russell Sage Foundation of New York. The book deals with the acceptance of urban planning since its inception as a national housing and city planning program in 1929.

Chapters are devoted to the subjects of: Growth and decay of cities; Background of the neighborhood unit plan; testing the plan; effect and obstacles; American programs; and the neighborhood unit abroad.

A considerable amount of reference is given for those desiring to pursue the subject further.

KNO-DRAFT ADJUSTABLE AIR DIFFUSERS. W. B. Connor Engineering Corp'n., New York, N. Y.

Bulletin K-20 covering the subject of a greater control of air conditioning performance has just been published by the W. B. Connor Engineering Company, New York. Contains features of special interest to Architects, Engineers, Contractors, Building Owners, Managers and Occupants, including photographs showing various types of installation, design drawings, charts and tables. Specifications and accessories are also included in the Bulletin.

WM. HORSTMAYER & CO., San Francisco, have been awarded a \$93,769 contract for additions to the Grammar School Building at Ross, California.

NEW PICTURE WINDOW

A three unit picture window with a large center glass area for an uninterrupted view, and out-swinging casements on either side for ventilation, has been announced by the Detroit Steel Products Company, Detroit, Mich.

The new picture window features a large fixed-light sash, glazed with a single pane of plate glass set in non-hardening putty, and flanked on each side by smaller, ventilating casements, to provide fresh air. The two vents swing out. Screens and storm sash may safely and easily be attached from the inside.

May be used in wall, bay or oriel, or in corner. Window seat or book shelf may be built around it.

CALIFORNIA FUNDS have been allotted for construction of additions to the Napa State Hospital which will cost an estimated \$3,590,297.

The Most Complete Line of STEELS and BUILDING MATERIALS Made by a Single Producer



See Sweet's Catalog File or write us for full information.

REPUBLIC STEEL CORPORATION

GENERAL OFFICES: CLEVELAND, OHIO

DENVER, COLORADO . . . CONTINENTAL OIL BUILDING
LOS ANGELES, CALIFORNIA . . . EDISON BUILDING
SALT LAKE CITY, UTAH . . . WALKER BANK BUILDING
SAN FRANCISCO, CALIFORNIA . . . RIALTO BUILDING
SEATTLE, WASH. WHITE-HENRY-STUART BUILDING

PACIFIC MANUFACTURING CO.

HIGH CLASS INTERIOR FINISH
QUALITY MILLWORK

142 SANSOME ST., SAN FRANCISCO
GARfield 1-7755

6820 MCKINLEY AVE., LOS ANGELES
THornwall 4196

BUILDERS EXCHANGE, OAKLAND

"AMERICAN - MARSH" CONDENSATION UNIT

Pumping
Machinery
for
Every
Purpose

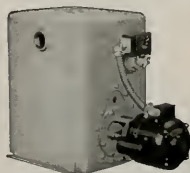

For Service
Call
DOuglas
2-6794
or
MUtual 8322

SIMONDS MACHINERY CO.
SAN FRANCISCO 816 FOLSOM
LOS ANGELES 455 EAST 4TH

VERMONT MARBLE COMPANY

Producers and Finishers
of
Domestic and Imported Marbles

525 MARKET STREET, SAN FRANCISCO
Phone SUtter 1-4747
3522 COUNCIL STREET
(Beverly Blvd. at Virgil Ave.)
LOS ANGELES 4, CALIF.
Telephone Fairfax 7834



NEW!

★ *Venetian Blinds*

BUILT WITH

REMOVABLE SLATS

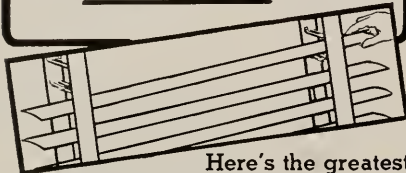

Here's the greatest
Blind improvement of 50 years
AMBASSADOR VENETIANS with
REMOVABLE SLATS

Just unsnap the fasteners (there's only one to each slat) and slip the slats out. Clean them . . . it's as easy as washing dishes, then put them back. It couldn't be simpler. • These revolutionary Ambassador Venetians are ideal for use in all

*Offices
Apartments
Hotels, Hospitals
Public Buildings
Factories*

May we show you how much better they are, how much tighter they close, and how little they cost?

GUNN, CARLE & Co.

20 POTRERO AVE. • SAN FRANCISCO 3

UNderhill 1-5480

IN THE NEWS

PARTNERSHIP FORMED

Morgan Stedman, Furber Libby and Dorothy Gray have formed a partnership for the practice of Architecture according to a recent announcement.

Offices of the firm which will be known as Morgan Stedman-Furber Libby-Dorothy Gray, Registered Architects, will be maintained in Palo Alto, California.

VETERAN HOUSING UNITS

The Biltwell Construction Company of San Francisco have been awarded a contract for the construction of 40 Veteran housing units by the Federal Public Housing Authority in San Francisco.

Thirty-two of the Units will be built at Willits, California, and eight Units will be built at Fort Bragg, California.

Cost is estimated at \$57,777.

NEW INTERMEDIATE SCHOOL at North Sacramento, California, will cost \$297,578, according to George C. Sellon, Architect. H. W. Robertson, Sacramento, general contractor.

MacDONALD, YOUNG & NELSON, San Francisco have been awarded contract for construction of a \$500,000 department store building in Santa Ana, California.

SCHOOL BONDS VOTED at Rodeo, California, for a \$225,000 Grammar School Building. Young, Potter, Dulin & Lloyd, Architects, Albany, California.

PALO ALTO HOME of S. A. Duca, designed by Architect Arthur D. Janssen of Atherton, will cost \$27,500.

COURT HOUSE AND JAIL. Architect Geo. C. Sellon, Sacramento, has announced construction of a new Court House and Jail for Downieville, Sierra County, California, to cost \$150,000.

WATER FILTERING PLANT costing \$425,000 will be constructed at Martinez, California, as a result of voters approving a bond issue at the

COURT HOUSE REMODEL plans at Oakland, California, will cost \$126,927 according to Will G. Corlett & Arthur W. Anderson, Architects. Robert L. Wilson, San Francisco, is the general contractor.

THE TORMEY COMPANY

GENERAL PAINTERS
AND DECORATORS

Phone UNDERhill 1-1913

563 FULTON STREET
San Francisco

IN THE NEWS

TAYLOR - WHEELER General Contractors, San Francisco, have been awarded contract for construction of a \$102,000 grammar school addition at Avenal, California.

THE "ZENITH" NEW LUMINAIRE

A new smartly designed fluorescent luminaire called the ZENITH has been announced by the Smoot-Holman Co., Inglewood, Calif.

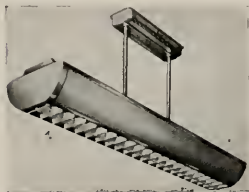

Polystyrene plastic side panels are guaranteed to maintain their shape and color. They are ribbed to permit proper light distribution while reducing surface brightness to a minimum.

Certified ballasts and starters are included in the components. May be installed individually or in continuous mounting. Opens from either side for re-lamping, cleaning or servicing.

PATENTED VENT CAP

Tested by the Research Committee of the Western Plumbing Officials Association and found to meet requirements set by the Board of Building and Safety, City of Los Angeles, a new patented vent cap has been developed by the HAMMEL RADIATOR ENGINEERING CO., Los Angeles.

The cap sets nearly flush with the roof and maintains an even pull regardless of unusual draft conditions or high velocity winds.

BANK BUILDING REMODEL. Swanstrom & Stahl, Contractors of Oakland, California, have been awarded a \$114,652 contract for an addition to the American Trust Company's bank building in Oakland. Reynolds & Chamberlain, are the architects.



**HERRICK
IRON WORKS**
STRUCTURAL STEEL
REINFORCING STEEL

18TH AND CAMPBELL STS.
OAKLAND, CALIF.
Phone GLencourt 1-1767

Phone GARfield 1-1164

Thomas B. Hunter
DESIGNER OF HEATING

AIR CONDITIONING
VENTILATING AND WIRING
SYSTEMS, MECHANICAL
AND ELECTRICAL EQUIP-
MENT OF BUILDINGS



41 SUTTER STREET
ROOM 710

San Francisco

California

MULLEN MFG. COMPANY

BANK, STORE AND OFFICE
FIXTURES—CABINET WORK
OF GUARANTEED QUALITY
CHURCH SEATING

Office and Factory

40-80 RAUSCH ST., Bet. 7th and 8th Sts.
San Francisco
Telephone UNDERhill 1-5815

Scott Company

HEATING - - PLUMBING - - TILE



243 MINNA STREET

SAN FRANCISCO

Phone EXbrook 2-6741

**DINWIDDIE
CONSTRUCTION
COMPANY**

BUILDERS

CROCKER BUILDING
SAN FRANCISCO

Fine
ENGRAVINGS

**POOR
RICHARD**
PHOTO ENGRAVING CO.
220-224 COMMERCIAL STREET
SAN FRANCISCO, CALIF.

A. F. MATTOCK CO.

Builders



212 CLARA STREET
SAN FRANCISCO

INDEPENDENT IRON WORKS

Steel Buildings
Service Stations
Steel Storage Tanks
Fabricated Plate Work
Steel & Sheet Metal Products
Fabricated Structural Steel
Steel Distributors

Eighth & Pine Sts. Oakland, 7

George F. Brayer

ELECTRICAL
CONTRACTOR

166 Seventh Street
San Francisco

Phone: MArket 1-1761

PITTSBURGH TESTING LABORATORY

ENGINEERS AND CHEMISTS

Testing and Inspection of Concrete,
Steel and Other Structural Materials

Design of Concrete Mixes

Offices in all principal cities

651 Howard St., San Francisco 5
EXbrook 2-1747

Index to Advertisers

ALADDIN Heating Corp.	48
ANGIER Pacific Corp.	*
ARCHITECTS Reports	4
ARCHITECT and Engineer	
Inside Back Cover	
BASALT Rock Company	Back Cover
BAXTER & Company, J. H.	36
BRAYER, Geo. F.	48
CLASSIFIED Advertising	43
CLINTON Construction Company	44
CONTINENTAL Water Heater Co.	30
DETROIT Steel Products Co.	5
DINWIDDIE Construction Co.	47
DUFFY Tile Co.	47
FORDERER Cornice Works	40
FOX Tile Co.	43
FULLER, W. P. Co.	*
GUNN, Carle & Company	46
HANKS, Inc., Abbott A.	48
HAWS Drinking Faucet Company	34
HERRICK Iron Works	47
HOGAN Lumber Company	44
HUNT, Robert W., Company	48
HUNTER, Thos. B.	47
INDEPENDENT Iron Works	48
JUDSON, Pacific-Murphy Corp.	40
KRAFTILE Company	2
MATTOCK, A. F., Co.	48
MICHEL & Pfeffer Iron Works	
Inside Front Cover	
MULLEN Mfg. Co.	47
MUELLER Brass Co.	*
NORTHERN California Electric Bureau	35
PACIFIC Coast Aggregates, Inc.	*
PACIFIC Coast Gas Association	7
PACIFIC Manufacturing Company	45
PACIFIC Portland Cement Company	8
PACIFIC Telephone & Telegraph Co.	33
PITTSBURGH Testing Laboratory	48
POOR RICHARD Engraving Co.	47
REMILLARD-Dandini Co.	48
REPUBLIC Steel Corporation	45
SANTA Maria Inn	44
SCOTT Co.	47
SIMONDS Machinery Company	45
SIMPSON Logging Co.	6
SISALKRAFT Company	44
SMOOT-Holman Co.	37
STANLEY Works, The	39
TAYLOR Co., Halsey W.	47
TORMEY Company, The	*
U. S. BONDS	9
VERMONT Marble Company	45
WESIX Company	*
WESTERN Asbestos Co.	1
WOOD, E. K., Lumber Company	36

*Indicates Alternate Months

ABBOT A. HANKS, INC. Engineers & Chemists

INSPECTING — TESTING — CONSULTING
CONCRETE • STEEL • MATERIALS
CHEMICAL AND TESTING
LABORATORIES
• RESEARCH AND INVESTIGATION •

TESTS OF STRUCTURAL MATERIALS
DESIGN OF CONCRETE MIXES
SHOP AND ERECTION INSPECTION OF
STRUCTURES AND EQUIPMENT
INVESTIGATION OF STRUCTURES
AND MATERIALS
TESTS AND INVESTIGATION OF
FOUNDATION SOILS
FIRE RESISTANCE AND INSULATION
TESTS

624 Sacramento Street, San Francisco

Robert W. Hunt Company ENGINEERS

Inspection • Tests • Consultation
Schools and Other Structures
Are Built as Designed

*When Construction Materials are
Inspected at point of Manufacture
and during Erection by*

ROBERT W. HUNT COMPANY

Cement, Concrete, Chemical, Metallurgical,
X-Ray and Physical Laboratories

Chicago - New York - Pittsburgh
Los Angeles - All Large Cities
San Francisco, 251 Kearny Street

REMILLARD-DANDINI Co.

Brick and
Masonry Products



400 MONTGOMERY STREET
SAN FRANCISCO, CALIF.

ALADDIN Heating Corp.

Specializing in
QUALITY HEATING
EQUIPMENT

2222 San Pablo Avenue
OAKLAND
TWinoats 3-1022

ARCHITECT AND ENGINEER

CALIFORNIA GOLD CENTENNIAL

BUTCH FLAY

4 Master Plans

PLUM LIBRARY

MAR 1 1948

PERIODICAL DEPT.

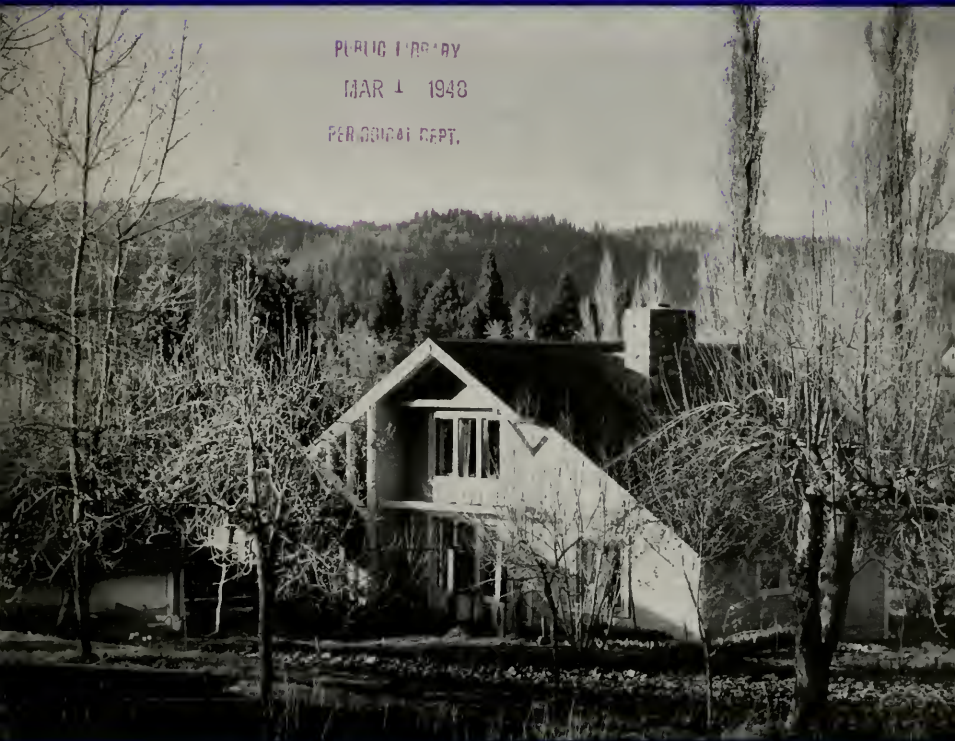

MULTON WATTS, CHICAGO, ILL.

FEBRUARY

1948



Plaques, Tablets
and Name Plates produced in
Bronze, Aluminum and other
Non-Ferrous Metals.

PLAQUES

MODELED IN BRONZE



by
Michel & Pfeffer Iron Works, Inc.

KENNETH OPIE, Manager Misc. and Ornamental Division
Tenth and Harrison Streets, San Francisco 3, California
Telephone MARKET 1-5966

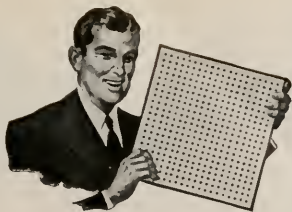

OVER 1000 YEARS of Combined Acoustical Experience

... At Your Service Through Western Asbestos Co.
Your Acousti-Celotex Distributor

MORE THAN 1000 years of combined experience, gained in over 100,000 installations—this is the great reservoir of practical knowledge available to you *only* through the Acousti-Celotex* Distributor Organization of which Western Asbestos Co. is your representative.

This knowledge has been gained in good company. For the nationwide Acousti-Celotex group has collaborated with hundreds of architects in effecting solutions to noise quieting problems.

Every day the men of this organization are helping to solve such problems as:

- How to diagnose acoustical and noise quieting difficulties ...
- How to reduce distracting noise to a gentle hush ...
- How to design architecturally for optimum acoustics ...
- How to be sure of mechanical perfection in the proper acoustical material and its application ...
- How to make sure of the acoustical installation's perfect appearance and continued satisfactory performance through the years.

Every man in this nationwide organization is hand picked. He is thoroughly trained in sound-conditioning practice. As a result, when you turn a job over to him, you know it will be trouble-free.

No matter how much or how little assistance you may need, Western Asbestos Co. is willing and able to help you without obligation. This extra service in no way affects their ability to compete on the smallest or the largest job you may have. That service is the unwritten *plus value* that goes with every specification for Acousti-Celotex.

A phone call or a note will bring a trained sound-conditioning expert to you from Western Asbestos Co.'s staff.

WESTERN ASBESTOS CO.

DISTRIBUTORS • ENGINEERS • CONTRACTORS

SAN FRANCISCO: 675 TOWNSEND STREET, HEMLOCK 4884

OAKLAND: LATHAM SQUARE BUILDING, TEMPLEBAR 7474

SACRAMENTO: 1224 EYE STREET, SACRAMENTO 2-8993

FRESNO: 1837 MERCED STREET, FRESNO 3-3277



Sound Conditioning with
ACOUSTI-CELOTEX

* Perforated Fibre Tile REG. U.S. PAT. OFF. SINCE 1923

1.



2.



3.



4.



1.



2.



3.



4.



Match up the people and the horns

(It may mean money to you!)

THE FIRST THREE, of course, are very easy.

The sea captain (1) goes with Cape Horn (3); the musician (2) with the French horn (4); and the pioneer (3) with the powder horn (2).

That leaves the Average American (4) matched up with the Horn of Plenty (1).

As such an American, you'd like that

to be true, wouldn't you?

It can be—and will be—for millions of Americans who, today, are putting money regularly into U. S. Savings Bonds.

In ten years, as the Bonds mature, these millions will find that they have truly created a Horn of Plenty for themselves!

For they'll get back \$4.00 for every

\$3.00 they're putting in today!

There are now *two* easy, automatic ways to buy U. S. Savings Bonds regularly. The Payroll Savings Plan for men and women on payrolls; the Bond-A-Month Plan for those not on payrolls but who have a bank checking account.

Let U. S. Savings Bonds fill up your personal Horn of Plenty . . . for the years to come!

Automatic saving is sure saving—U. S. Savings Bonds

Contributed by this magazine in co-operation with the Magazine Publishers of America as a public service.



ARCHITECT

Vol. 172

No. 2

AND ENGINEER

ARCHITECTS' REPORTS—Published Daily

Contents for

FEBRUARY

E. H. WILDER

Editor

MARK DANIELS, A.I.A.

Associate Editor

PROF. LELAND VAUGHAN

Landscape Architecture

MICHAEL GOODMAN

Planning

JOHN S. BOLLES, A.I.A.

Book Reviews



COVER PICTURE:

Gold was discovered in California just 100 years ago—1848—end among the famous old "Gold Digging" areas is DUTCH FLAT, Placer County.

Improved shelters of the "sourdoughs" have been replaced by modern homes as the residence of Mrs. Anna Young, created by Architect Bolton White, indicates.

[See Story on Page 18]

EDITORIAL NOTES	4
NEWS & COMMENT ON ART	7
MASS TRANSPORTATION AND TERMINALS, San Francisco and East Bay Cities	10
By GEORGE S. HILL	
A PROPOSED MODEL AIRPLANE FLYING FIELD, Oakland, California	12
By RALPH JONES, A.I.A.	
SOME ENGINEERING PHASES OF CONSTRUCTION	16
By JACK SINGLETON, Chief Engineer, American Institute of Steel Construction, Inc.	
HOME, Dutch Flat, California. Bolton White, A.I.A., Architect	18
By EUGENE BURNS	
PADDOCK POOL BUILDING, Los Angeles [Edla Muir, Architect, A.I.A.]	28
San Mateo [Wurster, Bernaddi & Emmons, Architects]	
A.I.A. ACTIVITIES	31
WITH THE ENGINEERS	32
IN THE NEWS	37, 43, 46, 47
LANDSCAPE ARCHITECTURE, Notes of the Profession	38
ESTIMATOR'S GUIDE, Building & Construction Materials	41
BUILDING TRADES WAGES, Northern & Central California	43
CLASSIFIED ADVERTISING	43
BOOK REVIEWS, Pamphlets & Catalogs	45
INDEX TO ADVERTISERS	48

ARCHITECT AND ENGINEER (Established 1905) is published on the 15th of the month by The Architect and Engineer, Inc., 68 Post St., San Francisco 4; Telephone EXbrook 2-7182. President, K. P. Kierulff; Vice-President and Manager, L. B. Penhorwood; Treasurer, E. N. Kierulff.

Los Angeles Office: Wentworth F. Green, 6605 Hollywood Blvd., Los Angeles 28. Telephone HEMpstead 3171.

Entered as second class matter, November 2, 1905, at the Post Office in San Francisco, California, under the Act of March 3, 1879. Subscriptions United States and Pan America, \$3.00 a year; \$5.00 two years; foreign countries \$5.00 a year; single copy 50c. ARCHITECTS' REPORTS are published daily from this office, Verooa S. Yallip, Manager. Telephone DC 2-2214.



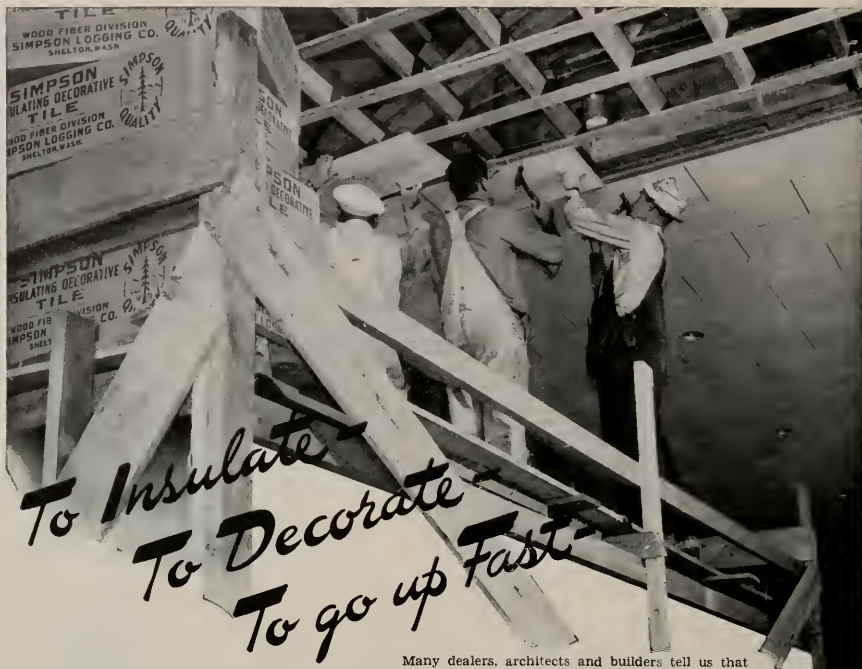

*To Insulate
To Decorate
To go up Fast*

Simpson
QUALITY SINCE 1895

**INSULATING
DECORATIVE TILEBOARD**



Many dealers, architects and builders tell us that they like the new Simpson Decorative Tileboard better because, among other things, it has a more attractive and serviceable finish. Simpson's specially developed gardenia-white finish gives a heavier and more durable covering. For this reason Simpson Decorative Tileboard is highly desirable for interior finish. It makes attractive, economical and serviceable interior walls above the wainscoting, dado or chair rail, along with the ceiling. It provides a suitable and inexpensive ceiling and wall insulation. This new tileboard has a natural finish level for decorative advantages. It has a perfected tongue and groove joint for quick, easy and permanent application. This improved product, made from long strong fibers of Douglas Fir is now being delivered to our distributors. Ask them about its advantages.

WOODFIBER DIVISION, SIMPSON LOGGING CO.
PLANT AT SHELTON, WASHINGTON

Sales Division SIMPSON INDUSTRIES, 101D White Building, Seattle 1, Washington

DISCUSS YOUR NEEDS WITH THE SIMPSON DISTRIBUTORS LISTED HERE

ARIZONA SASH, DOOR & GLASS CO.
521 S. 9th Ave.
Phoenix, Arizona Phone: 3-3151

ARIZONA SASH, DOOR & GLASS CO.
637 West St. Mary's Road
Tucson, Arizona Phone: 1699

CALIFORNIA BUILDERS SUPPLY CO.
700 Sixth Avenue, Oakland 4, Calif.
Phone: Templebar 4-B383

CALIFORNIA BUILDERS SUPPLY CO.
19th & S Sts., Sacramento 14, Calif.
Phone: 2-0788

CALIFORNIA BUILDERS SUPPLY CO.
3180 Hamilton Ave., Fresno, Calif.
Phone: 2-9470

CALIFORNIA PANEL & VENEER CO.
935-967 Alameda St., Los Angeles,
Calif. Phone: Trinitly 0057

CONTINENTAL LUMBER CO.
P. O. Box 2042
Boise, Idaho Phone: 450

ELLIOTT BAY LUMBER CO.
600 W. Spokane St.
Seattle, Wash. Phone: Elliott 8080

ELLIOTT BAY LUMBER CO.
2712 McDougall St.
Everett, Wash. Phone: Main 150

ELLIOTT BAY LUMBER CO.
Box 188—Union Gap Station
Yakima, Wash. Phone: 24671

EXCHANGE LUMBER & MFG. CO.
P. O. Box 1514, Spokane, Wash.
Phone: Glenwood 1621

FROST HARDWOOD LUMBER CO.
Market of State St., San Diego, Calif.
Phone: F7224

LUMBER DEALERS, INC.
1610 E. Washington Blvd.
1610 E. Washington Blvd.
Los Angeles, Calif.
Phone: Prospect 6183

LUMBER DEALERS, INC.
108 South Main St., Pueblo, Colo.
Phone: 4881

LUMBER DEALERS, INC.
423 N. 33rd, Billings, Mont.
Phone: 3911

MORRISON-MERRILL & CO.
352 No. Park St.
Reno, Nevada Phone: 2-2196

CHAS. E. SAND PLYWOOD CO.
1106 N. W. 16th Ave.
Portland, Oregon
Phone: Atwater 6421

SIMPSON INDUSTRIES
1610 E. Washington Blvd.
Los Angeles, Calif.
Phone: Prospect 6183

SIMPSON INDUSTRIES
Shelton, Wash. Phone: Shelton 6

UTAH LUMBER CO.
333 W. 1st So.
Salt Lake City 9, Utah
Phone: 4-4318

WESTERN DOOR & SASH CO.
5th & Cypress St. Oakland 7, Calif.
Phone: Templebar 2-8400

WESTERN DOOR & SASH CO.
9th & Parker St., Berkeley, Calif.
Phone: Ashbury 3-6472

NEWS AND COMMENT ON ART

UNIVERSITY OF OREGON SCHOOL OF ARCHITECTURE

The School of Architecture and Allied Arts has announced their March exhibit will feature the work of ECKBO, ROYSTON & WILLIAMS prominent landscape architects.

The Exhibit will be shown from March 6 to 20.

CALIFORNIA SCHOOL OF FINE ARTS

Special art classes for children are again being offered by the California School of Fine Arts, 800 Chestnut Street, San Francisco, for the Spring Term of 1948. Enrollment is open in three student groups with classes held each Saturday morning.

The first group is designed for students of the primary age and is supervised by Jean Kewell; the other two classes are for students of school age and are under the direction of Ruth Cravath Wakefield and Hassel Smith.

NEW ARTISTS' GROUP FORMED. An organization known as the "Artists' Group of Bay Area Associated" was formed recently at the Rudolph Schaeffer School of Design, San Francisco.

CITY OF PARIS SAN FRANCISCO

An exhibition of Oils, Gouache, and Tempera by Dorothy Brett and Ila McAfee of Taos, New Mexico, and Marousya Hadqadya of Hollywood, will be shown in the Rotunda Gallery, Fourth Floor, from February 4 to 28th.

In the Art In Action Shop, Painting of the Month will be by Otis Oldfield. New Ascher Scarfs will be shown, and a special exhibit of ceramics by Laura Andreson, Whitney Atchley, Tressa Cramer and Inguardt Olson will be shown February 1 to 28.

CALIFORNIA PALACE OF THE LEGION OF HONOR

Thomas Carr Howe, Jr., Director of the California Palace of the Legion of Honor, Lincoln Park, San Francisco, has announced the following schedule of exhibitions and special events for February:

EXHIBITIONS: Outstanding Americans of Negro Origin; Modern French Tapestries, Mexico, Real and Imaginary, drawings by Eugene Berman (opening February 28th); Ceramics by Dan Rhodes; Photographs by Cartier-Bresson, and Oils by Fred Sexton.

The Alma de Bretteville Spreckels Collection of Sculpture by Auguste Rodin; The Mildred Anna Williams Collection of Paintings, Sculpture, Tapestries and Furniture, and the Collis Potter Hunting-

ton Memorial Collection of 18th Century French Paintings, Sculpture, Tapestries, Furniture, and Porcelain.

EDUCATIONAL ACTIVITIES: Classes for children each Saturday morning at 10 o'clock. Instruction by Katharine L. Parker, Lilly Weil Jaffe, and Frank Lobdell. Adult painting each Saturday afternoon under direction of Frank Lobdell.

SPECIAL PROGRAMS: Organ Recital each Saturday and Sunday at 5 p.m. by Uda Waldrop. Free Motion pictures each Saturday at 2:30 p.m.

SAN FRANCISCO MUSEUM OF ART

The program of events and exhibitions scheduled for February at the San Francisco Museum of Art, Civic Center, San Francisco, will include:

EXHIBITIONS: Paintings by Keith Martin; John



Holland Memorial Exhibition; Photographs by W. Russell Everitt and Lawton Kennedy; Paintings by Helen Schwinger; The Sixty-seventh Oil & Sculpture Annual of the San Francisco Art Association.

ACTIVITIES: "From Spanish Colonial to Modern Times in Latin American Art" a series of three lectures by Dr. Alfred Neumeyer, February 12, 19 and

26 at 2:30 p.m., Symphony Luncheon, sponsored by the Women's Board February 27th 12-Noon. Henry Moore, first American showing, a color film of the artists work, narrated by Moore himself, February 27th at 8 p.m.

The San Francisco Museum of Art will be closed for renovation beginning March 1, 1948.

Winners In Annual International Design Competition Are Announced

There were six winners of the First Award and eleven winners of Honorable Mention in the annual competition of the American Institute of Decorators for fabrics, furniture, lighting and wall coverings used in the home-furnishing field during the year 1947.

Announcement of the winners was made at the Institute's headquarters in New York City and included two Californians in the First Award group and two Californians in the Honorable Mention group.

Designers whose achievements during the past year commanded top honors were:

Claire Falkenstein of Berkeley, for a wall covering design which she calls "Vertebrate Mass" and consists of lavender lines on a black background; Maurice Martine of Corona del Mar for a furniture design which embodies the combined use of metal, cords, and wood; Erwine Laverne and Mrs. Estelle Laverne of New York City, for a printed fabric; Joan L. Maag also of New York City, for a woven fabric; Kurt Versen of Englewood, New Jersey, for a lighting design.

Honorable Mention citations were awarded by the jury of seven to eleven designers in the same fields, and included in this group were:

Dorothy W. Liebes and Dorr Bothwell, both of San Francisco, for wall covering designs; Ruth Adler of Detroit, Else Regensteiner and Julia McVicker of Chicago, Pipsan Saarinen Swanson of Bloomfield Hills, Michigan; Angelo Testa of Chicago, and Samuel E. Tushingham of Detroit for fabric designs. Florence Knoll and George Nelson of New York for furniture designs, and Zahara Schatz of New York and Pipsan Saarinen Swanson for lighting designs.

The citation winners were feted at a banquet in their honor at the Architectural League of New York on Thursday night, February 26, when Joseph Mullen, President of the AID, made a personal

presentation of the citations. In addition to AID members, the function was attended by members of the Architectural League — artists, painters, sculptors, photographers, and editors—who participated in the ceremonies and helped to inaugurate a three-week exhibit of the 18 citation designs, besides 17 designs which were selected by the seven-man jury who judged the competition without knowing the names of the contestants.

After the exhibit closes at the Architectural League's galleries the 35 design entries will tour the country for one year, with the second showing in Los Angeles toward the end of March.

According to Theodor Muller, chairman of the Committee on Awards, the AID's annual competition is open to interior designers of all nations. Members of the jury represent the education, museum, architectural and retailing fields, in which they have distinguished themselves.

The AID's object in giving the annual awards is to make known to the consumer public what the market offers in good design; and to commend those who create designs in fields related to interior design and decoration.

The 1947 Jury consisted of Max Abramovitz, Deputy Director of Planning for the United Nations headquarters; W. E. S. Griswold, Jr., President of W & J Sloane Company, New York; Carl Koch, professor of Architecture, Massachusetts Institute of Technology; Samuel A. Marx, architect, Chicago; Mrs. Michelle Murphy, Curator of the Industrial Design Division, the Brooklyn Museum; Jack H. Per-Lee, Vice-President in charge of Home Furnishings at Lord & Taylor, New York; and Andrew C. Ritchie, Director of the Albright Art Gallery, Buffalo, N. Y.

The entries selected by the jury for citations and exhibition purposes represent designs which are in production and available for purchase on the current consumer market.

(See Illustrations on opposite Page)

WOOD-WIRE-CORD CHAIR

This functional chair of wood, wire and cord won First Award in the international competition of American Institute of Decorators, New York City.

Maurice Martine,
Designer
Corna del Mar,
California



FIRST AWARD

Wall Covering
Design called
"Vertebrate
Mass"—lavender
lines on black
background.

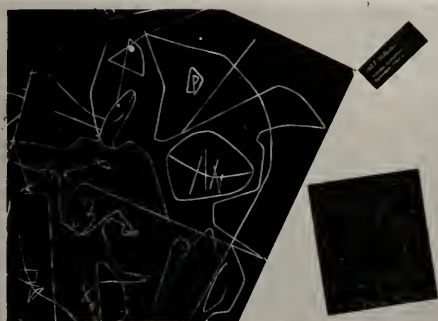

Claire
Falkenstein
Artist & Designer
Berkeley,
California



DETAILED VIEW OF FIRST AWARD CHAIR

Showing combined use of metal supports for seat of tightly stretched cords, back, legs, and wood.

Award made by a seven man jury.

Retail price of chair is \$39.50.



MASS TRANSPORTATION AND TERMINALS

SAN FRANCISCO AND EAST BAY CITIES

By **GEORGE S. HILL**

This article deals with the subject of providing rail facilities and mass transportation between San Francisco and the East-Bay cities.

The Army-Navy plan for a bridge from Army Street in San Francisco to Alameda has been endorsed by practically all of the civic groups in San Francisco. When constructed, this bridge will provide a direct outlet eastward from the center of the City and County of San Francisco and is therefore good long-range planning. With the Gold-

en Gate bridge to the north, the existing Trans-Bay bridge to the north-east, and the Army-Navy bridge to the east, San Francisco will have three well located bridges. Neither the twin bridge paralleling the existing structure nor the Army-Navy crossing, however, provide for mass transportation, although in its more recent report the cost of providing separate rail facilities has been estimated by the Army-Navy Board. The first report of the Army-Navy Board recommended that interurban

rail transportation be provided in a separate location.

If a poll were taken of the residents of San Francisco it is my belief that at least nine out of ten would be in favor of having direct rail facilities provided to the continental side of the bay. As it is, only one railroad has direct rail access to San Francisco. Nevertheless, the city would be benefited greatly by having through coast-wise train service and becoming the transcontinental rail terminal with an open door to other railway systems. In various reports, much has been said about transcontinental traffic, and not much mention has been made of the potentially valuable coast-wise rail traffic connecting Seattle, Portland and intermediate points with Los Angeles and San Diego. This traffic should pass through San Francisco. The Friendship Train from Los Angeles passed through Oakland before proceeding eastward completely by-passing San Francisco, and although this is of little importance now, it illustrates a condition which may be of vital importance in the future.

Los Angeles has three transcontinental rail lines—the Southern Pacific, the Santa Fe, and the Union Pacific. These three rail lines operate out of a union passenger station obtained by the City of Los Angeles only after 20 years of effort in proceedings which were carried to the Supreme Court of the United States three times, and there were many hearings before the California Railroad Commission and the Interstate Commerce Commission. No such delay would be necessary in the future, inasmuch as the question of jurisdiction was settled once for all. Upon completion of the station a three day celebration was held.

The argument has been raised that the volume of traffic would not justify the cost of providing such facilities in San Francisco, and that the railroads therefore would not voluntarily use them if they had them. There are however many intangible values which should be considered before it is decided to isolate the San Francisco peninsula from the continental side. Among some of the intangibles there is the added convenience to the travelling public. There is added convenience to the railroad management in the simplification of its terminal and transfer facilities and in through routing. There is added value to San Francisco in becoming the transcontinental terminus instead of being out at the end of a limb. This added value applies not only to the municipality but to the individual property owner as well. Added value

will accrue to the railroads in having adequate terminal facilities in San Francisco. A railroad without such facilities is useless. Adequate commuting facilities are of the greatest importance both to San Francisco and to all of the East-Bay communities.

If the city halls of San Francisco and Oakland were connected by a straight line, the line would pass in the vicinity of the Alameda Pier in the East-Bay and near the foot of Brannan Street in San Francisco. Practically no loss of time or distance therefore would result if the Oakland Pier were connected with Pier 42 near the foot of King Street in San Francisco.

It is proposed therefore to build a high level bridge in this location exclusively for mass transportation (both passenger and freight). Two tracks would be provided for through passenger and freight trains, and two tracks for interurban service. The upper deck would be for truck and bus service, and these would be separated. The suburban trains by one route would proceed under Rincon Hill via First Street to a subway in Market Street. The other route would pass the Third Street Station.

The through trains would proceed to the Third Street Station and there terminate or continue down the Peninsula.

The Third Street Station presents one of the few and perhaps the only site for a union passenger terminal within a practicable distance from the existing business center of San Francisco, inasmuch as it is the only site of sufficient size for such a terminal which is obtainable without excessive cost. It is the only site which can be constructed at grade or nearly so, and without undue interference with existing conditions. Located as it is at one side of the business district, it will not hamper future expansion of the district. The site will permit operating the station as a through station instead of a stub terminal. This permits the operation of more trains per track per hour and will not require backing into or out of the terminal. A railway terminal does not consist merely of a head house and concourse, but requires extensive space for trackage and connections, with facilities for baggage, mail, and express, as well as coach yards and engine facilities.

If rapid transit service were provided from the existing station site to and along Market Street, practically all of the objection to this site would disappear, inasmuch as the running time between the station and Market Street would be only two

(See Page 44)

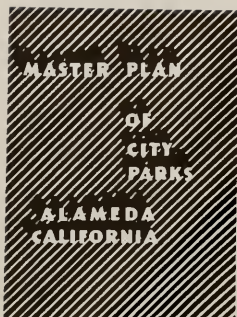

A PROPOSED MODEL AIRPLANE FLYING FIELD

Oakland, California

o o o

AN INTEGRAL PART OF A
MASTER PLAN FOR CITY PARKS

By

RALPH JONES,
A.L.A.



Photo shows the existing field chaos resulting from lack of segregation of activities — participants, spectators, workshop, parking — for ease of operation and for safety.



R. Cecchetti, Photo

The flying of model airplanes has become an extremely important recreational activity throughout the United States in recent years, and providing adequate facilities for this popular sport has been a real challenge to park and recreational agencies. Many cities are already proposing to include carefully developed plans for these model airplane fields in their park master plans.

When the functions of this new activity are understood and facilities are designed to satisfy the overall requirements, the plan in concept is quite unique. The main considerations are the safety of the participants and spectators and the need for an area that is orderly, comfortable, adequate,

easily operated and maintained, and compatible with the surrounding park areas.

Because the model airplanes travel at speeds as fast as 100 miles per hour and are held on circular course by thin control wires there is a potential danger to operators and spectators. Flight arches must also be of lawn as the planes are very delicate in construction and need a soft landing surface.

The spectators seating area must be able to accommodate upwards of 5000 people during "meets" without interference with contestants. Through proper planning however, controlling areas can be established to separate and protect

MODEL AIRPLANE FLYING FIELD . . .

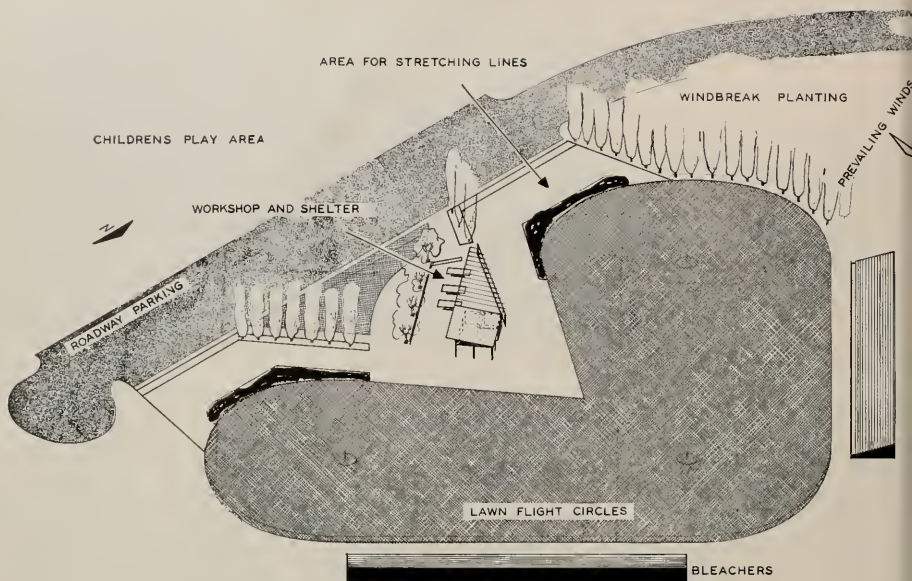

these groups, and at the same time provision can be made for the parking of automobiles. Likewise, by carefully planning, the related space can be arranged to confine operators to certain areas of specialized activity for their convenience and safety.

The sketches shown here are presented to implement this explanation of what the specialized activities are, why they are important and how a solution has been achieved in the general plan layout.

Inasmuch as state and national model airplane contests are held at such fields as shown here, it

is imperative that the numerous events be expedited with regularity and precision. The precision required in stretching lines is of utmost importance inasmuch as the length of the lines must be checked by officials before contestants may compete their model planes in speed classes.

Line stretching therefore, requires a separate area screened from nearby flying models and from paths of circulation.

Model airplane fields must also be outside of residential areas due to "whining" noises made by the miniature motors used, and many people consider the noise as obnoxious.



FLIGHT CIRCLES

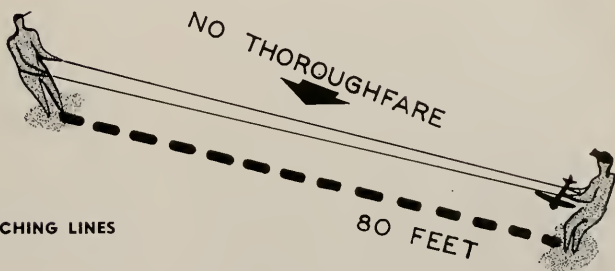

STRETCHING LINES

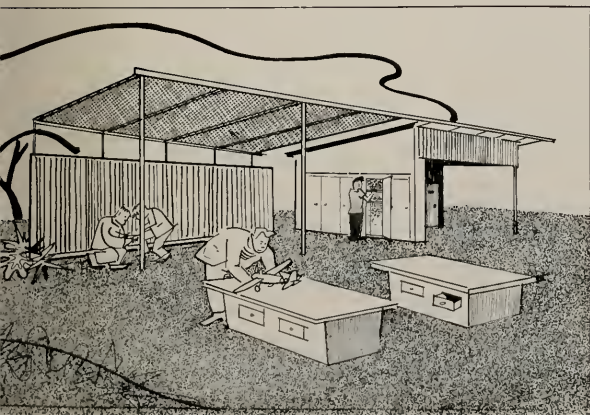

WORKSHOP AREA

Some Engineering Phases of Construction

By JACK SINGLETON

Chief Engineer, American Institute of Steel Construction, Inc.

It would be impossible to adequately cover all the engineering phases of construction in a single talk. I hold seminars with our district engineers annually, the meetings lasting day and night for the better part of a week, on this very subject, and we are still unfinished with the agenda when the session closes. So—the introduction of the word “some” is a lifesaver, both to you and to me.

At the time the American Institute of Steel Construction was formed, in 1921, there was most certainly a lack of uniformity in design specifications for structural steel. Prior to that time the producing steel companies, through their various handbooks, had published about the only available information on steel shapes and how to use them. A roll call of the most prominent engineers engaged in building design at the turn of the century reveals that a great majority of them secured their training on the use of structural steel in the design and drafting rooms of the steel fabricating companies themselves. Our colleges and universities gave instruction in the design of Fink roof trusses, and an individual railroad bridge or two—and precious little else. For that matter, some of them have not changed too greatly.

In 1923 the Institute knew what it wanted—a means of promoting uniformity in the design of structural steel. In that year George F. Swain, of Harvard; Milo B. Ketchum, of Illinois; E. R. Graham, of Graham, Anderson, Probst & White; W. J. Thomas, of George B. Post & Sons, New York; and Wilbur J. Watson, of Cleveland, prepared the first basic Institute specification for the design of structural steel in buildings.

That specification, evolved in 1923, has been revised and kept up to date. It has met with almost universal adoption in this country, and has served as a pattern for many foreign specifications. By its use, it is now possible to secure the degree of uniformity of thought and adaptation so necessary in this day and age.

On December 2, 1946, I made a talk to the Western Society of Engineers, subject “Recent Developments in Steel Construction.” The address really concerned more than was indicated in the title; I endeavored to stress the two fundamental facts which are often lost sight of, or perhaps deliberately neglected, in any study involving indeterminate structures: They are: 1. A Method of Analysis. 2. A Method of Design.

As concerns Item 1, there are literally scores of methods of analysis available. Some 30 years ago, when I was initially not personally satisfied with available theories, I spent considerable time in securing some 68 foreign and domestic expositions of such theory; the number has increased greatly since that time. I do not question the fact that almost anyone of them, in the hands of a properly qualified exponent, will secure results perfectly satisfying the requirements of a “Method of Analysis.” That method which seems best suited to the individual may be appropriately used. If the method is not economically feasible it will be so shown.

Granted that some analytical method is acceptable, as feasible or, in the last analysis usable, what you and I are primarily concerned with is a “Method of Design”—**not** a method of analysis of an indeterminate structure, but the adaptation of the results from such an analysis to a **Method** of design.

This thought is by no means an original one, but it is just as true today as when first expressed.

In any structure designed to resist wind or seismic forces we must, of course, introduce moment connections; we have done so for years largely by means of empirical design assumptions. As a result many of the connections have been heavy, but they have served their purpose. It is possible to achieve economy in design of a structure for static loads providing we can use a connection whose weight and cost of fabrication does not offset the saving in weight of main member—it is obvious that we penalize ourselves if we achieve an economy of 400 pounds in a beam and then require 500 pounds of moment connections to do the job.

EDITOR'S NOTE—This article is a copy of an address by Col. Jack Singleton delivered to members of the Structural Engineers Association of Northern California and the San Francisco Section, American Society of Civil Engineers, in San Francisco on February 17th.

As was the case in our original theories of continuity, where we considered a continuous beam as either free or fixed at the ends, with no "in-between" condition of semi-fixity, many beams in a structure have been considered as entirely freed-ended when no moment connection was used, or fully fixed when such a restraining joint was incorporated. Actually, of course, it is almost impossible to so restrain a beam or girder to the degree necessary to obtain full fixity.

The AISC Specification, with which most of you are familiar, is in no sense of the word frozen or static. As concerns beam-to-column joints, three types are recognized in our latest specification:

Type 1: commonly designated as "rigid frame" (continuous, restrained frame), assumes that the end connections of all members in the frame have sufficient rigidity to hold, virtually unchanged, the original angles between such members and the members to which they connect.

Type 2: commonly designated as "conventional" or "simple" framing (unrestrained, freed-ended), assumes that the ends of the beams and girders are connected for shear only, and are free to rotate under load.

Type 3: commonly designated as "semi-rigid framing" (partially restrained), assumes that the connections of beams and girders possess a dependable and known moment capacity intermediate in degree between the complete rigidity of Type 1 and the complex flexibility of Type 2.

Type 1 construction is unconditionally permitted under our 1946 specification. It is, however, a necessary condition of connections of this type that the calculated stresses and resultant strains in all members and their connections occur within the elastic range, and that the stresses do not exceed those allowed in our specification.

Type 2 construction is permitted under our specification according to the stipulations. Beam-to-column connections with seats for the reactions and with top clip angles for lateral support only are classed under Type 2.

In tier buildings, designed in general as Type 2 connections, in that beam-to-column connections other than wind connections are flexible, the distribution of wind moments as between the several joints of the frame, may be made by a recognized empirical method, provided that either:

1. The wind connections, designed to resist the assumed wind moments, are adequate to resist the moments induced by the gravity loading and the wind loading, at the increased unit stresses permitted therefor, or;

2. The wind connections, if welded, and if designed that resist the assumed wind moments, are so designed that larger moments, induced by the gravity loading under the actual condition of restraint, will be relieved by deformation of the connection material without overstress in the welds.

Type 3 (semi-rigid) construction will be permitted only upon evidence that the connections to be used are capable of resisting definite moments without overstress of welds. The proportioning of main members joined by such connections shall be predicated upon no greater degree of end restraint than the minimum known to be affected by the respective connections.

Types 2 and 3 construction may necessitate some non-elastic but self-limiting deformation of a structural steel part, but under forces which do not overstress the rivets, bolts or welds.

We have been using both riveted and welded moment connections for many years, particularly the former, yet in the early days we had little in the way of an exact method of analysis to start with and not well-grounded a theory as to design. In tall buildings, subject to the effect of internal forces—wind—we chose some methods of distribution of the wind effect. Probably one of the methods sponsored by Robins Fleming, or some other authority. We didn't change the details at each joint, nor even at each floor, simply because the moment due to wind had changed. We developed, largely as individuals, a series of connections of varying size and strength, with total values depending in large measure on the number of rivets used. When the moment became too great for a given connection we went to a larger one. That was, perhaps, the first recognition of the importance of a factual "Method of Design" used in conjunction with a theoretical "Method of Analysis." Strangely enough—or perhaps not so strangely after all—structures so designed have performed surprisingly well.

We have, as engineers, almost always endeavored to keep the stresses within the material of a member or in a joint, within the elastic limit of the material. It is possible, however, that overload or shock load might produce stresses within the plastic range without seriously effecting the structure, and we are desirous of studying this phase.

Our usual conception of the physical properties of a material is based upon the behavior of that material under one-directional loading in tension or compression. Individual members may so perform, and in such cases the solution is simple. When members are inter-related, as in structures

(See Page 25)



WINTER TERRACE

Photographs by Esther Born

HOME . . .

DUTCH FLAT, CALIFORNIA

BOLTON WHITE, Architect, A. I. A.

By EUGENE BURNS

A HOME built around a concert grand piano: that describes Architect Bolton White's design for Mrs. Anna Young's vacation home at Dutch Flat, California.

Using her Steinway concert grand — around which the musically-talented Mrs. Anna Young bases her own life, including operatic roles with the San Francisco Opera Company and instruct-

ing talented pupils—Architect White did the following:

He lofted the ceiling over the piano to twenty-four feet, to give the central space a cathedral-like spaciousness.

To back up the piano, he opened the side of the comparatively modest home with a huge 18-foot tall north window to let in a flood of light for good

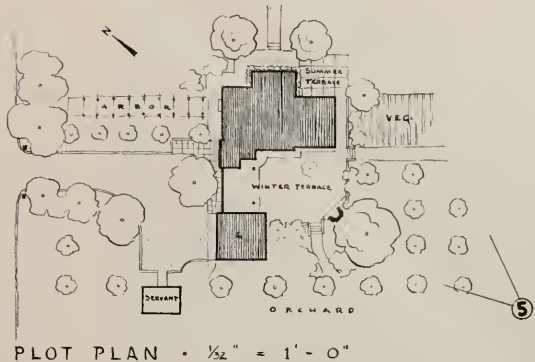

music reading.

Like the piano's exposed mechanical beauty, when the wing is up, Mr. White let the structural framing of the home show—thereby combining utility with economy, which artfully conceived, produced beauty. The floors, except for the kitchen and bath, are six inch oak planks. The walls are beveled knotty-pine, placed horizontally, thus bringing down the ceiling.

For comfortable music sessions, White added a huge fireplace which in normal weather heats the entire home, even the bathroom. It was made of granite from the nearby mountains.

Mr. White flanked the fireplace with seven-foot bookshelves for reading matter and music scores. There is also a built-in compartment for the record changer and hundreds of records—mostly operas.

For the inevitable musicals—when fine artists get together for weekends of music—the architect added a balcony. During last fall's concert, in

which three of Mrs. Young's students performed, the house accommodated 150 people—54 of them on the balcony!

Musical requirements fulfilled, Bolton White built about the large central space the necessary appurtenances of living, sleeping and service areas, keeping them to a workable minimum, although adequate to take care of week-end guests.

Mrs. Young's instructions to the Columbia, Stanford and California-trained architect were: "Bolton, I want a vacation home that will be compact and easy to maintain and yet sufficiently adaptable to accommodate week-end guests—plenty of them. And I may want to live in the house the year round."

Besides the concert grand piano, there were additional considerations Bolton White kept in mind: the site was gently sloping in an orchard; pleasant views were to the north and northeast; seasonal changes varied from hot summers to

HOME, Bolton White, A.I.A. . . .



heavy winter snows; and the town itself was made up from left-overs of the gold digging days.

Dutch Flat is an old stage-coach stop—a relict of the gold mining days, with a population of about 400. Up to its very limits, the valleys and hillsides have been churned up by placer mining. The townsite, reportedly, sits on three millions of gold—and the former owners of the Young site, still hold mining rights nine feet under the town-site.

To have built a modern exterior in Dutch Flat would have been wholly wrong. Hence to conform to the weather, the landscape, and the existing architecture of Dutch Flat, Bolton White made a very simple exterior, topping it with a steep barn-like roof to shed snow. But when one steps inside, the house unfolds—with disarming honesty and charm.

Mr. White made the main axis of the living room, north and south, capturing for his large window

**COMBINATION
LIVING AND
MUSIC ROOM**

Looking down into the spacious utility living room indicates the complete blending of facilities for a general use of the area for living and entertainment.

Exposed underside of long sloping roof adds to the warm feeling of the home.





LIVING ROOM

Opposite from the music portion of the large living room are the book shelves—old fashioned fireplace with its inlaid stone hearth.

Here again the long sloping roof's exposed rafters and beams become an integral part of a rough balcony which overlooks the entire room and is used for guests during musical presentations.

the most advantageous view. He made the exposure tall enough, 18 feet, to catch the full glory of the 75-year old poplars whose yellows, in the fall, are caught up in the matching golden-yellow of the roof overhangs and exposed frame members.

Windows at the fireplace end of the room, invite the southern sun. For summer use, there is a terrace on the northeast; another, on the south, is used on cooler evenings and in winter.

Guest accommodations, with bath, are located in the bunk room balcony above the southern end of the living room. Another bedroom and bath are on the main floor.

Doors leading to the exterior are mostly glass, while those leading from the central space to other rooms are cut out of the same length of pine paneling, thereby making them unnoticeable.

The house is of wood-frame construction, built on concrete foundations. For economy, structural framing was left exposed wherever possible. Exterior walls, of pine-beveled siding, were painted a warm grey; the trim a neutral white; oiled cedar shingles are used on the roof, and the roof structure is insulated with one-half inch insulation board laid over sheathing exposed on the interior.



BEDROOM

An upstairs bedroom is designed to practical use of the space afforded by the steep roof . . . with built in closets and adequate windows, which with the rough, exposed rafters give emphasis to "western style" of construction.

STAIRWAY

Using exposed beams of the downstairs room as basis of roughed stairway to second floor.



HOME, Bolton White, A.I.A. . . .

Interior walls are finished with white pine ship-lap, treated with a warm grey glaze—so that the pine knots won't jump out at you, but yet allow the grain to show through. The kitchen and baths are finished in plywood. Kitchen and entry floors are 12 by 12 inch red quarry tile.

The chimney, with a patent firebox, has ducts opening into the living room, the bedroom, and the bath. This, together with a combination wood and gas kitchen range, supplies ample heat for normal use. For winter extremes, however, there is an oil furnace in the basement.

A covered porch adjoining the southern terrace

serves as a protected passage to the garage, a shield against prevailing west winds, and a pleasant, shaded outdoor dining room.

All sash, trim, and doors were made on the site by local carpenters—while White camped on the homesite and drafted detail as the work progressed. The resultant feeling of intimacy between owner, workmen and architect is reflected instantly when one steps into the home.

"The home Bolton White designed," says Mrs. Young, "makes a fine place for me and my Steinway—and the guests it invites."

THE EXTERIOR

Of the Mrs. Anna Young home at historic Dutch Flat, is attractively landscaped to blend in with the surrounding area . . . yet the home retains a distinct individuality.

All Photography by Esther Born



SOME ENGINEERING PHASES OF CONSTRUCTION

(From Page 17)

involving continuity, the stress is usually not one-directional, and our usual ideas of the physical properties of the material therefore may no longer hold.

In the usual simple tension test the material may elongate considerably, after the yield point has been reached, before it finally fractures; it is then usually called a ductile material. The initial plastic yielding may then be termed an elastic failure. On the other hand, a material which breaks suddenly in the simple tension test, with little elongation or reduction in area is termed a brittle material. Actually, however, ductility or brittleness as exhibited by the type of fracture and the ability of the material to withstand permanent elongation without fracture depends not only on the physical nature of the material but on the **state** of stress as well.

The shear-strain energy theory of failure may be defined, without reference to strain energy, as:

"Plastic yielding in a ductile material will result when the octahedral shear stress reaches a certain limiting value."

I would like to quote from Hardy Cross, who has stated:

"The interpretation of stress analysis makes doubly necessary a clear idea of the action of the structural part up to the stage at which rupture is conceivable."

A great many brilliant engineers have, for years, been engaged in theoretical study of what takes place in the plastic range of stress. Only recently Dr. Bruce Johnston of Lehigh University, together with others of our Research Committee, headed by T. R. Higgins, Director of Engineering, AISC, have inaugurated physical tests as particularly relating to localized stresses in continuous structures, notably rigid frames, in which static loads have produced stresses beyond the elastic limit of the material. It is not possible at this time to give a complete report, but such a report will be given in the future.

We are particularly desirous of knowing what takes place within the plastic range of a rigid frame joint. A great many stress-strain tests and studies have been made, principally on members and joints progressively loaded so that local stresses will exceed the elastic limit of the material. Undoubtedly, upon the release of load, the yield point of the material, due to cold-working, has been raised. We do not yet know to what extent, nor what the effect of further loading will be. We are led to believe that certain rapidly applied types of loading, such as those resulting from seismic stress, will not, within ordinary ranges, endanger a joint.

The strain studies, obtained from electric strain gages such as the SR-4, reveal non-symmetrical patterns due to many factors, but the tests must be conducted further before quantitative results may be expressed. Suffice to say that we desire to know what takes place in a rigid-frame or similar type of joint, in the interest of economy, as well as in design technique.

The postwar rise in construction costs has introduced a real problem of foremost concern, not only to you, as individuals, but to the American public as a whole. What has been, in reality, a rapid inflation in the cost—or at least the price—of building during the past year or two has drawn a great deal of attention to "productivity"—in other words, the amount of work completed in a unit of time.

Some public statements have consisted of little more than condemnation of the building industry as a whole; some have broadly condemned labor. We must consider both sides of the question in attempting to make an analysis.

This we know: the investment type of structure which has for many years been the backbone of the building industry in this country is almost non-existent at this time. I speak of the office buildings, apartments, etc., which in the past years were built by individuals or groups as a means of securing a basic income from investment. Such investment building cannot return a fair profit—nor, for that matter, any appreciable profit—on material and labor costs such as now exist.

Just why is this so?

During the years of recovery from the depression, 1933 to 1939, productivity, or the amount of work done per unit of value, was slowly but steadily rising.

During the war period, 1940 to 1945, productivity in general dropped to a low level, largely due to the general adoption of the fee-contract system. Selective Service withdrew many of the younger men from the construction payroll; efficiency of those who remained inevitably dropped because of the higher-pay, less-work idea which obtained. The need for increased labor supply resulted in an influx of inexperienced workers. Wartime construction resulted in establishing many new records for speed, but seldom resulted in efficient production per dollar of cost. The underlying theory was much the same as we experienced, or advocated, in the Armed Services—"put enough men on it to get the job done **now**, regardless of cost."

From the end of the war to the spring of 1947 things were at their worst as concerned productivity. Essential building materials were lacking; black-market materials and black-market wages

introduced prohibitive costs. Contractors dared not make firm bids; architects and engineers dared not specify desired materials. Bricklayers who had laid 1,600 bricks per day in 1939 were now laying 300 to 400, yet with marked wage increases. Forms for concrete which had once cost 18 to 20 cents per contact foot were costing 60 to 70 cents. There is no need to go further; all materials and crafts appear in the picture.

I am happy to say, however, that beginning with the start of the general construction season in April of 1947 a rather marked improvement in productivity can be noted. Many problems of readjustment have not been made, but there is a healthy trend in the right direction.

The Bureau of Labor Statistics and the Department of Commerce prepare a joint estimate each month of the value of work performed in each principal type of construction. For all types of building construction the value of work performed in April, 1947, was \$603 millions. In September, 1947, the value rose to \$814 millions—an increase of 35%. Deflating these figures to 1939 building prices to provide a correction for price changes from Spring to Fall show an increase of 27½% in the actual physical work performed.

In view of this, it is significant that the increase in hours worked, and in total employment in the construction industry were much smaller. In the April-September period considered for private contract building construction, average hours per week rose less than 2½%; total employment increased from 1,685,000 to 1,900,000—a rise of 12¾%. Taken together these figures indicate an increase in man hours worked of 15½% in contrast with an increase of physical work performed of 27½%. These government figures indicate that productivity in the building construction industry is sharply on the increase, when it is realized that by using only 15½% more man hours of labor an increase in physical volume of 27½% resulted.

Conditions are, of course, by no means normal as yet. As materials needed for building come to the site when workers need them, as standards of performance and supervision are raised, as competition increases, and on all concerned begin to realize that "the honeymoon is over"—building productivity will go up further. Labor cannot do it all; management cannot do it all. Each realizes the necessity to joint responsibility and joint action, though cooperation.

In the structural steel fabricating industry the marked increase in labor rates, reflected in both rolling mill and fabricating shop costs, has perhaps had an adverse effect in the competitive markets, but not nearly so much as has been caused by the scarcity of the steel itself. We know that the present market could absorb many more hundreds of thousands of tons than can be furnished.

So often we hear complaints of steel shortages; our fabricators may even politely (?) gripe about the small amount of steel made available to them by the mills.

Now, as a matter of actual fact, the AISC issued a press release dated January 28, 1948, which states that shipments of fabricated structural steel for the year 1947 amounted to 1,915,144 tons, which is an increase of 23.4% over the 1,551,607 tons shipped in 1946. Further, it is 30.7% over the shipments in the average prewar years of 1936 to 1940 inclusive. So, when I meet with various groups of fabricators throughout the country, as I constantly do, and hear them generally say: "We simply can't get steel from the mills," it is refreshing to have them admit, during informal general discussions, that, while they could have turned out twice as much tonnage if the steel had been in their yards—well, "after all we did pretty well."

I personally believe the rolling mills deserve a great deal of credit for their handling of a situation which might very easily have been a great deal worse.

I am, of course, concerned about the very real shortage of shapes which holds up not only our building construction program, but our highway program as well. I cannot tell you that "deliveries can be made in 3 months—or 4—or 5." I believe that I can tell you that the situation is easing. I can point to specific jobs where fairly good deliveries were made.

It must be understood that the entire structural steel procurement picture has changed. Not so many years ago the rolling mills had what were called "Mill Stocks"; the steel warehouse supplies likewise were available. A fabricator could depend upon Mill Shipment in a matter of days—if a certain mill could not make the required delivery, some other mill could—and would. A few tons of special sections could always be secured from warehouse.

Surely you haven't forgotten what the Steel Industry did during War II. It not only furnished literally hundreds of millions of tons of material but, in doing so, depleted its own reserves. "Scrap," it may be said, is the lifeblood of steel; how can we collect "scrap," so necessary a material to feed into our furnaces, when it has been dissipated in countless millions of rounds of artillery fire over hundreds of miles of area? Think, also, of the hundreds of thousands of shipping lying on the ocean bottoms which are irreclaimable—the maimed and destroyed material of war.

It's not a pretty picture.

Too, it is not a problem which can be solved overnight because it involves the availability of basic materials, labor availability, labor costs, production efficiency, and inter- and intra-industry competitive conditions.

So, what the future holds is inevitably tied in with what has been done in the past.

Almost everywhere I go I am asked the inevitable question: "What do you think business conditions will be in 1948?"

My personal opinions, of course, could carry little weight. The joint estimate of the Departments of Commerce and Labor for total building in 1948 is \$15,200,000,000 as against \$12,665,000,000 in 1947. The Producers' Council figure is for \$14 billion in 1948; Engineering News-Record forecasts \$13½ billion with the prediction that "the gain in 1948 will not be in dollars alone; unlike 1947 there will be a rise in physical volume."

In 1947 the basic steel industry produced more than 84,000,000 tons—a tonnage greater than ever before made in a peacetime year. Walter S. Tower, President of American Iron and Steel Institute, states that steel production in 1948 should equal or exceed the output of 1947, assuming that existing and additional steel capacity can be operated without interruption from work stoppages or strikes, and without shortages of raw materials of the proper quality. The greatest possible deterrent to larger output may be insufficient quantities of good quality scrap.

Mr. Tower also states that the construction industry received approximately 3,368,000 tons more steel than in 1940; that figure constitutes 13.4% of the steel distributed in 1947, as against 10.8% in 1940.

Mr. Murray Shields, Vice-President and Economist of The Bank of the Manhattan Company, New York City, delivered an address on the subject "Some Guide Posts for Business Planning in 1948" at the Annual Convention of the AISC in November, 1947. His analysis was thorough and exhaustive, and I am only sorry that I cannot give it to you in complete form. I would, however, like to make these quotations from the paper which Mr. Shields so ably presented.

"Mortgage debt, installment debt, other obligations are all on the increase; they are at a new all-time high, but the general financial picture as one senses it from talking to bankers all over the country is that the financial stage is not set for a great financial debacle. It may be impossible to prevent a moderate recession, but the financial stage is not set for a great deflation, and we have never had a great depression in the United States without a paralyzing monetary and credit deflation.

"Now the second, and I think by far the most important, reason for assuming that if we have a depression it will be moderate, and that we will bounce up from it into a period of extremely good business is that we are in the midst of a technological revolution which will provide stimulation for

our economy for many years ahead. This is probably one of the most historically propitious moments in our economic history, for we are in the midst of a revolution in technology which has already provided vast new industries and gives promise that new investment in productive enterprise is going to be for a long while ahead a dynamic force making for economic expansion.

"It is not too much to say, I think, that we stand on the edge of one of the most glorious periods of man's struggle to increase his economic well-being, for the way has been cleared for a new adventure in conquering want and in raising the standard of living. The job has been done by the scientists in our laboratories. Let me sketch out for you, if I may, a history of what American industry has done.

"In the early '20's, American industry began to make substantial investments in scientific laboratories. The men who put tens of millions into scientific laboratories knew that you do not get anything at all out of it for five years. You are lucky if you get even one productive thing in ten years of research, and it is about fifteen years before that kind of activity, expensive as it is, begins to pay dividends. And unfortunately about the time that those great laboratories were ready to spew out new means of doing old things and new industries, the depression set in. The depression was so severe that industrialists could not justify investment in new capacity or take a chance in new things. At a time like that when business is not using present capacity to the full, it is virtually impossible to get authority for spending money on additional capacity.

"That depression went on year after year, it got worse and worse, and at one time the Federal Government actually refused deductibility for full amounts spent in scientific research. But did industry stop? No. In those years when industry was losing money, when it was penalized for this sort of thing, year by year it spent more dollars for the scientific research which was to play so heroic a part in the war. It was this research which made that war a sort of Buck Rogers episode, with new machines of all kinds, and new techniques to help us win it. It was because industry in the early '20's decided to do that kind of research, stuck doggedly to it during the '30's, that there was ready for use in the war, backed up in those scientific laboratories, a store-house of new things which were largely instrumental in our winning that war. Those things were produced primarily for peacetime application; they were put to use for the war, and now they are available, gentlemen, for an episode in our history of industrial development that is likely to make the In-

(See Page 35)



EDLA MUIR, Architect, A.I.A.

THE PLAN

The plan problem was to design one building to house two companies: the Swimming Pool company and the Maintenance company, with a common reception room and switchboard.

The separate shop building and the yard are devoted to the use of the Maintenance company.

As the plan is now, the west wing of the building, downstairs is for the use of the Maintenance company with access to the shop and the yard.

PADDOCK POOL BUILDING

LOS ANGELES, CALIFORNIA



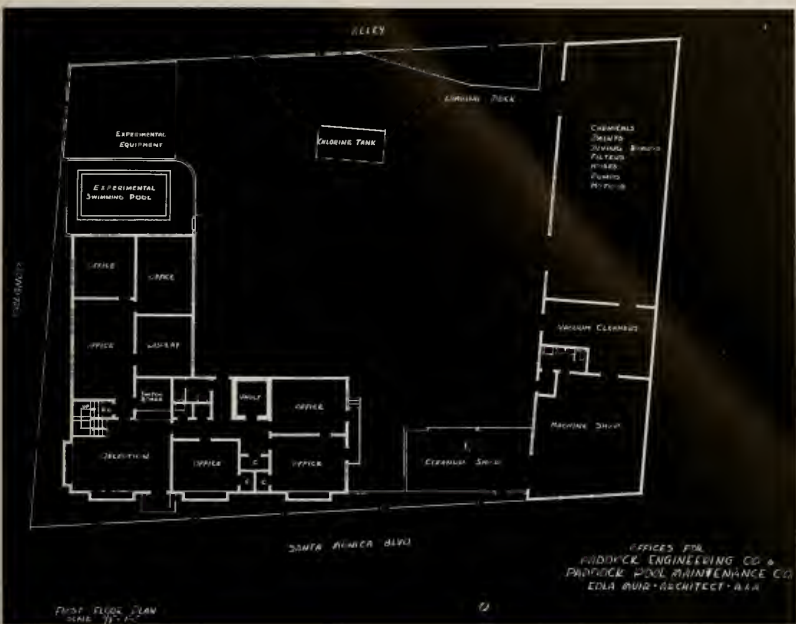

Upstairs, the open deck is for the use of all office employees, and will be furnished with garden furniture and planting.

One wall of the reception room is papered with blueprints of Paddock Pool drawings, pools, sections, equipment, and mechanical drawings—and

the dark blue wall contrasts well with a clear yellow ceiling.

The President's office is completely paneled in Ponderosa pine with a green carpet on the floor and dark brown leather furniture, as is the secretary's office adjacent.

The record vault is completely fireproof.

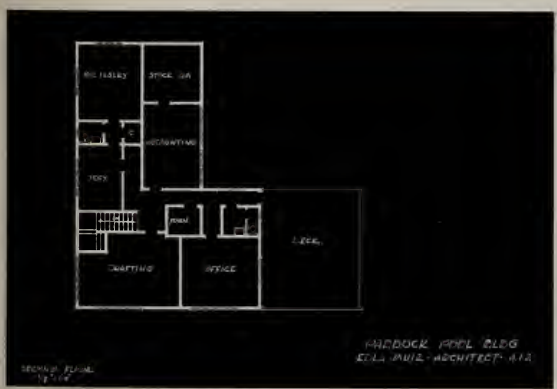

The spaces between the building and the sidewalk on both the Orlando Street and Santa Monica Blvd. sides is paved with various types of flagstone, colored cement and cast stone such as the Pool company uses for walks around swimming pools.

Outside of building is painted almost a black gray with pure white trim and white composition roof.



POOL AND BUILDING SAN MATEO

**WURSTER,
BERNARDI &
EMMONS,**

Architects



Paddock *Swimming Pool* **Services to Architects**

Standard pool plans.

Cost data.

Permanent exhibit of pool equipment, finishes, trims, accessories, and fittings.

Mechanical and structural specification service.

▶ **Swimming pool literature for clients on pools, filter plants, chlorinators, and pool accessories.**

New Paddock equipment catalog now in preparation. May we reserve a copy for you?

28 Years of INTEGRITY in Fine Pool Construction

Paddock Engineering Company

Southern California Office
8400 Santa Monica Blvd.,
Los Angeles 46 — HEMPstead 2315

Northern California Office
Seventh and Bay Shore Blvd.,
San Mateo — San Mateo 3-1889

Features of the combination office, display, fabricating shop and construction yard include:

- **Radiant Panel Heating:** Unique decorating and furnishings, including semi-circular desk with concealed switchboard surrounding receptionist; executive desks designed with maximum working space yet using a minimum of floor space. Office front of sliding glass panels opens to terrace around pool.
- **Full sized model of "People's Pool."** Display of paving materials copings, tile trims, and masonry. Filter exhibit featuring various types of pressure sand and diatomite filters; exhibit of chlorinators, pool heaters, pool fittings and accessories; photographic exhibit. Complete mechanical and structural specification service.



Arizona Chapter:
James Macmillan, President; Arthur T. Brown, Secretary,
740 N. Country Club Road, Tucson, Arizona.

Central Valley of California:
Herbert E. Goodpastor, President; Frank V. Mayo, Secretary,
307 Exchange Building, Stockton 2, California.

Colorado Chapter:
Raymond H. Ervin, President; James M. Hunter, Secretary,
2049 Broadway, Boulder, Colorado.

East Bay Chapter:
A. Lewis Kous, President; James H. Anderson, Vice-President;
Loy Chamberlain, Secretary; Chester H. Truchel,
Treasurer, Office, 3833 Piedmont Ave., Berkeley, California.

Montana Chapter:
Ralph H. Cushing, President; H. C. Cheever, Secretary,
Montana State College, Bozeman, Montana.

Northern California Chapter:
Hervey P. Clark, President; Lester Hurd, Vice-President;
Ralph Pollack, Secretary; William C. Ambrose, Treasurer,
605 Market Street, San Francisco.

Oregon Chapter:
Walter E. Church, President; Frank Roehr, Secretary;
Office 519 Builders Exchange Bldg., Portland 4, Oregon.

San Diego Chapter:
H. Louis Bodmer, President; Louis J. Gill, Secretary, 203
Granger Building, San Diego, California.

Santa Barbara Chapter (California):
Chester L. Carola, President; Robert I. Hoyt, Secretary,
116 E. Solá St., Santa Barbara, California.

CALIFORNIA COUNCIL OF ARCHITECTS
Vincent Palmer, President; Andrew Hass, Vice-President;
A. C. Martin, Jr., Secretary-Treasurer; 369 Pine
St., San Francisco 4.

Southern California Chapter:
Adrian Wilson, President; A. C. Martin, Jr., Vice President;
Walter L. Reichardt, Secretary; George E. Gable, Treasurer;
Chapter Headquarters, 3757 Wilshire Blvd., Los Angeles 5,
California.

Spokane Chapter (Washington):
Noel E. Thomson, President; Kenneth D. Stormont, Secretary,
Hutton Building, Spokane, Washington.

Utah Chapter:
George Cannon Young, President; Theodore R. Pope, Secretary,
29 South State Street, Salt Lake City 1, Utah.

Washington State Chapter:
Clifton J. Brady, President; Arrigo M. Young, Vice-President;
John Richards, 2nd Vice-President; Rait E. Dacker,
Sec.; Waldo B. Christenson, Treasurer, Office 1411 Fourth
Avenue Building, Seattle 1, Washington.

Hawaii Chapter:
Kenneth W. Roehrig, President; James Morrison, Secretary,
334 Federal Bldg., Honolulu 2, T. H.

**CALIFORNIA DIVISION
OF ARCHITECTURE**

The Division of Architecture, State of California, has opened an office in the California Building, 515 Van Ness Avenue, San Francisco.

WARREN WEBER, Architect, A.I.A., has opened offices for the practice of architecture in the Fenton Building, Portland, Oregon.

**THE PRODUCERS COUNCIL
NORTHERN CALIFORNIA CHAPTER**

Ernest Larson, President of the Chapter, reported on the "President's Conference" of the Producers Council which he recently attended in Chicago, and where many important phases of the Construction Industry were thoroughly discussed, at the regular February meeting in San Francisco.

Jos. A. Carlson was Program Chairman of the Meeting.

SUPERSONIC WIND TUNNEL building at McFlett Field will be extended under contract awarded to Carl N. Swenson Co., San Jose. Cost \$49,734.

**GENERAL ELECTRIC BUILDING
MOTOR PLANT AT SAN JOSE**

The general contract for construction of a new \$2,000,000 G-E motor plant in San Jose, California, has been awarded to Parker, Steffens & Pearce, San Francisco, contractors.

Plans call for construction and completion of the new plant by late summer.

E. K. WOOD LUMBER COMPANY is building a \$20,000 garage building at their Oakland, California, plant.

NEW OIL REFINERY. The Bechtel Corp'n of San Francisco, has been awarded a contract for the construction of a new oil refinery at Salt Lake City, Utah, for the Standard Oil Company at a cost of \$5,000,000.

FOR BETTER SERVICE
Remember that
KRAFTILE is
WESTERN HEADQUARTERS
FOR

- ▶ ACID Brick
- ▶ ACID-PROOF Joining Compounds
- ▶ ACID-PROOF Floor and Tank Construction
- ▶ ACID-PROOF Coatings
- ▶ GLAZED Structural Wall Units
- ▶ PATIO Tile
- ▶ QUARRY Tile
- ▶ SWIMMING POOL Overflow Gutter
- ▶ LIGHTWEIGHT CONCRETE BLOCKS

FOR COMPLETE INFORMATION AND PROMPT SERVICE, PHONE OR WRITE

KRAFTILE COMPANY
NILES, CALIFORNIA NILES 3611
SAN FRANCISCO 31: 50 Hawthorne St.—DOUGLAS 2-3780
LOS ANGELES 13: 406 South Main Street—MULLEN 7241

FOR COMPLETE INFORMATION AND PROMPT SERVICE, PHONE OR WRITE

KRAFTILE COMPANY
NILES, CALIFORNIA NILES 3611
SAN FRANCISCO 31: 50 Hawthorne St.—DOUGLAS 2-3780
LOS ANGELES 13: 406 South Main Street—MULLEN 7241

WITH THE ENGINEERS

Structural Engineers Association of Northern California

John A. Blume, President; Jesse Rosenwald, Vice President; Franklin P. Ulrich, Treas.; Geo. E. Solnar, Jr., Sec.; Wm. H. Popert, Consultant; Office, Room 719, 57 Post St., San Francisco 4. Phone SUtter 1-5474. DIRECTORS, A. W. Anderson, Henry J. Deegenkolb, John E. Rinne, Robert D. Dewell, and Wm. W. Moore.

San Francisco Section

L. A. Elsener, President; A. W. Earl and G. B. Woodruff, Vice-Presidents; John E. Rinne, Secretary-Treasurer; 225 Bush Street, San Francisco 20.

Structural Engineers Association of Southern California

Steve Barnes, President; Harry W. Eolin, Vice President; Lewis K. Osborn, Sec.-Treas. DIRECTORS, Richard W. Ware, Geo. E. Brandow, L. T. Evans, Harold P. King, and Donald F. Shugart. Office, 202 Architects Bldg., Los Angeles 13, Calif.

Puget Sound Engineering Council (Washington)

R. E. Kister, A. I. E. E., Chairman; E. R. McMillan, A. S. C. E., Vice Chairman; L. B. Cooper, A. S. M. E., Secretary; A. E. Nicholson, I. E. S., Treasurer; Offices, L. B. Cooper, c/o University of Washington, Seattle 5, Washington.

HEAR CHIEF ENGINEER AMERICAN INSTITUTE OF STEEL CONSTRUCTION

Col. Jack Singleton, chief engineer of the American Institute of Steel Construction, Inc., in New York City, on a nation-wide speaking tour addressed various engineering groups in the San Francisco-Oakland Bay area and Sacramento during his visit to California during February.

Singleton told a little of the history of steel and how this and the development of steel led to the



Col. Jack Singleton

founding of the American Institute of Steel Construction. This introductory part of the talk was of special value to engineers as it showed that considerable effort is constantly made to keep steel construction up to date and in step with the progress of other engineering fields. The major part of his talk covered the relationship of structural steel to the engineer and he

also told a few facts about this material as used on military bridges. Following his prepared talk, "Engineering Phases of Steel Construction", Singleton answered questions from the floor.

It was an opportunity for the engineers of California to learn more about the influence and economic position of the most important metal in our economy, from a man widely experienced in this field, Singleton being well qualified to talk about the military aspects of structural steel as he served as a captain in World War I and a colonel in World War II. In World War II he graduated from Command and General Staff School, served as Area Engineer in Kansas City, with Patton in the desert, and wound up as Colonel Corps. of Engineers, Chief, Bridge Branch, Office Chief of Engineers, Washington, D. C. In that capacity, directed bridge activities of the Engineer Board at Fort Bel-

voir, and the Bridge Test Station, Yuma, California, chiefly in the design and test of bridges used by our troops in the Rhine Crossings, in the Southwest Pacific, and India-Burma. For this work an entire plant was turned over to him. The bridges were assembled over one of the nearby rivers and complete tests made, including tests by bombing.

Singleton has evolved a new theory and method of design for continuous structures, and has achieved design and fabrication economies in structural steel. He is the author of "Manual of Structural Design," and "Manual of Moment Design," which are considered textbooks in the steel construction field.

AMERICAN SOCIETY OF CIVIL ENGINEERS SAN FRANCISCO SECTION

The Annual Joint Meeting of the members societies of the San Francisco Engineering Council was held the latter part of January at the Commerce High School Auditorium, San Francisco.

Raymond E. Davis, M ASCE, director of Engineering materials research and Professor of Civil Engineering at the University of California, Berkeley, spoke on "Observations on Europe by an Engineer."

Prof. Davis recently returned from a tour of the countries of Western Europe where he was consultant on dams for projected hydroelectric developments in Switzerland. His discussion included conditions in France, Switzerland, Belgium, Holland, Spain and Portugal.

AMERICAN SOCIETY FOR METALS PUGET SOUND CHAPTER—SEATTLE

Stainless steel in the form of castings was the subject for a talk presented to members of the Puget Sound Chapter by Mr. W. B. Kirby of the Electric Steel Foundry of Portland, Oregon. Mr. Kirby discussed the effect of different alloying elements and heat treatment on the corrosion resistance of castings; the technique of casting corrosion resistant alloys; the problems of design and the

necessity of breaking down complicated castings into components.

The importance of chromium in developing a thin adherent oxide film on stainless steels was emphasized. The steels discussed were the straight chromium steels, both martensitic and ferritic, and the austenitic steels. Nickel in the 18-8 type stainless steel acts as a producer and stabilizer of austenite. Carbon tends to reduce the corrosion resistance and every effort is made to keep it to a minimum. Moly is added to the austenitic steels to increase their resistance to sulphide.

Mr. Kirby stated that in order to obtain maximum corrosion resistance the chromium and other elements should be in solution. In the austenitic steel intergranular corrosion results when the material is not properly annealed or when heated in the sensitization range of approximately 800°F. to 1600°F. Austenitic steels susceptible to intergranular corrosion have chromium carbides precipitated in the grain boundaries. Proper heat treatment consists of quenching the castings from approximately 1000°F. into water. This results in dissolving the chromium carbides and retaining them in solution.

The speaker pointed out that chromium is the catalyst in the foundry process. The charge must be melted under a non-oxidizing slag so as to keep the chromium in the bath. The necessary additional chromium is added at the end of the heat because of its strong tendency to oxidize. The carbon electrode of the furnace must not touch the bath or else carbon pick up in the melt may result. The bath is heated to approximately 3200°F., but poured at 2900°F. The pouring temperature is the control for the grain size of the austenitic castings.

Mr. Kirby ended his talk by emphasizing the importance of discussing the design with the foundry and thus arriving at a satisfactory solution for both parties involved.

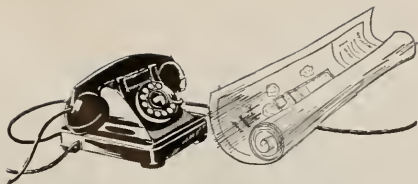

*Put telephone facilities
in your plans*



... for convenience later on

Wise builders know that built-in telephone conduit and outlets add much to the future comfort and convenience of their clients—cost only a trifle if put in during construction.

Just a few pieces of pipe or other tubing leading to outlet positions will provide raceways for telephone wires. Telephones can thus be moved or added in the future without drilling holes or running wire along baseboards.

This is just another of the small details that all add up to satisfied clients.

For free help in planning modern, built-in telephone wiring, call your local telephone company number and ask for "Architects and Builders Service."

**The Pacific Telephone
and Telegraph Company**



STRUCTURAL ENGINEERS ASSOCIATION OF NORTHERN CALIFORNIA

Herman Hennessey, sales engineer of the Aluminum Company of America, assisted by E. B. Burton of the same company, spoke before members of the Association at their February meeting on the subject, "Structural Applications of Aluminum."

Applicants for registration as Chemical Engineer, Electrical Engineer, Mechanical Engineer, or Petroleum Engineer under the California Civil Engineer's Act, will be required to take a written examination after June 30, 1948. Pecos H. Calahan, executive secretary of the Board of Registration points out that applicants may have to wait six or seven months before the Board can pass upon the written examinations.

Directors have sent letters of protest to steel com-

FOR
Distinctive Design
IN
ELECTRIC
WATER
COOLERS
SPECIFY
HAWS ...



Model HT-10
 Beautifully-Styled Electric
 Water Coolers

HAWS Electric Water Coolers are styled to enhance the interiors of today's and tomorrow's buildings. For office or lobby, for store or public buildings, HAWS Electric Water Coolers serve refreshing drinking water with complete sanitation...efficiently, dependably and economically... for the finest in Electric Water Coolers always specify HAWS... with the added convenience of HAWS Sanitary Drinking Fountains...



Model 7-A
 Vitreous china wall drinking fountain, with bubbler protecting bowl.

**FOR REMOTE
 INSTALLATION**

HAWS Electric Water Coolers give double-duty when installed with one or more HAWS Drinking Fountains connected to serve adjacent rooms. Large capacity cooling units provide ample supply of cooled water.

Write today for complete information on

HAWS ELECTRIC WATER COOLERS
 SANITARY DRINKING FOUNTAINS

HAWS DRINKING FAUCET CO.
 FOURTH and PAGE STREETS (Since 1909) BERKELEY 2, CALIFORNIA
 Agents and Sales Representatives in All Principal Cities

panies relative to current shortages of $\frac{3}{8}$ " and $\frac{1}{2}$ " reinforcing bars. These sizes are in great demand and essential to good construction.

**AMERICAN SOCIETY
 OF CIVIL ENGINEERS**

Richard E. Dougherty, vice-president, New York Central System, has been elected President of the American Society of Civil Engineers for 1948.

New vice presidents elected include Col. Carlitor S. Proctor, New York; and John W. Cunningham, Portland, Oregon. New Directors are Wm. McK. Griffin and Edmund A. Prentiss of New York; Joe D. Justin, Philadelphia; Julian Hinds, Los Angeles. Col. Webster L. Benham, Oklahoma City, and C. Glenn Cappel, New Orleans.

At the 95th Annual Meeting of the Society, recently held in New York, awards for the past year were presented to:

Dr. Boris A. Bakhmeteff, Professor of Civil Engineering, Columbia University, and Dean of Civil Engineering William Allan, School of Technology, College of the City of New York, the Norm Medal, for their paper, "The Mechanism of Energy Loss in Fluid Friction."

Thomas R. Camp, Boston consulting engineer the J. James R. Croes Medal for a paper, "Sedimentation and the Design of Settling Tanks."

R. F. Blanks and H. S. Meissner, of the U. S. Bureau of Reclamation office in Denver, the Thomas Fitch Rowland Prize for their paper, "Termination of Concrete Dams Due to Alkali-Aggregate Reaction."

Ross M. Riegel, head civil engineer, design department, Tennessee Valley Authority, Knoxville the James Paulie Prize for his paper, "Structural Features of Hydraulic Structures."

F. L. Ehasz, structural design engineer, Sanderson and Porter, New York City, the Collingwood Prize for Juniors for his paper, "Structural Steel Plants."

A. L. Genter, Baltimore consulting engineer, Rudolph Hering Medal for his paper, "Computational Coagulant Requirements in Sludge Conditioning."

Maurice L. Albertson, Associate Professor, Civil Engineering Department, Colorado A & M College, Fort Collins, Colorado, the J. C. Stevens Award for his discussion of a paper, "Evaporation from Free Water Surface."

A. A. Kalinske, engineer with Infilco, Inc., Chicago, the Karl Emil Hilgard Prize for his paper, "Conversion of Kinetic to Potential Energy in Pipe Expansions."

W. HEATH TALMADGE, ASME, has been appointed general manager of the Economy Steel Company of Los Angeles.

HOME ENGINEERING PHASES OF CONSTRUCTION

(From Page 27)

Industrial Revolution in England look puny in comparison. The reason is an obvious one. The Industrial Revolution took about fifty years. All the research was done in sheds back of the kitchen by some lone-wolf inventors. They just happened to new inventions, and if one invention could be made useful in industry until another one came along, somebody had to happen onto that one too. Years—and sometimes decades—elapsed between the major inventions.

Contrast that with the situation today. The need for something new causes our great research laboratories to organize their resources and skills so that we get what we need in an incredibly short period.

Our scientists have been developing new things and new processes in such volume that it is impossible to remake the United States, and in an incredibly short period of time. We are destined to escape into a decade, or a generation, at most, more technological development than we could have had in the old days in a hundred years of unorganized research.

Remember that in the twenties when we had full employment, new investment was running at nine billion dollars a year, while in the thirties, when we had eight million unemployed, new investment was running at less than a billion dollars per year. Therefore, the meaning of the technological revolution over the long years ahead is that we need heavy investment in new facilities, and that means prosperity.

A period of rapid technological progress means that that industry has been given the means for bringing consumer goods back into our markets. Automobiles, housing, and many other products will have been priced out of their markets. That is a real risk, but modern technology offers a means for reducing costs materially.

This is one of the most powerful forces making for good business in the long run—a powerful chain reaction of progress. It is from technological improvement to lower costs, from lower costs to wider markets, from wider markets to mass production, from mass production to still lower costs, and from lower costs to still wider markets. That is the process on which American economic progress has been based, and the fact of our technological revolution assures us that we are on the edge of a new period of economic advance.

Now, the point I want to make here is that while we may get a slump, it is surely not going to be a devastating depression, and it will be no

THIS CERTIFICATE

is evidence of electrical adequacy.



The Adequate Wiring program, in operation in Northern California, includes the presentation of this impressive certificate to the owner of each qualifying home.

It is tangible evidence of electrical adequacy, assuring your client that nothing has been overlooked in the wiring plans, and providing added value for loan or re-sale purposes . . . all factors which contribute toward the owner's satisfaction with the home you have designed.

The Adequate Wiring program offers you, without charge or obligation . . . a complete wiring layout service, to aid you in furnishing your clients with electrical plans and specifications. For detailed information, consult your local utility office or this Bureau.

**NORTHERN CALIFORNIA ELECTRICAL
BUREAU**

1355 Market Street, San Francisco 3



E. K. WOOD LUMBER CO.

SAN FRANCISCO General Offices: No 1 Drumm Street
LOS ANGELES Office and Yards: 4710 S. Alameda St — JE 3111
OAKLAND Yards and Wharves: 2111 Frederick St — KE 24277
OAKLAND Mill Sales Office: 827 Terminal Sales Bldg.

SAW MILLS: Roseburg, Oregon • Reedsport, Oregon
RETAIL YARDS: LOS ANGELES • OAKLAND • ONTARIO • HOLLYWOOD
 LONG BEACH • RIVERSIDE • TEMPLE CITY • SIERRA MADRE • INDIANO THERMAL
 LA VERNE • WHITTIER • PASADENA • SAN PEDRO

CZC

PRESSURE TREATED LUMBER
 • **PROTECTS AGAINST DECAY**
AND TERMITE ATTACK

Specify it in your home
Available through Lumber Dealers

LOS ANGELES 601 W. 5th Street Phone Michigan 6294	SAN FRANCISCO 333 Montgomery Street Phone DOuglas 2-3883
--	---

J. H. Baxter & Co.

AGENTS FOR WEST COAST WOOD PRESERVING CO. SEATTLE, WASH.

time to go out of business. It will be no time to burn the blueprints for expanding markets and production; it will be no time to throw out the research organization, to fire the essential staff. It will be, in fact, a great opportunity to prepare a plan for expansion, to let some contracts for new capacity and for improvement of present capacity, for intensifying sales and development activities, for expanding research, for putting good men on the staff so they can be trained in time to produce some real business when the business tide turns. The time for caution is now, not after business falls off.

"Now, may I close with a prediction? We may face some troubles ahead; it would be surprising if we did not, but we do not face another soul-searing decade of deflation. The stage isn't set for it. On the other hand, once our prices and costs are readjusted and the maladjustments cleared out of our economic system, we face a period of great opportunity—opportunity to build a business and to make profitable investments. It may well be one of the two or three opportunities which an individual or a business is given in a lifetime, to make some really productive investments."

We cannot disregard the fact that American Industry won War II. The German armies simply could not realize the degree to which are armies were mechanized and equipped. Coming back into the service after War I, I was equally non-plussed. In War I, a Captain of Combat Engineers, I had actually used Civil War Pontoon Bridges in France in 1918. In War II, as Chief of the Bridge Branch, OCE, I realized what strides had been made in my own particular sphere—bridges. Those bridges were available because Industry fabricated them, to carry loads undreamed of in 1917, in adequate quantity.

In Peace or War, the work of the American Institute of Steel Construction, in developing its "Standard Specification for the Design, Fabrication and Erection of Structural Steel for Buildings," has two primary objectives, as expressed in the following:

1. To provide the designing engineer and build in official with sound recommendations governing the use of structural steel in building construction—these recommendations to reflect to the fullest all knowledge derived from extensive experimental and analytical research, and to represent the consensus opinion of outstanding consulting engineers
2. To strive for a uniform adoption of these recommendations to the end that design practice may be standardized on a national scale, an promoting a common basis for the widest possible exchange of experience among practicing engineers in problems of design.

IN THE NEWS

SCHOOL BONDS VOTED

Bonds for the construction of new grammar school buildings in Redwood City and Menlo Park, California, have been approved by the voters. Menlo Park will spend \$10,000 for a new building while Redwood City will spend \$508,000 for new buildings and additions to present buildings.

TELEPHONE ADDITION. Swinson & Walberg, Contractors, San Francisco, have been awarded a contract for construction of an addition to the telephone exchange building in Sacramento. Estimated cost \$1,750,000.

ARCHITECT SELECTED. H. J. McGerty, Architect, Los Angeles, has been selected by the Visalia Union High School District to prepare plans for the construction of a new \$1,250,000 High School building in Visalia, California.

PLYWOOD PLANT. Work has started on the construction of a new plywood plant near Anderson, California. Cost is estimated at \$250,000.

HARDWARE STORE BUILDING. Cecil S. Moyer, Architect, Oakland, announces contract for \$100,000 has been awarded to Geo. Peterka & Son, for construction of a new hardware store building in San Leandro, California.

SCHOOL BOND ELECTION. Voters of Stockton, California, will go to the polls on March 9 to vote on approval of a \$5,250,000 bond issue for school improvements.

ARCHITECTS Leo J. Sharps and Irving F. Brown, Burlingame, California, have announced awarding a contract to Wm. F. Lee, Contractor, San Francisco, for the construction of a \$45,000 home in Hillsborough, California.

SCHOOL BONDS VOTED. \$125,000 for a 6-classroom Grammar School addition to the Union Elementary School District, Campbell, Santa Clara County, California.

DRUG STORE REMODEL. L. J. Ann Co., Contractors, San Francisco, have been awarded a \$40,000 contract for remodel of the Owl Drug Store in Oakland, California.

WESTERN MADE



Quality LIGHTING FIXTURES

The West supports one of America's leading manufacturers of lighting equipment... producing quality fixtures bearing a nationally known label. With production concentrated on the Pacific Coast, Smoot-Holman Co. assures western users a dependable source of supply for all types of commercial and industrial incandescent and fluorescent lighting.

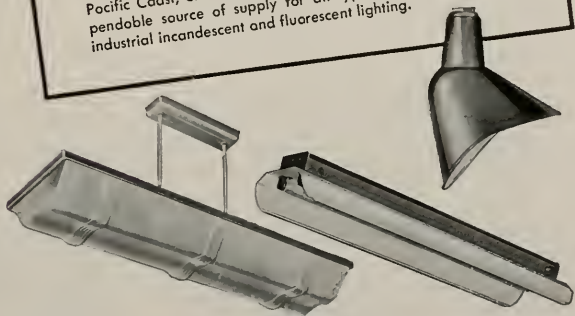

LOOK FOR THIS LABEL FOR THE FINEST IN
INCANDESCENT AND FLUORESCENT LIGHTING

LANDSCAPE ARCHITECTURE

Notes of The Profession

ASSOCIATION OF LANDSCAPE ARCHITECTS, SAN FRANCISCO REGION

Vernon Dean, President; Robert Royston, Vice-President; Ned Rucker, Treasurer;
E. L. Anderson, Secretary, 1736 Franklin, Oakland, California.

ARTHUR COBBLEDICK just completed a landscape setting for KGO's new 50,000 watt transmitter station near Dumbarton Bridge, San Mateo county. Unusual planting problems were encountered with the huge basins of concentrated salt water surrounding the new structure. Wind and saline tolerant shrubs in large sizes were planted in elevated boxes.

THE DIVISION OF LANDSCAPE DESIGN at the University of California has changed the method of judging student work. Members of the teaching staff plus either a practicing Architect, Engineer, or Landscape Architect from the Bay Area comprise a jury. Each student meets with this jury and presents his individual solution to the problem being judged, in the same manner that a professional designer presents his ideas to a client.

Long before the design is completed, each student has had the criticism of all members of the teaching staff. This coordinated method of criticism eliminates the tendency for a student to evolve a solution which is geared to a specific taste or style, and results in a more comprehensive understanding of the problem.

PROF. LELAND VAUGHAN, Division of Landscape Design, University of California, Berkeley, while on a recent trip east, conferred with Professor C. R. Sutton, Chairman of the Department of Landscape Architecture, Ohio State University, on the curricula offered in Landscape Architecture in various universities.

ALLAN H. REID, Landscape Architect, has been appointed by the Palo Alto Chamber of Commerce to act as liaison representative between the Chamber and the Palo Alto City Planning Commission. The appointment was at the request of the Planning Commission which is facing a crucial year due to rapid population growth in the area.

Mr. Reid is chairman of the Area Beautification Committee of the Chamber, which also comprises Architects Leslie Nichols and Morgan Stedman. This committee has made many recommendations for city improvement to the Chamber's Board of

Directors, all of which have been approved and are being worked out.

Among the recommendations is an ordinance which would establish a Street Tree Commission and designate its duties and purposes. City officials, the Palo Alto Garden Club, and other groups are being contacted to secure support for passage of the ordinance.

THE CALIFORNIA HORTICULTURAL COUNCIL, comprising seven member associations representing Landscape Architects, contractors, arborist's nurserymen, and professional gardener associations held its annual meeting early in December under the chairmanship of Ernest Higgins, at the San Francisco Junior College.

Officers elected for the new year included: Ray D. Hartman, President Leslie C. Mayne, 1st Vice President D. C. Schroder, 2nd Vice President Douglas Baylis, A.I.A., Treasurer; and Harry E. Nelson, Secretary.

Landscape Architects present at the meeting included Bernard Wiseltier and Allan Reid, the latter in conjunction with Harry Nelson of the San Francisco Junior College Horticultural department contributed to the occasion.

EXPANSION OF CENTRAL VALLEY PROJECT IS PROPOSED

Hearings will be held in Washington, D. C., in the immediate future, on legislation designed to expand the Central Valley Project (California) to include in the proposed American River development program.

As presented to Congress by President Harry Truman, the plan calls for immediate construction of a Folsom power plant, necessary transmission lines and canals and irrigation facilities which would be integrated into the presently authorized Central Valley Project.

Simultaneously, the President requested an initial construction appropriation of \$3,370,000 to the Army Corps of Engineers for the Folsom Dam which would develop a 1,000,000 acre-foot reservoir, a project already approved by the State of California, the Army and the Bureau of Reclamation.

SURVEY OF VENTILATION REQUIREMENTS IN CODES

An analysis of the various state industrial ventilation codes shows that legal requirements in regard to factory ventilation vary sharply from state to state, eleven states having no codes at all, and that a majority of states have codes which are inadequate or impractical. The analysis was made by Knowlton J. Caplan and Allen D. Brandt and presented in a paper before the 54th annual meeting of the American Society of Heating and Ventilating Engineers, held in New York February 1-5. Mr. Caplan is ventilation engineer, Michigan Department of Health, while Mr. Brandt is industrial hygiene engineer of Bethlehem Steel Co.

In their paper, titled "State Laws Concerning Industrial Exhaust Ventilation," the authors included a four page table summarizing the situation state-by-state.

The authors show that 25 states have only very general requirements concerning the health conditions in industry, and that only six states have what may be regarded as a reasonably complete code or set of standards covering a number of typical operations or exhaust hood types. Of these states having rather complete codes two of them contain the design requirement that the area of the main should be equal to the combined area of the

HEATFORM

The Superior Heat Circulating Fireplace

THE MOST EFFICIENT AND DURABLE

PRODUCES MORE HEAT because the air contacts the heating surface of the firebox and the upper throat. Super-heating round air passages connect both upper and lower heating chambers. This extra heating surface through and around the throat is the most valuable of all because it is directly above the fire.

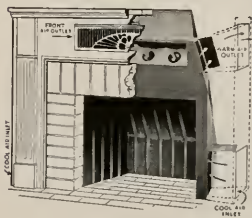

Front view of HEATFORM installed, with part of masonry cutaway.

GIVES MORE YEARS OF SERVICE

because of the die-pressed ribbed construction of the firebox. Large air inlet and outlet capacity allows for greater flow of air over the hot metal, thus preventing deteriorating temperatures. Masonry downdraft shelf; no exposed metal parts beneath the chimney to rust out.

For complete information see Sweet's Catalog or write
SUPERIOR FIREPLACE COMPANY
 EAST OF MISSISSIPPI RIVER • WEST OF MISSISSIPPI RIVER
 601-M NORTH POINT ROAD 1707-C EAST 15TH STREET
 BALTIMORE, MARYLAND LOS ANGELES 21, CALIF.



They're the fountains to specify... for 48

YEAR after year Halsey Taylor Drinking Fountains are the preferred specification of architects and school authorities who know and appreciate their unique advantages.

Modern in design, their distinctive features spell convenience and sanitation, and they are available in a wide variety of types. Write for latest literature.

The Halsey W. Taylor Co., Warren, O.
 WEST COAST PLANT, REDLANDS, CALIF.

HALSEY TAYLOR

Drinking Fountains

STRUCTURAL STEEL

For Class A Buildings,
Bridges, etc.

JUDSON PACIFIC - MURPHY CORP.

4300 EASTSHORE HIGHWAY
EMERYVILLE, CALIF.

FORDERER CORNICE WORKS

Manufacturers of

Hollow Metal Products • Interior Metal Trim
Elevator Fronts and Cabs
Metal Plaster Accessories • Sanitary Metal Base
Flat and Roll Metal Screens
Metal Cabinets • Commercial Refrigerators

269 POTRERO AVE.

SAN FRANCISCO, CALIF. HEMLOCK 4100

VALUABLE NEWS SERVICE

- BUILDING MATERIAL DEALERS
- CONTRACTORS
- ENGINEERS
- FINANCIAL INSTITUTIONS

ARCHITECTS REPORTS gives advance news on construction projects in Northern California, lists: name of projects, location, architect, proposed cost and other pertinent information.

HANDY individual slip-reports, issued daily at a total cost of only

\$10 a month

ARCHITECT'S REPORTS

Published Daily

The ARCHITECT and ENGINEER, Inc.

68 Post Street, San Francisco - DO 8311

branches plus 20 per cent. This criterion is recognized as being poor and inadequate for many types of systems.

With respect to particular operations, grinding and bulling were the most thoroughly covered, being mentioned by 12 states, five of which use the codes of the American Standards Association or closely similar data, and seven of which use standards other than ASA codes. Some of the non-ASA standards are far from practical. Spray coating and mine and tunnel ventilation were next in order of popularity, being covered by seven and six states respectively. There was little agreement in the requirements for these operations. The remainder of typical industrial operations was scattered throughout the legislation, more than 25 operations being covered in a sporadic manner.

After concluding their analysis, the authors recommended that specific and quantitative design criteria should not be included in legislation. Rather, such data, standards and recommendations should be incorporated in regulations or in advisory standards accompanying regulations in order that greater flexibility may be obtained. Furthermore, some means should be provided for the approval of control measures in those few instances in which the health hazard is adequately controlled, even though the control measures do not meet the standards and were provided under circumstances which do not fit the typical conditions upon which the standards were based.

NEW PORTABLE VILLAGE AT LOS ALAMOS

A complete village of 100 Goodyear "Wingfoot" portable two-bedroom homes is being shipped by truck from the Company's subsidiary at Litchfield Park, Arizona, to the U. S. Atomic Energy Commission installation at Los Alamos, New Mexico.

Carroll L. Tyler, manager of the Atomic Energy activities at Los Alamos, is in charge of the erection of the homes which will be used to house civilian workers and their families at the Atomic research center.

ANTIOCH MEDICAL BUILDING. Eldridge Spencer & Wm. C. Ambrose, Architects, San Francisco, have announced a new medical center building for Antioch, California. C. Norman Peterson, Berkeley, is the contractor.

PAROCHIAL SCHOOL at Modesto, H. A. Mint & Wilton Smith, Architects, San Francisco, have announced the awarding of a contract to the Pacific Coast Builders, San Francisco, for the construction of the St. Stanislaus Parochial School at Convent at Modesto, California. Cost of the project is \$437,950.

ESTIMATOR'S GUIDE

BUILDING AND CONSTRUCTION MATERIALS

PRICES GIVEN ARE FIGURING PRICES AND ARE MADE UP FROM AVERAGE QUOTATIONS FURNISHED BY MATERIAL HOUSES TO SAN FRANCISCO CONTRACTORS. 2½% SALES TAX ON ALL MATERIALS BUT NOT LABOR

All prices and wages quoted are for San Francisco and the Bay District. There may be slight fluctuation of prices in the interior and southern part of the state. Freight charge, at least, must be added in figuring country work.

BRICKS—Performance—\$10 per 1000 of contract. Labor and materials, \$10 per 1000 of contract.

BRICKWORK—
Common Brick—Per 1M laid—\$100.00 to \$120.00 (according to class of work).

Face Brick—Per 1M laid—\$215 to \$250 (according to class of work).

Brick Steps—\$3.50 per lin. ft.
Brick Veneer on Frame Bldg.—Approx. \$2.25 per sq. ft.

Common Brick—\$28.50 per M, truckload lots, f.o.b. job.

Face Brick—\$75 to \$90 per M, truckload lots, delivered.

Cartage—Approx. \$9.00 per M.

BUILDING PAPER—
1 ply per 1000 ft. roll.....\$5.30
2 ply per 1000 ft. roll.....7.80
3 ply per 1000 ft. roll.....9.70
Brownskin, Standard, 500 ft. roll.....8.00

BUILDING HARDWARE—
Sash cord com. No. 7.....\$2.65 per 100 ft.
Sash cord com. No. 8.....3.00 per 100 ft.
Sash cord spot No. 7.....3.65 per 100 ft.
Sash cord spot No. 8.....4.00 per 100 ft.
Sash weights, cast iron, 100.00 ton.
Nails, \$5.50 base.

CONCRETE AGGREGATES—
The following prices net to Contractors unless otherwise shown. Carload lots only.

	Bunker per ton	Del'd per ton
Gravel, all sizes	\$2.44	\$2.75
Top Sand	2.38	3.13
Concrete Mix	2.38	3.06
Crushed Rock, ¼" to ¾"	2.38	2.94

	Bunker per ton	Del'd per ton
Crushed Rock, ¼" to 1½"	\$2.38	\$3.13
Roofing Gravel	2.81	3.50
River Sand	2.50	3.06

Sand—

Lepis (Nos. 2 & 4)	3.56	3.94
Olympic (Nos. 1 & 2)	3.56	3.88

Cement—
Common (all brands, paper sacks), carload lots, \$3.02 per bbl. f.o.b. car; delivered \$3.60.
Cash discount on carload lots, 10c a bbl, 10th prox., less than carload lots \$4.00 per bbl. f.o.b. warehouse or delivered.
Cash discount 2% on L.C.L.

Trinity White	1 to 100 sacks, \$3.13 sack warehouse or del.; \$9.56 bbl. carload lots.
Medusa White	

DAMP-PROOFING and Waterproofing—

Two-coat work, \$8.00 per square.
Membrane waterproofing—4 layers of saturated felt, \$9.00 per square.
Hot coating work, \$5.00 per square.
Medusa Waterproofing, \$3.50 per lb. San Francisco Warehouse.
Tricocel waterproofing.
(See representative.)

ELECTRIC WIRING—\$15 to \$20 per outlet for conduit work (including switches).

Knob and tube average \$6.00 per outlet. (Available only for priority work.)

ELEVATORS—

Prices vary according to capacity, speed and type. Consult elevator companies. Average cost of installing a slow speed automatic passenger elevator in small four story apartment building, including entrance doors, about \$8000.00.

EXCAVATION—

Sand, \$1.00; clay or shale, \$1.50 per yard. Trucks, \$30 to \$45 per day.

Above figures are an average without water. Steam shovel work in large quantities, less; hard material, such as rock, will run considerably more.

FIRE ESCAPES—

Ten-foot galvanized iron balcony, with stairs, \$250 installed on new buildings; \$300 on old buildings.

FLOORS—

Composition Floors, such as Magnesite, 50c per square foot.

Linofloor—2 gages—\$3.00 per sq. yd.

Minopave—\$1.50 per sq. yd.

Battleship Linoleum—available to Army and Navy only—½" —\$3.50 sq. yd.
⅜" —\$3.50 sq. yd.

Terazzo Floors—\$1.50 per sq. ft.

Terazzo Steps—\$2.50 per lin. ft.

Mastic Wear Coat—according to type—20c to 35c.

Hardwood Flooring—

Standard Mill grades not available.
Victory Oak—T & G
¾" x 2¼" —\$252.00 per M. plus Cartage
½" x 2" —\$210.00
½" x 1½" —200.00

Prefinished Standard & Better Oak Flooring
¾" x 3¼" —\$265.00 per M. plus Cartage
½" x 2½" —237.00 per M. plus Cartage

Maple Flooring
¾" T & G Clear \$330.00 per M. plus Ctg.
2nd 305.00 per M. plus Ctg.
3rd 255.00 per M. plus Ctg.
Floor Layers' Wage, \$2.12½ per hr. (Legal as of July 1, 1947. Given us by Inleid Floor Co.)

GLASS—

Single Strength Window Glass.....\$.40 per □ ft.
Double Strength Window Glass......60 per □ ft.
Plate Glass, under 75 sq. ft.....1.50 per □ ft.
Polished Wire Plate Glass.....2.25 per □ ft.
Rgh. Wire Glass......60 per □ ft.
Obscure Glass......40 per □ ft.
Glazing of above is additional.
Glass Blocks.....\$2.75 per □ ft. set in place

HEATING—

Average, \$2.50 to \$3.00 per sq. ft. of radiation, according to conditions.
Warm air (gravity) average \$64 per register.
Forced air average \$91 per register.

INSULATION AND WALLBOARD—

Rockwool Insulation— [2"] \$65.00 per M sq. ft.
Cotton Insulation—Full-thickness (3½") \$95.50 per M sq. ft.
Aluminum Insulation—Foil-mounted on both sides \$33.50 per M sq. ft.
Tileboard—4'x8' panel \$9.00 per panel
Wallboard—½" thickness \$55.00 per M sq. ft.
Finished Plank \$49.00 per M sq. ft.
Ceiling Tileboard \$49.00 per M sq. ft.

IRON—Cost of ornamental iron, cast iron, etc., depends on designs.

LUMBER—

No. 1 Common \$90.00 per M
No. 2 Common 88.00 per M
Select O. P. Common 94.00 per M

Flooring—	Per M Deliv.
V.G., D.F. 8 & 8tr. 1 x 4 T & G Flooring	\$170.00
"C" and better—all	170.00
"D" and better—all	170.00
Rwd. Rustic—"A" grade, medium dry	150.00
8 to 24 ft.	
"B" grade, medium dry	150.00
Plywood	15c to 18c per ft.
Physord 9/c per ft.
Plywall 9c per ft.
Plyform 15c per ft.

Shingles (Rwd. not available)—
Red Cedar No. 1—\$13.00 per square; No. 2, \$10.50; No. 3, \$9.00.
Average cost to lay shingles, \$6.00 per square.
Cedar Shakes—Tapered: ½" to ¾" x 25"—\$17.00 per square.
Resawn: ¾" to 1¼" x 25"—\$22.00 per square
Average cost to lay shakes, 8.00 per square

MILLWORK—Standard.

D. F. \$150 per 1000. R. W. Rustic \$175 per 1000 [delivered].
Double hung box window frames, average with trim, \$12.50 and up, each.
Complete door unit, \$15 to 25.
Screen doors, \$6.00 to \$8.00 each.
Patent screen windows, \$1.25 a sq. ft.
Cases for kitchen pantries seven ft. high, per lineal ft., \$12.00 each.
Dining room cases, \$15.00 per lineal foot.
Rough and finish about \$1.00 per sq. ft.
Labor—Rough carpentry, warehouse heavy framing (average), \$65.00 per M.
For smaller work average, \$75.00 to \$85.00 per 1000.

MARBLE—(See Dealers)

PAINTING—

Two-coat work per yard 75c
Three-coat work per yard 1.00
Cold water painting per yard 25c
Whitewashing per yard 15c
Turpentine.....	\$1.85 per gal. in 5-gal. cont.
Raw Linseed Oil.....	\$3.33 per gal. in 5-gal. cont.

Boiled Linseed Oil.....	\$3.23 per gal. in drums.
Boiled Linseed Oil—\$3.33 per gal. in 5-gal. containers.	
Replacement Oil—\$2.75 per gal. in drums.	
\$2.75 per gal. in 5-gal. containers.	
Use Replacement Oil.....	\$3.00 per gal. in 1 gal. cont.
A deposit of \$7.50 required on all drums.	

PATENT CHIMNEYS—

6-inch \$2.00 lineal foot
8-inch 2.50 lineal foot
10-inch 3.50 lineal foot
12-inch 4.50 lineal foot

PLASTER—

Neat wall, per ton delivered in S. F. in paper bags, \$17.60.

PLASTERING (Interior)—

3 Coats, metal lath and plaster Yard \$3.00
Keene cement on metal lath 3.50
Ceilings with ¾ hot roll channels metal lath (lathed only) 3.00
Seilings with ¾ hot roll channels metal lath plastered 4.50
Single partition ¾ channel lath 1 side (lath only) 3.00
Single partition ¾ channel lath 2 inches thick plastered 8.00
4-inch double partition ¾ channel lath 2 sides (lath only) 5.75
4-inch double partition ¾ channel lath 2 sides plastered 6.75
Thermax single partition; 1" channels; 2¼" overall partition width. Plastered both sides 7.50
Thermax double partition; 1" channels; 4¾" overall partition width. Plastered both sides 11.00
3 Coats over 1" Thermax nailed to one side wood studs or joists 4.50
3 Coats over 1" Thermax suspended to one side wood studs with spring sound isolation clip 5.00
Note—Channel lath controlled by limitation orders.	

PLASTERING (Exterior)—

2 coats cement finish, brick or concrete wall Yard \$2.50
3 coats cement finish, No. 18 gauge wire mesh 3.50
Lime—\$4.00 per bbl. at yard.	
Processed LLime—\$4.15 per bbl. at yard.	
Rock or Grip Lath—¾"—30c per sq. yd.	
¾"—29c per sq. yd.	
Composition Stucco—\$4.00 sq. yard (applied).	

PLUMBING—

From \$150.00 per fixture up, according to grade, quality and runs.

ROOFING—

"Standard" tar and gravel, 4 ply—\$11.00 per sq. for 30 sqs. or over.	
Less than 30 sqs. \$14.00 per sq.	
Tile \$40.00 to \$50.00 per square.	
Redwood Shingles, \$15.00 per square in place.	
5/2 #1-16" Cedar Shingles, 4½" Exposure \$16.50 square

5/8 x 16"—#1 Cedar Shingles, 5" Exposure \$17.00 square
4/2 #1-24" Royal Shingles, 7½" Exposure \$18.25 square
Re-coat with Gravel \$5.50 per sq.	
Asbestos Shingles \$30 to \$60 per sq. laid	
1/2 x 25" Resawn Cedar Shakes, 10" Exposure \$18.50
3/4 x 25" Resawn Cedar Shakes, 10" Exposure 21.00
1 x 25" Resawn Cedar Shakes, 10" Exposure 22.00
Above prices are for shakes in place.	

SHEET METAL—

Windows—Metal, \$2.50 a sq. ft.
Fire doors (average), including hardware \$2.80 per sq. ft.

SKYLIGHTS—(not glazed)

Copper, \$1.25 sq. ft. (flat).
Galvanized iron, 65c sq. ft. (flat).
Vented hip skylights 90c sq. ft.

STEEL—STRUCTURAL—

\$220 per ton erected, when out of mill
\$270 per ton erected, when out of stock

STEEL REINFORCING—

\$200.00 per ton, in place.

STORE FRONTS (None available).

TILE—

Ceramic Tile Floors—\$1.70 per sq. ft.
Cove Base—\$1.35 per lin. ft.
Glazed Tile Wainscot—\$1.85 per sq. ft.
Asphalt Tile Floor ¾" x ¾"—\$.40 per sq. ft.
Light shades slightly higher.
Cork Tile—\$1.00 per sq. ft.
Mosaic Floors—See dealers.
Lino-Tile—\$1.00 per sq. ft.

Wall Tile—

Glazed Terra Cotta Wall Units (single faced) laid in place—approximate prices:

2 x 6 x 12 \$1.25 sq. ft.
4 x 6 x 12 1.50 sq. ft.
2 x 8 x 16 1.45 sq. ft.
4 x 8 x 16 1.75 sq. ft.

VENETIAN BLINDS—

75c per square foot and up. Installation extra.

WINDOWS—STEEL—

60c per square foot, \$5 for ventilators.

IN THE NEWS

CALIFORNIA DEPARTMENT OF PUBLIC WORKS OPENS NEW S. F. OFFICE

The Division of San Francisco Bay Toll Crossings of the California Department of Public Works has opened offices at 74 New Montgomery Street, San Francisco, with Edwin F. Levy office engineer.

THE CITY OF RICHMOND, California, is planning a new Civic Center consisting among other buildings of a new City Hall and a new Hall of Justice. City officials estimate the cost at \$1,500,000 and are taking bids on general contract, to close March 1st.

REVISION OF COMMERCIAL STANDARD FOR HARDWOOD DIMENSION LUMBER

The recommended revision of Hardwood Dimension Lumber, Commercial Standard CS60-36, has been approved for promulgation, according to the Commodity Standards Division, National Bureau of Standards. The revised standard will be identi-

fied as CS60-48 and will be effective for new production from February 25, 1948.

The original standard was developed in 1936.

The present edition sets forth minimum specifications for solid and glued-up hardwood dimension lumber in five grades of flat stock and four grades of squares, and covers a definition of the product, permissible defects, measurement, and tolerances for rough, surfaced, semifabricated, and completely fabricated hardwood dimension lumber.

TERRAZZO

for Floors and Wainscoting in Hospitals, Theaters, Hotels, Office Buildings, Schools and Sanitary

DECORATIVE • DURABLE • SANITARY



FOX TILE CO.

3247 E. 14th Street, Oakland

Phone: ANdover 1-0431

BUILDING TRADES WAGE (JOB SITES) NORTHERN AND CENTRAL CALIFORNIA

ATTENTION: The following are the PREVALING hourly rates of compensation being paid and in effect by employers by agreement between employees and their union; or as recognized and determined by the U. S. Department of Labor. (Revised to January 1, 1948.)

CRAFT	San Francisco	Alameda and Contra Costa	Marin	Vallejo	San Mateo	San Jose	Stockton	Sacramento	Fresno
ASBESTOS WORKERS	1.90	1.90	1.90	1.90	1.90	1.90	1.90	1.90	1.90
BRICKLAYERS	2.25	2.25	2.25	2.25	2.25	2.25	2.25	2.50	2.25
BRICKLAYERS, HODCARRIERS	1.75	1.75	1.75	1.75	1.75	1.75	1.87½	1.87½	1.75
CARPENTERS	2.00	2.00	2.00	2.00	2.00	2.00	2.00	2.00	2.00
CEMENT FINISHERS	2.02½	2.02½	2.02½	2.02½	2.02½	2.02½	2.02½	2.02½	2.02½
ELECTRICIANS	2.25	2.25	2.25	2.25	2.25	2.25	2.25	2.25	2.25
ENGINEERS: MATERIAL HOIST	2.00	2.00	2.00	2.00	2.00	2.00	2.00	2.00	2.00
PILE DRIVER	2.25	2.25	2.25	2.25	2.25	2.25	2.25	2.25	2.25
STRUCTURAL STEEL	2.25	2.25	2.25	2.25	2.25	2.25	2.25	2.25	2.25
GLASS WORKERS	1.87½	1.87½	1.87½	1.87½	1.87½	1.87½	1.87½	1.87½	1.87½
IRONWORKERS: ORNAMENTAL	2.10	2.10	2.10	2.10	2.10	2.10	2.10	2.10	2.10
REINF. RODMEN	2.00	2.00	2.00	2.00	2.00	2.00	2.00	2.00	2.00
STRUCTURAL	2.25	2.25	2.25	2.25	2.25	2.25	2.25	2.25	2.25
LABORERS: BUILDING & CONCRETE	1.40	1.40	1.40	1.40	1.40	1.30	1.40	1.40	1.30
LATHERS	2.25	2.25	2.25	2.25	2.25	2.25	2.25	2.25	2.25
MARBLE SETTERS	2.00	2.00	2.00	2.00	2.00	2.00	2.00	2.00	2.00
MOSAIC & TERRAZZO	2.00	2.00	2.00	2.00	2.00	2.00	1.75	1.75	1.75
PAINTERS	2.00	2.00	2.00	2.00	2.00	2.00	2.00	2.00	2.00
PILEDRIVERS	2.12½	2.12½	2.12½	2.12½	2.12½	2.12½	2.12½	2.12½	2.12½
PLASTERERS	2.25	2.50	2.25	2.50	2.25	2.25	2.05	2.05	2.05
PLASTERERS' HODCARRIERS	2.00	2.00	2.00	2.00	2.00	2.00	1.87½	1.87½	1.87½
PLUMBERS	2.25	2.25	2.25	2.25	2.25	2.25	2.25	2.25	2.25
ROOFERS	2.00	2.00	2.00	2.00	2.00	2.00	2.00	2.00	2.00
SHEET METAL WORKERS	2.00	2.00	2.00	2.00	2.00	2.00	2.00	2.00	2.00
SPRINKLER FITTERS	2.00	2.00	2.00	2.00	2.00	2.00	2.00	2.00	2.00
STEAMFITTERS	2.25	2.25	2.25	2.25	2.25	2.25	2.25	2.25	2.25
STONESETTERS (MASON'S)	2.25	2.25	2.25	2.25	2.25	2.25	2.25	2.25	2.25
TILESETTERS	2.15	2.15	2.15	1.90	2.15	1.90	1.90	1.90	1.90

Prepared and compiled by

CENTRAL CALIFORNIA CHAPTER, ASSOCIATED GENERAL CONTRACTORS OF AMERICA

with the assistance and cooperation of secretaries of Building Trades Unions, General Contractors Associations and Builders Exchanges of Northern California

CLASSIFIED ADVERTISING

RATE: 10c PER WORD . . . CASH WITH ORDER

MINIMUM \$2.50

HELP WANTED: Bldg. Specif. Writers for arch. work—perm. Civil Service \$395 & \$440 month. Annual increases, sick leave, retirement, L. A. County Civil Service, Rm. 102, Hall of Records, Los Angeles 12, Calif.

ARCHITECTS' REPORTS—A valuable advance news service giving building and construction information daily on projects in Northern California. Name, location, architect, proposed cost, etc., on individual slips. Ideal for securing new business leads. Hun-

dreds of items, total monthly cost only \$10. Don't delay, subscribe today. **ARCHITECT & ENGINEER, Room 618, 68 Post Street, San Francisco, California.** Phone Douglas 2-8311.

PHOTOGRAPHS: Specializing in building and construction photographs for publication, or historic records. For Industrial-Aerial. Publicity photography use the **INDUSTRIAL San Francisco.**

PHOTO'S, Room 722, Hearst Bldg., San Francisco, Phone SUTter 1-6953.

WANTED experienced Architectural Designer Draftsman small San Francisco office. Exceptional pay for exceptional man. Furnish detailed outline of previous experience. All replies confidential. Box 210, Architect & Engineer, 68 Post Street, San Francisco, California.

ENGRAVING—Good engravings are essential to a satisfactory job of printing reproduction. For the best, see Poor Richard Photo Engraving Co., 324 Commercial St.,

HOGAN LUMBER CO.

Wholesale and Retail

LUMBER

MILL WORK • SASH & DOORS

Office, Mill, Yard and Docks
SECOND AND ALICE STREETS • OAKLAND, CALIF.
Telephone GLencourt 1-6861

SISALKRAFT

REG. U. S. PAT. OFF.

"More than a building paper"

THE SISALKRAFT CO.

205 West Wacker Drive
Chicago, Ill.

55 New Montgomery Street
San Francisco, Calif.

CLINTON CONSTRUCTION CO. OF CALIFORNIA

General Contractors

923 FOLSOM STREET • SAN FRANCISCO
SUtter 1-3440

SANTA MARIA INN SANTA MARIA, CALIFORNIA

FRANK J. McCOY, General Manager
FERNAND E. PIMENTEL, Manager

On the
Coast
Highway
between
San
Francisco
and
Los
Angeles



American
or
European
Plan
•
Old
English
Tap
Room

MASS TRANSPORTATION

(From Page 11)

and one-half minutes.

The real interurban terminal would be an elongated terminal under Market Street itself with a mezzanine concourse for pedestrian traffic from property line to property line and extending from Third Street to Valencia Street with access directly to the basements of the stores and to the subways below. This method was successfully applied under State Street in Chicago. This mezzanine incidentally, would not prevent the construction of underpasses at Third Street and other selected crossings of Market Street.

Mass transportation by motor-coach would be provided for on the upper deck of the bridge with direct connections to the North Shore Highway and the East Shore Freeway in the East Bay cities and the Bay Shore Freeway in San Francisco. It is proposed that the connection with the Bay Shore Freeway be made by utilizing Channel Street. Channel Street is a needless and comparatively useless extension of the Bay and now serves as an open sewer discharging into the Bay. By filling in this channel the double purpose would be secured of removing a menace to the public health and providing an adequate bridge approach 200 feet wide. The City doubtless still holds title to this "street". A connection with the Bay Shore Freeway, now under construction, may be effected without difficulty in the vicinity of Sixteenth Street. An approach at right angles to Market Street between Second and Third Streets would connect with the "Minnetoma Project" endorsed by the Central Council of Civic Clubs.

If San Francisco is ever to have adequate and direct rail connections with the continental side of the Bay, the decision should be made now, and such facilities should be incorporated into the general plan. If this is not done, the difficulties of providing such facilities later will become insurmountable. The Pennsylvania Railroad spent over \$100,000,000 for its New York terminal facilities and connections at a time when construction costs were less than half what they are today.

ELMWOOD GRAMMAR SCHOOL. Elmore G. Ernst, Architect, Stockton announces Dan Nomellini, contractor, has been awarded a contract for completion of the Elmwood Grammar School, Stockton, at a cost of \$309,908.

CANNERY ADDITION AT GRIDLEY. The Cahill Construction Company of San Francisco has been awarded a contract for construction of an addition of two warehouses to the Libby McNeill & Libby plant at Gridley, California. Cost \$300,000.

BOOK REVIEWS PAMPHLETS AND CATALOGUES

PENCIL PICTURES By Theodore Kautzky, Reinhold Publishing Corp'n., 330 W. 42nd Street, New York. Price \$5.00.

This newest book by Kautzky is quite different from his previous book *Pencil Broad-sides* which dealt principally with technique, in that *PENCIL PICTURES* deals with the making of pictures in pencil out of the great variety of subject matter to be found in nature.

Landscapes of the seashore, farming country, mountains and woodlands are illustrated and analyzed with attention to the arrangement of picture element in line with value to produce pleasing design pattern.

Draftsmen, student, amateur, and artist will find in the plates shown inspiring examples from which to learn.

GUIDE FOR PLANNING FACILITIES FOR ATHLETICS, Recreation, Physical and Health Education. By Participants in National Facilities Conference. The Athletic Institute, Inc., 209 S. State Street, Chicago, Ill. Price \$1.00.

Compilation of ideas gathered by fourteen national agencies and fifty-four outstanding individuals from all parts of the nation who gathered for a two weeks working conference.

Included indoor and outdoor athletics, Recreation, Physical and Health Education and facilities; Diagrams, charts, and plans of areas, and uses of various construction materials.

PLYWOOD—What it is—What it Does. By Louis H. Meyer. McGraw-Hill Book Company, 330 W. 42nd Street, New York. Price \$3.50.

The author is one of the nation's outstanding advertising and Sales Counsels and was formerly Field Research Director of the U. S. Plywood Corp'n.

The book authoritatively covers the composition, structure, and mechanical characteristics of plywood and kindred laminates, as well as where and how to best use plywood.

Industrial designers, engineers, architects, builders, purchasing agents and others will find this book answers most of their technical questions relative to industrial manufacture and practical application of plywood.

100 FIREPLACE IDEAS. Price Fireplace Heater & Tank Corp'n., Buffalo, N. Y.

A 32-page booklet giving 100 ideas on fireplace design from Colonial America to the present day. Designs shown are variety of style and material. Free to Architects, Engineers, and Contractors.

PACIFIC MANUFACTURING CO.

HIGH CLASS INTERIOR FINISH
QUALITY MILLWORK

142 SANSOME ST., SAN FRANCISCO
Garfield 1-7755

6820 MCKINLEY AVE., LOS ANGELES
THornwall 4196

BUILDERS EXCHANGE, OAKLAND

"AMERICAN - MARSH" CONDENSATION UNIT

Pumping
Machinery
for
Every
Purpose

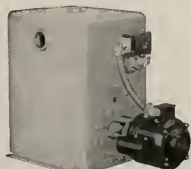

For Service
Call
DOuglas
2-6794
or
MUtual 8322

SIMONDS MACHINERY CO.
SAN FRANCISCO 816 FOLSOM
LOS ANGELES 455 EAST 4TH

VERMONT MARBLE COMPANY

Producers and Finishers
of
Domestic and Imported Marbles

525 MARKET STREET, SAN FRANCISCO
Phone SUrter 1-6747
3522 COUNCIL STREET
(Beverly Blvd. at Virgil Ave.)
LOS ANGELES 4, CALIF.
Telephone FAirfax 7834



The Most Complete Line of STEELS and BUILDING MATERIALS

Made by a Single Producer



See Sweet's Catalog File or write us for
full information.

REPUBLIC STEEL CORPORATION

GENERAL OFFICES: CLEVELAND, OHIO

DENVER, COLORADO . . . CONTINENTAL OIL BUILDING
LOS ANGELES, CALIFORNIA . . . EDISON BUILDING
SALT LAKE CITY, UTAH . . . WALKER BANK BUILDING
SAN FRANCISCO, CALIFORNIA . . . RIALTO BUILDING
SEATTLE, WASH. WHITE-HENRY-STUART BUILDING

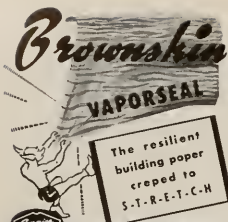

Quality Products Since 1895
ANGIER PACIFIC CORPORATION
 55 NEW MONTGOMERY ST. 7424 SENEZ BOULEVARD
 SAN FRANCISCO 5, CALIF. LOS ANGELES 44, CALIF.
 A complete line of Angier products available from your building material dealer

IN THE NEWS

METAL LATH MFGR'S

William F. Saunders has been appointed Pacific Coast representative for the Metal Lath Manufacturers Association with offices in Los Angeles and San Francisco.

Saunders is reactivating the Pacific Coast offices of the Association and will offer technical assistance to the construction industry in matters concerning metal lath and its application.

STORE REMODEL. Barrett & Hilp, Contractors, San Francisco have been awarded contract for remodel of the Jos. Magnin Co. store in Palo Alto.

SCHOOL CONTRACT has been awarded Carl Overaa & Co., Contractors of Richmond, California for a 15-classroom and kindergarten building in San Pablo, cost \$316,000.

NEW FACTORY. Cahill Bros. Contractors, San Francisco, have been awarded a \$1,250,000 contract for construction of two new factory buildings in San Francisco for the Best Foods, Inc.

RESIDENCE. Rene E. Johnson Contractor, Burlingame, California has been awarded a contract for the construction of an 8-room home at Palo Alto at an estimated cost of \$29,000.

HUNT FOODS have awarded a contract to Swinerton & Walberg Contractors of Oakland, for the construction of a new \$500,000 warehouse at Hayward, California Douglas McLellan, Los Angeles, is the architect.

VETERINARY HOSPITAL. Frank Hensley, Contractor, Reno, Nevada, has been awarded a \$25,000 contract for the construction of a veterinary hospital in Reno, Nevada.

\$100,000 RESIDENCE. Gardner A. Dailey is "framing" a \$100,000 residence for a client in Hillsborough, California. Wagner & Martinez, San Francisco, are the contractors.

FIBERGLAS. The Bechtel Corporation, San Francisco, has been awarded a contract for the construction of a \$2,000,000 factory and administration building for the Owens-Corning Fiberglas Corporation in San Jose, California.

TELEPHONE EXCHANGE ADDITION in Redwood City, California, costing \$110,000, will be constructed by Haas & Rothschild, general contractors, San Francisco.

MOORE & ROBERTS, general contractors, San Francisco, have been awarded contract for the construction of two ward buildings at the Napa State Hospital to cost \$1,887,777.

ENGINEER MOVES

Clarence H. Bazille, Consulting Mechanical and Electrical Engineer, has moved into new offices in the Pacific Building, San Francisco 3, California.

TOUGH as SHOE - LEATHER - and WATERPROOF, Too!

Specify
SISALKRAFT REINFORCED BUILDING PAPER
 FOR CURING AND PROTECTING
 CONCRETE SHEATHING
 AND COVERING MATERIAL

GUNN CARLE & CO
 20 POTRERO AVENUE • SAN FRANCISCO, CALIF.

MORE WINDOW VALUE FOR YOUR MONEY!



with
CECO
 Steel Windows

- Easy opening and closing . . . no sticking or warping.
- "Bonderized" as a protection against rust.
- Ceco steel windows provide for economical wall construction . . . enhance the architectural effect of the building.
- Weathertight . . . durable and fire resistive.
- The Ceco window line is so complete and so flexible that every type of building from the small residence to the largest institutional structure may be equipped with tight weather seal Ceco steel windows.

CONTACT THE NEAREST P.C.A. OFFICE



Pacific Coast Aggregates, Inc.

SAN FRANCISCO
 400 Alabama St.
 KLondike 2-1616

OAKLAND
 2400 Peralta St.
 GLencourt 1-0177

SACRAMENTO
 16th and A Sts.
 Ph. 3-6586

STOCKTON
 1020 E. Main St.
 Phone 8-8643

SAN JOSE
 790 Stockton Ave.
 Ballard 8670

FRESNO
 2150 G St. or 414 P St.
 Ph. 3-5168 Ph. 4-3045

Phone GArfield 1-1164

Thomas B. Hunter

DESIGNER OF HEATING

AIR CONDITIONING
VENTILATING AND WIRING
SYSTEMS, MECHANICAL
AND ELECTRICAL EQUIP-
MENT OF BUILDINGS

★

41 SUTTER STREET
ROOM 710

San Francisco California

Scott Company

HEATING - - PLUMBING - - TILE

★

243 MINNA STREET

SAN FRANCISCO

Phone EXbrook 2-6741

THE TORMEY COMPANY

GENERAL PAINTERS
AND DECORATORS

Phone UNderhill 1-1913

563 FULTON STREET
San Francisco

Fine
ENGRAVINGS

**POOR
RICHARD**
PHOTO ENGRAVING CO.
320-324 COMMERCIAL STREET
SAN FRANCISCO, CALIF.

IN THE NEWS

TILE COUNCIL

A. R. McMannis, sales manager of the United States Quarry Tile Company, has been elected 1948 chairman of the Tile Council of America. He succeeds D. Parry Forst of Trenton, N. J.

The Council comprises 93 per cent of all ceramic floor and wall tile produced in the United States.

V. M. Boget, sales manager of Gladding, McBean & Co., Los Angeles, was elected to the Advisory Committee.

RADII DRAWING

Precision cut from .030 mathematical quality plastic the new Radius Master No. 76 eliminates the old trial and error method for rapid, accurate drawing of radii.



All edges are smooth and clean. Radius point is precisely located, the center hole serving the particular radius. Radii on inner contours run up to 37/32nds in 32nd increments.

Manufactured by Rapidesign, Inc., Glendale, California.

UNIVERSITY SMALL HOMES COUNCIL of the University of Illinois has issued a basic plan for a farmhouse adaptable to requirements and living conditions on owner-operated farms and is flexible, with minor changes, for use in city locations. It is presented in an 8-page free circular. The house is planned on the modular principle (multiples of 4 inches).



THE WESIX "BILT-IN"

A compact heater that gives instant heat and luxurious comfort in the average size bathroom. Built by America's pioneer manufacturer of electric heating systems.

For our new catalog write

WESIX ELECTRIC HEATER CO.
390 1st Street, San Francisco



DINWIDDIE CONSTRUCTION COMPANY

•
BUILDERS

•
CROCKER BUILDING
SAN FRANCISCO



**HERRICK
IRON WORKS**
STRUCTURAL STEEL
REINFORCING STEEL

118TH AND CAMPBELL STS.
OAKLAND, CALIF.
Phone Glencourt 1-1767

INDEPENDENT IRON WORKS

Steel Buildings
Service Stations
Steel Storage Tanks
Fabricated Plate Work
Steel and Sheet Metal Products
Fabricated Structural Steel
Steel Distributors

Eighth & Pine Sts. Oakland, 7

MULLEN MFG. COMPANY

BANK, STORE AND OFFICE
FIXTURES—CABINET WORK
OF GUARANTEED QUALITY
CHURCH SEATING

Office and Factory
60-80 RAUSCH ST., Ber. 7th and 8th Sts.
San Francisco
Telephone UNDERhill 1-5815

PITTSBURGH TESTING LABORATORY

ENGINEERS AND CHEMISTS

Testing and Inspection of Concrete,
Steel and Other Structural Materials

Design of Concrete Mixes

Offices in all principal cities

651 Howard St., San Francisco 5
EXbrook 2-1747

A. F. MATTOCK CO.

Builders



212 CLARA STREET
SAN FRANCISCO

Index to Advertisers

ANGIER Pacific Corp.	46
ARCHITECTS Reports	40
ARCHITECT and Engineer
Inside Back Cover	
BASALT Rock Company	Back Cover
BAXTER & Company, J. H.	36
CLASSIFIED Advertising	43
CLINTON Construction Company	44
CONTINENTAL Water Heater Co.	*
DETROIT Steel Products Co.	5
DINWIDDIE Construction Co.	47
DUFFY TILE Co.	48
FORDERER Cornice Works	40
FOX Tile Co.	43
FULLER, W. P. Co.	*
GUNN, Carle & Company	46
HANKS, Inc., Abbott A.	48
HAWS Drinking Faucet Company	34
HERRICK Iron Works	47
HOGAN Lumber Company	44
HUNT, Robert W., Company	48
HUNTER, Thos. B.	47
INDEPENDENT Iron Works	48
JUDSON, Pacific-Murphy Corp.	40
KRAFTILE Company	31
MATTOCK, A. F., Co.	48
MICHEL & Pfeffer Iron Works
Inside Front Cover	
MULLEN Mfg. Co.	48
MUELLER Brass Co.	*
NORTHERN California Electric Bureau	35
PACIFIC Coast Aggregates, Inc.	56
PACIFIC Coast Gas Association	*
PACIFIC Manufacturing Company	45
PACIFIC Portland Cement Company	*
PACIFIC Telephone & Telegraph Co.	33
PADDOCK Engineering Co.	30
PITTSBURGH Testing Laboratory	48
POOR RICHARD Engraving Co.	47
REMILLARD-Dandini Co.	48
REPUBLIC Steel Corporation	45
SANTA Maria Inn	44
SCOTT Co.	47
SIMONDS Machinery Company	45
SIMPSON Logging Co.	6
SISALKRAFT Company	44
SMOOT-Holman Co.	37
STANLEY Works, The	*
SUPERIOR Fireplace Co.	39
TAYLOR Co., Halsey W.	39
TORMEY Company, The	47
U. S. BONDS	2
VERMONT Marble Company	45
WESIX Co.	47
WESTERN Asbestos Co.	1
WOOD, E. K., Lumber Company	36

*Indicates Alternate Months

Robert W. Hunt Company

ENGINEERS

Inspection • Tests • Consultation

Schools and Other Structures
Are Built as Designed

When Construction Materials are
Inspected at point of Manufacture
and during Erection by

ROBERT W. HUNT COMPANY

Cement, Concrete, Chemical, Metallurgical,
X-Ray and Physical Laboratories

Chicago • New York • Pittsburgh
Los Angeles • All Large Cities
San Francisco, 251 Kearny Street

REMILLARD-DANDINI Co.

Brick and
Masonry Products



400 MONTGOMERY STREET
SAN FRANCISCO, CALIF.

DUFFY TILE CO.



TILE CONTRACTORS
SHOWER DOORS
TUB ENCLOSURES

INSTALLATIONS
OF EVERY
DESCRIPTION
Modernizing, Repairing

"Not How Cheap
But How Good"
253 MINNA
YUkon 6-1489



ABBOT A. HANKS, INC.

Engineers & Chemists
INSPECTING — TESTING — CONSULTING
CONCRETE • STEEL • MATERIALS
CHEMICAL AND TESTING
LABORATORIES
• RESEARCH AND INVESTIGATION •

TESTS OF STRUCTURAL MATERIALS
DESIGN OF CONCRETE MIXES
SHOP AND ERECTION INSPECTION OF
STRUCTURES AND EQUIPMENT
INVESTIGATION OF STRUCTURES
AND MATERIALS
TESTS AND INVESTIGATION OF
FOUNDATION SOILS
FIRE RESISTANCE AND INSULATION
TESTS

624 Sacramento Street, San Francisco

ARCHITECT AND ENGINEER

I. MAGNIN & COMPANY BUILDING

San Francisco



MARCH

1948

METAL BUILDINGS



C. W. CLAUDIUS, Architect

**Flat Panel Type Buildings;
Steel Fabricated Buildings;
Drive-in Restaurants; Display
Buildings; Rest Rooms and
Service Stations**

BUILT TO YOUR SPECIFICATIONS

Write or telephone today
for complete information.



Michel & Pfeffer Iron Works, Inc.

W. A. JAMES, Manager Steel Building Division

Tenth and Harrison Streets, San Francisco 3, California

Telephone MArket 1-5966

ARCHITECT

Vol. 172

No. 3

AND ENGINEER

ARCHITECTS' REPORTS—Published Daily

E. H. WILDER
Editor

MARK DANIELS, A.I.A.
Associate Editor

PROF. LELAND VAUGHAN
Landscape Architecture

JOHN A. BLUME
Structural Engineering

MICHAEL GOODMAN
Planning

JOHN S. BOLLES, A.I.A.
Book Reviews



COVER PICTURE:

The New

I. MAGNIN & COMPANY
Building

Rising majestically among downtown San Francisco's commercial buildings is the new I. Magnin & Company's store. Facing the City's famed Union Square this newest addition to retail San Francisco is one of the "show places" of the West. (See Page 18.)

Contents for

MARCH

EDITORIAL NOTES	4
NEWS & COMMENT ON ART	8
CREATIVE REBELLION UNDER FIVE DOLLARS By DR. M. F. AGHA	11
TWO GARDENS FROM THE OFFICE OF THOMAS D. CHURCH, A.I.A.	12
DOCTORS HOSPITAL, San Francisco	14
RESEARCH INSTITUTE FOR EARTHQUAKE ENGINEERING, Being Organized	15
CALIFORNIA'S WATER SUPPLY IS ADEQUATE FOR LARGER POPULATION By EDWARD HYATT, State Engineer	15
BRITAIN'S LARGEST PREFABRICATED HOUSING ESTATE By JOAN LITTLEFIELD	16
THE NEW I. MAGNIN'S SAN FRANCISCO STORE By EDWIN H. WILDER	18
A.I.A. ACTIVITIES	31
WITH THE ENGINEERS	32
HEADLINE NEWS & VIEWS By E. H. W.	36
IN THE NEWS	37, 43, 46, 47
LANDSCAPE ARCHITECTURE, Notes of the Profession	38
ESTIMATOR'S GUIDE, Building and Construction Materials	41
BUILDING TRADES WAGE SCALES, Northern and Central California	43
CLASSIFIED ADVERTISING	43
BOOK REVIEWS, Pamphlets and Catalogues	45
INDEX TO ADVERTISERS	48

ARCHITECT AND ENGINEER (Established 1905) is published on the 15th of the month by The Architect and Engineer, Inc., 68 Post St., San Francisco 4; Telephone EXbrook 2-7182. President, K. P. Kierulff; Vice-President and Manager, L. E. Peohorwood; Treasurer, E. N. Kierulff.

Los Angeles Office: Wentworth F. Green, 6605 Hollywood Blvd., Los Angeles 28. Telephone HEmpstead 3171.

Entered as second class matter, November 2, 1905, at the Post Office in San Francisco, California, under the Act of March 3, 1879. Subscriptions United States and Pan America, \$3.00 a year; \$5.00 two years; foreign countries \$5.00 a year; single copy 50c. ARCHITECTS' REPORTS are published daily from this office, Vernon S. Yallop, Manager. Telephone DOuglas 2-8311.



EDITORIAL NOTES

The next time you are tempted to do business with a "Black" or "Grey" market operator in the building materials field, just remember that you are adding your support to higher construction costs, which is in reality a serious economic inflation.

Inflation is not a fantastic something-or-another which effects those around you, and something that you escape. If you think so, just give a little serious thought to the following:

"Several weeks ago I received a letter from the National University of Yunnan, Kunming, China. On this letter was \$30,500 in postage. Ten years ago this would have represented the ordinary man's hope for a lifetime savings. Today it is the amount required for air mail postage to deliver one letter from Kunming, China to the United States."

Inflation IS your problem, and only through refusal to become a party to inflationary practices can you escape the eventual results—individual and national bankruptcy.

National Monuments will gain attention as soon as the element of time between events, and people thinking meet on a common level.

In this connection the comments of Elmer Grey, Architect, of Pasadena, California are rather interesting:

"The designing of a national monument like the Lincoln Shrine (Redlands, California) entails a peculiar responsibility on the part of the architect. In residential and commercial work domestic circumstances and those of trade largely prescribe the nature of the design. But in the case of a monument that is a gift, the donor, must in many cases be told by the architect how much he should spend, in order to make the result suitable to its purpose.

"In doing this he may, of course, risk the pleasure of his client who may consider him presumptuous or extravagant in his demands. But if he fails to take that risk he falls short of his professional obligations for he is supposed to know more about such requirements than a layman."

The consensus among those in the Construction Industry who should be in a position to know, is that the outlook is quite favorable for sufficient production of building materials in 1948 to meet the nation's housing and other necessary construction requirements.

Reports from all parts of the nation submitted to members of the National Association of Home

Builders at their recent annual convention in Chicago, indicated there would be an adequate supply and production of materials to meet the demands for 1948 "barring any major economic upset."

Plant capacities have been expanded, transportation of materials has been improved, and raw materials have become more abundant.

Dean Thorndike Saville of the New York University, College of Engineering, has recommended a distinctly new approach to the problem of engineering education.

In a recent report to college officials, Dean Saville urges the establishment of a general, uniform, four-year course which substantially all engineering students would take. The first three years would have all the basic sciences and fundamental engineering subjects now offered, plus courses in history, public affairs and economics. Highly specialized subjects now on the increase in several sophomore and junior year curricula would be omitted. The senior year would have a considerable number of electives, designed on the one hand for those who expect to terminate their technological engineering education in four years with the degree of Bachelor of Engineering, and on the other hand for those who desire, aptitude, and ability planned or were selected to take a fifth year of specialized programs leading to the designated bachelor's degree such as A.E., C.E., M.E., and E.E.

Dean Saville believes that at least fifty per cent of the total completing their work for the Bachelor of Engineering, would be prepared through judicious choice of senior electives to pursue a career as contrasted to strictly professional objectives.

They would be better prepared for managerial posts even in industry and government than many of the present graduates, as they would also be for the types of non-specialized careers needed for sales, teaching and foreign service. They could also pursue graduate work in many other fields for which their aptitude and desires had developed.

Melvin H. Baker of Buffalo, New York, heads a Committee of the Construction Industry Information Committee whose objective is a fact-finding program which will give to the public a better understanding of the building industry.

Mr. Baker has a big job ahead of him, as the public-at-large during the past several years have not fared so well from the standpoint of individual building programs.



Fencraft Combination Windows, Types 636 and 616, joined with steel mullions to provide abundant daylighting—ideal for a hospital nursery. Sill vent tilts—guards against drafts, prevents children falling out.

How to get Larger Window Areas *with maximum economies*

The trend to larger window areas for better daylighting and better ventilation makes window cost more and more a point for consideration.

To get larger areas with maximum savings, give a thought to the use of standard window units, combined to make attractive, efficient sources for daylight, ventilation—as well as view.

Fenestra Fencraft Windows are ideal for this purpose. They're famous Fenestra quality in every respect—suitable for the finest buildings. Yet standardization of types and sizes has resulted in manufacturing economies that mean lower first cost. Standardization results in construction

economies, as well—for it permits co-ordination of window dimensions with those of commonly-used wall materials.

There's a wide range to choose from—many sizes and ventilator arrangements—in three popular types, Combination, Projected and Casement. Being steel, they can't warp, shrink or rot. Made by America's oldest and largest manufacturer of steel windows. You can count on them for quality construction that means better appearance, permanently easy operation and lower maintenance costs.

For information on types and sizes available, see Sweet's Architectural File for 1948 (Section 16a-14). Or mail the coupon.



FENCRAFT CASEMENT WINDOW

Safe washing—from inside. Easy to operate. Uniform screens, protected from outside dirt. "Homey" appearance makes them ideal for clubs, large homes, dormitories and nurses' homes.



FENCRAFT PROJECTED WINDOW

Open-out vent acts as weather-protecting canopy over opening. Open-in vent deflects air upward, sheds water outside. Widely used for schools. Horizontal lines are especially suited to low, wide buildings.

Fenestra

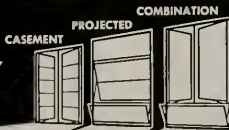

FENCRAFT INTERMEDIATE STEEL WINDOWS

Detroit Steel Products Company,
Dept. AE-3
2262 East Grand Blvd.,
Detroit 11, Michigan

Please send me data on types and sizes of the new Fencraft family of Fenestra Windows:

Name

Company

Address

*Discuss
Your Needs With
Your Nearest
Simpson Applicator*

ACOUSTICS NORTHWEST

Builders Exchange Bldg.
Portland 4, Ore.
Phone: Atwater 6443

ALLIED CONSTRUCTION & SPECIALTY CO., INC.

8455 Melrose Ave.
Los Angeles 46, Calif.
Phone: Walnut 0541

ANGELES INDUSTRIES

984 McGarry St., Los Angeles, Calif.
Phone: Vandike 1783

APPLICATION SERVICE CO.

420 Continental Oil Bldg.
Denver 2, Colo.
Phone: Alpine 4662

ARIZONA SASH, DOOR & GLASS CO.

657 W. St. Mary's Rd., Tucson, Ariz.
Phone: 1699

CONSOLIDATED ROOFING & SUPPLY CO.

520 S. 7th Ave., Phoenix, Ariz.
Phone: 47888

CONTINENTAL LUMBER CO.

P. O. Box 2042, Boise, Idaho
Phone: 450

CRAIG & PULLEN

320 Ward St., Honolulu, T. H.
Phone: 6107

CRAMER COMPANY

345 Vermont St., San Francisco, Calif.
Phone: Market 6411

CRAMER COMPANY

1928 Merced St., Fresno, Calif.
Phone: 3-1131

ELLIOTT BAY LUMBER COMPANY

600 W. Spokane St., Seattle, Wash.
Phone: Elliott 8080

ELLIOTT BAY LUMBER COMPANY

Box 188, Union Gap Station
Yakima, Wash.
Phone: 24671

EXCHANGE LUMBER & MFG. CO.

P. O. Box 1514, Spokane, Wash.
Phone: Glenwood 1621

FROST HARDWOOD LUMBER CO.

Market at State St., San Diego, Calif.
Phone: 6-7224

LUMBER DEALERS, INC.

423 N. 33rd, Billings, Mont.
Phone: 3911

UTAH LUMBER COMPANY

333 W. 1st South
Salt Lake City 9, Utah
Phone 4-4318

**NOW... YOU CAN
SPECIFY THE NEW**

Simpson
QUALITY SINCE 1895

ACOUSTICAL TILE

YES, architects and builders can now specify the new Simpson Acoustical Tile.

This new acoustical tile, made from Douglas fir fibers, is in production at our ultra-modern plant at Shelton. More and more of it is being produced daily as we carefully step up production. Many installations are now being made by Simpson applicators, following first shipments last month.

First reports from the field say that the acoustical tile has a better



than usual appearance by reason of its painted beveled edges, its attractive Oyster-white finish which gives it a

high light reflection, and its clean-drilled perforations, permitting repeated paintings without loss of acoustical efficiency. Specify Simpson Acoustical Tile on the next noise-quieting or acoustical installation.

Our technical field service is available without charge to architects, dealers and builders.

WOODFIBER DIVISION • SIMPSON LOGGING CO. • PLANT AT SHELTON, WASH.
SALES DIVISION • SIMPSON INDUSTRIES • 1010 WHITE BUILDING • SEATTLE 1, WASH.



The years melt away (as the years always do)

As **your years dwindle down**—as everybody's must—you'll need more than affection and companionship.

You'll need a place to live and food to eat. Which means you—not the family next door, but *you*—will need money.

There's only one way for most of us to get money—that's to save it. And for most of us, too, the best way to save money is through U. S. Savings Bonds.

Because U. S. Savings Bonds are the most widely and easily available investment to every citizen. Every bank sells them. Every post office sells them.

AND—most important—you can buy them *regularly* and *automatically* . . . which helps overcome human inertia and reluctance to save.

To do so, you just sign up for the Payroll Savings Plan

where you work, or for the Bond-A-Month Plan at the bank where you have a checking account. Then they really pile up.

Of course, there are other reasons for buying U. S. Savings Bonds.

They're SAFE. Backed by the credit of the United States, that's all.

They're PROFITABLE. You get 4 dollars out for 3 put in, after 10 years.

They're LIQUID. Like water. You can get your cash out of them at any time . . . in a few minutes . . . without penalty.

Remember those words "melt away." They say better than a volume of statistics that you have less time than you think, to save.

Save the easy, automatic way—with U.S. Savings Bonds

Contributed by this magazine in co-operation with the Magazine Publishers of America as a public service.



NEWS AND COMMENT ON ART

WINTER AND SPRING SCHEDULE MILLS COLLEGE ART GALLERY

The schedule of exhibitions and lectures announced by the Mills College Art Gallery for this Spring includes the following events:

Exhibitions: From March 17 to April the "Art for Living"; April 18 to May 9, Clarence Laughlin's Photographs of Louisiana Plantations, Robert Watson oils, and Nineteenth Century French Prints; May 23 to June 6, will be the annual Student Show.

Lectures will include H. L. Vaughan on "Contemporary Landscape Gardening" March 25 at 8 p.m.; a Conducted Tour through Modern Homes, 2-5 p.m. on April 1; "Interior Decoration in the Modern Home" by Richard B. Gump, 3 p.m. April 8 and "The Modern Stage and Contemporary Art" by Arch Lauterer on April 23, 8 p.m.

M. H. de YOUNG MEMORIAL MUSEUM SAN FRANCISCO

The Exhibitions and activities scheduled for the M. H. de Young Memorial Museum, Golden Gate Park, San Francisco, for the month of March will include the following events:

EXHIBITIONS: Chinese Paintings from the collection of Prince Giovanni Del Drago to March 28; Paintings, Watercolors and Prints by Hugo Steiner-Prag opening March 10; The Third Annual Faculty Show of the California School of Fine Arts; Student Work from the Mexican School of Art, Mexico City; Shang, Chou and Han Dynasty Bronzes—prehistoric through the Sung Dynasty Potteries Collection of Messrs. F. Low-Beer and W. Hochstadter, through March 28; Painting by Edgar Ewing, through March and Children's Apparel of the Victorian Era through March.

LECTURERS: Early Chinese Bronzes and Potteries, by Jan W. A. Kleijkamp; "Hugo Steiner-Prag and His Work," by Wolfgang Lederer and Chinese Paintings from the Del Drago Collection, by Millard Rogers, Saturday, March 20 at 3 o'clock.

The Chinese Dynasty Bronzes of the Messrs. F. Low-Beer, W. Hochstadter and Jan Kleijkamp collection New York, is composed of excellent and rare material recently brought from China and is being shown for the first time in the United States.

It comprises ritual bronzes designed and cast in China as early as twelve centuries before the Christian Era, combined with a collection of pottery made during this great period of art-expression and down to the Sixteenth Century, A. D. The extraordinary feeling for style in Chinese Art pervades in this exhibition.

The exhibition of Paintings by Edgar Ewing reflects the interesting and successful career of the artist. Winner of the Edward L. Ryerson Fellowship for Foreign Travel and Study, School of the Art Institute of Chicago, in 1935, Ewing traveled extensively abroad on a roving assignment to practically every country in Europe as well as North Africa.

As a member of the Corps of Engineers he saw service in the Philippines, India, Burma, and Japan and also caught brief glimpses of South America and Australia.

The artist has been honored with one man shows at Tretyakov Gallery, Chicago; Syracuse University; Exeter Academy; Stanford Art Gallery, and the University of Southern California where he is presently engaged as Assistant Professor of Fine Arts.

THE PHILADELPHIA ART ALLIANCE

Emil Frei, Jr., artist and native of San Francisco, is holding a one-man show at the Philadelphia (Pa.) Art Alliance during April featuring stained glass.

Working with Robert Harmon, Jules Gewinner, Milton Frenzel and Frances Deck, he has brought modern theories of abstraction into the stained glass industry.

Painting with light, which underlies the art of most fine stained glass, in itself demands a basic preoccupation with the abstract, and it is not surprising to find the modern designer frankly accepting the abstract as a visual means to spiritual stimulation.

Trained at the St. Louis School of Fine Arts, the Munich School of Arts and Crafts, and as a professional, in the studio of his own father, Emil Frei, Jr., has observed stained glass in Mexico, England, Germany, France, Italy and Scandinavia.

SAN FRANCISCO ART ASSOCIATION

Announcement is made of the Abraham Rosenberg \$1500 Fellowship for 1948, and is open to painters and sculptors who have attended the California School of Fine Arts for at least two semesters.

Intended primarily for study abroad, consideration will be given those who wish to pursue special research in this country.

The Fellowship was bequeathed by the late Abraham Rosenberg in the form of an endowment fund, revenue from which is being used to encour-

(See Page 10)

Third Annual FACULTY EXHIBITION

California School of
Fine Arts

Whitney Atchley (Ceramics) and Dorr Bothwell (Textile) are both faculty members of the California School of Fine Arts. Their work, together with that of twenty-eight other faculty members, appears in the current Third Annual Faculty Exhibition being held at the de Young Memorial Museum, Golden Gate Park. Viewed as the work of an artist faculty, the Show may be related to the Art School in several ways.

FIRST: The spirit of the exhibit as a whole reflects a creative attitude that is communicated to the students. SECOND: The range of activities from painting, sculpture, the graphic arts, illustration, ceramics to industrial design and allied commercial fields—advertising layout, lettering, packaging, textile and jewelry design—demonstrates the



VASE & BOWL (Thrown) By Whitney Atchley

ATTICA (Textile) By Dorr Bothwell



COMPOSITION (Oil) By Richard Diebenkorn

Winner of the San Francisco Art Association Emanuel Walter Purchase Prize. (67th Annual Exhibition of Paintings and Sculpture of the San Francisco Art Association.)

breadth of the curriculum. THIRD: The variety of mediums, from photography to plastics, indicates the diversity of means accessible to students in the School. On the other hand, the work is the products of thirty individual artists, all of whom have distinguished themselves in their respective fields and who have exhibited frequently in local and national shows.

Ricard Diebenkorn (See "Composition" on previous page) is this year's winner of the San Francisco Art Association Emanuel Walter Purchase Prize in the San Francisco Art Association 67th Annual Exhibition of Painting and Sculpture, which just closed at the San Francisco Museum of Art. Mr. Diebenkorn's paintings have been exhibited widely in the Bay Area. He also won the Albert M. Bender Grant-in-Aid for 1946-47.

SAN FRANCISCO ART ASS'N

(From Page 8)

age gifted artists who desire extended study in their particular fields. Its purpose is to assist painters and sculptors of exceptional qualifications toward contributing to the culture of America through the visual art mediums.

Applications must be received by the Board of Directors of the Art Association by April 12; work must be delivered by April 20.

ALTERATIONS TO THE SAN FRANCISCO MUSEUM OF ART

The Dinwiddie Construction Company has been awarded a contract for alterations to the San Francisco Museum of Art, Veterans War Memorial Building, at an estimated cost of \$106,858.

The work is being done through the offices of Dodge A. Riedy, city architect, City and County of San Francisco.

AMERICAN ACADEMY IN ROME FELLOWSHIP FOR STUDENTS

The American Academy in Rome announces eight Fellowships for mature students capable of doing independent work in musical composition, painting, sculpture, architecture, and landscape architecture. Research Fellowships carry a stipend of \$2500 a year and residence at the Academy. All other Fellowships carry a stipend of \$1250 a year, transportation to and from Rome, studio space, residence at the Academy if desired, and an addi-

tional travel allowance depending on costs in Europe. The total estimated value of each Fellowship is about \$3,000.

ARCHITECTURE: Two Fellowships. The Wm. Rutherford Mead Fund, the Daniel H. Burnham Fund, the Arnold W. Brunner Fund, and the Katharine Edwards Gordon Fund, provide for these Fellowships.

LANDSCAPE ARCHITECTURE: One Fellowship. The Garden Club of America provides for this Fellowship.

Requests for applications should be addressed to Miss Mary T. Williams, Executive Secretary, American Academy in Rome, 101 Park Avenue, New York 17, N. Y.

NEW YORK ARCHITECTURAL LEAGUE DESIGN EXHIBIT

The thirty-five winning designs of the New York Architectural League and the American Institute of Decorators competition for 1947, will be exhibited at the Los Angeles Museum of History, Science, and Art for a three week period beginning March 30.

Included among the winners and exhibitors will be Claire Falkenstein of Berkeley (Wall Covering); Maurice Martine of Corona Del Mar (Furniture Design); and Dorr Bothwell and Dorothy W. Liebes of San Francisco (Wall Covering Designs).

URGES CLOSER COOPERATION

John Hancock Callender, New York architect, advocates closer cooperation between merchant builders and architects "to raise the standards of design and construction" of low priced single family homes.

Callender believes that reputable merchant builders are rendering the greatest dollar values possible under today's conditions, but possibly they have not taken full advantage of the advances made in designs and construction built in the upper price brackets by custom builders.

ARCHITECTURAL FIRM MOVES

Morgan Stedman, Furber Libby and Dorothy Gray, architects who practice under the firm name of Stedman, Libby & Gray, have moved into larger offices at 310 University Avenue, Palo Alto, California.

SCHOOL BONDS DEFEATED. A proposed \$83,000 bond issue for the construction of an addition to the Soquel, California, Grammar School was recently defeated by the voters of that city.

Creative Rebellion Under Five Dollars

By DR. M. F. AGHA*

The Modern Movement in Architecture and Decoration was probably born in France, an offspring of fairly whimsical revolt against, what was then called, Academic Stagnation. After a happy and irresponsible childhood, it was exported to Germany, and came back to France as a full-fledged *Weltanschauung*, equipped with an aesthetic code, a social philosophy and an assortment of crusading slogans.

The slogans were dealing with broad issues (urbanism, mass production for the masses, and such) that could be solved only in the distant future; the appetite for new decorative fancies, however, could be satisfied immediately by just pretending that the issues are already solved and by changing the appearance of things accordingly. The changes at the beginning consisted mainly in making old things look new by stripping them of all ornamentation.

The Absence of Ornamentation, as a decorative principle, originally stemmed from the idea that only simple, machine-made things are legitimate in a functional house, the well-known "machine-for-living," and that they have a special kind of machine-made beauty, inconsistent with useless curlicues. It did not take the Old-Time-Moderns long to discover that hand-made things could be given that machine-made look at the cost of a little extra hand work.

Accordingly, wrought-iron railings were covered by plywood to make them look like concrete; carved paneling planed down and pickled to make it look like plywood; in Paris, gilded brass chandeliers and sculptured marble mantels painted white or black, to make them look as if they were not there; in Berlin, vertical Doric columns of the facades torn out and replaced by horizontal bal-

conies, to satisfy the craving for "Horizontalism"; in Vienna and Stockholm, curved chair legs straightened out to please worshippers of the Straight Line; in New York, somewhat later, the brownstone fronts camouflaged by glass brick; and tubular steel chairs built by hand for a limited group of connoisseurs, at great expense, to stimulate the effects of the functional use of the new, low cost, mass production materials that the masses were to enjoy in some happy future.

During this make-believe period the Early Moderns and their *avantgarde* clients had a lot of creative fun, and displayed a lot of decorative imagination, in spite of the avowed solemnity of their convictions and their presumably prosaic, engineering approach to problems.

After the usual thirty-year time lag, their ideas are being put to test in the U. S. A. today. The ideal conditions, that the inventors of Modern would only dream about, are here: large consumer body, (instead of a few aficionados); production facilities equal to any task (instead of imitation machine-work); specialized press, that is eager to get behind any new idea, even if it is thirty years old.

We do not know whether the Originators, in their hearts are very happy about this millenium. The fervor of pioneering, the excitement of battle against tradition have subsided; the Modern Design has settled down to business, with all the levelling-down and all the compromises that this implies; what was a Gesture of Protest, has become a Useful Object Under Five Dollars.

The Moderns always said it would happen sooner or later; they have worked for it and prayed for it; they have made their functional, unornamented, mass-produced, foam-rubber and plastic bed . . . and now they have to lie in it.

VETERANS MEMORIAL SCHOOL. Russell Mills, Reno, Nevada, Architect announces the awarding of a \$360,399 contract to the Walker Boudwin Construction Company for construction of an 11-classroom, auditorium and kitchen grammar school in Reno.

* Dr. Agha, a leader of the international art movement, is Chairman of the Advisory Board and past president of the New York Art Directors Club, Artist, lecturer, and author of monographs on photography, typography, and the graphic arts: from 1928 to 1943, Dr. Agha was art director in chief of *Vogue*, *Paris Vogue*, and *Vanity Fair*. "Creative Rebellion under Five Dollars" was delivered before members of the New York Architectural League and the American Institute of Decorators at a recent dinner meeting in New York.



Maynard L. Parker

TWO GARDENS FROM THE OFFICE OF
THOMAS D. CHURCH, A. L. A.



John C. Robinson



GARDEN OF MR. & MRS. BENJAMIN C. KEATOR
Burlingame, California



SWIMMING POOL TERRACE
THE THOMAS G. FRANCK GARDEN, San Mateo

DOCTORS HOSPITAL

... SAN FRANCISCO



In keeping with the rapid growth and extensive development of the Bay Area, plans have been completed and work started on conversion of the hospital building located at 1065 Sutter Street, San Francisco, into one of the newest and most modern hospitals of the West, to be known as DOCTORS HOSPITAL.

Present plans call for a complete remodeling of the exterior of the building and the installation of a black Vitralite base trim with a green Vitralite facing on the first floor front. The balance of the three and a half story building will be faced with a light green stucco which harmonizes with the green and black Vitralite. The building's interior is to be completely furnished with many of the newest in hospital facilities installed which will add to the convenience of physicians and patients.

Formation of the DOCTORS HOSPITAL Corporation by Dr. S. Nicholas Jacobs, Dr. Albert M. Jacobs, and Dr. Mortimer Weiss brings together three prominent physicians in the management of the hospital which is open to all ethical doctors of medicine and is a member of the Association of California Hospitals, Western Hospital Association, American Hospital Association and is approved by the American Medical Association.

Carrico & Gautier, San Francisco, are the general contractors.

RESEARCH INSTITUTE FOR EARTHQUAKE ENGINEERING IS BEING ORGANIZED

The second meeting of the Advisory Committee on Engineering Seismology was held in San Francisco on the 10th and 11th of February. The Committee was formed to make studies and recommendations for bridging the gap between earthquake research and practical aseismic design of structures. The Committee, of which Lydik S. Jacobsen of Stanford University is Chairman, has a membership representing the following agencies: Structural Engineers Association of California; Structural Engineers Association of Northern California; Structural Engineers Association of Southern California; American Society of Civil Engineers, Seattle, San Francisco, and Los Angeles Sections; Seismological Society of America, California Council of Architects, California Institute of Technology, Stanford University, University of California, California State Division of Architecture, Los Angeles County Regional Planning Commission, City and County of San Francisco, U. S. Bureau of Reclamation, and Departments of the Army and Navy.

Action was taken by the Committee to set up an Editorial Board whose duties are to assemble, correlate, and publish the extant information on engineering seismology. The function of the Editorial Board will be to keep the engineering profession informed on the data and analyses pertinent to the earthquake-resistant design of structures.

The Committee also took action to organize the collection and publication of engineering earthquake data subsequent to any major earthquake. Five destructive earthquakes have occurred in the United States during the past twenty-five years, but the lack of a formal organization for collecting and publishing earthquake data has resulted in incomplete records. The project now being undertaken by the Committee is intended to insure satisfactory coverage of all future destructive earthquakes.

The preparation of a bibliography of engineering seismology and the formation of a Library of engineering seismology literature is also being initiated by the Committee. The purpose is to make pertinent information readily available to the engineering profession.

The most significant action taken by the Committee is the plan for the formation of an Earthquake Research Institute. It was decided that to expedite progress on the problems of engineering seismology it was necessary to have an organization of technical personnel who would devote full time

to such work. The function of such an organization would be to analyze seismic data and make experimental and theoretical analyses with the specific objective of developing safe and economically feasible methods of aseismic design. An Earthquake Research Institute was established in Japan following the destructive Tokyo earthquake of 1923, but until now no active effort has been made to establish one in the United States. The Committee is now studying suitable methods for activating and financing such an organization. Because of the obvious relation between destructive earthquakes and matters pertaining to national defense, this is of considerable interest to the Army and Navy, as well as being of interest to engineers and all persons residing in the major earthquake zones of the United States.

California's Water Supply Is Adequate For Larger Population

By EDWARD HYATT, State Engineer

The total water supply of California is adequate for the needs of a far larger population and greatly expanded agricultural and industrial uses. However, during the past few months California has experienced a striking example of the need for increased water conservation. The cities of Santa Barbara and Ventura in southern California have been forced to restrict the use of water for municipal and industrial purposes.

Governor Earl Warren has been forced to declare an emergency in central California, providing reduced rail rates for the shipment of stock outside of the state and for the importation of feed, and the Public Utilities Commission has been forced to restrict the use of electricity in northern California. All because of shortages in available water supplies. These occurrences have dramatically emphasized the importance of and need for the conservation of all water supplies in California.

The development of the modern, highly complex life of California has been, throughout, closely interwoven with and dependent upon the conservation of the water resources of the state. Over forty per cent of California's crop-producing lands are dependent upon irrigation for their productivity, over seventy per cent of the electrical energy used in California cities and on California farms

(See Page 44)



ARCON HOUSES ON THE SHRUBLAND ESTATES, Great Yarmouth, England

BRITAIN'S LARGEST PREFABRICATED HOUSING ESTATE

By JOAN LITTLEFIELD

Britain's largest temporary prefabricated housing site is situated at Great Yarmouth, a large pleasure and fishing resort on the Norfolk Coast. Shrublands Estate, as it is called, designed by Borough Engineer H. F. Dyson, consists of 711 Arcon Houses, which later will be replaced by permanent dwellings. Grass verges and gardens are a feature of the scheme; trees and shrubs are to be planted in roads already named after them; and permanent shops in blocks of four, with three self-contained apartments above, and two taverns are planned.

Work on the roads of Shrublands Estate began in August 1945, and the last temporary houses

were completed in May 1947. Components were delivered by road from the Arcon distribution center at Beddington near Croydon (London), and at one time forty houses per week were put up.

Tenants come mostly from the bombed areas of Great Yarmouth. They include many veterans and around 1400 children. They have established a club in huts placed at their disposal by the contractors and will later be able to use a community center to be set up on a neighboring permanent housing estate. There have already been several competitions for the best garden.

The Arcon temporary house is a bungalow, with two bedrooms, large living room, lounge hall,

RIGHT: Skilled workmen are shown putting on the roof of one of the ARCON MARK V temporary pre-fabricated houses.



BELOW: Exterior view. Gardens are encouraged and entire site will be landscaped.

bathroom and kitchen fitted with many labor-saving devices.

Built on a solid concrete slab, it has a steel framework consisting of light hot rolled sections, fabricated into panels, complete with steel windows and doors. Purlins and roof trusses are of tubular steel. The external walling consists of two skins of corrugated asbestos-cement sheeting. Each sheet is eight feet high by two feet eleven inches wide. The sheets are butt jointed, but the joints in the outer skin do not coincide with those in the inner skin. The inner sheeting is fixed to the inner wall framework with hook bolts, and the outer sheeting is fixed to the inner sheeting with plastic seam bolts. The roof is made of corrugated asbestos-cement sheeting fixed to purlins and to a return lip on the gutter. Plastic headed bolts with appropriate clips are used for fixing.

The floor consists of framed timber panels, approximately ten feet by three, which span from the sill member of the steel wall framework to a steel spine tee. Screw jacks are built into all wall framework panels and into the spine tee, so that absolute level can be secured. Screw jacks are also incorporated in the floor panel at mid-span, to limit deflection by providing intermediate support. The partitions are timber framed plasterboard faced panels, seven feet five by two feet eleven, the plasterboard being glued to either side of the timber frame. These panels are located at floor level by metal clips nailed to the timber floor, and at ceiling level they are fixed by means of a clip direct to the roof steelwork.

The ceiling is made of timber framed plasterboard faced panels, five feet by four. The plaster-

(See Page 46)



*British Information
Service Photos*



Robert Skelton, Photo

**New Multimillion Dollar Store of I. Magnin & Company, San Francisco
Represents the Ultimate in Store Design and Interior Decor and is
A Great Tribute to the Store's Founder, Mary Ann Magnin, E. John Magnin and the Present
I. Magnin & Company Management, Headed by Grover A. Magnin, President.**

The New I. MAGNIN'S San Francisco

By **EDWIN H. WILDER**

For you who deserve the best the "welcome" sign is out at the new multimillion dollar store of the I. Magnin & Company in San Francisco where a gala opening to the public recently consummated more than two years of construction.

The building is without question one of the West Coast's most striking monuments to today's modified architectural design, and contains every comfort and convenience that modern equipment and materials can contribute to the shopping public.

It also represents a tradition in quality merchandising and is a truly great tribute to Mary Ann Magnin, founder of the store in 1849, to the late E. John Magnin, its President for many years, to Grover A. Magnin, present President of the Company, and to the many loyal employees and management which contributed during the past 99 years in making the institution grow from one of the West's pioneer stores into one of the West's spectacular showplaces.

STAIRWAY TO THE STARS

Glittering in a rich white marble and bronze metallic brightness the stairway at the Stockton Street entrance leads to the immediate Mezzanine Floor.

*(Tampon Vogue)
Studio Photo*





MEZZANINE FLOOR of straight grain bleached oak, lacquered and mirrored. Ample lighting from spacious stairway and indirect, subdued lighting fixtures. Designed for Gift Shop and Beauty Salon.

The imposing Vermont marble exterior structure is the result of modern engineering and construction skill in taking an old building which formerly stood on the site, and tearing it to pieces leaving only those structural steel members and a few other factors to be used again. Re-building is hardly an adequate way to express the process used by the contractors in demolishing the old building and construction of the new for there is little of the old structure incorporated in the gracious new.

To even the most casual observer the outward appearance of the beautiful white marble building is impressive. The massive marble fronting gives the structure an air of strength, permanence, and warmth that reflects true western hospitality, while the show windows on the ground floor and the upper floor windows conform to a pattern of conservativeness broken only by the spacious en-

trances to the main street floor which are located on Geary Street across from San Francisco's famous, historic, and popular Union Square and on Stockton Street, another of the City's busy thoroughfares.

The uniform show windows on Geary and Stockton Streets have been finished in eggshell, top grained, cowhide panels with a gilt bronze trim and offer a striking and pleasing contrast to display windows in the adjacent areas.

Patrons upon entering the store are immediately impressed with the Magnin tradition for an environment befitting the type of merchandise carried in stock. Liberal use of newly developed decorative metals, domestic and imported marbles, liberal use of glass and mirrors, and a complete harmony of color in walls, fixtures and furnishings in a preliminary introduction to the entire design and content of the ten-story building, with its multitude of

. . . I. MAGNIN'S, San Francisco

outstanding service features which have been developed by the store's management in conjunction with many constructive ideas and suggestions volunteered by the more than 1300 employees, to better serve the public.

Behind the scenes that greet the visitor are a multitude of new building materials, new uses of materials which have long been used in the building of buildings, and many long hours of work by skilled workmen who applied their respective crafts in putting together one of the finest structures possible.

Combined with labor's know-how and the proper materials, was the technical knowledge of the various contractors and structural engineers, and the utility and public service needs which were well planned and coordinated by the store's management, in conjunction with the architect.

While there are many outstanding features of

the building, probably of greatest interest is the net result of the combined efforts of everyone who had a part in the construction, as viewed by the visitor to the store.

The first floor with its walls of Rose de Brignole marble which was imported at great expense and considerable effort from France, and its extruded bronze trim, together with five great murals of glass depicting various feminine activities, done by the great artist Max Ingrand of France, and a modeled silver-leaf ceiling, and bronze-framed show cases of decorated glass which was also imported from France, all combine with a floor of pink Tennessee marble to present an exquisite welcome.

The Crystal Room on the first floor is also very startling to the visitor with its trim walls and ceiling of Sea Foam Blue. The floor is of parquetry Cremona marble which was secured and imported with great effort from Italy. The bronze show cases are

THE FIRST FLOOR, inviting threshold of great beauty, looking from the Geary Street entrance towards the elevators. Walls are of Rose de Brignole marble imported from France with extruded bronze trim. Modeled silver-leaf ceiling. Floor of pink Tennessee marble. Bronze framed show cases with decorated glass.



I. MAGNIN'S
San Francisco . . .

THE OVAL ROOM
for
CUSTOM MILLINERY

On the second floor.

It is of extruded bronze and Botticini marble trim, mirrored walls and indirect lighted.

The handmade V'Soske rug is dyed to match the walls.



ELEVATOR
VESTIBULE

Walls are of imported Rose de Brignole marble. The glass mural over doorway is by Mox Ingrand of France and depicts feminine activities.

Pink Tennessee marble floors.

of a highly decorated glass front which also was imported from France. From this location there is an immense staircase of decorated bronze and marble set in a marble pillar and wall combination, that leads to the Mezzanine floor.

Also located on the first floor is the Primavera Room with its paneled walls in modern design of Primavera from floor to ceiling, and here also is located the Laykin et Cie room which has been artistically done in light blue leather panels trimmed with bright nickel silver and a harmonizing marble floor.

The Mezzanine floor is finished in straight grain bleached oak which has been lacquered and mirrored. The Gift Shop is located here and the fixtures and furnishings have been designed in keeping with the objective use of the floor space. Provision has also been made on the Mezzanine for the Beauty Salon.

A battery of eight self-leveling elevators with bronze outer and safety doors operate between the main floor and the tenth floor which has been set

I. MAGNIN & COMPANY San Francisco, California

The following firms, participants in the construction of the new I. Magnin & Company building, have display advertisements in this issue:

Architect: Miller & Pflueger
General Contractor: Dinwiddie Construction Co.
Demolition: Emsco
Gunitite: J. H. Mohr, Inc.
Marble: Vermont Marble Co.
Insulation, Boilers, Piping: Plant Rubber & Asbestos Works
Glass: W. P. Fuller Company
Ornamental Iron: F. Kern & Sons Iron Works
Tile: Donlon Tile Company
Vault Doors: The Hermann Safe Company
Automatic Sprinklers: Viking Automatic Sprinkler Co.
Fixtures: L. & E. Emanuel Company
Furring, Lathing, Plastering: Patrick J. Ruane
Metal Doors: Fordeker Cornice Works
Plumbing: Scott Company
Photographs: Robert Skelton
Tampone Vogue Studios

DEMOLITION

of the exterior walls and interior floor slabs was done by **EMSCO**, 1020 Harrison St., San Francisco.





**THE
SHOE
ROOM**

The panel walls are of top grain eggshell cowhide with a bronze trim. The columns are mirrored and the center light fixture is imported.

aside, for the time being at least, as a combination utility floor for use of the employees as a lunch room, hospital with a nurse's office, the telephone switchboards, an employees' lounge finished in blue leather and chromium fixtures, and a sun deck where employees can take advantage of California's warm sunshine during leisure and rest periods.

In the intermediate floors is a series of interesting and correlated shops, stimulating a feeling of leisure and luxury in dignity that is of every convenience to the customer and even inspirational in its thoroughness. Soundproofing has been installed

in the luxurious fitting rooms, and deep soft carpets in many parts of the store complete a most peaceful atmosphere which reduces fatigue to a minimum.

The second floor is another delight which has been done in an eggshell motif with attractive bronze trim and here is located the Shoe Room, attractively decorated in top-grain eggshell cowhide with bronze trim. A unique semi-private evening slipper alcove has been added to the customer facilities of the second floor and here, too, in a setting of extruded bronze and Botticini marble trim, is the Millinery Room.

*To Protect their Magnificent
San Francisco Store against
FIRE —*

I. MAGNIN & CO. chose

Viking Automatic Sprinkler Co.

580 Market Street
San Francisco
EXbrook 2-6290

2715 E. 12th St.
Los Angeles
ANgelus 7191

**ORNAMENTAL IRON
BRONZE AND MISC. IRON**

— ALUMINUM WINDOWS —
in the construction of the new
I. MAGNIN & CO. BUILDING

installed by

F. KERN & SONS IRON WORKS

517 - 6th Street

EXbrook 2-7837



DURING EARLY CONSTRUCTION

Many of the most modern processes, and materials, were applied to the reconstruction of the I. Magnin store in San Francisco.

Here a workman is shown using a cement gun to apply an adhesive coating to structural surfaces of the building.

The Oval Room is of the same general design but has the added attraction of a handmade V'Soske rug dyed to match the walls. The Neglige and Boudoir Apparel Room with its attractive bronze and bright mirrored trim and cozy alcoves of modeled Camellias complete the diversified store facilities of the second floor.

On the third floor to further stimulate appeal and for sheer drama in modern store furnishings there is a wall-to-wall Recamier rose carpeting. Here there is a spreading out of the rooms with the unusual Oval Room and its large columns of highly decorated mirrors again representing the artistic work of France's famous Max Ingrad. The huge chandeliers which are suspended from the ceiling are of cast Orrefors glass and have been imported from Sweden. These delightful fixtures spread a soft light of evening atmosphere for the selection of evening dresses. The Baroque Room, also locat-

GENERAL
CONTRACTOR
for the new
I. MAGNIN & CO.
BUILDING - SAN FRANCISCO

•
**DINWIDDIE
CONSTRUCTION
COMPANY**

•
CROCKER BUILDING
SAN FRANCISCO



NEGLIGEE

The Negligee and Boudoir apparel room has a bronze and mirror trim, with the alcoves of modeled Camellias. Carpeting to match, and lighting indirect.

ed on the third floor, is graced with intriguing chandeliers of hand carved Honduras mahogany which was imported and has been sprayed chalk white to give it a most brilliant effect. The Custom Room, with its ethereal painting of the "Dove Maiden" by the famous Tommy Theurekauf, is wrought with a Fragonard like charm and yet has a very definite modern appeal.

The Fur Room is another complete delight with its sheer pearl grey draperies of nylon gauze which has been placed over white water glass.

INSULATION OF AIR CONDITIONING DUCT — BOILER INSULATION — STEAM LINES — HOT AND COLD WATER PIPING

in the new **I. MAGNIN & CO.** BUILDING, SAN FRANCISCO

INSTALLED BY

PLANT RUBBER & ASBESTOS WORKS

537 BRANNAN STREET

SUTTER 1-2100

VAULT DOORS

for the new

I. MAGNIN & CO. BUILDING

San Francisco -

INSTALLED BY

THE HERMANN SAFE CO.

SINCE 1889

Howard and Main Streets

Garfield 1-3041

San Francisco

Distinctive

TILE INSTALLATIONS

by

DONLON

TILE COMPANY

24 - 12th Street Market 1-1222

in the new

I. MAGNIN & CO.

BUILDING - - SAN FRANCISCO



LEFT: The leather panels in the second floor Shoe Department are ingeniously held together without nails, screws or tacks, by a single secret panel which interlocks all the others.

BELOW: Parquet floorwork in fifth floor cases shows the extraordinarily rich color variations possible with California burl walnut.

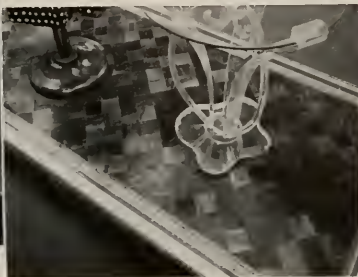

BELOW: The architect's conception of a semicircular treatment of the fourth floor sweater and lingerie display has been executed with spectacular beauty. All detailing and manufacturing of the intricate cabinet and fixture work was done in the Emanuel plant.



"PERFECTION IS NO TRIFLE, BUT TRIFLES MAKE PERFECTION"

That is the keynote of all Emanuel cabinet, fixture and interior woodwork. That which the architect or designer has in mind, we carry out to the last degree of perfection. Examples of our workmanship may be seen in the showcases, counters, fixtures, fitting rooms, paneling and other woodwork throughout the magnificent I. Magnin store.

L. & E. EMANUEL, INC.

General Contractors and Manufacturers of
Fine Wood Products

1485 Bayshore Avenue

San Francisco



ABOVE: Cabinet work is an integral and essential part of the architecture throughout the entire Magnin building.



LEFT: The Emanuel plant. After 91 years in cabinet and fixture work, we now occupy one of the finest plants of its kind in the West. Our dry kilns handle more than six hundred thousand board feet of lumber every month.



**SHOCKING
PINK**

Is this third floor room.

Ceiling lighting is made part of artistic design, while decorated glass column and pink rug are all combined into harmonious setting.

The large glass lighting fixture suspended in the center of the ceiling is imported.

- PLASTERING
 - FURRING & LATHING
- for
I. MAGNIN & CO.
new building — by
PATRICK J. RUANE

44 SAN JOSE AVENUE
SAN FRANCISCO 10

White Marble Lends Beauty to Building Design



NEW HOME OF I. MAGNIN & CO., SAN FRANCISCO

Timothy L. Pfluger, Architect

Dinwiddie Construction Co., Builders

IMPERIAL DANBY VERMONT MARBLE

DOMINATES THE EXTERIOR WHILE A VARIETY OF MARBLE TEXTURES GIVE WARMTH, COLOR AND RICHNESS TO THE INTERIOR. IMPERIAL DANBY VERMONT MARBLE QUARRIED, FABRICATED AND ERECTED, AND INTERIOR MARBLE FINISHED AND INSTALLED BY

VERMONT MARBLE COMPANY

525 MARKET STREET
SAN FRANCISCO 5

3522 COUNCIL STREET
LOS ANGELES 4

I. MAGNIN'S, San Francisco...

The fourth floor has been done in Blush Rose walls trimmed in a straight grain oak which has been bleached and lacquered. The furniture and fixtures of this floor are in keeping with the sports theme of the merchandise displayed here, and is richly covered with printed raw silk strongly resembling chintz. Individual shops on this floor have been designed to flow continually into each other, which creates an impression of contained completeness.

On the fifth floor, arrangements and planning have devoted the entire facilities to women's apparel. The floor has been done in a color scheme of flesh pink walls with a definite American walnut trim. The Powder Room contains several wall murals over a silver leaf and the ceiling has been done in sky blue, with Vert Issorie marble and marble trimmed with Crema marble from Italy and attractively decorated mirror doors adding to the appearance of the room. The plumbing and fittings are of gold plate and the ceiling is of gold leaf.

The sixth floor continues a continuity of color in walls and furnishings and emphasizes a scheme of mode and rose synonymous with junior miss and young women's interests. The seventh floor

is finished in an appropriate setting for a children's shop, and here again, convenience and comfort have been paramount factors in the arrangement of the facilities.

On the eighth floor the arrangement has been definitely designed to serve the executive and business offices of the store. Partial wood and glass partitions with exposed overhead set aside many departmental activities, while other portions have been modeled into individual offices, conference rooms, and private offices.

The ninth floor provides ample facilities for the various work-shop departments, alterations, cleaning and pressing, inspection, and other service workrooms.

The basement has been set aside for employees' lockers, an employee auditorium, fur vaults, miscellaneous repair departments, and the sub-basement, which has an entrance on the Stockton Street side for the use of trucks and delivery vehicles, is utilized for the receiving of merchandise and supplies, the shipping department, merchandise marking, the engineer, merchandise delivery and other general utility uses.

GUNITE

for the

I. MAGNIN & CO.
BUILDING - SAN FRANCISCO

by J. H. MOHR, Inc.

PAINTERS • DECORATORS

1685 KANSAS STREET
VALENCIA 4-1360
SAN FRANCISCO 10

SAND BLASTING • CEMENT GUN WORK • PLASTIC COATING

A. I. A.

American Institute



ACTIVITIES

of Architects

Arizona Chapter:
James Macmillan, President; Arthur T. Brown, Secretary,
740 N. Country Club Road, Tucson, Arizona.

Central Valley of California:
Herbert E. Goodpastor, President; Frank V. Mayo, Secre-
tary, 307 Exchange Building, Stockton 2, California.

Colorado Chapter:
Raymond H. Ervin, President; James M. Hunter, Secretary,
2049 Broadway, Boulder, Colorado.

East Bay Chapter:
A. Lewis Kouse, President; James H. Anderson, Vice-Presi-
dent; Loy Chamberlain, Secretary; Chester H. Treichel,
Treasurer, Office, 3833 Piedmont Ave., Berkeley, California.

Montana Chapter:
Ralph H. Cushing, President; H. C. Cheever, Secretary,
Montana State College, Bozeman, Montana.

Northern California Chapter:
Wm. Clement Ambrose, President; Lester W. Hurd, Vice-
President; Ralph N. Pollock, Secretary; Donald Beach
Kirby, Treasurer; Office 369 Pine Street, San Francisco.

Oregon Chapter:
Frank Roehr, President; Sidney W. Little, Vice-President;
J. Holman Barnes, Secretary; Don Edmundson, Treasurer,
Office 619 Builders Exchange Bldg., Portland 4, Oregon.

San Diego Chapter:
H. Louis Bodmer, President; Louis J. Gill, Secretary, 203
Grandge Building, San Diego, California.

Santa Barbara Chapter (California):
Chester L. Canola, President; Robert I. Hoyt, Secretary,
116 E. Solo St., Santa Barbara, California.

CALIFORNIA COUNCIL OF ARCHITECTS
Andrew T. Hass, President; Adrian Wilson, Vice-President;
Malcolm Reynolds, Secretary-Treasurer; Office 369 Pine
Street, San Francisco.

Southern California Chapter:
George Allison, President; A. C. Martin, Jr., Vice-President;
Anthony Thermin, Secretary; George E. Gable, Treasurer;
Chapter Headquarters, 3757 Wilshire Blvd., Los Angeles 5,
California.

Spokane Chapter (Washington):
Noel E. Thomson, President; Kenneth D. Stormont, Secre-
tary, Hutton Building, Spokane, Washington.

Utah Chapter:
George Cannon Young, President; Theodore R. Pope, Secre-
tary, 29 South State Street, Salt Lake City 1, Utah.

Washington State Chapter:
Clifton J. Brady, President; Arrijo M. Young, Vice-Presi-
dent; John Richards, 2nd Vice-President; Ralf E. Decker,
Secy; Waldo B. Christensen, Treasurer, Office 1411 Fourth
Avenue Building, Seattle 1, Washington.

Tacoma Society:
Chas. Rueger, President; Clarence Rueger, Vice-President;
W. W. Durham, Secretary-Treasurer.

Hawaii Chapter:
Kenneth W. Roehrig, President; James Morrison, Secretary,
334 Federal Bldg., Honolulu, T. H.

WASHINGTON STATE CHAPTER

The regular March meeting was held in the En-
gineers Club, Seattle, with a talk by Thomas H.
Williams, co-partner of the Northwest Laboratories,
on the subject of the "Value of Curiosity," in which
he analyzed his subject. Williams spent quite some
time in Chemical research in Dayton, Ohio.

CORPORATE MEMBER. Alvin S. Erickson,
Washington State College '29, with offices in
Wenatchee.

ASSOCIATE MEMBERS. Kenneth S. Ripley, Carl
F. Gould, Robert A. Floren, John S. Detlie, and
Robert H. Dietz.

Barrie D. Branch has become a **JUNIOR ASSO-
CIATE**, and Richard A. Nelson and Robert J. An-
derson have become **STUDENT ASSOCIATES**.

**CHARLES RUEGER of RUEGER & RUEGER Archi-
tects**, has been named president of the Tacoma
Society for the ensuing year. Clarence Rueger, of
the same firm, was named vice-president, and W.
W. Durham re-named secretary-treasurer. Meet-
ings are held on alternate Fridays.

A new **ROSTER of ARCHITECT'S OFFICES** has
been issued and many compliments received for
the fine work.

SOUTHERN CALIFORNIA CHAPTER

The regular March meeting, held in the Renais-
sance Room of the Biltmore Hotel, was one of the
social events of the year and honored the architec-
tural firm of Greene & Greene. Myron Hunt, Chair-

man of the meeting, introduced Charles S. Greene
and Henry M. Greene, two of Southern California's
noted architects, and a brief discussion of their
work followed. Climax of the evening was the

(See Page 35)

FOR BETTER SERVICE

Remember that

KRAFTILE is WESTERN HEADQUARTERS

FOR

- ♦ ACID Brick
- ♦ GLAZED Structural Wall Units
- ♦ ACID-PROOF Jointing Compounds
- ♦ PATIO Tile
- ♦ ACID-PROOF Floor and Tank Construction
- ♦ QUARRY Tile
- ♦ ACID-PROOF Coatings
- ♦ SWIMMING POOL Overflow Gutter
- ♦ LIGHTWEIGHT CONCRETE BLOCKS



♦ QUONSET Packaged Steel Buildings

♦ STRAN-STEEL Framing

For complete information and prompt service, phone or write

KRAFTILE COMPANY

NILES, CALIFORNIA NILES 3611
SAN FRANCISCO 5: 30 Hawthorne St.—DUGLASS 2-3780
LOS ANGELES 13: 406 South Main Street—MUTUAL 7241

WITH THE ENGINEERS

Structural Engineers Association of Northern California

John A. Blume, President; Jesse Rosenwald, Vice President; Franklin P. Ulrich, Treas.; Geo. E. Solnar, Jr., Sec.; Wm. H. Popert, Consultant; Office, Room 713, 57 Post St., San Francisco 4. Phone SUtter 1-5474. DIRECTORS, A. W. Anderson, Henry J. Deegenkolb, John E. Rinne, Robert D. Dewell, and Wm. W. Moore.

San Francisco Section

L. A. Elsener, President; A. W. Earl and G. B. Woodruff, Vice-Presidents; John E. Rinne, Secretary-Treasurer; 225 Bush Street, San Francisco 20.

Structural Engineers Association of Southern California

Steve Barnes, President; Harry W. Bolin, Vice President; Lewis K. Osborn, Sec.-Treas. DIRECTORS, Richard W. Ware, Geo. E. Brandow, L. T. Evans, Harold P. King, and Donald F. Shugar. Office: 202 Architects Bldg., Los Angeles 13, Calif. Puget Sound Engineering Council (Washington)

R. E. Kister, A. I. E. E., Chairman; E. R. McMillan, A. S. C. E., Vice Chairman; L. B. Cooper, A. S. M. E., Secretary; A. E. Nicholson, I. E. S., Treasurer; Offices, L. B. Cooper, c/o University of Washington, Seattle 5, Washington.

STRUCTURAL ENGINEERS ASSOCIATION OF SOUTHERN CALIFORNIA

About 180 engineers attended the Structural Engineers Association February meeting held in Los Angeles.

The evening was given over to a discussion of building regulations with particular reference to the Los Angeles City, Los Angeles County and Uniform Building Codes.

President S. B. Barnes presided at the meeting with Chuck Corbit as program Chairman.

Keynote of the meeting was the fact that building codes are intended for protection of public safety. Rowland Cravens, Chief of the Mechanical Inspection Division of the City of Los Angeles and con-

sultant to the Pacific Coast Building Officials Conference, presented and explained the procedure to be followed to effect changes in the uniform building code. The changes which have been approved as of the last Convention of the P.C.B.O.C. covered, among other things, provisions making possible the construction of large area modern type buildings in connection with industrial uses, airplane hangars, etc. Mr. Cravens explained that the uniform building code for Los Angeles City could now have identical requirements for seismic design. Some of the important changes in the uniform building code have reference to stairway enclosures for hotels and apartments over two stories in height. Important emphasis has been placed upon improved foundation design.

Fred Andres, representing the Los Angeles County Department of Building and Safety, discussed the pending revisions in the 1948 edition of the Los Angeles County code. This code will be available in the late spring and will consist of the 1946 uniform building code with the approved changes through the 1947 convention. Among the provisions which will be adopted will be the new requirements for plain and reinforced masonry as proposed in the Los Angeles City code and as recommended by the Structural Engineers Association's Building Code Committee. Mr. Andres stressed the fact that they were attempting to use the same wording as used in the Los Angeles City Code to assist in bringing about uniformity. A new chapter covering prefabricated construction has been added.

John Monning, secretary of the Board of Building and Safety Commission, City of Los Angeles, gave a brief review of the status of the Los Angeles City code. Monning stated that it was mandatory that the City building code be modernized each year. Suggested changes to the code are accumulated from various sources and correlated and then presented to impartial technical committees for review. The rough draft is then made and copies again made available to industrial committees and

Paddock *Swimming Pool* Services to Architects

Standard pool plans.

Cost data.

Permanent exhibit of pool equipment, finishes, trims, accessories, and fittings.

Mechanical and structural specification service.

Swimming pool literature for clients on pools, filter plants, chlorinators, and pool accessories.

New Paddock equipment catalog now in preparation. May we reserve a copy for you?

28 Years of INTEGRITY in Fine Pool Construction

Paddock Engineering Company

Southern California Office
8400 Santa Monica Blvd.,
Los Angeles 46—Hempstead 2315

Northern California Office
Seventh and Bay Shore Blvd.,
San Mateo—San Mateo 3-1859

trade associations for criticism. After reviewing the recommendations and criticisms, there is a public hearing at which time interested parties are appointed to thoroughly discuss the proposed changes. The code material is then placed in final form and is acted upon by the Building and Safety Commission after which it goes to the City Council, then to the City Attorney's office for final drafting after which it is again passed by the Board of Building and Safety Commissioners and finally acted upon by the City Council where it undergoes two hearings. The amendments are then signed by the Mayor and become effective thirty days thereafter. Mr. Monning stated that the new revisions to the City Code will be available in the late spring and will include a complete rewriting of the chapter on masonry and will also include new provisions covering fire proofing.

CALIFORNIA CIVIL SERVICE EXAMINATIONS

Final filing date for the examination of Assistant Safety Engineer (Industrial), State of California, will be March 27, with the examination date April 17, 1948.

Filing final for the position of Assistant Safety Engineer (Construction) has been set for March 27 with the examination on April 17, 1948.

Both examinations will be given in Sacramento, San Francisco, and Los Angeles.

Salary range for both positions is \$325 to \$395.

ENGINEER NAMED TO NATIONAL COMMITTEE

Akan E. Flonigan, Assistant Professor of the department of engineering at the University of California at Los Angeles has been appointed to the national finance committee of the Institute of Metals.

The Institute of Metals is a division of the American Institute of Mining and Metallurgical Engineers.

AMERICAN SOCIETY FOR METALS PUGET SOUND CHAPTER

Recent advancements in some of the fields of metallurgy were discussed by Mr. G. L. von Planck, Chief Metallurgist of Columbia Steel Company, San Francisco, California, before the Puget Sound Chapter of the American Society for Metals at the February meeting.

He mentioned the developments in high temperature alloys, especially the improvements in their fabrications. Adjustments made in their chemical composition, the difficulties encountered in rolling and forging of some of these alloys have been considerably reduced. Precision casting by the lost wax process has proved to be a decided advantage where other means have been found im-

How a thoughtful builder leaves his mark



That built-in telephone outlet is the stamp of a careful builder. He added conduit and outlets while the home was under construction. The cost was insignificant . . . just a few pieces of tubing leading to convenient telephone outlets provide raceways for telephone wire.

Clients appreciate thoughtfulness like



this. With built-in telephone facilities, telephones can be moved or added in the future without drilling holes or running wire along baseboards. Just a small detail . . . but a careful builder thinks of it.

for free help in planning modern, built-in telephone wiring, call your local telephone company office and ask for "Architects and Builders Service."

The **Pacific Telephone**
and Telegraph Company





MODERN DEPENDABILITY

YOU assure modern dependability in drinking water facilities when you specify *HAWS* Fountains. Simple maintenance, lasting durability and complete sanitation means real client-satisfaction. And your recommendations are backed by the reputation of a company which has built superior drinking fountains since 1909. Write for complete information, today.

HAWS DRINKING FOUNTAINS

HAWS DRINKING FAUCET CO.
 FOURTH and PAGE STREETS (Since 1909) BERKELEY 2, CALIFORNIA
 Agents and Sales Representatives in All Principal Cities



practical. Powder Metallurgy has shown real promise in this field and has proven its worth in other fields such as the production of bushings, bearings, gears, pinions and similar parts.

Mr. vonPlanck spoke of the many advancements in the metallurgy of welding. The lessons learned in the design of welded ship construction from research into the causes of the failure of some of the first all welded ships were discussed. The importance of the transition temperature from shear fracture to cleavage type fracture in notch impact testing as applied to ship construction was pointed out. Rimmed steel has the highest transition temperature (the temperature for a one inch notched specimen is approximately 80° F) followed by semi-killed steel, silicon killed steel, with the lowest temperature being that of aluminum killed steel. An attempt was made at one time to change the type of steel used for ship construction from semi-killed steel to a fully killed steel, but this was stopped due to the decreased production that would result.

The speaker stated that design along with the best welding technique were used to eliminate the conditions which were responsible for the higher transition temperatures of the semi-killed steels.

Recent progress in tin plating was another point of interest. The research which resulted in control of pores in tin plating has practically eliminated spoilage in canned foods. The development of very thin coatings for use on containers such as coffee cans has resulted in considerable savings.

In conclusion Mr. vonPlanck touched on a number of other interesting developments. Much progress has been made in the field of enameling steels, strong deoxidizers have been tried with success for the control of blistering. Lower temperature enamels have also been brought forth resulting in less warpage of the baked parts. Stainless clad steels are being widely used. Stainless W a precipitation hardening alloy has shown some very interesting high strength properties. The continuous galvanizing of steel sheet of various thicknesses which is bonded sufficiently to withstand severe forming operations is another achievement.

HOSPITAL WARD BUILDING

Victor A. Kaufenberg, general contractor of Martinez, California, has been awarded a contract for construction of a 50-bed addition to the Contra Costa County Hospital at Martinez to cost \$59,960. E. Geoffrey Bangs, San Francisco, is the architect.

SWIMMING POOL. The City of Redding, California, recently awarded a contract to J. P. Brennan of Redding for the construction of a swimming pool and change house to cost \$127,855.

A.I.A. ACTIVITIES

(From Page 31)

presentation of a special award by the Chapter which was received by Henry M. Greene for his firm.

Greene & Greene have held a leading position in domestic Architecture for the past fifty years and some of the best early work in Pasadena was that of Greene & Greene. So much interest has been developed in their work that a book is under preparation for use of students and others interested in California architecture.

An exhibition of photographs and drawings of buildings designed by Greene & Greene were also a part of the program.

* * *

President Allison has named the following Committee Chairmen to serve for the ensuing year: Chas. Fry, Membership; Henry F. Withey, Chapter By-Laws; Walter L. Reichardt, Architectural Comptitions; Welton D. Becket, Investment Advisory; Gregory Ain, Technical and Materials; Maynard Lyndon, Fee Standards; C. Day Woodford, Legislation; Lester H. Hibbard, Building Codes; Roy Lippincott, Examination; Olive Chadeayne, Lectures; John J. Landon, Meetings and Program; Eugene Weston, Jr., Civic Center; Paul O. Davis, Architectural Education and Registration; Graeme Joseph, Press and Public Relations; and Theodore Criley, Jr., Bulletin.

* * *

NEW MEMBERS. Twenty-seven new Institute Members, Associates and Junior Associates have been added to the Chapter since November, they include: INSTITUTE MEMBERS, Clifford A. Balch, John J. Kewell, Richard M. Day, Ernest L. McCoy, Cornelius M. Deasy, Arthur L. Minasian, Wm. M. Garton, Raymond R. Shaw, Jay Ellsworth, Clarence J. Smale, George J. Lind, Wilfred Tunstall, George M. Lindsey, Mary F. Knee, Charles M. Hutchinson, Allred Prescott, and Raphael Soriano. ASSOCIATE MEMBER, Robert G. Johnson, and JUNIOR ASSOCIATES, Carlos D. Arguellas, Albert Zuckerman, May C. Callas, Charles H. Jones, Glenn R. Cook, Edward B. Ulrich, Jr., Wynn H. G. Read, Howard van Heuklyn, and Howard B. van Heuklyn.

NORTHERN CALIFORNIA CHAPTER

Wm. Clement Ambrose was elected President of the Northern California Chapter of the American Institute of Architects, at the annual meeting, succeeding Hervey Parke Clark. Lester W. Hurd was re-elected Vice President; Ralph N. Pollack was renamed Secretary, and Donald Beach Kirby was named Secretary.

Directors elected were: Wilbur B. Pugh, John

(See Page 39)

WHO BENEFITS FROM ADEQUATE WIRING?

The presentation, over a period of years, of the merits of "electrical living" has made it synonymous with "better living" in the minds of the public. But, unless homes are adequately wired, the owners are due for disappointment and limitations in the use of electrical appliances and lighting equipment.

The architect who thoughtfully provides wiring adequate for efficient and economical operation of all electrical equipment . . . now and for years ahead . . . is sure to benefit from satisfied clients.



The Adequate Wiring program in operation in Northern California offers the architect a wiring layout service, to aid him in furnishing his clients with complete electrical plans and specifications . . . without obligation to the architect or his clients. For detailed information, consult your local utility office or this Bureau.

NORTHERN CALIFORNIA ELECTRICAL BUREAU

1355 Market Street

San Francisco 3

BAXCO
CHROMATED ZINC CHLORIDE

CZC

**PRESSURE TREATED LUMBER
● PROTECTS AGAINST DECAY
AND TERMITE ATTACK**

*Specify it in your home
Available through Lumber Dealers*

LOS ANGELES 601 W. 5th Street Phone Michigan 6294	SAN FRANCISCO 333 Montgomery Street Phone DOuglas 2-3883
--	---

J. H. Baxter & Co.

AGENTS FOR WEST COAST WOOD PRESERVING CO. SEATTLE, WASH.

HEADLINE NEWS AND VIEWS

By E. H. W.

The San Francisco Park Commission has authorized the construction of a "High Diving Tower" at the Fleichhacker Swimming Pool to cost \$12,765. Twelve thousand dollars should put quite a tower into the sky—perhaps the solution, and saving of taxpayers money, would have been to put a diving board on the nearby Golden Gate Bridge.

"Intelligent human beings, who have mastered many of the greatest forces of nature, have not yet mastered themselves. They have failed in reconciling the greatest force of all—human relationship": —Earl O. Shreve, President, Chamber of Commerce of the United States.

It is estimated that costs of construction have risen more than 100% over their levels of 1940, yet wholesale commodity prices have risen much higher.

The 1948 American Red Cross drive for funds will get underway during March. This is your annual opportunity to do your part to assist an organization which is seeking \$75,000,000 to carry on its disaster relief work.

In connection with teachers salaries, if there is any connection, the American Society of Civil Engineers advocates "a formula which applies slide-rule precision to the grading of teachers":—Oh, hum, no more apples?

A contractor tells us that "so much public attention has been centered on Black Market operators in the building materials business that they are seeking to hide under the guise of 'grey market' expeditors":—Black or Grey, they still add to the cost of building.

The opening paragraph of a publicity release says, and we quote, "How home owners can own their own home and pay off the mortgage in half the time it would ordinarily take, while saving money besides . . .":—We wonder too.

Here's a new point of view. "Engineering administration of the Marshall Plan to keep it unfettered by 'the cheap and tawdry shackles of political bias' " was recently advocated by William L. Batt, wartime vice-chairman of the War Production Board. Batt is a gentleman of no small experience in political know-how, he was one of those on the "inside" while most of us were on the "outside".

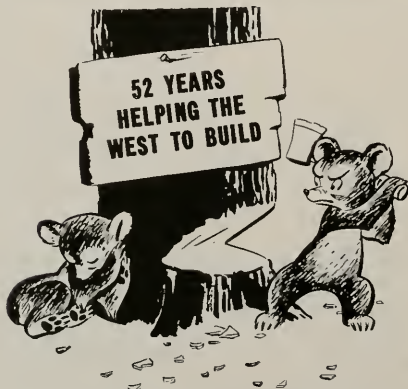

E. K. WOOD LUMBER CO.

SAN FRANCISCO General Offices: No. 1 Drumm Street
LOS ANGELES Office and Yards: 4710 S. Alameda St. — JE 3111
OAKLAND Yards and Wharves: 2111 Frederick St. — KE 4-8466
PORTLAND Mill Sales Office: 827 Terminal Sales Bldg.
SAW MILLS: Roseburg, Oregon • Reedsport, Oregon
RETAIL YARDS: LOS ANGELES • OAKLAND • ONTARIO • HOLLYWOOD
 LONG BEACH • RIVERSIDE • TEMPLE CITY • SIERRA MADRE • INDIAN WELLS • THERMAL
 LA VERNE • WHITTIER • PASADENA • SAN PEDRO

IN THE NEWS

WORLD TRADE CENTER BUILDING. The San Francisco World Trade Center Authority is contemplating the construction of a 40-story, reinforced concrete and structural steel building at an estimated cost of \$15,000,000.

BOXING ARENA

James Pinoli, Santa Rosa, California, has been awarded a general contract for the construction of a roller skating and boxing arena on the Redwood Highway south of the city of Santa Rosa.

The building will be a 1-story frame and stucco construction, 80x180 feet, and will cost approximately \$55,000.

NEW FIRE HOUSE. Architect Harry J. Devine, Sacramento, announces the immediate construction of a \$71,986 fire house for the city of Sacramento. Chas Guth, Sacramento, is the general contractor.

NEW GRAMMAR SCHOOL. Architects Swartz & Hyberg, Fresno, announce the awarding of a general contract to A. R. Liner, Contractor, Merced, California, for the construction of a new grammar school at Modesto. Cost \$288,405.

KRAFT PAPERBOARD. Merritt-Chapman & Scott Corporation of New York City has been awarded contract for construction of the Kraft Paperboard & Wallboard Mill, Building and Machinery near Sacramento, California at an estimated cost of \$17,000,000.

COUNTY HOSPITAL BUILDING. James P. Morton, Contractor, Placerville, California has been awarded contract for construction of El Dorado County Hospital Building Unit No. 1 at a cost of \$194,235. Harry J. Devine, Sacramento is the architect.

ARCHITECTS Bamberger & Reid of San Francisco have been selected to plan a new grammar school for the Novato (California) Elementary School District.



THE ROCKET... Luminous ring luminaire that approaches the perfect incandescent lighting fixture. Open concentric rings provide adequate shielding with no place for dust to accumulate.

Mfd. under Silvray patent
No. 2303747

A Western Institution

A COMPLETELY EQUIPPED PLANT for the development
and production of improved lighting equipment
... using better materials in construction ... to bring
you lower maintenance cost. Located to serve
the eleven Western States foster by reducing distance
... and more economically by reducing freight
charges. Look for the Smoot-Holman label.

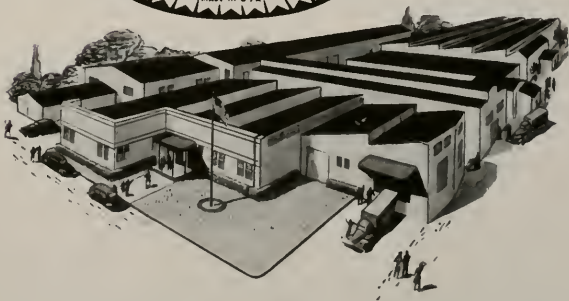

Offices in Principal Western Cities—Branch and Warehouse in San Francisco

LANDSCAPE ARCHITECTURE

Notes of The Profession

ASSOCIATION OF LANDSCAPE ARCHITECTS, SAN FRANCISCO REGION

Vernon Dean, President; Robert Royston, Vice-President; Ned Rucker, Treasurer;
E. L. Anderson, Secretary, 1736 Franklin, Oakland, California.

A special committee from the Association of Landscape Architects, composed of Ted Osmundson, Chairman; William Seabury, E. L. Anderson, and Robert Babcock, has collaborated with a committee from the East Bay Chapter of A.L.A., composed of Oscar Price, Chairman; Paul Hammarberg, Chester Treichel, in the design and execution of a highly successful exhibit at the California Spring Garden Show. Other cooperating organizations in the exhibit are East Bay Association of Architects, Keith Ponsford, Chairman; the Women's Architectural League; and the Brick Manufacturers Association.

* * *

The firm of Eckbo, Royston & Williams, and the firm of Thomas D. Church are exhibiting plans and sketches at Harvard and Oregon Universities at the request of these schools.

* * *

John Gregg, Professor Emeritus of Landscape Design at the University of California, is now in private practice, with a studio in his home. He is engaged in developing plans for several important projects.

* * *

Ari Inouye has moved his offices to 2063 Mountain Boulevard, Room 7, Oakland 11.

* * *

Howard Gilkey will conduct a tour to the Hawaiian Islands. The group of 30 people will leave San Francisco May 12 on the liner Lurline, and will return June 3. The tour is to include a study of the Hawaiian flora and gardens.

Mr. Gilkey is, as usual, the designer of the highly successful Spring Garden Show. Fifteen or more Landscape Architects of the region have taken part in the Show this year.

"WESTERN WOODLANDS" THEME OF CALIFORNIA SPRING GARDEN SHOW

The California Spring Garden Show, scheduled for opening in Oakland, California, on April 27, will feature a forest theme entitled "Western Woodlands."

Howard Gilkey, architect and designer for "Western Woodlands" declares this year's show will include exhibitors from a number of garden

clubs and horticulturists in other states. The latest blooms on the market will be displayed for both the amateur and the professional grower.

The size and scope of the California Spring Garden Show this year necessitated additional space to such an extent that the organization board of directors arranged with officials of the City of Oakland for the rental of the Oakland auditorium arena in addition to the exposition building used during the past several years. "The Hall of Flowers" a new show feature, will be used to house flower and table arrangements where noted artists will display; unique cut flower exhibits will be shown, and a new and varied assortment of garden furniture and wedding settings will be shown.

The main theme exhibit "Western Woodlands" will be seen in the exposition building where exhibitors are required to conform to theme. At the west end, placed in spectacular setting, will be a towering waterfall plunging from the ceiling, spiraling down over rocky crags to a winding brook below. Arched over the brook for dramatic vantage point will be "Overlook Bridge" where the visitor may stop for a panorama of the massed trees and flowers.

Deeply forested, the Show will use three giant redwood trees, supplemented by 50 second growth redwoods in contrast to more than 500 cedar and sycamores. Here and there heavily laden boughs of moss will drape over the richly grouped beds of blooms, more than 1000 in variety.

COLUMBIA STEEL COMPANY SELLS PROPERTY

The United States Steel Supply Company of Chicago, Illinois, has purchased the warehouse and facilities in San Francisco formerly owned by the Columbia Steel Company, at 1940 Harrison Street.

L. B. Worthington, president of the purchasing company, announced that Clifford W. Lord will be the company's district manager of properties in San Francisco and Los Angeles. The San Francisco property will be under the direct supervision of Frank B. Stewart.

A.I.A. ACTIVITIES

(From Page 35)

Lyon Reid, and Gifford E. Sobey.

In his annual report to Chapter Members, President Clark pointed out the many activities of the Chapter during the past year and the increasing interest in membership. While the year was one of postwar readjustment in many respects, considerable progress in developing a better understanding between Architects and the construction industry and the public was made.

A number of inter-regional meetings were held and two new Chapters, the East Bay Chapter and the Coast Counties Group of the Northern California Chapter, were formed.

Reports of committees also indicated a wide scope of interest and activity.

* * *

A recent membership report indicated that despite a reduction in members due to the formation of the East Bay Chapter, there are still more than 216 Corporate, Associate and Junior members in the Northern California Chapter, A.I.A.

* * *

The WOMEN'S ARCHITECTURAL LEAGUE have planned a Home Tour as part of their 1948 educational program.

* * *

Protests have been registered with San Francisco's new superintendent of schools against the city's announced policy of deducting one-half of one per cent from the Architect's fee on each school to be designed. The deduction would be paid to a newly selected co-ordinator of the City's school building program.

* * *

Of interest to the Northern California architects is the fact that this Section now has a full time investigator and special agent. His primary duties are enforcement of the Architects License Law and investigation of complaints against illegal practice.

NEW SCHOOL OF ARCHITECTURE UNIVERSITY OF ILLINOIS

The Chicago Undergraduate Division of the University of Illinois was established at Navy Pier as a part of the program of the State to meet its shore of the national emergency in higher education resulting from the overwhelmingly increased demand, primarily by veterans, for instruction at the University level.

Architecture and architectural engineering curricula, a part of the College of Fine and Applied Arts, is offered under the College of Engineering. Courses of instruction are identical with those available in similar fields of undergraduate work, and admission requirements are the same.



FAST RECOVERY WITH SPARTAN

Gas is faster and costs less, but in the SPARTAN, gas reaches its peak of efficiency. A double extra heavy boiler with three flues each running its entire length assures fast recovery of approximately one gallon a minute. So — where fast recovery is an added requirement — Spartan is the answer.



Water Heater Company Ltd.
LOS ANGELES • SAN FRANCISCO

FORDERER CORNICE WORKS

Manufacturers of

Hollow Metal Products • Interior Metal Trim
Elevator Fronts and Cabs
Metal Plaster Accessories • Sanitary Metal Base
Flat and Roll Metal Screens
Metal Cabinets • Commercial Refrigerators

269 POTRERO AVE.

SAN FRANCISCO, CALIF.

HEMLOCK 4100

STRUCTURAL STEEL

For Class A Buildings,
Bridges, etc.

JUDSON PACIFIC - MURPHY CORP.

4300 EASTSHORE HIGHWAY
EMERYVILLE, CALIF.

VALUABLE NEWS SERVICE

- BUILDING MATERIAL DEALERS
- CONTRACTORS
- ENGINEERS
- FINANCIAL INSTITUTIONS

ARCHITECTS REPORTS gives advance news on construction projects in Northern California, lists: name of projects, location, architect, proposed cost and other pertinent information.

HANDY individual slip-reports, issued daily at a total cost of only

\$10 a month

ARCHITECT'S REPORTS

Published Daily

The ARCHITECT and ENGINEER, Inc.

68 Post Street, San Francisco - DO 8311

NEW YORK A.I.A. MEDAL OF HONOR

Wallace K. Harrison, director of planning for the United Nations Headquarters Commission, was awarded the Medal of Honor for distinguished architectural work and the highest professional standing, by the New York Chapter of the American Institute of Architects at the Institute's 79th Annual Dinner recently.

Harrison is co-designer of New York's Rockefeller Center and the Trylon and Perisphere Theme of the New York World's Fair of 1939.

In another presentation William Potter, Chairman of the Chapter's Paraplegic Committee, accepted a "Certificate of Merit" on behalf of the Chapter from E. James Gambaro of the New York State Association of Architects. The Committee designed standard details for houses for the paraplegic veteran and incorporated these details in specially designed houses. These designs are to be distributed throughout the world by the American Red Cross.

ARCHITECT INVITED

Raphael Hume, noted American architect of New York, has been invited to serve as consultant architect on the re-building of the University of Nymegen in Holland, which is to be restored as a permanent memorial to the European dead of the 82nd Airborne Division which liberated Holland.

The American Committee to Aid Nymegen University includes former President Herbert Hoover, former Ambassador to Belgium Hugh Gibson and other noted Americans.

STATE CIVIL SERVICE

Final date for filing application for the examination of Associate Architectural Draftsman, State of California, has been set for March 20.

Final filing date for the examination of Senior Architectural Draftsman, State of California, is also on March 20.

Both examinations will be held on April 3, 1948, in Los Angeles, Sacramento, and San Francisco.

WURDEMAN AND BECKET APPOINTED SUPERVISING ARCHITECTS

Walter Wurdeman and Welton Becket, Architects of Los Angeles, have been appointed supervising architects to direct the \$31,000,000 building program at the University of California at Los Angeles, and the \$10,500,000 U.C.L.A. Medical School.

Wurdeman & Becket are one of the larger architectural firms in the Nation with some eighty employees.

ESTIMATOR'S GUIDE

BUILDING AND CONSTRUCTION MATERIALS

PRICES GIVEN ARE FIGURING PRICES AND ARE MADE UP FROM AVERAGE QUOTATIONS FURNISHED BY MATERIAL HOUSES TO SAN FRANCISCO CONTRACTORS. 2½% SALES TAX ON ALL MATERIALS BUT NOT LABOR

All prices and wages quoted are for San Francisco and the Bay District. There may be slight fluctuation of prices in the interior and southern part of the state. Freight cartage, at least, must be added in figuring country work.

BONDS—Performance—\$10 per \$1000 of contract. Labor and materials, \$10 per \$1000 of contract.

BRICKWORK—

Common Brick—Per 1M laid—\$100.00 to \$120.00 (according to class of work).

Face Brick—Per 1M laid—\$215 to \$250 (according to class of work).

Brick Steps—\$3.50 per lin. ft.

Brick Veneer on Frame Bldg.—Approx. \$2.25 per sq. ft.

Common Brick—\$28.50 per M, truckload lots, f.o.b. job.

Face Brick—\$75 to \$90 per M, truckload lots, delivered.

Cartage—Approx. \$9.00 per M.

BUILDING PAPER—

1 ply per 1000 ft. roll	\$3.30
2 ply per 1000 ft. roll	7.80
3 ply per 1000 ft. roll	9.70
Brownskin, Standard, 500 ft. roll	8.00

BUILDING HARDWARE—

Sash cord com. No. 7	\$2.65 per 100 ft.
Sash cord com. No. 8	3.00 per 100 ft.
Sash cord spot No. 7	3.65 per 100 ft.
Sash cord spot No. 8	4.00 per 100 ft.
Sash weights, cast iron, \$100.00 ton.	
Nails, \$5.50 base.	

CONCRETE AGGREGATES—

The following prices net to Contractors unless otherwise shown. Carload lots only.

	Bunker per ton	Del'd per ton
Gravel, all sizes	\$2.44	\$2.75
Top Sand	2.38	3.13
Concrete Mix	2.38	3.06
Crushed Rock, ¾" to ¾"	2.38	2.94

	Bunker per ton	Del'd per ton
Crushed Rock, ¾" to 1½"	\$2.38	\$3.13
Roofing Gravel	2.81	3.50
River Sand	2.50	3.06

Sand—

Lapis (Nos. 2 & 4)	3.56	3.94
Olympia (Nos. 1 & 2)	3.56	3.88

Cement—

Common (all brands, paper sacks), carload lots, \$3.02 per bbl, f.o.b. car; delivered \$3.60. Cash discount on carload lots, 10c a bbl, 10th Prox., less than carload lots \$4.00 per bbl. f.o.b. warehouse or delivered. Cash discount 2% on L.C.L.

Trinity White	} 1 to 100 sacks, \$3.13 sack warehouse or del.; \$3.56 bbl. carload lots.
Medusa White	

DAMP-PROOFING and Waterproofing—

Two-coat work, \$8.00 per square.

Membrane waterproofing—4 layers of set-urated felt, \$9.00 per square.

Hot coating work, \$5.00 per square.

Medusa Waterproofing, \$3.50 per lb. San Francisco Warehouse.

Tricozol waterproofing.

(See representative.)

ELECTRIC WIRING—\$15 to \$20 per outlet for conduit work (including switches).

Knob and tube average \$6.00 per outlet. (Available only for priority work.)

ELEVATORS—

Prices vary according to capacity, speed and type. Consult elevator companies. Average cost of installing a slow speed automatic passenger elevator in small four story apartment building, including entrance doors, about \$8000.00.

EXCAVATION—

Sand, \$1.00; clay or shale, \$1.50 per yard. Trucks, \$30 to \$45 per day.

Above figures are an average without water. Steam shovel work in large quantities, less; hard material, such as rock, will run considerably more.

FIRE ESCAPES—

Ten-foot galvanized iron balcony, with stairs, \$250 installed on new buildings; \$300 on old buildings.

FLOORS—

Composition Floors, such as Magnesite, 50c per square foot.

Lino-floor—2 gages—\$3.00 per sq. yd.

Mestipave—\$1.50 per sq. yd.

Battleship Linoleum—available to Army and Navy only—½" —\$3.50 sq. yd. ⅜" —\$3.50 sq. yd.

Terazzo Floors—\$1.50 per sq. ft.

Terazzo Steps—\$2.50 per lin. ft.

Mastic Wear Coat—according to type—20c to 35c.

Hardwood Flooring—

Standard Mill grades not available.

Victory Oak—T & G

¾" x 2¼" —\$252.00 per M. plus Cartage

½" x 2" —\$210.00

½" x 1½" —200.00

Prefinished Standard & Better Oak Flooring

¾" x 3¼" —\$265.00 per M. plus Cartage

½" x 2½" —237.00 per M. plus Cartage

Maple Flooring

¾" T & G Clear \$330.00 per M. plus Ctg.

2nd 305.00 per M. plus Ctg.

3rd 255.00 per M. plus Ctg.

Floor Layers' Wage, \$2.12½ per hr. (Legal as of July 1, 1947. Given us by Inlaid Floor Co.)

GLASS—

Single Strength Window Glass — \$.40 per □ ft.

Double Strength Window Glass — .60 per □ ft.

Plate Glass, under 75 sq. ft. — 1.50 per □ ft.

Polished Wire Plate Glass — 2.25 per □ ft.

Rgh. Wire Glass — .60 per □ ft.

Obscure Glass — .40 per □ ft.

Glazing of above is additional.

Glass Blocks — \$2.75 per □ ft. set in place

HEATING—

Average, \$2.50 to \$3.00 per sq. ft. of radiation, according to conditions.

Warm air (gravity) average \$64 per register.

Forced air average \$91 per register.

INSULATION AND WALLBOARD—

Rockwool Insulation— 12"	\$65.00 per M sq. ft.
Cotton Insulation—Full thickness (3%)	\$95.50 per M sq. ft.
Aluminum Insulation—Foil-mounted on both sides	\$33.50 per M sq. ft.
Tieboard—4"x6" panel	\$9.00 per panel
Wallboard— $\frac{1}{2}$ " thickness	\$55.00 per M sq. ft.
Finished Plank	\$69.00 per M sq. ft.
Ceiling Tieboard	\$69.00 per M sq. ft.

IRON—Cost of ornamental iron, cast iron, etc., depends on designs.

LUMBER—

No. 1 Common	\$90.00 per M
No. 2 Common	88.00 per M
Select O. P., Common	94.00 per M

Flooring—

Per M Delvd.	
V.G.-D.F. B & Btr. 1 x 4 T & G Flooring	\$170.00
"C" and better—all	170.00
"D" and better—all	170.00
Rwd. Rustic—"A" grade, medium dry	150.00
8 to 24 ft.	
"B" grade, medium dry	150.00
Plywood	15c to 18c per ft.
Plyscord	9/5c per ft.
Plywell	3c per ft.
Plyform	15c per ft.

Shingles (Rwd. not available)—

Red Cedar No. 1—\$13.00 per square; No. 2, \$10.50; No. 3, \$9.00.
Average cost to lay shingles, \$6.00 per square.
Cedar Shakes—Tapered: $\frac{1}{2}$ " to $\frac{3}{4}$ " x 25"—\$17.00 per square.
Resawn: $\frac{3}{4}$ " to 1 $\frac{1}{4}$ " x 25"—\$22.00 per square
Average cost to lay shakes,—8.00 per square

MILLWORK—Standard.

D. F. \$50 per 1000. R. W. Rustic \$175 per 1000 (delivered).
Double hung box window frames, average with trim, \$12.50 and up, each.
Complete door unit, \$15 to \$25.
Screen doors, \$6.00 to \$8.00 each.
Patent screen windows, \$1.25 a sq. ft.
Cases for kitchen pantries seven ft. high, per lineal ft., \$12.00 each.
Dining room cases, \$15.00 per lineal foot. Rough and finish about \$1.00 per sq. ft.
Labor—Rough carpentry, warehouse heavy framing (average), \$65.00 per M.
For smaller work average, \$75.00 to \$85.00 per 1000.

MARBLE—(See Dealers)

PAINTING—

Two-coat work	per yard 75c
Three-coat work	per yard \$1.00
Cold water painting	per yard 25c
Whitewashing	per yard 15c
Turpentine.....	\$1.85 per gal. in 5-gal. cont.
Raw Linseed	
Oil.....	\$3.33 per gal. in 5-gal. cont.

Boiled Linseed	\$3.23 per gal. in drums.
Oil.....	
Boiled Linseed Oil—\$3.33 per gal. in 5-gal. containers.	
Replacement Oil—\$2.75 per gal. in drums. \$2.75 per gal. in 5-gal. containers.	
Use Replacement Oil.....	\$3.00 per gal. in 1 gal. cont.
A deposit of \$7.50 required on all drums.	

PATENT CHIMNEYS—

6-inch	\$2.00 lineal foot
8-inch	2.50 lineal foot
10-inch	3.50 lineal foot
12-inch	4.50 lineal foot

PLASTER—

Neat wall, per ton delivered in S. F. in
paper bags, \$17.60.

PLASTERING (Interior)—

3 Coats, metal lath and plaster	Yard \$3.00
Keene cement on metal lath	3.50
Ceilings with $\frac{3}{4}$ " hot roll channels metal lath (lathed only)	3.00
5eilings with $\frac{3}{4}$ " hot roll channels metal lath plastered	4.50
Single partition $\frac{3}{4}$ " channel lath 1 side (lath only)	3.00
Single partition $\frac{3}{4}$ " channel lath 2 inches thick plastered	8.00
4-inch double partition $\frac{3}{4}$ " channel lath 2 sides (lath only)	5.75
4-inch double partition $\frac{3}{4}$ " channel lath 2 sides plastered	8.75
Thermax single partition; 1" channels; 2 $\frac{1}{4}$ " overall partition width. Plastered both sides	7.50
Thermax double partition; 1" channels; 4" overall partition width. Plastered both sides	11.00
3 Coats over 1" Thermax nailed to one side wood studs or joists	4.50
3 Coats over 1" Thermax suspended to one side wood studs with spring sound insula- tion clip	5.00
Note—Channel lath controlled by limitation orders.	

PLASTERING (Exterior)—

2 coats cement finish, brick or concrete wall	Yard \$2.50
3 coats cement finish, No. 18 gauge wire mesh	3.50
Lime—\$4.00 per bbl. at yard.	
Rock or Grip Lath—\$4.15 per bbl. at yard.	
Rock or Grip Lath—\$3.00 per sq. yd. $\frac{3}{4}$ "—29c per sq. yd.	
Composition Stucco—\$4.00 sq. yard (ap- plied).	

PLUMBING—

From \$150.00 per fixture up, according to
grade, quality and runs.

ROOFING—

"Standard" tar and gravel, 4 ply—\$11.00 per sq. for 30 sqs. or over. Less than 30 sqs. \$14.00 per sq.	
Tile \$40.00 to \$50.00 per square.	
Redwood Shingles, \$15.00 per square in place.	
5/2 #1-16" Cedar Shingles, 4 $\frac{1}{2}$ " Exposure	\$16.50 square

5/8 x 16"—#1 Cedar Shingles, 5" Exposure	\$17.00 square
4/2 #1-24" Royal Shingles, 7 $\frac{1}{2}$ " Exposure	\$18.25 square
Re-coat with Gravel \$5.50 per sq.	
Asbestos Shingles \$30 to \$60 per sq. laid.	
1/2 x 25" Resawn Cedar Shakes, 10" Exposure	\$18.50
3/4 x 25" Resawn Cedar Shakes, 10" Exposure	21.00
1 x 25" Resawn Cedar Shakes, 10" Exposure	22.00
Above prices are for shakes in place.	

SHEET METAL—

Windows—Metal, \$2.50 a sq. ft.
Fire doors (average), including hardware
\$2.80 per sq. ft.

SKYLIGHTS—(not glazed)

Copper, \$1.25 sq. ft. (flat).
Galvanized iron, 65c sq. ft. (flat).
Vented hip skylights 90c sq. ft.

STEEL—STRUCTURAL—

\$220 per ton erected, when out of mill.
\$270 per ton erected, when out of stock.

STEEL REINFORCING—

\$200.00 per ton, in place.

STORE FRONTS (None available).

TILE—

Ceramic Tile Floors—\$1.70 per sq. ft.
Glove Base—\$1.35 per lin. ft.
Clove Tile Wainscot—\$1.85 per sq. ft.
Asphalt Tile Floor $\frac{1}{4}$ " x $\frac{3}{4}$ "—\$.40 per sq. ft.
Light shades slightly higher.
Cork Tile—\$1.00 per sq. ft.
Mosaic Floor—See dealers.
Lino-Tile—\$1.00 per sq. ft.

Wall Tile—

Glazed Terra Cotta Wall Units (single faced)
laid in place—approximate prices:

2 x 6 x 12	\$1.25 sq. ft.
4 x 6 x 12	1.50 sq. ft.
2 x 8 x 16	1.45 sq. ft.
4 x 8 x 16	1.75 sq. ft.

VENETIAN BLINDS—

75c per square foot and up. Installation
extra.

WINDOWS—STEEL—

60c per square foot, \$5 for ventilators.

IN THE NEWS

HIGH SCHOOL CONTRACT. Lloyd Flowers & Shirley, contractors, Tulare, California, have been awarded general contract for construction of an addition to the High School at Corcoran, California. Cost is \$64,495. H. L. Gogerty Oriz, Los Angeles, is the architect.

SCHOOL CONTRACT. Swartz & Hyberg, Architects, Fresno, California, announced that the Mid-state Construction Company of Fresno, will build a \$196,123 Lincoln Grammar School at Sanger, California. The building will consist of 8 classrooms, auditorium and lunchroom.

RESIDENCE. Arthur D. Janssen, Architect, Atherton, California, announces M. C. Ingraham as the general contractors on a \$50,000, nine-room and three bath room, home in Atherton.

SCHOOL BONDS VOTED. Voters approved \$1,500,000 for the construction of two new grammar schools and an addition to the high school at Martinez, California. The new buildings will include a music room, cafeteria and gymnasium, and an addition to the shop of the Jr. High School. Additions to the high school include a new gymnasium, cafeteria, home economics and remodel of the girls gymnasium. Bamberger & Reid,

San Francisco, are the architects.

HEALTH CENTER. Eric Mendolsohn, Architect, San Francisco, reports the Maimonides Health Center is taking bids on a \$914,810 building to be built in San Francisco. Low bidders were Dinwiddie Construction, general contract; Otis Elevator, elevators, and Chas. Brown Hotel Supply Co. on kitchen equipment.

"There's still life in the old gray mare."

DON'T throw away those used paint brushes

CABOT'S BRUSH CLEANER

Positively removes old paint right down to the heel

GUNN CARLE & CO
20 POTRERO AVENUE • SAN FRANCISCO, CALIF.

BUILDING TRADES WAGE (JOB SITES) NORTHERN AND CENTRAL CALIFORNIA

ATTENTION: The following are the PREVAILING hourly rates of compensation being paid and in effect by employers by agreement between employers and their union; or as recognized and determined by the U. S. Department of Labor. (Revised to January 1, 1948.)

CRAFT	San Francisco	Alameda and Contra Costa	Marin	Vailejo	San Mateo	San Jose	Stockton	Sacramento	Fresno
	ASBESTOS WORKERS	1.90	1.90	1.90	1.90	1.90	1.90	1.90	1.90
BRICKLAYERS	2.25	2.25	2.25	2.25	2.25	2.25	2.25	2.25	2.25
BRICKLAYERS, HODCARRIERS	1.75	1.75	1.75	1.75	1.75	1.75	1.87½	1.87½	1.75
CARPENTERS	2.00	2.00	2.00	2.00	2.00	2.00	2.00	2.00	2.00
CEMENT FINISHERS	2.02½	2.02½	2.02½	2.02½	2.02½	2.02½	2.02½	2.02½	2.02½
ELECTRICIANS	2.75	2.75	2.75	2.75	2.75	2.75	2.75	2.75	2.75
ENGINEERS: MATERIAL HOIST	2.00	2.00	2.00	2.00	2.00	2.00	2.00	2.00	2.00
PILE DRIVER	2.25	2.25	2.25	2.25	2.25	2.25	2.25	2.25	2.25
STRUCTURAL STEEL	2.25	2.25	2.25	2.25	2.25	2.25	2.25	2.25	2.25
GLASS WORKERS	1.87½	1.87½	1.87½	1.87½	1.87½	1.87½	1.87½	1.87½	1.87½
IRONWORKERS: ORNAMENTAL	2.10	2.10	2.10	2.10	2.10	2.10	2.10	2.10	2.10
REINF. RODMEN	2.00	2.00	2.00	2.00	2.00	2.00	2.00	2.00	2.00
STRUCTURAL	2.25	2.25	2.25	2.25	2.25	2.25	2.25	2.25	2.25
LABORERS: BUILDING & CONCRETE	1.40	1.40	1.40	1.40	1.40	1.30	1.40	1.40	1.30
LATHERS	2.25	2.25	2.25	2.25	2.25	2.25	2.25	2.25	2.25
MARBLE SETTERS	2.00	2.00	2.00	2.00	2.00	2.00	2.00	2.00	2.00
MOOSAIC & TERRAZZO	2.00	2.00	2.00	2.00	2.00	2.00	1.75	1.75	1.75
PAINTERS	2.00	2.00	2.00	2.00	2.00	2.00	2.00	2.00	2.00
PILEDRIVERS	2.12½	2.12½	2.12½	2.12½	2.12½	2.12½	2.12½	2.12½	2.12½
PLASTERERS	2.75	2.75	2.75	2.75	2.75	2.75	2.75	2.75	2.75
PLASTERERS' HODCARRIERS	2.00	2.00	2.00	2.00	2.00	2.00	1.87½	1.87½	1.87½
PLUMBERS	2.25	2.25	2.25	2.25	2.25	2.25	2.25	2.25	2.25
ROOFERS	2.00	2.00	2.00	2.00	2.00	2.00	2.00	2.00	2.00
SHEET METAL WORKERS	2.00	2.00	2.00	2.00	2.00	2.00	2.00	2.00	2.00
SPRINKLER FITTERS	2.00	2.00	2.00	2.00	2.00	2.00	2.00	2.00	2.00
STEAMFITTERS	2.25	2.25	2.25	2.25	2.25	2.25	2.25	2.25	2.25
STONESETTERS (MASONS)	2.25	2.25	2.25	2.25	2.25	2.25	2.25	2.25	2.25
TILESETTERS	2.15	2.15	2.15	1.90	2.15	1.90	1.90	1.90	1.90

Prepared and compiled by

CENTRAL CALIFORNIA CHAPTER, ASSOCIATED GENERAL CONTRACTORS OF AMERICA

with the assistance and cooperation of secretaries of Building Trades Unions, General Contractors Associations and Builders Exchanges of Northern California

CLASSIFIED ADVERTISING

RATE: 10c PER WORD . . . CASH WITH ORDER

MINIMUM \$2.50

HELP WANTED: Bldg. Specif. Writers for arch. work—perm. Civil Service \$395 & \$440 month. Annual increases, sick leave, retirement, L. A. County Civil Service, Rm. 102, Hall of Records, Los Angeles 12, Calif.

ARCHITECT'S RECORDS—A valuable advance news service giving building and construction information daily on projects in Northern California. Name, location, architect, proposed cost, etc., on individual slips. Ideal for securing new business leads. Hun-

dreds of items, total monthly cost only \$10. Don't delay, subscribe today. ARCHITECT & ENGINEER, Room 618, 68 Post Street, San Francisco, California. Phone DOugles 2-8311.

PHOTOGRAPHS: Specializing in building and construction photographs for publication, or historic records. For Industrial-Aerial. Publicity photography use the INDUSTRIAL San Francisco.

PHOTO'S, Room 722, Hearst Bldg., San Francisco, Phone SUTter 1-6953.

WANTED experienced Architectural Designer or Draftsman small San Francisco office. Exceptional pay for exceptional man. Furnish detailed outline of previous experience. All replies confidential. Box 210, Architect & Engineer, 68 Post Street, San Francisco, California.

ENGRAVING—Good engravings are essential to a satisfactory job of printing reproduction. For the best, see Poor Richard Photo Engraving Co., 324 Commercial St.

SISALKRAFT

REG. U. S. PAT. OFF.

"More than a building paper"

THE SISALKRAFT CO.

205 West Wacker Drive
Chicago, Ill.

55 New Montgomery Street
San Francisco, Calif.

HOGAN LUMBER CO.

Wholesale and Retail

LUMBER

MILL WORK • SASH & DOORS

Office, Mill, Yard and Docks
SECOND AND ALICE STREETS • OAKLAND, CALIF.

Telephone GLencourt 1-6861

CLINTON CONSTRUCTION CO. OF CALIFORNIA

General Contractors

923 FOLSOM STREET • SAN FRANCISCO

SUtter 1-3440

SANTA MARIA INN SANTA MARIA, CALIFORNIA

FRANK J. McCOY, General Manager

FERNAND E. PIMENTEL, Manager

On the
Coast
Highway
between
San
Francisco
and
Los
Angeles



American
or
European
Plan
•
Old
English
Tap
Room

CALIFORNIA'S WATER SUPPLY IS ADEQUATE FOR LARGER POPULATION

(From Page 15)

is produced in hydroelectric plants, and hundreds of millions of gallons of water are used daily for domestic and industrial purposes in California municipalities.

The great need for conservation is the result of two factors. The first is the California climate. Practically all precipitation occurs during four winter months and is subject to periodic variations ranging from one to many years in length. The second is geographical in that many of the best agricultural lands and most of the desirable residential and industrial areas are located in regions of relatively low precipitation, far from the areas of maximum water production.

The development of water conservation has paralleled the growth of the state. At first farms were irrigated and municipalities were supplied with water either by short ditches diverting the natural flows of the streams or by shallow wells pumping from nearby underground basins. As irrigated areas spread and cities grew, it became necessary to build reservoirs to conserve the winter runoff for use in the summer and fall and to deepen the wells. Then, with continued growth, it became necessary to build larger reservoirs storing the surplus runoff of wet years for use during the dry periods, to still further deepen the wells and finally as local sources became completely utilized to build great systems of conduits bringing water hundreds of miles from areas of surplus supply to areas of water deficiency. At the present time millions of acre feet of water are annually stored in the reservoirs of California and over a thousand miles of major conduits have been built to bring water to metropolitan areas.

ARCHITECTS REOPEN OFFICES

Announcement has been made of the reopening of offices at 672 South Lafayette Park Place, Los Angeles, by Anthony Thormin and Arthur Wolfe, Architects.

Formerly with Albert B. Gardner, Thormin and Wolfe were the architects for many of the projects at the Broadway Crenshaw Center which recently opened to the public.

NEW BOYS GYMNASIUM at the Hayward (California) High School will cost \$505,000, according to Architects Dragon, Schmidts & Hardman of Berkeley. John E. Branagh, Piedmont, is the general contractor.

BOOK REVIEWS PAMPHLETS AND CATALOGUES

HOUSING AND THE STATE. By Bowley. The Macmillan Company, 60 5th Ave., New York. Price \$3.50.

Since much of the early teaching and techniques on housing were originally imported to the United States, it is not unreasonable to be interested in the current studies on the subject from England.

This book, according to the author, is proposed with hopes to provoke serious discussion of some aspects of housing policy in England and Wales; and to describe and explain some of the more important conditions which must be satisfied if certain types of housing policy are to be successful. As such, the book should be of interest to the student of housing.

"It is obviously impossible," says the author, "to examine all the aspects of the British experiment in peacetime housing." Therefore, she confines herself to considering how far the duties imposed on local authorities and the various subsidies given to them and private builders, in order to stimulate the provision of new houses; how their objective was achieved, in what ways they failed, and why.

The first part of the book is devoted to the examination of the three experiments which correspond to the stages the housing policy went through the twenty years between the end of the Great War and the outbreak of this war. The second part of the book is an attempt to summarize the conclusions reached and to show their relation to housing problems now. The book is replete with an impressive array of statistics and economic discussion. It is a powerful indictment of the present housing chaos in England.

Review by Michael Goodman

EXECUTONE ELECTRONIC COMMUNICATION.

Executone, Inc., 415 Lexington Ave., N. Y.

Communicating systems for industrial, commercial, institutional and residential buildings are shown in drawings, diagrams and photographs. Details on models and specific uses. A.I.A. File No. 35-4-51, manufacturers Form 255, available upon request to manufacturer.

OVERALL LIGHTING By Wakefield. F. W. Wakefield Brass Company, Vermilion, Ohio. A.I.A. File No. 31-F-23.

Catalog No. 48, contains many drawings, photographs, charts, and design uses of fluorescent and incandescent lighting equipment for schools, offices, drafting rooms and stores. Contains many new items.

"AMERICAN - MARSH" CONDENSATION UNIT

Pumping
Machinery
for
Every
Purpose

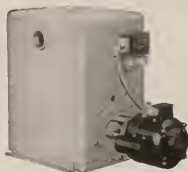

For Service
Call
DOuglas
2-6794
or
MUTual 8322

SIMONDS MACHINERY CO.
SAN FRANCISCO 816 FOLSOM
LOS ANGELES 455 EAST 4TH

VERMONT MARBLE COMPANY

Producers and Finishers
of
Domestic and Imported Marbles

525 MARKET STREET, SAN FRANCISCO
Phone SUtter 1-6747
3522 COUNCIL STREET
(Beverly Blvd. at Virgil Ave.)
LOS ANGELES 4, CALIF.
Telephone Fairfax 7834



The Most Complete Line of
STEELS and BUILDING MATERIALS
Made by a Single Producer



See Sweet's Catalog File or write us for
full information.

REPUBLIC STEEL CORPORATION
GENERAL OFFICES: CLEVELAND, OHIO

DENVER, COLORADO . . . CONTINENTAL OIL BUILDING
LOS ANGELES, CALIFORNIA . . . EDISON BUILDING
SALT LAKE CITY, UTAH . . . WALKER BANK BUILDING
SAN FRANCISCO, CALIFORNIA . . . RIALTO BUILDING
SEATTLE, WASH. WHITE-HENRY-STUART BUILDING

PACIFIC MANUFACTURING CO.

HIGH CLASS INTERIOR FINISH
QUALITY MILLWORK

142 SANSOME ST., SAN FRANCISCO
GARfield 1-7755

6820 MCKINLEY AVE., LOS ANGELES
THornwall 4196

BUILDERS EXCHANGE, OAKLAND

IN THE NEWS

EDUCATIONAL BUILDING

The D. W. Nicholson Corporation, San Leandro, have been awarded a \$100,000 contract for the construction of an educational building for Temple Sinai, Oakland. Wm. E. Schirmer, Oakland, is the architect.

SCHOOL BONDS APPROVED

Voters of Richmond, California, recently approved a \$3,590,000 bond issue. The funds are to

TILE

UNUSUAL AND PRACTICAL
INSTALLATIONS OF

CERAMIC AND FAIENCE TILE

for bathrooms, kitchens, vestibules, stores,
patios and cocktail bars



FOX TILE CO.

3247 E. 14TH STREET, OAKLAND
Phone: ANdaver 1-0431



Simple to install
Requires Only 2 1/4-in. headroom

"ECON-O-MATIC" . . . is the automatic Stanley Door Hardware Set that makes lightweight plywood doors 100% practical for garages. Designed for doors weighing up to 150 lbs. Cost little more than old-style hardware. For smart appearance — faultless action — long service — specify Stanley. The Stanley Works, New Britain, Conn.

*Copyrighted

STANLEY

Reg. U.S. Pat. Off.

HARDWARE · HAND TOOLS · ELECTRIC TOOLS

be used for the construction of nine new grammar schools, and five junior and senior high schools.

Dragon, Schmidts & Hardman of Berkeley, California, are the architects.

ARCHITECTS MOVE. The architectural firm of MARSH, SMITH & POWELL have moved into new offices at 300 Lane Mortgage Building, Los Angeles 14.

JEWELRY STORE REMODEL

The Albert S. Samuels Company jewelry store, San Francisco, will spend \$111,607 in interior and exterior remodeling. Roselyn & Gartner, San Francisco, are the architects, and Jacks & Irvine, San Francisco, is the general contractor.

ARCHITECT SELECTED. Reynolds & Chamberlain, Architects of Oakland, California, have been selected by the University of California for the new school of optometry to be built on the Berkeley campus at an estimated cost of \$300,000.

ARCHITECT SELECTED

Russell G. De Lappe, Architect of Berkeley, has been selected architect of the new Community Hospital to be built at Santa Rosa, California.

Plans call for construction of a 45-bed, modern, community hospital.

MAKE YOUR PLANS NOW TO ATTEND the American Institute of Architects convention to be held June 22-25 in Salt Lake City, Utah.

BRITAIN'S LARGEST PREFABRICATED HOUSING ESTATE

(From Page 17)

board is glued to one side of the timber frame and is backed with insulating material. The ceiling panels are supported either by angles forming part of the steel wall framework or by tees hung from the roof trusses.

The wall linings consist of panels similar to those used for the ceiling but larger—namely seven feet five by two feet eleven. The panels are located at floor level by metal clips nailed to the timber floor, and are fixed to the horizontal members of the steel wall framework by turnbuckles. To ensure vertical alignment between adjacent panels, the side rails of the timber panel frame are alternately tongued and grooved.

Eventually Arcon houses will have pressed steel, kitchen bathroom units and cupboards; but at present these are made of wood. Both bedrooms have fitted cupboards the length of one wall, and there is a roomy coat cupboard in the hall.

Scott Company

HEATING - - PLUMBING - - TILE

★

243 MINNA STREET
SAN FRANCISCO
Phone EXbrook 2-6741

THE TORMEY COMPANY

GENERAL PAINTERS
AND DECORATORS

Phone UNDERhill 1-1913

563 FULTON STREET
San Francisco

Phone GARfield 1-1164

Thomas B. Hunter

DESIGNER OF HEATING

AIR CONDITIONING
VENTILATING AND WIRING
SYSTEMS, MECHANICAL
AND ELECTRICAL EQUIP-
MENT OF BUILDINGS

★

41 SUTTER STREET
ROOM 710
San Francisco California

IN THE NEWS

PLANS APPROVED. Additions to the Redding, California, grammar school amounting to \$70,000 have been approved. J. Clarence Felciano, Santa Rosa, is the architect.

PRIMARY SCHOOL BUILDING. R. F. Johnson & Son, El Cerrito, California, have been awarded contract for the new McGregor Primary School Building in Albany. Cost \$94,641. Wm. H. Young, Albany, is the architect.

ARCHITECT SELECTED. Lynn R. Duckering, Architect, Santa Cruz, has been selected to plan a new 4-unit shop building for the Santa Cruz (California) High School.

HOSPITAL ADDITION. Skidmore, Owings & Merrill, associated architects, San Francisco, are working on plans for a \$3,000,000 addition to the Mt. Zion Hospital.

ARCHITECT SELECTED. Robert Stanton, Architect, of Pebble Beach, has been selected to do the Modesto Memorial Hospital of 100 beds, and the Salinas Memorial Hospital also of 100 beds. The Modesto building will cost \$1,000,000 while the cost of the Salinas structure has been set at \$2,000,000.

FIRE HOUSE. Stolte, Inc., have been awarded contract for construction of a fire house building at Pacific Grove, California. Cost, \$51,921. Architect, Robt. R. Jones, Carmel.

NEVADA STATE BUILDING. Walker Boudwin Construction Co. of Reno have been awarded a \$43,728 contract for remodeling of the State Building in Reno, Nevada. DeLongchamps & O'Brien are the architects.

NEW GRAMMAR SCHOOL. Donald Powers Smith, Architect, San Francisco, reports Wilfred H. May contractor of Belmont has been awarded a \$330,286 contract for a new grammar school building at Sunnyvale, California.



THE WESIX "BILT-IN"

A compact heater that gives instant heat and luxurious comfort in the average size bathroom. Built by America's pioneer manufacturer of electric heating systems.

For our new catalog write
WESIX ELECTRIC HEATER CO.
390 1st Street, San Francisco

WESIX



HERRICK IRON WORKS

STRUCTURAL STEEL
REINFORCING STEEL

18TH AND CAMPBELL STS.
OAKLAND, CALIF.
Phone GLencourt 1-1767

DINWIDDIE CONSTRUCTION COMPANY

BUILDERS

CROCKER BUILDING
SAN FRANCISCO

Fine
ENGRAVINGS

**POOR
RICHARD**
PHOTO ENGRAVING CO.
320-324 COMMERCIAL STREET
SAN FRANCISCO, 11

MULLEN MFG. COMPANY

BANK, STORE AND OFFICE
FIXTURES—CABINET WORK
OF GUARANTEED QUALITY
CHURCH SEATING

Office and Factory
60-80 RAUSCH ST., Bet. 7th and 8th Sts.
San Francisco
Telephone UNderhill 1-5815

PITTSBURGH TESTING LABORATORY

ENGINEERS AND CHEMISTS

Testing and Inspection of Concrete,
Steel and Other Structural Materials

Design of Concrete Mixes

Offices in all principal cities

651 Howard St., San Francisco 5
EXbrook 2-1747

A. F. MATTOCK CO.

Builders



212 CLARA STREET

SAN FRANCISCO

INDEPENDENT IRON WORKS

Steel Buildings
Service Stations
Steel Storage Tanks
Fabricated Plate Work
Steel & Sheet Metal Products
Fabricated Structural Steel
Steel Distributors

Eighth & Pine Sts. Oakland, 7

Index to Advertisers

ANGIER Pacific Corp.	*
ARCHITECTS Reports	40
BASALT Rock Company	Back Cover
BAXTER & Company, J. H.	36
CLASSIFIED Advertising	43
CLINTON Construction Company	44
CONTINENTAL Water Heater Co.	39
DETROIT Steel Products Co.	5
DINWIDDIE Construction Co.	25 & 47
DONLON Tile Company	26
DUFFY TILE Co.	48
EMSCO	23
L. & E. EMANUEL Company	27
FORDERER Cornice Works	40
FOX Tile Company	46
FULLER, W. P. Company	2
GUNN, Carle & Company	43
HANKS, Inc., Abbott A.	48
HAWS Drinking Faucet Company	34
HERMAN Safe Company	26
HERRICK Iron Works	47
HOGAN Lumber Company	44
HUNT, Robert W., Company	48
HUNTER, Thos. B.	47
INDEPENDENT Iron Works	48
JUDSON, Pacific-Murphy Corp.	40
KRAFTLE Company	31
F. KERN & Sons Iron Works	24
MATTOCK, A. F., Co.	48
MICHEL & Pfeffer Iron Works	
Inside Front Cover	
MOHR, S. H., Inc.	30
MULLEN Mfg. Co.	48
MUELLER Brass Co.	*
NORTHERN California Electric Bureau	35
PACIFIC Coast Aggregates, Inc.	*
PACIFIC Coast Gas Association	
Inside Back Cover	
PACIFIC Manufacturing Company	45
PACIFIC Portland Cement Company	*
PACIFIC Telephone & Telegraph Co.	33
PADDOCK Engineering Company	32
PITTSBURGH Testing Laboratory	48
PLANT Rubber & Asbestos Works	26
POOR RICHARD Engraving Co.	47
REMILLARD-Dandini Co.	48
REPUBLIC Steel Corporation	45
RUANE, Patrick J.	28
SANTA Maria Inn	44
SCOTT Co.	47
SIMONDS Machinery Company	45
SIMPSON Logging Co.	6
SISALKRAFT Company	44
SMOOT-Holman Co.	37
STANLEY Works, The	46
SUPERIOR Fireplace Company	*
TAYLOR Co., Halsey W.	*
TORMEY Company, The	47
U. S. BONDS	7
VERMONT Marble Company	29 & 45
VIKING Automatic Sprinkler Co.	24
WESIX Company	47
WESTERN Asbestos Company	*
WOOD, E. K., Lumber Company	36

*Indicates Alternate Months

REMILLARD-DANDINI Co.

Brick and
Masonry Products



400 MONTGOMERY STREET
SAN FRANCISCO, CALIF.

DUFFY TILE CO.



TILE CONTRACTORS
SHOWER DOORS
TUB ENCLOSURES

INSTALLATIONS
OF EVERY
DESCRIPTION
Modernizing, Repairing
"Net How Cheap
But How Good!"
253 MINNA
YUkon 6-1489



ABBOT A. HANKS, INC.

Engineers & Chemists

INSPECTING — TESTING — CONSULTING
CONCRETE — STEEL — MATERIALS
CHEMICAL AND TESTING
LABORATORIES

• RESEARCH AND INVESTIGATION •

TESTS OF STRUCTURAL MATERIALS
DESIGN OF CONCRETE MIXES
SHOP AND ERECTION INSPECTION OF
STRUCTURES AND EQUIPMENT
INVESTIGATION OF STRUCTURES
AND MATERIALS
TESTS AND INVESTIGATION OF
FOUNDATION SOILS
FIRE RESISTANCE AND INSULATION
TESTS

624 Sacramento Street, San Francisco

Robert W. Hunt Company

ENGINEERS

Inspection • Tests • Consultation
Schools and Other Structures
Are Built as Designed

When Construction Materials are
Inspected at point of Manufacture
and during Erection by

ROBERT W. HUNT COMPANY

Cement, Concrete, Chemical, Metallurgical,
X-Ray and Physical Laboratories

Chicago • New York • Pittsburgh
Los Angeles • All Large Cities
San Francisco, 251 Kearny Street

ARCHITECT AND ENGINEER

MONTREAL, CANADA

1948



1948

APRIL

1948

Drive-In Restaurants

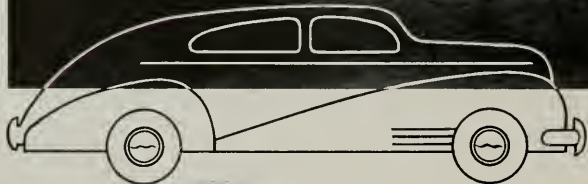

... Rest Rooms; Metal Canopies; Service Stations; Display Buildings; Steel Fabricated Buildings; Flat Panel Type Buildings... built to your own specifications! Write or telephone today for complete information.



Michel & Pfeffer Iron Works, Inc.

W. A. JAMES, Manager Steel Building Division

Tenth and Harrison Streets, San Francisco 3, California
Telephone Market 1-5966

ARCHITECT

Vol. 173

No. 1

AND ENGINEER

ARCHITECTS' REPORTS—Published Daily

Contents for

APRIL

E. H. WILDER

Editor

MARK DANIELS, A.I.A.

Associate Editor

PROF. LELAND VAUGHAN

Landscape Architecture

JOHN A. BLUME

Structural Engineering

MICHAEL GOODMAN

Planning

JOHN S. BOLLES, A.I.A.

Book Reviews



COVER PICTURE:

Among the most interesting cities of the Dominion of Canada is the historical city of Montreal. On the Cover we see Montreal as it looks from the elevated slopes of Mount Royal.

[See Page 17 for Story]

EDITORIAL NOTES	4
LANDSCAPE DESIGN, Theodore Osmundson, Jr., Landscape Architect	8
COOL COLORS—WARM COLORS, New Studies On Infra-Red Radiation	11
A FUNERAL HOME, Crosby-N. Gray & Co., Burlingame, California By EUGENE BURNS	13
ARCHITECTS IN MONTREAL, Canada—By William Arthur Newman, Architect	17
NEW WESTERN OFFICE, STATE INSURANCE BUILDING, Berkeley, California. James W. Placheck, Architect, A.I.A.	26
CALIFORNIA COUNCIL OF ARCHITECTS, Legislative Committee Report	30
A. I. A. ACTIVITIES	31
WITH THE ENGINEERS	32
HEADLINE NEWS & VIEWS, By E. H. W.	36
IN THE NEWS	37, 43, 46, 47
LANDSCAPE ARCHITECTURE, Notes of the Profession	38
ESTIMATOR'S GUIDE, Building and Construction Materials	41
BUILDING TRADES WAGE SCALES, Northern and Central California	43
CLASSIFIED ADVERTISING	43
BOOK REVIEWS, Pamphlets & Catalogues	45
INDEX TO ADVERTISERS	48

ARCHITECT AND ENGINEER (Established 1905) is published on the 15th of the month by The Architect and Engineer, Inc., 68 Post St., San Francisco 4; Telephone EXbrook 2-7182. President, K. P. Kierulff; Vice-President and Manager, L. B. Penhorwood; Treasurer, E. N. Kierulff.

Los Angeles Office: Wentworth F. Green, 5605 Hollywood Blvd., Los Angeles 28. Telephone HEmpstead 3171.

Entered as second class matter, November 2, 1905, at the Post Office in San Francisco, California, under the Act of March 3, 1879. Subscriptions United States and Pan America, \$3.00 a year; \$5.00 two years; foreign countries \$5.00 a year; single copy 50c. ARCHITECTS' REPORTS are published daily from this office, Verone S. Yallop, Manager. Telephone DOuglas 2-8311.



EDITORIAL NOTES

THE BUILDING INDUSTRY broke all previous records by putting 750,000 single family houses under construction in 1947, according to a recent survey conducted by the newly organized Construction Industry Information Committee. The Committee further reports that this was twenty-four per cent higher than the previous peak of 1941 when a record of 603,000 single family houses were started, and was thirty-one per cent higher than the 572,000 single family dwelling units started in 1925, which was the peak year for all housing construction.

The report also shows that some 105,000 multiple housing units were put under construction in 1947, which was a thirty per cent increase over the previous year.

A break-down of the report shows that during the latter part of the year new homes were being started at the rate of a million units a year, a ratio which is expected to continue well into 1948.

* * *

DO YOU KNOW that one out of every ten employed workers in the United States is directly on the public payrolls, and that you as a taxpayer contribute towards the support of some 5,808,000 persons who receive \$1,180,600,000.00 per month?

* * *

THE ASSOCIATED GENERAL CONTRACTORS OF AMERICA at its recent annual convention in Dallas, Texas, ratified the establishment of a National Joint Board for the settlement of jurisdictional disputes in the building and construction industry.

Establishment of the Board was encouraged by the National Labor Relations Board, and its organization will include seven national organizations of specialty contractors.

Principal objective of establishing the joint Board is to avoid the necessity of having to take jurisdictional disputes before the National Labor Relations Board by the process of hearing all matters by an impartial chairman, two members of the Building and Construction Trades and two members selected by employers, one of whom will represent the general contractors and one the specialty contractors in the construction industry.

The question of which union has jurisdiction over various operations in the construction industry is of great interest to both employer and labor and the plan proposed offers tremendous advantages to employers, the unions, and an even greater importance to the public who in the final analysis is vitally concerned.

DON'T YOU BELIEVE IT! Recent promotional activities in support of "The REIBER PLAN" as the panacea for all industrial, commercial, and residential ills of the San Francisco Metropolitan Bay Area, are offered with a certain amount of professional know-how in presenting a controversial subject to the public.

A cursory exploration to determine just WHO is behind the project, to the extent of producing a certain amount of printed promotion material, resulted in an evasive answer that "everything is being done for free."

If "The REIBER PLAN" is, as we have been advised, "for free" in its present stage and the printers have donated their time, the paper houses the paper-stock for printing the brochures, the advertising agencies have donated their talent in preparing copy, and the Post Office department has donated the use of the United States mails in the distribution of the proponent material, then in the interest of unselfish community harmony and support:

The engineers should donate their services, the manufacturers should contribute the materials "for free", and no one can accuse us of an ulterior motive, because we are donating this space and advice "for free" . . . well! Perhaps with a grain of salt.

* * *

A HOUSING INITIATIVE will, in all probability, be placed on the November ballot in California which has been designed by its sponsors to provide for a 100,000-unit housing program under State jurisdiction through a State Housing Authority. Proponents of the measure declare:

"Although this program in no way constitutes a threat to private enterprise, as any honest examination of it will demonstrate, we expect attack by the same selfish interest whose well-financed and well organized campaigns destroyed the Veterans Housing and the slum clearance programs."

* * *

THE NATIONAL CONFERENCE BOARD reports that a recent study of the purchasing power of the individual consumer dollar was 66 cents in August 1947, as compared with 45 cents for an industry dollar, and 53 cents for a construction dollar. Manufacturers now pay more than twice as much for an hour of labor as they did from 1935 to 1939.

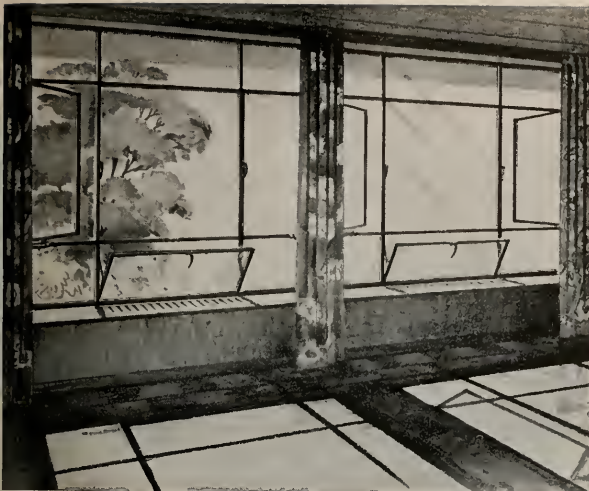

Fenecraft Combination Window

WINDOW BENEFITS

that create client satisfaction

Windows can be merely "holes" in the wall . . . or *planned* elements that provide better ventilation, finer appearance and better daylighting—windows that create lasting client satisfaction.

Fenecraft Combination Windows provide these benefits . . . and more:

FRESH AIR VENTILATION—hopper sill vent deflects air upward, provides protection from drafts; sheds rain or snow outside. Swing vents deflect breezes into the room when fuller ventilation is desired.

EASY OPERATION—simple to open, close or lock—with one hand.

DISTINCTIVE APPEARANCE—high-quality workmanship, plus excellent hardware.

SAFER—hopper vent prevents leaning out windows; important for children.

SAFER SCREENING—all screens attached or removed from inside the room.

. . . and **LOWER COST**—from standardization which results in manufacturing and installation economies.

That isn't the whole story, by far. For full information on the Fenestra family of Standardized Fenecraft Windows, mail the coupon.



FENCECRAFT PROJECTED WINDOW

—protection from weather, even when open. Open-out vent acts as canopy over opening. Open-in vent deflects air upward, sheds water outside.



FENCECRAFT CASEMENT WINDOW

—safe washing—from inside. Easy to operate. Interchangeable screens, protected from outside dirt. "Homey" appearance makes them ideal for clubs, large homes, dormitories, and nurses' homes.

Fenestra

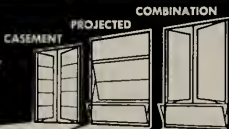

FENCECRAFT INTERMEDIATE STEEL WINDOWS

Detroit Steel Products Company,
Dept. AE-4
1310 63rd Street
Emeryville 8 (Oakland), California

Please send me data on types and sizes of the new Fenecraft family of Fenestra Windows:

Name

Company

Address

INDEPENDENT TESTS SHOW SIMPSON ACOUSTICAL TILE HAS HIGHEST SOUND ABSORPTION

Here's
Proof

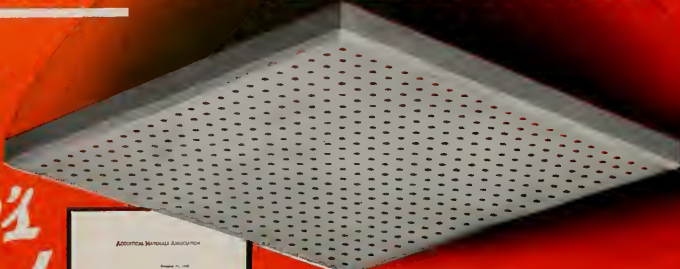

Acoustical Materials Association

Report No. 100

NO. 100. ACOUSTICAL TILE. (Comparative Tests of Various Acoustical Tiles.)

Tile	Mounting	Thickness	Sound Absorption Coefficient
Simpson Acoustical Tile	No. 1	1/2" (Cemented to solid backing)	.60
		3/4" (Nailed to wood furring strips)	.65
	No. 2	1/2" (Cemented to solid backing)	.75
		3/4" (Nailed to wood furring strips)	.75
Other Tile	No. 2	1/2" (Cemented to solid backing)	.65
		3/4" (Nailed to wood furring strips)	.70

Author: L. L. Peterson

COMPARE THESE TEST FIGURES
On Similar Perforated Acoustical Materials

NOISE REDUCTION COEFFICIENTS				
	Simpson Acoustical Tile	Brand B	Brand C	Brand D
1/2" Thickness No. 1 Mounting (Cemented to solid backing)	.60	.55	.55	.55
3/4" Thickness No. 2 Mounting (Nailed to wood furring strips)	.65	.60	.60	..
Maximum Thickness No. 1 Mounting	.75	.70	.70	.65
Maximum Thickness No. 2 Mounting	.75	.75	.75	.70

Tests accepted by the Acoustical Materials Association (report shown above) show that the new Simpson Acoustical Tile has the highest noise reduction coefficients of all drilled fiber acoustical materials in most thicknesses and types of mountings. You will see in the comparison chart that Simpson Acoustical Tile in the most widely used thickness and mountings outranks all other standard drilled acoustical materials. One-half inch Simpson Acoustical Tile has higher noise reduction coefficients on both No. 1 and No. 2 mountings than any similar product. On No. 1 mounting the maximum thickness (one inch) Simpson Acoustical Tile, has a higher noise reduction coefficient than any other perforated fiber acoustical material regardless of thickness. On No. 2 mounting this maximum thickness has a noise reduction coefficient equal to or greater than any other similar material. You are familiar with the other superior features of this new acoustical tile. Compare! Specify Simpson Acoustical Tile.

WOODFIBER DIVISION, SIMPSON LOGGING CO.

Plant at Shelton, Washington

Sales Division, SIMPSON INDUSTRIES
1010 White Building, Seattle 1, Washington



Simpson
SOUND ORIGINATOR
ACOUSTICAL
TILE

TRADE MARK
REGISTERED

DISCUSS THIS NEW ACOUSTICAL TILE WITH YOUR NEAREST SIMPSON APPLICATOR

ACOUSTICS NORTHWEST
Builders Exchange Bldg., Portland 4,
Oregon. Phone: Atwater 6443

ALLIED CONSTRUCTION & SPECIALTY
CO., INC. 8455 Melrose Ave., Los
Angeles 46, Calif. Phone: Walnut 0541

ANGELES INDUSTRIES
984 McGarry St., Los Angeles, Calif.
Phone: Vandike 1783

APPLICATION SERVICE CO.
420 Continental Oil Bldg., Denver 2,
Colorado. Phone: Alpine 4662

ARIZONA SASH, DOOR & GLASS CO.
657 W. St. Mary's Rd., Tucson, Ariz.
Phone: 1699

CONSOLIDATED ROOFING & SUPPLY CO.
520 S. 7th Ave., Phoenix, Ariz.
Phone: 4788B

CONTINENTAL LUMBER COMPANY
P. O. Box 2042, Boise, Idaho
Phone: 450

CRAIG & PULLEN
320 Ward St., Honolulu, T. H.
Phone: 6107

CRAMER COMPANY
345 Vermont St., San Francisco, Calif.
Phone: Market 0411

CRAMER COMPANY
1932 Merced St., Fresno, Calif.
Phone: 3-1121

DALE TILE CO.
1020 LaSalle Ave., Minneapolis 2,
Minnesota. Phone: BR 8821

ELLIOTT BAY LUMBER COMPANY
400 W. Spokane St., Seattle, Wash.
Phone: Elliott 8080

EXCHANGE LUMBER & MFG. CO.
P. O. Box 1314, Spokane, Wash.
Phone: Glenwood 1621

FROST HARDWOOD LUMBER CO.
Market at State St., San Diego, Calif.
Phone: F274

LUMBER DEALERS, INC.
423 N. 33rd, Billings, Mont.
Phone: 3911

UTAH LUMBER COMPANY
333 W. 1st South, Salt Lake City 9,
Utah. Phone: A-4318

NOW AVAILABLE...THE *Western-Holly*

"Californian" for Immediate Delivery!



MAXIMUM UTILITY
MINIMUM SIZE

Compare these Features

1. *Tempa-Plates*—Afford new cleanliness, beauty and efficiency.
2. *Four Large, High-Speed Burners*, Designed for easy cleaning—Automatic pilot lighting.
3. *Highly Polished*—Heat-reflecting Burner Saucers.
4. *One-Piece Oven Construction*, rounded corners, porcelain enameled—easily cleaned.
5. *Oven Temperature Control*—Exact, even, dependable heat regulation.
6. *High-Speed Broiler*—Roller Bearings—Glides out smoothly, drop front.
7. *ALL WHITE*—Porcelain Enamel Finish, fused on steel—As Washable as Fine China.

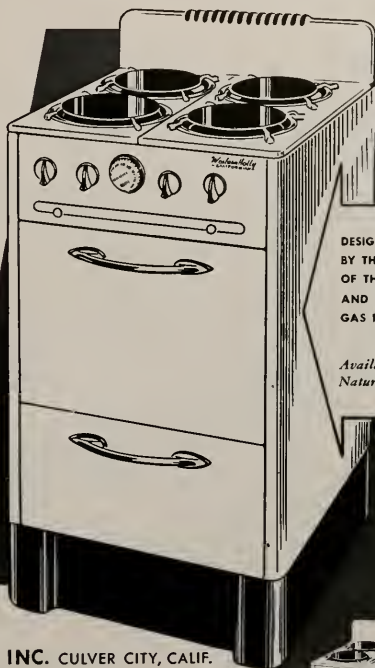

DESIGNED AND PRODUCED
BY THE MANUFACTURERS
OF THE *Continental*
AND *Town and Country*
GAS RANGES

* * *

Available For Manufactured,
Natural, or L.P. Bottled Gas

phone direct to

**WESTERN STOVE COMPANY, INC. CULVER CITY, CALIF.
Texas 02901**

© 1948, Western Stove Company, Inc., Culver City, Calif.

SPECIFICATIONS
Width—20 inches
Height—36 inches
Floor Space—20 by 23
inches
Oven—16 inches wide



Note—Generous Sized Oven and Broiler

WESTERN STOVE COMPANY, INC., CULVER CITY, CALIFORNIA, BRANCH OFFICES SAN FRANCISCO AND DALLAS



1. Plant Box at
Garden Entry

The Plan

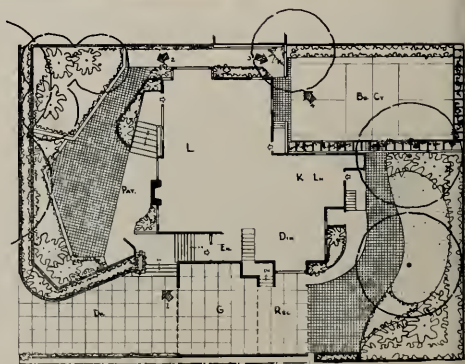

LANDSCAPE DESIGN

THEODORE OSMUNDSON, Jr., Association of Landscape Architects

LANDSCAPE ARCHITECT

OSMUNDSON, STALEY & GIBSON

Oakland and
Los Altos
California



2. In front patio, redwood bulkheads contain soil for planting and provides seat while tending flowers.

The garden for the home of Dr. and Mrs. K. W. Benson, Berkeley, California, presents a straightforward solution to several problems commonly found in the average conventionally built house.

When landscape architect, Theodore Osmundson, Jr. first surveyed the property, three glaring design faults stood out. First, the front lawn was too large and a burden on the owners; second, a single car garage located at the rear of the house, occupied an excessive proportion of the lot as its driveway extended the full length of the property and third, the only existing private area, that space off the kitchen, was undeveloped.

The landscape architect designed the garden to correct these three faults. First, the front lawn was eliminated by filling with soil until a level grade was established. This fill was contained by a brick retaining wall whose maximum height at the deepest point of fill was three feet. A two foot

planting space was allowed behind this wall and in front of a five foot grape stake fence which completely enclosed the area previously occupied by the front lawn. Brick and concrete are used as paving in this enclosed area. Planting is in raised beds behind redwood bulkheads at seat height. Seasonal flowers are planted only within reach from a sitting position on the bulkhead. Permanent shrubs are planted behind the flowers.

This patio will be complete when a landing and steps are built to give direct access from living room to patio.

The driveway has been shortened by moving the garage closer to the street and redesigning the entry steps so that the driveway can double as a front walk. Two narrow driveway strips will be removed and replaced by a concrete apron which will extend into the garage.

The private area off the kitchen has been paved



3. CHILDREN'S PLAYGROUND and BADMINTON COURT

with asphalt for use as a badminton court and dry play space for the owner's four children. Planning around the paving was selected for its ability to withstand the rough treatment that is inevitable in a play yard. The play court is enclosed by 2x4 redwood framing on two sides while the house and a 6 foot redwood stake fence enclose the other sides.

That part of the lot formerly occupied by the garage will be developed as a rhododendron and azalea garden and partially paved with brick.

The scheme provides three separate outdoor sitting areas, as the badminton court and the rhododendron garden behind the garage may be used for this purpose.

Maintenance is kept to a minimum by containing all planting in beds outlined by paving or raised behind brick walls and redwood bulkheads. At the request of the clients, no lawn will be used.

Brick and redwood used in all parts of the garden give it a feeling of warmth and unity.

4. REDWOOD LATTICE DETAIL



COOL COLORS - -

WARM COLORS - -

New Studies On Infra-Red Radiation

The idea that colors on the red side of the spectrum are warm and stimulating, while the opposite blue-green colors are cool and relaxing, is accepted as basic knowledge by color experts. It was no easy task to solve the problem of the connection between color and heat absorption and heat radiation.

Benjamin Franklin—a singularly gifted scientific observer—was highly interested in this problem. In one of his experiments he placed little pieces of cloth of different color on top of the snow and exposed them to winter sunshine. After a certain period of time the black cloth sank deeper and deeper because the snow melted rapidly under it. The intermediate colors sank slowly as the snow melted slowly underneath. The white cloth, however, remained on top of the snow. Franklin concluded from his observations that the darker the color, the greater the absorption of heat from the sun.

Infra-Red Absorption

New studies conducted at the Philadelphia Textile Institute shed additional light on the subject and demonstrated that the infra-red absorption characteristics of the dyestuffs used in fabrics are an important factor in warmth or coolness. A high infra-red absorbing dyestuff and a low infra-red absorbing dyestuff will produce many degrees difference in temperature under prolonged exposure to sunlight—differences as high as 14° F.

Here is the description of a characteristic experiment conducted by the Philadelphia Textile Institute. Two pieces of the same wool fabric were dyed black, one with Pontacyl Blue Black RC which is low in infra-red absorption and therefore reflects most of the infra-red in sunlight, and the other with Chromacyl Black W which absorbs most of the infra-red. The two fabrics are identical in appearance. Rectangular pieces of the two fabrics are laid over blocks of ice of the same size. Then they are placed side by side under infra-red lamps, which produce energy similar to that from

the sun but at higher intensity and at a uniform rate. Under the infra-red lamps, the ice melts very much faster under the fabric dyed with the high infra-red absorbing Chromacyl Black W than under the low infra-red absorbing Pontacyl Blue Black RC.

Another experiment which illustrates the heating effects resulting from infra-red absorption, is this. Two pieces of the same cotton poplin are dyed brown, one with Pontamine Brown BT, which reflects most of the infra-red and therefore is low in infra-red absorption and the other with Ponsol Brown BB, which absorbs most of the infra-red. The samples are mounted side by side under high-intensity infra-red lamps. The fabric dyed with Ponsol Brown BB heats up rapidly, chars and then burns; while the fabric dyed with the low-absorbing Pontamine Brown BT merely becomes somewhat warmer.

From White to Black

We know from long experience that light colors are preferable to avoid heat effects. In the tropics black clothes or even darker colors are carefully avoided,—white or a pale yellow are preferred. For some time it was customary in tropical regions to use red-colored under-garments or red-colored lining under the white or yellow tropical clothing in order to prevent heat injuries. However, exact scientific research work has given no proof for the effectiveness of such measures.

Putting the capacity of heat absorption for white material at 100, we see from this list the percentage of heat absorption by various colors

	Heat Absorption
White material	100%
Pale yellow	102%
Dark yellow	140%
Light grey	152%
Light green	152%
Dark green	161%
Red	168%
Light brown	198%
Black	208%

The effectful rays of the sun may be divided into

ultra-violet, visible and infra-red radiation. The visible light from the sun with its various colors and hues is the spectrum. These colors, in order from longest to shortest wave length, are: red orange, yellow, green, blue, violet. The ultra-violet radiation is on the shorter wave length side of the tion is on the shorter wave length side of the spectrum, these rays have a shorter wave length than violet. The infra-red radiation, on the other hand, is on the long wave side of the spectrum; it consists of radiation longer in wave length than visible red.

The Philadelphia Textile Institute explains in convincing manner what happens to the energy contained in the sun rays. When a beam of blue light falls on a surface such as a piece of white cloth, it can divide into three portions. If the cloth is thin or transparent, some of the blue light can pass through. This is known as **transmission** of light. Another portion can be retained in the fabric, the energy thus retained is used to raise the temperature of the cloth, or to cause chemical transformations of the fibers of which the cloth is made. This retention of light energy is known as **light absorption**. Finally, part of the blue light bounces back, that is, it is **reflected** by the fabric. It is this reflected light which reaches our eyes; and since the beam of light projected on the fabric is blue, the reflected light also is blue, and the white fabric appears blue to our eyes. Of the sunlight absorbed by materials, most is transformed into heat. And since the greatest fraction of this sunlight energy is in the infra-red region, it is obvious that the greatest heating effects are produced by the invisible but powerful infra-red.

Another observation of the Philadelphia Textile Institute is this. Dyes producing the same color in sunlight vary widely in their behavior toward the infra-red portion of the sunlight. Two blue dyes which produce colors identical to the human eye may differ sharply under infra-red. One blue dye may reflect most of this radiation while the other may absorb most of it. As a result, upon prolonged exposure to sunlight, two samples of the same fabric dyed with these two dyes will remain identical in appearance, but the one dyed with the infra-red absorbing dye will become many degrees warmer than the one dyed with the infra-reflecting dye.—Many practical applications are expected from these observations.

Surface Colors

A recent study of the National Bureau of Standards in Canada has confirmed the fact that surfaces painted with light colors absorb less heat, and therefore stay cooler than surfaces painted with dark colors. The various colors were brought in connection with a scale the basis of which was the lampblack surface which absorbs the most

heat and was, therefore, taken as 100. A glossy white painted surface remained cooler under sun exposure than any other type of surface. A flat white painted surface was a close second. The difference between the two white was explained by the fact that a smooth surface absorbs less heat than a slightly roughed one.

In recent years some large owners of tank cars, refrigerator cars, trucks, boats and similar equipment have found that light colored paints are highly efficient heat reflectors. The theoretical explanation of these observations may be enclosed in the new discoveries in the field of infra-red radiation.

NEW APARTMENT BUILDING FOR SAN JOSE

One of the major residential construction projects in the San Jose area is the contemplated construction of a 400 unit apartment building at a cost of \$2,500,000.

SHOP BUILDING

A contract has been awarded the Vezey Construction Company of Oakland, for the construction of a new building for the Paramount Built-In Fixture Company in Oakland. Cost of the added facilities to this company will run in the neighborhood of \$132,000.

SEWAGE PLANT

The City of Redwood City (California) has awarded a contract to the Fred J. Early Company of San Francisco, for the construction of a new sewage treatment plant at a cost of \$449,576. The plant will be of reinforced concrete construction.

ARCHITECT SELECTED. D. D. Stone and Lou Mulloy, Architects of San Francisco, have been selected to design the proposed Tuberculosis Hospital for San Mateo County. An election for approval of a \$1,500,000 bond issue to finance the project will be held in June.

STORE BUILDING. Wm. Radtke & Son, general contractors of Gilroy (California) have been awarded a \$150,000 contract for construction of a new store building in Gilroy to be occupied by the Woolworth Company. J. Lloyd Conrich, San Francisco, is the architect.

HIGH SCHOOL MUSIC BUILDING. Wm. Horstmeier, contractor, San Francisco, has been awarded a \$153,168 contract for the construction of a music building at the Burlingame High School. James H. Mitchell, San Francisco, is the Architect.



COLONIAL DESIGN THROUGHOUT

Photos by Whitefield Studio

A FUNERAL HOME

CROSBY - N. GRAY & CO.

BURLINGAME, CALIFORNIA

RICHARD M. BATES, Jr., Architect

By **ENGENE BURNS**

"The Crosby-N. Gray mortuary in Burlingame is the best planned mortuary I have ever seen and I've seen quite a few." "For a relatively small community, the mortuary is ideally planned . . ." "It is a splendidly planned building to carry out a mortician's work . . ." "The Crosby-N. Gray mortuary affords privacy and convenience to the operators and to the public . . ."

These are the reactions of professional visiting morticians viewing the fire-proof Crosby-N. Gray & Co. mortuary in Burlingame, California, designed by Richard M. Bates, Jr., Architect.

In recalling his days of planning, Architect Richard M. Bates Jr., confessed: "I once thought

that if there was one building less inspiring to design than a jail it was a mortuary . . . but after working on the Crosby-N. Gray job I found it the most interesting architectural problem I have ever tackled."

Mr. Bates incorporated these units into the building:

A large chapel seating two hundred and fifty people with a family room adjacent to seat twenty or more, and an organ loft adjoining. (This large chapel can be divided into two possible rooms by means of a heavy curtain).

A chapel with a seating capacity of one hundred together with a family room and organ loft.



ABOVE:—Spacious Reception Room showing one of three administrative offices in back-center, which lead from the large room and serve for the conduct of business matters.

BELOW:—Another view of the Reception Room with two doorways on either side of an attractive fireplace. Doorways open into an adjoining patio.



A large reception room with a fireplace and a patio adjacent.

In convenient locations, near the reception room, smoking rooms for both men and women with toilet facilities.

Adjacent to the reception room, three administrative offices. These consist of a business office, an arrangement room where preparations can be made for funeral services; an office for the secretary and bookkeeper; and a minister's room for changing of clothing and supply closets and coat closets.

From this business department, a private corridor was made to take the patrons directly to the display room to select caskets.

Besides three slumber rooms, where the bodies lay at rest for relatives and friends to visit, there is an embalming room with a back entrance, a dressing room, a flower room, and a six-car garage. The garage, obviously, is a space consumer.

To make matters even more complex, in the front part of the mortuary, on the second floor, an apartment was incorporated which included two bedrooms, a dining room, a bath, a kitchen, and a laundry. Additional quarters are provided for a night attendant and shower facilities for employees.

One of the difficult problems of the planning was to arrange all these units so that privacy and quiet can be maintained—"one service must not bump into the other." Corridors had to be placed

so that there would be no passing through other rooms.

The individual chapels and slumber rooms had to be placed and constructed so that disturbing sounds would not be conveyed from one to the other. No small feat. To assure silence, Architect Bates even had the lights controlled by soundless mercury switches.

With the exception of the apartment, all these units had to be on the ground floor, readily accessible. And the area of the lot was only 130 feet by 150 feet deep. Zoning restrictions further reduced the area by ten per cent.

"My chief concern," added Bates, "was to make this mortuary more like a dignified home and to take out of it the funeral aspects of most undertaking parlors."

The cast construction of the concrete building was nearly \$200,000.

The result of the planning and designing and construction was to make a building which is extremely successful from a utility and artistic point of view. Two services have been conducted simultaneously and as many as six bodies have lain in the funeral home at one time.

All parts of the building were designed in colonial architecture, both inside and outside, giving the building the dignity befitting its use. Soft pastel colors and appointments were carried out.

As any architect who may have designed a mortuary knows only too well, extremely few plans

(See Page 33)

ONE OF TWO CHAPELS . . . Combined Seating Capacity Three Hundred and Fifty Persons





The SUN LIFE BUILDING

MONTREAL, CANADA

ARCHITECTS In Montreal

By **WILLIAM ARTHUR NEWMAN, Architect**

An understanding, friendly group—these architects in Montreal, who are speeding up completion of new industrial structures, schools, churches, and scores of homes and apartments.

What do their buildings look like, and how are they solving problems today, where a million people live, work and play?

Editor's Note: Mr. Newman, former S. F. architect, was 17 years in charge of the Pacific States District, U. S. Public Bldgs. Administration.

It's an interesting experience to look about. Glance up and down Sherbrooke and other main streets. You have convincing testimony that various schools of architecture, during three hundred years, impressed their differences upon the city. Sometimes many styles are found in the same block, showing French, English, Romanesque, Gothic, Renaissance and modern influences.

The city was founded by the French in 1642. They brought their architecture with them. One



INTRIGUING SKYLINE OF MONTREAL'S DOWNTOWN BUSINESS CENTER

ARCHITECTS IN MONTREAL . . .

hundred years later, when the British took over the country, English types began to appear. A blending of these with modern styles is now the trend.

This greatest inland port of the world has arisen from a tiny village. In the days of Champlain, La-Salle and Marquette it was a wilderness, a thousand miles from the Atlantic. Now its harbor con-

struction extends sixteen miles along the river, serving steamers carrying products to hungry Europe.

The city has expanded its residential section around Mount Royal (its Twin Peaks). With your friend, the architect, drive along the slopes of Mount Royal some clear morning—it's delightful.

You overlook towering buildings in the fore-



WINDSOR SQUARE

One of the Historical Monuments to be seen in the City.



SHERBROOKE STREET

One of the Busiest in Montreal

ground, to ocean liners plying majestic St. Lawrence—and far beyond to the blue outlines of the Adirondacks. The panorama is the setting of this flourishing metropolis—the largest city in Canada.

It is different—in its great economic institutions and public buildings, in its parks, educational and recreational advantages, in its stately mansions, landscaped with spacious lawns, evergreens and flowers.

As in the United States, hotels, stores and transportation are overcrowded with a bustling throng of warmly hospitable people.

Under the influence of Montreal's present prosperity, the building industry has received a healthy impulse. Familiar sounds of hammer and saw call attention to building construction in progress.

One of the new structures, now rapidly nearing completion, is the 22-story Hotel Laurentien, at Windsor and Dorchester Streets, facing Dominion Square.

It is an excellent example of the relatively conservative character of the modern work of Associated Architects L. A. and P. C. Amos and C. Davis Goodman. Consulting Architect is Gordon MacLeod Pitts.

This hotel, in the business center, exemplifies the trend away from the traditional to modern design. In characteristic Canadian manner provision has been made for all social needs and comfortable living for exacting requirements of the modern traveling public.

Prefabrication of its one thousand bath rooms is a feature of interest, and leads us to contemplate what the next prefabricated step may be. Upon leaving the factory these bath rooms are completely furnished with all piping, conduits and wiring. All fixtures are installed, including shelving, towel racks, mirrors, light fixtures, doors, hardware, trim and threshold. Service connections are made from the outside, and bath rooms need not not be unlocked until the building is completed.



ARCHITECT'S PERSPECTIVE
of the new 22-story Hotel
Laurentien at Windsor and
Dorchester Streets and just
across the street from Do-
minion Square.

Near Mount Royal Park at Cote des Neiges and McGregor Street is the new edifice of First Church of Christ, Scientist, under construction. Its impressive beauty is a credit to Bernhardt E. Muller and Shorey & Ritchie, joint architects.

Judging from the architectural drawings and work already completed, this is a decided departure from conventional church design in Canada. The architects incorporated new ideas and retained proven old ones in developing their drawings

from the ideals that came naturally in the program in this field of religion.

They have met the requirements for appropriate facilities in a progressive manner and without the monotony of outmoded standards. The Sunday School section is on the first floor; the church auditorium, directly above.

Light stone for exterior walls is generally used to the auditorium floor line. The superstructure above is brick with stone trimmings.

A visit to the old section of the city shows build-



ABOVE:—The new modern residence in Montreal, like all other progressive cities throughout Canada, embodies today's architectural design and materials while retaining a certain localized atmosphere.

BELOW:—Here is a typical Duplex type of modern construction, showing the use of stone entrances, small steel-rail porches, and newest in window design.





**ARCHITECT'S PERSPECTIVE OF THE FIRST CHURCH OF CHRIST, SCIENTIST
Near Mount Royal at Cote des Neiges and McGregor Streets.**

ings of the early colonists huddled together—streets no more than eight feet wide; houses with no yard or space between adjoining buildings. This was done as a protection against warring Indians and the cold.

The Indians are no longer a threat, and modern insulation and heating equipment have reduced the cold weather problem. These have widened opportunities for residential building progress, which is developing along modern, sound and improving standards.

Heretofore the prevailing practice has generally been to design rooms small, (according to Cali-

fornia standards), small windows, steep roofs and heavy walls of stone and brick.

Now larger rooms are being designed for better living and working conditions. Glass blocks and more window area put additional daylight to work.

Increased transportation facilities and developments in outlying sections are giving the family of average income better housing in better neighborhoods, with more conveniences and comforts.

Some building construction is required, even during winter, and it is carried on.

INTERIOR

**First Church of
Christ, Scientist.
Montreal,
Canada.**



**ENTRANCE
TO
CHURCH**

**Bernhardt E. Muller
and Shorey & Rit-
chie, Architects.**

ARCHITECTS IN MONTREAL . . .

You who have supervised construction in zero weather appreciate the difficulties of these friendly neighbors of ours.

Br-rr! Visualize yourself, bundled from head to foot, directing the contractor who has responsibility for removing truck loads of snow all day long, many days in the week on any good size job; spreading sand under foot, in and outside the work to prevent slipping; dodging icicles hanging from tarpaulins enclosing the masonry.

The workers dig lumber out of piles covered with ice; scrape snow from concrete forms and

newly laid floors; melt ice from structural and reinforcing steel. Melt it about entrance gates to the job, so they may be opened and again at night, so they may be closed. Of course they heat all masonry materials before using; have plenty of salamanders and a blower hot-air system under tarpaulins to protect the work and permit it to proceed. These are daily construction responsibilities for winter months in this climate.

Finally winter is over; snow and ice disappear; the warm spring arrives. Architects dust off their extra drawing boards and clients start filling in.



HERE

**Is one of the
older types of
Duplex Homes.**

*Photographs by
The Author
and
Canadian National
Railways*

**NEW
STONE
RESIDENCE**

**Of modern architec-
ture to meet the
varied climate**



**VIEW of world famous Botanical Garden and Art Gallery at the University
of Montreal.**





FACING BERKELEY'S CIVIC CENTER . . . James W. Placheck, Architect

NEW WESTERN OFFICE

State Farm Insurance Companies

Berkeley, California

The newly completed Western Office building of the State Farm Insurance Companies in Berkeley, California, not only represents one of the few large office buildings on the Pacific Coast which has been designed by an architect to meet the specific needs of a large insurance company, but, it also adds another modern building to the City's beautiful new Civic Center.

When given the commission by company officials to design the building on the carefully selected site, Architect James W. Placheck was presented with two very important problems. The first being the need for planning and developing a strictly modern structure which would embody all the newest design, materials, and utility of a new building, and at the same time provide for current and expanded personnel required in the diversified scope of the company's business activities.

The second requisite was the designing of a building that would harmonize with the new Civic

Center, which is just across the street, and with the various municipal and governmental buildings which comprise the Civic Center group, and the Veteran's Memorial Building which is immediately to the West.

STATE FARM INSURANCE COMPANIES

The following firms, participants in the construction of the new State Farm Insurance Companies Building, Berkeley, California, have display advertising in this issue:

ARCHITECT: James W. Placheck, A.I.A.

GENERAL CONTRACTOR: Parker, Steffens & Pearce, Builders.

POWER-LIGHT: Central Electric Co.

PAINTING-DECORATING: D. Zelinsky & Sons.

MILLWORK: Clinton Mill & Mfg. Co.

STEELFORMS: Steelform Contracting Co.



ABOVE:—Entrance into the spacious reception lobby is across the street from Berkeley's beautiful Civic Center. The hand rails are of metal; doors at right and left are for entrance into offices; elevators are at the right.

BELOW:—Information Desk and offices of the District Agency. Working space for staff is at the right, while immediately behind the secretary's desk is one of the private offices.





OFFICE DESIGN

Uses every foot of available floor space to good advantage. Wood partitions separate departments, ample light, and openness for workers' comfort.

POWER - LIGHT

in the
STATE FARM INSURANCE BUILDING
by
CENTRAL ELECTRIC CO., Inc.

Since 1907

610 - 3rd St., San Francisco
EXbrook 2-2180

It is conceded by those who have seen the new State Farm Insurance Building that Architect Plé's check succeeded in both requirements.

The attractive six-story reinforced steel and concrete structure was nearly two years in construction from the time of ground breaking ceremonies in the latter part of April 1946.

The new building itself contains some 115,000 square feet of floor space and among the many special features to be incorporated in the structure are the new no-draft windows which permit plenty of ventilation without discomfort to those working within the room where the window is open. Ample

**PAINTING
AND**

DECORATING

State Farm Insurance Building
BERKELEY

D. ZELINSKY & SONS

SAN FRANCISCO • LOS ANGELES
"Leaders in the Pointing Industry"

MILLWORK

STATE FARM INSURANCE BUILDING

Supplied by

CLINTON MILL & MFG. CO.

Millwork • Sash • Doors
Frames and Cabinets

345 E. 7th Street, Oakland 6, Calif.

Telephone: GLencourt 1-9480

TABULATING ROOM

Operation of equipment is made easier through plenty of room and natural light.



Lighting is provided by cold cathode lighting which is supplemental to a great deal of natural lighting. Floors are of asphalt tile and movable steel partitions permit an expansion or consolidation of any department without having to do a major remodeling.

Two modern passenger elevators of the push-button self levelling type, and phone and electric wire conduits are set in the floor eight feet apart provide outlets every two feet so that any desk may be easily reached.

Taking advantage of the ideal climate, an outdoor patio and recreation deck has been provided on the roof, for use of employees during rest periods and the noon hour.

A breakdown of the new building shows the Basement is used for the boiler room, carpenter shop, storage and janitorial supplies; the First Floor is the Berkeley Agency of the Fire Company, purchasing department, and mailing and supply; the Second Floor is the accounting department, and agency headquarters

The Third Floor is departmental agencies; the Fourth Floor contains the administration offices and law library; the Fifth Floor contains the personnel department, training school for new employees, credit union office, and medical division including doctors office and nurses quarters

The Sixth Floor is devoted to insurance agency activities.

STEELFORMS FOR CONCRETE JOISTS

Used in forming the floors in
STATE FARM INSURANCE BUILDING
Berkeley, California

Furnished and Installed by
STEELFORM CONTRACTING COMPANY

666 Harrison St., San Francisco

833 E. Gage Ave., Los Angeles

CALIFORNIA COUNCIL A. I. A.

LEGISLATIVE ACTIVITIES

COMMITTEE REPORT*

During the 1948 Budget Session of the California State Legislature two measures were submitted for the purpose of assisting the State in preparing plans and specifications for the tremendous Public Works program which it now faces. The Department of Public Works, Division of Architecture, and the State Personnel Board, all admit that they are unable to provide plans and specifications for the highway and building programs for which funds have been appropriated.

Assemblyman Phillip Boyd, of Palm Springs, discussed with the Director of Finance the possibility of presenting urgency appropriation legislation which would provide \$20,000,000.00 for the retaining of private practicing Architects and Engineers for the performance of a major portion of the Public Works program. Mr. Boyd was informed by the Director of Finance, Mr. James Dean, that such a program did not appear to be in the public interest. It is difficult to understand how Mr. Dean could take the attitude that any measure that would help to expedite public work would not be in the public interest. Mr. Dean, it should be recalled, is a licensed Architect, and although he had maintained a private practice, the majority of his career has been spent as a public servant, and, as a result thereof, he has become a confirmed bureaucrat. It is always difficult for a man of bureaucratic tendencies to realize that the private practitioners can and should perform their services in the interest of the public.

Assemblyman Richard McCollister, of Marin and Sonoma Counties, submitted Assembly Concurrent Resolution No. 24. The Director of Finance did not oppose this resolution and it readily passed through the Assembly; however, in the Rules Committee meeting of the Senate, a Mr. Hamilton appeared on behalf of Mr. Purcell and the Department of Public Works, stating that the Department was violently opposed to the resolution. The Senate Committee meeting was held in the evening

of the last day of the session of the legislature, and, as a result of the appearance of the attorney for the Department of Public Works, no action was taken, with the resolution being permitted to die. The resolution is as follows:

Assembly Concurrent Resolution No. 24—Relative to employment of private firms by the Department of Public Works.

WHEREAS, Provisions in the Budget Bill now before the California Legislature, and appropriations of prior years, assure an expanded program of public works, now and for a considerable time in the future and

WHEREAS, The need of the people of California for highways, armories, schools, and other of said public works is immediate and urgent; and

WHEREAS, The program causes such an excess in the normal flow of architectural, engineering, surveying and other work in the Department of Public Works and in the Department of Finance that some of the urgent needs will inevitably be delayed and

WHEREAS, Many private firms and professional individuals in California, engaged in the construction business, could expedite the public works program; now, therefore be it.

RESOLVED BY THE ASSEMBLY OF THE STATE OF CALIFORNIA, THE SENATE THEREOF CONCURRING, That the Assembly and Senate of the State of California recommend that the Department of Public Works and the Department of Finance expedite the public works program of this State by contracting with and employing private firms and professional individuals in the construction business, whenever it is legal so to do and delay would result from a failure so to do; and be it further

RESOLVED, That the Chief Clerk of the Assembly transmit copies of this resolution to the Director of Public Works and to the Director of Finance of the State of California.

The principal work of the California Council of Architects Committee on Governmental Relations

(See Page 34)

*Note: This is the Report of the California Council of Architects, A.I.A., Committee on Governmental Relations of which Albert C. Martin, Jr., is the Chairman, and John S. Bolles and Adrian Wilson are members.

A. I. A.

American Institute



ACTIVITIES

of Architects

Arizona Chapter:
James Macmillan, President; Arthur T. Brown, Secretary,
740 N. Country Club Road, Tucson, Arizona.

Central Valley of California:
Herbert E. Goodpastor, President; Frank V. Mayo, Secretary,
307 Exchange Building, Stockton 2, California.

Colorado Chapter:
Raymond H. Ervin, President; James M. Hunter, Secretary,
2049 Broadway, Boulder, Colorado.

East Bay Chapter:
A. Lewis Kose, President; James H. Anderson, Vice-President;
Loy Chamberlain, Secretary; Chester H. Treichel,
Treasurer, Office, 3833 Piedmont Ave., Berkeley, California.

Montana Chapter:
Ralph H. Cushing, President; H. C. Cheever, Secretary,
Montana State College, Bozeman, Montana.

Northern California Chapter:
Wm. Clement Ambrose, President; Lester W. Hurd, Vice-President;
Ralph N. Pollack, Secretary; Donald Beach Kirby,
Treasurer; Office 369 Pine Street, San Francisco.

Oregon Chapter:
Frank Roshar, President; Sidney W. Little, Vice-President;
J. Halman Baines, Secretary; Don Edmundson, Treasurer,
Office 619 Builders Exchange Bldg., Portland 4, Oregon.

San Diego Chapter:
H. Louis Bodmer, President; Louis J. Gill, Secretary, 203
Granger Building, San Diego, California.

Santa Barbara Chapter (California):
Chester L. Corjola, President; Robert I. Hoyt, Secretary,
116 E. Solis St., Santa Barbara, California.

CALIFORNIA COUNCIL OF ARCHITECTS:
Andrew T. Hass, President; Adrian Wilson, Vice-President;
Malcolm Reynolds, Secretary-Treasurer; Office 369 Pine
Street, San Francisco.

Southern California Chapter:
George Allison, President; A. C. Martin, Jr., Vice-President;
Anthony Therma, Secretary; George E. Gable, Treasurer;
Chapter Headquarters, 3757 Wilshire Blvd., Los Angeles 5,
California.

Spokane Chapter (Washington):
Noel E. Thomson, President; Kenneth D. Stormont, Secretary,
Hutton Building, Spokane, Washington.

Utah Chapter:
George Cannon Young, President; Theodore R. Pope, Secretary,
29 South State Street, Salt Lake City 1, Utah.

Washington State Chapter:
Clifton J. Brady, President; Arrigo M. Young, Vice-President;
John Richards, 2nd Vice-President; Raif E. Decker,
Sec.; Waldo B. Christenson, Treasurer, Office 1411 Fourth
Avenue Building, Seattle 1, Washington.

Tacoma Society:
Chas. Rueger, President; Clarence Rueger, Vice-President;
W. W. Durham, Secretary-Treasurer.

Hawaii Chapter:
Kenneth W. Roshrig, President; James Morrison, Secretary,
334 Federal Bldg., Honolulu, T. H.

SOUTHERN CALIFORNIA CHAPTER

The April meeting was a joint meeting of the Southern California Chapter, A.I.A., and the Southern California Chapter of the American Institute of Decorators, with many national representatives of the latter group in attendance.

Speakers on the program included Mr. Gregor Norman-Wilcox, Art Curator of the Los Angeles Museum of History and Art who spoke on "Problems of Keeping the Peace," and Mr. John White, Jr., Field Secretary of the A.I.A. who was visiting the Sierra-Nevada District Chapters.

• • •

Richard Neutra recently returned from Saint Louis, Missouri, where he served on the Jefferson Memorial Expansion jury. The Congress of the United States has earmarked some twenty-million dollars for the memorial project.

• • •

With the founding of the Modern Institute of Art in Los Angeles recently, southern California now has its first Museum of Contemporary Art.

• • •

The Los Angeles County Board of Supervisors has adopted a maximum fee of 6 1/4 per cent for architectural services in conjunction with County projects. Efforts of the Chapter to clarify this "ceiling" on the basis if service rendered has been unsuccessful.

• • •

NEW MEMBERS: Carlton L. Camp, Charles W. Ertz, David Freedman, Everett R. Harman, and George D. Riddle.

NORTHERN CALIFORNIA CHAPTER

One of the outstanding exhibits at the recent National Home Show in San Francisco's Municipal Auditorium, was the result of Chapter activities. Members gathered together photographs, plans,

(See Page 40)

FOR BETTER SERVICE

Remember that

KRAFTILE is

WESTERN HEADQUARTERS

FOR

<ul style="list-style-type: none"> ◆ ACID Brick ◆ ACID-PROOF Jointing Compounds ◆ ACID-PROOF Floor and Tank Construction ◆ ACID-PROOF Coatings 	<ul style="list-style-type: none"> ◆ GLAZED Structural Wall Units ◆ PATIO Tile ◆ QUARRY Tile ◆ SWIMMING POOL Overflow Gutter
--	--

◆ LIGHTWEIGHT CONCRETE BLOCKS

 <p>STRAN-STEEL FRAMING</p>	<ul style="list-style-type: none"> ◆ QUONSET Packaged Steel Buildings 	<ul style="list-style-type: none"> ◆ STRAN-STEEL Framing
---	--	---

For complete information and prompt service, phone or write

KRAFTILE COMPANY

NILES, CALIFORNIA NILES 3611
SAN FRANCISCO 5: 50 Hawthorne St.—D'Ouglas 2-3780
LOS ANGELES 13: 406 South Main Street—MUTual 7241

WITH THE ENGINEERS

Structural Engineers Association of Northern California

John A. Blume, President; Jesse Rosenwald, Vice President; Franklin P. Ulrich, Treas.; Geo. E. Solnar, Jr., Sec., Office, Room 215, 55 New Montgomery St., San Francisco 5. Phone SUtter 1-7642. DIRECTORS, A. W. Anderson, Henry J. Degenkolb, John E. Rinne, Robert D. Dewell, and Wm. W. Moore.

San Francisco Section

L. A. Elsener, President; A. W. Earl and G. B. Woodruff, Vice-Presidents; John E. Rinne, Secretary-Treasurer; 225 Bush Street, San Francisco 20.

Structural Engineers Association of Southern California

Sieve Barnes, President; Harry W. Bolin, Vice President; Lewis K. Osborn, Sec-Treas. DIRECTORS, Richard W. Ware, Geo. E. Brandow, L. T. Evans, Harold P. King, and Donald F. Shugart. Office: 202 Architects Bldg., Los Angeles 13, Calif.

Puget Sound Engineering Council (Washington)

R. E. Kister, A. I. E. E., Chairman; E. R. McMillan, A. S. C. E., Vice Chairman; L. B. Cooper, A. S. M. E., Secretary; A. E. Nicholson, I. E. S., Treasurer; Offices, L. B. Cooper, c/o University of Washington, Seattle 5, Washington.

STRUCTURAL ENGINEERS ASSOCIATION OF SOUTHERN CALIFORNIA

The April meeting was honored by the presence of a number of members of the California State Board of Registration for civil and professional engineers. Executive Secretary of the Board, Pecos H. Calahan, introduced the following members of the Board:

Paul E. Jeffers, President, (Representing civil engineers); Asa G. Proctor, Vice president, (Representing civil engineers); A. V. Saph, Jr., (Representing structural engineers); W. H. Geis, (Representing petroleum engineers); Royal W. Sorenson, (Representing electrical engineers); Dean L. M. K. Boelter, (Representing Chemical engineers).

Mr. Jeffers spoke briefly and in a complimentary

manner about the work of the Division of Architecture in its interpretation and administration of the Field Act. This Act was sponsored by Representative Don Field of Glendale after the 1933 earthquake and has been the basis of structural design for public school buildings since that time.

Mr. Frank Ulrich, Chief of the Seismological Division of the U. S. Coast and Geodetic Survey was present and made brief remarks.

Program Chairman, Chuck Corbet introduced Mr. Edward Ainsworth, author and feature writer for the Los Angeles Times. Ainsworth spoke of the crusade under way for the elimination of smog in the Los Angeles area. He described the development of this problem, the peculiarity of the terrain of the Los Angeles area which, to some extent, pockets the fog, smoke and fumes. The first real serious indication of smog was in 1943 as the industries were getting well into war production. The unpleasant, eye-smarting which has been so annoying has been relieved to some extent and many of the industries have put in corrective measures.

After Ainsworth's very able description of the legal, political and promotional effort which was necessary to organize such a program, he introduced Dr. Louis McCabe the present director of the pollution control program for the Los Angeles Smog control Department. Dr. McCabe answered questions relative to the problems involved and the effect of various by-products as they are discharged in the air. He outlined a very practical program for reduction of this condition. He explained the new State law by which a County can now establish an air pollution district and police any place in this district whether within city limits or unincorporated limits.

Mr. Wallace, representing the Standard Oil Company, showed motion pictures illustrating the educational work which they have been doing in connection with Diesel trucks. These were very informative and showed the necessity for further educational work in order to eliminate the excessive smoke from this type of trucking equipment.

Paddock *Swimming Pool* Services to Architects

Standard pool plans.

Cost data.

Permanent exhibit of pool equipment, finishes, trims, accessories, and fittings.

Mechanical and structural specification service.

▶ Swimming pool literature for clients on pools, filter plants, chlorinators, and pool accessories.

New Paddock equipment catalog now in preparation. May we reserve a copy for you?

28 Years of INTEGRITY in Fine Pool Construction

Paddock Engineering Company

Southern California Office
8400 Santa Monica Blvd.,
Los Angeles 46—HEmpstead 2315

Northern California Office
Seventh and Bay Shore Blvd.,
San Mateo—San Mateo 3-1889

MORTUARY . . . Burlingame, California

(From Page 15)

of mortuaries are in existence—and the success of Mr. Bates' design is attested by the fact that requests for floor plans and pictures have been received from all parts of the country.

Architect Bates received his preliminary architectural training in Pennsylvania. He took two additional graduate years in architecture at the famed Ecole des Beaux Arts, Paris, France. During the late war, Bates supervised the construction of 2,000 Bates Prefabricated Structures, which he designed, at Benicia and Vallejo.

The principal owners of the mortuary are William J. Crosby Sr. of Burlingame; his son, William J. Crosby Jr., who is the manager and secretary-treasurer; and President Harold L. Wright, grandson of the Nathaniel Gray who founded San Francisco's oldest mortuary firm, N. Gray & Co., 1850.

Since the building's completion, two gratifying results have occurred: First, business has increased; and second, the owners of nearby property who first objected to the erection of a mortuary in the neighborhood are now favoring a complete rezoning of the district to permit other business organizations such as Crosby-N. Gray & Co. to move into the area.

JAIL EQUIPMENT NEW POLICE STATION

Construction of a new police station and jail building will start in Reno, Nevada, with the awarding of a contract to the Walker Boudwin Company of Reno in the amount of \$394,462, according to Blanchard Maher & Lockard, architects.

Contracts for new equipment have also been awarded, making the total cost of the new building and facilities approximately \$533,194.

NEW TELEPHONE EXCHANGE. Haas & Rothchild, San Francisco, contractors have been awarded a contract for the construction of a new telephone exchange in Pittsburg, California, at a cost of \$350,000. Harry A. Thomsen, Jr., San Francisco, is the architect.

WAREHOUSE comprising 5-story reinforced concrete and frame building will be built in San Francisco for the Lackman Bros. by the Mills Construction Company. Cost is \$70,000. Hyman Rosenthal, San Francisco, is the Structural Engineer.

SCHOOL BONDS VOTED. The Live Oak Elementary School District (California) recently voted \$100,000 for the construction of a new grammar school.

What's wrong here?



Take another look. See any sign of planning for built-in telephone facilities?

It's hard to see how a home can be really modern these days if the builder hasn't put in pipe or other tubing leading to well-located telephone outlets. That way telephones can be moved or added in the



future without drilling holes or running wires along baseboards. The cost? It's insignificant if the facilities are put in during construction.

for free help in planning modern, built-in telephone wiring, call your local telephone company office and ask for "Architects and Builders Service."

The Pacific Telephone
and Telegraph Company



for **BEAUTY
AND UTILITY...**

● WHEN you want handsome appearance plus dependable performance in the fountains you specify, you can be assured of client-satisfaction with HAWS! There are many HAWS models to choose from and all are made from the finest of materials by expert craftsmen. Extra care in engineering... closest check on manufacturing... assure highest quality in any type HAWS Fountain you specify. Write for catalog.

HAWS DRINKING FOUNTAINS
HAWS DRINKING FAUCET CO.
 1435 FOURTH STREET (Since 1909) BERKELEY 2, CALIFORNIA
 Agents and Sales Representatives in All Principal Cities



CALIFORNIA COUNCIL, A. I. A. LEGISLATIVE ACTIVITIES

(From Page 30)

for 1947 centered about activities in Sacramento during the session of the legislature. A number of items developed during that session which were subsequently followed through with the recommendation that they be continued into the next year.

Four items held the principal interest of the profession at the 1947 session of the legislature. They were:

1. Assembly Bill 2117 which would amend Section 18590 of the Government Code relating to services performed by contract, and, as such, would permit the retaining of private Architects and Engineers to perform services for the Department of Public Works.
2. Professional Engineers' Act which would set up the procedure for licensing under a "copyright law" the terms "Mechanical and Electrical Engineers."
3. Various amendments to the fire and safety codes.
4. Various amendments to the State Housing Act.

1. Assembly Bill 2117 passed the Assembly but was defeated in Senate Committee. The failure in Senate Committee can be attributed to the fact that both our own legislative counsel and the legislative counsel of the A.G.C. had not looked with favor upon highway legislation which was primarily supported by several members of this Committee. The frank statement was made by one Senator that the Bill was acceptable to him but he could not vote for it in view of the support it received from groups who had opposed the highway measure.

2. The Professional Engineers' Act, in its original form, was not acceptable to the Architects and Civil Engineers. In its final form it was approved by the Civil Engineers and was reviewed by counsel for the Architects. The Bill, as passed, appears to contain several ambiguities which will be clarified within the course of the next year.

3. In the main, the efforts of the Fire Marshal to enter the building inspection field were defeated; however, the State Fire Marshal's office by rules and regulations, is attempting to impose many of the measures which were defeated in the legislature.

4. The session ended with no radical action being taken by the legislature on housing legislation.

In addition to the above four items, two bills were introduced on which no positive action was taken. One of these bills provided for a commission to be set up to direct affairs of the Depart-

ment of Architecture, and the other provided for a commission to be set up over the Department of Public Works. The thesis of these two bills should not be forgotten in future legislation for they follow the pattern of sound democratic government.

In summing up the legislative session, particular credit should be given to the Builders' Exchange for their cooperation, and to the A.G.C. Chapters for their assistance. The Architects were notified of all joint legislative meetings conducted by these groups and were able to operate in harmony with them on all measures with the exception of the local licensing bill submitted by the electrical subcontractors. With the help of the Architects this bill was defeated. The Committee is also appreciative of the work done in our behalf by our legislative counsel, Attorney Gardiner Johnson, and his assistant, Mr. Perry Taft. Due credit should also be given to Assemblyman Tom Caldecott of Berkeley who pressed for passage of Assembly Bill 2117, and, for the first time on record, succeeded in getting Architects' legislation through the Assembly.

The question of the Professional Engineers' Act and its ambiguities has led to meetings with the State Board of Architectural Examiners and with Director Americh of the Department of Professional and Vocational Standards. The State Board of Architectural Examiners contemplates meeting with the Professional Engineers' Board in order to define the problems which appear to be involved.

The Committee has represented the Architects at the various meetings held by the Bureau of Hospital Inspection of the State of California, and the Federal Works Agency, Division on Hospitals. The Committee sent a representative to the Hospital Advisory Board meeting in Los Angeles to assist that Board in ascertaining the exclusive position of the Architects in regard to the design of hospitals. This position has been questioned by the Civil Engineers' group.

The Committee has been in constant touch with the National Committee on legislation and has endeavored to find Architects who will maintain contact with their Congressmen and Senators in the interest of the profession. As a result of the activities of the Committee and the Council, California maintains the best congressional contact of any state in the Union.

SCHOOL BONDS DEFEATED. Proposal to issue \$174,000 in bonds for construction of a new grammar school at Susanville, California, was recently defeated by the voters.

THIS CERTIFICATE

is evidence of electrical adequacy.



The Adequate Wiring program, in operation in Northern California, includes the presentation of this impressive certificate to the owner of each qualifying home.

It is tangible evidence of electrical adequacy, assuring your client that nothing has been overlooked in the wiring plans, and providing added value for loan or re-sale purposes . . . all factors which contribute toward the owner's satisfaction with the home you have designed.

The Adequate Wiring program offers you, without charge or obligation . . . a complete wiring layout service, to aid you in furnishing your clients with electrical plans and specifications. For detailed information, consult your local utility office or this Bureau.

**NORTHERN CALIFORNIA ELECTRICAL
BUREAU**

1355 Market Street, San Francisco 3

HEADLINE NEWS AND VIEWS

By E. H. W.

"The future progress and security of the United States depends upon modernizing our highway system and increasing its capacity"—Dwight W. Winkelman, Vice-president of the Associated General Contractors of America.

In The "Rumor" Department. Reports, from sources usually considered reliable, have it that the Southern California Auto Club and the California State Automobile Association are going to have a "look into" the very high automobile and truck license fees being charged by Director of Motor Vehicles Edgar E. Lampton's department. . .

Why not the Association of Manufacturers taking a peek into the Motor Vehicle Department's having the '48 tabs made at Folsom prison—while the tabs offer little tangible compensation for their high cost to the taxpayer, some private manufacturing plant could probably pay more State taxes if given the contract for making the tabs.

The Association of National Advertisers has advised the National Better Business Bureau that the Federal Trade Commission has no power to curb use of the word "free" in advertising. . . . That's some consolation, because there are a lot of people who read advertisements just to see what they would get free if they were to buy the product advertised. . . .

Sort of like the fellow who enjoyed looking at the massive mail-order catalogue because it made him realize how many things there were in this world he didn't want.

The U. S. Department of Commerce estimates new construction during 1948 will reach a total of \$15-Billion—a record breaking figure in dollar volume.

Modular Coordination Marches On. A recent report from the National Door Manufacturers Association declares, "Top flight authorities in building industry actively supporting nationwide program to reduce building costs."

"When the history of this era is written, its pages will be filled with bitter conflicts."—Earl O. Shreve, President Chamber of Commerce of the United States.

Engineers who are active in California, should make it a point to familiarize themselves with the recently enacted registration requirement for professional engineers practicing in California.



E. K. WOOD LUMBER CO.

SAN FRANCISCO General Offices: No. 1 Drumm Street
LOS ANGELES Office and Yards: 4710 S. Alameda St. — JE 3111
OAKLAND Yards and Wharves: 2111 Frederick St. — KE 4-8466
PORTLAND Mill Sales Office: 827 Terminal Sales Bldg.
SAW MILLS: Roseburg, Oregon • Reedsport, Oregon
RETAIL YARDS: LOS ANGELES • OAKLAND • ONTARIO • HOLLYWOOD
LONG BEACH • RIVERSIDE • TEMPLE CITY • SIERRA MADRE • INDIAN • THERMAL
LA VERNE • WHITTIER • PASADENA • SAN PEDRO

BAXCO

CHROMATED ZINC CHLORIDE

PLC

PRESSURE TREATED LUMBER
● **PROTECTS AGAINST DECAY**
AND TERMITE ATTACK

Specify it in your home
Available through Lumber Dealers

LOS ANGELES
601 W. 5th Street
Phone Michigan 6294

SAN FRANCISCO
333 Montgomery Street
Phone DOuglas 2-3883

J. H. Baxter & Co.

AGENTS FOR WEST COAST WOOD PRESERVING CO., SEATTLE WASH.

IN THE NEWS

POST OFFICE AT S. F. AIRPORT. Wellnitz & DeNarde, contractor, San Francisco, will build Post Office building at the San Francisco Airport to cost \$52,264.

ARCHITECT SELECTED. Higgins & Root, San Jose, architects have been selected to design the Anne Darling Grammar School addition and the Lincoln Glen Grammar School in San Jose.

AWALT BUYS WESTERN CRANE SERVICE

The business and assets of the Western Crane Service Corporation, founded in 1923 by E. J. Neville, has been acquired by Fritz Awalt who has long been identified with the construction and equipment industry on the west coast.

Dick Brogden, Bob Brogden, Ted Bardoli, Jack Campbell, and Les Mears and others who have been with the firm over a period of many years will continue with the new owner.

VETERINARY SCHOOL

The University of California Board of Regents have awarded contracts for the construction of a new school of veterinary medicine at the Davis campus at a cost of \$3,217, 237. Erbenraut & Summers, San Francisco, have the general contract (\$2,270,000); M. R. Carpenter, Sacramento, has the heating and ventilating (\$679,430); the Collins Electric Company and Manuel Joseph, Sacramento, have the electrical work (\$239,847) and other contracts total \$9,960.

Blanchard & Maher, San Francisco, are the architects.

NEW GRAMMAR SCHOOL.

Mark Bristol, Oakland, contractors have been awarded a contract for construction of a new grammar school at Rodeo (California) at a cost of \$191,324. Young & Lloyd, Albany, are the architects.

GRAIN ELEVATOR. A contract has been awarded to the Dinwiddie Construction Company for the construction of a \$1,076,937 grain elevator and terminal building in San Francisco for the State Board of Harbor Commissioners.

WESTERN MADE

LUMINAIRES

COMMERCIAL.....

INDUSTRIAL.....

INSTITUTIONAL.....

and FLOOD LIGHTS

Planned
Lighting by



Offices in Principal Western Cities—Branch and Warehouse in San Francisco

LANDSCAPE ARCHITECTURE

Notes of The Profession

ASSOCIATION OF LANDSCAPE ARCHITECTS, SAN FRANCISCO REGION

Vernon Dean, President; Robert Royston, Vice-President; Ned Rucker, Treasurer;
E. L. Anderson, Secretary, 1736 Franklin, Oakland, California.

ASSOCIATION OF LANDSCAPE ARCHITECTS SAN FRANCISCO REGION

A School Plant Planning Conference, sponsored by the Association of Landscape Architects, San Francisco Region, is to be held on May 7th and 8th at the Sonoma Mission Inn. Several educators, architects, and recreational planners will be present to discuss the problems involved in the development of school plants.

Francis Lange, A.L.A., has left the Federal Public Housing Administration, and joined the staff of the Architecture Division, Comptroller's office, University of California, as a Project Architect.

Irving Trimbel, A.L.A., has accepted a position

Now... An Easily Applied, Low Cost INSULATION & ACOUSTICAL COMPOUND

PERMA-DRI . . . an R.M.S. Product

- FOR • Anti-Sweat Protection
• Insulation
• Acoustical Treatment
• Artistic Textures

WHAT IT IS:

Selected granules of "Per-lite" blended with a durable high-strength binder. "Per-lite" is heat-processed Aluminum Silicate; non-absorbent, fireproof, chemically inert and non-crumbing.

Easily applied (brush or spray) over metal, concrete, masonry, asbestos-cement, wood, plaster, wallboard and all similar surfaces. Bonds firmly and gives full one-coat coverage; for increased insulation, may be built up to 1/2" or 3/4" thickness.

WHAT IT DOES:

RETARDS CONDENSATION—Keeps wall, ceiling, pipe or equipment surface temperatures close to air temperature, thus preventing moisture condensation.

GET THE FACTS about this versatile new material. Write for samples, complete data and prices.

STEPHENSON AIR BRUSH PAINT CO.

190 MAC ARTHUR BLVD. • OAKLAND 10, CALIFORNIA

INSULATES—K factor ranges up to .45 at 75° F. at various densities up to 11 lbs. per sq. ft. Excellent low-cost insulation for walls, ceilings, under roofs, bulkheads, etc.

PROVIDES SOUND CONTROL—Excellent acoustical properties; cuts both sound reflection and conduction.

DECORATES—Available in fine, medium and coarse grades; provides attractive texture. May be troweled after application for Travertine effects, etc. One coat covers completely, hides stains or any surface color. Material is naturally bone-white, may be tinted any color. Color goes clear through; mars or scratches don't show. Requires no painting, but can be painted with almost any type of oil or water paint if desired.

with the Bureau of Reclamation at Sacramento.

The Division of Beaches and Parks, State of California, is expanding its activities and development of State Parks, and is adding Landscape Architects to the staff of the Division.

The Division of Landscape Design, University of California, is providing the material for the summer issue of "Horizons" a national magazine, published at Iowa State College.

SOUTHERN CALIFORNIA CALIFORNIA ASSOCIATION OF LANDSCAPE ARCHITECTS

New officers of the California Association of Landscape Architects at Los Angeles for the coming year were installed by Association members during the first annual election meeting held in March at Los Angeles.

Newly elected officers include Maylon V. Chipman, Beverly Hills, president Dunckley Murray, West Los Angeles, vice-president; R. F. Dunbar, Long Beach, treasurer; John Eyerman, Los Angeles, recording secretary; Glenn L. Black, Van Nuys, corresponding secretary; John Rodger, Glendale, and Fred Barlow, Burbank, directors-at-large.

Association plans for the next year call for extensive participation and promotion of projects in the public interest.

Recently admitted new members include Robert

LINOLEUM

Armstrong, Nairne, Pabco, Sloane-Blabon

Linoleum, Asphalt and Rubber Tile
for any installation



FOX TILE CO.

3247 E. 14th Street, Oakland
Phone: ANdover 1-0431

O'Hanlon, Burbank; Jean P. McDaniel, Hollywood; Harold T. Teague, Van Nuys; and Robert Coelho, Los Angeles; for active membership; and Ernest Athenour, Hollywood; John S. Vosburg, Glendale; and Jack L. Schnetzler, Hollywood; for Associate membership.

John Bostic is now working in the office of Ferris L. Clampitt, C.A.L.A., in Beverly Hills.

A large housing project has taken new member Robert Coelho to Santa Fe, N. M., Coelho formerly worked in the Garrett Eckbo office in Los Angeles.

ARCHITECT APPOINTED CHAIRMAN

Jerrold Loebel, Chicago architect, has been appointed chairman of the Architecture and Applied Arts division of the \$15,000,000 special development program campaign of the Illinois Institute of Technology.

A partner of the firm of Loebel, Schlossman & Bennett, he is also midwest area chairman of the Urban Planning Committee of the American Institute of Architects, and a member of the Mayor's Housing Action Committee of the City of Chicago, Illinois.

Other members of the committee include: Raphael N. Friedman, John O. Merrill, Roy T. Christiansen, Charles F. Murphy, Charles H. Hammond, Alred Shaw, and Henry Balfanz all architects of Chicago.

Five buildings of the project have already been constructed.

SISKRAFT APPOINTS SALES MANAGER

W. L. Kennedy, manager of the New York branch office of the Siskraft Company, has been appointed Sales Manager of the company, and will take over his new duties with headquarters in Chicago.

RENO WAREHOUSE. John H. C. Roberts, Reno (Nevada), contractor has been awarded a \$108-430 contract for the construction of a 18,000 sq. ft. warehouse building in Reno, Nevada. Hyman & Appleton, San Francisco, are the architects.

SEWAGE TREATMENT PLANT for Shafter (California) will be built by the Trewwhitt, Shields & Fisher contracting firm at a cost of \$128,900.

SCHOOL BOND ELECTION. A \$240,000 bond issue will be presented to the voters of Davis at an election to be held May 4, 1948. Bonds are to build a new grammar school.

HEATFORM

The Superior Heat Circulating Fireplace

THE MOST EFFICIENT AND DURABLE

PRODUCES MORE HEAT because the air contacts the heating surface of the firebox and the upper throat. Super-heating round air passages connect both upper and lower heating chambers. This extra heating surface through and around the throat is the most valuable of all because it is directly above the fire.

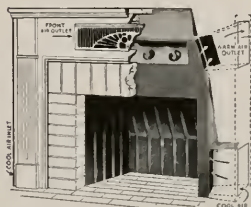

Front view of HEATFORM installed, with part of masonry cutaway.

For complete information see Sweet's Catalog or write
SUPERIOR FIREPLACE COMPANY
 EAST OF MISSISSIPPI RIVER • WEST OF MISSISSIPPI RIVER
 401-M NORTH POINT ROAD • 1707-C EAST 15TH STREET
 BALTIMORE, MARYLAND • LOS ANGELES 21, CALIF.

GIVES MORE YEARS OF SERVICE

because of the die-pressed ribbed construction of the firebox. Large air inlet and outlet capacity allows for greater flow of air over the hot metal, thus preventing deteriorating temperatures. Masonry downdraft shelf: no exposed metal parts beneath the chimney to rust out.



A drinking fountain isn't modern unless it's free from any possible source of contamination. Halsey Taylor Drinking Fountains have pioneered this idea of health-safety through the years, thus promoting hygiene and convenience for schools, hospitals, etc.

The Halsey W. Taylor Co., Warren, O.

West Coast Plant, Redlands, Calif.

HALSEY TAYLOR

Drinking Fountains



STRUCTURAL STEEL

For Class A Buildings,
Bridges, etc.

JUDSON PACIFIC - MURPHY CORP.

4300 EASTSHORE HIGHWAY
EMERYVILLE, CALIF.

FORDERER CORNICE WORKS

Manufacturers of

Hollow Metal Products • Interior Metal Trim
Elevator Fronts and Cabs
Metal Plaster Accessories • Sanitary Metal Base
Flat and Roll Metal Screens
Metal Cabinets • Commercial Refrigerators

269 POTRERO AVE.

SAN FRANCISCO, CALIF.

HEMLOCK 4100

VALUABLE NEWS SERVICE

- BUILDING MATERIAL DEALERS
- CONTRACTORS
- ENGINEERS
- FINANCIAL INSTITUTIONS

ARCHITECTS REPORTS gives advance news on construction projects in Northern California, lists: name of projects, location, architect, proposed cost and other pertinent information.

HANDY individual slip-reports, issued daily at a total cost of only

\$10 a month

ARCHITECT'S REPORTS

Published Daily

The **ARCHITECT** and **ENGINEER**, Inc.

68 Post Street, San Francisco - DO 8311

A. I. A. ACTIVITIES

(From Page 31)

models, working drawings, specifications, documents, and other interesting material and presented them in a manner which stimulated a great deal of public interest in the architectural profession. Cooperation in the project was secured from members of the Women's Architectural League.

• • •

A recent meeting of the Chapter was devoted to "problems of conducting an architectural office."

Dr. Herbert Clish, superintendent of Schools for San Francisco, and Dr. Nicholas L. Engelhardt, consultant on school planning, were principal speakers at the March 30th meeting.

• • •

Chester Root of the Coast Counties Group, A.I.A., is now serving on the Santa Clara County Planning Commission; William Hempel is a delegate to the California Council of Architects, and Gifford Sobey, recently attended a Chapter Director's meeting in San Francisco.

• • •

The Home Tours program recently sponsored by the Women's Architectural League, with tours through Marin county and the Peninsula, have been declared a tremendous success.

CALIFORNIA COUNCIL, A.I.A.

The Council has been particularly active with annual association matters and with the recent California Legislature sessions. Plans are progressing already, however, for the annual convention of the Council in Yosemite Park the latter part of September.

EAST BAY ASSOCIATION OF ARCHITECTS

Members were recently treated to a few legislative sidelights when Mr. Vernon Kilpatrick, Assemblyman from the 55th District and Chairman of the Assembly Interim Committee on Detention Homes and County and City Jails, spoke on the subject of "Jails".

Kilpatrick expressed the opinion more consideration should be given to construction of such buildings if they are to properly serve their purpose.

PRODUCERS COUNCIL MEETING NORTHERN CALIFORNIA CHAPTER

The Northern California Chapter of the Producers' Council, Inc., met in San Francisco on April 5th and heard a new Technicolor Story of Flat Glass entitled "The Heritage of Glass" described by Don W. Lyon of the Libby-Owens-Ford Glass Company.

ESTIMATOR'S GUIDE

BUILDING AND CONSTRUCTION MATERIALS

PRICES GIVEN ARE FIGURING PRICES AND ARE MADE UP FROM AVERAGE QUOTATIONS FURNISHED BY MATERIAL HOUSES TO SAN FRANCISCO CONTRACTORS. 2½% SALES TAX ON ALL MATERIALS BUT NOT LABOR

All prices and wages quoted are for San Francisco and the Bay District. There may be slight fluctuation of prices in the interior and southern part of the state. Freight certificates, at least, must be added in figuring entry work.

PAVING—Performance—\$10 per 1000 of contract. Labor and materials, \$10 per 1000 of contract.

BRICKWORK—
Common Brick—Per 1M laid—\$100.00 up (according to class of work).
Face Brick—Per 1M laid—\$200.00 end up (according to class of work).
Brick Steps—\$3.00 and up.
Common Brick Veneer on Frame Bldgs.—Approx. \$1.20 and up—according to class of work.
Face Brick Veneer on Frame Bldgs.—Approx. \$2.00 end up (according to class of work).
Common Brick—\$28.50 per M—truckload lots, delivered.
Face Brick—\$60.00 to \$90.00 per M, truckload lots, delivered.
Cartage—Approx. \$9.00 per M.
Los Angeles County Area—Residential, up to 4-family or apt., metal raceways, \$6.50 per outlet.

BUILDING PAPER—
ply per 1000 ft. roll..... \$5.30
ply per 1000 ft. roll..... 7.80
ply per 1000 ft. roll..... 9.70
townskin, Standard, 500 ft. roll..... 8.00

BUILDING HARDWARE—
ash card com. No. 7..... \$2.65 per 100 ft.
ash card com. No. 8..... 3.00 per 100 ft.
ash card spot No. 7..... 3.65 per 100 ft.
ash card spot No. 8..... 4.00 per 100 ft.
ash weights, cast iron, \$100.00 ton.
nails, \$5.50 base.

CONCRETE AGGREGATES—
The following prices net to Contractors unless otherwise shown. Carload lots only.

	Bunker per ton	Del'd per ton
Gravel, all sizes	\$2.44	\$2.75
Top Sand	2.38	3.13
Concrete Sand	2.38	3.06
Crushed Rock, ¾" to 1½"	2.38	2.94

	Bunker per ton	Del'd per ton
Crushed Rock, ¾" to 1½"	\$2.38	\$3.13
Roofing Gravel	2.81	3.50
River Sand	2.50	3.06

	Bunker per ton	Del'd per ton
Send— Lapis (Nos. 2 & 4)	3.56	3.94
Olympia (Nos. 1 & 2)	3.56	3.88

Cement—
Common (all brands, paper sacs), carload lots, \$3.02 per bbl. f.o.b. car; delivered \$3.60.
Cash discount on carload lots, 10c a bbl., 10th Prov., less than carload lots, \$4.00 per bbl. f.o.b. warehouse or delivered.
Cash discount 2% on L.C.L.

Trinity White } 1 to 100 sacks, \$3.13 sack
Medusa White } warehouse or del.; \$9.56
bbl. carload lots.

DAMP-PROOFING and Waterproofing—

Two-coat work, \$8.00 per square.
Membrane waterproofing—4 layers of saturated felt, \$9.00 per square.
Hot coating work, \$5.00 per square.
Medusa Waterproofing, \$3.50 per lb. San Francisco Warehouse.
Tricoel waterproofing.
(See representative.)

ELECTRIC WIRING—\$15 to \$20 per outlet for conduit work (including switches).

Knob and tube average \$6.00 per outlet. (Available only for priority work.)

ELEVATORS—

Prices vary according to capacity, speed and type. Consult elevator companies. Average cost of installing a slow speed automatic passenger elevator in small four story apartment building, including entrance doors, about \$8000.00.

EXCAVATION—

Send, \$1.00; clay or shale, \$1.50 per yard. Trucks, \$30 to \$45 per day.
Above figures are an average without water. Steam shovel work in large quantities, less: hard material, such as rock, will run considerably more.

FIRE ESCAPES—

Ten-foot galvanized iron balcony, with stairs, \$250 installed on new buildings; \$300 on old buildings.

FLOORS—

Composition Floors, such as Magnesite, 50c per square foot.
Lino-floor—2 gages—\$3.00 per sq. yd.
Mastipave—\$1.50 per sq. yd.
Bethlehem Linoleum—available to Army and Navy only—1/8" —\$3.50 sq. yd.
1/8" —\$3.50 sq. yd.
Terrazo Floors—\$1.50 per sq. ft.
Terrazo Steps—\$2.50 per lin. ft.
Mastic Wear Coat—according to type—20c to 35c.

Hardwood Flooring—

Standard Mill grades not available.
Victory Oak—T & G
11" x 2¼"..... \$252.00 per M. plus Cartage
½" x 2"..... \$210.00
½" x 1½"..... 200.00

Prefinished Standard & Better Oak Flooring
11" x 3¼"..... \$265.00 per M. plus Cartage
½" x 2½"..... 237.00 per M. plus Cartage

Maple Flooring
11" T & G Clear \$330.00 per M. plus Ctg.
2nd 305.00 per M. plus Ctg.
3rd 255.00 per M. plus Ctg.
Floor Layers' Wage, \$2.12½ per hr. (Legal as of July 1, 1947. Given us by Intaid Floor Co.)

GLASS—

Single Strength Window Glass..... \$.40 per sq. ft.
Double Strength Window Glass..... .60 per sq. ft.
Plate Glass, under 75 sq. ft..... 1.50 per sq. ft.
Polished Wire Plate Glass..... 2.25 per sq. ft.
Rgh. Wire Glass..... .60 per sq. ft.
Obscure Glass..... .40 per sq. ft.
Glazing of above is additional.
Glass Blocks..... \$2.75 per sq. ft. set in place

HEATING—

Average, \$2.50 to \$3.00 per sq. ft. of radiation, according to conditions.
Warm air (gravity) average \$64 per register.
Forced air average \$91 per register.

INSULATION AND WALLBOARD—

Rockwool Insulation— (2")	\$65.00 per M sq. ft.
Cotton Insulation—Full thickness (3%)	\$95.50 per M sq. ft.
Aluminum Insulation—Foil-mounted on both sides	\$33.50 per M sq. ft.
Tileboard—4'x6' panel	\$9.00 per panel
Wallboard—1/2" thickness	\$55.00 per M sq. ft.
Finished Plank	\$69.00 per M sq. ft.
Ceiling Tileboard	\$69.00 per M sq. ft.

IRON—Cost of ornamental iron, cast iron, etc., depends on designs.

LUMBER—

No. 1 Common	\$90.00 per M
No. 2 Common	88.00 per M
Select O. P., Common	94.00 per M

Flooring—

	Per M Deliv.
V.G.-D.F. B & Str. 1 x 4 T & G Flooring	\$170.00
"C" and better—all	170.00
"D" and better—all	170.00
Rwd. Rustic—"A" grade, medium dry	150.00
8 to 24 ft.	
"B" grade, medium dry	150.00
Plywood	15c to 18c per ft.
Plyscord	7/8c per ft.
Plywall	9c per ft.
Plyform	15c per ft.

Shingles (Rwd. not available)—

Red Cedar No. 1—\$13.00 per square; No. 2, \$10.50; No. 3, \$9.00.
Average cost to lay shingles, \$6.00 per square.
Cedar Shakes—Tapered: 1/2" to 3/4" x 25"—\$17.00 per square.
Resawn: 3/4" to 1 1/4" x 25"—\$22.00 per square
Average cost to lay shakes, — 8.00 per square

MILLWORK—Standard.

D. F. \$150 per 1000, R. W. Rustic \$175 per 1000 (delivered).
Double hung box window frames, average with trim, \$12.50 and up, each.
Complete door unit, \$15 to \$25.
Screen doors, \$6.00 to \$8.00 each.
Patent screen windows, \$1.25 a sq. ft.
Cases for kitchen pantries seven ft. high, per lineal ft., \$12.00 each.
Dining room cases, \$15.00 per lineal foot. Rough and finish about \$1.00 per sq. ft.
Labor—Rough carpentry, warehouse heavy framing (average), \$65.00 per M.
For smaller work average, \$75.00 to \$85.00 per 1000.

MARBLE—(See Dealers)

PAINTING—

Two-coat work	per yard 75c
Three-coat work	per yard \$1.00
Cold water painting	per yard 25c
Whitewashing	per yard 15c
Turpentine	\$1.85 per gal. in 5-gal. cont.
Raw Linseed Oil	\$3.33 per gal. in 5-gal. cont.

Bailed Linseed Oil	\$3.23 per gal. in drums.
Bailed Linseed Oil—\$3.33 per gal. in 5-gal. containers.		
Replacement Oil—\$2.75 per gal. in drums.		\$2.75 per gal. in 5-gal. containers.
Use Replacement Oil	\$3.00 per gal. in 1 gal. cont.
A deposit of \$7.50 required on all drums.		

PATENT CHIMNEYS—

6-inch	\$2.00 lineal foot
8-inch	2.50 lineal foot
10-inch	3.50 lineal foot
12-inch	4.50 lineal foot

PLASTER—

Neat wall, per ton delivered in S. F. in paper bags, \$17.60.

PLASTERING (Interior)—

3 Coats, metal lath and plaster	Yard \$3.00
Keene cement on metal lath	3.50
Ceilings with 3/4 hot roll channels metal lath (lath only)	3.00
Ceilings with 3/4 hot roll channels metal lath plastered	4.50
Single partition 3/4 channel lath 1 side (lath only)	3.00
Single partition 3/4 channel lath 2 inches thick plastered	8.00
4-inch double partition 3/4 channel lath 2 sides (lath only)	5.75
4-inch double partition 3/4 channel lath 2 sides plastered	8.75
Thermax single partition; 1" channels; 2 1/4" overall partition width. Plastered both sides	7.50
Thermax double partition; 1" channels; 4 1/4" overall partition width. Plastered both sides	11.00
3 Coats over 1" Thermax nailed to one side wood studs or joists	4.50
3 Coats over 1" Thermax suspended to one side wood studs with spring sound isolation clip	5.00
Note—Channel lath controlled by limitation orders.		

PLASTERING (Exterior)—

2 coats cement finish, brick or concrete wall	Yard \$2.50
3 coats cement finish, No. 18 gauge wire mesh	3.50
Time—\$4.00 per bbl. at yard.		
Processed L.L.L.M.—\$4.15 per bbl. at yard.		
Rock or Grip Lath—3/8"—30c per sq. yd.		
5/8"—29c per sq. yd.		
Composition Stucco—\$4.00 sq. yd. (applied).		

PLUMBING—

From \$150.00 per fixture up, according to grade, quality and runs.

ROOFING—

"Standard" tar and gravel, 4 ply	\$11.00 per sq. for 30 sqs. or over.
Less than 30 sqs.	\$14.00 per sq.
Tile \$40.00 to \$50.00 per square.		
Redwood Shingles, \$15.00 per square in place.		
5/2 #1-16" Cedar Shingles, 4 1/2" Exposure	\$16.50 square

5/8 x 16"—#1 Cedar Shingles, 5" Exposure	\$17.00 sq.
4/2 #1-24" Royal Shingles, 7 1/2" Exposure	\$18.25 sq.
Re-coat with Gravel	\$5.50 per sq.
Asbestos Shingles \$30 to \$60 per sq. ft.		
1/2 x 25" Resawn Cedar Shakes, 10" Exposure	\$11
3/4 x 25" Resawn Cedar Shakes, 10" Exposure	2
1 x 25" Resawn Cedar Shakes, 10" Exposure	
Above prices are for shakes in place		

SHEET METAL—

Windows—Metal, \$2.50 a sq. ft. Fire doors (average), including hardware, \$2.80 per sq. ft.

SKYLIGHTS—(not glazed)

Copper, \$1.25 sq. ft. (flat).
Galvanized iron, 65c sq. ft. (flat).
Vented hip skylights 90c sq. ft.

STEEL—STRUCTURAL—

\$220 per ton erected, when out of place. \$270 per ton erected, when out of place.

STEEL REINFORCING—

\$200.00 per ton, in place.

STORE FRONTS (None available).

TILE—

Ceramic Tile Floors—\$1.70 per sq. ft.
Cove Base—\$1.35 per lin. ft.
Glazed Tile Wainscot—\$1.85 per sq. ft.
Asphalt Tile Floor 1/2" x 3/4"—\$.40 per sq. ft. Light shades slightly higher.
Cork Tile—\$1.00 per sq. ft.
Mosaic Floors—See dealers.
Lino-Tile—\$1.00 per sq. ft.

Wall Tile—

Glazed Terra Cotta Wall Units (single laid in place—approximate prices):		
2 x 6 x 12	\$1.25
4 x 6 x 12	1.50
2 x 8 x 16	1.45
4 x 8 x 16	1.75

VENETIAN BLINDS—

75c per square foot end up, inside extra.

WINDOWS—STEEL—

60c per square foot, \$5 for ventilator.

IN THE NEWS

MEDICAL BUILDING. Architect Clarence C. Cuff, Sacramento, reports the awarding of a contract to John G. Piches of Roseville, for construction of a \$119,000 Medical-Dental and Apartment Building in Yuba City for Dr. Frank L. Herck.

NEW EXPANSION BIT
Of rugged construction, with a special "clean-cutting" head, the new CC-Expansion Bit manufactured by the Robert H. Clark Company of Beverly Hills, California,

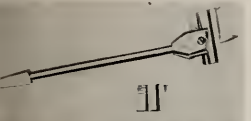

has a 3/4 in. shank of chrome-nickel steel, and a cutting capacity of 7/8 to 3 inches.

Blades are of heat-treated chromium vanadium steel and two sizes; one has a cutting capacity of 7/8 to 1 1/2 inches and the other from 1 1/2 to 3 inches; and are calibrated for quick accurate adjustment.

It is individually packed and fully guaranteed.

SCHOOL BOND ELECTION. The Lodi Union High School District, this month, are voting on the issuance of a \$1,750,000 bond issue

for new high and junior school buildings.

BERKELEY HIGH. The Dinwiddie Construction Company, San Francisco, have been awarded a \$1,076,450 contract for partial completion of the Berkeley High School auditorium. The structural steel frame has already been erected and the work to be done consists of enclosing the building only. Wm. G. Corlett & Henry Gutterson are the architects.

3 IN 1-KIMSUL

INSULATION
COLD • HEAT • SOUND
PERFECTLY CONTROLLED

TREATED AGAINST FIRE, MOISTURE, VERMIN AND INSECTS. ECONOMICAL, LIGHT, EASY TO HANDLE AND INSTALL.

GUNN CARLE & CO
20 POTRERO AVENUE • SAN FRANCISCO, CALIF.

BUILDING TRADES WAGE (JOB SITES) NORTHERN AND CENTRAL CALIFORNIA

ATTENTION: The following are the PREVAILING hourly rates of compensation being paid and in effect by employers by agreement between employees and their union; or as recognized and determined by the U. S. Department of Labor. (Revised to January 1, 1948.)

CRAFT	San Francisco	Alameda and Contra Costa	Marin	Vallejo	San Mateo	San Jose	Stockton	Sacramento	Fresno
	BESTO WORKERS	1.90	1.90	1.90	1.90	1.90	1.90	1.90	1.90
CKLAYERS	2.25	2.25	2.25	2.25	2.25	2.25	2.25	2.50	2.25
CKLAYERS, HODCARRIERS	1.75	1.75	1.75	1.75	1.75	1.75	1.87 1/2	1.87 1/2	1.75
RPENTERS	2.00	2.00	2.00	2.00	2.00	2.00	2.00	2.00	2.00
MENT FINISHERS	2.02 1/2	2.02 1/2	2.02 1/2	2.02 1/2	2.02 1/2	2.02 1/2	2.02 1/2	2.02 1/2	2.02 1/2
TRICIAN'S	2.25	2.25	2.25	2.25	2.25	2.25	2.25	2.25	2.25
GINEERS, MATERIAL HOIST	2.00	2.00	2.00	2.00	2.00	2.00	2.00	2.00	2.00
PILE DRIVER	2.25	2.25	2.25	2.25	2.25	2.25	2.25	2.25	2.25
STRUCTURAL STEEL	2.25	2.25	2.25	2.25	2.25	2.25	2.25	2.25	2.25
ASS WORKERS	1.87 1/2	1.87 1/2	1.87 1/2	1.87 1/2	1.87 1/2	1.87 1/2	1.87 1/2	1.87 1/2	1.87 1/2
ONWORKERS: ORNAMENTAL	2.10	2.10	2.10	2.10	2.10	2.10	2.10	2.10	2.10
REINF. RODMEN	2.00	2.00	2.00	2.00	2.00	2.00	2.00	2.00	2.00
STRUCTURAL	2.25	2.25	2.25	2.25	2.25	2.25	2.25	2.25	2.25
WORKERS: BUILDING & CONCRETE	1.40	1.40	1.40	1.40	1.40	1.30	1.40	1.40	1.30
HERS	2.25	2.25	2.25	2.25	2.25	2.25	2.25	2.25	2.25
ABLE SETTERS	2.00	2.00	2.00	2.00	2.00	2.00	2.00	2.00	2.00
SAIC & TERRAZZO	2.00	2.00	2.00	2.00	2.00	2.00	1.75	1.75	1.75
NTERS	2.00	2.00	2.00	2.00	2.00	2.00	2.00	2.00	2.00
EDRIVERS	2.12 1/2	2.12 1/2	2.12 1/2	2.12 1/2	2.12 1/2	2.12 1/2	2.12 1/2	2.12 1/2	2.12 1/2
STERERS	2.25	2.50	2.25	2.50	2.25	2.25	2.05	2.05	2.05
STERERS' HODCARRIERS	2.05	2.00	2.00	2.00	2.00	2.00	1.87 1/2	1.87 1/2	1.87 1/2
IMBERS	2.25	2.25	2.25	2.25	2.25	2.25	2.25	2.25	2.25
OFERS	2.00	2.00	2.00	2.00	2.00	2.00	2.00	2.00	2.00
SET METAL WORKERS	2.00	2.00	2.00	2.00	2.00	2.00	2.00	2.00	2.00
INKLER FITTERS	2.00	2.00	2.00	2.00	2.00	2.00	2.00	2.00	2.00
AMFITTERS	2.25	2.25	2.25	2.25	2.25	2.25	2.25	2.25	2.25
INSESETTERS (MASONS)	2.25	2.25	2.25	2.25	2.25	2.25	2.25	2.25	2.25
FESETTERS	2.15	2.15	2.15	2.15	2.15	2.15	1.90	1.90	1.90

Prepared and compiled by CENTRAL CALIFORNIA CHAPTER, ASSOCIATED GENERAL CONTRACTORS OF AMERICA with the assistance and cooperation of secretaries of Building Trades Unions, General Contractors Associations and Builders Exchanges of Northern California

CLASSIFIED ADVERTISING

RATE: 10c PER WORD . . . CASH WITH ORDER

MINIMUM \$2.50

ARCHITECT'S REPORTS—A valuable service giving building and construction information daily on projects in Northern California. Name, location, architect, proposed cost, etc., on individual slips. Ideal for securing new business leads. Hundreds of items, total monthly cost only \$10. No delay, subscribe today. ARCHITECT

& ENGINEER, Room 618, 68 Post Street. San Francisco, California. Phone DOugles 2-8311.

San Francisco. PHOTO'S, Room 722, Hearst Bldg., San Francisco, Phone SUtter 1-6953.

PHOTOGRAPHS: Specializing in building and construction photographs for publication or historic records. For Industrial/Aerial. Publicity photography use the INDUSTRIAL

ENGRAVING—Good engravings are essential to a satisfactory job of printing reproduction. For the best, see Poor Richard Photo Engraving Co., 324 Commercial St.

**CLINTON
CONSTRUCTION CO.
OF CALIFORNIA**

General Contractors

923 FOLSOM STREET • SAN FRANCISCO
SUtter 1-3440

HOGAN LUMBER CO.

Wholesale and Retail

LUMBER

MILL WORK • SASH & DOORS

Office, Mill, Yard and Docks
SECOND AND ALICE STREETS • OAKLAND, CALIF.
Telephone GLencourt 1-6861

SISALKRAFT

REG. U. S. PAT. OFF.

"More than a building paper"

THE SISALKRAFT CO.

205 West Wacker Drive
Chicago, Ill.

55 New Montgomery Street
San Francisco, Calif.

**SANTA MARIA INN
SANTA MARIA, CALIFORNIA**

FRANK J. McCOY, General Manager

FERNAND E. PIMENTEL, Manager

On the
Coast
Highway
between
San
Francisco
and
Los
Angeles



American
or
European
Plan
•
Old
English
Tap
Room

**NEW INSULATION AND
ACOUSTICAL COMPOUND**

A new compound for insulation, acoustical treatment and anti-sweat protection known as "Perma-Dri," has been developed by the Stephenson Air Brush Paint Company of Oakland, California.

Selected granules of heat-processed aluminum silicate are blended with a durable high-strength binder and may be applied by brush or spray to metal, wood, concrete, masonry, wallboard, plaster, asbestos-cement, and one coat provides full coverage.

The material is bone white, but may be tinted any color. Can be troweled after application for Travertine effects.

NEW LIGHTING

An all-plastic commercial fluorescent louver which eliminates eye-tiring surface brightness contrast is announced by HOLDENLINE Company of Cleveland.

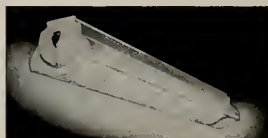

The "ARROWHEAD" has no metal restraining parts; sides, longitudinal and transverse louve sections made of same material. Self locking cannot warp, sag, expand or discolor under normal conditions. Surface or pendant mounted as individual units or in runs. Catalogue No. CP-240.

ASSUMES PRACTICE. Architect Allred W. Johnson, San Francisco, has taken over the practice of the late Earl B. Bertz.

HAROLD H. WEEKS, A.I.A. Architect

Prominent in San Francisco and the architecture profession for more than a quarter of a century, Harold H. Weeks, died at his home March 25th his 53rd birthday.

He was a member of the American Institute of Architects, the National Church Architecture Guild and the Masons.

WALLACE H. HUBBERT, A.I.A. Architect of San Francisco, died the latter part of February following a brief illness. He is survived by a wife and daughter.

CHARLES M. GUNN, 77, founder and retired president of Gunn, Carle & Company, San Francisco building materials firm, died February 25, 1940 at his home in Sausalito.

BOOK REVIEWS PAMPHLETS AND CATALOGUES

HOUSE FOR FAMILY LIVING. By Frederick Gutheim. The Woman's Foundation, Inc., 10 East 40th Street, New York City. Price 35 cents.

The book is the result of a study based upon finding of 52 architects, builders, planners, housing officials, home economists, medical and health authorities, anthropologists, psychologists, sociologists, safety engineers, child welfare experts, social workers and others.

Opinion is expressed that modern "efficiency apartments" and ultra modern living is in fact inefficient and badly designed for actual living.

The booklet is illustrated by the celebrated American artist Dong Kingman.

THEORY OF LIMIT DESIGN. By Van den Broek. John Wiley & Sons, Inc., 440 Fourth Ave., New York 16. Price \$3.50.

The author, J. A. Van den Broek is Professor of Engineering Mechanics at the University of Michigan and in the "THEORY OF LIMIT DESIGN", has clearly and logically presented the fundamental principles which constitute a basis for the belief that ductile stress distribution, rather than elastic stress analysis, is more properly synonymous with the theory of strength.

Van den Broek has carefully developed his arguments and has coordinated the simple criteria upon which limit design is based into an acceptable theory for design of redundant structures. The author makes use of problems, formulae, and examples to clarify the discussion.

COMMERCIAL STANDARD PREFABRICATED HOMES

The second edition of Prefabricated Homes, Commercial Standard CS125-47, are now available from the Commodity Standards Division of the National Bureau of Standards, Washington, D. C.

The original edition published in 1945 and has been revised to bring it in line with current recommendations for building code requirements for new dwelling construction.

The pamphlet sets forth minimum requirements for one, one-and-half, and two story prefabricated houses. It covers requirements for light and ventilation, space access and privacy, structural strength of the various component parts, thermal insulation and condensation control, and requirements for heating, plumbing, and electric wiring. It includes general requirements for materials and workmanship, site erection and assembly or prefabricated units, and protection during transportation and erection.

VERMONT MARBLE COMPANY

Producers and Finishers
of
Domestic and Imported Marbles

525 MARKET STREET, SAN FRANCISCO
Phone Sutter 1-6747
3522 COUNCIL STREET
(Beverly Blvd. at Virgil Ave.)
LOS ANGELES 4, CALIF.
Telephone Fairfax 7934



The Most Complete Line of
STEELS and BUILDING MATERIALS
Made by a Single Producer



See Sweet's Catalog File or write us for
full information.

REPUBLIC STEEL CORPORATION

GENERAL OFFICES: CLEVELAND, OHIO

DENVER, COLORADO . . . CONTINENTAL OIL BUILDING
LOS ANGELES, CALIFORNIA . . . EDISON BUILDING
SALT LAKE CITY, UTAH . . . WALKER BANK BUILDING
SAN FRANCISCO, CALIFORNIA . . . RIALTO BUILDING
SEATTLE, WASH. WHITE-HENRY-STUART BUILDING

PACIFIC MANUFACTURING CO.

HIGH CLASS INTERIOR FINISH
QUALITY MILLWORK

16 BEALE ST., SAN FRANCISCO
GARfield 1-7755

6820 MCKINLEY AVE., LOS ANGELES
THornwall 4196

BUILDERS EXCHANGE, OAKLAND

"AMERICAN - MARSH" CONDENSATION UNIT

Pumping
Machinery
for
Every
Purpose

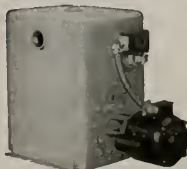

For Service

Call

DOuglas

2-6794

or

MUtual 8322

SIMONDS MACHINERY CO.

SAN FRANCISCO
816 FOLSOM

LOS ANGELES
455 EAST 4TH

IN THE NEWS

ARCHITECT SELECTED. Chas. E. Butner, San Jose, architect has been selected to design the Washington Grammar School addition, San Jose.

SCHOOL CONTRACT AWARDED. The Bingham Construction Company of Sacramento have been awarded a \$72,000 contract for construction of a grammar

school building at Bieber, California. Thomson & Evans, Oakland, are the architects.

APARTMENT BUILDING. The C. H. McEntyre & Company organization of Oakland, have started construction of 12-apartment buildings to contain 62 apartments in San Leandro, California. Estimated cost is \$500,000.

NEW SCHOOL. McCoy & Butler, Yuba City, contractors have been awarded a contract for the construction of a \$298,378 new gram-

mar school at Chester, California. Chas. F. Dean, Sacramento, is the architect.

POLICE STATION. Bonds have been voted for the construction of a \$150,000 police station in South San Francisco, according to W. H. Rowe, architect, who is preparing plans.

HIGH SCHOOL BOND ELECTION. The San Mateo Union High School District will vote on a proposed \$3,225,000 bond issue for the construction of new high school buildings. The election will be held on May 21st.

BRITISH HOME BUILDING. During 1947 some 186,134 houses were built in Great Britain. Of this total 139,739 were permanent dwellings, and 46,395 were temporary.

NEW FRESNO BANK

The Anglo California National Bank, with headquarters in San Francisco, has announced the construction of a new \$271,363 bank and office remodel of their Fresno office. H. Rafael Lake & Wm. Hartup, Fresno, are the architects.

NEW QUIJADA PIPE CUTTER

Has power driven rollers, automatic stop-start action ball bearing operation and is compact design to handle cutting of pipe in diameters ranging from 3/8" to 12 inches.

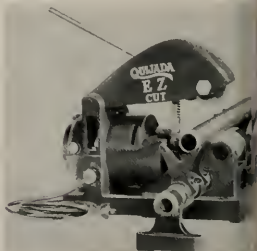

Manufactured by the Quijada Tool Company of Los Angeles, California, this portable machine has an integrally-mounted 1/2 h.p. 110-volt, universal type AC-IMotor with a direct gear drive the rollers. Gears are self lubricating. Automatic trip switch stops cutting operations when the cutting wheel contacts the pipe and automatically stops when the cutting is finished.

ARCHITECT AND ENGINEER

**Good Looking!..
Good Engineering!..
Good Investment!**



Timeproof ALUMINUM or PLASTEEL sheet Roof and Sidewalls . . . Eliminate periodic painting and maintenance.

Enduring rigid steel frame building. Quickly erected. Economical first cost and low maintenance. A thoroughly engineered structure, mechanically correct. Shipped complete and ready to erect. Like all Soule structural steel products, a good, timeproof investment. Be sure the Soule-way; you'll want to add to it some day. Made in the West for Western needs.

Immediate Delivery—Shipments made quickly from our Los Angeles plant. Order direct or through your local contractor.

Size 40-feet by 100-feet—Can be furnished longer or shorter in 15'-0" sections. Add any time in any direction without damage to first unit. 12-foot by 14-foot high door. Full 14-foot head room at

eaves with vertical sidewalls; no interfering interior columns.

Rugged Design—Designed to meet uniform building codes covering live and dead loads, high winds, earthquakes, etc.

Send coupon today for plans and prices

FIREPROOF • WEATHERPROOF
RODENT PROOF

SOULE STEEL COMPANY
6200 WILMINGTON AVE.
LOS ANGELES 1, CALIFORNIA 22A
Without obligation, send Catalog No. 200 and prices covering the 40' by 100' Soule Utility plans for use by my local contractor.

Name _____
Address _____
City _____
Name of contractor _____ State _____



Soule Utility STEEL BUILDINGS

SAN FRANCISCO • LOS ANGELES • PORTLAND

FABRICATORS OF STEEL BUILDING PRODUCTS SINCE 1911

THE TORMEY COMPANY

GENERAL PAINTERS
AND DECORATORS

Phone UNDERhill 1-1913

563 FULTON STREET
San Francisco

Brownskin
VAPORSEAL

The resilient building paper creped to S-T-R-E-T-C-H

Quality Products Since 1895

ANGIER PACIFIC CORPORATION
155 NEW MONTGOMERY ST. 7234 SHINSET BOULEVARD
SAN FRANCISCO 5, CALIF. • LOS ANGELES 44, CALIF.
A complete line of Angier products available from your building material dealer

IN THE NEWS

NEW SHUT-OFF VALVE

A new improved Warden automatic low pressure shut-off valve embodying the use of gravity-actuated shut-off mechanism is announced by the Security Valve Corp'n of Los Angeles.

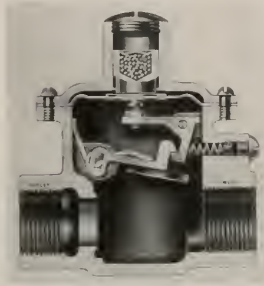

It automatically closes off gas lines when low pressures occur; for use on $\frac{3}{4}$ in. or 1 in. lines; compact and lightweight.

ARCHITECT SELECTED. Birge M. Clark & Walter Stromquest, Palo Alto, architects have been selected to design the Trace Grammar School addition in San Jose.

SCHOOL BONDS VOTED. Approval of a \$63,000 bond issue for the construction of a new grammar school near Woodland (California) was recently voted by residents of the Plainfield Union Elementary School District.

CHURCH REMODEL. The First Congregational Church in Berkeley, California, will erect a new Chapel building at a cost of \$125,000. Ratcliff & Ratcliff, are the architects.

NEW CITY HALL. Elmer J. Freethy, El Cerrito, has been awarded a \$1,588,000 contract for construction of a new City Hall and new Hall of Justice for the city of Richmond, Calif.

LIBRARY BUILDING at the Vallejo (California) Junior College will be built by Harry Rilingier, Vallejo, at a cost of \$119,278. Harry J. Devine, Sacramento, is the architect.

DINWIDDIE CONSTRUCTION COMPANY

BUILDERS

CROCKER BUILDING
SAN FRANCISCO



HERRICK IRON WORKS

STRUCTURAL STEEL
REINFORCING STEEL

18TH AND CAMPBELL STS.
OAKLAND, CALIF.
Phone GLencourt 1-1787

Phone GARfield 1-1164

Thomas B. Hunter

DESIGNER OF HEATING

AIR CONDITIONING
VENTILATING AND WIRING
SYSTEMS, MECHANICAL
AND ELECTRICAL EQUIP-
MENT OF BUILDINGS



41 SUTTER STREET
ROOM 710

San Francisco California

Scott Company

HEATING - - PLUMBING - - TILE



243 MINNA STREET
SAN FRANCISCO

Phone EXbrook 2-6741



WESIX Slide-Rule CALCULATOR

slide-rule" style, for quick computing of the direct WESIX Wireheat SYSTEM for any use. Available to architects, engineers, contractors and dealers.

WESIX ELECTRIC HEATER CO.

370 First Street, San Francisco

Fine
ENGRAVINGS

POOR RICHARD
PHOTO ENGRAVING CO.
320-324 COMMERCIAL STREET
SAN FRANCISCO, CALIF.

PITTSBURGH TESTING LABORATORY

ENGINEERS AND CHEMISTS

Testing and Inspection of Concrete,
Steel and Other Structural Materials

Design of Concrete Mixes

Offices in all principal cities

651 Howard St., San Francisco 5
EXbrook 2-1747

Mattock Construction Company

Builders



604 MISSION STREET
SAN FRANCISCO

INDEPENDENT IRON WORKS

Steel Buildings
Service Stations
Steel Storage Tanks
Fabricated Plate Work
Steel & Sheet Metal Products
Fabricated Structural Steel
Steel Distributors

Eighth & Pine Sts. Oakland, 7

MULLEN MFG. COMPANY

BANK, STORE AND OFFICE
FIXTURES—CABINET WORK
OF GUARANTEED QUALITY
CHURCH SEATING

Office and Factory
60-80 RAUSCH ST., Bet. 7th and 8th Sts.
San Francisco
Telephone UNderhill 1-5815

Index to Advertisers

ANGIER Pacific Corp.....	47
ARCHITECTS Reports	40
BASALT Rock Company.....	Back Cover
BAXTER & Company, J. H.	36
CENTRAL Electric Co.....	28
CLASSIFIED Advertising	43
CLINTON Construction Company.....	44
CLINTON Mill & Mfg. Co.....	28
CONTINENTAL Water Heater Co.....	39
DETROIT Steel Products Co.....	5
DINWIDDIE Construction Co.....	47
DUFFY TILE Co.....	48
FORDEER Cornice Works.....	40
FOX Tile Co.....	38
FULLER, W. P. Co.....	7
GUNN, Carle & Company	43
HANKS, Inc., Abbott A.....	48
HAW'S Drinking Faucet Company.....	34
HERRICK Iron Works.....	47
HOGAN Lumber Company.....	44
HUNT, Robert W., Company.....	48
HUNTER, Thos. B.....	47
INDEPENDENT Iron Works.....	48
JUDSON, Pacific-Murphy Corp.....	40
KRAFTILE Company	31
MATTOCK, A. F., Co.....	48
MICHEL & Pfeffer Iron Works.....	48
Inside Front Cover	
MULLEN Mfg. Co.....	48
MUELLER Brass Co.....	*
NORTHERN California Electric Bureau	35
PARKER, Steffens & Pearce	1
PACIFIC Coast Gas Association	*
PACIFIC Manufacturing Company.....	45
PACIFIC Portland Cement Company.....	*
PACIFIC Telephone & Telegraph Co.....	33
PADDOCK Engineering So.....	32
PITTSBURGH Testing Laboratory	48
POOR RICHARD Engraving Co.....	47
REMILLARD-Dandini Co.....	48
REPUBLIC Steel Corporation.....	45
SANTA Maria Inn.....	44
SCOTT Co.....	47
SIMONDS Machinery Company.....	45
SIMPSON Logging Co.....	6
SISALKRAFT Company	44
SMOOT-Holman Co.....	37
SOULE Steel Co.....	46
STANLEY Works, The	*
STEELFORM Contracting Co.....	28
SUPERIOR Fireplace Company	39
TAYLOR Co., Halsey W.....	39
TORMEY Company, The.....	47
U. S. BONDS	Inside Back Cover
VERMONT Marble Company	45
WESIX Company	47
WESTERN Asbestos Co.....	*
WESTERN-Holly Stove Co.....	7
WOOD, E. K., Lumber Company.....	36
ZELINSKY, D. & Sons	28

*Indicates Alternate Months

DUFFY TILE CO.



TILE CONTRACTORS

SHOWER DOORS

TUB ENCLOSURES



INSTALLATIONS
OF EVERY
DESCRIPTION
Modernizing, Repairing
"Not How Cheap
But How Good"
253 MINNA
YUkon 6-1489

ABBOT A. HANKS, INC. Engineers & Chemists

INSPECTING — TESTING — CONSULTING
CONCRETE • STEEL • MATERIALS
CHEMICAL AND TESTING
LABORATORIES
• RESEARCH AND INVESTIGATION •

TESTS OF STRUCTURAL MATERIALS
DESIGN OF CONCRETE MIXES
SHOP AND ERECTION INSPECTION OF
STRUCTURES AND EQUIPMENT
INVESTIGATION OF STRUCTURES
AND MATERIALS
TESTS AND INVESTIGATION OF
FOUNDATION SOILS
FIRE RESISTANCE AND INSULATION
TESTS

624 Sacramento Street, San Francisco

Robert W. Hunt Company ENGINEERS

Inspection • Tests • Consultation
Schools and Other Structures
Are Built as Designed

When Construction Materials are
Inspected at point of Manufacture
and during Erection by

ROBERT W. HUNT COMPANY

Cement, Concrete, Chemical, Metallurgical,
X-Ray and Physical Laboratories

Chicago - New York - Pittsburgh
Los Angeles - All Large Cities
San Francisco, 251 Kearny Street

REMILLARD-DANDINI Co.

Brick and
Masonry Products



400 MONTGOMERY STREET
SAN FRANCISCO, CALIF.

ARCHITECT AND ENGINEER

RADIO STATION KOMO Seattle, Washington



MAY

1948



Service Stations

... Rest Rooms; Drive-in Restaurants; Display Buildings; Metal Canopies; Steel Fabricated Buildings; Flat Panel Type Buildings... built to your specifications. For complete information, write or telephone



Michel & Pfeffer Iron Works, Inc.

W. A. JAMES, Manager Steel Building Division

Tenth and Harrison Streets, San Francisco 3, California

Telephone MArket 1-5966

ARCHITECT

Vol. 173

No. 2

AND

ENGINEER

ARCHITECTS' REPORTS—Published Daily

E. H. WILDER

Editor

MARK DANIELS, A.I.A.

Associate Editor

PROF. LELAND VAUGHAN

Landscape Architecture

JOHN A. BLUME

Structural Engineering

MICHAEL GOODMAN

Planning

JOHN S. BOLLES, A.I.A.

Book Reviews



COVER PICTURE:

Simple functional lines characterize Seattle's new Radio Station KOMO. Horizontal ribbing in gray concrete of stair tower is set-off from white cement finished exterior walls and entrance which is faced with Roman Brick. Fixed windows admit office light (See page 24).

Contents for

MAY

EDITORIAL NOTES	4
NEWS & COMMENT ON ART	11
RADIANT HEATING WITH ELECTRICITY	14
By REUBEN S. TICE	
PAINTING WITH LIGHT—Stained Glass, The Judson Studios, Los Angeles	17
NEW RADIO STATION KOMO, Seattle, Washington	24
A. I. A. ACTIVITIES	31
WITH THE ENGINEERS	32
HEADLINE NEWS & VIEWS	36
By E. H. W.	
IN THE NEWS	37, 43, 46
LANDSCAPE ARCHITECTURE, Notes of the Profession	38
ESTIMATOR'S GUIDE, Building & Construction Materials	41
BUILDING TRADES WAGE SCALES, Northern & Central California	43
CLASSIFIED ADVERTISING	43
BOOK REVIEWS, Pamphlets & Catalogues	45

ARCHITECT AND ENGINEER (Established 1905) is published on the 15th of the month by The Architect and Engineer, Inc., 68 Post St., San Francisco 4; Telephone EXbrook 2-7182. President, K. P. Kierulff; Vice-President and Manager, L. B. Penhorwood; Treasurer, E. N. Kierulff.

Los Angeles Office: Wentworth F. Green, 6605 Hollywood Blvd., Los Angeles 28. Telephone HEMPstead 3171.

Entered as second class matter, November 2, 1905, at the Post Office in San Francisco, California, under the Act of March 3, 1879. Subscriptions United States and Pan America, \$3.00 a year; \$5.00 two years; foreign countries \$5.00 a year; single copy 50c. ARCHITECTS' REPORTS are published daily from this office, Vernon S. Yallop, Manager.



EDITORIAL NOTES

WE ARE indebted to a southern California A.I.A. member for the following comment, and while we assume no responsibility for the thought expressed, it has stimulated our thinking to the point where we believe there may be other Architects harboring the same general reasoning, although their opinion may not be so audibly expressed:

"I am puzzled regarding some phases of our modern architecture and have thought perhaps you could enlighten me. As I look at the house plans that are published in some magazines I feel that the designing game is moving fast and that I will be hopelessly left behind unless somebody tells me promptly how I can begin to advance.

"A recent magazine, for instance, announces what it calls a program of '—study houses.' Do architects now have cases to study, in somewhat the same way that physicians study mumps or measles? Perhaps it would help me if you would interpret some of the language used in describing these houses. Of one such they say, 'the house is suspended over the land, existing in a free and independent relationship to its natural environment, permitting a choice of participation at the will of the occupants.'

"Just what do you suppose this house is suspended from? No airplanes, balloons or anything of that kind is shown in the illustration from which the house could be suspended. The only clue I have is that the house looks very much like one of the box kites that we boys used to make when we were kids.

"The article also says that the same house 'resembles a bridge in structure, it envelops the living space in a simple rectangle.' Don't they have rooms any more in up-to-date houses? Do people who are up to date live instead in 'spaces' and 'areas', somewhat after the manner of concentration camps, only surrounded principally by glass?

"I recently was asked to complete a house started by another owner, the former having gone broke soon after the house was started, where the original plans called for a partition between the Living and Dining Rooms to be an aquarium, consisting of two sheets of glass with a space between filled with water so gold fish could swim about in it. My client was not as

advanced in modernistic thinking as the original owner for he cut the fish wall out. He also decided to call one room a Kitchen, although it was originally an 'area'.

"Such things as these make me feel very much behind the times, and I would appreciate it if you would put me right. How is a fellow to know how to study a case when the modern style is so prolific in giving birth to progeny?"

IT HAS often been reported from sources which have been deemed reliable, that "An Ounce of Prevention is Worth a Pound of Cure", and while its application has not been limited to the medical profession, probably few Architects, if any, have applied the axiom to their own endeavor.

With the vast majority of architectural offices humming with an activity previously unknown, it might be a good time to take a few moments and give some serious thought to the perhaps not to distant future when the present back-log of industrial, commercial, and residential construction has been satisfied, and the continued construction of almost all types of work may be a little more indistinct.

It is a good investment in the future of your profession to give serious consideration now to ways and means of acquainting the public with the many advantages of professional architectural service. Such a program, today, may represent the "Ounce of Prevention" that may later, if ignored, require "a Pound of Cure."

THE building materials output during the year 1947 broke all previous records and if the present demand for all types of products is maintained, and the production is not seriously retarded for any length of time by work-stoppages, or diversions of essential materials to other uses than the Construction Industry, 1948 production should be the greatest in the nation's history.

Estimates of this year's production indicate it to be sufficient to meet all anticipated requirements, while in some lines it is even predicted the inventory situation may be liberally expanded.

While the building material market may be easing somewhat and the big transportation bottleneck improving considerably, it is still the best idea to order all materials for a job as early as is possible.



More Daylight—

WITH BETTER VENTILATION AS A BONUS!

When you plan larger daylighting areas, why not take advantage of the opportunity the larger wall opening affords for better ventilation?

With Fenecraft Projected Windows, large steel-strengthened areas of glass flood the room with daylight. All-weather ventilation is provided by two vents in each window unit. One opens out to form a canopy over the opening—to shed rain and snow. A sill vent opens in—deflecting incoming air upwards to prevent direct drafts. This vent likewise sheds rain and snow to the outside.

They're economical windows, too. Lower cost—in both manufacturing and installation—has been accomplished by standardization. Fenecraft Window units conform with modular dimensions of modern construction practice. Yet the variety that is achieved in making these windows of standard sections enables you to have all the design flexibility you wish, without the cost of "specials". There's a great range of types and sizes—a Projected, Combination and Casement Windows. That means a *right* window for every use—designed right... made right. See your Sweet's Architectural File for full information. Or mail the coupon.



FENCRAFT COMBINATION WINDOW

Generous fresh-air ventilation. Swing leaves deflect breezes into the room. In-tilting sill vent protects against drafts. Both sides easily and safely washed from inside.



FENCRAFT CASEMENT WINDOW

Safe washing on outside, from inside. Easy to operate. Interchangeable inside screens, protected from outside dirt.

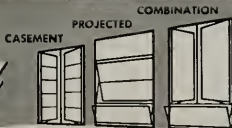

Detroit Steel Products Company,
Dept. AE-5,
1310 - 63rd Street
Emeryville (Oakland) California

Please send me data on types and sizes of the new Fenecraft family of Fenestra Windows:

Name _____

Company _____

Address _____

Fenestra

FENCRAFT INTERMEDIATE STEEL WINDOWS

Greatest Improvement in Perforated Acoustical Tile in Many Years

Simpson ACOUSTICAL TILE

QUALITY SINCE 1895

WITH EXCLUSIVE

HOLLOKORE DRILLED PERFORATIONS

SIMPSON
ACOUSTICAL TILE

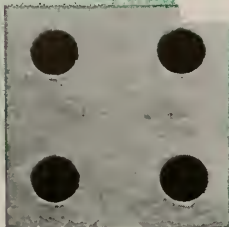

PRODUCT "B"



PRODUCT "C"

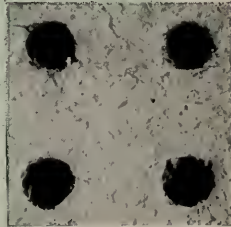

SEE THE DIFFERENCE SHOWN BY THESE

ENLARGED, UNRETOUCHED PHOTOGRAPHS

Quality, Appearance, Efficiency Unexcelled

SIMPSON HOLLOKORE drilling, the greatest improvement in perforated acoustical tile in many years, eliminates ragged, uneven holes. By the exclusive HOLLOKORE drilling process the perforations in Simpson Acoustical Tile are uniformly round with smooth, clean edges with no fibers to cause unsightly paint bridging when refinishing.

HIGHEST SOUND ABSORPTION

Independent tests show that the new Simpson Acoustical Tile has the highest noise reduction coefficients of all drilled fiber acoustical materials in the most commonly used thicknesses and types of mountings. This greater efficiency gives more sound absorption for your construction dollar. It gives this new acoustical tile with its finished bevels, its exclusive HOLLOKORE drilled perforations and new textured finish, a plus value at no greater cost. Give your clients this PLUS VALUE by specifying Simpson Acoustical Tile.



WOODFIBER DIVISION
SIMPSON LOGGING CO.
Plant at Shelton, Washington
Sales Division
SIMPSON INDUSTRIES
1010 White Bldg., Seattle 1, Wash.

DISCUSS THIS NEW ACOUSTICAL TILE WITH YOUR NEAREST SIMPSON APPLICATOR

ACOUSTICS NORTHWEST
Builders Exchange Bldg.
Portland 4, Ore. Arwater 6443
ALLIED CONSTRUCTION & SPECIALTY CO., INC.
8455 Melrose Ave.
Los Angeles 46, Calif. York 7268
ANGELES INDUSTRIES
984 McGarry St., Los Angeles, Calif.
Phone: Trinity 8121
APPLICATION SERVICE CO.
420 Continental Oil Bldg.
Denver 2, Colorado. Alpine 4662

M. H. BALDWIN
2804 East Howthorne
Tucson, Arizona. Phone: 2804-J
CONSOLIDATED ROOFING & SUPPLY CO.
520 S. 7th Ave.
Phoenix, Arizona. Phone: 47888
CONTINENTAL LUMBER CO.
P. O. Box 2042
Boise, Idaho. Phone: 450
CRAIG & PULLEN
338 Ward St.
Honolulu, T. H. Phone: 6107

CRAMER COMPANY
345 Vermont St.
San Francisco, California
Phone: Market 1-0411
CRAMER COMPANY
1933 Merced St.
Fresno, Calif. Phone: 3-1131
DALE TILE CO.
1020 LeSelle Ave.
Minneapolis 2, Minn. Phone: Br. 8831
ELLIOTT BAY LUMBER COMPANY
400 W. Spokane St.
Seattle, Wash. Elliott 8080

FROST HARDWOOD LUMBER CO.
Market at State St.
San Diego, Calif. Phone: F-722
LUMBER DEALERS, INC.
423 N. 33rd
Billings, Montana. Phone: 3911
MANSUR MATERIALS, INC.
E-210 Riverside Ave.
Spokane, Wash. MAIN 1249
UTAH PIONEER CORPORATION
333 W. 1st South
Salt Lake City 14, Utah
Phone: 4-1717

DEPENDABLE



A
"PACIFIC
PRODUCT"

Produced by

**PACIFIC PORTLAND
CEMENT COMPANY**

San Francisco • Los Angeles
Portland

Sold by

**YOUR BUILDING
MATERIALS DEALER**

UNIFORM - TIME TESTED

NOW AVAILABLE...THE

Western-Holly



"Californian"

for Immediate Delivery!

MAXIMUM UTILITY
MINIMUM SIZE

Compare these Features

1. *Tempa-Plates*—Afford new cleanliness, beauty and efficiency.
2. *Four Large, High-Speed Burners*, Designed for easy cleaning—Automatic pilot lighting.
3. *Highly Polished*—Heat-reflecting Burner Saucers.
4. *One-Piece Oven Construction*, rounded corners, porcelain enameled—easily cleaned.
5. *Oven Temperature Control*—Exact, even, dependable heat regulation.
6. *High-Speed Broiler*—Roller Bearings—Glides out smoothly, drop front.
7. *ALL WHITE*—Porcelain Enamel Finish, fused on steel—As Washable as Fine China.

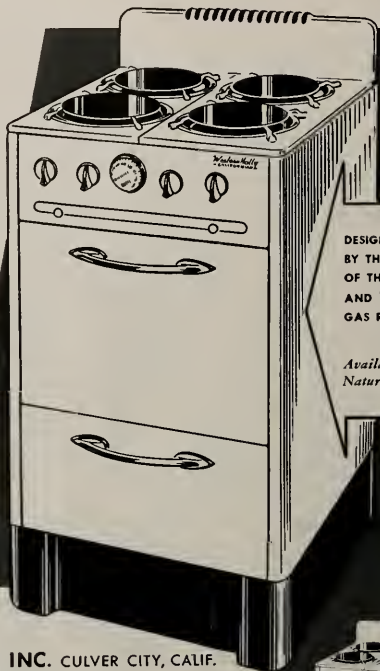

DESIGNED AND PRODUCED
BY THE MANUFACTURERS
OF THE Continental
AND Town and Country
GAS RANGES

* * *

Available For Manufacture
Natural, or L.P. Bottled

phone direct to

WESTERN STOVE COMPANY, INC. CULVER CITY, CALIF.

TEXAS 02901

© 1948, Western Stove Company, Inc., Culver City, Calif.

Western-Holly
CALIFORNIAN

COMPACT QUALITY

GAS RANGE

FOR COMPACT LIVING

THE MARK OF EXCELLENCE

SPECIFICATIONS

Width—20 inches
Height—36 inches
Floor Space—20 by 23 inches
Oven—16 inches wide



Note—Generous Sized Oven and Broiler

WESTERN STOVE COMPANY, INC., CULVER CITY, CALIFORNIA, BRANCH OFFICES: SAN FRANCISCO AND

ARCHITECT AND ENGINEER

MODERNITY...

one of the advantages that makes Ceramic Veneer the preferred facing material in the West!

Pacific Telephone & Telegraph Co.'s new Grand Ave. Toll Building in Los Angeles is another striking illustration of how well suited Anchored Type Ceramic Veneer is to modern design! The large, interesting scale of this machine-perfected terra cotta... its gleaming surface, soil-resistant as a china dish... and its permanent color... all contribute to the streamlined beauty of this structure.

Whether you are designing a monumental public building or modernizing a small shop front, Gladding, McBean & Co.'s Ceramic Veneer can serve both you and your client to better advantage. Proof of this is all around you: The majority of the larger buildings in all the principal Pacific Coast cities are faced with this modern, versatile material.

For technical data, photographs of installations and suggested specifications for all three types of Ceramic Veneer... Anchored, Adhesion and Handmade... send for catalog.

GLADDING, McBEAN & Co., Dept. 25
2901 Los Feliz Blvd., Los Angeles 26, Calif.
or 1275 Harrison St., San Francisco 3, Calif.
Please send me your 32-page Ceramic Veneer Catalog.

Name

Address

City State



CERAMIC VENEER

The modern, machine-perfected terra cotta

OFFICES AT: LOS ANGELES • SAN FRANCISCO • SEATTLE • PORTLAND • SPOKANE • DENVER



GAS...AND GLASS...EQUIPPED

Architect chooses "the modern fuel" for his own new home, which makes effective use of glass to bring kitchen and dining room outdoors

Unique in its conception of indoor-outdoor living, the contemporary Southern California home of Kemper Nomland, architect, A.I.A., includes a "glass-walled", gas-equipped kitchen (seen at left) and adjacent dining room with sliding glass-paneled wall which can be opened in fair weather.

There's Nothing More Modern than Gas Cooking

When you specify or recommend to your clients a new automatic gas range built to "CP" standards, you know it will be as modern as your most advanced designs . . . yet equally appropriate (and appreciated) in conventional settings. ★ Gas water heating and refrigeration also "belong" as essential elements in today's bright pattern of easier, happier living.

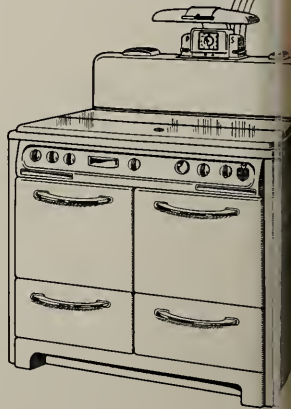

NEWS AND COMMENT ON ART

LUDINGTON COLLECTION Abstract and Surrealist Art

LIEBES, WILDENHAIN, MATISSE, MINOR WHITE

FEATURE REOPENING OF THE SAN FRANCISCO MUSEUM OF ART

When the San Francisco Museum of Art reopened its doors on May 13, the Bay Region art public had its first look at one of the most remarkable collections of Contemporary European and American paintings and sculptures in this country. Filling three large galleries, the Collection of WRIGHT S. LUDINGTON (Vice President of the Santa Barbara Museum of Art, a trustee of the newly formed Modern Institute of Art in Beverly Hills, and a fine painter in his own right) is unique in that each individual work is so exceptionally fine within the group of approximately seventy that will be shown.

The CLOWN WITH BOY of Georges Rouault, here illustrated, is included with two other works by this great artist. Pablo Picasso, perhaps best known of all contemporary European painters, is represented by eight famous paintings, including TWO ACROBATS WITH DOG, 1905, WOMAN WITH BLUE TURBAN, 1923, a HARLEQUIN, THREE NUDES from the Classical period, and examples from the cubist paintings of the early 1900's. Leger, Matisse, Braque, Derain, Dali, Matisse, Modigliani, Berman, Beckmann, Vlaminck, Utrillo, Kokoschka, De la Fresnaye, Tanguy and Rousseau are only a few of the best known European contemporaries whose magnificent paintings will be on view during this showing, to continue through June 20. Among the paintings by American artists are to be found works by Marsden Hartley, Max Weber, Yasuo Kuniyoshi, Georgia O'Keefe, Arthur Dove and Stuart Davis. The renovations of the San Francisco Museum of Art, just completed, will offer freshly covered walls, experimental lighting, and new installation methods to form an effective background for this exhibition and for all current and future showings.

To open the new Decorative Arts Gallery, a section of the Museum especially constructed for changing exhibitions in the interior decoration and industrial design fields, DOROTHY WRIGHT LIEBES, internationally known textile and color expert provided a group of her hand-woven textiles and machine produced fabrics made from her designs. FRANS WILDENHAIN, ceramics master from Holland, showed examples of his craft for the first time in San Francisco. The name Wildenhain is already well-known in this community due to Marguerite Wildenhain's superior stoneware which is especially familiar to Bay Region residents, since she has been actively working in this area for some years. Thus, the opportunity to see the works of Frans Wildenhain for the first time should prove of added interest to Museum visitors.

May and June will be stellar months at the Museum. Another exceptional show which will open May 13 also will be ABSTRACT AND SURREALIST AMERICAN ART. Circulated by the American Federation of Arts, approximately sixty works chosen from the two hundred and fifty-six in the original showing at the Chicago Institute of Art are to be seen here. A fascinating cross-section of these particular developments in American painting will include the work of such men as Calder, Feininger, Gorky, Gottlieb, Kantor, Motherwell, Rothko, Still, Woelffer and Hayter among many others. A section of this show will be devoted to artists of the Bay Region included in the Chicago exhibition, but not in the traveling group. Claire Falkenstein, Leah Rinne Hamilton, George Harris, Robert Howard, Adaline Kent and Robert McChesney are included in this group.

CLOWN WITH BOY

oil by Georges Roualt

French contemporary 1871—

From the Collection of Wright S. Ludington

San Francisco Museum of Art



The NATIONAL SERIGRAPH SOCIETY will provide an exhibition of new silk screen prints. MINOR WHITE, nationally recognized photography expert, will open the new photographic gallery with a selected showing of some of his most successful prints, and will supervise a photographic project of the California School of Fine Arts, "BENICIA" to be shown at the same time.

The original plates from the new book JAZZ by HENRI MATISSE have been selected to open the newly constructed Members Room in June. There are twenty of these plates which will be shown with an explanation of the new "au pochoir a la poupee" method of reproduction, a variation of the stencil method, with which they were finally reproduced for the book.

The above listed group of exhibitions is indicative of the continued general policy of emphasizing expansion, growth and trends in the whole contemporary art field. This renovation, the first since the Museum reopened in its present location in 1935 will be of considerable assistance to the Museum by providing increased study facilities, better staff offices, a new auditorium, the enlarged bookstore, and the special new galleries mentioned above. This change in the physical structure of the Museum is a logical development in the growth and expansion of a large museum devoted to carry ahead the ideals of contemporary art in America today.

OUTDOOR ART SHOW

The second San Francisco Outdoor Art Show will be held May 29 through May 31 in Union Square and Maiden Lane.

Northern California artists and craftsmen will have an opportunity to display their work, and offer it for sale to the public.

The number of works which may be entered is limited to five, of which at least one will be hung or displayed, and the others held in reserve.

One of the features of the Show will be an opportunity for the public to observe the craftsmen in actual process of designing and fabricating.

Participating in the event will be the San Francisco Art Association, San Francisco Women Artists, Artists Guild of San Francisco, California Society of Etchers, Mills College Ceramics Guild, Society of Western Artists, San Francisco Potters Association, Mills College Art Department, the College of Arts and Crafts, University of California Art Groups, the California School of Fine Arts, and many individuals.

SAN FRANCISCO ART ASSOCIATION ELECTS NEW OFFICERS

At its annual election of officers recently the following were elected to the Board of Directors:

Henry F. Swift, President; Eldridge T. Spencer, First vice president; Leah Rinne Hamilton, second vice president; Rose Pauson, third vice president; William W. Crocker, Treasurer and Karl Kaston, Secretary.

CALIFORNIA PALACE OF THE LEGION OF HONOR

Thomas Carr Howe, Jr., Director of the California Palace of the Legion of Honor, Lincoln Park, San Francisco, has announced the following schedule of exhibitions and special events for May:

EXHIBITIONS: Contemporary American Indian Art. Opening May 4; Retrospective Exhibition of the Work of Morris Graves, opening May 19; For Modern Interiors, closing May 23.

The Alma de Bretteville Spreckels Collection of Sculpture by Auguste Rodin.

The Mildred Anna Williams Collection of Paintings, Sculpture, Tapestries and Furniture.

The Collis Potter Huntington Memorial Collection of 18th Century French Paintings, Sculpture, Tapestries, Furniture and Porcelain.

GALLERY TOURS: "The Mysticism of Morris Graves," tour by Lilly Weil Jaffe, will be given on Wednesdays, May 19 and 26, at 2:30 p.m.

"East Meets West in Morris Graves," tour by Katherine L. Parker, will be given on Fridays, May 21 and 28, at 2:30 p.m.

EDUCATIONAL ACTIVITIES: Regular classes for children, ages 4 through 15, will continue each Saturday morning at 10:00. Instruction in the use of a variety of media will be given by Katherine L. Parker, Lilly Weil Jaffe, and Frank Lobdell. Admission free.

The painting class for adults, under the direction of Frank Lobdell, will continue each Saturday afternoon at 2:00. Admission free.

M. H. de YOUNG MEMORIAL MUSEUM

The program of exhibitions and activities at the M. H. deYoung Memorial Museum, Golden Gate Park, San Francisco, as announced for the month of May by Walter Heil, Director, includes:

EXHIBITIONS: Paintings by Mary Rogers, opening May 15; Watercolors by George Post, opening May 15; Paintings by Werner Philipp, opening May 20; and loans from the Museums collection.

(See Page 39)



HOME BEING CONSTRUCTED AT SAN JOSE, CALIFORNIA

RADIANT HEATING WITH ELECTRICITY

By REUBEN S. TICE

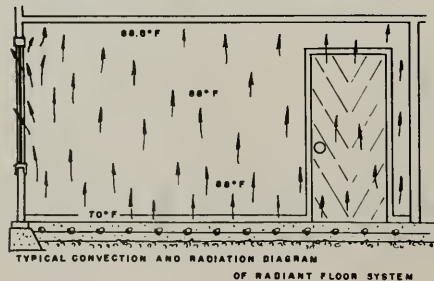
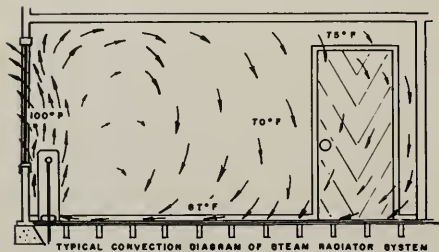

Heat, its creation and distribution, has always been a major engineering problem. Practical solutions to the many design difficulties encountered are limited by sources of adequate heat. The inefficient use of these sources present still greater problems for which there are apparently no effective remedies.

Good heating presents us with a five-fold problem. It must be adequate, dependable, efficient, convenient, and economical both to install and operate. Unless a heating system can satisfy all of these conditions, it is no better than the ordinary systems available so far.

Scientific research has made radical developments in all phases of industry, but our heating systems have all been tarred with the same stick. We have had to rely on the combustion of a variety of fuels, knowing that too great a percentage of our heat dollars were going up the chimney.

Forty years ago an English engineer accidentally rediscovered a 2,000 year old Roman plan for heating walls and floors and adapted it for modern use. Pipes through which hot water cir-

EDITOR'S NOTE: Mr. Reuben S. Tice is President of the Electradiant Corporation of Monterey, California.

culated were hidden in floors, walls or ceilings. Eliminated, was unsightly plumbing, and yet the problems of original heat creation, circulation, maintenance and repair had not been overcome.

Early in this decade electrical radiant heat experiments produced what appeared to be an answer. Wire grids, through which electrical energy was passed, were concealed in walls and ceilings. When properly controlled these grids provided a highly efficient, adequate method of producing heat.

However, other problems were encountered. The fine-wire, high resistant elements used were subject to frequent breakage, current consumption was high and installation was costly. Subsequent developments have improved this system but have not eliminated its more undesirable features.

Through a comprehensive analysis it became evident that these fallacies could not be overcome. There was no doubt that electricity was the ultimate solution to the heating problem, but its use must be of a more practical nature.

Experiments in our shop proved that a high-current, low voltage arrangement would permit the use of low resistance conductors; produce an adequate amount of heat; be easier to install; and practically eliminate maintenance and repair difficulties.

After considerable study a pilot installation was made using steel reinforcing bars. These bars were welded together into a continuous single circuit and embedded in a concrete floor. A step-down transformer supplied predetermined electrical values to this element with the control in the primary circuit. This first installation was successful though far from perfect.

The greatest difficulty encountered was an audible hum which persisted during the operating cycle of the system. Research was immediately started and it was discovered that a stranded steel cable would function more efficiently than steel bars and without the annoying hum. Tests proved that a 1/2" wire rope had the most satisfactory characteristics for the high-current, low-voltage principle use in ELECTRADIANT HEAT, under which name this patented system is now marketed.

Actually, there are several types of installation that have proven satisfactory—concrete slab or built-up wood floor being most popular. In the former, back fill is prepared as for a normal concrete slab floor, thoroughly drained, then stabilized with an application of oil, asphalt or other waterproofing means. Four or five inches of lightweight insulating concrete is then poured directly over the fill and allowed to set for two or three days for proper curing, then the wire rope is stapled in

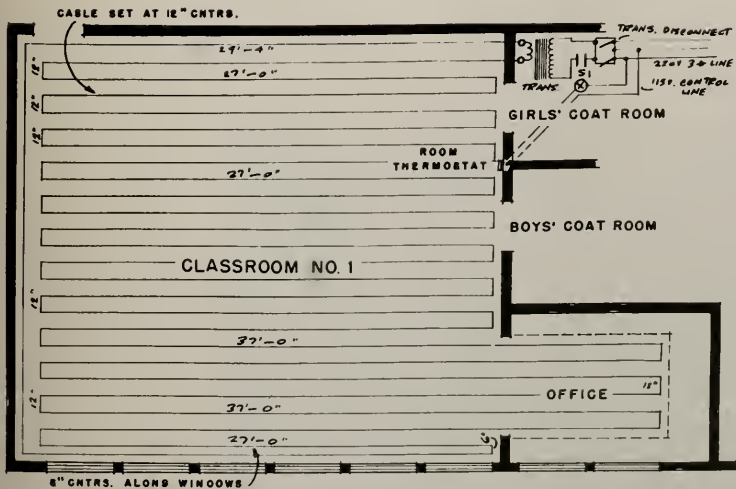

TYPICAL "ELECTRADIANT HEATING" GRID LAYOUT

RADIANT HEATING . . .

place directly onto the aggregate. The top slab, which may be from 2 to 4 inches thick is then laid. It is interesting to note at this point the speed—and the resultant economy—with which wire rope heating cable can be laid. A complete ELECT-RADIANT heating system in an average home of 1,200 square feet of floor can be installed by two men in a little more than 3 hours.

In wood floor ELECTRADIANT installations floor joists is laid 2½" to 3½" below what would be the normal level of the floor. Wooden sleepers are then laid on the sub-floor and glass fiber insulation is laid between these sleepers. The wire rope is then laid on top of the insulation and secured with glass fiber lined straps. Clean, dry, beach sand is then applied in sufficient quantity to cover the cable fastening straps to a depth of not less than one inch. Different type floor coverings such as asphalt, cork, linoleum or carpets can be used without adversely affecting radiation.

The simplicity of the electrical circuits involved in ELECTRADIANT heating is one of the system's principal features. The transformer used in an average home installation is about the size of a typewriter and can be placed in any convenient out-of-the-way corner such as a closet or alcove, providing such location is approved by the local electrical inspection department.

Supply specifications call for a 220 volt service capable of handling sufficient current for the job

to be done. Secondary transformer voltages range from 20 to 70 volts depending upon the total length of the cable. Current consumption varies from 10 to 15 watts per square foot of heated area.

These figures do not represent a basis for calculating the total wattage of the circuit for purposes of determining current consumption over any given period of time.

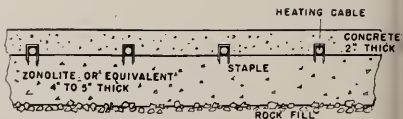

CONCRETE FLOOR INSTALLATION

Because of a zone control arrangement, the difference between apparent consumption and actual consumption is great, with actual wattage used being the lesser amount. It is through this method of control that ELECTRADIANT heat satisfies the economy factor of the five elements of good heating. In addition, this zoning gives users the advantage of maintaining different temperatures in different areas of their homes or plants.

Cable temperature during peak operation is slightly more than 110° F. Floor temperatures if installation is made according to our specifications,

(See Page 40)



Wire Rope Cables are laid over glass wool floor insulation with special clips for floor.

One foot of cable per square foot of floor area is required.

Painting with Light

-- Stained Glass

THE JUDSON STUDIOS

Los Angeles, California

In a little shop, in Mott Alley, opposite the old Los Angeles plaza, the year 1897 gave birth to an organization that has earned for The Judson Studios world acclaim. Three generations of the Judson family have fulfilled the artistic heritage given them by William Lees Judson, the grandfather and known as the founder of the College of Fine Arts and Architecture for the University of Southern California.

The Judson Studios, now located on the bank of the Arroyo Seco Parkway northeast of Los Angeles, is housed in the picturesque old building that formerly was the U. S. C. College of Fine Arts and Architecture.

Horace T. Judson heads the firm and is nationally prominent not only for his craftsmanship in glass, but also for his illustrated lectures pertaining to Christian Art, Symbolism and Stained Glass.

The Studios are nationally known for their work and their shops are of unusual interest to visitors from clubs, schools, and churches throughout the United States.

In the drafting room the artists crystalize in colored designs the ideals of religion or philosophy to fit the architecture of the building and the expression of faith for each client.

After the architect, designer, donor or interested party has been satisfied, the designer makes a full-sized cartoon and two carbon copies. The carbon copies are called outline and pattern drawings. From these drawings the exact detail, lead lines and shapes are made to size. The pattern drawing is cut by pattern shears into as many pieces as the designer has specified by heavy black lines. These patterns, made of a heavy grade paper, are then placed, with the help of an adhesive, to the surface of a large section of

THE JUDSON STUDIOS
Los Angeles
California



PAINTING WITH LIGHT . . .

plate glass located on an easel. The easels are always stationed in front of a daylight opening. The glass colors are then selected for each pattern by Mrs. Judson and given to a glass cutter who will cut the pieces to pattern and then return them to the specified position on the plate glass. By using this method, the color goal of the craftsman will be attained because true light flows through the glass.

From the cutting room the glass is taken to the painting department. Here the visitor begins to realize the volume of handling necessary to com-

plete a window. Each piece is handled from ten to fifteen times. The painter works in the same way as the glass selector, always keeping daylight filtering through the glass. The painting department's responsibility is one requiring much study, for here, the figure gains character and personality as the paint supplements the light and shadows inherent in the glass. The word "paint" hardly describes the material used in this department. Actually, it is powdered glass and is not to be mistaken with an enamel sometimes used as a cheap imitation of true stained glass. The danger



The installation of a window of this size presents a problem of scaffolding. The peak of this window is 75 feet from the ground and the scaffolding is set in sections and levels to enable easier installation.

of this process is that if the glass is not heated slowly and cooled very carefully, the enamel will craze and peel off. By using the powdered glass method the color beauty of the glass itself is predominant, as it should be. After having the outlines and shadows painted on the glass, it is then taken to the kilns where it is fired at approximately 1250° F. The pigment is vitrified and is thereby rendered permanent by its fusing into the glass surface.

The pieces are again reassembled by the glazier who has the outline drawing to use as a guide. The glazier selects the correct size of lead extru-



ABOVE—

Mr. John Herbert Buttrud—shown finishing the cartoon for the "Christ The King" window in the Church Divinity School in Berkeley, California.



LEFT—

Mr Robert D. Rives—shown finishing a full size medallion cartoon, for St. Josephs Church, Santo Ana, California.

PAINTING WITH LIGHT . . .

sions as specified by the drawing. The lead is shaped like the letter "H" and the glass pieces fit into each grooved side. After the glass pieces are in their lead frames, the many joints are soldered and the entire window is cemented on both sides to insure its being waterproof. The large cathedral-type windows are glazed in sections small enough for easy handling.

The windows are then reinforced with steel bars for additional stability and are ready for installation.

Before the windows are judged complete, each person associated with the window construction

is called to approve his work as well as the work of his fellow craftsman. In this way the constructive criticism expressed, creates as closely as possible, the perfect specimen. If the consensus of opinion desires some changes, they are made and again reviewed.

With the tremendous building program in progress throughout the country, stained glass through its renaissance of expression is enjoying the greatest boom in its long history. Stained glass and glass mosaics have such a definite place in modern architecture and the architects and designers are taking advantage of its use. The murals, pan-

(See Page 34)



Two of the men responsible for this panel are reviewing their phase of construction. Some of William Lee Judson's paintings can be seen on the walls of the Gallery where all work is reviewed before it is installed.

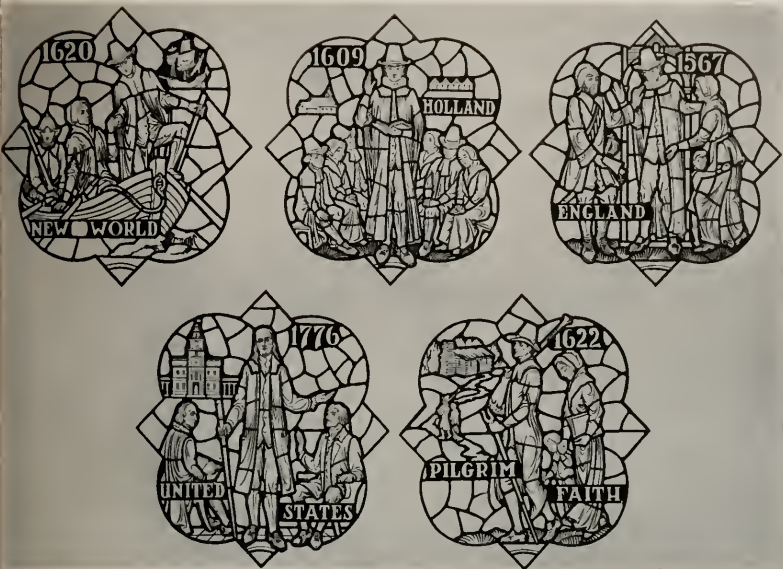

ABOVE—

Cartoon drawings of medallions for the First Congregational Church of Los Angeles. Describing the history of the Congregational Church. This window is called the "Pilgrim Faith" window.

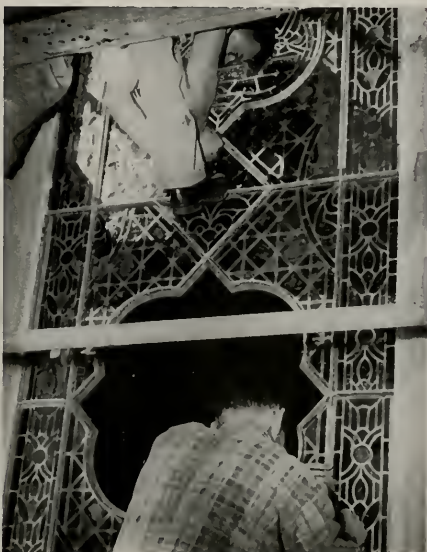

RIGHT—

This picture shows some of the interesting details of "The Pilgrim Faith" window as well as the problem of installation. Mr. Burian and Mr. Lowson, the two men pictured, are two of several ex-G.I. apprentices so necessary to perpetuate this ancient craft. The average age of the craftsmen in this field is 65 years.

PAINTING WITH LIGHT . . .



Mr. J. William Rundstrom, Mr. Judson's cousin and business associate, is shown tracing patterns on glass from the cartoon drawing of one of the "15 Mysteries of the Rosary" windows to be installed in St. Joseph's Church in Santa Ana, California.

Charles E. Thompson, shown cutting glass for the "Pilgrim Faith" window, is one of several craftsmen who have been associated with The Judson Studios for over one quarter century. The medallion shown on the easel is made up of the patterns cut from the cutline drawings. In the background, the medallion cartoon can be seen. The glass selector uses this and the colored sketch to enable him to choose the correct glass color gradation.



This is a picture of Mr. Walter Swatfield shown glazing one of the sections of a large window. The lead extrusions are being cut and the pieces fitted into their respective positions, later the joints will be soldered.



The "San Luis Rey" window, one of a series depicting the famous California Missions for The Inglewood Memorial Park Mausoleum in Inglewood, California.



WOOD PANELLED RECEPTION LOBBY

Photos, The Austin Co.

New Radio Station KOMO . . . Seattle

Washington

The opening of KOMO, Seattle's new radio station, recently has given the Pacific Northwest a precedent breaking radio broadcasting center in which the most advanced equipment and building techniques have been combined in a new building introducing latest principles of studio design and operations.

Here, for the first time, working radio has been placed on permanent public display. With live of KOMO's six broadcasting studios, plus its news room, grouped around a single operations control center visible to pedestrians from the street, Seattleites can follow the comings and goings of an-

nouncers, celebrities and engineers without even crossing the threshold of the station.

Conceived by O. W. Fisher, the engineer-president of Fisher's Blend Station, Inc., NBC affiliate, which owns and operates the station, the studio was designed in collaboration with station engineers, headed by F. J. Brott, Chief Engineer, and erected by The Austin Company, whose long experience and pioneering research in studio construction is reflected in many innovations.

Located at the head of the Denny Regrade, along which the city's main business district is expanding, the two-story and basement reinforced con-

crete studio building occupies one-quarter of a block, which is ultimately to be developed by the addition of an FM and television tower adjacent to the studio building and additional broadcasting facilities. Provisions have been made in the present building for the addition of another floor.

The entire street floor, except for the entrance lobby, reception lounge and a corner office, which has been leased to the United Press Association, is devoted to studio activities. The arrangement of three intimate studios—all of different sizes—along a central operations corridor has made it possible to hold the maximum distance between the master control console and the individual studio control booths to approximately fifty feet. This permits visual control of traffic to and from all studio entrances from the operations control desk, which has an unobstructed view of both the master control room and the recording department. People entering the building lobby can also be observed from the operations control center, which is situated at the head of the corridor facing the glass-enclosed street entrance.

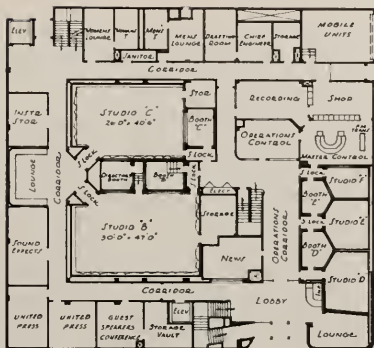

FIRST FLOOR PLAN

Traffic to and from the large audience participation studio, which has been located on the lower level, is handled over a stairway leading directly from the entrance vestibule to this studio, so that there is no occasion for these groups to enter the carpeted reception lobby.

The grouping of the three smaller studios, D, E and F, side by side along an outer wall, has made it possible to serve all three by a pair of identical control booths, each of which serves two of the three studios. The master control console is located at the head of this studio group at a point from which both of the control booths, and parts of the three studios, are visible.

A single engineer at the master control can handle broadcasts from Studio F without leaving his station, so that network broadcasts or recordings can be coordinated with live announcements and programs without additional staff.

The larger group accommodation studios, B and C—one 26 x 40 feet, and the other 30 x 47 feet—have been located parallel to each other, with a director's booth between them to permit the use of these facilities in combination. It will be possible,

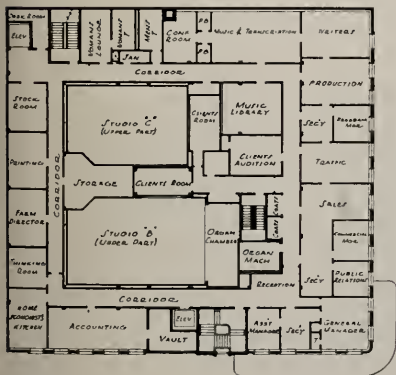

SECOND FLOOR PLAN

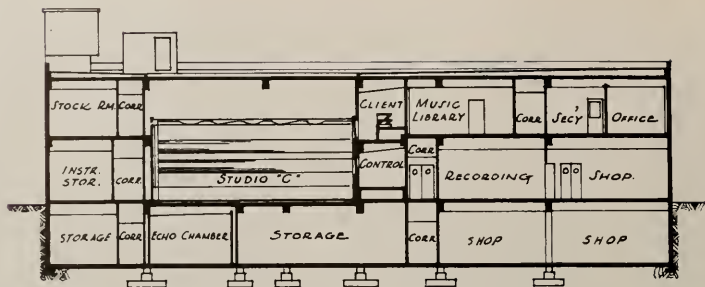

°LONGITUDINAL SECTION°

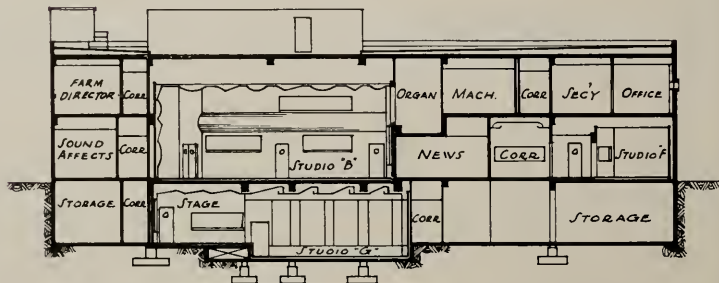

°LONGITUDINAL SECTION°

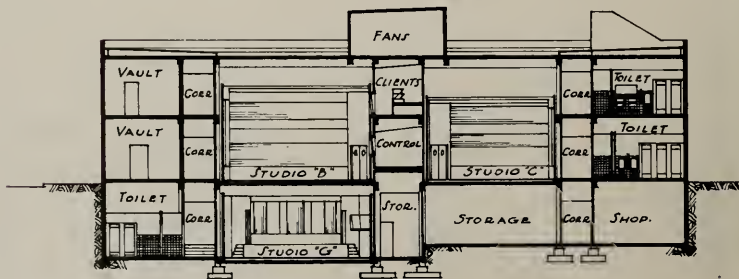

°CROSS SECTION°

**SECOND FLOOR
OFFICES**

Secretarial personnel occupy area between an office corridor on the left and private offices on the right.

Lighting is combination of units with incandescent lamps at either end of tube.

Walls are painted in two shades of tan in contrast with moss green carpet.



for instance, for a single musical director to conduct a symphony orchestra in the larger studio while the chorus participating in the same numbers follows him from the adjacent studio. Each of these studios has its own control booth, but these are at right angles to each other so that the conductor's booth is visible from both control posts. Combination broadcasts requiring the use of Studios B and C are controlled from a single booth in Studio B.

The large studios also have their own large storage rooms for props, while an artists' lounge and instrument storage room are conveniently located along the inner corridor flanking the artists'

entrance to these studios.

Clients' booths for the two larger studios have been strategically located on the second floor level at points from which broadcasts can be observed. The clients' audition room is also located on the second floor, where machinery for a large, modern organ and spacious organ chamber serving a movable console in the larger studio have also been installed. The executive and business offices, music and transcription libraries, script writing and program departments, a test kitchen and a "thinking" room, occupy the balance of this floor.

The control of traffic entering the second floor and executive wing from the lobby has been pro-



CONTROL ROOM. The ingenious arrangement of control facilities has drawn notional attention to KOMO. From his seat at the master control console, this engineer can see into the two 2-way control booths which serve three smaller studios located side by side on the left. He also has visual contact with the operations control center through the window on the right, and with the recording department which also adjoins the master control room.

BELOW is one of the group-accommodation studios.



. . . RADIO KUMO, SEATTLE

vided by the installation of a single vision panel in one office facing the compact reception area at the head of the public stairs. All other traffic to and from the operating area and to the clients' booths is controlled from the central operations desk on the ground floor facing the operations stairway, and front entrance lobby.

All of the studio units have been designed in accordance with the most advanced isolation practice, each being erected as a "room within a room" with floors, walls and ceilings completely separate from the surrounding structural elements. Floors, for instance, are "floated" on the structural concrete floor slabs by means of patented steel isolators, while ceilings are suspended in similar fashion. All walls and partitions are self-supporting and stand entirely free of the structural walls and columns, while glass panels, doors, and the like, have been mounted in special isolating materials which preclude the setting up of disturbing vibrations.

Acoustical treatment of the individual studios, control rooms, sound locks, as well as the auxiliary

areas and air-conditioning system, was developed to assure maximum technical perfection for the full range of broadcasts originating from these studios.

Perforated transite, backed up with rock wool, has been used with plywood to provide the combination of "live and dead" surfaces for effective acoustical control in the small studios, control booths and sound locks.

The two larger group studios and the audience participation studio have been treated with a combination of polycylindrical and splayed wall and ceiling surfaces in design calculated to produce precise reverberation and sound values.

Wood has been used in the cylindrical sections on the strength of recent research which established the effectiveness of wood panel resonance action in dispersion of echoes to enhance the tonal quality of orchestral music.

The same concern for functional efficiency which governed the design and lay-out of the operating facilities controlled the development of the architectural features, the lighting installation, the air conditioning system and the color scheme, as well

BROADCASTS from this small studio can be controlled from either of the two 2-way control booths serving the smaller studios. Perforated transite has been used in combination with plywood to obtain balanced "live and dead" wall and ceiling surfaces, painted in grey and blue.





This large audience participation studio has a specially designed control booth which affords a clear view of both stage and audience. Played and polycylindrical wall surfaces have been used, with an indirect lighting system over the audience and a direct system over the stage. Colored reflector spots for special stage lighting is concealed in coves directly in front of the stage.

as the selection of furnishings for the individual offices, public areas and studios.

Since the building was designed as a "controlled conditions" structure, natural lighting has been limited to that admitted through vision panels in the second floor offices along the street facade, through a tall shaft of structural glass serving the stairwell, and through the broad all-glass entrance doors. Illumination for the individual studios, control booths and public areas was engineered with a view to providing required intensity entirely without glare, despite the extensive amount of glass required for the station's unique system of visual controls. Holophane "controlens" incandescent fixtures have been installed in all the studios, with special combinations in the two larger group accommodation studios and the audience studio to permit different intensities according to the charac-

ter of studio activity. These studios are also equipped with special passage lights so that no part of the regular studio lighting need be switched on except when the studio is in actual use. In this way, all functional lighting units will have approximately the same burning period and can be relamped at one time.

The individual offices have been equipped with combination Holophane units incorporating both fluorescent and incandescent lamps which can be used together or separately, depending on the character and intensity of light preferred by the individuals in any given area.

The studios and operational areas are comfort-conditioned by one of the most modern air conditioning systems in the Pacific Northwest.

There are ten separate air conditioning systems

(See Page 46)

A. I. A.

American Institute



ACTIVITIES

of Architects

Arizona Chapter:

James Macmillan, President; Arthur T. Brown, Secretary, 740 N. Country Club Road, Tucson, Arizona.

Central Valley of California:

Herbert E. Goodpastor, President; Frank V. Mayo, Secretary, 307 Exchange Building, Stockton 2, California.

Colorado Chapter:

Raymond H. Erwin, President; James M. Hunter, Secretary, 249 Broadway, Boulder, Colorado.

East Bay Chapter:

A. Lewis Kove, President; James H. Anderson, Vice-President; Loy Chamberlain, Secretary; Chester H. Treichel, Treasurer. Office, 3833 Piedmont Ave., Berkeley, California.

Montana Chapter:

Ralph H. Cushing, President; H. C. Cheever, Secretary, Montana State College, Bozeman, Montana.

Northern California Chapter:

Wm. Clement Ambrose, President; Lester W. Hurd, Vice-President; Ralph N. Pollack, Secretary; Donald Beach Kirby, Treasurer. Office 369 Pine Street, San Francisco.

Oregon Chapter:

Frank Roehr, President; Sidney W. Little, Vice-President; I. Hoaman Baines, Secretary; Don Edmondson, Treasurer. Office 619 Builders Exchange Bldg., Portland 4, Oregon.

San Diego Chapter:

H. Louis Bodmer, President; Louis J. Gill, Secretary, 203 Granger Building, San Diego, California.

Santa Barbara Chapter (California):

Winsor Soule, President; Ralph Armitage, Vice-President; Robert Ingle Hoyt, Secretary; Lulah M. Riggs, Treasurer. Office 116 E. Solo St., Santa Barbara, California.

CALIFORNIA COUNCIL OF ARCHITECTS

Andrew T. Hass, President; Adrian Wilson, Vice-President; Malcolm Reynolds, Secretary-Treasurer. Office 369 Pine Street, San Francisco.

Southern California Chapter:

George Allison, President; A. C. Martin, Jr., Vice-President; Anthony Thormin, Secretary; George E. Gable, Treasurer; Chapter Headquarters, 3737 Wilshire Blvd., Los Angeles 5, California.

Spokane Chapter (Washington):

Noel E. Thomson, President; Kenneth D. Stormont, Secretary, Huton Building, Spokane, Washington.

Utah Chapter:

George Cannon Young, President; Theodore R. Pope, Secretary, 29 South State Street, Salt Lake City 1, Utah.

Washington State Chapter:

Clifton J. Brady, President; Arriro M. Young, Vice-President; John Richards, 2nd Vice-President; Ralf E. Decker, Sec.; Waldo B. Christensen, Treasurer. Office 1411 Fourth Avenue Building, Seattle 1, Washington.

Tacoma Society:

Chas. Rueger, President; Clarence Rueger, Vice-President; W. W. Durham, Secretary-Treasurer.

Hawaii Chapter:

Kenneth W. Roehrig, President; James Morrison, Secretary, 334 Federal Bldg., Honolulu, T. H.

NAMED TO STATE ARCHITECTURAL BOARD

Norman K. Blanchard, of the San Francisco architectural firm of Blanchard & Maher, was recently appointed to the California State Board of Architectural Examiners by Governor Earl Warren. Blanchard is a director of the San Francisco Federation of Arts, a graduate of the University of California, and a member of Tau Sigma Delta, architectural honor society.

Blanchard & Maher did extensive architectural work for the Navy on West Coast installations during the late war.

AMERICAN INSTITUTE OF ARCHITECTS CONVENTION

The Eightieth Annual Convention of The American Institute of Architects will be held in Salt Lake City, Utah, on June 22, 23, and 24th.

Indications already point to a record attendance and a down-to-business consideration of many phases of the architectural profession.

Two post-convention tours, under management of the United States Travel Agency, are luring many eastern architects West, as the tours will give an excellent opportunity to see some of the West Coast scenic and recreational attractions.

PRODUCERS COUNCIL MEETING NORTHERN CALIFORNIA CHAPTER

The regular May meeting of the Northern California Chapter of the Producers Council was held at the Athens' Athletic Club in Oakland.

Members heard a discussion of aluminum and saw a motion picture entitled "This is Aluminum"

which was presented by H. L. Hennessy of the Aluminum Company of America.

The meeting was held in Oakland in recognition of the newly formed East Bay Chapter, American Institute of Architects.

(See Page 33)

FOR BETTER SERVICE
Remember that
KRAFTILE is
WESTERN HEADQUARTERS
FOR

- ◆ ACID Brick
- ◆ ACID-PROOF Joining Compounds
- ◆ ACID-PROOF Floor and Tank Construction
- ◆ ACID-PROOF Coatings
- ◆ GLAZED Structural Wall Units
- ◆ PATIO Tile
- ◆ QUARRY Tile
- ◆ SWIMMING POOL Overflow Gutter
- ◆ LIGHTWEIGHT CONCRETE BLOCKS



- ◆ QUONSET Packaged Steel Buildings
- ◆ STRAN-STEEL Framing

For complete information and prompt service, phone or write

KRAFTILE COMPANY
NILES, CALIFORNIA NILES 3611
SAN FRANCISCO 3: 50 Hawthorne St.—DUGLAS 2-3780
LOS ANGELES 13: 406 South Main Street—MUTUAL 7241

WITH THE ENGINEERS

Structural Engineers Association of
Northern California

John A. Blume, President; Jesse Rosenwald, Vice President; Franklin P. Ulrich, Treas.; Geo. E. Solnar, Jr., Sec., Office, Room 215, 55 New Montgomery St., San Francisco 5, Phone SUTter 1-7642. DIRECTORS, A. W. Anderson, Henry J. Degenkolb, John E. Rinne, Robert D. Dewell, and Wm. W. Moore.

San Francisco Section

L. A. Elsener, President; A. W. Earl and G. B. Woodruff, Vice-Presidents; John E. Rinne, Secretary-Treasurer; 225 Bush Street, San Francisco 20.

Structural Engineers Association of
Southern California

Steve Barnes, President; Harry W. Bolin, Vice President; Lewis K. Osborn, Sec-Treas. DIRECTORS, Richard W. Ware, Geo. E. Brandow, L. T. Evans, Harold P. King, and Donald F. Shugart. Office: 202 Architects Bldg., Los Angeles 13, Calif.

Puget Sound Engineering Council
(Washington)

R. E. Kister, A. I. E. E., Chairman; E. R. McMillan, A. S. C. E., Vice Chairman; L. B. Cooper, A. S. M. E., Secretary; A. E. Nicholson, I. E. S., Treasurer; Offices, L. B. Cooper, c/o University of Washington, Seattle 5, Washington.

EXHIBIT BUILDINGS

Contract for construction of livestock buildings at the Fresno County Fair Grounds has been awarded to the Harris Construction Company of Fresno, \$236,069; and at Petaluma, the Fair Grounds improvements include 2 cattle barns and a horse barn.

STUDENT UNION BUILDING. Contract for construction of a \$125,000 student union building on the College of the Pacific campus at Stockton, California, has been awarded to Shepherd & Green, general contractors of Stockton. Wurster, Bernardi

& Emmons, San Francisco, are the architects,

STANDARD OIL

The Standard Oil Company has applied to the City of San Francisco for a building permit for the construction of a new office building to be located on Bush Street.

The cost of the building is to be \$4,700,000.

Swinerton & Walberg are general contractors on the project and Harry A. Thomsen, Jr. and Aleck L. Wilson of San Francisco are the architects.

RURAL FIRE HOUSES. Santa Clara County (California) has awarded a contract to the Bridges Construction Company of San Jose for the construction of 4 rural fire houses at a cost of \$104,000. Kress & Gibson, San Jose, are the architects.

NEVADA CONSTRUCTION

Construction projects in the State of Nevada include: a new grammar school at Steamboat Springs to cost \$34,718 (Russell Mills, Reno, Architect); Recreation School building at Fallon, \$53,400 (Blanchard, Maher & Lockhard, Reno, Architects); Veterans Hospital addition at Reno, \$141,845; a doctors' office building in Reno, \$52,200 (Russell Mills, Reno, Architect); and the El Rancho Hotel which will be built at a cost of \$1,200,000. Frank W. Green, Glendale, California, is the architect on this project.

ANNUAL MEETING

The annual meeting of the American Council of Commercial Laboratories will be held June 18-20, at Colorado Springs, Colorado.

Of particular interest to convention delegates is the contemplated activity of the Council in promoting the standards and quality of merchandise to be furnished Europe under the European Recovery Program.

The Council is composed of 38 of America's largest and oldest commercial laboratories.

JOHNSON BURNERS

really **SAVE Oil**

**In HOMES,
HOSPITALS
HOTELS
FACTORIES
STORES
PUBLIC
BUILDINGS**

**- wherever
dependable
automatic heat
is needed!**

Johnson Burners give you more usable heat from every gallon of oil that you buy. Why? Because they capture and utilize an exceptionally high percentage of the heat generated in combustion. This extra "efficiency" is the product of 45 years of oil-burner research and "know how." It is paying off in homes, skyscrapers and industries all over the nation. It can save fuel oil and money for you. Let your Heating Engineer or your nearest Johnson Dealer show you why and how.

S. T. JOHNSON CO.

940 Arlington Ave.
Oakland 8, California

401 No. Broad Street
Philadelphia 8, Pa.



A. I. A. ACTIVITIES

(From Page 31)

an Institute of Architects. Many architects were present.

EAST BAY CHAPTER A.I.A.

The regular meeting for April was held at the Leamington Hotel in Oakland, with Mr. John G. Marr, planning engineer for the City of Oakland, the guest speaker. His subject was "What Is In Prospect for Oakland." Also appearing and speaking was John J. White, Jr., Field Secretary for the American Institute of Architects, who was on a tour of the West.

The East Bay Chapter in collaboration with the Association of Landscape Architects, San Francisco Region, devoted considerable attention to construction of an exhibit at the recent California Spring Garden Show held in the Oakland Exposition Building. The theme of the exhibit was Contemporary Indoor-Outdoor Living.

Oscar M. Price, A.I.A., was chairman of the architects committee.

The Chapter is also sponsoring and directing an exhibit of contemporary residential architecture which is being shown in one of the larger downtown stores in Oakland. Committee chairman John Carl Warnecke, A.I.A., and John M. Evans, A.I.A., are handling arrangements for the exhibit.

WASHINGTON STATE CHAPTER, A.I.A.

The Washington State Supreme Court recently indicated its acceptance of the schedule of fees established by the Chapter in connection with contracts with public bodies.

The regular May meeting was held at the University of Washington jointly with the University's School of Architecture.

An interesting meeting was recently arranged by the Chapter's Education and Program Committees at the Seattle Chamber of Commerce with the showing of motion pictures on distinguished examples of recent architecture. Marshall Smith, chairman of the Program Committee presided.

Delegates to the A.I.A. Convention include: Valdo B. Christenson, Frank Stanton, Leonard W. Lindon, William H. Carleton, and Hugo W. Osterman. Alternates are Nelson J. Morrison, Paul H. Kirk, Edwin T. Turner, Francis E. Huggard, Lance L. Gowen, and F. Marshall Smith.

NORTHERN CALIFORNIA CHAPTER, A.I.A.

Eleven delegates to the annual A.I.A. Conven-

(See Page 35)

"You certainly had a thoughtful builder"



Builders who plan ahead provide conduit for built-in telephone facilities. It's installed when the home is under construction. Takes just a few pieces of pipe or other tubing material . . . run as a raceway to handy outlet positions. That way telephones can be added or moved in the future without drilling holes or running wire along baseboards. The cost? . . . Insignificant compared to the future convenience.



It's just one of those small details that stamp a builder as a thoughtful builder.

For free help

in planning modern, built-in telephone wiring, call your local telephone company number and ask for "Architects and Builders Service."

The **Pacific Telephone**
and Telegraph Company



FOR
Distinctive Design
IN
ELECTRIC
WATER
COOLERS
SPECIFY
HAWS ...

HAWS Electric Water Coolers are styled to enhance the interiors of today's and tomorrow's buildings. For office or lobby, for store or public buildings, HAWS Electric Water Coolers serve refreshing drinking water with complete sanitation...efficiently, dependably and economically... for the finest in Electric Water Coolers always specify HAWS... with the added convenience of HAWS Sanitary Drinking Fountains...

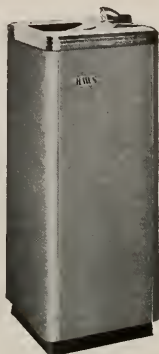

Model HT-10
 Beautifully-Styled Electric
 Water Coolers



Model 7-A
 Vitreous china wall drinking
 fountain, with bubbler pro-
 tecting cowl.

**FOR REMOTE
 INSTALLATION**

HAWS Electric Water Coolers give double-duty when installed with one or more HAWS Drinking Fountains connected to serve adjacent rooms. Large capacity cooling units provide ample supply of cooled water.

Write today for complete information an

HAWS ELECTRIC WATER COOLERS
 SANITARY DRINKING FOUNTAINS

HAWS DRINKING FAUCET CO.
 FOURTH and PAGE STREETS (Since 1909) BERKELEY 2, CALIFORNIA
 Agents and Sales Representatives in All Principal Cities

PAINTING WITH LIGHT

(From Page 20)

els, interesting facades and windows to be used in the construction of industrial buildings, public offices, schools, hospitals, churches, and homes. It presents a lifetime ambition to the artist and craftsmen associated in this work.

The broken, harmonious color of a stained glass window creates an interior atmosphere unequalled by the use of any other material. True stained glass is glass that is colored in its making by the use of metallic oxides or chlorides depending upon the desired color. Copper oxide produces rubies, blue and green but cobalt is the principal color of fine pure blues. Gold, fine selenium yellows, vermilion are made by using uranium, cadmium sulphide or titanium. The richest of rubies are made by using gold. These colors have never been known to fade in tone. Many of the pot glass windows come from England, France, and Belgium but several glass plants in this country are rapidly forging to the front in both quality and quantity.

Many architects and designers take their clients through the studios to witness the great variety of glass and mosaics from all corners of the globe as well as to see the many designs possible in its use.

NEW RECREATION BUILDING for the First Baptist Church of Santa Clara will be built by St. John & Powell, Oakland, contractors at a cost of \$72,632. Donald P. Smith, San Francisco, is architect.

APARTMENT BUILDINGS. Paul H. Hammarberg, Berkeley, architect has been selected to design 14-apartment buildings containing 123 apartments for Walnut Creek, California.

RESIDENCE. Architect Wilton Smith, San Francisco, has awarded a contract for the construction of a 9-room house (4-baths) for a client in San Jose, California. Cost \$48,469.

NEW GRAMMAR SCHOOL—Fairfield. Dr. J. W. Schmidts & Hardman, Architects of Berkeley, California, announced the awarding of a \$279,777 contract to the B & R Construction Company of San Francisco, for construction of a 12-classroom, cafeteria and administration grammar school building at Fairfield, California.

TREASURE ISLAND PAINTING. M. Williams & Sons, Oakland, have been awarded a contract for the exterior painting of 20 buildings on Treasure Island at a cost of \$29,765.

A. ACTIVITIES

(From Page 33)

in Salt Lake City, Utah, will be selected at the meeting, with considerable interest being shown in the seminar program which has as its theme "Design Fundamentals."

Results of the January State Board examinations indicate that 192 candidates took the examination. One hundred and twenty from southern California and seventy-two from northern California. Final announcement of those successfully passing the examination has not been made.

As suggested by Dr. Herbert Clish, San Francisco Public Schools, a committee has been formed as a sub-committee under Public Relations to consider the possibility of making up a sketch part of school classroom design standards. The committee comprises: Wm. Clement Ambrose, Lyon Reid, J. Francis Ward, Hervey Perker, and Donald Beach Kirby.

New Corporate Members. Furber Merrill Libby, George Thomas Rockrise, Andre Morilhay, and John Scoma.

FRANCIS McSWEENEY, A.I.A., Architect of San Francisco, has designed the "House of Tomorrow, 1950" in conjunction with the City's celebration of the Portola Festival which is to be presented in April.

Architect McSweeney has introduced to the general public a scheme for living in San Francisco's climate heretofore never achieved.

WORLD TRIP TO AIR. Hugh Davies, Long Beach Architect, left the Los Angeles Municipal Airport recently aboard a Trans World Constellation bound for a 45-day flying trip around the world. Davies is making the trip to "study architectural forms."

ARCHITECTURAL OFFICE

Frederick M. Mann, Jr., and Eugene E. D. Crawford Architects, have announced the opening of their offices under the firm name of Crawford & Mann, Architects, at 134 Eldridge Avenue, Mill Valley, California.

ARCHITECTURAL FIRM

Announcement has been made of the formation of a new architectural firm under the name of Ertz, Kuettners & Kuettners, Architects, A.I.A., with offices at 105 S.W. 18th Avenue, Portland 5, Oregon. Firm members are Chas. W. Ertz, Architect, Portland; Morgan H. Hartford, Architect, A.I.A.; and J. Kuettners, Architect, A.I.A.

Is Each Home You Plan a "GOOD RISK"?

Banks and other home financing institutions, experienced in home construction values, agree that a poorly wired home is not as good a "risk" as one with adequate wiring.

Homes, new or remodeled, which lack a sufficient number of circuits and convenience outlets, or which utilize wire of insufficient size, are handicapped for loan or resale purposes . . . and also fail to provide the efficient electrical service the modern family requires.

Make sure the homes you plan give your clients maximum value . . . financially and in the comforts and conveniences of electrical living . . . by specifying certified Adequate Wiring.

Your local utility office will be glad to assist, without cost or obligation in the preparation of wiring layouts.

NORTHERN CALIFORNIA ELECTRICAL BUREAU

1355 MARKET STREET
SAN FRANCISCO 5

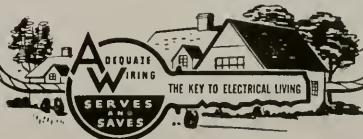

BAXCO

CHROMATED ZINC CHLORIDE

CZC

PRESSURE TREATED LUMBER

● **PROTECTS AGAINST DECAY
AND TERMITE ATTACK**

*Specify it in your home
Available through Lumber Dealers*

LOS ANGELES
601 W. 5th Street
Phone Mlchigan 6294

SAN FRANCISCO
333 Montgomery Street
Phone DOugles 2-3883

J. H. Baxter & Co.

AGENTS FOR WEST COAST WOOD PRESERVING CO. SEATTLE, WASH.

HEADLINE NEWS AND VIEWS

By E. H. W.

Pacific Coast Unlimited—The only limits to Pacific Coast growth are those set up by organizations and men:—Apologies to Frank E. Marsh Executive Vice-president of the San Francisco Bay Area Council.

The Pacific Regional Conference on the United Nations Educational Scientific and Cultural Organization was recently held in San Francisco. The purpose of the Conference, in case you don't know is to obtain worldwide understanding between peoples. We are interested in knowing how sponsoring interests are going to secure worldwide understanding of people when no individual community alone has complete understanding of its people.

A good example of governmental bureau pressure is the "publicity" releases emanating from the U. S. Department of the Interior, Bureau of Reclamation's Sacramento office, pertaining to the disposition of power being generated at the government's Shasta power plant. . .

Representatives of the Building and Construction Trades Department of the American Federation of Labor, The Associated General Contractors of America, and of seven national associations of specialty contractors have signed the Agreement for the establishment in the building and construction industry of the National Joint Board for the Settlement of Jurisdictional Disputes.

There is no question of a doubt—you can have successful private enterprise dictated to by any agency of the government. You either have private enterprise, or you have government enterprise.

Speaking before a luncheon meeting of the Building Industry Conference Board in San Francisco recently, C. W. Kraft, President of Kraft Company, released information prepared by the Producer Council, Inc., which forecasted a sum \$14-billion would be invested nationally in public and private construction during 1948.

The figure is 13 per cent greater than in 1947, but more than 10 per cent below the 1941 figure.

With few exceptions, Kraft predicted the materials supply market is favorable for 1948, although shortages may still be experienced in a few items.



E. K. WOOD LUMBER CO.

SAN FRANCISCO General Offices: No. 1 Drumm Street
LOS ANGELES Office and Yards: 4710 S. Alameda St. — JE 3111
OAKLAND Yards and Wharves: 2111 Frederick St. — KE 4-8466
PORTLAND Mill Sales Office: 827 Terminal Sales Bldg

SAW MILLS: Roseburg, Oregon • Reedsport, Oregon
RETAIL YARDS: LOS ANGELES • OAKLAND • ONTARIO • HOLLYWOOD
LONG BEACH • RIVERSIDE • TEMPLE CITY • SIERRA MADRE • INDO • THERMAL
LA VERNE • WHITTIER • PASADENA • SAN PEDRO

IN THE NEWS

REHABILITATION FOR BOYS

The State of California has selected a site for the construction of a new rehabilitation institution for boys near Tracy in San Joaquin county of the San Joaquin Valley. It is estimated the institution which will be of reinforced concrete construction, will cost approximately \$7,500,000.

SCHOOL BONDS VOTED

School bonds in the amount of \$9,000 were recently voted by San Ramon Valley Union High School District, Alameda county, California, for the construction of an addition to the High School. Carlett & Anderson, Oakland, are the architects.

LIBRARY ADDITION

A contract has been awarded to H. J. & K Corporation of San Francisco for the construction of an addition to the main library building at the University of California Berkeley campus at a cost of \$1,183,833.

Arthur Brown, Jr., San Francisco, is the Architect.

EXHIBIT BUILDING

The Younger Construction Company of San Francisco, has been awarded a \$87,987 contract for the construction of an exhibit at the Deer County Fair grounds in Nevada.

WAREHOUSE BUILDING

The Moore & Moore Construction Company of Stockton have been awarded a \$116,280 contract for the construction of a warehouse building in Stockton for the Flot Products, Inc.

MOTEL, consisting of 58-units to be built at Redding (California) by the Luigi Consentino construction company of Dunsmuir at an estimated cost of \$225,000.

HOSPITAL CONTRACT

A contract for construction of a new hospital building in Gridley (California) has been awarded to W. Robertson of Sacramento. Part of the project is \$264,986. Henry H. Gutterson, San Francisco, is architect.



... production geared to
**WESTERN LIGHTING
REQUIREMENTS**

FLUORESCENT ...

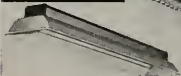

INCANDESCENT ...



Smoot-Holman quality lighting equipment is western-designed and western-made exclusively for western use.

Your lighting problems are quickly, efficiently and economically solved when you specify Smoot-Holman.

Planned
Lighting
by.



**SMOOTH-HOLMAN
COMPANY**

INGLEWOOD, CALIFORNIA

Offices in Principal Western Cities—Branch and Warehouse in San Francisco

LANDSCAPE ARCHITECTURE

Notes of The Profession

ASSOCIATION OF LANDSCAPE ARCHITECTS, SAN FRANCISCO REGION

Vernon Dean, President; Robert Royston, Vice-President; Ned Rucker, Treasurer;
E. L. Anderson, Secretary, 1736 Franklin, Oakland, California.

ASSOCIATION OF LANDSCAPE ARCHITECTS—SF REGION

In collaboration with the East Bay Chapter, A.L.A., an extensive exhibit was developed for the recent Oakland Spring Garden Show. The work was under the chairmanship of Theodore Osmondson, Jr.

Attendance records at the Show were broken.

APPOINTED TO SAN FRANCISCO ART COMMISSION

Douglas Bayliss, San Francisco, Landscape Architect was recently appointed to the San Francisco Art Commission by Mayor Elmer Robinson. He succeeds Thomas Church, resigned.

Bayliss is immediate past vice president of the San Francisco Federation of Arts and has for several years served as an officer and director of

the Association of Landscape Architects, and present represents the A.L.A. on the Building Industry Conference Board.

The new Commissioner is well known for his design of small home gardens, and for several extensive war housing developments as well as Apparel City, one of the few industrial projects in the Nation to be landscaped.

MILK PROCESSING PLANT. Wm. D. Rapp, Santa Rosa contractor, has been awarded a contract for the construction of a \$110,000 milk processing plant, same city.

SCHOOL BIDS REJECTED. Bids for the construction of an Academic Building at the Napa (California) Junior College have been rejected. The project is estimated to cost \$659,861. W. G. Corlett and W. W. Anderson, Oakland, are the architects.

SHASTA PLYWOODS PLANT

Donald Birmingham, general manager of the newly formed U. S. Plywood Corporation's Shasta Plywoods, Inc., reports that the new plywood mill being constructed near Anderson, in the northern end of the Sacramento Valley, California, should be completed by late summer, probably September.

Mill construction includes a machine shop building, railroad spur tracks, log pond, kilns, and several buildings.



"ECON-O-MATIC" . . . is the automatic Stanley Door Hardware Set that makes lightweight plywood doors 100% practical for garages. Designed for doors weighing up to 150 lbs. Cost little more than old-style hardware. For smart appearance — faultless action — long service — specify Stanley. The Stanley Works, New Britain, Conn.

*Copyrighted

STANLEY

Reg. U.S. Pat. Off.



Simple to Install
Requires Only 2 1/4-in. headroom

HARDWARE · HAND TOOLS · ELECTRIC TOOLS

TERRAZZO

for Floors and Wainscoting in Hospitals, Theaters, Hotels,
Office Buildings, Schools and Stores.
DECORATIVE • DURABLE • SANITARY



FOX TILE CO.

3247 E. 14th Street, Oakland
Phone: ANdover 1-0431

NEWS AND COMMENT ON ART

(From Page 13)

A ten week course of exercises in perception will be conducted by Charles Lindstrom, Friday afternoons 2 to 4 o'clock and on Saturday mornings from 10:15 to noon.

Miriam Lindstrom will give a set of four lectures in Tradition and Transition in Art History on Thursday afternoons at 3 o'clock, beginning May 13.

CITY OF PARIS

The Seventh Annual Pacific Coast Ceramic Exhibition and Sale of Sculpture and Pottery, will be held in the Rotunda Gallery from May 15 to June 12th. The Jury of selection and awards for this year is composed of Jean Goodwin Ames, Robert Howard, Marian Hartwell, Elena M. Netherby, and Beatrice Judd Ryan, Director.

Pictures of the Month are a group of eight Serigraphs of Hawaiian scenes, showing the traditional luau and the tropical fisherman as well as Polynesian landscapes, by Marion Cunningham. The group are shown in Memoriam for Marian Cunningham.

Also there is a retrospective exhibit of Paintings and prints.

CALIFORNIA SCHOOL OF FINE ARTS

Additions to the faculty for the Summer Sessions, June 21 to July 30, include Stanley W. Hayter and Helen Phillips of New York, and Edward Weston of Carmel.

Hayter will conduct classes in painting and print-making and will deliver a weekly lecture on contemporary painting. Helen Phillips returns to the scene of her former studies to conduct the summer course in sculpture, while Weston, will participate in the Photography Department's program as instructor at his Carmel Studio.

In addition to these guest instructors, the Summer Session faculty includes twenty members of its regular teaching staff who will conduct classes in landscape, figure and watercolor painting, various drawing classes, advertising layout, illustration, ceramics, design and color, and photography.

A class in drawing and painting for children of school age will be offered two mornings weekly.

David Park, Elmer Bischoff and Hassel Smith have a group show at the Museum through June 20th. Mr. Park is chairman of the Artist's Council; Hessel Smith is actively associated with the Artists Guild, and Elmer Bischoff is on the University of California Summer faculty as well as instructor at the Extension Division. All of the paintings on view are works which have been painted in 1948.

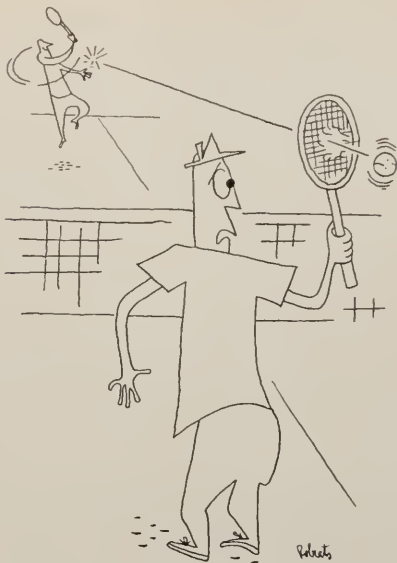

FAST RECOVERY WITH SPARTAN

Gas is faster and costs less, but in the SPARTAN, gas reaches its peak of efficiency. A double extra heavy boiler with three flues each running its entire length assures fast recovery of approximately one gallon a minute. So — where fast recovery is an added requirement — Spartan is the answer.



 **Continental**
Water Heater Company Ltd.

LOS ANGELES • SAN FRANCISCO

FORDERER CORNICE WORKS

Manufacturers of

Hollow Metal Products • Interior Metal Trim
Elevator Fronts and Cabs
Metal Plaster Accessories • Sanitary Metal Base
Flat and Roll Metal Screens
Metal Cabinets • Commercial Refrigerators

269 POTRERO AVE.

SAN FRANCISCO, CALIF.

HEMLOCK 4100

STRUCTURAL STEEL

For Class A Buildings,
Bridges, etc.

JUDSON PACIFIC - MURPHY CORP.

4300 EASTSHORE HIGHWAY
EMERYVILLE, CALIF.

VALUABLE NEWS SERVICE

- BUILDING MATERIAL DEALERS
- CONTRACTORS
- ENGINEERS
- FINANCIAL INSTITUTIONS

ARCHITECTS REPORTS gives advance news on construction projects in Northern California, lists: name of projects, location, architect, proposed cost and other pertinent information.

HANDY individual slip-reports, issued daily at a total cost of only

\$10 a month

ARCHITECT'S REPORTS

Published Daily

The ARCHITECT and ENGINEER, Inc.

68 Post Street, San Francisco - DO 8311

RADIANT HEATING

(From Page 16)

will average 70° to 74° F.

Adjustments of the circuit, after initial installation, are confined to conveniently located wall thermostats which operate at a fraction of one degree temperature differential. This insures evenly regulated heat throughout the rooms affected. To our knowledge, ELECTRADIANT heat is the only method where an absolutely even distribution of radiation is guaranteed over any given area. There can be no "cold spots." Every inch of element cable is exactly the same temperature.

While there are many ramifications to good heating installations, the most important is the proper insulation of the building. No heating system can operate at its maximum efficiency if it has to overcome abnormal heat losses. In fact, we have gone so far as to refuse to install ELECTRADIANT heat where plans did not call for, at least, roof insulating. In the majority of residence applications, we recommend full wall and ceiling insulation for the advantage of the home owner than for our own protection.

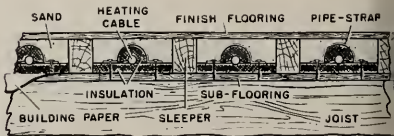

WOOD FLOOR INSTALLATION

Regarding costs, ELECTRADIANT heat is less expensive to install than most other systems whether of radiant or convection types. On the average the nominal first cost (and last cost) is around 70c per square foot of heated area. This figure does not include the cost of the service to the transformers.

Operating costs are not greater with ELECTRADIANT heat than for any other system using metered fuel. It must be pointed out, however that if fullest economy is to be realized, the system must be installed according to our specifications and too, that after installation the system must be used intelligently.

Until the present time, the Tice Electrical Shop has engineered, designed and installed all the ELECTRADIANT heating systems in use on the Pacific Coast today. Though demands are steadily increasing we are expanding to keep abreast of current orders. In the near future, we anticipate appointing dealers and contractors to handle actual installations. Using the plans for the home building or plant, we will continue to estimate heat

(See Page 44)

ESTIMATOR'S GUIDE

BUILDING AND CONSTRUCTION MATERIALS

PRICES GIVEN ARE FIGURING PRICES AND ARE MADE UP FROM AVERAGE QUOTATIONS FURNISHED BY MATERIAL HOUSES TO SAN FRANCISCO CONTRACTORS. 2½% SALES TAX ON ALL MATERIALS BUT NOT LABOR

All prices and wages quoted are for San Francisco and the Bay District. There may be slight fluctuation of prices in the interior and southern part of the state. Freight cartage, at least, must be added in figuring unit work.

ONDS—Performance—\$10 per \$1000 of contract. Labor and materials, \$10 per \$1000 of contract.

BRICKWORK—
Common Brick—Per 1M laid—\$100.00 up (according to class of work).
Face Brick—Per 1M laid—\$200.00 end up (according to class of work).
Brick Steps—\$3.00 and up.
Common Brick Veneer on Frame Bldgs.—Approx. \$1.20 and up—according to class of work).
Face Brick Veneer on Frame Bldgs.—Approx. \$2.00 and up (according to class of work).
Common Brick—\$28.50 per M—truckload lots, delivered.
Face Brick—\$60.00 to \$90.00 per M, truckload lots, delivered.
Cartage—Approx. \$9.00 per M.
Los Angeles County Area—Residential, up to 4-family or apt., metal railways, \$6.50 per outlet.

BUILDING PAPER—
1 ply per 1000 ft. roll.....\$5.30
2 ply per 1000 ft. roll.....7.80
3 ply per 1000 ft. roll.....9.70
Brownskin, Stender, 500 ft. roll.....8.00

BUILDING HARDWARE—
Sash cord cam, No. 7.....\$2.45 per 100 ft.
Sash cord cam, No. 8.....3.00 per 100 ft.
Sash cord spot No. 7.....3.65 per 100 ft.
Sash cord spot No. 8.....4.00 per 100 ft.
Sash weights, cast iron, \$100.00 ton.
Nails, \$5.50 base.

CONCRETE AGGREGATES—
The following prices net to Contractors unless otherwise shown. Carload lots only.

	Bunker per ton	Del'd per ton
Gravel, all sizes.....	\$2.44	\$2.75
Top Sand.....	2.38	3.13
Concrete Mix.....	2.38	3.06
Crushed Rock, ¾" to ¾".....	2.38	2.94

	Bunker per ton	Del'd per ton
Crushed Rock, ¾" to 1½".....	\$2.38	\$3.13
Roofing Gravel.....	2.91	3.50
River Sand.....	2.50	3.06

	Bunker per ton	Del'd per ton
Sand—		
Lepis (Nos. 2 & 4).....	3.56	3.94
Olympia (Nos. 1 & 2).....	3.56	3.88

Cement—
Common (all brands, paper sacks), carload lots, \$3.02 per bbl, f.o.b. car; delivered \$3.60.
Cash discount on carload lots, 10¢ a bbl, 10th Prox., less than carload lots \$4.00 per bbl, f.o.b. warehouse or delivered.
Cash discount 2% on L.C.L.

Trinity White	} 1 to 100 sacks, \$3.13 sack warehouse or del.; \$9.56 bbl, carload lots.
Medusa White	

DAMP-PROOFING and Waterproofing—
Two-coat work, \$8.00 per square.
Membrane waterproofing—4 layers of set-urated felt, \$9.00 per square.
Hot coating work, \$5.00 per square.
Medusa Waterproofing, \$3.50 per lb. San Francisco Warehouse.
Tricoceal waterproofing.
(See representative.)

ELECTRIC WIRING—\$15 to \$20 per outlet for conduit work (including switches).
Knob and tube average \$6.00 per outlet. (Available only for priority work.)

ELEVATORS—
Prices vary according to capacity, speed end type. Consult elevator companies. Average cost of installing a slow speed automatic passenger elevator in small four story apartment building, including entrance doors, about \$8000.00.

EXCAVATION—
Sand, \$1.00; clay or shale, \$1.50 per yard. Trucks, \$30 to \$45 per day.
Above figures are an average without water. Steam shovel work in large quantities, less; hard material, such as rock, will run considerably more.

FIRE ESCAPES—
Ten-foot galvanized iron balcony, with stairs, \$250 installed on new buildings; \$300 on old buildings.

FLOORS—
Composition Floors, such as Magnesite, 50¢ per square foot.
Linoflor—2 gages—\$3.00 per sq. yd.
Mastipave—\$1.50 per sq. yd.
Battlefield Linoleum—available to Army and Navy only—1/8" —\$3.50 sq. yd.
3/8" —\$3.50 sq. yd.
Terazzo Floors—\$1.50 per sq. ft.
Terazzo Steps—\$2.50 per lin. ft.
Mastic Wear Coat—according to type—20¢ to 35¢.

Hardwood Flooring—
Standard Mill grades not available.
Victory Oak—T & G
¾" x 2¼".....\$252.00 per M. plus Cartage
½" x 2".....210.00
½" x 1½".....200.00

Prefinished Standard & Better Oak Flooring
¾" x 3¼".....\$265.00 per M. plus Cartage
½" x 2½".....237.00 per M. plus Cartage
Maple Flooring
¾" T & G Clear \$330.00 per M. plus Ctg.
2nd 305.00 per M. plus Ctg.
3rd 255.00 per M. plus Ctg.
Floor Layers' Wage, \$2.12½ per hr. (Legal as of July 1, 1947. Given us by Inleif Floor Co.)

GLASS—
Single Strength Window Glass.....\$.40 per □ ft.
Double Strength Window Glass......60 per □ ft.
Plate Glass, under 75 sq. ft.....1.50 per □ ft.
Polished Wire Plate Glass.....2.75 per □ ft.
Rgh. Wire Glass......40 per □ ft.
Obscure Glass......40 per □ ft.
Glazing of above is additional.
Glass Blocks.....\$2.75 per □ ft. set in place

HEATING—
Average, \$2.50 to \$3.00 per sq. ft. of radiation, according to conditions.
Warm air (gravity) average \$64 per register.
Forced air average \$91 per register.

INSULATION AND WALLBOARD—

Rockwool Insulation—	
(2")	\$65.00 per M sq. ft.
Cotton Insulation—Full thickness	
(3 3/4")	\$95.50 per M sq. ft.
Aluminum Insulation—Foil-mounted	
on both sides	\$33.50 per M sq. ft.
Tileboard—4'x6' panel	\$9.00 per panel
Wallboard—1/2" thickness	\$55.00 per M sq. ft.
Finished Plank	\$69.00 per M sq. ft.
Ceiling Tileboard	\$69.00 per M sq. ft.

IRON—Cost of ornamental iron, cast iron, etc., depends on designs.

LUMBER—

No. 1 Common	\$90.00 per M
No. 2 Common	88.00 per M
Select O. P. Common	94.00 per M

Flooring— Per M Deliv.

V.G.-D.F. 8 & 8tr. 1 x 4 T & G Flooring	\$170.00
"C" and better—all	170.00
"D" and better—all	170.00
Rwd. Rustic—"A" grade, medium dry	150.00
8 to 24 ft.	
"B" grade, medium dry	150.00

Plywood

15c to 18c per ft.	
Plycord	9 1/2c per ft.
Plywell	9c per ft.
Plyform	15c per ft.

Shingles (Rwd. not available)—
 Red Cedar No. 1—\$13.00 per square; No. 2, \$10.50; No. 3, \$9.00.
 Average cost to lay shingles, \$6.00 per square.
 Cedar Shakes—Tapered: 1/2" to 3/4" x 25"—\$17.00 per square.
 Resawn: 3/4" to 1 1/4" x 25"—\$22.00 per square
 Average cost to lay shakes,—8.00 per square

MILLWORK—Standard.

D. F. \$150 per 1000. R. W. Rustic \$175 per 1000 (delivered).
 Double hung box window frames, average with trim, \$12.50 and up, each.
 Complete door unit, \$15 to \$25.
 Screen doors, \$6.00 to \$8.00 each.
 Patent screen windows, \$1.25 a sq. ft.
 Cases for kitchen pantries seven ft. high, per lineal ft., \$12.00 each.
 Dining room cases, \$15.00 per lineal foot.
 Rough and finish about \$1.00 per sq. ft.
 Labor—Rough carpentry, warehouse heavy framing (average), \$65.00 per M.
 For smaller work average, \$75.00 to \$85.00 per 1000.

MARBLE—(See Dealers)

PAINTING—

Two-coat workper yard 75c
 Three-coat workper yard \$1.00
 Cold water paintingper yard 25c
 Whitewashingper yard 15c
 Turpentine.....\$1.85 per gal. in 5-gal. cont.
 Raw Linseed
 Oil.....\$3.33 per gal. in 5-gal. cont.

Boiled Linseed\$3.23 per gal. in drums.
 Oil.....
 Boiled Linseed Oil—\$3.33 per gal. in 5-gal. containers.
 Replacement Oil—\$2.75 per gal. in drums.
 \$2.75 per gal. in 5-gal. containers.
 Use Replacement
 Oil.....\$3.00 per gal. in 1 gal. cont.
 A deposit of \$7.50 required on all drums.

PATENT CHIMNEYS—

6-inch	\$2.00 lineal foot
8-inch	2.50 lineal foot
10-inch	3.50 lineal foot
12-inch	4.50 lineal foot

PLASTER—

Neat wall, per ton delivered in S. F. in paper bags, \$17.60.

PLASTERING (Interior)—

3 Coats, metal lath and plaster	Yard \$3.00
Keene cement on metal lath	3.50
Ceilings with 3/4 hot roll channels metal lath (lathed only)	3.00
Ceilings with 3/4 hot roll channels metal lath plastered	4.50
Single partition 3/4 channel lath 1 side (lath only)	3.00
Single partition 3/4 channel lath 2 inches thick plastered	8.00
4-inch double partition 3/4 channel lath 2 sides (lath only)	5.75
4-inch double partition 3/4 channel lath 2 sides plastered	8.75
Thermax single partition; 1" channels; 2 1/4" overall partition width. Plastered both sides	7.50
Thermax double partition; 1" channels; 4 3/4" overall partition width. Plastered both sides	11.00
3 Coats over 1" Thermax nailed to one side wood studs or joists	4.50
3 Coats over 1" Thermax suspended to one side wood studs with spring sound isolation clip	5.00
Note—Channel lath controlled by limitation orders.	

PLASTERING (Exterior)—

2 coats cement finish, brick or concrete wall	Yard \$2.50
3 coats cement finish, No. 18 gauge wire mesh	3.50
Lime—\$4.00 per bbl. at yard.	
Processed LLime—\$4.15 per bbl. at yard.	
Rock or Grip Lath—3/4"—30c per sq. yd.	
1/2"—29c per sq. yd.	
Composition Stucco—\$4.00 sq. yd. (applied).	

PLUMBING—

From \$150.00 per fixture up, according to grade, quality and runs.

ROOFING—

"Standard" tar and gravel, 4 ply—\$11.00 per sq. for 30 sqs. or over.
 Less than 30 sqs. \$14.00 per sq.
 Tile \$40.00 to \$50.00 per square.
 Redwood Shingles, \$15.00 per square in place.
 5/2 #1-16" Cedar Shingles, 4 1/2"
 Exposure \$18.25 square

5/8 x 16"—#1 Cedar Shingles, 5"
 Exposure \$17.00 square
 4/2 #1-24" Royal Shingles, 7 1/2"
 Exposure \$23.00 square
 Re-coat with Gravel \$5.50 per sq.
 Asbestos Shingles \$30 to \$60 per sq. laid
 1/2 to 3/4 x 25" Resawn Cedar Shakes,
 10" Exposure \$24.00
 3/4 to 1 1/4 x 25" Resawn Cedar Shakes,
 10" Exposure \$29.00
 1 x 25" Resawn Cedar Shakes,
 10" Exposure 22.00
 Above prices are for shakes in place.

SHEET METAL—

Windows—Metal, \$2.50 a sq. ft.
 Fire doors (average), including hardware \$2.80 per sq. ft.

SKYLIGHTS—(not glazed)

Copper, \$1.25 sq. ft. [flat].
 Galvanized iron, 65c sq. ft. [flat].
 Vented hip skylights 90c sq. ft.

STEEL—STRUCTURAL—

\$220 per ton erected, when out of mill
 \$270 per ton erected, when out of stock

STEEL REINFORCING—

\$200.00 per ton, in place.

STORE FRONTS (None available).

TILE—

Ceramic Tile Floors—\$1.70 per sq. ft.
 Cose Base—\$1.35 per lin. ft.
 Glazed Tile Wainscot—\$1.85 per sq. ft.
 Asphalt Tile Floor 1/2" x 3/4"—\$.40 per sq. ft.
 Light shades slightly higher.
 Cork Tile—\$1.00 per sq. ft.
 Mosaic Floors—See dealers.
 Lino-Tile—\$1.00 per sq. ft.

Wall Tile—

Glazed Terra Cotta Wall Units (single face laid in place—approximate prices:

2 x 6 x 12	\$1.25 sq.
4 x 6 x 12	1.50 sq.
2 x 8 x 16	1.45 sq.
4 x 8 x 16	1.75 sq.

VENETIAN BLINDS—

75c per square foot and up. Installati extra.

WINDOWS—STEEL—

60c per square foot, \$5 for ventilators.

IN THE NEWS

AIR INDUSTRY ENGINEERS Sought by CALIFORNIA

The California State Civil Service Commission will accept applications up to June 1, 1948, for the positions of Airport Designer Engineer, Airport Planning Engineer, Air Safety and Enforcement representative, Field Representative, Chief Division of Aeronautical Development, Supervising Airport Engineer.

The positions are to be filled with California's new Aeronautics Commission and work will be in conjunction with the State's extensive airport and aircraft industry development program.

SCHOOL BOND ELECTION

Residents of the Lodi (California) Union High School District will vote April 27th on the issuance of \$2,500,000.00 in bonds with the revenues to be used in remodeling the present High School for use as

a Junior High School and for the construction of a new High School building.

reinforced concrete and steel.

The Lawrence Construction of Sacramento is the general contractor.

REMODEL STATE BUILDING

Contracts aggregating some \$361,009 were recently awarded for construction of additions to the Business & Professionals Building, Sacramento. The additions will be 6-stories and basement, approximately 76,000 sq. ft., and will be of

LODI HOSPITAL

The Lodi Memorial Hospital Association announce completion of working drawings of their new \$1,000,000 (100 bed) hospital. W. D. Peugh, San Francisco, is the architect.

TOUGH as SHOE - LEATHER - and WATERPROOF, Too!

Specify SISALKRAFT REINFORCED BUILDING PAPER

FOR CURING AND PROTECTING
CONCRETE SHEATHING
AND COVERING MATERIAL

GUNN CARLE & CO
20 POTRERO AVENUE • SAN FRANCISCO, CALIF.

BUILDING TRADES WAGE (JOB SITES) NORTHERN AND CENTRAL CALIFORNIA

ATTENTION: The following are the PREVAILING hourly rates of compensation being paid and in effect by employers by agreement between employees and their union; or as recognized and determined by the U. S. Department of Labor. (Revised to January 1, 1948.)

CRAFT	San Francisco	Alameda Contra Costa	Marin	Vallejo	San Mateo	San Jose	Stockton	Sacramento	Fresno
ASBESTOS WORKERS.....	1.90	1.90	1.90	1.90	1.90	1.90	1.90	1.90	1.90
BRICKLAYERS.....	2.25	2.25	2.25	2.25	2.25	2.25	2.25	2.50	2.25
CONCRETE FINISHERS.....	1.75	1.75	1.75	1.75	1.75	1.75	1.87½	1.87½	1.75
CARPENTERS.....	2.00	2.00	2.00	2.00	2.00	2.00	2.00	2.00	2.00
CEMENT FINISHERS.....	2.02½	2.02½	2.02½	2.02½	2.02½	2.02½	2.02½	2.02½	2.02½
ELECTRICIANS.....	2.25	2.25	2.25	2.25	2.25	2.25	2.25	2.25	2.25
ENGINEERS: MATERIAL HOIST.....	2.00	2.00	2.00	2.00	2.00	2.00	2.00	2.00	2.00
ENGINEERS: PILE DRIVER.....	2.25	2.25	2.25	2.25	2.25	2.25	2.25	2.25	2.25
ENGINEERS: STRUCTURAL STEEL.....	2.25	2.25	2.25	2.25	2.25	2.25	2.25	2.25	2.25
GLASS WORKERS.....	1.87½	1.87½	1.87½	1.87½	1.87½	1.87½	1.87½	1.87½	1.87½
IRONWORKERS: ORNAMENTAL.....	2.10	2.10	2.10	2.10	2.10	2.10	2.10	2.10	2.10
IRONWORKERS: REINF. RODMEN.....	2.00	2.00	2.00	2.00	2.00	2.00	2.00	2.00	2.00
IRONWORKERS: STRUCTURAL.....	2.25	2.25	2.25	2.25	2.25	2.25	2.25	2.25	2.25
LABORERS: BUILDING & CONCRETE.....	1.40	1.40	1.40	1.40	1.40	1.30	1.40	1.40	1.30
LATHERS.....	2.25	2.25	2.25	2.25	2.25	2.25	2.25	2.25	2.25
MARBLE SETTERS.....	2.00	2.00	2.00	2.00	2.00	2.00	2.00	2.00	2.00
MOSAIC & TERRAZZO.....	2.00	2.00	2.00	2.00	2.00	2.00	2.00	2.00	2.00
PAINTERS.....	2.00	2.00	2.00	2.00	2.00	2.00	2.00	2.00	2.00
PILEDRIVERS.....	2.12½	2.12½	2.12½	2.12½	2.12½	2.12½	2.12½	2.12½	2.12½
PLASTERERS.....	2.25	2.50	2.25	2.50	2.25	2.25	2.05	2.05	2.05
PLASTERERS: HODCARRIERS.....	2.00	2.00	2.00	2.00	2.00	2.00	1.87½	1.87½	1.87½
PLUMBERS.....	2.25	2.25	2.25	2.25	2.25	2.25	2.25	2.25	2.25
ROOFERS.....	2.00	2.00	2.00	2.00	2.00	2.00	2.00	2.00	2.00
SHEET METAL WORKERS.....	2.00	2.00	2.00	2.00	2.00	2.00	2.00	2.00	2.00
SPRINKLER FITTERS.....	2.00	2.00	2.00	2.00	2.00	2.00	2.00	2.00	2.00
STEAMFITTERS.....	2.25	2.25	2.25	2.25	2.25	2.25	2.25	2.25	2.25
STONESETTERS (MASONS).....	2.25	2.25	2.25	2.25	2.25	2.25	2.25	2.25	2.25
TILESETTERS.....	2.15	2.15	2.15	1.90	2.15	1.90	1.90	1.90	1.90

Prepared and compiled by

CENTRAL CALIFORNIA CHAPTER, ASSOCIATED GENERAL CONTRACTORS OF AMERICA

with the assistance and cooperation of secretaries of Building Trades Unions, General Contractors Associations and Builders Exchanges of Northern California

CLASSIFIED ADVERTISING

RATE: 10c PER WORD . . . CASH WITH ORDER

MINIMUM \$2.50

ARCHITECT'S REPORTS—A valuable evidence news service giving building and construction information daily on projects in Northern California. Name, location, architect, proposed cost, etc., on individual slips. Ideal for securing new business leads. Hundreds of items, total monthly cost only \$10. Don't delay, subscribe today. **ARCHITECT**

& ENGINEER, Room 618, 68 Post Street, San Francisco, California. Phone DOUGLASS 2-8311.

PHOTOGRAPHS: Specializing in building and construction photographs for publication, or historic records. For Industrial-Aerial-Publicity photography use the **INDUSTRIAL**

San Francisco. PHOTO'S, Room 722, Hearst Bldg., San Francisco, Phone SUtter 1-6953.

ENGRAVING—Good engravings are essential to a satisfactory job of printing reproduction. For the best, see Poor Richard Photo Engraving Co., 324 Commercial St.

HOGAN LUMBER CO.

Wholesale and Retail

LUMBER

MILL WORK • SASH & DOORS

Office, Mill, Yard and Docks

SECOND AND ALICE STREETS • OAKLAND, CALIF.

Telephone GLencourt 1-6861

SISALKRAFT

REG. U. S. PAT. OFF.

"More than a building paper"

THE SISALKRAFT CO.

205 West Wacker Drive
Chicago, Ill.

55 New Montgomery Street
San Francisco, Calif.

CLINTON CONSTRUCTION CO. OF CALIFORNIA

General Contractors

923 FOLSOM STREET • SAN FRANCISCO

SUtter 1-3440

SANTA MARIA INN SANTA MARIA, CALIFORNIA

FRANK J. McCOY, General Manager

FERNAND E. PIMENTEL, Manager

On the
Coast
Highway
between
San
Francisco
and
Los
Angeles



American
or
European
Plan
•
Old
English
Top
Room

RADIANT HEATING

(From Page 40)

losses and lay out the wiring system for every job. The amount of cable to be used in each case will be calculated to the last inch with bends clearly marked on the cable. All transformers, controls, cable and auxiliary equipment are designed particularly for each installation and are shipped directly from our plant to the job, together with directions and a simple working diagram. The technical and engineering staff of the Electradian Corporation may always be called on for assistance if any additional problems should arise.

ELECTRADIANT HEATING SYSTEMS are not recommended for use in buildings not completely insulated with a standard grade insulation. Controlled heat loss is an important factor in economical operation. While not essential, it is advantageous to glaze large glass window areas with dual insulating sections such as Thermopane or Twindow units.

SISALKRAFT SALES MANAGER DIES

L. W. (Larry) Smith of Chicago, for many years Sales Manager for the Sisalkraft Company, passed away the latter part of February, after a long illness.

He started in the lumber and building material industry in the lumber mills of the Pacific Northwest, and became identified with the Sisalkraft Company more than eighteen years ago in the sales department.

BAKERSFIELD SCHOOL. O. D. Williams, Jr., Bakersfield, contractor has been awarded a \$202,000 contract for the construction of the Fruitvale Grammar School addition, consisting of 4-classrooms, kindergarten, home economics, shop and garage. Ernest L. McCoy, Bakersfield, is the architect.

HIGH SCHOOL ADDITION. The B & R construction Company of San Francisco, have been awarded a \$129,777 contract for the construction of additions to the High School and Junior High School buildings at Pittsburg, California. Chas. F. Dean, Sacramento, is the architect.

JUVENILE HALL. The Nomellini Construction Company of Stockton, California, have been awarded a \$387,239 contract for the construction of a new Juvenile Hall building at French Camp, San Joaquin County. Jos. Losekann, Stockton, is the architect.

BOOK REVIEWS

PAMPHLETS AND CATALOGUES

THE HOUSE FOR YOU, To Build, Buy or Rent.
Published by John Wiley and Sons, Inc., New York. Illustrations by Henry Diamond and Lombard C. Jones.

It is interesting to note about this well constructed 300 page book that one of the authors is co-author of the architect's bible, the Architectural Graphic Standards, and that he is also the author of Architectural Specifications. In combination with Catherine Sleeper, who is an author in her own right and who contributed to this book her knowledge or writing in a lively manner and her experience in actually living and working in a house, such a team that combines architectural know-how with the practical aspect of housekeeping is hard to beat. In many ways this copiously illustrated and wittily presented book gives you the comparative advantages of all three subjects of building, buying or renting which the Sleepers have treated completely and impartially, showing comparative advantages of all and endeavoring to help you to decide what is the best solution for you. Very few books have attempted to do that much.

You will get more for your money when they show you what things to watch for in case you decide to rent or buy, with copious points to learn how a house is actually put together. If you decide to build, the book sets out to give you a sound basis for choosing a plan or style for yourself. Fortunately it is not a book of specific plans nor does it discuss houses which are already in existence. This technically accurate book is designed for easy reading. Personally, I would recommend the book to architects and all those related to the building profession in order to establish a rapport with clients' habitual language.

—Review by Michael Goodman.

REPRESENTATIVES APPOINTED

The Airtherm Mfg. Co. of St. Louis, Mo., producers of oil and gas fired heaters, convector radiators and steam unit heaters, recently announced the appointment of several new district representatives.

Included in the appointments were the Pacific Electric Sales Co. of Portland, Oregon, and the Pacific Engineering Equipment Co., San Fernando, California.

SCHOOL BONDS VOTED. Davis (California) voters approved \$240,000 for construction of a new grammar school recently. Leonard F. Starks, Sacramento, is the architect.

The Most Complete Line of
STEELS and BUILDING MATERIALS
Made by a Single Producer



See Sweet's Catalog File or write us for full information.

REPUBLIC STEEL CORPORATION

GENERAL OFFICES: CLEVELAND, OHIO

DENVER, COLORADO CONTINENTAL OIL BUILDING
LOS ANGELES, CALIFORNIA EDISON BUILDING
SALT LAKE CITY, UTAH WALKER BANK BUILDING
SAN FRANCISCO, CALIFORNIA RIALTO BUILDING
SEATTLE, WASH. WHITE-HENRY-STUART BUILDING

PACIFIC MANUFACTURING CO.

HIGH CLASS INTERIOR FINISH
QUALITY MILLWORK

16 BEALE ST., SAN FRANCISCO

Garfield 1-7755

6820 MCKINLEY AVE., LOS ANGELES

THornwall 4196

BUILDERS EXCHANGE, OAKLAND

"AMERICAN - MARSH"

CONDENSATION UNIT

Pumping
Machinery
for
Every
Purpose

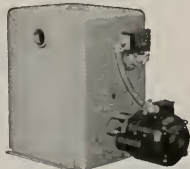

For Service
Call
DOuglas
2-6794
or
MUtual 8322

SIMONDS MACHINERY CO.

SAN FRANCISCO
816 FOLSOM

LOS ANGELES
455 EAST 4TH

VERMONT MARBLE COMPANY

Producers and Finishers
of

Domestic and Imported Marbles

525 MARKET STREET, SAN FRANCISCO
Phone SUtter 1-6747

3522 COUNCIL STREET
Beverly Blvd. at Virgil Ave. 1
LOS ANGELES 4, CALIF.
Telephone Fairfax 7834



RADIO KOMO, SEATTLE, WASHINGTON

(From Page 30)

all of which are served by a central refrigeration plant equipped with fifty horsepower Carrier refrigeration compressor capable of cooling equivalent to fifty tons per day.

Hot water for operation of the heating system is generated in a cast iron sectional boiler and circulated through coils in the several air conditioning systems and a special combination heating and ventilating facility developed for use in the office areas.

A specially designed system of battles and sound absorbing cells installed in the air conditioning fan ducts has reduced the operating noise level to a minimum which not only meets present requirements but will fulfill the more exacting demands of studios built in the future. Fan systems serving the various studios are set in operation from a central control panel in the operations control center and automatic zone controls maintain precise temperature and humidity conditions thereafter without further attention.

The second floor offices are heated and ventilated by an unusual system conceived by O. W. Fisher, KOMO president. It combines radiant heating and ventilation in hollow wall construction which permits control of temperatures in each individual room and control of air movement every nine feet around the perimeter of the walls. Air for office ventilation is provided from a central fan room where it is filtered and tempered before distribution to the hollow wall sections. At the point of introduction to the hollow wall, the air is reheated to provide effective radiation from the wall, then introduced into the room through continuous narrow grilles in the window sills or near the ceiling.

This provides the warm walls of a radiant heating system with the added advantage of sufficient air movement to insure comfortable, well ventilated offices.

The highly efficient studio layout and equipment have produced an operating broadcasting unit which has been rounded out by a decorative scheme that lends exceptional interest to the complete project. The simple functional exterior is entirely without ornamentation beyond the curved wall facing of Roman brick at the main entrance, and horizontal ribbing in the grey concrete which sets off the tall stair tower from the rest of the structure.

Wood paneling in the entrance lobby and corresponding dado in the reception lounge and operations corridor harmonize with the rich red pile carpeting in these areas. Colonial scenes and caricatures of NBC network stars have been repro-

duced in silver on the soft grey green upper walls in the reception lounge and operations corridor, respectively. The balance of the operations area has been decorated in various combinations of soft grey, which predominates, and muted blues, greens, coral, tan and yellow. Individual rooms, and in some instances single wall areas, have been painted in shades which provide sufficient contrast with surrounding areas from which they are visible to greatly enhance the interior perspectives. This is of particular importance in the smaller studios and central operations control room, where large areas of glass open up vistas in several directions.

The same principles have been followed in the painting of plaster walls in the offices and other work areas surrounding the operating units. The building's crowning decorative feature is the mural, "Across Horizons," by Edward T. Grigware, in which the celebrated painter of wartime action scenes has captured the spirit and character of radio in a combination of portraits and symbolic figures.

COUNTY HOSPITAL. San Benito county (California) has awarded a contract to Geo. C. Renz of Gilroy, for the construction of an \$83,440 Tuberculosis Ward Building at the County Hospital in Hollister. E. Geoffrey Bangs, San Francisco, is the Architect.

COUNTY FAIR BUILDINGS at Pleasanton, Alameda county, will be built under contract with Ted Bares Construction Company of Hayward at a cost of \$67,177. Kent & Hass, San Francisco are the architects.

SCHOOL BONDS VOTED. The Oakdale (California) Elementary School District will build a new 6-classroom grammar school building as the result of a recent election approving a \$125,000 bond issue.

SEWAGE TREATMENT PLANT. MacDonald, Young & Nelson, San Francisco, contractors have been awarded contract for construction of a \$559,000 sewage treatment plant for the Contra Costa County (California) Sanitary District.

NEW GRAMMAR SCHOOL, consisting of 8-classes, library and offices, will be built by the C. F. Parker Construction Company, San Francisco, for the Alta School of the Mill Valley (California) Elementary School District.

SCHOOL BOND ELECTION will be held June 1st for approval of \$2,140,000 additions to the high school and grammar schools of Alameda.

Brownskin
VAPORSEAL

The resilient building paper creped to S-T-R-E-T-C-H

Quality Products Since 1895

ANGIER PACIFIC CORPORATION
155 NEW MONTGOMERY ST. SAN FRANCISCO 2, CALIF. • 1224 SUNSET BOULEVARD LOS ANGELES 46, CALIF.

A complete line of Angier products available from your building material dealer

IN THE NEWS

APARTMENTS

The Metropolitan Life Insurance Company is planning on building a group of 11 apartment house buildings in Park Merced, San Francisco, at an estimated cost of \$30,000,000.

According to Leonard Schultze, Architect, the project will represent some 1,716 individual apartments in eleven 13-story buildings of reinforced concrete and steel construction.

The work is to be started immediately following approval of certain contemplated changes in the building code of San Francisco.

ARCHITECT SELECTED. Herbert E. Goodpastor & Wm. C. Hayes, Sacramento, Architects have been selected for the group of dormitory buildings to be built on the U. of C. campus at Davis at a cost of \$1,000,000.

SCHOOL CONTRACT awarded to B. & R. Construction Company of San Francisco, for the construction of a new grammar school at Napa, California. Cost \$161,847. Robert Stanton is the architect.

BOTTLING PLANT. The W. C. Tait Company, San Francisco, has been awarded a \$100,000 contract for the construction of a Seven-Up Bottling Co. plant in San Francisco.

RESIDENCE. Hyman, Appleton & Wolford, San Francisco, Architects, have awarded a contract to Jacks & Irvine (San Francisco) for the construction of a \$47,835 home for a client.

MUSEUM ADDITION. Shepherd & Green, Stockton, have been awarded a \$168,249 contract for additions to the Stockton Museum and Art Gallery.

SCHOOL CONTRACT AWARDED. The Litchfield Construction Company, San Rafael (California) has been awarded a \$174,894 contract for the construction of a new grammar school building in Santa Rosa. J. Clarence Felciano is the architect.

SPORTS AUDITORIUM. Architect W. D. Pugh, San Francisco, is working on a new \$1,000,000 sports auditorium for the Winterland Corporation of San Francisco.

HERRICK IRON WORKS

STRUCTURAL STEEL REINFORCING STEEL

1878 AND CAMPBELL STS. OAKLAND, CALIF. Phone 6Lencourt 1-1767

Phone 6Arfield 1-1164

Thomas B. Hunter
DESIGNER OF HEATING AIR CONDITIONING VENTILATING AND WIRING SYSTEMS, MECHANICAL AND ELECTRICAL EQUIPMENT OF BUILDINGS

★

41 SUTTER STREET ROOM 710
San Francisco California

Scott Company
HEATING - - PLUMBING - - TILE

★

243 MINNA STREET
SAN FRANCISCO
Phone EXbrook 2-6741

DINWIDDIE CONSTRUCTION COMPANY

•

BUILDERS

•

CROCKER BUILDING
SAN FRANCISCO

Subscribe Now —

ARCHITECT and ENGINEER

\$3.00 Per Year

THE TORMEY COMPANY
GENERAL PAINTERS AND DECORATORS

Phone UNderhill 1-1913

563 FULTON STREET, San Francisco

Fine
ENGRAVINGS

POOR RICHARD
PHOTO ENGRAVING CO.
220-224 COMMERCIAL STREET
SAN FRANCISCO 13

MULLEN MFG. COMPANY

BANK, STORE AND OFFICE
FIXTURES—CABINET WORK
OF GUARANTEED QUALITY
CHURCH SEATING

Office and Factory
40-80 RAUSCH ST., Bet. 7th and 8th Sts.
San Francisco
Telephone UNderhill 1-5815

PITTSBURGH TESTING LABORATORY

ENGINEERS AND CHEMISTS

Testing and Inspection of Concrete,
Steel and Other Structural Materials

Design of Concrete Mixes

Offices in all principal cities

651 Howard St., San Francisco 5
EXbrook 2-1747

Mattock Construction Company

Builders



604 MISSION STREET
SAN FRANCISCO

INDEPENDENT IRON WORKS

Steel Buildings
Service Stations
Steel Storage Tanks
Fabricated Plate Work
Steel & Sheet Metal Products
Fabricated Structural Steel
Steel Distributors

Eighth & Pine Sts. Oakland, 7

Index to Advertisers

ANGIER Pacific Corp.	40
ARCHITECTS Reports	40
BASALT Rock Company, .. . Back Cover	
BAXTER and Company, J. H.	36
CLASSIFIED Advertising	43
CLINTON Construction Company	44
CONTINENTAL Water Heater Co.	39
DETROIT Steel Products Co.	5
DINWIDDIE Construction Co.	47
DUFFY TILE Co.	48
FORDERER Cornice Works	40
FOX Tile Co.	38
FULLER, W. P. Co.	2
GLADDING, McBean & Co.	9
GUNN, Carle & Company	43
HANKS, Inc., Abbott A.	48
HAWS Drinking Faucet Company	34
HERRICK Iron Works	47
HOGAN Lumber Company	44
HUNT, Robert W., Company	48
HUNTER, Thos. B.	47
INDEPENDENT Iron Works	48
JOHNSON, S. T., Co.	32
JUDSON, Pacific-Murphy Corp.	40
KRAFTILE Company	31
MARBLE Institute of America	1
MATTOCK, A. F., Co.	48
MICHEL & Pfeffer Iron Works	
Inside Front Cover	
MULLEN Mfg. Co.	48
MUELLER Brass Co.	*
NORTHERN California Electric Bureau	35
PACIFIC Coast Gas Association	10
PACIFIC Manufacturing Company	45
PACIFIC Portland Cement Company	7
PACIFIC Telephone & Telegraph Co.	33
PADDOCK Engineering So.	32
PITTSBURGH Testing Laboratory	48
POOR RICHARD Engraving Co.	47
REMILLARD-Dandini Co.	48
REPUBLIC Steel Corporation	45
SANTA Maria Inn	44
SCOTT Co.	47
SIMONDS Machinery Company	45
SIMPSON Logging Co.	6
SISKRAFT Company	44
SMOOT-Holman Co.	37
SOULE Steel Co.	*
STANLEY Works, The	38
SUPERIOR Fireplace Company	*
TAYLOR Co., Halsey W.	*
TORMEY Company, The	47
U. S. BONDS	Inside Back Cover
VERMONT Marble Company	45
WESTIX Company	*
WESTERN Asbestos Co.	*
WESTERN-Holly Stove Co.	8
WOOD, E. K., Lumber Company	36

*Indicates Alternate Months

ABBOT A. HANKS, INC. Engineers & Chemists

INSPECTING — TESTING — CONSULTING
CONCRETE • STEEL • MATERIALS
CHEMICAL AND TESTING
LABORATORIES
• RESEARCH AND INVESTIGATION •

TESTS OF STRUCTURAL MATERIALS
DESIGN OF CONCRETE MIXES
SHOP AND ERECTION INSPECTION OF
STRUCTURES AND EQUIPMENT
INVESTIGATION OF STRUCTURES
AND MATERIALS
TESTS AND INVESTIGATION OF
FOUNDATION SOILS
FIRE RESISTANCE AND INSULATION
TESTS

624 Sacramento Street, San Francisco

Robert W. Hunt Company

ENGINEERS

Inspection - Tests - Consultation
Schools and Other Structures
Are Built as Designed

*When Construction Materials are
Inspected at point of Manufacture
and during Erection by*

ROBERT W. HUNT COMPANY

*Cement, Concrete, Chemical, Metallurgical,
X-Ray and Physical Laboratories*

Chicago - New York - Pittsburgh
Los Angeles - All Large Cities
San Francisco, 251 Kearny Street

REMILLARD-DANDINI Co.

Brick and
Masonry Products



400 MONTGOMERY STREET
SAN FRANCISCO, CALIF.

DUFFY TILE CO.

TILE CONTRACTORS
SHOWER DOORS
TUB ENCLOSURES

INSTALLATIONS
OF EVERY
DESCRIPTION
Modernizing, Repairing
"Not How Cheap
But How Good"
253 MINNA
YUkon 6-1489



ARCHITECT AND ENGINEER

CHINATOWN RE-DEVELOPMENT

U. C. School of Architecture

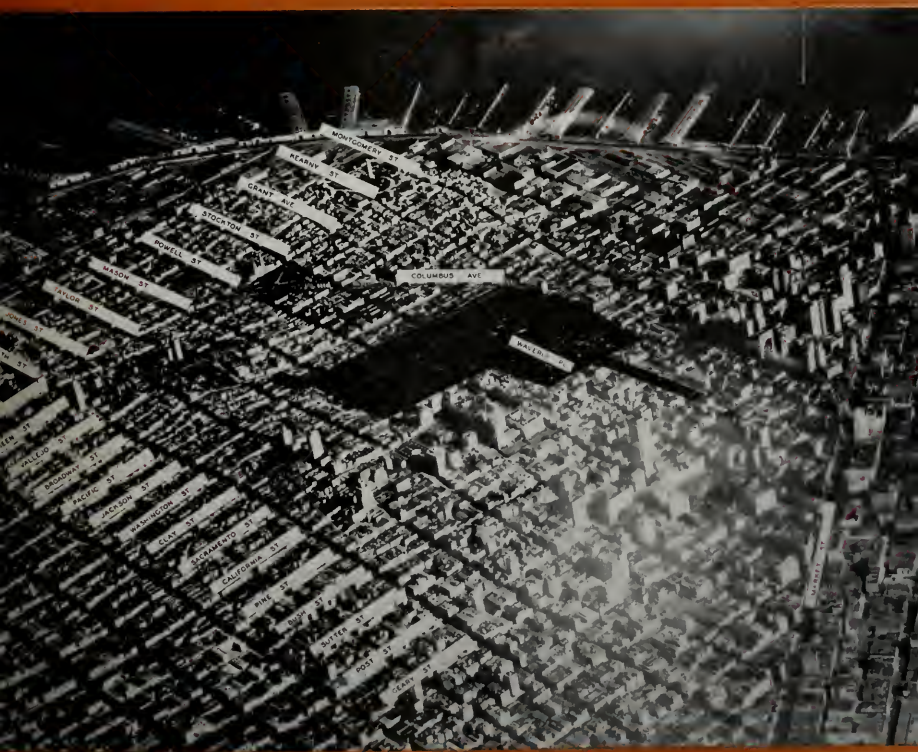

San Francisco, California

JUNE

1948

QUICK DELIVERY FROM STOCK PARTS

Spiral STAIRS



... occupy minimum area ... sizes from 4- to 8-foot diameters. Welded steel construction with heavy pipe columns and railings assure adequate strength, while non-skid checkered steel treads provide safety. ARISTON *Spiral* STAIRS are easily erected in new or existing buildings by your workmen or our mechanics. Write or phone for complete information.



Michel & Pfeffer Iron Works, Inc.

KENNETH OPIE, *Manager Misc. and Ornamental Division*

Tenth and Harrison Streets, San Francisco 3, California
Telephone MARKET 1-5966

ARCHITECT

Vol. 173 No. 3

AND

ENGINEER

ARCHITECTS' REPORTS—Published Daily

E. H. WILDER

Editor

MARK DANIELS, A.I.A.

Associate Editor

PROF. LELAND VAUGHAN

Landscape Architecture

JOHN A. BLUME

Structural Engineering

MICHAEL GOODMAN

Planning

JOHN S. BOLLES, A.I.A.

Book Reviews



COVER PICTURE:

Prof. Michael Goodman and Prof. Howard Moise of the School of Architecture, University of California, Berkeley, present on Page 19 the proposed Remodeling of Waverly Place in San Francisco's Chinatown. The cover illustration is an airplane view of San Francisco, with the dark area indicating the project.

Contents for

JUNE

EDITORIAL NOTES	4
NEWS & COMMENT ON ART	9
PAINTING TOWARD ARCHITECTURE	10
ARCHITECTS and LANDSCAPE ARCHITECTS COLLABORATE IN DESIGN OF EXHIBIT FOR California Spring Garden Show	14
SPECIALIZED SCHOOL CONSTRUCTION IN GREAT BRITAIN By Joan Littlefield	17
CHINATOWN RE-DEVELOPMENT, Direction of Prof. Michael Goodman and Prof. Howard Moise, Univ. of Calif.	19
NATIONAL TEACHER' SCHOOLS, Mexico City, Mexico	26
HOUSE for Mr. & Mrs. Wm. H. Burgess, Pasadena, California By Elmer Grey, A.I.A., Architect	28
MODERN MEDICAL CENTER, Tacoma, Washington By A. R. MacPherson	30
A. I. A. ACTIVITIES	33
WITH THE ENGINEERS	34
HEADLINE NEWS & VIEWS By E. H. W.	38
IN THE NEWS	39, 41, 45, 48, 49
LANDSCAPE ARCHITECTURE, Notes of the Profession	40
ESTIMATOR'S GUIDE, Building and Construction Materials	43
BUILDING TRADES WAGE SCALES, Northern & Central California	45
CLASSIFIED ADVERTISING	45
BOOK REVIEWS, Pamphlets and Catalogues	47
INDEX TO ADVERTISERS	50

ARCHITECT AND ENGINEER (Established 1905) is published on the 15th of the month by The Architect and Engineer, Inc., 68 Post St., San Francisco 4; Telephone EXbrook 2-7182. President, K. P. Kierulff; Vice-President and Manager, L. B. Penhorwood; Treasurer, E. N. Kierulff.

Los Angeles Office: Wentworth F. Green, 6605 Hollywood Blvd., Los Angeles 28. Telephone HEmpstead 3171.

Entered as second class matter, November 2, 1905, at the Post Office in San Francisco, California, under the Act of March 3, 1879. Subscriptions United States and Pan America, \$3.00 a year; \$5.00 two years; foreign countries \$5.00 a year; single copy 50c. ARCHITECTS' REPORTS are published daily from this office, Vernon S. Yallop, Manager. Telephone DOuglas 2-8311.



EDITORIAL NOTES

KEEPING the nation's homes in repair is one of the construction industry's biggest jobs with expenditures for 1948 estimated to run between \$2,600,000,000 and \$3,300,000,000. It is estimated one third of the homes will be painted, either inside or out, eight percent will be re-roofed, ten percent will have new heating equipment or old equipment overhauled, and about ten percent will have plumbing changes.

BERNARD Maybeck, internationally famous San Francisco Bay Area architect who is affectionately known to practically every Architect and most generally referred to by members of the architectural profession as "the grandfather of the California style of architecture," was recently accorded outstanding recognition through a featured article in LIFE magazine.

While much of the magazine material reflected the idealistic thinking of the author, the fact remains that the constructive influences of Bernard Maybeck's life in San Francisco and Oakland, and Berkeley, will long be felt and enjoyed by those whose privilege it is to live in a Maybeck designed home, to worship in a Maybeck designed church, to conduct business from a Maybeck designed commercial building, or just look at and enjoy the Palace of Fine Arts building in San Francisco.

IN considering the great importance of home construction it might be well to give a thought to the average home owner's financial ability, in that the purchase of a home, or the building of a new home, is in most instances a major financing project and frequently represents one of the largest single expenditures to be made from the family budget.

The ability to maintain a satisfactory financial solvency in home ownership is in the majority of cases contingent upon the opportunity of the individual to secure uninterrupted employment on an economic basis which permits the purchase of normal living essentials. Few of the large number of home owners are fortunate enough to be able to obtain home ownership other than from income derived from everyday earnings.

Failure to maintain financial solvency, whether it be from periods of unemployment, or illness, or any other cause, is in a great many instances a home catastrophe from which the normal family life frequently fails to rally. Many family break-ups can be traced to financial crack-ups.

Home ownership is, however, a good investment. Aside from the feeling of security that goes with a safe home ownership contract, there is some degree of satisfaction as an investment. Particularly at this time when great national and international life insurance companies are investing heavily in home development.

The fact that insurance companies are investing as much as \$2,000,000 of "customer" funds in individual residential construction projects in certain metropolitan areas is some reassurance that an investment in a home under today's conditions is fundamentally a sound project . . . sound from the standpoint of everyday living, sound from the standpoint of financing, and sound from the standpoint of a good investment.

Keeping pace with today's trends in home ownership is professional architectural assistance in home design and planning. Planning a home goes considerably further than arriving at the conclusion to own a home; it includes a multitude of modern conveniences which add to the enjoyment of living; modern methods of construction; uses of new as well as old materials, and many other factors familiar to the Architect, and are thereby readily available.

REPORTS indicate the building boom is on its course. Official sources report in the first quarter of this year more than 164,000 new units were started, a gain of some 15 per cent over the similar period of 1947. At this rate there will be in excess of 950,000 privately financed homes built throughout the nation this year and that will establish a new a time high.

In 1925 there were 937,000 homes built in the United States and for twenty-three years that figure has not been exceeded.

This year's home construction schedule could easily establish a new record, but a lot will depend on the labor market, the price of building material, the availability of materials, and the builders' ability to finance the construction.

THE NUMBER of patents issued during 1947 was the smallest since 1888. Officials report the decrease is due to new policies of the U. S. Patent Office which require inventors to make exceedingly detailed enclosures. Such disclosures entail a great deal of work in chemical cases that few can afford to do. As a result secret practice inventions have become more prevalent in preference to patenting.



HOW YOU CAN

Cut the cost of daylight and fresh air

You know the importance of abundant daylight and controlled fresh air in keeping students alert and cheerful. You probably recognize window walls as the mark of an up-to-date school.

But have you considered the economy in creating window walls by combining *standard* window units?

Fenestra* Fenecraft Steel Windows make it easy to get large window areas at low cost. Their standardization results in low first cost and simplified installation. Co-ordination of window dimensions with those of other wall materials minimizes installation costs. Even glass sizes are planned for inexpensive replacement.

Control of fresh air is an important benefit of Fenecraft Projected Windows. Open-out vents

form canopies over openings. Open-in vents deflect incoming air upward, shed rain to the outside. You get good ventilation whatever the weather. And the sill vent guards against the dangerous pastime of leaning out of windows.

All three types of Fenecraft Windows—Projected, Casement and Combination—are designed to beautify both the inside and outside of the building. They offer permanently-easy operation . . . weather-tightness . . . safer cleaning . . . firesafety . . . low maintenance. You can be confident of the high quality of Fenecraft Windows, for they are made by skilled craftsmen in the shops of America's oldest and largest steel window manufacturer. For full information, including types and sizes, mail the coupon. *®



FENCRAFT COMBINATION WINDOW—generous fresh-air ventilation. Swing leaves deflect breezes into the room. In-tilting sill vent protects against drafts. Both sides easily and safely washed from inside.



FENCRAFT CASEMENT WINDOW—safe washing on outside, from inside. Easy to operate. Interchangeable inside screens, protected from outside dirt.



FENCRAFT INTERMEDIATE STEEL WINDOWS

Detroit Steel Products Company,
Dept. AE-5,
1310, 63rd St.,
Emeryville 8, Oakland, California.

Please send me data on types and sizes of the new Fenecraft family of Fenestra Windows.

Name

Company

Address

Now! ... For the first time you can

SPECIFY 60%

A MINIMUM OF

SOUND ABSORPTION

without increasing costs!

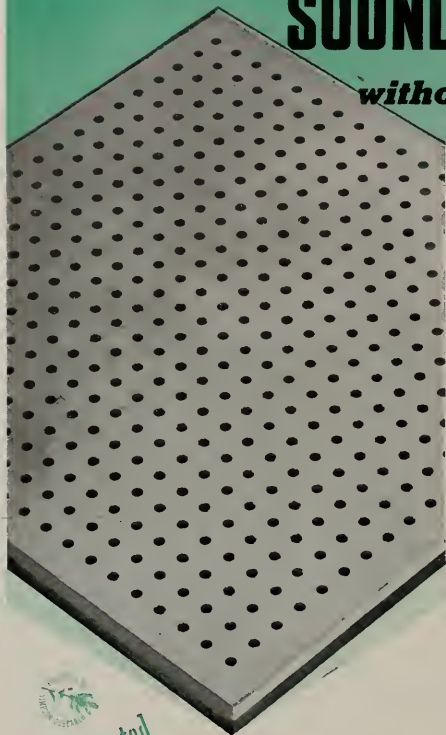

● A material having a noise reduction coefficient of .60 is the minimum ceiling treatment necessary to quiet effectively, the average office, bank, restaurant, schoolroom, corridor or other rooms of normal dimensions. Experience with actual installations and the scientific analysis of hundreds of noise quieting problems both bear out this statement. Now, for the first time, this high sound absorption value is available in 1/2" perforated material installed on a solid backing. Tests accepted by the Acoustical Materials Association show that the new Simpson Acoustical Tile has the highest noise reduction coefficients of all drilled fiber acoustical materials in the most widely used thicknesses and types of mountings. Of course, the 1/2" Simpson Acoustical Tile costs less than thicker materials. You help reduce building costs and at the same time give your client an efficient job when you specify 60%.

Simpson
QUALITY SINCE 1855

ACOUSTICAL TILE

With Exclusive **HOLLOKORE**
Drilled Perforations

WOODFIBER DIVISION, SIMPSON LOGGING CO., Shelton, Washington
Sales Division SIMPSON INDUSTRIES, 1010 White Bldg., Seattle, Washington

Discuss this New Acoustical Tile with your nearest Simpson Acoustical Contractor.

ACOUSTICS NORTHWEST
Builders Exchange Bldg.
Portland 4, Ore.
Phone: Atwater 5443

ANGELES INDUSTRIES
984 McGarry St.
Los Angeles, Calif.
Phone: Trinity 3121

APPLICATION SERVICE CO.
420 Continental Oil Bldg.
Denver 2, Colorado.
Phone: Alpine 4662

ASBESTOS PRODUCTS COMPANY
1780 Kettner Blvd., San Diego, Calif.
Phone: Franklin 7665

M. H. BALDWIN
2804 East Hawthorne
Tucson, Arizona. Phone: 2804-J

CONSOLIDATED ROOFING &
SUPPLY CO.
520 S. 7th Ave.
Phoenix, Arizona. Phone: 47888

CONTINENTAL LUMBER CO.
P. O. Box 2042
Boise, Idaho. Phone: 450

CRAIG & PULLEN
338 Ward St.
Honolulu, T. H. Phone: 6107

CRAMER COMPANY
345 Vermont St.
San Francisco, California
Phone: Market 1-0411

CRAMER COMPANY
1933 Merced St.
Fresno, Calif. Phone: 3-1131

DALE TILE CO.
1020 LaSalle Ave.
Minneapolis 2, Minn. Phone: Br. 8831

ELLIOTT BAY LUMBER COMPANY
600 W. Spokane St.
Seattle, Wash. Elliott 8081

LUMBER DEALERS, INC.
423 N. 33rd
Billings, Montana. Phone: 5-1111

JAANSUR MATERIALS, INC.
E-210 Riverside Ave.
Spokane, Wash. MAin 124
UTAH PIONEER CORPORATION
333 W. 1st South
Salt Lake City 14, Utah
Phone: 4-1717

decay
termite
protected
with
PENTACHLOROPHENOL

ECONOMY ... one of
the advantages that makes
Ceramic Veneer the preferred
facing material in the West!



CERAMIC VENEER is Gladding, McBean & Co.'s modern, machine-perfected terra cotta. It is the exterior facing material used on the majority of the larger buildings in the principal Pacific Coast cities ... *and for many reasons!* Take economy, for example. The Marin Dairymen's Milk Co., Ltd., building in San Francisco (*which is illustrated above*) had to provide sanitation with utmost economy right from low first cost through to minimized maintenance. Architect Harry Thomsen, Jr., achieved everything desired by specifying Anchored Type Ceramic Veneer.

For technical data, photographs of installations and suggested specifications for all three types of Ceramic Veneer ... Anchored, Adhesion and Handmade ... send coupon for free catalog.



GLADDING, McBEAN & CO.

CERAMIC VENEER

The modern, machine-perfected terra cotta

OFFICES AT: LOS ANGELES • SAN FRANCISCO • SEATTLE

GLADDING, McBEAN & Co., Dept. 26
2901 Los Feliz Blvd., Los Angeles 26, Calif.
or 1275 Harrison St., San Francisco 3, Calif.

Please send me your free 32-page Ceramic Veneer Catalog.

Name
Address
City State

NOW AVAILABLE...THE

Western-Holly



"Californian" for Immediate Delivery!

MAXIMUM UTILITY
MINIMUM SIZE

Compare these Features

1. *Tempa-Plates*—Afford new cleanliness, beauty and efficiency.
2. *Four Large, High-Speed Burners*, Designed for easy cleaning—Automatic pilot lighting.
3. *Highly Polished*—Heat-reflecting Burner Saucers.
4. *One-Piece Oven Construction*, rounded corners, porcelain enameled—easily cleaned.
5. *Oven Temperature Control*—Exact, even, dependable heat regulation.
6. *High-Speed Broiler*—Roller Bearings—Glides out smoothly, drop front.
7. *ALL WHITE*—Porcelain Enamel Finish, fused on steel—As Washable as Fine China.

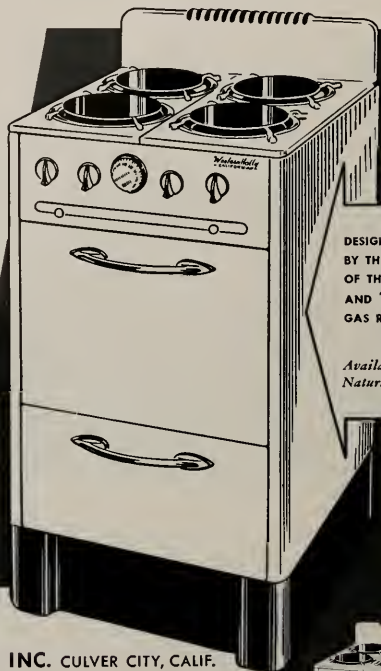

DESIGNED AND PRODUCED
BY THE MANUFACTURERS
OF THE *Continental*
AND *Town and Country*
GAS RANGES

* * *

Available For Manufacture
Natural, or L.P. Bottled Gas

phone direct to

WESTERN STOVE COMPANY, INC. CULVER CITY, CALIF.

TEXAS 02901

© 1948, Western Stove Company, Inc., Culver City, Calif.

Western-Holly

CALIFORNIAN
GAS RANGE

COMPACT QUALITY

FOR COMPACT LIVING

THE MARK OF EXCELLENCE

SPECIFICATIONS

Width—20 inches
Height—36 inches
Floor Space—20 by 23
inches
Oven—16 inches wide



Note—Generous Sized Oven and Broiler

WESTERN STOVE COMPANY, INC., CULVER CITY, CALIFORNIA, BRANCH OFFICES: SAN FRANCISCO AND BOSTON

ARCHITECT AND ENGINEER

NEWS AND COMMENT ON ART

WESTERN ARTISTS EXHIBITION

The Denver Art Museum announces the 54th Annual Exhibition for Western Artists, to be held at the Cappell House Galleries from July 1 to August 31. The annual is open to all western artists and the fields of competition include painting, drawing, print making, sculpture and ceramics.

ART LEAGUE OF CALIFORNIA

Two exhibitions of particular interest to San Francisco Bay Area artists will be on display at

the Art League of California, San Francisco, until June 30th.

One is the Commercial Art in San Francisco exhibit comprising work of advertising agencies, retail stores, and outdoor advertising firms. The work includes black and white illustrations for newspaper advertising, hand lettering, and full color design for greeting cards and wrapping paper, and illustrations for billboards, magazine and transit advertising. Development of ideas from layout to final product is shown.

The other exhibit is Nicholas Dunphy's California and is a group of etchings showing various places of popular interest throughout California.

SAN FRANCISCO MUSEUM OF ART

A memorial exhibition of the work of Marion Cunningham will be held at the Museum from June 29 to July 18.

The exhibition of wallpapers by James Kemble Mills, shown at the Museum last fall, will go on circuit in May. The exhibition consists of designs done by seventeen California artists. The Colorado Springs Fine Arts Center will have the show the month of May; the City Art Museum of St. Louis will have it in July; Akron, Ohio, will exhibit it in August, and Kansas City in October.

New Members. Following are new members of the San Francisco Art Association: Foster Jewell, Walter E. Kuhlman, Frank Lobdell, John P. Hultberg, and Charles W. Ward. Artist members include Irene Edwards, and Belle Hillman, associate artist Mrs. Roger Kent, Osgood Hooker and James Tomlinson, lay members.

(See page 35)

KING DRAGON:

This masterpiece of ink-pointing by the famous dragon painter of the Sung Dynasty (1142 A. D.) Chan Sar Yang. Size of Scroll 10 feet 6 inches by 3 feet 4 inches.

From the Masterpieces of Chinese Paintings. Collection of Chan Peng Yin, F.R.S.A. (London, England). Now on exhibit at the De Young Memorial Museum.

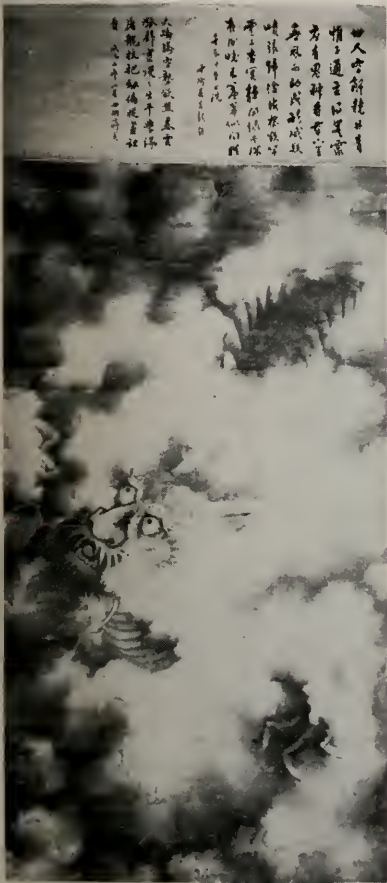

川團十郎
元上松銀

五段亭
國貞五
繪



KUNISADA
JAPANESE ACTOR
1805
Color Woodcut

PAINTING TOWARD ARCHITECTURE

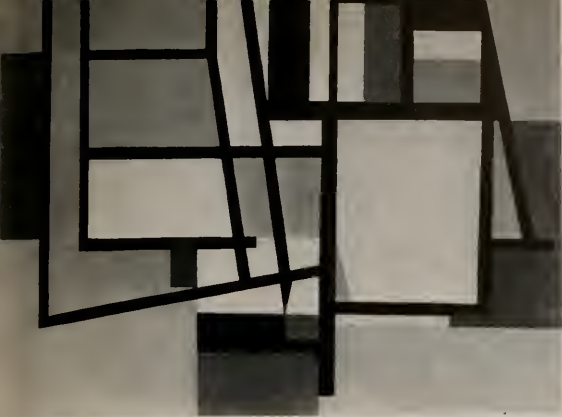

ILYA BOLOTOWSKI

**PERPENDICULARS
AND DIAGONALS**

1945

Oil on Canvas

CHARLES SHEELER

**ON A THEME OF
FARM BUILDINGS**

1947

Tempera

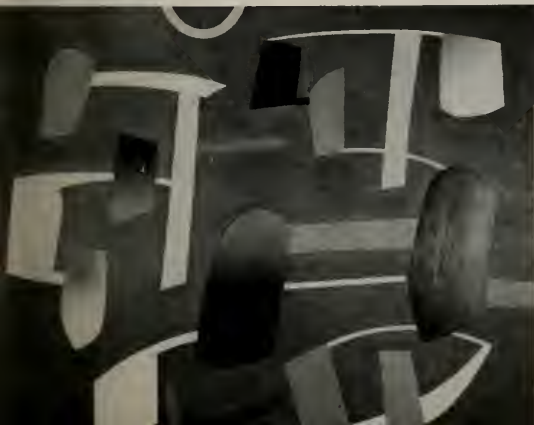

JEAN HELION

COMPOSITION

1934

Oil on Canvas

*All Photo's by
"The Miller Company"*

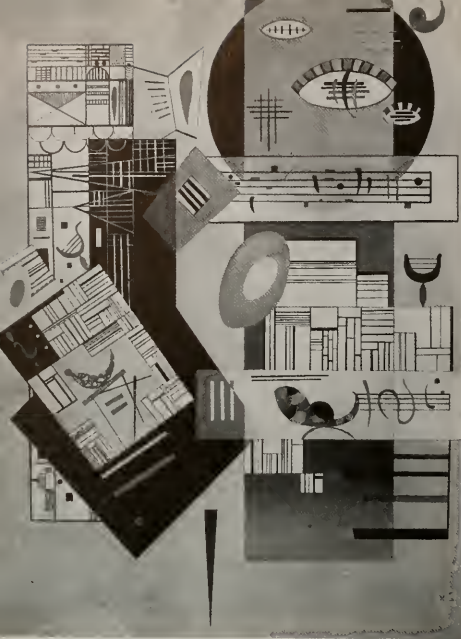

VASILY KANDINSKY

ANIMATED STABILITY 1935

Oil on Canvas

"Painting Toward Architecture," a unique collection of abstract art sponsored by the Miller Company of Meriden, Connecticut, brings to the California Palace of the Legion of Honor a July exhibition of incalculable value to architects, artists, students, and all others interested in structure and design.

Some 40 paintings and sculptures are included in the collection, which makes its Pacific Coast bow in San Francisco on a nation-wide tour that will cover 36 cities in a period of three years.

Although other business and industrial concerns have launched art exhibitions such as the Abbott Collection of Naval Aviation Paintings at the California Palace of the Legion of Honor a few years ago, the Miller Company is pioneering a highly practical effort to show the relationship between fine arts and industry. The abstract, which still puzzles many people, becomes wholly logical and comprehensible when translated into architecture or industrial design—and even typography or advertising layout.

Unlike some firms who have sought to exploit the publicity value of art, the Miller Company's interest is immediately related to its business of manufacturing lighting fixtures. The Company was founded in 1844, when Edward Miller produced a brass whale-oil lamp, and its history parallels the evolution of lighting. With the advent of the fluorescent tube, the Miller Company began to consider lighting—not as a "fixture" or accessory

JUAN GRIS

STILL LIFE WITH PEARS

1913

Oil on Canvas



ARCHITECT AND ENGINEER

—but as an integral part of ceilings and the architectural plan as a whole. Miller engineers, collaborating with architects, now hope to stimulate new ideas by means of abstract painting and sculpture where principles of design, disposition of mass and volume, and arrangements of shapes and colors can be utilized without structural limitations.

The original idea for the current exhibition was contributed by Mrs. Burton G. Tremaine, Jr., art director of the firm, and wife of its present president, who succeeded the founder's son in 1934. In the latter part of 1943, shortly before their marriage, Mr. Tremaine asked his future wife how the new concept of lighting, under the descriptive name "Ceilings Unlimited", could be translated to the nation's industrial architects. She immediately suggested the connection between painting and architectural design and the plan of the Miller Collection was conceived. She mentioned Mondrian and other Dutch "neo-plasticists," as well as Russian constructivists, and explained how their work in pure design had influenced typography, linoleum, and the architecture of such men as Le Corbusier in France, Oud in Holland, and Gropius and Mies van der Rohe in Germany. Soon after, Mrs. Tremaine was made art director of the Company and began assembling examples of abstract painting.

The collection has grown to the present showing of 41 paintings and eight pieces of sculpture, ranging from rigid geometry to provocative calligraphy. Its significance, stated *Art News*, "lies not only in the art itself, but also in the spirit with which it was bought and the uses to which it has been put. The Tremaines have made abstract and non-objective art intelligible in terms of application. They have seen its coherent design, the relations of its colors, and its experiments with new materials not as ends in themselves, but as starting points for ultimate translation into the most widely seen and understood (and the most living) twentieth-century art forms—architecture and advertising layout. In that application they hope it will be approached and understood by many people who have heretofore dismissed it as anything from sheer mathematics to incomprehensible doodling."

Among the artists represented in the exhibition are Picasso, Braque, Gris, Legar, Klee, Kandisky, Arp, Miranda, Miro, Ozenfant, de Rivera, Mondrian and other leading figures of analytical cubism, neo-plasticism, purism and other schools of painting.

The collection had its premier exhibition during December of last year at Hartford's Wadsworth Atheneum. Bookings included Minneapolis, Akron, Baltimore and Milwaukee. The Pacific Coast tour, which begins with the current showing at the California Palace of the Legion of Honor, includes two other cities—Los Angeles in August and Portland in September.

In a lecture on the exhibition, Henry Russell Hitchcock, professor of art, Wesleyan University, and newly appointed to Smith College, analyzed modern painting as a source of architectural design. He showed the influence of Japanese prints



MODERN BUILDING INTERIOR Showing effects of "Painting Toward Architecture."

on the buildings of Frank Lloyd Wright, the painting of Ozenfant and the architecture of LeCorbusier, and the neo-plasticism of van Doesburg and Mondrian on the Dutch architect Oud. He predicted that the work of contemporary American artists would be similarly influential in helping solve problems of architectural design. He mentioned John Marin, Charles Sheeler and Georgia O'Keefe as painters who might be expected to stimulate new developments on design.

An illustrated catalog of the exhibition with an introduction by Professor Hitchcock has been published by the Miller Company.



ARCHITECTS and LANDSCAPE ARCHITECTS COLLABORATE IN DESIGN OF EXHIBIT for California Spring Garden Show

At the 16th annual California Spring Garden Show there was a prize-winning exhibit which portrayed to more than 100,000 people the benefits of careful planning for comfort and convenience in outdoor-indoor living. This exhibit was designed and installed by the East Bay Chapter of the American Institute of Architects and the Association of Landscape Architects, who were assisted by the East Bay Association of Architects and the Women's Architectural League. It was a truly collaborative effort, in which it was shown, that for good





living, house and garden are inseparable, and must be designed as one if the greatest efficiency and comfort is to be attained.

The exhibit consisted of a portion of a lanai separated from the garden only by glass for protection in inclement weather. Brick paving pattern and lines of the design carried through structure and garden. The outdoor area was simple in design, and attained a spacious feeling in keeping with the simplicity of the structure.

Visitors to the show were brought into the lanai, and thus given the opportunity to view the ensemble with the perspective of a resident rather than that of the envious outsider who peers at a house and garden from the street. The realization of this objective viewpoint was difficult in show design. The problem was effectively solved in the design of the structure, which gave inviting views of the interior while retaining the feeling of enclosure.

The various specialized skills of the Architect





and the Landscape Architect were blended and utilized to the fullest extent to produce an outstanding example of their work.

Responsibility for planning and installing the exhibit rested with Architects Keith Ponsford and Oscar Price of Oakland, and Landscape Architects Theodore Osmundson, Jr. and E. L. Anderson, also of Oakland. They were assisted by Lewis Koue, President of the East Bay Chapter of A.I.A., and Landscape Architects Ralph Jones of Alameda, and Vernon M. Dean of Berkeley, President of the Association of Landscape Architects. Valuable help in installing the exhibit was given by Ken-

neth Jenner, associated with Huetting & Schromm, Landscape Contractors. Others who assisted in an advisory capacity were Floyd Herbert Mick and Ned S. Rucker, members of the Association of Landscape Architects, and Chester Treichel and Paul Hammarberg of the East Bay Chapter of the A.I.A.

Nurseries and material supply and manufacturing companies helped in supplying all the various materials needed to make the exhibit.

The Architects and Landscape Architects of this region are most appreciative of the efforts of all these people.

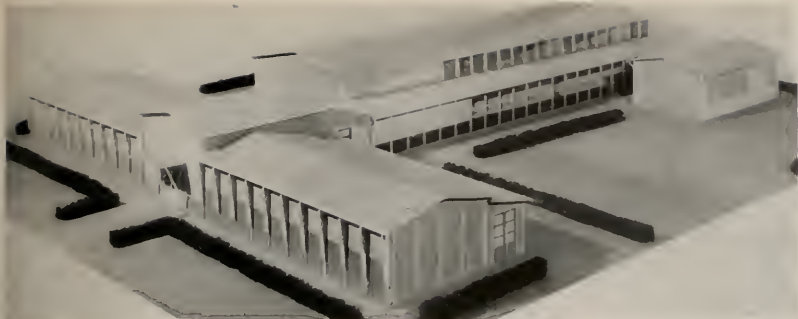

BRITISH INFORMATION SERVICE PHOTO'S

SPECIALIZED SCHOOL CONSTRUCTION IN GREAT BRITAIN

By **JOAN LITTLEFIELD**

The Bristol Aeroplane Company, one of the five aircraft firms mass-producing aluminum houses for the British Government, is now experimenting with aluminum unit construction for permanent school buildings. In collaboration with the Northern Aluminum Company of Banbury, Oxfordshire, the engineers and technicians of the Bristol organization have produced a number of full size components of a classroom. They aim to provide education authorities with a range of standard units which can be assembled in different ways to produce the buildings necessary for a modern school. This will enable a local education board to design a school of the size and type it desires, or merely to add aluminum units to an existing building.

One of the first of these schools is scheduled for erection next September. England's Ministry of Education is expected to purchase 25 aluminum schools this year.

Fully developed, the aluminum units can com-

prise a complete school building of two stories, including staff rooms and lavatory units. Buildings of wide span, such as assembly halls and gymnasias have not been included, since authorities may prefer to build these in traditional materials. But a hall with a span of up to fifty feet could be constructed without any fundamental alteration to the system.

The roof of the aluminum units is manufactured in 16'3", 24'3", 32'3" and 40'3" spans. It is formed of gauge aluminum sheet bonded to a layer of fiberboard and riveted in the factory to two light aluminum trusses at 4 ft. centers, to the underside of which is fixed the finished ceiling. This consists of insulating board overlaid with a glass silk quilt, to give good thermal and acoustic insulation. Alternatively, perforated sheet aluminum supporting a layer of glass can be used. This forms a complete four feet wide section of roof, incorporating, structural frame, weatherproof external skin, in-

ternal ceiling, and thermal and acoustic insulation.

The deep eaves of the roof, designed to reduce glare, are painted on the underside. An ingenious feature of the design is the reversal of the gutter—an aluminum extrusion to form a seating and connection between roof and wall panels.

The wall panels, though uniformly wide (4 feet), are 12'9" high for classrooms, 9'3" for lavatories and staff rooms, 8'3" for corridor walls, and 7'3" for cloakroom walls. They are so designed that the glass area can be varied vertically in wide ranges by the insertion of a solid panel. Thus a wall panel may have no windows, or else be entirely glazed.

The side rails of the wall panels are bolted together, thus forming the structure frame of the building and the subframe to the windows. The panels are bolted at the base to the template rail and at the top, by means of a special section, to the roof. Wind loading is taken up in the panels between corridor and classrooms, and also by

triangular bracing diaphragms attached to the external panels.

End walls are formed from corrugated sheeting in framed panels filled with glass wool, but as the structural frame is complete at this point, orthodox materials, such as brick, could be used. The wall panelling separating corridor from classrooms incorporates locker units.

To erect a single-story school building, aluminum templates are bolted to an in situ base and the wall chassis up-ended. These are braced into position until one gable or cross wall is inserted, when the roof can be added. Roof units are light enough to be handled without the use of cranes and can be guided into position by two men with suitable tackle.

The Company state that an aluminum school can be delivered at the site within eight weeks of receipt of an order. A spokesman, speaking at a recent exhibition for education authorities and architects, said that a school for 480 pupils to be erected on a prepared site would cost about £28,000 (\$112,000), excluding lighting and heating.

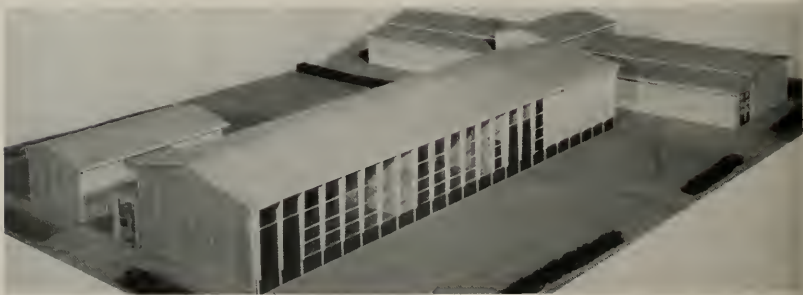

Experiments in the building of prefabricated aluminum schools are being made by one of five British aircraft manufacturers. The units make a complete two story school building, or may be used as an addition to existing facilities.



Chinatown Redevelopment

SAN FRANCISCO

PROF. MICHAEL GOODMAN and PROF. HOWARD MOISE

THE PROBLEM

San Francisco is a City of hills and of beautiful views which its existing street pattern has disre-

garded. New or replotted streets should be adjusted to follow the contours and take advantage of the view.

It is a City which is confined by water barriers on the North, West, and East and by a county line on the South. It can grow therefore only by more intensive use of its limited area and this has resulted in land values which are the highest of any City in the country except New York.

Chinatown is a microcosm of the City, its land values are excessive and it too is confined within barriers. These are not physical but psychological, the barriers created by avarice and race prejudice; the inevitable result has been overcrowding of land, overcrowding of units and exorbitant rents for housing which is substandard in every way.

The problem is to replace this decayed housing with livable modern housing planned for convenience and amenity for sun, air, outlook, outdoor living, space, gardens, trees and safe play areas. This result must be achieved without destroying the picturesque assets of the existing Chinatown shopping area.

The study is not offered as a final solution of the problem but as a contribution to our limited experimental knowledge in the housing field with special reference to San Francisco.

THE PLAN

An eight block area containing almost no structures of permanent value and bounded by Broadway, Powell, Clay and Taylor streets has been selected as the most suitable for redevelopment. All existing structures would be razed and utilities adjusted to three new diagonal streets so related to the grades as to minimize site development costs.

The development comprises: (1) a central area containing two and three story buildings with walled gardens and integral garages, (2) eight skyscrapers type apartment buildings to increase population density and provide view apartments, (3) perimeter structures containing row houses and apartments, (4) two nursery school buildings and two play areas, (5) minimum neighborhood shopping facilities located at the northeast and southwest corners of the development, and (6) additional garages.

The new street pattern is designed to permit access while discouraging through traffic. Pedestrian traffic through the two long central blocks is provided for by three pedestrian ways which extend to Powell and to Taylor Streets.

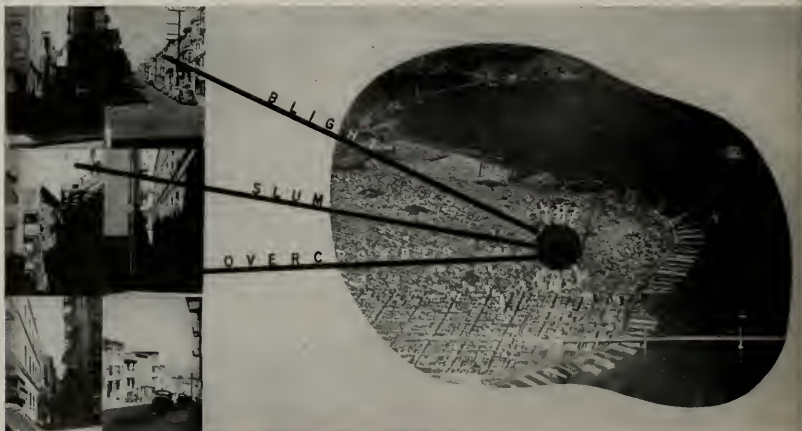

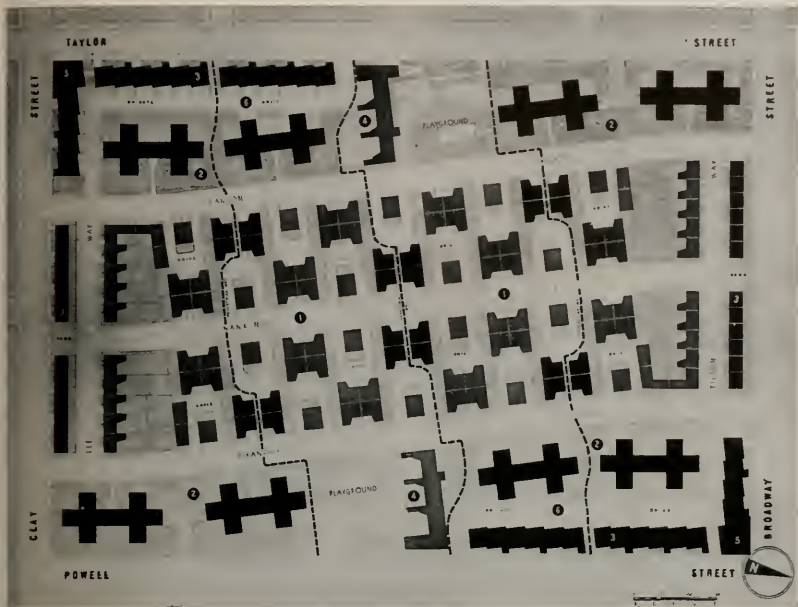

THE CENTRAL AREA

The clover leaf plan for the typical building with fireproof and soundproof party walls was adopted to achieve a maximum of sight and sound privacy on a minimum of land. The lot is 45' by 57'. Area consists of 2565 square feet, 17 families per acre, with ample outdoor living space and 44' between side windows.

The buildings which straddle the pedestrian ways have an additional story containing four studio type apartments. Placing entrances to these units in the passages will ensure adequate upkeep of the latter.

The pattern is varied by the introduction of two unit buildings and row houses with garages, and a few one story units. Every unit has garden and balcony.



THE SHOP FRONTS are to be re-designed to a maximum height of 20 feet. The story above this height may be incorporated in the remodeling design for similar occupancy. The present street is 41.3 ft. wide and 275 feet long.

Eight skyscraper type apartment buildings are included in the project to offset the low coverage in the central area. The height of these buildings as shown is such that the view from the upper four would not be obstructed by the lower four. These buildings might be higher to increase total density.

In all buildings garage space is provided in a basement and sub-basement. In addition to six penthouse apartments with private roof gardens. Common roof space is provided for the use of all tenants. Restaurants, and other facilities could be located in the lower stories.

PERIMETER BUILDINGS

Buildings on the perimeter streets are developed as view apartments (c) and (d) and as row houses (e). Space for the neighborhood stores is provided at the corner of Clay and Taylor streets and at the corner of Broadway and Powell streets. Garage space has been developed under the (c) and (d)

type apartments. Row houses have integral garages.

SCHOOLS AND PLAY AREAS

An existing primary school close at hand makes the provision of a primary school within the project area unnecessary. Two playgrounds are provided, their total area comprising 10% of the ground area of the project. Small green spaces at each end of the Nanking Road provide outdoor sitting space for adults as well as views into the project. Two nursery schools provide day care for 180 children.

Chinatown is one of the most congested districts in any large city in the United States not excepting New York and Chicago. It houses an estimated population of 20,000 people in an area of some twenty blocks. Nearly all those under forty are American citizens. The rapidly changing family pattern will soon be totally Americanized.

Chinatown is preponderantly a slum unfit for

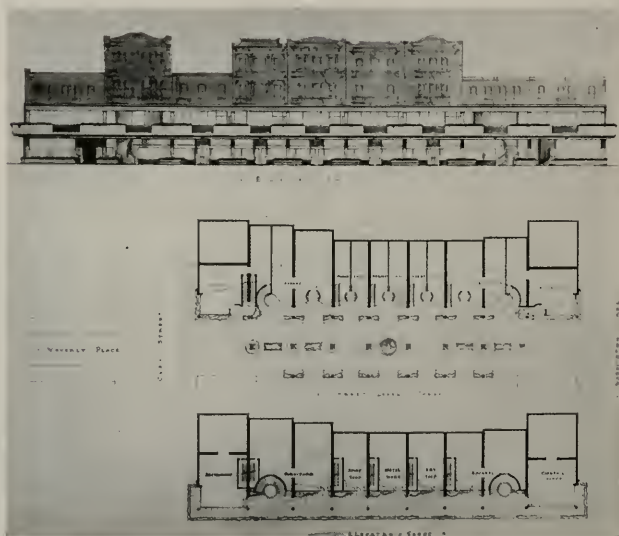

human habitation. Photographs record the narrow dark alleys with their corollary of sunless, windowless rooms and the dreary rows of outmoded wooden, yardless houses .

On the maps of the San Francisco real property survey of 1939, Chinatown stands out as the blackest part of the city in every aspect of bad housing. Here population density, overcrowding, lack of sanitary facilities, percentage of converted structures, and of structures of substandard status are highest. Here also the percentage of owner occupancy is lowest.

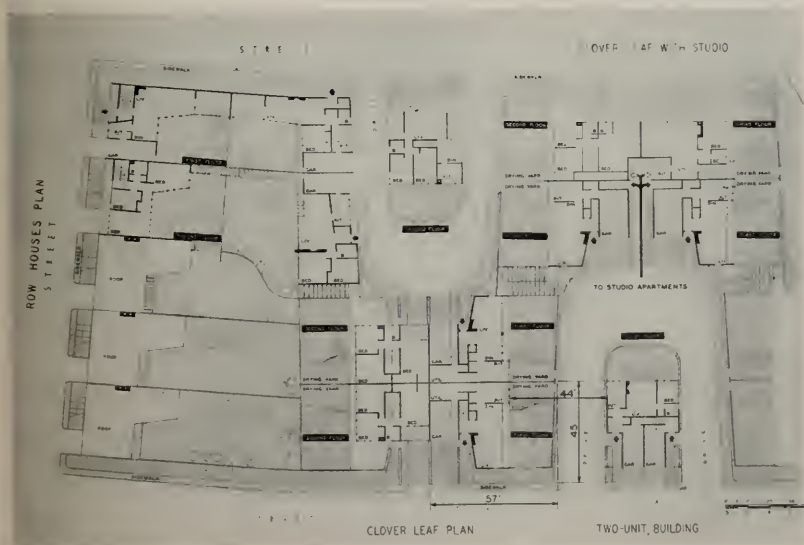
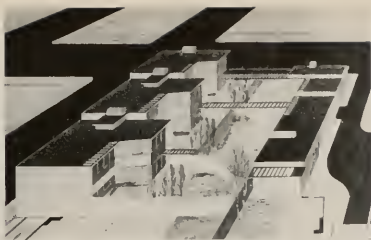



FRONT ELEVATION

APARTMENT **A · B**

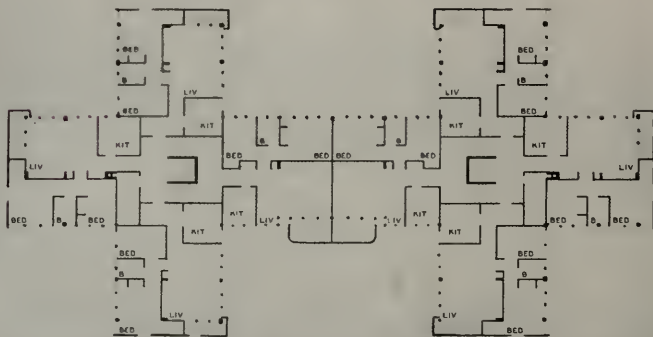

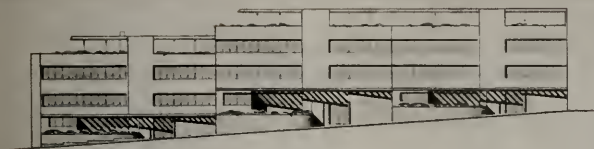

ELEVATION
ON TAYLOR STREET



TYPICAL FLOOR PLAN
APARTMENT

D

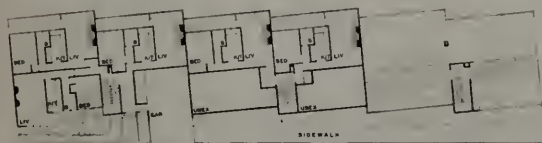

FIRST FLOOR

BASEMENT

TOP FLOOR

TAYLOR STREET

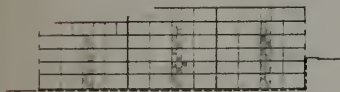

SECTION -1-1



SECTION -2-2



5 - A L E



DESIGNED BY MARIO PANI, Architect

NATIONAL TEACHERS' SCHOOLS MEXICO CITY

Many American educators with inadequate plant facilities are looking with "envy" at new scholastic buildings in Mexico City that will better serve the basic function of supplying well-lighted, versatile study and lecture areas. New developments in design, materials, heating, and lighting in many respects have outmoded the "traditional" educational building.

Mexico City's National Teachers' Schools have proved what can be done with modern construction methods and ideas adapted to today's educational requirements.

Mario Pani, architect for the educational development, has centered his buildings around a ten-story tower. The tower, soaring above surrounding

buildings, clearly identifies the main entrance to the heart of the school.

The tower houses all the common services of the schools for both men and women. Impressive construction savings were achieved by not duplicating these services.

Access to the tower from the wings branching outward from its base is accomplished by two "bridges". Elevators serve the tower's upper floors. The tower contains a central foyer, medical service, management offices, botanical laboratory, zoological laboratory, physics laboratory, chemical laboratory, laboratory of social science, pedagogical museum and conference hall.

On the eastern and western sides of the tower

are buildings, which on the two upper floors, hold shops for boys and girls as well as additional management offices. These rooms are supported by columns nine meters high, which, in turn, result in open but protected loggias for study and circulation on the ground level. The second levels of the wings contain the tower connecting "bridges."

The shops are enclosed and have easy access from the halls of the schools, and can be adapted to any type of work areas. Saw-type windows provide excellent northern lighting. The shops also have independent exits to play fields and study spaces.

The two large wings which flank the shop areas or columned sections have a capacity of 2,100 pupils, simultaneously. They are two symmetrical bodies that follow a curved line. Their windows have southern exposure and permit graduated uniform lighting through a system of exterior, venetian-type, adjustable curtains.

Entering through the lower floor of the tower and following the central axis in a straight line, one arrives in a spacious auditorium. Designed to seat 650, it is finished in a thin wood veneer bonded to a flexible fabric backing. Bronze and iron windows, murals, and interior plants complete the decor. Unusual indirect lighting, air conditioning, and sound equipment fit it for any auditorium use.

Of unusual interest is the auditorium's stage. It has been constructed for either simple ceremonies with a few people, or can be easily expanded

for a mass performance. The transformation is attained by means of a curtain which can be pulled so as to leave a small stage in front. This small forward platform has a floor that can be unmounted. With the curtain open, the auditorium attains its full depth, suitable for large performances.

The school's library is reached by a lateral staircase from the central tower. The library and adjoining pedagogical museum can take care of a great number of students. Reading rooms and the book department do not have direct connection, but books are received and delivered through a very simple system. Stacks are provided for 200,000 books.

In back of the library is the pedagogical museum. Here modern architecture is manifest with clean structure and curved as well as straight walls permitting maximum exploitation and exposition.

The primary schools, annexed to the Teachers' Schools, take part in the functional whole. Its halls are an integral part of the organ to which they belong. The two bodies of the primary schools open in a "V" form, leaving in the center a space occupied by an open air theater. This open auditorium accommodates 2,600 people.

In the primary school's experimental hall a unique design has been employed. It has class rooms laid out on the lower level. At a convenient height is a gallery for teachers who learn how a class is conducted by observation. The children

(See page 42)

MAIN AUDITORIUM

Accommodates 650 people.

Stage provides for either large or small functions by adjustable curtain and unmounting floor.

Finished in Flexwood, with bronze and iron windows, murals, and interior plants completing the decor.

Indirect lighting, air conditioning, and sound equipment add to modern design.





CALIFORNIA RANCH TYPE HOME

Southern California

HOUSE

Mr. and Mrs. Wm. H. Burgess

PASADENA, CALIFORNIA

By **ELMER GREY, A.I.A.** Architect

People choose one style or another for their homes when they build largely, I presume, because of their backgrounds. In the case of the house of Mr. & Mrs. William H. Burgess of Pasadena pictured above, another factor entered into the case.

Their property is located in an outlying district, savoring very much of the country, and faces a street named Barhite Ranch Road; so it was par-

ticularly fitting that their house should be of the California ranch type.

The plan of the house largely speaks for itself, but a brief explanation will make the reasons for some of its features clearer. Because of high building costs the owners were restricted for the present to 1000 sq. ft. and planned for a possible extension at a later day. They did not want the present house to look too small, so it was extended virtually

COST: Approximately \$8.00 a square foot.

**Hardwood Floors
Tiled Shower and Lavatory**

Steel Sash in large Bay window



across the entire lot. This had the added advantage of giving views from the rooms over a valley toward the front, and upon a magnificent range of mountains toward the back.

The property had a decided slope from one side to the other. The long axis of the house had to cross this slope; and in order that it would not appear too high above the ground at the low end, the difference in levels was recognized by dropping the living room two steps below the Dinette, and the Bedroom and Den two more steps below the Living Room.

Looking from the house toward the back the view of the mountains will never be taken away.

This of course, influenced very much the planning of the house. It was for this reason that the large bay window was made to face the back of the lot, and that steel sash and steel mullions were used in the bay. It was for this reason also that a pergola was planned in the back upon which the Kitchen and Dinette open; thus making possible dining out of doors while facing the mountains.

The house has a tile shower and tiled Pullman lavatory in the bathroom, hardwood floors elsewhere and is heated by two floor furnaces. The outside is finished with 1x12" rough boards cut to a slightly undulating, wavy line at the bottom, and painted and rubbed down to give an aged appearance.

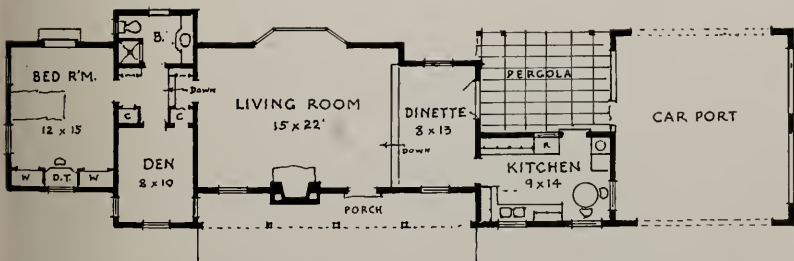

**FLOOR PLAN
HOUSE FOR MR. & MRS. WM. H. BURGESS, PASADENA
ELMER GREY, ARCHITECT**



Architectural Drawing of Completed Tacoma Medical Center.

MODERN MEDICAL CENTER

TACOMA, WASHINGTON

By **A. R. MacPherson**

Following the general trend of modern industry towards decentralization of industries from crowded cities into more advantageous suburban communities, doctors in many cities are now moving out of their sky-scraper medical buildings and locating in ground floor medical centers constructed out in residential areas.

A number of these community medical enterprises have been established in Pacific Coast cities in recent years. One is now being completed in Tacoma, Washington, by Paul A. Hungate, who also constructed the famous Seattle Medical Center which houses 160 doctors and dentists.

Principal features stressed in the new type medical layouts are their home-like service and appearance, with each doctor occupying a ground-floor unit resulting in complete elimination of elevators or stairways. Patients can drive right up to their doctor's door, thus eliminating parking meters and the usual merry-go-round of trying to find a parking spot. Also notable is the complete absence of the confusing roar of traffic coupled with its accompanying dangers to life and limb always so imminent in the busy downtown areas.

Tacoma, like other cities, has a downtown skyscraper medical building housing most of the city's



One of Medical Buildings Under Constructions

doctors. Increasing traffic congestion had aggravated and complicated the patients' problems to the point where they dreaded a visit to their doctor's office. Parking space could seldom be found either at curb parking meters or in adjacent public garages, and sick people are in no mind or condition to safely cope with the traffic perils in the business districts.

Tacoma's new \$750,000 medical center, like

those in other cities, has completely solved the distressing problems of dispensing medical service from downtown medical buildings. Located out in a quiet residential area midway between two of the city's largest hospitals, the enterprise covers an entire city block. It comprises 40 units of individual buildings, all one-story ground floor with 1,000 square feet of floor space, each building equipped with its own heating plant and all neces-

Single Doctors Unit in Medical Center





COMPLETED UNITS

Smith, Carroll & Johanson, Architects

sary utilities.

Architects for the new center were Smith, Carroll and Johanson, who also developed the Seattle center and that city's Swedish hospital. Construction of the project was carried out under the supervision of James Purvis of Tacoma.

Each unit cost approximately \$17,000 including basement excavations with concrete walls and foundations. All utilities such as gas water heaters and gas heating furnaces are installed in the basements, with storage space available for doctors' use. Buildings vary in dimensions and designs according to the number of doctors housed in them. A few structures are built for individual occupancy while others may house 4 or more doctors. Walls of the buildings are constructed with 2" by 12" Roman tile brick with window frames of steel.

Ready mixed mortar for placing bricks was de-

livered on the site as needed by a mobile mortar mixer of 2½ cu. yd. capacity, with cement being added to the mortar as it was used on the job. A mobile plaster mixer was employed for mixing all plaster used in the buildings. All structures were insulated between walls with rock wool. Excavating of basements was carried out with a digger shovel of ½ cu. yd. capacity.

The project comprises 4 rows of bungalow-type buildings, each standard unit consisting of a reception room, three examination rooms, a recovery room, a laboratory and the doctor's private office. There are no inside rooms. Interior decorations are finished with pastel shades and light woodwork, with venetian blinds covering all windows.

Two parallel paved streets are cut thru the pro-

(See page 46)

Typical Interior View of Waiting Room in Doctor's Building Unit of Tacoma Medical Center.



A. I. A.

American Institute



ACTIVITIES

of Architects

Arizona Chapter:

James Macmillan, President; Arthur T. Brown, Secretary, 740 N. Country Club Road, Tucson, Arizona.

Central Valley of California:

Herbert E. Goodpastor, President; Frank V. Mayo, Secretary, 307 Exchange Building, Stockton 2, California.

Colorado Chapter:

Raymond H. Ervin, President; James M. Hunter, Secretary, 2049 Broadway, Boulder, Colorado.

East Bay Chapter:

A. Lewis Kase, President; James H. Anderson, Vice-President; Ley Chamberlain, Secretary; Chester H. Trichel, Treasurer, Office, 3833 Piedmont Ave., Berkeley, California.

Montana Chapter:

Ralph H. Cushing, President; H. C. Cheever, Secretary, Montana State College, Bozeman, Montana.

Northern California Chapter:

Wm. Clement Ambrose, President; Lester W. Hurd, Vice-President; Ralph N. Pollack, Secretary; Donald Beach Kirby, Treasurer; Office 363 Pine Street, San Francisco.

Oregon Chapter:

Frank Roehr, President; Sidney W. Little, Vice-President; J. Holman Baines, Secretary; Don Edmundson, Treasurer, Office 619 Builders Exchange Bldg., Portland 4, Oregon.

San Diego Chapter:

H. Louis Bodmer, President; Louis J. Gill, Secretary, 203 Granger Building, San Diego, California.

Santa Barbara Chapter (California):

Winsor Soule, President; Ralph Armitage, Vice-President; Robert Ingle Hoyt, Secretary; Lutch M. Riggs, Treasurer; Office 116 E. Sola St., Santa Barbara, California.

CALIFORNIA COUNCIL OF ARCHITECTS

Andrew T. Hoss, President; Adrian Wilson, Vice-President; Malcolm Reynolds, Secretary-Treasurer; Office 369 Pine Street, San Francisco.

Southern California Chapter:

George Allison, President; A. C. Martin, Jr., Vice-President; Anthony Thermin, Secretary; George E. Gable, Treasurer; Chapter Headquarters, 3757 Wilshire Blvd., Los Angeles 5, California.

Spokane Chapter (Washington):

Noel E. Thomson, President; Kenneth D. Stormont, Secretary, Hutton Building, Spokane, Washington.

Utah Chapter:

George Cannon Young, President; Theodore R. Pope, Secretary, 29 South State Street, Salt Lake City 1, Utah.

Washington State Chapter:

Clifton J. Brady, President; Arrigo M. Young, Vice-President; John Richards, 2nd Vice-President; Ralf E. Decker, Sec.; Waldo B. Christenson, Treasurer, Office 1411 Fourth Avenue Building, Seattle 1, Washington.

Tacoma Society:

Chas. Rueger, President; Clarence Rueger, Vice-President; W. W. Durham, Secretary-Treasurer.

Hawaii Chapter:

Kenneth W. Roehrig, President; James Morrison, Secretary, 334 Federal Bldg., Honolulu, T. H.

WASHINGTON STATE CHAPTER

The regular May meeting was a joint conference with the University of Washington architectural students and the University of Washington Alumni and included a tour of the three new buildings being constructed on the university campus.

Perry B. Johanson explained the new Medical Building; Paul Thiry the Electrical Engineering Building, and John P. Jones conducted the tour of the Civil Engineering Building.

As a special feature an exhibit of student work was displayed in Judgement Hall in the School of Architecture, and the first 25 drawings in the Alumni prize competition "School of Architecture Building" were shown at the Henry Art Gallery.

F. Marshall Smith acted as Program Chairman.

* * *

CORPORATE MEMBERS: Kenneth G. Branch, Harold B. Foss, and Victor Steinbrueck have been added to the membership. Other new members include ASSOCIATES Arthur E. W. Dodds, John H. Whitney, and Thomas A. Smith; JUNIOR ASSOCIATES William T. Joiner and Harold H. Kesselring, and STUDENT ASSOCIATES Alan C. Liddle and Daniel M. Streissguth.

* * *

ERIC RISING, President of the Architects' Bowling League, recently presented Robert L. Durham, of the firm of Stuart & Durham, with a trophy for winning the league championship for 1948. Members of the winning team included Parker, Gangnes, Conrad, Carey and Graham.

The Constitution and By-Laws have been brought up to date, through the assistance of Clyde Grainger, and have been reproduced by the Executive Secretarial Office at the direction of the Executive Board. Distribution restricted.

FOR BETTER SERVICE

Remember that

KRAFTILE is

WESTERN HEADQUARTERS

FOR

<ul style="list-style-type: none"> ◆ ACID Brick ◆ ACID-PROOF Jointing Compounds ◆ ACID-PROOF Floor and Tank Construction ◆ ACID-PROOF Coatings 	<ul style="list-style-type: none"> ◆ GLAZED Structural Wall Units ◆ PATIO Tile ◆ QUARRY Tile ◆ SWIMMING POOL Overflow Gutter ◆ LIGHTWEIGHT CONCRETE BLOCKS
--	---



STAR STEEL FRAMING

- ◆ QUONSET Packaged Steel Buildings

- ◆ STRAN-STEEL Framing

For complete information and prompt service, phone or write

KRAFTILE COMPANY

NILES, CALIFORNIA NILES 3611

SAN FRANCISCO 3: 20 Hawthorne St.—DOUGLAS 3-3780

LOS ANGELES 13: 406 South Main Street—MUTUAL 7241

WITH THE ENGINEERS

Structural Engineers Association of Northern California

John A. Blume, President; Jesse Rosenwald, Vice President; Franklin P. Ulrich, Treas. Geo. E. Solnar, Jr., Sec., Office, Room 215, 55 New Montgomery St., San Francisco 5, Phone SUtter 1-7642. DIRECTORS, A. W. Anderson, Henry J. Degenkolb, John E. Rinne, Robert D. Dewell, and Wm. W. Moore.

San Francisco Section

L. A. Elsener, President; A. W. Earl and G. B. Woodruff, Vice-Presidents; John E. Rinne, Secretary-Treasurer; 225 Bush Street, San Francisco 20.

Structural Engineers Association of Southern California

Steve Barnes, President; Harry W. Bolin, Vice President; Lewis K. Osborn, Sec-Treas. DIRECTORS, Richard W. Ware, Geo. E. Brandow, L. T. Evans, Harold P. King, and Donald F. Shugart. Office: 202 Architects Bldg., Los Angeles 13, Calif.

Puget Sound Engineering Council (Washington)

R. E. Kister, A. I. E. E., Chairman; E. R. McMillan, A. S. C. E., Vice Chairman; L. B. Cooper, A. S. M. E., Secretary; A. E. Nicholson, I. E. S., Treasurer; Offices, L. B. Cooper, c/o University of Washington, Seattle 5, Washington.

STRUCTURAL ENGINEERS ASSOCIATION SOUTHERN CALIFORNIA

Steve Barnes, President of the Association, presided at the June meeting with the first part of the program devoted to an interesting talk and explanation by A. V. Saph, consulting structural engineer of San Francisco and member of the Board of Registration for civil engineers, of the new professional engineers act. Mr. Saph answered many questions relative thereto.

The principal subject for the meeting was the Parkway Construction Program in the Los Angeles Metropolitan Area. The two speakers on the subject were Mr. Hugo H. Winter, Engineer for the City of Los Angeles and Mr. Leonard C. Hollister of the State Department of Public Works.

Mr. Winter in his talk, said that in 1910 Los Angeles area had 18,000 automobiles. At the present time we have approximately one and a half million cars for the four million people. In 1960 a population of six million persons in the Los Angeles area is expected which will add approximately one million cars to the area within the next twelve years. The widespread area of Los Angeles with low density of population has been conducive to individual automobile travel and 80% of all travel is by private automobile. The 1925 street widening program fortunately was quite extensive and due to this the traffic situation has been kept reasonably well in hand. However, it is rapidly getting to an acute stage.

Winter pointed out the fact that streets are intended to serve both traffic and the buildings facing on the streets, whereas the entire plan of freeways or parkways is to serve and be concerned only with the rapid movement of traffic. Very close coordination between the City of Los Angeles, the County of Los Angeles and the State Highway Department has been obtained in the development of the program.

The superimposing of an extensive parkway sys-

tem upon a city already developed is both expensive and very complex.

Some of the parkway systems would provide for rapid transit lines in addition to automobile traffic. The new parkways will be of the highest type design; the minimum horizontal radius of curvature will be 2000', the maximum vertical grades will be 4% with 7% as a maximum for ramps; lanes will be 12' in width and the entire system will be designed for automobile speeds of 60 m.p.h. Elevation of the road surfaces and sight distances will be planned for this speed. A high degree of drainage will be installed so that the pavements will be safe in wet weather.

The system must be built unit by unit to minimize the inconvenience of areas under construction and to take advantage of new developments as the work proceeds. This is also necessary to keep the construction in balance with a reasonable financing plan. The intersections of the parkways must be designed so that speed and flow can be maintained. These intersections become very complex and the old cloverleaf system is now considered unsatisfactory. The program originally contemplated as a ten year program is now conceived as a fifteen year program. This is principally due to gas tax adjustments.

Mr. Hollister, chief designer for the State Department of Public Works, Division of Highways and Bridges, gave a very interesting discussion of the structural design proposals involved in the bridge intersection structures, etc. He stated that the Arroyo Seco is highly successful as a parkway and is also serving to develop data as a guide for the present design in order to ascertain what to do what not to do. Every consideration is given to the aesthetic side of the design of the super-structure and these will involve good architectural taste. The many problems involved in a four level intersecting structure such as will occur on the Hollywood-Santa Ana freeway system were described by Hollister. These involved not only structural an-

architectural problems of considerable magnitude but the handling of all types of utilities constitute a major problem. One of these four level intersecting structures will have its first level 15 to 20 feet below grade. The second level will carry Figueroa Street and will consist of reinforced concrete slab and beam construction approximately 420' long. The top level will consist of hollow concrete box girder construction.

Hollister discussed the rise in cost involved in this type of work as compared to the costs approximately 10 years ago. This high cost is of further incentive to the Design Department to keep the structures as simple and as economical as possible.

Interesting data was given concerning the Commander Hein bridge across Cerritos channel. This structure steel bridge with its center lift span has many interesting features, one of which is the fact that the weight to be lifted is only 81 lbs per square foot of roadway. This is an exceptionally light roadway design when compared with many eastern lift span bridges which run from 180 to 500 lbs. per square foot.

The Association will hold its annual Field Day at the Rio Hondo Golf Club on August 4.

C. D. Wailes, Jr., Chairman
Publicity Committee.

NEWS AND COMMENT ON ART

(From page 8)

PAT WALL GALLERY MONTEREY

An exhibit of the work of Dan Harris was recently shown at the Pat Wall Gallery in Monterey, California.

Entitled "Reconstructions In Time" some ten subjects were displayed from May 23rd to June 12th.

SAN FRANCISCO MUSEUM OF ART

The San Francisco Museum of Art will present the following exhibitions and activities during the month of June.

EXHIBITIONS: The Wright S. Ludington Collection of Contemporary European and American Paintings and Sculpture, through June 20; Textiles, by Dorothy Liebes and Ceramics by Frans Wildenhain to June 27; Paintings by Elmer Bischoff, David Park and Hassell Smith, through June 20; San Francisco International Salon of the California Camera Clubs, Closes June 23; Twelfth Annual Drawing and Print Exhibition of the San Francisco Art Association, June 9 to July 4.

CONTRACT for construction of 8-stores and office building to cost \$100,000 has been awarded to E. Y. Richardson, Contractor, San Leandro.

"This builder thought of everything!"



One sure mark of a thoughtful builder... built-in telephone facilities. Just a few pieces of pipe or other tubing material... run as raceways to handy outlet positions... mean a great deal of convenience in the future. And the cost is insignificant if put in while the home is under construction.

With built-in telephone conduit and outlets, telephones can be added or moved in the future without drilling holes or running wires along baseboards. Just one of those small but important details that stamp a builder as a thoughtful builder.



For free help in planning modern, built-in telephone facilities, call your local telephone company number and ask for "Architects and Builders Service."

**The Pacific Telephone
and Telegraph Company**



When installation of drinking water facilities is a problem...

here are two simple solutions

Solution No. 1

WHEN supply and waste lines are easily accessible, no finer source of drinking water can be found than this modern HAWS Electric Water Cooler. Quickly and easily installed...this unit blends in with any surroundings... actually enhances the appearance of the interiors you design. Electrical connections are simple...just plug into any convenient outlet.



Model HT-10
Electric
Water Cooler

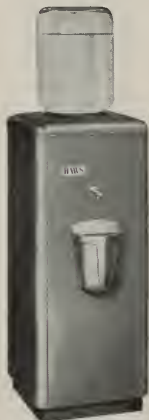

Model HTBC-3
Electric
Bottled Water Cooler

Solution No. 2

WHEN plumbing is a problem...forget it! Specify this attractive bottled water cooler! Cool, fresh water is always available without installation effort. Can be plugged into any electrical outlet. Waste receptor is easily detached for emptying.

FOR convenience of installation and continued client satisfaction with the drinking water facilities you specify, HAWS Electric Water Coolers and Sanitary Drinking Fountains are your most logical answer.

Write for information and literature

HAWS ELECTRIC WATER COOLERS
SANITARY DRINKING FOUNTAINS

HAWS DRINKING FAUCET CO.
1435 FOURTH STREET (Since 1909) BERKELEY 2, CALIFORNIA
Agents and Sales Representatives in All Principal Cities

IN THE NEWS

APPOINTED SALES RESEARCH ENGINEER

Appointment of Harry R. O'Brien as sales research engineer of the Woodfiber Division, Simpson Logging Company, has been made by R. Seeley, general manager, Simpson Industries, Seattle.

O'Brien, formerly western field representative for the Douglas Fir Plywood Association, will spend most of his time in the field covering 11 eleven western states in the interest of Simpson Insulating Board Products. He will contact distributors, dealers and architects in a merchandising and consulting capacity.



HARRY R. O'BRIEN
Sales Research Engineer

O'Brien will make his headquarters at the Simpson Industries offices in the White-Henry Studio Building, Seattle.

"Obie" has a wide acquaintanceship among western lumbermen and lumber dealers as result of his connection with the Douglas Fir Plywood Association.

Formerly of Savannah, Georgia, O'Brien resides with his wife and son in Tacoma where he plans to remain for the time being.

He was graduated from Georgia Tech and later did graduate work at M. I. T. O'Brien served as major during the war with the Army Air Forces.

SCHOOL CONTRACT AWARDED

A contract for construction of a new 16-room, kindergarten, auditorium and cafeteria grammar school in Bakersfield, California, has been awarded to the construction firm of O. D. Williams, Bakersfield.

Architects for the work are Wright, Metcalf and Parsons, of Bakersfield.

ARCHITECT SELECTED. Oscar R. Thayer, Burgame, has been selected architect for the new 94,500 San Mateo County "Fiesta" buildings.

NEW CHAPTER FORMED OF THE ASSOCIATED GENERAL CONTRACTORS

A charter has been granted for the formation of the Mid-Continent Pipe Line Chapter of the Associated General Contractors of America, Inc. with headquarters in Houston, Texas.

The group is composed of contractors who specialize in the construction of cross-country pipe lines for the transmission of oil and gas.

Past president Warren S. Bellows presented the charter.

Officers of the new chapter are: T. R. Jones, Dallas, Texas, President; H. C. Price, Bartlesville, Oklahoma, first vice president; Ray L. Smith, El Dorado, Kansas, second vice president; J. C. Britton, Fort Worth, Texas, secretary, and A. L. Forbes, Houston, Texas, treasurer.

G. L. Harvey of Houston has been named executive secretary.

BERKELEY SHOPPING CENTER of Telegraph Avenue, between 50th and 51st streets will cost \$1,000,000. Willis F. Lynn, Berkeley, is the general contractor; John B. Anthony, Oakland, is the architect.

MANTECA GRAMMAR SCHOOL. General contract for \$166,000 has been awarded to M. A. Little San Francisco for construction of an 8-classroom, music, library and office building.

COLD STORAGE PLANT. E. A. Hathaway Company of San Jose, has been awarded a \$210,000 contract for the construction of a cold storage building at Hayward, California, for the Hunt Foods Inc.

SCHOOL BONDS VOTED at Santa Rosa for construction of an \$80,000 grammar school addition.

SCHOOL BONDS VOTED. Los Altos (California) will build a new \$309,000 grammar school as the result of a recent bond election.

STADIUM BLEACHERS will be erected at the Modesto (California) High School to cost \$21,000. Frank Wynkoop & Associates, Fresno, are the architects.



—is the Certified Adequate Wiring emblem on new or remodeled homes.

It is tangible evidence of electrical adequacy, assuring your client that nothing has been overlooked in his wiring plans, and providing added value for loan or resale purposes . . . all factors which contribute toward the owner's satisfaction with the home you have designed.

The Adequate Wiring program offers you . . . without charge or obligation . . . a complete wiring layout service, to aid you in furnishing your clients with electrical plans and specifications. For detailed information, consult your local utility office or this Bureau.

**NORTHERN CALIFORNIA
ELECTRICAL BUREAU**

1355 Market Street, San Francisco 3



E. K. WOOD LUMBER CO.

SAN FRANCISCO General Offices: No. 1 Drumm Street
LOS ANGELES Office and Yards: 4710 S. Alameda St. — JE 3111
OAKLAND Yards and Wharves: 2111 Frederick St. — KE 4-8466
PORTLAND Mill Sales Office: 827 Terminal Sales Bldg.

SAW MILLS: Roseburg, Oregon • Reedsport, Oregon

RETAIL YARDS: LOS ANGELES • OAKLAND • ONTARIO • HOLLYWOOD
 LONG BEACH • RIVERSIDE • TEMPLE CITY • SIERRA MADRE • INDIO • THERMAL
 LA VERNE • WHITTIER • PASADENA • SAN PEDRO

HEADLINE NEWS AND VIEWS

By E. H. W.

The annual business volume of the average retail store has climbed from \$23,000 in 1939 to \$59,000 in 1947, according to a recent study by Reynolds Knight.

For the first time in the history of the steel industry, western mill prices are at a parity with those for similar products produced by Eastern steel mills. Elimination of the \$3 per ton differential by Columbia Steel is the reason.

Home building construction figures for the first quarter of 1948 indicate the current year will be record twelve-month period. More than twice as many new dwelling units were started in the first three months of 1948 under FHA inspection than were started in the same period of 1947.

"Welding construction is being handicapped by code writers putting restrictions of no value, but of great expense, on welded structures made under their codes." A. F. Davis, Vice-president, Lincoln Electric Co.

The American people, with their usual understandable reluctance, but with characteristic realism and individual rationality, appear to have reached the realization that the United States stands in the front line of an international aggression target.

Perhaps the elections this Fall will change the picture.

Los Angeles tops by a wide margin the volume of business done in the construction industry in April.

A contract has been awarded for the construction of a 10-story dormitory building to house Illinois Institute of Technology students at Chicago. Two 4-story dormitories are also under construction, and when completed, the program will house single and married students in a self-contained study, work, and living area.

It had to happen eventually. San Francisco promotes promotional Los Angeles. The Port Festival House to be given away during San Francisco's Portola Festival cost some \$35,000, which the best Los Angeles could do in the way of giving away a house in connection with the Construction Industries Home and Building Exposition was a \$15,000 job.

CZC

PRESSURE TREATED LUMBER
 ● PROTECTS AGAINST DECAY
 AND TERMITE ATTACK

*Specify it in your home
 Available through Lumber Dealers*

<p>LOS ANGELES 601 W. 5th Street Phone Michigan 6294</p>	<p>SAN FRANCISCO 333 Montgomery Street Phone DOugles 2-3883</p>
---	--

J. H. Baxter & Co.

AGENTS FOR WEST COAST WOOD PRESERVING CO. SEATTLE, WASH.

IN THE NEWS

ARCHITECT SELECTED

lanchar, Maher & Lockard, Nevada, architects have been selected for the Greyhounds bus depot, shop building anditories building to be built in Mateo.

SCHOOL BONDS VOTED

approval of \$3,225,000 school bonds for construction of new high school buildings and additions to existing high school buildings in Mateo, has been announced.

NEW FLOOR SAFE

A new DeLuxe Floor Safe in three models for home use, office, store, industry and business of all kinds has been announced by the H. & W. Specialties Company of Toledo, Ohio.



This precision built to assure maximum protection against fire and theft; seamless, and non-rust-steel one inch thick; has removable head that is drill proof, and of chrome nickel steel. The new DeLuxe Floor Safe also employs two separate rellocking devices, and is available in several models.

SCHOOL CONTRACT AWARDED

Cartich Bros. & Stevenso, general contractors, Redwood City, California, have been awarded a \$3,075 contract for the construction of a 7-classroom addition to John Gill Grammar School in Redwood City. Franklin, Kump & K, San Francisco, are the architects.

NEW APARTMENTS to be constructed in San Mateo (California) include 38 buildings housing some 400 apartments. Cost is estimated at \$4,000,000.

MUNICIPAL HOSPITAL. Bonds have been approved for the construction of a new \$250,000 municipal hospital at Roseville, California.



IT PAYS TO USE

Planned Lighting!

NEW PORCELAIN ENAMEL TECHNIQUES NOW ENABLE SMOOT-HOLMAN TO PRODUCE A MORE RUGGED FINISH WITH HIGHER REFLECTIONS UP TO 92%. LOOK FOR THIS LABEL OF QUALITY:



OFFICES IN PRINCIPAL WESTERN CITIES
BRANCH AND WAREHOUSE IN SAN FRANCISCO

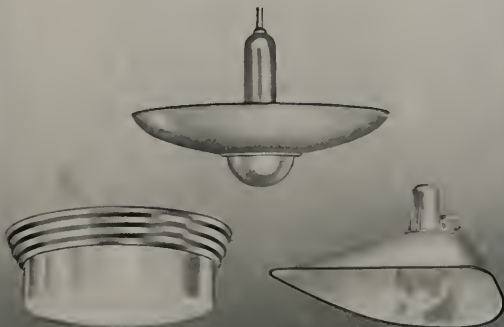

LANDSCAPE ARCHITECTURE

Notes of The Profession

ASSOCIATION OF LANDSCAPE ARCHITECTS, SAN FRANCISCO REGION

Vernon Dean, President; Robert Royston, Vice-President; Ned Rucker, Treasurer;
E. L. Anderson, Secretary, 1736 Franklin, Oakland, California.

Seven of the top-ranking architects in Chicago have joined forces to serve on a voluntary committee to push the raising of funds for a new \$500,000 Architecture and Applied Arts building for the Illinois Institute of Technology's new functional campus.

The building is to be built as a part of the University's \$15,000,000 development program.

SCHOOL CONTRACT AWARDED

A contract has been awarded Leo Epp, contractors of San Francisco, for the construction of a 21-classroom grammar school in Oakland, California, at a cost of \$591,877.

AUTO SUPPLY REMODEL

Barrett & Hilp, San Francisco, have been

awarded a \$100,000 contract for remodel of the Frank Edwards Company, Van Ness Avenue, San Francisco, building which was recently destroyed by fire.

GENERAL SCHOOL CONTRACT

Stolte Inc., Monterey, California, have been awarded a \$293,400 contract for the construction of a 15-classroom, kindergarten, office and cafeteria grammar school building in Monterey. Robert Stanton, Pebble Beach, is the architect.

GRAMMAR SCHOOL

The J. D. O'Connor Construction Company, San Rafael, California, have been awarded contract for the construction of a \$130,816 addition to the Larkspur (California) grammar school. C. F. Gromme, San Rafael, is the Architect.

SCHOOL BONDS DEFEATED

A project involving the construction of some new grammar school buildings and the repair and remodeling of many present schools at an estimated cost of \$87,000,000 was recently rejected by the voters of San Francisco.

SEWAGE TREATMENT PLANT

A general contract has been awarded to Sto Inc., Oakland, for the construction of a sewage treatment plant for the city of Santa Cruz, California. Estimated cost of the project, which is to be of reinforced concrete construction, is \$242,900. Harry N. Jenks, of Palo Alto, is the engineer.

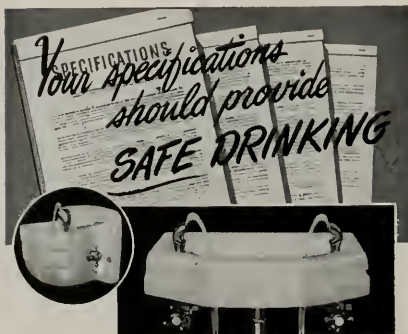

In the designing of schools, churches, hospitals, and other public buildings, the provision of safe drinking water supply is as vital as any phase of the specifications. Halsey Taylor Drinking Fountains are accepted as foremost in hygiene, convenience and design. Ask for latest catalog.

THE HALSEY W. TAYLOR CO., WARREN, OHIO

HALSEY TAYLOR
Drinking Fountains



TILE

UNUSUAL AND PRACTICAL
INSTALLATIONS OF
CERAMIC AND FAIENCE TILE

for bathrooms, kitchens, vestibules, stores,
patios and cocktail bars

FOX TILE CO.

3247 E. 14TH STREET, OAKLAND
Phone: ANdover 1-0431

IN THE NEWS

HIGH SCHOOL ADDITION BIDS REJECTED

Bids for construction of a 3-class room, domestic science, and art room addition to the Oroville, California, Union High School were recently rejected. Cost of the work is estimated at \$150,834. E. Geoffrey Bangs, San Francisco, is the architect. New bids are being taken.

PREPARATORY SCHOOL. The Robert McCarthy Company, San Francisco, has been awarded a \$220,000 contract for construction of a preparatory school in San Jose (California). Paul A. Ryan and John L. Lee, San Francisco, are the architects.

RECREATION BUILDING

A contract has been awarded to the Willis F. Lynn Company of Berkeley, for the construction of a \$125,000 Recreation Building in Oakland, California.

Of reinforced concrete and structural steel the building will contain 12 bowling alleys, a restaurant and cocktail lounge. Miller & Varnecke of Oakland, are the architects.

OFFICE BUILDING. A general contract has been awarded to the W. Robertson Company of Sacramento for the construction of a three story office building in Sacramento. Herbert Goodpastor, Sacramento, is the Architect. Cost of project is \$242,887.

INTERMEDIATE SCHOOL

A contract has been awarded to W. Robertson, Sacramento (California) contractor for the construction of a new 4-class room, toilet rooms, and boiler room intermediate school in Orland, California. O. A. Deichmann, San Francisco, is the architect.

SWIMMING POOL and Bath House for the City of Willows will be built by the Berlinger Construction Company of Chico at a cost of \$36,000, according to O. A. Deichmann, Architect of San Francisco.

HIGH SCHOOL ADDITION

A general contract has been awarded Frank A. Payne & Son of Orinda, California, for the construction of a 4-classroom, 4-sci-

ence room, and shop building to the Lafayette High School at a cost of \$273,700. Franklin, Kump & Falk, San Francisco, are the architects.

70-RESIDENCES. Hugh B. Coddington of Santa Rosa (California) has announced the immediate construction of seventy residences in Santa Rosa at a cost of \$8,000 each.

SHOPPING CENTER

Announcement has been made of the construction of a new shopping center at a group of residences near Sacramento, California, on the Stockton highway.

The project will cost an estimated \$6,000,000.

NEW GRAMMAR SCHOOL of 25 classrooms, kindergarten, assembly, cafeteria and utility, at Bakersfield, to cost \$452,888. L. H. Hansen & Son, Fresno, are the contractors; Ernest L. McCoy, Bakersfield, is the architect.

OROVILLE HIGH ADDITION

Three classrooms, a domestic science and an art room will be added to the Oroville, California, high school at a cost of \$122,564.

E. Geoffrey Bangs, San Francisco, is the Architect and the general contractor is Adams & Chittenden of Auburn, California.

SCHOOL BONDS VOTED. San Leandro, California, recently approved a \$435,000 bond issue for the construction of a new grammar school building.

SWIMMING POOL. The California Builders Company of Oakland, have been awarded a \$113,163 contract for the construction

of a swimming pool and dressing room building for the City of Oakland. Irwin M. Johnson and associate, Wm. C. Helms, Oakland, are the architects.

WAREHOUSE. Architect Fred L. Swartz & Wm. G. Hyberg of Fresno announced the awarding of a contract to Lewis C. Nelson & Sons of Selma, California, for construction of a warehouse building in Fresno for the Salvation Army to cost \$56,900.

ALWINTITE

aluminum double-hung

residential windows

... represents more

than thirty-five years

experience in fine

window manufacture

WESTERN ASBESTOS

COMPANY

675 Townsend Street, San Francisco 3

Telephone: HEmlock 1-4884

OAKLAND • SACRAMENTO • FRESNO • SAN JOSE

"There's still life in the old gray mare."

DON'T throw away those used paint brushes

CABOT'S BRUSH CLEANER

Positively removes old paint right down to the heel

GUNN CARLE & CO

20 POTRERO AVENUE • SAN FRANCISCO, CALIF.

STRUCTURAL STEEL

For Class A Buildings,
Bridges, etc.

JUDSON PACIFIC - MURPHY CORP.

4300 EASTSHORE HIGHWAY
EMERYVILLE, CALIF.

FORORDERER CORNICE WORKS

Manufacturers of

Hollow Metal Products • Interior Metal Trim
Elevator Fronts and Cabs
Metal Plaster Accessories • Sanitary Metal Base
Flat and Roll Metal Screens
Metal Cabinets • Commercial Refrigerators

269 POTRERO AVE.

SAN FRANCISCO, CALIF.

HEMLOCK 4100

VALUABLE NEWS SERVICE

- BUILDING MATERIAL DEALERS
- CONTRACTORS
- ENGINEERS
- FINANCIAL INSTITUTIONS

ARCHITECTS REPORTS gives advance news on construction projects in Northern California, lists: name of projects, location, architect, proposed cost and other pertinent information.

HANDY individual slip-reports, issued daily at a total cost of only

\$10 a month

ARCHITECT'S REPORTS

Published Daily

The ARCHITECT and ENGINEER, Inc.

68 Post Street, San Francisco - DO 8311

NATIONAL TEACHERS SCHOOLS MEXICO CITY, MEXICO

(From page 27)

receiving their lessons do not see or hear those observing them. Thus the old system of mixing pupils with future teachers is eliminated.

General use of aluminum venetian-type curtain for interior lighting control is new to Mexico. These curtains prevent the direct rays of the sun from entering the inside rooms and produce a uniform light.

Mexico's natural construction products—stone, aluminum, and iron—have been used throughout the buildings. Decorative details both within and without solidify the Mexican expression. The bas-relief sculpture on the upper level of the tower loggia-wings are by Luis Ortiz Monasterio and show the source and development of Mexican culture. Six large paintings by Jose Clemente Orozco decorate the tower entrance foyer, and one pirotone line painting by the same artist covers a 40 square meter area of the curved wall of the open auditorium.

Garden and pools surrounding the buildings reflect the architectural trend. Orange trees, willow and flowering tropical trees and shrubs brighten and contrast with the reddish facade of the buildings. Exterior gardens are more formal with interior courts planted in a freer style.

The group of buildings which forms the National Teachers' School occupy an area of 119,000 square meters and contain two normal schools of 42 halls with observation schools, annexed, with 36 hall and a capacity of 3,600 pupils in two shifts; two experimental primary schools with 40 halls and capacity of 4,000 pupils in two shifts; making a total of 11,000 pupils in two shifts. This is in addition to the central tower section with its 8 halls capable of accommodating 800 pupils in two shifts.

MEDICAL-DENTAL and APARTMENT BUILDING, comprising 9 suites of offices and 10 apartments will soon be built in Yuba City (California). John G. Pitches, Roseville, is the General Contractor and Clarence C. Cuff, Sacramento, is the architect.

SCHOOL BONDS APPROVED

Voters of the Hayward Union High School District have approved a \$1,000,000 bond issue.

Funds are a preliminary amount for the construction of two new high school buildings at a total cost of \$4,000,000.

Dragon, Schmidts & Hardman, Berkeley, are the Architects.

ESTIMATOR'S GUIDE

BUILDING AND CONSTRUCTION MATERIALS

PRICES GIVEN ARE FIGURING PRICES AND ARE MADE UP FROM AVERAGE QUOTATIONS FURNISHED BY MATERIAL HOUSES TO SAN FRANCISCO CONTRACTORS. 2½% SALES TAX ON ALL MATERIALS BUT NOT LABOR

All prices and wages quoted are for San Francisco and the Bay District. There may be slight fluctuation of prices in the interior southern part of the state. Freight cartage, at least, must be added in figuring entry work.

INDEXES—Performance or Performance plus Labor and Material Bond(s), \$10 per \$1000 on contract price. Labor & Material Bond(s) only, \$5.00 per \$1000 on contract price.

BRICKWORK—

Common Brick—Per 1M laid—\$100.00 up (according to class of work).
 Face Brick—Per 1M laid—\$200.00 and up (according to class of work).
 Brick Steps—\$3.00 and up.
 Common Brick Veneer on Frame Bldgs.—Approx. \$1.20 end up—according to class of work.
 Face Brick Veneer on Frame Bldgs.—Approx. \$2.00 and up (according to class of work).
 Common Brick—\$28.50 per M—truckload lots, delivered.
 Face Brick—\$60.00 to \$90.00 per M, truckload lots, delivered.
 Cartage—Approx. \$9.00 per M.
 Los Angeles County Area—Residential, up to 4-family or apt., metal reweaves, \$6.50 per outlet.

PLYWOOD PAPER—

ply per 1000 ft. roll \$5.30
 ply per 1000 ft. roll 7.80
 ply per 1000 ft. roll 9.70
 Townskin, Standard, 500 ft. roll 8.00

LOADING HARDWARE—

ish cord com. No. 7 \$2.65 per 100 ft.
 ish cord com. No. 8 3.90 per 100 ft.
 ish cord spot No. 7 3.65 per 100 ft.
 ish cord spot No. 8 4.00 per 100 ft.
 ish weights, cast iron, \$100.00 ton.
 oils, \$5.50 base.

CONCRETE AGGREGATES—

The following prices net to Contractors unless otherwise shown. Carload lots only.

	Bunker per ton	Del'd per ton
Gravel, all sizes	\$2.44	\$2.75
Top Sand	2.38	3.13
Concrete Mix	2.38	3.06
Crushed Rock, ¾" to 1½"	2.38	2.94

	Bunker per ton	Del'd per ton
Crushed Rock, ¾" to 1½"	\$2.38	\$3.13
Roofing Gravel	2.81	3.50
River Sand	2.50	3.06

SEND—

Lapis (Nos. 2 & 4)	3.56	3.94
Olympic (Nos. 1 & 2)	3.56	3.88

CEMENT—

Common (all brands, paper sacks), carload lots, \$3.02 per bbl. f.o.b. car; delivered \$3.60. Cash discount on carload lots, 10¢ a bbl., 10th Prox., less than carload lots \$4.00 per bbl. f.o.b. warehouse or delivered.
 Cash discount 2% on L.C.L.

Trinity White { 1 to 100 sacks, \$3.13 sack
 Medusa White { warehouse or del.; \$9.56
 bbl. carload lots.

DAMP-PROOFING and Waterproofing—

Two-coat work, \$8.00 per square.
 Membrane waterproofing—4 layers of saturated felt, \$9.00 per square.
 Hot coating work, \$5.00 per square.
 Medusa Waterproofing, \$3.50 per lb. San Francisco Warehouse.
 Tricoel waterproofing.
 (See representative.)

ELECTRIC WIRING—\$15 to \$20 per outlet for conduit work (including switches).

Knob and tube average \$6.00 per outlet. (Available only for priority work.)

ELEVATORS—

Prices vary according to capacity, speed and type. Consult elevator companies. Average cost of installing a slow speed automatic passenger elevator in small four story apartment building, including entrance doors, about \$8000.00.

EXCAVATION—

Sand, \$1.00; clay or shale, \$1.50 per yard. Trucks, \$30 to \$45 per day.
 Above figures are an average without water. Steam shovel work in large quantities, less; hard material, such as rock, will run considerably more.

FIRE ESCAPES—

Ten-foot galvanized iron balcony, with stairs, \$250 installed on new buildings; \$300 on old buildings.

FLOORS—

Composition Floors, such as Magnesite, 50¢ per square foot.

Linofloor—2 gages—\$3.00 per sq. yd.

Masticpave—\$1.50 per sq. yd.

Battleship Linoleum—available to Army and Navy only—1/8" —\$3.50 sq. yd.
 3/8" —\$3.50 sq. yd.

Terazzo Floors—\$1.50 per sq. ft.

Terazzo Steps—\$2.50 per lin. ft.

Mastic Wear Coat—according to type—20¢ to 35¢.

Hardwood Flooring—

Standard Mill grades not available.

Victory Oak—T & G

3/4" x 2 1/4" \$252.00 per M. plus Cartage
 1/2" x 2" \$210.00

1/2" x 1 1/2" 200.00

Prefinished Standard & Better Oak Flooring
 3/4" x 3 1/4" \$265.00 per M. plus Cartage
 1/2" x 2 1/2" 237.00 per M. plus Cartage

Maple Flooring

3/4" T & G Clear \$330.00 per M. plus Ctg.
 2nd 305.00 per M. plus Ctg.
 3rd 255.00 per M. plus Ctg.

Floor Layers' Wage, \$2.12 1/2 per hr. (Legal as of July 1, 1947. Given us by Inleif Floor Co.)

GLASS—

Single Strength Window Glass \$.40 per sq. ft.
 Double Strength Window Glass60 per sq. ft.
 Plate Glass, under 75 sq. ft. 1.50 per sq. ft.
 Polished Wire Plate Glass 2.25 per sq. ft.
 Rgh. Wire Glass60 per sq. ft.
 Obscure Glass40 per sq. ft.

Glazing of above is additional.

Glass Blocks \$2.75 per sq. ft. set in place

HEATING—

Average, \$2.50 to \$3.00 per sq. ft. of radiation, according to conditions.

Warm air (gravity) average \$64 per register.

Forced air average \$91 per register.

INSULATION AND WALLBOARD—

Rockwool Insulation— (2")	\$65.00 per M sq. ft.
Cotton Insulation—Full thickness (3 3/4")	\$95.50 per M sq. ft.
Aluminum Insulation—Foil-mounted on both sides	\$33.50 per M sq. ft.
Tileboard—4'x6' panel	\$9.00 per panel
Wallboard—1/2" thickness	\$55.00 per M sq. ft.
Finished Plank	\$69.00 per M sq. ft.
Ceiling Tileboard	\$69.00 per M sq. ft.

IRON—Cost of ornamental iron, cast iron, etc., depends on designs.

LUMBER—

No. 1 Common	\$90.00 per M
No. 2 Common	88.00 per M
Select O. P. Common	94.00 per M

Flooring—

V.G.-D.F. 8 & 8lr. 1 x 4 T & G Flooring	\$170.00
"C" and better—all	170.00
"D" and better—all	170.00
Rwd. Rustic—"A" grade, medium dry	150.00
8 to 24 ft.	
"B" grade, medium dry	150.00
Plywood	15c to 18c per ft.
Physcord	9/3c per ft.
Plywall	3c per ft.
Plyform	15c per ft.

Shingles (Rwd. not available)—

Red Cedar No. 1—	\$13.00 per square;
No. 2,	\$10.50; No. 3, \$9.00.
Average cost to lay shingles,	\$6.00 per square.
Cedar Shakes—Tapered: 1/2" to 3/4" x 25"—	\$17.00 per square.
Resawn: 3/4" to 1 1/4" x 25"—	\$22.00 per square
Average cost to lay shakes,	\$8.00 per square

MILLWORK—Standard.

D. F. \$150 per 1000. R. W. Rustic \$175 per 1000 (delivered).
Double hung box window frames, average with trim, \$12.50 and up, each.
Complete door unit, \$15 to \$25.
Screen doors, \$6.00 to \$8.00 each.
Patent screen windows, \$1.25 e sq. ft.
Cases for kitchen pantries seven ft. high, per lineal ft., \$12.00 each.
Dining room cases, \$15.00 per lineal foot. Rough and finish about \$1.00 per sq. ft.
Labor—Rough carpentry, warehouse heavy framing (average), \$65.00 per M.
For smaller work average, \$75.00 to \$85.00 per 1000.

MARBLE—(See Dealers)

PAINTING—

Two-coat work	per yard 75c
Three-coat work	per yard \$1.00
Cold water painting	per yard 25c
Whitewashing	per yard 15c
Turpentine,	\$1.85 per gal. in 5-gal. cont.
Raw Linseed Oil,	\$3.33 per gal. in 5-gal. cont.

Boiled Linseed

Oil	\$3.23 per gal. in drums.
Boiled Linseed Oil—	\$3.33 per gal. in 5-gal. containers.
Replacement Oil—	\$2.75 per gal. in drums. \$2.75 per gal. in 5-gal. containers.
Use Replacement Oil—	\$3.00 per gal. in 1 gal. cont.
A deposit of \$7.50 required on all drums.	

PATENT CHIMNEYS—

6-inch	\$2.00 lineal foot
8-inch	2.50 lineal foot
10-inch	3.50 lineal foot
12-inch	4.50 lineal foot

PLASTER—

Neat wall, per ton delivered in S. F. in paper bags, \$17.60.

PLASTERING (Interior)—

3 Coats, metal lath and plaster	Yard \$3.00
Keene cement on metal lath	3.50
Ceilings with 3/4" hot roll channels, metal lath (lathed only)	3.00
Ceilings with 3/4" hot roll channels, metal lath plastered	4.50
Single partition 3/4" channel lath 1 side (lath only)	3.00
Single partition 3/4" channel lath 2 inches thick plastered	8.00
4-inch double partition 3/4" channel lath 2 sides (lath only)	5.75
4-inch double partition 3/4" channel lath 2 sides plastered	8.75
Thermax single partition; 1" channels; 2 1/4" overall partition width. Plastered both sides	7.50
Thermax double partition; 1" channels; 4 3/4" overall partition width. Plastered both sides	11.00
3 Coats over 1" Thermax nailed to one side wood studs or joists	4.50
3 Coats over 1" Thermax suspended to one side wood studs with spring sound isolation clip	5.00
Note—Channel lath controlled by limitation orders.	

PLASTERING (Exterior)—

2 coats cement finish, brick or concrete wall	Yard \$2.50
3 coats cement finish, No. 18 gauge wire mesh	3.50
Lime—\$4.00 per bbl. at yard.	
Processed LLime—\$4.15 per bbl. at yard.	
Rock or Gyp Leth—3/4"—30c per sq. yd.	
1/4"—29c per sq. yd.	
Composition Stucco—\$4.00 sq. yard (applied).	

PLUMBING—

From \$150.00 per fixture up, according to grade, quality and runs.

ROOFING—

"Standard" tar and gravel, 4 ply—	\$11.00 per sq. for 30 sqs. or over.
Less than 30 sqs.	\$14.00 per sq.
Tile	\$40.00 to \$50.00 per square.
Redwood Shingles,	\$15.00 per square in place.
5/2 #1-16" Cedar Shingles, 4 1/2" Exposure	\$18.25 square

5/8 x 16"—#1 Cedar Shingles, 5" Exposure	\$17.00 sq. ft.
4/2 #1-24" Royal Shingles, 7 1/2" Exposure	\$23.00 sq. ft.
Re-coat with Gravel	\$5.50 per sq.
Asbestos Shingles	\$30 to \$60 per sq. ft.
1/2 to 3/4 x 25" Resawn Cedar Shakes, 10" Exposure	\$2.00
3/4 to 1 1/4 x 25" Resawn Cedar Shakes, 10" Exposure	\$2.00
1 x 25" Resawn Cedar Shakes, 10" Exposure	\$2.00

Above prices are for shakes in place.

SHEET METAL—

Windows—Metal,	\$2.50 a sq. ft.
Fire doors (average), including hardware	\$2.80 per sq. ft.

SKYLIGHTS—(not glazed)

Copper,	\$1.25 sq. ft. (flat).
Galvanized iron,	65c sq. ft. (flat).
Vented hip skylights	90c sq. ft.

STEEL—STRUCTURAL—

\$220 per ton erected, when out of place
\$270 per ton erected, when out of place

STEEL REINFORCING—

\$200.00 per ton, in place.

STORE FRONTS (None available).

TILE—

Ceramic Tile Floors—	\$1.70 per sq. ft.
Cove Base—	\$1.35 per lin. ft.
Glazed Tile Wainscot—	\$1.85 per sq. ft.
Asphalt Tile Floor 1/8" x 3/4"—	\$.40 per sq. ft.
Light shades slightly higher.	
Cork Tile—	\$1.00 per sq. ft.
Mosaic Floors—	See dealers.
Lino-Tile—	\$1.00 per sq. ft.

Wall Tile—

Glazed Terra Cotta Wall Units (single laid in place—approximate prices:	
2 x 6 x 12	\$1.25
4 x 6 x 12	1.50
2 x 8 x 16	1.45
4 x 8 x 16	1.75

VENETIAN BLINDS—

75c per square foot end up. Install extra.

WINDOWS—STEEL—

60c per square foot, \$5 for ventilator

IN THE NEWS

ARCHITECTS IN NEW BUILDING

The architectural firm of Koblik and Fisher of Sacramento, California, have moved into their new building on 13th street, according to a recent announcement.

The one-story building, constructed especially for the firm, cost \$25,000.

Arthur Sauer, structural engineer, also occupies space in the building.

NEW CABINET SPRING HINGE

A new 2 inch, as well as a 1 1/4 inch, wrought steel cabinet spring hinge has been announced by The STANLEY WORKS of New Britain, Conn.

The hinge is positive in action and is designed for use on cabinet doors that must remain closed when not in use.

The Company has also just announced a new screen door brace designed to prevent or correct sagging screen doors. Feature of



this 21 inch, wrought steel brace is a brass adjustment screw, located at one end, for quick and easy regulation and desired tension. It is applied to the inside of the door.

GLASS CONTAINER FACTORY

A contract amounting to \$500,000 has been awarded the firm of Larsen & Larsen, San Francisco, for the construction of a glass container factory at Hayward, California.

According to officials of the Atlas Imperial Diesel Engine Company of Oakland, owners of the building, the plant will be occupied by the Hunt Food Company when completed.

NEW BUSINESS DISTRICT

Plans have been completed for the purchase of a site of land near Hayward, California, for the construction of a block of new store buildings. Cost of the project is estimated at \$1,000,000.

ARCHITECTURAL OFFICE

Raymond L. Blackwell and Hans G. R. Schickele, architects, have announced the opening of offices in Berkeley, California, for the general practice of Architecture.

BUILDING TRADES WAGE (JOB SITES) NORTHERN AND CENTRAL CALIFORNIA

ATTENTION: The following are the PREVAILING hourly rates of compensation being paid and in effect by employers by agreement between employees and their union; or as recognized and determined by the U. S. Department of Labor. (Revised to January 1, 1948.)

CRAFT	San Francisco	Alameda and Contra Costa	Marin	Vallaja	San Mateo	San Jose	Stockton	Sacramento	Fresno
	RESTOS WORKERS	1.90	1.90	1.90	1.90	1.90	1.90	1.90	1.90
ICKLAYERS	2.25	2.25	2.25	2.25	2.25	2.25	2.25	2.50	2.25
ICKLAYERS, HODCARRIERS	1.75	1.75	1.75	1.75	1.75	1.75	1.87 1/2	1.87 1/2	1.75
ARPENTERS	2.00	2.00	2.00	2.00	2.00	2.00	2.00	2.00	2.00
EMENT FINISHERS	2.02 1/2	2.02 1/2	2.02 1/2	2.02 1/2	2.02 1/2	2.02 1/2	2.02 1/2	2.02 1/2	2.02 1/2
ELECTRICIANS	2.25	2.25	2.25	2.25	2.25	2.25	2.25	2.25	2.25
ENGINEERS: MATERIAL HOIST	2.00	2.00	2.00	2.00	2.00	2.00	2.00	2.00	2.00
ENGINEERS: PILE DRIVER	2.25	2.25	2.25	2.25	2.25	2.25	2.25	2.25	2.25
STRUCTURAL STEEL	2.25	2.25	2.25	2.25	2.25	2.25	2.25	2.25	2.25
GLASS WORKERS	1.87 1/2	1.87 1/2	1.87 1/2	1.87 1/2	1.87 1/2	1.87 1/2	1.87 1/2	1.87 1/2	1.87 1/2
ONWORKERS: ORNAMENTAL	2.10	2.10	2.10	2.10	2.10	2.10	2.10	2.10	2.10
ONWORKERS: REIN. RODMEN	2.00	2.00	2.00	2.00	2.00	2.00	2.00	2.00	2.00
STRUCTURAL	2.25	2.25	2.25	2.25	2.25	2.25	2.25	2.25	2.25
LABORERS: BUILDING & CONCRETE	1.40	1.40	1.40	1.40	1.40	1.30	1.40	1.40	1.30
LABORERS: OTHERS	2.25	2.25	2.25	2.25	2.25	2.25	2.25	2.25	2.25
BRICK SETTERS	2.00	2.00	2.00	2.00	2.00	2.00	2.00	2.00	2.00
OSAIC & TERRAZZO	2.00	2.00	2.00	2.00	2.00	2.00	2.00	1.75	1.75
PAINTERS	2.00	2.00	2.00	2.00	2.00	2.00	2.00	2.00	2.00
PAINTERS: LEADERS	2.12 1/2	2.12 1/2	2.12 1/2	2.12 1/2	2.12 1/2	2.12 1/2	2.12 1/2	2.12 1/2	2.12 1/2
PAINTERS: MASTERERS	2.25	2.50	2.25	2.50	2.25	2.25	2.05	2.05	2.05
PAINTERS: MASTERERS: HODCARRIERS	2.00	2.00	2.00	2.00	2.00	2.00	1.87 1/2	1.87 1/2	1.87 1/2
PAINTERS: JUNGERS	2.25	2.25	2.25	2.25	2.25	2.25	2.25	2.25	2.25
PAINTERS: JOBBERS	2.00	2.00	2.00	2.00	2.00	2.00	2.00	2.00	2.00
PAINTERS: SHEET METAL WORKERS	2.00	2.00	2.00	2.00	2.00	2.00	2.00	2.00	2.00
PAINTERS: CRINKLER FITTERS	2.00	2.00	2.00	2.00	2.00	2.00	2.00	2.00	2.00
PAINTERS: SHAMFITTERS	2.25	2.25	2.25	2.25	2.25	2.25	2.25	2.25	2.25
PAINTERS: ONESETTERS (MASONS)	2.25	2.25	2.25	2.25	2.25	2.25	2.25	2.25	2.25
PAINTERS: LESETTERS	2.15	2.15	2.15	1.90	2.15	1.90	1.90	1.90	1.90

Prepared and compiled by

CENTRAL CALIFORNIA CHAPTER, ASSOCIATED GENERAL CONTRACTORS OF AMERICA

with the assistance and cooperation of secretaries of Building Trades Unions, General Contractors Associations and Builders Exchanges of Northern California

CLASSIFIED ADVERTISING

RATE: 20c PER WORD . . . CASH WITH ORDER

MINIMUM \$5.00

ARCHITECT'S REPORTS—A valuable advance news service giving building and construction information daily on projects in Northern California. Name, location, architect, proposed cost, etc., on individual slips. Deal for securing new business leads. Hundreds of items, total monthly cost only \$10. Don't delay, subscribe today. ARCHITECT

& ENGINEER, Room 618, 68 Post Street, San Francisco, California. Phone DOugles 2-8311.

PHOTOGRAPHS: Specializing in building and construction photographs for publication, or historic records. For Industrial-Aerial. Publicity photography use the INDUSTRIAL

San Francisco. PHOTO'S, Room 722, Hearst Bldg., San Francisco, Phone SUtter 1-6953.

ENGRAVING—Good engravings are essential to a satisfactory job of printing reproduction. For the best, see Poor Richard Photo Engraving Co., 324 Commercial St.,

SISALKRAFT

REG. U. S. PAT. OFF.

"More than a building paper"

THE SISALKRAFT CO.

205 West Wacker Drive
Chicago, Ill.

55 New Montgomery Street
San Francisco, Calif.

CLINTON CONSTRUCTION CO. OF CALIFORNIA

General Contractors

923 FOLSOM STREET • SAN FRANCISCO

SUtter 1-3440

HOGAN LUMBER CO.

Wholesale and Retail

LUMBER

MILL WORK • SASH & DOORS

Office, Mill, Yard and Docks

SECOND AND ALICE STREETS • OAKLAND, CALIF.

Telephone GLencourt 1-6861

SANTA MARIA INN SANTA MARIA, CALIFORNIA

FRANK J. McCOY, General Manager

FERNAND E. PIMENTEL, Manager

On the
Coast
Highway
between
San
Francisco
and
Los
Angeles



American
or
European
Plan
•
Old
English
Tee
Room

MODERN MEDICAL CENTER

(From page 32)

ject for the special use of patients who enter the units by way of private walks and inside entrances, thus eliminating any contact with traffic on adjacent streets. Each building has parking space for 4 to 8 cars. Doctors' private entrances are on the opposite side or outside, as with the outer rows of buildings.

Eventually, the project will be beautified with shade trees surrounding the block, green lawns around the buildings and parking strips, with shrubberies and flower gardens lending a colorful park-like aspect to the area.

Financing of the enterprise was accomplished thru the Mutual Life Insurance Co. with final approval of the CPA as the units are all taken over by the doctors who have the option of either renting or buying their own establishment. Eventually, it is expected that each physician will own his own unit with costs apportioned to the various facilities included.

Among other important advantages of the new medical center to the city as a whole is the fact that approximately 1,000 cars per day pass thru the center, thus relieving congested downtown areas by the same number. City bus lines running by the center offer convenient transportation from all parts of the city to patients not using autos.

Doctors everywhere have become so enthusiastic over these "grounded" medical centers which possess so many advantages over the downtown medical buildings, they are now demanding similar projects in many other cities. Upon completion of the Tacoma center, Hungate will go to California to establish like enterprises in several cities requesting his services in promoting and organizing the doctors in the communities for mutual cooperation in establishing such cooperative ventures.

SCHOOL ADDITION. Sacramento (California) Board of Education will build a \$321,940 addition to the Tahoe Grammar School. Gordon Stafford is the Architect and Holdener Construction Company is the general contractor.

DENTAL BUILDING. Contract has been awarded Robert Norlie Contractor for construction of a Dental Office Building in Chico, California, at a cost of \$20,000. A. W. Story, Chico, is the architect.

GYMNASIUM. R. Pedersen & Son, Fresno, have been awarded a \$67,061 contract for construction of a gymnasium building, Central Union High School of Fresno.

BOOK REVIEWS

PAMPHLETS AND CATALOGUES

AIR CONDITIONING. Heating Coils. Cooling Coils. McQuary, Inc., Minneapolis, Minn.

New literature on heating and cooling coils, including the new plate type ripple-fins and many other features, has been issued by the McQuary, Inc., Minneapolis, Minn. Identified as A.I.A. FILE No. 30-C-4, the catalogues contain photographs of various installations; drawings; charts, and scales. Copies are available from the manufacturer.

WESTERN PINE ASSOCIATION. Portland, Oregon.

Publication of a new edition of their Directory of Membership was announced recently by the Western Pine Association.

Dated June 1, 1948, the directory lists 256 firms, their locations, sales office addresses and a percentage breakdown of their production by species. The booklet also gives a listing of the staple products handled and factory products and specialties. It contains the names of 50 more firms than were listed in the Jan. 1, 1948, edition.

Copies may be secured by writing the Western Pine Association, Yeon Building, Portland 4, Oregon. The directory may be obtained either flat, measuring 8½ x 11 inches, or folded to 8½ x 3½ inches.

THIRTY-THREE YEARS FOR SMOOT-HOLMAN CO.

Smoot-Holman Company this year celebrates a third of a century of West Coast manufacturing. Established in 1915, by C. E. Smoot, President and G. W. Holman, Vice President, the company has achieved world-wide acceptance of its pressed steel plumbing fixtures.

A Western leader in the field of industrial, commercial, fluorescent and outdoor lighting equipment Smoot-Holman manufactures under strict R. L. M. and Fleur-olier specifications. The main plant is located in Inglewood, California with a branch and warehouse in San Francisco and offices in principal Western cities.

PACIFIC MANUFACTURING CO.

High Class Interior Finish Quality
Millwork

16 Beale St., San Francisco
Garfield 1-7755
2215 El Camino Real, San Mateo
S. M. 5-0687
304 Bryant Street, Palo Alto
P. A. 3373
2610 The Alameda, Santa Clara
S. C. 607 (Factory)
6820 McKinley Avenue, Los Angeles
Thornwall 4196

MAIN OFFICE — SANTA CLARA

"AMERICAN - MARSH" CONDENSATION UNIT

Pumping
Machinery
for
Every
Purpose

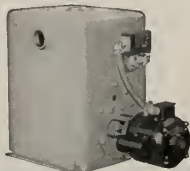

For Service
Call
DOuglas
2-6794
or
MUtual 8322

SIMONDS MACHINERY CO.
SAN FRANCISCO 816 FOLSOM
LOS ANGELES 455 EAST 4TH

VERMONT MARBLE COMPANY

Producers and Finishers
of
Domestic and Imported Marbles

525 MARKET STREET, SAN FRANCISCO
Phone Sutter 1-6747
3522 COUNCIL STREET
(Beverly Blvd. at Virgil Ave.)
LOS ANGELES 4, CALIF.
Telephone Fairfax 7834



The Most Complete Line of
STEELS and BUILDING MATERIALS
Made by a Single Producer



See Sweet's Catalog File or write us for
full information.

REPUBLIC STEEL CORPORATION

GENERAL OFFICES: CLEVELAND, OHIO

DENVER, COLORADO CONTINENTAL OIL BUILDING
LOS ANGELES, CALIFORNIA EDISON BUILDING
SALT LAKE CITY, UTAH WALKER BANK BUILDING
SAN FRANCISCO, CALIFORNIA RIALTO BUILDING
SEATTLE, WASH. WHITE-HENRY-STUART BUILDING

IN THE NEWS

MUNICIPAL BONDS have been voted for construction of a \$155,000 recreation building for Burlingame, California. Sharpe & Brown are the architects.

NEW STORES. Architects Roselyn & Gartner of San Francisco have announced that work will start immediately on a group of new store buildings in Hayward

(California) which will cost some \$750,000.

NEW THEATER. A contract has been awarded to the Mariposa Construction Company, San Francisco, for construction of a 500-seat theater building at Escalon, California. O. A. Deichman, San Francisco, is the architect.

LANDSCAPING. A contract has been awarded to the Christensen Nursery Company of Belmont for landscaping the new Lewis Hall

and Chemistry Buildings on the University of California campus at Berkeley. Cost \$13,185.

SCHOOL BIDS REJECTED. Bids for construction of an addition to the Coleman Grammar school in San Rafael, California, were rejected recently. Kirby & Mulvihill, San Francisco, are the architect.

PREFAB RESIDENCES. A general contract has been awarded to the Harry Y. Dorman construction Company of Sacramento for the erection of 30-prefab employee residences at the Preston School of Industry at a cost of \$129,452.

LABOR TEMPLE BUILDING to be built in San Jose (California) will cost \$183,795, according to L. Richards, Architect, who reports contract has been awarded to the Carl N. Swenson Company of San Jose.

SCHOOL BONDS VOTED for additions to the high school at Dinuk (California) in the amount of \$287,000. Fred L. Swartz & Wm. Tyber Fresno, are the architects.

BASEBALL GRANDSTAND. Contract for construction of a baseball grandstand for the City of Salinas (California) was awarded to F. Hampshire of Salinas, for \$42,430. Chas. E. Butner, Salinas, is the architect.

BONDS DEFEATED. Voters in Piedmont (California) defeated proposed \$250,000 bond issue for the construction of a swimming pool and bath house.

SCHOOL BONDS VOTED. San Anville (California) recently approved a \$174,000 bond issue for the construction of a new grammar school building.

MEMORIAL HOSPITAL at San Rosa (California) costing \$1,000,000 has been awarded to Barrett Hilt, San Francisco. Frank Georgeson, San Francisco, is the Architect.

MURPHY'S WINDMILL. Weller & DeNardo Contractors have been awarded a \$28,885 contract by the San Francisco Park Commission for repairs to the famed Murphy Windmill at the beach entrance to Golden Gate Park.



Immediate Steel Service

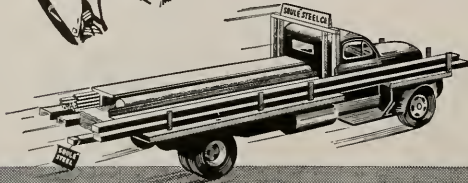

Windows and Doors



Reinforcing Commodities

Merchant Steel

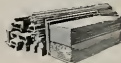

Metal Lath Commodities

Steelforms

Light Steel Construction



Steel Buildings

Phone { SAN FRANCISCO • Valencia 4-4141
LOS ANGELES • Lafayette 0911



55-25

Soulé STEEL COMPANY

SAN FRANCISCO • LOS ANGELES • PORTLAND • SEATTLE

FABRICATORS OF STEEL BUILDING PRODUCTS SINCE 1911

Subscribe
Now —

ARCHITECT and ENGINEER

\$3.00
Per Year

THE TORMEY COMPANY

GENERAL PAINTERS
AND DECORATORS

Phone Underhill 1-1913

563 FULTON STREET
San Francisco



Brownskin
VAPORSEAL

The resilient building paper creped to S-T-R-E-T-C-H

Quality Products Since 1895

ANGIER PACIFIC CORPORATION
54 NEW MONTGOMERY ST. 7414 SUNSET BOULEVARD
SAN FRANCISCO 5, CALIF. 4031 AMESLEY AVE. CALIF.
A complete line of Angier products available from your building material dealer



Fine ENGRAVINGS

POOR RICHARD
PHOTO ENGRAVING CO.

320-324 COMMERCIAL STREET
SAN FRANCISCO 11

IN THE NEWS

BOWLING ALLEY

Contract for the construction of a bowling alley in San Carlos, California, has been let to Peter Sorensen, Redwood City, Contractor. Cost of the project is \$50,000.

NEW TYPE VENTED HEATER

Styled to blend into any room treatment, a new type vented heater is being introduced by the Holly Manufacturing Company of Pasadena.



The heater is available with inputs of 37,000 BTU and 45,000 BTU for natural or manufactured gas; require a wall opening of only 28" by 51"; finished in baked enamel; and top panel louvers give a downward and outward direction to the warmed air flow, while lower louvers near the base (which is raised off floor) give off radiant heat.

GENERAL CONTRACT AWARDED

Guy E. Hall, Bakersfield, contractor has been awarded a general contract for the construction of an Economics and Cafeteria Building for the East Bakersfield High School at a cost of \$476,817. Chas. H. Biggar, C. H. Alford and W. J. Thomas, Bakersfield, are the architects.

THEATER BUILDING at Watsonville (500 seats) will be built by T. H. Rosewall, Watsonville contractor at a cost of \$100,000. Vincent G. Raney, San Francisco, is the Architect.

ELEMENTARY SCHOOL for Oakland, California, costing \$512,250 will be built by Willis F. Lynn, Contractor.

Phone GARfield 1-1164

Thomas B. Hunter

DESIGNER OF HEATING

AIR CONDITIONING
VENTILATING AND WIRING
SYSTEMS, MECHANICAL
AND ELECTRICAL EQUIP-
MENT OF BUILDINGS

★

41 SUTTER STREET
ROOM 710

San Francisco

California

Scott Company

HEATING - - PLUMBING - - TILE

★

243 MINNA STREET

SAN FRANCISCO

Phone EXbrook 2-6741

DINWIDDIE CONSTRUCTION COMPANY

BUILDERS

CROCKER BUILDING
SAN FRANCISCO



HERRICK IRON WORKS

STRUCTURAL STEEL
REINFORCING STEEL

18TH AND CAMPBELL STS.
OAKLAND, CALIF.
Phone GLencourt 1-1787

**PITTSBURGH
TESTING LABORATORY**

ENGINEERS AND CHEMISTS

Testing and Inspection of Concrete,
Steel and Other Structural Materials

Design of Concrete Mixes

Offices in all principal cities

651 Howard St., San Francisco 5
EXbrook 2-1747

**Mattock Construction
Company**

Builders



604 MISSION STREET
SAN FRANCISCO

**INDEPENDENT
IRON WORKS**

Steel Buildings
Service Stations
Steel Storage Tanks
Fabricated Plate Work
Steel and Sheet Metal Products
Fabricated Structural Steel
Steel Distributors

Eighth & Pine Sts. Oakland, 7

**MULLEN MFG.
COMPANY**

BANK, STORE AND OFFICE
FIXTURES—CABINET WORK
OF GUARANTEED QUALITY
CHURCH SEATING

Office and Factory
60-80 RAUSCH ST., Bet. 7th and 8th Sts.
San Francisco
Telephone UNdarhill 1-5815

Index to Advertisers

ANGIER Pacific Corp.	49
ARCHITECTS Report	42
BASALT Rock Company..... Back Cover	
BAXTER & Company, J. H.	38
CLASSIFIED Advertising	43
CLINTON Construction Company	46
CONTINENTAL Water Heater Co.	*
DETROIT Steel Products Co.	5
DINWIDDIE Construction Co.	49
DUFFY TILE Co.	50
FORDERER Cornice Works	42
FOX Tile Co.	40
FULLER, W. P. Co.	2
GLADDING, McBean & Co.	7
GUNN, Carle & Company	41
Hanks, Inc., Abbott A.	50
HAWS Drinking Faucet Company	36
HERRICK Iron Works	49
HOGAN Lumber Company	46
HUNT, Robert W., Company	50
HUNTER, Thos. B.	49
INDEPENDENT Iron Works	50
JOHNSON, S. T. Co.	*
JUDSON, Pacific-Murphy Corp.	42
KRAFTILE Company	33
MARBLE Institute of America	*
MATTOCK, A. F., Co.	50
MICHEL & Pfeffer Iron Works Inside Front Cover
MULLEN Mfg. Co.	50
MUELLER Brass Co.	*
NORTHERN California Electric Bureau	37
PACIFIC Coast Gas Association	*
PACIFIC Manufacturing Company	47
PACIFIC Portland Cement Company	*
PACIFIC Telephone & Telegraph Co.	35
PADDOCK Engineering Co.	*
PITTSBURGH Testing Laboratory	50
POOR RICHARD Engraving Co.	49
REMILLARD-Dandini Co.	50
REPUBLIC Steel Corporation	47
SANTA Maria Inn	46
SCOTT Co.	49
SIMONDS Machinery Company	47
SIMPSON Logging Co.	6
SISALKRAFT Company	46
SMOOT-Holman Co.	39
SOULE Steel Co.	48
STANLEY Works, The	*
SUPERIOR Fireplace Company	*
TAYLOR Co., Halsey W.	40
TORMEY Company, The	49
U. S. BONDS	1
VERMONT Marble Company	47
WESTIC Company	*
WESTERN Asbestos Co.	41
WESTERN-Holly Stove Co.	8
WOOD, E. K., Lumber Company	38

*Indicates Alternate Months

Robert W. Hunt Company

ENGINEERS

Inspection - Tests - Consultation
Schools and Other Structures
Are Built as Designed

When Construction Materials are
Inspected at point of Manufacture
and during Erection by

ROBERT W. HUNT COMPANY

Cement, Concrete, Chemical, Metallurgical,
X-Ray and Physical Laboratories

Chicago - New York - Pittsburgh
Los Angeles - All Large Cities
San Francisco, 251 Kearny Street

REMILLARD-DANDINI CO.

**Brick and
Masonry Products**



400 MONTGOMERY STREET
SAN FRANCISCO, CALIF.

DUFFY TILE CO.

TILE CONTRACTORS
SHOWER DOORS
TUB ENCLOSURES



INSTALLATIONS
OF EVERY
DESCRIPTION
Modernizing, Repairing
"Not Now Cheap
But How Good!"
253 MINNA
YUkon 6-1489

ABBOT A. HANKS, INC.
Engineers & Chemists

INSPECTING — TESTING — CONSULTING
CONCRETE • STEEL • MATERIALS
CHEMICAL AND TESTING
LABORATORIES
• RESEARCH AND INVESTIGATION

TESTS OF STRUCTURAL MATERIALS
DESIGN OF CONCRETE MIXES
SHOP AND ERECTION INSPECTION
STRUCTURES AND EQUIPMENT
INVESTIGATION OF STRUCTURES
AND MATERIALS
TESTS AND INVESTIGATION OF
FOUNDATION SOILS
FIRE RESISTANCE AND INSULATION
TESTS

624 Sacramento Street, San Francisco

ARCHITECT AND ENGINEER

JAMES GRAHAM MANUFACTURING COMPANY, Newark, California

LIBRARY

JUL 29 1948

DEPT



FREDERICK H. REIMERS, Architect

1948



STEEL STAIRS FOR TANKS

Economical, sturdy and fireproof, ARISTON Steel Stairs are expertly engineered and constructed for all industrial uses. Quickly and easily installed by your workmen or our mechanics.



Michel & Pfeiffer Iron Works, Inc.

KENNETH OPIE, Manager Misc. and Ornamental Division
Tenth and Harrison Streets, San Francisco 3, California
Telephone MArket 1-5966

ARCHITECT

Vol. 174 No. 1

AND ENGINEER

ARCHITECTS' REPORTS—Published Daily

E. H. WILDER
Editor

MARK DANIELS, A.I.A.
Associate Editor

PROF. LELAND VAUGHAN
Landscape Architecture

JOHN A. BLUME
Structural Engineering

MICHAEL GOODMAN
Planning

JOHN S. BOLLES, A.I.A.
Book Reviews

★

COVER PICTURE:

New Office Building of the Graham Manufacturing Company, Newark, California, designed by Architect Frederick H. Raimers, and built by Williams-Burrows, Incorporated.

For details see page 24

Contents for

JULY

EDITORIAL NOTES	4
NEWS & COMMENT ON ART	11
New Approach to an Old Problem	12
By PATRICIA P. COLEMAN	
STUDENT WORK, From the Division of Landscape Design, University of California, Berkeley	15
PAINTING FOR DISINFECTATION OF ROOMS AND BUILDINGS, The Germ and Mildew Destroying Effects of Paint	20
By DR. W. SCHWEISHEIMER	
TROPICAL ROOF, Africa Development	21
TRUCK SALES & SERVICE, San Francisco, California	22
OFFICE BUILDING, James Graham Manufacturing Company, Newark, California	24
By EUGENE BURNS	
ENGINEERING PRINCIPLES, In House Design	27
GARDENS IN FUTURE CHINATOWN, San Francisco	29
By ALBERT WILSON, Botanist, National Broadcasting Company	
A.I.A. ACTIVITIES	31
WITH THE ENGINEERS	32
HEADLINE NEWS & VIEWS	36
By E. H. W.	
LANDSCAPE ARCHITECTURE, Notes of the Profession	38
BOOK REVIEWS, Pamphlets and Catalogues	45
IN THE NEWS	46, 47

ARCHITECT AND ENGINEER (Established 1905) is published on the 15th of the month by The Architect and Engineer, Inc., 68 Post St., San Francisco 4; Telephone EXbrook 2-7182. President, K. P. Kierulff; Vice-President and Manager, L. E. Peahorwood; Treasurer, E. N. Kierulff.

Los Angeles Office: Weatworth F. Green, 6605 Hollywood Blvd., Los Angeles 28. Telephone HEmpstead 3171.

Entered as second class matter, November 2, 1905, at the Post Office in San Francisco, California, under the Act of March 3, 1879. Subscriptions United States and Pan America: \$3.00 a year; \$5.00 two years; foreign countries \$5.00 a year; single copy 50c. ARCHITECTS' REPORTS are published daily from this office, Vernon S. Yallop, Manager. Telephone DOUglas 2-8311.



EDITORIAL NOTES

Nearly 20,000,000 tons of raw steel has been lost as a result of major strikes since the beginning of 1946—nearly the total amount of steel supplied to the automobile industry in both 1946 and 1947. It's no wonder new automobiles are scarce and high priced.

.....

THERE may be some unpublished reason which justifies the State of California in going to New York City to employ an engineer capable of informing the State Department of Public Works how and where the State of California should locate and build a second Bay crossing, however, we fail to detect even the slightest need for such action.

Nowhere in the world will you find a more centralized headquarters for top-notch engineering talent than on the Pacific Coast where many of the world's major engineering projects are conceived and developed for localized execution.

With such an array of internationally recognized engineering talent on the West Coast readily available to assist the State of California with its second Bay crossing problems, there must be some factor other than engineering ability which causes the State Department of Public Works to seek engineering services in New York.

Perhaps to the well known quotation, "All is fair in love and war", there should be an amendment to include "and politics".

.....

APPRENTICES in the building trades show a steady increase according to a recent survey, and those who are prone to wonder what will happen to the Construction Industry in the future should take cognizance of the fact that the ranks of the men who build the nation's commercial, industrial, and residential structures are increasing at this time.

The fact that the latest figures show some 128,200 apprentices are in training, which incidently is an increase from the 115,100 in training at the first of the year, is indicative of two very important factors.

First, it shows that the building trades have something specific and permanent to offer in the way of satisfactory employment for those who are seeking a sound means of meeting economic conditions and earning a livelihood which embodies a certain amount of security over a longer period of time.

Second, this substantial increase in apprentices in the building trades shows the results of an

effort of capital and labor to solve a situation within the industry which was fast becoming detrimental to the building trades and to the construction industry.

Continued cooperation among all interests recognize and meet the vigorous demand for building labor will certainly accrue to the lasting benefit of everyone concerned in the construction industry . . . builders, who provide employer labor unions, who provide manpower; and government, which provides capital.

Property is the fruit of labor; property is desirable; it is a positive good in the world. That some men should be rich shows that others may become rich, and hence is just encouragement to industry and enterprise.—Abraham Lincoln.

.....

WELDING INSPECTION for structural work in school buildings throughout California will be placed under an economical and adequate procedure by the Architectural Division of the State Department of Public Work, if the recommendations of a special committee of the Structural Engineers Association of Northern California are accepted.

Inspection of structural welds for schools, with particular reference to the Gamma Ray and Magna-Flux methods as proposed by the State Division of Architecture, was recently considered by the Research Committee of the Structural Engineers Association with the conclusion being reached that:

"All welds called for on design plans and/or specifications shall be inspected, unless such inspection is waived on the plans and approved by the State. (2) Welders shall be periodically certified by the State. (3) Inspectors shall be periodically certified by the State. (4) All welds which are defective shall be replaced or corrected. (5) With the assurance of competent welding and inspection as specified above, full reliance should be placed on adequate visual inspection of welds rather than on Gamma Ray or Magna-Flux methods of inspection, which are impractical and controversial in many cases for structural welds."

ATTENTION: Inadvertently credit for the drawings of the CHINATOWN RE-DEVELOPMENT feature appearing in the JUNE 1948 issue of ARCHITECT & ENGINEER was omitted. Mr. Steven Lee prepared the Chinatown Re-Development drawings toward his degree for Master in Architecture, and the design for the Waverly Place remodeling in Chinatown should be credited to Mr. Connequ. We are sorry that the students participating in the project were not recognized in the original publication.



Fenecraft Combination Windows, Types 636 and 616, joined with steel mullions to provide abundant daylighting—ideal for a hospital nursery. Sill vent tilts in—guards against drafts, prevents children falling out.

How to get Larger Window Areas *with maximum economies*

The trend to larger window areas for better daylighting and better ventilation makes window cost more and more a point for consideration.

To get larger areas with maximum savings, give a thought to the use of standard window units, combined to make attractive, efficient sources for daylight, ventilation—as well as view.

Fenestra Fenecraft Windows are ideal for this purpose. They're famous Fenestra quality in every respect—suitable for the finest buildings. Yet standardization of types and sizes has resulted in manufacturing economies that mean lower first cost. Standardization results in construction

economies, as well—in that it permits co-ordination of window dimensions with those of commonly-used wall materials.

There's a wide range to choose from—many sizes and ventilator arrangements—in three popular types, Combination, Projected and Casement. Being steel, they can't warp, shrink or rot. Made by America's oldest and largest manufacturer of steel windows. You can count on them for quality construction that means better appearance, permanently easy operation and lower maintenance costs.

For information on types and sizes available, see Sweet's Architectural File for 1948 (Section 16a-14). Or mail the coupon.



FENECRAFT CASEMENT WINDOW

Safe washing—from inside. Easy to operate. Uniform screens, protected from outside dirt. "Homey" appearance makes them ideal for clubs, large homes, dormitories and nurses' homes.



FENECRAFT PROJECTED WINDOW

Open-out vent acts as weather-protecting canopy over opening. Open-in vent deflects air upward, sheds water outside. Widely used for schools. Horizontal lines are especially suited to low, wide buildings.

Fenestra



FENECRAFT INTERMEDIATE STEEL WINDOWS

Detroit Steel Products Company,
Dept. AE-7
1310 - 63rd Street,
Emeryville (Oakland), Calif.

Please send me data on types and sizes of the new Fenecraft family of Fenestra Windows:

Name

Company

Address

MOCK & MORRISON

ARCHITECTS

RESEARCH BUILDING

TACOMA, WASHINGTON

June 9, 1943

Simpson Industries,
1010 White Building,
Seattle 1, Washington.

Gentlemen:

In answer to your inquiry, we are pleased to be able to say that the Simpson Acoustical Tile recently installed in the Meeker Grade School in Puyallup, Washington, has proved to be very satisfactory in both performance and appearance.

Our experience with previous schools has indicated that a material having a minimum noise-reduction coefficient of .60 is necessary for adequate quieting of the average school classroom or corridor. The specifications for the Meeker School called for a perforated fiber material having this value. In the past it has been necessary to use material up to 3/4" thick in order to obtain the necessary minimum coefficient of .60.

As a result of our experience with Simpson Acoustical Tile in the Meeker School, this material has been approved for and is now being installed in the Maplewood School, also in Puyallup.

Very truly yours,

MOCK & MORRISON

By *E. T. Mock*

E. T. Mock

ETM/R

HERE is a typical example of an architectural firm making a substantial saving in building costs for its client and at the same time providing an adequate noise-quieting installation with fine appearance. Mock & Morrison, widely known architects of Tacoma, Washington, specified a perforated fiber acoustical material having a minimum noise reduction coefficient of .60, for noise-quieting of the classrooms and corridors in the new addition to the Meeker Grade School, Puyallup, Washington. 1/2" Simpson Acoustical Tile, with its unmatched sound absorption, met the specifications at a considerably lower cost than that of the thicker materials formerly necessary to give the desired amount of quieting.

WOODFIBER DIVISION, SIMPSON LOGGING CO.

Plant at Shelton, Washington

Sales Division: SIMPSON INDUSTRIES
1010 White Bldg., Seattle 1, Washington

Discuss This New Acoustical Tile With Your Nearest Simpson Acoustical Contractor

ACOUSTICS NORTHWEST

Builders Exchange Bldg.
Portland 4, Ore. Phone: Alwater 6443

ANGELES INDUSTRIES

984 McGarry St., Los Angeles, Calif.
Phone: Trinity 8121

APPLICATION SERVICE CO.

420 Continental Oil Bldg.
Denver 2, Colorado.
Phone: Alpine 4662

ASBESTOS PRODUCTS COMPANY

1780 Kettner Blvd., San Diego, Calif.
Phone: Franklin 7665

M. H. BALDWIN

2804 East Hawthorne
Tucson, Arizona. Phone: 2804-J

COAST INSULATING PRODUCTS

634 South Western Ave.
Los Angeles 5, Calif.
Phone: Fitzroy 1118

CONSOLIDATED ROOFING & SUPPLY CO.

520 S. 7th Ave.
Phoenix, Arizona. Phone: 47888
CONTINENTAL LUMBER CO.
P. O. Box 2042
Boise, Idaho. Phone: 450

CRAIG & PULLEN

338 Ward St.
Honolulu, T. H. Phone: 6107

CRAMER COMPANY

345 Vermont St.
San Francisco, California
Phone: Market 1-0411

CRAMER COMPANY

1933 Merced St.
Fresno, Calif. Phone: 3-1131

DALE TILE CO.

1020 LaSalle Ave.
Minneapolis 2, Minn. Phone: Br. 8831

ELLIOTT BAY LUMBER COMPANY

600 W. Spokane St.
Seattle, Wash. Elliott 8088

LUMBER DEALERS, INC.

423 N. 33rd
Billings, Montana. Phone: 2-1111

MANSON MATERIALS, INC.

E-210 Riverside Ave.
Spokane, Wash. Main 124

UTAH PIONEER CORPORATION

333 W. 1st South
Salt Lake City 14, Utah
Phone: 4-1717



Ultra-modern kindergarten, Meeker Grade School, Puyallup, Washington, showing Simpson Acoustical Tile installation. Similar installations were also made in all other classrooms and corridors in the new school addition.

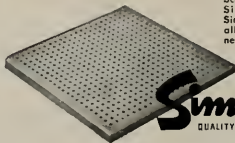

Simpson
QUALITY SINCE 1895
ACOUSTICAL TILE

With Exclusive **HOLLOKORE**
Drilled Perforations



Contractor: N. P. Severin Co., Chicago

BEAUTY . . . one of the advantages that makes

Ceramic Veneer the preferred facing material in the West!

Clean lines, massive simplicity and warm-hued Granitex Anchored Type Ceramic Veneer facing combine to make the U. S. Court House in Seattle one of the most beautiful modern structures in the West! W. E. Reynolds, Commissioner, and Gilbert Stanley Underwood, Architect, also specified Adhesion Type Ceramic Veneer for interior walls because this machine-perfected terra cotta

is permanent, non-fading and as soil-resistant as a fine china plate.

Not only in Seattle but in all the principal Pacific Coast cities, you'll find the majority of the larger buildings faced with Ceramic Veneer. So why not investigate how this modern facing material can serve you and your clients?

Dept. 27



GLADDING, McBEAN & CO.

CERAMIC VENEER

The modern, machine-perfected terra cotta

OFFICES AT: LOS ANGELES • SAN FRANCISCO • SEATTLE • PORTLAND • SPOKANE

THE *Western-Holly* ECONOMY QUARTETTE OFFERS YOU THE BIGGEST VALUE IN COMPACT SIZE GAS RANGE



Model C-482

1. Tempa-Plates—Afford new cleanliness
2. Four Large, High-Speed Burners
3. Automatic Top Pilot Lighting
4. One-Piece Oven Construction
5. Open Temperature Control
6. High-Speed Broiler

SPECIFICATIONS

Model C-482 (Left)
 Model S-482 (Right)
 Width: 20 inches
 Height: 35 inches
 Floor Space: 20 by 25 inches
 Oven: 16 inches wide

Model S-482 (Right)
 More moderately priced, this model has all the features listed above, except Tempa-Plates are replaced by spiders. Has black enamel top.



Model S-482



"Californian 20"



"Californian 30"

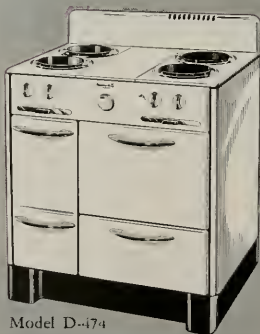

Model D-474

Model D-474 (Left)
 All features listed above plus handy storage compartment.

Model S-474 (Right)
 Has same features as D-474, except Tempa-Plates are replaced by spiders. Has black enamel top.

SPECIFICATIONS

Model D-474 (Left)
 Model S-474 (Right)
 Width: 30 inches
 Height: 35 inches
 Floor Space: 30 by 25 inches
 Oven: 16 inches wide



Model S-474

for Immediate Delivery!

phone direct **TEXAS 02901**

WESTERN STOVE COMPANY, INC.

CULVER CITY, CALIF.

© 1948, Western Stove Company, Inc., Culver City, Calif.

ARCHITECT AND ENGINEER

This kind of magic is easy!



NOTHING in your hands! Nothing up your sleeves! But look . . .

. . . out of your *present income* grows a wonderful future. There's a home in the country, college for your children, travel and fun for the whole family, even a comfortable retirement income for yourself.

And this is no trick, no illusion. *It really can happen!* It is happening right now for millions of wise Americans who are buying U. S. Savings Bonds *automatically* on the Payroll Savings Plan.

Here's how the magic works. All you do is sign up for the Payroll Plan. Then regularly, automatically, part of everything you earn is used to purchase Savings Bonds.

And magically, week after week, these *automatic savings* pile up the money you'll need to pay for the future you want!

Don't forget that every dollar you put into Savings Bonds is a "money-making dollar"—

that \$75 Bond you buy today will be worth \$100 in just 10 years. And these Bonds play a big part in helping keep our country financially sound and strong, too.

They're always available at any bank or post office. But the surest way—the easiest way—to build financial security for your future is to buy them *automatically* on the Payroll Plan.

If you're not on a payroll, and have a checking account, you can still enjoy the magic of automatic saving with the Bond-A-Month Plan. Ask about it at your bank.

AUTOMATIC SAVING IS SURE SAVING — U.S. SAVINGS BONDS

Contributed by this magazine in co-operation
with the Magazine Publishers of America as a public service.



A THIRD OF A CENTURY

of West Coast Manufacturing



C. E. SMOOT



G. W. HOLMAN

SMOOT-HOLMAN CO. this year observes its 33rd year of West Coast Manufacturing experience. With the obvious advantages of location, SMOOT-HOLMAN CO. combines know-how engineering and production standards that place this firm among the country's leading R. L. M. manufacturers. To the critical buyer, the SMOOT-HOLMAN label is an assurance of dependable performance at reduced maintenance cost.

Offices in
Principal
Western
Cities



Branch and
Warehouse
in
San Francisco

Manufacturers of
INDUSTRIAL, COMMERCIAL,
FLUORESCENT AND OUTDOOR
LIGHTING EQUIPMENT
PRESSED STEEL PLUMBING
FIXTURES
AMMUNITION CHUTING

NEWS AND COMMENT ON ART

CITY OF PARIS

A Group Show of Watercolors, Gouache, and Oil on paper by French and American artists from the Binet Gallery in New York, will be shown in the Rotunda Gallery from July 14 to August 7. At the same time there will be a Gouache display by Frances Baldwin of San Francisco.

The Art in Action Shop will feature Pictures of the Month by Matthew Barnes; and for your summer wardrobe, handwoven Guatemalan textiles in Original costumes designed by Syd Springer. Also demonstrations on the Weav-Rite Loom, July 1 to 31.

M. H. DE YOUNG MEMORIAL MUSEUM

Opening of the 1948 La Tausca Art Exhibition on June 25 afforded an opportunity to become more aware of industry's participation in the field of art. The exhibition comprises the paintings of 62 contemporary artists and is a comprehensive cross-section of the trends of art in America today.

An Award Jury consisting of the nationally known artists Alexander Brook, Louis Bouche, Ben Shahn, Bradley W. Tomlin and Vaclav Vytlačil awarded first prize to Nicholas Vasilieff; Second prize to Stuart Davis; Third prize to Charles Howard; Fourth prize to Everett Spruce, and Fifth prize to Yasuo Kuniyoshi.

A panel of eight artists and three museum directors formed the Invitation Jury. They were: Guy Pene du Bois, Adolf Dehn, Robert Gwathmey, Karl Knaths, Yasuo Kuniyoshi, Loren McIver, Waldo Peirce, Everett Spruce and Donald J. Bear of the Santa Barbara Museum of Art, Daniel Defenbacher of the Walker Art Center in Minneapolis, and Mrs. Juliana Force of the Whitney Museum of American Art in New York.

The exhibition is being shown at prominent museums in a nationwide tour during 1948.

ANNUAL PACIFIC NORTHWEST ART AND CRAFTS EXHIBIT

The Second Annual Pacific Northwest Arts and Crafts Show will be held in Bellevue, Washington, on August 4 to 8, 1948, according to an announcement by Carl S. Pefley, President of the Fair.

Last year more than 30,000 persons visited the Show which was held for two days only, and it is expected the attendance will be much greater this year.

Exhibitions will be national in scope with many prominent artists showing.

LANDSCAPE IN COLORS

By Tung Mun Mein

A well-known landscapist of the Ming Dynasty (1368 A.D.). Size of scroll is 9 feet 6 inches by 2 feet 5 inches.

From the Masterpieces of Chinese Paintings, The Collection of Chan Peng Yin, F.R.S.A. (London) now at the De Young Memorial Museum, San Francisco.





MR. CHAMPION NIXON

**At Work on the
Potter's Wheel.**

**Student Work in the
Background.**

*Photographs by
Frederic Sweger*

A NEW APPROACH TO AN OLD PROBLEM

By PATRICIA P. COLEMAN

Beauty and bread—two of the most meaningful words in the dictionaries of the world. Beauty—the feeder of man's moral or aesthetic sense, his eye, ear and intellect. Bread—the sustainer of the physical needs of man. Dynamic and packed with consequence, beauty and bread represent two basic needs of man. Progress and peace hinge on the equality of these widely diverse poles of his existence, one as necessary to his happiness as the other.

Modern educators recognize the need of interlocking the business of earning a livelihood and the dominant need for beauty in the life of every person. The old biblical adage that man does not live by bread alone has been given practical application in city sponsored educational programs. The emphasis is on courses affording the pleasure of creation and a sense of accomplishment. Ceramics easily leads the field in popularity.



Regular Monthly Exhibitions of Student's Work Shows the Remarkable Progress Obtained in the Development of Creative Thinking and Work in Ceramics.

A GROUP OF STUDENTS

Typifying the many who attend ceramics classes of night after the day's business of earning a livelihood.

All have one thing in common — they find relaxation and personal satisfaction in the creation of beauty by their own hands and out of their own imagination.





MR. CHAMPION NIXON

Demonstrating one of the techniques in glazing.

San Francisco boasts an unusual school of this type. Under the tutelage of Champion Nixon, day and night classes are conducted at the Nixon Craft Studios in 551 Davis Street. This address to old time San Franciscans meant Sanguinetti's, the famed night spot of the 20's, which offered relaxation and color to many after dreary hours spent at work.

Although the setting has changed the same atmosphere of lighthearted gaiety remains inside the ceramic school of today. The classes are informal and pleasant. A friendly community feeling prevades the studio and is conducive to the creation of distinctive work. This is part of a design for a new approach to teaching by the instructor, Champion Nixon, and it is to him that credit is due. His unique method of instruction has resulted in the creation of distinguished objects of beauty and capacity filled classes.

One of the finest potters in America, Champion Nixon is an outstanding artist. Aside from this he is an example of that rare person—the born teacher. He is not an average man. There are no half-

way measures for him. He believes in quality only the true artist can. Filled with boundless energy his personality radiates enthusiasm and reflects the keen enjoyment he finds in his work. Mr. Nixon likes and understands people. Perhaps this accounts in part for his successful career as teacher.

Freedom and originality are the keys to his different maneuver in teaching. He does not simply lay textbook rules before his students. Everyone learns by doing. In this approach example is the by-word, imitation is eliminated and his students are free to create at will. As the days pass his pupils absorb more and more from this notable technique. It is not long before the student finds within himself some of the magic of creation which marks the difference between art and the ordinary.

A student of the University of Southern California, Champion Nixon has been in the professional realm practically all his life winning acclaim as an artist as well as a teacher. For five years he worked as student and assistant to Dr. Glen L.

(See Page 40)

Student Work

From the Division of Landscape Design University of California, Berkeley

The work shown on the following pages is a collaborative effort by students in Architecture and Landscape Architecture working on a major site planning problem. Landscape Design 116 is a course offered each year during the spring semester to a limited group of students in Architecture and Landscape Architecture of high Junior or Senior standing. It is under the direction of Robert Royston, Landscape Architect, and Nicholas Cirino, Architect and Engineer.

The students are divided into groups, which are usually composed of 2 students in Architecture and 2 students in Landscape Architecture. The entire semester is spent in space organization for a specific site.

Step I An actual site is chosen for development, and examined thoroughly by the student group.

Step II Each group writes its own program for the site, and, as technical advisers, begin to develop that program.

Step III A basic contour model of the terrain is made by each group.

Step IV Preliminary site layouts are developed by each student. Final site plans are developed by each group after analysis of the individual studies. This phase covers the determination of relationships between buildings, utilities, roads and walks, recreation facilities, planting, and open space, at a scale of 1"—100'.

Step V Areas of intensified treatment (i. e., shopping centers, schools, and multiple dwelling units) are studied again by each student, and then developed by each group at a larger scale, 1"—40'.

Step VI Each student progresses then to the problems of individual sites (i. e., the house and lot) and carries his analysis through in detail.

Step VII The model is completely developed as projected by the plans.

Step VIII Each group develops a written analysis of its solution to the problem.

Step IX Complete sets of Preliminary Drawings, Model, Program, and Report are submitted for judgment.

Step X Final criticism and judgment is held. Each group presents its solution verbally to the jury.

This year the jury was composed of:
John Funk—Architect.

Edward Williams—Landscape Architect.

Howard Moise—Architect.

Nicholas Cirino—Engineer.

Robert Royston—Landscape Architect.

The project shown on these pages represents the work of G. E. Kostritsky and E. L. Jacobs, students in Architecture; H. E. Troller and S. T. Kaneko, students in Landscape Architecture. The following explanation of the problem, and its solution, is an excerpt from the Report which accompanied the drawings, photos, and model.

The Problem

Approximately 270 acres of undeveloped grazing land, with eroded valleys and steep slopes, and located about 20 minutes from the city, was selected as the site for a theoretical community development. Some few basic decisions were made concerning the community, i. e., approximately 400 families, people of a middle income group. It was felt that the efforts of the designers should be directed toward provision of the greatest possible convenience, comfort and safety for the residents of the community.

Solution to the Problem and Schedule of Study

A base model of the topography was made. The slopes, the valleys and flat lands were studied. All areas with 20% or less gradient were marked

See Designs on following four pages

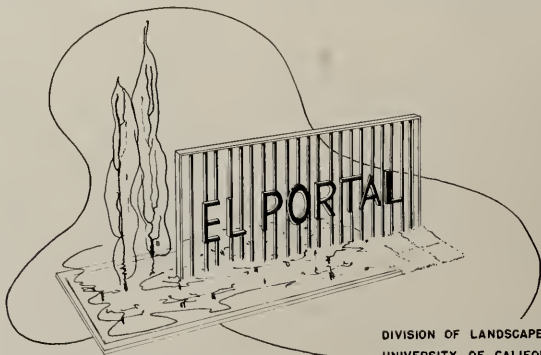
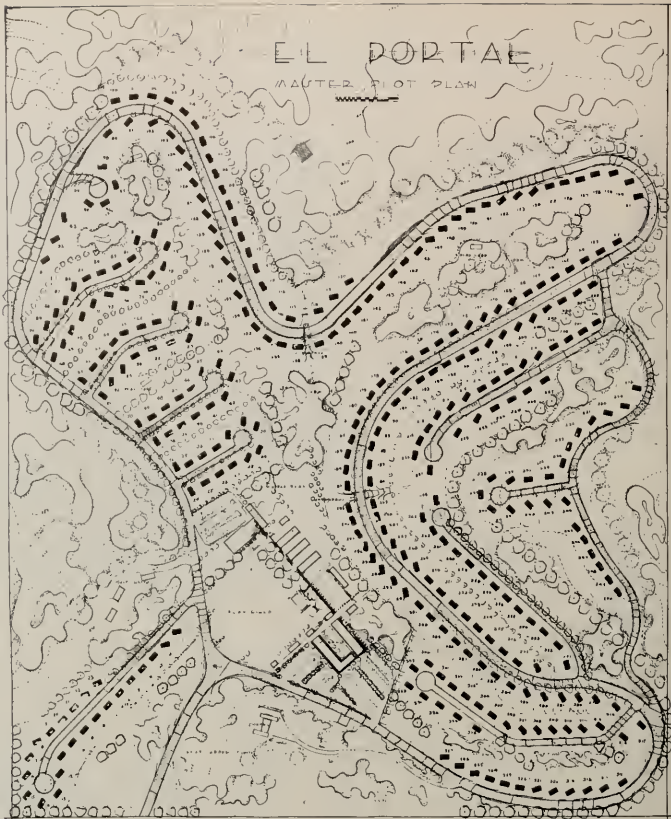

ENTRANCE SIGN

DIVISION OF LANDSCAPE DESIGN
UNIVERSITY OF CALIFORNIA
BERKELEY

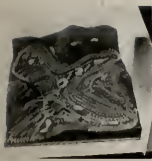

ROAD PATTERN

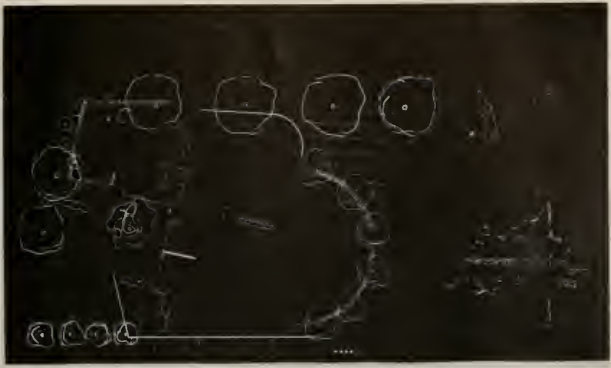

SINGLE UNIT DEVELOPMENT LOT 74

DESIGNING STAFF

H.E. TROLLER

G.E. KOSTRITSKY

S.T. KANEKO

E.L. JACOBS

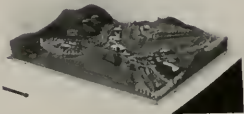

BUILDING PATTERN

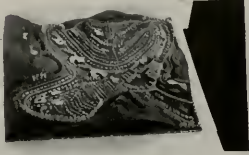

EXISTING LAND



LOT 293

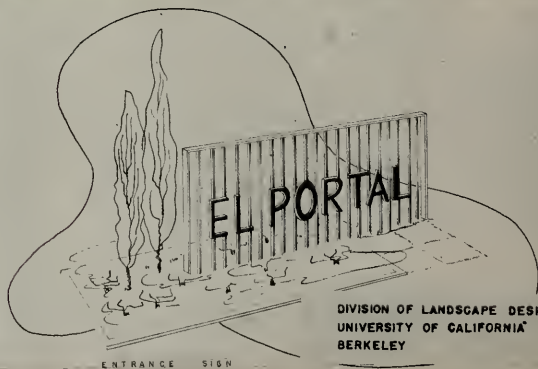

ENTRANCE SIGN

DIVISION OF LANDSCAPE DESIGN
UNIVERSITY OF CALIFORNIA
BERKELEY



EXISTING LAND



MULTIPLE UNIT HOUSING

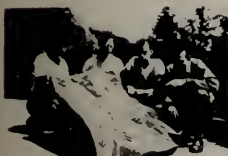

DESIGNING STAFF L TOR

KANEKO L ARCH

JACOBS ARCH

TROLLER L ARCH

KOSTRITSKY ARCH



ROAD PATTERN

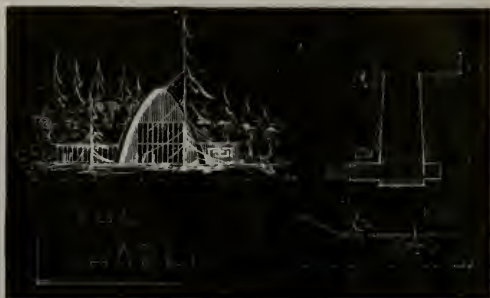

NON-SECTARIAN CHAPEL



BUILDING PATTERN



BUILDING PATTERN



PERSPECTIVE OF COMMUNITY CENTER

Painting for Disinfection of Rooms and Buildings

The Germ and Mildew Destroying Effects of Paint

By DR. W. SCHWEISHEIMER

Dr. Henry A. Gardner, director of the Scientific Section of the National Paint, Varnish and Lacquer Association, Washington, D. C., has made comparative tests on a laboratory wall surface in order to find out the germ-destroying power of paint. One coat of paint was applied in those tests to a small area of the wall. After drying, this surface as well as the adjoining area of the unpainted surface were lightly rubbed with swabs moistened in sterile water. These were planted in agar sugar, an excellent medium for the growth of germs.

The following results were obtained in the experiments:

Unpainted area—positive growth in agar; painted area—negative growth in agar. This means that the painted part of the wall contained no germs which could grow on the agar solution, while the unpainted part contained such germs (bacteria).

New paints have been invented to destroy germs and mildew. They are of importance in industry as well. Protective coatings are necessary to prolong the life of ferrous metal ducts. Film deposits from new protective coatings are said to be resistant to aging and oxidation, chemical fumes, and solvent vapors. New paints, containing metallic copper, have been developed by research chemists. They protect a ship's bottom from barnacle infestation and eliminate the necessity of frequent dry docking to remove barnacles and other marine-growth. New paints have proved effective in preventing barnacle infestation in fouling water for as long as two years. This is about four times the service life of ship-hull paints meeting ordinary specifications.

Anti-Fouling Paint

Such developments, we learn from "Chemical Industries", is expected to reduce the operation and the maintenance costs of ships frequenting

waters in which bad infestation with marine life normally occurs. So severe is the fouling in many waters that it is not unusual for an unprotected ship to carry one hundred tons of marine organisms on its hull. Within six months from the time a ship is cleaned and painted in dry dock, barnacle infestation often increases the ship's fuel consumption as much as fifty per cent. Antifouling paints, therefore are of high importance for conservation and efficiency of boats.

Proper painting of rooms and buildings is a highly protective measure against infection of any kind. Some decades ago, when medicine just had started understanding the science of bacteria, much was thought of thorough disinfection of every part of a sick room by chemical means after the patient had recovered. Liquid chemicals as well as disinfectant vapors were used to destroy the pathological germs connected with the disease which undoubtedly had remained in the room. Today we are no longer as anxious about this particular kind of disinfection.

What we want and demand, however, are newly painted or freshly papered rooms when a man with an infectious disease had been sick or had died within their walls. This is a comparatively simple procedure and it lessens remarkably the danger of transmission of germs to other people as experience has shown. Painting by itself usually destroys most of the germs which are not too resistant against such influences. There are, in addition, quite a few sorts of paint which contain certain substances toxic for bacteria and which, consequently, may be considered actual disinfectants. Compounds of copper and mercury are sometimes added to paints in order to have such germ-destroying or anti-fouling action.

Most important is the use of disinfecting paint

(See Page 34)



TROPICAL ROOF— AFRICA DEVELOPMENT

A new light-weight, easily transported and easily erected type of roof has been designed and produced by some of the British firms who make a specialty of manufacturing temporary prefabricated houses.

Construction comprises a steel frame supported on steel columns, with considerable air space between ceiling of building and roof which allows

for ventilation and circulation of air for cooling purposes.

The roof will be used in the British colonial development of Africa wherein it is proposed to expend some fifty million pounds in a project to grow ground nuts on three and a quarter million acres of land in East and Central Africa.

CALIFORNIA MANUFACTURERS ESTABLISH NEW DEPARTMENTS

A special department of the California Manufacturers Association, under the direction of George C. Kinsman, has been established to consider problems of fuel, power and water.

Objectives of the new department will be to secure adequate fuel and power supplies at reasonable rates through study of statewide conditions.

NEW GRAMMAR SCHOOL

A contract has been awarded to the S. C. Giles & Company of Stockton for the construction of a 6-classroom, cafeteria, playroom and office Grammar School building in Stockton at a cost of \$549,842.

Victor Galbraith is the Architect; Ernest D. Francis the Structural Engineer, and A. A. Coddington of San Francisco, the Mechanical Engineer.

CLAY PRODUCTS PLANT

A contract has been awarded to Larsen & Larsen, San Francisco, for the construction of a \$200,000 clay products plant at Warm Springs (Alameda County).

GLASS CONTAINER FACTORY

Larsen & Larsen have been awarded a \$500,000 contract for the construction of a glass container plant at Hayward, California.



Photo by

Dean Stone

and

Hugo Steccati

TRUCK SALES AND SERVICE

SAN FRANCISCO, CALIFORNIA

Among the recently constructed buildings on the West Coast which presents the newer lines in architectural design and at the same time meets the needs for a firm engaged in a very competitive business is the Diamond T Truck Sales and Service in San Francisco, California.

The problem of the architect was to design a building for general sales and service of new and used trucks and at the same time provide for a wide variety of activities connected with the distribution of truck parts, storage of new equipment and parts, a complete repair department, new

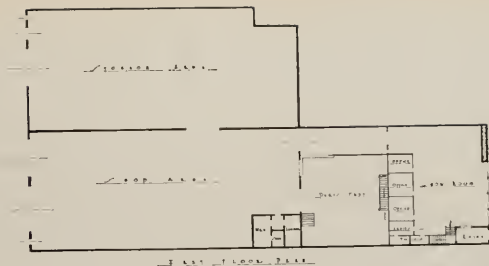

ARCHITECT:

Irvin Wm. Goldstine, A.I.A.

Bruce E. Heiser, Consultant



truck display space, and executive and sales offices—all in one building.

Use of a spacious display front and mezzanine floor combined new truck display and sales offices. The windows are rain free and the glass has been set at an angle which eliminates glare and street light reflection, but at the same time permits

a maximum of natural lighting in the showroom and offices.

Arrangement of the shop, parts department, and storage has been designed to fit the lot requirement of 136 feet deep and 65 feet wide. An alley at the rear of the building has been utilized for entrance into and exit from the building.



*Photo by
Chas. M. Hiller
and
B. V. Washburn*



Architect: Frederick H. Reimers

Builder: Williams-Burrows, Inc.

Office Building

James Graham Manufacturing Co.
Newark, California

By EUGENE BURNS

The James Graham Manufacturing Co., pioneer stove maker of the Pacific coast and builder of the famed Wedgewood gas kitchen stove, has recently completed one of the west's most modern office buildings.

Architect Frederick H. Reimers, who designed the modern office building, combined the general business offices with the management of the fac-

tory personnel and the executive departments.

The office building, which cost approximately two hundred thousand dollars, is part of a post-war three quarter million dollar construction program which was supervised by Frank Stuart of Williams & Burrows, Inc., building contractors.

The new structure provides these office requirements: A main entrance lobby with information

desk and telephone switchboard; a large business office with a file room, vault and office for the manager; a purchasing manager's office; a sales department with sales office, display room, and an advertising department; a personnel manager's office for the six hundred and fifty employees, and a paymaster's office; and a conference room and executive offices including those of President Clarence Graham, son of the founder.

Since its inception in 1882 the James Graham Manufacturing Co. has dominated the town of Newark, California, which is located near the Dumbarton bridge approach on the east side of San Francisco Bay. When the new building was dedicated recently school let out for the afternoon so that all the children could attend the grand opening and get extra servings of ice cream.

"The James Graham Manufacturing Co. had its beginnings when U. S. Senator James G. Fair, who owned most of the surrounding land, started his narrow-gauge railway which ran from Santa Cruz to Newark," said Vice President Harry W. Jackson,

who has been with the organization since 1893. "In those days," he recalled, "everyone coming to San Francisco from the south, rode the train from Santa Cruz to its northern terminus, Newark, and then ferried on the old 'Newark' from Dumbarton Point to San Francisco. James Graham, the founder, made all of the railway's foundry work."

For many decades, the James Graham Manufacturing Co. made pot-bellied cast iron stoves—many of which are still in use and even today, occasionally, the company is called upon to make a replacement for such companies as the Canadian National Railway (formerly the Canadian Pacific Railway).

"Mr. Graham, a Canadian by birth, always liked fine china so when he introduced the first gas kitchen range to the American market, he named it 'Wedgwood' in honor of the justly famous British line of china—only he added an 'e' to the Wedgwood name," said Mr. Jackson.

Architect Reimers used a light steel frame for the 180' by 80' building. Steel pipe columns support



OFFICE BUILDING . . .

the long span and open web steel joists, permitting movable non-load bearing partitions built of wood studs and metal lath and plaster.

Windows are steel casements, installed in continuous batteries allowing for maximum incidental light, with approximately 50 per cent of these sash operative for ventilation. Floors and walls are of reinforced concrete, the exterior face of the exposed concrete is stucco. The interior faces are furred and metal lath and plaster covered. The roof is a composition built-up roof over two-inch wooden planks.

The automatically-controlled heating system is a modified air conditioning system, circulating heated air from the fan and furnace room in the basement to all spaces in the building, with the returned air being taken back to the furnace by means of concrete duct lines below the concrete floor slab. Temperature requirements can be adjusted to individual spaces.

Structural glazed wall tile units are used in all

lavatory rooms as partitions, with ceramic tile used over the concrete floor slabs. All of the other interior partitions are of wood studs and plaster, with the surfaces painted in pleasing and eye-restful colors. The executive offices are covered with Flexwood wall covering in matched panels of hardwood. Ceilings throughout have Acoustic-Celotex perforated tiles applied over the wood furring. The roof is insulated with two thickness Celotex boards with the composition roofing applied over.

All artificial lighting for the main spaces are fluorescent tube fixtures set to the ceilings in batteries forming strips of light and producing good distribution of the light as well as providing the proper amount of light for the individual and the work to be done in the space.

The concrete floors or work areas and corridors are covered with Asphaltic tile. All doors, trim, moulds, and other exposed woodwork is of plain oak.



ENGINEERING PRINCIPLES

IN HOUSE DESIGN

The critical needs of the building industry have focused attention on methods for saving material. In this connection, the strength of houses should be given careful scrutiny, not because houses need be stronger—for few fail—but to judge how much material is superfluous. In carrying out an extensive research program on building materials and structures, the National Bureau of Standards has developed and applied an engineering approach to house design which promises substantial aid to the building industry. This approach, accomplished through application of accepted engineering principles, facilitates the use of unconventional materials and unusual methods of construction.

Strength of houses in the past has been made adequate by patterning them after those which have withstood the test of service conditions. Architects and builders of small structures have followed closely the traditional methods handed down from craftsmen of medieval England. From these traditions, cities have crystallized building codes that are now enforced under the police power of the community.

Except in rare instances, houses have been strong enough to withstand the loads imposed in service. When weaknesses have become apparent, they were more often attributable to defects in relatively small portions of the house than to a general insufficiency of materials. However, available service records do not provide accurate criteria for judging how much excessive material is being used in the construction of houses.

Building material is costly as is the labor required to shape and fit it into place. Application of engineering principles to the design of houses presents a complete and logical method for determining allowable loads for walls, floors, and roofs and makes it practicable to develop house constructions that have sufficient strength yet require the least amount of material and labor. This is the procedure that is followed in the construction

of great bridges and other spectacular structures. Intensities of the service loads are first estimated; each material is then selected to serve a specific function and so distributed as to provide structures of adequate strength at minimum cost. The vast fund of technical information on materials can be utilized similarly for the benefit of dwelling houses when applicable engineering principles and design practices are developed and used.

Suggested methods for designing small houses to have adequate strength without waste of material are described and illustrated in considerable detail in a recent Building Materials and Structures Report of the National Bureau of Standards. Because this is a pioneering attempt to apply engineering principles in the design of houses, further studies will no doubt be needed before universally acceptable methods are developed.

Subjecting complete houses to known loads is very expensive and requires time; therefore, Bureau engineers followed the procedure of applying loads to specimens which accurately reproduced the most important structural parts of a house. These parts, such as walls, floors, partitions and roof, have been designated as "elements." For each element, the prescribed methods of loading in the laboratory simulated the actual loads under service conditions. Results of measurements on the structural elements of a house are especially useful to architects and engineers, and approximate closely the results which would be obtained by testing a complete, full-sized house. It is possible, by this method of test, to determine the structural properties of a new construction without waiting for a performance test over a period of years.

In actual service, house walls are subjected to vertical compressive loads by the dead weight of the walls, floors, and roof above; and by live loads such as wind, weight of snow on the roof, and furniture or persons on the floor. Horizontal transverse (bending) loads caused by the wind act upon the outside faces of such walls and some-

times upon the inside faces.

Walls may also be required to withstand concentrated loads, that is, large forces over a small area such as a ladder placed against either face. Impact loads may be applied accidentally to a wall, for example, by a truck backing against the outside or by a person or bookcase falling against the inside face of the wall. Concentrated and impact loads, to a considerable extent, are unavoidable under service conditions. Racking (shearing) loads are applied to a wall by intersecting walls against which a wind is blowing. This effect is simulated in the laboratory by forces at diagonally opposite corners of the wall.

The same kinds of forces act on load-bearing partitions as on outside walls, but their magnitudes may differ. Nonload-bearing partitions are not designed for compressive or racking loads, which under service conditions, are negligible and may therefore be ignored. However, impact and concentrated loads, through accident, are sometimes applied to nonload-bearing partitions.

Floors are subjected to transverse, concentrated, and impact loads. Transverse loads result from the weight of furniture and persons; concentrated loads occur under the legs of heavy furniture; and impact loads are caused by objects falling or persons jumping on the floor.

Roofs must withstand transverse and concentrated loads. The former type is caused by wind and the weight of snow or workmen; the latter by the weight of material and tools during construction or repair of the roof.

Fundamental data on the wind, snow, and occupancy loads that are likely to be imposed have therefore been obtained, and convenient computational methods developed by the National Bureau of Standards for estimating the manner in which these service loads are distributed to the different structural elements of houses. That is, for each element of a house, compressive, transverse, and racking loads were computed by recognized principles of engineering mechanics for typical one- and two-story frame houses in several locations representative of extreme wind and snow loads in the United States. Allowable loads (those considered safe) for 100 wall, partition, floor, and roof constructions were then compared with assumed actual loads for the two types of houses in three locations. The comparison shows that some had insufficient strength while others were much stronger than necessary.

This engineering approach to strength of houses will, it is believed, open the way for designers to introduce unconventional materials and unusual methods of fabrication through laboratory tests

to determine whether the construction possess adequate strength. Such data will greatly shorten the time required to develop and obtain acceptance of new types of construction for houses. At the same time, a substantial saving of materials as well as improved protection against storm damage should result.

NEW BUILDING FUNDS FOR UNIVERSITY OF CALIFORNIA

State funds totaling \$12,243,500 have been added to the University of California's postwar building program to bring the sum thus far provided by the State for this purpose to over \$107,000,000.

The new funds include \$9,677,000 appropriated by the 1948 Legislature for seven projects.

The Legislative action which added to the University's record breaking building fund, embracing over 70 projects on all eight campuses, included appropriation of \$2,000,000 for the establishment of general education programs on both the Davis and Riverside campuses.

Other construction includes "home management houses" to be used as home economics "Laboratories" on the Berkeley and Los Angeles campuses; a virus laboratory at Berkeley to be directed by Dr. Wendell M. Stanley, Nobel Prize winning biochemist who will leave the Rockefeller Institute for Medical Research at Princeton, New Jersey, to join the University of California faculty this summer; a sewage disposal plant at Davis; Medical School expansion and Law School expansion, both at Los Angeles, and a site for the development and capital improvements at Santa Barbara.

Incorporated in the University's current budget are funds for a Cancer Research Genetics Laboratory; development of additional space in the Engineering Testing Laboratory for use by the Institute of Transportation and Traffic Engineering at the Berkeley campus.

STORAGE WAREHOUSE

A general contract has been awarded to Cahill Bros., San Francisco, for the construction of a storage warehouse in San Francisco for the Bekins Van & Storage Company. W. Adrian is the Engineer. Cost \$279,793.

SUPER MARKET

Daley Bros., Belmont, California, have been awarded a contract for the construction of a super market building for Lucky Stores, Inc., in Modesto, California, at a cost of \$250,000. Frank Constable, Architect.

GARDENS IN FUTURE CHINATOWN

By **ALBERT WILSON, Botanist**
Garden Authority, National Broadcasting Co.

San Francisco is hemmed in by water and in the middle of San Francisco the Chinese are hemmed by custom until they are gasping for room and for breath. In this day when tuberculosis is a rapidly retreating plague it is still rampant in Chinatown. Chinatown behind those picturesque facades of Grant Ave. lie in semidarkness, the most crowded slum in the United States.

In the June 1948 issue of *Architect and Engineer* students of the University of California, School of Architecture have presented a proposed redevelopment of Chinatown. They have included eleven illustrations which show the plan for this development. And they have supported their plan with a statement of the emergency. "It houses 20,000 people in an area of 20 blocks of houses.—Chinatown is—a slum unfit for human habitation. Photographs record the narrow dark alleys with their corollary of sunless, windowless rooms and the dreary rows of outmoded wooden, yardless houses. On the maps of the San Francisco real property survey of 1939 Chinatown stands out as the blackest part of the city in every respect of bad housing. Here population density, overcrowding, lack of sanitary facilities, percentage of converted structures and of structures of substandard status are highest. Here also the percentage of owner occupancy is lowest."

The authors also present briefly their plan which proposes to do away with this slum. I quote it: "The Plan: an eight block area in which there are few buildings of permanent value are bounded by Broadway, Powell, Clay and Taylor streets, has been selected as the most suitable for redevelopment. All existing structures would be taken down and utilities adjusted to three new diagonal streets so related to the grades as to minimize site development costs. The development comprises (1) a central area containing two and three story buildings with walled gardens and integral garages. (2) Eight skyscraper type apartment buildings to increase population density and provide view

apartments. (3) Perimeter structures containing row houses and apartments. (4) Two nursery school buildings, and two play areas. (5) Minimum neighborhood shopping facilities located at the northeast and southeast corner of the development; and additional garages."

In forthright language these men of the University present the problem which is "to replace this (viciously) decayed housing with livable modern housing planned for convenience and amenity for sun, air, outlook, outdoor living, space, gardens, trees and safe play areas. This result they propose must be achieved without destroying the picturesque assets of the existing Chinatown shopping area."

It is clear this is a serious problem of slum living and slum clearance. In the first place let us remember for generations the Chinese of San Francisco have had no other place where they could go to live. When they tried to spread out they came face to face with deed covenants which instantly turned them back, and the effect is a ghetto with some concentration camp overtones. This sounds disagreeable and in order that we may be moved to do something about it we must face the fact that it is disagreeable.

But while we were looking for responsibility let us and our Chinese fellow citizens not forget that they too have responsibility in this matter. By some unfortunate combination of circumstances the Chinese of California when they have escaped from the ghetto and were able to build as they pleased have not and do not establish homes which from the California point of view are attractive. In fact they have a genius for putting up temporary shacks and then making them permanent. They pay little attention to landscaping and in fact they are inclined to carry a piece of slum with them wherever they go, and plant them in the new place. Now this is wrong. And it is one of the

reasons for the restricted deed covenants, and it is unnecessary for me to say I know a half dozen of the loveliest places to live down the Peninsula built and owned and cared for with exquisite taste by Chinese families.

Now what business is all of this of ours; what has it to do with good gardens. It has everything to do with it, for in this redevelopment of Chinatown which in one form or another is imperative and inevitable gardens will play a big part. And these gardens must be not **wrong** but **right**, they must be **good gardens**. They can be superlative gardens. The Chinese have a genius for gardens in the old country. Their abilities in fact are very high, and although they haven't used this genius of theirs in this country other than for truck gardens and for the culture of flowers for the market, yet they have native capacities for accomplishing marvels in the gardens around their own houses and apartments. Even with the desperately restricted opportunities in Chinatown you can find here and there sprouts of this gardening genius breaking through. I took a special trip over there the other day to refresh my memory on this subject. I looked into a store window, it wasn't crowded with things for sale each with big price marks, no this one had one object sitting in the very middle all by itself. I stopped to study it, and saw a shallow dish made with square corners and rounded

smooth edges and covered with a restful shade of blue glaze. In it was a composition, a garden upon which much care and attention had been exerted.

You got the effect of a reflecting pool laying quietly at the base of a rugged deeply marked slate and gray and green rock. If in your mind you saw it far away it became a majestic mountain. Sprouting from a cleft low down was a clump of broad leaved primrose heavy with yellow flowers and buds. Along side was a grassy sedge with flower parts brown and tuffly gracefully arching against the rock, and a bug with two fragile tines of antennae sitting on some of the blades. The bottom of the dish was filled with clear water through which could be seen pebbles exactly like those in a clear mountain lake. A second low rock with more low plants close by including some green moss built out like a little sloping meadow with a tiny frog sitting to one side occupied another section of the dish which completed the composition. It engaged my attention for some time and while I was studying it, measuring its accurate proportions, its simplicity and good taste, among the rattle of footsteps one palpably slowed down and quit altogether. Then a deep musical rumble over my shoulder announced "Well my friend you'd think you were looking down into a lake of the Sierras."

And moving on I passed a hotel, there sitting in a beautiful teakwood stand was a big glazed pot filled with a vigorously growing plant known as ophiopogon. The leaves stood up like blades, dull green ending in a point like that of a paring knife. The whole pot was filled with this plant, it had just finished flowering, purple beadlike fruit had formed and these were held above the leaves in clusters. That whole window by the side of the entrance door was given over to this plant, no curtain cheated it of light or sun, and it had evidently never been allowed to lack for water nor suffer under the attack of enemies. But is was the glazed pot that engaged by attention. The thought here had evidently come from some beloved garden, for all around the outside were beautiful chrysanthemums, the buds of some closed, of others wide open above the leaves spread out and lifelike.

Going further on into Chinatown I glanced up and saw a firescape with a narrow landing opposite a long window which in reality was a door. Sitting tight in one corner was a tub painted green in which was growing a bamboo, the golden yellow bamboo whose leaves rustled gently in the cool breeze. Looking down at the next level in the same firescape I saw a large glazed pot in which a shiny leaved healthy looking camellia was growing. There were no other plants, these two

(See Page 39)



Colorful porcelain-enameled iron sheets are economically produced... simply and quickly installed... produce a distinctive, permanent, lightweight veneer for every type of building exterior. They are adaptable for interior application, too.

*** WRITE TODAY for complete information and literature**



*** VENEER * PANELS
* FLASHED - PANELS
* SPECIAL SHAPES**

ARCHITECTURAL PORCELAIN CONSTRUCTORS

**2827 UNION STREET • OAKLAND 8, CALIFORNIA
TELEPHONE TWINOAKS 3-5154**

A. I. A.

American Institute



ACTIVITIES

of Architects

Arizona Chapter:

James Macmillan, President; Arthur T. Brown, Secretary, 740 N. Country Club Road, Tucson, Arizona.

Central Valley of California:

Herbert E. Goodpastor, President; Frank V. Mayo, Secretary, 307 Exchange Building, Stockton 2, California.

Colorado Chapter:

Roymond H. Ervin, President; James M. Hunter, Secretary, 2049 Broadway, Boulder, Colorado.

East Bay Chapter:

A. Lewis Koue, President; James H. Anderson, Vice-President; Loy Chamberlain, Secretary; Chester H. Treichel, Treasurer, Office, 3833 Piedmont Ave., Berkeley, California.

Montana Chapter:

Ralph H. Cushing, President; H. C. Cheever, Secretary, Montana State College, Bozeman, Montana.

Northern California Chapter:

Wm. Clement Ambrose, President; Lester W. Hurd, Vice-President; Ralph N. Pollack, Secretary; Donald Beach Kirby, Treasurer, Office 369 Pine Street, San Francisco.

Oregon Chapter:

Frank Roehr, President; Sidney W. Little, Vice-President; J. Holman Baines, Secretary; Don Edmondson, Treasurer, Office 619 Builders Exchange Bldg., Portland 4, Oregon.

San Diego Chapter:

H. Louis Bodmer, President; Louis J. Gill, Secretary, 203 Granger Building, San Diego, California.

Santa Barbara Chapter (California):

Winsor Soule, President; Ralph Armitage, Vice-President; Robert Ingle Hoyt, Secretary; Luth M. Riera, Treasurer; Office 116 E. Sold St., Santa Barbara, California.

CALIFORNIA COUNCIL OF ARCHITECTS

Andrew T. Haas, President; Adrian Wilson, Vice-President; Malcolm Reynolds, Secretary-Treasurer, Office 369 Pine Street, San Francisco.

Southern California Chapter:

George Allison, President; A. C. Martin, Jr., Vice-President; Anthony Thermin, Secretary; George E. Gable, Treasurer; Chapter Headquarters, 3757 Wilshire Blvd., Los Angeles 5, California.

Spokane Chapter (Washington):

Noel E. Thomson, President; Kenneth D. Stormont, Secretary, Hutton Building, Spokane, Washington.

Utah Chapter:

George Cannon Young, President; Theodore R. Pope, Secretary, 29 South State Street, Salt Lake City 1, Utah.

Washington State Chapter:

Clifton J. Brady, President; Arrigo M. Young, Vice-President; John Richards, 2nd Vice-President; Ralf E. Decker, Sec.; Waldo B. Christensen, Treasurer, Office 1411 Fourth Avenue Building, Seattle 1, Washington.

Tacoma Society:

Chas. Rueger, President; Clarence Rueger, Vice-President; W. W. Durham, Secretary-Treasurer.

Hawaii Chapter:

Kenneth W. Roehrig, President; James Morrison, Secretary, 324 Federal Bldg., Honolulu, T. H.

RECEIVES A.I.A.

GOLD MEDAL AWARD

Charles D. Maginnis, A.I.A. Architect of Boston, Massachusetts, who is nationally famous for his works in ecclesiastical architecture, was awarded the Gold Medal Award of The American Institute of Architects at their recent 80th Annual Meeting in Salt Lake City, Utah.

The Medal, which is the highest honor the A.I.A. can confer, was presented to Maginnis by Douglas W. Orr of New Haven, Conn., President of the American Institute of Architecture. The award was made at the annual dinner session.

FIRST JOINT COOPERATIVE CONFERENCE IS SUCCESS

The first meeting of the National Joint Cooperative Committee of The American Institute of Architects and The Associated General Contractors of America was held in Washington, D. C. the latter part of June.

Established in May, committee members agreed that the general purpose of the group will be to provide an avenue through which building construction problems of mutual concern and interest to architects and contractors can be presented. The problems will be studied for possible applications to professional and construction services in the building field.

Consideration will be given any problem submitted by the general contractors, architects, and others in the construction industry, as well as public and private groups and individuals in general.

A.I.A. committee members present at the organi-

zation meeting were: James R. Edmunds, Jr., Baltimore, Mr. Edward G. Conrad, Cleveland, Ohio; Harry B. Tour, Knoxville, Tenn., and the A.G.A. members present were: Walter L. Couse, Detroit,

(See Page 37)

FOR BETTER SERVICE

Remember that

KRAFTILE is

WESTERN HEADQUARTERS

FOR

<ul style="list-style-type: none"> ◆ ACID Brick ◆ ACID-PROOF Jointing Compounds ◆ ACID-PROOF Floor and Tank Construction ◆ ACID-PROOF Coatings 	<ul style="list-style-type: none"> ◆ GLAZED Structural Wall Units ◆ PATIO Tile ◆ QUARRY Tile ◆ SWIMMING POOL Overflow Gutter
--	--

◆ LIGHTWEIGHT CONCRETE BLOCKS

◆ QUONSET Packaged Steel Buildings

◆ STRAN-STEEL Framing

For complete information and prompt service, phone or write

KRAFTILE COMPANY

NILES, CALIFORNIA NILES 3611
SAN FRANCISCO 5: 50 Hawthorne St.—DUgglas 2-3780
LOS ANGELES 13: 406 South Main Street—MULual 7241

WITH THE ENGINEERS

Structural Engineers Association of
Northern California

John A. Blume, President; Jesse Rosenwald, Vice President; Franklin P. Ulrich, Treas.; Geo. E. Solnar, Jr., Sec., Office, Room 215, 55 New Montgomery St., San Francisco 5, Phone SUtter 1-7642. DIRECTORS, A. W. Anderson, Henry J. Degenkolb, John E. Rinne, Robert D. Dewell, and Wm. W. Moore.

San Francisco Section

L. A. Elsener, President; A. W. Earl and G. B. Woodruff, Vice-Presidents; John E. Rinne, Secretary-Treasurer; 225 Bush Street, San Francisco 20.

Structural Engineers Association of
Southern California

Steve Barnes, President; Harry W. Bolin, Vice President; Lewis K. Osborn, Sec-Treas. DIRECTORS, Richard W. Ware, Geo. E. Brandow, L. T. Evans, Harold P. King, and Donald F. Shugart. Office: 202 Architects Bldg., Los Angeles 13, Calif.

Puget Sound Engineering Council
(Washington)

R. E. Kister, A. I. E. E., Chairman; E. R. McMillan, A. S. C. E., Vice Chairman; L. B. Cooper, A. S. M. E., Secretary; A. E. Nicholson, I. E. S., Treasurer; Offices, L. B. Cooper, c/o University of Washington, Seattle 5, Washington.

U. C. ENGINEERS WIN HEATING MEDAL

The 7th International Heat Congress has awarded a medal to two University of California engineers in recognition of the excellence of their paper presented to the Congress in Paris last year.

The two engineers are B. F. Raber and F. W. Hutchinson, professors of mechanical engineering. The medal was awarded to the two engineers by the Directing Committee of the Congress.

The paper presented was entitled Rational Analysis of Panel Heating and Cooling systems, a subject in which the two University of California engineers are international authorities. The paper described the authors' researches over a period of

several years.

Professors Raber and Hutchinson are the authors of two recent books: Refrigeration and Air Conditioning Engineering, and Panel Heating and Cooling Analysis, both published by John Wiley and Sons, Inc.

STUDENTS WIN AWARD IN CIVIL ENGINEERING

Willis L. Chilcote and Charles A. Stengel, students, have been voted the Francis Keally prize in civil engineering by the faculty committee of the Carnegie Institute of Technology, according to Professor Frederic T. Mavis, head of the department.

The prize which is awarded annually for "marked ability in engineering related to building construction" was won by Chilcote and Stengel for their paper on "Structural Tests of a Basket-Handle Frame of Reinforced Concrete."

ILLUMINATING ENGINEERS SOCIETY ELECTS OFFICERS

The Illuminating Engineering Society has elected Lee E. Taylor, Detroit, Michigan, President of the Society for the year starting October 1, 1948.

Other officers elected to serve with Taylor are A. H. Manwaring, Philadelphia, General Secretary; E. M. Strong, Ithaca, New York, Treasurer; Walter Sturrock, Cleveland, Ohio, Vice-President and Directors Myrtle Fahsnyder, Bloomfield, N. J., and Hoyt Steele, Des Plaines, Illinois.

The I.E.S. was founded in 1906 for the study evaluation and discussion of the numerous phases of the art and science of illumination and the publication of reports and Recommended Practices or illuminating engineering and related subjects. The Society has over 6,500 members and is supported by 40 Sections and Chapters throughout the United States and Canada.

FEDERAL AGENCIES REQUEST COORDINATE BID OPENINGS

Agencies of the federal government have re-



"ECON-O-MATIC" . . . is the automatic Stanley Door Hardware Set that makes light-weight plywood doors 100% practical for garages. Designed for doors weighing up to 150 lbs. Cost little more than old-style hardware. For smart appearance — faultless action — long service — specify Stanley. The Stanley Works, New Britain, Conn.

*Copyrighted

STANLEY

Reg. U. S. Pat. Off.



Simple to Install
Requires Only 2 1/4-in. headroom

HARDWARE · HAND TOOLS · ELECTRIC TOOLS

...sisted the national Associated General Contractors to issue a system to coordinate bid opening dates on federal projects of \$1,000,000 or more. The national A.G.C. on behalf of its members, has pledged its cooperation to obtain bidding date information regarding large state, municipal, industrial, commercial and other non-federal projects. No attempt will be made to control the dates of such projects but the information will be used to avoid conflict in advertising federal projects. The federal agencies have endorsed the A.G.C. resolution passed at the Dallas Convention recommending avoiding bid openings on Mondays and days immediately preceding or following holidays. The Corps of Engineers will act as the clearing house for other agencies.

STRUCTURAL ENGINEERS WANTED

Structural, mechanical, and electrical engineers are needed for California's \$250,000,000 State building program for the design of new hospitals, institutions, and office buildings, according to the California State Personnel Board.

Applications will be accepted continuously for Senior Structural Engineers. Other applications are being accepted for examination on July 27 and

RADIO AND ELECTRICAL APPLIANCE ASSOCIATION

The Southern California Radio and Electrical Appliance Association, Inc., will hold its first annual all electrical Exposition in the Pan Pacific Auditorium in Los Angeles on August 20-29.

The event is being sponsored by representatives of radio, television, electric appliance dealers, retailers, manufacturers, and utility companies.

RESIDENCE

Shorps & Brown, Architects of Burlingame, California, have awarded a contract to R. A. White, Contractor, for the construction of a \$46,303 residence in Hillsborough.

PAINTING CONTRACT

A contract for painting 299 Units of the Parker Homes project near McClellan Field, Sacramento county, has been awarded to Wm. Reid, Sacramento contractor for \$41,473, by the Housing Authority of Sacramento county.

SCHOOL BONDS VOTED

Electors of the Davis Elementary School District, Davis, California, recently approved a \$240,000 bond issue for the construction of a new 10-room cafeteria and office grammar school building. Leonard F. Starks, Sacramento, is the Architect.



*Thoughtful things like this
help make a client happy*

Built-in telephone facilities are the mark of a thoughtful, modern builder. For telephone conduit and outlets, installed while the house is under construction, add much to the future value and convenience of the home. Just a few pieces of tubing leading to well-located outlets...that's all it takes. The cost is small. And telephones can be added or moved later on without drilling holes or running wire along baseboards.

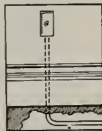

For free help in planning modern, built-in telephone conduit, call your local Pacific Telephone office and ask for "Architects and Builders Service."

**The Pacific Telephone
and Telegraph Company**





ALWAYS SPECIFY

HAWS

Write today
for complete
information.

**Electric Water Coolers
and Sanitary Drinking Fountains**

HAWS DRINKING FAUCET CO.

1435 FOURTH STREET (Since 1909) BERKELEY 2, CALIFORNIA
Agents and Sales Representatives in All Principal Cities

PAINTING FOR DISINFECTION OF ROOMS AND BUILDINGS

(From Page 20)

in hospitals, hotels and other institutions where rooms are continuously inhabited by other people. It has been known for a long time that the air of a room may be contaminated through coughing or sneezing of a patient with tuberculosis of the lungs or the larynx. We call this droplet infection. The finer particles of the sneezed-out or coughed-out liquid may float in the air of the room for some time.

These liquid particles which carry around tubercle bacilli, settle to the walls or to the ceiling, sink to the floor where they dry out, become powder and dust, and may be found later in the dust which contaminates the air of the room. Whenever such air is inhaled by other people, germs of the respective disease are brought into the body by way of the air-passages.

Paint and Puerperal Fever

It took centuries until men understood the infectious nature of puerperal fever and how to protect mothers against its dangers. Quite a few years ago, Dr Max Starkloff,—who at that time was Health Commissioner of St. Louis, in a remarkable example gave evidence how lives were saved through the application of paints to the walls of sick rooms in hospitals. This occurred in a lying-in hospital of which Dr. Starkloff had knowledge. In a given period there had been more than a hundred cases of puerperal fever, with a high death rate. The walls and ceilings were re-painted. After this had been done, it was noted that in a similar period following, cases of puerperal fever had practically disappeared from the hospital. We do not want to go as far as to consider the re-painting of the walls the only reason for this decided improvement, but undoubtedly it was largely responsible for this saving of the lives of as many mothers.

Droplet infection plays a major part in the transmission of infectious germs in grippé (influenza), whooping cough, infectious cold, sinus trouble, etc. It is important also in the transmission of several highly infectious diseases as measles, scarlet fever, pneumonia, diphtheria, tonsillitis. Painting does not come too late for destroying those germs. Some less resistant germs, it is true, retain their infective power only for one hour or less while they remain suspended in the air in form of droplets. The germs of epidemic grippé, influenza etc. are dried (desiccation) destroys them. Other germs, however, stay infective for weeks and months. They may be a danger to everyone who stays in the erstwhile sick room.

City Laws Require Redecorating of Rooms

That is the reason why it is so important to

a newly painted rooms and the reason why in many cities regulations require that new tenants of apartments and houses be protected by re-decorating the rooms before they are permitted to move in. You never know who has lived in your room before you,—or may have died in your new room. The former tenant of the room may have had a bad cough, and his cough bacteria or other particles of his disease may have contaminated the walls of the room.

According to British publications it has been established that the insecticide DDT can be successfully incorporated in oil-bound water paints so as to produce a surface which possesses insecticidal properties for some time. It remains to determine how long such surfaces will remain effective since it is economically important to decide whether it will be better to use such special protective paints initially in new houses—or to use them only when there is evidence that infestation with insects is beginning or is likely to begin.

To be afraid of germs—or for that of insects—is of no avail,—as little as are other kinds of exaggeration. What we need, what the painter needs, is knowledge,—the knowledge of the functioning of germs and bacteria and how to be protected against their dangerous effects. Equipped with this knowledge, the painter will be able to do an important job in protecting human beings against hazards which can be prevented.

REPRESENTATIVE APPOINTED

E. J. Benson, special representative for the Chemiseal Company, announces the appointment of the Patten-Blinn Lumber Company, Los Angeles, as distributor of its products in the territory covered by their 22-branch yards throughout southern California.

The Chemiseal Company with main offices in Detroit, Michigan, have a plant at Oakland, California.

DOCTOR'S OFFICE BUILDING

A general contract has been awarded Williams Burrows, Burlingame, California, for the construction of a Doctor's Office Building in San Mateo, California. Angus McSweeney, San Francisco, is the Architect. Estimated cost \$23,000.

BUS DEPOT

Wm. Radthe, Gilroy, California, contractor has been awarded a \$27,500 contract for the construction of a new bus depot at Gilroy.



When you specify Certified Adequate Wiring for homes you design, you not only guarantee the full enjoyment of electrical living, but you also increase the value for loan or resale purposes.

Certified Adequate Wiring is more than just adequate wiring. The presentation of an Adequate Wiring Certificate means that the wiring has been planned, installed and inspected according to approved standards. It means, too, that the home is electrically modern and will stay that way for many years to come.

Thus Certified Adequate Wiring offers benefits far beyond its cost, and the architect who specifies it is sure of satisfied clients.

NORTHERN CALIFORNIA ELECTRICAL BUREAU

1355 Market Street, San Francisco 3

BAXCO

CHROMATED ZINC CHLORIDE

PCZC

PRESSURE TREATED LUMBER
● **PROTECTS AGAINST DECAY**
AND TERMITE ATTACK

Specify it in your home
Available through Lumber Dealers

LOS ANGELES
601 W. 5th Street
Phone Michigan 6294

SAN FRANCISCO
333 Montgomery Street
Phone DOuglas 2-3883

J. H. Baxter & Co.

AGENTS FOR WEST COAST WOOD PRESERVING CO., SEATTLE, WASH.



E. K. WOOD LUMBER CO.

SAN FRANCISCO General Offices: No. 1 Drumm Street
LOS ANGELES Office and Yards: 4710 S. Alameda St. — JE 3111
OAKLAND Yards and Wharves: 2111 Frederick St. — KE 4-8466
PORTLAND Mill Sales Office: 827 Terminal Sales Bldg.

SAW MILLS: Roseburg, Oregon • Reedsport, Oregon
RETAIL YARDS: LOS ANGELES • OAKLAND • ONTARIO • HOLLYWOOD
LONG BEACH • RIVERSIDE • TEMPLE CITY • SIERRA MADRE • INDIO • THERMAL
LA VERNE • WHITTIER • PASADENA • SAN PEDRO

HEADLINE NEWS AND VIEWS

By E. H. W.

"Last year, operating at an average 93% of rated capacity, the steel industry in the United States produced between 53 and 54% of the total world production of steel." Dr. R. E. Zimmerman, Vice president, U. S. Steel Corp.

Labor organizations in the building industry recently inaugurated important steps to increase productivity by bringing labor practices in closer accord with modern building techniques. Such action was inevitable and essential.

"Efforts to modernize building codes as a means of reducing construction costs are making better progress than at any time in the past": Melvin H. Baker, Chairman, Construction Industry Information Committee.

Labor and materials for the construction of a new \$14,000 biological laboratory have been given to the University of California at Los Angeles by a donor who prefers to remain anonymous.

"Favorable public opinion has become almost as important to industry today as good sources of raw materials and efficient manufacturing and marketing methods":—Dr. Claude S. Robinson, President, Opinion Research Corp'n.

"I seriously question the financial feasibility or desirability of two more (Bay) crossing structures". —G. L. Fox, Manager, San Francisco Chamber of Commerce.

"Steel occupies the same position in our economy as it does in a building. It is the framework upon which virtually everything else is hung":—Reynolds Knight ("BEHIND THE SCENES IN AMERICAN BUSINESS")

"West Coast sawmills surmounted obstacles of floods, strikes and vacations to maintain a record lumber production for the first 21 weeks of 1947, exceeding the same period in 1947 by 100-million feet":—H. E. Smith, Secretary West Coast Lumbermen's Ass'n.

Representatives of the press were recently given a preview of the \$35,000.00 Portola Festival House, being erected in San Francisco in conjunction with pending Portola Festival and Pageant. The House is to be given away at a public drawing during the Festival, but, in the meantime the project is open to public inspection.

A. I. A. ACTIVITIES

(From Page 31)

Michigan, co-chairman, and William Muirhead, Durham, North Carolina.

NORTHERN CALIFORNIA CHAPTER, A.I.A.

Among the twenty distinguished architects made Fellows of The American Institute of Architects at the organizations recent 80th Annual meeting in Salt Lake City, Utah, was Gardner A. Dailey, San Francisco.

The architects named Fellows were honored for their notable contributions to the advancement of the profession in original design, education and public service, and in selecting Dailey for this high honor the Institute recognized his devotion of "talents to simple, direct, contemporary architectural solutions. He has produced buildings of integrity, quality and distinction: thereby the architectural profession has been stimulated and its horizons expanded."

Winner of three first prizes in national competitions for domestic architecture, Mr. Dailey designed the U. S. Merchant Marine Cadet Training School in San Mateo, California, and the Brazil Pavilion at the Golden Gate International Exposition in San Francisco. Dailey is also a Visiting Critic in the Yale University Department of Architecture.

SOUTHERN CALIFORNIA CHAPTER, A.I.A.

Members were recently treated to a first hand view of the operation of the Kaiser Co., Inc., Iron and Steel Division plant at Fontana, California. Explanations of the plant construction were outlined by Phillip Daniel who served as chief Assistant Architect to the staff Architect Arthur Mann during the time of the building of the plant.

President George Allison being on a vacation, the meeting was presided over by Al Martin, Jr.

BONDS VOTED

A special election in Arbuttle, California, recently provided some \$75,000 for an addition to the Arbuttle Union Elementary School District's grammar school.

SEWAGE TREATMENT PLANT

A general contract has been awarded to Stolte, Inc., San Leandro, for the construction of a \$99,774 sewage treatment plant in Marin county (California) for the Marin County Sanitary District, San Anselmo.

The construction will be of reinforced concrete. Harry N. Jenks, Palo Alto, is the Engineer.

**SO MUCH
HOT WATER**

20
30
40

**SO
FAST**

40
GALLONS
PER HOUR

**IN SO SMALL
A SPACE**

14 1/4"
16 1/4"
18 1/4"

THE *Continental* GLADIATOR

QUEEN SIZE in beauty—
KING SIZE in performance

Engineering ingenuity has put everything in this sized heater to meet the rigid tests of the American Gas Association.

Slim and beautiful for the modern home, with the new plus features for complete safety and peak performance.

One of a new complete line designed to conserve space.



Check the size YOUR HOUSEHOLD NEEDS
STORAGE TANK CAPACITY GUIDE

Number Bedrooms	Number Bathrooms	Storage Cap. Gallons
1	1 or 2	30
1	3 or 4	40
2	2 or 3	40
2	4 or 5	50
3	3	50
3 or 4	4 or 5	75"

Approved by American Gas Association, Inc.

Continental
WATER HEATER COMPANY LTD.
1801 Potodena Avenue Los Angeles 31, California

LANDSCAPE ARCHITECTURE

Notes of The Profession

ASSOCIATION OF LANDSCAPE ARCHITECTS, SAN FRANCISCO REGION

Vernon Dean, President; Robert Royston, Vice-President; Ned Rucker, Treasurer;
E. L. Anderson, Secretary, 1736 Franklin, Oakland, California.

WASHINGTON LANDSCAPE ARCHITECTS ELECT

The Washington Society of Landscape Architects held its third annual election of officers early in June in Seattle and selected the following officers for the ensuing year:

Robert J. Hansen, Seattle, President; Sherman Ingels, Steilacoom, Vice-president, and Arthur McClish, Seattle, Secretary-treasurer.

The Washington Society of Landscape Architects, now in its third year, meets monthly and is composed of thirteen landscape architects living in Washington. The Society recently elected two honorary members: Dr. John Hanley, well known garden authority, and Professor Frederick Cuthbert, of the University of Oregon, Department of Landscape Architecture.

PLANS FOR IDEAL NEIGHBORHOOD SOUGHT

With an eye to building better communities throughout the country, organized home builders have undertaken an ambitious program to find plans for an ideal neighborhood. This search has taken the form of a nationwide contest sponsored by the Community Development and Shopping Center Committee of the National Association of Home Builders, an Association of over 13,000 private home builders.

Committee Chairman William P. Atkinson, Oklahoma City builder, in revealing details of the national and regional competitions announced that a series of awards will be made for the winning plans, which will be displayed at the National Home Builders Exposition in Chicago, in February, 1949.

Three regional awards and three national awards are being offered in each of five classes, with additional honorable mentions. Awards will be made for the best small groups of single family homes under fifty units with emphasis on economy housing, best single family group over fifty units with emphasis on economy housing, best residential community, best garden apartment of multiple group and best suburban shopping center where construction is 25% complete. Judgments will be based on such factors as ingenuity, soundness of design, consumer appeal and construction.

The national awards committee is composed of distinguished leaders in land and community development headed by J. C. Nichols of Kansas City, Missouri. Twenty regional juries will be formed by regional vice-presidents of NAHB with two additional judges appointed by each. Material to be entered for judging includes location maps, development plans showing significant features or projects, brief outline specifications of site improvements, and other necessary planning data.

Atkinson announced that entries must be mailed to the various regional headquarters of NAHB by November 1, 1948.

Home Builders and other interested persons may obtain complete information from any one of the 115 local home builders associations throughout the United States or by writing to the National Association of Home Builders, 1028 Connecticut Avenue, N. W., Washington, D. C.



PREVENT FIRES and EXPLOSIONS
Caused by **EARTHQUAKES!**

SAFETY ENGINEERS and scientists say the Sentinel is the most accurate and dependable earthquake actuated shut-off valve in the world!* On the job 24 hours a day! A record of more than 10 years of reliable service... **proven** during a period which included two major seismic disturbances. * Names on request

Plus a Manual Control For Other Emergencies!

Take No Chances... Install The
SENTINEL
AUTOMATIC GAS SHUT-OFF VALVE

Designed to shut off automatically when there's an earth shock or explosion sufficient to damage buildings or pipe lines. Listed by the Underwriters' Laboratories and specified by leading architects and engineers for installation in schools, fire stations, factories, theaters, churches, stores, municipal, military and utility buildings. A. I. A. File No. 29-F-6 Write for illustrated folder.

Indispensable in live seismic regions.
Recommended for use with Liquefied Petroleum Gases.
Thousands installed in the United States.
List of installations available on request.
Available at leading wholesale plumbing establishments.
Indorsed by National Bd. of Fire Underwriters.
Leading Fire Prevention Engineers Approve.

SECURITY VALVE CO.
410 San Fernando Rd., Los Angeles 31, California
Phone CAphil 6191

GARDENS IN CHINATOWN

(From Page 30)

comprised the entire garden of the apartments. It was something growing, just a tiny reminder of a garden.

And then around a corner in an alley upon the second story of a brick apartment building were window boxes on the narrow sills. In all of these boxes it was clearly a case of anything that would grow. The exposure, the limited hours of sunlight, the constant stiff breeze, and dust blown up from the low limited the variety of plant to select. Geraniums, aspidistra that will take anything, narcissus and rose bulbs will at least send up foliage, and succulents of various kinds made up most of these window box gardens. In one of the corner windows where more of the afternoon sun reached there were some annuals, low snapdragons and daisies in a variety of color that light up like a cheerful light that came from the building. In fact, on that stroll that day I saw everywhere little sprigs of green, a plant here a flower there, purely simple attempts at gardening under the most difficult and discouraging conditions.

And just as I was about to leave Chinatown I looked into another shop window and saw hanging on the wall an exquisite picture. It was composed of all the gaily colored insects that could be found in China. Red beetles, brown lady birds, green and blue, long legged green praying mantis, brilliant blue, golden and shiny black bugs, and brilliantly winged butterflies resting on lacy flowers. The reflected on the whimsical state of the mind which led this Far Eastern artist to select and preserve the terrors of the garden in this lovely way that they were terrors no longer but a thing of beauty.

We see then the Chinese love gardens, but here in San Francisco they have not developed them. Now that this reconstruction of Chinatown is before us let us encourage the Chinese themselves to bring out their own culture, their own inheritance and develop their own Chinese gardens. Let them bring here into their gardens that Chinese quality which the students of art have long classed as high. I know an engineer who has worked in China three separate times. The first time he told me just what he wanted done, he told them to do this way, and do it exactly as his blue prints said. He got nowhere. The next two times he presented his plans, the Chinese carried them out their way, and it was a better job than he ever dreamed of.

I have recently visited a Chinese garden down the peninsula. The owners first took me from the street into the house. Indeed it wasn't a house, it was a home because it was filled with beautiful things that showed restraint and taste. And then

(See Page 43)

HEATFORM

The Superior Heat Circulating Fireplace

Before you recommend a heat circulating fireplace be sure you have complete information on the HEATFORM

- THE MOST EFFICIENT AND DURABLE OF ALL
- Comparison proves HEATFORM has these advantages:

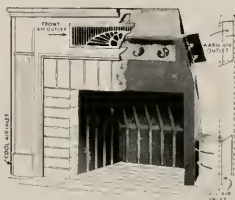

Front view with part of masonry cut away.

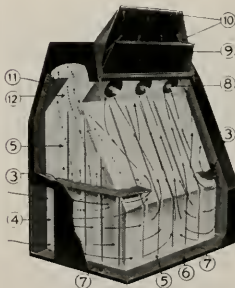

Rear and side view — with part of outer metal lining cut away showing the inside lining of firebox. Arrows showing contact and flow of air to and over all heating surfaces.

For complete information see SWEET'S Catalog Section 29-G-8

The HEATFORM proved by 27 years of use in homes all over America and advertised in nationally circulated magazines.

SUPERIOR FIREPLACE COMPANY

East of Mississippi River

West of Mississippi River

601-M North Point Road
Baltimore, Maryland

1707-C East 15th Street
Los Angeles 21, Calif.

also manufacturers of farm dampers, fuel grates, ash dumps, cleanout doors and drop screens.

MORE HEATING SURFACE BECAUSE—

- Heating chambers around the throat as well as the lower firebox.
- Large air passages at each end of throat plus superheating round air flues directly through the throat connecting the lower and upper heating chambers.
- Large cool air inlets and warm air outlets.
- The foregoing results in much larger volume of warm air circulation.

MORE YEARS OF SERVICE BECAUSE—

- Ribbed reinforced boiler-plate firebox controls warpage.
- No exposed metal parts beneath the chimney to rust out.
- Perfect contact of air to all heating surfaces, and unobstructed flow of air removes heat faster and prevents metal from reaching deteriorating temperature.

KEY TO PHOTO AT LEFT:

3. Horizontal baffle plates which direct a large volume of air intake to the lower rear heating chamber and over the hottest of the metal.
4. Large air inlets at floor level.
5. Ribs individually die formed into the boiler plate add strength and neutralize expansion.
6. Location of rear cool air inlet.
7. Bottom view of air heating chambers.
8. Superheating, connecting round air passages through the throat.
9. Heat control damper has underslung poker friction control to regulate draft.
10. Smoke dome.
11. Side air passages from lower to upper heating chamber.
9. Heat control damper has underslung poker friction control to regulate draft.
10. Smoke dome.
11. Side air passages from lower to upper heating chamber.
12. Inner lining of the throat.

FORDERER CORNICE WORKS

Manufacturers of

Hollow Metal Products • Interior Metal Trim
Elevator Fronts and Cabs
Metal Plaster Accessories • Sanitary Metal Base
Flat and Roll Metal Screens
Metal Cabinets • Commercial Refrigerators

269 POTRERO AVE.

SAN FRANCISCO, CALIF.

HEMLOCK 4100

STRUCTURAL STEEL

For Class A Buildings,
Bridges, etc.

JUDSON PACIFIC - MURPHY CORP.

4300 EASTSHORE HIGHWAY
EMERYVILLE, CALIF.

VALUABLE NEWS SERVICE

- BUILDING MATERIAL DEALERS
- CONTRACTORS
- ENGINEERS
- FINANCIAL INSTITUTIONS

ARCHITECTS REPORTS gives advance news on construction projects in Northern California, lists: name of projects, location, architect, proposed cost and other pertinent information.

HANDY individual slip-reports, issued daily at a total cost of only

\$10 a month

ARCHITECT'S REPORTS

Published Daily

The ARCHITECT and ENGINEER, Inc.
68 Post Street, San Francisco - DO 8311

A NEW APPROACH TO AN OLD PROBLEM

(From Page 14)

kens, internationally known potter. Three he circled the Americas spending his time in study of art and storing ideas for original in teaching. Today these ideas are proving worth and earning for him a host of followers. His wife, Miriam, is interested in art and often two pool their experiments in glazing while two year old son, Forrest watches with rapt attention.

Many rehabilitated veterans will remember Nixon for his work at Letterman General Hospital. Stationed at Letterman during the waning years of the war after two years service for the Navy he taught in the Occupational Therapy Shop where ceramic making was prized for its therapeutic value.

A framework for tomorrow's educational program are the methods of this teacher. Concealed as a pattern wherein nothing remains static it is ever-growing the design points the patterns creations of beauty. Exciting the imagination the procedure bears watching. The focus falls on the future—and on the man who evolved the pattern, Champion Nixon.

SCHOOL BUILDINGS

Among the contracts awarded during the past few weeks for the construction and reconstruction of school buildings were the following:

ANDERSON (Shasta County) Grammar School addition, 10 classrooms, offices and toilet rooms, \$190,000. O. A. Deichmann, Architect, and L. G. Shalzy, Contractor; **OAKLAND**, Hamilton Jr. High School Classroom addition, \$249,777. John E. Branagh, Contractor; **OAKLAND**, Elmhurst Jr. High School Classroom addition, \$229,000. Swinerton & Walberg, Contractor; **LAFAYETTE**, (Contra Costa County) Academics Building addition, 8-rooms and shop building, \$273,700. Frank A. Payne & Son, Contractor; **OROVILLE** High School addition, 3-classroom domestic science and art room, \$122,564. Adams & Chittenden, Contractor; **SAN RAFAEL**, High School swimming pool \$94,983. Younger & Younger, Inc., Contractor.

Valley Home (Stanislaus County) Grammar School, \$70,300. Donald Thompson, Contractor; **EUREKA** High School gymnasium and swimming pool, \$715,000. Geo. J. Maurer & Son, Contractor; **SAN JOSE** Bellarmine College Preparatory, \$1,000,000. Roberty McCarthy Co., Contractor.

CHURCH CONTRACT has been awarded to J. A. McNeil Company of Oakland for the construction of a \$175,000 new church building in Woodland (California) for the Holy Rosary Parish.

ESTIMATOR'S GUIDE

BUILDING AND CONSTRUCTION MATERIALS

PRICES GIVEN ARE FIGURING PRICES AND ARE MADE UP FROM AVERAGE QUOTATIONS FURNISHED BY MATERIAL HOUSES TO SAN FRANCISCO CONTRACTORS. 2½% SALES TAX ON ALL MATERIALS BUT NOT LABOR

All prices and wages quoted are for San Francisco and the Bay District. There may be slight fluctuation of prices in the interior and southern part of the state. Freight cartage, at least, must be added in figuring country work.

BONDS—Performance or Performance plus Labor and Material Bond(s), \$10 per \$1000 on contract price. Labor & Material Bond(s) only, \$5.00 per \$1000 on contract price.

BRICKWORK—
Common Brick—Per 1M laid—\$100.00 up (according to class of work).
Face Brick—Per 1M laid—\$200.00 and up (according to class of work).
Brick Steps—\$3.00 and up.
Common Brick Veneer on Frame Bldgs.—Approx. \$1.20 and up—according to class of work.

Face Brick Veneer on Frame Bldgs.—Approx. \$2.00 and up (according to class of work).
Common Brick—\$28.50 per M—truckload lots, delivered.
Face Brick—\$60.00 to \$90.00 per M, truckload lots, delivered.
Cartage—Approx. \$9.00 per M.
Los Angeles County Area—Residential, up to 4-family or apt., metal raceways, \$6.50 per outlet.

BUILDING PAPER—
1 ply per 1000 ft. roll.....\$5.30
2 ply per 1000 ft. roll.....7.80
3 ply per 1000 ft. roll.....9.70
Brownstik, Standard, 500 ft. roll.....8.00

BUILDING HARDWARE—
Sash cord com. No. 7.....\$2.65 per 100 ft.
Sash cord com. No. 8.....3.00 per 100 ft.
Sash cord spot No. 7.....3.65 per 100 ft.
Sash cord spot No. 8.....4.00 per 100 ft.
Sash weights, cast iron, \$100.00 ton.
Nails, \$5.50 base.

CONCRETE AGGREGATES—
The following prices net to Contractors unless otherwise shown. Carload lots only.

	Bunker per ton	Del'd per ton
Gravel, all sizes.....	\$2.44	\$2.75
Top Sand.....	2.38	3.13
Concrete Mix.....	2.38	3.06
Crushed Rock, ¼" to ¾".....	2.38	2.94

	Bunker per ton	Del'd per ton
Crushed Rock, ¾" to 1½".....	\$2.38	\$3.13
Roofing Gravel.....	2.81	3.50
River Sand.....	2.50	3.06

	Bunker per ton	Del'd per ton
Sand— Lapis (Nos. 2 & 4).....	3.56	3.94
Olympia (Nos. 1 & 2).....	3.56	3.88

Cement—
Common (all brands, paper sacks), carload lots, \$3.02 per bbl. f.o.b. car; delivered \$3.60.
Cash discount on carload lots, 10c a bbl., 10th Prov., less than carload lots \$4.00 per bbl. f.o.b. warehouse or delivered.
Cash discount 2% on L.C.L.

Trinity White	1 to 100 sacks, \$3.13 sack warehouse or del.; \$9.56 bbl. carload lots.
Medusa White	

DAMP-PROOFING and Waterproofing—

Two-coat work, \$8.00 per square.
Membrane waterproofing—4 layers of saturated felt, \$9.00 per square.
Hot coating work, \$5.00 per square.
Medusa Waterproofing, \$3.50 per lb. San Francisco Warehouse.
Tricoat waterproofing.
(See representative.)

ELECTRIC WIRING—\$15 to \$20 per outlet for conduit work (including switches).

Knob and tube average \$6.00 per outlet. (Available only for priority work.)

ELEVATORS—

Prices vary according to capacity, speed and type. Consult elevator companies. Average cost of installing a slow speed automatic passenger elevator in small four story apartment building, including entrance doors, about \$8000.00.

EXCAVATION—

Sand, \$1.00; clay or shale, \$1.50 per yard. Trucks, \$30 to \$45 per day.
Above figures are an average without water. Steam shovel work in large quantities, less: hard material, such as rock, will run considerably more.

FIRE ESCAPES—

Ten-foot galvanized iron balcony, with stairs, \$250 installed on new buildings; \$300 on old buildings.

FLOORS—

Composition Floors, such as Magnesite, 50c per square foot.
Linoflor—2 gages—\$3.00 per sq. yd.
Mastipave—\$1.50 per sq. yd.
Battleship Linoleum—available to Army and Navy only—¼" —\$3.50 sq. yd.
¾" —\$3.50 sq. yd.
Terazzo Floors—\$1.50 per sq. ft.
Terazzo Steps—\$2.50 per lin. ft.
Mestic Waar Coat—according to type—20c to 35c.

Hardwood Flooring—

Standard Mill grades not available.
Victory Oak—T & G
¾" x 2¼".....\$252.00 per M. plus Cartage
½" x 2".....\$210.00
½" x 1½".....200.00

Refinished Standard & Better Oak Flooring
¾" x 3¼".....\$285.00 per M. plus Cartage
½" x 2½".....237.00 per M. plus Cartage

Maple Flooring
¾" T & G Clear \$330.00 per M. plus Ctg.
2nd 305.00 per M. plus Ctg.
3rd 255.00 per M. plus Ctg.
Floor Layers' Wage, \$2.12½ per hr. (Legal as of July 1, 1947. Given us by Inlaid Floor Co.)

GLASS—

Single Strength Window Glass.....\$.40 per □ ft.
Double Strength Window Glass......60 per □ ft.
Plate Glass, under 75 sq. ft.....1.50 per □ ft.
Polished Wire Plate Glass.....2.25 per □ ft.
Rgh. Wire Glass......60 per □ ft.
Obscure Glass......40 per □ ft.
Glazing of above is additional.
Glass Blocks.....\$2.75 per □ ft. set in place

HEATING—

Average, \$2.50 to \$3.00 per sq. ft. of radiation, according to conditions.
Warm air (gravity) average \$64 per register.
Forced air average \$91 per register.

INSULATION AND WALLBOARD—

Rockwool Insulation—	
(2")	\$65.00 per M sq. ft.
Cotton Insulation—Full thickness	
(3/4")	\$95.50 per M sq. ft.
Aluminum Insulation—Foil-mounted	
on both sides	\$33.50 per M sq. ft.
Tiileboard—4"x6" panel	\$9.00 per panel
Wallboard—1/2" thickness	\$55.00 per M sq. ft.
Finished Plank	\$69.00 per M sq. ft.
Ceiling Tileboard	\$69.00 per M sq. ft.

IRON—Cost of ornamental iron, cast iron, etc., depends on designs.

LUMBER—

No. 1 Common	\$90.00 per M
No. 2 Common	\$88.00 per M
Select O. P. Common	\$94.00 per M

Flooring—	Per M Delvd.
V.G.-D.F. B & Btr. 1 x 4 T & G	\$170.00
"C" and better—all	170.00
"D" and better—all	170.00
Rwd. Rustic—"A" grade, medium dry	150.00
8 to 24 ft.	
"B" grade, medium dry	150.00
Plywood	15c to 18c per ft.
Plyscod	9 1/2c per ft.
Plywall	9c per ft.
Plyform	15c per ft.

Shingles (Rwd. not available)—
 Red Cedar No. 1—\$13.00 per square; No. 2, \$10.50; No. 3, \$9.00.
 Average cost to lay shingles, \$6.00 per square.
 Cedar Shakes—Tapered: 1/2" to 3/4" x 25"—\$17.00 per square.
 Resawn: 3/4" to 1 1/4" x 25"—\$22.00 per square
 Average cost to lay shakes,—8.00 per square

MILLWORK—Standard.

D. F. \$150 per 1000. R. W. Rustic \$175 per 1000 (delivered).
 Double hung box window frames, average with trim, \$12.50 and up, each.
 Complete door unit, \$15 to \$25.
 Screen doors, \$6.00 to \$8.00 each.
 Patent screen windows, \$1.25 a sq. ft.
 Cases for kitchen pantries 12 in. high, per lineal ft., \$12.00 each.
 Dining room cases, \$15.00 per lineal foot.
 Rough end finish about \$1.00 per sq. ft.
 Labor—Rough carpentry, warehouse heavy framing (average), \$65.00 per M.
 For smaller work average, \$75.00 to \$85.00 per 1000.

MARBLE—(See Dealers)

PAINTING—

Two-coat workper yard 75c
 Three-coat workper yard \$1.00
 Cold water paintingper yard 25c
 Whitewashingper yard 15c
 Turpentine.....\$1.85 per gal. in 5-gal. cont.
 Raw Linseed
 Oil.....\$3.33 per gal. in 5-gal. cont.

Boiled Linseed
 Oil.....\$3.23 per gal. in drums.
 Boiled Linseed Oil—\$3.33 per gal. in 5-gal. containers.
 Replacement Oil—\$2.75 per gal. in drums.
 \$2.75 per gal. in 5-gal. containers.
 Use Replacement
 Oil.....\$3.00 per gal. in 1 gal. cont.
 A deposit of \$7.50 required on all drums.

PATENT CHIMNEYS—

6-inch	\$2.00 lineal foot
8-inch	2.50 lineal foot
10-inch	3.50 lineal foot
12-inch	4.50 lineal foot

PLASTER—

Neat wall, per ton delivered in S. F. in paper bags, \$17.60.

PLASTERING (Interior)—

3 Coats, metal lath and plaster	Yard \$3.00
Keene cement on metal lath	3.50
Ceilings with 3/4 hot roll channels metal lath (lathed only)	3.00
5eilings with 3/4 hot roll channels metal lath plastered	4.50
Single partition 3/4 channel lath 1 side (lath only)	3.00
Single partition 3/4 channel lath 2 inches thick plastered	8.00
4-inch double partition 3/4 channel lath 2 sides (lath only)	5.75
4-inch double partition 3/4 channel lath 2 sides plastered	8.75
Thermax single partition; 1" channels; 2 1/4" overall partition width. Plastered both sides	7.50
Thermax double partition; 1" channels; 4 1/4" overall partition width. Plastered both sides	11.00
3 Coats over 1" Thermax nailed to one side wood studs or joists	4.50
3 Coats over 1" Thermax suspended to one side wood studs with spring sound insulation clip	5.00
Note—Channel lath controlled by limitation orders.	

PLASTERING (Exterior)—

2 coats cement finish, brick or concrete wall	Yard \$2.50
3 coats cement finish, No. 18 gauge wire mesh	3.50
Limc—\$4.00 per bbl. at yard.	
Processed LLime—\$4.15 per bbl. at yard.	
Rock or Grip Lath—3/4"—30c per sq. yd.	
1/2"—29c per sq. yd.	
Composition Stucco—\$4.00 sq. yard (applied).	

PLUMBING—

From \$150.00 per fixture up, according to grade, quality and runs.

ROOFING—

"Standard" tar and gravel, 4 ply—\$11.00 per sq. for 30 sqs. or over.
 Less than 30 sqs. \$14.00 per sq.
 Tile \$40.00 to \$50.00 per square.
 Redwood Shingles, \$15.00 per square in place.
 5/2 # 1-16" Cedar Shingles, 4 1/2"
 Exposure\$18.25 square

5/8 x 16"—# 1 Cedar Shingles, 5"
 Exposure\$17.00 square
 4/2 # 1-24" Royal Shingles, 7 1/2"
 Exposure\$23.00 square
 Re-coat with Gravel \$5.50 per sq.
 Asbestos Shingles \$30 to \$60 per sq. ft.
 1/2 to 3/4 x 25" Resawn Cedar Shakes,
 10" Exposure\$24
 3/4 to 1 1/4 x 25" Resawn Cedar Shakes,
 10" Exposure\$29
 1 x 25" Resawn Cedar Shakes,
 10" Exposure22
 Above prices are for shakes in place.

SHEET METAL—

Windows—Metal, \$2.50 a sq. ft.
 Fire doors (average), including hardware \$2.80 per sq. ft.

SKYLIGHTS—(not glazed)

Copper, \$1.25 sq. ft. (flat).
 Galvanized iron, 65c sq. ft. (flat).
 Vented hip skylights 90c sq. ft.

STEEL—STRUCTURAL—

\$220 per ton erected, when out of stock
 \$270 per ton erected, when out of stock

STEEL REINFORCING—

\$200.00 per ton, in place.

STORE FRONTS (None available).

TILE—

Ceramic Tile Floors—\$1.70 per sq. ft.
 Cove Base—\$1.35 per lin. ft.
 Glazed Tile Wainscot—\$1.85 per sq. ft.
 Asphalt Tile Floor 1/8" x 3/4"—\$.40 per sq. ft.
 Light shades slightly higher.
 Cork Tile—\$1.00 per sq. ft.
 Mosaic Floors—See dealers.
 Lino-Tile—\$1.00 per sq. ft.

Wall Tile—

Glazed Terra Cotta Wall Units (single face laid in place—approximate prices:
 2 x 6 x 12\$1.25 sq
 4 x 6 x 121.50 sq
 2 x 8 x 161.45 sq
 4 x 8 x 161.75 sq

VENETIAN BLINDS—

75c per square foot and up. Install extra.

WINDOWS—STEEL—

60c per square foot, \$5 for ventilators

PLANTS IN CHINATOWN

(From Page 39)

ly led me to the garden, you could recognize at once that it was definitely in the Chinese style, it was made up of the traditional Chinese components. The moment you entered you felt yourself tranquilized as though you had at that moment come from the roaring city into a remote mountain valley. You kept looking forward down a path, your feet leaping over or swinging around obstacles such as a peony bush, dwarf lemon, a clump of pansy-anthemums, finally to a weeping willow and on the other side at the Moon-gate at the far end, and a long path curved out of sight.

On the other side of the path far to the left were beds of lilies and that symbol of summer the lotus, and glints of light from the water of the pool from which they stood up. At one side grew a clump of bamboo which for the Chinese stands traditionally for long life. And not far away there was also the fragrant shrub called "winter sweet", so common in the cold January. In the garden too was a plum tree with clumps of narcissus at its roots and symbols of winter; a second clump of peonies in bloom of spring, and another wide bed of chrysanthemums symbol of fall.

Back toward the house in glazed pots and wood-

en tubs with stout handles were the oleander, hibiscus or rose of sharon, gardenia, and pomegranate. A season later these would be shifted on and the aspect of the garden would have undergone a change. Another aspect for the sake not so much of novelty as of propriety, for the Chinese garden tolerates no tiresome monotonies.

So Chinatown if it is appropriately redeveloped will have gardens in the Chinese manner. In the designing, the newer radical schools of Chinese art as well as American will have to be used with great discrimination and the main dependent will be the reliable Chinese garden of the past.

LINOLEUM

Armstrong, Nairne, Pabco, Sloane-Blabon

**Linoleum, Asphalt and Rubber Tile
for any installation**



3247 E. 14th Street, Oakland

Phone: ANdover 1-0431

BUILDING TRADES WAGE (JOB SITES) NORTHERN AND CENTRAL CALIFORNIA

ATTENTION: The following are the PREVAILING hourly rates of compensation being paid and in effect by employers by agreement with the employers and their union; or as recognized and determined by the U. S. Department of Labor. (Revised to January 1, 1948.)

CRAFT	San Francisco		Alameda and Contra Costa		Marin	Vallejo	San Mateo	San Jose	Stockton	Sacramento	Fresno
	1.90	1.90	1.90	1.90							
MASTERS WORKERS	2.25	2.25	2.25	2.25	2.25	2.25	2.25	2.25	2.25	2.50	2.25
CLAYERS	1.75	1.75	1.75	1.75	1.75	1.75	1.75	1.87 1/2	1.87 1/2	1.87 1/2	1.75
CLAYERS, HODCARRIERS	2.00	2.00	2.00	2.00	2.00	2.00	2.00	2.00	2.00	2.00	2.00
PAINTERS	2.02 1/2	2.02 1/2	2.02 1/2	2.02 1/2	2.02 1/2	2.02 1/2	2.02 1/2	2.02 1/2	2.02 1/2	2.02 1/2	2.02 1/2
PLASTER FINISHERS	2.25	2.25	2.25	2.25	2.25	2.25	2.25	2.25	2.25	2.25	2.25
PLASTERERS	2.00	2.00	2.00	2.00	2.00	2.00	2.00	2.00	2.00	2.00	2.00
PLASTERERS: MATERIAL HOIST	2.25	2.25	2.25	2.25	2.25	2.25	2.25	2.25	2.25	2.25	2.25
PILE DRIVER	2.25	2.25	2.25	2.25	2.25	2.25	2.25	2.25	2.25	2.25	2.25
PIPELAIN	2.25	2.25	2.25	2.25	2.25	2.25	2.25	2.25	2.25	2.25	2.25
PIPELAIN: STRUCTURAL STEEL	1.87 1/2	1.87 1/2	1.87 1/2	1.87 1/2	1.87 1/2	1.87 1/2	1.87 1/2	1.87 1/2	1.87 1/2	1.87 1/2	1.87 1/2
PIPELAIN: ORNAMENTAL	2.00	2.00	2.00	2.00	2.00	2.00	2.00	2.00	2.00	2.00	2.00
PIPELAIN: REINF. RODMEN	2.25	2.25	2.25	2.25	2.25	2.25	2.25	2.25	2.25	2.25	2.25
PIPELAIN: STRUCTURAL	1.40	1.40	1.40	1.40	1.40	1.40	1.30	1.40	1.40	1.40	1.30
PIPELAIN: BUILDING & CONCRETE	2.25	2.25	2.25	2.25	2.25	2.25	2.25	2.25	2.25	2.25	2.25
PIPELAIN: MEAS.	2.00	2.00	2.00	2.00	2.00	2.00	2.00	2.00	2.00	2.00	2.00
PIPELAIN: BLE SETTERS	2.00	2.00	2.00	2.00	2.00	2.00	2.00	2.00	2.00	2.00	2.00
PIPELAIN: PAIC & TERRAZZO	2.00	2.00	2.00	2.00	2.00	2.00	2.00	1.75	1.75	1.75	1.75
PIPELAIN: MEAS.	2.00	2.00	2.00	2.00	2.00	2.00	2.00	2.00	2.00	2.00	2.00
PIPELAIN: DRIVERS	2.12 1/2	2.12 1/2	2.12 1/2	2.12 1/2	2.12 1/2	2.12 1/2	2.12 1/2	2.12 1/2	2.12 1/2	2.12 1/2	2.12 1/2
PIPELAIN: MEAS.	2.25	2.50	2.25	2.50	2.25	2.25	2.25	2.05	2.05	2.05	2.05
PIPELAIN: MEAS. HODCARRIERS	2.00	2.00	2.00	2.00	2.00	2.00	2.00	1.87 1/2	1.87 1/2	1.87 1/2	1.87 1/2
PIPELAIN: MEAS.	2.25	2.25	2.25	2.25	2.25	2.25	2.25	2.25	2.25	2.25	2.25
PIPELAIN: MEAS.	2.00	2.00	2.00	2.00	2.00	2.00	2.00	2.00	2.00	2.00	2.00
PIPELAIN: MEAS. METAL WORKERS	2.00	2.00	2.00	2.00	2.00	2.00	2.00	2.00	2.00	2.00	2.00
PIPELAIN: MEAS. WINKER FITTERS	2.00	2.00	2.00	2.00	2.00	2.00	2.00	2.00	2.00	2.00	2.00
PIPELAIN: MEAS. WINKER FITTERS	2.25	2.25	2.25	2.25	2.25	2.25	2.25	2.25	2.25	2.25	2.25
PIPELAIN: MEAS. WINKER FITTERS	2.25	2.25	2.25	2.25	2.25	2.25	2.25	2.25	2.25	2.25	2.25
PIPELAIN: MEAS. WINKER FITTERS	2.15	2.15	2.15	1.90	2.15	1.90	1.90	1.90	1.90	1.90	1.90

Prepared and compiled by

CENTRAL CALIFORNIA CHAPTER, ASSOCIATED GENERAL CONTRACTORS OF AMERICA

with the assistance and cooperation of secretaries of Building Trades Unions, General Contractors Associations and Builders Exchanges of Northern California

CLASSIFIED ADVERTISING

RATE: 20c PER WORD ... CASH WITH ORDER

MINIMUM \$5.00

ARCHITECT'S REPORTS—A valuable advice news service giving building and construction information daily on projects in all parts of California. Name, location, architect, proposed cost, etc., on individual slips. Ideal for securing new business leads. Hundreds of items, total monthly cost only \$10.00. Write today, subscribe today. ARCHITECT

& ENGINEER, Room 618, 68 Post Street, San Francisco, California. Phone DOUGLAS 2-8311.

PHOTOGRAPHS: Specializing in building and construction photographs for publication, or historic records. For Industrial-Aerial-Publicity photography use the INDUSTRIAL

San Francisco. PHOTO'S, Room 929, Hearst Bldg., San Francisco, Phone SUItter 1-6953.

ENGRAVING—Good engravings are essential to a satisfactory job of printing reproduction. For the best, see Poor Richard Photo Engraving Co., 324 Commercial St.,

**CLINTON
CONSTRUCTION CO.**
OF CALIFORNIA

General Contractors

923 FOLSOM STREET • SAN FRANCISCO

SUtter 1-3440

HOGAN LUMBER CO.

Wholesale and Retail

LUMBER

MILL WORK • SASH & DOORS

Office, Mill, Yard and Docks

SECOND AND ALICE STREETS • OAKLAND, CALIF.

Telephone GLencourt 1-6861

SISALKRAFT

REG. U. S. PAT. OFF.

"More than a building paper"

THE SISALKRAFT CO.

205 West Wacker Drive

Chicago, Ill.

55 New Montgomery Street

San Francisco, Calif.

SANTA MARIA INN
SANTA MARIA, CALIFORNIA

FRANK J. McCOY, General Manager

FERNAND E. PIMENTEL, Manager

On the
Coast
Highway
between
San
Francisco
and
Los
Angeles



American
or
European
Plan
•
Old
English
Tap
Room

STUDENT WORK

(From Page 19)

as possible building sites. Studies were next made of the location of various architectural elements. It was felt that all things drained naturally to the center, and that the community was like a living organism. Thus the flat land became the heart, and the valleys the veins and arteries. As in any healthy organism, the circulation had to be clear and logical; therefore, the valleys, with their natural flow, were utilized for pedestrian ways, while a peripheral road was established for automobile traffic.

After considerable study, 2 check dams were thrown across the wash to prevent further erosion, and to catch soil washed down from cut and fill operations.

Secondary roads were then established, and kept below the 15% agreed maximum grade. Lots were placed on slopes less than 20% and were deliberately varied in shape and size to make use of available ground. A minimum size of 80' x 120' was set.

Finally houses were located and placed to make use of the view, and to form a pleasing pattern.

All single dwelling units were arranged sympathetically with the contour and general character of the land.

Community center architecture was deliberately designed to be rigid and logical with the tree pattern providing a transition between nature and man-made elements.

Major tree pattern study resulted in a skin for the "organism" by pulling in all loose ends, and creating a natural visual terminus. Tall trees (*Eucalyptus globulus*) performed this function, and carried down into the heart in a rhythmic series of verticals, which snow-ball or increase as they move toward the community center. A rigid pattern in upper space clearly tells the story of the importance of the architecture below. A minor tree pattern was designed to further the separation of the lower space into neighborhoods and to define greenbelts and roads. Large clumps of trees were provided in the valleys and upon the hills to enhance the beauty of the site, and check erosion.

Conclusion

The designers feel that the finished design solves the fundamental desire of all healthy-minded people for a quiet, natural environment where children can grow with nature, and yet have all the benefits of the city.

BOOK REVIEWS

PAMPHLETS AND CATALOGUES

CHROMEDGE METAL TRIMS. B & T Metals Co., Columbus 16, Ohio. Catalogue A.I.A. File No. 23-i.

A sixty-eight page booklet profusely illustrated with drawings, photographs, charts, scales and other important information pertaining to metal trims and their many uses.

The catalogue also contains a handy visual index, a numerical index, and a section devoted to general information on the subject. The material is very well presented.

THE SPECTROGRAPHIC ANALYSIS OF TIN AND TIN LEAD SOLDERS. By D. M. Smith. Tin Research Institute, Fraser Road, Greenford, Middlesex, England.

A new booklet, gives comprehensive summary of present knowledge on the subject of Metallurgical Analysis of Tin and Tin-lead alloys by the spectrograph. Results of hitherto unpublished work by the author are included as are tables of wavelengths suitable for the use as internal standards; estimated limits of detection for impurities; an adequate bibliography and photographs of typical arc spectra. Copies available from publisher.

MECHANICAL DRAFT COOLING TOWERS. Binks Mfg. Co., Chicago, Ill.

Architects and Engineers concerned with the design of large scale air conditioning systems will find interesting information on the subject of masonry type cooling towers in a new Bulletin No. 38, recently issued by Binks Mfg. Co., 3114 Carroll Ave., Chicago, Ill.

The Bulletin gives data on tower capacities, dimensions, fan size, and other specifications.

GRAMMAR SCHOOL

A 9-classroom, office and toilet Grammar School building will be built for the Salsipuedes Union Elementary School District, Santa Cruz County, at a cost of \$175,270, according to John I. Easterly, Architect, of Watsonville. T. H. Rosewall is the contractor.

THE SIX-ROOM HOUSE is leading the home construction parade, and according to a recent survey by the National Association of Home Builders, today's average home costs between \$9,000 and \$10,000.

"AMERICAN - MARSH"

CONDENSATION UNIT

Pumping
Machinery
for
Every
Purpose

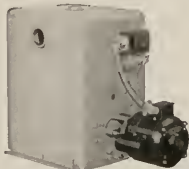

For Service
Call
DOuglas
2-6794
or
MUtual 8322

SIMONDS MACHINERY CO.
SAN FRANCISCO 816 FOLSOM
LOS ANGELES 455 EAST 4TH

VERMONT MARBLE COMPANY

Producers and Finishers
of
Domestic and Imported Marbles

525 MARKET STREET, SAN FRANCISCO
Phone SUtter 1-6747
3522 COUNCIL STREET
(Beverly Blvd. at Virgil Ave.)
LOS ANGELES 4, CALIF.
Telephone Fairfax 7834



The Most Complete Line of
STEELS and BUILDING MATERIALS
Made by a Single Producer



See Sweet's Catalog File or write us for
full information.

REPUBLIC STEEL CORPORATION
GENERAL OFFICES: CLEVELAND, OHIO

DENVER, COLORADO CONTINENTAL OIL BUILDING
LOS ANGELES, CALIFORNIA EDISON BUILDING
SALT LAKE CITY, UTAH WALKER BANK BUILDING
SAN FRANCISCO, CALIFORNIA RIALTO BUILDING
SEATTLE, WASH. WHITE-HENRY-STUART BUILDING

PACIFIC MANUFACTURING CO.

High Class Interior Finish Quality
Millwork

16 Beale St., San Francisco
GARfield 1-7755
2215 El Camino Real, San Mateo
S. M. 5-0687
304 Bryant Street, Palo Alta
P. A. 3373
2610 The Alameda, Santa Clara
S. C. 607 (Factory)
6820 McKinley Avenue, Los Angeles
THornwall 4196
MAIN OFFICE — SANTA CLARA

IN THE NEWS

NEW DRY PROCESS REPRODUCTION UNIT

A new streamlined Dry Process Reproduction Unit complete with the New Harvey "Almo-Fume" Dry Developer has been announced by Peck & Harvey of Chicago, Illinois.

Designed to save time and cost in answering the many reproduction needs in drafting room, shop, lab, and office, it quickly makes a

ACOUSTI-CELOTEX

Sound Conditioning

... brings you the
benefit of an
accumulated experience
of over a
quarter century

WESTERN ASBESTOS COMPANY

675 Townsend Street, San Francisco 3

Telephone: HEMlock 1-4884

OAKLAND • SACRAMENTO • FRESNO • SAN JOSE

3 IN 1-KIMSUL

INSULATION
COLD • HEAT • SOUND
PERFECTLY CONTROLLED

TREATED AGAINST FIRE, MOISTURE, VERMIN AND INSECTS. ECONOMICAL,
LIGHT, EASY TO HANDLE AND INSTALL.

GUNN CARLE & CO
20 POTRERO AVENUE • SAN FRANCISCO, CALIF.

variety of Dry Prints, Positives, and negatives by exposure and dry development in a matter of seconds.

SF YACHT HARBOR REPAIR.

The San Francisco Park Commission has awarded a \$24,843 contract to the Duncanson-Harrellson Co., for repairs to the San Francisco Yacht Harbor.

ARCHITECT SELECTED

Confer & Willis, Architects of Oakland, have been selected to do the new Brookfield Grammar School in Oakland. Estimated cost \$300,000.

NAVAL RESERVE Training Center at Sacramento (California) to cost \$196,609 will be built by MacDonald, Young & Nelson, San Francisco, contractors.

ENLISTED MEN'S SERVICE CLUB

A contract has been awarded to the M & K Corporation of San Francisco, for the construction of an Enlisted Men's Service Club at the Presidio of San Francisco at an estimated cost of \$280,069.

SCHOOL BONDS DEFEATED. Voters turned down a \$2,500,000 bond issue for construction of new high school buildings at Lodi, California, recently.

OFFICE & FACTORY

A general contract has been awarded to W. K. Owen of Emeryville for the construction of a brick and frame and stucco office, factory and warehouse building in San Leandro to be occupied by the St. Regis Paper Company.

Cost of the building is \$300,000.

NEW EXECUTIVE LUMINAIRES

Engineered for correct illumination and ease of maintenance, a new line of fluorescent and slimline Executive Luminaire lighting fixtures has been announced by the ELECTRIC PRODUCTS COMPANY of Chicago.

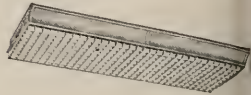

Available in 2 and 4 lamp unit louvered or glass bottoms, the standard 40 watt fluorescent and 51 watt slimline sizes. Finished in durable baked enamel, it is wire complete and has a reflectivity factor of 87%.

FIRE HOUSE & DRILL TOWER. Burlingame (California) will spend \$65,000 in the construction of a fire house and Drill tower, according to Sharps & Brown, Architects.

ARCHITECT SELECTED

Oscar R. Thayer, Burlingame (California), has been selected to do the new recreation buildings for the City of Burlingame. Estimate cost of the project is \$155,000.

SCHOOL BONDS VOTED

A special election at Madras (California) approved \$397,000 for the construction of three grammar school buildings.

HIGH SCHOOL ADDITION. \$238,936 will be spent in the addition of five classrooms and cafeteria to the Wasco Union High School. Franklin, Kump & Falgout, San Francisco, are the Architects.

NEVADA HOSPITAL

A contract has been negotiated by the directors of the Church Public Hospital at Fallon, Nevada, for the construction of a 24-bed hospital. Cost is \$152,000.

DeLongchamps & O'Brien, Reno, Nevada, are the Architects. Wendell E. Nelson of Fallon is the contractor.

ARCHITECT AND ENGINEER

Brownskin

VAPORSEAL

The resilient
building paper
creped to
S-T-R-E-T-C-H

Quality Products Since 1895

ANGIER PACIFIC CORPORATION

51 NEW MONTGOMERY ST. SAN FRANCISCO 9, CALIF. • 7425 SOMMER HOLLOWAY LOS ANGELES 46, CALIF.

A complete line of Angier products available from your building material dealer

Subscribe
Now —

**ARCHITECT
and
ENGINEER**

\$3.00
Per Year

**THE TORMEY
COMPANY**

**GENERAL PAINTERS
AND DECORATORS**

Phone UNDERhill 1-1913

563 FULTON STREET
San Francisco

Fine
ENGRAVINGS

**POOR
RICHARD**
PHOTO ENGRAVING CO.
320-324 COMMERCIAL STREET
SAN FRANCISCO, 11.

IN THE NEWS

NEW SANITARY MOTOR

Designed for use in dairies, food process, canning and beverage plants this new motor incorporates several novel features which improve machinery installations where sanitation is essential.

It is totally enclosed, non-ventilated, and of various sizes, with the entire base enclosed by the motor housing finished to a flat surface. Mounting bolt holes are located in accordance with NEMA standards, and the base is designed for use of a built-in conduit box.

It is manufactured by the Louis Allis Company of Milwaukee, Wisconsin.

MARSHALL HONORED

Secretary of State George C. Marshall was awarded a certificate of honorary membership in The American Society of Mechanical Engineers. E. G. Bailey, New York, nationally known engineer and power authority and President of the ASME conferred the honor.

CONTRACT AWARDED

A contract has been awarded to Parker, Steffens & Pearce of San Francisco, for the construction of a Marine Firemen's office building in San Francisco, at a cost of \$249,455.

Architect for the project is Harold H. Weeks, San Francisco.

SWIMMING POOL

The Eureka Board of Education has awarded a contract to George I. Maurer & Son for the construction of a Gymnasium and Swimming Pool at the Eureka (California) High School. Cost of the work is \$679,700. Masten & Hurd, San Francisco, are the Architects.

NEW JAIL

The first unit of a new Court-house and Jail is to be built at Downieville (California) by Paul I. Jenks of Grass Valley at a cost of \$77,114. Geo. C. Sellon, Sacramento, is the Architect.

Scott Company

HEATING - - PLUMBING - - TILE

★

243 MINNA STREET
SAN FRANCISCO
Phone EXbrook 2-6741

**DINWIDDIE
CONSTRUCTION
COMPANY**

BUILDERS

CROCKER BUILDING
SAN FRANCISCO



**HERRICK
IRON WORKS**
STRUCTURAL STEEL
REINFORCING STEEL

18TH AND CAMPBELL STS.
OAKLAND, CALIF.
Phone GLencourt 1-1767

Phone GARfield 1-1164

Thomas B. Hunter
DESIGNER OF HEATING

AIR CONDITIONING
VENTILATING AND WIRING
SYSTEMS, MECHANICAL
AND ELECTRICAL EQUIP-
MENT OF BUILDINGS

★

41 SUTTER STREET
ROOM 710
San Francisco California

Mattock Construction Company

Builders



604 MISSION STREET
SAN FRANCISCO

Subscribe to ARCHITECTS REPORTS

Individual slip-reports give advance information on construction projects in northern California—name, location, Architect, cost, and other valuable data.

68 Post Street Douglas 2-8311

MULLEN MFG. COMPANY

BANK, STORE AND OFFICE
FIXTURES—CABINET WORK
OF GUARANTEED QUALITY
CHURCH SEATING

Office and Factory
60-80 RAUSCH ST., Bet. 7th and 8th Sts.
San Francisco
Telephone UNDERhill 1-5815

PITTSBURGH TESTING LABORATORY

ENGINEERS AND CHEMISTS

Testing and Inspection of Concrete,
Steel and Other Structural Materials

Design of Concrete Mixes

Offices in all principal cities

651 Howard St., San Francisco 5
EXbrook 2-1747

Index to Advertisers

ANGIER Pacific Corp.	47
ARCHITECTURAL Porcelain Constructors	30
ARCHITECTS Reports	46
BASALT Rock Company	Back Cover
BAXTER & Company, J. H.	36
CLASSIFIED Advertising	43
CLINTON Construction Company	44
CONTINENTAL Water Heater Co.	37
DETROIT Steel Products Co.	5
DINWIDDIE Construction Co.	47
DUFFY Tile Co.	48
FORDERER Cornice Works	40
FOX Tile Co.	43
FULLER, W. P. Co.	*
GLADDNG, McBean & Co.	7
GUNN, Carle & Company	46
HANKS, Inc., Abbott A.	48
HAWS Drinking Faucet Company	34
HERRICK Iron Works	47
HOGAN Lumber Company	44
HUNT, Robert W. Company	48
HUNTER, Thos. B.	47
JOHNSON, S. T. Co.	*
JUDSON, Pacific-Murphy Corp.	40
KRAFTILE Company	31
MARBLE Institute of America	2
MATTOCK, A. F. Co.	48
MICHEL & Pfeffer Iron Works	Inside Front Cover
MULLEN Mfg. Co.	48
MUELLER Brass Co.	*
NORTHERN California Electric Bureau	35
PACIFIC Coast Gas Association	Inside Back Cover
PACIFIC Manufacturing Company	45
PACIFIC Portland Cement Company	1
PACIFIC Telephone & Telegraph Co.	33
PITTSBURGH Testing Laboratory	48
POOR RICHARD Engraving Co.	47
REMILLARD-Dandini Co.	48
REPUBLIC Steel Corporation	45
SANTA Maria Inn	44
SCOTT Co.	47
SECURITY Valve Company	38
SIMONDS Machinery Company	45
SIMPSON Logging Co.	6
SISALKRAFT Company	44
SMOOT-Holman Co.	10
SOULE Steel Co.	*
STANLEY Works, The	32
SUPERIOR Fireplace Company	39
TAYLOR Co., Halsey W.	*
TORMEY Company, The	47
U. S. BONDS	9
VERMONT Marble Company	45
WESIX Company	*
WESTERN Asbestos Co.	46
WESTERN-Holly Stove Co.	8
WOOD, E. K., Lumber Company	36

*Indicates Alternate Months

ABBOTT A. HANKS, INC. Engineers & Chemists

INSPECTING — TESTING — CONSULTING
CONCRETE • STEEL • MATERIALS
CHEMICAL AND TESTING
LABORATORIES
• RESEARCH AND INVESTIGATION •

TESTS OF STRUCTURAL MATERIALS
DESIGN OF CONCRETE MIXES
SHOP AND ERECTION INSPECTION OF
STRUCTURES AND EQUIPMENT
INVESTIGATION OF STRUCTURES
AND MATERIALS
TESTS AND INVESTIGATION OF
FOUNDATION SOILS
FIRE RESISTANCE AND INSULATION
TESTS

624 Sacramento Street, San Francisco

Robert W. Hunt Company ENGINEERS

Inspection • Tests • Consultation
Schools and Other Structures
Are Built as Designed

When Construction Materials are
Inspected as point of Manufacture
and during Erection by

ROBERT W. HUNT COMPANY

Cement, Concrete, Chemical, Metallurgical,
X-Ray and Physical Laboratories

Chicago • New York • Pittsburgh
Los Angeles • All Large Cities
San Francisco, 251 Kearny Street

REMILLARD-DANDINI Co.

Brick and
Masonry Products



400 MONTGOMERY STREET
SAN FRANCISCO, CALIF.

DUFFY TILE CO.

TILE CONTRACTORS
SHOWER DOORS
TUB ENCLOSURES

INSTALLATIONS
OF EVERY
DESCRIPTION
Modernizing, Repairing
"Net How Cheap
But How Good"
253 MINNA
YUkon 6-1489



ARCHITECT AND ENGINEER

UNIVERSITY MICROFILMS

International Headquarters



UNITED AIR LINES

1947

1948

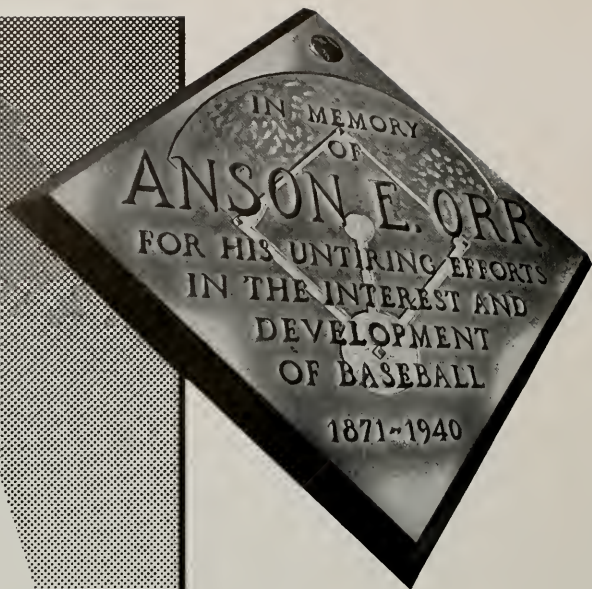

BRONZE PLAQUES

by Michel & Pfeffer Iron Works, Inc.

*for vivid detail
and design*

Attractive plaques, tablets and name plates carefully executed by expert craftsmen to your specifications or our design. In bronze or aluminum.

Write for new descriptive bulletin



Michel & Pfeffer Iron Works, Inc.

KENNETH OPIE, Manager Misc. and Ornamental Division
Tenth and Harrison Streets, San Francisco 3, California
Telephone MArket 1-5966

ARCHITECT

Vol. 174

No. 2

AND ENGINEER

ARCHITECTS' REPORTS—Published Daily

Contents for

AUGUST

E. H. WILDER

Editor

MARK DANIELS, A.I.A.

Associate Editor

PROF. LELAND VAUGHAN

Landscape Architecture

JOHN A. BLUME

Structural Engineering

MICHAEL GOODMAN

Planning

JOHN S. BOLLES, A.I.A.

Book Reviews



COVER PICTURE:

new United Air Lines Airport terminal at Merced, California, designed by KUMP & FALK, Architects-Engineers, San Francisco, California, recently awarded national recognition for "sound progress in design."

Photo Roger Sturtevant

EDITORIAL NOTES	4
NEWS & COMMENT ON ART	6
A CAMERA IS A SOMETIMES THING, By Douglas Baylis, Landscape Architect	8
THE LANDSCAPE DEVELOPMENT OF THE LOS ANGELES AIRPORT	10
LLOYD ALDRICH, City Engineer; NICHOLAS M. CIRINO, A.I.A. Architect; EDWARD J. WATERHOUSE, Landscape Architect; HENRY C. SOTO CORP'N, Landscape Contractors	
ADDITION TO DETROIT STEEL PRODUCTS	17
THE RE-BIRTH OF DARWIN, AUSTRALIA, By R. Drake	18
STUYVESANT TOWN, Borough of Manhattan, New York	28
A.I.A. ACTIVITIES	31
WITH THE ENGINEERS	32
HEADLINE NEWS & VIEWS, By E. H. W.	36
LANDSCAPE ARCHITECTURE, Notes of the Profession	38
ESTIMATOR'S GUIDE, Building and Construction Materials	41
BUILDING TRADES WAGE, Northern and Central California	43
CLASSIFIED ADVERTISING	43
BOOK REVIEWS, Pamphlets and Catalogues	45
INDEX TO ADVERTISERS	48

ARCHITECT AND ENGINEER (Established 1905) is published on the 15th of the month. The Architect and Engineer, Inc., 68 Post St., San Francisco 4; Telephone EXbrook 182. President, K. P. Kierulff; Vice-President and Manager, L. B. Peahorwood; Treasurer, E. N. Kierulff.

Los Angeles Office: Wentworth F. Green, 6605 Hollywood Blvd., Los Angeles 28. Telephone HEmpstead 3171.

Entered as second class matter, November 2, 1905, at the Post Office in San Francisco, California, under the Act of March 3, 1879. Subscriptions: United States and Pan America, \$3.00 a year; \$5.00 two years; foreign countries \$5.00 a year; single copy 50c. ARCHITECTS' REPORTS are published daily from this office, Vernon S. Yallop, Manager.



EDITORIAL NOTES



"WHAT IS THE COMMUNITY CHEST?" The chances are ten to one that you think it is a group of organizations that help people, and such a conclusion is correct, except that you probably think the people it helps are "other people" and not by chance you.

In this respect you are wrong, because you and your family benefit as much as the other fellow's family by the presence of hospitals, health centers, Y.M.'s and Y.W.'s, the Scouts, and many other important phases of every community which come under Red Feather services.

Among the most familiar of the Red Feather services is the Community Chest, a wholesome democratic force which unites people of all faiths, all political beliefs, and all walks of life in an orderly plan for the good of the entire community.

The Community Chest, which is seeking your support this Fall, allocates the money raised through voluntary services fairly among its member agencies, thus delivering a maximum value of every dollar raised.

PROFESSIONAL ENGINEERS ACT of California, a measure passed by the last session of the Legislature and requiring the licensing of Mechanical, Electrical, Chemical and Petroleum Engineers as well as Civil and Structural Engineers, does not change the position of the Architect according to an interpretation by Pecos H. Calahan, Executive Secretary of the Department of Professional and Vocational Standards, Board of Registration for Civil and Professional Engineers, State of California.

In reply to a direct question—"Will you kindly inform me as to my status as an Architect in relation to the new law licensing mechanical, electrical, chemical and petroleum engineers," Calahan has this to say:

"The amendment to the Civil Engineers' Act (Article 8) does not in any way affect the practice of an Architect. In the first place, the amendment does not prohibit the practice of either electrical or mechanical engineering, and in the second place, if it did, the exemption (Section 673 of the law) is still effective, whereby an Architect may practice professional engineering in connection with his architectural commission."

CONTINUED BUILDING OPPORTUNITIES exist in most communities throughout the nation and a recent survey in the City of Seattle, Washington, and surrounding area gives an interesting insight into the residential situation there.

The report shows that nearly eighty per cent of the families living in the region own, or are buying, their own home; that the family income is approximately twenty-eight per cent above the national average, and that the backlog in home building indicates a five year building period with an annual new construction expenditure of more than one hundred million dollars per year.

Multiply this one comparatively small area by the national possibilities and you will find the construction industry and the architectural profession have a tremendous opportunity for the next few years at least.

Collectivism as practiced by both labor and capital has a danger point that leads to regimentation—Regimentation leads to a class system—A class system leads to peasantry and to slavery. Prove your American principles of living, working and playing . . . VOTE at every election.

SOMETHING TO THINK ABOUT in regard to the nation-wide housing shortage is contained in a message recently released by the National C Bank of New York which suggests that any further grants to ease the situation could lead to more expensive housing rather than to more housing.

Materials and labor available for construction are fully employed now and any "measures" to increase the demand could not proportionately increase the supply; they could only increase competition for materials already in the market and for workers who already have jobs. This could only drive construction costs further upward."

The current exorbitant rise in building costs and prices, the Bank points out, is due to economic money terms, low productivity due to union restrictions, inefficient workers, weakening of incentives to increase man-power output, the unevenness of material supply, and poor building conditions.

Paced by a gain of 60 per cent in expenditure for new housing, the total volume of new construction in the first half of 1948 reached \$7.7 billion, an increase of more than \$2 billion over the same period of last year.—Construction Industry Information Committee.

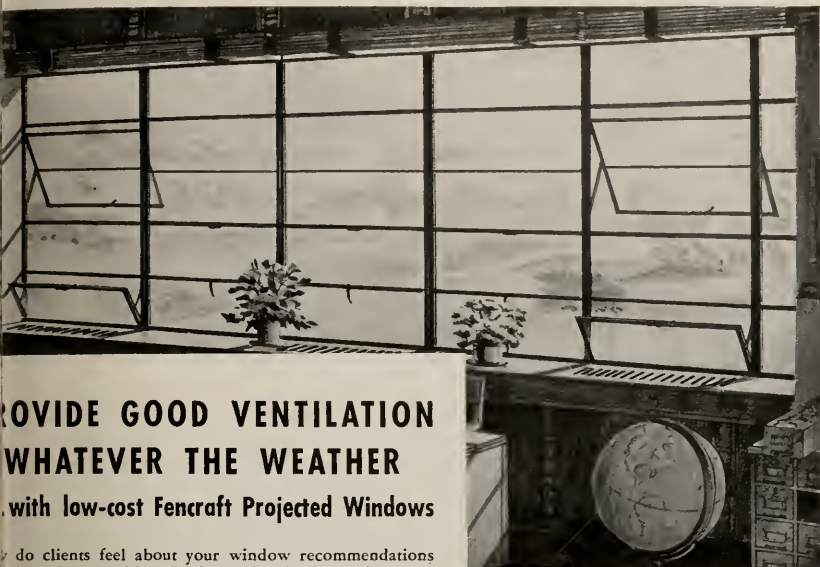

PROVIDE GOOD VENTILATION WHATEVER THE WEATHER

with low-cost Fencraft Projected Windows

Do clients feel about your window recommendations when it's raining and blowing? Or when it's hot and muggy? Are windows designed to provide good ventilation under the most adverse conditions:

IN-OUT VENT forms canopy over the opening. It sheds rain and snow away from the opening.

UP VENT deflects incoming air upward and thus prevents drafts at desk level. And it sheds rain and snow to the outside.

UP-DOWN VENT is easy to reach, always easy to open. Each stays in the selected position and closes to a weathertight fit.

Fencraft Projected Windows are safer—the sill vent prevents wind blowing out, guards against falls. Close-fitting screens are easily attached or removed from inside the room.

Economical, too. Standardization results in lower manufacturing costs. Dimensions co-ordinate with modern masonry practice to reduce installation time and costs. Maintenance is simple for steel can't warp, swell, shrink or rot.

There's beauty in the trim horizontal lines of Fencraft windows. Extra firesafety because they're steel. They're designed right for the modern buildings that are coming from the architect's drafting boards. Mail the coupon for full information.

FENCRAFT COMBINATION WINDOW

Generous fresh-air ventilation. Swing leaves deflect breezes into the room. In-tilting sill vent protects against drafts. Both sides easily and safely washed from inside.



FENCRAFT CASEMENT WINDOW

Safe washing on outside—from inside. Easy to operate. Interchangeable inside screens, protected from outside dirt.

Fenestra

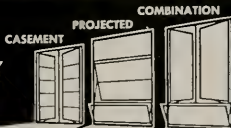

FENCRAFT INTERMEDIATE STEEL WINDOWS

Detroit Steel Products Company
Dept. AE-8
2262 East Grand Blvd.
Detroit 11, Michigan

Please send me data on types and sizes of the new Fencraft family of Fenestra Windows:

Name

Company

Address

NEWS AND COMMENT ON ART

PAINTINGS BY BAY REGION ARTISTS. Opening August 9, continuing through September 12. The fifty works in this exhibition were assembled by Museum invitation on the basis of a list of active artists who have been noted representative of the art activity in this region by their fellow exhibitors. This particular show is especially selective in that it includes only paintings and drawings. Sculptures were not included in the exhibition because, from it, a smaller group of paintings and drawings will be chosen to be circulated to other museums throughout the United States by the American Federation of Arts. San Franciscans will find a variety of expression, much creative originality, and ample opportunity to view the various directions present in Bay Region contemporary art development.

EXHIBITIONS will include: Drawings by Henri Matisse, circulated by the American Federation of Arts, August 12 to September 2; St. Louis Jefferson Memorial Exhibition, during August; Paintings and Drawings by Le Corbusier, through October 10th; Photographs by Rose Mandel, August and September; Hans Richter—Art in Cinema Exhibition, through September 24th; Moholy-Nagy Retrospective Exhibition; California Decorative Arts and Crafts, through September; Paintings by Ethel Weiner and Martin Snipper, and Sculpture by Blanche Phillips; Symbolism in Painting; Paintings by John Piper, Photographs by Alma Lavenson, and the Second Annual United Nation Poster Competition.

PHILADELPHIA ART ALLIANCE SPONSORS NATIONAL EXHIBIT

The Philadelphia Art Alliance has announced it will sponsor a nationwide exhibit of crafts and invited workers in the various fields to enter their products.

The show, to be held at the Art Alliance galleries, 251 S. 18th St., Philadelphia, will run from October 27 through January 2, and, according to Dorothy Kohl, executive director of the Art Alliance, probably will be the most comprehensive crafts exhibit ever held in Philadelphia.

Eligible for entry are examples of all recognized handicrafts and machine made articles, such as pottery, tiles, mosaics, woodcarving, weaving, embroidery (original designs), batik, bookbinding, leatherwork, metalwork, jewelry (ceramic jewelry excluded), glass, decorated trays, plastics, dolls, toys and general decorative accessories.

There is no entrance fee for the exhibition, and the Art Alliance will bear the expense of unpacking, repacking and insurance. Only work which can be shown in cases will be accepted.

CALIFORNIA SCHOOL OF FINE ARTS

The California School of Fine Arts announces that enrollments are being accepted for the Fall Term, which opens September 13.

Hours for registration are 10:00 a.m. to 12:00 noon and 2:00 to 4:00 p.m. Mondays through Fridays, and by appointment.

The School is offering a comprehensive new program in its three departments: Painting, Sculpture, Graphic Arts Design for Commerce & Industry; and Photography.

Both day and evening classes will be held during the 18-week semester.

SAN FRANCISCO MUSEUM OF ART

Scheduled for exhibition during the month of August and continuing through September will be a group of Paintings by Wolfgang Paalen.

In this exhibition, Bay Region gallery visitors will have their first opportunity to see thirty paintings and drawings by the Austrian-born painter Wolfgang Paalen. All of these works have been created since 1940, while the artist has been living in Mexico. From 1920 to 1940 Paalen was studying and painting in France, Italy, Germany, Spain, Switzerland, Greece and Czechoslovakia. He collaborated with the "Surindépendants" and "Abstraction-Creation" from 1932 to 1935, belonged to the Surrealist group from 1936 to 1940, and organized the "Exposicion Internacional del Surrealismo" in Mexico, 1940. A book has been written about him by Gustav Regler, and his works have been published in: *Cahiers d'Art*, *Abstraction-Creation*, *Transition*, *London Bulletin*, *Review of Modern Art*, *Surrealism* by Herbert Read, *Dictionnaire Abrege du Surrealisme*, *Art of This Century*, *Letras de Mexico*, *Dyn* and many others. He had one-man exhibitions at: *Galerie Vignon*, Paris 1934; *Galerie Pierre*, Paris 1936; *Galerie Renou Colle*, Paris 1938; *Guggenheim Jeune Gallery*, London 1938; *Julien Levy Gallery*, New York 1939; and *Art of This Century*, New York 1945.

Wolfgang Paalen says of his own works, "I believe we can reach a new degree of consciousness which, beyond all ideologies, is religious in quality and scientific in method. Art is an instrumental means to reach this state. I consider my paintings as a first ideography of this new consciousness. The subject matter is no longer an abstraction from or a distortion of nature, but visualization of new patterns in which feeling and thinking are integrated into a coherent whole.

"I want to paint paintings which sound like gong, echoing through all our levels of consciousness and thus linking our secret awareness of the past to our hidden memory of the future."

A CAMERA IS A SOMETIMES THING

By DOUGLAS BAYLIS, Landscape Architect

Are you confused by the glamorous and glittering array of cameras in the local markets. Me too! Maybe the old Brownie you operate on occasion doesn't quite produce the results you had in mind. I have three cameras and still have problems!

Assuming for the purpose of this discussion that you are an architect, engineer, landscape architect or someone allied to the field of design, just what is the best camera for your use as a "business tool"? My field is garden design. The equipment should preferably be not too complex or too bulky to do a technical job of recording construction details, "before and after" information and a reasonable portrayal of finished construction. Finding the answer may prove to be troublesome.

Photography, even for the professional photographer, is a complex and expensive business. The facts are illustrated by this simple story: a photographer, given an assignment of shooting a completed building or garden, will drive up to the job with approximately one thousand dollars worth of equipment or more. Cameras, interchangeable lens, film holders with various types of film, light meters, tripods, filters and all the host of miscellaneous items needed to do the job. During the shooting he will often sigh and say, "Now if I had just had a 20 inch lens, I really could get this shot." The equipment you see on the job is just a part of the sad news—the investment in his darkroom equipment for processing the negative is equal if not many times more than the camera equipment.

The problems involved in any recommendation for your purchase of a simple, flexible camera without spending a small fortune is filled with many pitfalls. Cruel fact number one: no camera is versatile enough to do all the jobs you have in mind. If you are going to "get along" with just one camera, you will have to adjust yourself to its limitations.

Cold, hard fact number two: most miniature cameras (most cameras having a negative size under $2\frac{1}{4} \times 3\frac{1}{4}$ ") do not readily permit the use of interchangeable lens or interchangeable film holders. This of course, at one fell stroke, simplifies the taking of pictures but complicates matters in the limitations of what you can do with the equipment. Miniature cameras with 35 mm. film also gives the amateur the problem of whether or not he wants to get into processing and enlarging the exposed film in a darkroom, at an additional expense of course. If you decide to have a darkroom, the 35 mm. camera becomes a compact, useful instrument as it is very possible to get reasonably good projection prints to the size of 8" x 10" or larger. Nothing is more aggravating than to own a small camera and have to be entirely dependent on commercial processing to get enlargements of the best exposures. A darkroom and the time to work on your films permits the only reasonable chance to have better than average pictures; it also carries the responsibility for a greater technical knowledge and expenditure of time. Have I painted a dark enough picture? It is just to show you what problems there are in the "You snap the picture, we do the rest" will-o-the-wisp.

Just for a matter of comparison, we include a chart giving some ideas of the possibilities and limitations of various popular cameras. No attempt has been made to include all possibilities or to exhaust the fund of technical information. You have to supply the balance by some research yourself. Everyone will end up with a different camera and a variation of the standard set of accessories. Being equipped to do the job is only part of the way, but that is not enough! Nowadays there are plenty of amateur photographers who have an abundance of professional equipment who do not produce a good picture; this is undoubtedly due to a lack of creative training and thinking. Fortunately most designers, with a background training in the handling of space, volume,

CAMERAS (Partial Listing)	NEGATIVE SIZE	ADVANTAGE For Architectural Photography	DISADVANTAGE For Architectural Photography
Contax Exakta Leica Kardon, Etc.	35 mm.	Good, compact equipment, easy to operate, inexpensive film cost, color slides for projection. Possible to get a ground glass viewer an expensive models; interchangeable lens, too.	Small view-finder makes composing picture rather very difficult. Small negative makes if you do not have your own darkroom for prints. Low cost of film gives tendency to be inexpensive cameras not versatile or accurate.
"Single Lens Reflex" Graflex Korelle-Reflex, Etc.	Various 2 1/4" x 2 1/4"	Ground glass focusing screen. Large negative size makes enlargements very easy. Color slides very good for projection on 2 1/4" x 2 1/4" film. Simple operation.	Best to have cameras mounted on a tripod, image disappears as you press the shutter pin down" diaphragm cuts down light on screen. Larger Graflex (old types) tend to be
Twin Lens Reflex Rollei Cord Ikkoflex Rollei Flex Ansoco Reflex	2 1/4" x 2 1/4"	Good "all around" cameras. One lens views the picture. The other lens takes the picture. Eliminates disadvantages of single lens reflex.	Any roll film camera has disadvantage of poses on one strip. Some should be underdeveloped, this is not. One development has to do the job. No lens attachments. No correction for architectural distortions.
Largest Cameras in Miniature Group Speed or Crown Graphic Voigtländer	2 1/4" x 3 1/4"	Have interchangeable lens and film holders. Ground glass back. Good, compact equipment.	Need a darkroom to load and unload film. Difficult cameras to focus on viewing screen. Limited movements and adjustments for correction of architectural distortions.
"Professional Cameras" Crown Graphic B. & J. Press Busch Pressman Meridian Graphic View	4" x 5"	"Professional film size" standard equipment. Contact prints are good size to see. Small enlargement factor to make 8" x 10" prints. Nice working sized equipment.	View cameras are more versatile for architectural work than press cameras. Equipment begins heavy, film costs mount up; takes more experience to make a picture. Need two lenses—"wide angle" and "medium."
Professional View Cameras Ansoco View Eastman View Deardorf View Graphic View	5" x 7"	Large negative size gives contact prints without needing enlargement. Best cameras for architectural work. Have all adjustments.	Now you may need a "caddy" to help equipment. Film costs expensive. Greater needed to get a good picture. Camera not as good as other than professional use. Need at least two lenses—"wide-angle," "medium" and "close-

color, form, mass and composition should be able to transfer the ability and training in basic arrangement to the ground glass viewing screen. Not that your pictures should necessarily strive to be "arty" but merely for a competent placement of the subject matter on the negative.

All of which brings us to the importance of using a camera equipped with a ground glass focusing screen: if you are going to take a picture, professionally or merely for amusement, it is important to see the picture and compose the elements of the subject prior to snapping the shutter. At the same time it is important to have the camera mounted on a tripod; in this fashion you are forced to shoot the picture in an orderly manner; you are given time to think about the subject matter, the exposure reading, lens opening, shutter speed, adjustment of the lens shade and other important operations.

Some professional photographers, in a complex situation, may take only two or three important shots in a day, surely an amateur can afford to spend ten to twenty minutes to do an average

picture. The variables in any setup are: what lens shall I use, what film will do the job best, what exposure will give me the best detail in shadow and highlight without recording wind movement. Obviously if you have only one lens, one film type in your camera, the job is greatly simplified. This is the reason, however, that a professional outfit is much more likely to come away with better picture.

We have been singing the praises for the camera photographer, now what are the odds for an amateur? No matter what business or profession you engage in, you are best equipped to know the important technical details that should be recorded than would someone who is unfamiliar with your work. This makes finding the subject matter a cinch; an engineer may be able to capture important stages of construction by being on the job at the right moment. The architect may snap the most favorable light and shadow of his structure, a landscape designer may not be able to record the best light but may be lucky enough to get the seasonal color in his garden at its best

The part-time photographer may spend a greater proportion of time to do his own work in the darkroom than would be practical or remunerative for the professional. The amateur may take 35 mm. or 2 1/4" x 2 1/4" color slides for projection on a movie screen very readily and at slight cost.

If there is any chance for material to be published in technical, professional or "home service" magazines, the preferred film size is 4" x 5" and a print size of 8" x 10", glossy. Any deviations from these established sizes should be larger and not smaller. Surprisingly enough there is a great demand these days for more and more "how to do it" photographs showing various stages of construction in addition to the usual record and "glamour" shots of finished work.

Now, assuming that you have a reasonable amount of good equipment, this will mean that you are ready and willing to take better than amateur photographs. Why not invest some time to really learn how the equipment functions? A good way, but costly, is to use the outfit until you are sure of getting results and can depend on the product. In many of our larger cities, the University Extension Division gives excellent instruction during four or five semesters a year. The cost of attending these courses is low and the times are optional. Adult Education Groups, short summer courses in Art Schools, private classes by practising photographers will give the necessary and important technical and artistic details most necessary to making a picture. This instruction will pay

off in a saving of time and money. Now if I have convinced you that photography is not for you, write in and we will send you the name of a good professional in your neighborhood. If you are still interested, here are ten rules for better architectural photography:

1. Use a tripod.
2. Use a camera with a ground glass focusing screen.
3. Use the proper filters, with discretion, for both color transparencies and black and white shots.
4. Use a sunshade.
5. Use a light meter to compute exposures.
6. Use a small level to test the adjustment of your camera on the tripod. Distortion of architectural lines occur unless the axis of the camera is at right angles and level with the subject. (View cameras have adjustments to correct distortion but even they should be tested with a level before shooting.)
7. Develop a critical viewpoint for the composition on the ground glass before your shot.
8. Shoot two or three negatives of each subject! Vary your exposures. Keep a record. Compare the results. This is strictly a professional method of getting results—try it for awhile.
9. Get some competent information for all of the operations of your equipment.
10. Buy good equipment, standard makes, even if you can only afford second hand cameras. Keep them in good working condition.

U. C. AGRICULTURAL BUILDINGS UNDER WAY

Three new buildings are near completion for the expanding University of California College of Agriculture. One is the Insecticide Laboratory at the Citrus Experiment Station at Riverside, another is the new Forestry Building on the Berkeley campus, and the third, the Soils and Irrigation Building on the Davis campus.

The Riverside Insecticide Laboratory, which will cost between \$450,000 and \$500,000, will provide facilities for a study of insects which are believed to be carriers of virus damaging to citrus and other fruits.

The Berkeley Forestry Building, a \$1,200,000 structure, will provide facilities for branches and divisions of the College of Agriculture working on the varied problems of forestry which are becoming more and more an important factor in the State's economy.

The Soils and Irrigation Building at Davis, will cost approximately \$600,000. It is to be connected by an arcade with the Plant Science Building, so that laboratories on joint projects will be available.

Other construction under way includes the Plant Science Building, costing more than a million dollars, on the Davis campus, where work also has started on a \$62,000 irrigation system. One of the most ambitious projects is the new Veterinary Medicine Building at Davis, started this spring, which is expected to cost \$3,500,000. In addition, the Regents of the University have provided \$200,000 for expansion of the utilities system at Davis, and \$50,000 to expand the heating plant and utilities system on the Riverside campus. At Meloland, Imperial County, offices, laboratories and homes for staff men and research students are under construction.



William Eccles

Photos

CORNER PLANTING at the New Los Angeles Municipal Airport

The Landscape Development Of The Los Angeles Airport

LLOYD ALDRICH City Engineer
 NICHOLAS M. CIRINO A.I.A. Architect
 EDWARD J. WATERHOUSE Landscape Architect
 HENRY C. SOTO CORPN. Landscape Contractor

Installation of the irrigation system, cement curbs, lawns, and gardens at the Los Angeles Airport has just been completed by Henry C. Soto Corporation, Landscape Contractors, after four months construction at a cost of \$59,000.00.

Landscape design is free flowing and informal in character with bold mass plantings of exotic plant material which thrive in the semi-tropical climate. From its inception, the treatment was designed to reflect the international character of the airport whose seven major airlines serve the world. It was also the desire of the Airport Commissioners that plenty of color and fragrance should play a prominent part in the garden scene.

Pleasing Palm groupings dominate the area adjacent to the airline terminal buildings and include

Mexican Fan Palms, Erythea palms in green and glaucous blue, Canary Island and Reclinata dates Cocos australis, Trachycarpus and dwari Chamaerops. Dracena, Yucca, New Zealand Flax, Bamboo Indian Ginger, Strelitzia, and Aloe further carry out the semi-tropical effect.

Abundant color in shrub and tree has been furnished by such species as Hibiscus, Oleander, Cassia, Veronica, Clerodendron, Brachychiton and Eucalypti. In addition there is plenty of variation in both texture and color in the evergreen foliage of trees and shrubs. Dark, leathery Carob, Blighia, and Rubber contrast with the light traces of Evergreen Elm, Camphor and Queensland Pteris.

Fragrance greets the incoming air traveler, especially at night from such plants as Jasmine, Brisbane Box, and Hymenosporum. Flowering annuals and perennials include Godetia, Penstemon, Snapdragon, Phlox, Stock, Calendula, Painted Daisy, Primula, Sweet Allyssum, and Petunia. In addition, there are several named varieties of geraniums in both ivy leaved and pubescent type.

Small, cheery garden plots at the long line of Passenger Terminal feature foundation plantings of evergreen shrubs with lawns inclosed by low curbs and compact dwarf myrtus. Nearly one half mile of this low myrtus edging will be allowed to grow naturally in soft rolls rather than in typical hard clipped hedges.

Seven species of Eucalypti from native Australia have a practical as well as aesthetic use in the landscape scheme. Prevailing winds from the ocean will be somewhat broken by these trees when they have reached a medium height. Besides this, the slim outlines will pierce the skyline irregularly and will also serve to break up the long horizontal lines of the terminal buildings with vertical accent. Groups have been used at the corners of one of the large hangar buildings. Species include Eucalyptus ficifolia (Scarlet flowering), Eucalyptus sideroxylon rosea (Pink Ironbark), Eucalyptus rudis (Desert Gum), Eucalyptus corynocalix (Sugar gum), Eucalyptus leucoxylon rosea (White Ironbark), Eucalyptus citriodora (Lemon gum) and Eucalyptus robusta (Swamp Mahogany).

Planting outside the fence and bordering the main highway is a carpet of bronze and gold ice plant ground cover with a background of oleander. Composition and form of these oleanders are in

rhythmic waves of red, pink, and white and should be particularly effective in the warm summer months. Variation in height along the fence is introduced by the use of such plants as Undulatum, Cataline cherry, and Carolina plum. The fence, itself is planted to variegated Algerian Ivy which has a large leaf and cream and white marking.

Principal shrub masses bordering entrance roads are Carissa grandiflora (Natal Plum) and Viburnum suspensum (Sweet Viburnum) supplemented by Blue Plumbago and Yellow bush Acacia.

Hexagonal Redwood tubs containing evergreen shrubs and small trees cast shadow patterns against the two tone stucco wall of the Service Building. The upper floor of this building accommodates the Cocktail Lounge, Dining Room and Observation Platform. Potted plants such as Grecian Laurel, Red Berry, and Myrtus are also grouped at entrances on this upper deck. Redwood tubs show the grain of the natural wood through the treatment of linseed oil and a small molding around the top casts shadow around the rim.

Free form planting islands in principal roads are planted to ground covers of Southern Yellow Jessamine and Blue Creeper from Morocco. Accent and irregular shadow is furnished by the columnar fastigate Podocarpus and by Hawaiian Hibiscus in Apricot and Pink.

Although the contract was awarded in competitive bidding, the Airport Commission was highly pleased with the contractor's cooperative spirit in making this a fine planting. Many plants were furnished by the contractor above the specified height and spread in the interest of a fine planting well done.

Newly developed mechanical auger is used for digging holes for planting of trees and shrubs.



One of the traffic islands fringing the main passenger traffic entrances is planted with a ground cover of Gelsemium.



Olive trees—Oleanders are planted along the fence, with variegated ivy at each fence post.

Mesembrianthum has been planted for a ground cover.



Group planting in coordination with the surrounding airport buildings and their general utility uses is represented in one of the areas between sidewalk and drive-way in front of the numerous passenger depots where Palm trees predominate with Thormium Tenax and Veronica border.



One of the other
by areas Palms
Aloes are used
good advantage.



In this region, which is adjacent to a portion of the aircraft "tie-down" area, Olive trees and shrubs have been used in combination with Ice-plant.

Below:- The fence along Century Boulevard, one of the highways adjacent to the airport and in proximity to one of the aircraft parking areas, is planted with Olive trees.



Technical aspects of this landscape construction included grading; the digging, transportation, and re-planting of large trees; soil treatment by the use of peat humus; irrigation system and mechanical digging.

Latest modern machinery was employed thus keeping well within the time limit of four months for completion. Small, light, rubber tired bull-dozers enabled operators to move large and small quantities of earth and establish very minute grades in lawn areas. Small scrapers and mechanical loaders dug out the sterile soil and replaced with the garden loam treated with peat humus.

Large trees were placed with "A" frames and truck booms and were securely guyed and attached to dead men. Large olives were thinned and shaped after planting and all wounds painted

with antiseptic asphaltum.

Eight water meters were installed ranging from 3" to 1" size. Feeders and laterals served the entire project and large pipe was accurately placed under roads without disturbing concrete pavement by means of a patented jack. City ordinance required the installation of "vacuum breakers", "backflow regulators" and "anti-siphon valves" so as to prevent drainage water from seeping back into the domestic water system.

Greatest labor saver was the large augur which dug holes for trees and shrubs by the hundreds rather than by the dozen. This tool placed on a small tractor attracted most attention during early planting. Landscape contract included 6 weeks maintenance period for all lawn, shrub, and tree plantings.

STANDARD STOCK FOR PONDEROSA PINE DOORS

A Recommended Revision of Standard Stock Ponderosa Pine Doors, Commercial Standard CS120-46, has been submitted to manufacturers, distributors and users of this product for written acceptance, according to an announcement by the Commodity Standards Division of the National Bureau of Standards.

The revision as approved by the Standing Committee, was proposed by the National Door Manufacturers Association. The purpose is to bring the standard in line with present manufacturing prac-

tice. Two new grades designated as "No. 1F" and "No. 2F" for doors having panels made from Douglas fir plywood, together with illustrations of the grade marks, are now included in the standard. Also requirements for the prefitting of interior and exterior doors are given. The standard sticking patterns have been reduced to "Cove and Bead" and "Ovolo A". The patterns "Bead and Cove" and "Ovolo B or Rule Joint" were not retained.

Mimeograph copies of the Recommended Revision may be obtained from the Commodity Standards Division, National Bureau of Standards, Washington 25, D. C.

Sprinkler system in operation. View shows parts of three planted areas with the island at the left planted with Gelsemium as a ground cover. Los Angeles Airport.



CARL H. WITTENBERG NAMED EXECUTIVE GLADDING McBEAN

Fred B. Ortman, President of Gladding, McBean Co., West Coast producers of ceramic products announced the election of Carl H. Wittenberg to the position of Executive Vice President at a special meeting of the Board of Directors recently held in San Francisco.

"We are fortunate to secure Mr. Wittenberg to fill this position of importance in view of the enlarged management responsibilities created by the recent extensive expansion of the company's facilities. He is well fitted by both technical and personal qualifications to fill this position, and we are looking forward to his association with us," Ortman stated.

Carl H. Wittenberg comes to Gladding, McBean & Co. from Columbia Steel Company where he held the position of Manager of the Southern Division.

Now living in Beverly Hills and a resident of the Los Angeles area for the past 28 years, Wittenberg is well known in Southern California business and social circles. He is a member of the California Club, Los Angeles Country Club, Rotary Club and other service organizations. Graduated from Rensselaer Polytechnic Institute in 1920 with a degree in civil engineering, his studies were interrupted by World War I. He served overseas with the 308th Field Artillery as Captain. While still in uniform he attended the University of Edinburgh, Scotland, before returning to this country to complete his civil engineering studies.

As a director of the Beverly Hills YMCA and the Volunteers of America, he has long been associated with programs of civic betterment and youth guidance. He is active in the work of the Los Angeles Chamber of Commerce, and the California Manufacturers Association.

UNIVERSITY OF CALIFORNIA EXTENSION COURSES IN L. A.

Southern California demand for instruction in a wide variety of courses dealing with home building, decoration and furnishing has resulted in the offering this fall of the largest list of such classes ever planned by University of California Extension for this area, according to Dr. Paul H. Sheats, associate director.

West side residents may arrange to attend evening classes at U. C. L. A. while business men and women may attend them at 813 South Hill Street in metropolitan Los Angeles.

Scheduled for mid-September opening are classes in Real Estate Law (September 13), Gardening and Landscaping, Structural Pest Control (September 14), Planning the Small House, Introduction to City Planning (September 15), Interior Decoration, Planning the Small House (September 16), Real Estate Appraising (September 17), Furniture Construction (September 18), Home Planning Architectural Drawing (September 25). Detailed information concerning the University's fall semester of classes for adults is available on request to the Hill Street or U. C. L. A. offices of University Extension.



Post Office Entrance

Planted Redwood tubs are used for cement areas. . . Similar tubs were used on the upper deck of the same building. Los Angeles Airport.



Newly Completed Addition to Emeryville Plant

Alben Froberg, Architect

ADDITION TO DETROIT STEEL PRODUCTS . . . Oakland, California, Plant

Emeryville, California, Plant prior to Remodeling





Aerial Photograph of Darwin Taken on October 1, 1945

The Re-birth of DARWIN AUSTRALIA

By R. DRAKE

Just a few years ago, on February 19, 1942, Japanese planes bombed Darwin, Australia's northernmost capital. They were the first enemy bombs ever to fall on Australian soil. For the next three and a half years Darwin was a front-line

Editor's Note: Australians believe that, within another five years, they will have a new city in the far north of their continent, a city with a rugged past, a gracious present, and a splendid future.

town, a military base populated almost entirely by soldiers, sailors and airmen. Now the civilians are back, building again where the Japanese destroyed.

The Darwin the Japanese destroyed was hardly a thing of beauty. It had never quite grown out of the adolescent awkwardness and roughness of the pioneer town. It was the undeveloped, capital of Australia's most neglected region, the North-

. . . RE-BIRTH OF DARWIN

ern Territory. By clearing away the old, the Japanese have made room for the new Darwin, a city altogether of the twentieth century.

Another thing the war did for Darwin, as for the whole Northern Territory, was to show to thousands of young Australians in uniform the many promises of the neglected North, and the possible charms of life in Darwin. It is, in fact a place of much natural beauty, set in a fine situation overlooking the Timor Sea, in a garden of sweet smelling creamy and soft pink frangipanni.

Darwin has a very good prospect of growing in beauty and might, as the Northern Territory and the neighboring cattle-lands of the Kimberleys and the Barkly Tableland grow in wealth.

Just at present, Darwin is in a rather unlovely stage of transition, but plans for its glory are very well advanced plans, and it is probable that work on the most important public utilities will begin within a few weeks.

Surveyors are busy, marking out sections of the new business, banking and residential areas. The Commonwealth Government has voted \$130,000 as first contribution for building a sewage system, and the Darwin Administration has funds for

houses for Government employees. Architects are working on plans for three blocks of flats. It is only a small beginning: a first small nibble at five years of hard work that will raise a fine new city on the ruins of the old.

In November last year, the Commonwealth Minister for the Interior, Mr. Johnson, prophesized that within five years Darwin would have become a beautiful show city, a worthy front door for Australia. The re-building, Mr. Johnson said, would be done in stages, and the big aerodromes, built as bases from which to attack the Japanese, would be retained.

The new city has been planned for a population of 25,000. The kind of community planning that is to be seen in the new settlements taking shape in other Australian capitals will dominate Darwin. The city will be laid out in seven zones, each with a population of 2,000 to 4,000 and each with its own primary school. Three community centre, each with kindergarten and creche, will be so placed that each of the seven zones will have a community centre easily accessible. In two shopping centre, the shops will face open squares from which wheeled traffic will be banned.

Diagrammatic Photograph of the New Town Plan for Darwin



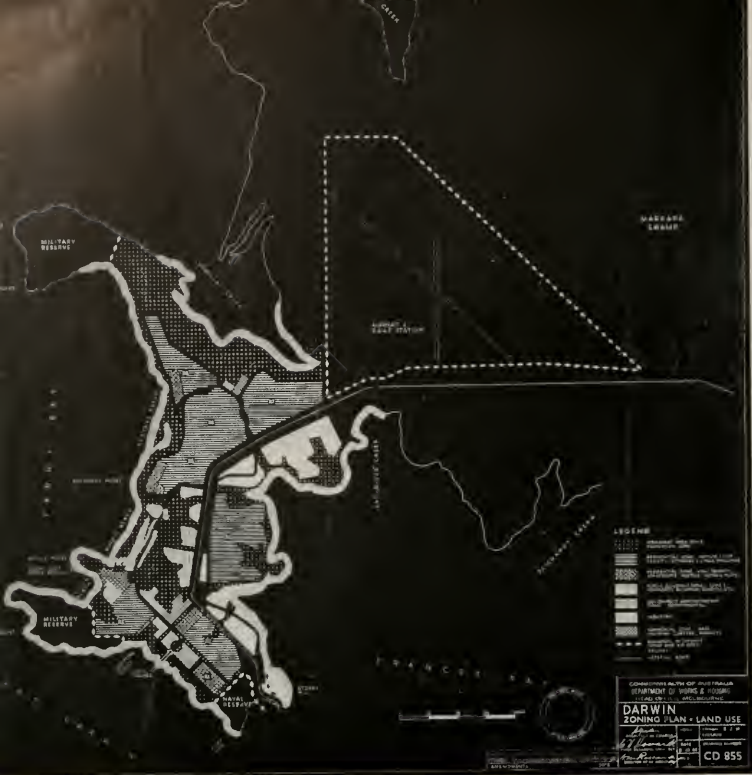

Department of Works and Housing—Zoning Plan and Land Use

The main streets will be built with high-speed traffic cross-overs; other streets will be winding and shaded, with the houses placed, not in rows, but grouped according to architectural design amid trees and lawns and gardens. Plans for the houses themselves have been much influenced by observations in tropical parts of South America by a Government architect recently back from a tour of survey.

The centre of the city will be a civic square. On the outskirts will be the zone for heavy industry, with light industry near the port. On the foreshore, natural vegetation will be disturbed as little as possible, and facing the sea across the esplanade will be the public buildings, administrative of-

fices, and hotel: Darwin's front to the world.

One of the biggest, and most urgent, jobs is the re-building of Darwin's port. The port committee has a plan for building new wharves and stores—a strict plan which will not tolerate mean or temporary buildings in the port area.

It will be a big job before substance is given to the dream Darwin with bricks and concrete. The country round Darwin provides nine-tenths of the ingredients of cement but almost everything else needed for building will have to be brought in by ship or road transport.

Still, there is a lot of determination, in Darwin itself, and in all parts of the Commonwealth, that the job must be done.

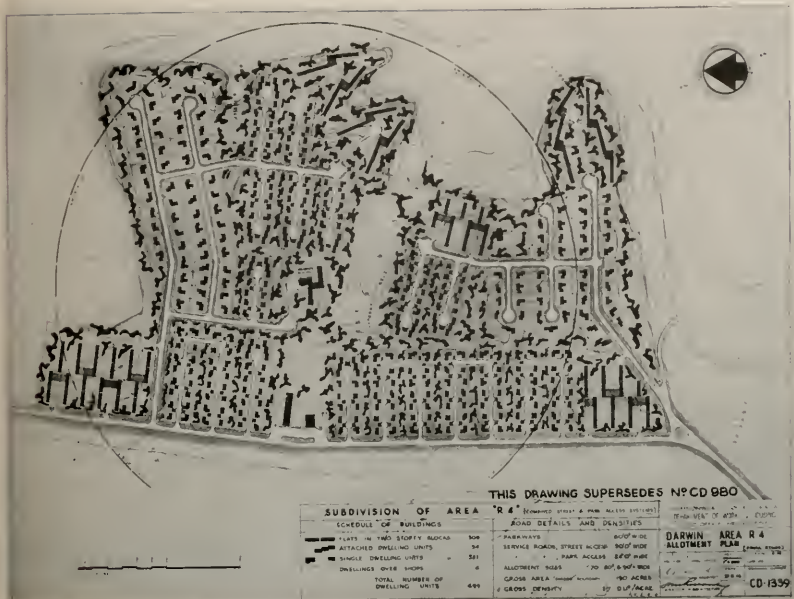

Details of Subdivision of Area "R-4"



Administrative Offices and oil tanks

All Photos
Official
Australian
Department
of Information



Detailed Schedule of Buildings and Allotments

A Typical Government School





Details of Subdivision of "R-2"—Relating to the Park Access System

Darwin's Main Street, with center, Victoria Hotel.





Above: The Residency, Official Home of the Administrator

Below: Section of the Administration Mess, showing typical housing construction. Practically all building have been placed on concrete piles, as a protection against white ants.





The ruined Bank of New South Wales in Darwin's main street. It was burned out by incendiary bombs fired into the city by the Japanese during the late war.



**A
Bomb
Damaged
Residence**

STORE REMODEL

The Dinwiddie Construction Company, San Francisco, have been awarded a contract for the construction and remodel of a store and loft building at 567 Market Street, San Francisco.

The project calls for the remodeling of the two top floors at a cost of \$78,236.

ELLISON AND KING ENGINEERS ON THE DIAMOND T TRUCK BUILDING

Due to an unintentional error in our July issue, the name of Ellison and King was omitted at the engineers on the new Diamond T Truck Sales and Service Building, San Francisco.

NEW OFFICE BUILDING

The Insurance Company of North America have let a contract with MacDonald, Young & Nelson, San Francisco general contractors, for the construction of a \$498,495 office building in San Jose (California).

The building will be 2-stories and basement, 100 feet by 200 feet.

Wurster, Bernardi & Emmons, San Francisco, are the Architects.

For the first time this year, the Los Angeles Housing Authority is accepting new applications for low-rental housing units.

CHURCH ARCHITECTURE

A conference on Protestant church architecture will be held on October 11 and 12 at the Pacific School of Religion in Berkeley under the auspices of the Interdenominational Bureau of Architecture.

There will be speakers from the various denominations, both clergy and laymen, who will consider all phases of church building programs; the church proper, its educational and recreational adjuncts and the financing problems of church committees.

Architects are invited to participate in the program. It is planned to have an exhibition of plans and photographs of recently planned or executed work.

Any architect who is interested is advised to get in touch with Ralph Pollack, Northern California Chapter, A.I.A., who is making the arrangements with Dr. Conover of the Interdenominational Bureau.

Dollar volume of merchants wholesalers on the Pacific Coast for April was 11 per cent above April, last year, and sales for the 4 months were up 9 per cent, according to the U. S. Bureau of Census. The national average was 10 per cent increase.

SCHOOL CONTRACT for new Vista school at Albany (California) has been awarded to the Pacific Co., Oakland. Cost \$92,592. Wm. H. Young is the Architect.

A typical Darwin street, showing the tropical type of housing.





Model of Stuyvesant Town, which the Metropolitan Life Insurance Company is now completing in the Borough of Manhattan, New York City, for 8,755 families of moderate income. About one third of the apartments are now occupied.

STUYVESANT TOWN

Borough of Manhattan

New York City

The big insurance companies in the United States developed immense building projects before the war,—and now they go on with their projects in increased intensity, a most fortunate happening for a great many city-dwellers. The proper kind of investment is one of the main difficulties facing today the insurance companies in their search for an average income. The building of apartment blocks, besides its eminent social value, has proven highly appropriate for the investment needs of insurance companies.

Stuyvesant Town which the Metropolitan Life Insurance Company started shortly after the end of the war in the Borough of Manhattan, New York City—the very heart of New York—was conceived

under the new Redevelopment Companies Law of New York State. This law was passed by the Legislature to encourage and facilitate the reconstruction of rundown city areas. The new building complex is near the East River—not far from the part of New York where the new skyscrapers of the home of the United Nations are to be erected.

Big Demolition Job

The demolition of the existing buildings constituted a job of unusual dimensions. Work was begun late in 1945, and over 500 buildings had to be wrecked, many of them out-dated tenements and shacks. Three thousand families who lived in the area, had to be evacuated—a large task

which was carried out with a minimum of inconvenience for all the families concerned. Boarded-up flats, vacant stores and empty lots were common. Nowhere was there a park. In the latter part of the Eighteenth Century when Manhattan was still a green island, Peter Stuyvesant 3rd, great grandson of the famous Dutch governor, built his home, Petersfield in this neighborhood, along lawns that sloped to the East River.

The plan provided for the rehabilitation of 18 city blocks. Before demolition of the existing buildings could be carried out, a Tenant Relocation Bureau was established—something new in building operations. It was the Company's endeavor to aid those families who had to leave, in finding satisfactory accommodations elsewhere in the city. The Bureau gathered information concerning vacant apartments in the five boroughs of the greater city. The bureau even utilized a station wagon to take husbands and wives on trips to apartments in other parts of the city they wanted to see.

Those tenants who moved out prior to a certain date, were granted one month's rent to cover moving expenses. At the end of 1945, virtually all of the families had left the district and most of the business and industrial firms also had gone to other locations. There was no need to evict a single family.

In 1946 demolition of the old buildings and construction of the new ones proceeded simultaneously. In August of that year steel began to rise on the building site.

The gross area of the land is 75 acres—within center lines of old boundary streets—the net area (total area within new building lines) is 61 acres. The new Stuyvesant Town is almost suburban in its appeal even though it is still within easy walking distance of one of the large arteries of New York, Fifth Avenue.

Housing 24,000 Persons

Thirty-five fireproof apartment structures have been built or are in the process of completion. They are twelve and thirteen stories high, with some ten story wings. After their completion, they will contain 8,755 apartments and house about 24,000 persons. They cover about one-quarter of the land. A three acre center park is in construction, lawns, gardens, trees, paths and ten play sections for children. There are garages and provision has been made for some stores. Transit facilities are good.

When the Metropolitan Life announced that some of the new buildings would be ready in Fall of 1947 and declared that preference in leasing would be given to war veterans, altogether about 200,000 letters of applicants have been received. While the letters, in the main, came from New

York City, a great many letters came from other cities such as Washington, Philadelphia and Boston. Veterans described urgently the hardship of living in overcrowded quarters with other families.

Apartments in Stuyvesant Town range from one bedroom to three bedrooms in size. A one bedroom apartment consists of a living room, dining foyer, kitchen, bathroom and bedroom. All rentals include gas and electricity. The rentals are as follows: for a one bedroom suite, \$50 to \$70; for a two bedroom suite, \$62-\$87; for a three bedroom suite, \$76-\$91.

On August 1, 1947, the first building completed received its first tenants. In the Spring of 1948, about 2,500 families were living in Stuyvesant Town apartments. Not before the Spring of next year the remaining apartments will be filled completely.

The contract of the Metropolitan Life with the City of New York for the construction of Stuyvesant Town has as a principal the Stuyvesant Town Corporation which the Metropolitan Life organized as a redevelopment company. The contract provided for the exercise of power of condemnation by the City on behalf of the Stuyvesant Town Corporation so that the necessary land could be assembled for the undertaking. The contract also specified that for twenty-five years the Corporation will pay taxes based on the 1943 assessed valuations of the area (land and old buildings). Thereafter taxes are to be paid on the assessed valuation of Stuyvesant Town (land and building).

As a consequence of this contract, the City of New York will obtain annually during the next twenty-five years all of the taxes which the district had yielded in 1943. The tax yield actually will be even higher because the element of tax delinquency as it formerly related to individual parcels no longer exists. The contract provides for rents scaled at moderate levels. Rentals are established in the contract at an average of \$17 a room monthly.

Stuyvesant Town therefore will be populated by families of a moderate income under the plan of veterans' preference. The Stuyvesant Town Corporation will limit its gross return to six per cent. The design of the new community was the work of a Board of Design composed of Gilmore D. Clarke, chairman; Irwin Clavan, Architect; Henry F. Richardson, George Gove and Andrew J. Eken. Starrett Bros. & Eken, Inc. are the general contractors.

There is no doubt that mass building by Insurance Companies is important for home-seeking people in our emergency time of housing shortage. The United States so far has done little to

fill the enormous gaps in the building program. The idea to build one-family houses on a large scale is very attractive—but it does not fulfill the urgent needs of the postwar years. Apartment buildings on a large scale can satisfy the emergency need for homes in a comparatively short time. Right now apartment houses are preferable to one-family houses though the latter may be more desirable in the long run. Necessity comes first!

COMMUNITY STORE

Howard E. Sweeting, San Francisco, Architect has announced the awarding of a contract to the Plymouth Construction Company of Oakland, for the construction of a Community Store Building in San Leandro at a cost of \$300,000.

ARCHITECT SELECTED

Victor Galbraith, Stockton, California, has been selected the architect for a 4-class room addition to the August Grammar School at Stockton. Estimated cost \$100,000.

PLANT RUBBER & ASBESTOS BECOMES PARAFFINE DIVISION

The Plant Rubber & Asbestos Works, for many years a corporation wholly owned by The Paraffine Companies, Inc., has become the "Insulation Division" of Paraffine according to a recent announcement by company officials.

The change in operation involves the name under which the products are to be manufactured only. Products heretofore identified as "Plant" will in the future be identified as "Pabco".

CALIFORNIA MANUFACTURERS ASSOCIATION APPOINTS SCHENK

Harry Schenk has been appointed and will become Executive Vice-president of the California Manufacturers Association early in August, succeeding Alvin E. Hewitt, resigned.

Schenk comes to the Association from Oregon where he has served the past five years as assistant Secretary of State. Prior to his work in the Capital city, Schenk was manager of the Oregon Newspaper Publishers Association and a widely known newspaper publisher.

Buildings being completed. Hundreds of trees were planted on new lawns covering the sites of old tenements. Stuyvesant Town, New York.



ARCHITECT SELECTED

The architectural firm of Wright, Metcalf & Parsons, Bakersfield, California, has been selected by the Kern County Union High School District to prepare plans and specifications for the Kernville High School addition, and the addition of a classroom and shop building to the McFarland High School. Cost of the projects was not stated.

ELECTRICAL MANUFACTURER ACQUIRES LA PLANT

Recognizing the rapid industrial expansion in the Los Angeles area and the ever increasing need for electrical apparatus in that territory, Cutler-Hammer, Inc., pioneer electrical manufacturers, Milwaukee, Wisconsin, have acquired the business of the West Electric Products Co., 1795 Pasadena Avenue, Los Angeles, California.

Mr. W. G. Tapping, Cutler-Hammer District Sales Manager, will be in charge of the new plant. Sale of the firm's products in the Los Angeles area will continue to be handled by the Company.

The present operating personnel of the West Electric Products Company will be retained the company's announcement states. The new plant will be integrated with other plants in the manufacture of motor control, panel-boards, lifting magnets, magnetic brakes, electric heating devices and allied electric apparatus.

FOR BETTER SERVICE

Remember that

KRAFTILE is

WESTERN HEADQUARTERS

FOR

- ▶ ACID Brick
- ▶ ACID-PROOF Jointing Compounds
- ▶ ACID-PROOF Floor and Tank Construction
- ▶ ACID-PROOF Coatings
- ▶ LIGHTWEIGHT CONCRETE BLOCKS
- ▶ GLAZED Structural Wall Units
- ▶ PATIO Tile
- ▶ QUARRY Tile
- ▶ SWIMMING POOL Overflow Gutter



▶ QU'ONSET Packaged Steel Buildings

▶ STRAN-STEEL Framing

For complete information and prompt service, phone or write

KRAFTILE COMPANY

NILES, CALIFORNIA NILES 3611
SAN FRANCISCO 3: 30 Hawthorne St.—DOUGLAS 2-3780
LOS ANGELES 13: 406 South Main Street—MUTUAL 7241

CALIFORNIA COUNCIL OF ARCHITECTS

The 21st Annual Convention of the California Council of Architects is scheduled for September 26-28, at Yosemite National Park, and according to Wayne S. Hertzka, Chairman of the 1948 Convention, a large number of Architects have already indicated their intention of attending.

Yosemite is a perfect setting for an Architectural Convention and Engineers, Landscape Architects and others are being urged to send in their reservation as early as possible to facilitate the handling of space accommodations in the Valley.

An impressive program of technical subjects relating to the practice of architecture is being prepared and according to reports, everyone attending the convention will enjoy the entertainment and recreational attractions being planned.

SOUTHERN CALIFORNIA CHAPTER

The details of a special school exhibit to be held in Long Beach, October 4-9, in conjunction with the Annual Convention of the Southern California Chapter, A.I.A., is being handled through the Chapter's offices in Pasadena.

The exhibit is being sponsored by the Association of California Public School Superintendents. A fee of \$100 is required of all entrants.

"WHAT IS HAPPENING TO OUR UNITED NATIONS HEADQUARTERS" was the subject of a discussion on August 12th, led by Charles Bennet as moderator. Those taking part in the discussion included Richard Neutra, Sumner Spaulding, Paul Williams, and Walter Wurdeman.

Members joined with the Producers Council on August 10th, for the annual outing which was held this year at the Rio Hondo Country Club in Downey. Baseball, Golf, Ping-Pong, Horse-shoes and a diversified program of entertainment made the event a tremendous success according to all reports.

ARCHITECT SELECTED

John B. Anthony, Architect of Oakland (California) has been selected by the Oakland Board of Education to draft plans for an addition to the Claremont Junior High School consisting of a gymnasium, shop and cafeteria.

Of reinforced concrete construction, it is estimated the project will cost approximately \$190,000.

ARCHITECT SELECTED

The architectural firm of Wright, Metcalf & Parsons of Bakersfield, California, has been selected to do the new Potomac & King Streets Grammar School in Bakersfield. Cost of the project has not been announced.

A. I. A.

American Institute



ACTIVITIES

of Architects

Arizona Chapter:
James Macmillan, President; Arthur T. Brown, Secretary,
740 N. Country Club Road, Tucson, Arizona.

Central Valley of California:
Frank V. Mayo, President; John W. Bombarger, Vice-
president; Ivan C. Satterlee, Treasurer; William Kohlik,
Secretary, 2203 13th St., Sacramento, California.

Colorado Chapter:
Raymond H. Ervin, President; James M. Hunter, Secretary,
2049 Broadway, Boulder, Colorado.

East Bay Chapter:
A. Lewis Kouss, President; James H. Anderson, Vice-
President; Loy Chamberlain, Secretary; Chester H. Treichel,
Treasurer, Office, 3833 Piedmont Ave., Berkeley, California.

Montana Chapter:
Ralph H. Cushing, President; H. C. Cheever, Secretary,
Montana State College, Bozeman, Montana.

Northern California Chapter:
Wm. Clement Ambrose, President; Lester W. Hurd, Vice-
President; Ralph N. Pollack, Secretary; Donald Beach
Kirby, Treasurer; Office 369 Pine Street, San Francisco.

Oregon Chapter:
Frank Roehr, President; Sidney W. Little, Vice-President;
J. Holman Baines, Secretary; Don Edmondson, Treasurer.
Office 619 Builders Exchange Bldg., Portland 4, Oregon.

San Diego Chapter:
H. Louis Bodmer, President; Louis J. Gill, Secretary, 203
Granger Building, San Diego, California.

Santa Barbara Chapter (California):
Winsor Soule, President; Ralph Armitage, Vice-President;
Robert Ingle Hoyt, Secretary; Lulah M. Rags, Treasurer;
Office 116 E. Sol St., Santa Barbara, California.

CALIFORNIA COUNCIL OF ARCHITECTS
Andrew T. Hass, President; Adrian Wilson, Vice-President;
Malcolm Reynolds, Secretary-Treasurer; Office 369 Pine
Street, San Francisco.

Southern California Chapter:
George Allison, President; A. C. Martin, Jr., Vice-President;
Anthony Therman, Secretary; George E. Gable, Treasurer;
Chapter Headquarters, 3757 Wilshire Blvd., Los Angeles 5,
California.

Spokane Chapter (Washington):
Noel E. Thomson, President; Kenneth D. Stormont, Secre-
tary, Hutton Building, Spokane, Washington.

Utah Chapter:
George Cannon Young, President; Theodore R. Pope, Secre-
tary, 29 South State Street, Salt Lake City 1, Utah.

Washington State Chapter:
Waldo B. Christenson, President; Perry B. Johanson, 1st
Vice-President; John G. Richards, 2nd Vice-President;
Hugo W. Osterman, Treasurer; and Bliss Moore, Jr., Secre-
tary, Offices 714 American Building, Seattle 4, Washington.

Tacoma Society:
Chas. Rueger, President; Clarence Rueger, Vice-President;
W. W. Durham, Secretary-Treasurer.

Hawaii Chapter:
Kenneth W. Roehrig, President; James Morrison, Secretary,
334 Federal Bldg., Honolulu, T. H.

NORTHERN CALIFORNIA CHAPTER

Indications are that the work being done, under the chairmanship of Andy Hass, to convince the State Department of Public Works that the office of State Architect is not able to meet all the requirements for architectural service as far as State work is concerned, and that the State of California should use the services of Architects engaged in the general practice of architecture, is progressing very satisfactorily.

The State Architect has indicated a willingness to let some work out to private Architects under certain civil service restrictions.

Hass recently conferred with the State officials and additional consideration is expected.

* * *

Members heard a talk recently by Harold Bishop of the Hartford Insurance Company on the subject "Surety Bonds for Construction Contracts", which was very informative and educational.

* * *

The U. C. School of Architecture reports that graduates have had little difficulty in obtaining employment this year, a few students, however, are seeking drafting room employment.

* * *

NEW MEMBERS: Additional membership in the Chapter includes: **Corporate Members**, Warren Erskine, San Francisco; Frank Merwin, San Francisco, and Harold Keyes, Manila, P. I., **Associate Member**, Hewitt Wells, San Francisco. **Junior Associate Members**, Milton F. Johnson, Stanford Uni-

versity. Roland Gibbs, chairman of the membership committee, reports that 25 new members have been accepted during the first half of this year.

PREVENT FIRES and EXPLOSIONS

Caused by **EARTHQUAKES!**



Plus a Manual Control For Other Emergencies!

Indispensable in live seismic regions.

Recommended for use with Liquefied Petroleum Gases.

Thousands installed in the United States.

List of installations available on request.

Available at leading wholesale plumbing establishments.

Indorsed by National Bd. of Fire Underwriters.

Leading Fire Prevention Engineers Approve.

SAFETY ENGINEERS and scientists say the Sentinel is the most accurate and dependable earthquake actuated shut-off valve in the world! On the job 24 hours a day! A record of more than 10 years of reliable service... **proven** during a period which included two major seismic disturbances. * Names on request

Take No Chances... Install The SENTINEL AUTOMATIC GAS SHUT-OFF VALVE

Designed to shut off automatically when there's an earth shock or explosion sufficient to damage buildings or pipe lines. Listed by the Underwriters' Laboratories and specified by leading architects and engineers for installation in schools, fire stations, factories, theaters, churches, stores, municipal, military and utility buildings. A. I. A. File No. 29-F-6

Write for illustrated folder.

SECURITY VALVE CO.
410 San Fernando Rd., Los Angeles 31, California
Phone CA 6101 6191

WITH THE ENGINEERS

Structural Engineers Association of Northern California

John A. Blume, President; Jesse Rosenwald, Vice President; Franklin P. Ulrich, Treas.; Geo. E. Solnar, Jr., Sec., Office, Room 215, 55 New Montgomery St., San Francisco 5, Phone SUtter 1-7642. DIRECTORS, A. W. Anderson, Henry J. Degenkolb, John E. Rinne, Robert D. Dewell, and Wm. W. Moore.

San Francisco Section

L. A. Elsener, President; A. W. Earl and G. B. Woodruff, Vice-Presidents; John E. Rinne, Secretary-Treasurer; 225 Bush Street, San Francisco 20.

Structural Engineers Association of Southern California

Steve Barnes, President; Harry W. Bolin, Vice President; Lewis K. Osborn, Sec.-Treas. DIRECTORS, Richard W. Ware, Geo. E. Brandow, L. T. Evans, Harold P. King, and Donald F. Shugart. Office: 202 Architects Bldg., Los Angeles 13, Calif.

Puget Sound Engineering Council (Washington)

R. E. Kister, A. I. E. E., Chairman; E. R. McMillan, A. S. C. E., Vice Chairman; L. B. Cooper, A. S. M. E., Secretary; A. E. Nicholson, I. E. S., Treasurer; Offices, L. B. Cooper, c/o University of Washington, Seattle 5, Washington.

STRUCTURAL ENGINEERS ASSOCIATION NORTHERN CALIFORNIA

The regular August meeting was postponed until September when members will hear a program devoted to the subject of Vermiculite in Building Construction. The nominating committee for selecting candidates for the officers and directors for 1949 will be selected at this meeting also.

According to all reports the recent meeting with Junior Members in charge was a huge success, and the talk by J. E. Arnison was interesting and refreshing.

STRUCTURAL ENGINEER, the next examination for this classification to be held by the California Board of Registration for Civil and Professional Engineers, will be held on September 17 and 18th, according to word received by President John Blume from Pecos H. Calahan, executive secretary of the State Board.

BUILDING CODE COMMITTEE. M. K. Pregnonff, Chairman, has submitted a committee report to the Directors on the proposed changes in lumber stress provisions of the Uniform Building Code. The report was accepted by the Directors and has been forwarded to the Pacific Coast Building Officials Conference.

NEW MEMBER. Boyd G. Eubank, Albany, California. Four applications for membership have been received and one for Affiliate membership.

1948 ANNUAL CONVENTION STRUCTURAL ENGINEERS ASSOCIATION OF CALIFORNIA

Announcement has been made that the 1948 Annual Conference of the Structural Engineers Association of California will be held on October 21-24 at the Santa Barbara Biltmore Hotel.

Arrangements have been made for numerous entertainment features including the golf tournament at the Montecito Country Club on Thursday afternoon, October 21st.

Reservations should be made at once, and may be sent to Charles M. Cirbit, Jr., 714 West Olympic Blvd., Los Angeles 15, California.

Convention Chairman Don Shugart asks that reservations be made as early as possible and that they NOT be made at the Hotel.

ARCHITECT SELECTED

Leonard F. Starks, Sacramento, Architect has been selected to do an addition to the Vacaville High School, Vacaville, California. Bonds amounting to \$237,000 have been approved.



You get more for your money with a modern, automatic JOHNSON BURNER

You'll like the fuel-savings that a Johnson Burner will give you. And you'll like its quiet, carefree dependability. If you are still using old-style, wasteful equipment, let your Heating Engineer show you what a difference an automatic Johnson Burner can make in your fuel and service bills.

There's a Johnson Burner for every heating need . . . all precision-built to last . . . all engineered to maximum efficiency . . . all backed by a 45-year record of leadership. See the Johnson Burner dealer near you.



S. T. JOHNSON CO.

940 Arlington Ave.
Oakland 8, California
401 No. Broad Street
Philadelphia 8, Pa.

TECHNICAL STUDY MADE TO LOWER BUILDING COSTS

At least \$15,000,000 a year is being spent by the building industry on organized technical research designed to lower the cost and improve the quality of housing and other construction, according to a study made by economists of the Construction Industry Information Committee.

"Moreover, large additional amounts are being spent for construction research by universities, technical colleges, and institutions, and another \$1,500,000 by Federal agencies, the Committee reported recently.

"This large annual outlay results in a steady stream of new building products, improvements in the quality and performance of existing products, and improved methods of combining individual building materials in such a way as to raise the quality of finished structures.

"While there is pressing need for expansion of building research, accomplishments to date have been far more spectacular than the public realizes.

"Among the many completely new products developed in the industry's extensive research program are gypsum board, fluorescent lighting, baseboard and radiant heating, glazed structural tile, new types of insulation, laminated wood arches, and glass block.

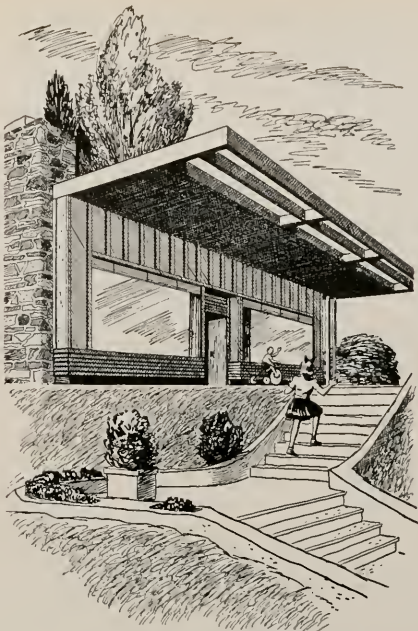

ASSOCIATED GENERAL CONTRACTORS MEET

The annual Mid-Year meeting of the Governing and Advisory Boards of the Associated General Contractors of America, Inc., will be held September 13-15, in the Edgewater Beach Hotel, Chicago, Ill.

NORTHERN CALIFORNIA CHAPTER THE PRODUCERS COUNCIL

Members held a very interesting and educational meeting on August 2, at the Palace Hotel in San Francisco, when the subject of "Unification of the Architectural Profession" was given considerable discussion.

Presentation of the subject was made by John S. Bolles, vice-chairman of the National Committee on Unification of the American Institute of Architects, and Past President of the California Council of Architects.

Bolles outlined the progress being made in California and the Pacific Coast under the national program and pointed out that numerous other areas were also giving considerable attention to the subject.

Many architects and members, as well as guests were present.

If it's really modern...it has built-in telephone facilities

Careful builders these days plan for built-in telephone conduit and outlets installed while the house is under construction. The cost is insignificant...just a few pieces of tubing leading to convenient outlet locations provide raceways for telephone wire. Thus telephones can be moved or added later on without drilling holes or running wire along baseboards. Means a lot to the future value and livability of any modern home.

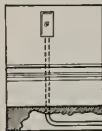

For free help in planning modern, built-in telephone conduit, call your local Pacific Telephone office and ask for "Architects and Builders Service."

**The Pacific Telephone
and Telegraph Company**



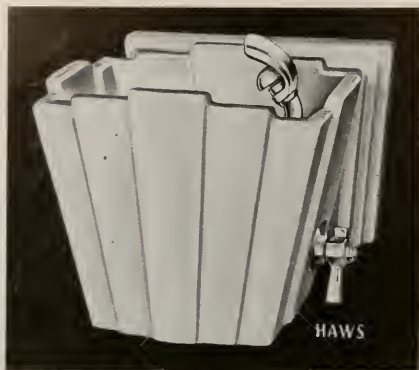

for **BEAUTY
AND UTILITY...**

● WHEN you want handsome appearance plus dependable performance in the fountains you specify, you can be assured of client-satisfaction with HAWS! There are many HAWS models to choose from and all are made from the finest of materials by expert craftsmen. Extra care in engineering... closest check on manufacturing... assure highest quality in any type HAWS Fountain you specify. Write for catalog.

HAWS DRINKING FOUNTAINS

HAWS DRINKING FAUCET CO.
1435 FOURTH STREET (Since 1909) BERKELEY 2, CALIFORNIA
Agents and Sales Representatives in All Principal Cities



**ARCHITECTS WILL EXHIBIT
IN AUSTRALIA**

Six leading Pacific Coast architectural firms have been invited to exhibit photographs and plans of their work in Australia during September, and October of this year. The architects are Pietro Belluschi, Portland; Mario Corbett, San Francisco; Gardner A. Dailey, San Francisco; Harwell Hamilton Harris, Los Angeles; Kump & Falk, San Francisco; and Wurster, Bernardi & Emmons, San Francisco.

Presented jointly by the Australian-American Association and the Royal Victorian Institute of Architects, the exhibit will open at the Melbourne Town Hall September 15 for a week's duration. Following the Melbourne stay, the exhibit will travel to Sydney, and possibly to Adelaide and Brisbane pending future arrangements.

Similarity of climatic and topographical conditions along the Pacific Coast and in Australia was one of the considerations which led to the invitation to exhibit. American-Australian friendship and good will was another. The idea for the exhibit grew after last year's visit to the United States by John Buchan, namesake of the late Lord Tweedsmuir, noted British novelist and wartime Governor-General of Canada. One of the most prominent architects in the state of Victoria, Buchan belongs to the Melbourne and Geelong firm of Buchan, Laird & Buchan.

Representing the American group for the opening ceremonies and other events connected with the exhibition will be Ernest J. Kump, architect and school planning consultant who has designed such buildings as the Fresno City Hall, the Accolanes Union High School at Lafayette and the U. S. Navy Ordnance and Optical Shop Building at Hunters Point, San Francisco.

While at Melbourne Kump will call on the Lord Mayor of Melbourne, attend a luncheon given in his honor by the Australian-American Association, deliver some lectures to architectural students at the University of Melbourne and the Architectural Institute, and go to a reception sponsored by the Royal Victorian Institute of Architects. Later he will inspect some state housing and development projects at Gippsland, Victoria, in a party escorted by Buchan. After leaving Sydney, where many of the events in Melbourne are to be repeated, Kump will spend a week in New Zealand.

Following the exhibit's return to the United States, it is expected to go on a nation-wide tour.

Contributions by the individual exhibitors are as follows:

Belluschi: Peter Kerr Cottage, Gearhart By-the-Sea, Oregon; the Portland Art Museum, Portland, Oregon; the New Oregonian Building, Portland

Oregon; the Equitable Office Building, Portland, Oregon; Edris Morrison Photographic Studio, Portland, Oregon; the Church of St. Thomas More, Green Hills, Oregon; Addition to the Ladd and Bush Bank, Salem, Oregon; the First National Bank, Salem, Oregon; Belluschi Farm House, Aloha, Oregon; Recreation Center, Wartime Housing Project, Bagley Downs, Washington; Drive-In Restaurant, Jantzen Beach, Oregon; John Platt House, near Portland, Oregon; and the P. L. Menefee Ranch House, near Yamhill, Oregon.

Corbett: Belloc House, De Silva Island, San Francisco Bay, California; and the Fuller Guest House, Lake County, California.

Dailey: U. S. Merchant Marine Cadet Training School, Coyote Point, San Francisco Bay, California; New Dining Room, Royal Hawaiian Hotel, Waikiki Beach, Oahu, Hawaii; Dr. Heil House, San Francisco, California; Hudson House, Montebrey Peninsula, California; and the Owens House, Sausalito, California.

Harris: Bircher House, Los Angeles, California; and the Havens House, Berkeley, California.

Kump & Falk (Ernest J. Kump, architect and Mark Falk, structural engineer): City Hall, Fresno, California; Sill Building, Bakersfield, California; United Air Lines Airport Terminal, Merced, California; U. S. Navy Ordnance and Optical Shop Building, San Francisco, California; Acalanes Union High School, Lafayette, California; Carmel High School, Carmel-By-the-Sea, California; Las Lomas Elementary School, Menlo Park, California; Laurel Elementary School, San Mateo, California; Sunnybrae Elementary School, San Mateo, California; White Oaks Elementary School, San Carlos, California; Pre-fabricated School Buildings, Albany-Berkeley, California; and the Pre-Bilt House, San Anselmo, California.

Wurster, Bernardi & Emmons (William Wilson Wurster, Theodore Bernardi and Don Emmons): Schuckl Office Building, Sunnyvale, California; Stern Hall Dormitory, University of California, Berkeley, California; Clark Beach House, Aptos, California; McIntosh House, Los Gatos, California; and the Wolski House, San Francisco, California.

SAN LEANDRO SCHOOL

Swinerton & Walberg, general contractors of Oakland (California) have been awarded a contract for the construction of a new academic building, a cafeteria building, and a gymnasium for the San Leandro Senior High School Group at a cost of \$1,423,400. The buildings are to be of reinforced concrete.

Miller & Warnecke of Oakland are the Architects.

"PENNY WISE - - POUND FOOLISH"

Home owners today demand abundant electrical living — without dread of being limited at some future time in the use of new electrical equipment.

That is why those who try to cut building costs by the installation of poor or inadequate electrical wiring are doomed to disappointment, inconvenience and the ultimate expense of re-wiring.

Prevent such annoyances by advising your clients not to be "Penny Wise — Pound Foolish" where wiring is concerned. Certified Adequate Wiring costs so little more than an inferior wiring job, and it is a lasting guarantee of full enjoyment of electrical living now and in the years ahead.

NORTHERN CALIFORNIA ELECTRICAL BUREAU

1355 Market Street, San Francisco 3



QUALITY building material COSTS YOU LESS

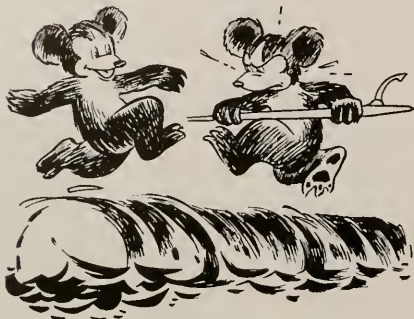

E. K. WOOD LUMBER CO.

SAN FRANCISCO General Offices: No. 1 Drumm Street
LOS ANGELES Office and Yards: 4710 S Alameda St - JE 3111
OAKLAND Yards and Wharves: 2111 Frederick St. - KE 4-8466
PORTLAND Mill Sales Office: 827 Terminal Sales Bldg.

SAW MILLS: Roseburg, Oregon • Reedsport, Oregon

RETAIL YARDS: LOS ANGELES • OAKLAND • ONTARIO • HOLLYWOOD
 LONG BEACH • RIVERSIDE • TEMPLE CITY • SIERRA MADRE • INDIO • THERMAL
 LA VERNE • WHITTIER • PASADENA • SAN PEDRO

HEADLINE NEWS AND VIEWS

By E. H. W.

Many women who wouldn't be caught dead in a five-year-old fur coat, give little thought to replacing their obsolete furniture and hand-me-down, out of date home accessories.

New dwelling units placed in construction under Federal Housing Administration financing programs totaled 131,346 for the first five months of this year, which is an increase of 72,482 over the corresponding period of 1947.

Payment of personal Federal taxes in 1947 represented more than the total amount spent by the same people for homes, new cars, new furniture, religious and charitable purposes, private education, and medical care and death expenses.

"One of the most important things we should all try to do is to make economy in government politically popular. In the long run, our government and our kind of life will survive or perish on the question of solvency." — Ralph Bradford, Executive Vice-Pres., Chamber of Commerce of the United States.

President Harry Truman, in signing the compromised housing bill passed by the late Congress, characterized the act as "leeny-weeeny" housing legislation. Harry should remember that it's better to have a foot in the door, even if it is a small door, than nothing.

"While in most areas non-residential construction costs are still showing a tendency to move slightly upward, there are signs that stabilization might occur at or near present cost levels, although an increasing amount of exports for European recovery and the expanded defense program may be unsettling factors in the future, particularly regarding supplies of steel and equipment items available for construction work." — Associated General Contractors' of America.

"Private residential construction which fell 58 per cent between 1942 and 1945, has since made a gain of 472 per cent."—Construction Industry Information Committee.

The public housing issue, defeated in the last session of Congress, was suddenly revived by President Truman's call for a special session and once more the effort to force socialized housing is before Congress. The question! Government Control or Private Enterprise?

BAXCO

CHROMATED ZINC CHLORIDE

CCC

PRESSURE TREATED LUMBER

● **PROTECTS AGAINST DECAY
AND TERMITE ATTACK**

*Specify it in your home
Available through Lumber Dealers*

LOS ANGELES
601 W. 5th Street
Phone Mlchigan 6294

SAN FRANCISCO
333 Montgomery Street
Phone DOugles 2-3883

J. H. Baxter & Co.

AGENTS FOR WEST COAST WOOD PRESERVING CO. SEATTLE, WASH

IN THE NEWS

EMODEL RENO'S FAMOUS HOTEL

The construction firm of Shu-maker & Evans of Los Angeles, have been awarded a contract to remodel the Golden Hotel at Reno, Nevada, at an estimated cost of \$300,000, according to the El Rancho Reno, Inc., which recently acquired the property.

Renovation includes the four-story hotel building and the various ground floor buildings.

RESIDENCE

Architect John K. Branner of San Francisco is doing a \$50,000 house in Menlo Park (California) and announced recently that construction work will be done by Jacks & Irvine Contractors of San Francisco.

HANNA CENTER

The architectural firm of Mario J. Ciampi of San Francisco and the firm of J. Francis Ward and John Colles, Architects, report that the working drawings for the new Archbishop Hanna Center for Boys are soon to be completed.

The buildings, which will be of reinforced concrete and frame construction, are to be erected near the popular Boyes Springs area in Sonoma County, at an estimated cost of \$1,250,000.

GRAMMAR SCHOOL

An addition will be made to the Single Grammar School of Woodland (California) at a cost of \$245,993, according to Dragon, Schindis & Hardman, Architects of Berkeley. Contract for the work has been let to the Central California Construction Company of Sacramento.

JUVENILE DETENTION HOME

With courtrooms, meeting rooms and offices in San Francisco will cost \$2,750,000 according to City Architect Dodge A. Riedy and architect William G. Merchant of San Francisco. Bonds for the project have been approved by the voters.

TWO SEWAGE TREATMENT

plants in San Francisco will cost approximately \$15,000,000 according to Bonds recently approved by the voters of the City by the Golden Gate.

**SMOOT-HOLMAN
MEANS
DEPENDABILITY**



COMMERCIAL

Strategically located in the West, Smoot-Holman Company is one of America's foremost manufacturers of luminaires. Whenever you buy lighting equipment look for the Smoot-Holman label, the symbol of dependability, quality and integrity.

INDUSTRIAL



Offices in Principal Western Cities—Branch and Warehouse in San Francisco

LANDSCAPE ARCHITECTURE

Notes of The Profession

ASSOCIATION OF LANDSCAPE ARCHITECTS, SAN FRANCISCO REGION

Vernon Dean, President; Robert Royston, Vice-President; Ned Rucker, Treasurer;
E. L. Anderson, Secretary, 1736 Franklin, Oakland, California.

DETENTION HOME

Architect W. D. Peugh, San Francisco, recently announced that Younger & Hallstein contractors of San Francisco have been awarded a general contract for the construction of an detention home building in Woodland, for Yolo county. Cost \$166,977.

W. P. FULLER COMPANY ANNOUNCE STAFF CHANGES

The W. P. Fuller Company have announced recent personnel changes including the appointment of T. L. Dowling as district sales manager in southern California; I. W. Tabler, manager of the Stockton branch, and James P. Fraser, manager of the San Diego office.

FANCY SHANTIES

Reports indicate that there is a growing trend towards the better type of residences in many areas of the Pacific Coast.

For example: Architect Frederick H. Reimers of San Francisco is doing a seven room, three-bath, home on Somerset Road in Oakland which is costing the owner some \$42,000.

Down in Santa Clara County, Architect Chas E. Butler of San Jose is doing a \$50,000 home consisting of eight rooms and three baths while up in Sonoma County, Architects Pollack & Pope of San Francisco are doing a little private residence of eleven rooms and six baths which will set the owners back a mere \$63,751.

Over in Piedmont (California) Architects Anderson & Simon of Oakland are watching over construction of a twelve room and live bath private residence which is costing some \$94,400 and represents a two story frame and stucco construction.

All of these homes are under construction, or have been recently completed.

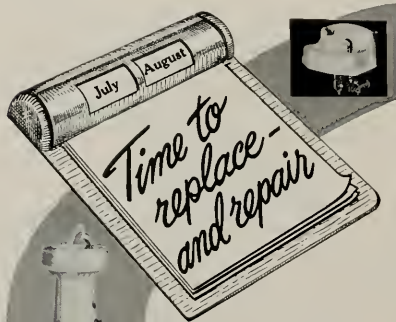

School authorities and architects, with modernization plans at hand, recognize the fitness of Halsey-Taylor Drinking Fountains for this purpose. Their distinctive features promote the utmost in hygiene and convenience! Have you our latest literature?

The Halsey W. Taylor Co.
Warren, O.



SA-4

HALSEY TAYLOR
Drinking Fountains

STUDENT PRIZE WINNER

William Kasper, Brooklyn, N. Y., a junior Civil Engineering student at New York University College of Engineering, has been awarded second prize in the Annual Bridge Design Competition sponsored by the American Institute of Steel Construction.

TERRAZZO

for Floors and Wainscoting in Hospitals, Theaters, Hotels,
Office Buildings, Schools and Stores.
DECORATIVE • DURABLE • SANITARY



FOX TILE CO.

3247 E. 14th Street, Oakland

Phone: ANdover 1-0431

YOUTH GUIDANCE CENTER

Bids are being taken on the new Youth Guidance Center to be built by the City and County of San Francisco in the immediate future at an estimated cost of \$2,800,000. Wm. G. Merchant, San Francisco is the Architect, together with George A. Riedy, San Francisco City Architect.

ARCHITECTS MOVE

The architectural firm of Dragon, Smith & Hardman have moved their offices to 1320 University Avenue, Berkeley, California.

NEW PACKING SHEDS

The Santa Cruz (California) Pickle and Sprout Growers Association have announced the construction of 3 packing shed buildings at an estimated cost of \$120,000. K. J. McGranahan of Santa Cruz is the General Contractor.

NEWSPAPER-RADIO

The Palo Alto Times of Palo Alto (California) will soon build a combined newspaper and radio station building at a cost of \$260,000, according to Birge M. Clark and Walter Stromquist, Palo Alto, Architects.

WAGE CONTRACT

Thomas MacClosky, San Francisco has been awarded a general contract for the construction of a sewage treatment and pumping plant at Castroville (California) for the Castroville County Sanitation District, at a cost of \$111,210.

NEW BUILDING

Architect G. H. Hilburn, Modesto (California) announces the construction of a 1-story, reinforced concrete block, steel roof truss building in Modesto. Also an addition to the Floden-Button turkey packing plant.

NEWWARD GRAMMAR SCHOOL

A contract for \$287,887 has been awarded to George Petersen & Sons of San Leandro for the construction of a 14-classroom, office and toilet Grammar School building at Hayward (California). Anson & Simonds of Oakland are Architects.

HOME FOR AGED

The Jewish Federation of Oakland have announced plans for the construction of a Home for the Aged in Oakland (California) at an estimated cost of \$350,000. Wm.

E. Schirmer of Oakland is the Architect.

FIESTA

Oscar R. Thayer, Architect of Burlingame (California) announces the awarding of a contract to the Biltwell Construction Company of San Francisco for the construction of a new Fiesta Building in San Mateo.

Consisting of a one story building, 260' by 320', reinforced concrete, structural steel and concrete

block walls with wood roof trusses, the new building will cost \$237,777.

COMMUNITY HOSPITAL

A general contract has been awarded to the Lembke Construction Company of Las Vegas (Nevada) for the construction of a Community Hospital at Carson City, at a cost of \$75,422.

The building, a one story brick and frame construction, was designed by Russell H. Clopine, Architect of Reno.

DOHRMANN'S
Union Square
San Francisco, Calif.
Albert R. Williams
and Associates
Architects



**FORMULA FOR
A Modern Store Front**
$$\frac{W + A}{P + E} = AP^*$$

* TAKE the factors of lightness of Weight plus fine Appearance and divide by exceptional Permanence plus real Economy... and the answer comes out Architectural Porcelain—as accurate as algebra!

FOR EXAMPLE: the store front illustrated represents a saving of 90% in weight of the veneer... when done in Architectural Porcelain...with the factors of appearance, permanence and economy completely maintained.

YOUR VENEER FRONT PROBLEMS can be easily solved with APCO Architectural Porcelain...the modern building exterior material. APCO Porcelain Enamel on steel has proved its worth as a basic building material. It

WRITE TODAY for complete information on how you can use

APCO

ARCHITECTURAL PORCELAIN

is distinctively different from any other finish... affords the Architect and Designer unlimited possibilities for the use of color, pattern or surface texture for exterior or interior application.

ARCHITECTURAL PORCELAIN CONSTRUCTORS
2827 UNION STREET • OAKLAND 8, CALIFORNIA

STRUCTURAL STEEL

For Class A Buildings,
Bridges, etc.

JUDSON PACIFIC - MURPHY CORP.

4300 EASTSHORE HIGHWAY
EMERYVILLE, CALIF.

FORDERER CORNICE WORKS

Manufacturers of

Hollow Metal Products • Interior Metal Trim
Elevator Fronts and Cabs
Metal Plaster Accessories • Sanitary Metal Base
Flat and Roll Metal Screens
Metal Cabinets • Commercial Refrigerators

269 POTRERO AVE.

SAN FRANCISCO, CALIF.

HEMLOCK 4100

VALUABLE NEWS SERVICE

- BUILDING MATERIAL DEALERS
- CONTRACTORS
- ENGINEERS
- FINANCIAL INSTITUTIONS

ARCHITECTS REPORTS gives advance news on construction projects in Northern California, lists: name of projects, location, architect, proposed cost and other pertinent information.

HANDY individual slip-reports, issued daily at a total cost of only
\$10 a month

ARCHITECT'S REPORTS

Published Daily

The **ARCHITECT** and **ENGINEER**, Inc.

68 Post Street, San Francisco - DO 8311

ENGINEER SELECTED FOR SANTA BARBARA PROJECT

E. R. Crocker, Bureau of Reclamation engineer for the past 39 years, and nationally known designer of tunnels, has been named builder of the Santa Barbara county project for which Congress recently voted \$1,000,000 in funds and \$1,600,000 in contract authorization for this fiscal year.

Present plans call for conclusion of a repayment contract with the Santa Barbara County Water Agency and start of work on the six mile Tecolote Tunnel and the South Coast Conduit which are badly needed to supply domestic and irrigation water to the coastal area.

The \$35,000,000 Santa Barbara County Project is the first Bureau of Reclamation project along the California coast and the first bordering the Pacific Ocean. The Projects chief feature will be the Cachuma Dam and a 210,000 acre-foot capacity reservoir and its connecting tunnel and conduit will supply the coast with a safe yield of water sufficient for the area for the next half century. It will supply the city of Santa Barbara with 16,600 acre feet of domestic water annually, and will irrigate some 30,000 acres of highly productive land, over half of which is not now irrigated. No electric power is involved, and under the contract being negotiated the local water users will repay the Government the entire cost of the project.

Crocker comes to California from the Bureau Denver offices where he has been assistant chief of the canal engineering division for years. He will take over immediately while engineer Jerome Fertig, who has carried on the planning work, will become chief of the development division at Santa Barbara.

SOUTHERN CALIFORNIA DISTRICT MANAGER

Thomas L. Dowling has been appointed southern California district sales manager of W. F. Fuller & Company, succeeding the late M. G. McKinlay.

Dowling was previously manager of the Fuller Stockton branch, and began his business career with the pioneer paint, glass and wallpaper firm as a clerk in the glass department of the Oakland branch in 1917.

He has also been manager of Fuller offices in San Jose, and Seattle.

SANTA LUCIA SCHOOL

A general contract has been awarded to Harold C. Geyer of Monterey (California) for the construction of a 6-classroom, kindergarten, office and toilet rooms grammar school building near the Airport Tract in Salinas, California.

To be known as the Santa Lucia School the building will be of frame and stucco.

ESTIMATOR'S GUIDE

BUILDING AND CONSTRUCTION MATERIALS

PRICES GIVEN ARE FIGURING PRICES AND ARE MADE UP FROM AVERAGE QUOTATIONS FURNISHED BY MATERIAL HOUSES TO SAN FRANCISCO CONTRACTORS. 2½% SALES TAX ON ALL MATERIALS BUT NOT LABOR

All prices and wages quoted are for San Francisco and the Bay District. There may be slight fluctuation of prices in the interior and southern part of the state. Freight charge, at least, must be added in figuring country work.

BONDS—Performance or Performance plus Labor and Material Bond(s), \$10 per \$1000 on contract price. Labor & Material Bond(s) only, \$5.00 per \$1000 on contract price.

BRICKWORK—
Common Brick—Per 1M laid—\$100.00 up (according to class of work).
Face Brick—Per 1M laid—\$200.00 end up (according to class of work).
Brick Steps—\$3.00 and up.
Common Brick Veneer on Frame Bldgs.—Approx. \$1.20 and up—according to class of work.
Face Brick Veneer on Frame Bldgs.—Approx. \$2.00 and up (according to class of work).
Common Brick—\$28.50 per M—truckload lots, delivered.
Face Brick—\$60.00 to \$90.00 per M, truckload lots, delivered.
Cartage—Approx. \$9.00 per M.
Los Angeles County Area—Residential, up to 4-family or apt., metal raceways, \$6.50 per outlet.

BUILDING PAPER—
1 ply per 1000 ft. roll..... \$5.30
2 ply per 1000 ft. roll..... 7.80
3 ply per 1000 ft. roll..... 9.70
Brownskin, Standard, 500 ft. roll..... 8.00
Sisalraft, reinforced, 500 ft. roll..... 7.00

BUILDING HARDWARE—
Sash cord com. No. 7..... \$2.65 per 100 ft.
Sash cord com. No. 8..... 3.00 per 100 ft.
Sash cord spot No. 7..... 3.65 per 100 ft.
Sash cord spot No. 8..... 4.00 per 100 ft.
Sash weights, cast iron, \$100.00 ton.
Nails, \$5.50 base.

CONCRETE AGGREGATES—
The following prices net to Contractors unless otherwise shown. Carload lots only.

	Bunker per ton	Del'd per ton
Gravel, all sizes	\$2.44	\$2.75
Top Sand	2.38	3.13
Concrete Mix	2.38	3.06
Crushed Rock, ¼" to ¾"	2.38	2.94

	Bunker per ton	Del'd per ton
Crushed Rock, ¾" to 1½"	\$2.38	\$3.13
Roofing Gravel	2.81	3.50
River Sand	2.50	3.06

Sand—
Lepis (Nos. 2 & 4)..... 3.56 3.94
Olympia (Nos. 1 & 2)..... 3.56 3.88

Cement—
Common (all brands, paper sacks), carload lots, \$3.02 per bbl. f.o.b. car; delivered \$3.60.
Cash discount on carload lots, 10c a bbl., 10th Frox., less than carload lots \$4.00 per bbl. f.o.b. warehouse or delivered.
Cash discount 2% on L.C.L.

Trinity White { 1 to 100 sacks, \$3.13 sack
Medusa White { warehouse or del.; \$9.56 bbl. carload lots.

DAMP-PROOFING and Waterproofing—

Two-coat work, \$8.00 per square.
Membrane waterproofing—4 layers of saturated felt, \$9.00 per square.
Hot coating work, \$5.00 per square.
Medusa Waterproofing, \$3.50 per lb. San Francisco Warehouse.
Tricoloc waterproofing.
(See representative.)

ELECTRIC WIRING—\$15 to \$20 per outlet for conduit work (including switches).

Knob and tube average \$6.00 per outlet. (Available only for priority work.)

ELEVATORS—

Prices vary according to capacity, speed and type. Consult elevator companies. Average cost of installing a slow speed automatic passenger elevator in small four story apartment building, including entrance doors, about \$8000.00.

EXCAVATION—

Sand, \$1.00; clay or shale, \$1.50 per yard. Trucks, \$30 to \$45 per day.
Above figures are an average without water. Steam shovel work in large quantities, less; hard material, such as rock, will run considerably more.

FIRE ESCAPES—

Ten-foot galvanized iron balcony, with stairs, \$250 installed on new buildings; \$300 on old buildings.

FLOORS—

Composition Floors, such as Magnesite, 50c per square foot.
Linoflor—2 gages—\$3.00 per sq. yd.
Mastipave—\$1.50 per sq. yd.
BattleShip Linoleum—available to Army and Navy only—1/8"—\$3.50 sq. yd.
3/8"—\$3.50 sq. yd.
Terrazo Floors—\$1.50 per sq. ft.
Terrazo Steps—\$2.50 per lin. ft.
Mastic Wear Coat—according to type—20c to 35c.

Hardwood Flooring—

Standard Mill grades not available.
Victory Oak—T & G
¾" x 2¼"..... \$252.00 per M. plus Cartage
½" x 2"..... \$210.00
½" x 1½"..... 200.00

Refinished Standard & Better Oak Flooring
¾" x 3¼"..... \$265.00 per M. plus Cartage
½" x 2½"..... 237.00 per M. plus Cartage

Maple Flooring
¾" T & G Clear \$330.00 per M. plus Ctg.
2nd 305.00 per M. plus Ctg.
3rd 255.00 per M. plus Ctg.
Floor Layers' Wage, \$2.28½ per hr. (Legal as of July 1, 1947. Given us by Inlaid Floor Co.)

GLASS—

Single Strength Window Glass..... \$.40 per □ ft.
Double Strength Window Glass..... .60 per □ ft.
Plate Glass, under 75 sq. ft..... 1.50 per □ ft.
Polished Wire Plate Glass..... 2.25 per □ ft.
Rgh. Wire Glass..... .80 per □ ft.
Obscure Glass..... .40 per □ ft.
Glazing of above is additional.
Glass Blocks..... \$2.75 per □ ft. set in place

HEATING—

Average, \$2.50 to \$3.00 per sq. ft. of radiation, according to conditions.
Warm air (gravity) average \$64 per register.
Forced air average \$91 per register.

INSULATION AND WALLBOARD—

Rockwool Insulation— (2")	\$45.00 per M sq. ft.
Cotton Insulation—Full-thickness (3%)	\$95.50 per M sq. ft.
Sisalation Aluminum Insulation—Foil-mounted on both sides	\$23.50 per M sq. ft.
Tileboard—4'x8' panel	\$9.00 per panel
Wallboard—1/2" thickness	\$55.00 per M sq. ft.
Finished Plank	\$49.00 per M sq. ft.
Ceiling Tileboard	\$49.00 per M sq. ft.

IRON—Cost of ornamental iron, cast iron, etc., depends on designs.

LUMBER—

No. 1 Common	\$90.00 per M
No. 2 Common	88.00 per M
Select O. P. Common	94.00 per M

Flooring—	Per M Delvd.
V.G.-D.F. 8 & Btr. 1 x 4 T & G Flooring	\$170.00
"C" and better—all	170.00
"D" and better—all	170.00
Rwd. Rustic—"A" grade, medium dry	150.00
8 to 24 ft.	
"B" grade, medium dry	150.00
Plowwood	15c to 18c per ft.
Plyscord	9 1/2c per ft.
Plywall	9c per ft.
Plyform	15c per ft.

Shingles (Rwd. not available)—
Red Cedar No. 1—\$13.00 per square; No. 2, \$10.50; No. 3, \$9.00.
Average cost to lay shingles, \$6.00 per square.
Cedar Shakes—Tapered: 1/2" x 3/4" x 25"—\$17.00 per square.
Retawn: 3/4" to 1 1/4" x 25"—\$22.00 per square
Average cost to lay shakes,—8.00 per square

MILLWORK—Standard.

D. F. \$150 per 1000. R. W. Rustic \$175 per 1000 (delivered).
Double hung box window frames, average with trim, \$12.50 and up, each.
Complete door unit, \$15 to \$25.
Screen doors, \$6.00 to \$8.00 each.
Patent screen windows, \$1.25 a sq. ft.
Cases for kitchen pantries seven ft. high, per lineal ft., \$12.00 each.
Dining room cases, \$15.00 per lineal foot. Rough and finish about \$1.00 per sq. ft.
Labor—Rough carpentry, warehouse heavy framing (average), \$65.00 per M.
For smaller work average, \$75.00 to \$85.00 per 1000.

MARBLE—(See Dealers)

PAINTING—

Two-coat workper yard 75c
Three-coat workper yard \$1.00
Cold water paintingper yard 25c
Whitewashingper yard 15c
Turpentine.....\$1.85 per gal. in 5-gal. cont.
Raw Linseed
Oil.....\$3.33 per gal. in 5-gal. cont.

Boiled Linseed Oil.....\$3.23 per gal. in drums.
Boiled Linseed Oil—\$3.33 per gal. in 5-gal. containers.
Replacement Oil—\$2.75 per gal. in drums.
\$2.75 per gal. in 5-gal. containers.
Use Replacement Oil.....\$3.00 per gal. in 1 gal. cont.
A deposit of \$7.50 required on all drums.

PATENT CHIMNEYS—

6-inch\$2.00 lineal foot
8-inch 2.50 lineal foot
10-inch 3.50 lineal foot
12-inch 4.50 lineal foot

PLASTER—

Neat wall, per ton delivered in S. F. in paper bags, \$17.60.

PLASTERING (Interior)—

3 Coats, metal lath and plaster	Yard \$3.00
Keene cement on metal lath	3.50
Ceilings with 3/4 hot roll channels metal lath (lathed only)	4.00
Sealings with 3/4 hot roll channels metal lath plastered	3.50
Single partition 3/4 channel lath 1 side (lath only)	3.00
Single partition 3/4 channel lath 2 inches thick plastered	8.00
4-inch double partition 3/4 channel lath 2 sides (lath only)	5.75
4-inch double partition 3/4 channel lath 2 sides plastered	6.75
Thermax single partition: 1" channels; 2 1/4" overall partition width. Plastered both sides	7.50
Thermax double partition: 1" channels; 4 1/4" overall partition width. Plastered both sides	11.00
3 Coats over 1" Thermax nailed to one side wood studs or joists	4.50
3 Coats over 1" Thermax suspended to one side wood studs with spring sound isolation clip	5.00

Note—Channel lath controlled by limitation orders.

PLASTERING (Exterior)—

2 coats cement finish, brick or concrete wall	Yard \$2.50
3 coats cement finish, No. 18 gauge wire mesh	3.50
Lime—\$4.00 per bbl. at yard.	
Processed LLime—\$4.15 per bbl. at yard.	
Rock or Grip Lath—3/8"—30c per sq. yd.	
3/8"—29c per sq. yd.	

Composition Stucco—\$4.00 sq. yard (applied).

PLUMBING—

From \$150.00 per fixture up, according to grade, quality and runs.

ROOFING—

"Standard" tar and gravel, 4 ply—\$11.00 per sq. for 30 sas. or over.
Less than 30 sas. \$14.00 per sq.
Tile \$40.00 to \$50.00 per square.
Redwood Shingles, \$15.00 per square in place.
5/2 # 1-16" Cedar Shingles, 4 1/2" Exposure\$18.25 square

5/8 x 16"—#1 Cedar Shingles, 5" Exposure\$17.00 square
4/2 # 1-24" Royal Shingles, 7 1/2" Exposure\$23.00 square
Re-coat with Gravel \$5.50 per sq.
Asbestos Shingles \$30 to \$60 per sq. laid.
1/2 to 3/4 x 25" Resawn Cedar Shakes, 10" Exposure\$24.00
3/4 to 1 1/4 x 25" Resawn Cedar Shakes, 10" Exposure\$29.00
1 x 25" Resawn Cedar Shakes, 10" Exposure 22.00
Above prices are for shakes in place.

SHEET METAL—

Windows—Metal, \$2.50 a sq. ft.
Fire doors (average), including hardware \$2.80 per sq. ft., size 12'x12'. \$3.75 per sq. ft., size 3'x6'.

SKYLIGHTS—(not glazed)

Copper, \$1.25 sq. ft. (flat).
Galvanized iron, 65c sq. ft. (flat).
Vented hip skylights 90c sq. ft.

STEEL—STRUCTURAL—

\$220 per ton erected, when out of mill.
\$270 per ton erected, when out of stock.

STEEL REINFORCING—

\$200.00 per ton, in place.

STORE FRONTS (None available).

TILE—

Ceramic Tile Floors—\$1.70 per sq. ft.
Cove Base—\$1.35 per lin. ft.
Glazed Tile Wainscot—\$1.85 per sq. ft.
Asphalt Tile Floor 1/4" x 3/8"—\$.40 per sq. ft. Light shades slightly higher.
Cork Tile—\$1.00 per sq. ft.
Mosaic Floors—See dealers.
Lino-Tile—\$1.00 per sq. ft.

Wall Tile—

Glazed Terra Cotta Wall Units (single faced) laid in place—approximate prices:
2 x 6 x 12\$1.25 sq. ft.
4 x 6 x 12 1.50 sq. ft.
2 x 8 x 16 1.45 sq. ft.
4 x 8 x 16 1.75 sq. ft.

VENETIAN BLINDS—

75c per square foot and up. Installation extra.

WINDOWS—STEEL—

60c per square foot, \$5 for ventilators.

IN THE NEWS

ARCHITECT SELECTED

Arthur D. Janssen, Architect, of Atherton (California) has been selected to do the new high school soon to be built in the Menlo Park Ravenswood area in San Mateo County by the Sequoia Union High School District.

ARCHITECT

Blanchard & Maher, Architects, of San Francisco have been selected to do the 10 classroom addition to the Redwood City High School. The project also calls for the construction of a new gymnasium and remodel of the old gymnasium.

UNION HALL

The Sailors Union of the Pacific have applied for a building permit to construct a \$750,000 Union Hall Building in San Francisco. Wm. G. Merchant is the Architect and the M. & K. Corporation the General Contractor.

DEPARTMENT STORE Remodel. The J. C. Penney Company, San Francisco, will spend \$328,758 in installing escalators in their 5th & Market Street store.

ABATTOIR

The Earl W. Heple Construction Company of San Jose (California) have been awarded a contract for the construction of an addition to the San Jose Meat Company abattoir on Berryessa Road, Santa Clara County.
Myron C. Gould & Associates

of San Francisco are the engineers. Cost of the project is estimated at \$211,000.

BIDS REJECTED. The Oakland Board of Education recently rejected bids for remodeling of the Emerson School building. Estimate \$29,256.

BONDS VOTED. Voters recently approved a bond issue of \$5,250,000 for the construction of new high schools and grammar schools in Stockton (California).

**CONCRETE SHEATHING
AND COVERING MATERIAL**

TOUGH as SHOE - LEATHER - and WATERPROOF, Too!

Specify
SISALKRAFT REINFORCED BUILDING PAPER
FOR CURING AND PROTECTING

GUNN CARLE & CO

20 POTRERO AVENUE • SAN FRANCISCO, CALIF.

BUILDING TRADES WAGE (JOB SITES) NORTHERN AND CENTRAL CALIFORNIA

ATTENTION: The following are the PREVAILING hourly rates of compensation being paid and in effect by employers by agreement between employees and their union; or as recognized and determined by the U. S. Department of Labor. (Revised to January 1, 1948.)

TRADE	San Francisco	Alameda Contra-Costa	Marin	Vallajo	San Mateo	San Jose	Stockton	Sacramento	Fresno
ASBESTOS WORKERS	1.90	1.90	1.90	1.90	1.90	1.90	1.90	1.90	1.90
BRICKLAYERS	2.25	2.25	2.25	2.25	2.25	2.25	2.50	2.50	2.25
BRICKLAYERS, HODCARRIERS	1.75	1.75	1.75	1.75	1.75	1.87 1/2	1.87 1/2	1.87 1/2	1.75
CARPENTERS	2.00	2.00	2.00	2.00	2.00	2.00	2.00	2.00	2.00
CEMENT FINISHERS	2.02 1/2	2.02 1/2	2.02 1/2	2.02 1/2	2.02 1/2	2.02 1/2	2.02 1/2	2.02 1/2	2.02 1/2
ELECTRICIANS	2.25	2.25	2.25	2.25	2.25	2.25	2.25	2.25	2.25
ENGINEERS: MATERIAL HOIST	2.00	2.00	2.00	2.00	2.00	2.00	2.00	2.00	2.00
ENGINEERS: PILE DRIVER	2.25	2.25	2.25	2.25	2.25	2.25	2.25	2.25	2.25
ENGINEERS: STRUCTURAL STEEL	2.25	2.25	2.25	2.25	2.25	2.25	2.25	2.25	2.25
GLASS WORKERS	1.87 1/2	1.87 1/2	1.87 1/2	1.87 1/2	1.87 1/2	1.87 1/2	1.87 1/2	1.87 1/2	1.87 1/2
IRONWORKERS: ORNAMENTAL	2.15	2.15	2.15	2.15	2.15	2.15	2.15	2.15	2.15
IRONWORKERS: REINF. RODMEN	2.00	2.00	2.00	2.00	2.00	2.00	2.00	2.00	2.00
IRONWORKERS: STRUCTURAL	2.25	2.25	2.25	2.25	2.25	2.25	2.25	2.25	2.25
LABORERS: BUILDING & CONCRETE	1.40	1.40	1.40	1.40	1.40	1.30	1.40	1.40	1.30
LATHERS	2.25	2.25	2.25	2.25	2.25	2.25	2.25	2.25	2.25
MARBLE SETTERS	2.00	2.00	2.00	2.00	2.00	2.00	2.00	2.00	2.00
MOSAIC & TERRAZZO	2.00	2.00	2.00	2.00	2.00	2.00	1.75	1.75	1.75
PAINTERS	2.00	2.00	2.00	2.00	2.00	2.00	2.00	2.00	2.00
PILEDRIVERS	2.12 1/2	2.12 1/2	2.12 1/2	2.12 1/2	2.12 1/2	2.12 1/2	2.12 1/2	2.12 1/2	2.12 1/2
PLASTERERS	2.25	2.50	2.25	2.50	2.25	2.25	2.05	2.05	2.05
PLASTERERS: HODCARRIERS	2.00	2.00	2.00	2.00	2.00	2.00	1.87 1/2	1.87 1/2	1.87 1/2
PLUMBERS	2.25	2.25	2.25	2.25	2.25	2.25	2.25	2.25	2.25
ROOFERS	2.00	2.00	2.00	2.00	2.00	2.00	2.00	2.00	2.00
SHEET METAL WORKERS	2.00	2.00	2.00	2.00	2.00	2.00	2.00	2.00	2.00
SPRINKLER FITTERS	2.00	2.00	2.00	2.00	2.00	2.00	2.00	2.00	2.00
STEAMFITTERS	2.25	2.25	2.25	2.25	2.25	2.25	2.25	2.25	2.25
STONESETTERS (MASON'S)	2.25	2.25	2.25	2.25	2.25	2.25	2.25	2.25	2.25
TILESETTERS	2.15	2.15	1.90	1.90	1.90	1.90	1.90	1.90	1.90

Prepared and compiled by

CENTRAL CALIFORNIA CHAPTER, ASSOCIATED GENERAL CONTRACTORS OF AMERICA

with the assistance and cooperation of secretaries of Building Trades Unions, General Contractors Associations and Builders Exchanges of Northern California

CLASSIFIED ADVERTISING

RATE: 20c PER WORD . . . CASH WITH ORDER

MINIMUM \$5.00

CONSTRUCTION ENGINEER (CIVIL) GENERAL SUPERINTENDENT PROJECT MANAGER

Twenty five years of wide practical experience on frame, steel, concrete and masonry bldgs. of all types. Estimating, sub-division, sales, detailing & specification writing back-

ground. Dependable, energetic. Excellent local references. Have car. Free to travel. P.O. Box 807, San Mateo, Calif.

PHOTOGRAPHS: Specializing in building and construction photographs for publication, or historic records. For Industrial-Aerial. Publicity photography use the **INDUSTRIAL**

San Francisco.
PHOTO'S, Room 929, Hearst Bldg., San Francisco, Phone SUTTER 1-6953.

ENGRAVING—Good engravings are essential to a satisfactory job of printing reproduction. For the best, see Poor Richard Photo Engraving Co., 324 Commercial St.,

HOGAN LUMBER CO.

Wholesale and Retail

LUMBER

MILL WORK • SASH & DOORS

Office, Mill, Yard and Docks

SECOND AND ALICE STREETS • OAKLAND, CALIF.

Telephone GLencourt 1-6861

SISALKRAFT

REG. U. S. PAT. OFF.

"More than a building paper"

THE SISALKRAFT CO.

205 West Wacker Drive
Chicago, Ill.

55 New Montgomery Street
San Francisco, Calif.

CLINTON CONSTRUCTION CO. OF CALIFORNIA

General Contractors

923 FOLSOM STREET • SAN FRANCISCO

SUtter 1-3440

SANTA MARIA INN SANTA MARIA, CALIFORNIA

FRANK J. McCOY, General Manager

FERNAND E. PIMENTEL, Manager

On the
Coast
Highway
between
San
Francisco
and
Los
Angeles



American
or
European
Plan
•
Old
English
Tap
Room

CASTRO LANE GRAMMAR SCHOOL BAKERSFIELD

Architects Chas. H. Biggar, C. B. Alford and W. J. Thomas of Bakersfield (California) have completed plans for a 14 classroom, kindergarten, auditorium and cafeteria grammar school building southwest of Bakersfield in Kern County.

A general contract in the amount of \$322,995 has been awarded to the construction firm of Johnson & Johnson of Bakersfield.

WORK ON CENTRAL VALLEY PROJECT STEPPED UP

Aiming towards completion of major features of the initial works of the Central Valley Project in 1951, a heavy irrigation and power construction program for the fiscal year has been outlined by Richard L. Boke, regional director at Sacramento.

In accordance with Congressional emphasis in the appropriation bill recently passed, the program will focus chiefly on rapid extension of the Friant-Kent and Delta-Mendota canals, work on the Tracy Pumping Plant, and installation of additional power features at Shasta and Keswick dams.

SCHOOL AND CHURCH BUILDING PROGRAM

The Catholic Church will spend more money for new hospitals and high schools than any other type of building in the next ten years. Churches are third.

This was announced at the completion of a nation-wide Catholic building survey begun last fall among pastors, religious superiors and college officials by the business and industry foundation of the college of St. Joseph's of Indiana.

The foundation made the survey in connection with the National Catholic Building Convention and Exposition, as an educational service to Catholic builders.

With information on 1,534 building programs, the college foundation has estimated that the Church will spend ten billion dollars in the next decade on U. S. Construction, remodeling, furnishing, equipment and maintenance.

Grade schools and college buildings will be about equal in Catholic building expenditures. There will be more for recreation centers than convents, and twice as much for convents as for priests' homes.

The average Catholic hospital will cost \$1,168,237; college building, \$535,877; high school \$471,446; grade school \$136,892; recreation center, \$135,581 church, \$123,762; convent, \$82,881; and rectory, \$35,509.

BOOK REVIEWS

PAMPHLETS AND CATALOGUES

NEW ELECTRIC HEATING GUIDE. Westinghouse Electric Corporation, Emeryville, California. Price \$2.00.

A practical guide to the design and installation of electric heating for homes for contractors, architects, builders, and engineers.

Containing 42 pages, the illustrated manual reduces the complicated procedure of designing an electric heating system to the simple process of selecting the required heating capacity for a given room from the proper chart.

Charts are easy to use and take into consideration such factors as degrees of insulation and the number of exposed walls, floor area, window area, double or single pane glass and other pertinent data. Copy may be secured from any Westinghouse Electric Supply Company office.

MARBLE FORECAST. Marble Institute of America, 108 Forster Avenue, Mount Vernon, New York.

Architects and builders will welcome this booklet which describes the varieties, colors, and specifications of foreign and domestic Marbles available for immediate installation.

One section is devoted to color ranges of Marble and includes every tone from creamy white to reddish brown, grayish-pink, blue gray and gold, and black. Issued by the Marble Institute of America, the booklet provides the latest and most complete information on current Marble supplies and future production, also lists member companies from whom additional and detailed information may be secured.

"SKY-GLO" Luminous Louver System. Benjamin Electric Mfg. Co., Des Plaines, Ill. A. I. A. File No. 31-4-14.

A comprehensive bulletin on the new louvered ceiling lighting system containing 28-pages of illustrations, photographs, architectural drawings, engineering charts and specification tables of particular interest to Architects, Engineers, Contractors, consulting engineers, and lighting specialists.

Copies are available upon request of the manufacturer.

THEATRE CONTRACT

The George W. Carter Company of Los Angeles have been awarded a \$367,000 contract for the construction of a 1200 seat theatre in Fresno (California) Carl Moeller is the Architect.

VERMONT MARBLE COMPANY

Producers and Finishers
of
Domestic and Imported Marbles

525 MARKET STREET, SAN FRANCISCO
Phone SUTTER 1-6747
3522 COUNCIL STREET
(Beverly Blvd. at Virgil Ave.)
LOS ANGELES 4, CALIF.
Telephone FAirfax 7834



The Most Complete Line of
STEELS and BUILDING MATERIALS
Made by a Single Producer



See Sweet's Catalog File or write us for full information.

REPUBLIC STEEL CORPORATION

GENERAL OFFICES: CLEVELAND, OHIO

DENVER, COLORADO CONTINENTAL OIL BUILDING
LOS ANGELES, CALIFORNIA EDISON BUILDING
SALT LAKE CITY, UTAH WALKER BANK BUILDING
SAN FRANCISCO, CALIFORNIA RIALTO BUILDING
SEATTLE, WASH. WHITE-HENRY-STUART BUILDING

PACIFIC MANUFACTURING CO.

High Class Interior Finish Quality
Millwork

16 Beale St., San Francisco
GARfield 1-7755

2215 El Camino Real, San Mateo
S. M. 5-0687

304 Bryant Street, Palo Alto
P. A. 3373

2610 The Alameda, Santa Clara
S. C. 607 (Factory)

6820 McKinley Avenue, Los Angeles
THArnwall 4196

MAIN OFFICE — SANTA CLARA

"AMERICAN - MARSH" CONDENSATION UNIT

Pumping
Machinery
for
Every
Purpose

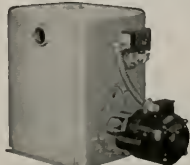

For Service
Call
DOuglas
2-6794
or
MUtual 8322

SIMONDS MACHINERY CO.

SAN FRANCISCO
814 FOLSOM

LOS ANGELES
455 EAST 4TH

IN THE NEWS

MAIN ENTRANCE

The McCoy & Butler Construction Company of Yuba City (California) have been awarded an \$18,239 contract for the construction of a main entrance to the Butte County Fair Grounds at Gridley.

Raymond R. Franceschi of Sacramento is the Architect.

GRAIN GROWERS

The Pendleton Grain Growers, Inc., of Pendleton (Oregon) are taking bids on the construction of a group of buildings to include a grain elevator, administration building, shop building, frozen food locker building, feed and seed warehouse, petroleum warehouse, a loading dock and railroad tracks.

To be of reinforced concrete construction, it is estimated the cost of the project will be in excess of \$1,177,949.

NEW CHURCH

The 23rd Avenue Baptist Church of Oakland (California) is raising funds for the construction of a new church and Sunday school in Oakland. Preliminary estimate is \$250,000. Donald Powers Smith of San Francisco is the Architect.

WAREHOUSE

Ralph Wyckoff, San Jose, Architect has designed a new warehouse and office building in San Jose. Consisting of a one story and basement, reinforced concrete and steel building it is estimated the cost at \$257,507.

Earl W. Heple of San Jose is the general contractor.

PRETTY SWEET

The Chase Candy Company of San Jose (California) are building an addition to their factory building at a cost of \$500,000. The project consists of a one story addition of reinforced concrete and a frame machine shop of 3,000 square feet.

BONDS VOTED

Voters have approved the issuance of \$2,814,000 for the construction of additions to the High School and Grammar Schools of Alameda (California).

Architects for the High School work are Franklin, Kump & Falk of San Francisco, and for the Grammar School the Architects are Kent & Haas of San Francisco.

SORORITY HOUSE

The Robert L. Wilson Construction Company of San Francisco (California) have been awarded a \$150,000 contract for the construction of a Sorority House in Berkeley for the Kappa Kappa Gamma Sorority.

Warren C. Perry of San Francisco is the Architect. Construction will be a three story frame and stucco, concrete floor, building designed to accommodate 48 girls.

APARTMENT

A contract for \$106,000 has been awarded to the California Builders of Oakland (California) for the construction of a three story frame and stucco apartment building in Oakland.

RESIDENCE

Architect Frederick H. Reimers of San Francisco is working on a home to be built in Oakland (California) at a cost of \$85,000. The residence will be of two story design containing fourteen rooms.

ARCHITECT AND ENGINEER



Soulé gives you the greatest dollar value per square foot. Go and see a completed Soulé Steeline Building — you'll see why!

Soulé is an all-purpose building of clear-span design. Easily modified to any type front, window arrangement or door locations. Easily partitioned.

Soulé gives you a choice of time delaying PLASTEEL walls and roof or bright, modern aluminum (both corrugated for extra strength).

Soulé design meets all uniform Building Codes.

Delivered to your Building Site

By special truck loadings Soulé delivers pre-fabricated steel buildings, complete to the last bolt, right to your building site. Avoids handling damage! Saves you time!



NOTE THE RUGGED STEEL GIRDES (actual photo)

Steel is supreme for LOW-COST, PERMANENT BUILDINGS

If you want secure protection from dry-rot, rodents, termite-damage, fungus, hurricane velocity winds, and other structure destroying elements, be sure you buy the *Soulé Steeline Building*. 7 years of Soulé research and engineering development make the *Soulé Steeline Building* a definitely superior structure. 36 years of Soulé specialized "skyscraper" fabricating, erecting and designing experience is a Soulé exclusive EXTRA you'll be safer having. Steel is supreme in building — *Soulé is supreme in steel!*



Factory Trained Crews

Soulé Steeline Buildings are easily erected by any crew using Soulé "prints marked prints"; but for downright speed an experienced Soulé crew is it . . . will save you time and perhaps money too.

FREE . . . Illustrated Folder

SOULE STEEL COMPANY
1750 Army Street,
SAN FRANCISCO 24 • Valencia 4-4141

Without obligation, please send Soulé Utility Building folder . . .

NAME _____
ADDRESS _____
CITY _____

SS-51

The Soulé basic size is 40' wide by 100' long (longer or shorter in 19'-9" multiples). 14' vertical side walls, 21' ridge. Extra large 12' x 14' doors. Soulé heavy-duty type industrial steel windows. It will pay you handsomely to go over the Soulé engineering details with a Soulé Engineer!

Soulé

SAN FRANCISCO - LOS ANGELES
PORTLAND - SEATTLE

Buildings

Fabricators of STEEL BUILDING PRODUCTS SINCE 1911

TYLE-BORD

...America's finest
plastic coated
wallboard
for residential,
commercial and
industrial use

WESTERN ASBESTOS

COMPANY

675 Townsend Street, San Francisco 3

Telephone: HElock 1-4884

OAKLAND • SACRAMENTO • FRESNO • SAN JOSE

THE TORMEY COMPANY

GENERAL PAINTERS
AND DECORATORS

Phone UNderhill 1-1913

563 FULTON STREET
San Francisco

DINWIDDIE CONSTRUCTION COMPANY

BUILDERS

CROCKER BUILDING
SAN FRANCISCO

IN THE NEWS

ACADEMIC BUILDING

The Napa Union High School and Junior College District have awarded a contract to the Pacific Coast Builders of San Francisco (California) for the construction of an Academic Building at the Napa Junior College.

To be of reinforced concrete and frame construction the building will cost some \$726,476.

W. G. Corlett & A. W. Anderson of Oakland are the Architects.

COUNTY FAIR

J. P. Brennan of Redding (California) has been awarded a contract for the construction of a exhibit building and cafeteria for the Shasta County Fair grounds at MacArthur (California.) Cost of the one story, Concrete block building is \$100,041.

STORE & OFFICE

A. E. Erickson & Sons of North Sacramento have been awarded a \$200,000 contract for the construction of a new store and office building in Sacramento for the Blumenfeld Theatres of San Francisco.

Herbert Goodpastor of Sacramento is the Architect.

BONDS VOTED

A bond issue of \$160,000 has been approved for the construction of a new grammar school building in Petaluma (California).

BIDS REJECTED. The Woodland Board of Education recently rejected bids for remodeling the Beamer Grammar School at an estimated cost of \$45,000.

NEW NEVADA HOTEL

The newly organized El Rancho Hotel Company of Reno, Nevada, has let a contract to Shumaker & Evans of Las Angeles (California) for the construction of a hotel-motel near Reno, at a cost of \$1,200,000.

The El Rancho, when completed, will be operated as a part of the Thos. Hull Enterprises of Hollywood, California, operators of hotel and motel properties throughout California.

Frank W. Green of Glendale (California) is the Architect.

INCINERATORS TRASH BURNERS

Steel-Cased, Down-Draft Types

EXCEPTIONAL
Construction and Values

JNJ FIREBRICK
CONSTRUCTION CO.

San Francisco

345 Vermont St.

UN 1-2144



**HERRICK
IRON WORKS**
STRUCTURAL STEEL
REINFORCING STEEL

18TH AND CAMPBELL STS.
OAKLAND, CALIF.
Phone GLencourt 1-1747

Phone GArdfield 1-1164

Thomas B. Hunter
DESIGNER OF HEATING

AIR CONDITIONING
VENTILATING AND WIRING
SYSTEMS, MECHANICAL
AND ELECTRICAL EQUIP-
MENT OF BUILDINGS

★

41 SUTTER STREET
ROOM 710

San Francisco

California

Scott Company

HEATING • PLUMBING
REFRIGERATION

★

San Francisco
Oakland
San Jose
Los Angeles

MULLEN MFG. COMPANY

BANK, STORE AND OFFICE
FIXTURES—CABINET WORK
OF GUARANTEED QUALITY
CHURCH SEATING

Office and Factory
60-80 RAUSCH ST., Bet. 7th and 8th Sts.
San Francisco
Telephone UNDERhill 1-5815

PITTSBURGH TESTING LABORATORY

ENGINEERS AND CHEMISTS

Testing and Inspection of Concrete,
Steel and Other Structural Materials

Design of Concrete Mixes

Offices in all principal cities

651 Howard St., San Francisco 5
EXbrook 2-1747

Mattock Construction Company

Builders



604 MISSION STREET
SAN FRANCISCO

Brownskin
VAPORSEAL

The resilient building paper creped to S-T-R-E-T-C-H

Quality Products Since 1815

ANGIER PACIFIC CORPORATION
55 NEW MONTGOMERY ST. 7426 SUNSET BOULEVARD
SAN FRANCISCO 5, CALIF. LOS ANGELES 48, CALIF.

A complete line of Angier products available from your building material dealer

Index to Advertisers

ANGIER Pacific Corp.	48
ARCHITECTURAL Porcelain Constructors	39
ARCHITECTS Reports	40
BASALT Rock Company Back Cover	
BAXTER & Company, J. H.	36
CLASSIFIED Advertising	43
CLINTON Construction Company	44
CONTINENTAL Water Heats Co.	*
DETROIT Steel Products Co.	5
DINWIDDIE Construction Co.	47
DUFFY Tile Co.	48
FIREBRICK Construction Co., J. N. J.	47
FORDERER Cornice Works	40
FOX Tile Co.	38
FULLER, W. P. Co.	*
GLADDING, McBean & Co.	*
GUNN, Carle & Company	43
HANKS, Inc., Abbott A.	48
HAWS Drinking Faucet Company	34
HERRICK Iron Works	47
HOGAN Lumber Company	44
HUNT, Robert W., Company	48
HUNTER, Thos. B.	47
JOHNSON, S. T. Co.	32
JUDSON, Pacific-Murphy Corp.	40
KRAFTILE Company	30
MARBLE Institute of America	*
MATTOCK, A. F., Co.	48
MICHEL & Pfeffer Iron Works	
Inside Front Cover	
MULLEN Mfg. Co.	48
MUELLER Brass Co.	*
NORTHERN California Electric Bureau	35
PACIFIC Coast Gas Association	*
PACIFIC Manufacturing Company	45
PACIFIC Portland Cement Company	
Inside Back Cover	
PACIFIC Telephone & Telegraph Co.	33
PITTSBURGH Testing Laboratory	48
POOR Richard Engraving Co.	*
REMILLARD-Dandini Co.	48
REPUBLIC Steel Corporation	45
SANTA Maria Inn	44
SCOTT Co.	47
SECURITY Valve Company	31
SIMONDS Machinery Company	45
SIMPSON Logging Co.	*
SISALKRAFT Company	44
SMOOT-Halman Co.	37
SOULE Steel Co.	46
STANLEY Works, The	*
SUPERIOR Fireplace Company	*
TAYLOR Co., Halsey W.	38
TORMEY Company, The	47
U. S. BONDS	1
VERMONT Marble Company	45
WESTIX Company	*
WESTERN Asbestos Co.	47
WESTERN-Holly Stove Co.	2
WOOD, E. K., Lumber Company	36

*Indicates Alternate Months

DUFFY TILE CO.

TILE CONTRACTORS
SHOWER DOORS
TUB ENCLOSURES

INSTALLATIONS OF EVERY DESCRIPTION
Modernizing, Repairing
"Not How Cheap But How Good"
253 MINNA
YUkon 6-1489

ABBOT A. HANKS, INC. Engineers & Chemists

INSPECTING — TESTING — CONSULTING
CONCRETE • STEEL • MATERIALS
CHEMICAL AND TESTING
LABORATORIES

• RESEARCH AND INVESTIGATION •

TESTS OF STRUCTURAL MATERIALS
DESIGN OF CONCRETE MIXES
SHOP AND ERECTION INSPECTION OF
STRUCTURES AND EQUIPMENT
INVESTIGATION OF STRUCTURES
AND MATERIALS
TESTS AND INVESTIGATION OF
FOUNDATION SOILS
FIRE RESISTANCE AND INSULATION
TESTS

624 Sacramento Street, San Francisco

Robert W. Hunt Company ENGINEERS

Inspection - Tests - Consultation
Schools and Other Structures
Are Built as Designed

When Construction Materials are
Inspected at point of Manufacture
and during Erection by

ROBERT W. HUNT COMPANY

Cement, Concrete, Chemical, Metallurgical,
X-Ray and Physical Laboratories

Chicago - New York - Pittsburgh
Los Angeles - All Large Cities
San Francisco, 251 Kearny Street

REMILLARD-DANDINI Co.

Brick and
Masonry Products



400 MONTGOMERY STREET
SAN FRANCISCO, CALIF.

ARCHITECT AND ENGINEER

PRIZE WINNING EXHIBIT



Marin County Architects & Landscape Architects

SEPTEMBER

1948

steel service stations

modern design
minimum cost
ease of erection
low upkeep
longer life

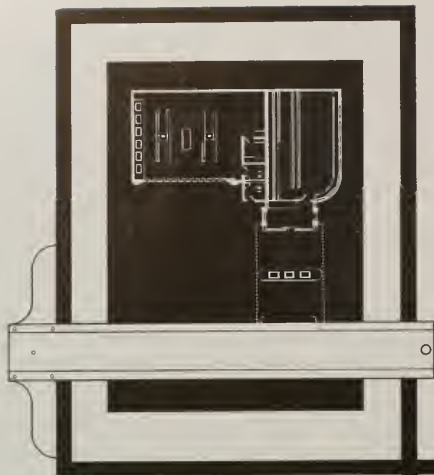

Michel & Pfeffer Iron Works, Inc.

W. A. JAMES, Manager Steel Building Division
Tenth and Harrison Streets, San Francisco 3, California
Telephone: MArket 1-5966

ARCHITECT

Vol. 174

No.3

AND ENGINEER

ARCHITECTS' REPORTS—Published Daily

Contents for

SEPTEMBER

E. H. WILDER

Editor

MARK DANIELS, A.I.A.

Associate Editor

PROF. LELAND VAUGHAN

Landscape Architecture

JOHN A. BLUME

Structural Engineering

MICHAEL GOODMAN

Planning

JOHN S. BOLLES, A.I.A.

Book Reviews



COVER PICTURE:

Sponsored by the Northern California Chapter of the A.I.A., and the Landscape Architects Association, the illustrated exhibit won first prize at the recent Marin (California) Art & Garden Show. See story on page 25.

EDITORIAL NOTES	4
NEWS & COMMENT ON ART	9
THE SPANISH MASTERS OF 20TH CENTURY PAINTING By ROBERT M. CHURCH	10
NEW CENTRAL WASHINGTON TUBERCULOSIS HOSPITAL	13
THE SEISMIC PROBABILITY MAP OF THE UNITED STATES By FRANKLIN P. ULRICH	14
LONGER LIFE, Better Health of Workers in the Building Industries By DR. W. SCHWEISHEIMER	15
NEW METROPOLITAN FEDERAL SAVINGS AND LOAN ASSOCIATION Los Angeles, California By LEONARD E. MILLER	16
CALIFORNIA COUNCIL OF ARCHITECTS Twenty-first Annual State Convention, Yosemite Park	20
ARCHITECT EXHIBIT (See Cover Illustration)	25
CITY STREETS AND MODERN TRANSPORTATION By CARL J. RUTLAND, Dallas, Texas	26
RESEARCH IN REINFORCED CONCRETE Sponsored by Foundation	30
A.I.A. ACTIVITIES	33
WITH THE ENGINEERS	34
HEADLINE NEWS & VIEWS By E. H. W.	38
IN THE NEWS	39, 48, 49
LANDSCAPE ARCHITECTURE Notes of the Profession	40
ESTIMATOR'S GUIDE, Building and Construction Materials	43
BUILDING TRADES WAGE SCALE, Northern & Central California	45
INDEX TO ADVERTISERS	50

ARCHITECT AND ENGINEER (Established 1905) is published on the 15th of the month by The Architect and Engineer, Inc., 68 Post St., San Francisco 4; Telephone EXbrook 2-7182. President, K. P. Kierulff; Vice-President and Manager, L. B. Penhorwood; Treasurer, E. N. Kierulff.

Los Angeles Office: Wentworth F. Green, 6505 Hollywood Blvd., Los Angeles 28. Telephone HEmpstead 3171.

Entered as second class matter, November 2, 1905, at the Post Office in San Francisco, California, under the Act of March 3, 1879. Subscriptions United States and Pan America, \$3.00 a year; \$5.00 two years; foreign countries \$5.00 a year; single copy 50c. ARCHITECTS' REPORTS are published daily from this office, Vernon S. Yallop, Manager. Telephone DOuglas 2-8311.



CALIFORNIA COUNCIL CONVENTION

The Annual Convention of the California Council of Architects of the American Institute of Architects will be held this month in Yosemite National Park.

Representing as it does the Architectural Profession of California, it is entirely proper and fitting that this year's Convention should be held in an area where Nature moulded some of its most beautiful and spectacular scenery.

Surrounded by the best that Nature has to offer in design, the Architects, their families, and allied interests, should be inspired to greater accomplishments in the development of the A.I.A. and individual effort.

ARCHITECTS WIN POINT

The determined effort of the Architects of California, working in cooperation with numerous engineering groups and allied interests, has brought some indication of ultimate results in convincing State of California officials and executives that consideration should be given private practitioners in the matter of awarding state work.

The long and fast rule that all architectural and engineering service on state building and construction projects should be performed by state department and bureau personnel, may be adjusted in the immediate future as official state barriers are beginning to waiver their heretofore adamant position.

Recent conferences between representatives of the State and private industry indicate that some of the \$300-million-dollar building program now under consideration by the State of California may find its way into the offices of individual Architects and Engineers.

Architects are to be asked to submit their qualifications to receive State jobs and while such a plan is a far cry from interference of private industry by government, it is at least a beginning point in a State policy which has been entirely wrong.

THE most precious possession in this World, the right to life, liberty, and the pursuit of happiness, can be lost unless we continually recognize that eternal vigilance is the price of Liberty.

THE BRITISH VIEWPOINT

A recent Conference on Housing Layout in Theory and Practice held at the Royal Institute of British Architects in London, England, developed some interesting thinking in conjunction with city and neighborhood planning throughout the British Isles.

The Right Hon. Lewis Silkin, M. P., Minister of

Town and Country Planning, although a lawyer himself, observed that "Housing layout in the past has been a subject which has not given very great scope to the professional architect and planner, at any rate in recent years.

"The layouts of the 18th century in London, in Edinburgh, in Bath, and so on, have never been repeated: they are in a class by themselves. They were carried out by both private enterprise and by public action. . . ."

In commenting further Silkin says, "All that I would say about development by private builders is that in the main it has been carried out without any plan, mostly on the outskirts of existing towns, and that it constitutes to a very large extent one of the evils with which we at the Ministry of Town and Country Planning are trying to deal—the evil of ribbon development and of the sprawl and bad expansion of existing towns.

"It is in the field of local authority housing that some attempt has been made to plan layout and the location of our houses. . . . The housing estate of the inter-war years has been an estate of dwellings for one class of the community only; the majority of the estates were for people who were being rehoused from slum areas, or who were living in overcrowded conditions, whose means were limited and for whom, therefore, dwellings had to be provided at the lowest possible rents. That in itself is a limitation which prevents imaginative planning."

In the matter of segregation, Michael Waterhouse, M. C., President of the Institute, told the assembly: "We heard a good deal about the evils of segregation. It is easy to talk about the mixing of the population, but it is difficult to accomplish. It was done successfully at Port Sunlight—an old but very interesting experiment in housing. It is strange how those who accuse others of snobbishness are so often snobs themselves.

"We have blamed the speculative builder for ruining the countryside. All the blame should not go to him for he has only catered for the 'snob' who wanted to buy a house as little like a 'council house' as possible. I fear segregation will go on for a long time. We are insular people and we like to keep ourselves to ourselves. We come together in times of national emergency and crisis.

"This mixing of the people is one of the most difficult of the many problems those interested in housing have to solve."

By changing the names of the speakers and the specific localities under consideration, the balance of the discussion could apply to most any American metropolitan city.

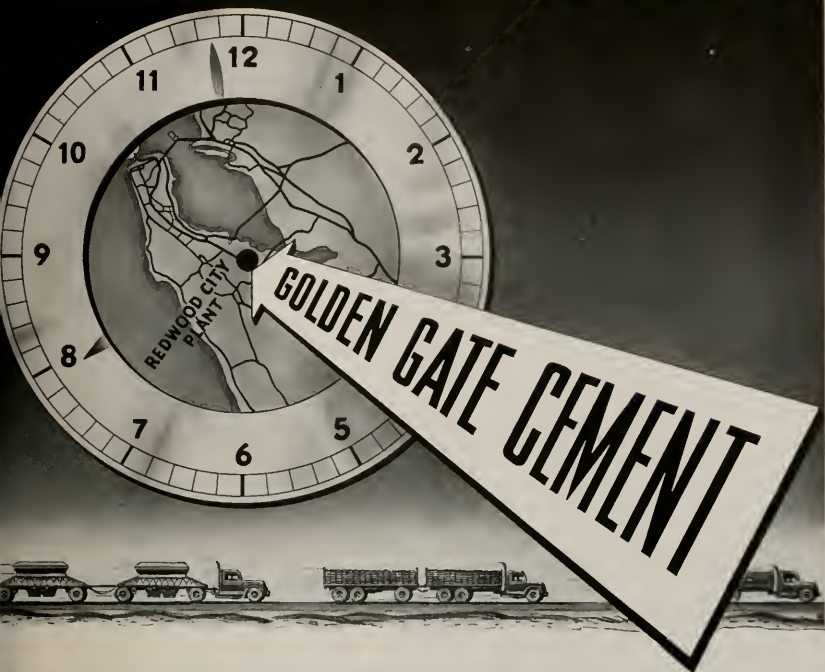

Prompt Delivery that Keeps Right Up to Schedule

With its main plant located at Redwood City Harbor, Pacific Portland Cement Company maintains "On Time" service to construction jobs throughout the Bay Area. Giant 120 barrel "bulk trucks" roll continuously like a

"pipeline of service" to dealers' batching plants—thence by truck or mixer to the project. Whether shipment is by Truck, Rail or Water—bulk or sacks—you can depend on Golden Gate Cement arriving right on schedule.

At the "Hub" of Construction



PACIFIC PORTLAND CEMENT COMPANY
Plant at Redwood City... Nearest to Bay Area Construction

PERMANENCE...

... one of the advantages that makes Ceramic Veneer the preferred facing material in the West!

When you are designing a building to last beyond tomorrow, face it with *permanence*... with Gladding, McBean & Co.'s Ceramic Veneer. This machine-perfected terra cotta is a dense, uniform, high-quality facing impervious to all climatic conditions... to atmospheric gases, smoke and steam... and to erosion. Ceramic Veneer is fire-resistant, non-conductive, non-fading. It gives you and your clients earthquake-proved construction and minimum upkeep.

These advantages explain why so many federal, state and civic structures in the West are clothed in Ceramic Veneer. The Appraiser's Building in San Francisco is an excellent example of the monumental beauty and permanence provided by Anchored Type Ceramic Veneer.

W. E. REYNOLDS, Commissioner, Public Building Administration
GILBERT STANLEY UNDERWOOD, Consulting Architect
CLINTON CONSTRUCTION CO., General Contractors



GLADDING, McBEAN & CO.

CERAMIC VENEER

The modern, machine-perfected terra cotta

OFFICES AT: LOS ANGELES • SAN FRANCISCO • SEATTLE • PORTLAND • SPOKANE

Simpson
QUALITY SINCE 1895

ACOUSTICAL TILE

WITH
EXCLUSIVE
HOLLOKORE
PERFORATIONS

ARCHITECTS: If you have not received your sample of Simpson Acoustical Tile, please write us for it.

Cuts Sound Control Costs by Giving

60% to 65% Average Sound Absorption with 1/2" Material

IN THESE days of high building costs, here is an opportunity to *reduce* the cost of sound control installations. Alert architects have found that an average sound absorption value (noise reduction coefficient) of .60 is the *lowest* safe value to specify for effective quieting of the average room. Simpson Acoustical Tile in the 1/2" thickness gives a .60 noise reduction coefficient on a solid backing . . . and .65 on furring strips!

Formerly, thicker perforated materials . . . at greater cost . . . were necessary to meet these specifications. Simpson has reduced costs . . . with a super-efficient acoustical tile which, in addition, gives new beauty with its finished bevels and smooth, round perforations obtained through Simpson's exclusive Hollokore drilling process. On your next job it will pay you to investigate Simpson Acoustical Tile and *specify the absorption.*

WOODFIBER DIVISION, SIMPSON LOGGING CO. Plant at Shelton, Washington
SALES DIVISION: 1010 White Bldg., Seattle 1, Wash.

THESE SIMPSON APPLICATORS ARE READY TO SERVE YOU:

ACOUSTICS NORTHWEST
Builders Exchange Bldg.
Portland 4, Oregon, AT 6443

ANGELES INDUSTRIES
984 McGarry St.
Los Angeles, Calif., TR 8121

ASBESTOS PRODUCTS CO.
1780 Kettner Blvd.
San Diego, Calif., FR 7665

M. H. BALDWIN
2804 East Hawthorne
Tucson, Arizona, Ph.: 2804-J

EAST INSULATING PRODUCTS
634 South Western Ave.
Los Angeles 5, Calif., FI 1118

**CONSOLIDATED ROOFING
& SUPPLY CO.**
520 S. 7th Ave.
Phoenix, Arizona, Ph.: 47888

CONTINENTAL LUMBER CO.
P. O. Box 2042
Boise, Idaho, Phone: 450

CRAIG & PULLEN
338 Ward St.
Hondolulu, T. H., Phone: 6107

CRAMER COMPANY
1224 I Street
Sacramento, Calif., Ph.: 28991

CRAMER COMPANY
345 Vermont St.
San Francisco, Calif., MA 1-0411

CRAMER COMPANY
1933 Merced St.
Fresno, Calif., Phone: 3-1131

DALE TILE CO.
1020 LaSalle Ave.
Minneapolis 2, Minn., 8R 8831

ELLIOTT BAY LUMBER CO.
600 W. Spokane St.
Seattle, Washington, EL 8080

LUMBER DEALERS
T. A. Box 5222
Denver, Colorado, TA 6141

LUMBER DEALERS, INC.
423 N. 33rd
Billings, Mont., Phone: 3911

MANSUR MATERIALS INC.
E-210 Riverside Ave.
Spokane, Washington, MA 1249

UTAH PIONEER CORP.
333 W. 1st South
Salt Lake City 14, U., Ph.: 4-1717

WARREN SALES CO.
1211 East McDowell
Phoenix, Ariz., Phone: 3-8975



**ONLY SIMPSON
ACOUSTICAL TILE GIVES ALL
THESE PLUS VALUES**

- Higher Sound Absorption
- Hollokore Drilled Perforations
- Finished Bevels
- High Light Reflection
- Smart New Finish
- High Heat Insulation
- Moderate Cost
- Ease of Application
- Pentachlorophenol Protection
- Low Maintenance Cost

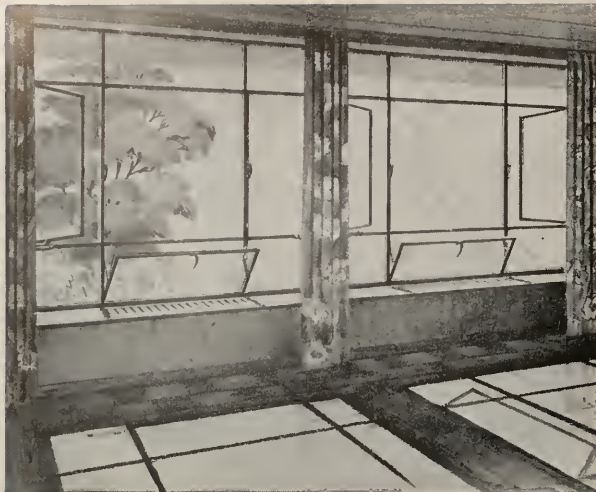

Fencraft Combination Window

WINDOW BENEFITS

that create client satisfaction

Windows can be merely "holes" in the wall . . . or *planned* elements that provide better ventilation, finer appearance and better daylighting—windows that create lasting client satisfaction.

Fencraft Combination Windows provide these benefits . . . and more:

FRESH AIR VENTILATION—hopper sill vent deflects air upward, provides protection from drafts; sheds rain or snow outside. Swing vents deflect breezes into the room when fuller ventilation is desired.

EASY OPERATION—simple to open, close or lock—with one hand.

DISTINCTIVE APPEARANCE—high-quality workmanship, plus excellent hardware.

SAFER—hopper vent prevents leaning out windows; important for children.

SAFER SCREENING—all screens attached or removed from inside the room.

. . . and **LOWER COST**—from standardization which results in manufacturing and installation economies.

That isn't the whole story, by far. For full information on the Fenestra family of Standardized Fencraft Windows, mail the coupon.



FENCRAFT PROJECTED WINDOW

—protection from weather, even when open. Open-out vent acts as canopy over opening. Open-in vent deflects air upward, sheds water outside.



FENCRAFT CASEMENT WINDOW

—safe washing—from inside. Easy to operate. Interchangeable screens, protected from outside dirt. "Hamey" appearance makes them ideal for clubs, large homes, dormitories, and nurses' homes.

Fenestra

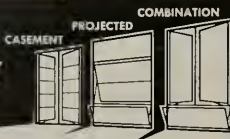

FENCRAFT INTERMEDIATE STEEL WINDOWS

Detroit Steel Products Company,
Dept. AE-9
1310 63rd Street
Emeryville 8 (Oakland), California

Please send me data on types and sizes of the new Fenecraft family of Fenestra Windows:

Name

Company

Address

NEWS AND COMMENT ON ART

SAN FRANCISCO ART COMMISSION

Under charter provisions, approval by the San Francisco Art Commission is mandatory for all buildings on City property, with the exception of that under State control and of the museums. Such approval is not usually sought until after all other boards and commissions have passed on the project. This procedure can be very wasteful of time and effort on the part of the project architect, as the Art Commission may reject a design after the working drawings are complete. It may even be that the whole project is invalidated by some future operation of another agency known only by the Commission, such as a State highway through a building site.

Architects are strongly urged to submit preliminary sketches to the Art Commission just as soon as they are in a presentable stage. Any suggested changes can then be incorporated in the design before it has progressed to a point where they would be impossible to include without spoiling the whole conception.

If the architects understood and followed this course of action it might prove unnecessary to ask for a charter change at the present time. Otherwise this may be necessary in order to give the Commission power enough to fulfil its proper purpose. The Architects Committee of the Art Commission has requested all City departments to submit their projects in the very early stages, and are ready to act as consultants in planning the programs, thus saving conflict with projects of other departments. They have the backing of the Mayor in this proceeding and are receiving strong support from Howard Zellerbach, president of the Art Commission.

ARCHITECTURAL AWARD WON BY UNIVERSITY STUDENT

The annual judging of the Kenneth M. Murchison award, a nation-wide competition sponsored by the Beaux-Arts Institute of Design, was held recently at the University of Illinois' Navy Pier branch in Chicago.

The jury of 26 prominent architects from the Chicago area chose the design submitted by Richard Nevara, a 19-year-old architecture student at the U. of I.'s Navy Pier school, as the first prize winner. Second place went to Marvin Goody, a sophomore at the University of Pennsylvania.

The designs judged had been assigned to archi-

ture students throughout the country as part of their regular class work. The specifications called for the design of a small bank in a town of 60,000 population. The design included a simple plan, a front elevation, and an interior perspective.

More than 500 drawings were entered in the competition. The jurors were in session from 10:30 a.m. Saturday to 6 p.m. that afternoon. They chose a first place winner, a second place winner, four first mention place winners, 11 first mentions, and 129 mentions.

Nevara, the first prize winner, titled his design, "A Small Bank in Arizona." The judges termed his design as one "equally adaptable for any type of climate."

Among the colleges and groups with entries receiving awards of mention or above were the University of Pennsylvania; Layton School of Art, Milwaukee; University of Notre Dame; Western Reserve University, Cleveland; Oklahoma A & M; University of Illinois, Urbana and Navy Pier, and the T-Square Club, Philadelphia.

The display of small bank designs was exhibited to more than 100 bankers in the Chicago area at a preview showing. The bankers generally agreed with the jury of architects in the award of the prize winning designs.

Following the viewing of the designs by the bank representatives the display was opened to the public. More than 300 visitors, among them many architects, visited the showing at the Navy Pier school.

Otto Teegen, chairman of the board of trustees of the Beaux-Arts Institute, came from New York to direct the judging. Professor H. B. McEldowney, head of the department of architecture at the Chicago Undergraduate Division, was in charge of arrangements.

Other prominent architects on the jury included Roy T. Christiansen, Ernest Grunfeld, Jr., Harmon N. Goldstone, Sigurd E. Naess, Howard L. Cheney, Lawrence B. Perkins, and Charles Rummel, who authored the program.

EXHIBIT BUILDING. Younger & Hallsteen, San Francisco, contractors have been awarded a \$133,979 contract for the construction of a one-story 100 x 160-foot reinforced concrete and steel exhibit building for the Butte County Fair at Gridley (California). Raymond R. Franceschi, Sacramento, is the Architect.

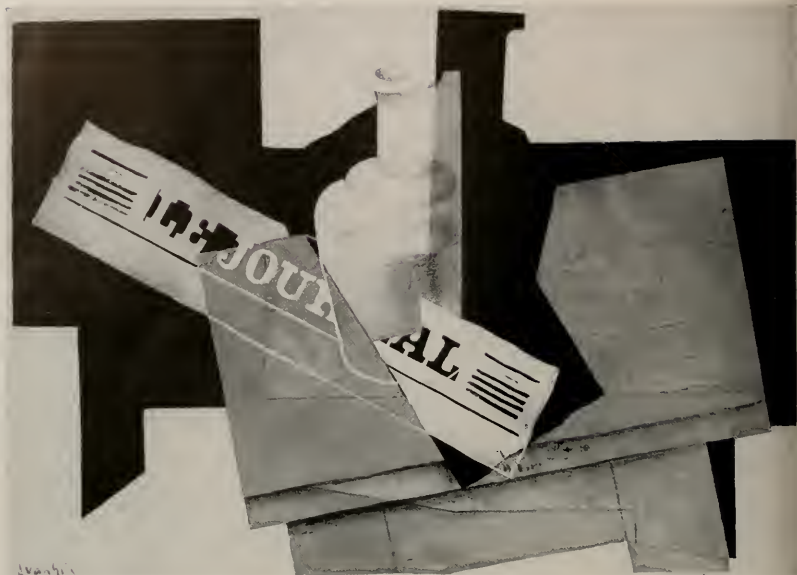

JUAN GRIS, *Le Journal*, 1916

The SPANISH MASTERS of 20th CENTURY PAINTING

PABLO PICASSO

JUAN GRIS

JOAN MIRO

By ROBERT M. CHURCH

Assistant Curator, San Francisco Museum of Art

This first large-scale exhibition to be organized since the war by the San Francisco Museum of Art includes approximately twenty-one paintings

by each of these three great contemporaries.

Gathered from private and public collections from all corners of the United States, the paintings

shown have been carefully chosen in order that they offer as representative a selection from the work of each artist as is possible.

Pablo Picasso, who has often been described as the most significant of living painters, certainly requires no special introduction to the gallery visiting public. His works are now considered among those classics in contemporary art which have been viewed and reviewed by everyone interested in this specialized field. The group of his paintings includes pictures from the very early "STREET SCENE," 1900, through the "NATURE MORTE AU GRUYERE," 1944 and the "INTERIEUR FEMME ASSISE ET NU DEBOUT," 1944. A fine "HARLEQUIN" painted in 1918 is in this collection, and "WOMAN IN YELLOW," 1907 from the period in the artist's development when careful study of African Negro sculpture had a pronounced influence on his work. The "STILL LIFE WITH GUITAR AND STARS," 1924 was painted among a series of large and magnificently colored still-life

compositions produced between 1924 and 1926, all of them more-or-less in the Cubist tradition. Perhaps the best known painting by Picasso in this exhibition is the 1906 "PORTRAIT OF GERTRUDE STEIN," for which she sat eighty times, only to have the face painted out at the end of this time (it was painted in by the artist from memory some months later). Picasso has said of his own paintings, "There is no abstract art. You must always start with something. Afterward you can remove all traces of reality. There's no danger then, anyway, because the idea of the object will have left an indelible mark. It is what started the artist off, excited his ideas, and stirred up his emotions. Ideas and emotions in the end will be prisoners in his work."

Juan Gris, whose production covered a shorter period of time, is represented by works from a "STILL LIFE" painted in 1911, through two paintings, "PIPE AND OPEN BOOK" and "STAND WITH RED CLOTH," both finished in 1926, the year before his death. Certainly one of the most important

JOAN MIRO Catalan Landscape (The Hunter) 1923-24

Oil On Canvas Collection Museum of Modern Art,

New York City, New York



Harlequin, 1918
OIL by Picasso



Collection of Joseph Pulitzer, Jr.

protagonists of the Cubist movement, Gris was an artist who devoted himself to the ideas of cubism and in so doing "added to the stock of emblem by which man recognizes the outer world a set of noble, simple, intense forms." Gris' entire production covered no longer than seventeen years. Since his death his considerable importance in the Cubist movement has increased with the resulting careful study of his finished creations. The serene clear statement made by his paintings is clearly evident in this comprehensive group of works. Gertrude Stein in her "Life and Death of Juan Gris" summed up his life's work from her own very personal point of view when she writes "Therein Juan Gris is not everything but more than anything. He made that thing. He made the thing. He made a thing to be measured. Four years of partly illness much perfection and rejoicing beauty and perfection and then at the end there came a definite creation of something. This is what is to be measured. He made something that is to be measured. And that is that something."

Juan Miro's clear color, simple forms, patterns, symbols, and never failing humor have interested the art public, ever since his 1925 exhibition at Galerie Pierre, Paris. In all of his paintings Miro has been called essentially Catalan—a kind of fantastic visionary. Though his colors are not all the sombre colors of the great Spanish masters of the post-Renaissance, El Greco, Zurbaran, Velazquez and Goya, they nonetheless reflect the brilliance of Catalonian folk life and art. The earlier paintings in this particular exhibition are "NUDE WITH MIRROR" and "LANDSCAPE WITH OLIVE TREES" of 1919. In these pictures Miro first realized his need to refine and personalize his expression from the powerful influence of Van Gogh, and the Fauve and Cubist movements. Also in these earlier paintings we begin to see already the attempt, not to break away from, but to synthesize pictorial expression with extra-pictorial suggestion in order to develop a new basic element on which to build his conception of contemporary painting. A whole series of experiments from 1911 through 1945 are included in this exhibition in an attempt to trace this unique artist's progress toward his ideal "the picture which would be rich in suggestion without employing a distracting realism" (from "Miro" by James Johnson Sweeney). The latest pictures "WOMAN IN THE NIGHT," 1944, "WOMEN AND BIRDS IN THE NIGHT," 1945, and "WOMAN AT SUNRISE," 1946, perhaps come closest to this ideal. There is a great wealth of material suggesting realistic shapes, but new simplified forms based on suggestion rather than

(See Page 46)



JOHN W. MALONEY, A.I.A. Architect

New Central Washington Tuberculosis Hospital

Among major construction projects of the Pacific Northwest is the new \$2,000,000 Central Washington Tuberculosis Hospital which is now nearing completion at Selah, Washington.

Of newest design and incorporating many latest developments in materials, the building will provide for some 150 beds which are to be available for the treatment of tuberculosis patients from the surrounding counties of Grant, Kittitas, Klickitat, Benton, Franklin and Yakima.

The hospital is a five story and basement, steel and concrete structure, and while construction was started last year in November, it is estimated

by the hospital management that the project will not be completed until late next Spring, probably May or June.

According to John W. Maloney, Seattle, Architect, plans for the building include the newest in hospital facilities and equipment as well as convenience design to meet the requirements of hospital management and convenience of patients.

Foundations have been installed which will permit the construction of additional floors to the hospital when and if they are needed at some future time.

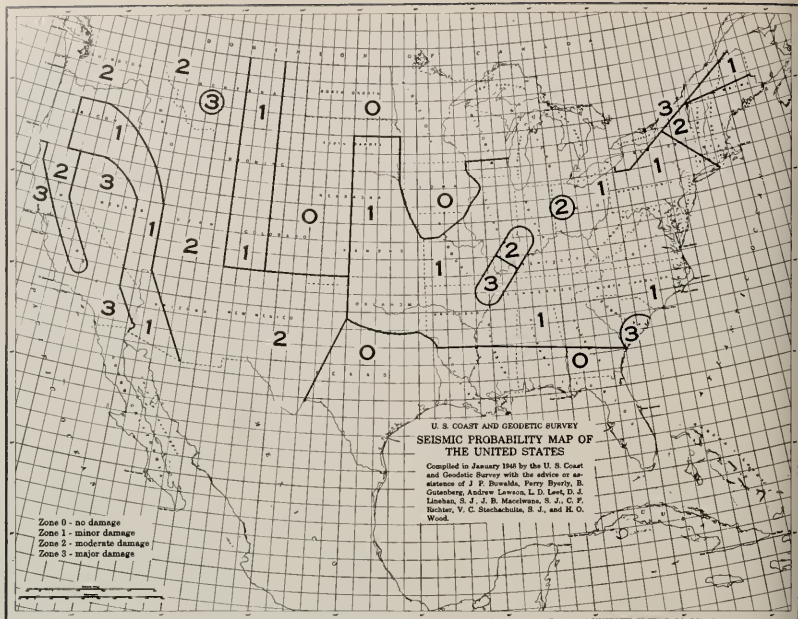

THE SEISMIC PROBABILITY MAP OF THE UNITED STATES

By **FRANKLIN P. ULRICH**

In working up a seismic probability map, it is necessary to adopt some general criteria. A compilation of records shows that between 70 and 80 per cent of earthquakes occur in the same general regions, although not necessarily at the same epicenters where previous earthquakes have occurred and that these regions are generally within fairly well-defined zones or belts. Hence, a picture of what has taken place in a region in the past is probably the best forecast of what to expect in the future. It should be realized that such a picture

will not be uniform. Parts of the country have been thickly settled over a period of hundreds of years, whereas other parts are sparsely settled and, in some cases, for only a relatively short period. The present network of seismological stations combined with additional stations under construction or proposed and the intensive earthquake information programs now being carried out will assure adequate earthquake information for seismic probability maps in the future. As additional and more nearly uniform information becomes available, it will no doubt be necessary to revise such seismic maps.

In preparing the present seismic map, the latest available earthquake distribution map of the United States was used in fixing the probability

(See Page 41)

* Excerpts from article, "Zones of Earthquake Probability in the United States," by Franklin P. Ulrich, Chief, Seismological Field Survey, USCGS, March 1948 *Building Standards Monthly*.

LONGER LIFE

BETTER HEALTH OF WORKERS IN THE BUILDING INDUSTRIES

RECENT HEALTH FIGURES FROM BRICK MASONS TO ROOFERS

By DR. W. SCHWEISHEIMER

In the fabulous good olden times—so the story goes—people were better, were healthier and lived longer. It is easy to tell those things though it would be hard to prove them. To give an example: It is hard either to prove or to refute the statement that Methuselah has reached an old age of a thousand years—or Noah of six hundred years,—or Moses only 120 years.

As soon as we are able to check such statements, the view is changed. Statistical figures give clear evidence that the average human life is longer today than at any time of history—and further extension of life can be expected in the future.

Special Figures for Roofers

Recent studies by Louis I. Dublin and Robert J. Vane of the Metropolitan Life Insurance Company have shown remarkable differences in the death rate (mortality) from certain diseases in different occupations. There are special figures for roofers and slaters contained in those tables, and they give some interesting information.

The figure for principal disease of heart, blood-vessels and kidneys are 95 per cent for roofers and slaters when compared with the average figure of 100 among all occupied males, ages 15 to 64 years. This is a little better than the average. Still better is the figure for organic diseases of the heart with 87 per cent. Figures for cancer are somewhat above average,—but we cannot do anything with this figure since both cause and development of cancer are still a mystery in medicine. One

figure which shows a decidedly higher percentage than the average is that of accidents which is 217 per cent—or more than double the average. This figure surely is connected with occupational hazards of roofers and slaters.

Figures for Builders and Building Contractors

Striking in the figures for builders and building contractors in the Metropolitan Life study is the low figure for tuberculosis of the lungs with only 72 per cent of the average. Higher than average is the figure for pneumonia which is 125 per cent. The figure for principal diseases of heart, blood vessels and kidneys are 105 per cent, about the average. Organic diseases of the heart are 96 per cent, while the figure for cerebral hemorrhage and apoplexy is comparatively higher with 132 per cent. The figure for cancer is very low,—but nothing can be done with that figure for the reasons mentioned. The figure for accidents of builders and building contractors is 171 per cent, rather high.

In this connection, the figure for accidents of building wreckers with 296 per cent may be mentioned. This shows a very high occupational hazard though it does not reach the highest accident figure of different occupations: that of electric light and power linemen with an index of 374 per cent.

Figures for Brick and Stone Masons

Most of the statistical figures for brick and stone masons are better than the average. The principal diseases of heart, blood vessels and kidneys are 88 per cent of the average,—and the figure for

(See Page 31)

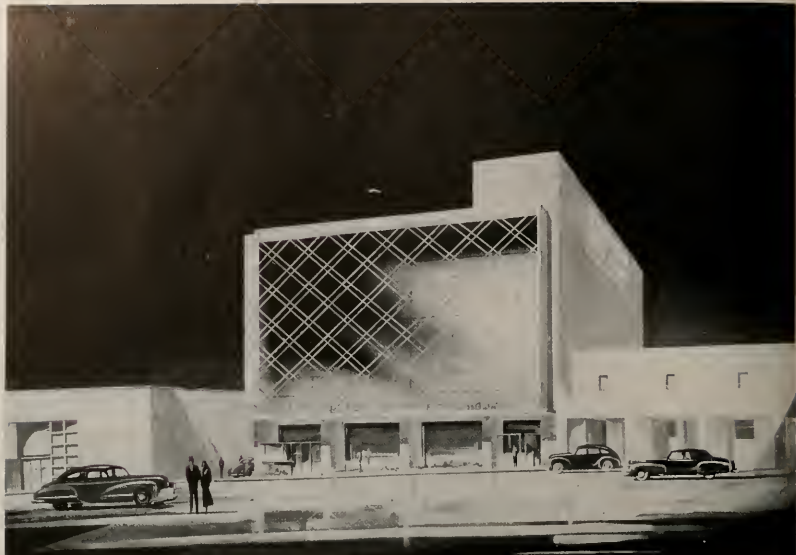

Stiles Clements Associated, Architects & Engineers

NEW METROPOLITAN FEDERAL SAVINGS and LOAN ASSOCIATION

—Los Angeles, California

By LEONARD E. MILLER

The Metropolitan Federal Savings and Loan Association of Los Angeles, since its organization thirteen years ago, has grown from original assets of \$26,000 to over \$12,000,000 today. As an inevitable corollary of this phenomenal growth, their original offices in the heart of the Los Angeles financial district have become increasingly inadequate. Not only did they need more room, but the traffic problem in the congested Spring Street district has provided increasing inconvenience to their customers. It was decided to construct a home of their own.

The new location chosen was on Wilshire Boulevard near Figueroa, a section still in down-town Los Angeles, yet eight blocks from the old financial district. But the new location offered many definite advantages. It lay in the direction of the present growth of the Los Angeles business district. There is at present considerable new construction in the immediate neighborhood. The new General Petroleum building—a modern limit height building occupying a solid half block, is a stone's throw away. The proposed new Statler Hotel will be just around the corner. Another financial insti-

tution is building five blocks away.

In designing the new home office, some definite problems were presented to the architect, Stiles Clements Associated Architects and Engineers; and the contractor, the Gunther and Shirley Company, both of Los Angeles.

The main complication was the comparatively small size of the lot, as the property measured only 76½ by 57 feet. This made it imperative to develop a design which would have the appearance of greater size. The building had to be distinctive enough to avoid being overlooked among the many large buildings surrounding it. Yet this distinction could not be attained through extreme novelty in design. The home office of a financial institution may be modern, but it must also be dignified. It dare not suggest a departure from that conservation which is essential to the banking business.

The Stiles Clements organization successfully negotiated this narrow channel between the Scylla of dignity at the cost of distinction, and the Charybdis of distinction at the cost of dignity. Clean modern lines, and the most modern construction methods and materials were used. The outstanding features are the solid glass front, set in steel sash extending from the marquee to the top floor, and the front design. This front design is a large grille, 18 inches in front of the glass area, made of double rows of extruded aluminum tubing in a diamond pattern. This gives the effect of greater size.

The four story and basement building is of reinforced concrete, with provision for future addition of another two stories. The exterior of the building will be concrete and gunite with a painted plaster finish. A thin gunite projection forms a frame for the large north window on the Wilshire Boulevard front, which extends from the

DETAILS OF ENTRANCE — Looking Towards Street



marquee to the fourth floor.

The engineering department of Stiles Clements has developed a structural system using a modified flat slab and wide, shallow beams. This permits the installation of air conditioning ducts without increasing the over-all floor to floor height. This construction, combined with the use of gunite filler walls, has resulted in unusually fast progress, with an estimated completion time of eight months.

The interior of the building is designed for the ultimate in comfort for the occupant. All ceilings are acoustically treated, and the entire space is air-conditioned, including the basement. There is abundant daylight and artificial lighting. A total area of 23,000 square feet gives plenty of room for future expansion as well as rentable office area on the upper floors, which have been left

undivided for tenant layouts.

Mechanical equipment is either in the basement or on the roof. One passenger elevator has been provided to handle present requirements, and space has been allowed to add another elevator when the building is extended to six stories.

Starting with large areas of plate glass to provide an open feeling, and setting them off with Arizona flagstone and extensive planting areas to get away from a "store front" look, the architects have designed an unusual setting and interior for the owner-occupied first floor and mezzanine. The underside of the marquee flows through the glass front and becomes the ceiling inside. Even the counters which seem to "flow" in an informal manner have been designed around the owner's requirements and activities. The lighting has been

ENTRANCE-WAY INTO BUILDING





INTERIOR OFFICE in Relation to Street

given special thought. Fluorescent cove lighting provides the general illumination, while recessed spot lights furnish additional foot candles where required over desks and work areas. The counters are raised on runners, allowing the carpet to go straight through from wall to wall.

The main lobby has Terrazzo floor, marble and plaster walls, and cove lighting. The directors room on the first floor is paneled with flush birch plywood, and has cove lighting.

Because of the small size of the property, parking space is provided a short distance away from the building.

Underpinning of the two adjoining buildings was found to be necessary. This was done by setting up a boring machine next to the old building, and drilling a series of circular holes down to the depth of the underpinning. The holes were then squared up to the foundation, and gunite underpinning put in.

MEMORIAL HOSPITAL. The New England Construction Company of Paso Robles have been awarded a \$464,900 contract for the construction of a 25-bed Memorial Hospital in Paso Robles. Robert Stanton of Pebble Beach is the Architect.

HOSPITAL ADDITION. Barret & Hilp, San Francisco contractors, have been awarded a \$637,982 contract for the construction of an X-ray and laboratory building for the Peralta Hospital in Oakland. D. D. Stone & Lou Mulloy, San Francisco, are the Architects.

PUBLIC LIBRARY. Parker, Steffans & Pearce, San Francisco, contractors have been awarded a \$517,850 contract for the construction of a new Public Library building in Richmond (California). The City of Richmond is the owner.

POLICE STATION. Jos. Bettancourt, San Bruno, has been awarded a general contract for the construction of a \$134,535 Police Station in South San Francisco (California). W. H. Rowe, San Francisco, is the Architect.

CALIFORNIA COUNCIL OF ARCHITECTS

YOSEMITE PARK —PROGRAM—

Sunday, September 26

10:30—Registration starts for members, delegates and guests.

At Registration Desk.

12:30—Informal Luncheon.

2:00—Get settled and acquainted.
Sightseeing.

Souvenir photos of couples.

6:00—Cocktail Party.

7:00—Informal Dinner.

9:00—Fire Fall from Glacier Point.

All registration and room assignments for both Ahwahnee and Camp Curry will be in the Entrance Lobby of the Ahwahnee.

Sign-up for sports and games and conducted tours of the Park.

Ahwahnee Dining Room. All meals will be served here for both Camp Curry and Ahwahnee guests.

Conducted tours around the floor of the Park or to Glacier Point, or you can roam or drive around by yourself as you prefer.

Be sure to have a picture taken of yourself and wife on the Terrace of the Ahwahnee.

On the Lounge Terrace of the Ahwahnee. Your Host—the California Council of Architects.

Greetings by Andrew T. Hass, President, California Council of Architects.
Entertainment.

Viewed from Entrance Terrace of the Ahwahnee. An unforgettable sight—a waterfall of fire dropping from 3200 feet above the hotel.

TWENTY-FIRST ANNUAL STATE CONVENTION

SEPTEMBER 26 - 27 - 28

PROGRAM — Continued

9:10—Outdoor Colored Movies.

On lawn of Entrance Terrace.

Monday, September 27

Ahwahnee Dining Room.

8:45—Breakfast—AIA Chapter Officers and
Council Delegates.

9:45—Opening Session. California Council of
Architects.

Foyer Lounge (next to Entrance Lobby). Andrew
T. Hass, President, California Council of Archi-
tects, presiding.

Meeting of Women's Architectural
League.

Tudor Lounge (Mezzanine at end of Main Lounge).
Mrs. Bolton White, President, Women's League of
San Francisco, presiding. All women guests are
cordially invited.

Report by Committee of Governmental
Relations.

Al C. Martin, Chairman. A progress report on the
proposed changes to the Architect's Practice Act.

10:00—Report by Liaison Committee to the State
Department of Public Works.

Albert J. Evers, Chairman. A progress report on
the Committee's efforts to obtain State work for
the Architects.

10:15—Report by Committee on Architectural Fees.

George B. Allison, Chairman. A progress report
on suggested changes and additions to the fee
schedules.

10:30—Seminar on Office Practice and Architects'
Legal Liabilities.

Walter C. See, Chairman. Designed for a free
exchange of ideas on how to improve the operation
of your office.

12:00—Adjourn.

12:05—Group Picture.

Entrance Terrace of the Ahwahnee. Everyone present, including ladies and guests.

12:15—Luncheon.

Ahwahnee Dining Room. Walter R. Hagedohm, Chairman Public Relations Committee, presiding.

Guests Speakers:

Mr. Edmund R. Purves, Washington, D. C., Director Public and Professional Relations for the AIA.

Mr. Robert J. McAndrews, Los Angeles, of Young & Rubican Advertising Agency on "Your Personal Public Relations."

2:00—School House Seminar.

Foyer Lounge. John L. Reid, Chairman. An informal discussion of School House planning problems. Report on School House Contracts.

Sports and Games.

Golfing at the Ahwahnee
Horseback Riding
Tennis
Croquet
Badminton
Horseshoes
Bicycling
Fishing

Or just plain loafing.
Archery
Checkers
Ping-Pong
Bridge
Gin Rummy
Hikes
Tours

5:00—Fashion Style Show Tea.

Entrance Terrace. Presented by the Lanz Dress Shops of San Francisco and Los Angeles. Men are invited.

6:00—Cocktails.

El Dorado Bar on the Mezzanine, or your own private parties.

7:00—Dinner.

Ahwahnee Dining Room. Informal. Dinner dresses Optional. Remarks by Glenn Stanton, Portland, Oregon, New National Vice President, AIA.

9:00—Fire Fall.

Entrance of the Ahwahnee.

9:15—Dancing.

In the Solarium of the Ahwahnee at end of Main Lounge.

Tuesday, September 28

9:45—Business Session.

Foyer Lounge. Adrian J. Wilson, Vice President, California Council of Architects, presiding.

Reports by Ways and Means Committee.

Vincent Palmer, Chairman. A progress report on Committee's work.

10:00—Discussion on California Housing Initiative Bill and the New Federal Housing Bill.

John S. Bolles, Moderator.

10:45—Discussion: Conflict of requirements of the Uniform Building Code, the State Housing Act and the State Fire Marshal's Codes.

Earl T. Heitschmidt, former Regional Director, AIA, and representative of the Los Angeles Chamber of Commerce to Sacramento.

11:00—"Building Trends In the West."

Remarks by Charlie H. Salyers, AIA, new chief of California State Division of Housing.
Thomas J. Holden, New York, President, F. W. Dodge Corporation.

11:30—Resolutions.

Resolutions should be presented in writing to the Resolutions Committee before 6:00 p.m., September 27.

12:00—Luncheon.

Sponsored by the Women's Architectural League, Mrs. Chester H. Treichel, presiding.
Guest Speaker: Mrs. Arthur C. Maurahan, Decorator, on "Don't Throw Out the Baby with the Bath Water."

2:00—Finals in sports and games events.

Look over the array of prizes on display and then go out and fight like ——!
Golf tournament at Wawona Hotel's 9-hole course and also at the Ahwahnee's tricky pitch and putt course. Take your pick.

6:00—Cocktails.

You know where you want to go by now.

7:30—Sportsmen's Dinner.

Sponsored by the Producers' Council. This one is really going to be different. Prizes and surprises.

Wednesday, September 29

9:00—Farewell Breakfast.

Ahwahnee Dining Room.

**AN INVITATION
TO THE ARCHITECT'S WIFE**

This letter is to urge you and your husband to make a special effort to attend the Convention this September 26th, 27th and 28th at the Ahwahnee in Yosemite.

The program is planned so that you will get the most out of the short stay in Yosemite Valley. The Convention Committees have planned many events for the women, including a fashion show, bridge party, cocktail parties and a dinner dance.

Our League, composed of the wives of architects, will hold a meeting Monday morning, and you are especially invited to attend. Tuesday we will sponsor a luncheon with the men.

Other activities include golfing, horseback riding, bicycling, badminton, swimming, hiking, and sight-seeing tours. If you are not sports-minded, perhaps breakfast in bed and complete relaxation will appeal to you.

Yosemite, always beautiful, is at its best in Autumn. The vacation crowds are gone, the air has an exhilarating tang, and the coloring is magnificent.

All in all, we expect to have a wonderful three days, and we sincerely hope you and your husband will be with us.

The Women's Architectural League.

CONVENTION NOTES

Registration Fee—\$15.00.

Wives attending with husbands will be included in single registration fee.

Hotel Rates and Registration Fee will include all meals, banquets, dancing, Sunday night cocktail party and Souvenir Photographs of all couples.

Dress

Informal dress is the thing at Yosemite. Women may wear dinner dresses at the Monday night dinner and dance if they wish. Men are requested to wear coat and tie at dinners—not required at breakfast or lunch.

Tipping

Instead of tipping at each meal, it has been gen-

erally agreed that 10% of the daily meal charge—75c—will be added to each guest's hotel bill.

Taxi Service

Between Camp Curry and the Ahwahnee—25c. Call telephone operator.

Business Sessions & Seminars

All members, guests and ladies are invited to attend.

Hotel Rates

At the Ahwahnee—\$14.00 per day, each.

At Camp Curry—\$10.50 per day, each.

Rates are on the American plan and include all meals at the Ahwahnee.

ARCHITECTS EXHIBIT

See Cover Illustration

The exhibit commanding the most attention at the recent Marin Art & Garden Show was designed and constructed by a group of Marin County Architects and Landscape Architects. The exhibit was sponsored in the name of the Northern California Chapter of the A.I.A. and the Landscape Architects Association, with the financial underwriting left entirely to the Marin Architects and the contributing contractors.

The exhibit received first prize at the show.

The group undertaking the "selling" of Architecture and Landscape Architecture to the thousands who saw the Marin Art & Garden Show were Architect Frederick Mann, Chairman, Landscape Architect Robert Royston, Co-Chairman, and Architects John Bolles, Eugene Crawford, William Van Fleet, Don Works and George Hill. The exhibit was built by Barrett & Hilp, General Contractors, with painting by J. H. Mohr, Inc., electric work by

Cimino Electric Company, and plants by Pacific Nurseries. Haydite Products furnished and erected the Haydite block wall and paving, while McNear Brick Company contributed the Haydite gravel for the terrace.

The exhibit was designed as an outdoor living area with a background mural painting by Jose Moya del Pino. Peter Bolles, the eleven year old son of Architect John Bolles, contributed the sculpture for the pool. Furnishings were supplied by "Moderntrend" of San Rafael.

The individuals who have devoted so much of their time and money to the success of the Architects' exhibits at the recent Oakland, San Francisco and Marin shows should be praised for their work, for it is this type of exhibit that brings Architecture to the home building public. The American Institute of Architects' Chapters should enlarge upon this phase of their activities.

AMERICAN SOCIETY OF TOOL ENGINEERS

Kenneth T. Norris, President of the Norris Stamping and Manufacturing Company of Los Angeles, will be the featured speaker at the banquet of the Semi-Annual Convention of the American Society of Tool Engineers scheduled to be held in Los Angeles October 11 to 13.

Norris will speak on the subject "Western Industrial Problems", with movie-actor Edward Arnold acting as toastmaster of the banquet program.

The banquet will climax the three-day Semi-Annual Convention program. Built around the theme of "Progress on the Pacific", the meeting will feature technical sessions and tours of industrial plants in the Los Angeles area.

The technical session scheduled for Monday night, October 11, will feature Hall L. Hibbard, Vice President and Chief Engineer, Lockheed Aircraft Corporation. He will discuss aircraft development and jet propulsion in a talk entitled "Adventures in Space."

The Tuesday night session will consider "The Petroleum Industry--Tooling and Refining" with six leaders of the industry discussing various phases of the business.

The schedule of tours includes: October 11—All-day tour of Lincoln-Mercury Assembly Plant, Ford Motor Company, Los Angeles Harbor Area and Signal Hill; Afternoon tour—United States Steel Products Co., American Can Co. October 12—All-day trip to Kaiser Co., Inc., Steel Plant, Fontana; Afternoon tours—U. S. Electric Motors, Inc.; Firestone Tire and Rubber Co., Southgate Plant; American Can Co.; United States Steel Products Co. October 13—All-day tour of motion picture lots and beach area. Afternoon tours—Aluminum Company of America; Vernon Works; Owens-Illinois Glass Co.; U. S. Electrical Motors, Inc.

FACTORY AND OFFICE BUILDING. The Adhesive Products, Inc., Albany (California) have let a contract for the construction of a \$250,000 factory and office building. Wm. Horsmeyer, San Francisco, is the contractor.

MEXICAN COMMUNITY CENTER. Sacramento (California) will build a \$23,000 Mexican Community Center. Contract has been awarded to Fred W. Clark, same city; Leonard F. Starks, Architect.

CITY STREETS and MODERN TRANSPORTATION

By **CARL J. RUTLAND**

**Chairman, Citizens Traffic Commission
Dallas County, Dallas, Texas**

The theme of the panel on city streets and modern transportation held in conjunction with this year's Businessmen's Conference on Urban Problems in Detroit might well have been taken from the address of Jay D. Runkle, chairman of the board, National Retail Dry Goods Association, made at last year's Conference in Washington.

He issued a strong challenge for action to effectuate some of the projects which had been discussed and well clarified as to feasibility. Shouldn't we recognize by now that it is not a question of a lack of knowledge, but a lack of determination to take known and proven steps which will alleviate many of our street traffic problems and foster better transportation?

Our downtown areas were never planned for today's or tomorrow's concentration of motor vehicle traffic. It is too late and far too expensive to even dream of major changes to make conditions ideal. There is no need to procrastinate, hoping that some major plan or major action will do the job. At that, no one big project would ever achieve results. But many small and large improvements in specific areas will produce great benefits. We might as well recognize that fact and go to work.

The downtown physical pattern has changed very little, but more and more we continue to pour vehicles and people into the area. It is already taxed far beyond its street capacity. It bulges like a Toonerville trolley. As it nears the bursting stage, it becomes too irritating to blast one's way through, too exasperating to find a place to park, and some-

times too inconvenient to visit it by some uncomfortable mass transportation units. Then what would you do? You wouldn't go downtown.

Business concerns want PEOPLE to come into the downtown area, not particularly vehicles. Vehicles are merely the means to the end. People—shoppers—employees—traders—they are the lifeblood of downtown business. Only people make business. That's the reason chain stores make a careful statistical survey of people passing given locations before they select a site. Without people, downtown business could not survive, but those same people must be freed from intolerable delay and irritation, else business will suffer.

Develop Better Mass Transportation

Mass transportation systems now carry approximately 60 per cent of all those who daily go into and out of the downtown area. They do it with only 10 per cent as much street space as would be utilized if the same number went by private car (if that were physically possible). A 50 passenger bus does the work of 29 automobiles. Better service would attract still more shopping persons. Our transit systems should carry at least 75 per cent of those who are habitues of the downtown area. This increase would have a tremendous effect in further alleviating congestion. Mass transportation is definitely a common denominator to every kind of street traffic. Improve its service and carrying capacity, and it benefits every person and every vehicle which uses the street and every agency which depends upon street traffic. Unquestionably

every downtown business establishment has a vital economic interest in the efficiency of the public transit system. Many of the employees and customers of that business depend entirely upon it for transportation. Good transit service aids materially in preventing reductions in downtown real estate values. It actually means more to retailers than providing expensive parking space for their patrons, although the latter is essential.

Any downtown business loses or profits in almost direct proportion to the passenger carrying capacity of the transit system. However, very few such business interests initiate ideas and purposefully meet with transit management to cooperate in obtaining improved types of services. Few retailers, in their contract advertising, tell of transit conveniences and urge patronage. Very few publicly take the leadership in urging and supporting increased fares where necessary to achieve faster, safer, and more adequate capacity service. Even the city has a very definite economic interest because good transit service is a definite factor in maintaining taxable values in the downtown area. But the city very seldom manifests such interest by appropriate action of one kind or another. Failure to expand and modernize service in many instances may be charged to the indifference of some city governing bodies and public utility commissions. They refuse to grant satisfactory rates whereby services may be improved which will reduce traffic congestion and bring more people into the downtown area. The result: some cities are taking over the transit lines. The taxpayers are saddled with additional burden. Service is still not improved and traffic becomes more stagnated.

Moving thousands of vehicles and people daily with safety and dispatch is a science, not guesswork. Yet in many cities a traffic signal is installed because a neighbor suggested it to a councilman. Certain traffic favors are granted to one business executive simply because, apparently, it is good politics. The merchant, the mayor, the civic leader, the businessman; not one of these is a competent traffic authority. They, as well as hundreds of other citizens have theoretical ideas as to what should be done. Of course they are sincere, but they don't know all sides to the problem. No plan or long range list of individual objectives with reasons therefore, has ever been presented to them or to the community as a whole, so they continue to theorize, guess, and criticize.

A competent Traffic Engineering Department, on a level with public works, water, and health, is essential in any city over 75,000 population. Admittedly there is a scarcity of traffic engineers, but why shouldn't a city pick one of its best engineers and send him off to a national training school for a period? Such an engineer can then do a good

job, prepare good plans, and prevent recurring wasteful expenditures previously made by theorizing and guessing at what should be done in traffic.

Through a special committee or a permanent traffic organization, the merchants, the press, and other business interests can persuade the City Council to set up such a department. The head of that department will later need that same public support in carrying out his recommendations.

Many Plans Now Available

No single plan will serve all communities, although many patterns have already been set, and formulas have been developed. Some of these fit the exact needs of some communities. They include designated "through" streets, reversible traffic flow, staggered hours, off-street parking, truck re-routing, parking prohibitions, parking meters, one-way streets, channelization, progressive signal systems, loading and unloading restrictions, mass transportation services, street widening, turning prohibitions, and enforcement of regulations. There are ample publications from authoritative sources, and manuals to be used as a guide. The needed push to achieve is not there.

The needed well-planned traffic project, or product, is meritorious. The merchant, the motorist, the shopper, the public official, and all citizens are the buyers of that product. They are literally hungry for it and clamor for it daily. But there is no seller for this product. There is no organization to package, advertise, sell, and deliver the product. According to a recent Gallup poll, 31 per cent of the people in the cities in the 100,000 to 500,000 population bracket are concerned about traffic more than housing (18%), corrupt politics (11%), blight and sanitation (10%), drinking (7%), and not enough jobs (7%). In cities above 500,000, traffic still rated 31 per cent with only housing above it with 37 per cent.

In substantially all of our larger cities the capacity of streets and the transit system to handle traffic is far exceeded during a relatively short period of time in the morning and again in the late afternoon. This is simply due to the fact that too many working people report for and leave their work at practically the same hours of the day. The afternoon peak generally is higher due to the shopper load superimposed upon that of the workers. The application of a simple plan of staggering the reporting and leaving time of workers by industry groups, including retail stores, can materially reduce harmful congestion on the streets.

Obviously, it will take teamwork and an influencing organization to develop, promote and sell whatever project may be determined upon. No one businessman, public official or civic leader can or will do it alone. It is too huge a task and too nebulous. He fears harmful opposition. He may

tread on a customer's toes. Politics may be involved. But some kind of a community organization—perhaps called a Downtown Traffic Committee—is absolutely essential. It could front for many of these projects and put them across. Sometimes there is resentment to the city's doing the job, regardless of its merit. Composing the organization would be one or more representatives from retailers, wholesalers, motor fleet lines, chamber of commerce, the press, certain city authorities, mass transportation, real estate board, downtown property owners, parking station groups, taxicab interests. All of these have a direct economic interest. Properly organized, this group could accomplish almost anything it desires. It also can prevent unnecessary expenditures that might otherwise ensue from political pressure upon the City Administration. Some funds will be necessary but only for an executive secretary with a very small staff for promotional purposes only. It is not always necessary to consume months of time and spend large sums of money conducting widespread research and printing a long report on the merits of certain projects. That's not the organization's job anyhow. The City Traffic Engineering Department and Public Utilities supervisor should conduct such research and furnish technical data. The organization furnishes the push, promotes the project and sells it to the community. This year's Conference might well be the spring board for its members to call together a few civic and business leaders, and develop such an organization. In my opinion two very important projects could be immediately undertaken by such an organization.

1. A system of staggered working hours for a select list of downtown business groups. This costs no money but definitely spreads the peak periods.
2. A study of mass transportation needs and a meeting with its officials to help bring about improved service.

These are some of the important questions which the members of the panel on City Streets and Modern Transportation will try to clarify. Losses to the nation's business due to the inadequacy of these facilities are reaching huge sums each year. The expert opinion of panel members should shed a great deal of light on what some communities are doing to rectify this insufficiency which has reached a point of definite crisis in most of our communities.

U. S. C. COLLEGE OF ARCHITECTURE STUDENTS DESIGN MODEL CITY

Citizens in communities near Los Angeles are being given an idea of how their cities could look in the future by senior students of the College of Architecture at the University of Southern California.

With proper planning and the use of engineering and architectural techniques already at their disposal, citizens are being shown the current practices employed by modern planning commission offices in the larger cities of America. It is a matter of planning the redevelopment of cities, especially those wherein the blight has already appeared. Legislation has been adopted in many states, including California, providing for this type of rebuilding.

The remodeling, suggested by student plans, presumes that the city is constantly in the process of building, although the ideas presented may not be realized for some 50-75 years. The proposals are at hand at least when the time comes to conform to some plan which will assure better urban living facilities.

Typical is the 33 by 44-foot scale model of the city of Long Beach, presented to its citizens in co-operation with the Junior Chamber of Commerce, city officials and civic leaders. The plan was recently presented at a banquet, attended by 300 officials and business executives.

Features of the project include a downtown shopping area with the principal streets completely closed to vehicular traffic yet providing parking areas close to stores and buildings. Mass transit facilities within two blocks of the business district are arranged. The project reduces the 113 acres of paved street areas in the business district to 45 acres by closely integrating the street and automobile parking lot systems. Areas thus saved provide additional pedestrian ways, building sites and for special features in making possible a more attractive community.

Long Beach is divided into areas for hotels, hospitals, industrial zones and neighborhood living units with schools, playgrounds and local shopping facilities all designed to serve the people with the greatest convenience and the least traffic hazards.

The eight S.C. seniors who devised the program spent a year in working out its provisions. They first worked with the local planning department in Long Beach. They studied zoning maps and accumulated data on health, juvenile delinquency, population density, assessed evaluations etc.

A similar program was developed for Santa Monica with nine students being responsible for the replanning of an area between Ballona Creek and Santa Monica Canyon. A 28-foot detailed relief map made to scale provided freeways, areas for public buildings and for new communities for both resort and permanent residential areas. The plan will be presented to members of the Los Angeles County Planning Congress at a meeting in Santa Monica on August 12. Students will

(See Opposite Page)

TILED—for Lasting Beauty



AT THE DUFFY TILE SHOW ROOMS in San Francisco may be seen this beautiful neo angle showers enclosure, finished in real clay tile of sparkling freshness. Color scheme, burgundy and salmon pink.

meet with the congress to explain their program.

"It is not our intention to sell these communities a plan", said Dean Arthur B. Gallion of the U.S.C. College of Architecture. "We hope to interest people, not merely experts, in learning what sort of a city can be obtained by using the principles and techniques of planning."

Both the Long Beach and Santa Monica projects were under the direction of Simon Eisner, planning department who is also an instructor at S.C.

In previous semesters the cities of Santa Ana, Santa Anita and the central portion of downtown Los Angeles were also studied by the embryo architects under the direction of other local professional men.

Not only are the S. C. students making their own theoretical training practical but they are providing Southern California communities with an opportunity to see themselves in the distant future as revealed through the imaginative minds of citizens who may someday help their dreams come true.

SPONSORED BY FOUNDATION

Creation of a Council to carry out studies and experimental research in reinforced concrete, under sponsorship of the Engineering Foundation, and to interpret the results in the form of a code for the design of concrete structures, has been announced by Dr. A. B. Kinzel, chairman of the Foundation's board. It is anticipated that such a code may permit the use of reinforced concrete in longer span structures than now considered possible and should eliminate much of the uncertainty in design.

The research will be undertaken with approval of The American Society of Civil Engineers, one of the four engineering societies that established the Foundation. It is one of two new projects receiving support from the Foundation this year.

In working with concrete, Dr. Kinzel pointed out, the engineer is dealing with a material in which deformation is not proportional to the stress. In the past, concrete and steel have been combined and the design was based on the incorrect assumption that the strain in the concrete is, as in steel, pro-

portional to the stress.

The Committee on Masonry and Reinforced Concrete, of the American Society of Civil Engineers, has been studying reinforced concrete for several years, Dr. Kinzel explained. This Committee concluded that carefully planned laboratory tests are necessary as a guide to further study and recommended to the Engineering Foundation that the entire theory of reinforced concrete be studied critically with a view to evolving a workable scientific theory for the design of concrete structures.

"Until recently the methods used for the design of reinforced concrete were essentially empirical," Dr. Kinzel continued. "On the basis of results obtained from an extensive set of tests conducted by the University of Illinois and Lehigh University, rational procedures have been established for the design of centrally loaded reinforced concrete columns. These tests demonstrated the inadequacy of the old theory."

Two investigations have been recommended by the A.S.C.E. committee for immediate consideration by the Council.

The first is to be carried on at Ohio State University. Its purpose is to determine the shape of the stress block in reinforced concrete in the compression zone by means of photoelastic methods. This proposed study is a continuation of pilot tests which have already been made at the University.

The second investigation is to be conducted by Professor Richart and associates at the University of Illinois. It will be concerned with reinforced concrete members subject to combined bending and direct stress. It is proposed to build and test 126 eccentrically loaded specimens with varying eccentricity ratios, varying percentages of steel, and for three different strengths of concrete.

The Council on Research in Reinforced Concrete is composed of authorities in the field and representatives from interested organizations. They are: Robert Blanks, Director of Research, Bureau of Reclamation, Denver, Colo., chairman; Professor Jewell M. Garrelts, Columbia University, secretary; Professor Clyde T. Morris, Ohio State University; Professor Frank E. Richart, University of Illinois; F. R. Smith, chairman of the Committee on Manonry, American Railway Engineering Association; Raymond Archibald, chairman, Bridge Specification Committee, American Association of State Highway Officials; Albert E. Cummings, research engineer, Raymond Concrete Pile Company; Arthur J. Boase, Portland Cement Association; and Harold D. Jolly, chairman, Engineering Practice Committee, Reinforcing Steel Institute.

FOR BETTER SERVICE
Remember that
KRAFTILE is
WESTERN HEADQUARTERS
FOR

- ▶ ACID Brick
- ▶ ACID-PROOF Jointing Compounds
- ▶ ACID-PROOF Floor and Tank Construction
- ▶ ACID-PROOF Coatings
- ▶ LIGHTWEIGHT CONCRETE BLOCKS
- ▶ GLAZED Structural Wall Units
- ▶ PATIO Tile
- ▶ QUARRY Tile
- ▶ SWIMMING POOL Overflow Gutter



- ▶ QUONSFT Packaged Steel Buildings
- ▶ STRAN-STEEL Framing

For complete information and prompt service, phone or write

KRAFTILE COMPANY

NILES, CALIFORNIA NILES 3611
SAN FRANCISCO 5: 50 Hawthorne St.—DOUGLAS 2-3780
LOS ANGELES 13: 406 South Main Street—MUTUAL 7241

LONGER LIFE BETTER HEALTH OF WORKERS IN THE BUILDING INDUSTRY

(From Page 15)

organic diseases of the heart is the same. The figure for diseases of the kidneys is very low with 67 per cent, that for cerebral hemorrhage and apoplexy is 95 per cent. The figure for tuberculosis of the lungs is 107 per cent—a little higher than the average—while the figure for pneumonia is a little lower, 94 per cent. Among brick and stone masons too the figure for accidents is higher than the average, 137 per cent, though it is decidedly lower than that of roofers and building contractors.

People Live Longer Today Than Ever

Roofers, builders and other workers in the building industries today get older than 66 years of life on the average. Since the beginning of history the average length of life has steadily increased—even if we should assume that some single persons have reached a high "biblical" age in antiquity. Yet, further progress is still possible. Within the course of the next ten or twenty years, extension of the average length of life to at least 70 years should well be possible.

In the past century the health figures of workers in the building industry were much worse. We do not have many reliable statistical figures of that period, but we have figures of the death rate of roofers in England during the years 1890 to 1892. When we put the average death rate of all men between 25 and 65 years of age at that time at 100, that of roofers was 132—nearly one third above the average. Better was the figure for masons which, with 100, was just the average.

Causes of Better Health and Longer Life

The main reasons why roofers, builders, masons and other workers in the building industry live longer today and enjoy better health, are the same as those for the general population: remarkable improvements in the hygiene of everyday living and better working conditions for the average worker. The housing situation though bad at present in many countries after the War, is incomparably better for the average person anywhere than it was during the Middle Ages or even half a century ago.

Food is better and more plentiful today, and better nutrition has strengthened the general resistance of many people against disease of any kind. The danger of epidemic outbreaks can be limited in most cases. Progress in medicine and surgery is of advantage to every age group. The use of insulin—discovered in 1921-22—has given longer life and full working efficiency to innumerable diabetics who previously had felt like in-

valids. The diabetic roofer or builder who has had his daily injection of insulin—administered by himself—is as efficient as any normal man, in every way.

Better protective laws take care of the health of the working man, they prevent child labor which had many victims in former times. Poisonous materials are eliminated from all producing processes—and where this cannot be done entirely, extraordinary precautions are prescribed for protection of those who handle such materials.

There is more understanding for occupational diseases and for the connection of the health of working people with the actual level of production. Conditions are not 100% perfect everywhere—as can be seen from the high accident figures in the building industry—but they are decidedly better than at the beginning of the century.

Matters stand particularly better for the older group of roofers and builders and masons—and this is the more important since the older age group forms a steadily rising percentage in every occupational group. We are developing to a "nation of elders". People not only live longer today, they stay longer young and capable of work as well. Statistical experts see good reason that the death rate of the older age groups will improve still further in the coming decades, and death will be



Colorful porcelain-enameled iron sheets are economically produced... simply and quickly installed... produce a distinctive, permanent, lightweight veneer for every type of building exterior. They are adaptable for interior application, too.

★ **WRITE TODAY** for complete information and literature



- ★ **VENEER** ★ **PANELS**
- ★ **FLASHED - PANELS**
- ★ **SPECIAL SHAPES**

ARCHITECTURAL PORCELAIN CONSTRUCTORS
2827 UNION STREET • OAKLAND 8, CALIFORNIA
TELEPHONE TWINGAKS 3-5154

HEATFORM

The Superior Heat Circulating Fireplace

Before you recommend a heat circulating fireplace be sure you have complete information on the HEATFORM

- THE MOST EFFICIENT AND DURABLE OF ALL
- Comparison proves HEATFORM has these advantages:

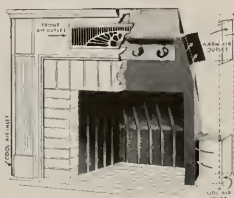

Front view with part of masonry cut away.

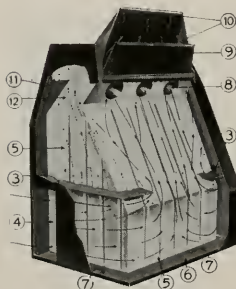

Rear and side view — with part of outer metal lining cut away showing the inside lining of firebox. Arrows showing contact and flow of air to and over all heating surfaces.

For complete information see
SWEET'S Catalog Section
29-G-8

The HEATFORM proved by 27 years of use in homes all over America and advertised in nationally circulated magazines.

SUPERIOR FIREPLACE COMPANY

East of Mississippi River

West of Mississippi River

401-M North Point Road
Baltimore, Maryland

1707-C East 15th Street
Los Angeles 21, Calif.

also manufacturers of form dampers, fuel grotes, ash dumps, cleanout doors and drape screens.

postponed.

The eminent value of older men in every occupational group has been shown in some recent publications in the medical press. In Canada Dr. Lydia G. Giberson has stated that in industry the skilled worker on the average is well beyond his 40th year of age—and he is all important to production. Dr. Carlson, in a report to the Congress on Industrial Health in Chicago, has drawn the conclusion that by forced idleness of the increasing army of older men in our midst we are forging a dangerously weak link in that large part of society whose experience, wisdom and relative unselfishness could guide those with less experience and wisdom.

FAR WEST CONFERENCE ON CHURCH ARCHITECTURE

Through the cooperation of the Northern California-Western Nevada Council of Churches, representing some twenty-five denominations and a tentative construction program of more than \$700 million, the East Bay Chapter and the Northern California Chapter of the A.I.A., and the Interdenominational Bureau of Architecture have arranged an all-day conference on Church architecture to be held at the First Congregational Church in Berkeley on Monday, October 11th.

Practical suggestions, including the problem of exterior design, will be discussed by churchmen and architects, with a special exhibit of church design being prepared.

Similar conferences will be held in the First Methodist Church in Sacramento, October 12; a Fresno on October 13th, and in the First Congregational Church at Los Angeles on October 15th.

The Interdenominational Bureau of Architecture is located in New York City.

NEW OFFICES OPENED

The L. D. Reeder Company of Sacramento, California, have announced the completion of their new offices and sales building at 3026 "V" Street in Sacramento.

Other offices of the firm are located in San Diego, San Francisco, Los Angeles, Fresno, Seattle, and Portland.

NEW BOWLING ALLEY

A contract has been awarded to Wilfred H. May of Belmont (California) for the construction of a 12-alley Bowling Alley Building in Redwood City at a cost of \$100,000.

The building of one story construction will be of reinforced concrete and structural steel, corcrete blocks design. Wallace A. Stephen of Burlingame is the Architect.



Arizona Chapter:
James Macmillan, President; Arthur T. Brown, Secretary, 740 N. Country Club Road, Tucson, Arizona.

Central Valley of California:
Frank V. Mayo, President; John W. Bomberger, Vice-President; Ivan C. Scatterlee, Treasurer; William Koblik, Secretary, 2203 13th St., Sacramento, California.

Central Coast Counties Chapter:
Bryce M. Clark, President; Lisle Fred Richards, Secretary-Treasurer; Thomas E. Elston, Jr., Chester Rod and Henry Morgan Stedman, Directors, Office, 411 Lafayette Street, San Jose.

Colorado Chapter:
Raymond H. Ervin, President; James M. Hunter, Secretary, 2049 Broadway, Boulder, Colorado.

East Bay Chapter:
A. Lewis Kous, President; James H. Anderson, Vice-President; Loy Chamberlain, Secretary; Chester H. Treichel, Treasurer, Office, 3533 Piedmont Ave., Berkeley, California.

Montana Chapter:
Ralph H. Cushing, President; H. C. Cheever, Secretary, Montana State College, Bozeman, Montana.

Northern California Chapter:
Wm. Clement Ambrose, President; Lester W. Hurd, Vice-President; Ralph N. Pollack, Secretary; Donald Beach Kirby, Treasurer; Office 369 Pine Street, San Francisco.

Oregon Chapter:
Frank Roehr, President; Sidney W. Little, Vice-President; J. Holman Baines, Secretary; Don Edmondson, Treasurer, Office 519 Builders Exchange Bldg., Portland 4, Oregon.

San Diego Chapter:
H. Louis Bodmer, President; Louis I. Gill, Secretary, 203 Grainger Building, San Diego, California.

Santa Barbara Chapter (California):
Wings Soule, President; Ralph Armitage, Vice-President; Robert Ingle Hoyt, Secretary; Lulah M. Riggs, Treasurer; Office 116 E. Solá St., Santa Barbara, California.

CALIFORNIA COUNCIL OF ARCHITECTS
Andrew T. Hass, President; Adrian Wilson, Vice-President; Malcolm Reynolds, Secretary-Treasurer; Office 369 Pine Street, San Francisco.

Southern California Chapter:
George Allison, President; A. C. Martin, Jr., Vice-President; Anthony Thermin, Secretary; George E. Gable, Treasurer; Chapter Headquarters, 3757 Wilshire Blvd., Los Angeles 5, California.

Spokane Chapter (Washington):
Noel E. Thomson, President; Kenneth D. Stormont, Secretary, Hutton Building, Spokane, Washington.

Utah Chapter:
George Cannon Young, President; Theodore R. Pope, Secretary, 29 South State Street, Salt Lake City 1, Utah.

Washington State Chapter:
Waldo B. Christenson, President; Perry B. Johanson, 1st Vice-President; John G. Richards, 2nd Vice-President; Hugo W. Osterman, Treasurer; and Bliss Moore, Jr., Secretary. Offices 714 American Building, Seattle 4, Washington.

Tacoma Society:
Chas. Rueger, President; Clarence Rueger, Vice-President; W. W. Durham, Secretary-Treasurer.

Hawaii Chapter:
Kenneth W. Roehrig, President; James Morrison, Secretary, 334 Federal Bldg., Honolulu, T. H.

WASHINGTON STATE CHAPTER

Honor Awards to craftsmen, a report on the A.I.A. Convention in Salt Lake City, and an illustrated talk by John Paul Jones on his travels to Brazil and other parts of South America, featured the September meeting of the Chapter, held at the Engineers Club in Seattle.

The Exhibits Committee reported opportunities for the Architects to exhibit at the Puyallup Fair, and the Puget Sound Industry & Labor Exposition. Jack Morse is Chairman of the Committee.

The Board of Directors reaffirmed the appointment of the Chairman of the Building Industry Contact Committee as a liaison representative with the Seattle Construction Council.

The first postwar display of the last word in Building Materials will be held under the auspices of the Producers Council on October 21st at the New Washington Hotel.

Secretary Bliss Moore, Jr., has been appointed a member of the King County Planning Commission, while Lister Holmes is now Chairman of the Seattle City Planning Commission. Clyde Grainger, former Chairman, is also a member of the Commission.

Chapter delegates attending the Institute Convention in Salt Lake City, included Waldo B. Christenson, Robert L. Durham, Arthur P. Herrman, Paul H. Kirk, Higo W. Osterman, F. Marshall

Smith, Frant Stanton, and Honorary delegate Charles H. Alden.

NEW MEMBERS: Tenny F. Bellemey, ASSO-

(See Page 37)

PREVENT FIRES AND EXPLOSIONS
Caused by **EARTHQUAKES!**



Plus a Manual Control For Other Emergencies!

Indispensable in live seismic regions.
Recommended for use with Liquefied Petroleum Gases.
Thousands installed in the United States.
List of installations available on request.
Available at leading wholesale plumbing establishments.
Indorsed by National Bd. of Fire Underwriters.
Leading Fire Prevention Engineers Approve.

Take No Chances ... Install The
SENTINEL
AUTOMATIC GAS SHUT-OFF VALVE

Designed to shut off automatically when there's an earth shock or explosion sufficient to damage buildings or pipe lines. Listed by the Underwriters' Laboratories and specified by leading architects and engineers for installation in schools, fire stations, factories, theaters, churches, stores, municipal, military and utility buildings. A. I. A. File No. 29-F-6
Write for illustrated folder.

SECURITY VALVE CO.
410 San Fernando Rd., Los Angeles 31, California
Phone CAphol 6191

WITH THE ENGINEERS

Structural Engineers Association of Northern California

John A. Blume, President; Jesse Rosenwald, Vice President; Franklin P. Ulrich, Treas.; Geo. E. Solnar, Jr., Sec., Office, Room 215, 55 New Montgomery St., San Francisco 5, Phone SUtter 1-7642. DIRECTORS, A. W. Anderson, Henry I. Degenkolb, John E. Rinne, Robert D. Dewell, and Wm. W. Moore.

San Francisco Section

L. A. Elsener, President; A. W. Earl and G. B. Woodruff, Vice-Presidents; John E. Rinne, Secretary-Treasurer; 225 Bush Street, San Francisco 20.

Structural Engineers Association of Southern California

Steve Barnes, President; Harry W. Bolin, Vice President; Lewis K. Osborn, Sec-Treas. DIRECTORS, Richard W. Ware, Geo. E. Brandow, L. T. Evans, Harold P. King, and Donald F. Shugart. Office: 202 Architects Bldg., Los Angeles 13, Calif.

Puget Sound Engineering Council (Washington)

R. E. Kister, A. I. E. E., Chairman; E. R. McMillan, A. S. C. E., Vice Chairman; L. B. Cooper, A. S. M. E., Secretary; A. E. Nicholson, I. E. S., Treasurer; Offices, L. B. Cooper, c/o University of Washington, Seattle 5, Washington.

ANNUAL CONVENTION STRUCTURAL ENGINEERS ASSOCIATION—1948

Arrangements are being completed for holding of the 1948 Annual Convention of the Structural Engineers Association of California in Santa Barbara on October 21 to 24th, and according to Don Shugart, Convention Committee Chairman, a wide variety of technical and entertainment programs will be offered to delegates during the four days.

Among subjects tentatively scheduled for discussion are a symposium on Lightweight Concrete, and a plastic model method of structural analysis.

There will be a golf tournament and plenty of entertainment.

STRUCTURAL ENGINEERS ASSOCIATION OF NORTHERN CALIFORNIA

The September meeting was held in Oakland with Murray Erick, Structural Engineer, presenting a sound motion picture on the "Use of Lightweight Aggregates in Modern Construction." It was pointed out that further consideration of the subject will be given at the annual convention of the Structural Engineers Association which is to be held in Santa Barbara from October 21 to 24th. The motion picture, "Production of Vermiculite Light Weight Aggregate" was made available through the cooperation of the Vermiculite Research Institute.

John A. Blume, President, called attention to consideration of the possibilities of incorporating the group as a non-profit organization.

STRUCTURAL ENGINEERS ASSOCIATION, SOUTHERN CALIFORNIA

The Structural Engineers Association of Southern California held their Annual Field Day at the Rio Hondo Country Club on Wednesday, August 4th. Approximately 150 engineers and guests attended and enjoyed the various activities.

A golf tournament under the supervision of Harry Bolin attracted considerable attention, the low gross prize going to J. G. Middleton with a score of 78. Peter Horn won the low net with a score of 82. The blind bogey was won by Ralph De Line.

While the golfers were golfing, the baseball fans enjoyed an hilarious game of soft ball which was umpired by Sam Hobbs, Engineer for the Portland Cement Association. No one seemed to win the game but the umpire had a terrific workout. During the afternoon and early evening, the Tyrolienne orchestra entertained the group with music and songs.

During the evening an interesting and diversified



"ECON-O-MATIC" . . . is the automatic Stanley Door Hardware Set that makes lightweight plywood doors 100% practical for garages. Designed for doors weighing up to 150 lbs. Cost little more than old-style hardware. For smart appearance — faultless action — long service — specify Stanley. The Stanley Works, New Britain, Conn.

*Copyrighted

STANLEY

Reg. U. S. Pat. Off.



Simple to Install
Requires Only 2 1/4-in. headroom

HARDWARE · HAND TOOLS · ELECTRIC TOOLS

program was arranged by Chuck Corbit which was well received by the guests. The meeting was presided over by President Steve Barnes.

AMERICAN SOCIETY OF CIVIL ENGINEERS, SAN FRANCISCO SECTION

"Economic Policy and the Problem of Inflation" was the subject of a technical program recently presented by Dr. Frank Kidner, Director of the Bureau of Business and Economic Research and Associate Professor of Economics at the University of California.

Dr. Kidner, a noted authority on the subject, presented an examination of the monetary and fiscal causes of inflation and methods of controlling the price spiral.

* * *

California State Senator Thomas Maloney recently addressed the Junior Forum on the subject, "Inside Your State Government." A lively discussion followed.

* * *

Walter Dreyer, past-president of the Section, has been named by the National Security Resources Board to a special group who will study power problems of aluminum production.

* * *

MEMBERSHIP. The Section's membership has been increased by the following: J. S. Cotton, MEMBER; J. S. Johnson, Fred R. Henderson, and N. L. Hinkson, ASSOCIATE MEMBERS and Charles B. Lusk and Glenn G. Snider, JUNIORS.

NEW YORK UNIVERSITY OF ENGINEERING

Students registered for the Fall term at the New York University College of Engineering total more than 1594 as against a total of 1522 for last year, according to College officials.

The report shows the number of veterans entering as freshmen has decreased over a year ago. Numerous transfer students are entering the College from colleges which inaugurated two year pre-engineering curricula for veterans.

LIGHTING ENGINEER RESIGNS

Dr. Ward Harrison, international authority on lighting, and director of engineering for General Electric's Lamp Department at Nela Park, near Cleveland, Ohio, resigned his position recently after having served the General Electric Company for more than 39 years.

Dr. Harrison, whose retirement under pension provisions of the company, plans on continuing special assignments for the Lamp Division and will serve as consultant for several lighting companies.

Thoughtful builders plan for concealed telephone wiring

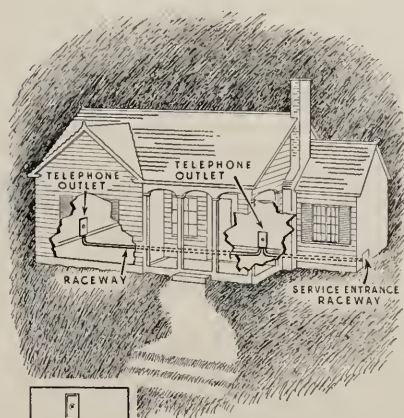

A house that's really modern these days has telephone conduit and outlets built-in while construction is going on. That way, with just a small outlay for tubing material, telephones can be moved or added later on...without drilling holes or running wire along baseboards.

Built-in telephone facilities are just one small detail of a soundly planned home... a detail that thoughtful builders remember and clients appreciate.



For free help in planning modern, built-in telephone wiring, call your local telephone company number and ask for "Architects and Builders Service."

The Pacific Telephone
and Telegraph Company



MODERN DEPENDABILITY

YOU assure modern dependability in drinking water facilities when you specify *HAWS Fountains*. Simple maintenance, lasting durability and complete sanitation means real client-satisfaction. And your recommendations are backed by the reputation of a company which has built superior drinking fountains since 1909. Write for complete information, today.

HAWS DRINKING FOUNTAINS

HAWS DRINKING FAUCET CO.
FOURTH and PAGE STREETS (Since 1909) BERKELEY 2, CALIFORNIA
Agents and Sales Representatives in All Principal Cities



He will continue his active interest in the Illuminating Engineering Society and other engineering society affairs.

ENGINEER NAMED FELLOW BY ILLUMINATING GROUP

Professor L. M. K. Boelter, Dean of the College of Engineering at the University of California at Los Angeles, has been named a Fellow of the Illuminating Engineering Society.

Boelter was chosen for this honor because of "leadership in the field of illuminating engineering."

ENGINEERS LECTURE FOR U. C. EXTENSION

Fourteen new appointees will be added to the teaching staff of the Department of Engineering, University Extension, University of California, according to Dr. L. M. K. Boelter, dean of the U. C. L. A. College of Engineering and head of engineering study for University Extension.

Appointed to conduct engineering courses for the adult education division of the University during the new fall semester which opens in mid-September are: Dr. Moses A. Greenfield, Dr. William E. Frye and Raymond T. Gabler of North American Aviation; Dr. George Brown and Charles Matthews of Douglas Aircraft; Johanna E. Allering and D. P. Krynine, U. C. L. A.; Edward Edison Manager, Television Service Shop; Chandler Ross, Chief Designer at Aerojet Engineering Corporation; Horace E. Wheeler of Long Beach Public Schools; Edward M. O'Connor, Chief Engineer of the city of Long Beach; Jack Gordon Elam, Geologist of Richfield Oil Company; J. P. Maxfield, Engineer Consultant; and Robert K. Harris, Project Manager of James I. Barnes Construction Company.

All will conduct specialized engineering classes during the fall Extension semester starting in mid-September. Courses will be held for the most part during evening hours at the downtown Los Angeles center, 813 South Hill Street, and at U. C. L. A. and other convenient classrooms. Class bulletins are available on request to the Hill Street center.

APPOINTED SALES MANAGER

Patrick G. Train has been appointed sales manager for the Architectural Porcelain Constructors according to a recent announcement from the firm executives offices in Oakland, California, manufacturers of allied products in architectural porcelain enamel for home and commercial use.

Train was formerly general sales manager of the Lorentzen Company, Oakland.

A.I.A. ACTIVITIES

(From Page 33)

CIATE: Kenneth L. Hargreaves and Warren A. Brown, JUNIOR ASSOCIATES; and George K. Zema, STUDENT ASSOCIATE. The membership now totals two hundred and twenty-three.

TACOMA ACTIVITIES

W. W. Durham has been appointed secretary of the Tacoma Planning Commission.

Plans are going forward for resumption of regular meetings, following the usual summer vacations.

SOUTHERN CALIFORNIA CHAPTER

The September meeting was devoted to subjects of mutual interest to Architects and Engineers and represented a joint session of the Chapter with the Southern California Division, Structural Engineers Association.

Speakers included Clarence J. Derrick, Commissioner of the Los Angeles Department of Public Works whose subject was "The New Look—Engineering or Architecture"; and Adrian Wilson and George Brandow reporting on the Progress of Discussions with the State Division of Architecture regarding their policy for Structural and Architectural services.

John Monning, Secretary to the Los Angeles City Board of Building and Safety Commissioners, discussed the Los Angeles City Building Code Revisions which are being proposed for adoption.

The recent Field Day, sponsored by the Producers Council, was a tremendous success and according to reports established a new high in camaradery.

The Legislative Committee has submitted a report on the Housing Initiative Constitutional Amendment which will be presented to the voters of California at the November General Election that it "feels that the measure will not accomplish the purpose for which it is intended and, therefore, feels the Chapter should oppose the Housing Initiative Constitutional Amendment."

Cassatt Griffin has been named Chairman of the annual Honor Awards program for 1949 and is busy organizing the exhibition and selecting a out-of-town jury.

Paul O. Davis, Education Committee Chairman, has arranged some excellent forum meetings for the future months.

"Bob" Alexander has been appointed President (See Page 45)

WHAT'S MISSING?

Look back at architectural plans for homes designed 20 years ago and you'll find them strangely deficient in facilities for electrical living.

Wired chiefly for lighting and a few small appliances, these homes lack circuits and power for today's expanded electrical needs.

The demand for new electrical servants is certain to increase even more in the next years ahead so that wiring systems not planned for extra load will soon be obsolete.

Be sure the homes you design stay modern electrically by specifying Certified Adequate Wiring—enough circuits of large enough wire and abundant outlets and switches to last a lifetime.



NORTHERN CALIFORNIA ELECTRICAL BUREAU

1355 Market Street, San Francisco 3

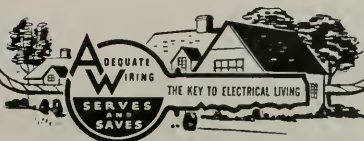

BAXCO

CHROMATED ZINC CHLORIDE

CZC

PRESSURE TREATED LUMBER

● **PROTECTS AGAINST DECAY
AND TERMITE ATTACK**

*Specify it in your home
Available through Lumber Dealers*

LOS ANGELES
601 W. 5th Street
Phone Michigan 6294

SAN FRANCISCO
333 Montgomery Street
Phone DOuglas 2-3883

J. H. Baxter & Co.

AGENTS FOR WEST COAST WOOD PRESERVING CO. SEATTLE, WASH.

QUALITY building material COSTS YOU LESS



E. K. WOOD LUMBER CO.

SAN FRANCISCO General Offices: No. 1 Drumm Street
LOS ANGELES Office and Yards: 4710 S. Alameda St. — JE 3111
OAKLAND Yards and Wharves: 2111 Frederick St. — KE 4-8466
PORTLAND Mill Sales Office: 827 Terminal Sales Bldg.

SAW MILLS: Roseburg, Oregon • Reedsport, Oregon

RETAIL YARDS: LOS ANGELES • OAKLAND • ONTARIO • HOLLYWOOD
LONG BEACH • RIVERSIDE • TEMPLE CITY • SIERRA MADRE • INDIRIO • THERMAL
LA VERNE • WHITTIER • PASADENA • SAN PEDRO

HEADLINE NEWS AND VIEWS

By E. H. W.

A total of 131,346 new dwelling units financed and built under the various programs of the Federal Housing Administration were placed under construction during the first five months of this year. This is nearly two and a quarter times the number of units started in the same period of 1947.

October 3rd-9th is Fire Prevention Week—Now is a good time to "check" on the prevention of fires.

It is estimated some 94,000 new dwellings were started in July of this year—about 13,000 more than were started in the same month a year ago—representing a most favorable market for the building materials industry.

National Home Week was observed September 5-11, with local groups and organizations emphasizing the importance of the American home. I was open house for the home builders and gave rise to much wishful thinking on the part of many embryo home owners.

"American businessmen, chamber of commerce secretaries, industrial plant managers and others likely to be approached have been alerted by U. S. Army Intelligence authorities against inquiries from the Soviet zone of eastern Germany."—Business in Action.

Income of San Francisco Bay Area in 1947 amounted to \$4½ billion dollars, an increase of \$400 million dollars over 1946.—San Francisco Chamber of Commerce.

"Progress of the Pacific" will be the theme of the Semi-Annual Convention of the American Society of Tool Engineers which is scheduled for October 11-13, in Los Angeles.

"So great has been the stream of new products and the improvement in materials and method that very few buildings could have been erected in accordance with today's specifications 25 years ago."—Construction Industry Information Committee.

More than 2,000 paint chemists are employed in the Paint Industry and the large companies budget hundreds of thousands of dollars annually in research for improvement in paints, lacquers, and varnishes.

IN THE NEWS

SWIMMING POOL

Technique & Yeomans of Vallejo (California) have been awarded a \$9,746 contract for the construction of a Swimming Pool and Dressing Room at the Vallejo Junior College. Harry J. Devine, Sacramento, is the Architect.

ARCHITECT SELECTED

Architects D. D. Stone & Lou Mayo of San Francisco have been selected to do the new Porter-Cochran (California) Hospital. Estimated cost \$500,000.

MAUSOLEUM

The Dinwiddie Construction Company of San Francisco have been awarded a \$432,000 contract for the construction of an addition to the Mt. View Cemetery Association's Mausoleum in Oakland. W. Day & H. M. Michelsen of San Francisco are the Architects.

NEW HOSPITAL

Voters of the Mark Twain Hospital District in San Andreas, Calaveras County (California) recently approved the issuance of \$350,000 bonds for the construction of a seventy-five bed General Hospital. Robert Stanton of Pebble Beach, is the Architect.

CTRICAL

The Collins Electrical Company of Stockton (California) have been awarded a \$73,888 contract for the installation of a electrical distribution system in the Stockton State Hospital at Stockton.

The work consists of underground duct lines, manholes, pull boxes, high and low voltage cables, and high and low voltage switch gear.

EDUCATION SET-BACK.

Voters of San Francisco recently rejected a \$87,000,000 bond issue for the construction of 35 new grammar schools.

STABLES

The Pacific Company of Oakland (California) have been awarded a \$115,000 contract for the construction of five stables at Golden Gate Fields (California). 210 stalls and 40 tack rooms are included in the project.



*Western
Headquarters*

FOR

CERTIFIED LIGHTING

The West's primary source of quality lighting equipment. The SMOOT-HOLMAN label is certification of dependable construction... your assurance of maximum performance with minimum maintenance cost.

SMOOT-HOLMAN COMPANY

INGLEWOOD, CALIFORNIA

Offices in principal western cities -
Branch and Warehouse in
San Francisco

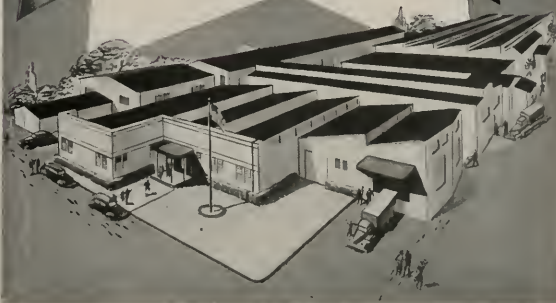

LANDSCAPE ARCHITECTURE

Notes of The Profession

ASSOCIATION OF LANDSCAPE ARCHITECTS, SAN FRANCISCO REGION
Emil L. Anderson, President; Vernon M. Dean, Vice-President; Ralph W. Jones,
Secretary; Paul M. Steinmetz, Recording Secretary; Prentiss French,
Treasurer. Directors at Large: Geraldine Knight Scott, Wayne
Gray, H. L. Vaughan and Douglas H. Baylis.

NEW YORK MUSEUM

The New York Chapter of the American Institute of Architects will sponsor an exhibition of "Tomorrow's World", Work, Play and Live, at the New York Museum of Science and Industry, R.C.A. Building, Rockefeller Center, to be held from October 1st to 29th, 1948, it has been announced by Eleanor Pepper, Chairman of the sub-committee on Exhibitions.

The theme exhibit will be a large panorama in three dimensions, approximately thirty feet in diameter, which will be located on the main floor of the museum and which will be designed by members of the Chapter and will portray the following:

The psychologists say that we are the product

of heredity and environment. There is very little that we can do about heredity, but there is much that can be done with environment. If we are to have better people in a better civilization, then environment can create that ideal. The creator of our environment is the architect. From the moment we are born until the last minutes of our life, we are living in a background created by the architects. A child is born in the hospital, grows up in the home, is taught in the schools; people seek their pleasures and cultural pursuits, as well as religious solace, in edifices built by the architect. The community in which we live is the product of the architect. The architect today is planning for a better community, for better homes, for better living. This theme exhibit will show the plans that today's architects have for "Tomorrow's World".

Outstanding industrial organizations in all allied fields will be invited to be represented in this exhibition by participating in the theme panorama and by their individual exhibits.



KAPCO MEMBRANE

Recent moisture permeability tests prove Kapco membrane surpasses felt duplex paper 8,500 to 1.

OTHER ADVANTAGES:

Economical

Maximum moisture seal with minimum thickness.

Durable

Eliminates puncturing of membrane—more rigid than paper.

Easy Application

Simply overlap joints and seal with cold trowel mastic cement.



W. J. BURKE & Co.

2690 Harrison St., San Francisco 10, Calif., VA 4-6811

2257 East 15th Street
Los Angeles 21, Calif. • 5416 14th Avenue N.W.
Seattle 7, Washington

KAPCO UNDERLAYMENT

Waterproof

... protects sub flooring.

Moisture Proof

... prevents destruction, buckling and racking of linoleum, rubber tile.

Cushionized

... easy to walk on.

Sound Deadening

... eliminates squeaks.

Fast Application

... easily cut with linoleum knife.

Reduces Labor Costs 50%

... Simply use stopping hammer.

Available from
W. J. Burke and
Co. on nominal
rental basis.



ENGINEERING COLLEGE HOST TO METALS GROUP

The College of Engineering at the University of California at Los Angeles was host to the American Institute of Mining and Metallurgical Engineers, Metals Group, for their first fall meeting in September.

The American Welding Society and the American Society for Metals were also in attendance.

Dean L. M. K. Boelter of U.C.L.A. was the principal speaker and spoke on "A Philosophy of Engineering," following which a conducted tour visiting the electron microscope, the differential analyzer, the gage laboratory, the metals processing laboratory and the cyclotron was made.

PAROCHIAL SCHOOL. Carl A. Swenson Company, San Jose, have been awarded a \$178,394 contract for the construction of a new eight-class room, kindergarten, cafeteria, office and clinic Parochial School in San Jose (California). H. A. Minton & Wilson Smith, San Francisco, are the Architects.

THE SEISMIC PROBABILITY MAP OF THE UNITED STATES — From Page 14

zones.

In deciding upon the number of seismic probability zones to use in this map, it has been customary in the past to use four. While a greater number of zones might occasionally appear desirable and probably could well be used at some future time when additional and more detailed information is available, the present number of four appears to fit very well into an almost natural classification of earthquake possibilities.

In general, zone O includes that area where there appears to be no reasonable probability of any earthquake damage and where earthquake intensity has not generally been greater than IV (the intensities refer to the Modified Mercalli Scale). Zone 1 is the area where the intensity has been V or VI at the maximum: where earthquake damage has been minor, an intensity normally below the point of any structural damage. As we have no positive assurance that, in the future, there will not be a greater earthquake in any region than we

have had in the past, any region which has felt an earthquake of intensity VI should, as a safety measure, provide for some earthquake protection. Zone 2 would include that area where moderate structural damage (intensities VII to VIII) has occurred frequently, or where greater damage (intensity IX or higher) might be expected at long intervals. Zone 3 includes that area where major destructive earthquakes have occurred in the past and might reasonably be expected at any future time.

If the above classification were rigorously followed, there would be endless differences of opinion over some of the zones and, particularly, over small regions or islands. The central Montana region is given as probability zone 3 because of two strong earthquakes in recent years (1925 and 1935) and a third moderately strong shock (November 1947) with many other smaller shocks. Islands of probability zone 3 are shown for the St. Louis and Charleston regions because of the

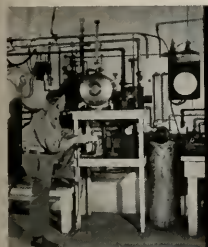

Continental...

*in continuous research to bring you
the latest scientific improvements in the
most space-saving gas water heaters...*

Illustrated: The Gladiator, one of our new complete line. **QUEEN SIZE** for beauty; **KING SIZE** for performance.

MUSHROOM BURNER is one of the improvements standard in most models. Gas ports drilled on the sides prevent clogging, put the pilot close to the door opening, and afford greater impact of gas into the heater.

CONDENSATION SUMP in the floor pan collects condensation moisture until the heat from the burner vaporizes it. This prevents any water drip to the floor. Our heaters are housebroken.

Continental

WATER HEATER COMPANY, LTD. 1801 Pasadena Avenue • Los Angeles 31, California



FORDERER CORNICE WORKS

Manufacturers of

Hollow Metal Products • Interior Metal Trim
Elevator Fronts and Cabs
Metal Plaster Accessories • Sanitary Metal Base
Flat and Roll Metal Screens
Metal Cabinets • Commercial Refrigerators

269 POTRERO AVE.

SAN FRANCISCO, CALIF.

HEMLOCK 4100

STRUCTURAL STEEL

For Class A Buildings,
Bridges, etc.

JUDSON PACIFIC - MURPHY CORP.

4300 EASTSHORE HIGHWAY
EMERYVILLE, CALIF.

VALUABLE NEWS SERVICE

- BUILDING MATERIAL DEALERS
- CONTRACTORS
- ENGINEERS
- FINANCIAL INSTITUTIONS

ARCHITECTS REPORTS gives advance news on construction projects in Northern California, lists: name of projects, location, architect, proposed cost and other pertinent information.

HANDY individual slip-reports, issued daily at a total cost of only

\$10 a month

ARCHITECT'S REPORTS

Published Daily

The ARCHITECT and ENGINEER, Inc.

68 Post Street, San Francisco - DO 8311

severity and destructiveness of shocks in these regions. Islands of probability zone 3 have also been suggested for the regions of Boston, Sonora (extending into Arizona) and for northern Utah but it is doubtful if the shocks in these regions reach the intensity of the Charleston and St. Louis shocks, and they have been left in the zone 2 regions. The separation between zones 2 and 3 cannot be determined as definitely as between the other zones.

It is very probable that no two persons would prepare identical seismic probability maps. Differences of opinion, as indicated in the preceding paragraph, may come from appraisals based on frequency of strong earthquakes as compared with very strong activity at infrequent intervals. Knowledge of geologic structure may lead to differences of opinion regarding regions which seismic history fails to indicate as active. At present there are not sufficient data available to prepare a general seismic probability map of the country based on surface geology. The zone limits shown on this map are based almost entirely on earthquake history and represent the general combined opinions of a number of scientists.

RE-ELECTED MANAGER LOS ANGELES HOUSING AUTHORITY

At the recent annual meeting of the Commissioners of the Los Angeles City Housing Authority, Nicola Giulii was re-elected to his eleventh term as Chairman of the Commission and Lloyd A. Mashburn was re-elected to his fifth term as Vice-chairman.

Giulii was chairman of the old Municipal Housing Commission from 1933 to 1938 and has held the chairmanship of the new commission since its organization in 1938. He has also served as president of the National Public Housing Conference.

Other members of the Commission include John E. Fishburn, Jr., Maurice Saeta, and George A. Beavers, Jr.

COLLEGE OF PACIFIC TO HOLD LUMBER MERCHANTS CONFERENCES

Announcement has been made by the College of the Pacific, Stockton, California, that they will again hold a series of conferences during the Fall term devoted to the Lumber Industry.

Sponsored by the Lumber Merchants Association, the thirty-day session will be devoted to discussions on lumber, various building materials and subjects allied to the Western building industry.

Among those scheduled to appear on the program is R. L. Hilton of the Roofing and Waterproofing Engineering Department of The Pacific Paraffine Companies, Inc. He will discuss roofing and asbestos cement siding.

ESTIMATOR'S GUIDE

BUILDING AND CONSTRUCTION MATERIALS

PRICES GIVEN ARE FIGURING PRICES AND ARE MADE UP FROM AVERAGE QUOTATIONS FURNISHED BY MATERIAL HOUSES TO SAN FRANCISCO CONTRACTORS. 2½% SALES TAX ON ALL MATERIALS BUT NOT LABOR

All prices and wages quoted are for San Francisco and the Bay District. There may be slight fluctuation of prices in the interior and southern part of the state. Freight cartage, at least, must be added in figuring country work.

BONDS—Performance or Performance plus Labor and Material Bond(s), \$10 per \$1000 on contract price, Labor & Material Bond(s) only, \$5.00 per \$1000 on contract price.

BRICKWORK—

Common Brick—Per 1M laid—\$100.00 up (according to class of work).
 Face Brick—Per 1M laid—\$200.00 and up (according to class of work).
 Brick Steps—\$3.00 and up.
 Common Brick Venear on Frame Bldgs.—Approx. \$1.20 and up—according to class of work.
 Face Brick Venear on Frame Bldgs.—Approx. \$2.00 and up (according to class of work).
 Common Brick—\$28.50 per M—truckload lots, delivered.
 Face Brick—\$60.00 to \$90.00 per M, truckload lots, delivered.
 Cartage—Approx. \$9.00 per M, Los Angeles County Area—Residential, up to 4-family or apt., metal raceways, \$6.50 per outlet.

BUILDING PAPER—

1 ply per 1000 ft. roll	\$5.30
2 ply per 1000 ft. roll	7.80
3 ply per 1000 ft. roll	9.70
Brownfin, Standard, 500 ft. roll	8.00
Sisalraft, reinforced, 500 ft. roll	7.00

BUILDING HARDWARE—

Sash cord com. No. 7	\$2.65 per 100 ft.
Sash cord com. No. 8	3.00 per 100 ft.
Sash cord spot No. 7	3.65 per 100 ft.
Sash cord spot No. 8	4.00 per 100 ft.
Sash weights, cast iron, \$100.00 ton.	
Nails, \$5.50 base.	

CONCRETE AGGREGATES—

The following prices net to Contractors unless otherwise shown. Carload lots only.

	Bunker per ton	Del'd per ton
Gravel, all sizes	\$2.44	\$2.75
Too Sand	2.38	3.13
Concrete Mix, ¼"	2.38	3.06
Crushed Rock, ¼" to ¾"	2.38	2.94

	Bunker per ton	Del'd per ton
Crushed Rock, ¾" to 1½"	\$2.38	\$3.13
Roofing Gravel	2.81	3.50
River Sand	2.50	3.06

Sand—
 Lepis (Nos. 2 & 4) 3.56 3.94
 Olympia (Nos. 1 & 2) 3.56 3.88

Cement—

Common (all brands, paper sacks), carload lots, \$3.02 per bbl. f.o.b. car; delivered \$3.60. Cash discount on carload lots, 10c a bbl., 10th Prov., less than carload lots \$4.00 per bbl. f.o.b. warehouse or delivered.
 Cash discount 2% on L.C.L.

Trinity White	{ 1 to 100 sacks, \$3.13 sack warehouse or del.; \$9.56 bbl. carload lots.
Medusa White	

DAMP-PROOFING and Waterproofing—

Two-coat work, \$8.00 per square.
 Membrane waterproofing—4 layers of saturated felt, \$9.00 per square
 Hot coating work, \$5.00 per square.
 Medusa Waterproofing, \$3.50 per lb. San Francisco Warehouse.
 Tricoceol waterproofing.
 (See representative.)

ELECTRIC WIRING—\$15 to \$20 per outlet for conduit work (including switches).

Knob and tube average \$6.00 per outlet. (Available only for priority work.)

ELEVATORS—

Prices vary according to capacity, speed and type. Consult elevator companies. Average cost of installing a slow speed automatic passenger elevator in small four story apartment building, including entrance doors, about \$8000.00.

EXCAVATION—

Sand, \$1.00; clay or shale, \$1.50 per yard. Trucks, \$30 to \$45 per day.

Above figures are an average without water. Steam shovel work in large quantities, less; hard material, such as rock, will run considerably more.

FIRE ESCAPES—

Ten-foot galvanized iron balcony, with stairs, \$250 installed on new buildings; \$300 on old buildings.

FLOORS—

Composition Floors, such as Magnesite, 50c per square foot.
 Linoflor—2 gages—\$3.00 per sq. yd.
 Mastipave—\$1.50 per sq. yd.
 Battleship Linoleum—available to Army and Navy only—¼"—\$3.50 sq. yd.
 ¾"—\$3.50 sq. yd.
 Terazzo Floors—\$1.50 per sq. ft.
 Terazzo Steps—\$2.50 per lin. ft.
 Mastic Wear Coat—according to type—20c to 35c.

Hardwood Flooring—

Standard Mill grades not available.
 Victory Oak—T & G
 ¾" x 2¼" \$252.00 per M, plus Cartage
 ½" x 2" \$210.00
 ½" x 1½" 200.00
 Prefinished Standard & Better Oak Flooring
 ¾" x 3¼" \$265.00 per M, plus Cartage
 ½" x 2½" 237.00 per M, plus Cartage
 Maple Flooring
 ¾" T & G Clear \$330.00 per M, plus Ctg.
 2nd 305.00 per M, plus Ctg
 3rd 255.00 per M, plus Ctg
 Floor Layers' Wage, \$2.28½ per hr. (Legal as of July 1, 1947. Given us by Inlaid Floor Co.)

GLASS—

Single Strength Window Glass	\$.40 per □ ft.
Double Strength Window Glass	.60 per □ ft.
Plate Glass, under 75 sq. ft.	1.50 per □ ft.
Polished Wire Plate Glass	2.25 per □ ft.
Rgt. Wire Glass	.60 per □ ft.
Obscure Glass	.40 per □ ft.

Glazing of above is additional.
 Glass Blocks—\$2.75 per □ ft. set in place

HEATING—

Average, \$2.50 to \$3.00 per sq. ft. of radiation, according to conditions.
 Warm air (gravity) average \$64 per register.
 Forced air average \$91 per register.

INSULATION AND WALLBOARD—

Rockwool Insulation—	
(2")	\$65.00 per M sq. ft.
Cotton Insulation—Full thickness	
(3½")	\$95.50 per M sq. ft.
Sulation Aluminum Insulation—Foil-mounted	
on both sides	\$23.50 per M sq. ft.
Tileboard—4½" panel	\$9.00 per panel
Wallboard—½" thickness	\$55.00 per M sq. ft.
Finished Plank	\$69.00 per M sq. ft.
Ceiling Tileboard	\$69.00 per M sq. ft.

IRON—Cost of ornamental iron, cast iron, etc., depends on designs.

LUMBER—

No. 1 Common	\$90.00 per M
No. 2 Common	86.00 per M
Select O. P. Common	94.00 per M

Flooring—

Per M Delivd.	
V.G., D.F. B & Btr. 1 x 4 T & G Flooring	\$170.00
"C" and better—all	170.00
"D" and better—all	170.00
Rwd. Rustic—"A" grade, medium dry	150.00
B to 24 ft.	
"B" grade, medium dry	150.00
Plywood	15c to 18c per ft.
Plyscord	9½c per ft.
Plywall	9c per ft.
Plyform	15c per ft.

Shingles (Rwd. not available)—

Red Cedar No. 1—	\$13.00 per square; No. 2, \$10.50; No. 3, \$9.00.
Average cost to lay shingles,	\$6.00 per square.
Cedar Shakes—Tapered: ½" to ¾" x 25"—	\$17.00 per square.
Resawn: ¾" to 1¼" x 25"—	\$22.00 per square
Average cost to lay shakes,—	8.00 per square

MILLWORK—Standard.

D. F. \$150 per 1000. R. W. Rustic \$175	per 1000 (delivered).
Double hung box window frames, average	with trim, \$12.50 and up, each.
Complete door unit, \$15 to \$25.	
Screen doors, \$6.00 to \$8.00 each.	
Patent screen windows, \$1.25 a sq. ft.	
Cases for kitchen pantries seven ft. high,	per lineal ft., \$12.00 each.
Dining room cases, \$15.00 per lineal foot.	
Rough and finish about \$1.00 per sq. ft.	
Labor—Rough carpentry, warehouse heavy	framing (average), \$65.00 per M.
For smaller work average, \$75.00 to \$85.00	per 1000.

MARBLE—(See Dealers)

PAINTING—

Two-coat work	per yard 75c
Three-coat work	per yard \$1.00
Cold water painting	per yard 25c
Whitewashing	per yard 15c
Turpentine	\$1.85 per gal. in 5-gal. cont.
Raw Linseed	
Oil	\$3.33 per gal. in 5-gal. cont.

Boiled Linseed	\$3.23 per gal. in drums.
Oil	
Boiled Linseed Oil—	\$3.33 per gal. in 5-gal. containers.
Replacement Oil—	\$2.75 per gal. in drums.
	\$2.75 per gal. in 5-gal. containers.
Use Replacement	
Oil	\$3.00 per gal. in 1 gal. cont.
A deposit of \$7.50 required on all drums.	

PATENT CHIMNEYS—

6-inch	\$2.00 lineal foot
8-inch	2.50 lineal foot
10-inch	3.50 lineal foot
12-inch	4.50 lineal foot

PLASTER—

Neat wall, per ton delivered in S. F. in paper bags, \$17.60.

PLASTERING (Interior)—

3 Coats, metal lath and plaster	Yard \$3.00
Keene cement on metal lath	3.50
Ceilings with ¾ hot roll channels metal lath (lath only)	3.00
Ceilings with ¾ hot roll channels metal lath plastered	4.50
Single partition ¾ channel lath 1 side (lath only)	3.00
Single partition ¾ channel lath 2 inches thick plastered	8.00
4-inch double partition ¾ channel lath 2 sides (lath only)	5.75
4-inch double partition ¾ channel lath 2 sides plastered	8.75
Thermax single partition; 1" channels; 2¼" overall partition width. Plastered both sides	7.50
Thermax double partition; 1" channels; 4¾" overall partition width. Plastered both sides	11.00
3 Coats over 1" Thermax nailed to one side wood studs or joists	4.50
3 Coats over 1" Thermax suspended to one side wood studs with spring sound insulation clip	5.00
Note—Channel lath controlled by limitation orders.	

PLASTERING (Exterior)—

2 coats cement finish, brick or concrete wall	Yard \$2.50
3 coats cement finish, No. 18 gauge wire mesh	3.50
Lime—	\$4.00 per bbl. at yard.
Processed L.L.Lime—	\$4.15 per bbl. at yard.
Rock or Grip Lath—	¾"—30c per sq. yd.
	¾"—29c per sq. yd.

* Composition Stucco—\$4.00 sq. yard (applied).

PLUMBING—

From \$150.00 per fixture up, according to grade, quality and runs.

ROOFING—

"Standard" tar and gravel, 4 ply—	\$11.00 per sq. for 30 sqs. or over.
Less than 30 sqs.	\$14.00 per sq.
Tila	\$40.00 to \$50.00 per square.
Redwood Shingles, \$15.00 per square in place.	
5/2 # 1-16" Cedar Shingles, 4½" Exposure	\$18.25 square

5/8 x 16"—# 1 Cedar Shingles, 5" Exposure	\$17.00 square
4/2 # 1-24" Royal Shingles, 7½" Exposure	\$23.00 square
Re-coat with Gravel	\$5.50 per sq.
Asbestos Shingles \$30 to \$60 per sq. laid.	
½ to ¾ x 25" Resawn Cedar Shakes, 10" Exposure	\$24.00
¾ to 1¼ x 25" Resawn Cedar Shakes, 10" Exposure	\$29.00
1 x 25" Resawn Cedar Shakes, 10" Exposure	22.00

Above prices are for shakes in place.

SHEET METAL—

Windows—Metal, \$2.50 a sq. ft. Fire doors (average), including hardware \$2.80 per sq. ft., size 12'x12'. \$3.75 per sq. ft., size 3'x6'.

SKYLIGHTS—(not glazed)

Copper, \$1.25 sq. ft. (flat). Galvanized iron, 65c sq. ft. (flat). Vented hip skylights 90c sq. ft.

STEEL—STRUCTURAL—

\$220 per ton erected, when out of mill. \$270 per ton erected, when out of stock.

STEEL REINFORCING—

\$200.00 per ton, in place.

STORE FRONTS (None available).

TILE—

Ceramic Tile Floors—\$1.70 per sq. ft. Cove Base—\$1.35 per lin. ft. Glazed Tile Wainscot—\$1.85 per sq. ft. Asphalt Tile Floor ½" x ¾"—\$.40 per sq. ft. Light shades slightly higher. Cork Tile—\$1.00 per sq. ft. Mosaic Floors—See dealers. Lino-Tile—\$1.00 per sq. ft.

Wall Tile—

Glazed Terra Cotta Wall Units (single faced) laid in place—approximate prices:

2 x 6 x 12	\$1.25 sq. ft.
4 x 6 x 12	1.50 sq. ft.
2 x 8 x 16	1.45 sq. ft.
4 x 8 x 16	1.75 sq. ft.

VENETIAN BLINDS—

75c per square foot and up. Installer extra.

WINDOWS—STEEL—

60c per square foot, \$5 for ventilators.

A.I.A. ACTIVITIES

(From Page 37)

of the Los Angeles City Planning Commission, and Tony Thormin has been named to the Board of Building and Safety Commissioners.

PRODUCERS' COUNCIL OFFERS STUDENT AWARDS AT U.C.

The Southern California Chapter of the Producers' Council is offering three prizes to fourth year students at the University of Southern California, College of Architecture.

The awards of one hundred, fifty, and twenty-five dollars, respectively, are to be made on the basis of scholastic record.

The Southern California Chapter of the A.I.A. will appoint an awards committee to make the final selections, according to an announcement by Pete Van Zandt, President of the Council.

NEW YORK CIVIC DESIGN COMMITTEE

The Civic Design Committee of the New York Chapter of the A.I.A., through its chairman, Geoffrey Platt, has presented the Committee's program for the redevelopment of the East Midtown Area

to Robert F. Wagner, Jr., chairman of the New York City Planning Commission.

The proposed development is in relation to the expansion of the retail shopping belt as well as to the United Nations headquarters.

Mr. Platt stated, "The City Planning Commission is being urged by the Civic Design Committee to consider these proposals at this time because the recent passage by Congress of the \$65,000,000 loan assures the building of the United Nations headquarters and is bound to have a profound influence on the City."

The presentation was made at a luncheon at the Architectural League, in the form of a booklet entitled "East Midtown Manhattan" and gives details of the comprehensive proposals.

The architect's proposal is a program which includes many projects already recommended by various public organizations for development over a period of 5 to 20 years. The adoption of such a program involves no public expenditure.

In order to make the city's expenditure of \$15,000,000 for immediate street changes worthwhile, the architect's report declares that it requires the assurance of an eventual more comprehensive program.

BUILDING TRADES WAGE (JOB SITES) NORTHERN AND CENTRAL CALIFORNIA

ATTENTION: The following are the PREVAILING hourly rates of compensation being paid and in effect by employers by agreement between employees and their union; or as recognized and determined by the U. S. Department of Labor. (Revised to January 1, 1948.)

CRAFT	San Francisco	Alameda and Contra Costa	Marin	Vallejo	San Mateo	San Jose	Stockton	Sacramento	Fresno
ASBESTOS WORKERS	1.90	1.90	1.90	1.90	1.90	1.90	1.90	1.90	1.90
BRICKLAYERS	2.25	2.25	2.25	2.25	2.25	2.25	2.25	2.50	2.25
BRICKLAYERS, HODCARRIERS	1.75	1.75	1.75	1.75	1.75	1.75	1.87½	1.87½	1.75
CARPENTERS	2.00	2.00	2.00	2.00	2.00	2.00	2.00	2.00	2.00
CEMENT FINISHERS	2.02½	2.02½	2.02½	2.02½	2.02½	2.02½	2.02½	2.02½	2.02½
ELECTRICIANS	2.25	2.25	2.25	2.25	2.25	2.25	2.25	2.25	2.25
ENGINEERS: MATERIAL HOIST	2.00	2.00	2.00	2.00	2.00	2.00	2.00	2.00	2.00
ENGINEERS: FILE DRIVER	2.25	2.25	2.25	2.25	2.25	2.25	2.25	2.25	2.25
ENGINEERS: STRUCTURAL STEEL	2.25	2.25	2.25	2.25	2.25	2.25	2.25	2.25	2.25
GLASS WORKERS	1.87½	1.87½	1.87½	1.87½	1.87½	1.87½	1.87½	1.87½	1.87½
IRONWORKERS: ORNAMENTAL	2.10	2.10	2.10	2.10	2.10	2.10	2.10	2.10	2.10
IRONWORKERS: REINF. RODMEN	2.00	2.00	2.00	2.00	2.00	2.00	2.00	2.00	2.00
IRONWORKERS: STRUCTURAL	2.25	2.25	2.25	2.25	2.25	2.25	2.25	2.25	2.25
LABORERS: BUILDING & CONCRETE	1.40	1.40	1.40	1.40	1.40	1.30	1.40	1.40	1.30
LATHERS	2.25	2.25	2.25	2.25	2.25	2.25	2.25	2.25	2.25
MARBLE SETTERS	2.00	2.00	2.00	2.00	2.00	2.00	2.00	2.00	2.00
MOSAIC & TERRAZZO	2.00	2.00	2.00	2.00	2.00	2.00	1.75	1.75	1.75
PAINTERS	2.00	2.00	2.00	2.00	2.00	2.00	2.00	2.00	2.00
PAINTERS: FILE DRIVERS	2.12½	2.12½	2.12½	2.12½	2.12½	2.12½	2.12½	2.12½	2.12½
PLASTERERS	2.25	2.50	2.25	2.50	2.25	2.25	2.05	2.05	2.05
PLASTERERS: HODCARRIERS	2.00	2.00	2.00	2.00	2.00	2.00	1.87½	1.87½	1.87½
PLUMBERS	2.25	2.25	2.25	2.25	2.25	2.25	2.25	2.25	2.25
ROOFERS	2.00	2.00	2.00	2.00	2.00	2.00	2.00	2.00	2.00
SHEET METAL WORKERS	2.00	2.00	2.00	2.00	2.00	2.00	2.00	2.00	2.00
SINKLER FITTERS	2.00	2.00	2.00	2.00	2.00	2.00	2.00	2.00	2.00
STEAMFITTERS	2.25	2.25	2.25	2.25	2.25	2.25	2.25	2.25	2.25
STONESETTERS (MASON'S)	2.25	2.25	2.25	2.25	2.25	2.25	2.25	2.25	2.25
TILESETTERS	2.15	2.15	2.15	1.90	2.15	1.90	1.90	1.90	1.90

Prepared and compiled by

CENTRAL CALIFORNIA CHAPTER, ASSOCIATED GENERAL CONTRACTORS OF AMERICA

with the assistance and cooperation of secretaries of Building Trades Unions, General Contractors Associations and Builders Exchanges of Northern California

CLASSIFIED ADVERTISING

RATE: 20c PER WORD . . . CASH WITH ORDER

MINIMUM \$5.00

CONSTRUCTION ENGINEER (CIVIL) GENERAL SUPERINTENDENT PROJECT MANAGER

Twenty five years of wide practical experience on frame, steel, concrete and masonry jobs of all types. Estimating, sub-division, sales, detailing & specification writing back-

ground. Dependable, energetic. Excellent local references. Have car. Free to travel. P.O. Box 807, San Mateo, Calif.

WANTED: Product Engineer with experience wanted as a permanent addition to the staff of an industrial Development Department located in Minnesota. Work involves product

development including travel for consumer contacts. Program relates to products from wood. Submit details education, experience, references, salary requirement, photograph. All replies considered confidential and will be acknowledged. Reply Box 238, Architect and Engineer, Inc., 68 Post St., San Francisco, Calif.

SISALKRAFT

REG. U. S. PAT. OFF.

"More than a building paper"

THE SISALKRAFT CO.

205 West Wacker Drive
Chicago, Ill.

55 New Montgomery Street
San Francisco, Calif.

CLINTON CONSTRUCTION CO. OF CALIFORNIA

General Contractors

923 FOLSOM STREET • SAN FRANCISCO
SUtter 1-3440

HOGAN LUMBER CO.

Wholesale and Retail

LUMBER

MILL WORK • SASH & DOORS

Office, Mill, Yard and Docks
SECOND AND ALICE STREETS • OAKLAND, CALIF.
Telephone GLencourt 1-6861

TILE

UNUSUAL AND PRACTICAL INSTALLATIONS OF CERAMIC AND FAIENCE TILE

for bathrooms, kitchens, vestibules, stores,
patios and cocktail bars



FOX TILE CO.

3247 E. 14TH STREET, OAKLAND
Phone: ANdover 1-0431

NEWS AND COMMENT ON ART

(From Page 12)

realism now fill his canvases. These forms combine poetically, with vigorous, brilliant, lyric combinations of colors and compositions to make some of the most interesting and vital paintings of our time. Miro has said, "Have you ever heard of greater nonsense than the aims of the abstractionist group?—As if the signs that I transcribe on a canvas, at the moment when they correspond to a concrete representation of my mind, were not profoundly real, and did not belong essentially to the world of reality! To me, subject matter seems vital in order that a rich or robust theme should be present to give the spectator an immediate blow between the eyes before a second thought can interpose. In this way poetry pictorially expressed speaks its own language."

The San Francisco Museum of Art, recently completely renovated has installed the exhibition in such a way as to present each of the three artists separately and, insofar as is possible, the paintings are presented chronologically so that the gallery visitor can more easily establish an idea of the individual scope of each man. The Catalog for the exhibition contains reproductions of all paintings included in this showing, and descriptive articles by Herbert Read, Sidney Janis, Donald Gallun, Daniel-Henry Kahnweiler, Juan Larrea and Man Ray.

The exhibition will be open from September 14 through October 17 at the San Francisco Museum of Art, and from October 26 through November 28 at the Portland Art Museum.

WILL SPEAK AT ARTS AND CRAFTS MEETING

Paul Cary and Louis Shawl, two outstanding San Francisco Commercial artists, will be guest speakers at the October 1 meeting of the California College of Arts and Crafts alumni society in Guild Auditorium on the college campus in Oakland at 8 p.m.

Their talks will center on the forthcoming exhibition of commercial art at the San Francisco Museum of Art, from October 13 to November 7, under sponsorship of the San Francisco Advertising Club, according to announcement by Louis Moulthrop, alumni president, who will preside at the October 1 meeting.

COMMERCIAL BUILDING. E. S. McKittrick, Oakland contractor has been awarded a \$59,878 contract for the construction of a new commercial building in Albany, California. Young & Lloyd, Albany, are the Architects.

MEASUREMENT AND RECORDING OF HEAT EXCHANGE BEING STUDIED

The rapid measurement and recording of heat exchange between the human body and its environment is being studied by the Research Laboratory of the American Society of Heating and Ventilating Engineers, ASHVE President, Professor G. L. Tuve, announced recently. This study is being sponsored by the Naval Medical Research Institute and the Office of Naval Research.

The initial investigation is concerned with the possibility of designing, developing and constructing a calorimeter capable of holding a human subject. In addition to measuring the heat exchange of the body with its surroundings, the calorimeter must be capable of creating sudden changes in environment. Thus observations of the heat exchange of the human body under a variety of experimental conditions can be made.

Previous research has established the mechanics by which the temperature control system of the body maintains approximately constant internal temperatures over a wide range of environmental conditions. However, little is known about the effect of environment on the heat generated within the body. It is hoped that these studies will add materially to our understanding of the effect of environment on human metabolism.

Almost from its inception in 1919, the ASHVE Research Laboratory in cooperation with medical authorities, has been investigating the effect of atmospheric environment on human beings and their sense of comfort. Since 1946 the Medical School of the University of Illinois has been conducting research sponsored by ASHVE on the so-called "shock effect" encountered when entering or leaving a summer air-conditioned space. The results of all these studies have contributed greatly to human comfort and health.

SCHUELER IS APPOINTED GENERAL SALES MANAGER

Justin M. Jacobs, president of the Benbow Manufacturing Company in Redwood City, recently announced the appointment of A. A. Schueler as general sales manager of the firm.

The Benbow Company is the manufacturer of a lightweight fully insulated Trac Trolley System.

NEW GRAMMAR SCHOOL. A contract has been awarded the Wm. J. Kutz company, Martinez, California, for the construction of a new 6-classroom, kindergarten, office and toilet room Grammar School near Concord. Estimated cost is \$129,619. Confer, Ponsford & Price, Oakland, are the Architects.

The Most Complete Line of STEELS and BUILDING MATERIALS

Made by a Single Producer



See Sweet's Catalog File or write us for full information.

REPUBLIC STEEL CORPORATION

GENERAL OFFICES: CLEVELAND, OHIO

DENVER, COLORADO . . . CONTINENTAL OIL BUILDING
LOS ANGELES, CALIFORNIA . . . EDISON BUILDING
SALT LAKE CITY, UTAH . . . WALKER BANK BUILDING
SAN FRANCISCO, CALIFORNIA . . . RIALTO BUILDING
SEATTLE, WASH. WHITE-HENRY-STUART BUILDING

PACIFIC MANUFACTURING CO.

High Class Interior Finish Quality
Millwork

16 Beale St., San Francisco
Garfield 1-7755

2215 El Camino Real, San Mateo
S. M. 5-0687

304 Bryant Street, Palo Alto
P. A. 3373

2610 The Alameda, Santa Clara
S. C. 607 1 Factory

6820 McKinley Avenue, Los Angeles
Thornwall 4196

MAIN OFFICE — SANTA CLARA

"AMERICAN - MARSH" CONDENSATION UNIT

Pumping
Machinery
for
Every
Purpose

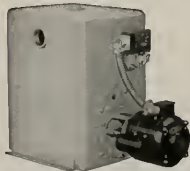

For Service
Call
DOuglas
2-6794
or
MUtual 8322

SIMONDS MACHINERY CO.

SAN FRANCISCO
816 FOLSOM

LOS ANGELES
455 EAST 4TH

VERMONT MARBLE COMPANY

Producers and Finishers
of
Domestic and Imported Marbles

525 MARKET STREET, SAN FRANCISCO
Phone SUtter 1-6747

3522 COUNCIL STREET
(Beverly Blvd. at Virgil Ave.)

LOS ANGELES 4, CALIF.
Telephone Fairfax 7834



IN THE NEWS

UNION HALL

The Sailors Union of the Pacific have applied for a building permit to construct a \$750,000 Union Hall Building in San Francisco. Wm. G. Merchant is the Architect and the M. & K. Corporation the General Contractor.

FOUR BATHS

Architect Donnell Jaekle of San Jose is doing a \$40,000 residence

ANGIER

BUILDING PAPERS

Standard Brownskin

Economy Brownskin

Brownskin Vaporseal

Copperskin

Ansulate • Burlamat

WESTERN ASBESTOS

COMPANY

675 Townsend Street, San Francisco 3

Telephone: HEmlack 1-4884

OAKLAND • SACRAMENTO • FRESNO • SAN JOSE

"There's still life in the old gray mare."

DON'T throw away those used paint brushes

CABOT'S BRUSH CLEANER

Positively removes old paint right down to the heel

GUNN CARLE & CO
20 POTRERO AVENUE • SAN FRANCISCO, CALIF.

in Santa Clara (California) consisting of a two story frame and stucco building of eleven rooms and four baths.

Pasetta Construction Company of Santa Clara is the general contractor.

WATER

The E. J. Freethy Company of El Cerrito (California) have been awarded a \$48,837 contract for the construction of a 1,000,000 gallon capacity reservoir for the East Bay Municipal Utility Department.

ARCHITECT SELECTED

Herbert Goodpastor, Architect of Sacramento (California) has been selected to do the plans for the First Baptist Church in Sacramento.

BONDS VOTED. Voters recently approved a bond issue of \$5,250,000 for the construction of new high schools and grammar schools in Stockton (California).

LAW SCHOOL REMODEL

Wagner & Martinez, General Contractors of San Francisco, have been awarded a \$780,000 contract for the remodeling of the Stanford University Law School building at Palo Alto.

Weihe, Frick & Kruse, San Francisco, are the Architects.

CONSULTING ARCHITECTS

Wurster, Bernardi & Emmons, San Francisco, Architects, have been selected as consulting architects for a municipal bus yard addition and remodel in San Francisco.

HIGH SCHOOL BONDS

Bonds totaling more than \$945,000 have been voted by the Plumas County Union High School District, Quincy (California) for the construction of a New High School at Chester and additions to the

NEW STEEL WAREHOUSE

The Pacific Iron & Steel Company of Los Angeles have purchased a site in San Leandro (California) for the construction of a new warehouse building.

BONDS were recently voted for the construction of new grammar nia) amounting to \$315,000.

Quincy, Portola, and Greenville. present high school buildings at school buildings in Napa (California).

COURT HOUSE REMODEL

A contract has been awarded R. S. Knight to remodel the basement of the Sonoma County Court House in Santa Rosa. C. A. Calkins, Santa Rosa, is the architect.

RADIO STATION

The American Broadcasting Company have been issued a building permit to construct a new radio station in San Francisco.

NEWSPAPER & RADIO

Nichols-White, Inc., of Palo Alto, have been awarded a \$241,285 contract for the construction of a 1-story and basement newspaper plant and radio station in Palo Alto for the Palo Alto Times. Birge M. Clark & Walter Stromquist are the architects.

BOND ELECTION

Voters of Mt. View (California) will go to the polls October 5th to vote on a \$425,000 bond proposal for the construction of a new Civic Center Building and a new Fire House.

INFIRMARY

Contracts have been awarded for a \$603,928 improvement to the Tulare-Kings Counties Joint Tuberculosis Hospital at Springville. General contract was given to R Pedersen & Son of Fresno. W. D. Coates & J. P. Miller of Fresno are the architects.

BOND ELECTION

Voters of Berkeley, California will go to the polls on November 2nd to vote on a proposed \$7,786,000 bond election for improvement of the city's elementary junior high and high schools.

MULLEN MFG. COMPANY

BANK, STORE AND OFFICE
FIXTURES—CABINET WORK
OF GUARANTEED QUALITY
CHURCH SEATING

Office and Factory
60-80 RAUSCH ST., Bet. 7th and 8th Sts.
San Francisco
Telephone UNDERhill 1-5815

Subscribe to ARCHITECTS REPORTS

Individual slip-reports give advance
information an construction projects
in northern California—name, loca-
tion, Architect, cost, and other valu-
able data.

68 Post Street Douglas 2-8311

THE TORMEY COMPANY

GENERAL PAINTERS
AND DECORATORS

Phone UNDERhill 1-1913

563 FULTON STREET
San Francisco

IN THE NEWS

SWIMMING POOL

The San Rafael (California) Board of Education has awarded a contract to Younger & Hallsteen, Inc., of San Francisco, for the construction of a swimming pool at the San Rafael High School. Donald Beach Kirby & Thomas B. Mulvin, San Francisco, are the architects.

MORE HOUSES

The Golden Gate Construction Company of Stockton (California) has awarded a general contract to Home Builders, Inc. of the same city for the construction of five hundred and seventeen residences.

The new houses are to be built in College View, of one story frame construction, and will cost \$6,500 each.

SEWAGE PLANT

The Napa (California) Sanitation District have awarded a general contract to the Fred J. Early, Jr., Company of San Francisco, for the construction of a \$1,108,864 sewage plant and connecting sewage lines.

E. E. Lowell, Vallejo, Contractor was awarded the sewer contract for \$330,301.

SALESROOM

The Wm. Volker & Company of Kansas City (Missouri) have awarded a contract to Daily Bros. of Belmont (California) for the construction of a \$381,710 office, salesroom, warehouse and factory building in Portland, Oregon. Francis A. Constable is the Architect.

CHEMICAL PLANT

The Mt. Eden Chemical Company have announced plans for the construction of a new chemical plant in Alameda county to cost approximately \$100,000. The Murphy Construction Company of Redwood City are the general contractors.

BEAUTY

A contract in the amount of \$155,000 has been awarded to Swinerton & Walberg, General Contractors, for remodeling of the Elizabeth Arden Beauty Salon in San Francisco. Angus MacSweeney is the Architect.



HERRICK IRON WORKS STRUCTURAL STEEL REINFORCING STEEL

1878 AND CAMPBELL STS.
OAKLAND, CALIF.
Phone GLAncourt 1-1767

Phone GARfield 1-1164

Thomas B. Hunter DESIGNER OF HEATING

AIR CONDITIONING
VENTILATING AND WIRING
SYSTEMS, MECHANICAL
AND ELECTRICAL EQUIP-
MENT OF BUILDINGS



41 SUTTER STREET
ROOM 710

San Francisco California

Scott Company

HEATING • PLUMBING
REFRIGERATION



San Francisco
Oakland
San Jose
Los Angeles

DINWIDDIE CONSTRUCTION COMPANY

•
BUILDERS
•

CROCKER BUILDING
SAN FRANCISCO

Fine
ENGRAVINGS

POOR
RICHARD

PHOTO ENGRAVING CO.
320-324 COMMERCIAL STREET
SAN FRANCISCO, 11

**Mattock Construction
Company**
Builders



604 MISSION STREET
SAN FRANCISCO

Subscribe
Now —

**ARCHITECT
and
ENGINEER**

\$3.00
Per Year

**PITTSBURGH
TESTING LABORATORY**

ENGINEERS AND CHEMISTS

Testing and Inspection of Concrete,
Steel and Other Structural Materials

Design of Concrete Mixes

Offices in all principal cities

651 Howard St., San Francisco 5
EXbrook 2-1747

**INCINERATORS
TRASH BURNERS**

Steel-Cased, Down-Draft Types

EXCEPTIONAL

Construction and Values

UNJ FIREBRICK CO
CONSTRUCTION CO.

San Francisco

345 Vermont St.

UN 1-2144

Index to Advertisers

ANGIER Pacific Corp	*
ARCHITECTURAL Porcelain Constructors	31
ARCHITECTS Reports	42
BASALT Rock Company	Back Cover
BAXTER & Company, J. H.	38
BURKE, W. S. & Co.	40
CLASSIFIED Advertising	45
CLINTON Construction Company	46
CONTINENTAL Water Heater Co.	41
DETROIT Steel Products Co.	8
DINWIDDIE Construction Co.	49
DUFFY Tile Co.	50
FIREBRICK Construction Co., J. N. J.	50
FORDERER Cornice Works	42
FOX Tile Co.	46
FULLER, W. P. Co.	*
GLADDING, McBean & Co.	6
GUNN, Carle & Company	48
HANKS, Inc., Abbott A.	50
HAWES Drinking Faucet Company	36
HERRICK Iron Works	49
HOGAN Lumber Company	46
HUNT, Robert W., Company	50
HUNTER, Thos. B.	49
JOHNSON, S. T. Co.	*
JUDSON, Pacific-Murphy Corp.	42
KRAFTILE Company	30
MARBLE Institute of America	2
MATTOCK, A. F., Co.	50
MICHEL & Pfeiffer Iron Works
Inside Front Cover	
MULLEN Mfg. Co.	49
MUELLER Brass Co.	*
NORTHERN California Electric Bureau	37
PACIFIC Coast Gas Association	1
PACIFIC Manufacturing Company	47
PACIFIC Portland Cement Company	5
PACIFIC Telephone & Telegraph Co.	35
PITTSBURGH Testing Laboratory	50
POOR Richard Engraving Co.	49
REMILLARD-Dandini Co.	50
REPUBLIC Steel Corporation	47
SCOTT Co.	49
SECURITY Valve Company	33
SIMONDS Machinery Company	47
SIMPSON Logging Co.	7
SISALKRAFT Company	46
SMOOT-Holman Co.	39
SOULE Steel Co.	*
STANLEY Works, The	34
SUPERIOR Fireplace Company	32
TAYLOR Co., Halsey W.	*
TORMEY Company, The	49
U. S. BONDS Inside Back Cover
VERMONT Marble Company	47
WESIX Company	*
WESTERN Asbestos Co.	48
WESTERN-Holly Stove Co.	*
WOOD, E. K., Lumber Company	38

*Indicates Alternate Months

Robert W. Hunt Company
ENGINEERS

Inspection - Tests - Consultation
Schools and Other Structures
Are Built as Designed

When Construction Materials are
Inspected at point of Manufacture
and during Erection by

ROBERT W. HUNT COMPANY

Cement, Concrete, Chemical, Metallurgical,
X-Ray and Physical Laboratories

Chicago - New York - Pittsburgh
Los Angeles - All Large Cities
San Francisco, 251 Kearny Street

REMILLARD-DANDINI Co.

Brick and
Masonry Products



400 MONTGOMERY STREET
SAN FRANCISCO, CALIF.

DUFFY TILE CO.

TILE CONTRACTORS
SHOWER DOORS
TUB ENCLOSURES



INSTALLATIONS
OF EVERY
DESCRIPTION
Modernizing, Repairing
"Not How Cheap
But How Good"
253 MINNA
YUKon 6-1489

ABBOT A. HANKS, INC.
Engineers & Chemists

INSPECTING — TESTING — CONSULTING
CONCRETE • STEEL • MATERIALS
CHEMICAL AND TESTING
LABORATORIES
• RESEARCH AND INVESTIGATION •

TESTS OF STRUCTURAL MATERIALS
DESIGN OF CONCRETE MIXES
SHOP AND ERECTION INSPECTION OF
STRUCTURES AND EQUIPMENT
INVESTIGATION OF STRUCTURES
AND MATERIALS
TESTS AND INVESTIGATION OF
FOUNDATION SOILS
FIRE RESISTANCE AND INSULATION
TESTS

624 Sacramento Street, San Francisco

ARCHITECT AND ENGINEER

POWER STATION IN DOWNTOWN SAN FRANCISCO



William Gladstone Merchant, Architect

OCTOBER

1948

metal doors and entrances

push bars

window guards
and grilles

ornamental stair
railings

counter screens

building letters

plaques

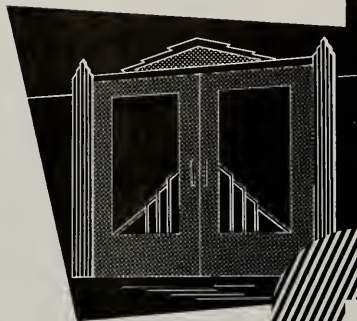

dependable craftsmanship in metal work for buildings

Experience in design, complete facilities and expert workmanship provide a dependable source of supply for building construction.

ARISTON Metal Products includes a wide variety of items in steel, iron, bronze and aluminum. Estimates or quotations promptly furnished on request.



Michel & Pfeffer Iron Works, Inc.

KENNETH OPIE, Manager Misc. and Ornamental Division
Tenth and Harrison Streets, San Francisco 3, California
Telephone MArket 1-5966

ARCHITECT

Vol. 175

No. 1

AND

ENGINEER

ARCHITECTS' REPORTS—Published Daily

E. H. WILDER

Editor

MARK DANIELS, A.I.A.

Associate Editor

PROF. LELAND VAUGHAN

Landscape Architecture

JOHN A. BLUME

Structural Engineering

MICHAEL GOODMAN

Planning

JOHN S. BOLLES, A.I.A.

Book Reviews



COVER PICTURE:

Pacific Gas & Electric Company's new \$4,800,000 power station at 8th and Mission Streets, San Francisco, is a stately symbol of modern design by Architect William Gladstone Marchant of San Francisco and a tribute to the indispensable service of electricity to a great city. (See story on page 30.)

Contents for

OCTOBER

EDITORIAL NOTES	2
NEWS & COMMENT ON ART	7
PLANNING THE DEVELOPMENT of the Smaller Community By Carl W. Hogg, Salem, Oregon	9
UNIQUE IN THE WEST, VETERAN'S MEMORIAL BUILDING Eugene, Oregon. By Arthur W. Prieaulx	11
ANGLO CALIFORNIA NATIONAL BANK, Oakland, California H. H. Winner, Architect	19
COVER PICTURE (Pacific Gas & Electric Power Station)	30
A. I. A. ACTIVITIES	31
WITH THE ENGINEERS	32
HEADLINE NEWS & VIEWS, By E. H. W.	36
IN THE NEWS	37, 39, 43, 46, 47
LANDSCAPE ARCHITECTURE, Notes of the Profession	38
ESTIMATOR'S GUIDE, Building and Construction Materials	41
BUILDING TRADES WAGE SCALES, Northern and Central California	43
INDEX TO ADVERTISERS	48

ARCHITECT AND ENGINEER (Established 1905) is published on the 15th of the month by The Architect and Engineer, Inc., 68 Post St., San Francisco 4; Telephone EXbrook 2-7182. President, K. P. Kierulff; Vice-President and Manager, L. B. Penhorwood; Treasurer, E. N. Kierulff.

Los Angeles Office: Wentworth F. Green, 6605 Hollywood Blvd., Los Angeles 28. Telephone HEMstead 3171.

Entered as second class matter, November 2, 1905, at the Post Office in San Francisco, California, under the Act of March 3, 1879. Subscriptions United States and Pan America, \$3.00 a year; \$5.00 two years; foreign countries \$5.00 a year; single copy 50c. ARCHITECTS' REPORTS are published daily from this office. Vernon S. Yallop, Manager. Telephone DOuglas 2-8311.



New!— "Like nothing else you've ever seen!"

FULLER COLOR CONTROL PLAN

The easiest, quickest, most profitable way to handle every interior wall color problem



WHAT IT IS:— A practical, profit-proved color tool, perfected after job-test consultations with qualified Architects and Painting Contractors.

Examine the photograph above. Note the **SIZE** of the color cards—11 x 11 inches—the biggest in the industry. Every color in this kit is *usable*—216 colors in all! They're grouped by colors and filed in sequence in 6 moulded plastic cases. Each card has its simple formula

printed on back. In addition, you get a supply of small color swatches, with formula, to leave with your foreman or your client.

All this—6 plastic cases, 216 different 11 x 11 color cards, each with its own exact formula, 2592 small swatches—in a compact carrying case. The finest color tool in the painting industry. Sold below cost to Architects or Painting Contractors by W. P. Fuller & Co.

Handsome black leather Fuller Color Control Plan kit is as easy to carry as a small traveling bag.





Furnishings courtesy of W. & J. Sloane, San Francisco

What **FULLER** **COLOR CONTROL** **PLAN** does—

You're quick to appreciate, so let's waste no words. This Plan cuts time, trouble, misunderstanding and cost of color selection, mixing and checking. Example: Women want green, but seldom know *what* green. This kit contains 72 greens! Big 11 x 11 cards give immediate grasp of color intensity; make comparison with room accessories satisfying. Stimulates decision *without expensive paintouts!* Color quickly mixed from exact formula. Color checking sure. Small swatches let client match fabrics accurately.

Your business-like presentation builds confidence in your "know-how," hastens decisions, saves money. Practically pre-guarantees satisfaction. Ask your Fuller Representative for demonstration. Decide on the basis of *profits to you!*

and how the **FULLER COLOR CONTROL PLAN** saves on the job



This way makes money! Showing colors one at a time ends confusion. Big cards stimulate decision. Printed formulas cuts mixing time, assures color accuracy—saves color supervisor's time. Client pre-disposed to approve. The profitable way!



This way loses money! Wasteful hours tinting paintouts trying to get "what's in her mind." More slow work making room-batch match the paintout. Client apt to remain skeptical—pre-disposed to disapprove. The costly way!

"Finest color tool in the painting industry"



For Schools . . . Little Flower School, San Antonio, Tex.
Architect: Julian & White, San Antonio. Contractor:
Lynn & Morse, San Antonio. 221 Fenecraft Windows.

How Fenecraft gave these Architects

finer windows at Lower Cost

Fenecraft* Windows are designed to provide the quality you want in buildings of character . . . and to help you solve today's problem of costs.

Standardization makes it possible to achieve this double goal. For standardization of types and sizes permits manufacturing efficiency. That means lower unit cost. It results in lower installation costs, too— for Fenecraft Window dimensions are co-ordinated with those of collateral wall materials.

These are the finest windows we have ever built. We've applied our long experience in designing top-quality casement sections, and used the finest materials and workmanship, to produce, in Fenecraft, windows in keeping with the finest buildings.

Here's beauty—plus durability. Utility, too—in easy screening, safer washing, firesafety, better day-lighting and controlled ventilation. These are good reasons why architects are specifying Fenecraft Casement, Projected and Combination Windows for all types of buildings. For full information on types and sizes, see Sweet's Architectural File for 1948 (Section 16a-14) or mail the coupon.

For All Types of Buildings

Made by America's Oldest and Largest Steel Window Manufacturer



For Hospitals . . . Annie M. Warner Hospital, Gettysburg, Pa. Architect: John B. Hamme, York, Pa. Contractor: Earl L. Gump, Chambersburg, Pa. 86 Fenecraft Windows.



For Office Buildings . . . Research & Development Building, Sinclair Refining Company, Harvey, Ill. Engineers & Contractor: The Austin Company. 428 Fenecraft Windows.



For Industrial Buildings . . . L. C. Smith & Corona, Syracuse, N. Y. Architect: Carl W. Clark, Cortland, N. Y. Contractor: J. D. Taylor Construction Corporation, Syracuse. 1214 Fenecraft Windows.

*Trademark

Fenestra

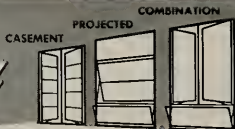

FENECRAFT INTERMEDIATE STEEL WINDOWS

Detroit Steel Products Company,
Dept. AE-10
2262 East Grand Blvd.,
Detroit 11, Michigan

Please send me data on types and sizes of the new Fenecraft family of Fenestra Windows.

Name

Company

Address

NEWS AND COMMENT ON ART

M. H. DE YOUNG MEMORIAL MUSEUM—SAN FRANCISCO

Walter Heil, Director of the M. H. deYoung Memorial Museum, San Francisco, has announced the following schedule of exhibitions for the month of September:

Retrospective Exhibition of Paintings, Water-colors, Drawings and Prints by Max Beckman (1948), opening September 17th; a loan Exhibition of African Negro Art, opening September 23rd; Paintings by Nancy Davis Galantiere, opening September 3rd; The Age of Exploration; Paintings by Henry J. Dietrich; French Primitives which consists of 20 paintings from Paris; Significant War Scenes by Battlefront Artists representing the works of 16 artists commissioned to "capture for the future the outstanding episodes of the War"; Painting by Felix Ruvolo and an exhibition of Contemporary Quilts and Woodcuts designed by Florence Saltzman Heidel which opens on September 1st.

WATER COLOR AWARD

"Facade" a painting by Clinton Adams, assistant professor of art at the University of California at Los Angeles, won the Pasadena Art Institute

Award of Merit in the 28th annual exhibit of the California Water Color Society.

The painting depicts discarded stage sets on a motion picture studio back lot. It will be on display at the Pasadena Art Institute during October and will then circulate to other California cities.

A resident of Santa Monica, Adams has exhibited widely in Los Angeles, San Francisco and elsewhere.

EXHIBITION HALL. The Otis H. Smith Construction Company of Larkspur (California) have been awarded a contract for the construction of an exhibition hall for the Marin Art & Garden Center of Ross. Gardner A. Dailey, San Francisco, is the Architect.

MILLS COLLEGE ART GALLERY

The Mills College Art Gallery, Oakland, California, will hold an exhibition of the best Student Work of the Previous Year, from October 15th to November 7th.

Shown in the exhibition will be photographs of the frescoes of the Lacondan Indians in Southern Mexico; Etchings by Rocz of the prophet statues

"PAPILLION"

By
Don Cardwell
of
Petaluma
California



FIRST PRIZE in Wallpaper Design Competition, sponsored by John R. McPhee for California School of Fine Arts students.

by Alejadinho; and The Age of Exploration.

The gallery is open on Wednesday, Friday and Sunday from 2 to 5 p. m.

PAT WALL GALLERY AT MONTEREY

The Pat Wall Gallery of Monterey, California, is currently exhibiting a group of paintings and pottery by Polina Pillin.

THE ART LEAGUE OF CALIFORNIA

The Art League of California, which is located at 582 California Street, San Francisco, is exhibiting a one-man show by Louis J. Hughes of San Francisco.

The exhibit contains a diversified group of watercolors.

Events scheduled for the near future include exhibits of the work of Louis Siegriest and Melvin Fowler.

ACQUIRES GREAT REMBRANDT PORTRAIT

The California Palace of the Legion of Honor, San Francisco, recently announced acquisition of Rembrandt's "Portrait of a Rabbi," the first work by the celebrated Dutch master to enter a San Francisco collection.

Acquisition of the masterpiece was made possible by the late H. K. S. Williams, who established a fund to provide for the growth of the Mildred Anna Williams Collection, the memorial collection bearing his wife's name.

Art authorities hail the "Portrait of a Rabbi" as one of the most important works by Rembrandt to appear on the art market for many years. It was purchased from the Schaeffer Galleries of New York.

CALIFORNIA PALACE OF THE LEGION OF HONOR

Thomas Carr Howe, Jr., Director of the California Palace of the Legion of Honor, has announced the following schedule of exhibitions and special events for October:

Exhibitions: Mobiles and Articulated Sculpture, opening October 2; Photographs of San Francisco by Max Yavno, opening October 12; European Rooms in Miniature by Mrs. James Ward Thorne, through October; Harnett and His Followers, through October, and Paintings by Grandma Moses, through October.

Educational Activities: Regular art classes for children, ages 4 through 15, resumed on Oc-

tober 2 at 10:00 a. m. Instruction under the direction of Katharine L. Parker, Lilly Weil Jaffe and Frank Lobdell. Admission free.

Painting class for adults resumed on Saturday, October 2, at 2:00 p. m. Under the direction of Frank Lobdell. Admission free.

Tours of the Thorne Rooms each Tuesday and Thursday at 10:30 a. m. Conducted by Mrs. Laduska Wilson. Each Friday at 2:30 p. m. conducted by Miss Katharine L. Parker. Special groups may arrange for tours by telephoning the Educational Department of the Museum, BA 1-5610.

Wednesday Gallery Tours conducted by Mrs. Lilly Weil Jaffe at 2:30 p. m. Mobiles and Articulated Sculptures, October 6 and 13. Grandma Moses, October 20 and 27.

Organ Programs: Organ recital by Ulda Waldrop, every Saturday and Sunday, 3 p. m.

COLLEGE ARTISTS WIN COUNTY FAIR PRIZES

Three first prizes, two second prizes, and one third prize were won by members of the University of California at Los Angeles art department at the Los Angeles County Fair.

Jan Stussy, instructor, won first prize for his lithograph "Rocks." Margaret Riswold, assistant professor, won first prize in the weaving class with a Fortsman wool fabric for a man's overcoat, and second prize with a Strook beige and brown suit material.

Margaret Lecky, lecturer, took first and second prizes in the bookbinding classification. Arthur Adair, lecturer, was awarded third prize in the ceramics division for a red bowl.

CALIFORNIA SCHOOL OF FINE ARTS

Courses in the technical arts associated with film making and play production have been added to the curriculum and will be taught by Arch Lauterer, nationally known set designer, and Sidney Peterson, noted director and producer.

Day and evening classes are now being offered for the Fall and Winter terms in painting, sculpture, graphic arts, design for commerce and industry, and photography. Some thirty-seven instructors comprise the staff.

RARE COLLECTION ON EXHIBIT

Miniatures, water colors, and drawings of the late Kate Chandler-Thomson, V.P.R.M.S., F.R.S.A., have been placed on display in Studio 12 of the Studio Building, 1367 Post Street in San Francisco.

(See page 33)

Planning The Development of the Smaller Community

By **CARL W. HOGG**

Vice-Chairman, Long Range Planning Commission, Chamber of Commerce,
Salem, Oregon

The subject of planning the development of the smaller community was given an important place on the program of the Businessmen's Conference on Urban Problems, which was recently held in Detroit, under the auspices of the Chamber of Commerce of the United States.

Within the past few years the idea of exercising organized foresight, guidance, and control over the growth and development of our cities and towns has received wide acceptance. It is recognized that many of today's municipal headaches have their roots in the unplanned, haphazard way in which our communities, like Topsy, have "just growed up."

But while the idea of planning is readily grasped, detailed methods of making this planning effective are still being perfected. That is particularly true in the smaller community. The metropolis has vast resources; it can set up and maintain a planning commission staffed by trained experts with less strain upon its annual budget than would be involved in the full-time employment of a single planner by the small town.

Nevertheless, a surprising amount of planning is being done in the smaller population centers. As an illustration, the League of Wisconsin Municipalities recently published a list of 81 cities and 45 villages in that state known to have planning commissions. Tennessee is another state that has been very active along this line. And all over the country, other examples could be cited.

Underlining the importance of planning for the smaller community is the increasing tendency of American industry to decentralize its production

facilities. A recent study by the National Industrial Conference Board reveals that of all manufacturing plants established during the period 1940-1947, only one-third were located in cities of 100,000 population and over, and almost one-third were placed in towns of 10,000 or less. A number of industrial corporations accept decentralization as a considered policy.

Principles Established

At the opening session of the 1947 Businessmen's Conference on Urban Problems we learned, among other things, that a community plan should be rigid enough to resist thoughtless or selfish variations, yet flexible enough to adjust itself to new and unforeseen developments. We learned that a planning commission should have a detached viewpoint free from the detail of administrative duties, yet should maintain close liaison with the operating departments of the local government. We learned that proper attention to public relations is a very important function of a planning commission, so that the general public will not only be familiar with the plan, but will feel that it has taken part in its development. We learned that commission members should be a cross-section of the community, with emphasis on leadership and vision. We learned that making the community a better place in which to earn a living is fully as important an aim as making it a better place in which to live. And finally, we learned that the job of planning cannot be done once and for all, but must be a continuing process.

Applying these principles, and others that will

(See page 45)



**Simplicity is Effective In This Entrance With Southern Colonial Design
Faithfully Detailed.**

Percy D. Bentley, Architect



Quiet Dignity is a Fitting Theme for this Unique Veteran's Memorial Building.

Unique In The West

Veteran's Memorial Building

EUGENE, OREGON

By **ARTHUR W. PRIAULX**

Probably one of the most distinctive and unique living war memorials built in the west is the Veteran's Memorial Building just completed at Eugene, Oregon, at a cost of \$100,000 and designed by Percy D. Bentley.

Architect Bentley's problem was to design a structure that would provide lodge rooms, club and lounge facilities, dining rooms and offices for all of the veteran's organizations of the community and still avoid the appearance of a public building.

By using a modified southern colonial design he achieved the desired effect and utilized a style of architecture which is purely American and ideally suited for a veteran's memorial building. He has

kept his lines and overall design in tasteful simplicity which gives a warm dignity to the building without austerity. There is a daintiness about the exterior which lends additional character yet the whole atmosphere is distinctly masculine.

The front elevation viewed from Willamette Street creates a striking appearance located, as it is, just on the edge of Eugene's main business district. A two-story portico runs the full length of the 135-foot-long structure. It is supported by a series of columns made up of laminated wood and housed. The cornices and columns are colonial in design and detail.

Under the covered ambulatory is a full length cement porch. A charming, yet simple double-



Native Oregon woods are used and featured throughout the building.

This entrance hall stairway which leads to the upstairs and the main Lodge Hall is an excellent example of the Architect's effective use of dignified simplicity.

Auxiliary Hall, storage lockers, and other utility areas are also located on the second floor.

The Architect's Floor Plans (below) shows how complete all space was utilized.

entrance door, in colonial detail, forms the main entrance and is in the exact center of the building. Green-shuttered French doors open from the ambulatory into rooms which face the front of the building and shuttered windows directly beneath the portico, opening into second-floor rooms, continue the colonial theme.

Throughout the building Architect Bentley has

utilized native woods in halls, main public rooms and lounges. A colonial detailed stairway, in the true tradition of the style, winds up from the main entrance hall, is built of Douglas fir lumber. Walls of the main entrance and the stair well are in checkerboard plywood panels 16 by 16 inches, with grain of wood of alternate panels at right angles to give the checkerboard effect. All wood

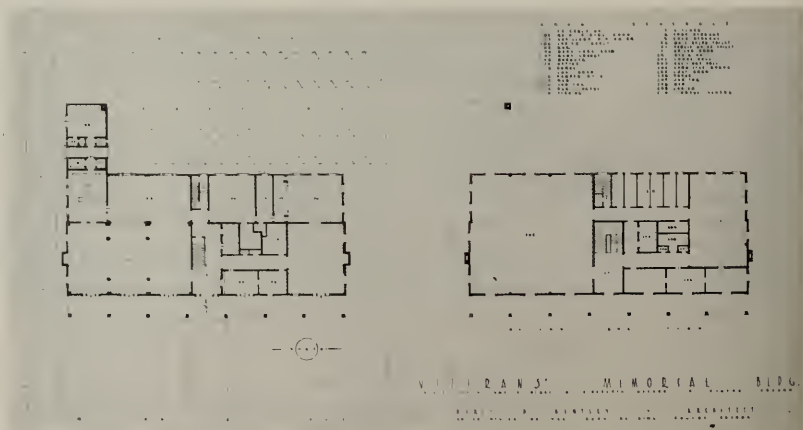

RIGHT: The Women's lounge has been done with a colonial detail throughout and large wood wall panels.

BELOW: West Coast Hemlock paneling, a fireplace, and a distinct atmosphere of warmth and coziness features the Men's Lounge.

Both lounges are located on the First Floor.



has been stained in natural color.

One of the charming rooms in the building is the main dining room which opens to the left of the entrance hall. A large fireplace occupies one end of the 30 by 60 foot room which also has been finished in 24 by 24-inch plywood panels. Exposed beams, which have been housed, and which are supported by structural wooden columns, are an interesting feature. The room has been done in a

soft grey which lends a quiet dignity to the dining atmosphere. All lighting is semi-indirect. A modern kitchen adjoins the dining room and facilities have been installed so that 400 patrons can be served at one time.

Handily located at the rear of the main floor is a large ladies lounge which is plastered and finished with wood panel strips. A colonial detailed cornice has been used in most of the lower floor



VETERAN'S MEMORIAL . . .

rooms, which was specially selected to conform to the main theme of the building.

Reached by a short hallway from the main entrance lobby and at the opposite end of the building from the dining room is the men's lounge and club room. A very large fireplace occupies the main wall of this extraordinarily home-like room. The walls are random width West Coast hemlock panels finished in a natural color with a slight stain effect.

Adjoining the men's lounge is a cocktail lounge which is masculine and country-clubbish. The cocktail room can be entered from the ladies lounge. This room has been done in Western red cedar panels of random width and finished in natural color. Rough, fir ceiling beams add to the general effect. Bar and backbar have been built of walnut. As in the other lounge rooms, Architect Bentley has obtained a warmth and intimacy

in the cocktail room which is agreeably noticeable.

Offices, rest rooms, coat rooms and telephone booths open off the short hall which leads to the men's lounge on the main floor. The entire ground floor is a cement slab covered with asphalt tile flooring. A 20 by 30 foot central heating plant, oil fired, supplies hot water for panel heating units incased in the cement floor for the downstairs rooms. The second floor is heated by strip radiation with heating units in the baseboard.

Another attractive room is the main lodge hall on the second floor. It is 60 by 60 feet and is large enough for dances, meetings of the various veteran's organizations and public gatherings. Feature of this room is the curved-arch ceiling, supported by glued-up, laminated wooden trusses built on a 60-foot radius. All glued-up trusses were fabricated by Timber Structures, Inc. Walls are of plywood panels and the maple floor has been constructed

The Main Dining Hall Has Utility as Well as a Calm Atmosphere





Exposed Fir Beams and Natural Wood Panels are a Feature of this Cocktail Lounge and Utility Recreation Room.

on a spring design built up of three layers of 1 by 2 inch wooden spring strips laid on the floor joists with each layer diagonal to the one directly beneath.

A smaller, 30 by 50 foot, ladies lodge hall occupies the opposite end of the second floor. It, too, has an arch ceiling with smaller glued-up laminated trusses on a 30-foot radius supporting the ceiling. Walls have been papered over plywood to give the woman's touch to this room which is used by the various veteran's auxiliary groups. Semi-indirect lighting has been very effectively used in both lodge rooms.

Besides the two lodge or meeting rooms on the second floor, there are six property and paraphernalia rooms, three officers rooms, coat rooms, rest rooms and additional telephone booths. Every effort has been made in designing the building to provide complete utility and usability. Rooms are comfortable and large and none of them resemble the typical facilities in the average public building. There is more an atmosphere of the very large home or the country club about the entire establishment.

In addition to the rather unusual front elevation, the architect has utilized native soft woods elsewhere in an attractive manner. Side and rear exterior walls of the structure have been finished in vertical grain, Western red cedar siding and the entire exterior of the building has been painted in white, broken only by the green shutters around front windows and French doors under the ambulatory. The roof is of cedar shingles and unpainted.

When the Eugene living war memorial idea was first discussed, the veteran's group decided they wanted to build something that would be permanent, would be a useful addition to the city's life and at the same time would be a fitting and lasting memorial to all veterans of World War II. Athletic fields, swimming pools, parks and similar installations were considered, but, finally the American Legion determined that a memorial building should be built which would be completely functional, used every day of the year and would fill a definite void in the community where public buildings for special groups like the vet-

VETERAN'S MEMORIAL . . .

erans were lacking. The American Legion originally sponsored the memorial building. They raised funds for the purchase of the centrally located property on which the structure now stands. Other veteran's groups and civic organizations gave them a hand in the financing. Now that the building has been completed it has been turned over to all veteran's organizations for their use and management.

Probably nothing else more clearly emphasizes

the popular support and backing of this project than the fact that no general contractor was employed to erect the structure. Lumber manufacturers, plywood manufacturers and other suppliers donated considerable of the material. Legionnaires, skilled in the building trades, were on the job from the day the first yard of cement was poured. Spark plug of the entire project for the Legionnaires was Frank Strong, a Eugene businessman, who died recently, just before the building was completed.

Glued Trusses Lend Height and Large Lighting Fixtures Furnish Ample Lighting for this Spacious Public Meeting Room.



To him belongs much of the credit for pushing along the early financing and taking care of the hundreds of details which develop in constructing a building of this size.

Architect Bentley assumed much more of the load of supervision and direction of actual construction than an architect normally would be called upon to do, because of the unusual manner in which the building was constructed without general contracting direction.

In the short space of time the Veteran's Memorial Building has been opened it has become a popular meeting place not only for veterans but for their friends and non-veteran groups. Organizations, other than veterans, may use the meeting rooms, and a small charge is made to care for actual up-

keep and expense of building maintenance. It is expected the building will become self-supporting through income from dining room and cocktail lounge and small service charges for room rentals.

So many veterans and businessmen had a hand in building the Veteran's Memorial building, watching each detail of construction as the splendidly designed edifice rose from its cement base, that it probably has attracted more widespread individual interest from the start than most modern buildings enjoy. Certain it is that Eugene is mighty proud of its newest public building and it is one of the outstanding tourist attractions, even though lawns and landscaping have not been completed.

Distinction is Added to this Smaller Meeting Room by the use of Small Trusses, Inconspicuous Lighting Fixtures and Wall Design.



ANGLO CALIFORNIA NATIONAL BANK



DISTINCTIVE, MODERN, NEW BANK
Oakland, California

Anglo California National Bank

MARKS A NEW ERA IN WEST
COAST BANKING PRINCIPLES OF
CUSTOMER FACILITIES AND SERVICE

Oakland, California

One of the most modern and distinctive banking offices in the United States, and the only one of its kind on the Pacific Coast, was opened for public inspection recently when the Anglo California National Bank held a preview of its new Oakland Main Office at Fifteenth and Broadway.

The bank, formerly at 1560 Broadway, opened for regular business at the new location at 10:00 a. m. on Monday, September 20. The move to

larger quarters was made necessary by steadily increasing business reflecting the rapid growth of Oakland and the East Bay Area.

An outstanding feature of the new quarters is the main banking room, located on the second floor and served by a new, modern electric stairway of the latest type, capable of carrying 6000 persons per hour each way. Two large collective-control elevators, as well as regular stairways, are also



H. H. Winner
Architect

Attractive New Building with Entrance Facing on Broadway.



BEFORE: Located at Fifteenth and Broadway in the heart of downtown Oakland (California) the building was occupied by a variety of merchandising establishments with numerous style store fronts.

AFTER: New architectural design is synonymous with strength and dignity of a great financial institution which occupies second floor of the building while new store fronts are correlated to balance of structure.



provided. The decision to adopt this unique "above-the-street" plan was partly motivated by the bank's wish to avoid breaking the continuity of retail business in the heart of Oakland's downtown shopping district, which usually occurs when a large bank locates on ground level. It was equally felt that the elevated design would afford the bank's customers greater quiet and spaciousness than the conventional ground-floor arrangement.

The work of converting the original two-story and basement building, occupying a plot 101 feet on Broadway by 125 feet on Fifteenth Street, began in July, 1947. The structural portions of this building were of reinforced concrete. A mezzanine, third floor and roof of steel and reinforced concrete construction were added to the original building.

Banking facilities are located on all four levels of the enlarged and modernized building. The im-

**ANGLO CALIFORNIA NATIONAL BANK
Oakland, California**

The following firms, participants in the construction of the new Anglo California National Bank, have display advertisements in this issue:
 Architect: H. H. Winner.
 General Contractor: Stolte, Inc.
 Vault Doors, Deposit Boxes and Burglar Alarm: Herman Safe Company.
 Aluminum Railings, Chrome Bronze Screens: C. E. Toland Company.
 Work Area Lighting: Hub Electric Company.
 Bank Fixtures: Mullen Mfg. Co.
 Rubber Tile and Linoleum Floors: Armor Tile Company.
 Electric Installation & Fixtures: Del Monte Electric Co.
 Ceramic Veneer: Albert Hallert.
 Plastering, Furring and Lathing: Bay Plastering Co.
 Ceramic Veneer & Terra Cotta: N. Clark & Sons.
 Painting and Decorating: D. Zelinsky & Sons.
 Photographs: Commercial Studios—Westinghouse Electric.

Portion of Second Floor Main Banking Rooms with Tellers Windows in Background.





UPPER: Commercial tellers' windows are well lighted and convenient.

BELOW: General view of main banking rooms, showing a portion of the officers' area in the foreground.

posing entrance is at ground level, the deposit vaults are located downstairs and the mobile contract department is on the third floor. The main banking room has a clerestory and is two stories high.

Contemporary in architectural design, the interior of the building is characterized by clean lines and simplified ornamentation. The walls are finished with adhesive ceramic terra cotta in a warm deep ivory tone.

The entrance consists of three sets of plate glass doors with large plate glass windows overhead up to a height of 18 feet above the threshold.

Extruded steel window frames are used throughout.

Delicately veined Botticino marble from Italy of a soft color is used for the walls of the foyer, elevator corridor, the counters, top screen railings. Belgian black marble is used for trim and bases.

The entrance lobby is decorated with two photomurals, showing aerial views of the Ocean





Main Banking Room—Head of Electric and Regular Stairways in Center. Stairway to Third Floor at Right, and Elevator to all Floors at Extreme Right.

metropolitan area, printed in sepia, set in a shallow recess on each side of the lobby with a narrow stainless steel frame.

Floors in the foyer and the stairways are of travertine. Tile is used on the floors of the safe deposit department, rubber tile on the second and third floors. Travertine is laid tile-pattern in front of the entrance, with a ribbed tile sidewalk extending to the curb.

Metal work on the electric stairways and stair railings is of aluminum, with alomalite finish; on top screens and wickets of bronze with satin chromium finish.

Woodwork is of straight-grain white oak, finished in a warm light tone to match the furniture. Walls are finished in a mottled and stippled effect to harmonize with the marble.

Counters with low glass screens in metal frames are used throughout in place of the traditional tellers' cages. There are twenty-six service windows on the main banking floor. Handsomely ap-

pointed lounges are provided for customers and there are also lounges and a lunch room for members of the staff.

Modern lighting fixtures are used for the foyer and clerestory ceilings, fluorescent fixtures for the main banking floor ceilings, fluorescent and incandescent elsewhere. Illuminated directional and departmental signs of an original design, made of thick engraved lucite plates edge-lighted on all sides by concealed neon tubing, with satin-finish chromium plated bronze bases, are placed at strategic points.

The bank is acoustically treated throughout, reducing to a minimum the noise usually associated with a busy bank.

The heating system is steam, with copper convectors. Ventilation is of the forced-air type with blowers for induction and eduction.

Approximately 26,650 square feet of floor space in the building are devoted to banking purposes. Of this area, 12,000 square feet are devoted to the

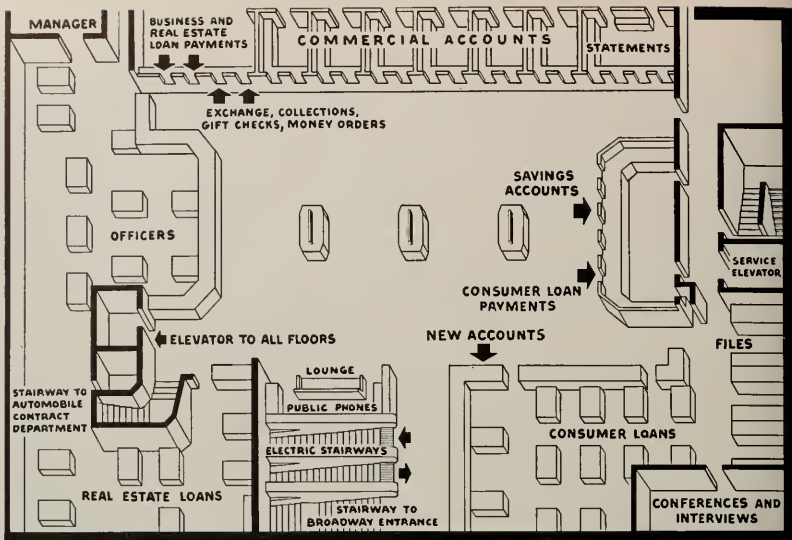

Artists Guide to the Various Banking Departments of the New Anglo California National Bank Showing Location of Each Department, Stairways, and Elevators.

STOLTE INC.

GENERAL CONTRACTORS

ANGLO-CALIFORNIA NATIONAL BANKS
 15th & Broadway, Oakland
 E. 14th & 35th Avenue, Oakland
 2295 Shattuck Avenue, Berkeley

8451 SAN LEANDRO STREET • OAKLAND

Telephone TRinidad 2-1064

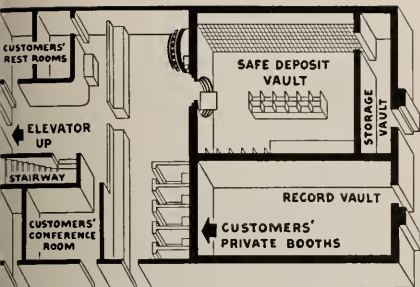

DRAWING AT LEFT shows location of Safe Deposit Vault and Customer Conference Rooms, Rest Rooms and Private Booths. The vaults are protected by steel and concrete and latest automatic safety devices.

DRAWING BELOW shows plan of the Contract Department which is located on the Third Floor. A complete service for automobiles, industrial machinery, and household is maintained here.

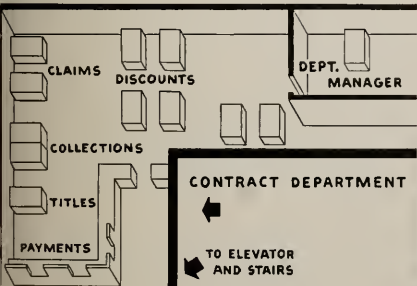

CHROME BRONZE SCREENS & WICKETS and ALUMINUM RAILINGS

in

Anglo-California
National Bank, Oakland

Manufactured and Installed by

C. E. TOLAND COMPANY
METAL CRAFTSMEN
334 RITCH STREET • SAN FRANCISCO

VAULT DOORS — SAFE DEPOSIT BOXES
TELLERS COIN LOCKERS

Also

FEDERAL GRADE-A-BURGLAR ALARM

Furnished and Installed by

THE HERMANN SAFE CO.

Since 1889

HOWARD & MAIN STS.

SAN FRANCISCO, CALIF.

ANGLO CALIFORNIA BANK . . .

main banking floor, 13,750 square feet to the departmental areas, working space and staff facilities on other floors, and 900 square feet to the ground-floor entrance.

A feature of the safe deposit vaults is the huge vault door, nine feet in diameter, 22 inches thick and weighing 70,000 pounds, said to be one of the heaviest, if not the heaviest, in the West outside of Government and Federal Reserve Bank installations. The vault door is equipped with a double combination and quadruple time lock, as well as a thermostated burglar alarm that reacts immediately to the touch of an acetylene torch. The door is fitted to the door frame with such precision

WORK AREA LIGHTING

ANGLO-CALIFORNIA NATIONAL BANK

15th & Broadway, Oakland

H. H. Winner, Architect—Chas. Von Bergen, Elec. Engr.

Fixtures

Designed and manufactured by
HUB ELECTRIC COMPANY
Chicago

Resident Engineer, JAMES MUNDSTOCK
320 Market Street, San Francisco

Other Resident Engineers: F. C. HENKEL, Portland;
WM. A. MCGUIRE, Los Angeles; GLENN B. GAER, Denver.

BANK FIXTURES

ANGLO-CALIFORNIA NATIONAL BANK
OAKLAND

FURNISHED AND
INSTALLED BY

MULLEN MFG. CO.

Bank, store and office fixtures.
cabinet work of guaranteed
quality, church seating.

Office and Factory
60-80 Rausch Street, San Francisco
Telephone: UNderhill 1-5815

that the bolts could not be thrown if a heavy line of dust were allowed to accumulate in the ridges and is so well balanced that it can be opened and closed by one person in spite of its tremendous weight.

Another feature is the depressible platform which allows level access to and from the vaults



Giant modern Vault Door in the safe deposit department of the new Anglo California National Bank in Oakland. The door is 22 inches thick, 9 feet in diameter, and weighs 70,000 pounds.

PAINTING and DECORATING

Anglo-California Bank
Oakland



D. ZELINSKY & SONS
SAN FRANCISCO • LOS ANGELES
"Leaders in the Painting Industry"

YES -- ARMOR TILE CO.

furnished the
RUBBER TILE AND LINOLEUM FLOORS and
SHEET RUBBER SIDEWALK
for the new
ANGLO-CALIFORNIA NATIONAL BANK
15th and Broadway, Oakland

ARMOR TILE CO.

1101 MacArthur Blvd.

San Leandro



The vertical brackets alongside the electric stairway tracks support the balustrade on which the handrail travels. Both stairways are reversible; they can be set for up-going traffic on right with down traffic on left (See photographs on Page 29).

It takes a lot of work and equipment to install a modern electric stairway and pictured here is the first pair of step axles which form a continuous moving chain that returns back underneath the upper moving surface. The heavy welded truss on the bottom carries the load with step roller tracks on each side. Flanking the tracks, foreground, are big sheaves for guiding the flexible rubber handrails.

CERAMIC VENEER

on the new Anglo-California
National Bank, Oakland, by

ALBERT HALLERT

Masonry Contractor
2500 Sixty-fifth Ave., Oakland
SWEETWOOD 8-1047

PLASTERING FURRING LATHING

IN THE NEW
ANGLO-CALIFORNIA NATIONAL BANK
15th & Broadway, Oakland

by

BAY PLASTERING CO.
8451 SAN LEANDRO STREET
OAKLAND, CALIFORNIA
Phone TRinidad 2-1064

ELECTRIC WIRING and FIXTURES in

ANGLO CALIFORNIA NATIONAL BANK
OAKLAND

DEL MONTE ELECTRIC CO.
8275 San Leandro St., Oakland, Cal.

and eliminates the outmoded ramps.

Elwood J. Schmitt, vice president and manager of the office, heads a staff of 85. A complete banking service is rendered.

Anglo Bank, now in its seventy-fifth year, has resources in the neighborhood of half a billion dollars

and serves some 185,000 depositors through twenty-four offices in the San Francisco Bay area and the Central Valley. Other East Bay offices are located at East Fourteenth Street and Thirty-fifth Avenue, opened last December, and at Shattuck Avenue and Bancroft Way, Berkeley.



CERAMIC VENEER HELPS MAKE BANKING HISTORY!

The new Oakland office of the Anglo-California National Bank is making West Coast banking history. It is the first example here of a new concept in banking office design.

Helping to carry out this ultra-modern concept, *Adhesion Type* CERAMIC VENEER Terra Cotta was chosen for the facing material of both facades. This material was chosen not only for beauty and modern dignity in design, but even more for permanence and ease of maintenance. Consideration as a sound investment by a firm long-experienced in building economy is valued testimony on behalf of our product.

... For complete information and details, write

N. CLARK & SONS

Division of

Pacific Clay Products

605 MARKET STREET • SAN FRANCISCO 5, CALIFORNIA

H. H. Winner, *Architect*
Stolte, Inc., *General Contractor*

Recent Contracts also using CERAMIC VENEER . . .

Nudelman Bros. Building
Portland, Oregon
Engineers' Building
Oregon State College
Pacific Telephone &
Telegraph Co.
Roseburg, Oregon
Mapes Hotel
Reno, Nevada



Los Angeles
Portland
Salt Lake City



OPENING ceremonies on September 18, 1948, in bank foyer, with Mr. Allard A. Calkins, President, cutting the ribbon at the foot of the electric stairway leading to the second floor main banking facilities.



PATRONS take the electric stairway upstairs to "save" and do their banking the easy way.

Joseph Magnin Company, women's wear retailers, has leased space in the building for its Oakland store and will occupy the ground floor, other than the portion used for the bank entrance, and also the mezzanine and part of the basement.

Architect for the new building is H. H. Winner of Ross, Stolte, Inc., of Oakland is the general contractor and James M. Smith of San Francisco the structural engineer.



Gift Subscription For Christmas 1948

As a service to its readers **GIFT SUBSCRIPTIONS** to **ARCHITECT & ENGINEER** magazine are available for this year's Christmas giving.

REGULAR SUBSCRIPTION Rate will apply:

United States and Pan America

\$3.00 a year; two years \$5.00.

Foreign countries \$5.00 a year.

**PLEASE SEND ARCHITECT & ENGINEER
AS A GIFT To:**

name..... occupation.....

address..... city..... zone..... state.....

Sign my gift card: From.....

name..... occupation.....

address..... city..... zone..... state.....

Sign my gift card: From.....

name..... occupation.....

address..... city..... zone..... state.....

Sign my gift card: From.....

Your Name

Address..... city..... zone..... state.....

Enclosed is my check for

KAPCO
has the odds
8500 to 1...



KAPCO MEMBRANE

Recent moisture permeability tests prove Kapco membrane surpasses felt duplex paper 8,500 to 1.

OTHER ADVANTAGES:

Economical

Maximum moisture seal with minimum thickness.

Durable

Eliminates puncturing of membrane—more rigid than paper.

Easy Application

Simply overlap joints and seal with cold trowel mastic cement.



W. J. BURKE & Co.

2690 Harrison St., San Francisco 10, Calif., VA 4-6811

2257 East 15th Street Los Angeles 21, Calif. • 5416 14th Avenue N.W. Seattle 7, Washington

KAPCO UNDERLAYMENT

Waterproof

... protects sub flooring.

Moisture Proof

... prevents destruction, buckling and rotting of linoleum, rubber tile.

Cushionized

... easy to walk on.

Sound Deadening

... eliminates squeaks.

Fast Application

... easily cut with linoleum knife.

Reduces Labor Costs 50%

... Simply use stapling hammer. Available from W. J. Burke and Co. on nominal rental basis.



COVER PICTURE

Pacific Gas & Electric Power Station San Francisco

Completion this month of the Pacific Gas & Electric Company's new \$4,800,000 power station in San Francisco will mark a major step in increasing the power facilities of the city, as well as inaugurate several unique engineering features in a strictly ultra-modern building.

New 110,000-volt underground transmission cables to the Station will bring high-voltage power into the heart of San Francisco for the first time in history where the current will be transformed to lower voltages and switched into the network of distribution substations.

The appearance of dignity and strength was essential to a structure housing such a great amount of electrical energy, thus the purpose of the structure was the prime consideration in development of the design. The dignity is conveyed by the simple outline of the structural mass, and by the repetition of vertical bays along the north and south facades. The feeling of strength is incorporated principally by the use of great hand-tooled stones, massive grille, and two large sculptured panels. The panels, rendered by Robert B. Howard, San Francisco sculptor, tell the story of electricity.

The building is 200 feet long, 137 feet wide and three stories tall. The exterior is constructed of pre-cast stone in 5 foot by 7½ foot blocks. Travertine and black-green are used in the exterior walls and the base is polished black cast stone. The bas reliefs are of the same material and color as the walls. The stone surfaces are all hand-tooled.

The exterior stone work was used as forms for the pouring of concrete, the stone being held in place by bolting through the interior wooden forms. All members of the large stone grille were set in place first and then filled with concrete.

The windowless structure is artificially lighted and mechanically ventilated. The wall surface behind the grille is lighted by large floods. Each of the bays is separately lighted, and the relief panels are to be lighted by floodlights placed in black cast pylons below.

The exterior design and treatment were the work of William Gladstone Merchant, San Francisco architect. Architectural drawings and mechanical and electrical features were designed by P. G. and E. personnel, and construction itself was under supervision of the company's construction department.

BRANCH LIBRARY. Kent & Hass, San Francisco Architects, have been selected to design a \$150,000 addition to the Marina Branch Library.

FOR BETTER SERVICE

Remember that

KRAFTILE is
WESTERN HEADQUARTERS
FOR

- ▶ ACID Brick
- ▶ ACID-PROOF Jointing Compounds
- ▶ ACID-PROOF Floor and Tank Construction
- ▶ ACID-PROOF Coatings
- ▶ LIGHTWEIGHT CONCRETE BLOCKS
- ▶ GLAZED Structural Wall Units
- ▶ PATIO Tile
- ▶ QUARRY Tile
- ▶ SWIMMING POOL Overflow Gutter



- ▶ QUONSET Packaged Steel Buildings
- ▶ STRAN-STEEL Framing

For complete information and prompt service, phone or write

KRAFTILE COMPANY

NILES, CALIFORNIA NILES 3611
SAN FRANCISCO 3: 50 Hawthorne St.—DUgless 2-3780
LOS ANGELES 13: 406 South Main Street—MUTual 7241



Arizona Chapter:
James Macmillan, President; Arthur T. Brown, Secretary,
740 N. Country Club Road, Tucson, Arizona.

Central Valley of California:
Frank V. Mayo, President; John W. Bomberger, Vice-
president; Ivan C. Satterlee, Treasurer; William Koblik,
Secretary, 2203 13th St., Sacramento, California.

Central Coast Counties Chapter:
Birge M. Clark, President; Lisle Fred Richards, Secretary-
Treasurer; Thomas E. Elston, Jr., Chester Root and Henry
Morgan Stedman, Directors. Office, 411 Lafayette Street,
San Jose.

Colorado Chapter:
Raymond H. Ervin, President; James M. Hunter, Secretary,
2948 Broadway, Boulder, Colorado.

East Bay Chapter:
A. Lewis Kous, President; James H. Anderson, Vice-Presi-
dent; Loy Chamberlain, Secretary; Chester H. Trichel,
Treasurer, Office, 3883 Piedmont Ave., Berkeley, California.

Montana Chapter:
Ralph H. Cushing, President; H. C. Cheever, Secretary,
Montana State College, Bozeman, Montana.

Northern California Chapter:
Wm. Clement Ambrose, President; Lester W. Hurd, Vice-
President; Ralph N. Pollock, Secretary; Donald Beach
Kirby, Treasurer; Office 369 Pine Street, San Francisco.

Oregon Chapter:
Frank Roehr, President; Sidney W. Little, Vice-President;
J. Holman Baines, Secretary; Don Edmundson, Treasurer.
Office 619 Builders Exchange Bldg., Portland 4, Oregon.

San Diego Chapter:
H. Louis Edman, President; Louis J. Gill, Secretary, 203
Granger Building, San Diego, California.

Santa Barbara Chapter (California):
Winsor Soule, President; Ralph Airmage, Vice-President;
Robert Ingle Hoyt, Secretary; Lutch M. Riggs, Treasurer;
Office 116 E. Solá St., Santa Barbara, California.

CALIFORNIA COUNCIL OF ARCHITECTS
Andrew T. Haas, President; Adrian Wilson, Vice-Presi-
dent; Malcolm Reynolds, Secretary-Treasurer; Office 369 Pine
Street, San Francisco.

Southern California Chapter:
George Allison, President; A. C. Martin, Jr., Vice-President;
Anthony Therman, Secretary; George E. Gable, Treasurer;
Chapter Headquarters, 3757 Wilshire Blvd., Los Angeles 5,
California.

Spokane Chapter (Washington):
Noel E. Thomson, President; Kenneth D. Stormont, Secre-
tary, Hutton Building, Spokane, Washington.

Utah Chapter:
George Cannon Young, President; Theodore R. Pope, Secre-
tary, 29 South State Street, Salt Lake City 1, Utah.

Washington State Chapter:
Waldo B. Christenson, President; Perry B. Johanson, 1st
Vice-President; John G. Richards, 2nd Vice-President;
Hugo W. Osterman, Treasurer; and Bliss Moore, Jr., Secre-
tary, Offices 714 American Building, Seattle 4, Washington.

Tacoma Society:
Chas. Rueger, President; Clarence Rueger, Vice-President;
W. W. Durham, Secretary-Treasurer.

Hawaii Chapter:
Kenneth W. Roehrig, President; James Morrison, Secretary,
334 Federal Bldg., Honolulu, T. H.

SOUTHERN CALIFORNIA CHAPTER

The regular October meeting was held in the Elks Club, Los Angeles, and represented a joint meeting of the Chapter and the Producers Council of Southern California.

Arranged by the Chapter's Technical and Materials Committee, in conjunction with the Producers Council, the program was devoted to an exhibition and discussion of new materials and methods.

Gregory Ain, acted as chairman and conducted a Forum with many interesting and educational questions and answers being discussed.

Highlights of the recent Yosemite Convention were also reported, it being pointed out the attendance and programs being exceptionally good, to say nothing of the excellent weather.

CENTRAL COAST COUNTIES CHAPTER

Birge M. Clark of Palo Alto was chosen president of the Central Coast Counties Chapter of the A.I.A. at the annual meeting, with Lisle Fred Richards, Santa Clara, elected as secretary-treasurer. Directors named were Thomas S. Elston, Jr., of Carmel, Chester Root of San Jose, and Henry Morgan Stedman of Palo Alto.

The regular August meeting was held in San Jose with several important items coming before the membership for consideration, among them being the action of the Santa Clara County Building Inspector asking for an 8-inch exposure to the weather on shake roofs.

It was pointed out that the general practice in such construction was a 10-inch exposure.

Wayne Hertzka, San Francisco, architect and
(See Page 34)

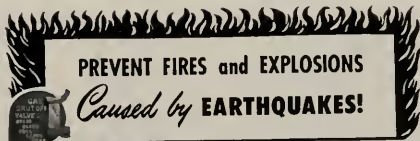

Plus a Manual Control For Other Emergencies!

SAFETY ENGINEERS and scientists say the Sentinel is the most accurate and dependable earthquake actuated shut-off valve in the world! On the job 24 hours a day! A record of more than 10 years of reliable service... **proven** during a period which included two major seismic disturbances. * Names on request

Indispensable in live seismic regions.
Recommended for use with Liquefied Petroleum Gases.
Thousands installed in the United States.
List of installations available on request.
Available at leading wholesale plumbing establishments.
Indorsed by National Bd. of Fire Underwriters.
Leading Fire Prevention Engineers Approve.

Take No Chances... Install The
SENTINEL
AUTOMATIC GAS SHUT-OFF
VALVE

Designed to shut off automatically when there's an earth shock or explosion sufficient to damage buildings or pipe lines. Listed by the Underwriters' Laboratories and specified by leading architects and engineers for installation in schools, fire stations, factories, theaters, churches, stores, municipal, military and utility buildings. A. I. A. File No. 29-F-6
Write for illustrated folder.

SECURITY VALVE CO.
410 San Fernando Rd., Los Angeles 21, California
Phone CAptol 6191

WITH THE ENGINEERS

Structural Engineers Association of Northern California

John A. Blume, President; Jesse Rosenwald, Vice President; Franklin P. Ulrich, Treas.; Geo. E. Solnar, Jr., Sec., Office, Room 215, 55 New Montgomery St., San Francisco 5, Phone SUtter 1-7642. DIRECTORS, A. W. Anderson, Henry J. Degenkolb, John E. Rinne, Robert D. Dewell, and Wm. W. Moore.

San Francisco Section

L. A. Elsener, President; A. W. Earl and G. E. Woodruff, Vice-Presidents; John E. Rinne, Secretary-Treasurer; 225 Bush Street, San Francisco 20.

Structural Engineers Association of Southern California

Steve Barnes, President; Harry W. Bolin, Vice President; Lewis K. Osborn, Sec-Treas. DIRECTORS Richard W. Ware, Geo. E. Brandow, L. T. Evans, Harold P. King, and Donald F. Shugart. Office: 202 Architects Bldg., Los Angeles 13, Calif.

Puget Sound Engineering Council (Washington)

R. E. Kister, A. I. E. E., Chairman; E. R. McMillan, A. S. C. E., Vice Chairman; L. B. Cooper, A. S. M. E., Secretary; A. E. Nicholson, I. E. S., Treasurer; Offices, L. B. Cooper, c/o University of Washington, Seattle 5, Washington.

STRUCTURAL ENGINEERS ASSOCIATION OF NORTHERN CALIFORNIA

"The Economic Trend in California" was the subject of a talk by Edwin McInnis, Trust Officer of the Bank of America, before members of the Association at their October meeting.

According to the speaker, expanding industrial and commercial activities throughout the west have been accompanied by expanded and more complete financial services, with needs of the construction industry being taken care of on a local basis rather than having to seek financial backing elsewhere.

CONVENTION. A large delegation is expecting to attend the annual convention in Santa Barbara, October 21-24, according to last reports.

NEW MEMBERS. John F. Mitchell, Arthur B. Smith, Jr., James Louise Stratta, George E. Solnar, Jr., and Robert Richard Matheu have been elected to membership. A. M. Chambliss, and Hal Colling have been elected affiliate memberships.

SIDNEY BAMBERGER

The unexpected and untimely death of Sidney Bamberger on September 18 came as a grievous shock to his many friends. His course of action was always planned to heighten the standards of ethics and service of the engineering profession, and his fine influence will not be easily replaced.

Sid was graduated from Cal Tech in 1933 and received his Master of Science in 1936. He practiced structural engineering with Mark Falk in Los Angeles, and during the recent war was chief engineer of Pollock Stockton Ship Building Company. After the war he was in the department of structural design for Kump & Falk, architects and engineers, and since 1946 he was engaged in private practice of architecture and engineering with John L. Reid under the firm name of Bamberger and Reid.

Sid is survived by his wife Sally, and three children, Tommy, Joan and Johnny.

NAMED DIVISIONAL HEAD PUBLIC HEALTH SERVICE

Edmund C. Garthe, Sanitary Engineer, has been appointed head of the Land and Air Carrier Section of the Sanitary Engineering Division of the Public Health Service, according to a recent announcement by Leonard A. Scheele, Surgeon General.

The Land and Air Carrier Section is concerned with the compliance by common carriers with the requirements of the Interstate Quarantine Regulations regarding the sanitary quality of food and drinking water served on conveyances operating

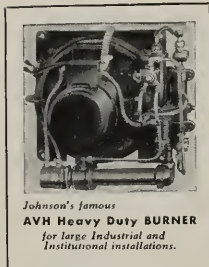

Johnson's famous
AVH Heavy Duty BURNER
for large industrial and
institutional installations.



Johnson's famous
BANKHEAT BURNER
A favorite replacement and conversion
unit.

THERE'S A TIME-TESTED JOHNSON BURNER FOR EVERY HEATING NEED!

For homes or skyscrapers . . . for hotels or hospitals . . . for water heating in farmhouses or factories . . . for intricate industrial processes . . . even for firing bake ovens and kitchen ranges . . . there's a Johnson Burner that will do the job right.

Ask your Heating Engineer . . . he knows. And he knows that "Johnson" is one of the oldest names in the oil-burner industry . . . a name that, for more than 40 years, has stood for sound engineering, fine craftsmanship and integrity.

If you want low-cost heating, dependable heating . . . find out what Johnson Burners can do for you.

... *Johnson Oil Burners* ...
S. T. JOHNSON CO.
940 Arlington Ave., Oakland 8, Calif.
401 No. Broad St., Philadelphia 8, Pa.

in interstate traffic. Sources of water used on trains and airplanes are inspected to determine compliance with the Drinking Water Standards prescribed in the regulations.

Garthe, a registered professional engineer in Illinois, is a member of the American Society of Civil Engineers, the Federal Sewage Research Association, and the American Public Health Association.

SOCIETY OF TOOL ENGINEERS MOVE INTO NEW BUILDING

I. F. Holland, president of the American Society of Tool Engineers, has announced the establishment of the association in its new building in Detroit, Michigan.

"Erecting and owning this building is typical of ASTE progress," declared Holland who also pointed out that the organization was established but 16 years ago with an original membership of seven. Today the group represents some 18,000 members and 76 affiliated chapters throughout the United States and Canada.

The new building contains 12,000 square feet and is on a 224 by 100 foot lot in Northwest Detroit. It contains general offices, facilities for national committee conferences and meetings, and staff.

TIMBER STRUCTURES MOVE OFFICES

Timber Structures, Inc., recently moved its Pacific Southwest offices from San Francisco to Oakland, where office space has been more than doubled.

The new quarters also provide a display room for models, full size sections, and photographs.

NEWS AND COMMENTS ON ART

(From page 8)

through November 30.

The exhibit includes a detailed study of the skyline of London as planned by Christopher Wren and a careful documentation of the great English cathedrals in water colors, tempera and pencil drawings.

The work is representative of architectural studies by Miss Chandler-Thompson which have been acquired for private and public collections. Her work has been purchased by the Royal Society of Arts, the Royal Water Color Society, the Imperial War Museum, and the Victoria and Albert Library.

A native of San Francisco, Miss Chandler-Thompson, lived for many years in England where she was made a Fellow of the Royal Society of Arts, one of the few Americans to hold that honor.

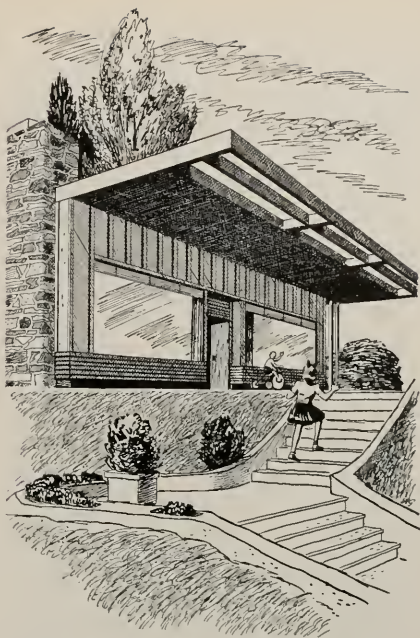

If it's really modern...it has built-in telephone facilities

Careful builders these days plan for built-in telephone conduit and outlets installed while the house is under construction. The cost is insignificant...just a few pieces of tubing leading to convenient outlet locations provide raceways for telephone wire. Thus telephones can be moved or added later on without drilling holes or running wire along baseboards. Means a lot to the future value and livability of any modern home.

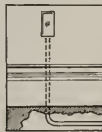

For free help in planning modern, built-in telephone conduit, call your local Pacific Telephone office and ask for "Architects and Builders Service."

The **Pacific Telephone**
 and Telegraph Company



ALWAYS SPECIFY

HAWS

Write today
for complete
information.

**Electric Water Coolers
and Sanitary Drinking Fountains**

HAWS DRINKING FAUCET CO.

1435 FOURTH STREET (Since 1909) BERKELEY 2, CALIFORNIA
Agents and Sales Representatives in All Principal Cities

A. I. A. ACTIVITIES

(From page 31)

chairman of the California Council of Architects Annual Convention, outlined the Yosemite program and urged all members to attend.

COLUMBIA UNIVERSITY

More than 50 evening courses in architecture and related subjects and six advanced day courses, leading to the degree of Bachelor of Architecture are being offered at Columbia University this year.

The courses will cover design, construction, history, planning and housing, and theory.

HEITSCHMIDT IS NAMED HEAD OF HOME SHOW

Earl T. Heitschmidt, A.I.A., Los Angeles, architect, has been named president of the Construction Industries Exposition Home Show of Southern California.

Composed of thirteen construction industry associations and the Los Angeles Chamber of Commerce, the group sponsor an annual Home Show which has developed into one of the major attractions of southern California each year, and is the largest exposition of its kind in the nation.

Other officers elected include William Curlet, Associated General Contractors of America, first vice president; J. A. Powers, president of the Mason Contractors Exchange of Southern California, second vice-president; A. L. Stone, director of the National Electrical Contractors Association, Los Angeles Chapter, treasurer; Milton J. Brock, president of the National Association of Home Builders of the United States, secretary, and D. D. Durr, executive vice-president.

EAST BAY ASSOCIATION OF ARCHITECTS MEET

The East Bay Association of Architects is participating as a group in the planning of an experimental classroom to be built in Stanislaus County to scientifically determine the best solution for natural lighting of school classrooms. This is of nation-wide interest, for authorities differ greatly on the subject. Some advocate lighting from one side of the room only, others from both sides. Even skylights have been tried. North, south, east and west light has been in turn recommended. It has been found that poor lighting directly affects the health of children through nerves and muscles as well as the eyes.

The problem was presented to the architects at a recent meeting held at the Hotel Claremont by Mr. Owen J. Cook, Director of Business Research for

Stanislaus County, who has been studying the problem for some time. It was decided to design a classroom that would have light from all sides, with movable ceiling and walls. Windows on any given side will be blacked out with shades, and the results studied with highly sensitive lightmeters furnished by the P. G. & E. Engineering & Research Department. Walls will be moved to study classroom widths in relation to windows and the ceiling pitched at various angles for light reflection.

The classroom will be actually put to use during the experiment so that it may be conducted on a practical basis as well as a theoretical one.

Dr. Chas. Bursch, Assistant Division Chief of School Planning for the State of California Department of Education, who is well known throughout the State, and Dr. Darell Boyd Harmon, authority on child welfare, Director of Educational Services of the Texas State Department of Health, will assist as consultants.

NORTHERN CALIFORNIA CHAPTER

The state convention at Yosemite has commanded major attention, although a great many phases of the profession has been considered by members at recent meetings, including the final organization and election of officers of the Coast Counties Chapter at San Jose; the San Francisco Planning Commission; the Regional Conference on Church Construction; and conferences with State of California officials on the current policies of the Department of Architecture relating to public works.

Membership continues to increase with Minord S. Thresher becoming an Associate and Rifat Parag a Junior Associate.

Members returning from the Yosemite convention are unanimous in their opinion that it was one of the outstanding conferences of Architects, and allied interests, ever held in the West.

NORTH CAROLINA STATE FORMS SCHOOL OF DESIGN

North Carolina State College of the University of North Carolina at Raleigh, has announced the formation of a School of Design with Henry L. Kamp-hoefner, formerly professor of Architecture at the University of Oklahoma, as the first Dean.

Two departments are now a part of the new school. The Department of Landscape Architecture has Edwin G. Thurlow as head, and Professors Lawrence B. Enersen and Morley J. Williams begin their second year with the college and their first in the new school.

The Department of Architecture, formerly in the School of Engineering, is being re-organized with

(See page 40)

THIS CERTIFICATE

is evidence of electrical adequacy.



The Adequate Wiring program, in operation in Northern California, includes the presentation of this impressive certificate to the owner of each qualifying home.

It is tangible evidence of electrical adequacy, assuring your client that wiring has been overlooked in the wiring plans, and providing added value for loan or re-sale purposes . . . all factors which contribute toward the owner's satisfaction with the home you have designed.

The Adequate Wiring program offers you, without charge or obligation . . . a complete wiring layout service, to aid you in furnishing your clients with electrical plans and specifications. For detailed information, consult your local utility office or this Bureau.

NORTHERN CALIFORNIA ELECTRICAL BUREAU

1355 Market Street, San Francisco 3

HEADLINE NEWS AND VIEWS

By E. H. W.

Pour-ing it on! A new product in the form of a fluid linoleum has been developed. This should save a lot of worry among amateurs who try various means of covering the floor.

Fly-by-night operators in the home building field had better flee—The National Association of Home Builders, through its Executive Vice-President Frank W. Cortright, has offered its services to Federal Housing Expediter Tighe H. Woods to assist in running "gyp" operators out of business.

New construction in August totaled \$1,785,000,000, the highest figure for any month in history—thirty-one per cent increase over August of last year.

Installation of traffic lights in San Francisco, and many West Coast cities, has long passed the point of logical planning—and now appears to be reaching the saturation point in manufacturer-city official relationships with as many as three different types of traffic lights and directional signs being installed at the same street intersection.

\$12.4 million has been appropriated by Congress for administration of the new housing act—just a token of the amount needed according to seasoned observers of the Washington merry-go-round.

The principal difference between wartime controls and those imposed by recent Congress is that goods priced under \$50 or more than \$4000 will be exempt under the new regulations. Higher down payments and shorter time in which to pay are also provided for.

Impossible—"Things to Come. Pocket alarm watch for public speakers has a self propping back and a luminous face."—Reynolds Knight in "Behind the Scenes in American Business."

A recent survey by real estate brokers shows that there is still a shortage of well located business and office space in 81 per cent of U. S. cities.

THE largest single item in an all-time high of \$1,785,000,000 of new construction for the month of August was private, non-farm home building.

LEADING manufacturers report that in most industries the dollar volume of sales during the first half of 1948 reached a new high, with an increase of about 19 per cent over the same period of last year. Bank loans to business are rising again.



E. K. WOOD LUMBER CO.

SAN FRANCISCO General Offices: No. 1 Drumm Street

LOS ANGELES Office and Yards: 4710 S. Alameda St. — JE 3111

OAKLAND Yards and Wharves: 727 Kennedy St. — KE 4-8466

PORTLAND Mill Sales Office: 827 Terminal Sales Bldg.

SAW MILLS: Roseburg, Oregon • Reedsport, Oregon

RETAIL YARDS: LOS ANGELES • OAKLAND • ONTARIO • HOLLYWOOD
LONG BEACH • RIVERSIDE • TEMPLE CITY • SIERRA MADRE • INDIRIO • THERMAL
LA VERNE • WHITTIER • PASADENA • SAN PEDRO

BAXCO

CHROMATED ZINC CHLORIDE

CZC

PRESSURE TREATED LUMBER

● PROTECTS AGAINST DECAY
AND TERMITE ATTACK

Specify it in your home
Available through Lumber Dealers

LOS ANGELES
601 W. 5th Street
Phone Michigan 6294

SAN FRANCISCO
333 Montgomery Street
Phone DOugles 2-3883

J. H. Baxter & Co.

AGENTS FOR WEST COAST WOOD PRESERVING CO. SEATTLE, WASH

IN THE NEWS

GAMING CASINO

Plans have been announced for the interior and exterior remodel of the gaming rooms and restaurant at Cal-Neva Lodge, Lake Tahoe, Nevada, at an estimated cost of \$280,000.

SCHOOL ADDITION

The B. & R. Construction Company of San Francisco have been awarded a \$317,747 contract for construction of 13-classrooms, office, cafeteria, library and multi-purpose room addition to the Jordan Grammar School in Gilroy. Frank Kump & Falk are the Architects.

TAFT SCHOOL

A 4-classroom, office, and toilet rooms will be added to the Taft School in Redwood City (California) at a cost of \$112,932. Daley & Belmont, is the contractor. Thur D. Janssen, Atherton, is the architect.

TAFT SCHOOL

The Litchfield Construction Company of San Francisco, have been awarded a \$225,880 contract for construction of additions to the Taft School in Mendocino (California).

C. A. Caulkins, Santa Rosa, is the Architect.

DEHYDRATOR

The Shatto & Lunceford Construction Company of Sebastopol (California) are building a \$100,000 dehydrator plant at Sebastopol for R. E. Oehlmann Dehydrator Company.

HOSPITAL

Plans are underway for the construction of a \$1,000,000 addition to the St. Agnes Hospital in Fresno (California). Swartz & Hyberg of Fresno are the Architects.

RESIDENCE

Architect Ralph Wastell of Oakland is doing an \$80,000 home for client in Oakland. The contractor is Robert P. Forbes of Piedmont.

HOTEL REMODEL

Architect A. Dailey, San Francisco, is remodeling the Clift Hotel in San Francisco. Jacks & Irvine have the contract for \$146,422.

Light FOR A
MILLION DOLLAR MARKET
New Smoot-Holman "Educator"
Improves Indirect Lighting
In Schools



Manufactured
under patent
No. 23-3747

Smoot-Holman's new RE 500 Educator is designed to provide "safer" light — better vision — for students in every type of classroom. The Educator's concentric rings distribute maximum effective lighting on reading and writing surfaces. The assembly of matte finished rings presents an extremely low surface brightness and eliminates the accumulation of dirt, paper wads or insects...

SIMPLE AS **A B C** TO INSTALL



MANUFACTURERS OF
FINE LIGHTING EQUIPMENT

OFFICES IN PRINCIPAL WESTERN CITIES • BRANCH AND WAREHOUSE IN SAN FRANCISCO

LANDSCAPE ARCHITECTURE

Notes of The Profession

ASSOCIATION OF LANDSCAPE ARCHITECTS, SAN FRANCISCO REGION

Emil L. Anderson, President; Vernon M. Dean, Vice-President; Ralph W. Jones,

Secretary; Paul M. Steinmetz, Recording Secretary; Prentiss French,

Treasurer. Directors at Large: Geraldine Knight Scott, Wayne

Gray, H. L. Vaughan and Douglas H. Baylis.

The City of Stockton has improved its Civic Center by the development of a Civic Center Square. A total of \$13,705.34 was appropriated for this work.

The plan for the park, which comprises one city block, is formal in design with sidewalks and beds of bright-colored flowers on a background of dark green lawn indicating the pattern.

To develop the park a deep, muddy slough was filled in, sidewalks constructed, streets paved and lighting equipment installed. Then came grading, pipe and sprinklers for the irrigation system, then the lawns and flower plantings. The flowers were in masses of blue and yellow to carry the California Centennial motif.

Arthur Cobbleddick reports that landscape operations are about to start on a new Hillsdale Apartment project in San Mateo. This five and one half million dollar project extends over twenty acres and will consist of 507 garden apartments comprising the first unit. Cobbleddick is collaborating with Architect Edwin A. Wadsworth in providing each apartment with an outdoor terrace adjoining the broader landscaped areas.

Preservation of the native oaks and laurels along Laurel Creek affords a pleasing background for the development.

* * *

Prentiss French represented the Association of Landscape Architects at the twenty-first Annual State Convention held at Yosemite Park, September 26-27-28.

* * *

The Board of Directors of the California Spring Garden Show have appointed Ned S. Rucker as show designer and supervisor for the Spring show in 1949. Rucker will be assisted by an advisory board, chosen from the Association of Landscape Architects and comprised of E. L. Anderson, President of the Association of Landscape Architects, Thomas D. Church, Theodore Osmundson, Jr., H. L. Vaughan, and Douglas Baylis.

* * *

The October meeting of the Association of Landscape Architects, held at the Claremont Hotel on October 22, was addressed by Mr. Sterling S. Winans, director of Recreation, Recreation Commission, State of California, on the subject "Recreation in California." It is obvious that the expansion of our population, and the growth of our cities, is making the problem of outdoor recreation one of great importance to all Landscape Architects, Architects, and other planners.

* * *

Professor H. W. Shepherd of the Division of Landscape Design, University of California, is on sabbatical leave through the school year 1948-49. Professor Shepherd has undertaken a study of the plants of Australia and New Zealand in their native habitat. He will collect plants and photos

(See page 44)



John Hancock Mutual Life Insurance Co. office building, Boston, Mass. Cram and Ferguson, Architects. Turner Construction Co., Contractors.

In New England's largest office building



It is only natural that architects specify Halsey Taylor Drinking Fountains for their important new buildings! Modern in design and convenience, health-safe, trouble-proof, they're the logical choice of prominent architects and builders everywhere. The Halsey W. Taylor Co., Warren, Ohio.

HALSEY TAYLOR
DRINKING FOUNTAINS

A-5

IN THE NEWS

ARCHITECT SELECTED

J. S. Gould, San Francisco Architect, has been selected to do the Excelsior Branch Library in San Francisco. Estimated cost \$125,000.

NEW THEATER

Wm. A. Teschler, contractor, has been awarded a contract for the construction of a 500-seat theater in Lakeport (California).

Vincent G. Raney, San Francisco, is the Architect.

NEW CHROMALOX ELECTRIC RECESSED WALL HEATER

High efficiency, attractive appearance and quiet operation are all features of this new Chromalox electric recessed wall heater manufactured by the Edwin L. Wiegand Company of Pittsburgh, Pa.

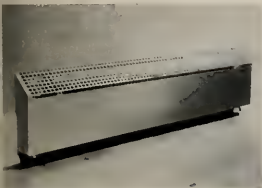

Equipped with built-in thermostat, pressure type fan with long life ball bearing motor the heater is available in 2, 3, 4 and 5 kw. for 236-volt a.c. operation. It is finished in smooth silver gray hammettone, or in neutral prime coat.

DOCTORS' OFFICES

Oscar W. Meyer, contractor, has been awarded a \$50,000 contract for the construction of a 1-story reinforced concrete and frame Drug Store & Doctors' Office Building in San Jose.

Kress & Gibson, San Jose, are the Architects.

SCIENCE

The Taft (California) Union High School District has awarded a \$632,800 contract to the Trewitt, Shields & Fisher Construction Company of Fresno, for construction of a new Science Building. Ernest L. McCoy, Bakersfield, is the Architect.

ARCHITECT MOVES

Leon Hyzen, architect and industrial designer, has moved his office to 1129 North Dearborn Street, Chicago, and is extending his practice to include architecture, store planning and industrial design.

APPOINTED

Jonathan H. Sprague, Jr., of Boston, Mass., has been appointed

a technical representative of the Monsanto Chemical Company in Washington, D. C.

CONTRACT

Allred P. Fisher, San Francisco contractor, has been awarded a \$500,000 contract for the construction of an addition to the Willows (California) High School. Maston & Hurd, San Francisco, are the architects.



BURKE and KOBER
Industrial Designers



- * VENEER
- * PANELS
- * FLASHED-PANELS
- * SPECIAL SHEETS

Unique name and design arrangement are unlimited with APCO Architectural Porcelain Enamel Veneer for exterior and interior installation. The smooth, colorful surface is ideal for light reflection... and the clean appearance is impressive and attractive. APCO lightweight porcelain enameled iron sheets offer a saving in building construction. Specify APCO Architectural Porcelain Veneer for economy, quality and permanent beauty in the buildings you are now planning. Write today for detailed information.

ARCHITECTURAL PORCELAIN CONSTRUCTORS

2827 UNION STREET, OAKLAND 8, CALIFORNIA

APCO

ARCHITECTURAL PORCELAIN

STRUCTURAL STEEL

For Class A Buildings,
Bridges, etc.

JUDSON PACIFIC - MURPHY CORP.

4300 EASTSHORE HIGHWAY
EMERYVILLE, CALIF.

FORDERER CORNICE WORKS

Manufacturers of

Hollow Metal Products • Interior Metal Trim
Elevator Fronts and Cabs
Metal Plaster Accessories • Sanitary Metal Base
Flat and Roll Metal Screens
Metal Cabinets • Commercial Refrigerators

269 POTRERO AVE.

SAN FRANCISCO, CALIF.

HEMLOCK 4100

VALUABLE NEWS SERVICE

- BUILDING MATERIAL DEALERS
- CONTRACTORS
- ENGINEERS
- FINANCIAL INSTITUTIONS

ARCHITECTS REPORTS gives advance news on construction projects in Northern California, lists: name of projects, location, architect, proposed cost and other pertinent information.

HANDY individual slip-reports, issued daily at a total cost of only

\$10 a month

ARCHITECT'S REPORTS

Published Daily

The ARCHITECT and ENGINEER, Inc.
68 Post Street, San Francisco - DO 8311

A. I. A. ACTIVITIES

(From page 35)

Mathew Nowicki, Poland's representative on the 15-man Board of Design for the United Nations Center in New York, as Professor of Architecture and acting head. New associate professors are James W. Fitzgibbon, Edward W. Waugh, and Duncan Stuart. Other members of the faculty are Assistant Professor George Matsumoto, visiting Assistant Professor Stanislava Nowicki, instructors John C. Knight and John H. Moehlman and Margaret Crosby Fitzgibbon and graduate assistant David George.

Lewis Mumford will be a member of the new staff as visiting Professor of Architecture and will spend six ten-day periods on the Raleigh campus where he will give a series of public lectures and seminars with the advanced students in Architecture and Planning. Mumford will also lecture at the University in Chapel Hall as a part of the program in the graduate department of the City and Regional Planning.

Plans are being projected to include work in Textile, Industrial, Ceramic and Furniture Design in collaboration with the schools and departments already in the College where the present work in those fields is concerned mainly with production and management. The new School of Design will coordinate those activities with the new facilities and faculties in design.

Professors Ross Shumaker, associate Professor William L. Baumgarten and assistant Professor Alexander Crane who were members of the Department of Architecture before the reorganization will continue in the new school. F. Carter Williams returns to the staff as visiting associate professor on a part time basis for the fall term.

WASHINGTON STATE CHAPTER

The October meeting was devoted to a general discussion of the St. Louis Memorial Competition by John Detlie with a critique by members of the University School of Architecture Faculty as a preliminary step toward developing local talent to win national competitions.

Competition drawings were also shown.

* * *

Clare Moffitt has been re-appointed the Chapter's representative on the A.I.A. Technical Committee.

* * *

NEW MEMBERS: Corporate Members Edward E. Sands, Thomas F. Horgis, Jr., and Edward K. Mahlum.

* * *

TACOMA ACTIVITIES: Efforts are being made to put the matter of a Civic Center on the November ballot.

ESTIMATOR'S GUIDE

BUILDING AND CONSTRUCTION MATERIALS

PRICES GIVEN ARE FIGURING PRICES AND ARE MADE UP FROM AVERAGE QUOTATIONS FURNISHED BY MATERIAL HOUSES TO SAN FRANCISCO CONTRACTORS. 2½% SALES TAX ON ALL MATERIALS BUT NOT LABOR

All prices and wages quoted are for San Francisco and the Bay District. There may be slight fluctuation of prices in the interior and southern part of the state. Freight cartage, at least, must be added in figuring country work.

BONDS—Performance or Performance plus Labor and Material Bond(s), \$10 per \$1000 on contract price. Labor & Material Bond(s) only, \$5.00 per \$1000 on contract price.

BRICKWORK—
Common Brick—Per 1M laid—\$100.00 up (according to class of work).
Face Brick—Per 1M laid—\$200.00 and up (according to class of work).
Brick Steps—\$3.00 and up.
Common Brick Veneer on Frame Bldgs.—Approx. \$1.20 and up—according to class of work.

Face Brick Veneer on Frame Bldgs.—Approx. \$2.00 and up (according to class of work).
Common Brick—\$28.50 per M.—truckload lots, delivered.
Face Brick—\$60.00 to \$90.00 per M, truckload lots, delivered.
Cartage—Approx. \$9.00 per M, Los Angeles County Area—Residential, up to 4-family or apt., metal raceways, \$6.50 per outlet.

BUILDING PAPER—
1 ply per 1000 ft. roll.....\$5.30
2 ply per 1000 ft. roll.....7.80
3 ply per 1000 ft. roll.....9.70
Brownskin, Standard, 500 ft. roll.....8.00
Siskalraft, reinforced, 500 ft. roll.....7.00

BUILDING HARDWARE—
Sash cord com. No. 7.....\$2.65 per 100 ft.
Sash cord com. No. 8.....3.00 per 100 ft.
Sash cord spot No. 7.....3.45 per 100 ft.
Sash cord spot No. 8.....4.00 per 100 ft.
Sash weights, cast iron, \$100.00 ton.
Nails, \$5.50 base.

CONCRETE AGGREGATES—
The following prices net to Contractors unless otherwise shown. Carload lots only.

	Bunker per ton	Del'd per ton
Gravel, all sizes.....	\$2.44	\$2.75
Top Sand.....	2.38	3.13
Concrete Mix.....	2.38	3.06
Crushed Rock, ¼" to ¾".....	2.38	2.94

	Bunker per ton	Del'd per ton
Crushed Rock, ¾" to 1½".....	\$2.38	\$3.13
Roofing Gravel.....	2.81	3.50
River Sand.....	2.50	3.06

	Bunker per ton	Del'd per ton
Lapis (Nos. 2 & 4).....	3.56	3.94
Olympia (Nos. 1 & 2).....	3.56	3.88

Cement—
Common (all brands, paper sacks), carload lots, \$3.02 per bbl, f.o.b. car; delivered \$3.60.
Cash discount on carload lots, 10c a bbl, 10th Prov., less than carload lots \$4.00 per bbl, f.o.b. warehouse or delivered.
Cash discount 2% on L.C.L.

Trinity White }
Medusa White } 1 to 100 sacks, \$3.13 sack warehouse or del.; \$9.56 bbl, carload lots.

DAMP-PROOFING and Waterproofing—

Two-coat work, \$8.00 per square.
Membrane waterproofing—4 layers of saturated felt, \$9.00 per square.
Hot coating work, \$5.00 per square.
Medusa Waterproofing, \$3.50 per lb. San Francisco Warehouse.
Tricosal concrete waterproofing, 50c a cubic yd. and up.

ELECTRIC WIRING—\$15 to \$20 per outlet for conduit work (including switches).

Knob and tube average \$6.00 per outlet. (Available only for priority work.)

ELEVATORS—

Prices vary according to capacity, speed and type. Consult elevator companies. Average cost of installing a slow speed automatic passenger elevator in small four story apartment building, including entrance doors, about \$8000.00.

EXCAVATION—

Sand, \$1.00; clay or shale, \$1.50 per yard. Trucks, \$30 to \$45 per day.
Above figures are an average without water. Steam shovel work in large quantities, less; hard material, such as rock, will run considerably more.

FIRE ESCAPES—

Ten-foot galvanized iron balcony, with stairs, \$250 installed on new buildings; \$300 on old buildings.

FLOORS—

Composition Floors, such as Magnesite, 50c per square foot.
Linoform—2 gages—\$3.00 per sq. yd.
Mastipave—\$1.50 per sq. yd.
Bethleship Linoalum—available to Army and Navy only—1/8"—\$3.50 sq. yd. 1/8"—\$3.50 sq. yd.
Terrazo Floors—\$1.50 per sq. ft.
Terrazo Steps—\$2.50 per lin. ft.
Mastic Wear Coat—according to type—20c to 35c.

Hardwood Flooring—

Standard Mill grades not available.
Victory Oak—T & G
1½" x 2¼".....\$252.00 per M. plus Cartage
1/2" x 2".....\$210.00
1/2" x 1½".....200.00

Refinished Standard & Better Oak Flooring
1½" x 3¼".....\$265.00 per M. plus Cartage
1/2" x 2½".....237.00 per M. plus Cartage

Maple Flooring
1½" T & G Clear \$330.00 per M. plus Ctg.
2nd 305.00 per M. plus Ctg.
3rd 255.00 per M. plus Ctg.
Floor Layers' Wage, \$2.28½ per hr. (Legal as of July 1, 1947. Given us by Inlaid Floor Co.)

GLASS—

Single Strength Window Glass.....\$.40 per □ ft.
Double Strength Window Glass......60 per □ ft.
Plate Glass, under 75 sq. ft.....1.50 per □ ft.
Polished Wire Plate Glass.....2.25 per □ ft.
Rgh. Wire Glass......60 per □ ft.
Obscure Glass......40 per □ ft.
Glazing of above is additional.
Glass Blocks.....\$2.75 per □ ft. set in place

HEATING—

Average, \$2.50 to \$3.00 per sq. ft. of radiation, according to conditions.
Warm air (gravity) average \$64 per register.
Forced air average \$91 per register.

INSULATION AND WALLBOARD—

Rockwool Insulation— (2")	\$65.00 per M sq. ft.
Cotton Insulation—Full thickness (3")	\$95.50 per M sq. ft.
Sisalation Aluminum Insulation—Foil-mounted on both sides	\$23.50 per M sq. ft.
Tileboard—4'x8' panel	\$9.00 per panel
Wallboard—1/2" thickness	\$55.00 per M sq. ft.
Finished Plank	\$69.00 per M sq. ft.
Ceiling Tileboard	\$69.00 per M sq. ft.

IRON—Cost of ornamental iron, cast iron, etc., depends on designs.

LUMBER—

No. 1 Common	\$90.00 per M
No. 2 Common	88.00 per M
Select O. P. Common	94.00 per M

Flooring—	Per M Deliv.
V.G.-D.F. B & Btr. 1 x 4 T & G Flooring	\$170.00
"C" and better—all	170.00
"D" and better—all	170.00
Rwd. Rustic—"A" grade, medium dry	150.00
8 to 24 ft.	
"B" grade, medium dry	150.00

Plywood	15c to 18c per ft.
Plycord	9 1/2c per ft.
Plywall	7c per ft.
Plyform	15c per ft.

Shingles (Rwd. not available)—
Red Cedar No. 1—\$13.00 per square; No. 2, \$10.50; No. 3, \$9.00.
Average cost to lay shingles, \$6.00 per square.
Cedar Shakes—Tapered: 1/2" to 3/4" x 25"—\$17.00 per square.
Resawn: 3/4" to 1 1/4" x 25"—\$22.00 per square
Average cost to lay shakes,—8.00 per square

MILLWORK—Standard.

D. F. \$150 per 1000. R. W. Rustic \$175 per 1000 (delivered).

Double hung box window frames, average with trim, \$12.50 and up, each.

Complete door unit, \$15 to \$25.
Screen doors, \$6.00 to \$8.00 each.

Patent screen windows, \$1.25 a sq. ft.
Cases for kitchen pantries seven ft. high, per lineal ft., \$12.00 each.

Dining room cases, \$15.00 per lineal foot.
Rough and finish about \$1.00 per sq. ft.

Labor—Rough carpentry, warehouse heavy framing (average), \$65.00 per M.

For smaller work average, \$75.00 to \$85.00 per 1000.

MARBLE—(See Dealers)

PAINTING—

Two-coat workper yard 75c
Three-coat workper yard \$1.00

Cold water paintingper yard 25c
Whitewashingper yard 15c

Turpentine.....\$1.85 per gal. in 5-gal. cont.
Raw Linseed

Oil.....\$3.33 per gal. in 5-gal. cont.

Boiled Linseed
Oil.....\$3.23 per gal. in drums.
Boiled Linseed Oil—\$3.33 per gal. in 5-gal. containers.
Replacement Oil—\$2.75 per gal. in drums.
\$2.75 per gal. in 5-gal. containers.
Use Replacement
Oil.....\$3.00 per gal. in 1 gal. cont.
A deposit of \$7.50 required on all drums.

PATENT CHIMNEYS—

6-inch	\$2.00 lineal foot
8-inch	2.50 lineal foot
10-inch	3.50 lineal foot
12-inch	4.50 lineal foot

PLASTER—

Neet wall, per ton delivered in S. F. in paper bags, \$17.60.

PLASTERING (Interior)—

3 Coats, metal lath and plaster	\$3.00
Keene cement on metal lath	3.50
Ceilings with 3/4 hot roll channels metal lath (lath only)	3.00
Ceilings with 3/4 hot roll channels metal lath plastered	4.50
Single partition 3/4 channel lath 1 side (lath only)	3.00
Single partition 3/4 channel lath 2 inches thick plastered	8.00
4-inch double partition 3/4 channel lath 2 sides (lath only)	5.75
4-inch double partition 3/4 channel lath 2 sides plastered	8.75
Thermax single partition; 1" channels; 2 1/4" overall partition width. Plastered both sides	7.50
Thermax double partition; 1" channels; 4 1/4" overall partition width. Plastered both sides	11.00
3 Coats over 1" Thermax nailed to one side wood studs or joists	4.50
3 Coats over 1" Thermax suspended to one side wood studs with spring sound insulation clip	5.00
Note—Channel lath controlled by limitation orders.	

PLASTERING (Exterior)—

2 coats cement finish, brick or concrete wall	\$2.50
3 coats cement finish, No. 18 gauge wire mesh	3.50
Lime—\$4.00 per bbl. at yard.	
Processed LLime—\$4.15 per bbl. at yard.	
Rock or Grip Lath—1/2"—30c per sq. yd.	
1/4"—29c per sq. yd.	
Composition Stucco—\$4.00 sq. yerd (applied).	

PLUMBING—

From \$150.00 per fixture up, according to grade, quality and runs.

ROOFING—

"Standard" tar and gravel, 4 ply—\$11.00 per sq. for 30 sqs. or over.
Less than 30 sqs. \$14.00 per sq.
Tile \$40.00 to \$50.00 per square.
Redwood Shingles, \$15.00 per square in place.

5/2 #1-16" Cedar Shingles, 4 1/2" Exposure	\$18.25 square
--	----------------

5/8 x 16"—#1 Cedar Shingles, 5" Exposure \$17.00 square

4/2 #1-24" Royal Shingles, 7 1/2" Exposure \$23.00 square.

Re-coat with Gravel \$5.50 per sq.

Asbestos Shingles \$30 to \$60 per sq. laid.
1/2 x 3/4 x 25" Resawn Cedar Shakes, 10" Exposure \$24.00

3/4 to 1 1/4 x 25" Resawn Cedar Shakes, 10" Exposure \$29.00

1 x 25" Resawn Cedar Shakes, 10" Exposure 22.00

Above prices are for shakes in place.

SHEET METAL—

Windows—Metal, \$2.50 a sq. ft.
Fire doors (average), including hardware \$2.80 per sq. ft., size 12'x12'. \$3.75 per sq. ft., size 3'x6'.

SKYLIGHTS—(not glazed)

Copper, \$125 sq. ft. (flat).
Galvanized iron, 65c sq. ft. (flat).
Vented hip skylights 90c sq. ft.

STEEL—STRUCTURAL—

\$220 per ton erected, when out of mill.
\$270 per ton erected, when out of stock.

STEEL REINFORCING—

\$200.00 per ton, in place.

STORE FRONTS (None available).

TILE—

Ceramic Tile Floors—\$1.70 per sq. ft.
Cove Base—\$1.35 per lin. ft.
Glazed Tile Wainscot—\$1.85 per sq. ft.
Asphalt Tile Floor 1/2" x 3/8"—\$.40 per sq. ft.
Light shades slightly higher.
Cork Tile—\$1.00 per sq. ft.
Mosaic Floors—See dealers.
Lino-Tile—\$1.00 per sq. ft.

Wall Tile—

Glazed Terra Cotta Wall Units (single faced) laid in place—approximate prices:

2 x 6 x 12	\$1.25 sq. ft.
4 x 6 x 12	1.50 sq. ft.
2 x 8 x 16	1.45 sq. ft.
4 x 8 x 16	1.75 sq. ft.

VENETIAN BLINDS—

75c per square foot and up. Installation extra.

WINDOWS—STEEL—

60c per square foot, \$5 for ventilators.

ARCHITECT AND ENGINEER

IN THE NEWS

PRESS BUILDING

J. H. Vienop, contractor of Napa, has been awarded a \$27,000 contract for the construction of a press building for the Napa (California) Daily Register. Ed. R. French, Jr., of Napa, is the Architect.

ENGINEERS APPOINTED

The engineering firm of Clyde C. Richard Kennedy, San Francisco, have been appointed engineers for the southeast sewage treatment plant to be built by the City and County of San Francisco. Construction is to be of reinforced concrete.

ARCHITECT SELECTED

Higgins & Root Architects of San Jose (California) have been selected architects for an \$80,000 addition to the Lincoln Glen Grammar School in San Jose. Construction to be of frame and stucco.

GENERAL CONTRACT for the construction of a Church and Recreation Hall for the Church of Christ of Latter Day Saints in Gridley (California) has been awarded to the File & Stoddard Construction Company of Gridley. Harold W. Burton of Los Angeles is the Architect.

NEW GRAMMAR SCHOOL at Chowchilla (California) costing

\$239,152 will be constructed by Graham & Jensen of Merced. Frank Wynkoop & Associates of Fresno are the Architects.

NEWSPAPER REMODEL. E. Normensen of San Jose (California) has been awarded an \$80,000 contract for remodel of the offices of the San Jose Mercury-Herald newspaper. Eldridge T. Spencer & the Architects.

3 IN 1-KIMSUL

INSULATION
COLD • HEAT • SOUND
PERFECTLY CONTROLLED

TREATED AGAINST FIRE, MOISTURE, VERMIN AND INSECTS. ECONOMICAL, LIGHT, EASY TO HANDLE AND INSTALL.

GUNN CARLE & CO
20 POTRERO AVENUE • SAN FRANCISCO, CALIF.

BUILDING TRADES WAGE (JOB SITES) NORTHERN AND CENTRAL CALIFORNIA

ATTENTION: The following are the PREVAILING hourly rates of compensation being paid and in effect by employers by agreement between employees and their union; or as recognized and determined by the U. S. Department of Labor. (Revised to January 1, 1948.)

CRAFT	San Francisco	Alameda and Contra Costa	Marin	Vallejo	San Mateo	San Jose	Stockton	Sacramento	Fresno
	ASBESTOS WORKERS	1.90	1.90	1.90	1.90	1.90	1.90	1.90	1.90
BRICKLAYERS	2.25	2.25	2.25	2.25	2.25	2.25	2.25	2.25	2.25
BRICKLAYERS, HODCARRIERS	1.75	1.75	1.75	1.75	1.75	1.75	1.87 1/2	1.87 1/2	1.75
CARPENTERS	2.00	2.00	2.00	2.00	2.00	2.00	2.00	2.00	2.00
CEMENT FINISHERS	2.02 1/2	2.02 1/2	2.02 1/2	2.02 1/2	2.02 1/2	2.02 1/2	2.02 1/2	2.02 1/2	2.02 1/2
ELECTRICIANS	2.25	2.25	2.25	2.25	2.25	2.25	2.25	2.25	2.25
ENGINEERS; MATERIAL HOIST.	2.00	2.00	2.00	2.00	2.00	2.00	2.00	2.00	2.00
PILE DRIVER	2.25	2.25	2.25	2.25	2.25	2.25	2.25	2.25	2.25
STRUCTURAL STEEL	2.25	2.25	2.25	2.25	2.25	2.25	2.25	2.25	2.25
GLASS WORKERS	1.87 1/2	1.87 1/2	1.87 1/2	1.87 1/2	1.87 1/2	1.87 1/2	1.87 1/2	1.87 1/2	1.87 1/2
IRONWORKERS: ORNAMENTAL	2.10	2.10	2.10	2.10	2.10	2.10	2.10	2.10	2.10
REINF. RODMEN	2.00	2.00	2.00	2.00	2.00	2.00	2.00	2.00	2.00
STRUCTURAL	2.25	2.25	2.25	2.25	2.25	2.25	2.25	2.25	2.25
LABORERS: BUILDING & CONCRETE	1.40	1.40	1.40	1.40	1.40	1.30	1.40	1.40	1.30
LATHERS	2.25	2.25	2.25	2.25	2.25	2.25	2.25	2.25	2.25
MARBLE SETTERS	2.00	2.00	2.00	2.00	2.00	2.00	2.00	2.00	2.00
MOSAIC & TERRAZZO	2.00	2.00	2.00	2.00	2.00	2.00	1.75	1.75	1.75
PAINTERS	2.00	2.00	2.00	2.00	2.00	2.00	2.00	2.00	2.00
PILEDRIVERS	2.12 1/2	2.12 1/2	2.12 1/2	2.12 1/2	2.12 1/2	2.12 1/2	2.12 1/2	2.12 1/2	2.12 1/2
PLASTERERS	2.25	2.50	2.25	2.50	2.25	2.25	2.05	2.05	2.05
PLASTERERS' HODCARRIERS	2.00	2.00	2.00	2.00	2.00	2.00	1.87 1/2	1.87 1/2	1.87 1/2
PLUMBERS	2.25	2.25	2.25	2.25	2.25	2.25	2.25	2.25	2.25
ROOFERS	2.00	2.00	2.00	2.00	2.00	2.00	2.00	2.00	2.00
SHEET METAL WORKERS	2.00	2.00	2.00	2.00	2.00	2.00	2.00	2.00	2.00
SPRINKLER FITTERS	2.00	2.00	2.00	2.00	2.00	2.00	2.00	2.00	2.00
STEAMFITTERS	2.25	2.25	2.25	2.25	2.25	2.25	2.25	2.25	2.25
STONESETTERS (MASON'S)	2.25	2.25	2.25	2.25	2.25	2.25	2.25	2.25	2.25
TILESETTERS	2.15	2.15	2.15	1.90	2.15	1.90	1.90	1.90	1.90

Prepared and compiled by

CENTRAL CALIFORNIA CHAPTER, ASSOCIATED GENERAL CONTRACTORS OF AMERICA

with the assistance and cooperation of secretaries of Building Trades Unions, General Contractors Associations and Builders Exchanges of Northern California

CLASSIFIED ADVERTISING

RATE: 20c PER WORD... CASH WITH ORDER

MINIMUM \$5.00

CONSTRUCTION ENGINEER (CIVIL) GENERAL SUPERINTENDENT PROJECT MANAGER

Twenty five years of wide practical experience on frame, steel, concrete and masonry buildings, of all types. Estimating, sub-division, sales, detailing & specification writing background. Dependable, energetic, Excellent local references. Have car. Free to travel.

P.O. Box 807, San Mateo, Calif.

WANTED: Product Engineer with experience wanted as a permanent addition to the staff of an industrial Development Department located in Minnesota. Work involves product development including travel for consumer contacts. Program relates to products from wood. Submit details education, experience, references, salary requirement, photograph.

All replies considered confidential and will be acknowledged. Reply Box 238, Architect and Engineer, Inc., 68 Post St., San Francisco, Calif.

ENGRAVING—Good engravings are essential to a satisfactory job of printing reproduction. For the best, see Poor Richard Photo Engraving Co., 324 Commercial St., San Francisco.

**CLINTON
CONSTRUCTION CO.
OF CALIFORNIA**

General Contractors

923 FOLSOM STREET • SAN FRANCISCO
SUtter 1-3440

HOGAN LUMBER CO.
Wholesale and Retail
LUMBER

MILL WORK • SASH & DOORS

Office, Mill, Yard and Docks
SECOND AND ALICE STREETS • OAKLAND, CALIF.
Telephone GLencourt 1-6861

SISALKRAFT
REG. U. S. PAT. OFF.

"More than a building paper"

THE SISALKRAFT CO.

205 West Wacker Drive
Chicago, Ill.

55 New Montgomery Street
San Francisco, Calif.

LINOLEUM

Armstrong, Nairne, Pabco, Sloane-Blabon
Linoleum, Asphalt and Rubber Tile
for any installation

FOX TILE CO.

3247 E. 14th Street, Oakland
Phone:: ANdover 1-0431

LANDSCAPE ARCHITECTURE

(From page 38)

of plants which are used in ornamental horticulture in California, or are applicable to use here. After a lengthy stay in Australia and New Zealand, Shepherd expects to continue around the world and return to California via New York in August, 1949.

The Division of Landscape Design, University of California, announces the appointment of Burton Litton as lecturer in the Division. Mr. Litton graduated from the University of California in 1941 with honors. Since that time he has spent one year at the Harvard graduate school of design; he has worked in the office of William Penn Mott in Oakland; served as a Lieutenant in the Navy and spent one year at Iowa State College where he served as a teaching assistant in the Department of Landscape Architecture. Mr. Litton will substitute for Professor H. W. Shepherd through the school year 1948-49.

As a result of a recent Civil Service examination for the position of Associate Landscape Architect by the State of California, William Seabury has been appointed to a position in the State Architect's office.

Arthur Cobblestick has been appointed to the executive board of the Association of Landscape Architects to complete the unexpired term of Wayne Gray, who, as a site planner for United Air Lines, has been transferred to Denver.

The Association of Landscape Architects announces with great regret the death on August 27, 1948, of Milton Butts in Healdsburg, California. Milton Mutts' friends in the profession, and in the allied professions, were numerous. He had an enviable professional record of employment with the Farm Security Administration from 1938 through 1940, and was subsequently engaged in private practice. His death is a decided loss to the field of Landscape Architecture and Planning.

SACRAMENTO ARCHITECT

Architect Herbert Goodpastor has announced the removal of his offices to 1812 J Street in Sacramento, California.

ARCHITECT SELECTED

The architectural and engineering firm of De, Leuw, Cather & Co., of Chicago, Ill., have been appointed to do a new central repair shop for the San Francisco Public Utilities Commission. Estimate of project cost is \$1,000,000.

SMALLER COMMUNITY

(From page 9)

be brought out, to the task of planning for the smaller community is the assignment of the opening panel session of the 1948 Conference. For this purpose, the smaller community is defined as one with a population of less than 50,000. Several of our panel members represent communities considerably below this figure.

Essentially, the planning procedure in smaller areas differs from that of the major city in scale and method rather than in principle. The primary problem, as I have already indicated, is that of ways and means money available for planning is limited. This places great emphasis upon the voluntary services of community leaders supplemented, to the extent possible and necessary, by professional consultation.

Questions for Discussion

Can an effective planning job be done in this way? That is one of the important points to be explored.

The term "planning" is fairly comprehensive. Within it we find numerous subdivisions. One of these is the zoning of land to control its use. Assuming that an effective zoning plan has been adopted, is this enough planning for the small community? That is another question which can be explored.

Another special problem met with in a great many communities is the provision of adequate parking facilities. Finding an answer to this question has a direct and important bearing upon the prosperity of its businessmen.

And, in addition, there is the problem of fringe development—the spread of urban-type homes and, in many cases, business establishments outside the legal boundaries of the incorporated city. What problems are involved in this modern trend? What type of leadership will guide us to a solution of these growing problems?

In this connection, what are the special problems of the satellite community—the town politically distinct but economically linked to a larger city?

All of these questions, and many more, tie in to the planning process in the smaller community. To solve them we must realize what a real source of power in community affairs are its businessmen—the citizens who have a tangible economic stake in its future development. To help them to supply this power in the interest of better, more realistic, and more effective planning is the ultimate objective.

ARCHITECTS MOVE

The architectural firm of Edward D. Cerruti & John B. Hudspeth have moved their offices to the Syndicate Building, Oakland, California.

PACIFIC MANUFACTURING CO.

High Class Interior Finish Quality Millwork

16 Beale St., San Francisco
GARfield 1-7755

2215 El Camino Real, San Mateo
S. M. 5-0687

304 Bryant Street, Palo Alto
P. A. 3373

2610 The Alameda, Santa Clara
S. C. 607 (Factory)

6820 McKinley Avenue, Los Angeles
THornwell 4196

MAIN OFFICE — SANTA CLARA

"AMERICAN - MARSH" CONDENSATION UNIT

Pumping
Machinery
for
Every
Purpose

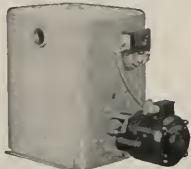

For Service
Call
DOuglas
2-6794
or
MUtual 8322

SIMONDS MACHINERY CO.
SAN FRANCISCO 816 FOLSOM
LOS ANGELES 455 EAST 4TH

VERMONT MARBLE COMPANY

Producers and Finishers
of
Domestic and Imported Marbles

525 MARKET STREET, SAN FRANCISCO
Phone Sutter 1-6747
3522 COUNCIL STREET
(Beverly Blvd. at Virgil Ave.)
LOS ANGELES 4, CALIF.
Telephone Fairfax 7834



The Most Complete Line of STEELS and BUILDING MATERIALS

Made by a Single Producer



See Sweet's Catalog File or write us for
full information.

REPUBLIC STEEL CORPORATION

GENERAL OFFICES: CLEVELAND, OHIO

DENVER, COLORADO . . . CONTINENTAL OIL BUILDING
LOS ANGELES, CALIFORNIA . . . EDISON BUILDING
SALT LAKE CITY, UTAH . . . WALKER BANK BUILDING
SAN FRANCISCO, CALIFORNIA . . . RIALTO BUILDING
SEATTLE, WASH. WHITE-HENRY-STUART BUILDING

IN THE NEWS

ARCHITECT MOVES

David Freedman, A.I.A. Architect, has moved his offices to the Commerce Building, 407 Commercial Center Street, Beverly Hills, California.

ARCHITECT SELECTED

Architect Raymond R. Franceschi of Sacramento has been se-

lected as the architect for a Veteran's Memorial Building to be built in Auburn, California, at an estimated cost of \$40,000.

MARINE HOSPITAL

Drawings are in progress by Douglas D. Stone & Lou Malloy for a \$2,500,000 addition to the U. S. Marine Hospital in San Francisco.

HOSPITAL

A fund raising drive will be conducted during November for con-

struction of a 50-bed hospital in Hanford (California) by the 3rd Order of St. Dominic. Estimated cost of the project is \$500,000 according to Swartz & Hyberg, Fresno, Architects.

NEW AIR DIFFUSER

Effective control of ceiling smudge is obtained by addition of an Anti-smudge Cone which is designed to fit snugly between the outer rim of the diffuser and the ceiling, to a KNO-DRAFT Adjustable Air Diffuser.



Immediate Steel Service

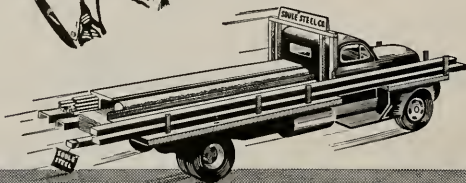

Windows and Doors



Reinforcing Commodities

Merchant Steel



Metal Lath Commodities

Steelforms

Light Steel Construction



Steeline Buildings

Phone { SAN FRANCISCO • VALENCIA 4-4141
LOS ANGELES • LAFAYETTE 0911

SS-25

Soulé STEEL COMPANY

SAN FRANCISCO • LOS ANGELES • PORTLAND • SEATTLE

FABRICATORS OF STEEL BUILDING PRODUCTS SINCE 1911



These units, available from the W. B. CONNOR ENGINEERING CORP'N, New York, require less space; provide greater latitude between ceiling opening and outside rim of diffuser; and are available from 2 to 18 inch neck diameter.

SCHOOL

The Robert McCarthy Company of San Francisco have been awarded a \$412,000 contract for the construction of a \$412,000 St. Bernard's Parochial High and Grammar School at Eureka, California. Harry J. Devine, Sacramento, is the Architect.

ARCHITECT AND ENGINEER

THE TORMEY COMPANY

**GENERAL PAINTERS
AND DECORATORS**

Phone UNDERhill 1-1913

563 FULTON STREET
San Francisco

MULLEN MFG. COMPANY

BANK, STORE AND OFFICE
FIXTURES—CABINET WORK
OF GUARANTEED QUALITY
CHURCH SEATING

Office and Factory
60-80 RAUSCH ST., Bet. 7th and 8th Sts.
San Francisco
Telephone UNDERhill 1-5815

ACOUSTI-CELOTEX

Acousti Lock Board

Nailock Channels

...for better

suspended

acoustical ceilings

WESTERN ASBESTOS COMPANY

675 Townsend Street, San Francisco 3

Telephone: HElock 1-4884

OAKLAND • SACRAMENTO • FRESNO • SAN JOSE

IN THE NEWS

BOND ELECTION

Contra Costa County voters will go to the polls November 2nd to decide issuance of \$3,000,000 in bonds for construction of new county buildings in the cities of Richmond and Martinez.

COMMUNITY HOSPITAL

Hillsborough voters will decide on November 2nd, whether to issue \$2,950,000 for construction of a 100-bed community hospital.

Architects are D. D. Stone & Lou Mulloy of San Francisco.

NEW WALL TYPE CONVECTOR

A new Wall Panel Type Convector for steam or hot water that sends a diffused warm current of air upwards over a large area has been announced by the REMPE CO., of Chicago.

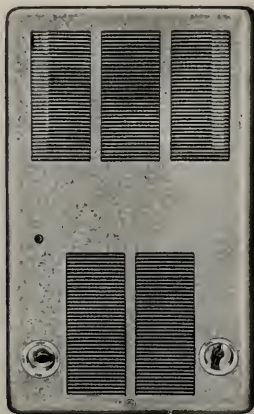

Requiring a minimum of space it is easily installed and permits persons to work close to windows in comfort. Two steel tube circuits pass through fins giving maximum heat transfer to full area of 3" wide by 6" high fins. Made in sizes from 18" to 116" in length; height 8", and depth 3".

ST. ANTHONY'S CONVENT

A contract has been awarded John F. Tulloch, Oakland, for construction of St. Anthony's Convent in Oakland. Wm. E. Schirmer is the Architect.

Phone GARfield 1-1164

Thomas B. Hunter

DESIGNER OF HEATING

AIR CONDITIONING
VENTILATING AND WIRING
SYSTEMS, MECHANICAL
AND ELECTRICAL EQUIP-
MENT OF BUILDINGS

★

41 SUTTER STREET
ROOM 710

San Francisco

California

Scott Company

HEATING • PLUMBING
REFRIGERATION

★

San Francisco

Oakland

San Jose

Los Angeles

DINWIDDIE CONSTRUCTION COMPANY

BUILDERS

CROCKER BUILDING
SAN FRANCISCO



HERRICK IRON WORKS

STRUCTURAL STEEL
REINFORCING STEEL

18TH AND CAMPBELL STS.
OAKLAND, CALIF.
Phone GLEncourt 1-1767

Mattock Construction Company

Builders



604 MISSION STREET
SAN FRANCISCO



Quality Products Since 1895
ANGIER PACIFIC CORPORATION
18 NEW MONTGOMERY ST. SAN FRANCISCO 5, CALIF.
7124 SUNSET BOULEVARD
LOS ANGELES 46, CALIF.
A complete line of Angier products available from your building material dealer

INCINERATORS TRASH BURNERS

Steel-Cased, Down-Drift Types

EXCEPTIONAL
Construction and Values

JNJ FIREBRICK CONSTRUCTION CO.

San Francisco

345 Vermont St.

UN 1-2144

PITTSBURGH TESTING LABORATORY

ENGINEERS AND CHEMISTS

Testing and Inspection of Concrete,
Steel and Other Structural Materials

Design of Concrete Mixes

Offices in all principal cities

651 Howard St., San Francisco 5
EXbrook 2-1747

Index to Advertisers

ARMOR Tile Co.	26
ANGIER Pacific Corp.	48
ARCHITECTURAL Porcelain Constructors	39
ARCHITECTS Reports	40
BASALT Rock Company,.....	Back Cover
BAXTER & Company, J. H.	36
BAY Plastering Co.	27
BURKE, W. J. Co.	30
CLARK, N. & Sons	28
CLASSIFIED Advertising	43
CLINTON Construction Company	44
CONTINENTAL Water Heater Co.	*
DEL Monte Electric	27
DETROIT Steel Products Co.	6
DINWIDDIE Construction Co.	47
DUFFY Tile Co.	48
FIREBRICK Construction Co., J. N. J. 48	
FORERER Cornice Works	40
FOX Tile Co.	44
FULLER, W. P. Co.	4 & 5
GLADDING, McBean & Co.	*
GUNN, Carle & Company	43
HALLERT, Albert	27
HANKS, Inc., Abbott A.	48
HAWS Drinking Faucet Company	34
HERMANN Safe Co.	25
HERRICK Iron Works	47
HOGAN Lumber Company	44
HUB Electric Co.	26
HUNT, Robert W., Company	48
HUNTER, Thos. B.	47
JOHNSON, S. T. Co.	32
JUDSON, Pacific-Murphy Corp.	40
KRAFTLE Company	30
MARBLE Institute of America	*
MATTOCK, A. F., Co.	48
MICHEL & Pfeiffer Iron Works	*
Inside Front Cover	
MULLEN Mfg. Co.	26 & 47
MUELLER Brass Co.	*
NORTHERN California Electric Bureau	35
PACIFIC Coast Gas Association	*
PACIFIC Manufacturing Company	45
PACIFIC Portland Cement Company ..	*
PACIFIC Telephone & Telegraph Co.	33
PITTSBURGH Testing Laboratory	48
POOR Richard Engraving Co.	*
REMILLARD-Dandini Co.	48
REPUBLIC Steel Corporation	45
SCOTT Co.	47
SECURITY Valve Company	31
SIMONDS Machinery Company	45
SIMPSON Logging Co.	3
SISALKRAFT Company	44
SMOOTH-Holman Co.	37
SOULE Steel Co.	46
STANLEY Works, The.	*
STOLTE, Inc.	24
SUPERIOR Fireplace Company	*
TAYLOR Co., Halsay W.	38
TOLAND Co., C. E.	28
TORMEY Company, The.	47
U. S. BONDS	Inside Back Cover
VERMONT Marble Company	45
WESIX Company	*
WESTERN Asbestos Co.	47
WESTERN-Holly Stove Co.	*
WOOD, E. K., Lumber Company	36
ZELINSKY, D. & Son	26

*Indicates Alternate Months

REMILLARD-DANDINI Co.

Brick and
Masonry Products



400 MONTGOMERY STREET
SAN FRANCISCO, CALIF.

Robert W. Hunt Company ENGINEERS

Inspection - Tests - Consultation
Schools and Other Structures
Are Built as Designed

When Construction Materials are
Inspected at point of Manufacture
and during Erection by

ROBERT W. HUNT COMPANY

Cement, Concrete, Chemical, Metallurgical,
X-Ray and Physical Laboratories

Chicago - New York - Pittsburgh
Los Angeles - All Large Cities
San Francisco, 251 Kearny Street

DUFFY TILE CO.

TILE CONTRACTORS
SHOWER DOORS
TUB ENCLOSURES

INSTALLATIONS
OF EVERY
DESCRIPTION
Modernizing, Repairing
"Not How Cheap
But How Good"
253 MINNA
YUKON 6-1489



ABBOT A. HANKS, INC. Engineers & Chemists

INSPECTING — TESTING — CONSULTING
CONCRETE — STEEL — MATERIALS
CHEMICAL AND TESTING
LABORATORIES

• RESEARCH AND INVESTIGATION •

TESTS OF STRUCTURAL MATERIALS
DESIGN OF CONCRETE MIXES
SHOP AND ERECTION INSPECTION OF
STRUCTURES AND EQUIPMENT
INVESTIGATION OF STRUCTURES
AND MATERIALS
TESTS AND INVESTIGATION OF
FOUNDATION SOILS
FIRE RESISTANCE AND INSULATION
TESTS

624 Sacramento Street, San Francisco

ARCHITECT AND ENGINEER

AIRCRAFT ENGINE "U" TYPE TEST CELLS — San Francisco

PEOPLE'S LIBRARY

NOV 20 1948

PERIODICAL DEPT.

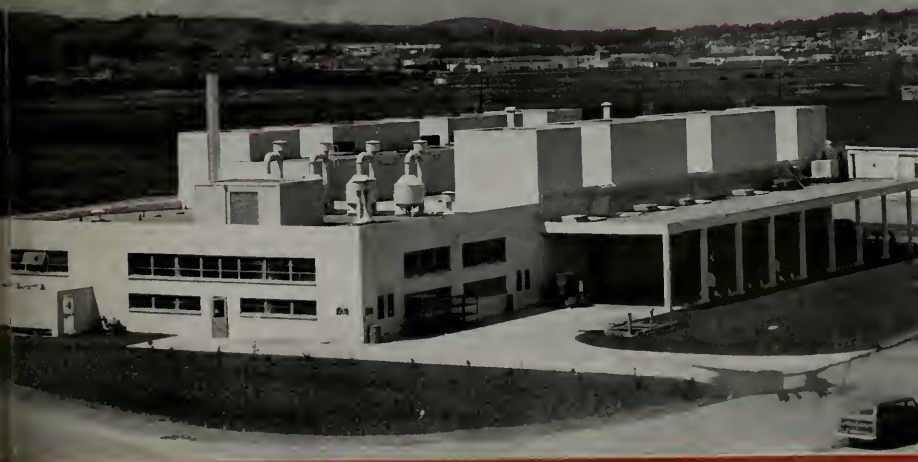

NOVEMBER

1948

MISCELLANEOUS IRONWORK



door frames
pipe rails
steel stairs
fire escapes
sidewalk doors
wire guards



Michel & Pfeffer Iron Works, Inc.

KENNETH OPIE, Manager Misc. and Ornamental Division
Tenth and Harrison Streets, San Francisco 3, California
Telephone MArket 1-5966

SINCE 1912

ARCHITECT

Vol. 175

No. 2

AND

ENGINEER

ARCHITECTS' REPORTS—Published Daily

E. H. WILDER

Editor

MARK DANIELS, A.I.A.

Associate Editor

PROF. LELAND VAUGHAN

Landscape Architecture

JOHN A. BLUME

Structural Engineering

MICHAEL GOODMAN

Planning

JOHN S. BOLLES, A.I.A.

Book Reviews



COVER PICTURE:

Illustration shows 16-foot cylindrical "U" type test cells and 108 ft. by 200 ft. reinforced concrete building designed for testing large aircraft engines at the United Air Lines Maintenance Base at the great San Francisco Airport. (See Page 22)

ARCHITECT & ENGINEER
is indexed regularly by
ENGINEERING INDEX, INC.

Contents for

NOVEMBER

EDITORIAL NOTES	4
NEWS & COMMENT ON ART	11
AURELIA REINHARDT ALUMNAE MEMORIAL HOUSE Mills College, Oakland, California. Clarence W. Mayhew, Architect	13
PLANNING AND REDEVELOPMENT OF THE LARGER COMMUNITY By WILLIS H. HALL, Chm. City Planning Commission, Detroit, Michigan	14
LIGHTWEIGHT CONCRETE CONSTRUCTION By MURRAY ERICK	15
ANNUAL CONVENTION STRUCTURAL ENGINEERS ASSOCIATION Report on Santa Barbara Conference	17
THE COUNTRY HOUSE of Mr. & Mrs. W. R. Heringer W. R. YELLAND, A.I.A., Architect	18
SURVEY SHOWS MANY NEW BUILDING PRODUCTS	21
UNITED AIR LINE MAINTENANCE BASE at San Francisco	22
A.I.A. ACTIVITIES	31
WITH THE ENGINEERS	32
HEADLINE NEWS & VIEWS By E. H. W.	36
IN THE NEWS	37, 46
LANDSCAPE ARCHITECTURE. Notes of the Profession	38
ESTIMATOR'S GUIDE, Building and Construction Materials	41
BUILDING TRADES WAGE SCALES, Northern and Central California	43
BOOK REVIEWS and Pamphlets	45
STATEMENT OF OWNERSHIP	47
INDEX TO ADVERTISERS	48

ARCHITECT AND ENGINEER (Established 1905) is published on the 15th of the month by The Architect and Engineer, Inc., 68 Post St., San Francisco 4; Telephone EXbrook 2-7182. President, K. P. Kierulff; Vice-President and Manager, L. B. Penhorwood; Treasurer, E. N. Kierulff.

Los Angeles Office: Wentworth F. Green, 6605 Hollywood Blvd., Los Angeles 28. Telephone HEMPstead 3171.

Entered as second class matter, November 2, 1905, at the Post Office in San Francisco, California, under the Act of March 3, 1879. Subscriptions United States and Pan America, \$3.00 a year; \$5.00 two years; foreign countries \$5.00 a year; single copy 50c. ARCHITECTS' REPORTS are published daily from this office. Vernon S. Yallop, Manager. Telephone DOuglas 2-8311.



They all agree

We quote....

FULLER'S NEW COLOR CONTROL PLAN

is the finest tool in the painting industry

One glance at Fuller's Color Control Plan kit (below) indicates the worth of this job-tested, profit-proved color tool.

Detail: 216 separate 11x11-inch color samples. Every color usable! Colors arranged in sequence in 6 moulded plastic cases. In addition, a supply of small swatches for each color, to leave with foremen and clients. Kit contents fitted into durable black leather carrying case.

Expensive only to Fuller. Fuller sells complete kit well below cost to Architects, Painting Contractors, Designers, Consultants. Ask for demonstration. W. P. Fuller & Co.



Fuller Color Control Plan kit as light and easy to carry as a small traveling bag!

ALLISON & RIBLE—LOS ANGELES Architects

"The forms of contemporary architecture are frequently enhanced by the skillful use of colors. Intensive studies of what color can do has brought forth many interesting new standards in commercial paint products. Most architects will welcome measures and devices which will assist them in their problems of color selection and which will tend to streamline this operation."

E. W. MOLANDER—SPOKANE of Funk-Molander-Johnson, Architects

"... a definite time saver for my clients as well as for myself, and has proven itself a worthy investment."

MILLARD SHEETS—POMONA Dean, College of Fine Arts, Scripps College

"New Fuller Decorator Colors are years ahead of any competitive colors available to the public. Their high intensity and vitality of color, greater light-proofness and amazing covering power are the reasons why I can make this statement."

ELIZABETH BANNING— LOS ANGELES and SAN FRANCISCO Color Consultant

"Mixing paintouts and waiting for them to dry is slow and costly. Big Color Control Plan paint samples save dollars for me and the painting contractor."





**Fuller's COLOR CONTROL PLAN
can cut costs on any job—**

Remember the cartoon? Painter, after umpteen paintouts, says to dear lady: "Madam, has it occurred to you that maybe there ain't no such color?"

Fuller's BIG 11 x 11-inch Color Control Plan samples break that bottleneck. Use them as "portable paintouts"—paintouts clients can handle, compare, judge color intensity, move about to match fabrics.

Exact printed formula for each color cuts expensive mixing of paintouts. Stops costly labor of matching room-batch quantity to small paintout quantities. And makes color checking the finished job practically automatic.

Furnishings courtesy of W. & J. Sloane, San Francisco

**—and makes your customers
your best salesmen**

Example: Woman wants green—"Oh, a deep green!" (There are 72 greens in this kit!) You pull out Eucalyptus or Laurel—nor all 72 greens to confuse her, but the one or two nearest her color-scheme idea. Your immediate and efficient presentation hastens her decision. After decision, give her small swatch of "her" color. She shops with it for fabrics.

It's a business-like presentation with professional equipment. Eases her mind, stimulates confidence, predisposes her to approve finished job. You gain a warm booster!



THEY ALL AGREE—

*"the finest color tool in
the painting industry"*

EDITORIAL NOTES

BUILDING COSTS

Citing United States Department of Commerce figures for residential construction put in place, the National Association of Home Builders points out that the inflationary trend of the national economy is steadily pushing the cost of residential building upward, and while the greatly increased total dollar of construction is an indication of tremendous activity in the home building field, the comparative cost of such construction has moved steadily upward.

Increased costs are to be expected with wage increases.

Transportation, general manufacturing, steel, coal and fuel, have all felt the impact of higher wage scales, and while some of these industries may not be directly allied to the construction industry, they have a direct bearing on the national economy and therefore rising costs of production have reflected higher building costs.

According to those within the building field who make a minute study of all phases of the construction industry, there is nothing in the current trend of events to indicate a drop in the costs of residential building within the foreseeable future. They support their position by pointing out the experience of a home builder in the Washington, D. C. area who recently stated "a two-bedroom bungalow which sold for \$3,000 in July of 1941, now costs \$8,150 to construct."

"Americans love to be individualists. They claim the right to be as good as any King or Prince who walked this earth. They can make their own choice as they think best. No Rulers or dictators tell them what to do."—Thomas Jefferson.

HOUSING

In Great Britain under the current Coalition Government's sponsorship, government housing is experiencing at least two important factors which should be of great interest to those in the United States who advocate a Government Housing program as the only solution to America's low-cost housing needs.

In a recent speech, Aneurin Bevan, Britain's Minister of Health, stated that the total number of homes completed or repaired in Britain since the war had reached the figure of 750,000, and that an examination of this housing figure shows some 743,513 families have been rehoused since 1945 under the postwar program by the construction of new buildings, the repair of unoccupied structures, the repair of war damaged dwellings, and the conversion of existing premises into residential uses.

Mr. Bevan does not disclose, in building support of Government housing, that nearly 20% of the homes made available to families under the program are of temporary construction, nor does he point out that the average three-bedroom house built by the British Public Housing Authority during the last year cost \$4,986 to build and that this figure is an increase of \$3,448 or more than 226% increase over prewar home construction costs.

Rents under the program, according to "official" records, have increased more than an average of \$1.00 weekly over the top rent figures anticipated by Government officials in setting up their postwar housing program, a figure admittedly well above the prewar rent level.

The reasons advanced by housing authorities for the unprecedented increase in home construction costs are that lumber prices have increased 400%, labor costs have gone up greatly, and overhead costs have risen considerably above anticipated levels.

It is interesting to note that present trends in Britain's housing program is towards the development and construction of entirely new cities rather than slum clearance where Planning Commission studies and surveys indicate innumerable complications and excessive costs.

"KNOWLEDGE is, in every country, the surest basis of public happiness", George Washington.

BUILDING MATERIALS SEMINAR COLLEGE OF THE PACIFIC

A course on Merchandising Building Materials, given 3 times previously at the College of the Pacific will be run again this Fall. Developed jointly by the Manufacturer-Dealer Coordinating Committee of the Producers' Council, Inc. and the National Retail Lumber Dealers Association this course has been included in the curricula of schools and colleges all over the country.

"The course", according to C. W. Kraft, Chairman of the Technical Information Committee of the Northern California Chapter of the Producers' Council, "includes product information, business subjects, construction and estimating and general subjects of interest to the retail building materials dealer and is designed to train dealer sales personnel."

Raymond H. Brown, a member of the Producers' Council will present the subject of Modular Coordination and George E. Solnar, Jr., Manager of the Clay Brick Manufacturers Association of Northern California will lecture on Clay Products.

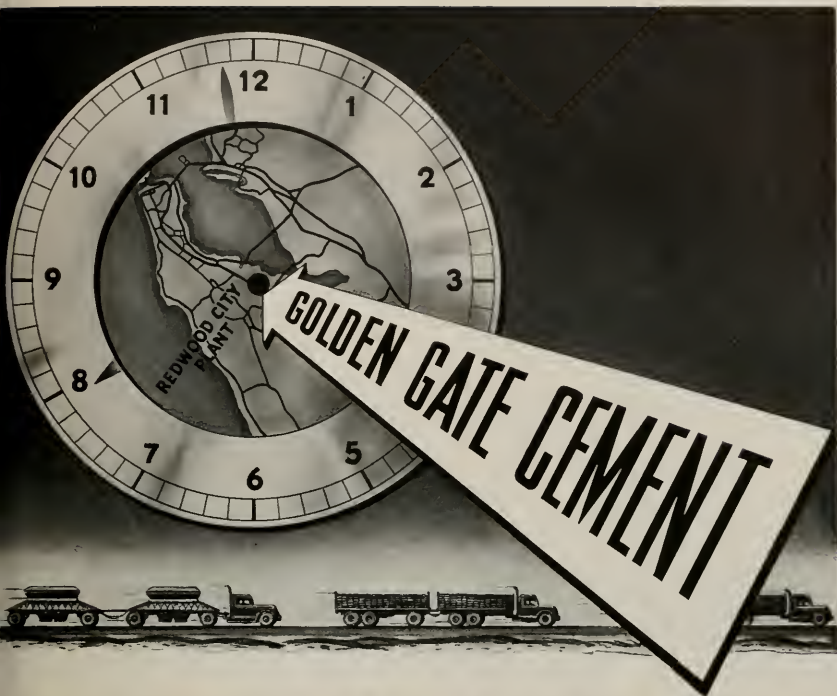

Prompt Delivery that Keeps Right Up to Schedule

With its main plant located at Redwood City Harbor, Pacific Portland Cement Company maintains "On Time" service to construction jobs throughout the Bay Area. Giant 120 barrel "bulk trucks" roll continuously like a

"pipeline of service" to dealers' batching plants—thence by truck or mixer to the project. Whether shipment is by Truck, Rail or Water—bulk or sacks—you can depend on Golden Gate Cement arriving right on schedule.

At the "Hub" of Construction



PACIFIC PORTLAND CEMENT COMPANY

Plant at Redwood City... Nearest to Bay Area Construction

The MODERN trend

This interesting example of contemporary design is from the drawing-board of one of San Francisco's best-known architects, Angus McSweeney, A.I.A. It was built in "The Uplands," Hillsborough, California, by Carl Bessett, general contractor.



Complete GAS equipment

Like the vast majority of newer-type homes, this has an automatic gas range, automatic gas water heater and other gas equipment. In fact . . .

92.8 per cent of all California city and suburban homes, old and new, enjoy the unrivaled advantages of gas fuel.

When you plan for gas and recommend gas-fired appliances, you not only assure your clients of the most modern, dependable, economical service, but also accumulate for yourself, an added measure of good will.

THE PACIFIC COAST GAS ASSOCIATION

The West Prefers

GAS

Better · Quicker · Cheaper

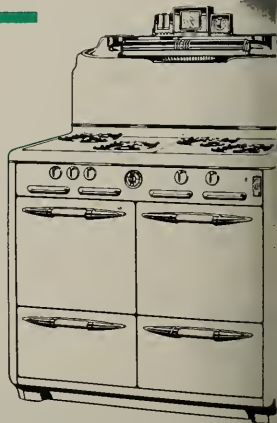
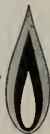

"CP" on a gas range means meets 17 minimum standards for safety, modern features and performance and that it is fully-automatic.



65%

AVERAGE SOUND ABSORPTION WITH
SIMPSON 1/2" ACOUSTICAL TILE—NO. 2 MOUNTING
(Furring Strips)



60%

AVERAGE SOUND ABSORPTION WITH
SIMPSON 1/2" ACOUSTICAL TILE—NO. 1 MOUNTING
(Cemented to solid backing)

Simpson
QUALITY SINCE 1895.

ACOUSTICAL TILE

With Exclusive HOLLOKORE Drilled Perforations

More Efficient—Mounted Either Way

Why pay more? . . . 1/2-inch Simpson Acoustical Tile gives you the absorption required to meet the minimum needs of the average room at less cost than the thicker materials formerly necessary. And Simpson Acoustical Tile with its deluxe finish and Hollokore drilled perforations also gives new beauty and style! In other thicknesses, too, Simpson Acoustical Tile leads the field in absorption, beauty and economy. Its pleasing white finish on surface and bevels stays clean longer and is easier to maintain. You give your clients *plus value* and lower costs when you call for Simpson Acoustical Tile and *specify the absorption!*

WOODFIBER DIVISION, SIMPSON LOGGING COMPANY
Plant at Shelton, Washington
SALES DIVISION, 1010 WHITE BLDG., SEATTLE 1, WASH.

decay **Protected**
termite **WITH**
PENTACHLOROPHENOL

DISCUSS YOUR ACOUSTICAL INSTALLATIONS WITH YOUR NEAREST SIMPSON APPLICATOR

ACOUSTICS NORTHWEST

Builders Exchange Bldg., Phone:
Altwater 6442, Farland 4, Ore.

ANGELES INDUSTRIES

984 McGarry St., Phone: Trinity 8121

Los Angeles 21, Calif.

ASBESTOS PRODUCTS COMPANY

1780 Keitner Blvd., Phone: Franklin

7663, San Diego, Calif.

A. H. BALDWIN

2804 East Howthorne, Phone: 2804-J

Tucson, Arizona

COAST INSULATING PRODUCTS

634 South Western Ave., Phone:

Fitzroy 1118, Los Angeles 5, Calif.

CONSOLIDATED ROOFING & SUP. CO.

520 South 7th Ave., Phone: 47888

Phoenix, Ariz.

CONSTRUCTION SPECIALTIES CO.

2026 Arapahoe Street, Phone: Alpine

4819, Denver, Colorado

CONTINENTAL LUMBER CO.

P. O. Box 237, Phone: 450

Boise, Idaho

CRAMER COMPANY

345 Vermont St., Phone: Market 1-0411

San Francisco 3, Calif.

CRAMER COMPANY

1933 Merced St., Phone: 3-1131

Fresno, Calif.

CRAMER COMPANY

1224 I Street, Phone: 28991

Sacramento, Calif.

DALE TILE COMPANY

1020 LaSalle Ave., Phone: Broadway

8831, Minneapolis 2, Minn.

ELLIOTT BAY LUMBER CO.

600 W. Spokane St., Phone: Elliott

8080, Seattle, Wash.

LUMBER DEALERS, INC.

423 N. 33rd, Phone: 3911

Billings, Mont.

MANSUR MATERIALS, INC.

E-120 Riverside Ave.

Phone: Main 1249, Spokane 8, Wash.

UTAH PIONEER CORPORATION

335 W. 1st South, Phone: 4-1717

Salt Lake City 14, Utah

WARREN SALES CO.

1211 East McDowell Rd.

Phone: 3-8975, Phoenix, Ariz.



Contractor: N. P. Severin Co., Chicago

BEAUTY . . . one of the advantages that makes **Ceramic Veneer the preferred facing material in the West!**

Clean lines, massive simplicity and warm-hued Granitex Anchored Type Ceramic Veneer facing combine to make the U. S. Court House in Seattle one of the most beautiful modern structures in the West! W. E. Reynolds, Commissioner, and Gilbert Stanley Underwood, Architect, also specified Adhesion Type Ceramic Veneer for interior walls because this machine-perfected terra cotta

is permanent, non-fading and as soil-resistant as a fine china plate.

Not only in Seattle but in all the principal Pacific Coast cities, you'll find the majority of the larger buildings faced with Ceramic Veneer. So why not investigate how this modern facing material can serve you and your clients?



GLADDING, McBEAN & CO.

CERAMIC VENEER

The modern, machine-perfected terra cotta

OFFICES AT: LOS ANGELES • SAN FRANCISCO • SEATTLE • PORTLAND • SPOKANE

NEWS AND COMMENT ON ART

SAN FRANCISCO MUSEUM OF ART

The schedule of events and exhibitions for November at the San Francisco Museum of Art, which is located in the War Memorial Building, San Francisco's Civic Center, includes:

EXHIBITIONS: Twenty-third Annual Exhibition of San Francisco Women Artists, opening November 12th; Paintings by Gordon Onslow-Ford to December 12th, and Landscape Design 1948, November 18 to December 24.

EVENTS will include programs for the children, Famous Films, and Gallery Tours.

M. H. DE YOUNG MEMORIAL MUSEUM

Walter Heil, Director of the M. H. deYoung Memorial Museum, Golden Gate Park, San Francisco, has announced the following schedule of events and exhibitions for the month of November.

EXHIBITIONS: African Negro Art, an important Loan Exhibition assembled from the foremost American public and private collections, closing November 19th; Paintings by George Grosz, close November 29th; Paintings by Lilly Cushing, Paint-

ings and Scrolls by Lo Kit-ling, and Dresses and Accessories of Goldrush Days, through November. A showing of Trends in Textile Design opened on November 6th.

On December 9th a showing of Masterpieces from the Berlin Museums, representing a collection of some of the world's great masterpieces will open. These are the famous salt mine pictures that were located by the American armies in Germany and are being exhibited in cooperation with the Department of the Army of the United States.

EVENTS: A series of lectures on Appreciation of Textiles, accompanied by illustrated slides and originals, will be given by Dr. Elizabeth Moses, Tuesdays at 3 p. m., November 9, 16 and 23.

SAN FRANCISCO CRAFTSMAN SHOW

The M. H. deYoung Memorial Museum has invited the artists and craftsmen of San Francisco and the Bay Area to submit representative works to be shown in a comprehensive exhibition of Modern Decorative Arts early in the Spring, celebrating the California Centennial.

The exhibition will include furniture, ceramics, textiles, metal work and jewelry with emphasis

A MAN ON A GREEN ISLAND Oil — 1939

Gordon Onslow Ford

From the
Exhibition
by
Gordon Onslow-Ford
at the
San Francisco
Museum of Art



being laid on the strictly contemporary design.

All entries will be submitted to a special committee and jury to be formed in the near future, and all those interested may obtain complete information by contacting Dr. Elizabeth Moses, Curator of Decorative Art at the deYoung Memorial Museum. Entries should be in early.

CALIFORNIA PALACE OF THE LEGION OF HONOR

Thomas C. Howe, Jr., Director of the California Palace of the Legion of Honor, Lincoln Park, San Francisco, has announced the following schedule of exhibitions and special events for November.

EXHIBITIONS: French Paintings from San Francisco collections, November 6-21; European Rooms in Miniature by Mrs. James Ward Thorne, through November; Mobiles and Articulated Sculpture, through November 21st; Photographs of San Francisco by Max Yavno, through November 21st.

ACTIVITIES: Art Classes for children, ages 4 to 15, each Saturday morning at 10 o'clock, with instruction by Katharine L. Parker, Lilly Weil Jaffe, and Frank Lobdell. Adult painting each Saturday at 2:00 p. m., with instruction by Frank Lobdell.

Tours of the Thorne Rooms each Tuesday and Thursday at 10:30 a. m., conducted by Mrs. Laduska Wilson, and each Friday at 2:30 p. m. by Miss Katharine L. Parker. Wednesday Gallery Tours conducted by Mrs. Lilly Weil Jaffe at 2:30 p. m. Mobiles and Articulated Sculpture, November 3rd, 10th and 17th, and Museum collections, November 24th.

Organ Programs by Uda Waldrop every Saturday and Sunday at 3:00 p. m., and Free motion pictures each Saturday at 2:30 p. m.

PORTLAND ART MUSEUM

The president and trustees of the Portland (Oregon) Art Association have announced the appointment of Thomas C. Colt, Jr., as Director of the Association.

A special exhibition of the works of Picasso, Gris and Miro, three Spanish masters, and an evening reception at the Museum recently introduced the new director to patrons of the Museum.

CITY OF PARIS

The Rotunda Gallery of the City of Paris, San Francisco, will present an exhibition of Paintings by Madame Suzanne de Tesson, and an exhibit

of Sculpture by Frances Baxier from November 10 to December 4.

Other exhibits include Pictures of the Month by Frank Marvin Blasingame, Paintings of Ships and Horses by Raffaello Montalboddi, and in the Art in Action Shop a Guatemalan theme will prevail.

ARCHITECTS IN EAST SPONSOR LECTURES

A series of lectures pertaining to Architectural Registration is being sponsored by the New York Chapter of the A.I.A., according to an announcement by Ben J. Small, Chairman of the Chapter's Education Committee.

There will be a general resume of each subject to cover the full scope of the New York State registration. The subjects to be discussed will include Architectural Design, History and Theory of Architecture, Architectural Engineering, Architectural Practice, and Equipment.

AWARDED AMERICAN LEGION EMPLOYER CITATION

The National Steel Construction Company of Seattle, Washington, has been awarded the American Legion's first nation-wide Employer Citation in recognition of its program of hiring disabled veterans.

In accepting the award Frank N. Killien, vice president of National Steel, disclosed that plans for employing disabled veterans were actually made during the war, and some of the company's departments were laid out and set up for employment of the physically handicapped.

DONATES ARCHITECTURAL LIBRARY TO COLLEGE

Earnest A. Grunsfeld, Jr., Chicago architect, recently donated his library of standard architectural volumes to the Illinois Institute of Technology.

The gift is an important addition to the architectural library and makes available to students some 300 volumes.

ARCHITECT SELECTED

The firm of Appleton & Wolfard, San Francisco architects, have been selected to do the new Parkside Branch Library in San Francisco. Estimated cost \$150,000.

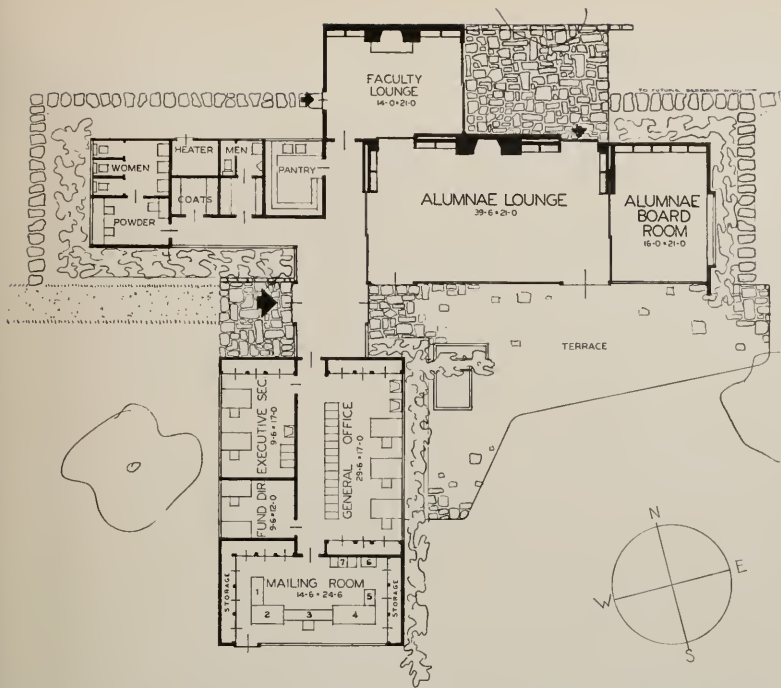

Clarence W. Mayhew, Architect

AURELIA REINHARDT Alumnae Memorial House

MILLS COLLEGE

Oakland, California

Construction of the Aurelia Reinhardt Alumnae Memorial House on the Mills College campus was started early this month under the supervision of John Brown, plant manager and Clarence W. Mayhew, architect.

The building is being erected by the Alumnae Association in memory of Dr. Reinhardt, who served as president of Mills College from 1916 to 1943, and who passed away in January of this year.

Contemporary in design, with natural redwood and stone veneer exteriors and a tile roof, the

rambling units will center about one large sheltered terrace and an adjacent smaller one. The building will be insulated and have radiant heating and sound proof ceilings. Veneer paneling, a huge fireplace and glass from ceiling to floor will feature the main lounge.

The Memorial House will contain alumnae business and executive offices, mailing room, lounge, board of directors' room, Women's Faculty Club room, a kitchen-pantry, and power and cloar room totaling more than 5000 square feet of floor

(See Page 30)

PLANNING

and

RE-DEVELOPMENT

of The Larger Community

By **WILLIS H. HALL**

Chairman, City Plan Commission

Detroit, Michigan

Not many years ago an enterprising city planner captured a brief period of publicity by writing a book entitled "Can Our Cities Survive?" His answer to his own question was, as we might expect, decidedly pessimistic. For my part I must emphatically reject any such conclusion, and I am sure all thinking businessmen will concur in denying the reality of such a fate for our larger communities. But as is often the case, there is just enough truth in such a scare title to merit our serious consideration of the problems involved in the growth and change of our cities, both great and near great.

The trek of people from our farms and countryside to metropolitan centers is continuing and growing. As these newcomers bolster the inadequate birth rates of the cities and further swell population figures, the cities themselves spread further and further, engulfing new unbuilt areas at one end of the process and leaving wornout, rundown, impoverished areas at the other. Certainly there are few of us who would maintain that our cities today are as attractive, as pleasant, or as good as we might reasonably expect them to be in consideration of our technical knowledge, our wealth and our high standard of living. And these deficiencies are not limited to the amenities.

They are just as pronounced in terms of the utilities and facilities provided for living, for working and for carrying on business. In witness thereof I might mention our traffic congestion, high accident rates, local transportation costs and fire losses.

But just as surely as our cities are not doomed by their inherent weaknesses nor glorified by their own beauty and perfection, there are real and ever-present opportunities for gradual but continuous improvement so as to ever more closely approach realizable ideals. Proper planning is the first and in many respects the most important step in modernizing and beautifying our cities.

It is axiomatic that planning is preparation for action. This means that a plan not realizable or capable of being executed is not a plan at all, but merely a dream. City planning, therefore, to merit the name, must be realistic and practicable. In laying out plans and programs for the best possible improvement and development of a community, city planning must recognize all the conditions and circumstances of the situation, and limit its proposals and objectives to those attainable under its tools of effectuation, legal and financial.

I have outlined my philosophy of city planning at some length because I believe this approach is

(See Page 34)

LIGHTWEIGHT CONCRETE CONSTRUCTION

**Note: The following address was delivered by Mr. Murray
Erick before the Structural Engineers Association of Northern
California in Oakland, California, on September 14, 1948.*

Light weight concrete and vermiculite plaster fire protection were used primarily for economic reasons, in the building of the General Petroleum and Prudential Insurance Buildings in Los Angeles.

Preliminary studies indicated a dead weight saving of approximately 30 per cent in each building, thereby effecting considerable savings in structural steel, reinforcing steel and footing costs.

Preliminary estimates indicated a cost premium for light weight concrete of less than \$5.00 per yard, and the costs of vermiculite plaster fire-protection of beams and columns to be substantially less than the costs of concrete fire-protection.

Exhaustive tests have been conducted during the past few years, by both the Underwriters Laboratories and the Bureau of Standards, whereby fire protective ratings are soundly established for the various uses of vermiculite plaster.

During the past several years, I have become pretty thoroughly convinced that the construction industry has been largely stagnant and is fast approaching one of the most critical periods of its life.

Sure, we have a higher quality of steel, cement and many other manufactured products. We have construction equipment far superior to that in use only a few years ago. Still, we are getting less production per man hour of labor in most trades than at any time in the last twenty-five years. We are using nearly as much steel and cement and many other costly materials as we were using ten or twenty years ago.

Building codes are, in many respects, as outmoded as a Model T Ford. Consequently, building costs have pyramided to a point that only a relatively small percentage of prospective owners can afford to build, and then only in cases of dire necessity.

The Construction Industries rank second only to agriculture in importance in the nation. Consequently, it is probable that a major recession in construction activities might well be the beginning of another serious depression. Unless something is done to stop the fast mounting spiral of building costs, the public will not be able to build and a recession in the industry is inevitable.

In the design of the General Petroleum and Prudential Insurance Buildings, we have made a feeble start toward effecting economies and modernization of construction. There is a lot of ground work to be done yet before full advantage can be taken of the possibilities developed in these two buildings.

Light weight concrete isn't new.

Cinders, Haydite, Rocklite, Pumice and Airox have been used as aggregates for light weight concrete in ship construction, bridges and many buildings for more than thirty years, and have been proven structurally sound.

In the past five or so years, the use of light weight aggregates for concrete and vermiculite for plaster and fire protection has been rapidly expanding and has been given a great deal of publicity, some good and some not so good.

Some building codes have been revised to permit the use of light weight concrete and of vermiculite plaster fire protection.

There is still a lot of work to be done in the modernization of building codes and in the education or enlightenment of the construction industry before we can take full advantage of the possibilities of light weight building construction.

A lot of the ground work, so necessary to the recognition of new materials and methods of construction, the economics thereof and the justification for drastic revisions in building codes, has already been done. During the past four years I have been assembling some of this more important data, of which the following is only a part:

1. An article by the Vermiculite Research Institute, of Evanston, Illinois, entitled "The Contribution of Vermiculite to Fire Protective Construction."
2. An article published by the Vermiculite Research Institute entitled "The Use of Vermiculite Plaster and Concrete for Fire-proofing Steel Structures," dealing specifically with the Mercantile Bank Building, Dallas, Texas.
3. Letters of approval by the Board of Building and Safety Commissioners of the City of Los Angeles of vermiculite plaster fire protection of structural members in a Type I building.

4. An article in The Wall Street Journal of April 22, 1948, entitled "Lightweight Building."
5. An article in the July, 1948, issue of the Architectural Record entitled "Light Weight Aggregates."
6. A report by the National Bureau of Standards (U. S. Department of Commerce) entitled "Building Materials and Structures—Report BMS82."

Of this data, Items 1, 5 and 6 are, I believe, of sufficient importance to warrant a briefing of them here.

Item 1 summarizes the results of fourteen fire tests of various structural elements wherein vermiculite plaster was used as fire protection. The fire resistive ratings and the authority therefor are given in a clear and concise tabular form.

Item 5 is an excellent technical paper on practically all of the light weight aggregates. The characteristics of each of the materials, weights, concrete strengths, limitations of use, etc., are quite thoroughly covered.

Item 6 is, in my opinion, one of the most important and interesting documents on fire-resistive standards that I have ever seen. This document was published by the National Bureau of Standards in 1942 as a guide to the construction industry and building departments in the revision of building codes and the modernization of building construction.

Chapter III summarizes the results of surveys of the combustible contents of buildings of various occupancies. It is interesting to note that, with rare exceptions, the weight of combustibles in any of the light occupancy buildings does not exceed 15 pounds per square foot of floor area. Fifteen pounds of combustibles per square foot of floor constitutes a potential fire severity hazard of only one and one-half hours, according to the committee's report.

The National Bureau of Standards in this bulletin recommends that the fire-protective requirements in the buildings be consistent with the prevailing fire hazards.

Table I of Chapter I sets forth their recommendations of fire protection for the structural elements of Type I buildings.

This information, from an authoritative and unbiased source, has been available to us and building department officials for six years, and still we are spending the owner's money in providing fire protection far in excess of these recommended standards.

As I stated earlier, we have only made a start toward the possible ultimate in light weight building construction. Proper revisions in building codes must come first, and it is up to the con-

struction industry to lay aside the petty interests of various branches of the industry and force the adoption of essential modern revisions of our codes.

I want to repeat here a few figures developed in our preliminary work leading up to the use of light weight construction in the General Petroleum and Prudential Insurance Buildings.

Light weight concrete of 2,500 pound compressive strength weighs 95 pounds per cubic foot, as against 145 pounds per cubic foot for stone concrete. The cost premium was, roughly, \$5.00 per cubic yard.

Vermiculite plaster fire protection of beams and columns weighs approximately 10% of the weight of stone concrete fire-proofing and costs considerably less. For example, concrete encasement of an 18 inch wide-flange 50 pound beam weighs 225 pounds per foot of beam and costs \$3.50 to \$4.00 per lineal foot. Vermiculite plaster fire protection of this beam weighs only 23 pounds and costs \$2.60 to \$2.80 per lineal foot. This weight saving is 10% of the load carrying capacity of the beam on a 25 foot span. With beams at 8 foot centers, it represents an average dead weight reduction in the building of 25 pounds per square foot of building area. With structural steel at \$200 per ton, it is readily seen that the fire protection costs of a building closely approximate the costs of the structural steel.

The summary of dead weights and design live loads of the General Petroleum and Prudential Insurance Buildings has been well publicized, but since these figures tell the story of light weight building construction in a few words, here they are again:

General Petroleum Building

Dead weight as designed.....	25,800 tons
Dead weight saving.....	13,100 tons
Design live load 1st story columns	8,300 tons

Prudential Insurance Building

Dead weight as designed.....	32,000 tons
Dead weight saving.....	15,600 tons
Design live load 1st story columns	14,300 tons
Structural steel saving each building, at least	1,000 tons.

In closing, let me again stress the vital necessity of a united effort by the entire construction industry to modernize building codes and construction methods before the saturation point in costs starts a recession in the No. 2 industry of the country.

NEW TELEPHONE EXCHANGE. The Pacific Telephone & Telegraph Company have awarded a contract to Johnson, Drake & Piper of Oakland (California) for the construction of a \$415,000 addition to the San Rafael telephone offices. Clark & Beutler, San Francisco, are the Architects.

ANNUAL CONVENTION

Structural Engineers Association

OF CALIFORNIA

Santa Barbara, California

One of the best conventions ever held by the Structural Engineers Association of California was held in Santa Barbara on October 21st to 24th, with more than 216 structural engineers and their wives in attendance.

Opening with a Public Relations Program, John Blume, president of the Northern California Chapter presiding, the convention got off to a good start with Henry Powers, chairman of the Public Relations Committee of the Southern California Chapter, speaking on the subject of Public Relations as it applies to the structural engineers and the proposed formation of a public relations committee of the state association to coordinate the efforts of the engineer groups. Larry Wise, assistant editor of Engineering News-Record spoke on the responsibility of each engineer in improving the public relations of his firm and profession, and Paul Jeffers of the State Board of Registration also spoke on the subject.

The association emblem, a project initiated by the Northern California Chapter was presented by John Blume and unanimously endorsed. The report of the committee appointed to draft a new state constitution was given by George Brandon in the absence of A. V. Saph, chairman, and while accepted by the convention must be ratified by each of three Chapters before final adoption.

Committee reports included Engineering Seismology by John A. Blume, secretary of the Advisory Committee on Engineering Seismology, George Housner of the SEACSC, and W. K. Cloud presented a paper by Franklin P. Ulrich on activities of the U. S. Coast and Geodetic Survey.

Henry J. Brunner gave an interesting and instructional report on the recent conference with Japanese seismologists and engineers on the

Fukui earthquake at which he was an official representative from the United States.

Light weight concrete and numerous other subjects of keen interest to the engineers were discussed and considered, while the special entertainment provided for delegates and guests contributed considerable towards making the conference a success.

Northern California Chapter representatives included John A. Blume, president; Jessie Rosenwald, vice-president; George E. Solnar, secretary, and directors Arthur W. Anderson, Harry J. Degenkolb, William W. Moore, and many others.

Southern California Chapter representatives included S. B. Barnes, president; Harry Bolin, vice president; Lewis Osborn, secretary-treasurer, and general convention chairman Don Shugart.

The Central California Chapter, which was in attendance for the first time since its inauguration, was represented by L. C. Hollister, president; Arthur A. Sauer, vice president and a good delegation.

PRODUCERS COUNCIL

Northern California Chapter

The Annual Christmas Jinx of the Northern California Chapter of the Producers' Council will be held on December 1st at the Claremont Hotel in Berkeley, California, according to Joe Carlson, President.

Committees in charge of this year's event include Wayne Rawlings, Chairman of the Banquet; Art Staet, Ticket Chairman, and Jerry Barr, Golf Tournament Chairman.

A steller program of entertainment has been arranged according to all advance information.



View from Sacramento River Bank

Photos by R. M. Yelland

Mr. and Mrs. W. R. Heringer

SACRAMENTO COUNTY, CALIFORNIA



Covered Areas at the
Front of the House

"The COUNTRY HOUSE"

W. R. YELLAND, A. I. A. Architect

The Heringer house is a ranch house located a few miles above Walnut Grove along the banks of the Sacramento River. Due to a slight curve in the river bank and the curve formed in shaping the house a rather pleasant elliptical basin appears when seen from the banks of the river. This piece of ground is beautifully shrubbed and planted and forms the forecourt for the house. An entrance drive circles the garden and extends to the garage.

The house comprises 8 rooms, all of which are strung out to give as long a horizontal line as possible to conform with the flat stretches of land seen beyond. Terraces and covered walks have been incorporated in the scheme, desirable features in the warm Sacramento Valley.

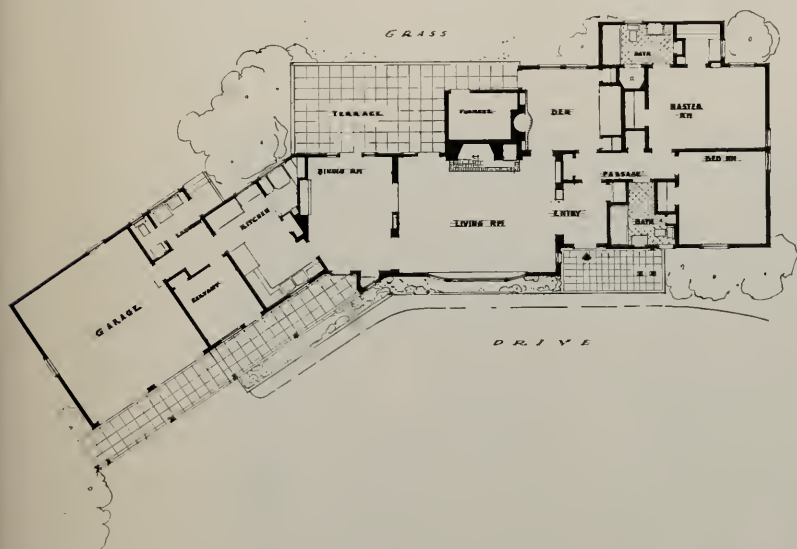

HERINGER HOUSE . . .

**The Heringer
Living Room,
looking toward
Entry Hall and
Den.**

**Exposed over-
head beams,
and fireplace.**



The exterior of the house is composed of several materials. The dominating material is stucco. However, considerable board and batten and rough brick are found as a backdrop for the curved areas. The roof is shingled. While the ridge is not straight or level, an effort has been made to form all irregularities in a smooth line. The interior is composed of materials comparable to those of the exterior, namely plaster, brick and wood. These materials have been carefully blended by weathering and coloring so that one passing through the house may be conscious of a craftsmanship, yet does not realize the association of different materials used in combination.

Room arrangement is such that the bedroom space is augmented by a den which may be closed off from the living part of the house when desired. An entry hall separates the bedroom and den from the living room. The utility part of the house and the servant room are purposely arranged in conjunction with the garage so that supplies arriving may reach the kitchen without undue cartage. Maintenance and operation of the house have been made simple by installation of mechanical appliances wherever possible.



**Entrance Porch
To
Residence**

SURVEY SHOWS MANY NEW BUILDING PRODUCTS

An impressive array of new and improved building products resulting from the multi-million dollar research activities of the building industry is described in the latest economic study of the Construction Industry Information Committee.

The study covers a wide range of building products, including: floor, wall and roofing materials; plumbing, heating and ventilating systems; construction metals and electrical products.

Within the six month since the committee's economic consultants began their fact-finding program, a dramatic series of reports has been issued and has received wide public acceptance on the merits of its sound, factual approach.

The current study rounds up the results of extensive research and development by individual companies, as well as by their trade associations, in cooperation with government agencies and educational institutions.

Floor, wall, and roofing materials—the specialty finishing products—are outstanding for progress in economies of manufacture, greater durability and flexibility, and more pleasing color and appearance.

Some of the findings of the committee's survey are:

Until the early 1920's there was only one general insulation product—a "quilt" of fibers stitched between sheets of heavy paper, effective enough but expensive. Insulation materials are now available in the form of blankets, batts or large pads, loose granules, or rigid sheets which can take the place of wood sheathing, giving the owners of homes and other buildings a wide selection from which to meet specific insulation needs.

Acoustical products are now available for every type of use. Research determined the best materials to absorb sound of different frequency ranges under different conditions. Acoustical plaster is used in new construction. Perforated tiles are easily and quickly installed in completed buildings, and are used in new construction as well.

Asphalt tile has been made so flexible it may be

used on ordinary wood subfloors and is now available in lighter colors, as a result of research which found a way to replace asphalt with synthetic resins. Asphalt roofing has been made more durable.

Soft floor coverings, such as linoleum and composite tile, have likewise been greatly improved in color and durability.

Asbestos, formerly a minor material except for pipe and tank insulation, is now combined with Portland cement to produce flat and corrugated board for exterior siding which is weatherproof and fireproof. Paintstaking research has brought great improvement in asbestos shingles and in the use of asbestos for underground pipe and conduit.

Vitreous china plumbing fixtures have been made stronger, and acid-resisting enamels have become standard for enamelled iron sinks. Careful, detailed work has been done on the simplification of plumbing piping.

Every type of heating system has reached high standards of performance, and the manufacturers themselves have participated in study projects designed to reject inefficient systems and to assure the most efficient installations of their products. The evolution of steam and hot water radiators, warm air systems, furnaces and boilers, and automatic firing devices to their present efficiency has resulted from consistent experimental work. Radiant heating is a recent development, adding to the many choices of heating systems now available. Ingenious devices control temperature to an almost perfect degree in all types of buildings. Air conditioning is only about 20 years old but has been developed so expertly that it has established a new standard for some types of manufacturing operations, as well as the recognized standard of comfort for retail establishments and other places serving the general public.

In the fields of construction metals, recent emphasis has been on the development of light materials for light loads, bringing economy both in the use of material and in handling by labor, and in many cases greater convenience to owners of buildings.

Some of the developments have been: light steel framing for house construction; light gage steel structural floor systems giving easy accessibility to electric wiring for the changing needs of tenants; aluminum alloys for vertically swinging garage doors, double-hung and casement window sash, revolving and swinging doors, frames, roofing, siding, flashings, eaves troughs and downspouts, and all kinds of ornamental work; the use of aluminum and magnesium for light-weight power tools and other more efficient construction equipment.

Steel and iron applications in construction have

(See Page 30)



"WORLD'S FINEST" Aircraft Maintenance Base

Photos Courtesy The Austin Company

UNITED AIR LINES MAINTENANCE BASE

SAN FRANCISCO, CALIFORNIA

Hailed as the world's finest and most modern, a huge new "push button" airline maintenance base was recently completed and dedicated by California's Governor Earl Warren and W. A. Patterson, president of United Air Lines at San Francisco and today is contributing its full share to top-flight operating efficiency.

"Maintenance hub of the Main Line" is what officials call the veritable aircraft factory where as many as 11 Mainliners can be overhauled simultaneously. Actually, the place is a sort of

"house of magic"—declared to be at least seven years ahead of its time—where an array of new devices and methods have been brought together to produce "new" planes at periodic overhaul intervals.

Situated at the north end of San Francisco's Municipal Airport, the base covers 116 acres on which there are 700,000 square feet of buildings.

Gathered here are approximately 1,400 experts in all phases of aircraft maintenance—craftsmen who have the "know how" born of years of ex-

perience. According to F. A. Page, manager of the base, it is expected their number will be doubled within the next five years as all United's maintenance activities are concentrated at San Francisco and as the company's fleet continues to grow.

Right now, all United's 70 four-engined DC-6 and DC-4 Mainliners and Cargoliners are maintained here while the company's 74 twin-engined DC-3 planes are maintained at Cheyenne. The Cheyenne operation will be closed by the end of this year, at which time all Mainliners and Cargoliners will be handled at San Francisco.

Housed in the two-and-a-half story steel and concrete buildings and hangars of the big base are innovations which, introduce a new era of efficiency in aircraft overhaul—an efficiency being reflected in flight performance. Civil and military aviation leaders from all parts of the world have been visiting the base to study its many features.

The most spectacular feature, perhaps, is a "push button" maintenance dock embodying a system of suspended metal catwalks which completely surround a DC-6 so that such planes can

be moved into the hangar and put in readiness for the overhaul crew in a matter of minutes instead of hours.

Elevators connecting this dock with various overhaul shops, overhead conveyors in the shops, new and novel machinery, an elaborate lighting system, a modern color scheme throughout and a production line system which provides a smooth flow of work from start to finish make the establishment, in truth, "tomorrow's maintenance base today."

Buildings include a major two-and-a-half story structure, having a full frontage of 650 feet, which houses offices, shops and six airplane docks, two separate overhaul hangars, and a building housing six engine test cells.

The three newest hangars at the base, including the "push button" dock, each measure 130 by 130 ft. Height is 48 feet; door clearance, 35 feet, which allows the towering Mainliner 300 rudder to slip in with a five-foot leeway. The big Boeing Stratocruisers which will start taking the United's routes early in 1949 have 41-foot high rudders. However,

CONTINUOUS horizontal bands of projected steel sash emphasize the length of this new shop building with more than a quarter of a million square feet of floor space is devoted to the overhaul of aircraft engines and other airplane parts. Corrugated asbestos siding has been used throughout the structure, which has an overall length of 485 feet.





MODERNISTIC

Entranceway is of modernistic architectural design and concrete construction thereby combining utility and beauty.

(United Air Lines Photo)

a folding device on the rudder post will enable them to have use of the same hangars.

A Mainliner 300 (DC-6) comes into the base for overhaul after every 700 hours of flying; a Mainliner 230 (DC-4), after every 1,000 hours. This means that, about every three months, each plane in United's fleet is completely overhauled from engines to cabin upholstery, from instruments and radio equipment to its outside paint. Such major overhauls are in addition to periodic inspections and checks given all planes at line stations. In addition to a thorough check of every plane at every stop, more exhaustive checks are performed between every 25 and 45 hours of flying, before completion of 80 hours, and before completion of every 150 hours.

From the time a Mainliner enters the base, it receives all the solicitous care which trainers give thoroughbred horses.

You see the big DC-6 move up to the massive doors of the hangar. A push of a button sends the doors folding upward in just 15 seconds. A small tractor attached by a tow-bar to the Mainliner pulls the big plane (wing spread, 117½ feet; length, 100 feet, 7 inches) along a white center line into the "push button" dock. So snugly does the plane nestle into the dock's forward platform that it is difficult to see where the plane stops and the platform begins.

Hydraulic jacks lift the plane several inches off the floor and catwalks are lowered from a metal framework on either side of the plane. Next, a

giant metal framework is lowered from the ceiling to fit like a glove around the entire tail assembly. This framework actually consists of two units which fit on either side of the empennage. Each unit weighs almost a ton, but is moved down into place smoothly and evenly by electric power. Next, a hydraulically-operated ramp comes up from the floor to connect with the long catwalks at the level of the main cabin door.

Within 10 minutes from the time the giant craft first nosed its way through the big hangar door, as many as 50 workers are swarming all over it. Their tasks are made easier by lights mounted in the floor and by a battery of more than 220 mercury arc and incandescent lamps in the ceiling.

Everyone knows his particular task. Electric hoist operators prepare to lift the four engines off their mounts even as mechanics are unfastening

connections. Cabin maintenance crew members begin removing all chairs, wall upholstery and carpets. Radio and electric instrument technicians start taking out equipment which will go to their respective shops. Painters are removing insignia and other outside markings from the wing, fuselage and tail preparatory to repainting with the aid of giant stencils. Other workers are removing the tires. Still others are checking the wing stabilizer and control surfaces for superficial dents.

Engines of the Mainliner are moved on engine and mount dollies along the same hangar level to a vast power plant department. There they are made ready for a "Saturday night bath" deluxe. Meanwhile, seats, electrical equipment and other parts are placed in elevators and whisked to ramps which lead directly to the honeycomb of shops.

SEVERAL HUNDRED members of the engineering and production staff attached to the base occupy this large second floor office area, located at one end of the shop building. Continuous runs of concealed fluorescent lighting, mounted flush with the acoustic ceiling on ten foot centers, delivers uniform illumination of 60-foot-candles throughout the office area, which is also fully air conditioned.





All of the operating controls and metering devices required for engine testing in the new "test cells," are grouped around double-glazed observation windows in compact and convenient arrangement. Six control desks, similar to one illustrated above, are paired in the control passages extending through the cell block. Sperry controls (left foreground) and potentiometer is mounted flush on desk at right with slant gauge directly above window. Engine in position for testing is seen in test cell.

After a quick steaming to remove outside layers of grease and dirt, the engines are disassembled and parts are strung along a 1,280-foot overhead chain conveyor. From reduction gear and cylinders to the front support plate and main crankcase, the engine is reduced to so many parts. Those which cannot be hung directly on conveyor hooks are placed in screened-over metal trays attached to the conveyor.

Slowly, a few inches per minute, the electrically driven conveyor moves engine parts toward a unique piece of equipment called an engine washer tank—a 160-foot long hairpin-shaped affair containing 30,000 gallons of a strong detergent solution. Into the tank go the parts, to emerge five hours later, scrubbed cleaner than a mother could hope to scrub behind junior's ears.

In other sections of the department, cylinders

and other parts are tested for flaws and any changes in size down to one ten-thousandth of an inch. After that, they are strung on a 1,650-foot conveyor where they remain until time for re-assembly. Parts of each engine are kept together. Replacement parts may be installed, but not parts from another engine.

Engine parts are replaced primarily on the basis of their condition and regardless of the time they have been in service. By such replacements, a Mainliner engine becomes virtually new after every five or six overhauls.

United's big base can process up to eight complete 18-cylinder engines a day—as it must in order to take care of the nearly 600 engines in the company's fleet. By the way, those 600 Pratt & Whitney twin-row and double Wasps have

enough total power to drive four aircraft carriers of the Midway class or 16 modern destroyers with ease.

After reassembly of the engines, they are taken to the test cell building where they are run-in for four and a half hours before being recertified. Refrigeration and heating equipment in the test cells permits technicians to determine engine performance under the widest range of climatic conditions.

In a shop adjoining the test cells is something else new to airline maintenance—80 tons of machinery, from air decompressors to electric motors and heavy test chambers, employed in checking the functioning of carburetors. By this means, the performance of the carburetor under flight conditions can be thoroughly studied on the ground. In a decompression chamber, altitudes of up to 50,000 feet can be simulated.

While engine overhaul has been taking place, propellers from the Mainliner 300 have been overhauled and checked. Each blade has been removed and polished if necessary. Electric de-icer boots have been checked with resistance meters. Reassembled propellers then have been sent by overhead conveyor for further checking in a special balancing room.

Radio equipment, instruments and electrical devices from the Mainliner have gone to a department which is as vast as it is intricate. In the instrument section of this department, an electric-grid filter removes dust from the air. Also, blowers keep the room pressure slightly above atmospheric pressure so there will be no chance for dust to seep in when doors are opened.

In this department, radio sets are calibrated in specially insulated rooms; altimeters are reset in

GROUND FLOOR SHOPS with a ceiling of 22 ft. 3 in. maintained to accommodate the extensive system of continuous chain conveyors and monorails required to handle engines and engine parts during all phases of overhaul and cleaning. Continuous runs of fluorescent lighting units extend the full length of the 27-foot wide aisles for an overall distance of 480 feet. The stairway at the left leads to a mezzanine from which persons in charge of engine overhaul can maintain visual control of operations on all sides.



MAINTENANCE BASE . . .

special decompression chambers; generators and hydraulic systems are checked, and automatic pilots are given deflection tests on special benches. Such benches, chambers, test cells and other devices help keep the nerve and artery systems of the modern airliner functioning.

The cabin overhaul shop features an 84-foot-long cutting table on which literally dozens of fabric patterns can be cut at one time. When it is realized that the normal life of a Mainliner chair's upholstery is only one year, the task of this department can be appreciated. Cloth used each year in this shop would make nearly a 40-mile-long carpet, one foot wide.

Electro-plating, welding, tire and other shops contribute their full share in getting the Mainliner back into the air. Tires, incidentally, are replaced at each overhaul.

In four days, the Mainliner is ready to leave the dock—a "new airplane." It does not wait for its original engines; a newly overhauled set has been installed. While in the dock, the plane itself has been inspected in minute detail. Wiring for the cabin lighting system has been studied inch by inch for possible flaws in insulation; windows have been checked and summarily discarded if they have shown the beginnings of the tiniest crack or have been loose in their mountings.

Test pilots take the Mainliner aloft for a four-hour check flight after overhaul. Accompanying

the flight are technicians who check the functioning of radio, instrument and electric equipment which has gone through their shops.

Such is the overhaul of a Mainliner at the "big base."

Nothing which can contribute to the highest standards of maintenance has been overlooked here. Heating and air conditioning systems maintain proper temperatures throughout the base. Lighting is varied—mercury, fluorescent and incandescent, used separately or in combination. Total illumination is approximately 262,500 candlepower, enough to light nearly 2,000 average homes. The electric wiring of the base—from cables as thick as a man's wrist to slender lamp-type cords—would stretch out for 120 miles.

Visitors are particularly impressed with the color scheme. Varying shades of blue, green and gray alternate from wall to wall, from hangar to hangar, from shop to office—affording a new concept for factory-like structures.

Construction of the "maintenance hub of the Main Line" began as long ago as 1940 and its development was pushed in 1942 when United began flying four-engined planes across the Pacific under contract for the Army Air Transport Command. Latest additions were started about a year ago. Chiefly responsible for design of the base was Nicholas Boratynski, regional engineer for United.

STATE OF CALIFORNIA SEEKS ENGINEERS

Civil Service examinations for Assistant Safety Engineers (Electrical) and Associate and Senior Communications Engineers have been scheduled by the California State Personnel Board for November 30, December 2nd.

Complete information is available from the Board's office at 1015 L Street in Sacramento, California.

NATIONAL JOINT COOPERATIVE COMMITTEE ANNOUNCED

The American Society of Civil Engineers and the Associated General Contractors of America have established a new National Joint Cooperative Committee.

Purpose of the Committee is to study matters of mutual concern to civil engineers, general contractors, and the public with a particular view to recommending procedures for carrying out construction more economically.

Scheduled for consideration and study are: Construction courses in engineering colleges to train men for construction; making work in construction and designing public works attractive to young engineers; Standard contract clauses for engineering construction clearly understood by engineers and contractors clear and definite specifications clearly understood by all parties; design which can obtain maximum benefits from mechanical construction operations, and equitably and clearly understood bidding and awarding procedure for engineering construction.

APPOINTED

G. L. Tuve, President of the American Society of Heating and Ventilating Engineers, has been appointed chairman of the Advisory Committee for the 9th International Heating and Ventilating Exposition which is to be held in Chicago, January 24th to 28th.

The exposition is under the auspices of the A. S. H. V. E. in conjunction with its 55th Annual Meet-

ing which represents seventeen associations in the allied fields of acoustics, architecture, air filtration, insulation and fuels.

COMMERCIAL STANDARD FOR COPPER NAPHTHENATE

The National Bureau of Standards has announced the establishment of Copper Naphthenate Wood-Preservative (spray, brush, dip application) Commercial Standard CS152-48.

The recommended commercial standard was proposed by manufacturers and approved by other interests and was circulated by the National Bureau of Standards to producers, distributors, testing laboratories, and users for written acceptance.

The propose of the commercial standard is to provide a nationally recognized specification for copper naphthenate wood-preservative for the guidance of buyers, sellers, and testing laboratories; to promote fair competition and consumer confidence in products conforming to the standard; and to provide a basis for labeling and guaranteeing the quality of the product.

PRODUCERS COUNCIL, INC., NORTHERN CALICORNIA

Fred J. Mahr, Industrial Development Engineer with the Pacific Gas & Electric Company, was the principal speaker at the October meeting of the Council in San Francisco.

His subject was "Kilowatt Builders" and the amazing growth, industrial and otherwise, of California unfolded as Mahr outlined his company's extensive program of building steam and hydro-electric plants.

Among the newest projects contemplated is a \$50,000,000 steam electric power plant at Antioch, California.

WEST COAST LUMBER PRODUCTION UPPED

Production, orders and shipments of lumber from sawmills of the Douglas fir region of Washington and Oregon for the first seven months of 1948 exceed the same period last year by a considerable margin, according to a recent report of H. V. Simpson, executive vice president of the West Coast Lumbermen's Association.

In 30 weeks of 1948 West Coast mills produced 5,052,620,000 board feet of lumber, topping last year by 184 million feet for the same period. Total order file of 5,095,122,000 board feet so far in 1948, exceeds mill production by 43 million feet. Mills report an unfilled order file totaling 669,964,000 feet. Shipments for the 30 weeks top both orders and production, amount to 5,109,806,000 feet.

A threatened shortage of railroad cars may reduce shipments during the early fall from West

PREVENT FIRES and EXPLOSIONS

Caused by **EARTHQUAKES!**



Plus a Manual Control For Other Emergencies!

SAFETY ENGINEERS and scientists say the Sentinel is the most accurate and dependable earthquake actuated shut-off valve in the world! On the job 24 hours a day! A record of more than 10 years of reliable service . . . **proven** during a period which included two major seismic disturbances. * Names on request

Take No Chances . . . Install The

SENTINEL

AUTOMATIC GAS SHUT-OFF VALVE

Designed to shut off automatically when there's an earth shock or explosion sufficient to damage buildings or pipe lines. Listed by the Underwriters' Laboratories and specified by leading architects and engineers for installation in schools, fire stations, factories, theaters, churches, stores, municipal, military and utility buildings. A. I. A. File No. 29-F-6 Write for illustrated folder.

SECURITY VALVE CO.
410 San Fernando Rd., Los Angeles 31, California
Phone CApital 6191

KAPCO

has the odds

8500 to 1...



KAPCO MEMBRANE

Recent moisture permeability tests prove Kapco membrane surpasses felt duplex paper 8,500 to 1.

OTHER ADVANTAGES:

Economical
Maximum moisture seal with minimum thickness.

Durable
Eliminates puncturing of membrane—more rigid than paper.

Easy Application
Simply overlap joints and seal with cold trowel mastic cement.



KAPCO UNDERLAYMENT

Waterproof
... protects sub flooring.

Moisture Proof
... prevents destruction, buckling and rotting of linoleum, rubber tile.

Cushionized
... easy to walk on.

Sound Deadening
... eliminates squeaks.

Fast Application
... easily cut with linoleum knife.

Reduces Labor Costs 50%
... Simply use stapling hammer. Available from W. J. Burke and Co. on nominal rental basis.



W. J. BURKE & Co.

2690 Harrison St., San Francisco 10, Calif., VA 4-6811

2257 East 15th Street Los Angeles 21, Calif. • 5416 14th Avenue N.W. Seattle 7, Washington



Gift Subscription For Christmas 1948

As a service to its readers **GIFT SUBSCRIPTIONS** to **ARCHITECT & ENGINEER** magazine are available for this year's Christmas giving.

REGULAR SUBSCRIPTION Rate will apply:

United States and Pan America

\$3.00 a year; two years \$5.00.

Foreign countries \$5.00 a year.

**PLEASE SEND ARCHITECT & ENGINEER
AS A GIFT TO:**

name..... occupation.....

address..... city..... zone..... state.....

Sign my gift card: From.....

name..... occupation.....

address..... city..... zone..... state.....

Sign my gift card: From.....

name..... occupation.....

address..... city..... zone..... state.....

Sign my gift card: From.....

Your Name.....

Address..... city..... zone..... state.....

Enclosed is my check for.....

Coast mills. Home builders and construction industry throughout the nation, which depend on the high grade structural and finish lumber of this section, have not been held up for lack of West Coast lumber, a record which the industry is proud of as its contribution to postwar recovery.

SCHOOL CONTRACTS AWARDED

Among the many contracts recently awarded for the construction of new or additions to school buildings in California are:

Di Giorgio Grammar School (Kern County) \$188,000. Fred S. Macomber, Los Angeles, contractor; C. B. Alford & W. J. Thomas, Bakersfield, Architects.

Teague Grammar School (Fresno County) \$157,430. Harris Construction Company, Fresno, contractor; Franklin & Simpson, Fresno, Architects.

BERKELEY EXCHANGE. Monson Bros. of San Francisco have started construction of a \$1,225,000 addition to the Ashberry Telephone Exchange in Berkeley.

NEW BUILDING MATERIALS

(From Page 21)

benefited from extensive research programs too numerous for mention. One of the recent studies dealt with the design of re-enforcing bars for the most effective bond to the surrounding concrete. Considerable work also has been done to prevent corrosion in steel pipe.

Electrical development in construction has moved forward on a tremendous scale. A "bus duct" system for factory wiring and the raceway system used in structural steel floors for office buildings provide plug-ins wherever and whenever desired. Research has produced silent electric light switches, eliminated the need for fuses, made it feasible to connect wires without soldering.

These are some of the results of research on building products.

MILLS COLLEGE MEMORIAL

(From Page 13)

space. Additional space is being reserved for a future bedroom wing.

Present plans call for immediate erection of offices and service wings at an approximate cost of \$29,000. These units are to be completed within the next five months, while the lounge and other units will be added at later dates as funds become available.

Reinhardt House will be built near the College Art Gallery and craft shops, adjacent to the College Shop and Tea Room.

A. I. A.

American Institute



ACTIVITIES

of Architects

Arizona Chapter:

James Mccmillan, President; Arthur T. Brown, Secretary, 740 N. Country Club Road, Tucson, Arizona.

Central Valley of California:

Frank V. Mayo, President; John W. Bomberger, Vice-president; Ivan C. Sotterlee, Treasurer; William Koblik, Secretary, 2203 13th St., Sacramento, California.

Central Coast Counties Chapter:

Burce M. Clark, President; Lisle Fred Richards, Secretary-Treasurer; Thomas E. Elston, Jr., Chester Rod and Henry Morgan Stedman, Directors, Office, 411 Lafayette Street, San Jose.

Colorado Chapter:

Raymond H. Ervin, President; James M. Hunter, Secretary, 2049 Broadway, Boulder, Colorado.

East Bay Chapter:

A. Lewis Koue, President; James H. Anderson, Vice-President; Loy Chamberlain, Secretary; Chester H. Treichel, Treasurer, Office, 3633 Piedmont Ave., Berkeley, California.

Montana Chapter:

Ralph H. Cushing, President; H. C. Cheever, Secretary, Montana State College, Bozeman, Montana.

Northern California Chapter:

Wm. Clement Ambrose, President; Lester W. Hurd, Vice-President; Ralph N. Pollack, Secretary; Donald Beach Kirby, Treasurer; Office 363 Pine Street, San Francisco.

Oregon Chapter:

Frank Roehr, President; Sidney W. Little, Vice-President; Holman Baines, Secretary; Don Edmondson, Treasurer, Office 619 Builders Exchange Bldg., Portland 4, Oregon.

Pasadena Chapter (California)

Breo, Freeman, President; Melville Garton, Vice-President; Roland E. Cozie, Treasurer; Burton Bomberger, Secretary; and Robert Ainsworth, Harold J. Bissner and Roy A. Koerber, Directors, Offices, 1041 E. Green St., Pasadena 1.

San Diego Chapter:

H. Louis Eodmer, President; Louis J. Gill, Secretary, 203 Granger Building, San Diego, California.

Santa Barbara Chapter (California):

Winsor Soule, President; Ralph Armitage, Vice-President; Robert Ingie Hoyt, Secretary; Lutah M. Riggs, Treasurer; Office 116 E. Solo St., Santa Barbara, California.

CALIFORNIA COUNCIL OF ARCHITECTS

Andrew T. Hass, President; Adrian Wilson, Vice-President; Malcolm Reynolds, Secretary-Treasurer; Office 369 Pine Street, San Francisco.

Southern California Chapter:

George Allison, President; A. C. Martin, Jr., Vice-President; Anthony Thermin, Secretary; George E. Cable, Treasurer; Chapter Headquarters, 3757 Wilshire Blvd., Los Angeles 5, California.

Spokane Chapter (Washington):

Noel E. Thomson, President; Kenneth D. Stormont, Secretary, Huton Building, Spokane, Washington.

Utah Chapter:

George Cannon Young, President; Theodore R. Pope, Secretary, 28 South State Street, Salt Lake City 1, Utah.

Washington State Chapter:

Waldo E. Christenson, President; Perry B. Johanson, 1st Vice-President; John G. Richards, 2nd Vice-President; Hugo W. Caterman, Treasurer; and Elbas Moore, Jr., Secretary, Offices 714 American Building, Seattle 4, Washington.

Tacoma Chapter:

Chas. Rueger, President; Clarence Rueger, Vice-President; W. W. Durham, Secretary-Treasurer.

Hawaii Chapter:

Kenneth W. Roehrig, President; James Morrison, Secretary, 334 Federal Bldg., Honolulu, T. H.

SOUTHERN CALIFORNIA CHAPTER

Details of Holland's architectural trends were outlined in a talk by H. Wijdeveld before members at the November meeting.

Wijdeveld, visiting Professor of Architecture, University of Southern California, as a well-known Architect from Holland who has practiced in and near Amsterdam for many years and because of a wide variety of activities in the architectural field was able to discuss many interesting phases of the profession.

An open forum was also held on the "Proposed Revisions to the Architects' Act" with A. C. Martin, Jr., Chairman of the Legislative Committee of the California Council of Architects serving as chairman.

The Exhibit Committee under the direction of Jack C. Lipman, Chairman, has been very active in promoting public displays of architecture.

NEW MEMBERS. The following are new members of the Chapter: INSTITUTE MEMBERS: Alfred V. Chaix, Richard L. Cook, Victor D. Gruen, David E. Herrald, Thomas J. Russell, Aaron Wabash, Raymond Whalley, and Rudolph Wilson. JUNIOR ASSOCIATES, James F. Geary, Pierre P. Claeysens, Richard A. Jampol, Elmo K. Lathrop, Joseph H. Johnson, John M. Scheideman, and Oliver L. Stockton.

Adrian Wilson, past president of the Chapter, is serving as a member of the Board of Appeals of the Los Angeles County Building Department.

Jan Reiner, on leave from the U. S. C. School of

Architecture faculty, is spending several months Czecho-Slovakia.

Victor Gruen has just returned from Vienna, his home prior to 1938.

(See Page 43)

FOR BETTER SERVICE

Remember that

KRAFTILE is

WESTERN HEADQUARTERS

FOR

▶ GLAZED Structural Wall Units	▶ FACE and Romao Brick
▶ SWIMMING POOL Overflow Gutter	▶ ACID Brick
▶ PATIO TILE	▶ ACID-PROOF Jointing Compounds
▶ QUARRY Tile	▶ ACID-PROOF Costings
▶ BRICKETTES	
▶ STRAN-STEEL Framing	

For complete information and prompt service, phone or write

KRAFTILE COMPANY

NILES, CALIFORNIA NILES 3611
 SAN FRANCISCO 5: 50 Hawthorne St.—DOUGLAS 2-3780
 LOS ANGELES 13: 406 South Main Street—MUTUAL 7241

WITH THE ENGINEERS

Structural Engineers Association of Northern California

John A. Blume, President; Jesse Rosenwald, Vice President; Franklin P. Ulrich, Treas.; Geo. E. Solnar, Jr., Sec., Office, Room 215, 55 New Montgomery St., San Francisco 5, Phone SUTTER 1-7642. DIRECTORS, A. W. Anderson, Henry J. Degenkolb, John E. Rinne, Robert D. Dewell, and Wm. W. Moore.

San Francisco Section

L. A. Elsener, President; A. W. Earl and G. B. Woodruff, Vice-Presidents; John E. Rinne, Secretary-Treasurer; 225 Bush Street, San Francisco 20.

Structural Engineers Association of Southern California

Steve Barnes, President; Harry W. Bolin, Vice President; Lewis K. Osborn, Sec-Treas. DIRECTORS, Richard W. Ware, Geo. E. Brandow, L. T. Evans, Harold P. King, and Donald F. Shuqart. Office: 202 Architects Bldg., Los Angeles 13, Calif.

Puget Sound Engineering Council (Washington)

R. E. Kister, A. I. E. E., Chairman; E. R. McMillan, A. S. C. E., Vice Chairman; L. B. Cooper, A. S. M. E., Secretary; A. E. Nicholson, I. E. S., Treasurer; Offices, L. B. Cooper, c/o University of Washington, Seattle 5, Washington.

STRUCTURAL ENGINEERS NAME STATE COMMITTEE

A state public relations committee of the Structural Engineers Association of California has been named with Henry Powers, Northern California Chapter, serving as chairman; and comprising George Brandow representing the Southern California Chapter, and George E. Goodall representing the Central California Chapter.

STRUCTURAL ENGINEERS ASSOCIATION OF SOUTHERN CALIFORNIA

Officers for 1949, as reported by the Nominating Committee, were presented to the regular November

meeting on the 3rd, and included Harry W. Bolin for President; Ernest C. Hillman, Jr., Vice-president; Robert J. Short, Secretary-treasurer; and John G. Case and Lewis K. Osborn, Board of Directors.

Kemper Nornland, A.I.A., reported his impressions of the recent Structural Engineers Association annual convention at Santa Barbara, as viewed by the architect, and John Minasian outlined some of the technical papers which were reported at the convention.

An interesting motion picture was presented in technicolor on the subject of "Rail Steel and the World of Today," narrated by Lowell Thomas, and presented by member James E. Pollak.

STRUCTURAL ENGINEERS ASSOCIATION OF NORTHERN CALIFORNIA

The November meeting was devoted to consideration of Association Teamwork and the Advancement of California with staff members of the California State Chamber of Commerce taking part in the discussions, including Clark Gallo-way, Manager of the Central Coast District; Robert Shillito, Director of the Transportation and Highway Department; James Gofourth, Director of the Industrial Department, and Herbert Ormsby, Director of Research.

Edwin McInnis, addressed the members at their October meeting on the subject "The Economic Trend in California," predicting continued prosperity.

The Industrial Section of the California State Chamber of Commerce has passed a resolution recommending the State Chamber support the building industry in its stand that engineers and architects in private practice be allowed to participate in state building programs.

The CANONS of ETHICS, prepared by the Engineering Council for Professional Development have been recommended to the Board of Directors

*For added charm
in
Any setting*

USE STANLEY BLACK ORNAMENTAL HARDWARE!

Stanley Black Ornamental Hardware was inspired by Colonial and Early American pieces. It is ideal not only for summer camps, lodges and guest houses, but also for single and multiple family dwellings, apartments and private executive offices. Your customers will appreciate the extra beauty of Stanley Black Ornamental Hardware. Recommend it! Send for descriptive folder now. The Stanley Works, New Britain, Conn.

STANLEY

Reg. U.S. Pat. Off.

HARDWARE • HAND TOOLS • ELECTRIC TOOLS • STEEL STRAPPING

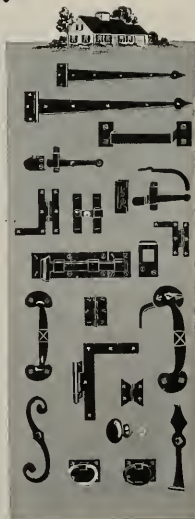

for approval by the Professional Welfare Committee, G. A. Sedgwick, chairman.

CALIFORNIA ENGINEER ELECTED PRESIDENT OF CIVIL ENGINEERS

Franklin Thomas, Professor of Civil Engineering and Dean of Students at California Institute of Technology, Pasadena, was nominated without opposition as the 1949 President of the American Society of Civil Engineers by the organization's Board of Directors at the Society's annual Fall meeting which was held recently in Boston, Mass.



Dean Franklin Thomas

Confirmation of the nomination is scheduled late this year by letter ballot of the more than 24,000 members and Dean Thomas is expected to take office at the Society's Annual Meeting in New York City in January.

Long active in civic affairs, Dean Thomas has been a member of the Board of Directors of the Metropolitan Water District of Los Angeles since its organization in 1928, and is Chairman of the Colorado River Board of California, to which he was appointed as a member by Governor Earl Warren last year. He was a national Director of the American Society of Civil Engineers from 1930 to 1933 and a Vice-President in 1944-45.

Dean Thomas was born in Red Oak, Iowa, 1885, graduated from the University of Iowa in 1908 with a B. E. degree, and spent the following year at McGill University doing graduate work. He became associated with the California Institute of Technology in 1913 as associate professor of civil engineering, and with the exception of 1918 when he served as a first lieutenant in the Engineer Corps Reserve, has been identified with the Institute becoming Dean of Students in 1944.

AMERICAN SOCIETY FOR METALS

Puget Sound Chapter

Fatigue failures in tail shafts of large ships is a problem constantly facing the consulting metallurgist in the marine field according to Mr. L. T. Holt, President of the L. T. Holt Company, Seattle. Mr. Holt is one of the Pacific Northwest's pioneer consulting physical metallurgists and spoke before the Puget Sound Chapter of The American Society for Metals at the October meeting on the subject "Investigation into the Failure of Machine and Engine Parts."

The subject was covered by a series of slides

(See Page 39)



Thoughtful things like this help make a client happy

Built-in telephone facilities are the mark of a thoughtful, modern builder. For telephone conduit and outlets, installed while the house is under construction, add much to the future value and convenience of the home. Just a few pieces of tubing leading to well-located outlets... that's all it takes. The cost is small. And telephones can be added or moved later on without drilling holes or running wire along baseboards.

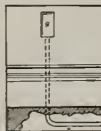

For free help in planning modern, built-in telephone conduit, call your local Pacific Telephone office and ask for "Architects and Builders Service."

The Pacific Telephone
and Telegraph Company



FOR
Distinctive Design
IN
ELECTRIC
WATER
COOLERS
SPECIFY
HAWS ...

HAWS Electric Water Coolers are styled to enhance the interiors of today's and tomorrow's buildings. For office or lobby, for store or public buildings, HAWS Electric Water Coolers serve refreshing drinking water with complete sanitation...efficiently, dependably and economically... for the finest in Electric Water Coolers always specify HAWS... with the added convenience of HAWS Sanitary Drinking Fountains...



Model HT-10
 Beautifully-Styled Electric
 Water Coolers



Model 7-A
 Vitreous china wall drinking
 fountain, with bubbler pro-
 tecting cowl.

**FOR REMOTE
 INSTALLATION**

HAWS Electric Water Coolers give double-duty when installed with one or more HAWS Drinking Fountains connected to serve adjacent rooms. Large capacity cooling units provide ample supply of cooled water.

Write today for complete information on

***HAWS* ELECTRIC WATER COOLERS
 SANITARY DRINKING FOUNTAINS**

HAWS DRINKING FAUCET CO.
 FOURTH and PAGE STREETS (Since 1909) BERKELEY 2, CALIFORNIA
 Agents and Sales Representatives in All Principal Cities

**PLANNING AND RE-DEVELOPMENT
 LARGER COMMUNITY**

(From Page 14)

the keynote of the discussion on "Planning and Redevelopment of the Larger Community," considered at the recent Businessmen's Conference on Urban Problems held in Detroit. We did not talk about the general theory of city planning or even subdivisions of that theory. There were selected several well-defined and widely-recognized phases of urban problems, currently important and susceptible of effective treatment. Each of these subjects were briefly outlined as a prelude to round table discussions among the group. Experience in Detroit was used to illustrate the points made.

Of all the separable and distinct sections of a city I think all will agree that the central business district is most important. Here is the greatest concentration of assessed values. It is the number one point of origin and destination for mass transit riders and private vehicle users. More business is transacted here than in almost all local shopping centers combined. And finally, by its appearance, convenience and general effect a city is more often rated by the visitor than by any other single area of that community. How the central business district of a city can be improved is therefore of vital concern to every citizen of every community, and especially to the businessmen of the nation. We will give an analysis of Detroit's downtown area and the specific remedies prescribed to make it more attractive to the shopper and more secure for its office building and store owners.

Slum Clearance

Slums and blighted areas have received more general attention in recent years than any other aspect of our cities' conditions. Figures have been bandied about to show that from 10 to 30% of our larger cities' areas are in a state of physical and economic decay, necessitating quick and drastic action. Whatever the true percentage of slum areas may be, and it varies in each community, there seems to be general agreement that something ought to be done about it, and also that not enough is being done. We propose to present the highlights of what American cities are doing to clear slums as a prelude to discussion on what more should be done, and how an expansion and quickening of this program should be carried out within the enterprise system.

Outlying Commercial Development

Local shopping centers throughout the city in the aggregate approach the central business district in importance to residents and to community welfare. Successful subdividers and developers have worked out, from theory and from trial and

error, tested and proven principles for distribution, location and design of neighborhood business areas. To what extent is this hard-won experience being exploited in new developments throughout our communities? Surely a review of this subject is timely and informative to those concerned with civic progress.

Recent years have brought increasing use of the term "neighborhood" in city planning. Since Clarence Perry first formalized the term in 1929 the neighborhood concept seems to have gained acceptance, so that today every new city plan is built around and upon it. Thus, it seems pertinent in a conference of this kind to closely examine this principle and see for ourselves whether it is merely a theoretical term or a workable tool for city development and redevelopment. Does the neighborhood have a practical basis, and is it founded on a realistic appraisal of residential areas in either their present or future form? Is it applicable to any one or all of the three general classes of residential sections of a large community; namely, the developing, the deteriorating and the redevelopment areas? A better understanding and agreement on the significance of the neighborhood approach will be extremely useful in our search for solutions to urban problems.

Urban Redevelopment

Slum clearance and rebuilding for housing have been practically synonymous for many years. Lately, however, we talk of redevelopment of slum areas. This is a broader approach which enables us to see more clearly both our objectives and the procedures to attain them.

In many cities the badly blighted and slum areas subject to clearance and rebuilding are now largely residential in character, although frequently with an admixture of run-down industry and business. The best future land use for some of these areas may not be residential at all, but rather for industry. Rebuilding of such sections with dwellings might doom these residences to ultimate and inevitable blight again. Thus, it has appeared that redevelopment in these cases for industry or commerce might in the long run be more realistic and productive for the community. Relief of industrial site shortage, increased employment opportunities and enhanced tax base could easily follow a program of this kind. Since subsidy of some kind and from some source now seems unavoidable if timely redevelopment is to be attained, may not subsidy for industrial redevelopment prove more productive and less costly for the community? Competent testimony by an expert on industrial needs applied to this type of redevelopment will open up new approaches to the problems of urban slums and blight.

(See Page 44)



OUT-MODED WIRING-- A LIABILITY

Homes built 20 years ago are electrically obsolete. Wired chiefly for lights and a few small appliances these homes lack the power for today's expanded electrical needs.

Bankers and other lenders, consequently, place wiring high on the list of factors to be checked as contributors to home depreciation and early obsolescence.

To protect the owner's investment, architects today are placing increased emphasis on adequate wiring — enough circuits of large enough wire, and plenty of conveniently placed outlets and switches — for all present and future needs.

NORTHERN CALIFORNIA ELECTRICAL BUREAU

1355 MARKET STREET
SAN FRANCISCO 3

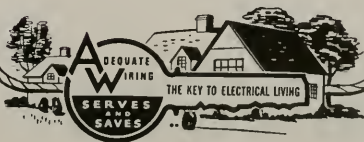

QUALITY building material COSTS YOU LESS

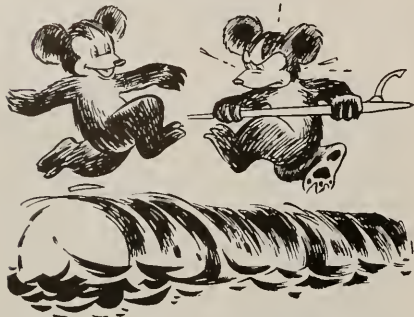

E. K. WOOD LUMBER CO.

SAN FRANCISCO General Offices: No. 1 Drumm Street
LOS ANGELES Office and Yards: 4710 S. Alameda St.—JE 3111
OAKLAND Yards and Wharves: 727 Kennedy St.—KE 4-8466
PORTLAND Mill Sales Office: 827 Terminal Sales Bldg.

SAW MILLS: Roseburg, Oregon • Reedsport, Oregon

RETAIL YARDS: LOS ANGELES • OAKLAND • ONTARIO • HOLLYWOOD
 LONG BEACH • RIVERSIDE • TEMPLE CITY • SIERRA MADRE • INDIO • THERMAL
 LA VERNE • WHITTIER • PASADENA • SAN PEDRO

BAXCO

CHROMATED ZINC CHLORIDE

CCZC

PRESSURE TREATED LUMBER
 ● **PROTECTS AGAINST DECAY
 AND TERMITE ATTACK**

*Specify it in your home
 Available through Lumber Dealers*

LOS ANGELES
 601 W. 5th Street
 Phone Michigan 6294

SAN FRANCISCO
 333 Montgomery Street
 Phone DOugles 2-3883

J. H. Baxter & Co.

AGENTS FOR WEST COAST WOOD PRESERVING CO. SEATTLE, WASH

HEADLINE NEWS AND VIEWS

By E. H. W.

Development of a new, low-cost board that repels rats has been announced by the U. S. Plywood Corp'n.—John L. Lewis should be interested.

American cities are not planned for the "art of living" but for the "art of making money."—Clip Sheet, U. C.

We must remember that the biggest room in the world is the room for improvement.—Karl Bock, Pres. American Institute of Decorators.

Entries to the Merit Award Competition, Third International Lighting Exposition, will close on January 15, 1949.

"One-quarter of every dollar of industry's payroll is spent for handling. Yet handling adds nothing to a product except cost."—S. W. Gibb, President, Material Handling Institute.

"Continuation of the business boom into 1949 depends more on construction than any other factor." Business Week.

New and expanded industrial ventures in the San Francisco Bay Area and Northern California during July, 1948, accounted for 56 projects with an estimated expenditure of \$21,884,700.—Industrial Dept., San Francisco Chamber of Commerce

"Business managements in responsible positions in almost four million separate businesses, by their day-to-day decisions, help to determine the level of economic activity."—Business Action.

It is estimated that the backlog of orders for new automobiles in this country is more than 7,300,000. This represents a tremendous amount of money awaiting spending by the public.

"In sharp contrast to two years ago, the attitude of the European countries is now largely one of optimism instead of despair."—Paul G. Hoffman ECA.

The Los Angeles City Housing Authority is the largest landlord in Los Angeles operating a total of 13,589 units housing approximately 55,000 persons.

Recent tests on the Pacific Electric circuit breaker are believed to be the largest short circuit interruptions ever made.

IN THE NEWS

ARCHITECT SELECTED

Birge M. Clark & Walter Stromquist, Palo Alto architects, have been selected for the proposed addition to the Santa Clara County Tubercular Hospital at San Jose.

BONDS VOTED

Bonds have been approved for the construction of a new junior college at Redding (California) in the amount of \$1,180,500, plus \$500,000 for an addition to the high school.

SCHOOL CONTRACT

A general contract has been awarded to Pacific Coast Builders of San Francisco, for the construction of a new Elementary School building at Pittsburg (California) to cost \$569,500. Chas. F. Dean, Sacramento, is the Architect.

REPAIR "GJOA"

San Francisco's Park Commission has decided to repair the famous ship "Gjoa" used by Capt. Amundsen during expeditions to the North Pole. The ship is on exhibition in Golden Gate Park.

YOUTH CENTER

The Piedmont (California) Community Church has awarded a contract to the California Builders Company of Oakland, for the construction of a \$120,413 addition to the Church's Education and Youth Center.

BONDS LOSE

A \$1,000,000 Bond Issue for construction of High School buildings in Chico and Paradise (California) were recently defeated by the voters of the school district.

Likewise a \$1,250,000 Bond Issue for construction of High School buildings in Merced, Atwater, and Livingston was also rejected by the voters of the Merced Union High School District.

HOSPITAL ADDITION

The Mills Memorial Hospital at San Mateo (California) has awarded a \$366,000 contract to the Louis C. Dunn Company of San Francisco for the construction of an addition to the hospital building. Skidmore, Owings & Merrill of San Francisco are the architects.

At Helms Bakeries' New Plant



BETTER LIGHTING

CONTRIBUTES TO A BETTER PRODUCT

Seventeen years of experience qualifies Helms Bakeries to say what makes good bread... and efficient bakeries. Day and night shifts over a period of nearly two decades have proven to this outstanding company, the importance of more efficiently, more comfortably lighted interiors to a better product.

The installation of Certified Smoot-Holman industrial fluorescent lighting equipment in Helms' new plant in Montebello, California, is Helms' answer to this need. Smoot-Holman industrial lighting fixtures are a positive guarantee of maximum performance with minimum maintenance cost.



Offices in Principal Western Cities—Branch and Warehouse in San Francisco

LANDSCAPE ARCHITECTURE

Notes of The Profession

ASSOCIATION OF LANDSCAPE ARCHITECTS, SAN FRANCISCO REGION
Emil L. Anderson, President; Vernon M. Dean, Vice-President; Ralph W. Jones,
Secretary; Paul M. Steinmetz, Recording Secretary; Prentiss French,
Treasurer. Directors at Large: Geraldine Knight Scott, Wayne
Gray, H. L. Vaughan and Douglas H. Baylis.

SAN FRANCISCO'S NEWEST COMMUNITY PROJECT

A general contract has been awarded to the MacDonald, Young & Nelson Construction Company of San Francisco by Stoneson Brothers for the construction of a new community center in the area north of Parkmerced in San Francisco.

The new construction will consist of four ten-story reinforced concrete apartment buildings containing automatic elevators; ten three-story apartment buildings which will contain 683 four, five and six room apartments, of frame and stucco; a large reinforced concrete shopping center, and a theater building.

Known as the "Stonestown" Community Project,

it is estimated it will cost in excess of \$30,000,000 to complete.

The architect is Angus McSweeney of San Francisco.

GENERAL CONTRACT AWARDED. The Dinwiddie Construction Company, San Francisco, has been awarded a \$600,000 contract for the construction of a new store building in San Mateo (California) for the Parrott Investment Company. W. P. Day & Harry Michelson of San Francisco are the Architects.

NEW STEAM ELECTRIC PLANT. The Pacific Gas & Electric Company have announced preliminary plans for the construction of a \$50,000,000 steam electric power plant near Antioch, California. Bechtel Corporation is the Contractor.

APPOINTED TRAFFIC MANAGER OF W. P. FULLER & COMPANY

The appointment of E. P. Camous to the position of Traffic Manager of the W. P. Fuller & Company, West Coast paint manufacturers, has been announced by A. H. Brawner, President.



E. P. CAMOUS

Camous, a graduate of the University of San Francisco in 1939 with the degree of B.S. in Economics, succeeds former Traffic manager N. B. Wagner, who retired after completing 50 years of service with the paint, glass, and wallpaper firm.

During the late War Camous served as Administrative Assistant to the Officer in Charge of the Commercial Communications Section, Signal Office, Ninth Service Command.

Camous is promoted to his new position from the Traffic Department where he has been serving as Assistant Traffic Manager under Wagner.



Colorful porcelain-enameled iron sheets are economically produced... simply and quickly installed... produce a distinctive, permanent, lightweight veneer for every type of building exterior. They are adaptable for interior application, too.

★ WRITE TODAY for complete information and literature



- ★ VENEER ★ PANELS
- ★ FLASHED - PANELS
- ★ SPECIAL SHAPES

ARCHITECTURAL PORCELAIN CONSTRUCTORS

2827 UNION STREET - OAKLAND 8, CALIFORNIA
TELEPHONE TWINOAKS 3-5154

WITH THE ENGINEERS

(From Page 33)

showing actual failures investigated by the L. T. Holt Company. In most premature fatigue failures of tail shafts the nuclei could be traced to the rough machined surface of the shafting. Keyways were also shown to be the point of origination of many fatigue cracks. The steel itself was seldom found to be the source of the trouble. Fabrication defects or design was usually responsible for service failures. He showed one example where very dirty steel was responsible. Mr. Holt's studies into failures of machine and engine parts were very instructive and interesting.

Two motion pictures on the manufacture of steel were presented. One presented by Alleghany Ludlum showed the melting and casting of stainless steel and the other, melting and fabrication of steel for ship shafting by Isaacsan Iron Works, of Seattle, Washington. The pictures brought to conclusion a very worthwhile evening.

ENGINEERING DEAN RETURNS TO COLLEGE

Prof. Morrrough P. O'Brien, Dean of the College of Engineering, University of California, has returned to the Berkeley campus after a year's leave of absence spent in private industry.

While on leave, Dean O'Brien served as director of research and engineering for the Air Reduction Company. The research and engineering activities under his direction included chemical and physical research and chemical and mechanical engineering. His work also included the direction of a reorganization of the technical phases of the company's activities and formulation of technical plans and policies for the company.

Construction work valued at 15 million dollars was completed during the year he was associated with the company.

PACIFIC COAST BUILDING OFFICIALS CONFERENCE

The Pacific Coast Building Officials Conference at its recent annual meeting in Sacramento, adopted more than 150 specific changes to the Uniform Code, several of which are of particular interest to Structural Engineers.

Of more than passing interest are the following: New occupancy table allowing reduced fire-resistance in exterior walls under certain conditions and occupancies; new roof loading requirements; an increase in basic stresses for lumber but not for fastenings; revised concrete chapter to conform with the latest A.C.I. recommendations; increased allowable bolt stresses in Masonry.

Approved changes in the Steel Chapter to con-

King Size... FOR PERFORMANCE

*Queen Size...
FOR BEAUTY*

Continental
GLADIATOR

Chosen by the National magazine

MADMOISELLE LIVING for its model home



We have "castled" our Gladiator in one of the most publicized model homes ever built. It will protect the King with a wonderful 40 gallon an hour recovery and efficient, clean operation. The Queen will delight in its all over white beauty. Checkmate all your customers with the Gladiator.

Continental WATER HEATER COMPANY LTD.

1801 PASADENA AVENUE, LOS ANGELES 31, CALIFORNIA



STRUCTURAL STEEL

For Class A Buildings,
Bridges, etc.

JUDSON PACIFIC - MURPHY CORP.

4300 EASTSHORE HIGHWAY
EMERYVILLE, CALIF.

FORDERER CORNICE WORKS

Manufacturers of

Hollow Metal Products • Interior Metal Trim
Elevator Fronts and Cabs
Metal Plaster Accessories • Sanitary Metal Base
Flat and Roll Metal Screens
Metal Cabinets • Commercial Refrigerators

269 POTRERO AVE.

SAN FRANCISCO, CALIF. HEMLOCK 4100

VALUABLE NEWS SERVICE

- BUILDING MATERIAL DEALERS
- CONTRACTORS
- ENGINEERS
- FINANCIAL INSTITUTIONS

ARCHITECTS REPORTS gives advance news on construction projects in Northern California, lists: name of projects, location, architect, proposed cost and other pertinent information.

HANDY individual slip-reports, issued daily at a total cost of only

\$10 a month

ARCHITECT'S REPORTS

Published Daily

The ARCHITECT and ENGINEER, Inc.

68 Post Street, San Francisco - DO 8311

form to latest A.I.S.C. specifications; complete revision of the Chapter on foundations and piles; and a new earthquake probability map of the United States was approved for inclusion in the index.

It is expected the 1949 edition of the Uniform Code, including all approved changes, will be available early in the year.

NEW DISTRICT SALES MANAGER

George L. Cobb has been appointed to the post of district sales manager for the Soule' Steel Company, according to a recent announcement by Edw. L. Soule', president.



George L. Cobb

He will have charge of the company's sales program throughout northern California and Nevada, with headquarters in the general offices in San Francisco.

Cobb is a graduate of the School of Engineering, Stanford University, is active in civic affairs, and has been with Soule' for the past fourteen years holding the positions of sales engineer and advertising manager prior to his present appointment.

The Soule' organization also maintain facilities in Los Angeles, Portland, and Seattle for fabricating steel building products and for marketing its new pre-fabricated all metal buildings.

CONTRACTOR APPOINTED TO ADVISORY COUNCIL

Walter L. Couse, general contractor of Detroit, Michigan, has been appointed to the Advisory Council of the United States Senate Interstate Commerce Subcommittee on Trade Policies.

The subcommittee is investigating the effect on the national economy of Supreme Court and Federal Trade Commission decisions challenging the legality of basing point and other delivered price systems where the seller absorbs freight costs to meet the lower prices of competitors located closer to the customer.

General contractors are customers for a large number of construction materials that have ordinarily been sold on a delivered price basis. Couse will bring to the council the problems of the contract construction industry relating to pricing policies.

ESTIMATOR'S GUIDE

BUILDING AND CONSTRUCTION MATERIALS

PRICES GIVEN ARE FIGURING PRICES AND ARE MADE UP FROM AVERAGE QUOTATIONS FURNISHED BY MATERIAL HOUSES TO SAN FRANCISCO CONTRACTORS. 2½% SALES TAX ON ALL MATERIALS BUT NOT LABOR

All prices and wages quoted are for San Francisco and the Bay District. There may be slight fluctuation of prices in the interior and southern part of the state. Freight cartage, at least, must be added in figuring country work.

BONDS—Performance or Performance plus Labor and Material Bond(s), \$10 per \$1000 on contract price. Labor & Material Bond(s) only, \$5.00 per \$1000 on contract price.

BRICKWORK—

Common Brick—Per 1M laid—\$100.00 up (according to class of work).
Face Brick—Per 1M laid—\$200.00 and up (according to class of work).
Brick Steps—\$3.00 and up.
Common Brick Veneer on Frame Bldgs.—Approx. \$1.20 and up—according to class of work).
Face Brick Veneer on Frame Bldgs.—Approx. \$2.00 and up (according to class of work).
Common Brick—\$28.50 per M—truckload lots, delivered.
Face Brick—\$40.00 to \$90.00 per M, truckload lots, delivered.
Cartage—Approx. \$9.00 per M.
Los Angeles County Area—Residential, up to 4-family or apt., metal raceways, \$6.50 per outlet.

BUILDING PAPER—

1 ply per 1000 ft. roll	\$5.30
2 ply per 1000 ft. roll	7.80
3 ply per 1000 ft. roll	9.70
Brownskin, Standard, 500 ft. roll	8.00
Sisalcraft, reinforced, 500 ft. roll	7.00

BUILDING HARDWARE—

Sash cord com. No. 7	\$2.65 per 100 ft.
Sash cord com. No. 8	3.00 per 100 ft.
Sash cord spot No. 7	3.65 per 100 ft.
Sash cord spot No. 8	4.00 per 100 ft.

Sash weights, cast iron, \$100.00 ton.
Nails, \$5.50 base.

CONCRETE AGGREGATES—

The following prices net to Contractors unless otherwise shown. Carload lots only.

	Bunker per ton	Del'd per ton
Gravel, all sizes	\$2.44	\$2.75
Top Sand	2.38	3.13
Concrete Mix	2.38	3.06
Crushed Rock, ¼" to ¾"	2.38	2.94

	Bunker per ton	Del'd per ton
Crushed Rock, ¾" to 1½"	\$2.38	\$3.13
Roofing Gravel	2.81	3.50
River Sand	2.50	3.06

Sand—

Lapis (Nos. 2 & 4)	3.56	3.94
Olympia (Nos. 1 & 2)	3.56	3.88

Cement—

Common (all brands, paper sacks), carload lots, \$3.02 per bbl, f.o.b. car; delivered \$3.60.
Cash discount on carload lots, 10c a bbl, 10th Prot., less than carload lots \$4.00 per bbl, f.o.b. warehouse or delivered.
Cash discount 2% on L.C.L.

Trinity White	{ 1 to 100 sacks, \$3.13 sack warehouse or del.; \$9.56 bbl. carload lots.
Medusa White	

DAMP-PROOFING and Waterproofing—

Two-coat work, \$8.00 per square.
Membrane waterproofing—4 layers of saturated felt, \$9.00 per square.
Hot coating work, \$5.00 per square.
Medusa Waterproofing, \$3.50 per lb. San Francisco Warehouse.
Tricalcon concrete waterproofing, 50c a cubic yd. and up.

ELECTRIC WIRING—\$15 to \$20 per outlet for conduit work (including switches).

Knob and tube average \$6.00 per outlet. (Available only for priority work.)

ELEVATORS—

Prices vary according to capacity, speed and type. Consult elevator companies. Average cost of installing a slow speed automatic passenger elevator in small four story apartment building, including entrance doors, about \$8000.00.

EXCAVATION—

Sand, \$1.00; clay or shale, \$1.50 per yard.
Trucks, \$30 to \$45 per day.
Above figures are an average without water. Steam shovel work in large quantities, less; hard material, such as rock, will run considerably more.

FIRE ESCAPES—

Ten-foot galvanized iron balcony, with stairs, \$250 installed on new buildings; \$300 on old buildings.

FLOORS—

Composition Floors, such as Magnesite, 50c per square foot.
Linoflor—2 gages—\$3.00 per sq. yd.
Mastipave—\$1.50 per sq. yd.
Battleship Linoleum—available to Army and Navy only—1/8"—\$3.50 sq. yd.
3/8"—\$3.50 sq. yd.
Terrazo Floors—\$1.50 per sq. ft.
Terrazo Steps—\$2.50 per lin. ft.
Mastic Wear Coat—according to type—20c to 35c.

Hardwood Flooring—

Standard Mill grades not available.
Victory Oak—T & G
¾" x 2¼" \$252.00 per M. plus Cartage
½" x 2" \$210.00
½" x 1½" 200.00

Prefinished Standard & Better Oak Flooring
¾" x 3¼" \$265.00 per M. plus Cartage
½" x 2½" 237.00 per M. plus Cartage

Maple Flooring

¾" T & G Clear \$330.00 per M. plus Ctg.
2nd 305.00 per M. plus Ctg.
3rd 255.00 per M. plus Ctg.
Floor Layers' Wage, \$2.28½ per hr. (Legal as of July 1, 1947. Given us by Inlaid Floor Co.)

GLASS—

Single Strength Window Glass	\$.40 per □ ft.
Double Strength Window Glass	.60 per □ ft.
Plate Glass, under 75 sq. ft.	1.50 per □ ft.
Polished Wire Plate Glass	2.25 per □ ft.
Rgh. Wire Glass	.60 per □ ft.
Obscure Glass	.40 per □ ft.

Glazing of above is additional.
Glass blocks \$2.75 per □ ft. set in place

HEATING—

Average, \$2.50 to \$3.00 per sq. ft. of radiation, according to conditions.
Warm air (gravity) average \$64 per register.
Forced air average \$91 per register.

INSULATION AND WALLBOARD—

Rockwool Insulation— (2")	\$65.00 per M sq. ft.
Cotton Insulation—Full-thickness (3%)	\$95.50 per M sq. ft.
Sisalation Aluminum Insulation—Foil-mounted on both sides	\$23.50 per M sq. ft.
Tileboard—4'x6' panel	\$9.00 per panel
Wallboard—1/2" thickness	\$55.00 per M sq. ft.
Finished Plank	\$69.00 per M sq. ft.
Ceiling Tileboard	\$69.00 per M sq. ft.

IRON—Cost of ornamental iron, cast iron, etc., depends on designs.

LUMBER—

No. 1 Common	\$90.00 per M
No. 2 Common	\$88.00 per M
Select O. P. Common	\$4.00 per M

Flooring—	Per M Delvd.
V.G., D.F., B & Btr. 1 x 4 T & G Flooring	\$170.00
"C" and better—all	170.00
"D" and better—all	170.00
Rwd. Rustic—"A" grade, medium dry	150.00
8 to 24 ft.	
"B" grade, medium dry	150.00
Plywood	15c to 18c per ft.
Plycord	9c per ft.
Plywall	7c per ft.
Plyform	15c per ft.

Shingles (Rwd. not available)—
Red Cedar No. 1—\$13.00 per square; No. 2, \$10.50; No. 3, \$9.00.
Average cost to lay shingles, \$6.00 per square.
Cedar Shakes—Tapered: 1/2" to 3/4" x 25"—\$17.00 per square.
Resawn: 3/4" to 1 1/4" x 25"—\$22.00 per square
Average cost to lay shakes,—8.00 per square

MILLWORK—Standard.

D. F. \$150 per 1000. R. W. Rustic \$175 per 1000 (delivered).
Double hung box window frames, average with trim, \$12.50 and up, each.
Complete door unit, \$15 to \$25.
Screen doors, \$6.00 to \$8.00, each.
Patent screen windows, \$1.25 a sq. ft.
Cases for kitchen pantries seven ft. high, per lineal ft., \$12.00, each.
Dining room cases, \$15.00 per lineal foot.
Rough and finish about \$1.00 per sq. ft.
Labor—Rough carpentry, warehouse heavy framing (average), \$65.00 per M.
For smaller work average, \$75.00 to \$85.00 per 1000.

MARBLE—(See Dealers)

PAINTING—

Two-coat workper yard 75c
Three-coat workper yard \$1.00
Cold water paintingper yard 25c
Whitewashingper yard 15c
Turpentine.....\$1.85 per gal. in 5-gal. cont.
Raw Linseed
Oil.....\$3.33 per gal. in 5-gal. cont.

Boiled Linseed Oil.....\$3.23 per gal. in drums.
Boiled Linseed Oil—\$3.33 per gal. in 5-gal. containers.
Replacement Oil—\$2.75 per gal. in drums.
\$2.75 per gal. in 5-gal. containers.
Use Replacement Oil.....\$3.00 per gal. in 1 gal. cont.
A deposit of \$7.50 required on all drums.

PATENT CHIMNEYS—

6-inch	\$2.00 lineal foot
8-inch	2.50 lineal foot
10-inch	3.50 lineal foot
12-inch	4.50 lineal foot

PLASTER—

Neat wall, per ton delivered in S. F. in paper bags, \$17.60.

PLASTERING (Interior)—

3 Coats, metal lath and plaster	Yard \$3.00
Keene cement on metal lath	3.50
Ceilings with 3/4 hot roll channels metal lath (lathed only)	3.00
Ceilings with 3/4 hot roll channels metal lath plastered	4.50
Single partition 3/4 channel lath 1 side (lath only)	3.00
Single partition 3/4 channel lath 2 inches thick plastered	8.00
4-inch double partition 3/4 channel lath 2 sides (lath only)	5.75
4-inch double partition 3/4 channel lath 2 sides plastered	8.75
Thermax single partition; 1" channels; 2 1/4" overall partition width. Plastered both sides	7.50
Thermax double partition; 1" channels; 4 1/4" overall partition width. Plastered both sides	11.00
3 Coats over 1" Thermax nailed to one side wood studs or joists	4.50
3 Coats over 1" Thermax suspended to one side wood studs with spring sound insulation clip	5.00
Note—Channel lath controlled by limitation orders.	

PLASTERING (Exterior)—

2 coats cement finish, brick or concrete wall	Yard \$2.50
3 coats cement finish, No. 18 gauge wire mesh	3.50
Line—\$4.00 per bbl. at yard.	
Processed L.L. Lime—\$4.15 per bbl. at yard.	
Rock or Grip Lath—3/4"—30c per sq. yd.	
1/4"—29c per sq. yd.	
Composition Stucco—\$4.00 sq. yard (applied).	

PLUMBING—

From \$150.00 per fixture up, according to grade, quality and runs.

ROOFING—

"Standard" tar and gravel, 4 ply—\$11.00 per sq. for 30 sqs. or over.
Less than 30 sqs. \$14.00 per sq.
Tile \$40.00 to \$50.00 per square.
Redwood Shingles, \$15.00 per square in place.
5/2 # 1-16" Cedar Shingles, 4 1/2" Exposure\$18.25 square

5/8 x 16"—# 1 Cedar Shingles, 5" Exposure\$17.00 square
4/2 # 1-24" Royal Shingles, 7 1/2" Exposure\$23.00 square
Re-coat with Gravel \$5.50 per sq.
Asbestos Shingles \$25 to \$40 per sq. laid.
1/2 to 3/4 x 25" Resawn Cedar Shakes, 10" Exposure\$24.00
3/4 to 1 1/4 x 25" Resawn Cedar Shakes, 10" Exposure\$29.00
1 x 25" Resawn Cedar Shakes, 10" Exposure 22.00
Above prices are for shakes in place.

SHEET METAL—

Windows—Metal, \$2.50 a sq. ft.
Fire doors (average), including hardware \$2.80 per sq. ft., size 12'x12'. \$3.75 per sq. ft., size 3'x6'.

SKYLIGHTS—(not glazed)

Copper, \$1.25 sq. ft. (flat).
Galvanized iron, 65c sq. ft. (flat).
Vented hip skylights 90c sq. ft.

STEEL—STRUCTURAL—

\$220 per ton erected, when out of mill.
\$270 per ton erected, when out of stock.

STEEL REINFORCING—

\$200.00 per ton, in place.

STONE FRONTS (None available).

TILE—

Ceramic Tile Floors—\$1.70 per sq. ft.
Glove Base—\$1.35 per lin. ft.
Glazed Tile Wainscot—\$1.85 per sq. ft.
Asphalt Tile Floor 1/4" x 1/4"—\$.40 per sq. ft.
Light shades slightly higher.
Cork Tile—\$1.00 per sq. ft.
Mosaic Tiles—See dealers.
Lino-Tile—\$1.00 per sq. ft.

Wall Tile—

Glazed Terra Cotta Wall Units [single faced] laid in place—approximate prices:
2 x 6 x 12\$1.25 sq. ft.
4 x 6 x 12 1.50 sq. ft.
2 x 8 x 16 1.45 sq. ft.
4 x 8 x 16 1.75 sq. ft.

VENETIAN BLINDS—

75c per square foot and up. Installation extra.

WINDOWS—STEEL—

60c per square foot, \$5 for ventilators.

A.I.A. ACTIVITIES

From Page 31)

NORTHERN CALIFORNIA CHAPTER

John G. Barter, insurance specialist, recently discussed the subject "Professional Group Accident and Sickness Policy" for architects who are members of one of the A.I.A. Chapters in California. The matter of insurance for members has been considered and approved by the California Council of Architects.

The first Fall meeting of the Women's Architectural League was held at the home of Architect and Mrs. Abe Appleton recently.

MEMBERSHIP: The Institute has elected to the status of Member Emeritus Harris C. Allen, F.A.I.A. Other changes in the Chapter roll are:

Advanced to Corporate Membership: Frederick M. Mann, Junior, Clement A. Mullins, Jane Moorehead Parug.

Transferred: Charlie Salyers, from San Diego Chapter; R. P. Tobin, from New Jersey Chapter.

New Corporate Members: Albert Edward Alexander, Eugene E. D. Crawford, John I. Easterly, John A. Huberty, Albert H. Larsen, Francis A.

Lockwood, Ernest F. Winkler.

Associate: Clifford B. Holser.

Junior Associate: Leslie W. Niemi, Byron C. Singletary.

ARCHITECT HONORED

Richard J. Neutra, F.A.I.A., has been nominated as an Honorary Member of the Royal Institute of British Architects. An honorary degree as Doctor of the Technical Sciences has also been conferred upon Mr. Neutra by the University of Graz and Austria's Secretary of Education.

APPOINTED TO SCHOOL OF ARCHITECTURE FACULTY

Michael Czaja, Architect, has been appointed to the faculty of the School of Architecture at the University of California at Berkeley, according to a recent announcement.

Prior to engaging in architectural activities in California, Czaja served as associate professor of Architecture at Washington State College and Director of Architecture at Bennington College, Bennington, Vermont.

During the recent Summer, he served as visiting professor of design at Stanford University.

BUILDING TRADES WAGE (JOB SITES) NORTHERN AND CENTRAL CALIFORNIA

ATTENTION: The following are the PREVAILING hourly rates of compensation being paid and in effect by employers by agreement between employees and their union; or as recognized and determined by the U. S. Department of Labor. (Revised to January 1, 1948.)

CRAFT	San Francisco		Alameda and Contra Costa		Marin	Vallejo	San Mateo	San Jose	Stockton	Sacramento	Fresno
	San Francisco	Alameda and Contra Costa	Marin	Alameda and Contra Costa							
ASBESTOS WORKERS	1.90	1.90	1.90	1.90	1.90	1.90	1.90	1.90	1.90	1.90	1.90
BRICKLAYERS	2.25	2.25	2.25	2.25	2.25	2.25	2.25	2.25	2.25	2.25	2.25
BRICKLAYERS, HODCARRIERS	1.75	1.75	1.75	1.75	1.75	1.75	1.75	1.87½	1.87½	1.87½	1.75
CARPENTERS	2.00	2.00	2.00	2.00	2.00	2.00	2.00	2.00	2.00	2.00	2.00
CEMENT FINISHERS	2.02½	2.02½	2.02½	2.02½	2.02½	2.02½	2.02½	2.02½	2.02½	2.02½	2.02½
ELECTRICIANS	2.25	2.25	2.25	2.25	2.25	2.25	2.25	2.25	2.25	2.25	2.25
ENGINEERS: MATERIAL HOIST	2.00	2.00	2.00	2.00	2.00	2.00	2.00	2.00	2.00	2.00	2.00
ENGINEERS: PILE DRIVER	2.25	2.25	2.25	2.25	2.25	2.25	2.25	2.25	2.25	2.25	2.25
ENGINEERS: STRUCTURAL STEEL	2.25	2.25	2.25	2.25	2.25	2.25	2.25	2.25	2.25	2.25	2.25
GLASS WORKERS	1.87½	1.87½	1.87½	1.87½	1.87½	1.87½	1.87½	1.87½	1.87½	1.87½	1.87½
IRONWORKERS: ORNAMENTAL	2.10	2.10	2.10	2.10	2.10	2.10	2.10	2.10	2.10	2.10	2.10
IRONWORKERS: REINF. RODMEN	2.00	2.00	2.00	2.00	2.00	2.00	2.00	2.00	2.00	2.00	2.00
IRONWORKERS: STRUCTURAL	2.25	2.25	2.25	2.25	2.25	2.25	2.25	2.25	2.25	2.25	2.25
LABORERS: BUILDING & CONCRETE	1.40	1.40	1.40	1.40	1.40	1.40	1.30	1.40	1.40	1.40	1.30
LATHERS	2.25	2.25	2.25	2.25	2.25	2.25	2.25	2.25	2.25	2.25	2.25
MARBLE SETTERS	2.00	2.00	2.00	2.00	2.00	2.00	2.00	2.00	2.00	2.00	2.00
MOSAIC & TERRAZZO	2.00	2.00	2.00	2.00	2.00	2.00	2.00	2.00	1.75	1.75	1.75
PAINTERS	2.00	2.00	2.00	2.00	2.00	2.00	2.00	2.00	2.00	2.00	2.00
PAINTERS: PILEDRIVERS	2.12½	2.12½	2.12½	2.12½	2.12½	2.12½	2.12½	2.12½	2.12½	2.12½	2.12½
PLASTERERS	2.25	2.50	2.25	2.50	2.25	2.25	2.25	2.05	2.05	2.05	2.05
PLASTERERS: HODCARRIERS	2.00	2.00	2.00	2.00	2.00	2.00	2.00	1.87½	1.87½	1.87½	1.87½
PLUMBERS	2.25	2.25	2.25	2.25	2.25	2.25	2.25	2.25	2.25	2.25	2.25
ROOFERS	2.00	2.00	2.00	2.00	2.00	2.00	2.00	2.00	2.00	2.00	2.00
SHEET METAL WORKERS	2.00	2.00	2.00	2.00	2.00	2.00	2.00	2.00	2.00	2.00	2.00
SPRINKLER FITTERS	2.00	2.00	2.00	2.00	2.00	2.00	2.00	2.00	2.00	2.00	2.00
STEAMFITTERS	2.25	2.25	2.25	2.25	2.25	2.25	2.25	2.25	2.25	2.25	2.25
STONESETTERS (MASON'S)	2.25	2.25	2.25	2.25	2.25	2.25	2.25	2.25	2.25	2.25	2.25
TILOSETTERS	2.15	2.15	2.15	2.15	2.15	2.15	2.15	2.15	2.15	2.15	2.15

Prepared and compiled by

CENTRAL CALIFORNIA CHAPTER, ASSOCIATED GENERAL CONTRACTORS OF AMERICA

with the assistance and cooperation of Secretaries of Building Trades Unions, General Contractors Associations and Builders Exchanges of Northern California

CLASSIFIED ADVERTISING

RATE: 20c PER WORD . . . CASH WITH ORDER

MINIMUM \$5.00

CONSTRUCTION ENGINEER (CIVIL) GENERAL SUPERINTENDENT PROJECT MANAGER

Twenty five years of wide practical experience on frame, steel, concrete and masonry bldgs. of all types. Estimating, sub-division, sales, detailing & specification writing background. Dependable, energetic. Excellent local references. Have car. Free to travel. P.O. Box 807, San Mateo, Calif.

WANTED: Product Engineer with experience wanted as a permanent addition to the staff of an industrial Development Department located in Minnesota. Work involves product development including travel for consumer contacts. Program relates to products from wood. Submit details education, experience, references, salary requirement, photograph. All replies considered confidential and will be acknowledged. Reply Box 238, Architect and Engineer, Inc., 68 Post St., San Francisco, Calif.

ENGRAVING—Good engravings are essential to a satisfactory job of printing reproduction. For the best, see Poor Richard Photo Engraving Co., 324 Commercial St., San Francisco.

PHOTOGRAPHY: Building, Construction, Publicity, Aerial photographs by thoroughly experienced Photographers, Black & White, Color, Stills and Motion Pictures. DEB Photos, 929 Hearst Building, San Francisco.

HOGAN LUMBER CO.

Wholesale and Retail

LUMBER

MILL WORK • SASH & DOORS

Office, Mill, Yard and Docks
SECOND AND ALICE STREETS • OAKLAND, CALIF.
Telephone GLencourt 1-6861

SISALKRAFT

REG. U. S. PAT. OFF.

"More than a building paper"

THE SISALKRAFT CO.

205 West Wacker Drive
Chicago, Ill.

55 New Montgomery Street
San Francisco, Calif.

CLINTON CONSTRUCTION CO. OF CALIFORNIA

General Contractors

923 FOLSOM STREET • SAN FRANCISCO
SUtter 1-3440

TERRAZZO

for Floors and Wainscoting in Hospitals, Theaters, Hotels,
Office Buildings, Schools and Stores.
DECORATIVE • DURABLE • SANITARY



FOX TILE CO.

3247 E. 14th Street, Oakland
Phone: ANdover 1-0431

PLANNING AND RE-DEVELOPMENT LARGER COMMUNITY

(From Page 35)

We have talked much, and properly so, of urban problems and their solutions within the metropolitan city. Not all the problems, however, will stay within the city or, on the other hand, can be solved within its boundaries. There appears to be growing and continuing movement of industry and residences beyond our central city limits. This movement we call decentralization, and its effects are manifested in both the central city and its surrounding area, both rural and urbanized. Where this movement is both unguided and uncontrolled the results may be disastrous for all. Regional planning is frequently organized in such cases in an effort to minimize the evil effects and increase the possible benefits. Inquiry should now be made of regional planning as to how it regards decentralization, what it proposes to do about this mounting problem of cities, and what cities themselves may do to discourage or prevent undesirable migration of real community assets of business, industry and people.

POOR HOUSING COSTLY FOR FARM ANIMALS

The latest comprehensive, controlled test made to determine the effect of stabling conditions on a dairy herd's milk production reveals that poor housing cost \$4.81 a day in lost production. Milk output dropped from 16,025 pounds in the first 15 days of the test to 12,880 pounds in the final 15 days.

The 60-day test showed that cows kept in a drafty, uninsulated barn became ill, fluctuated widely in production and even died. A similar herd housed in a modern barn insulated full-thick with mineral wool and mechanically ventilated, maintained a steady rate of output. The owner of this barn stated he realized a 42 per cent return on his investment in ventilating equipment and insulation.

Complete details of the test, reported in a 16-page illustrated pamphlet, may be obtained without cost by writing the Construction Research Bureau, 12 East 41st Street, New York City. The uninsulated barn used in the test was selected from among those surveyed by the New Jersey College of Agriculture, when it made its 162-barn survey. The insulated barn was built from plans provided by the college.

ARCHITECT SELECTED

W. D. Peugh, Architect, San Francisco, has been selected to develop plans for the new Potrero Branch Library in San Francisco. Estimated cost \$125,000.

BOOK REVIEWS

PAMPHLETS AND CATALOGUES

WADE DRAINS. Wade Manufacturing Co., Elgin, Illinois. A.I.A. File No. 29-C.

This new Catalog (W-55) is designed to make available quickly and conveniently, carefully engineered products for general or specific drainage and maintenance. Section and page headings are arranged for ready reference with each group described as to type, size, dimension, weight and price.

Contains numerous tables and illustrations. Copies available from Wade Mfg. Co., Elgin, Illinois.

A QUALITY HOME CAN COST LESS. West Coast Lumberman's Association, Portland, Oregon.

A practical and informative eight-page booklet, in four colors, which traces the construction of an actual house, and through a simple step-by-step analysis shows where today's home builder can effect economies through the proper use of lumber grades.

The booklet is designed to give the dealer practical assistance in finding proper market for low grade lumber, and to assist in reducing building costs.

Copies available from West Coast Lumbermen's Ass'n, 1410 S. W. Morrison Street, Portland, 5, Oregon.

BROCHURE ON STRAN-STEEL. Kraftile Company, Niles, California.

The Kraftile Company, Niles, California, offers a 132 page brochure on Stran-Steel lightweight framing material featuring the patented Stran-Steel nailing groove, Attachment of collateral materials, fixture installations, and framing applications on various types of structures are detailed, with drawings and illustrations by Smith, Hinchman and Gryllis, Inc., architectural and engineering firm of Detroit.

The brochure is available to architects and engineers free (normal cost 50c) when requested on architect's or engineer's letterhead from KRAFTILE COMPANY, Niles, California, or the firm's San Francisco office at 50 Hawthorne Street, Kraftile Company also offers a 23-page illustrated catalog of Stran-Steel framing for the asking.

SCHOOL BONDS APPROVED. Voters of Modesto (California) have approved \$1,682,000 in bonds for the construction of new High School Buildings. Harry J. Devine of Sacramento is the Architect.

"AMERICAN - MARSH"

CONDENSATION UNIT

Pumping
Machinery
for
Every
Purpose

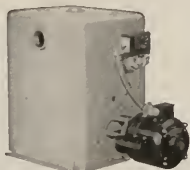

For Service
Call
DOuglas
2-6794
or
MUTual 8322

SIMONDS MACHINERY CO.
SAN FRANCISCO 816 FOLSOM
LOS ANGELES 455 EAST 4TH

VERMONT MARBLE COMPANY

Producers and Finishers
of
Domestic and Imported Marbles

525 MARKET STREET, SAN FRANCISCO
Phone SUtter 1-6747
3522 COUNCIL STREET
(Beverly Blvd. at Virgil Ave.)
LOS ANGELES 4, CALIF.
Telephone Fairfax 7834



**The Most Complete Line of
STEELS and BUILDING MATERIALS**
Made by a Single Producer



See Sweet's Catalog File or write us for
full information.

REPUBLIC STEEL CORPORATION
GENERAL OFFICES: CLEVELAND, OHIO

DENVER, COLORADO CONTINENTAL OIL BUILDING
LOS ANGELES, CALIFORNIA EDISON BUILDING
SALT LAKE CITY, UTAH WALKER BANK BUILDING
SAN FRANCISCO, CALIFORNIA RIALTO BUILDING
SEATTLE, WASH. WHITE-HENRY-STUART BUILDING

PACIFIC MANUFACTURING CO.

High Class Interior Finish Quality
Millwork

16 Beale St., San Francisco
GARfield 1-7755
2215 El Comina Real, San Mateo
S. M. 5-0687
304 Bryant Street, Palo Alto
P. A. 3373
2610 The Alameda, Santa Clara
S. C. 607 (Factory)
6820 McKinley Avenue, Los Angeles
THarnwell 4196
MAIN OFFICE — SANTA CLARA

IN THE NEWS

CADDY HOUSE

The Bridges Construction Company have bid \$12,432 for construction of a Caddy House for the San Jose (California) Country Club. Higgins & Root, San Jose are the architects.

NEW FLOOR FURNACE

A new directional, louver-type register for the Stubby floor furnace, has been announced by the

Holly Manufacturing Company of Pasadena.

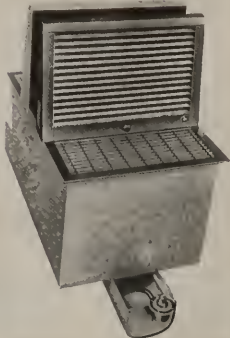

Known as the "Clearflo" it produces a uniform heat discharge over the entire register face and directs the heat down and out into the room. The assembly will fit either 2 x 3" or 2 x 4" stud wall construction and may be installed from above the floor without patching. Easily cleaned they meet all A.G.A. requirements.

NEW SUNBEAM

The Sunbeam Lighting Company of Los Angeles recently announced a new product No. 903-48 comprising a deep troffer recessed unit fitted with alba-lite glass and remote control starters.

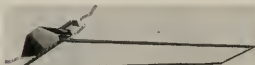

Other features include an exclusive light guard which eliminates light leaks between glass and

frame and provision for easy maintenance. The unit can be used separately or in continuous runs.

NEW PUMP

A new two-position circulating pump (horizontal or vertical) has been announced by the Marsh Heating Equipment Division of the Jas P. Marsh Corp'n of Skokie, Ill.

Other features of the pump include, special rubber coupling with brass inserts that is secure to



the motor shaft and pump shaft to eliminate transmission vibration, protecting bearings, and oil cup seal which is water tight.

Available for 1 1/4" or 1 1/2" pipe; operates on 1/6 h.p. motor, single phase, 60 cycle, 110 volt unit.

SPECIALTY TOOL

A specialty tool for hard to reach parts and places has just been put on the market by EMCO ENTERPRISES of Chicago, Illinois. Precision made, acid proof and cadmium plated it can be taken apart for cleaning.

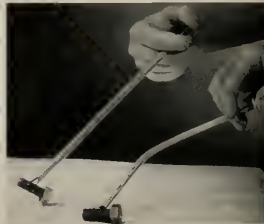

The shaft is flexible cable encased in flexible housing with expanding and retracting fingers which enable it to reach in and grab a tight hold on anything, with ample flexibility to work around corners or S-turns.

ARCHITECT SELECTED.

James H. Mitchell, San Francisco architect, has been selected to design the new Bay Park grammar school in Burlingame, California.

ALWINTITE

aluminum double-hung
residential windows
... represents more
than thirty-five years
experience in fine
window manufacture

WESTERN ASBESTOS

COMPANY

675 Townsend Street, San Francisco 3

Telephone: HElock 1-4884

OAKLAND • SACRAMENTO • FRESNO • SAN JOSE

CONCRETE SHEATHING
AND COVERING MATERIAL

**TOUGH as SHOE - LEATHER -
and WATERPROOF, Too!**

Specify
SISALKRAFT REINFORCED BUILDING PAPER
FOR CURING AND PROTECTING

GUNN CARLE & CO
20 POTRERO AVENUE • SAN FRANCISCO, CALIF.

**STATIONERY
SCHOOL & OFFICE
SUPPLIES**

•
Printing Engraving
Announcements

CENTER STATIONERY

468 McAllister

San Francisco UN 1-3703

**STATEMENT OF THE OWNERSHIP, MAN-
AGEMENT, CIRCULATION, ETC., RE-
QUIRED BY THE ACT OF CONGRESS
OF AUGUST 21, 1912, AS AMENDED BY
THE ACTS OF MARCH 3, 1933, AND
JULY 2, 1946.**

Of the Architect and Engineer, published
monthly at San Francisco, Calif., for October
1, 1948.

State of California }
City and County of San Francisco } SS.

Before me, a notary public in and for the
state and county aforesaid, personally ap-
peared L. B. Penhorwood, who, having been
duly sworn according to law, deposes and says
that she is the Business Manager of The Archi-
tect and Engineer, and that the following is
to the best of her knowledge and belief, a true
statement of the ownership, management (if
daily paper, the circulation), etc., of the aforesaid
publication for the date shown in the
above caption, required by the Act of August
24, 1912, as amended by the Acts of March 3,
1933, and July 2, 1946, (section 537, Postal
Laws and Regulations), printed on the reverse
of this form, to wit:

1. That the names and addresses of the pub-
lisher, editor, managing editor, and business
managers are:

Publisher, The Architect and Engineer, Inc.,
68 Post St., San Francisco, Calif.

Editor: Edwin H. Wilder, 68 Post St., San
Francisco, Calif.

Managing Editor—None.
Business Manager, L. B. Penhorwood, 68
Post St., San Francisco, Calif.

2. That the owner is: (If owned by a cor-
poration, its name and address must be stated
and also immediately thereunder the names
and addresses of stockholders owning or
holding one per cent or more of total amount
of stock. If not owned by a corporation, the
names and addresses of the individual owners
must be given. If owned by a firm, com-
pany, or other unincorporated concern, its
name and address, as well as those of each
individual member, must be given.)

The Architect and Engineer, Inc., 68 Post
St., San Francisco, Calif.

K. P. Kierulff, 68 Post St., San Francisco,
Calif.

E. N. Kierulff, 68 Post St., San Francisco,
Calif.

L. B. Penhorwood, 68 Post St., San Fran-
cisco, Calif.

F. W. Jones, 1153 McKinley Ave., Oakland,
Calif.

V. S. Yallop, 68 Post St., San Francisco,
Calif.

E. J. Cardinal, 942 Howard St., San Fran-
cisco, Calif.

Sewall Smith, Lafayette, Calif.

3. That the known bondholders, mortgagees,
and other security holders owning or holding
one per cent or more of total amount of bonds,
mortgages, or other securities are: (If there
are none, so state.)
None.

4. That the two paragraphs next above, giv-
ing the names of the owners, stockholders, and
security holders, if any, contain not only the
list of stockholders and security holders as they
appear upon the books of the company but
also, in cases where the stockholder or security
holder appears upon the books of the company
as trustee or in any other fiduciary relation,
the name of the person or corporation, for
whom such trustee is acting, is given; also
that the said two paragraphs contain state-
ments embracing affiant's full knowledge and
belief as to the circumstances and conditions
under which stockholders and security holders
who do not appear upon the books of the com-
pany as trustees, hold stock and securities in a
capacity other than of a bona fide owner; and
this affiant has no reason to believe that any
other person, association, or corporation has
any interest direct or indirect in the said stock,
bonds, or other securities than as so stated by
him.

5. That the average number of copies of each
issue of this publication sold or distributed,
through the mails or otherwise, to paid sub-
scribers during the twelve months preceding
the date shown above is: (This information is
required from daily publications only.)

L. B. Penhorwood, Business Mgr.

Sworn to and subscribed before me this 30th
day of September, 1948.

(Seal) IRENE CRESPI
Notary Public in and for the City and County
of San Francisco, Calif.

(My commission expires Jan. 3, 1951)

Scott Company

HEATING • PLUMBING
REFRIGERATION

★

San Francisco
Oakland
San Jose
Los Angeles

**MULLEN MFG.
COMPANY**

BANK, STORE AND OFFICE
FIXTURES—CABINET WORK
OF GUARANTEED QUALITY
CHURCH SEATING

Office and Factory
60-80 RAUSCH ST., Bet. 7th and 8th Sts.
San Francisco
Telephone UNderhill 1-5815

**THE TORMEY
COMPANY**

**GENERAL PAINTERS
AND DECORATORS**

Phone UNderhill 1-1913

563 FULTON STREET
San Francisco

**DINWIDDIE
CONSTRUCTION
COMPANY**

•
BUILDERS
•

CROCKER BUILDING
SAN FRANCISCO



**HERRICK
IRON WORKS**
STRUCTURAL STEEL
REINFORCING STEEL

18TH AND CAMPBELL STS.
OAKLAND, CALIF.
Phone Glancourt 1-1747

Phone GARfield 1-1164

Thomas B. Hunter

DESIGNER OF HEATING

AIR CONDITIONING
VENTILATING AND WIRING
SYSTEMS, MECHANICAL
AND ELECTRICAL EQUIP-
MENT OF BUILDINGS

★

41 SUTTER STREET
ROOM 710

San Francisco California

Fine
ENGRAVINGS

**POOR
RICHARD**
PHOTO ENGRAVING CO.
320-324 COMMERCIAL STREET
SAN FRANCISCO, CALIF.

INCINERATORS

TRASH BURNERS

Steel-Cased, Down-Draft Types

EXCEPTIONAL

Construction and Values

UNJ FIREBRICK CO.
CONSTRUCTION

San Francisco

345 Vermont St.

UN 1-2144

PITTSBURGH

TESTING LABORATORY

ENGINEERS AND CHEMISTS

Testing and Inspection of Concrete,
Steel and Other Structural Materials

Design of Concrete Mixes

Offices in all principal cities

651 Howard St., San Francisco 5

EXbrook 2-1747

Mattock Construction Company

Builders



604 MISSION STREET

SAN FRANCISCO

Subscribe
Now —

**ARCHITECT
and
ENGINEER**

**\$3.00
Per Year**

Index to Advertisers

ANGIER Pacific Corp.	*
ARCHITECTURAL Porcelain Constructors	38
ARCHITECTS Reports	40
BASALT Rock Company	Back Cover
BAXTER & Company, J. H.	36
BURKE, W. S. & Co.	29
CLASSIFIED Advertising	43
CENTER Stationery	47
CLINTON Construction Company	44
CONTINENTAL Water Heater Co.	39
DETROIT Steel Products Co.	1
DINWIDDIE Construction Co.	47
DUFFY Tile Co.	48
FIREBRICK Construction Co., J. N. J.	48
FORDERER Carnice Works	40
FOX Tile Co.	44
FULLER, W. P. Co.	4-5
GLADDING, McBean & Co.	10
GUNN, Carle & Company	46
HANKS, Inc., Abbott A.	48
HAWS Drinking Faucet Company	34
HERRICK Iron Works	47
HOGAN Lumber Company	44
HUNT, Robert W., Company	48
HUNTER, Thos. B.	47
JOHNSON, S. T. Co.	*
JUDSON, Pacific-Murphy Corp.	40
KRAFTILE Company	31
MARBLE Institute of America	2
MATTOCK, A. F., Co.	48
MICHEL & Pfeffer Iron Works	Inside Front Cover
MULLEN Mfg. Co.	47
MUELLER Brass Co.	*
NORTHERN California Electric Bureau	35
PACIFIC Coast Gas Association	8
PACIFIC Manufacturing Company	45
PACIFIC Portland Cement Company	7
PACIFIC Telephone & Telegraph Co.	33
PITTSBURGH Testing Laboratory	48
POOR Richard Engraving Co.	47
REMILLARD-Dandini Co.	48
REPUBLIC Steel Corporation	45
SCOTT Co.	47
SECURITY Valve Company	29
SIMONDS Machinery Company	45
SIMPSON Logging Co.	9
SISKRAFT Company	44
SMOOT-Holman Co.	37
SOULE Steel Co.	*
STANLEY Works, The	32
SUPERIOR Fireplace Company	*
TAYLOR Co., Halsey W.	47
TORMEY Company, The	47
U. S. BONDS	Inside Back Cover
VERMONT Marble Company	45
WESIX Company	*
WESTERN Asbestos Co.	46
WOOD, E. K., Lumber Company	36

*Indicates Alternate Months

DUFFY TILE CO.



TILE CONTRACTORS

SHOWER DOORS

TUB ENCLOSURES

INSTALLATIONS
OF EVERY
DESCRIPTION
Modernizing, Repairing
"Not How Cheap
But How Good"
253 MINNA
YUKon 6-1489



ABBOT A. HANKS, INC. Engineers & Chemists

INSPECTING — TESTING — CONSULTING
CONCRETE • STEEL • MATERIALS
CHEMICAL AND TESTING
LABORATORIES

• RESEARCH AND INVESTIGATION •

TESTS OF STRUCTURAL MATERIALS
DESIGN OF CONCRETE MIXES
SHOP AND ERECTION INSPECTION OF
STRUCTURES AND EQUIPMENT
INVESTIGATION OF STRUCTURES
AND MATERIALS
TESTS AND INVESTIGATION OF
FOUNDATION SOILS
FIRE RESISTANCE AND INSULATION
TESTS

624 Sacramento Street, San Francisco

Robert W. Hunt Company

ENGINEERS

Inspection • Tests • Consultation

Schools and Other Structures
Are Built as Designed

When Construction Materials are
Inspected at point of Manufacture
and during Erection by

ROBERT W. HUNT COMPANY

Cement, Concrete, Chemical, Metallurgical,
X-Ray and Physical Laboratories

Chicago - New York - Pittsburgh

Los Angeles - All Large Cities

San Francisco, 251 Kearny Street

REMILLARD-DANDINI Co.

**Brick and
Masonry Products**



400 MONTGOMERY STREET
SAN FRANCISCO, CALIF.

ARCHITECT AND ENGINEER

DEC 24 1912



1
9
4
8

36 years of progress!



Careful planning with consistent high quality workmanship account for the leadership of Michel & Pfeffer Iron Works in the progress of Service Station design and construction. 36 years experience is your guarantee of results. Write for descriptive catalog.



Michel & Pfeffer Iron Works, Inc.

W. A. JAMES, Manager Steel Building Division
Tenth and Harrison Streets, San Francisco 3, California
Telephone: MArket 1-5966

ARCHITECT

Vol. 175

No. 3

AND ENGINEER

ARCHITECTS' REPORTS—Published Daily

E. H. WILDER

Editor

MARK DANIELS, A.I.A.

Associate Editor

PROF. IELAND VAUGHAN

Landscape Architecture

JOHN A. BLUME

Structural Engineering

MICHAEL GOODMAN

Planning

JOHN S. BOLLES, A.I.A.

Book Reviews



COVER PICTURE:

The Staff and Management of the ARCHITECT & ENGINEER magazine wish you and yours a very Merry Christmas and a Happy New Year.

ARCHITECT & ENGINEER
is indexed regularly by
ENGINEERING INDEX, INC.

Contents for

DECEMBER

EDITORIAL NOTES	4
NEWS & COMMENT ON ART	6
PARKING AND TRUCK LOADING	8
By THEODORE M. MATSON, Bureau of Highway Traffic, Yale University	
THE CONSTRUCTION OUTLOOK FOR 1949	10
By DWIGHT W. WINKELMAN, President, Associated General Contractors of America	
SALEM OREGON BRANCH, First National Bank of Portland	12
PIETRO BELLUSCHI, A. I. A., Architect	
NEW DESIGN IN LOCKER CONSTRUCTION	16
SEVERN RIVER BRIDGE IS EUROPE'S LONGEST SUSPENSION SPAN	17
SCOTLAND'S HOUSING PROGRAM	18
By WILLIAM BARRIE DICKSON	
60th ANNIVERSARY SWINERTON & WALBERG CONSTRUCTION COMPANY	22
APPLICATION OF "OVERTIME ON OVERTIME" TO BUILDING INDUSTRY	24
A.I.A. ACTIVITIES	29
WITH THE ENGINEERS	30
HEADLINE NEWS & VIEWS	34
By E. H. W.	
IN THE NEWS	35, 37, 41, 45
LANDSCAPE ARCHITECTURE, Notes of the Profession	36
ESTIMATOR'S GUIDE, Building and Construction Materials	41
BUILDING TRADES WAGE SCALES, Northern and Central California	41
BOOK REVIEWS, Pamphlets and Catalogs	43
INDEX TO ADVERTISERS	46
INDEX TO ARTICLES & ILLUSTRATIONS, Vol. 172 to 175, 1948	47

ARCHITECT AND ENGINEER (Established 1905) is published on the 15th of the month by The Architect and Engineer, Inc., 68 Post St., San Francisco 4; Telephone EX800k 2-7182. President, K. P. Kierulff; Vice-President and Manager, L. B. Penhorwood; Treasurer, E. N. Kierulff.

Los Angeles Office: Wentworth F. Green, 6505 Hollywood Blvd., Los Angeles 28. Telephone HEMPstead 3171.

Entered as second class matter, November 2, 1905, at the Post Office in San Francisco, California, under the Act of March 3, 1879. Subscriptions United States and Pan America, \$3.00 a year; \$5.00 two years; foreign countries \$5.00 a year; single copy 50c. ARCHITECTS' REPORTS are published daily from this office, Vernon S. Yallop, Manager. Telephone DOUGlas 2-8311.

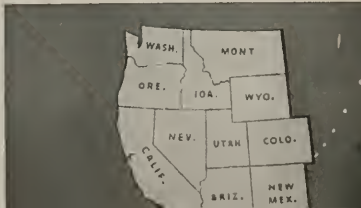

EDITORIAL NOTES

PROFESSIONAL OPPORTUNITY

Professional groups and cooperative organizations, as well as individuals, are frequently advised on the opportunity and need for developing "Public Relations" programs for the stimulation of favorable public interest which will accrue to the advantage of each participant.

The term "Public Relations" is one which has been sadly abused and very much misused, resulting in an increasing state of confusion in the minds of those who seek to profit by a program of complete understanding between themselves and those around them.

Definitions of "Public Relations" are vague and varied and no two people seem to agree on the same thing. To some it is "free publicity", to others it is "institutional advertising", or house-organ pamphlets and booklets or bulletins. Some feel it is the successful conduct of "reception rooms", "public appearances", or "community activities," and to by far the greater majority the term "Public Relations" represents something less tangible and less understandable than any of these.

As a matter of fact everyone has public relations whether they so desire or not, and while there is a considerable difference between "Public Relations" and a "Public Relations Program", the quality of service rendered or the product itself represents a relation with the public. Treatment of employees, attitude towards the community, common courtesies extended associates and business contacts—these and many more items of every day conduct slowly but surely make an impression on the people who make up our "publics."

If we are doing a commendable job in conducting our business, the reaction of these "publics" will be favorable—if we make a good product, sell it at a fair price, and back it up with good service, then we will have good customer relations. If we can develop good "publics", good "customers" and good "employee" relations and maintain a financial structure which is sound and equitable, we may be considered as having good "Public Relations".

On the other hand, if we are not so successful in the conduct of our business, if we have trouble with our product—trouble with our employees, trouble with our finances, trouble with our neighbors and associates, and trouble with ourselves, then we can consider we have poor "Public Relations" and something should be done immedi-

ately to correct those factors which are in error.

A sound and satisfactory "Public Relations" can not be turned on and off at will. It must be a sincere principle, thoroughly believed, and honestly followed at all times.

RESIDENTIAL COSTS

The United States Federal Reserve Board which is one of the most exacting of all Federal agencies, has made a survey of price ranges that can be afforded by the prospective home buyer.

The Board's 1948 Survey of Consumer Finances, the section devoted to expenditures for Durable Goods, shows that 2,200,000 homes, new and existing, were purchased in 1947 at an average price of about \$7,000, with about 40 per cent of these buyers being veterans of World War II.

The medium price paid for new homes in 1947 was between \$7500 and \$8500, for used dwellings between \$5000 and \$6000. Forty per cent of all houses purchased were obtained by families with annual incomes of \$2999 or less.

When asked in 1948 how much they would pay for a new house one-half of all prospective home buyers said they would pay more than the \$7500 and about 14 per cent said they would pay more than \$12,500.

VETERAN ADMINISTRATION LOANS

Lack of realistic cooperation between lending institutions and government agencies has resulted in many veterans being denied benefits intended for them under the law, according to a report prepared by the Mortgage Finance Committee of the National Association of Home Builders.

During 1946, 1947 and the first quarter, the report points out, veterans' housing loans were approved at the rate of more than half a million per year. The second quarter of this year saw a sharp drop as 75,000 veterans obtained housing loans. In the month ending September 25 only 22,000 loans were approved.

The Committee report urges standardization of foreclosure procedures, removal of the present uncertainty regarding the incontestability clause and a restudy of the rate of interest allowed on GI loans. While the total VA loan program is skidding to a halt, the FHA-VA combination loan is on the increase, the report indicates. This type of mortgage is a minor part of the entire program to date.

Since the beginning of the VA loan program 1,314,637 veterans have had housing loans approved.



4
HIGHER
LIGHT
REFLECTION

5
NEW
IMPROVED
FINISH

NOW... BETTER THAN EVER...

Improved Finish with Higher Light Reflection

Now, after months of experiment our research laboratories have developed and perfected a new finish formula. It gives Simpson Acoustical Tile an improved, luxurious white finish, free from glare, yet having an even higher light reflection than before. Now Simpson Acoustical Tile, with this new finish together with its clean, smooth Hollo-kore drilled perforations, its finished bevels and higher sound absorption, offers even greater plus value in beauty, efficiency and economy. For more information, ask the nearest authorized Simpson Acoustical Contractor listed below, or write Simpson Logging Company, Sales Division, 1065 Stuart Building, Seattle 1, Washington.

60-65%
AVERAGE SOUND ABSORPTION
WITH 1/2" MATERIAL!

A noise reduction coefficient of .60 is the lowest safe value to specify for effective quieting of the average office, schoolroom, bank, restaurant, or similar room of normal dimensions. Now for the first time this high value may be obtained with 1/2" perforated material on a solid backing. Only super-efficient Simpson Acoustical Tile gives noise reduction coefficients of .60 (solid backing) and .65 (furring strips) in the 1/2" thickness. And of course, 1/2" material costs less than thicker materials, formerly required to achieve the same results. It is easy to see... when you call for Simpson Acoustical Tile and specify the absorption, that you reduce building costs and give your client an efficient and pleasing job, too.

Simpson
QUALITY SINCE 1895

WITH EXCLUSIVE HOLLOKORE
DRILLED PERFORATIONS

ACOUSTICAL TILE



THESE ARE SIMPSON ACOUSTICAL CONTRACTORS OFFERING
A COMPLETE ACOUSTICAL SERVICE

ACOUSTICS NORTHWEST
Builders Exchange Bldg. Phone: Atwater 6443, Portland 4, Ore.
ANGELES INDUSTRIES
984 McGarry St. Phone: Trinity 8121 Los Angeles 21, Calif.
ASBESTOS PRODUCTS COMPANY
1780 Kettner Blvd. Phone: Franklin 7665, San Diego, Calif.
M. H. BALDWIN
2804 East Hawthorne. Phone: 2804-J Tucson, Arizona
COAST INSULATING PRODUCTS
634 South Western Ave. Phone: Fitzroy 1118, Los Angeles 5, Calif.

CONSOLIDATED ROOFING & SUP. CO.
520 South 7th Ave. Phone: 47888 Phoenix, Ariz.
CONSTRUCTION SPECIALTIES CO.
2026 Arapahoe Street. Phone: Alpine 4819, Denver, Colorado
CONTINENTAL LUMBER CO.
P. O. Box 237. Phone: 450 Boise, Idaho
CRAMER COMPANY
345 Vermont St. Phone: Market 1-0411 San Francisco 3, Calif.

CRAMER COMPANY
1933 Merced St. Phone: 3-1131 Fresno, Calif.
CRAMER COMPANY
1224 I Street. Phone: 28991 Sacramento, Calif.
DALE TILE COMPANY
1020 LaSalle Ave. Phone: Broadway 8831, Minneapolis 2, Minn.
ELLIOTT BAY LUMBER CO.
600 W. Spokane St. Phone: Elliott 8080, Seattle, Wash.

LUMBER DEALERS, INC.
423 N. 33rd. Phone: 3911 Billings, Mont.
MANSUR MATERIALS, INC.
E 120 Riverside Ave. Phone: Main 1249, Spokane 8, Wash.
UTAH PIONEER CORPORATION
335 W. 1st South. Phone: 4-1717 Salt Lake City 14, Utah
WARREN SALES CO.
1211 East McDowell Rd. Phone: 3-8975, Phoenix, Ariz.

NEWS AND COMMENT ON ART

SAN FRANCISCO MUSEUM OF ART

The exhibitions and events scheduled at the San Francisco Museum of Art, War Memorial Building, San Francisco, for the month of December will include:

EXHIBITIONS: Landscape Design—1948, through December 24th; Permanent and Loan Collection of the San Francisco Museum of Art will be shown from December 14 through January 16th; Christmas Trees, San Francisco; Photographs by C. L. Feehe, to January 16th; Twenty-third Annual Exhibition of the San Francisco Women Artists; and Paintings by Gordon Onslow-Ford.

In connection with the Twenty-third Annual Exhibition of the San Francisco Women Artists, prize winning awards for this year's event went to Claire Falkenstein's oil "FLY BALL;" Blanche Phillips' oil "MOTHER and CHILD;" Ethel Weiner's oil "HANGING CLOTHES;" E. M. Smith's tempera "MARTINI;" Dorothy McKee's watercolor "CONGLOMERATION;" Florence Gulli Rossi's watercolor "AN EVENING AT THE FAIR;" Margaret Bruton's terrazzo "SCYLLA and CHRYBDIS;" Juliette Steele's monotype "THE CATACOMBS;" and Ellen Brantzen's photograph "NORTH BEACH SIESTA" and Imogen Cunningham's photograph "LEAVES."

Paintings by Ella Alluisi and Ethel Pearce, Sculpture by Esther Fuller, and Decorative Arts by Elena Montalvo Netherby, Florence S. Walter, Nell Sinton and Florence Alston Swift were given honorable mention.

* * *

Gallery tours will be conducted each Tuesday afternoon and on Sunday's when no special gallery lecture is scheduled.

* * *

Children's Art Sessions each Saturday morning; and Know Your World Film Series each Saturday and Sunday afternoons.

WATER COLOR AWARD

Jan Stussy, instructor in art at the University of California at Los Angeles, has been awarded first prize and a cash award of \$200 for his water color, "I TRY, and TRY," by the San Francisco Art Association.

PORTRAITS

A special Exhibition of Paintings by Louis B. Siegriest, West Coast artist, will be shown at the Art League of California, 582 California Street, San Francisco, during December.

The exhibit includes temperas and oils in a new series of richly atmospheric "Portraits" of place and people, done in the usual Siegriest integrity and with unique highly emotional use of color.

ROSENBERG FELLOWSHIP 1949

The San Francisco Art Association has announced the Abraham Rosenberg Fellowship for 1949 of \$1,500.00.

Granted annually to further the development of mature artists, the Fellowship is open to painters and sculptors who have attended the California School of Fine Arts for at least two semesters.

Applications should be made prior to February 14th, and work must be delivered by February 21st, 1949.

M. H. DE YOUNG MEMORIAL MUSEUM

The program for December as announced by Walter Heil, Director, includes a special Exhibition of the "Masterpieces from the Berlin Museums" which represents an exhibition of world famous paintings sponsored by the United States Army, and were found during the war in a salt mine at Merkers, Germany after the capture of the town by the 90th Infantry Division.

Many of the great names of the art world are represented: Rembrandt, Vermeer, Hals, Botticelli, Giorgione, Titian, Memling, Rubens, Velasquez, and many others.

The exhibit will be open to the public from 10:00 a.m. to 10:00 p.m. during the showing which will close on December 29th.

* * *

SPECIAL LECTURE. Dr. Alfred Neumeyer, Director of the Department of Art at Mills College will give a special lecture on the Berlin paintings at 11 a.m., December 16th.

CALIFORNIA PALACE OF THE LEGION OF HONOR

Thomas Carr Howe, Jr., director of the California Palace of the Legion of Honor at Lincoln Park, San Francisco, has announced the following schedule of exhibitions and special events for December.

EXHIBITIONS: Third Annual Exhibition of Painting containing approximately 150 works in oil and representing a cross section of painting being produced in the United States.

Submitted to a jury composed of Donald Bear, Director, Santa Barbara Museum of Art; Alfred Frankenstein, Art Critic, San Francisco Chronicle; Richard Freeman, Assistant Director, San Francis-

co Museum of Art; Alexander Fried, Art Editor, San Francisco Examiner; and Kenneth Ross, Art Editor, Los Angeles Daily News, the work has been limited to artists within a 50-mile radius of San Francisco.

European Rooms in Miniature by Mrs. James Ward Thorne will also be shown.

* * *

EDUCATIONAL activities will include Art Classes for children on Saturdays; Adult Painting classes on Saturdays; Tours of the Thorne Rooms; and Special Lectures on the Third Annual Exhibition and Creative Trends in American Painting by Dr. Jermayne MacAgy on Wednesdays.

* * *

Organ recital each Saturday and Sunday and Free Motion Pictures each Saturday afternoon.

CITY OF PARIS

The Rotunda Gallery of the City of Paris, San Francisco, will offer an Exhibition of Painting by William Malherbe of Paris and New York during December.

In The Art In Action Shop the Pictures of the Month will feature Paintings and Prints by Dorr Bothwell; an exhibition of San Francisco scenes by Cicely Easley; and California in the Autumn by Harry Cummins.

TRADE DESIGN COUNCIL IS FORMED

The American Institute of Decorators through its president, Karl Bock, has announced the formation of the A.I.D. Trade Design Council, whose purpose will be to arrange with manufacturers of all home furnishing products to make designs and models available to A.I.D. Members.

The Shaw Furniture Company of Cambridge, Massachusetts, has already made available a group of five pieces together with models and prices.

2nd ANNUAL NATIONAL HOME WEEK SCHEDULED

The second annual National Home Week has been set for September 11-17, 1949, according to a recent announcement of the National Association of Home Builders.

Home builders in leading cities throughout the nation are already making plans for reporting every phase of the home building industry to the public during the week, including showing of

"model homes", on-site demonstrations, latest building methods, and newest building materials, household appliances and fixtures.

ANNOUNCES AWARD FOR DESIGN MANUSCRIPT

The Trustees of the James F. Lincoln Arc Welding Foundation have announced a joint award of \$5,000 to Professor C. D. Williams of the University of Florida, and to Professor E. C. Harris of Penn College, Cleveland, Ohio, for their co-authorship of a textbook manuscript in the Foundation's Textbook Award Program.

Prof. Williams is head professor of Civil Engineering, is a member of the International Association of Bridge and Structural Engineers, Society of Experimental Stress Analysis, American Concrete Institute and is the author of the book "Analysis of Statistically Indeterminate Structures."

Prof. Harris is Chairman of the Department of Structural Engineering, is a member of the American Society of Engineering Education, American Welding Society, and the American Society for Testing Materials.

The Jury of Awards in the structural section of the Textbook Award Program which rated the manuscript entered was composed of Dr. E. E. Dreese of Ohio State University, Chairman; Dr. H. E. Wessman of New York University, now Dean of Engineering, the University of Washington; Professor F. W. Stubbs, formerly of Rhode Island State College, now of the University of Illinois; and Professor G. E. Large of Ohio State University.

ADVERTISING AGENCY EXPANDS

Calvin D. Wood, of the Calvin D. Wood Advertising Agency, has announced the enlargement of his organization and the addition of William H. Grace as a member of the firm, which will be known as Wood & Grace, Inc., with general offices in San Francisco.

The incorporation signifies an advance in scope and capacity to serve in the field of market analysis, merchandising counsel, advertising, sales promotion and account management.

HOUSING production in the non-farm areas in California during 1948 will amount to about 210,000 dwelling units, which is about 65,000 more than 1947.

PARKING

And Truck Loading

By **THEODORE M. MATSON**
Director, Bureau of Highway Traffic,
Yale University

Among the problems of urban areas developing as a result of the automotive revolution in transportation, there are perhaps none which touch as closely and as frequently so many citizens as those which are associated with their daily use of the streets. The need for movement to and fro within urban areas in pursuit of earning a livelihood, carrying on shopping and business transactions and in seeking recreational outlet is obvious. These traffic movements touch nearly every adult citizen daily.

The dynamic forces developed by traffic are impinging on the physical and financial development of our cities. While the fundamental importance of transportation as a basic economic utility is well recognized, the importance of automotive transportation in the competition which exists between cities and, indeed, among the diverse areas of a given city is not generally fully appreciated or understood.

Facilities for Collection and Discharge

Intimately associated with any form of transportation are the terminals of collection and discharge. Yet with drastic changes in mode of transportation so closely allied with the popular use of the private passenger automobile and the motor truck, we have inherited out of the past and continued to develop a physical transportation system which is highly aberrated for urban areas. Thus, with this changing form of transport, we have an investment in vehicles capable of high speeds of transmission which is not utilized with its full efficiency because we have failed to develop the routes and terminals suited to this form of travel.

The development of highway traffic terminals in

every American city is an important factor in gaining and maintaining a high degree of efficiency from our automotive transportation investment. It is self evident that movement alone does not accomplish the ends of transportation. Regardless of the form or speed of transport, once the movement has been consummated, loading, unloading and temporary storage of the vehicles and goods of transportation are essential to the purposes of travel.

Curb parking and truck loading facilities in most urban areas are grossly inadequate and are therefore becoming subject to increasingly more stringent regulations. As the demand for street space for movement increases, curb parking and loading must continue to wither away and in the larger centers will become outlawed. But even if promiscuous curb parking were to be tolerated, it can never adequately satisfy the terminal demands of highway traffic except in areas of light urban development.

Now, if the battle of curb parking and loading is a lost cause from the viewpoint of satisfying terminal demands, it follows that more off-street parking and loading terminals must be developed. But this action poses many questions. How much development is required? Where should it be located? How should it be designed? What regulations concerning such development should be applied? What means should be used for the acquisition of sites? How shall these items be administered? Above all, how shall off-street facilities be financed? And, finally, what are the policies, programs, and procedures which should be employed for the common good of the urban community as a whole?

Motivating Forces

If it be allowed that progress stems from gains achieved and if it is agreed that gains usually are not gifts, but are linked inexplicably with the costs and risks of achievement, what then are the motivating forces which can be harnessed in securing adequate off-street parking and loading facilities?

In this connection it is submitted that the value of real property for commercial purposes is closely linked with its accessibility to the population and the other resources of the community. If all the other factors are equal and equal accessibility exists, then the efficiency of the terminals of transport is an important factor in the competition for trade. Moreover, terminal demands arise out of the very nature of the use to which each particular parcel of land is put. Yet that very land use is the source of economic gain or utility. Is it not incumbent, therefore, on each parcel of land to provide or assist to its fair share in providing suitably for its terminal demand?

Again, whether from the viewpoint of the private automobile or truck operator, the advantages of suitable terminals for the vehicle and goods of transportation are evident. The enjoyment of these advantages are worth something to the individual involved whether he be engaged in the business of transportation for a gain or as an incidental matter in working, shopping, carrying on business, or for pleasure. Here, then, is a second economic interest which can be harnessed in securing parking and trucking terminals.

Community of Interest

The very nature of highway traffic terminals develops a community of interest and motivation. In the first place no particular parcel of land can isolate its highway terminal problem from that of its neighbor for it may on the one hand create a problem which area-wise transcends its boundaries or on the other hand it may enjoy with other land users a common terminal. Again, it is recognized that accessibility is a fundamental factor in land value. If accessibility to a land parcel is associated with satisfactory parking space, it follows that the very stability of land value is enhanced or destroyed by adequacy of parking terminals.

The Tax Rate

Because those properties in the central business districts contribute so heavily to the tax income of a city, any change in their assessed value will modify tax rates in the outlying areas and in this case the entire community of interest, for as the relatively heavy burden of taxes leaves the central business district, it is inevitably passed to the outlying sections of the city. This change, however, is slow and subtle. It is not a satisfactory basis for winning elections by those officials who are elected by majority vote.

And so it is seen that the motivating forces to be harnessed in the development of highway terminal facilities are threefold—(1) the individual land owner who uses land in such a way as to create a highway terminal demand; (2) the users of highway vehicles themselves; and (3) the community of interest which exists by juxtaposition of land holdings directly or indirectly through the tax structure.

With these motivating interests in mind, policies, programs, and procedures should be adopted which will satisfactorily reflect and meet the needs of a given urban area. The amount, location, design, financing, acquisition, and management of highway terminals, whether for parking or trucking, must gain at least positive agreement if not active support from these three areas of motivation.

Responsibility

Because of the unique position of the land owner, due to the capital value at stake, the leadership and struggle for terminal facilities should probably stem from him or he will lose to his competition the privilege of serving the community. Neither the individual vehicle owner nor the elected representative stand to gain or lose so much so rapidly as the land user who requires more satisfactory highway terminal facilities. It seems clear that the vehicle owners cannot individually take any leadership in providing parking space for their use in the central business districts. Moreover, because there are so many of them, with such diversified detailed considerations, it seems a formidable task to so organize them into a unified body capable of taking leadership. Again, in a democratic society, governmental officials, dependent on the electorate for their position, cannot assume strong leadership, but rather are sensitive only to reflecting the wishes of the electorate. It seems to follow, therefore, that the leadership in the struggle for off-street parking facilities must arise from the relatively small number of land owners and their supporters whose property values are affected by parking conditions. Such leadership presupposes group action due to the community interest inherent in parking facilities.

Ancillary Facilities

In the competition for survival, the efficiency of methods in handling highway freight and also the accommodation of the patrons upon whom survival depends are very real factors. The privilege of rendering service to a community may well be lost through a failure to secure the ancillary facilities which go with that service. Parking terminals are as essential to stores, office buildings and manufacturing plants as are the display counters, ele-

(See Page 42)

The CONSTRUCTION OUTLOOK FOR 1949

By DWIGHT W. WINKELMAN
President, The Associated
General Contractors of America

It is always a pleasure for me to meet with a group of engineers, because I believe and feel that engineers and contractors are the same kind of people, who talk the same language, and have the same objective.

In construction, the most frequent contacts of contractors is with civil engineers. These men are designers of construction projects, in one of their functions. But today many civil engineers are the heads of contracting organizations, or hold responsible positions in such companies.

But whether or not civil engineers are part of contracting organizations or are in the design or administrative side of construction, the aim of both the engineers and contractors is to provide the public with more and better construction for less money.

Construction is becoming such an exact and diversified activity these days that contractors do also come in direct contact with many other kinds of engineers.

We as contractors have great respect for engineers; and I hope and do believe that this feeling is mutual.

America Progresses Through Construction

The officers of your society have indicated that you would like me to speak briefly on what I see is ahead for construction next year.

Before I actually speak on this, I would like to discuss with you very briefly the importance of

From an address delivered to the Washington Society of Engineers, November 17, 1948.

construction to the nation, and to the world at the present time.

In our association we frequently refer to the phrase, America Progresses through Construction. By that we mean that practically every form of our civilized life requires some kind of construction for its growth and development.

We need more homes for better living; more factories for increased production; more highways, airports, railroads and other facilities for increased transportation; more stores and other facilities for increased business activities.

Also we need more hospitals, schools, libraries, churches, recreation areas, and other facilities for our educational, health, cultural and recreational needs.

We need dams and other projects for the development of our resources.

Further, if our nation is to be able to sustain its defense program and the program of aid to other nations it must be strong and productive. It is the facilities built by the construction industry which makes this nation strong.

Construction Volume

In looking ahead in construction, I hope that you will remember from recent events how easy it is to be wrong. All I can say is that this is the way I see it, and I will be backing up my guessing with all my investment in a construction company.

First, let us consider the volume of construction. Latest government estimates are that the volume of new construction put in place during 1948 will be approximately \$18,000,000,000. In addition, maintenance and repair operations will account for another \$6,000,000,000. This makes a construction

total in the neighborhood of \$24,000,000,000.

My belief is that, barring such events as a war or an economic collapse in this country, the volume of construction during 1949 will be about the same as this year.

There may be some dropping off in the very high rate of industrial and public utility construction. But the difference probably will be made up by the increase in public construction.

It looks as though we will have a large volume of construction for development of resources, such as flood control, reclamation, and water power.

Our highway construction program must increase if we are to keep pace with increasing traffic demands. Federal aid is stimulating new airport construction.

Almost daily we read of the necessity for a large amount of school construction for the next few years, and of hospitals.

Unless there are serious upsets to our economy, there should be a large volume of construction next year, and for a number of years in the future. There still exists a tremendous demand for new construction.

Construction Costs

Everyone these days is conscious of high costs. That certainly applies to those of us who are in the construction industry. Construction is a long term investment, and any person thinks carefully about an investment made for the next 25 to 50 years.

Construction costs now are high compared to costs before the war. So are the costs of practically everything else. The important question is, are construction costs out of line with other prices?

Recently studies have been made comparing construction costs with particularly the wholesale commodity price index compiled by the U. S. Bureau of Labor Statistics. This index of wholesale prices of all commodities is considered a good index of the general price trend.

On the basis that the 1939 average equals 100, a comparison of the wholesale price index with one of the construction cost indexes shows that a dollar invested in construction the first six months of 1948 had an extra buying power 23 per cent greater than the dollar invested for commodities.

Using other construction cost indexes, the extra purchasing power would be greater, or less. The point is that there is reasonable assurance that construction costs are in line with other costs in the economy.

The Future of Costs

Undoubtedly your next question is about the future of construction costs, or when will they come down.

Contractors throughout the country have been giving concentrated thought to that question. Through the A.G.C. contractors have adopted

statements to inform the public on this subject. In substance this is what we have said:

1. In an economy subjected to the inflationary pressures of World War II construction costs generally cannot return to the levels prevailing before the war unless the nation suffers an economic catastrophe.
2. The public should not be led to relieve that there will be quick or drastic reductions in construction costs.
3. Reductions will come through the elimination of business uncertainties, increased productivity of workmen, increased efficiency of management, improved design, development of more efficient methods of construction, and other factors. These will come about, but the changes will be gradual.

There are indications that construction costs are tending to level off and stabilize at the present time. Many other prices in our economy are leveling off now, and you will note that they are at or near the prices which have been prevailing recently. The same is true in construction.

If you wish to predict the future of construction costs, you will not be far wrong, probably, if you estimate that they will follow the same general trend as the prices in our economy as a whole.

Greater Quality an Element of Cost

You men as engineers should clearly understand one of the factors which is partly responsible for present costs of construction now. That is the greatly improved design and increasingly complex nature of many construction projects now compared to the past.

There is greater precision and accuracy required in projects now. There are many mechanical improvements, such as air conditioning, which are now considered a normal part of a new structure which formerly were never contemplated.

It is impossible to compare the cost of a mile of highway now with a mile twenty years or so ago. Now a modern highway is wider, has heavier pavement, has underpasses and overpasses, has flatter curves, has less steep grades. The average first class highway now requires about thirty times the excavation that a modern one of the twenties required.

These improvements in construction projects are eminently worth while, but they have been a factor adding to cost.

What the Industry Is Doing

However, let there be no misunderstanding. Neither general contractors nor others in the industry are going to take the fact that our entire economy is on a higher cost plane as an excuse for not exerting every effort to hold costs to a minimum and to cut them to the fullest extent compatible with quality.

(See Page 32)



EXTERIOR view of the new Salem (Oregon) branch bank building of The First National Bank of Portland. Finished in granite to a height of seven feet nine inches and marble in five foot squares extending up the remaining twenty-four feet.

Salem, Oregon, Branch First National Bank of Portland

Pietro Belluschi, A. I. A.
Architect

Combining functional design with the modern Italian motif which is characterized by a clean-swept, unbroken facade, Pietro Belluschi, Portland, Oregon, architect, has given the Pacific Northwest its most striking financial institution in form of the Salem, Oregon, branch of the First National Bank of Portland.

The structure is the most modern one in Oregon's capital city and has attracted visitors from as far away as Vancouver, B. C., in search of new ideas for bank buildings. The exterior of the structure is faced with granite to a height of seven feet

and nine inches, and with five-foot-square marble for the remaining 24 feet. Figures in bas-relief, depicting business, industry, commerce and agriculture break the otherwise clean sweep of the marble front.

As modern as tomorrow's banknote, the interior combines beauty with utility and the demands of modern business. Matching the modern tone of the exterior of the building, lighting of the lobby is attained by seventeen spheres, 20 inches in diameter, which are suspended from the ceiling by 10-foot natural bronze half-inch tubing. Other

FIRST FLOOR PLAN

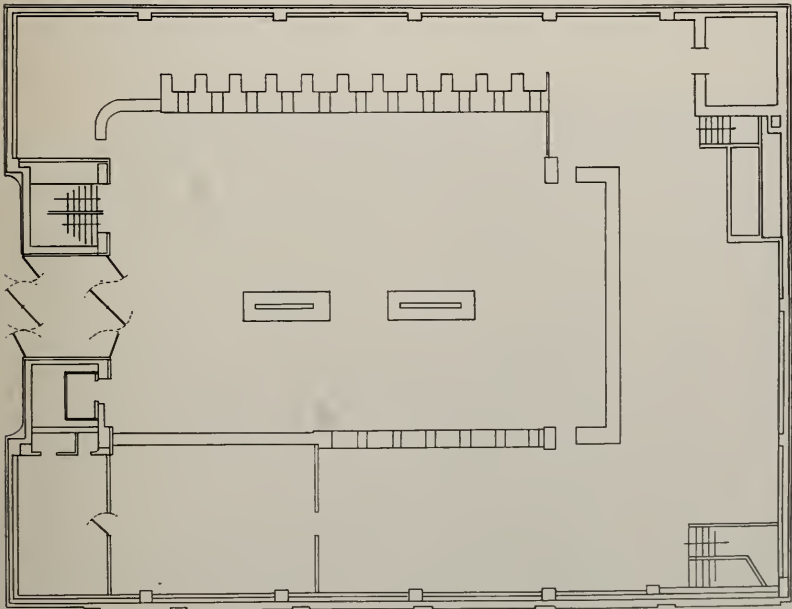



CUSTOMERS service department located under the mezzanine is convenient for utility use and is well lighted with four-tube globe semi-recessed fixtures.

BELOW: Directors' Room with wall finished in bleached birch paneling, placed on a latticed fir framework to prevent creeping.



ROY H. WOLFORD,
Photos

departments of the bank are illuminated by semi-recessed globe tubing.

Walls are finished with bleached birch paneling, placed over a latticed framework of fir to prevent creeping. Flooring is rubber tile and the ceiling is travertine acoustone. Interior columns are of steel and concrete, faced with plaster. Taking

its place as a community institution, the bank provided a comfortable meeting room for the convenience of civic organizations.

The building covers a ground area 109 feet by 82 feet six inches and is 31 feet nine inches high. The lobby ceiling is 26 feet high. Heating is by warm air which is filtered and conditioned.

GENERAL VIEW of the well designed, spacious interior showing simplicity in the arrangement of customer and banking facilities, and the conservative use of contrasting building materials. The lighting fixtures are spheres, 20 inches in diameter, suspended from the ceiling by a half-inch natural bronze tube. Floor is rubber tile and the ceiling is travertine acoustone.



New Design In LOCKER CONSTRUCTION

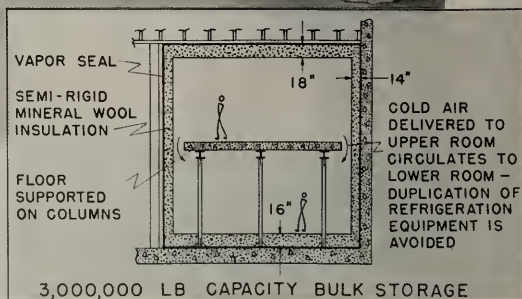

Industrial Mineral Wool Institute Photo

Both initial and operating costs of refrigerating equipment have been cleverly minimized at the new 3,000,000 lb. Susquehanna Locker Plant, Sunbury, Pennsylvania by: (1) providing an air space between the edges of the dividing floor and the walls of two bulk storage rooms, situated one above the other, thus permitting cold air delivered to the upper room to circulate downward to the room below, and (2) using greater-than-standard thicknesses of mineral wool insulation on the floors, walls, and ceilings to reduce the load on refrigerating equipment.

The novel air-gap construction eliminates duplication equipment, ducts, diffusers, etc., in the lower

room as well as reducing refrigeration capacity and maintenance. The floor between the storage rooms, of course, is supported on columns rather than by the walls of the building.

The extra mineral wool results in an appreciable reduction of operating time and power costs. Fourteen, 16 and 18 inch thicknesses insulate outside walls, floor, and ceiling respectively.

The men shown in the photograph are receiving seven carloads of diced carrots to be stored in transit on their way to a food processing plant. The lathing is placed between stacked cartons to prevent them from freezing together. Bulk storage rooms are maintained at -5°F .



WIND-TUNNEL TEST MODEL

British Information Service Photo

Severn River Bridge Is Europe's Longest Suspension Span

The British Government has shown faith in its policy of domestic expansion by recently authorizing an approximate \$45,000,000 project for the construction of a suspension bridge across the River Severn and Wye. The project, which has a long history of previous considerations and rejection, is one of the key points in the road construction proposals of Britain and will contribute to the success of the new industries now being developed

in South Wales. Building of the proposed bridge would reduce the distance from London to South Wales by ten miles and from Bristol to South Wales by 50 miles.

The authorizing Order, which was made by Mr. Alfred Barnes, Minister of Transport, under the Trunk Roads Act, 1946, came into force on 1st August. It was, in effect, the Minister's decision

(See Page 27)



NEW BRITISH STEEL AND CONCRETE HOUSES HAVE AMERICAN LOOK

DESIGN by B.I.S.F.

Scotland's HOUSING PROGRAM

By WILLIAM BARRIE DICKSON*

All building in Scotland today is adventurous. None of our local authorities need to be told that. Even the casual observer, who passes a row of roofless shells which will be new "council houses" when timber is available to complete them, gets a glimpse of the uncertainties local authorities faced when they started to build postwar houses in the traditional way.

Nor was there anything cut-and-dried about the operations of the firms producing the prefabricated temporary houses which have survived initial

criticism to improve many a Scots housewife's conception of what a kitchen and bathroom should be like. It is true that their makers evaded some risks by making houses in warm, well-lighted factories. They did so at the cost of encountering ifs and buts the traditional house-builder escapes.

But of all Scotland's builders there are surely none who know the adventures of house-building more intimately than those who are building houses without bricks. These are the "permanent non-traditional" house-builders, and I have just spent some instructive days learning how they are faring.

Fears that enterprise has wilted in Scotland are briskly dispelled by the evidence of the numbers of individuals and groups which are tackling this

* Scottish newspaperman who is now industrial press officer with the Scottish Information Office. During the war, he served as a gunner captain in the British Army in Middle East, France and Germany. He re-entered journalism to edit the "Braunschweiger Neue Press" for the Control Commission.

most adventurous branch of building.

The two biggest forces, however, are the Scottish Special Housing Association Limited, which is the instrument of Government, and the Scottish Housing Group, an association of building contractors, assembled to answer the need for central planning.

The Scottish Special Housing Association was set up by the Department of Health in 1937 to pioneer non-traditional methods of building, particularly methods which reduced the number of bricklayers required.

It was formed as a limited company for the sake of ease of administration, is governed by a council of nine non-technical people, and directed by its general manager, Mr. A. S. Findlay, O.B.E., as the special instrument of the Secretary of State for Scotland in housing.

The Association's general program is restricted to building in those areas which are indicated by the Secretary of State as being in greatest need, and by this means it is possible to increase building in such areas without calling upon the local authority's finances.

In addition to its general program, which is expected to amount to about 100,000 or one-fifth of the houses estimated to be required in Scotland,

the Association has been given the responsibility of providing the new houses required in mining areas to make possible the big transfer of miners and their families from the exhausted coal fields, particularly in Lanarkshire, to the developing fields elsewhere, particularly in the East of Scotland.

The Association also has an important part to play in erecting new houses for key-workers brought in to start the new factories opening in the Scottish Development Areas.

Although the Association can best be envisaged as an extraterritorial local authority, it has an important advantage over a local authority when, for reasons of common good, houses must be allocated to incoming key-workers over the heads of local people who have been on the authority's housing list for years.

While local councillors might have difficulty in convincing their electors that right has been done, the Association is just remote enough to be saddled with the responsibility of the choice of tenant, and it philosophically accepts this role of whipping-boy for the local authorities.

Apart from this advantage the Association's position is exactly the same as that of any Town or County Council in its housing authority manifestation. It receives the same housing subsidy,

THE AIREY HOUSE. Of pre-cast concrete construction, this is one of the new types of houses designed by the British Iron and Steel Federation suitable for rural areas in groups of 50 or more.





FIRST WEIR STEEL PREFAB SEMI-VILLA. Painters line off window frames and put the finishing touches to the first Weir steel house in Knightswood, Glasgow.

with the addition of a Treasury grant equivalent to the amount which local authorities find from their own funds. These, with the rents of the houses already built, are the Association's sources of income. For in all cases S.S.H.A. houses remain the property of the Association, so that it is in business both as estate agent and building contractor.

Before the war, when local authorities were more reluctant to accept non-traditional houses than they are today, the Association developed by direct labor the no-fines concrete method of house building, since Scotland had no contractors experienced in this method.

Since the war its use of direct labor has been mainly in the preparation of sites for houses, the laying of roads, sewers, and other main services for which the Association possesses extensive and modern equipment. The Association is about to re-embark on house erection by direct labor.

The Association claims that it gets no special preference in the allocation of building materials by virtue of its official sponsorship. Its experience of shortages parallels that of the Scottish Housing Group, which might be described as the private enterprise counterpart of the S.S.H.A.

The Scottish Housing Group, unlike the S.S.H.A., which has been building non-traditional and traditional houses in the proportion of eight to three, was set up for the sole purpose of constructing permanent non-traditional houses and owes its existence to Mr. Ralph Whitson, its chairman, whose experience of Government group contracting during the war—particularly on the construction of Mulberry Harbor—convinced him that Scottish building contractors could only undertake this new type of building on a large scale through the provision of a common secretarial and technical service which would negotiate contracts with the Department of Health for Scotland, allocate the

work among the members and provide them with plans, specifications and technical advice on the construction of the houses.

As a result, thirty-four firms of building contractors in all parts of Scotland have become members of the Group, which is thus able to undertake building for any local authority. The headquarters of the Group are in Glasgow, its secretary being Mr. C. F. Hardie, a young civil engineer.

Of the four types of non-traditional house built by the Group, the British Iron and Steel Federation house occupies a special position, as it is built under a direct order placed by the Department of Health for Scotland. The others undertaken by the Scottish Special Housing Association are the Whitson-Fairhurst the Hilcon and the Orlit. (See below.) These are built in numbers and in areas laid

(See Page 26)

THE ORLIT HOUSE

The prime member of the system is an 6¾" square precast concrete post or stanchion which is assembled with precast beams to form a reinforced concrete monolithic frame. The walls are formed by enclosing the stanchions in two layers of concrete in the form of thin slabs and blocks, thereby forming a cavity interrupted only by the stanchions. The slabs are medium sized being in no case more than 4' 0" in any one direction, permitting easy production, transport, easy handling and flexibility in planning. In erection the stanchions are placed in sockets in a prepared foundation, plumbed, wedged and grouted, beams are assembled and the structural frame is completed. The wall structure is independent of the frame, isolation being by means of felt strips placed between the frame and the slabs.

The houses have floors and flat roof of precast reinforced concrete channels. Ceilings are of plaster board or fibre board fixed to the underside of the channels. Service pipes are grouped together, and pipes, conduits, etc., are run in ducts within the wall.





60th ANNIVERSARY OF SWINERTON & WALBERG CONSTRUCTION COMPANY, Engineers and Builders
TOP ROW: Superintendent C. C. Nemetz (left); A. B. Swinerton, and Superintendent R. I. Gunn.

SECOND ROW FROM TOP: Pipeline group, left to right, Richard Walberg, Borney Lauthere, Jim Howe, Tam Flynn and G. W. Abernathy.

THIRD ROW FROM TOP: A. B. Swinerton; J. W. Lindsay, Manager, Los Angeles office; D. B. Gladstone, Manager, Oakland office; Fred Pierson, Manager, Sacramento office; and Richard Walberg (left to right).

BOTTOM is group photograph taken at the 60th Anniversary Dinner in San Francisco.



COMPOSITE DRAWING OF STRUCTURES ERECTED BY THE SWINERTON ORGANIZATION

60th Anniversary SWINERTON & WALBERG Construction Company

Representing \$1,200,000,000
Worth of Major Construction

A lot of history and progress have been made in the American construction industry since 1888, when the late Charles J. Lindgren established what today has grown into the West's oldest building organization, the Swinerton & Walberg Co. This Company, with its predecessors, the Charles J. Lindgren Company and Lindgren & Swinerton, Inc. has completed a total of one billion and 200 million dollar's worth of major construction in its sixty years of continuous activities.

Alfred B. Swinerton has given 41 years of his life to this firm. It was back in 1907, just after the San Francisco earthquake and fire, that he joined Pioneer Lindgren and the company soon became known as Lindgren & Swinerton, Inc. This company survives today as one of the important Swinerton Organizations, concentrating its efforts on building developments in Los Angeles and Southern California.

Meanwhile the Swinerton & Walberg Co. centers its attention on San Francisco and Northern Cali-

fornia, and among its current office-building operations is the erection of the Bush Street addition to the Standard Oil Building, the first 22-story business structure to be built in the city by the Golden Gate since 1931, when this same company completed Mills Tower there.

In addition to the Swinerton & Walberg Co., and Lindgren & Swinerton, Inc., the Swinerton group consists of Engineers, Limited, Haddock-Engineer, Limited, and the Pacific Pipeline & Engineers, Limited.

On the occasion of observing its 60th anniversary, the Swinerton & Walberg Co. gave a dinner on October 29th to 150 of its key men, who were summoned from jobs now under construction throughout the West.

So extensive and varied have been the construction achievements of this organization that it would be difficult to choose a "leading item" among its accomplishments. For example, it has built, in their entirety, four famous hotels: the Fairmont Hotel and

the Sir Francis Drake, in San Francisco; the Hotel Del Monte on California's beautiful Monterey Peninsula; and the Royal Hawaiian, in Honolulu. It also built the Post Street addition to the St. Francis Hotel, a 5-story addition to the New Fielding Hotel and remodeled the Hotel Plaza in San Francisco.

In the field of outstanding big-city buildings, a mere glance at only a part of its San Francisco record is revealing and impressive, as it includes the Pacific Telephone & Telegraph Company, the Matson and the Southern Pacific buildings; 111 Sutter Street and 450 Sutter Street; and the Stock Exchange. Add to these such attractive San Francisco structures as the War Memorial Opera House and the Public Library, and you still have not been given anything like a complete picture of its operations.

Swinerton & Walberg industrial construction has been exceedingly extensive, too, including major plants for American Can, the California Packing Corporation, the Western Sugar Refinery, the California-Hawaii Sugar Refinery, the Coca-Cola plant at Oakland, the Chrysler plant at San Leandro, the DuPont plant at Richmond and the Columbia Steel Company's foundry at Pittsburg.

Now under construction or just completed are: the Dodge Assembly plant, Hunt's Foods' large warehouse, the Fibreboard plant at Antioch and the General Foods proposed plant at San Leandro.

Notable among construction projects of this organization in Los Angeles and environs are: the Santa Anita Race Track, the Wyvernwood Housing Development with its 1,100 family units, the Los Angeles Manual Arts High School, the Armstrong Cork Company's plant, the I. Magnin building in Hollywood, plant additions for the U. S. Rubber Company and Naval Storage facilities at San Pedro.

Other notable accomplishments, with the aid of

partners, was the completion, during the late World War, of vast United States Naval defenses in the Panama Canal Zone, the Rocky Mountain Arsenal in Denver and the Huntsville Arsenal in Alabama.

In its operations farther afield has been one of accomplishing the near-impossible, or at least what amounted to the ultra-difficult. This was the building of the Barco Pipeline from the Venezuelan border to the Gulf of Darien, a distance of 280 miles, over some of the most impassable terrain in the world. This pipeline was installed from a level of 100 feet to a 6,410-foot elevation of the Andes Mountains and then through virgin jungle, a mass of tangled vegetation as impenetrable as anything Nature can create. Besides the natural barriers, there were hostile native Indians, who presented this modern progress.

This particular job required eight months for completion and included the building of 450 miles of roads and five airports. Tractors and other heavy equipment had to be transported by air as well as the food supply for 7,000 workmen for a period of seven months. A whole fleet of tri-motor airplanes were kept busy on this gigantic task from the beginning to the end.

This firm holds a world's record for speed in its construction of an oil pipeline, for the Shell Oil Company, from Bakersfield to Martinez, California, a distance of 350 miles, in only 70 working days. This record was achieved in 1936 and never has been equaled since.

In addition to all of the above major contributions, the Swinerton organization is playing a vital part in the Nation's present security program. Through its Engineers, Limited, and Haddock-Engineers, Limited, it is today engaged in nearly 20 million dollars' worth of housing and general construction for the Atomic Energy Commission.

APPLICATION OF "OVERTIME ON OVERTIME" TO BUILDING INDUSTRY

A comprehensive analysis of the application of the Wage and Hour Law and the Supreme Court's so-called "overtime on overtime" decision to the building and construction industry has been made by the Building Trades Employers' Association of New York City.

The report, prepared by Joseph G. Fink and L. Metcalfe Walling of the law firm of Eidlitz, French, Fink & Markle, counsel to the BTEA, has been published as a four-page bulletin and made available

to the members of the 23 trade associations affiliated with the BTEA.

Mr. Walling, former administrator of the Wage and Hour Law, points out that the report not only serves as a guide for the building industry but is applicable to virtually every business or industrial concern whose employees may work more than forty hours a week. It is based on a series of questions covering specific cases, submitted to William R. McComb, present administrator of the

Wage and Hour Law. In his answers, Mr. McComb gave new and previously unpublished rulings on questions of possible premium payment for overtime work.

Although the Wage and Hour Law was enacted ten years ago, the report says that "it is not clear even to this day in the absence of definite ruling by the United States Supreme Court, which employees of building contractors are covered and which are not covered."

After considerable research and careful analysis of court decisions and rulings made by the Wage and Hour Law Administrator, Messrs. Fink and Walling have expressed the opinion that:

"1) Building contractors, as such, are not exempt from the law;

2) Many staff employees either in the home or branch office of the contractor or at the site of construction are within the coverage of the law without regard to the nature of the work done by the contractor;

3) Certain mechanics and laborers of the contractor performing work in the repair, alteration or reconstruction of industrial or commercial buildings generally are within the coverage of the Act."

To obviate the possibility of claims for extra premium pay for work performed on Saturday, Sunday, holidays, or after basic work hours, under the "overtime on overtime" ruling, they suggest:

"Change wherever possible all union agreement and practice so that the work week will begin on Monday, with Saturday and Sunday falling at the end. In that way, work performed on Saturday or Sunday will be classified as true overtime and will be creditable against statutory overtime and not subject to the 'overtime on overtime' ruling for extra premium pay."

Commenting on the report, Mr. Walling said:

"The confusion and uncertainty with which the Supreme Court decision in the longshoremen cases under the Wage and Hour Law was greeted last June, has increased by leaps and bounds since then. Although it was first thought that the so-called 'overtime on overtime' rule announced by the Supreme Court, would not have widespread application outside certain industries, it has become apparent that it does affect, in many ways, the work schedules and pay practices of many employers under the Wage and Hour Law.

"One of the industries which may be most directly affected is the building and construction industry. Because of the widespread demand for information and guidance, the statement on the application of the Wage and Hour Law and the decisions on overtime is being distributed to its members by the Building Trades Employers' Asso-

ciation of New York City. Since the problem, however, is of much wider application than the building industry, the information contained in the bulletin will be of interest to many employers and employees in other industries and a limited number of copies will be available for distribution to them.

"Specific questions were submitted to my successor, the present administrator of the Wage and Hour Law, who gave us specific answers on the creditability of premium pay for certain hours worked toward overtime pay required by the statute. His rulings covered such vital points as premium wages paid for work performed prior to the start of the regular shift, and wages paid for overtime work necessitated by inclement weather, which are of particular concern to the building industry.

"Among the matters on which the administrator ruled which are of general concern to all industries operating under the Wage and Hour Law, is the question of whether premium rates of pay for Saturday and Sunday work can be credited toward overtime pay required by the statute. In order to avoid having Saturday and Sunday pay considered premium pay for special time worked or 'disagreeable hours', as the Supreme Court termed it, and therefore not creditable, these days must follow a regularly scheduled work week. If the payroll week begins on Monday, for instance, and 40 hours are worked through Friday night, Saturday and Sunday are true overtime days within the meaning of the statute and the recent Supreme Court decision.

"The problem, then, of 'overtime on overtime' in such a work week is thereby avoided. The Supreme Court decision has undoubtedly caused many unions and employers to review their collective agreements. It is possible, we think, to adjust work schedules so that there will be a minimum of interference with collective bargaining and existing pay schedules, and so avoid or minimize the effect of the so-called 'overtime on overtime' rule."

YOUTH CENTER. Wm. G. Merchant, San Francisco, has been appointed architect for the construction of an addition to the Youth Guidance Center, San Francisco.

EQUIPMENT BUILDING. Walter Wagner, Architect, Fresno (California) reports the Harris Construction Company have been awarded a \$65,000 contract for the construction of a sales and service building for the Allied Equipment Company in Madera.

SCOTLAND'S HOUSING

(From Page 21)

down by the Department of Health, in consultation with the local authorities.

The B.I.S.F. house (see Page) is steel-framed, with upper walls of sheet steel and a corrugated asbestos roof, produced as a four-apartment semi-detached cottage. Steel shortages do not affect its building program, as the steel frames had already been made before Sir Stafford Cripps' re-allocation of steel was imposed. In common with other framed houses it has the advantage of speedy erection of the shell, enabling inside work to go on unhindered by bad weather. New building is at the rate of ninety a week, with the possibility that 4000 will be completed this year, given supplies of timber.

The Whitson-Fairhurst house is possibly the most versatile of the non-traditional houses. The framework is of pre-cast reinforced concrete but its walls can be of any material, and some of the houses of this type will be brick-walled since bricks are now in satisfactory supply. Possible shortages were considered at every point in the design of this house, and it has been planned to avoid being tied to any given material.

Its versatility goes further, for the Whitson-Fairhurst can be built as a four-apartment semi-detached, a five-apartment type, a terrace, or a flatted house. The Whitson-Fairhurst is now reaching completion stages.

The Orlit house (see Page 21) is also built on a reinforced concrete framework, and is walled with concrete blocks already faced so that they require no treatment on the site. It can be built with a pitched roof, but because of the timber shortage eighty per cent of these houses will have flat concrete roofs. It is a more highly prefabricated house than the Whitson-Fairhurst, and is built in the same basic types. Orlits are also now reaching completion.

The Hilcon house is steel-framed, and because of the shortage of steel the program of building for this type is limited to a total of 550 houses.

In addition to these four houses, orders for the bulk of the output of the Atholl houses have been placed by the S.S.H.A. in addition to a preliminary order for Terran-Clyde houses.

The perils of this branch of building are well exemplified at the Bellshill factory of the Terran-Clyde house, where work is practically at a standstill because fresh allocations of steel will not be available until the third quarter of this year.

The Terran-Clyde house is frameless, and is built of pre-cast reinforced concrete units. The Bellshill factory is equipped to produce building units for 100 houses a week, but it is impossible to say when this potential will be fulfilled.

Nearby, at Coatbridge, however, the Weir Hous-

ing Corporation's conveyor belts are busy, as the factory's 400 workers speed up to a tempo which is expected to produce 40 houses a week soon. (See Page 20.)

Apart from the Permanent Aluminum House being erected by the Blackburn Company for a number of local authorities, the Weir is the most highly prefabricated of the permanent non-traditional houses, and is constructed with steel walls and roof. The house is a four-apartment cottage type built in blocks of two and four houses and future models will have pitched roofs. The main task of erection is done by the Weir Company's own workmen. Approximately 2700 will be built for the S.S.H.A. and a further 1300 for local authorities.

The Atholl House, produced at a former Royal Ordnance Factory at Cardonald, Glasgow, is at present being produced as a four-in-a-block flatted type, though a semi-detached cottage is projected.

Sponsored by the late Duke of Atholl, development of the Atholl House is being continued by a private limited company whose president is the Duchess of Atholl. Steel-framed and walled, the house has a pitched, tiled roof. Approximately 1000 will be built this year.

The permanent aluminum house is very highly prefabricated, and, though more expensive than the other types, is much speedier in erection on the site. It is built in blocks of two, semi-detached bungalow type.

As in the case of traditional houses, the shortage of timber has involved alteration in the construction of non-traditional houses. Flat roofs have taken the place of pitched roofs in some cases, and concrete has had to be used as a flooring material, raising the problem of finding a suitable and sympathetic floor-covering at a reasonable cost.

For other materials the builders, both traditional and non-traditional, are up against problems created by the export program which sends the cookers and stoves of Falkirk, the wash-basins and sanitary equipment of Barrhead, to the ends of the earth in search of foreign currency.

Other shortages have arisen through the general acceptance of building materials which came into use as substitutes—plaster-boards for example—and have developed because of ease of handling and their economy in the use of scarce types of labor.

Are non-traditional houses likely to have a permanent place in house construction in Scotland and so become "traditional"? The facts that double the best prewar annual output of houses is achieved; that they economize on scarce types of labor; and that the use of native as against imported materials will probably have to be extended, all point to a continuing need to reinforce traditional by non-traditional methods.

SEVERN RIVER BRIDGE

(From Page 17)

on the Inspector's report of a public inquiry held at Bristol last September into the scheme for the construction of a new road linking the main road from Gloucester to Bristol (A.38) on the east of the Severn Estuary with the main road from Gloucester to South Wales (A.48) on the west side. Including the Severn and Wye Bridges, the new road will extend from the A.38 road north of Almondsbury to the A.48 road south of Haysgate, a distance of about eight miles. The total cost will be about \$45,000,000.

The Minister of Transport inspected the proposed site in the autumn of 1945. Since that time preliminary work has been pushed forward. Soundings in the river and borings in the bed were carried out throughout the winter by men working from craft moored in the Severn Estuary. They worked in shifts, day and night, in the worst of weather conditions. As a result of the information obtained as to the depth and nature of the river bed and difficulties likely to be encountered in deep water construction, it has now been decided to build the eastern tower of the bridge on a rock outcrop known as Great Ulverstone instead of further into the river bed as was originally proposed. The effect of this will be to increase the length of the large centre span of the bridge by 300 feet to 3,300 feet, the longest in Europe.

Other preparatory work for the building of the foundations of the main piers and anchorages is nearing completion, and it is intended to begin construction in the spring of next year. Before work on the actual construction of the bridge can be started it will be necessary to build a breakwater on the western foreshore of the estuary for the protection of the workmen and to permit the existing ferry between Aust and Beachley to operate during the construction of the Beachley pier. The construction of the breakwater will be started this winter.

Various measures for the protection of navigation on the Severn during construction of the bridge have been agreed after consultations with the Gloucester Harbour Trustees and other authorities concerned. Other parts of the project are being planned so that each phase of construction fits into its appropriate order—the bridge over the River

Wye the approach roads to both sides of the bridges, the land for which has yet to be acquired, and the super-structure of the Severn Bridge upon which extensive and careful research into its aerodynamic properties have still to be carried out on a model in a large and elaborate wind-tunnel specially constructed for the purpose. On this part of the work a team of physicists and engineers will be engaged for about eighteen months.

The construction will take several years to complete and the labor force engaged upon it is expected to build up to its peak of about 2,500 men in 1951 and 1952.



Raymond Loewy, Architect
Daley Bros., General Contractor

*Modern marketing
-means
modern materials*



- ★ VENEER
- ★ PANELS
- ★ FLASHED-PANELS
- ★ SPECIAL SHEETS

Write today for
detailed information

APCO

ARCHITECTURAL PORCELAIN

You'll say "M-m-m-m", too... when you see how smoothly this modern material flows in your plans for up-to-date structures!

The smooth, colorful surface of APCO Architectural Porcelain Enamel Veneer was chosen by the designer of this ultra-modern super market for its quality of blending perfectly with the entire color and material scheme. The toughness and permanence and economy of APCO Veneer tied in, too, with the perfectly worked out budget of the client. Specify APCO Architectural Porcelain Veneer for the buildings you are planning now!

ARCHITECTURAL PORCELAIN CONSTRUCTORS

2827 UNION STREET, OAKLAND 8, CALIFORNIA



Gift Subscription For Christmas 1948

As a service to its readers **GIFT SUBSCRIPTIONS to ARCHITECT & ENGINEER magazine** are available for this year's Christmas giving.

REGULAR SUBSCRIPTION Rate will apply:

United States and Pan America

\$3.00 a year; two years \$5.00.

Foreign countries \$5.00 a year.

**PLEASE SEND ARCHITECT & ENGINEER
AS A GIFT To:**

name..... occupation.....

address..... city..... zone..... state.....

Sign my gift card: From.....

name..... occupation.....

address..... city..... zone..... state.....

Sign my gift card: From.....

name..... occupation.....

address..... city..... zone..... state.....

Sign my gift card: From.....

Your Name

Address..... city..... zone..... state.....

Enclosed is my check for.....

Details of Construction

The Severn Bridge will be the largest suspension bridge in Europe and the third largest in the world. Only two bridges—both in the United States, have longer centre spans—Golden Gate, 4,200 feet; and George Washington, 3,500 feet. In addition to the center span of 3,300 feet, the Severn Bridge will have two side spans, each of about 1,000 feet. The vertical clearance for shipping will be 110 feet above high water near the towers and about 120 feet in the center.

The concrete anchorages to take the pull of the main cables will each be about 250 feet long by about 130 feet wide. The concrete piers will be about 200 feet long by 60 feet wide. The steel towers, which will rest on these piers and support the main cables, will rise to a height of 480 feet above high water. Each tower will consist of two legs about 30 feet by 30 feet, braced by panels at roadway level, at the top, and at about 70 feet above the roadway.

Accommodation for road traffic on the bridge will consist of two carriageways, each 24 feet in width two cycle tracks, each 9 feet wide; and two footpaths, each 6 feet wide. The bridge over the Wye will have six spans of 150 feet, two spans of 175 feet, and a central span of 200 feet. The central span is for navigation purposes and provides a headway of 52 feet above high water mark. The Consulting Architect is Sir Percy Thomas, P.P.R. I.B.A.

CONTRACT AWARDED

A contract has been awarded to Moore & Moore of Stockton (California) for the construction of a \$506,307 gymnasium building and heating plant for the Edison High School in Stockton. J. Upton Clowdsley, is the Architect.

GRAMMAR SCHOOL. The Richmond (California) Board of Education has let a contract to Gaspard & Henderson of San Francisco, for the construction of a 10-room addition to the Washington Grammar School at a cost of \$149,648. Dragon, Schmidts & Hardman of Berkeley, are the Architects.

TELEVISION STATION. Barrett & Hilp, San Francisco, have been working on preliminary plans for a television radio station to be built in San Francisco for the Chronicle. Irwin Wm. Goldstine is the Architect.

BASEBALL PARK. Architect Harry J. Devine, Sacramento, announces awarding of a \$269,313 contract to the Lawrence Construction Company for reconstruction of the Sacramento Baseball Park which recently burned.

A. I. A.

American Institute



ACTIVITIES

of Architects

Arizona Chapter:

James Macmillan, President; Arthur T. Brown, Secretary, 740 N. Country Club Road, Tucson, Arizona.

Central Valley of California:

Frank V. Mayo, President; John W. Bomberger, Vice-president; Ivan C. Satterlee, Treasurer; William Koblik, Secretary, 2203 13th St., Sacramento, California.

Central Coast Counties Chapter:

Birge M. Clark, President; Lisle Fred Richards, Secretary-Treasurer; Thomas E. Elston, Jr., Chester Root and Henry Morgan Steadman, Directors, Office, 411 Lafayette Street, San Jose.

Colorado Chapter:

Raymond H. Ervin, President; James M. Hunter, Secretary, 2049 Broadway, Boulder, Colorado.

East Bay Chapter:

A. Lewis Koue, President; James H. Anderson, Vice-President; Loy Chamberlain, Secretary; Chester H. Treichel, Treasurer, Office, 3833 Piedmont Ave., Berkeley, California.

Montana Chapter:

Ralph H. Cushing, President; H. C. Cheever, Secretary, Montana State College, Bozeman, Montana.

Northern California Chapter:

Wm. Clement Ambrose, President; Lester W. Hurd, Vice-President; Ralph N. Pollock, Secretary; Donald Beach Kirby, Treasurer; Office 363 Pine Street, San Francisco.

Oregon Chapter:

Frank Roehr, President; Sidney W. Little, Vice-President; J. Holman Bates, Secretary; Don Edmundson, Treasurer, Office 619 Builders Exchange Bldg., Portland 4, Oregon.

Pasadena Chapter (California):

Breo, Freeman, President; Melville Garton, Vice-President; Roland E. Coate, Treasurer; Burton Romberger, Secretary; and Robert Ainsworth, Harold J. Bussner and Roy A. Kazebier, Directors, Offices, 1041 E. Green St., Pasadena 1.

San Diego Chapter:

C. J. Paderewski, President; Walter C. See, Vice-President; Robert Bradt, Treasurer; George Hatch, Secretary, San Diego Trust & Savings Bank Building, San Diego 1.

Santa Barbara Chapter (California):

Winsor Sault, President; Ralph Armitage, Vice-President; Robert Ingle Hoyt, Secretary; Lutah M. Riggs, Treasurer; Office 116 E. Sola St., Santa Barbara, California.

CALIFORNIA COUNCIL OF ARCHITECTS

Andrew T. Hens, President; Adrian Wilson, Vice-President; Malcolm Reynolds, Secretary-Treasurer; Office 363 Pine Street, San Francisco.

Southern California Chapter:

A. C. Marrus, Jr., President; John Rex, Vice President; Maynard Lyndon, Secretary; Jack C. Lipman, Treasurer, Chapter Headquarters, 3757 Wilshire Blvd., Los Angeles 5, California.

Spokane Chapter (Washington):

Noel E. Thomson, President; Kenneth D. Stormont, Secretary, Hutton Building, Spokane, Washington.

Utah Chapter:

George Cannon Young, President; Theodore R. Pope, Secretary, 29 South State Street, Salt Lake City 1, Utah.

Washington State Chapter:

Waldo B. Christenson, President; Perry B. Johanson, 1st Vice-President; John G. Richards, 2nd Vice-President; Hugo W. Ostman, Treasurer; and Bliss Moore, Jr., Secretary, Offices 714 American Building, Seattle 4, Washington.

Tacoma Society:

Chas. Rueger, President; Clarence Rueger, Vice-President; W. W. Durham, Secretary-Treasurer.

Hawaii Chapter:

Kenneth W. Roehrig, President; James Morrison, Secretary, 334 Federal Bldg., Honolulu 1, H.

"URBS IN HORTO" OR "THE CITY IN THE GARDEN"

Howard T. Fisher, architect and engineer of Chicago and New York, has expressed the opinion in open letters to the mayor of Chicago and the Governor of Illinois that "Metropolitan Chicago is mediaeval and grossly inefficient."

Citing as the basis of his argument the recent statements of sociologists that delinquency among juveniles, as well as adults, is steadily increasing in the depressed areas of the city, Fisher urges the adoption of a five point program for civic betterment.

The five points include: Appointment of a joint governor-mayor committee; Study of problems by civic organizations; assistance of federal aid; overcome traffic congestion; and early rehabilitation of the city's slum areas.

WASHINGTON STATE CHAPTER

The meeting on December 2nd was devoted to a consideration of the Small House Plan Bureau and its relation to the Chapter, while the annual Christmas Party was held on December 11th at the Rainier Golf and Country Club with dinner and dancing.

The Architects Bowling League for 1948-1949 will comprise six teams instead of the four teams which participated in the past year's schedule.

The University of Washington School of Architecture held its annual Initiation Banquet recently

at the Town & Country Club with Jack Rushmore presiding.

(See Page 33)

FOR BETTER SERVICE

Remember that

KRAFTILE is

WESTERN HEADQUARTERS

FOR

<ul style="list-style-type: none"> ◆ GLAZED Structural Wall Units ◆ SWIMMING POOL Overflow Gutter ◆ PATIO TILE ◆ QUARRY Tile 	<ul style="list-style-type: none"> ◆ FACE and Roman Brick ◆ ACID Brick ◆ ACID-PROOF Jointing Compounds ◆ ACID-PROOF Coatings
--	--

◆ BRICKETTES

◆ STRAN-STEEL Framing

For complete information and prompt service, phone or write

KRAFTILE COMPANY

NILES, CALIFORNIA NILES 3611

SAN FRANCISCO 5: 50 Hawthorne St.—DOUGLAS 2-3780

LOS ANGELES 13: 406 South Main Street—MUTUAL 7241

WITH THE ENGINEERS

Structural Engineers Association of Northern California

Jesse Rosenwald, President; Arthur W. Anderson, Vice-President; Franklin P. Ulrich, Treasurer; George E. Solnar, Jr., Secretary; and Directors Henry J. Degenkolb, John E. Rinne, George A. Sedgwick, Harold O. Sjöberg, and John A. Blume.

American Society of C. E. San Francisco Section

L. A. Elsener, President; A. W. Earl and G. B. Woodruff, Vice-Presidents; John E. Rinne, Secretary-Treasurer; 225 Bush Street, San Francisco 20.

Structural Engineers Association of Southern California

Steve Barnes, President; Harry W. Bolin, Vice President; Lewis K. Osborn, Sec-Treas. DIRECTORS, Richard W. Ware, Geo. E. Brandow, L. T. Evans, Harold P. King, and Donald F. Shugart. Office: 202 Architects Bldg., Los Angeles 13, Calif.

Puget Sound Engineering Council (Washington)

R. E. Kister, A. I. E. E., Chairman; E. R. McMillan, A. S. C. E., Vice Chairman; L. B. Cooper, A. S. M. E., Secretary; A. E. Nicholson, I. E. S., Treasurer; Offices, L. B. Cooper, c/o University of Washington, Seattle 5, Washington.

APPOINTED STAFF ENGINEER

Robert E. Bounds, well known in western engineering circles, has been appointed Staff Engineer of the insulations division of The Paraffine Companies, Inc., with offices in San Francisco.

He was formerly engineer in the Los Angeles offices of the Plant Rubber and Asbestos Works.

NEW FIELD OF STUDY OFFERED AT UNIVERSITY OF CALIFORNIA

A new field of study has been opened to students at the University of California at Berkeley with the establishment of a department of ceramic

engineering, according to Prof. Murrough P. O'Brien, dean of the College of Engineering.

The new department will be headed by Dr. Joseph A. Pask, associate professor of ceramic engineering and will offer a coordinated program of instruction and research covering all phases of the ceramic industry.

In its research work the new department plans to collaborate with the State Division of Mines in a study of the nonmetallic resources of the state, primarily clay, talc and perlite.

ENGINEER AIDS U. C. EXTENSION

Robert V. Roth, formerly production manager for Lorimer Diesel Engine Company of Oakland, has been appointed a lecturer in Mechanical Engineering and Principal Extension Representative for Engineering on the Berkeley campus, University of California.

STRUCTURAL ENGINEERS' ASSOCIATION OF NORTHERN CALIFORNIA

Results of the annual business meeting on December 7th in San Francisco show the following officers and directors will serve for the new year: Jesse Rosenwald, President; Arthur W. Anderson, Vice President; George E. Solnar, Jr., Secretary; Franklin P. Ulrich, Treasurer; and Henry J. Degenkolb, John E. Rinne, George A. Sedgwick and Harold O. Sjöberg, directors.

Other matters coming before the meeting included a discussion of Committee reports, officers' reports, delegates' reports, and election returns.

H. J. Sjöberg has been named Chairman of the Joint Committee on Lateral Forces.

J. G. Wright has been named Chairman of the Legislative Committee.

H. L. Klyce has been named Chairman of the Junior Activities Committee; G. A. Sedgwick has

PREVENT FIRES and EXPLOSIONS

Caused by **EARTHQUAKES!**



Plus a Manual Control For Other Emergencies!

SAFETY ENGINEERS and scientists say the Sentinel is the most accurate and dependable earthquake actuated shut-off valve in the world! On the job 24 hours a day! A record of more than 10 years of reliable service . . . **proven** during a period which included two major seismic disturbances. * Names on request

Take No Chances . . . Install The **SENTINEL** AUTOMATIC GAS SHUT-OFF VALVE

Designed to shut off automatically when there's an earth shock or explosion sufficient to damage buildings or pipe lines. Listed by the Underwriters' Laboratories and specified by leading architects and engineers for installation in schools, fire stations, factories, theaters, churches, stores, municipal, military and utility buildings. A. I. A. E. No. 29-F-6 Write for illustrated folder.

Indispensable in live seismic regions.

Recommended for use with Liquefied Petroleum Gases.

Thousands installed in the United States.

List of installations available on request.

Available at leading wholesale plumbing establishments.

Indorsed by National Bd. of Fire Underwriters.

Leading Fire Prevention Engineers Approve.

SECURITY VALVE CO.

410 San Fernando Rd., Los Angeles 31, California
Phone CAmp 6191

been named Chairman of the Professional Welfare Committee; and J. J. Gould has been named Chairman of the Consulting Practice Committee.

NEW MEMBERS. William K. Cloud and Charles. U. Kring have been elected members of the Association.

STRUCTURAL ENGINEERS ASSOCIATION OF SOUTHERN CALIFORNIA

The December meeting was devoted to a consideration of the relationship between the designing Engineer and the General Contractor with E. S. McKittrick, President of the E. S. McKittrick Company, general contractors, leading the discussions.

A sound and techni-color film was shown illustrating the construction of a 95-story modern skyscraper.

WELDED WIRE REINFORCEMENT FOR CONCRETE PIPE

Simplified Practice Recommendation R234-48 covering Welded Wire Fabric Reinforcement for Concrete Pipe has just been issued by the Commodity Standards Division of the National Bureau of Standards.

This fabric is used to reinforce concrete sewer and culvert pipe, and is made by spacing longitudinal and transverse wires at regular intervals and welding them together where they cross to form rectangular openings.

The recommendation gives the area of longitudinal wires per linear foot of fabric, and the spacing and gauge of longitudinal and transverse wires for each of the recommended styles of fabric. Sketches are included. Sixty-three styles of fabric are included which is a reduction of 80 per cent from the former industry styles.

INFORMATION WANTED

The architectural and engineering firm of ORR, PALMER, INSLEE, HUBER and STRANGE, 3006 Wilshire Blvd., Los Angeles 5, are interested in receiving manufacturers' literature pertaining to general practice, with especial emphasis on schools, apartment projects, and commercial and industrial buildings.

MEDICAL BUILDING. Drawings are practically completed for a 42-suite Medical Building in Sacramento, which Architects Wurdeman & Becket of Los Angeles estimate will cost \$750,000.

MORE than 300 civil engineering students from 14 northeastern colleges and universities attended a recent meeting of the American Society of Civil Engineers (Student Conference) in Boston, Mass.

How a thoughtful builder leaves his mark



That built-in telephone outlet is the stamp of a careful builder. He added conduit and outlets while the home was under construction. The cost was insignificant . . . just a few pieces of tubing leading to convenient telephone outlets provide raceways for telephone wire.

Clients appreciate thoughtfulness like



this. With built-in telephone facilities, telephones can be moved or added in the future without drilling holes or running wire along baseboards. Just a small detail . . . but a careful builder thinks of it.

for free help in planning modern, built-in telephone wiring, call your local telephone company office and ask for "Architects and Builders Service."

The Pacific Telephone and Telegraph Company





CONSTRUCTION OUTLOOK FOR 1949

(From Page 11)

It would be impossible here for me to describe all of the steps which the industry is taking. I do want to mention an important type of work which is being undertaken cooperatively now by some of the professional societies and associations in the industry. I believe that it is one of the significant developments in the industry.

Next week there will be held the first meeting of a newly established national joint cooperative committee between the American Society of Civil Engineers and The Associated General Contractors of America.

The type of work which this committee can undertake is the study of bidding and awarding practices, contract forms, specifications, design, and all matters of mutual interest to civil engineers and general contractors, as well as economic factors bearing with unusual harshness on construction.

Earlier this year a similar national joint cooperative committee was established by the American Institute of Architects and the A.G.C.

Through the association, general contractors maintain similar committees with the Associated Equipment Distributors, National Association of State Aviation Officials and the American Association of State Highway Officials.

In labor relations, an important activity is being carried out through the National Joint Board for the Settlement of Jurisdictional Disputes. The Building and Construction Trades Department of the American Federation of Labor, seven national organizations of specialty contractors, and the A.G.C. participated in the agreement establishing this body.

Conclusion

The recent war brought into sharper focus the important relationship of engineers and contractors. This was to a large extent an engineers' war, and the contractor-engineer team through the industry built more than \$49,000,000,000 of war projects, and as a part of the armed services developed the construction techniques which made possible the type of warfare which became victorious.

Our future development will depend largely on the work of you men as engineers. But I believe that all of us realize that as our engineering skills increase, we must give increasing consideration to developing the human relationships which will really make the world a better place in which to live. I know that you are aware of your responsibilities toward that end.

MODERN DEPENDABILITY

YOU assure modern dependability in drinking water facilities when you specify HAWS Fountains. Simple maintenance, lasting durability and complete sanitation means real client-satisfaction. And your recommendations are backed by the reputation of a company which has built superior drinking fountains since 1909. Write for complete information, today.

NEW HAWS Catalog!

... showing the complete line of sanitary drinking fountains of all types, electric water coolers, faucets and accessories is now available!



SEND FOR YOUR
FREE COPY TODAY



HAWS ELECTRIC WATER COOLERS
SANITARY DRINKING FOUNTAINS
HAWS DRINKING FAUCET CO.
1435 FOURTH STREET (Since 1909) BERKELEY 10, CALIFORNIA
Agents and Sales Representatives in All Principal Cities

A. I. A. ACTIVITIES

(From Page 29)

TACOMA LETTER: Various phases of Architectural practice have been under consideration including such items as advertising in newspapers when they are put out as progress issues; number of prints for contractors, and other similar subjects, including what days should constitute Holidays of sufficient importance to justify closing the office. Meetings are being held every two weeks.

NEW CHAPTER ASSOCIATE. Omer L. Mithun has been elected to Associateship, and Julian S. Agranoff and Herbert K. Gallagher have been named Student Associates. Thomas E. Dustan, J. Hays Faulk and Harry N. Roberts have applied for Associate memberships in the Chapter.

NORTHERN CALIFORNIA CHAPTER

The California State Work project; San Francisco Schoolhouse Program; the San Francisco Civic Center Development and other public works programs were given considerable discussion at the regular Chapter meeting for November. Also considered were proposed amendments to the By-Laws of the Chapter and display material for the product literature competition.

The San Francisco Chapter of the Women's Architectural League held its December meeting at the California School of Fine Arts with a report by J. H. Mattson on "Are Architectural Students Meeting the Requirements of the Profession."

MEMBERSHIP. Thirty-seven members have been added to the membership roll during 1948. Recent new corporate members include Paul James Huston and Francis Ellsworth Lloyd, while James Bernard has become a Junior Associate.

SOUTHERN CALIFORNIA CHAPTER

The regular December meeting heard Gilbert Morris, Superintendent of Building, Building and Safety Department of the City of Los Angeles, discuss the "Proposed Ordinance Regarding Existing and Future Parapet Wall Construction" which is of particular interest to all architects in southern California. John Monning and R. P. Cravens, representing the Building Department of Los Angeles were present to discuss the City's building code revisions.

NEW OFFICERS elected by acclamation to serve for the ensuing year were: A. C. Martin, Jr., President (See Page 38)

"PENNY WISE -- POUND FOOLISH"

Home Owners today demand abundant electrical living — without dread of being limited at some future time in the use of new electrical equipment.

That is why those who try to cut building costs by the installation of poor or inadequate electrical wiring are doomed to disappointment, inconvenience and the ultimate expense of re-wiring.

Prevent such annoyances by advising your clients not to be "Penny Wise — Pound Foolish" where wiring is concerned. Certified Adequate Wiring costs so little more than an inferior wiring job, and it is a lasting guarantee of full enjoyment of electrical living now and in the years ahead.

NORTHERN CALIFORNIA ELECTRICAL BUREAU

1355 Market Street, San Francisco 3

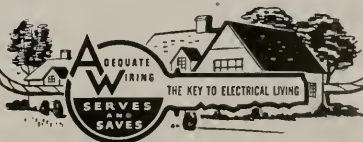

HEADLINE NEWS AND VIEWS

By E. H. W.

"If the industry cannot produce lower cost homes, the next Congress will certainly legislate the Federal government into the housing business."—Frank W. Cortright, Exec. Vice-Pres. National Association of Home Builders of the U. S.

"RETAIL sales in the nation currently are running at an annual rate of \$127 billion, almost 12 percent higher than 1947."—National Industrial Conference Board.

Government payrolls, federal, state and local, were \$120-million in July and 12 per cent greater than July of last year. July payrolls are usually the lowest.

Steel production in the first nine months of 1948 was only 2 per cent below the total output for the year 1946, and was 3.6 per cent over the same period of 1947.

The estimated total bookings of fabricated structural steel for the month of October were 160,736 tons, a decline of 11 per cent from the previous month.—American Institute of Steel Construction

Unless there are serious upsets to our economy, there should be a large volume of construction next year, and for a number of years in the future. There still exists a tremendous demand for new construction.—Dwight W. Winkelman, Pres. The Associated General Contractors of America, Inc.

California led the nation in home building in urban areas, and according to the San Francisco Chamber of Commerce, "A glimpse at the over-all housing picture throughout the Nation indicates that the private home builders have their second wind and are getting ready to pile up a real score this year."

Oregon and Washington's timber industries spent \$3,696,767 in 1947 for direct forest fire protection and an additional \$2,568,835 was spent by state agencies for the same purpose.

"NOT only are the 'first hundred years the hardest' but, as far as traffic congestion is concerned, that's only the beginning."—Col. Wm. N. Carey, Exec.-Sec. American Society of Civil Engineers.

"A free society is the severest test on earth of the mental and moral capacities of Human beings."—Dr. Raymond Rubicam.

BAXCO

CHROMATED ZINC CHLORIDE

CZC

PRESSURE TREATED LUMBER

● **PROTECTS AGAINST DECAY
AND TERMITE ATTACK**

*Specify it in your home
Available through Lumber Dealers*

LOS ANGELES
601 W. 5th Street
Phone Michigan 6294

SAN FRANCISCO
333 Montgomery Street
Phone DOugles 2-3883

J. H. Baxter & Co.

AGENTS FOR WEST COAST WOOD PRESERVING CO. SEATTLE, WASH.

QUALITY building material COSTS YOU LESS



E. K. WOOD LUMBER CO.

GENERAL OFFICES: • P. O. Box 1618, Oakland, Calif.
LOS ANGELES Office and Yards: 4710 S. Alameda St.—JE 3111
OAKLAND Yards and Wharves: 727 Kennedy St.—KE 4-8466
PORTLAND Mill Sales Office: 827 Terminal Sales Bldg.

SAW MILLS: Roseburg, Oregon • Reedsport, Oregon

RETAIL YARDS: LOS ANGELES • OAKLAND • ONTARIO • HOLLYWOOD
LONG BEACH • RIVERSIDE • TEMPLE CITY • SIERRA MADRE • INDO • THERMAL
LA VERNE • WHITTIER • PASADENA • SAN PEDRO

IN THE NEWS

ARCHITECT SELECTED

Gordon Stafford of Sacramento has been selected as the architect for the new Fruit Ridge Grammar School (Sacramento County). Harry J. Devine of Sacramento is the Supervising Architect. Cost of the building is estimated at \$219,000.

WOMEN'S DORMITORY

The San Francisco Theological Seminary of San Anselmo (California) has awarded a contract for \$124,933 to the construction firm of Younger & Hallsten for the building of a women's dormitory building. James H. Mitchell, San Francisco, is the architect.

TIMBER DATA.

The Timber Engineering Company of Washington, D. C., has prepared and issued a brochure "For Users of Wood and Forest Products" which is designed primarily for the use of young architects, engineers and other young men who have come into the industry since the war.

The bulletin covers timber engineering and design, timber and forest products research, product development and wood chemistry.

SEWAGE PLANT

The North Point Sewage Plant to be constructed by the City and County of San Francisco in the immediate future will cost an estimated \$8,289,525 according to latest reports from the San Francisco Department of Public Works.

HOSPITAL BONDS

The Patterson Hospital District has approved \$300,000 in bonds for the construction of a 25-bed hospital building at Patterson (California). Work will be started at once, according to D. D. Stone & Lou Mulloy of San Francisco, who are architects on the work.

AIRCRAFT

A contract has been awarded to Armco Drainage & Metal Products, Inc. of Berkeley, for the construction of a 10-unit Hangar Building at the Sonoma County Airport, near Santa Rosa, at a cost of \$14,165.

SCHOOL BONDS have been approved for the construction of a \$94,000 Grammar School building at Lone.

ANNOUNCING THE NEW



CONSTELLATION

SLIMLINE



After months of laboratory and engineering research, SMOOT-HOLMAN now introduces CONSTELLATION — a new instant-start, high efficiency SLIMLINE luminaire.

✓ For better merchandising in stores, service stations, etc. For better sight in schools (shielded model available soon), offices and other applications where fluorescent lighting is desired.

CONSTELLATION takes the 96" slimline lamp.

SMOOT-HOLMAN COMPANY • INGLEWOOD, CALIF.

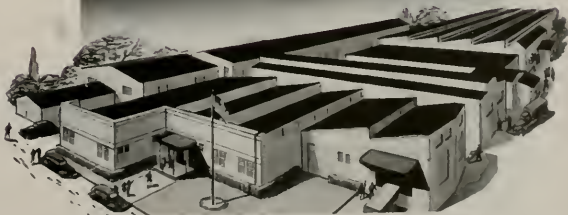

Office in Principal Western Cities Branch and Warehouse in San Francisco

LANDSCAPE ARCHITECTURE

Notes of The Profession

ASSOCIATION OF LANDSCAPE ARCHITECTS, SAN FRANCISCO REGION
Emil L. Anderson, President; Vernon M. Dean, Vice-President; Ralph W. Jones,
Secretary; Paul M. Steinmetz, Recording Secretary; Prentiss French,
Treasurer. Directors at Large: Geraldine Knight Scott, Wayne
Gray, H. L. Vaughan and Douglas H. Baylis.

The Association of Landscape Architects will again collaborate with the East Bay Chapter of the American Institute of Architects in the design and execution of a unit at the California Spring Garden Show. Committees will soon be appointed by Lewis Koue, President of the East Bay Chapter, A.I.A., and E. L. Anderson, President of the Association of Landscape Architects, to carry out the work.

The Committee on Registration for Landscape Architects is progressing with its work, and has written a proposed bill for presentation to the State Legislature. Almost all Landscape Archi-

ects in the state have been consulted, and the Committee is actively seeking the advice and support of Architects and Engineers. They will welcome any suggestions which may be made.

Bernard Wiseltier, past President of the Association of Landscape Architects, and Lynn Harriss, A.L.A., have recently returned from Los Angeles where they consulted Landscape Architects of that region on the subject of registration.

The Association of Landscape Architects held a most successful Christmas party at the Hotel Claremont, December 16. Vice President Vernon Dean served as master of ceremonies and head bouncer.

*In the new
AMERICAN STOVE
building • St. Louis*



ARCHITECT — Harris Armstrong
CONTRACTOR — Gamble Construction Co.

ONE of America's truly outstanding projects... and Halsey Taylor fountains were selected! It is significant that for the country's finest public and private structures these modern health-safe fountains are usually preferred! The Halsey W Taylor Co., Warren, O.

Halsey Taylor

DRINKING FOUNTAINS

West Coast Plant, Redlands, Calif.

STATE OF CALIFORNIA SEEKING TECHNICIANS

The California State Personnel Board has announced it will conduct nation-wide examinations for electrical and mechanical engineers, draftsmen, designers, and specification writers to fill positions with the State Department of Architecture in connection with California's \$250,000,000 state building program.

All applicants must be United States citizens and the salary ranges from \$415 to \$584 per month.

WEST COAST SAWMILLS NEAR PEAK PRODUCTION

West Coast sawmills appear to be reaching a new peace-time output with some 1505 Douglas Fir mills in western Oregon and Washington producing more than 5,792,259,000 board feet in the first 34 weeks of this year.

Inability of water mills to ship by boat and a continuing shortage of railroad cars for the next two months may cut into shipments, according to Harris E. Smith, secretary of the West Coast Lumbermen's Association.

Mills report they are in the best position since the war to supply lumber needed for the nearly 950,000 new homes which will be built in the nation this year.

IN THE NEWS

SHOP BUILDING

The Turlock (California) High School District has awarded a \$106,826 contract to A. J. McMurray of Yreka for the construction of an Agricultural Shop Building at the Turlock High School. Frank Mayo and Eric Johnson, Stockton, are the architects.

EMERGENCY LITE

A new emergency light unit that plugs into any standard outlet, whenever the regular lighting current fails, has been developed by the U-C LITE Manufacturing Company of Chicago.



Known as Big Beam Model 2-AD Special the unit automatically switches on to meet the need for emergency lighting in theaters, hospitals, amusement buildings, night clubs, institutions, department stores and other places where confusion arises from light failures. Floodlight heads are 5-in. in diameter.

SCHOOL BONDS

Voters of Mill Valley (California) will vote at a special election on February 1st whether to approve a \$2,045,000 bond issue for the purpose of building a new High School building in San Anselmo, and for the construction of an addition to the Tamalpais High School.

HOSPITAL

The Lodi Memorial Hospital Association of Lodi (California) has announced plans for the construction of a 75-bed Hospital in the immediate future at an estimated cost of \$1,000,000. W. D. Pugh of San Francisco is the architect.

NEW CHURCH

The First Christian Church of Woodland (California) has awarded a contract to the Goodenough Construction Company of Stockton

for the construction of a church building in Woodland at a cost of \$108,275. Dragon, Schmidts & Hardman of Berkeley are the architects.

ARCHITECT SELECTED

W. Coates & Maurice Metz of Fresno (California) have been selected to design an addition to the Laton High School at Laton, California.

SHOPPING CENTER

The architectural firm of Roselyn & Gartner of San Francisco are working on preliminary drawings

for a \$1,500,000 Shopping Center near Hayward in Alameda County. Project consists of a department store, stores, theater, market, bank, laundry, roof restaurant, and roof parking.

WARD BUILDING

A contract has been awarded to Peter Sartorio of San Francisco for the construction of a 50-bed ward building at the Contra Costa County Hospital in Martinez. Cost of the work is \$69,951, according to E. Geoffrey Bangs, Architect, of San Francisco.

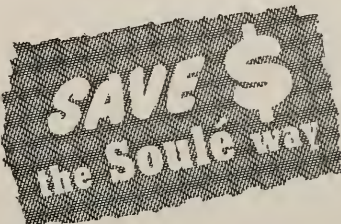

COMPARE OVER-ALL COSTS Your building dollars reach farther when you build the Soule way. Experienced Soule Dealer-Contractors give you quotations on turnkey jobs and handle every construction detail. Soule quality plus local field service is tops in value and savings!

READILY ADAPTED The Soule Steeline Building is prefabricated for economy. It is easily modified for the specific needs of industry, stores, show-rooms, warehouses, farms, etc. Practically any arrangement (or number) of windows and doors.

30, 40 & 50-FOOT WIDTHS Soule clear-span widths fit property best. Any length in multiples of 19'-9". Soule pre-fabricates special buildings for any need.

QUICKEST DELIVERY When you build the Soule way completion is a matter of days, not weeks! The complete Steeline Building is on the site by the time your foundation is ready!



- Meets all Building Codes
- Rigid, all-steel frame
- Aluminum or Plasteel sheets
- Spacious, clear-span design
- Vertical sidewalls
- Insect, fungus and rot-proof

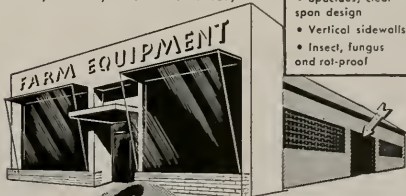

Soule Steeline Buildings \$5-700
UTILITY

Sold and Erected by:

WESTERN SOULÉ PLANTS
SAN FRANCISCO • LOS ANGELES
PORTLAND • SEATTLE



SOULÉ STEEL CO.
1750 Army Street • San Francisco 24
Phone: VALENCE 4-4141

FABRICATORS OF STEEL BUILDING PRODUCTS SINCE 1911

STEEL

STRUCTURAL
and
REINFORCING
for
ALL TYPE OF STRUCTURES

JUDSON PACIFIC - MURPHY CORP.

4300 EAST SHORE HIGHWAY
EMERYVILLE, CALIF.

FORDERER CORNICE WORKS

Manufacturers of

Hollow Metal Products • Interior Metal Trim
Elevator Fronts and Cabs
Metal Plaster Accessories • Sanitary Metal Base
Flat and Roll Metal Screens
Metal Cabinets • Commercial Refrigerators

269 POTRERO AVE.

SAN FRANCISCO, CALIF.

HEMLOCK 4100

VALUABLE NEWS SERVICE

- BUILDING MATERIAL DEALERS
- CONTRACTORS
- ENGINEERS
- FINANCIAL INSTITUTIONS

ARCHITECTS REPORTS gives advance news on construction projects in Northern California, lists: name of projects, location, architect, proposed cost and other pertinent information.

HANDY individual slip-reports, issued daily at a total cost of only

\$10 a month

ARCHITECT'S REPORTS

Published Daily

The ARCHITECT and ENGINEER, Inc.

68 Post Street, San Francisco - DO 8311

A. I. A. ACTIVITIES

(From Page 33)

dent; John Rex, Vice-president; Maynard Lyndon, Secretary; Jack C. Lipman, Treasurer; and Paul O. Davis was named a Director to serve for a three year term.

ARCHITECTURAL DESIGN CONTEST ANNOUNCED

Architectural students throughout the United States, Cuba, and Canada are eligible to compete for prizes totaling \$25.00 in a national design contest sponsored by the Beaux-Arts Institute of Design of New York and the Tile Council of America.

The contest calls for the designing of an elementary school and kindergarten in which special attention is given to the use of clay tile. In addition to this contest the Beaux-Arts Institute of Design is sponsoring 31 other competitions during the 1948-49 school year.

WASHINGTON UNIVERSITY STEEDMAN FELLOWSHIP

The eighteenth competition for the James Harrison Steedman Memorial Fellowship in Architecture will take place in the spring of 1949 and offers an award of \$3000 for a year of study and travel in foreign lands.

The competition is open to all graduates of accredited architectural schools in the United States, who have had at least one year of practical work in the office of an architect, including one year's residence in St. Louis, Mo., and who are between the ages of 21 and 31 at the time of appointment.

The competition consists of a 15-consecutive-hour preliminary sketch followed by a six-week development period. The winner of the Fellowship is expected to spend a year in fulfillment of some predetermined plan of architectural research. Upon the conclusion of this term he is required to present a report summarizing the results of his study.

The preliminary exercise will be held on Saturday, February 19th at the School of Architecture, Washington University, St. Louis, Mo. Application blanks may be obtained from the University.

The Governing Committee of the Steedman Fellowship consists of Joseph D. Murphy, Dean of the School of Architecture; Kenneth E. Wischmeyer, President of the St. Louis Chapter, A.I.A., and Louis LaBeaume, Chairman.

HIGH SCHOOL ADDITION. Stolte, Inc., have been awarded a \$153,768 contract for construction of an addition to the Pacific Grove High School. Robert Stanton, Pebble Beach, is the Architect.

ARCHITECT & ENGINEER

ESTIMATOR'S GUIDE

BUILDING AND CONSTRUCTION MATERIALS

PRICES GIVEN ARE FIGURING PRICES AND ARE MADE UP FROM AVERAGE QUOTATIONS FURNISHED BY MATERIAL HOUSES TO SAN FRANCISCO CONTRACTORS. 3% SALES TAX ON ALL MATERIALS BUT NOT LABOR

All prices and wages quoted are for San Francisco and the Bay District. There may be slight fluctuation of prices in the interior and southern part of the state. Freight cartage, at least, must be added in figuring country work.

BONDS—Performance or Performance plus Labor and Material Bond(s), \$10 per \$1000 on contract price. Labor & Material Bond(s) only, \$5.00 per \$1000 on contract price.

BRICKWORK—

Common Brick—Per 1M laid—\$100.00 up (according to class of work).

Face Brick—Per 1M laid—\$200.00 and up (according to class of work).

Brick Steps—\$3.00 and up.

Common Brick Veneer on Frame Bldgs.—Approx. \$1.20 and up—according to class of work.

Face Brick Veneer on Frame Bldgs.—Approx. \$2.00 and up (according to class of work).

Common Brick—\$33.00 per M—truckload lots, delivered.

Face Brick—\$60.00 to \$90.00 per M, truckload lots, delivered.

Cartage—Approx. \$9.00 per M.

BUILDING PAPER—

1 ply per 1000 ft. roll \$5.30

2 ply per 1000 ft. roll 7.80

3 ply per 1000 ft. roll 9.20

Brownskin, Standard, 500 ft. roll 8.00

Sisalcraft, reinforced, 500 ft. roll 7.00

BUILDING HARDWARE—

Sash cord com. No. 7 \$2.65 per 100 ft.

Sash cord com. No. 8 3.90 per 100 ft.

Sash cord spot No. 7 3.65 per 100 ft.

Sash cord spot No. 8 4.00 per 100 ft.

Sash weights, cast iron, \$100.00 ton.

Nails, \$5.50 base.

CONCRETE AGGREGATES—

The following prices net to Contractors unless otherwise shown. Carload lots only.

	Bunker per ton	Del'd per ton
Gravel all sizes	\$2.44	\$2.90
Top Sand	2.38	3.13
Concrete Mix	2.38	3.06
Crushed Rock, 1/4" to 3/8"	2.38	2.94

	Bunker per ton	Del'd per ton
Crushed Rock, 3/4" to 1 1/2"	\$2.38	\$3.13
Roofing Gravel	2.81	3.50
River Sand	2.50	3.06

Sand—		
Lapis (Nos. 2 & 4)	3.56	3.94
Olympia (Nos. 1 & 2)	3.56	3.88

Cement—

Common (all brands, paper sacks), carload lots, \$3.02 per bbl. f.o.b. car; delivered \$3.60. Cash discount on carload lots, 10c a bbl., 10th prox., less than carload lots \$4.00 per bbl. f.o.b. warehouse or delivered. Cash discount 2% on L.C.L.

Trinity White	1 to 100 sacks, \$3.13 sack warehouse or del.; \$9.56 bbl. carload lots.
Medusa White	

DAMPPOOFING and Waterproofing—

Two-coat work, \$9.00 per square.

Membrane waterproofing—4 layers of saturated felt, \$10.00 per square.

Hot coating work, \$5.00 per square.

Medusa Waterproofing, \$3.50 per lb. San Francisco Warehouse.

Tricosal concrete waterproofing. 50c a cubic yd. and up.

ELECTRIC WIRING—\$15 to \$20 per outlet for conduit work (including switches).

Knob and tube average \$6.00 per outlet. (Available only for priority work.)

ELEVATORS—

Prices vary according to capacity, speed and type. Consult elevator companies. Average cost of installing a slow speed automatic passenger elevator in small four story apartment building, including entrance doors, about \$8000.00.

EXCAVATION—

Sand, \$1.00; clay or shale, \$1.50 per yard. Trucks, \$30 to \$45 per day.

Above figures are an average without water. Steam shovel work in large quantities, less; hard material, such as rock, will run considerably more.

FIRE ESCAPES—

Ten-foot galvanized iron balcony, with stairs, \$250 installed on new buildings; \$300 on old buildings.

FLOORS—

Composition Floors, such as Magnesite, 50c per square foot.

Linoflor—2 gages—\$3.00 per sq. yd.

Mastipave—\$1.50 per sq. yd.

Battleship Linoleum—available to Army and Navy only—1/8" —\$3.50 sq. yd. 3/8" —\$3.50 sq. yd.

Terazzo Floors—\$1.50 per sq. ft.

Terazzo Steps—\$2.50 per lin. ft.

Mastic Wear Coat—according to type—20c to 35c.

Hardwood Flooring—

Standard Mill grades not available.

Victory Oak—T & G

3/4" x 2 1/4" —\$252.00 per M. plus Cartage

1/2" x 2" —\$210.00

1/2" x 1 1/2" —200.00

Prefinished Standard & Better Oak Flooring

3/4" x 3 1/4" —\$265.00 per M. plus Cartage

1/2" x 2 1/2" —237.00 per M. plus Cartage

Maple Flooring

3/4" T & G Clear \$330.00 per M. plus Ctg.

2nd 305.00 per M. plus Ctg.

3rd 255.00 per M. plus Ctg.

Floor Layers' Wage, \$2.28 1/2 per hr. (Legal as of July 1, 1947. Given us by Inlaid Floor Co.)

GLASS—

Single Strength Window Glass—.40 per sq. ft.

Double Strength Window Glass—.60 per sq. ft.

Plate Glass, under 75 sq. ft.—1.50 per sq. ft.

Polished Wire Plate Glass—.25 per sq. ft.

Rgh. Wire Glass—.60 per sq. ft.

Obscure Glass—.40 per sq. ft.

Glazing of above is additional.

Glass Blocks—.275 per sq. ft. set in place

HEATING—

Average, \$2.50 to \$3.00 per sq. ft. of radiation, according to conditions.

Warm air (gravity) average \$64 per register.

Forced air average \$91 per register.

INSULATION AND WALLBOARD—

Rockwool Insulation— (2")	\$45.00 per M sq. ft.
Cotton Insulation—Full-thickness (3%)	\$95.50 per M sq. ft.
Sisalation Aluminum Insulation—Aluminum coated on both sides	\$23.50 per M sq. ft.
Tileboard—4"x6" panel	\$9.00 per panel
Wallboard—1/2" thickness	\$55.00 per M sq. ft.
Finished Plank	\$69.00 per M sq. ft.
Ceiling Tileboard	\$69.00 per M sq. ft.

IRON—Cost of ornamental iron, cast iron, etc., depends on designs.

LUMBER—

No. 1 Common	\$85.00 per M
No. 2 Common	\$83.00 per M
Select O. P. Common	\$90.00 per M

Flooring—

	Per M Delvd.
V.G., D.F. 8 & 8tr. 1 x 4 T & G Flooring	\$225.00
"C" and better—all	225.00
"D" and better—all	225.00
Rwd. Rustic—"A" grade, medium dry	185.00
8 to 24 ft.	
"B" grade, medium dry	150.00
Plywood	18c to 20c per ft.
Plyscord	11 1/2c per ft.
Plywall	9c per ft.
Plyform	15c per ft.

Shingles (Rwd. not available)—

Red Cedar No. 1—	\$13.00 per square; No. 2, \$10.50; No. 3, \$9.00.
Average cost to lay shingles, 6c per square.	
Cedar Shakes—Tapered: 1/2" to 3/4" x 25"—	\$17.00 per square.
Resawn: 3/4" to 1 1/4" x 25"—	\$22.00 per square
Average cost to lay shakes,—	8.00 per square

MILLWORK—Standard.

D. F. \$150 per 1000. R. W. Rustic \$175 per 1000 (delivered).
Double hung box window frames, average with trim, \$12.50 and up, each.
Complete door unit, \$15 to \$25.
Screen doors, \$8.00 to \$12.00 each.
Patent screen windows, \$1.25 a sq. ft.
Cases for kitchen pantries seven ft. high, per lineal ft., upper \$9.00 to \$11.00; lower \$12.00 to \$13.00.
Dining room cases, \$20.00 per lineal foot. Rough and finish about \$1.00 per sq. ft.
Labor—Rough carpentry, warehouse heavy framing (average), \$75.00 per M.
For smaller work average, \$85.00 to \$100. per 1000.

MARBLE—(See Dealers)

PAINTING—

Two-coat work	per yard 85c
Three-coat work	per yard \$1.10
Cold water painting	per yard 25c
Whitewashing	per yard 15c
Turpentine.....	\$1.85 per gal. in 5-gal. cont.
Raw Linseed	
Oil.....	\$3.33 per gal. in 5-gal. cont.

Boiled Linseed	
Oil.....	\$3.23 per gal. in drums.
Boiled Linseed Oil—	\$3.33 per gal. in 5-gal. containers.
Replacement Oil—	\$2.75 per gal. in drums.
\$2.75 per gal. in 5-gal. containers.	
Use Replacement	
Oil.....	\$3.00 per gal. in 1 gal. cont.
A deposit of \$7.50 required on all drums.	

PATENT CHIMNEYS—

6-inch	\$2.50 lineal foot
8-inch	3.00 lineal foot
10-inch	4.00 lineal foot
12-inch	5.00 lineal foot

PLASTER—

Neat wall, per ton delivered in S. F. in paper bags, \$17.60.

PLASTERING (Interior)—

3 Coats, metal lath and plaster	Yard \$3.00
Keene cement on metal lath	3.50
Ceilings with 3/4 hot roll channels metal lath (lathed only)	3.00
Ceilings with 3/4 hot roll channels metal lath plastered	4.50
Single partition 3/4 channel lath 1 side (lath only)	3.00
Single partition 3/4 channel lath 2 inches thick plastered	8.00
4-inch double partition 3/4 channel lath 2 sides (lath only)	5.75
4-inch double partition 3/4 channel lath 2 sides plastered	8.75
Thermax single partition; 1" channels; 2 1/4" overall partition width. Plastered both sides	7.50
Thermax double partition; 1" channels; 4 1/4" overall partition width. Plastered both sides	11.00
3 Coats over 1" Thermax nailed to one side wood studs or joists	4.50
3 Coats over 1" Thermax suspended to one side wood studs with spring sound isolation clip	5.00
Note—Channel lath controlled by limitation orders.	

PLASTERING (Exterior)—

2 coats cement finish, brick or concrete wall	Yard \$2.50
3 coats cement finish, No. 18 gauge wire mesh	3.50
Lime—	\$4.00 per bbl. at yard.
Processed LLime—	\$4.15 per bbl. at yard.
Rock or Grip Lath—	3/4"—30c per sq. yd.
1/4"—	27c per sq. yd.
Composition Stucco—	\$4.00 sq. yard (applied).

PLUMBING—

From \$175.00 per fixture up, according to grade, quality and runs.

ROOFING—

"Standard" tar and gravel, 4 ply—	\$11.00 per sq. for 30 sqs. or over.
Less than 30 sqs.	\$14.00 per sq.
Tile	\$40.00 to \$50.00 per square.
Redwood Shingles,	\$15.00 per square in place.
5/2 # 1-16" Cedar Shingles, 4 1/2" Exposure	\$18.25 square

5/8 x 16"—#1 Cedar Shingles, 5" Exposure	\$18.00 square
4/2 # 1-24" Royal Shingles, 7 1/2" Exposure	\$23.00 square
Re-coat with Gravel	\$5.50 per sq.
Asbestos Shingles \$35 to \$45 per sq. laid, 1/2 to 3/4 x 25" Resawn Cedar Shakes, 10" Exposure	\$24.00
3/4 to 1 1/4 x 25" Resawn Cedar Shakes, 10" Exposure	\$29.00
1 x 25" Resawn Cedar Shakes, 10" Exposure	22.00
Above prices are for shakes in place.	

SHEET METAL—

Windows—Metal,	\$2.50 a sq. ft.
Fire doors (average), including hardware	\$2.80 per sq. ft., size 12'x12'. \$3.75 per sq. ft., size 3'x6'.

SKYLIGHTS—(not glazed)

Copper,	\$1.25 sq. ft. (flat).
Galvanized iron,	65c sq. ft. (flat).
Vented hip skylights	90c sq. ft.

STEEL—STRUCTURAL—

\$220 per ton erected, when out of mill.
\$270 per ton erected, when out of stock.

STEEL REINFORCING—

\$200.00 per ton, in place.

STORE FRONTS (None available).

TILE—

Ceramic Tile Floors—	\$1.70 per sq. ft.
Cove Base—	\$1.35 per lin. ft.
Glazed Tile Wainscot—	\$1.85 per sq. ft.
Asphalt Tile Floor 1/4" x 3/4"—	\$.40 per sq. ft.
Light shades slightly higher.	
Cork Tile—	\$1.00 per sq. ft.
Mosaic Floors—	See dealers.
Lino-Tile—	\$1.00 per sq. ft.

Wall Tile—

Glazed Terra Cotta Wall Units (single faced) laid in place—approximate prices:	
2 x 6 x 12	\$1.25 sq. ft.
4 x 6 x 12	1.50 sq. ft.
2 x 8 x 16	1.45 sq. ft.
4 x 8 x 16	1.75 sq. ft.

VENETIAN BLINDS—

75c per square foot and up. Installation extra.

WINDOWS—STEEL—

60c per square foot, \$5 for ventilators.

IN THE NEWS

NEW LIGHTING

A new, instant-start, simply constructed fluorescent lighting unit has been added to the SMOOT-HOLMAN Company line of fluorescent fixtures called the "Constellation" Slimline.



Simple in design, trouble free, easily installed and low cost in maintenance, the Constellation comes in satin aluminum and baked enamel for single or continuous mounting. Ninety-seven and one-quarter inches in length, it takes a 96-inch T-8 cathode Slim-

line lamp. Complete information and specification available from SMOOT-HOLMAN Company, Inglewood, California.

COUNTY BUILDING

A contract for \$269,447 has been awarded the B. & R. Construction Company of San Francisco for the construction of a new county office building and remodel of the Solano County Court House at Fairfield. Harry J. Devine of Sacramento is the architect.

NATORIUM

The City of Salinas (California) has awarded a \$134,712 contract to Stolte Inc. of Monterey, for the construction of a Natorium Building at Sherwood Park in Monterey County. J. H. Cline Company of Oakland is the Structural Engineer.

BRIDGE AWARD

Duncanson-Harrelson was awarded a San Francisco has been award-

ed a \$124,227 contract for the construction of a new double leaf Basquile bridge over Islais Creek at Third Street in San Francisco.

ROLLS AND HOLDS

A new Roller Catch for interior doors that permits smooth, silent operation with a simple push action has just been announced by THE STANLEY WORKS of New Britain, Conn.

Easily installed at any desired

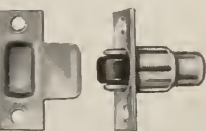

location on door; finger tip adjustment, and adjustment of 3/4" between door and casing. Available in any standard hardware finish, and usable with any make decorative knob or pull.

BUILDING TRADES WAGE (JOB SITES) NORTHERN AND CENTRAL CALIFORNIA

ATTENTION: The following are the PREVAILING hourly rates of compensation being paid and in effect by employers by agreement between employees and their union; or as recognized and determined by the U.S. Department of Labor. (Revised to November 1, 1948.)

CRAFT	San Francisco		Alameda		Costa		Fresno		Marin		Sacramento		Clara		Santa Mateo		Solano		Stockton		Walsonville	
	Francisco	Alameda	Costa	Fresno	Marin	Sacramento	Clara	Santa Mateo	Solano	Stockton	Walsonville											
ASBESTOS WORKERS	2.16	2.16	2.16	2.16	2.16	2.16	2.16	2.16	2.16	2.16	2.16	2.16	2.16	2.16	2.16	2.16	2.16	2.16	2.16	2.16	2.16	2.16
BRICKLAYERS	2.81 1/4	2.81 1/4	2.81 1/4	2.50	2.81 1/4	2.81 1/4	2.81 1/4	3.00	2.81 1/4	2.81 1/4	2.81 1/4	3.00	2.81 1/4	2.81 1/4	2.81 1/4	2.81 1/4	2.81 1/4	2.81 1/4	2.81 1/4	2.81 1/4	2.81 1/4	2.81 1/4
BRICKLAYERS, HODCARRIERS	2.25	2.25	2.25	2.25	2.25	2.00	1.75	2.25	2.25	2.25	2.25	2.25	2.25	2.25	2.25	2.25	2.25	2.25	2.25	2.25	2.25	2.25
CARPENTERS	2.16	2.16	2.12 1/2	2.12 1/2	2.16	2.12 1/2	2.16	2.12 1/2	2.16	2.12 1/2	2.16	2.12 1/2	2.16	2.12 1/2	2.16	2.12 1/2	2.16	2.12 1/2	2.16	2.12 1/2	2.16	2.12 1/2
CEMENT FINISHERS	2.15	2.15	2.15	2.15	2.15	2.15	2.15	2.15	2.15	2.15	2.15	2.15	2.15	2.15	2.15	2.15	2.15	2.15	2.15	2.15	2.15	2.15
ELECTRICIANS	2.50	2.40	2.40	2.25	2.40	2.40	2.40	2.40	2.40	2.40	2.40	2.40	2.40	2.40	2.40	2.40	2.40	2.40	2.40	2.40	2.40	2.40
ELEVATOR CONSTRUCTORS	2.45	2.45	2.45	2.45	2.45	2.45	2.45	2.45	2.45	2.45	2.45	2.45	2.45	2.45	2.45	2.45	2.45	2.45	2.45	2.45	2.45	2.45
ENGINEERS: MATERIAL HOIST	2.37 1/2	2.37 1/2	2.37 1/2	2.37 1/2	2.37 1/2	2.37 1/2	2.37 1/2	2.37 1/2	2.37 1/2	2.37 1/2	2.37 1/2	2.37 1/2	2.37 1/2	2.37 1/2	2.37 1/2	2.37 1/2	2.37 1/2	2.37 1/2	2.37 1/2	2.37 1/2	2.37 1/2	2.37 1/2
PILE DRIVER	2.40	2.40	2.40	2.40	2.40	2.40	2.40	2.40	2.40	2.40	2.40	2.40	2.40	2.40	2.40	2.40	2.40	2.40	2.40	2.40	2.40	2.40
STRUCTURAL STEEL	2.00	2.00	2.00	2.00	2.00	2.00	2.00	2.00	2.00	2.00	2.00	2.00	2.00	2.00	2.00	2.00	2.00	2.00	2.00	2.00	2.00	2.00
GLAZIERS	2.25	2.25	2.25	2.25	2.25	2.25	2.25	2.25	2.25	2.25	2.25	2.25	2.25	2.25	2.25	2.25	2.25	2.25	2.25	2.25	2.25	2.25
IRONWORKERS: ORNAMENTAL	2.15	2.15	2.15	2.15	2.15	2.15	2.15	2.15	2.15	2.15	2.15	2.15	2.15	2.15	2.15	2.15	2.15	2.15	2.15	2.15	2.15	2.15
REINF. RODMEN	2.40	2.40	2.40	2.40	2.40	2.40	2.40	2.40	2.40	2.40	2.40	2.40	2.40	2.40	2.40	2.40	2.40	2.40	2.40	2.40	2.40	2.40
STRUCTURAL	2.40	2.40	2.40	2.40	2.40	2.40	2.40	2.40	2.40	2.40	2.40	2.40	2.40	2.40	2.40	2.40	2.40	2.40	2.40	2.40	2.40	2.40
LABORERS: BUILDING	1.52 1/2	1.52 1/2	1.52 1/2	1.42 1/2	1.52 1/2	1.52 1/2	1.52 1/2	1.42 1/2	1.52 1/2	1.52 1/2	1.52 1/2	1.42 1/2	1.52 1/2	1.52 1/2	1.52 1/2	1.52 1/2	1.52 1/2	1.52 1/2	1.52 1/2	1.52 1/2	1.52 1/2	1.52 1/2
CONCRETE	1.52 1/2	1.52 1/2	1.52 1/2	1.42 1/2	1.52 1/2	1.52 1/2	1.52 1/2	1.42 1/2	1.52 1/2	1.52 1/2	1.52 1/2	1.42 1/2	1.52 1/2	1.52 1/2	1.52 1/2	1.52 1/2	1.52 1/2	1.52 1/2	1.52 1/2	1.52 1/2	1.52 1/2	1.52 1/2
LATHERS	2.81 1/4	2.81 1/4	2.81 1/4	2.81 1/4	2.81 1/4	2.81 1/4	2.81 1/4	2.81 1/4	2.81 1/4	2.81 1/4	2.81 1/4	2.81 1/4	2.81 1/4	2.81 1/4	2.81 1/4	2.81 1/4	2.81 1/4	2.81 1/4	2.81 1/4	2.81 1/4	2.81 1/4	2.81 1/4
MARBLE SETTERS	2.25	2.25	2.25	2.25	2.25	2.25	2.25	2.25	2.25	2.25	2.25	2.25	2.25	2.25	2.25	2.25	2.25	2.25	2.25	2.25	2.25	2.25
MOOSAIC & TERRAZZO	2.00	2.00	2.00	2.00	2.00	2.00	2.00	2.00	2.00	2.00	2.00	2.00	2.00	2.00	2.00	2.00	2.00	2.00	2.00	2.00	2.00	2.00
PAINTERS	2.15**	2.15**	2.15**	2.15**	2.15**	2.15**	2.15**	2.15**	2.15**	2.15**	2.15**	2.15**	2.15**	2.15**	2.15**	2.15**	2.15**	2.15**	2.15**	2.15**	2.15**	2.15**
PLEDRIVERS	2.25	2.25	2.25	2.25	2.25	2.25	2.25	2.25	2.25	2.25	2.25	2.25	2.25	2.25	2.25	2.25	2.25	2.25	2.25	2.25	2.25	2.25
PLASTERERS	2.25*	2.50*	2.50*	2.25*	2.25*	2.25*	2.25*	2.25*	2.25*	2.25*	2.25*	2.25*	2.25*	2.25*	2.25*	2.25*	2.25*	2.25*	2.25*	2.25*	2.25*	2.25*
PLASTERERS, HODCARRIERS	2.00*	2.25*	2.25*	1.77 1/2*	2.00*	2.00*	2.00*	2.00*	2.00*	2.00*	2.00*	2.00*	2.00*	2.00*	2.00*	2.00*	2.00*	2.00*	2.00*	2.00*	2.00*	2.00*
PLUMBERS	2.37 1/2	2.37 1/2	2.37 1/2	2.37 1/2	2.37 1/2	2.37 1/2	2.37 1/2	2.37 1/2	2.37 1/2	2.37 1/2	2.37 1/2	2.37 1/2	2.37 1/2	2.37 1/2	2.37 1/2	2.37 1/2	2.37 1/2	2.37 1/2	2.37 1/2	2.37 1/2	2.37 1/2	2.37 1/2
ROOFERS	2.16	2.16	2.16	1.87 1/2	2.16	2.00	2.00	2.00	2.16	2.16	2.16	2.00	2.16	2.16	2.16	2.16	2.16	2.16	2.16	2.16	2.16	2.16
SHEET METAL WORKERS	2.12 1/2	2.12 1/2	2.12 1/2	2.12 1/2	2.12 1/2	2.12 1/2	2.12 1/2	2.12 1/2	2.12 1/2	2.12 1/2	2.12 1/2	2.12 1/2	2.12 1/2	2.12 1/2	2.12 1/2	2.12 1/2	2.12 1/2	2.12 1/2	2.12 1/2	2.12 1/2	2.12 1/2	2.12 1/2
SPRINKLER FITTERS	2.37 1/2	2.37 1/2	2.37 1/2	2.37 1/2	2.37 1/2	2.37 1/2	2.37 1/2	2.37 1/2	2.37 1/2	2.37 1/2	2.37 1/2	2.37 1/2	2.37 1/2	2.37 1/2	2.37 1/2	2.37 1/2	2.37 1/2	2.37 1/2	2.37 1/2	2.37 1/2	2.37 1/2	2.37 1/2
STEAMFITTERS	2.37 1/2	2.37 1/2	2.37 1/2	2.37 1/2	2.37 1/2	2.37 1/2	2.37 1/2	2.37 1/2	2.37 1/2	2.37 1/2	2.37 1/2	2.37 1/2	2.37 1/2	2.37 1/2	2.37 1/2	2.37 1/2	2.37 1/2	2.37 1/2	2.37 1/2	2.37 1/2	2.37 1/2	2.37 1/2
STONEMEN (MASON'S)	2.81 1/4	2.81 1/4	2.81 1/4	2.25*	2.81 1/4	2.81 1/4	2.81 1/4	2.81 1/4	2.81 1/4	2.81 1/4	2.81 1/4	2.81 1/4	2.81 1/4	2.81 1/4	2.81 1/4	2.81 1/4	2.81 1/4	2.81 1/4	2.81 1/4	2.81 1/4	2.81 1/4	2.81 1/4
TILESETTERS	2.67 1/2	2.67 1/2	2.67 1/2	2.15	2.67	2.00	2.00	2.67 1/2	2.67 1/2	2.67 1/2	2.67 1/2	2.67 1/2	2.67 1/2	2.67 1/2	2.67 1/2	2.67 1/2	2.67 1/2	2.67 1/2	2.67 1/2	2.67 1/2	2.67 1/2	2.67 1/2

* 6 Hour Day. ** 7 Hour Day.

Prepared and compiled by:

CENTRAL CALIFORNIA CHAPTER, ASSOCIATED GENERAL CONTRACTORS OF AMERICA with the assistance and cooperation of secretaries of General Contractors Associations and Builders Exchanges of Northern California.

CLASSIFIED ADVERTISING

RATE: 20c PER WORD ... CASH WITH ORDER

MINIMUM \$5.00

CONSTRUCTION ENGINEER (CIVIL) GENERAL SUPERINTENDENT PROJECT MANAGER

Twenty five years of wide practical experience on frame, steel, concrete and masonry bldgs. of all types. Estimating, sub-division, sales, detailing & specification writing background. Dependable, energetic. Excellent local references. Have car. Free to travel. P.O. Box 807, San Mateo, Calif.

WANTED: Product Engineer with experience wanted as a permanent addition to the staff of an industrial Development Department located in Minnesota. Work involves product development including travel for consumer contacts. Program relates to products from wood. Submit details education, experience, references, salary requirement, photograph. All replies considered confidential and will be acknowledged. Reply Box 238, Architect and Engineer, Inc., 68 Post St., San Francisco, Calif.

ENGRAVING—Good engravings are essential to a satisfactory job of printing reproduction. For the best, see Poor Richard Photo Engraving Co., 324 Commercial St., San Francisco.

PHOTOGRAPHY: Building, Construction, Publicity, Aerial photographs by thoroughly experienced Photographers. Black & White, Color, Stills and Motion Pictures. DEB Photos, 929 Hearst Building, San Francisco.

SISALKRAFT

REG. U. S. PAT. OFF.

"More than a building paper"

THE SISALKRAFT CO.

205 West Wacker Drive
Chicago, Ill.

55 New Montgomery Street
San Francisco, Calif.

CLINTON CONSTRUCTION CO. OF CALIFORNIA

General Contractors

923 FOLSOM STREET • SAN FRANCISCO
SUtter 1-3440

HOGAN LUMBER CO.

Wholesale and Retail

LUMBER

MILL WORK • SASH & DOORS

Office, Mill, Yard and Docks
SECOND AND ALICE STREETS • OAKLAND, CALIF.
Telephone GLencourt 1-6861

TILE

UNUSUAL AND PRACTICAL INSTALLATIONS OF CERAMIC AND FAIENCE TILE

for bathrooms, kitchens, vestibules, stores,
patios and cocktail bars



FOX TILE CO.

3247 E. 14TH STREET, OAKLAND
Phone: ANdaver 1-0431

PARKING AND TRUCK LOADING

(From Page 9)

vator lobbies, and storage bins. Adequate terminals for the accommodation of patrons, parkers, and goods suited to automotive methods of transportation are essential in the competition to serve a given population.

The foregoing paragraphs pose the current opinions, thoughts and problems facing those communities now struggling with inadequate parking and truck loading facilities in the central business districts. Much has been done in the last few years, both legislatively and by actual construction, to solve these problems.

LETTERS TO THE EDITOR

December 10, 1948

Architect and Engineer
68 Post Street
San Francisco 4, California
Gentlemen:

We are asking for your help in a survey which we are conducting to find out:

1. What size pipe is being installed in the new homes, built in your territory, for conducting water outside for use in a garden hose?
2. What size pipe is used for the same purpose in the majority of homes which have already been built in your territory?

(Size of pipe to be expressed in terms of inches—such as ½ inch, ¾ inch, etc.)

Your answers to the above questions will greatly assist us in our study of this important piece of plumbing equipment.

Thank you very much for your cooperation.

Sincerely yours,

C. C. SQUIRES,
Merchandising & Research Dept.
Fletcher D. Richards, Inc., New York.

ARCHITECT SELECTED

George C. Sellon of Sacramento has been selected by the Sacramento Board of Education to draft plans for the new Riverview Park Grammar School in Sacramento.

ARCHITECT MOVES

The architectural offices of Arthur H. Memmler, Architect, have been moved to 6514 Raymond Street, Oakland, California, according to a recent announcement.

OPENS ARCHITECTURAL OFFICES IN SAN FRANCISCO

Henry V. Chescoe, Architect, has announced the opening of offices in the Hearst Building, San Francisco, for the general practice of Architecture.

BOOK REVIEWS PAMPHLETS AND CATALOGUES

ONE METAL ROOF For The Life Of Your Building.
International Nickel Company, Inc. 67 Wall
Street, New York 5, N. Y.

New illustrated, 24-page booklet to help architects and contractors, discusses the destructive effect of smoke, fumes and other corrosive agents common to industrial centers on roofs.

Material presented in non-technical language showing examples of many buildings. In the last section of the booklet, a fully illustrated description is given of Monel's adaptability to current architectural and roofing designs and practices.

PUBLIC HEALTH ENGINEERING, Vol. 1. By Earle B. Phelps. John Wiley & Sons, Inc. 440 Fourth Ave., New York 16, N. Y. Price \$7.50

Public Health Engineering, Vol 1., by Earle B. Phelps, Professor Emeritus of Sanitary Science at Columbus University and Professor of Sanitary Science at the University of Florida, was written primarily to teach municipal and civil engineers, in the light of present-day sanitary science, what to design and build and why in order to protect public health most effectively.

The book covers the entire field of environmental sanitation, with subject matter divided into two parts—a discussion of the air contact, broadly defined to include atmosphere pollution from smoke, odors and noise, ventilation, illumination and insect problems; and a discussion of the water contact, including the uses and abuses of water resources, stream sanitation, sewage treatment and conservation of water supplies.

Material included in the book is also of value to medical health officers.

CEILINGS UNLIMITED. The Miller Company, Meriden, Conn.

A revised edition of the book published in 1945-46 by the Miller Company which created considerable interest among architects, lighting engineers, electrical contractors, and commercial executives. It illustrates and describes in detail Miller Fluorescent Troffer Lighting Systems, and gives complete engineering and installation details, and illumination performance.

Shows examples of how architects and engineers have made use of the opportunity afforded them to create attractive ceiling designs by adopting the Miller method of combining lighting equipment. Copies available upon request.

VERMONT MARBLE COMPANY

Producers and Finishers
of
Domestic and Imported Marbles

525 MARKET STREET, SAN FRANCISCO
Phone SUtter 1-6747
3522 COUNCIL STREET
(Beverly Blvd. of Virgil Ave.)
LOS ANGELES 4, CALIF.
Telephone Fairfax 7834



The Most Complete Line of
STEELS and BUILDING MATERIALS
Made by a Single Corporation



See Sweet's Catalog File or write us for
full information.

REPUBLIC STEEL CORPORATION

GENERAL OFFICES: CLEVELAND, OHIO

DENVER, COLORADO CONTINENTAL OIL BUILDING
LOS ANGELES, CALIFORNIA EDISON BUILDING
SALT LAKE CITY, UTAH WALKER BANK BUILDING
SAN FRANCISCO, CALIFORNIA RIALTO BUILDING
SEATTLE, WASH. WHITE-HENRY-STUART BUILDING

PACIFIC MANUFACTURING CO.

High Class Interior Finish Quality
Millwork

16 Beale St., San Francisco
GARfield 1-7755
2215 El Camina Real, San Mateo
S. M. 5-0687
304 Bryant Street, Palo Alto
P. A. 3373
2610 The Alameda, Santa Clara
S. C. 607 (Factory)
6820 McKinley Avenue, Los Angeles
THornwall 4196
MAIN OFFICE — SANTA CLARA

"AMERICAN - MARSH" CONDENSATION UNIT

Pumping
Machinery
for
Every
Purpose

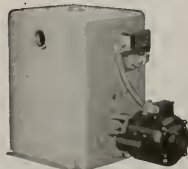

For Service
Call
DOuglas
2-6794
or
MUtual 8322

SIMONDS MACHINERY CO.

SAN FRANCISCO
816 FOLSOM

LOS ANGELES
455 EAST 4TH

Put this
"DEAD SPACE"
to work



Specify a
WESIX
CORNER CABINET
Electric Water Heater

There's extra space without extra square feet when you specify a Wesix corner cabinet electric water heater. Here's how it economizes on floor area, offers more work surface in kitchen and saves water heating cost.

1. Utilizes "dead space" in kitchen corner.
2. Top of heater offers additional work surface.
3. Eliminates need of closet or recess to house heater.
4. Ideal for homes without basement.
5. Saves water heating dollars. Requires shorter pipe run for hot water delivery to taps.

Range, washing machine or movable cabinets should be placed on one side of water heater to provide accessibility, 30" and capacity. Approx. 36" high, 30" wide, 25" deep. Extra heavy insulation keeps top cool. Available with double heating element. Also table top and round Wesix automatic electric water heaters.

Ask why - more buy

WESIX

For full information Write Department AE

WESIX ELECTRIC HEATER CO.

290 First Street - San Francisco 5

TELEPHONE

The Pacific Telephone and Telegraph Company has awarded a \$125,000 contract to Wm. D. Rapp of Santa Rosa (California) for the construction of a Telephone Exchange Building at Fort Bragg.

NEW WALL TYPE CONVECTOR

A new Wall Panel Type Convector for steam or hot water that sends a diffused warm current of air upwards over a large area has been announced by the REMPE CO., of Chicago.

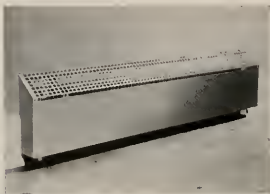

Requiring a minimum of space, it is easily installed and permits persons to work close to windows in comfort. Two steel tube circuits pass through fins giving maximum heat transfer to full area of 3" wide by 6" high fins. Made in sizes from 18" to 116" in length; height 8", and depth 3".

SCHOOL CONTRACT

Nomellini Construction Company of Lodi (California) has been awarded a \$392,718 contract for the construction of a Parochial School and Convent in Stockton. Blanchard & Maher of San Francisco are the architects.

SEWAGE PLANT

The Franceschi Construction Company of Fresno (California) has been awarded a \$739,503 contract for the construction of a sewage treatment plant at San Lorenzo

in Alameda County for the Oro Loma Sanitary District. Work will be of reinforced concrete construction.

AIRPORT

Monterey (California) will spend \$200,000 for construction of administration buildings at the municipal airport in the near future. Robert R. Jones, Carmel, is the architect.

BUS DEPOT. Henry G. Mercer contractor, has been awarded a \$40,000 contract for the construction of a bus depot and restaurant at Ukiah, California.

● sound control surveys made without obligation

Gold Bond
SOUND CONTROL PRODUCTS
Made by National Gypsum Company

SOUND CONDITIONING FOR:
SCHOOLS . OFFICES
AUDITORIUMS . HOTELS
RESTAURANTS . THEATRES
HOSPITALS . FACTORIES

Whether your problem is the elimination of noise or the scientific acoustical treatment of interiors to provide better hearing conditions, we can recommend the type of installation and materials best suited for the job. A phone call will arrange a consultation at your convenience without cost or obligation.

VAN ARSDALE-HARRIS CO.
ENGINEERS & CONTRACTORS
Distributors
595 Fifth Street
San Francisco
EXbrook 2-4404

Yes, CABOT'S STAINS
Give Natural Beauty
To any design in any site

Colors that Stay True
A Superior Wood Preserver
Cost 1/3 as much as good paint

GUNN CARLE & CO
20 POTRERO AVENUE • SAN FRANCISCO, CALIF.

MULLEN MFG. COMPANY

BANK, STORE AND OFFICE
FIXTURES—CABINET WORK
OF GUARANTEED QUALITY
CHURCH SEATING

Office and Factory
40-80 RAUSCH ST., Bet. 7th and 8th Sts.
San Francisco
Telephone UNderhill 1-5815

IN THE NEWS

COMMUNITY HOSPITAL

Bonds have been approved for the construction of a 100-bed Peninsula Community Hospital in Hillsborough (California) at a cost of \$2,950,000. D. D. Stone & Lou Mulloy of San Francisco are the architects.

NEW CHROMALOX ELECTRIC RECESSED WALL HEATER

High efficiency, attractive appearance and quiet operation are all features of this new Chromalox electric recessed wall heater manufactured by the Edwin L. Wiegand Company of Pittsburgh, Pa.



Equipped with built-in thermostat, pressure type fan with long life ball bearing motor, the heater is available in 2, 3, 4 and 5 kw. for 236-volt a.c. operation. It is finished in smooth silver gray hamertone, or in neutral prime coat.

MARKET BUILDING

Work has started on a \$240,000 new market building in Burlingame (California) to be occupied by Lucky Stores Inc. Thomsen & Wilson of San Francisco are the architects.

BONDS have been approved for the construction of a new \$580,000 county court house and jail building at Ukiah (California). C. A. Caulkins of Santa Rosa is the architect.

DINWIDDIE CONSTRUCTION COMPANY

•
BUILDERS
•

CROCKER BUILDING
SAN FRANCISCO

THE TORMEY COMPANY

GENERAL PAINTERS
AND DECORATORS

Phone UNderhill 1-1913

563 FULTON STREET
San Francisco



HERRICK IRON WORKS

STRUCTURAL STEEL
REINFORCING STEEL

18TH AND CAMPBELL STS.
OAKLAND, CALIF.
Phone GLencourt 1-1767

Subscribe
Now —

**ARCHITECT
and
ENGINEER**

\$3.00
Per Year

Phone GARfield 1-1164

Thomas B. Hunter

DESIGNER OF HEATING

AIR CONDITIONING
VENTILATING AND WIRING
SYSTEMS, MECHANICAL
AND ELECTRICAL EQUIP-
MENT OF BUILDINGS

★

41 SUTTER STREET
ROOM 710

San Francisco

California

Scott Company

HEATING • PLUMBING
REFRIGERATION

★

San Francisco
Oakland
San Jose
Los Angeles

Fine
ENGRAVINGS



**POOR
RICHARD**
PHOTO ENGRAVING CO.
320-324 COMMERCIAL STREET
SAN FRANCISCO, CALIF.

PITTSBURGH TESTING LABORATORY

ENGINEERS AND CHEMISTS

Testing and Inspection of Concrete,
Steel and Other Structural Materials

Design of Concrete Mixes

Offices in all principal cities

651 Howard St., San Francisco 5
EXbrook 2-1747

Matlock Construction Company

Builders



604 MISSION STREET
SAN FRANCISCO

Brownskin
VAPORSEAL

The resilient building paper creped to S-T-R-E-T-C-H

Quality Products Since 1895

ANGIER PACIFIC CORPORATION
55 NEW MONTGOMERY ST. SAN FRANCISCO 5, CALIF. 7424 SUMMIT BOULEVARD, LOS ANGELES 46, CALIF.
A complete line of Angier products available from your building material dealer.

STATIONERY SCHOOL & OFFICE SUPPLIES

Printing Engraving
Announcements

CENTER STATIONERY

468 McAllister

San Francisco UN 1-3703

Index to Advertisers

ANGIER Pacific Corp.....	46
ARCHITECTURAL Porcelain Constructors	27
ARCHITECTS Reports	38
BASALT Rock Company.....	Back Cover
BAXTER & Company, J. H.	34
CLASSIFIED Advertising	41
CENTER Stationery	46
CLINTON Construction Company.....	42
CONTINENTAL Water Heater Co.....	*
DETROIT Steel Products Co.....	1
DINWIDDIE Construction Co.....	45
DUFFY Tile Co.	46
FORDERER Cornice Works	38
FOX Tile Company.....	42
FULLER, W. P. Company.....	*
GLADDING, McBean & Company	2
GUNN, Carle & Company.....	44
HANKS, Inc., Abbott A.	46
HAWS Drinking Faucet Company	32
HERRICK Iron Works	45
HOGAN Lumber Company.....	42
HUNT, Robert W., Company	46
HUNTER, Thos. B.	45
JOHNSON, S. T. Company.....	*
JUDSON, Pacific-Murphy Corp.....	38
KRAFTILE Company	29
MARBLE Institute of America	*
MATTOCK, A. F., Company.....	46
MICHEL & Pfeffer Iron Works	Inside Front Cover
MULLEN Mfg. Company	45
MUELLER Brass Company	*
NORTHERN California Electric Bureau	33
PACIFIC Coast Gas Association	*
PACIFIC Manufacturing Company	43
PACIFIC Portland Cement Company	*
PACIFIC Telephone & Telegraph Co.	31
PITTSBURGH Testing Laboratory.....	46
POOR Richard Engraving Company	45
REMILLARD-Dandini Company	46
REPUBLIC Steel Corporation.....	43
SCOTT Company	45
SECURITY Valve Company.....	30
SIMONDS Machinery Company.....	43
SIMPSON Logging Company.....	5
SISALKRAFT Company	42
SMOOT-Holman Company	35
SOULE Steel Company	37
STANLEY Works, The	*
SUPERIOR Fireplace Company.....	*
TAYLOR Company, Halsey W.....	36
TORMEY Company, The	45
U. S. BONDS	Inside Back Cover
VAN ARSDALE-Harris Company.....	44
VERMONT Marble Company	43
WESIX Company	44
WESTERN Asbestos Company	*
WOOD, E. K., Lumber Company.....	34

*Indicates Alternate Months

ABBOT A. HANKS, INC. Engineers & Chemists

INSPECTING — TESTING — CONSULTING
CONCRETE • STEEL • MATERIALS
CHEMICAL AND TESTING
LABORATORIES
• RESEARCH AND INVESTIGATION •

TESTS OF STRUCTURAL MATERIALS
DESIGN OF CONCRETE MIXES
SHOP AND ERECTION INSPECTION OF
STRUCTURES AND EQUIPMENT
INVESTIGATION OF STRUCTURES
AND MATERIALS
TESTS AND INVESTIGATION OF
FOUNDATION SOILS
FIRE RESISTANCE AND INSULATION
TESTS

624 Sacramento Street, San Francisco

Robert W. Hunt Company ENGINEERS

Inspection - Tests - Consultation
Schools and Other Structures
Are Built as Designed

When Construction Materials are
Inspected at point of Manufacture
and during Erection by

ROBERT W. HUNT COMPANY

Cement, Concrete, Chemical, Metallurgical,
X-Ray and Physical Laboratories

Chicago - New York - Pittsburgh
Los Angeles - All Large Cities
San Francisco, 251 Kearny Street

REMILLARD-DANDINI Co.

Brick and
Masonry Products



400 MONTGOMERY STREET
SAN FRANCISCO, CALIF.

TILE CONTRACTORS

Shower Doors, Tub Enclosures
Medicine Cabinets

INSTALLATIONS OF EVERY
DESCRIPTION

Modernizing - Repairing

DUFFY TILE CO.

253 Minna St., S. F. YUkon 6-1489

ARCHITECT and ENGINEER

INDEX TO ARTICLES AND ILLUSTRATIONS

Volumes 172-175, 1948

A

A.I.A. Legislative Activities	April 30
Airplane Flying Field, Model Proposed (Ralph Jones)	Feb. 12
Airport, Los Angeles Municipal, Landscape Development	Aug. 10
Apartments, Stuyvesant Town, New York City	Aug. 27
Architects in Montreal (Wm. A. Newman)	April 17
Art Gallery and Botanical Gardens, Montreal	April 25

B

Bank Bldg., Anglo Calif. National Bank, Oakland, H. H. Winner	Oct. 19
Bank Bldg., Metropolitan Federal Savings & Loan Assn., Los Angeles (Stiles Clement) Leonard E. Miller	Sept. 16

C

Camera, A Sometimes Thing (Douglas Baylis)	Aug. 7
Church, First, Christ, Scientist, Montreal (B. E. Muller)	April 22
City Planning:	
China Town, San Francisco, Re-development (Michael Goodman)	June 19
Rebirth of Darwin, Australia	Aug. 18
City Streets and Transportation (Carl J. Rutland)	Sept. 26
Planning the Larger Community (Carl W. Hogg)	Oct. 9
Planning the Smaller Community (W. H. Hall)	Nov. 14
Competition Winners, Institute of American Decorators	Feb. 8
Construction Outlook for 1949 (Dwight W. Winkelman)	Dec. 10
Concrete Construction Lightweight	Nov. 15
Convention, California Council of Architects, Yosemite	Sept. 20
Convention, Structural Engineers Assn. of Calif.	Nov. 17
Cool Colors, Warm Colors	April 11
Creative Rebellion Under Five Dollars (Dr. M. F. Agha)	Mar. 11

E

Engineering Phases of Construction (Jack Singleton)	Feb. 16
Earthquake Engineering Institute	Mar. 14

Engineering Principles in House Design	July 27
Exhibition, California School of Fine Arts	Mar. 9

F

Factory Bldg., Detroit Steel Products Co., Oakland (Alban Froberg)	Aug. 17
Factory Bldg., Western Calif. Fish Co., Oakland	Jan. 17
Funeral Home Burlingame (Richard M. Bates) (Eugene Burns)	April 13

G

Gardens, Two by Thos. D. Church	Mar. 13
Gardens in Future China Town (Albert Wilson)	July 29
Garden, Prize Winning, Marin County	Sept. Cover
Garden Show, California	June 14
Glass, Stained, Painting with Light (Judson Studios)	May 17

H

Health, Better, of Workers in Building Industry (Dr. W. E. Schweisheimer)	Sept. 15
Heating, Radiant, with Electricity (R. S. Tice)	May 14
Hospital, Doctors, San Francisco	Mar. 14
Hospital, Modern Medical Center, Tacoma (A. MacPherson)	June 30
Hospital, New Central Tuberculosis, Selah, Wash. (John W. Maloney)	Sept. 13
Hotel, Laurentian, Montreal	April 20
Housing, Pre-Fabricated in Britain (Joan Littlefield)	Mar. 16

L

Landscape Design (Osmundson Staley & Gibson)	April 9
Landscape Design Student Work, University of California	June 15
Landscape Development of Los Angeles Airport	Aug. 10
Locker Construction, New Design Inc.	Dec. 16

M

Mass Transportation and Terminals (Geo. S. Hill)..... Feb. 10

N

News & Comment on ArtJan.-Dec.
 Competition on International Design. Feb. 8
 Creative Ceramics (Patricia Coleman)..... July 12
 Exhibition, Calif. School of Fine Arts..... Mar. 9
 Ludington Collection, Abstract Art..... May 11
 Painting Toward Architecture Exhibit (The Miller Co.) June 11
 Spanish Masters of 20th Century Sept. 10

O

Office Bldg., Jas. Graham Mfg. Co., Oakland
 (Fredk. H. Reimers) Eugene Burns..... July 24
 Office Bldg., Paddock Eng. Co., Los Angeles (Edla Muir) Feb. 28
 Office Bldg., State Farm Insurance, Berkeley
 (Jas. W. Plachek) April 26
 Office Bldg., Sun Life Bldg., Montreal..... April 16
 "Overtime on Overtime," Application to Building Industry Dec. 24

P

Painting & Disinfection (Dr. W. E. Schwaisheimer)..... July 20
 Painting Toward Architecture (The Miller Co.)..... June 10
 Parking and Truck Loading (Theodore M. Matson)..... Dec. 8
 Power Station, Pacific Gas & Electric Co., San Francisco. Oct. Cover

R

Radio Station, KOMO, Seattle. May 24
 Reinhart, Aurelia, Alumnae Memorial House, Mills College
 (Clarence W. Mayhew)..... Nov. 13
 Residences:
 Adobe Entrance (Clarence F. Cullimore)..... Jan. 18
 Adobe, Modern (Clarence F. Cullimore)..... Feb. 20
 Adobe, Manuel Dominguez, Compton Jan. 23
 Adobe Ranch House, Carmel Valley Jan. 24
 Adobe, Kirk B. Johnson, Santa Barbara Jan. 26
 Adobe, San Ysidro, Santa Barbara. Jan. 27

Anna Young, Dutch Flat (Bilton White)..... Feb. 18
 Modern in Montreal..... April 21
 Mr. & Mrs. Wm. H. Burgess, Pasadena (Elmer Grey) June 28
 Mr. & Mrs. W. R. Heringer, Sacramento
 (W. R. Yelland)..... Nov. 18

S

Salem Oregon Branch, First National Bank of Portland
 (Pietro Belluschi) Dec. 12
 School, Specialized Construction, in Great Britain..... June 17
 School, National Teachers, Mexico City (Mario Pani)..... June 26
 School, Reinhart Memorial Alumnae House, Mills College..... Nov. 13
 Scotland's Housing Program (William Barrie Dickson)..... Dec. 18
 Seismic Probability Map of the United States
 (Franklin P. Ulrich)..... Sept. 14
 Severn River Bridge is Europe's Longest Suspension Span Dec. 17
 Shopping Center, Corte Madera (K. & P. Steinmetz)..... Jan. 12
 Store Bldg., Ah Fong Flower Shop, San Mateo
 (Oscar Thayer) Jan. 14
 Store Bldg., Peninsula Furniture Co., Millbrae
 (Oscar Thayer) Jan. 16
 Store Bldg., I. Magnin & Co., S. F. (Miller & Pflueger)..... Mar. 16
 Store Bldg., Diamond T. Truck Co., San Francisco
 (Irvin W. Goldstine)..... July 22
 Stuyvesant Town Development, New York City..... Aug. 27
 Swinerton & Walberg, 60th Anniversary..... Dec. 22

U

United Air Lines Terminal, Merced..... August Cover
 United Air Lines, Maintenance Base, S. F. Nov. 22
 Urban Redevelopment in San Francisco..... Jan. 11

V

Veterans Memorial Bldg., Eugene, Ore. (Percy D. Bentley)
 Arthur W. Priault..... Oct. 11

W

Water Supply, California, Adequate for Increased Population
 (Edw. Hyatt) Mar. 15

Main

