

The ARCHITECT & ENGINEER



JULY 1922

*Published in San Francisco
50 cents a copy - \$2⁵⁰ a year*

The world's
best ~ ~
made in the
West.

PACIFIC





THE ARCHITECT AND ENGINEER

CONTENTS FOR JULY, 1922

GARDEN AND DRIVE APPROACH, LITTLE BROOK FARM, LOS GATOS	<i>Frontispiece</i>
<i>Emerson Knight, Landscape Architect and Engineer</i>	
RECENT GARDENS IN SAN FRANCISCO AND ENVIRONS . . .	47
<i>Emerson Knight</i>	
AN ENGLISH VIEW OF THE DISADVANTAGES OF HIGH BUILDINGS	61
SIXTY-FOOT COLUMNS ECONOMICAL IN FIVE-STORY BUILDINGS	63
BUILDING FOR THEO. H. DAVIES & Co., HONOLULU, T. H. . .	65
<i>Irving F. Morrow</i>	
WAR UPON WOOD WASTE WAGED BY GOVERNMENT	86
BACK PLASTERED CONSTRUCTION	87
<i>Joseph Losekani</i>	
ARCHITECTURAL REGISTRATION BOARDS	95
WHY AN ARCHITECT?	98
A. I. A. CONVENTION	100
STREET ADVERTISING—AN ARCHITECT'S POINT OF VIEW . .	102
<i>Charles Cressey</i>	
EDITORIAL—THE STEP-BACK BUILDING	104
WITH THE ARCHITECTS	108
WITH THE ENGINEERS	112
THE CONTRACTOR	114

Published Monthly by

THE ARCHITECT AND ENGINEER, INC.

626-27 Foxcroft Building, San Francisco

W. J. L. Kierulff
President

Frederick W. Jones
Vice-President

L. B. Penhorwood
Secretary



GARDEN AND DRIVE APPROACH, LITTLE BROOK FARM, LOS GATOS
EMERSON KNIGHT LANDSCAPE ARCHITECT AND ENGINEER

THE ARCHITECT AND ENGINEER

*720.5
Ar 24⁷⁰
189749

JULY
1922



VOL. LXX.
NO. 1

Recent Gardens in San Francisco and Environs

By EMERSON KNIGHT, Landscape Architect and Engineer*



Ranch Home Garden of Mr. L. M. Kaye,
Los Altos
Emerson Knight, Landscape Architect

GOOD gardens, as the history of their art demonstrates, are not self created. They are conceived, constructed and planted by a good designer. The site, the exposure, topography and soil must all be considered as well as the relation of the garden area to the house and to the highway. A new home or a public building, though beautiful when the architect has finished his work, depends on the landscape architect and engineer to create its setting, a background for its architectural merit and charm, retaining its dignity and nobility and accenting its beauty, linking it naturally and intimately with its grounds. The garden designer must possess the discretion and sensitiveness to grasp the intention of the architect, must strive through patient study to understand both architect and owner.

San Francisco has a rugged climate quite unlike that of its surrounding counties and yet it is a healthful, beneficial one that wins many admirers, the city thus deserving careful individual attention in garden planning. A limited number of deciduous plants may be employed only in very sheltered situations and some conifers must be omitted because they are not adapted to our prevailing weather; still there is available a wide range of suitable splendid materials amongst the broadleaved evergreen trees and shrubs and quite a variety of conifers are both thrifty and handsome. Many annuals and perennials will do well if given reasonable protection and good effects may often be had through the wise choice

*704 Market Street, San Francisco.

of hardy groundcovers and vines. Wind and fog necessitate sturdy plant growth. In large private or public planting spaces, drouth resisting materials should be generously used, including California native varieties and vigorous exotics from Australia. Such interesting plants, well chosen and grouped, give to our Golden Gate, Buena Vista and other parks, also certain private gardens the natural virile character which renders them so attractive.

In the ideal country home belt extending from Burlingame into the heart of the Santa Cruz mountains, in the transbay cities together with their satellites and the numerous nestled towns of the north counties, a much wider range of both deciduous and evergreen plant life and tenderer flowers may be relied upon for effects of color, delicacy, fragrance and luxuriance.

All home gardens should possess, where space permits, inner or inclosed courts or patios for the exclusive use of the owners where privacy and quiet charm may be felt as their very essence, inviting moods of con-



POOL COURT, HOUSE OF MR. DON LEE, SAN FRANCISCO
Emerson Knight, Landscape Architect.

templation. High hedges may serve to screen service yards, outbuildings or undersirable neighborhood vistas or they may act as partition walls, separating a seclusive garden living space from a vegetable plot; also they may be used in pairs with a hidden passage between, leading from one cozy garden nook to another. Pergolas or arbors if covered by flowering or fruitful vines insure grateful shade on hot days. Let there be a tranquil pool to reflect the colors of the sky or one given over to lilies and aquatic life, or a bath for birds, but most essential in all livable gardens are comfortable seats in sheltered, sequestered sunwarmed locations. If there are children, they should be provided with distinct play areas where they may give free vent to all their energies. Small children may fittingly have recreation within easy reach of a mother's call on alluring plots of hardy grass, partly surrounded by strong shrubbery windbreaks.

Upon any piece of property which a client entrusts to the care of the landscape architect and engineer, the latter has one or more of four functions to perform:

When acreage or an estate includes virgin timber, natural streams, lakes or ponds, hills, valleys or picturesque rock formations or may command noble views, every phase or feature that can contribute to the ideal picture conceived by the landscape designer must be conserved. In some instances preservation alone is required yet pruning trees for vistas and skillful tree surgery are sometimes advisable.

Often a certain number of dead, defective or badly formed trees and shrubs are found on an estate or perhaps groups or specimens are so positioned that they cut off cherished or inspiring vistas. In all such cases even if some of the trees are healthy they should be removed to realize a more unified picture or a nobler prospect. Many owners become so attached to trees in general that they oppose cutting down any healthy ones even when the aim is for a finer effect in the future. Usually it takes courage on the part of the landscape designer to insist on the eliminations which he knows may ultimately win the owner's approval.

In the development of private gardens it frequently happens that the construction of collateral features will go on simultaneously with the erection of the residence and related buildings. Such features may include drives and walks, walls, terraces, steps and balustrades, fountains, rills and swimming pools, game and recreation areas, as well as belvederes and casinos. It is desirable and strongly advisable in such cases for the owner, architect and landscape designer to have early conferences on the ground so that the resulting work may be harmonious and coherent. Any home and its gardens should be cordially married and both should fit naturally into the surrounding country, free from discordant contrasts or ostentation.

Garden planting is the final process in creating a finished home picture. The landscape architect has not only colors at his disposal, similar to the landscape painter; he has also plant materials, varying greatly in form, size, texture and habit or personality. With the color of flowers and the bloom of trees and shrubs and a wealth of shades of green foliage contrasted with wood, stone, brick or concrete or with water, thinking always of pictures, each a part of the whole concept, he paints garden moods. But these are only the beginning of a fascinating evolution in plant life, the consummation of which may only be realized by a devoted owner and a sympathetic gardener, supported by the guidance of the designer in maintenance.

GARDEN PHOTOGRAPH ANALYSIS

In the garden of Mr. Don Lee in Presidio Terrace, San Francisco, the front portion includes robust plants, the larger forms of masculine habit to resist wind and weather and to conform to the architectural tone of the residence. In the protected sunny court at the rear, the larger plantings are also forceful yet contrasted by more delicate border and bulbous flowers, the placidity of the pool with its lilies and the simple flagging of Colorado white marble.

At the San Francisco National Training school, what seemed a hopeless middle space and backyard—a state of chaos and dull disorder, save for the one noble eucalyptus tree which was rescued with some difficulty—was transformed by means of concrete retaining walls and fills and a pergola which connects the two units of the school, at the same time making a division between the front garden and the rear sunken one with its bird bath, and by introducing brick walks, grass plots, hardy hedges and such other plants as would resist the draughts between the buildings.

At the home of Mr. Harry B. Allen in Sea Cliff, San Francisco, planted this Spring, the rich dignity of the architecture of Messrs. Bliss



COURT OF LILY POOL, HOUSE OF MR. DON LEE, SAN FRANCISCO, CALIFORNIA
HENRY C. SMITH, ARCHITECT EMERSON KNIGHT, LANDSCAPE ARCHITECT



HOUSE OF MR. DON LEE, SAN FRANCISCO, CALIFORNIA
H. C. SMITH, ARCHITECT EMERSON KNIGHT, LANDSCAPE ARCHITECT

Front Aspect of Garden Two Years After Planting

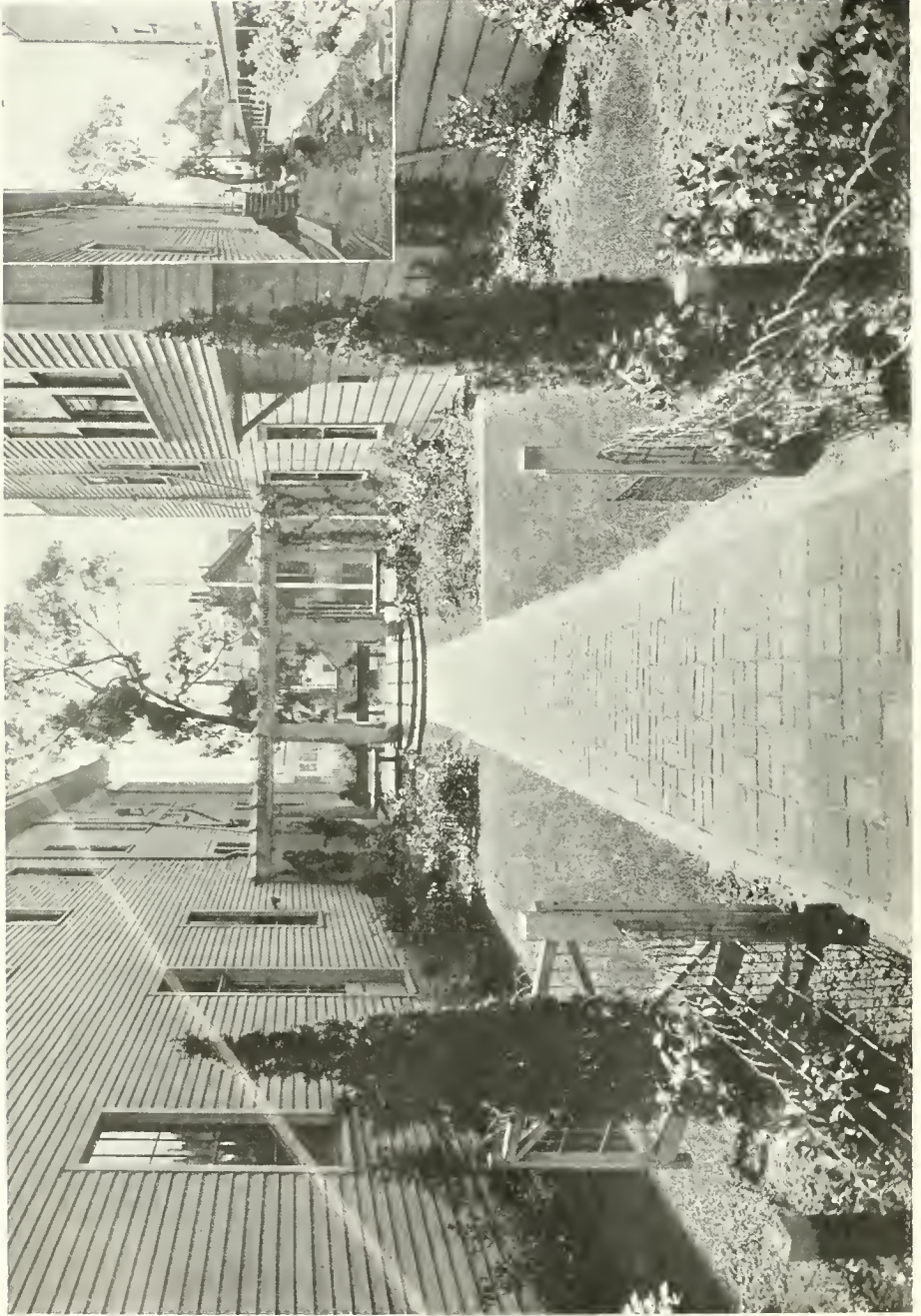

Insert Shows Same View Before Improvements Were Made.
GARDEN AND PERGOLA, NATIONAL TRAINING SCHOOL, SAN FRANCISCO
EMERSON KNIGHT
LANDSCAPE ARCHITECT AND ENGINEER

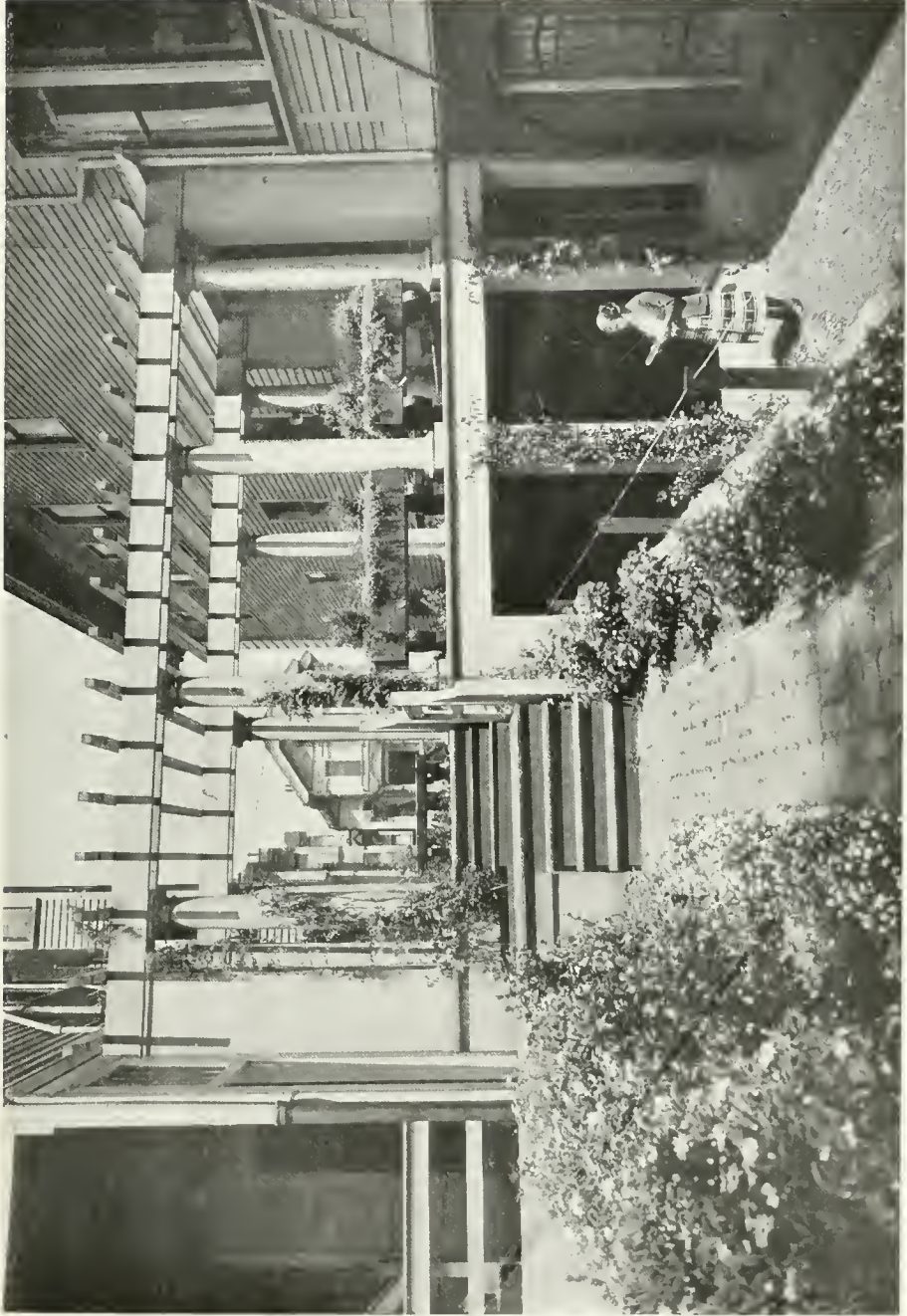

GARDEN AND PERGOLA, NATIONAL TRAINING SCHOOL, SAN FRANCISCO
LANDSCAPE ARCHITECT AND ENGINEER
EMERSON KNIGHT

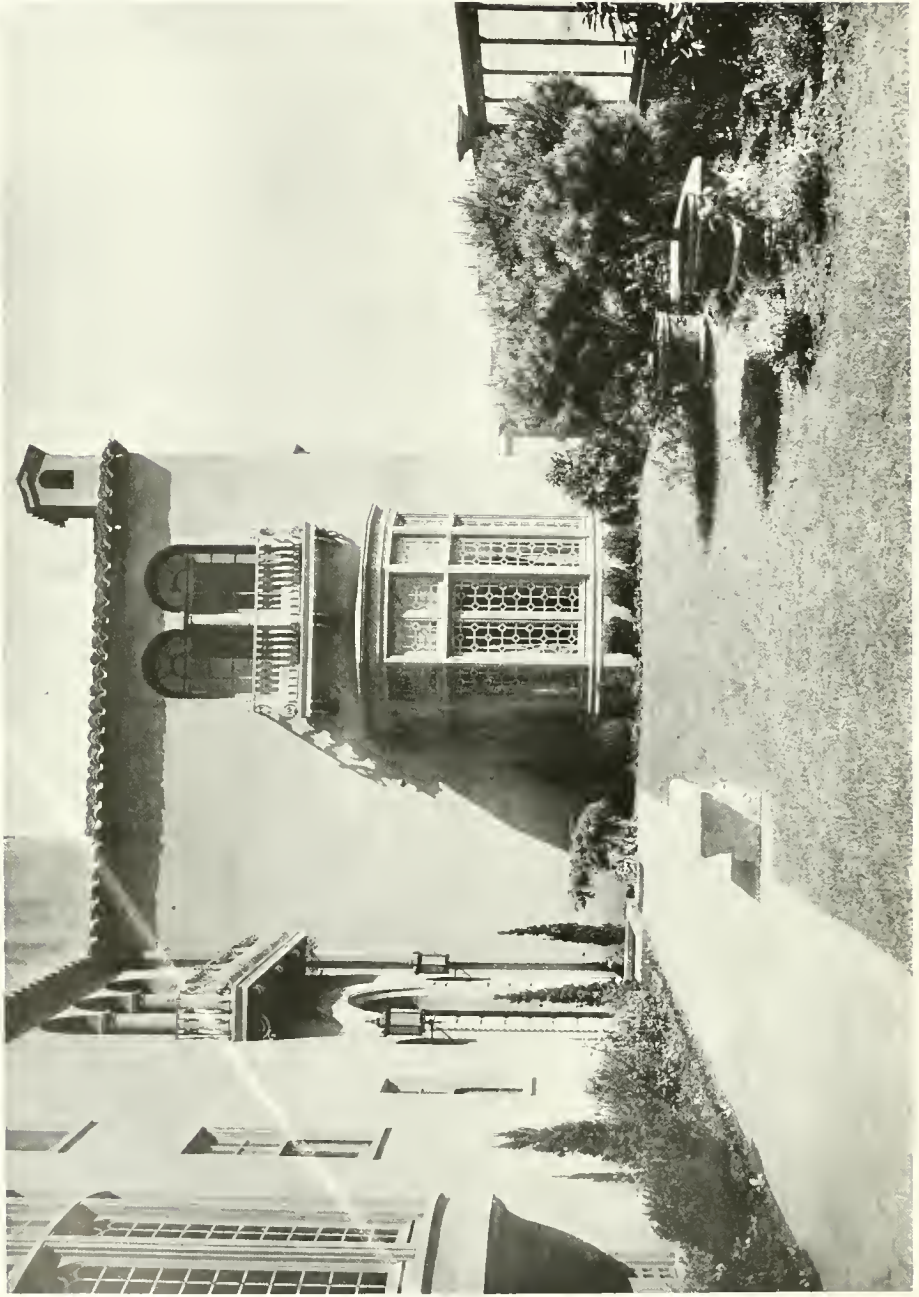

RESIDENCE OF MR. HARRY B. ALLEN, SEA CLIFF, SAN FRANCISCO, CALIFORNIA
BLISS & FAVILLE, ARCHITECTS EMERSON KNIGHT, LANDSCAPE ARCHITECT

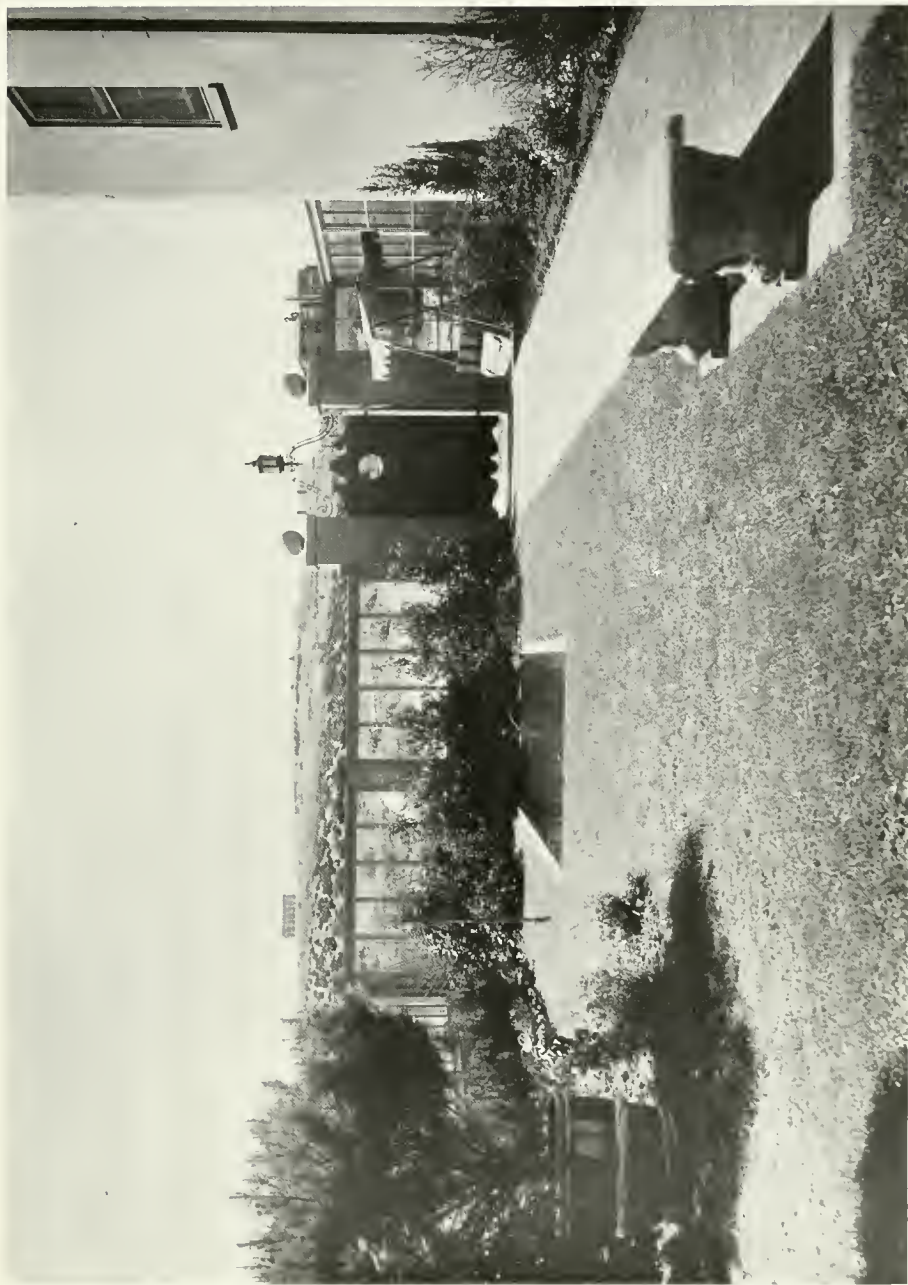

GARDEN, RESIDENCE OF MR. HARRY B. ALLEN, SAN FRANCISCO
EMERSON KNIGHT LANDSCAPE ARCHITECT AND ENGINEER



LILY POOL, HOUSE OF MR. DON LEE, SAN FRANCISCO
Emerson Knight, Landscape Architect



GARDEN HOUSE, RESIDENCE OF MR. F. H. HARRIS
Emerson Knight, Landscape Architect



RUBBLE STONE STAIRWAY, LITTLE BROOK FARM, LOS GATOS
EMERSON KNIGHT LANDSCAPE ARCHITECT AND ENGINEER

Insert on Right Shows Planting of Madrones Fully Developed



POOL AND TURNING COURT, LITTLE BROOK FARM, LOS GATOS
EMERSON KNIGHT LANDSCAPE ARCHITECT AND ENGINEER



FOOT ENTRANCE, LITTLE BROOK FARM, LOS GATOS
EMERSON KNIGHT LANDSCAPE ARCHITECT



Little Brook Farm, Los Gatos
Drive Flanked by Ornamental Plants



Little Brook Farm, Los Gatos
Planting Developed

& Faville has been sympathetically studied and shrubs and trees of aristocratic foliage and character have been largely used, set off by the grace of heathers, breath of heaven, roses, pansies and violas, and by the distinction of a pair of pines of a dwarf Japanese variety which stand as sentinels guarding a recess in the shrubbery with its curved seat. The two stone benches are of California travertine, carved with dolphins on the legs, sea horses on the end faces of the legs and shells at slab corners. They were designed jointly by Mrs. Harry B. Allen and the author. A special urn of terra cotta now contains the giant juniper *Pfitzeriana* of the prostrate form, at the terminus of the walk. An unusual feature of this garden-by-the-sea is its windbreak of clear glass with wood encasement and paneled base, over six feet in height and enclosing all of the garden boundary unprotected by the house.

Mr. Max M. Cohn's "Little Brook Farm," in the foothills of Los Gatos, is charmingly situated, half a mile above the highway on secluded triple knolls that command a superb panorama of the Santa Clara Valley. Between these heights flows a creek luxuriant with native growth and provided with hidden resting spots, and pools alive with fish. A barbecue oven stands convenient to the open platform built directly over the creek, and beneath the shade of alders, bays and willows, many a delicious meal is enjoyed to the music of running water or the wind voices in the trees. The stone from Los Gatos Creek, native to the locality plays an important role in the formation of rubble work in walls, steps, seats, parapets and platforms. A gate and six lamps are of wrought iron and original design and the latter thoroughly light the climb of eighty-one steps from the drive crossing at the creek to the house terrace. The axis of the stairs at the upper end is dominated by a fine madrone. Because of the devotion of a faithful Italian gardener, a wide variety of plants flourish here imparting a joyous abundance of color and fragrance, symbolizing a keen sense of beauty and order, a deep love for plants and generous hospitality on the part of the owners.

An English View of High Buildings

THE Town Planning Institute have had under consideration proposals which have been made in reference to the height of buildings in London, the relaxation of restrictions on such height, as at present administered by the London County Council. Particular attention has been given to the experience gained in regard to this subject in American cities, where the greatest use has been made of unrestricted opportunities to erect high buildings, both for residential and commercial purposes, and some notes upon this experience are attached.

It may be remarked that the agitation in London for the relaxation of restriction on the heights of buildings comes at a time when a number of American cities have found it necessary to impose, and many others contemplate imposing, restrictions as drastic as possible in view of the has already been permitted. Anybody who knows the objection of the American citizen to any regulations limiting his freedom to build as he likes will realize how generally recognized and how serious must have been the evils springing from the absence of such restrictions before their adoption could have been carried by general consent. It must be recognized moreover, that in the majority of American cities the conditions are such that the evils arising from excessively high buildings are much less apparent than they would be in London; the streets and the footways are generally wider and capable of dealing with a greater volume of traffic and the atmosphere is clearer. On Manhattan Island, which forms the central area of New York, there are eleven "avenues" running from one end of the Island to the other, each 100 feet wide, and the latitude of the city is the same as that of Rome or Constantinople, so that the sun attains a higher average altitude, and consequently its rays have greater opportunity to penetrate into narrow streets or spaces; there is also greater intensity of light.

The Town Planning Institute have arrived at the following general conclusions on the matter:

(1) In considering restrictions on the height of buildings in London, full account should be taken of the climatic conditions there prevalent, of the winter height of the sun, the general intensity of light, the prevalence of mist, and the humidity of the atmosphere. They should also be considered in reference to the general width and direction of existing streets; to the policy that is likely to be adopted in the future in regard to the development of Greater London and its outer regional area; to the existing congestion of traffic, and to the practicability of providing increased transport facilities; and, in particular, regard should be had to the effect of any proposals on the general health and well-being of the occupants and users of the buildings, and the convenience of the public generally.

(2) It is clear that an increase in the height of buildings must add to any existing congestion of traffic and must throw a greater strain upon all public services. The volume both of pedestrian and vehicular traffic must be greater, and the capacity of drainage, water supply, and other conduits may need to be increased, as well as the public transport services, both for passengers and goods.

(3) Experience shows that it is extremely difficult to secure adequate circulation of air and sufficient light to the lower rooms where high buildings are adopted. It is common experience that in American cities a vastly greater proportion of rooms, both those in tenement dwellings and those in business premises, require artificial light to be burned

throughout the day than is the case in London. So important is this effect in America that frequently a high building standing alone and benefiting by the light over the area of adjacent property is so seriously depreciated in value when the adjacent owners also increase the height of their buildings that the rent received falls to little more than enough to pay the local rates.

(4) It is by no means clear that the concentration of increasing volumes of retail trade in a few centralized establishments, or the concentration of general commerce on more restricted areas, which is the chief reason for the demand for increased height of buildings, is itself generally desirable in the public interest. In a city like New York, where the central area consists of an island surrounded by wide rivers, reasons of economic necessity may exist which are quite absent in the case of most towns, like London, where there is an unlimited area over which expansion can take place; and in view of the serious disadvantages arising from development by increased height, it is considered that some overwhelming public advantage and not merely a benefit to a limited number of prosperous businesses would need to be established to justify the relaxation of existing regulations, and the institute are of opinion that no such general public advantage has been established.

(5) It is, of course, recognized that there may be situations so advantageously placed as regards open space about them, and so well served by existing roads and other services, that in these cases a reasonable increase of height might be permitted without public disadvantage. The institute are of opinion, however, that it is not possible to provide for anything further than the existing discretionary powers of the London County Council without incurring great danger, unless and until a comprehensive plan for dealing with building development and traffic problems throughout the whole of London is prepared; and that any such exceptional increase should then only be allowed in the case of specific sites fixed upon such a plan, agreed with owners, generally conforming with the requirements of comprehensive planning, and subject to special rating to compensate upon all public services.

The Institute therefore recommended:

(1) That no relaxation at present be made in the regulations dealing with the height of buildings.

(2) That so soon as the form of the future government of Greater London, now under consideration, has been determined, a development plan of the whole of the area should be prepared, and zoning regulations on the lines of those recently enacted for the city of New York, but adapted to the special conditions prevailing in London, should be framed and given effect to. These regulations would deal with the height, density, use and character of buildings generally, and the zoning plan could provide for those exceptional sites, if any, where some increase of the general limit of height could wisely be permitted.

Consideration has been given to the conditions in American towns where an unrestricted limitation as to height has obtained, and more particularly to the report which has recently been made in New York by a commission charged with the duty of investigating existing conditions and of drafting regulations as to restrictions. The committee consisted of representatives of the different boroughs, who were assisted by a technical staff. The final report of this commission was submitted on December 23, 1913, and, after holding a series of public hearings resulting in certain modifications, was finally approved in the year 1916.

In considering this report in its reference to the requirements of London, the Town Planning Institute have had in mind the peculiar conditions of New York as regards its wider streets and intenser light. The subsoil of London for the foundations of high buildings is in no way so suitable as is the solid rock upon which the city of New York rests, and not only is the question of cost of foundation one to be considered in the erection of such heavy buildings, but there is also the question of interference with existing drainage schemes and disturbance to buildings on adjacent sites.

Even having regard to these natural advantages for the erection of high buildings in New York, the report referred to states that: "There is an intimate and necessary relation between conservation of property values as here proposed and the conservation of public health, safety and general welfare; throughout the city the areas in which values have been depressed by the invasion of inappropriate uses or lack of building control as to height, courts and open spaces, are the areas in which the worst conditions as to sanitation and safety prevail and where there is the greatest violation of the things essential to public comfort, convenience and order."

Another point that is brought out in the report is that, after high buildings are erected in sufficient number so as to prevent adequate light and air being obtained for each building, they do not pay.

One of the elements which prevent high buildings from paying is the great cost of providing lifts and the great area of the most valuable floor space taken up by the lift service. It is claimed by authorities that it takes three times the lift capacity in car mileage for the second flight of ten stories as for the first flight of ten stories.—Abstract from the Surveyor, London, in *Engineering and Contracting*.

Sixty-Foot Columns Economical in 5-Story Buildings

In all office building construction, a saving in the time of erection always means a direct saving in the cost of the building, for the floor space is rented sooner and a return on the money invested is obtained. For this reason, anything that can be done to speed up the erection of the frame of a building will be found to be economical.

This was found to be the case in the erection of a five-story steel frame office building at Santa Rosa. Here the time of erection was shortened by using columns sixty feet long. The columns were made strong enough to carry the load above the first floor and erected as one unit. The first-story column had to be of considerable heavier section, but from the second floor to the roof, the column was erected in one piece,

It was found that the saving in splice plates and rivets and the shop work saved by the elimination of the splices more than made up for the extra material required to give sufficient area at the lower end of the column. Another item of delay eliminated was the necessity for repeated raising of the derricks as is the ordinary procedure when erecting two stories at a time. It was unnecessary also to plank entire bays for riveting.



ARCADE, BUILDING FOR THEO. H. DAVIES & CO., LTD., HONOLULU, T. H.
LOUIS CHRISTIAN MULLGART, ARCHITECT

Building for Theo. H. Davies & Co., Honolulu, T. H.

By IRVING F. MORROW*

HONOLULU may consider itself favored in the possession of a building of genuine importance. As far back as December, 1917, The Architect and Engineer printed a series of striking drawings by Mr. Louis Christian Mullgardt, Architect, showing various aspects of a proposed Commercial Center for the island city. The first of these buildings to be undertaken (in fact, the only one undertaken to date) was the building for Messrs. Theo. H. Davies & Co., Ltd. A selection of working drawings of this building, as well as photographs of a one-quarter inch scale plaster model, was presented in The Architect and Engineer of March, 1920, along with a brief account of some of the considerations which had influenced the building's conception and working out. The structure now stands completed and occupied, and even at the risk of a certain amount of repetition it will probably be worth while to run over some of the more important matters involved.



DESIGN FOR BANK OF BISHOP & CO., HONOLULU, T. H.
Louis Christian Mullgardt, Architect.

Messrs. Theo. H. Davies & Co., Ltd., conduct a wholesale business in dry goods, hardware and groceries. This building houses their entire activities, embracing warehouse, shipping, executive and accounting offices. It is four stories in height over the entire block bounded by Bishop, Merchant, Alakea and Queen streets.

The construction is fireproof throughout. It consists of a reinforced concrete frame with mushroom columns and slab floors. The structure was designed by Mr. R. S. Chew, Engineer. The finished floors are of puddled mosaic, except in the warehouse departments, where they are of cement made with crushed black rock (the island sand is coral sand, too soft for such use). The exterior walls are faced with terra cotta. The interior walls of the arcades are cement of a Pompeian red color. This cement, as well as that on the elaborate and amusing roof houses, is treated with a field of combed texture, with edges and corners of smooth finish. All doors and window sash are metal, and all glass is wire glass of Florentine pattern. Everything about the building, from its largest to its smallest aspects, has been handled with a view to stability and permanence, in fact as well as in expression.

*Architect. Member of the firm of Morrow & Garren, Architects.

Anyone conversant with Mr. Mullgardt's work will be prepared for innovations in policy as well as in the more superficial phases of aspect. In fact, the virtue or justification of Mr. Mullgardt's originality has always been that novelty of aspect has never stood as an erratic or irresponsible end in itself, but has been a growth out of an unprejudiced reconsideration of essentials of policy, developed under the play of an active fancy and disciplined by a sensitive taste. At several points he



ELEVATOR HOUSE ON ROOF. BUILDING FOR THEO. H. DAVIES & CO.
Louis Christian Mullgardt, Architect

has diverged from current commercial practice in this building, and considers that results have justified the course adopted.

Two innovations which will seem incomprehensible to the orthodox are the elimination of basement and of sprinkler system. In explaining Mr. Mullgardt's attitude on the policy involved here I can perhaps do no better than to quote what I wrote in the article accompanying the

working drawings and model of the building in the issue of March, 1920, as this was but a paraphrase and condensation of Mr. Mullgardt's own words:

"At several points the building makes departures from the current practice in commercial structures. For instance, in the matter of a basement. Construction above ground is less expensive than that below and increases the visible mass and impressiveness of the building as well. Furthermore, space underground is less valuable than space above by



UPPER STORY ON COURT, BUILDING FOR THEO H. DAVIES & CO.
Louis Christian Mullgardt, Architect

reason of the lack of natural light and air. Provided, therefore, that there are contemplated no unusual loads which would necessitate excessive floor construction, a story added to the building above ground has every advantage over one placed below. In this particular case the height of the water level with reference to that of the ground would have rendered waterproofing an expensive undertaking. These considerations have all led to the entire elimination of basement. Elevator-machinery, etc., is placed on the roof."

"Mention might also be made of the problems arising out of the protection and the insurance of stock. Such buildings are commonly equipped with elaborate automatic sprinkler systems as a safeguard against fire. But whatever utility may be credited to a sprinkler system, these several positive objections and disadvantages were charged against it. The expense of installation is large. Because of its depth below the structural members of the ceiling, the height of the building must be increased if the amount of clearance is not to be diminished, and this adds to the cost of construction. If the sprinkler system is not to remain entirely exposed, all ceilings must be furred down under it, adding another considerable item of expense. Under the best of conditions it is unsightly. Finally, being automatic, there is the insurmountable risk of



ROOF HOUSES, BUILDING FOR THEO. H. DAVIES & CO., LTD., HONOLULU, T. H.
Louis Christian Mullgardt, Architect

Cordova tile manufactured and erected by Gladding, McBean & Co., San Francisco.

its working at the wrong time or failing to work at the right time. The inadvertent injury of a sprinkler head may lead to substantial damage by water; or even a trivial fire may be attended by extensive water loss; while a real fire, by reason of special conditions of draught, etc., may develop to considerable proportions, before fusing any of the sprinkler heads in a high ceiling. It would seem, on the other hand, that the ideal precaution against fire would consist, first, of a system of enunciators placed in and among the articles endangered; and second, in the division of the building both horizontally and vertically into a number of fire resisting compartments each of moderate extent, in any one of which a conflagration could be localized and handled by means of hose and stand-pipe. The expense of necessary apparatus and structure would be slight. Furthermore, barring some general calamity, it is unreasonable to sup-

pose that fire would break out in more than one compartment, or at most two or three simultaneously; for which reason insurance on stock might be materially reduced. This matter was given thorough consideration, and the owners were convinced that, even in the face of the increased insurance rates imposed by the underwriters in the absence of a sprinkling system, the latter method of fire protection offers a substantial saving as compared with the outlay for a sprinkler system and the increased construction necessitated by it, without any increase in risk."

The question of the terra cotta is one to which Mr. Mullgardt rightly attaches considerable importance. It is a curious fact—perhaps not so curious after all when one considers psychological tendencies, but none the less a fact—that marked technical advances ultimately conspire to



ROOF HOUSES, BUILDING FOR THEO. H. DAVIES & CO., LTD., HONOLULU, T. H.
Louis Christian Mullgardt, Architect

Cordova tile manufactured and erected by Gladding, McBean & Co., San Francisco.

obliterate the logical limits inherent in the medium or process involved. When mind and hand fall into a routine, execution absorbs attention and energy at the expense of the informing spirit. Much art of primitive periods which is technically uncouth is recognized as vital, while periods of decadence are not uncommonly characterized by high degrees of dexterity. In the past third of a century or so the American terra cotta industry has made enormous progress on its technical side, but on the whole it may be asserted that the principal use designers have made of their increased opportunities is to invade the province of other materials. Now to imitate stone so closely that one is for a moment deceived may be a clever trick of virtuosity, but it has little significance as art. In making a deliberate break with this subversive tendency Mr. Mullgardt

has rendered a real service to terra cotta. His design really derives its quality from the characteristics of its material. Long straight lines and large flat surfaces have been avoided in deference to a material which naturally warps and twists to a certain degree in its manufacture. There has been no attempt at exactness in joints. Grinding has not been resorted to; instead, the glaze returns over the edge into the joint, and the mortar, varying roughly from a half to three-quarters of an inch in thickness, has been raked rather deeply. Several of the detailed photographs show very clearly the character of this work, as the general views

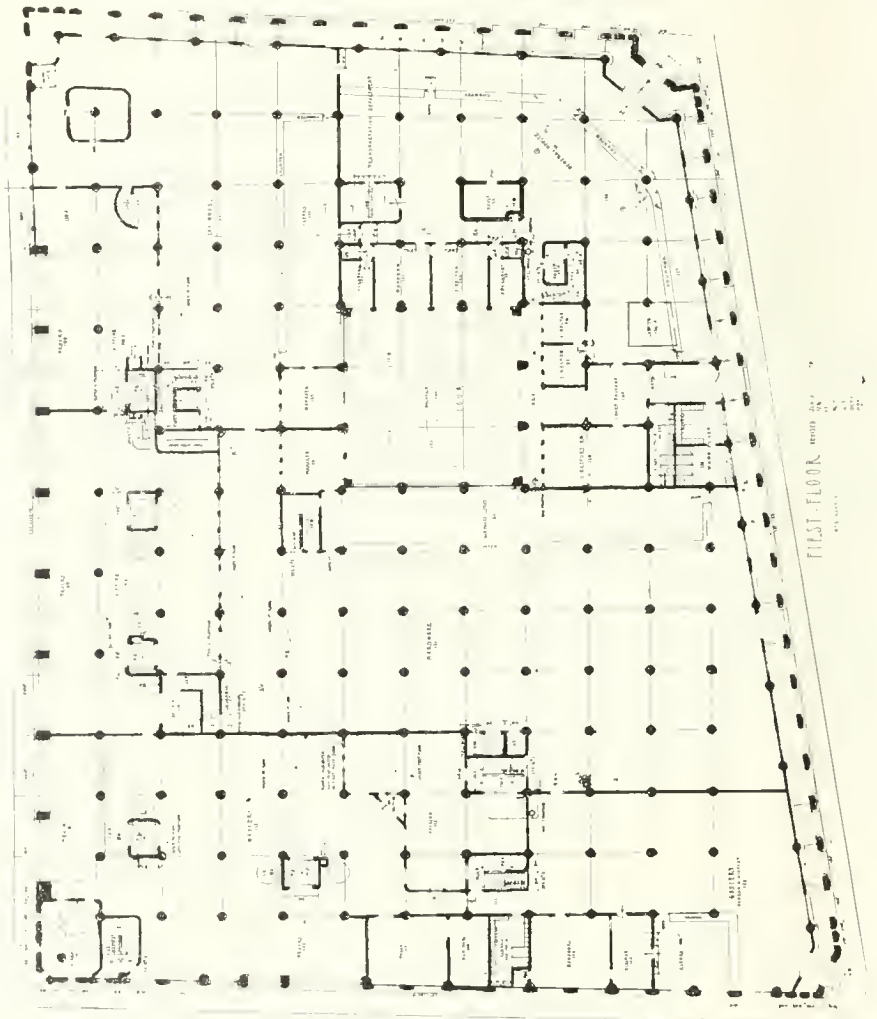

PLAN OF FIRST FLOOR, BUILDING FOR THEO. H. DAVIES & CO., LTD.
Louis Christian Mullzardt, Architect

suggest its quality. Only the color is not here evident. This is of a prevalently brownish tone, continually changing, and varied with greenish tints. The brilliant tropical light has called for a value much deeper than that commonly used in terra cotta, but it avoids the somberness often felt in brick structures. The surface is a dull enamel finish.

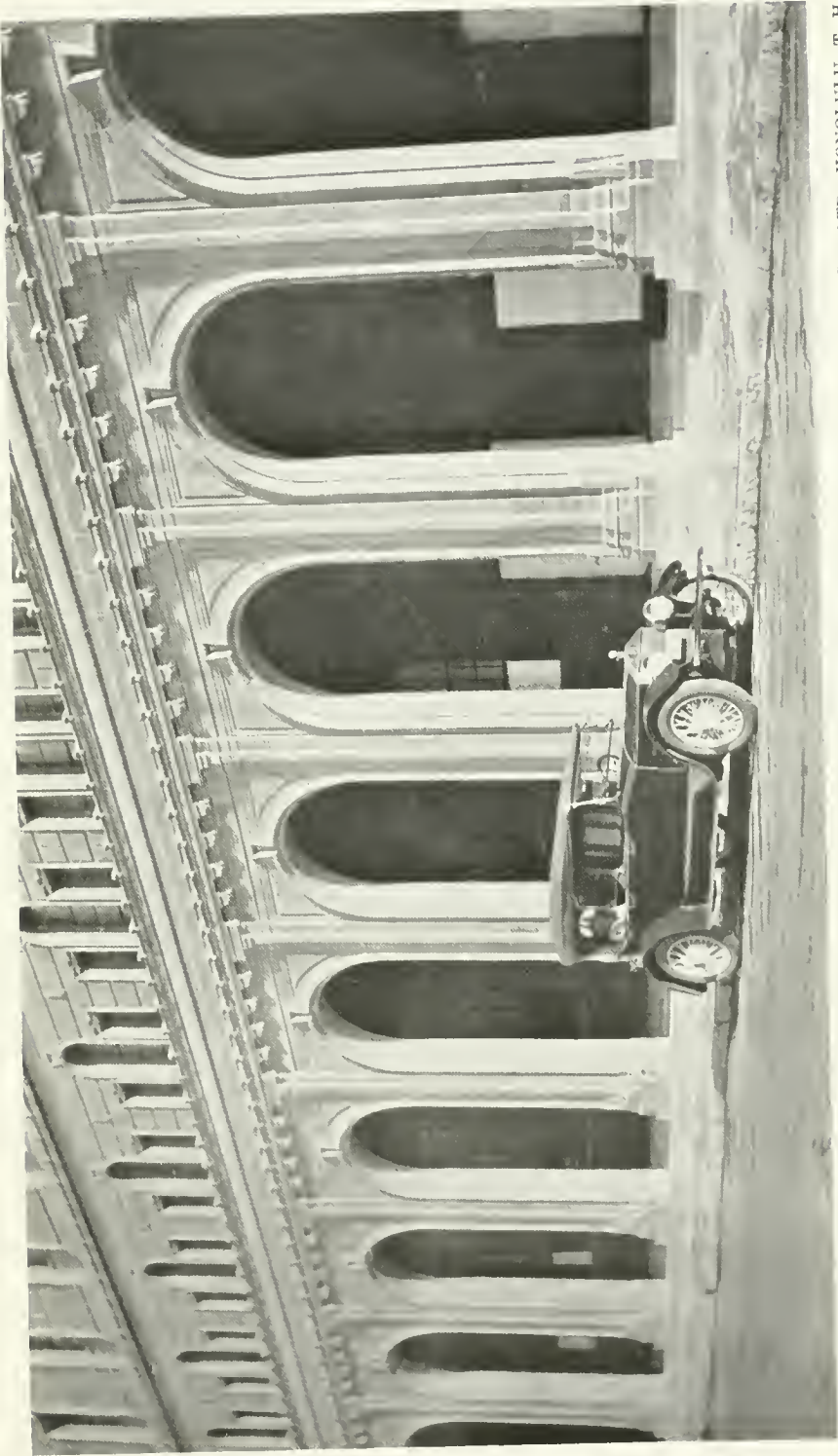

ARCADE, BUILDING FOR THEO. H. DAVIES & CO., LTD., HONOLULU, T. H.
LOUIS CHRISTIAN MULLGARDT, ARCHITECT

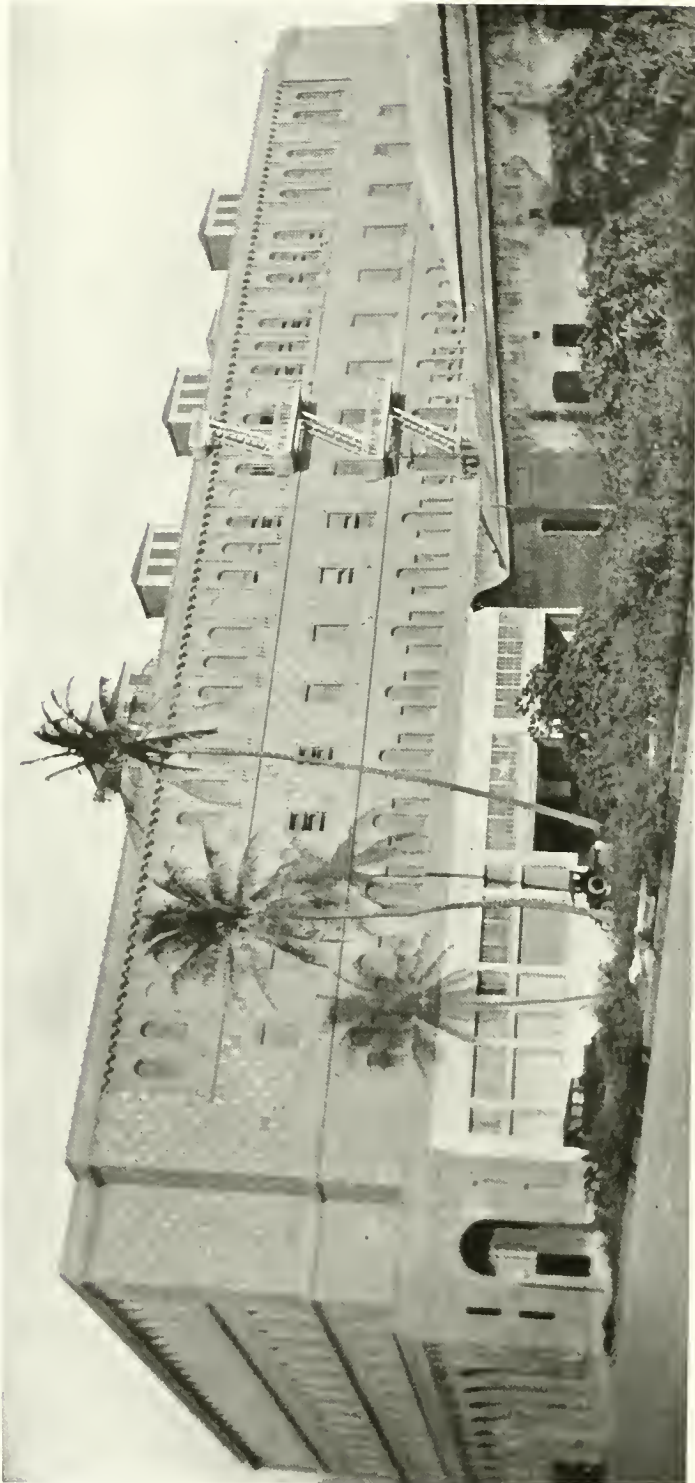

GENERAL VIEW, CORNER OF BISHOP AND QUEEN STREETS, BUILDING FOR THEO. H. DAVIES
& CO., LTD., HONOLULU, T. H.
LOUIS CHRISTIAN MULLGART, ARCHITECT

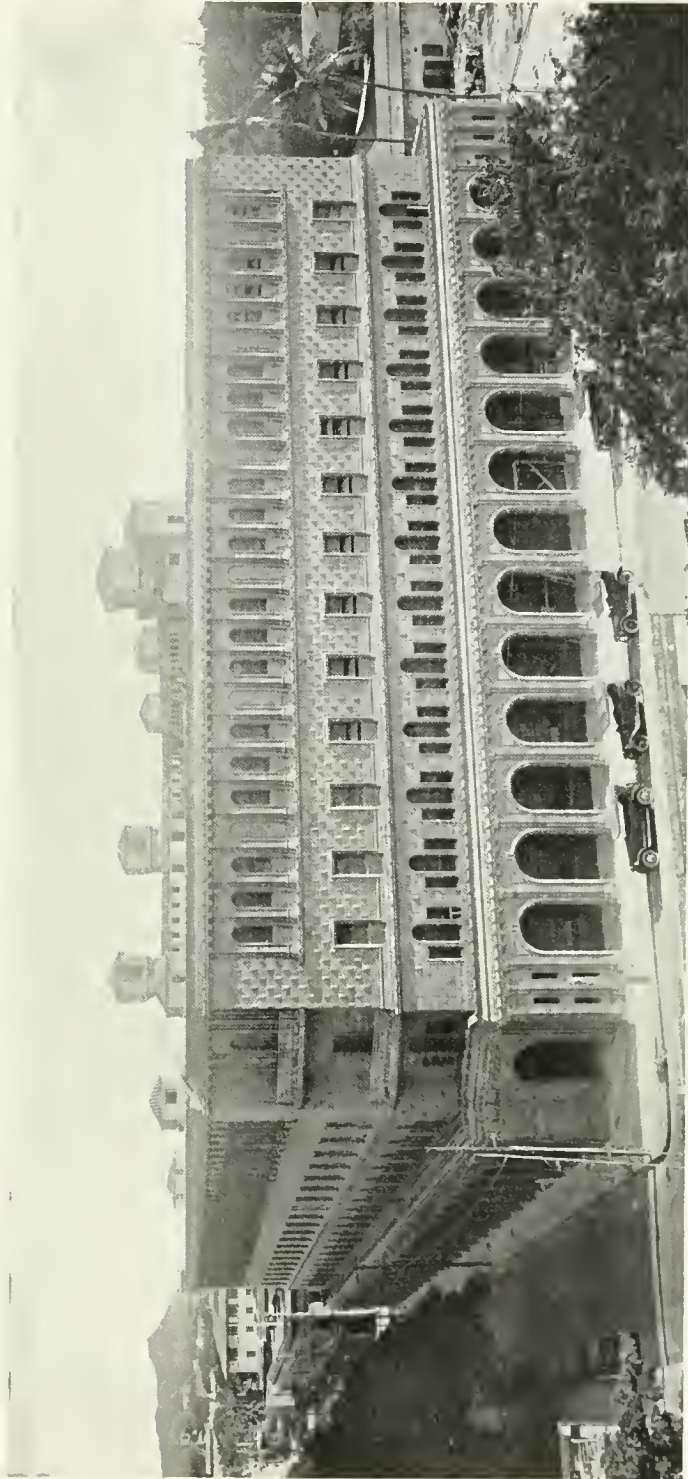

GENERAL VIEW, CORNER OF MERCHANT AND BISHOP STREETS, BUILDING FOR THEO. H. DAVIES & CO., LTD., HONOLULU, T. H. LOUIS CHRISTIAN MULLGARDT, ARCHITECT
Terra Cotta manufactured and erected by Gladding, McBean & Co., San Francisco.

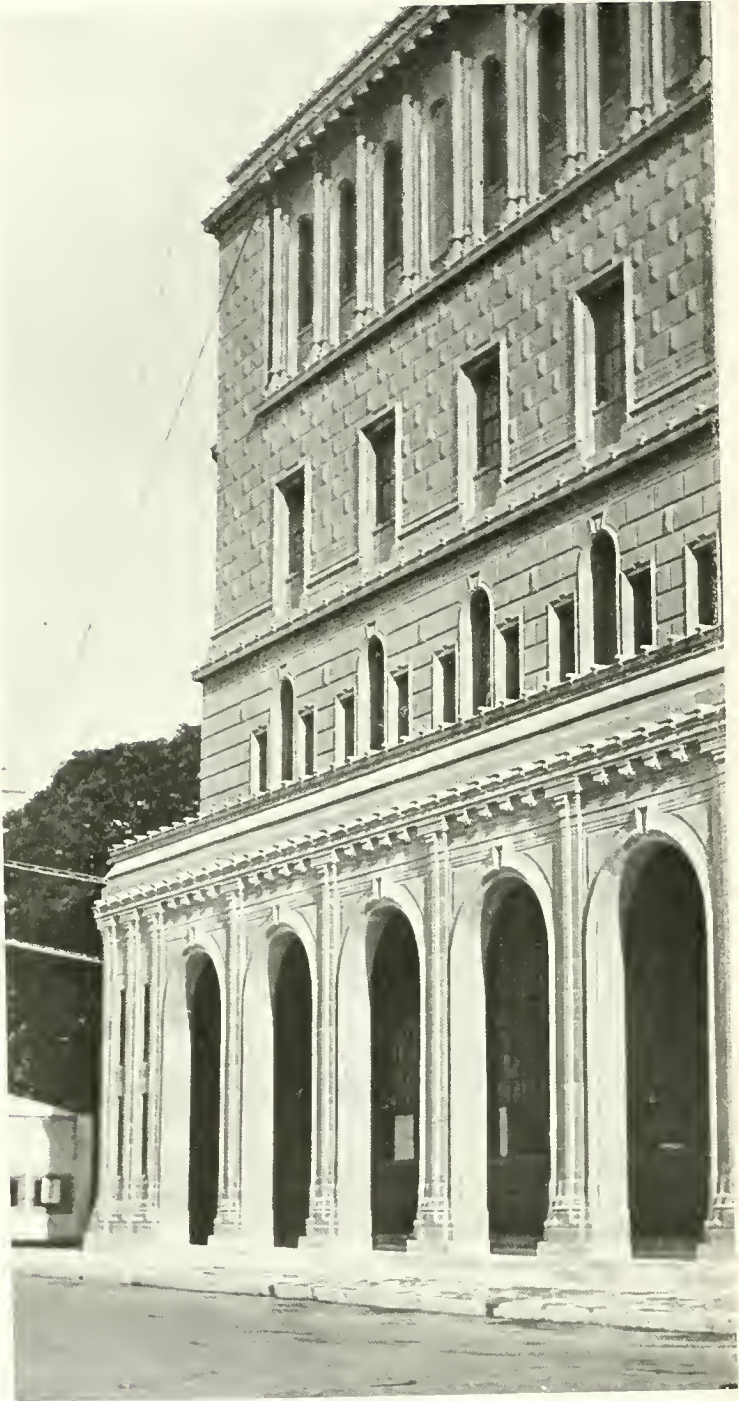

CORNER, BUILDING FOR THEO. H. DAVIES & CO., LTD., HONOLULU.
T. H. LOUIS CHRISTIAN MULLGARDT, ARCHITECT

Terra Cotta manufactured and erected by Gladding, McBean & Co., San Francisco.



DETAIL AT SHIPPING DEPARTMENT, BUILDING FOR THEO. H. DAVIES & CO., LTD.
HONOLULU, T. H. LOUIS CHRISTIAN MULLGARDT, ARCHITECT
Terra Cotta manufactured and erected by Gladding, McBean & Co., San Francisco.

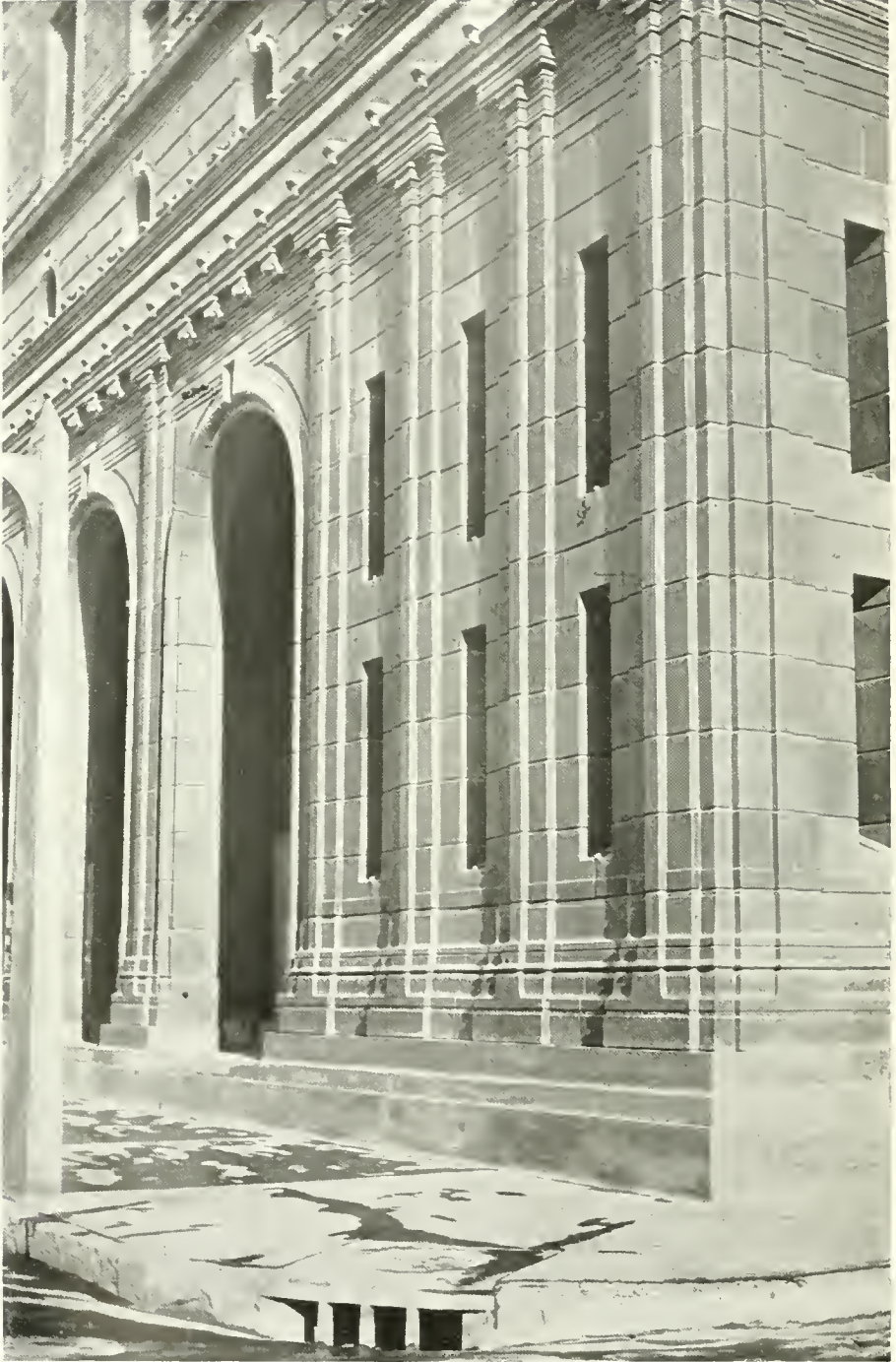

VIEW OF CORNER, BUILDING FOR THEO. H. DAVIES & CO., LTD.,
HONOLULU, T. H. LOUIS CHRISTIAN MULLGART, ARCHITECT

Terra Cotta manufactured and erected by Gladding, McBean & Co., San Francisco.

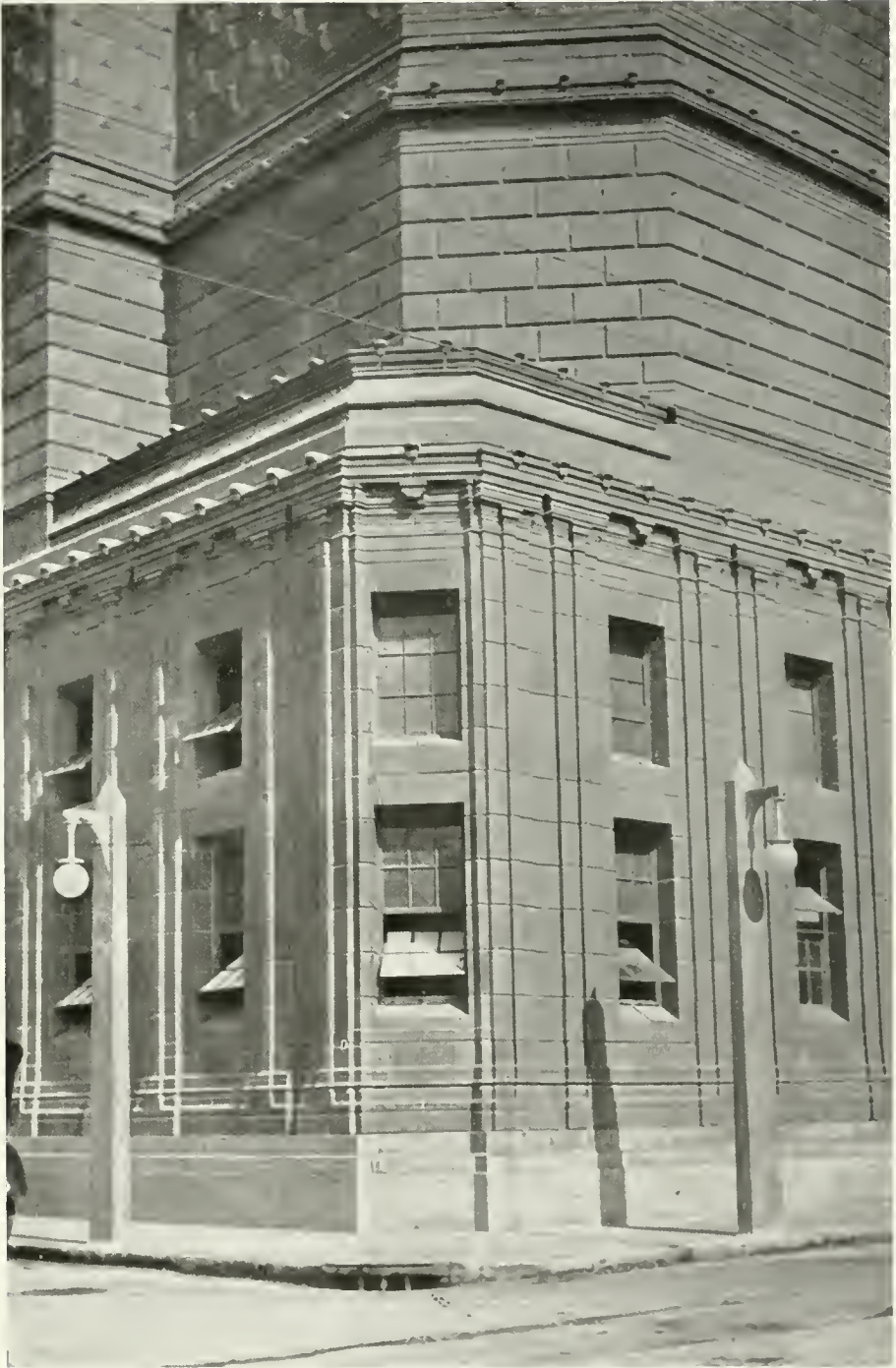

CORNER OF QUEEN AND ALAKEA STREETS, BUILDING FOR THEO H. DAVIES & CO., LTD.,
HONOLULU, T. H. LOUIS CHRISTIAN MULLGARDT, ARCHITECT



SHIPPING DEPARTMENT, QUEEN STREET, BUILDING FOR THEO. H. DAVIES
& CO., LTD., HONOLULU LOUIS CHRISTIAN MULLGART, ARCHITECT



VIEW ON ALAKEA STREET, BUILDING FOR THEO. H. DAVIES & CO., LTD.,
HONOLULU, T. H. LOUIS CHRISTIAN MULLGARDT, ARCHITECT

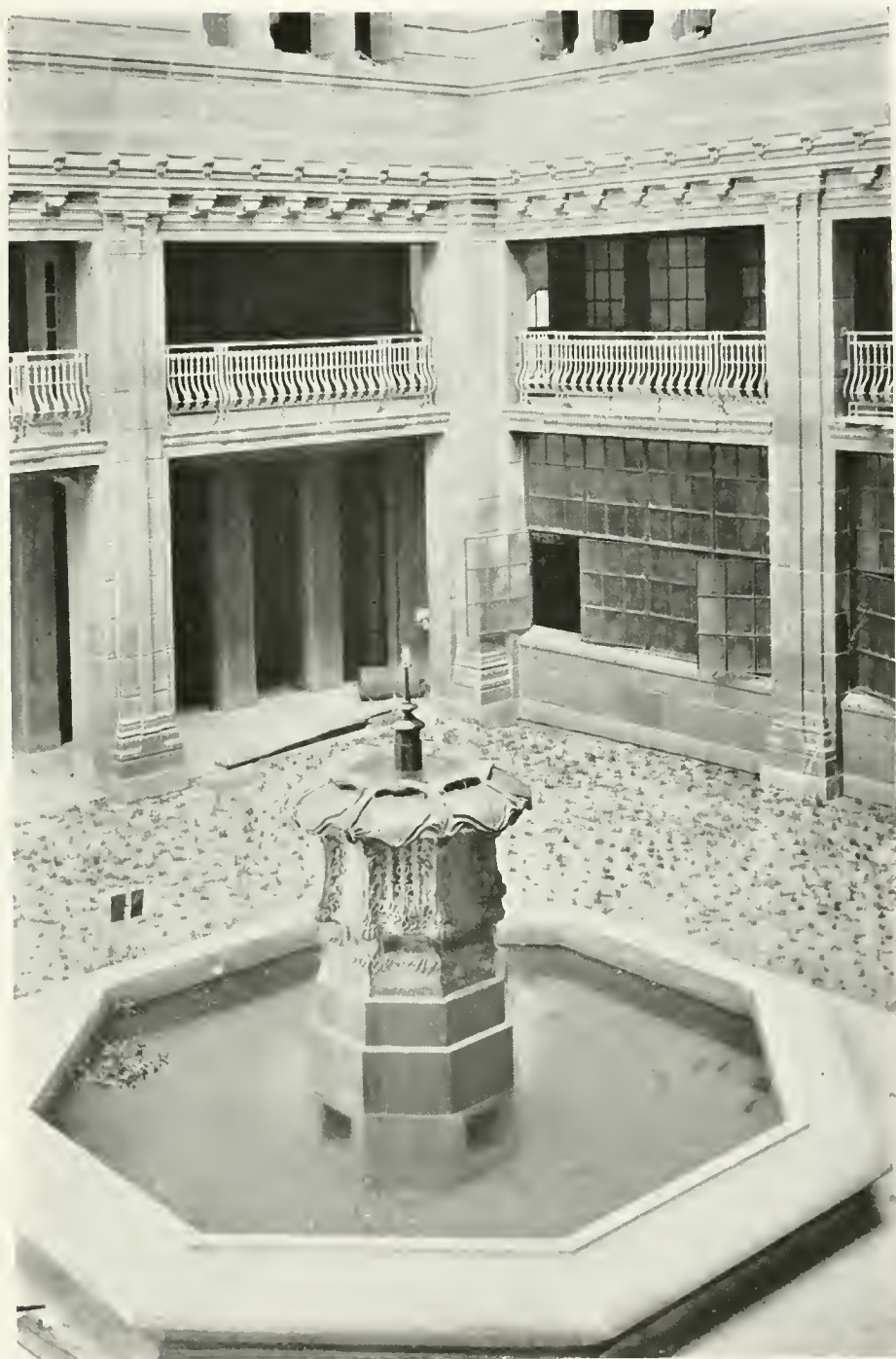

FOUNTAIN IN COURT, BUILDING FOR THEO. H. DAVIES & CO., LTD.,
HONOLULU, T. H. LOUIS CHRISTIAN MULLGARDT, ARCHITECT

Terra Cotta manufactured and erected by Gladding, McBean & Co., San Francisco.



BASE OF ARCADE PIER, BUILDING FOR THEO H. DAVIES & CO., LTD.,
HONOLULU, T. H. LOUIS CHRISTIAN MULLGARDT, ARCHITECT
Terra Cotta manufactured and erected by Gladding, McBean & Co., San Francisco.



ELEVATION OF ARCH, BUILDING FOR THEO. H. DAVIES & CO., LTD.,
HONOLULU, T. H. LOUIS CHRISTIAN MULLGARDT, ARCHITECT
Terra Cotta manufactured and erected by Gladding, McBean & Co., San Francisco.

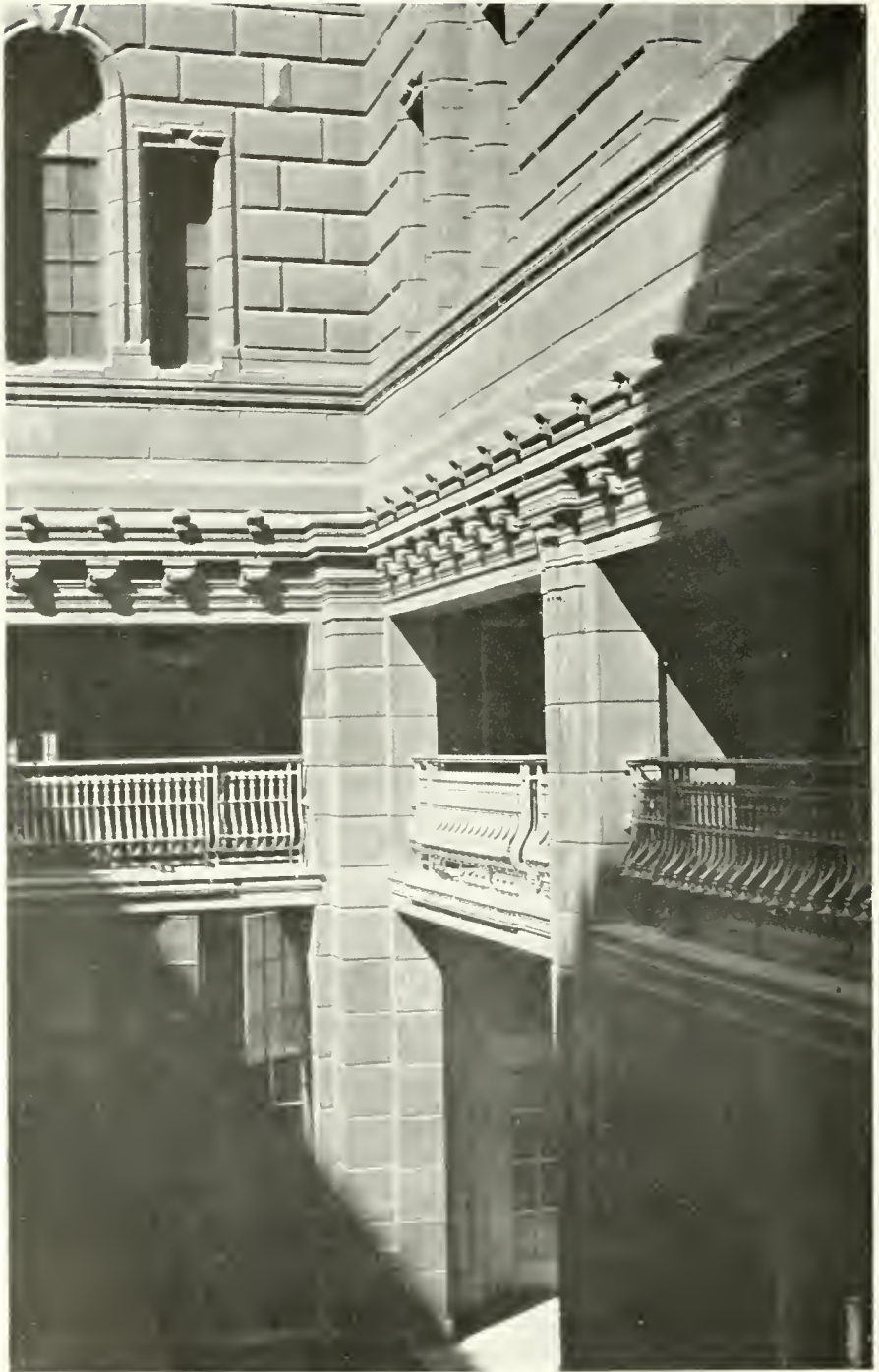

CORNER OF COURT, BUILDING FOR THEO. H. DAVIES & CO., LTD.,
HONOLULU, T. H. LOUIS CHRISTIAN MULLGARDT, ARCHITECT

Terra Cotta manufactured and erected by Gladding, McBean & Co., San Francisco.



DETAIL OF COURT, BUILDING FOR THEO. H. DAVIES & CO., LTD.,
HONOLULU, T. H. LOUIS CHRISTIAN MULLGARDT, ARCHITECT

War Upon Wood Waste Waged by Government

"Only thirty per cent of the wood in a forest now gets into the form of seasoned, unplanned lumber. Of this an additional 10 to 25 per cent is lost in the process of manufacture. In extreme cases as little as three per cent of the wood in the forest may reach the finished product."

This statement is made in a booklet issued by the Department of Agriculture, entitled Forest Products Laboratory, describing the work and aims of the experimental laboratory maintained by the Forest Service, in cooperation with the University of Wisconsin, at Madison, Wis.

The booklet outlines how, through investigation and experiment, the laboratory is devising and broadcasting practical commercial methods by which this enormous waste of the country's timber supply can be reduced. By reducing this waste, it is pointed out, the life of our present forests will be prolonged and the problem of growing new forests made simpler, because by preventing the waste of timber less timber will have to be grown.

Among the various methods studied at the laboratory for decreasing waste of forest products is the treatment of woods with preservatives resisting decay. Through such treatment an annual saving of one and one-half billion board feet is estimated to be possible in the case of railroad ties alone, and the preservation of other classes of timber would, in the aggregate, greatly relieve the drain on our forests.

* * *

University of Porto Rico

After being on leave for a year Mr. Frederick W. Revels, Director of the Department of Architecture at Syracuse University, is returning to take up his work, having spent the time in organizing and putting into operation a Department of Architecture in the University of Porto Rico. Mr. Revels will return to this country in June. Two men will be employed in the new department at the University of Porto Rico for the next year, one to take Mr. Revel's place as Professor of Architecture, and an instructor. The selection of men for these posts has not yet been made. Mr. Revels feels that this is a good opportunity for the right men to do some good service.

* * *

Movies for Lumber Industry

The lumber division of the Department of Commerce announces that the government will assist lumber manufacturers by taking motion pictures of their plants and operations, and will also arrange to have these pictures shown before engineering societies, manufacturers, and other wood users both in the United States and in foreign countries.

The government is prepared to pay all the expenses of the experts who will direct this work, but the films themselves will have to be paid for by the firms wishing such services.

* * *

Warping of Concrete Roads

It has been recently found, in the course of experiments by the United States bureau of public roads, that the edges of concrete roads curl up and down in response to changes in temperature. The unequal expansion and contraction of the upper and lower sides of the concrete slab under the influence of heat cause this curling. At the time of day when the surface of the road becomes the hottest it expands more than the cooler under side and the sides move downward. At night when the edges cool, they curl upward.



RESIDENCE, STOCKTON, CALIFORNIA. LOSEKANN & CLOUDSLEY, ARCHITECTS
Showing Application of Metal Lath Direct to Studs Without Sheathing Boards.

Back Plastered Construction

By JOSEPH LOSEKANN*

IN the selection of the materials of construction most economical for dwellings, the majority of home builders have used the available materials in a manner established by custom, without regard to a better and more fire resistive construction in which these same materials may be used to greater advantage.

The principal qualities every home builder desires in his home and which in a great measure determine the choice of building materials are in most cases overlooked and a selection made in the hope of an economy ultimately destroyed by maintenance and repairs.

The conscientious architect has the following qualities in mind in building the home: beauty, durability, low up-keep, resistance to fire, low first cost, low heating cost. The materials or combination of materials fulfilling these qualifications should be considered regardless of following custom or obsolete practice and to the exclusion of all so-called economical materials.

There is no question that frame construction lends itself quite readily to the economical features of a building and to a considerable extent fulfills some of these qualifications. We have, however, the question of resistance to fire, up-keep and durability to consider which in a great part are overlooked in the selection of frame construction for the home.

We have available information as to the fire losses in dwelling construction over a period of five years which amounts to over one billion,

*Member of the firm of Losekann & Cloudsley, Architects, Stockton, California.

five hundred million and the loss of life to approximately fifteen thousand. These enormous losses are due in great part to inadequate construction or the improper combination of available material. It is true that the major structural material is wood and wood will burn, but we can take steps to properly protect it from the flames and not condemn its use.

There is one material which lends itself more readily to building construction and that is cement stucco, but it has been abused and its improper use has caused a tendency to lean towards less fire resistive types of construction. Cement mortar or stucco is a material which in itself combines all the necessary qualifications as far as the skin coat of the building is concerned, and it is only necessary to determine the proper base or wall on which to apply the stucco to have solved all these conditions for the completed structure.

The question has been asked so many times that if stucco presents all the necessary qualifications, why do we have so many cracked and blotched surfaces? It has been our experience that stucco itself is not at fault but the application and our not availing ourselves of the wealth of information presented by such bodies as the Underwriters' Association, Bureau of Standards, and eminent testing laboratories of research, which would keep us from continuing to make the errors in construction for which stucco is blamed.

It has been the practice throughout California to use sheathing boards over the studs, then a waterproofed paper, wood furring strips, a re-dipped galvanized wire or metal lath and the stucco. Upon examining some thirty or forty buildings constructed during a period of from one to five years we found that the surface of the stucco was cracked and in all cases where paint was not used, the surface presented a blotched and badly stained appearance. Most of these cracks appeared over the wood furring strips, some along the stud line and a great many near the watertable and the ground.

From this investigation we came to the conclusion that the introduction of wood in the stucco surface in the form of sheathing and furring strips cut down the thickness of the stucco coat over these strips and the alternate shrinking and swelling of the sheathing and wood strips caused the cracks. The blotched and stained appearance was made by the entrance of water through these cracks and at the ground by the capillary attraction of the stucco taking water from the surface of the ground.

To correct these faults, it is obvious that all wood should be eliminated from the stucco, that the stucco be suitably waterproofed and that the surface be separated from the ground surface by a distinct break, either a course of brick or concrete.

It was decided that although tile, solid concrete, stone or some other material of like nature was of greater value as a base for stucco than wood, their cost would be prohibitive and that if wood could be properly used, from its economical value alone, we would have gained much for dwelling construction.

Some twenty-five years ago it was thought necessary to nail wood sheathing on wood studs before the application of the reinforcing material and stucco. This custom has persisted in many locations but the back plastered form of construction has been found in the laboratory of practical experience to be more satisfactory in every respect. The tendency toward back plastered construction appeared first in New England

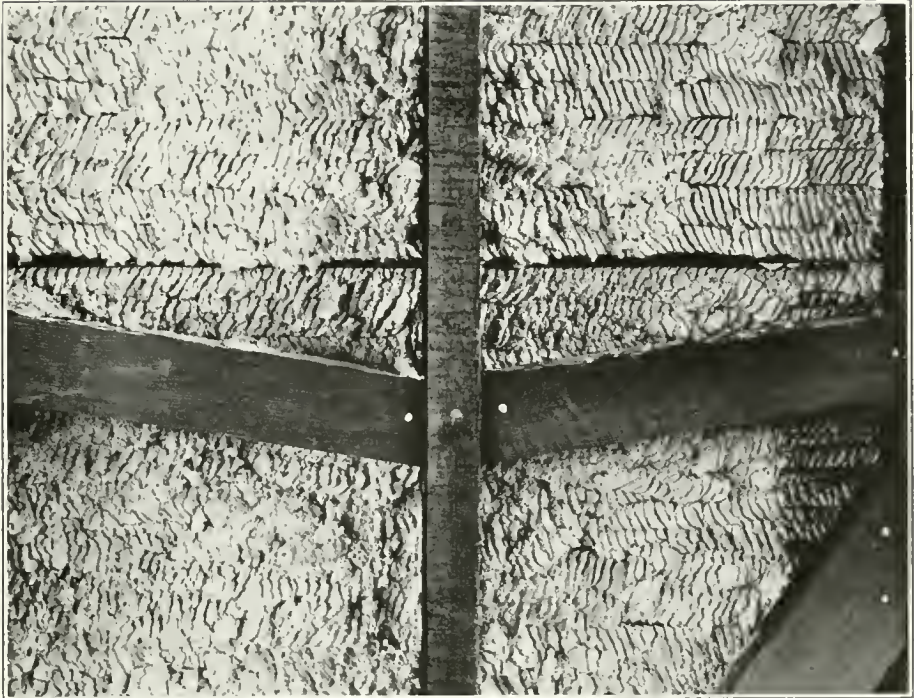

RESIDENCE, STOCKTON, CALIFORNIA. LOSEKANN & CLOUDSLEY, ARCHITECTS
Back of Metal Lath Between the Studs Before Back Plastering.

and such satisfactory results were obtained that it was decided by the United States Bureau of Standards at Washington to investigate all types of stucco construction on studs with a view of giving authoritative and unbiased information for the benefit of the public.

This series of tests was of a practical nature and followed a preliminary series begun in 1911. A two story building was erected, 200 ft. long, 26 ft. wide and 25 ft. high. The exterior walls were divided into panels approximately 10 ft. 2 in. high, each panel containing a window. Fifty-six panels were thus provided with various bases for plaster and various types of mixtures and methods of application. Of all the fifty-six panels erected, panel No. 15 is the one which has received a rating "Excellent" in all inspections by the United States Bureau of Standards, taken through a period of ten years. The construction of panel No. 15 is metal lath, attached directly to the studs with lath back plastered between the studs, stucco mixture being one part cement, one-tenth hydrated lime, three of sand (parts by weight.)

Quoting from the report on this panel, page 29, United States Bureau of Standards Technologic Paper No. 70:

"Superficial inspection: Color—uniform dark gray; no cracks; surface rough; general appearance excellent. Detailed inspection; no cracks; bond good; condition—excellent."

In other words, back plastered metal lath without sheathing has the full 100 per cent rating, the same as monolithic concrete or brick.

The Underwriters' Laboratories, Inc., at Chicago, is the organization to which all insurance companies look for authoritative information on

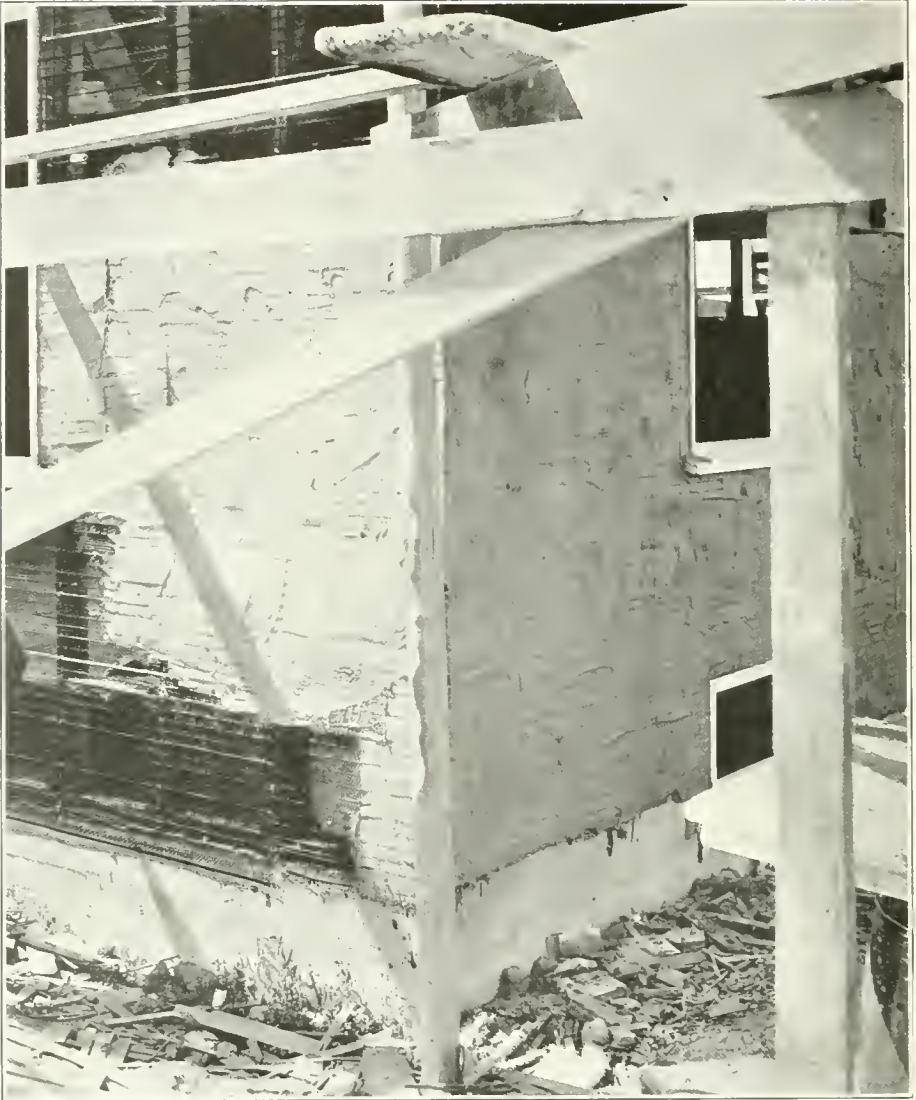

RESIDENCE, STOCKTON, CALIFORNIA. LOSEKANN & CLOUDSLEY, ARCHITECTS
Showing Metal Lath With First Coat of Plaster.

fire prevention matters. It is supported by the fire underwriting interests and is the recognized authority in that field. After a very exhaustive fire test on back plastered metal lath and Portland cement construction on wood studs, they have issued a report from which the following is quoted:

“This back plastered construction can be expected to provide sufficient heat insulation to prevent the ignition of the wooden supports to which it is attached for about one hour when exposed to fire of the degree of severity to which stucco finished buildings are likely to be subjected under average fire exposures.”

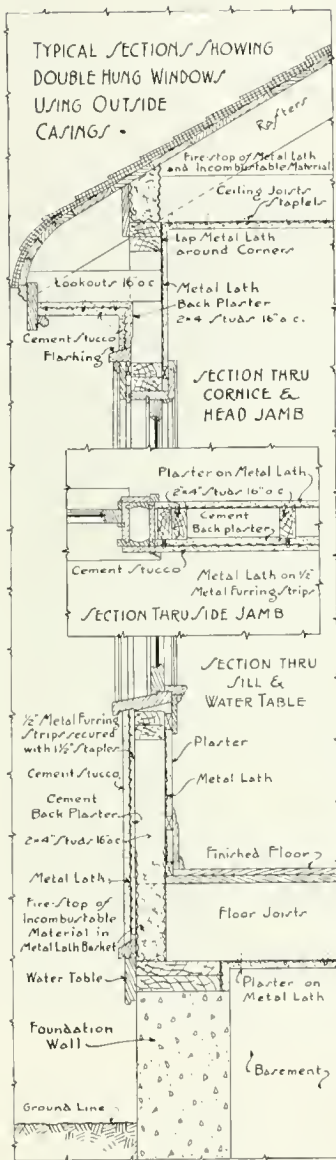

CEMENT STUCCO CONSTRUCTION ON METAL LATH BACK PLASTERED.

Place Metal Lath over studing or over a previously placed furring strip as shown.

Attach Lath directly or over furring strips with 1 1/2" 14 galvanized wire staples approximately 8" c.c staples to span heavy ribs of lath and furring strips.

All Metal Lath to be placed horizontally.

Cement Plaster applied to exterior face and Cement Back Plaster to inner face between studs.

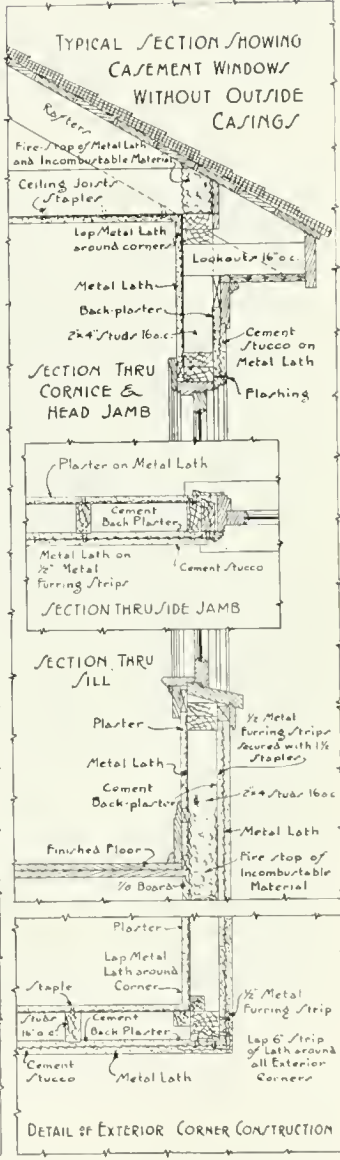
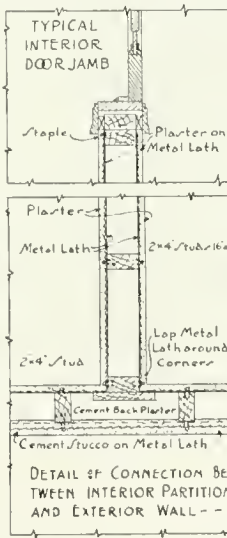

DETAILS OF CONSTRUCTION FOR CEMENT STUCCO ON METAL LATH BACK PLASTERED

The American Concrete Institute is composed of representatives of the United States Bureau of Standards, the Portland cement industry, concrete engineers, contractors, building officials, etc., who are anxious to standardize the use of Portland cement and find the best methods of construction with that material. Their committee on the "Treatment of Concrete Surfaces" is under the chairmanship of Mr. J. C. Pearson of the United States Bureau of Standards, is composed of manufacturers, contractors, an architect and an engineer insuring an unbiased and authoritative opinion. This committee has just recently rendered a report on a "Standard Recommended Practice for Portland Cement Stucco" in

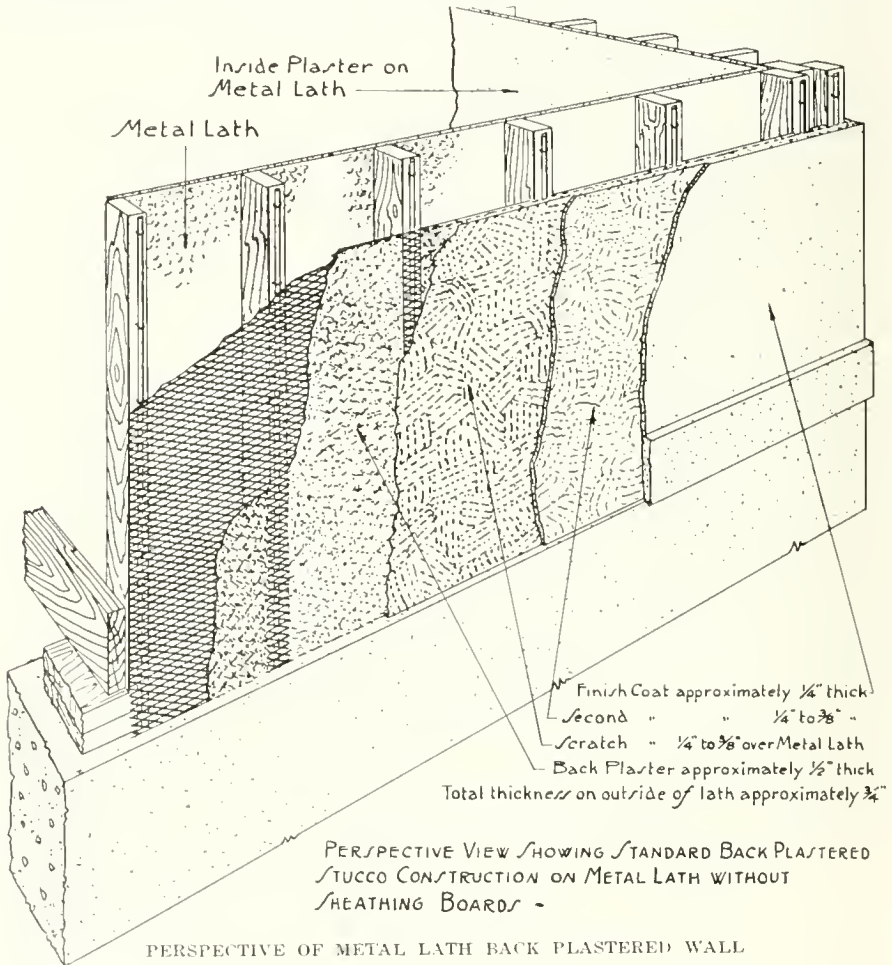

which they give the preference to the back plastered construction by virtue of its position in the report on "Back Plastered Construction on Frame Walls," and reference to the Underwriters' Laboratories' report and the United States Bureau of Standards' report above mentioned. They further state:

"The use of wood lath as a base for cement stucco finds many advocates and many opponents, but the Committee does not feel it can recommend wood lath for cement stucco."

Recent tests made by Professor J. C. Peebles at the Armour Institute

of Technology indicate that the back plastered stucco on metal lath for exterior walls is satisfactory from the standpoint of insulation and fuel saving. As noted above, the experience in the rugged New England climate shows that back plastered construction is entirely satisfactory.

In order to determine the strength of back plastered construction in resisting distortion, two distinct tests were but recently completed and serve to check fully, not only each other, but the findings of the United States Bureau of Standards, mentioned above. At the Armour Institute of Technology, Professor J. C. Peebles tested these samples, as follows:

Sample No. 1—Six inch, standard hollow building tile, laid in Portland cement, stuccoed with Portland cement and plastered inside with Gypsum plaster.

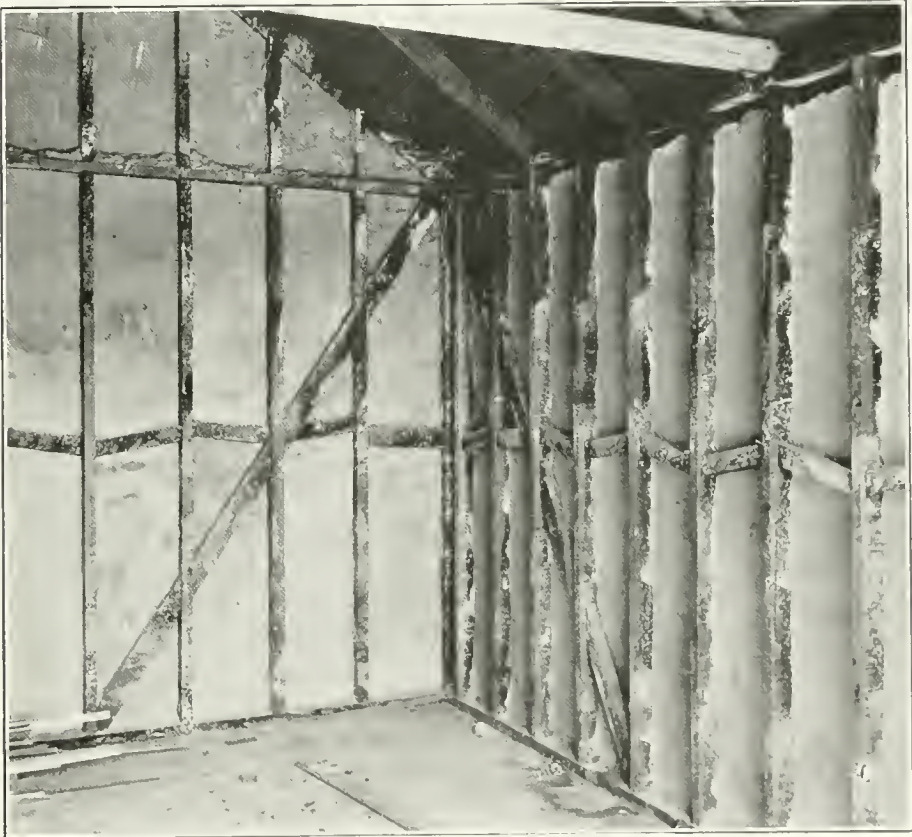

RESIDENCE, STOCKTON, CALIFORNIA. LOSEKANN & CLOUDSLEY, ARCHITECTS
Showing Back Plaster Between Studs of Exterior Wall.

Sample 2—Portland Cement Stucco on 3.4 pound Diamond Mesh Metal Lath furred out over $\frac{7}{8}$ in. sheathing, nailed to 2x4 studs. Inside plaster on 2.5 pound Diamond Mesh Metal Lath.

Sample 3—Back plastered construction using Portland Cement for exterior stucco and Gypsum plaster on metal lath for interior wall.

The samples were standard construction by ordinary mechanics, sizes 42x42 inches, and were tested in an Olson machine with the direct pressure on opposite corners, simulating diagonal stresses due to wind, earthquake or settlement, and were under a steady pressure. The final

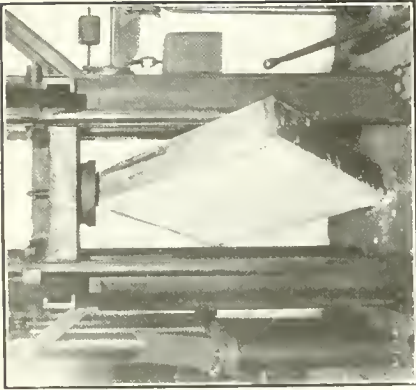

Method of Testing Back Plastered Slab by Armour Institute, Chicago.



Test Conducted by Armour Institute, showing superiority of Metal Lath over other forms of construction.

crushing strength of the three samples was—hollow building tile, 9600 pounds; metal lath over wood sheathing, 10,000 pounds; back plastered metal lath construction, 11,200 pounds.

A test very similar to the one conducted at Armour Institute was recently completed at Omaha before the Building Committee of that city. These investigations again proved the great resistance of back plastered construction to distortion. Where wood sheathing, lath and cement stucco showed cracks at 2100 pounds pressure, the back plastered metal lath sample showed no cracks at 3500 pounds, the limit of the machine. Distortion at 2100 pounds for the back plastered construction was 3-16 inches whereas for the sheathed construction it was 1 1/8 inches.

Metal lath as a base for cement stucco construction needs no introduction. Its usefulness as a fire retardant and its success as a stucco base has been established through a period of long service. Unfortunately prospective builders have looked upon it as costly and it has been placed in the class of fire resistive materials, desirable but too expensive for house construction.

In back plastered construction it is possible to use metal lath to advantage and without adding to the expense and at the same time accomplish all the desirable qualities of a permanent structure at no economical loss.

In this type of construction a metal lath stiff enough to span the

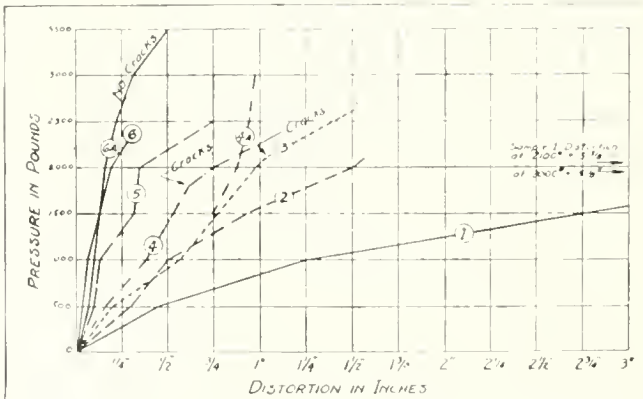

STIFFNESS OF STUCCO AS SHOWN BY TEST BEFORE OMAHA BUILDING COMMITTEE

stud spacing is used and the mortar is applied after nailing the lath to the face of the studs. After the first or scratch coat is applied, the metal lath is then back plastered between the studs and the additional mortar coats applied to the exterior which forms a solid cement sheathing properly reinforced. The stud framing used for this type of construction is similar to that used for other types except that braces between the studs are set back one inch from the face of the stud.

The cost of back plastered construction is cheaper than most types of wood sheathed construction, besides the added advantage of strength and durability which the wood sheathed type does not possess. It has been our experience that close to 10 per cent can be saved over the exterior cost by use of this type of construction.

Back plastered construction has not been used to any extent in the West, although it is the prevailing type of stucco construction in the East and has been such for over fifteen years. The lack of its use in the West can be attributed to the fact that stucco in the West does not undergo the severe extremes of climate that prevail in the East and builders were not compelled to devise a construction to withstand climatic conditions. Although it is possible to build stucco with almost any kind of reinforcement to withstand this mild Western climate, it must not be overlooked that it is also necessary to provide a structural strength and fire protection which the present types do not possess in as great a degree as back plastered construction. Unfortunately, in the present type of stucco construction any economic saving is at the expense of the strength and durability of the construction, while in the back plastered type the strength and durability is permanent and the cost of construction less than the cheapest grade of wood sheathed construction.

* * *

Architectural Registration Boards

THE National Council of Architectural Registration Boards held its first annual meeting at Washington, D. C., May 10th, the Pacific Coast being represented by Mr. John Parkinson, architect of Los Angeles, Mr. Sylvain Schnaittacher, architect of San Francisco, Mr. Chandler C. Cohagen of the Montana State Board and Mr. Lee A. Thomas of Bend, Oregon.

The Council was incorporated under the laws of the State of Illinois as a corporation "but not for profit" on March 21, 1921, and on March 26, 1921, the officers elected at St. Louis were formally elected by the designated directors of the corporation and the Council is now fully equipped to function legally as a corporate body of the State of Illinois.

On January 3, 1921, the Council office was formally opened for business, with Mrs. Louis E. Durham in charge as Executive Secretary. The profession had to be told of the work of the Council and in that service the professional press has given most helpful cooperation.

With publicity came a volume of correspondence—inquiries for information as to how to get registered without proving competency; airing of pet peeves against registration officers; dissertations on "my greatness—everybody knows that I am the greatest moving picture architect in America;" "Nobody can build schools 'like' I can;" It is ridiculous to ask me to have my record in practice proved and recorded; everybody knows me;" "Registration isn't getting me any jobs;" "The officers of thus and such a state do not answer my letters;" They have taken my money and not given me a certificate;" "They did not give me

a fair deal;" "I have been discriminated against;" "All that State wants is to get our fees—anybody can pass who pays for it;" etc., etc. "Why cannot a corporation practice a profession?" (Inferentially its members escape individual responsibility) "Suppose a corporation is organized consisting of six engineers, two architects and one professional braggadocian, otherwise known as a 'business getter,' would it be all right to have one member of the firm registered as an architect, or would all have to be registered?" "Can you get the business getter through without an examination?" "Can member states get the Council's service in investigating applications without paying for it?" "It seems a useless expense for an applicant to pay the Council's fees for investigation and also the State fees?" "Why doesn't the Council do this work for nothing?" "Of course the States cannot permit any of their fees," and so on ad infinitum.

It was soon found that in order to answer the various inquiries it would be desirable to prepare a series of circulars of advice covering different phases of the work. In consequence, the Secretary of the Council prepared an address on the legal regulation of the practice of architecture which was first read before the Illinois Society of Architects and widely distributed in pamphlet form and reprinted in several of the architectural magazines.

The second circular was a general circular of advice concerning examinations and adequate preparations for entrance upon the practice of architecture. This circular attempted to epitomize the conclusions reached at the St. Louis conference and to cover the whole subject exhaustively. In this year's convention the subject matter of this circular is made the chief topic of discussion. This circular has been forwarded to all active and associate members as well as to Chapters of the American Institute of Architects and each was invited to criticize same and to send in its constructive criticism.

Circular No. 3 is a circular of instruction to Examining Committees as to methods of conducting Senior N. C. A. R. Examinations. The idea of embodying the standard N. C. A. R. examination as one of the features of the Constitution and By-Laws of the Council was a new one not conceived of at St. Louis and was added by the officers as a possibility but without much faith as to its immediate use. It was felt that a good many applicants would oppose the paying of the additional examination fee without any possibility of same being returned and which would be in addition to all State examining fees. Contrary to our expectations, this feature of the Council's work has proved the most popular of all and the demands for this type of examination are continuous and insistent. So far, we have only been able to arrange for two such examinations—both conducted by the Illinois Examining Board—one for Seniors and one for Juniors.

The Senior examination was participated in by some twenty-one prominent architects of Illinois and adjoining States. Four have taken the Junior examination, there is one applicant for Senior examination on file and two applications for Junior to be conducted at the next meeting of the Examining Board.

The purpose of this standard N. C. A. R. examination is to provide an examination equal in stringency to the minimum requirements of all States having registration laws and to give that examination official status by having it conducted by legally constituted examining officials of some State having registration laws.

This is the first time such a procedure has been attempted by any profession. The medical profession have tried to accomplish the same result in another way—by having standard examinations conducted by the Carnegie Foundation—but have discovered that while the examinations might be all right from the standpoint of stringency requirement, still they could not constitute a basis of reciprocal exchange, due to the fact that most laws only provide for reciprocal exchange between States having laws regulating the practice of the profession involved and stipulate that this exchange shall be predicated on equal stringency of examination requirements.

By the simple expedient of providing a standard voluntary examination to be given by the various States and taking this examination under the direction of the regular State examining officials, it would seem as though a legal basis had been created for reciprocal transfer.

The architectural profession has one peculiarity which differentiates it from most of the other learned professions. While a large portion of its functions is involved in questions concerning conservation of property, life, health and safety and, therefore, falls under the police power of the States, the other portion of the functions of an architect concern the spiritual welfare of society embodied in the subject of aesthetics. So far, the American commonwealth has not progressed sufficiently far to make sins against the aesthetic sense crimes against society and, therefore, punishable under the penal code. In consequence, proficiency in this portion of architectural competency cannot be made compulsory under the police power of the State and, therefore, all laws promulgated under the educational power of the State may, and very properly do, lay down requirements concerning the laws of balance proportion, history of art and architecture. These peculiarities of the function of an architect prohibit the possibility of all States adopting uniform standard examinations for registration or licensure, but do not prevent the States having license laws from giving voluntary examinations to those electing to take same covering the question of aesthetics.

A comparative study of existing registration laws was presented at the meeting by Mr. William P. Bannister, Secretary of the New York State Board for Registration of Architects, as follows:

The preliminary education required as a condition precedent to technical examinations is, probably, one of the most difficult problems to overcome in the effort to extend the right to practice from one State to another without delay, because of necessary examinations in academic subjects. The laws in the following States do not seem to require that the applicant for technical examinations shall have had any preliminary education except such as may be prescribed by the Board of Examiners:

California, Colorado, Florida, Michigan, Montana, North Carolina, Oregon, South Carolina, Utah, Virginia, Washington.

The laws in the following States require a high school course or equivalent, and such additional courses in mathematics, history and language as may be prescribed by the Board:

Georgia, Illinois, New Jersey, Pennsylvania.

The laws in the following States fix the preliminary education as follows:

Louisiana—Good primary education.

North Dakota and Wisconsin—High school graduation.

New York and Idaho—High school graduation or equivalent plus two college years in language, mathematics and history; examinations in these subjects resting with the State Department of Education and not with the Board.

The requirements as to professional training leading to examination are as follows:

California—Five years in architect's office, or three years if college graduate.

Colorado—Three years in architects office.

Florida—A period of practice prescribed by the Board.

Georgia—Three years' practice subsequent to graduation from a school of architecture approved by the American Institute of Architects.

Idaho—Three years' practice in the office of a reputable architect.

Illinois—Three years' experience in the office of a registered architect.

Louisiana—Two years' practice subsequent to graduation from school of architecture, as provided by the rules of the Board.

Michigan—Two years' experience subsequent to graduation from an approved school of architecture, or six years in the office of a registered architect.

Montana—Experience as approved by the Board.

New Jersey—Three years in the office of a reputable architect subsequent to graduation from an approved school of architecture.

New York—Five years in the office of a reputable architect subsequent to educational tests fixed by law; or three years in the office of a reputable architect subsequent to graduation from a school of architecture approved by the University of the State of New York.

North Carolina—Prescribed by the Board.

North Dakota—Three years in office of reputable architect.

Oregon—Prescribed by the Board.

Pennsylvania—Five years' competent practice or three years' practice subsequent to graduation from a school of architecture duly approved.

South Carolina—At least two years' experience in architecture.

Utah—None.

Washington—Graduation from a recognized school of architecture.

Wisconsin—At least five years' practical experience in office of a reputable architect.

* * *

Why an Architect?

AN architect does more than build a house. He provides a setting for a personality. He interprets the occupants in terms of their dwelling. He puts four walls and a roof around the atmosphere of a family. Every client is an individual study. The architect sells not only experience and skill; primarily he sells service. He looks after the physical details of building; his roofs do not leak, his paints do not peel, his chimneys do not smoke. He also studies the habits and characteristics of his client, and seeks above all to provide a home in which the owner will be comfortable, happy, satisfied. Beyond the technical side of his profession he will aim to produce those intangible values that make all the difference between a family barracks and a home in which a family will abide content.

To attain this result the architect draws on his expert acquaintance with building problems in all their multiplicity. Technical skill and artistic gifts combine to make the architect, and it would be strange indeed if a man possessing these qualities could not save his client from many mistakes of judgment and many unwise expenditures. He draws plans, prepares specifications, obtains bids, writes contracts, supervises construction, makes sure the owner gets what he pays for. When the completed building is 'delivered' the owner may know that his materials are 'right,' his house well designed, his workmanship 'sound.' About one owner in three assumes the architect has no interest in the site, that the dimensions of the lot and the owner's limit of cost are all he cares to know. On the contrary, the architect studies the site. Often he has topographical survey made with foot contours. He helps the owner place

the building on the lot with reference to the views it may command, its distance from the street, the opportunity for lawn and gardens. He advises as to the style of architecture that fits the location and the suitability of the materials to be used, whether brick, stone or timber. He suggests the arrangement of rooms in terms of the site, so that vulnerable points will not be exposed to freezing blasts and living rooms will not be shut away from sunlight and outlook, so that the approach will be effective and the general arrangement convenient. Then the architect is ready for his rough preliminary drawings. After these have been studied he will make the final and complete drawings, the working plans and specifications.

* * *

Four times in five the owner tells the architect what he wants, and how much he will spend, and the architect replies that the two are not compatible. Whenever the owner fixes an absolute ultimate of expenditure the architect has no option but to help his client to scale his building accordingly. Here two facts usually emerge: that a small house is more difficult to design than a large one, if it is not to be merely commonplace, and that an able architect can do remarkable things in the way of elimination and yet keep the essentials. Moreover, experience brings prescience so that the architect will help the owner to avoid those after-thought 'extras' and those expensive deviations from the original plans that always run fast into money. He will try to locate every fixture and foresee every detail so that his first plans will direct all operations to the driving of the last nail.

Without an architect the owner is in the hands of his builder or contractor. Doubtless the average contractor means to be honest, but without supervision he is exposed to temptation and it is to his advantage to skimp. Unless the owner is an expert and has time to devote to supervision the builder may use materials below specifications and 'get away with it.' Are there pitchy knots in the lath? They mean yellow spots in the plaster after awhile. Punky framing lumber with many edges is not strong enough. Such terms as 'shift' and 'slash' mean nothing to the tyro, but if the wrong material is used the floors will splinter up. An owner once noticed that his specifications called 'only' for 'extra' singles, and added 'No. 1.' Therefore he roofed his house not with the best shingles, but with the worst. Shingles are graded down from 'extra,' or knotless; to 'clear,' with no knots in their exposed portions; and 'extra No. 1,' with knots anywhere. Clapboarding is 'clear' or 'extra,' which should be used? Flooring is 'clear,' 'factory,' and 'No. 2,' which shall you choose? How shall you select your interior finish from the scores that will be urged on your attention? One famous building firm will employ only three crews of plasterers, men who are sure to build 'for keeps,' whose work will not be 'all out' in ten years. Asbestos shingles may be laid in a half-dozen ways producing as many effects and corresponding differences in cost. A certain architect wrought patiently and tactfully to convince his well-meaning but deluded client that a house should have no clapboarding, but block siding; the owner since has expressed his gratitude. An architect will avoid vexing delays. The plumbing and the heating may be in process of installation and the electricians at work before the carpenters finish. Competent supervision means both that the tradesmen shall be punctually on the premises and that the several crews shall not get into each other's way.

As the building business is organized today the contractor and the owner are bound by a standard form of agreement which provides that the contractor shall follow the architect's plans and fulfill the General Conditions of the contract. These General Conditions also are cast in the standard form of the American Institute of Architects. There are some forty-five articles in all, covering all manner of contingencies, defining carefully the rights and duties of all the parties, and treating of documents, drawings, claims, insurance, payments, liens, sub-contracts, corrections, and a hundred other topics. Contractors usually make estimates or submit competitive bids, and here again the owner may well accept the advice of his architect. For estimates vary greatly. Often the highest is really the cheapest. One bidder is accurate and careful; another merely takes a chance with no genuine knowledge back of his proposals; a third may be a shyster who intends to parcel out the job among a score of sub-contractors from each of whom he will exact a profit. Many large contractors today maintain extensive organizations and are well educated and efficient men. But they can hardly be expected to take such an individual interest as does the architect who first conceives the plan, then sketches his vision, and finally watches its development in terms of wood and stone.

The architect almost invariably saves his client the full amount of his fee. He avoids waste of space, time, and materials, and all three mean money. He is not merely a superior sort of watchman, yet he makes sure that what is done is well done. Work well done is permanent, vastly reducing the cost of upkeep.

Choose your architect with care. Then trust him. When he tells you that plain things live and gewgaws do not survive believe him. When your views differ be willing to 'be shown.' Remember he is trained to apply skilled intelligence to achieve results that fit your needs.—House Beautiful.

* * * *

A. I. A. Convention

THE 55th annual convention of the American Institute of Architects is now a matter of history. The reputation of Chicago as a summer resort, in the opinion of the delegates, is shattered. Certainly no convention was ever held when the weather conditions were so unfavorable.

In reviewing the work of the convention, no particular outstanding feature can be mentioned. Perhaps the most important action was Resolution No. 14.

"Resolved, that the Institute become an association member of the American Construction Council and that the Board of Directors be instructed to extend to it the fullest possible support and cooperation, along the lines indicated by the proposed by-laws and that all members of the Institute are urged to aid the purpose of the council by becoming, wherever possible, sustaining members and taking part in its local activities."

In view of the changing conditions in the building industry mention should be made of the resolution adopted by the convention relating to the National Board for Jurisdictional Awards, which referred the whole matter, so far as Institute participation is concerned, to the Board of Directors for restudy in the light of present labor conditions.

As is customary in all conventions of the Institute, the recommenda-

tions of the Board of Directors were generally adopted without amendments.

Mention might be made of a number of minor amendments to the Constitution and By-Laws of the Institute.

Of course, no convention could adjourn without attempting to amend the Canons of Ethics.

Canon No. 11 was stricken out and the following paragraph was by a vote of the convention added to paragraph 4 of the Circular of Advice:

"To compete knowingly with a fellow architect for employment on a basis of professional charges is inconsistent with the spirit of this code. An architect should take reasonable steps to ascertain if other architects are also under consideration, and in no event should he depart from his own or any general standard of charges for the purpose of underbidding some competitor."

"The Schedule of Charges of the A. I. A. is recognized as a proper minimum of payment. The locality or the nature of the work, the quality of service to be rendered, the skill of the practitioner or other circumstances, frequently justify a higher charge than indicated by the schedule."

The entire paragraph, however, was referred to the Board of Directors for phraseology before being issued.

The Board's recommendation relating to fellowships, reading as follows, was approved by the convention.

"Amend Article II, Section 1, to read: Fellowship in the American Institute of Architects is conferred upon a Member who is a citizen of the United States, who, in the opinion of an authorized Jury of Fellows, shall have notably contributed to the advancement of the Profession in design, construction, literature, education or public service.

"The above Jury shall be composed of six Fellows appointed by the President, who shall make six appointments for the first year with varying terms, and two appointments each succeeding year.

The election for President resulted in a somewhat spirited contest between William B. Faville, the successful candidate and Burt L. Fenner of New York. The election of Mr. Faville, who has for many years been an officer of the Institute, has broken a precedent of many years standing. Mr. Faville is the first President ever elected from west of the Missouri river.

Western delegates did not overlook the fact that the New York Chapter had candidates for four out of a possible six of the eight offices to be filled—Monthly Bulletin Illinois Society of Architects.

* * *

Architects Favor Open Shop

Following a discussion of changing conditions in the building industry the American Institute of Architects at a meeting in Chicago, June 8th, unanimously adopted a resolution in favor of the "open shop" in the building trades.

The board of directors was instructed to draw up an amendment to the plan of the national board of jurisdictional awards in favor of the open shop.

“Street Advertising”

An Architect's Point of View

By CHARLES CRESSEY

FEW people, I am sure, will assume for a moment that an architect has, or can have, knowledge of, or any interest in such a purely commercial matter as advertising. Having, therefore, a perfectly irresponsible position and no hope whatever of convincing anyone or attaining anything by these present comments, I can cheerfully assert that never in history has the appearance of street advertising so thoroughly deserved the death penalty upon its authors, than in this, our own era of letters and liberty to use them. Curses bring about their own cure however, and advertising, like the rest of things, is already better in spots.

Magazines and printed advertisements are being designed with precision, beauty and skilled effect. In marked contrast, however, is the clutter and spew of letters to be seen in street advertisements. It is a paradox too that never before, probably, has lettering itself reached such a status of fine art or high originality as in the work of many modern sign writers.

It is the plain duty of the business man to give these artists a fair field, and that field will never occur where size is the only measure of the value of a sign. The size of a sign should not rest alone on the ability to pay for it, but first upon its effect on the appearance of the city and its immediate neighborhood.

Clearness and visibility of signs depend less upon size than most business men seem to understand. Advertising has great value in adding color and interest to city streets, a fact appreciated by few so fully as by the architect, who, when alone in the field of business advertisement (as he stood for centuries), used lettering, symbolism and massed color with good judgment and a fine appreciation of knowing when to stop.

The latter art is the need of today in street advertisements, and there is less hope in restraint by law than in the good sense of the business man's grasping the fact that good money is being thrown to the winds by the congestion and indiscriminate massing of sign upon sign.

The eye and brain can only take in so much, and both are dulled to absolute indifference by the present over-lettered condition of business streets. Advertising is necessary, is good, is helpful, and welcome in moderation. Why not get together in healthy co-operation to beautify the streets and gain a real efficiency too by that effort.

If you plan your advertising in advance as you plan the other requirements of a building, the architect will meet this practical need as successfully as he is solving the rest of modern problems. There is absolute insanity in disfiguring costly frontages on which, not only the often thankless work of the architect has been given, but also that of hundreds of interested workers. The building worker is, despite the scoffer, more often devoted to his craft than is generally realized, and it is not good advertising to ignore this considerable section of the public.

If the common plan of random advertising is right, then architectural building is entirely wrong, and street frontages should become a simple system of scaffold poles on which to hang advertisements.

It is noteworthy that some of the most successful business houses do practically no lettered advertising on walls of their buildings. It is true, also, of the direct opposite in other cases, though the effort of the

owner to live up to and earn the cost of this advertising may be more responsible for success than is the splash he makes on the landscape.

The splendid success of the new illuminated advertising groups on vacant lots, is a field of promise, especially where lawns and landscape planting are used. I have had little personal success in proving that the public memory carries the written message of street signs in any measure proportionate to its cost, but have found that the true advertisement and attraction lie in distinctive illumination, color effects, motion or pictorial treatments rather than wording.

I look forward to a return of trade emblems and craft marks. Has any modern device done any better advertising for its particular business than the wooden Indian, the barber's pole, or the gilded charm on the pawnbroker's haven of hope. A modern heraldy worthy of the business of the day is needed. There is both demand for, and obvious success in, using projecting signs on buildings, both in ancient and modern advertising, where confusion is avoided, and I suggest that a system of vertical signs along the curb lines would meet present conditions best. A tall, decorative standard for street lighting and illuminated signs could be designed to give to the merchant a true publicity and add, too, a stately beauty to city streets.

Concluding, may I remind you that civic beauty is now a vital financial asset and that the individual merchant holds this factor largely in the hollow of his hand. There is, also, what may be called "invisible advertising," which expresses itself in sculpture, tree planting and decorative civic features. The wise advertiser will stimulate these, near his own headquarters, as a landmark and direction finder, readily adopted by the public. The ancient business man knew this better than we in the present day, and he used architecture for its practical advertising value.

As further brief headings for thoughts on signs, I suggest:

THAT good taste is the final measure of values in advertising.

THAT permanence is the danger zone of advertising in words.

THAT efficiency in word signs demands frequent change.

THAT the nature of the business is more important than the name.

THAT clearness and directness are more vital than size.

THAT blank and background have greater values than words.

THAT result from advertising is more than attention to advertising.

THAT disfigured buildings may reflect doubt of the house within.

THAT final efficiency in advertisement lies in making the public connoisseurs of advertising.

THAT fine buildings have the personal value of fine clothes.

THAT fine buildings disfigured compare with fine clothes disfigured.

THAT towers, domes or spires have values in silent salesmanship.

* * *

Advertising Signs—Futuristic Nightmares

Heaven knows there are enough avenues of publicity open to those who wish to sell their goods without making our rural landscapes a futuristic nightmare," said A. R. Hirst, State highway engineer of Wisconsin.

"The state and counties, by legislation, can keep advertising signs off the highway rights of way, but only public opinion, probably, can stop the desecration of the landscape.

"If an outraged public would boycott advertisers who persist in disfiguring nature with commercial appeals the practice would soon cease.

"Protection of natural beauty should be inculcated at schools in order that the next generation will be possessed of an aesthetic sense that will refuse to countenance such practices."

THE Architect and Engineer

Incorporated

Founded 1905 by E. M. C. WHITNEY

W. J. L. Kierulff - President and Manager
 Fred'k W. Jones - Vice-Pres. and Editor
 L. B. Penhorwood - Secretary
 T. C. Kierulff - Attorney

Associate Editors

Irving F. Morrow - Architectural Critic
 Chas. H. Cheney - City Planning
 August G. Headman - Book Reviews
 Wilbur David Cook - Landscape Architecture
 Wm. B. Gester - Inspection and Tests
 O. P. Shelley, C. E. { Fireproof Construction
 F. W. Fitzpatrick {
 T. Ronneberg, C. E. - Structural Steel
 W. H. Lowe - Roofs and Roofing
 Fred'k N. Woods, Jr. - Rock and Gravel
 Chas. Felix Butte - Electrical Construction
 J. W. Fricke - School Equipment
 Will J. French - Department of Safety

Published Monthly in the Interest of the
 Architects, Structural Engineers, Contractors
 and the Allied Trades of the Pacific Coast by
 The Architect and Engineer, Inc.

PUBLICATION OFFICE:

627-629 Foxcroft Building, San Francisco
 Telephone Douglas 1828

The publishers disclaim any responsibility for
 statements made in the advertisements of this
 magazine.

Terms of Subscription

(Including postage) to all parts of the United
 States, \$2.50 per annum; to Canada 75c
 additional; to all Foreign points \$1 additional

Vol. LXX. July, 1922 No. 1

THE STEP-BACK BUILDING

Mr. Rollin C. Chapin, an Eastern architect, writes of the step-back building of which several examples have recently been built in New York, as indicating a "new type of American architecture." There is really nothing particularly new about this type of construction. Mr. F. W. Fitzpatrick of Chicago wrote of step-back buildings for this magazine as far back as ten years ago. The time for building this type of structure, however, seems not to have arrived until recently, hence the "discovery" of a "new" American Architecture. Writing of his observations in an Eastern publication, Mr. Chapin observes:

"Probably no one who has visited New York City during the past year or two has failed to notice that

a new type of skyscraper has come into being. Instead of the cut-and-dried 'scraper to which we have been so long accustomed, with its 20 to 40 stories of facade rising unbroken from the street and crowned by a huge projecting cornice, we observe that these newer buildings begin to step back from the building line at a certain height, something in the manner of superimposed blocks of diminishing sizes. These tower-like upper stories are treated in interesting variety, not one side only, but all four as a unit, and the great ugly cornice is conspicuously lacking. What a relief to at last see business buildings designed in three dimensions!

"This new type of building is the result of New York's new zoning law. This law broadly stated, operates in two ways to bring about a more harmonious development of the city. First, by its "use regulations," it segregates the manufacturing plants from the retail sections and both from the residence districts. Second, by its "height regulations," it divides the city into districts in each of which the allowable height of the street facade has a definite relation to the width of the street, varying from street width to two and one-half times the street width. This limit is not, however, on the total height of the building, but on the vertical height at the building line. Above that limit buildings may be extended to a height limited only by economical considerations, but the portions above the limiting height must not extend beyond a diagonal line drawn through the center of the street and the limiting height at the street line. Other provisions effect the height on the rears, on courts, side streets, etc. In a general way, this means that above the height limit all buildings must be contained within a pyramid whose sides have a slope of about 75 degrees. Therefore, a

large building may rise to considerable height above the facade height limit, while a smaller building cannot economically be built much higher than that limit.

"It will be seen that this law has given the architect a new problem. He must use greater skill in planning in order to make it economically desirable to build to great heights, and at the same time he is given almost unlimited scope to his imagination in designing in three dimensions.

"While not a great number of buildings have been erected since this law was passed, the few that have been are so satisfactory, both economically and aesthetically, as to fully justify the law. A notable example is the Heckscher building, near Columbus Circle, designed by Messrs. Warren & Wetmore."

Mr. Chapin thinks that this style of tall building is destined to become the prototype for all American cities. He believes the idea could be applied on a smaller scale to our moderate-sized cities. It is true we need some remedy for the oft-repeated crime of treating architecturally only the street facades of our buildings, and allowing the other sides, perhaps more conspicuous than the embellished one, to glare at us with their bare common brick surfaces, ugly signs, and what-not. Some such regulation as New York's, would help to answer this need, and would do much to beautify our business sections.

MAKING HEADWAY OUT OF THE WOODS

In a big San Francisco factory recently a pessimistic director was advocating retrenchment and talking of business depression. Another director asked: "Jim, how far can a dog run into the woods?"

"Why, as far as he wants to, I suppose."

"No," replied the colleague, "he can only run to the middle. After

that he is running out of the woods."

Business, maintained this director, had long since passed the middle of the woods into which the war had flung it. It is now "running out of the woods." As success today is due to yesterday's preparation, so will success tomorrow be due to preparation, expansion, investments and planning of today.

Notes and Comments

AIMING FOR HIGHER STANDARDS

Greater cooperation with all classes of business, as well as greater development of the construction industry towards the establishment of high standards of ethics and efficiency is expected because of the election of Mr. Arthur S. Bent of Los Angeles, as Director for the Civic Development Department, Chamber of Commerce of the United States.

Mr. Bent is president of the Associated General Contractors of America, and is engaged in business as the senior partner of Bent Brothers, engineering construction, Los Angeles. In addition to the above mentioned activities, he is a member of the boards of directors of the American Concrete Institute, Southern California Concrete Pipe Association, Merchants and Manufacturers Association of Los Angeles, Rotary Club and Trustee of Pomona College.

Mr. Bent's practical knowledge and experience will be of great assistance in the work of the Chamber of Commerce, especially through the Civic Development Department, the special work of which is to give service and assistance on organization problems of local Chambers of Commerce, education, housing, city planning and zoning, citizenship, immigration, Americanization, and Civic Research.

STEEL AS AN ARCHITECTURAL MATERIAL

The Engineering Review, London

One of the difficulties with which structural steelwork has had to contend in the past in attaining its legitimate position for buildings other than workshops, has been that architects are trained principally from the artistic and historical standpoint and that they have regarded steelwork as inherently ugly.

This difficulty is a strange one from one viewpoint, because in a steel frame building the steelwork can be completely hidden and the external walls, which function only as fillings between the openings of the steelwork, can receive architectural treatment to follow any style or order desired. If architects are willing to take structural engineers into their counsels early in the development of the plans of a building much economy of materials can be effected and many vexatious alterations of plans avoided, and it is hoped that the younger generation of architects is being trained with due regard to the legitimate function of steelwork in construction, and that they will not adhere to older methods because they understand them better. The architect has to cover a very wide range of activities, in all of which it is humanly impossible for him to be a specialist, and one cannot see that he should regard it as derogatory to his professional standing for him to refer matters relating to steel construction to engineers who have specialized upon that class of work and who are familiar with its technical intricacies.

But a new school is arising among architects which objects to the hiding of the members upon which the building relies for its strength, and is opposed to "sham" wherever it can be avoided. It is from this school of architects that we may hope for much future prog-

ress in steel construction. As engineers we have always denied that steel structures are inherently ugly; in fact, we believe that there is close co-relation between efficiency and beauty. We believe that the architects can, and ultimately will, succeed in designing buildings with exposed steelwork that will give the necessary artistic effect for which the architects are legitimately striving; but the dictum as to the undesirability of putting new wine in old bottles applies here as in many other matters, and it will be necessary to cast right aside ideas of architectural form which were based upon stone block construction.

A PLEA FOR HARMONY IN COLOR

The Shrine convention, as an obligation, comprehensive of her unbounded hospitality, put San Francisco on her mettle. In no way is it apparent that San Francisco failed to discharge her duty—in many ways she seems to have succeeded beyond expectations—but of all the ways in which she could so express herself, perhaps the least regarded, but the best handled, was the purely artistic character of her street decorations.

Market street, from the ferry to the Civic Center, was decorated in a manner that did credit to the occasion; it was a well ordered plan of decoration. It was happily executed. It illustrated the wisdom of adopting a comprehensive design and of having it intelligently carried out.

It consisted of a uniform scheme of treatment, that dominated all elements of decorative effort; it suppressed the bad effect of individual attempts where same unfortunately failed, and at the same time it did not minimize individual effort where same was meritorious, but it dominated, and it established a precedent for future festive decorative schemes.

It was a success, for after all it was simple. It was so simple in design that it was uniform; therein was its value. Over and above all, it possessed color harmony. Red, green, and yellow—the colors employed—indiscriminately used by the thoughtless or unintelligent, resulted in many instances in a clashing of colors totally lacking in harmony, but in the official Market street scheme these same conflicting colors were made to blend in a harmony of soft tones—wit-ness the banners of rug shaped design that were hung on both sides of Market street, as contrasted with the garish buntings, as used by individual decorators through-out the same district.

The Panama Pacific Exposition, noted for its color scheme, owed its success in that regard to a well-considered plan, evolved by a group of internationally famous artists, working under the direction of Jules Guerin.

Is it not time that San Francisco should recognize that such success cannot be otherwise achieved? Is it not time that our local merchants adopt a policy of formulating for future celebrations—a plan based on the principles of design and color? San Francisco is supposed to know how, but she will lose her reputation unless she learns to know how. . . .

The same text, and the lesson it teaches, relating to color schemes, might well have been taken home by visiting Shriners. No doubt every Shrine Temple ever so often must order new uniforms. No Shrine temple wants its uniforms changed; that is where the point comes in.

Each temple, without changing its style of uniform, could, in ordering new ones, employ the best local artists to select and blend the reds, blues and green into harmonious tones, so as to avoid garish color conflict without adding to the cost of tailoring. Local temples could

vie with each other as to which one could achieve the most artistic result. The Couturieres of the Rue de la Paix owe their fame to their color harmonies.

Every country, in achieving commercial supremacy, has in doing so always become at once a patron of the fine arts. The United States is in that position to-day, and it is certain that the impending American Renaissance in art is destined to be the greatest in history.

Local merchants and the Shriners will probably lead this movement. Artistic expression will become a unit of measurement, by which the value of commercial success will be appraised.

WILLIS POLK.

San Francisco Building Permits.

Building permits in San Francisco for the first six months of this year indicate a steady increase in construction work. While complete figures for June are not available at this writing, the indications point to a very favorable total. The record for April and May as compared with the records for the same months in 1919, 1920, and 1921, is most encouraging, and indicates that building is not only back to normal, but is jumping ahead of the three previous years. The following interesting tabulation is furnished by Mr. J. P. Morgan, building inspector of San Francisco:—

	1919.	1920.	1921.	1922.
January	\$492,106	\$1,636,733	\$1,246,808	\$5,528,978
February	355,377	2,648,272	3,126,581	2,830,991
March	908,831	2,759,087	2,941,401	3,289,251
April	1,092,706	2,000,672	1,913,592	3,992,720
May	950,819	3,879,060	1,097,161	4,377,066

The permits issued during the last month were classified as follows:

Class.	Number.	Total.
A	2	\$185,000
B	4	460,000
C	30	901,440
Frames	243	1,365,358
Alterations	368	326,912
Public	1	97,991
	648	\$3,336,701

Since May, 1906, the building operations in San Francisco, as evidenced from the permits issued by the city, has reached the enormous sum of \$407,207,701.

The building permits issued in Oakland so far this year (five months) and for the same period in 1921 are as follows:—

	Permits	Value
1922	3435	\$8,773,659
1921	2843	5,181,468

With the Architects

Building Reports and Personal Mention of
Interest to the Profession

San Francisco Architect Honored.

The design by Mr. Lewis P. Hobart, Architect of San Francisco, for a memorial in memory of the world war heroes from Hawaii, has been selected from twenty other competitive plans by a jury consisting of Architects Bernard Maybeck of San Francisco, Ellis F. Lawrence of Portland, and W. R. B. Wilcox, of Seattle, the Governor of Hawaii, and the Mayor of Honolulu. The successful plan embodies a scheme providing for a temple of music, a plaza, and a coliseum, seating 6,000 persons, and surrounding a great natatorium. The movement to erect this monument was fostered by the American Legion of the island, and the necessary funds have been appropriated by the legislature. The buildings will cover about six acres, and future development of the park probably will include four acres more. Mr. Hobart's plan will be shown in a future number of this magazine. Messrs. Weeks and Day, San Francisco architects, received an award of \$500.00 for their design.

* * *

More University Buildings.

There is promise of three more pretentious buildings for the University of California campus in Berkeley in the near future. Mr. John Galen Howard, the University architect, has completed plans and bids are being taken for the new Haviland hall and also for a mechanics' building. Mr. Bernard Maybeck has been commissioned by Mr. W. R. Hearst to prepare plans for a new fire-proof girls' gymnasium and recreation building to replace the structure recently destroyed by fire on the campus. All three buildings will involve an expenditure of more than \$1,000,000.

* * *

Architect Headman Busy.

Contracts have recently been awarded by Architect August G. Headman, of San Francisco, for two business buildings on Sutter street, and plans are being prepared for a third structure on Mission street. Plans are being prepared by the same architect for a frame and stucco residence to be erected at Divisadero and Union streets, San Francisco, for Mrs. Margaret Butler, at an estimated cost of \$15,000, and plans have been finished or bids taken for a two-story frame apartment house at Marysville for Mr. Frank C. Powell.

Personal.

Mr. Phillip T. Primm has opened an office for the practice of landscape architecture in conjunction with the office of Architects Gable and Wyant, at 634 S. Western Ave., Los Angeles. Mr. Primm was formerly a member of the firm of Primm & Kortenhorst of Cleveland, and during the last two years has made a special study of California plantings and gardens.

Prof. Carl Thomas, an engineer, has been appointed a member of the Board of Directors of the city of Pasadena, succeeding Mr. Joseph Gaunt, resigned.

Fitting tributes were paid by city officials and citizens of Long Beach to the memory of Captain Albert deRuiz, former city engineer of Long Beach, who died May 29 of heart trouble, resulting from an attack of influenza. Mr. deRuiz was for nineteen years in the service of the city of Long Beach. He was a graduate of Annapolis, and was for many years in the navy.

Mr. Clarence L. Wilson, for twelve years engaged in architectural work and superintendence of building construction in Southern California, has been appointed general outside superintendent in the office of Architect W. Horace Austin, Long Beach, succeeding Mr. George F. Deatherage.

* * *

Los Angeles Odd Fellows' Hall

Architects Morgan, Walls, and Morgan, Van Nuys building, Los Angeles, are preparing drawings for a three-story and basement Class A store and lodge building to be erected at 11th and Flower streets, Los Angeles, for the Odd Fellows' Hall Association. The estimated cost is \$300,000.

* * *

Good Shepherd Home.

Plans are being prepared by Architect Albert C. Martin, Higgins building, Los Angeles, for a group of fireproof buildings for the Home of the Good Shepherd on Arlington street, Los Angeles, estimated to cost \$250,000.

* * *

San Pedro Hotel.

A four-story Class A hotel, to cost \$200,000, will be erected at Sixth and Mesa streets, San Pedro, for Mr. J. D. Finley, from plans by Architect William F. Bowen, Union League building, Los Angeles.

Six-story Apartment House.

Plans have been completed by Architects Sam L. Hyman and A. Appleton, Foxcroft building, San Francisco, for a six-story steel frame apartment house to be erected on the south-west corner of Powell and Pine streets, San Francisco, for the Oser Estate Corporation. There are to be 48 two and three-room apartments. The building will cost \$150,000.

* * *

Visits California Friends

A recent San Francisco visitor was Mr. Prentice Duell, well known architect and writer of Spanish architecture, and for the past year a member of the faculty of the University of Illinois. Mr. Duell is planning a course of study in the University of Pennsylvania next fall.

* * *

Color in Interior Decoration

The article on "Color in Interior Decoration," by Mr. John Chapman in the June number of *The Architect and Engineer* should have been credited to California Southland in which publication the article first appeared.

* * *

Six Stucco Homes.

Six frame and stucco homes, to cost from \$11,000 to \$13,000, are to be erected on Taylor street, near Jackson, San Francisco, from plans by Architect E. H. Hildebrand, 110 Sutter street, San Francisco.

* * *

\$100,000 Apartments.

A six-story class C store and apartment house will be erected on the south-west corner of Geary and Jones streets, San Francisco, for the S. and G. Gump Realty Company. Mr. Milton Latham, 454 Montgomery street, San Francisco, is the architect.

* * *

Store and Office Building.

Plans have been completed by Architects Righetti and Hirschfeld, of San Francisco, for a two-story class C store and office building on Columbus avenue, San Francisco, for Mr. Edward Cerruti. The improvements will cost \$45,000.

* * *

Stockton Architects Organize.

The Stockton Architects' Association has been organized with Messrs. Glenn Allen president; W. J. Wright vice-president, and J. M. Burke secretary. The association will hold an annual exhibition every January.

* * *

New School for Redding.

Plans are being prepared by Architects Woollett and Lamb of Sacramento, for a large two-story schoolhouse at

Redding, Shasta County, to cost \$110,000. There are to be ten classrooms and an auditorium.

* * *

Sacramento Skyscraper.

Architects George C. Sellon and Company, Mitau building, Sacramento, have been commissioned to prepare plans for a twelve-story class A store and office building for the California State Life Insurance Company, at Tenth and J streets, Sacramento, at an estimated cost of \$700,000. The building will contain approximately 250 offices. The exterior will be of pressed brick and terra cotta, with granite base. The Lindgren Company will be managers of construction.

* * *

Two Oakland Hospitals.

Two new hospitals are to be built in Oakland this summer—one by the Fabiola Hospital Association, consisting of a \$200,000 annex, from plans by Architect George W. Kelham, of San Francisco; and the other, a five-story \$600,000 structure for the Sisters of Providence at Webster and Summit streets.

* * *

Berkeley Stores.

Plans are being prepared by Architect W. E. Schirmer, of Oakland, for a one-story brick store building at Shattuck avenue and Haste street, Berkeley, for Mrs. Milicent Merriweather. Mr. Schirmer has also made plans for several residences in Oakland and Berkeley, and alterations to a commercial garage on San Pablo avenue, Oakland, for stores and apartments.

* * *

Five-story Apartment House.

Mr. James Duvaras has had plans prepared by Architect Henry Shermund, Hearst building, San Francisco, for a five-story concrete apartment house on the north-west corner of 8th avenue and Fulton street, San Francisco, to cost \$130,000.

* * *

Building for Santa Clara College.

Working drawings are being completed by Architect John J. Donovan, Pacific building, Oakland, for a three-story reinforced concrete science building, 59 x 160, with terra cotta tile roof and white cement exterior, for Santa Clara college. Cost of the structure is estimated at \$150,000.

* * *

San Jose Lodge Building.

The San Jose Knights of Columbus will construct an \$85,000 store and lodge building from plans by Architect Leo J. Devlin, Pacific building, San Francisco.

Distinction for San Francisco Bay

AUSTIN WHITTLESEY, whose pencil drawing is reproduced on this page by courtesy of Pencil Points, is a San Francisco boy, at present a member of the staff of Mr. Bertram Grosvenor Goodhue's office in the East. His early



Pencil Sketch, Carmona, by Austin Whittlesey.

training was with his father, Mr. Charles F. Whittlesey, and other architects in San Francisco, including Mr. Lewis P. Hobart. Young Whittlesey early reached the conclusion that Mr. Goodhue was the only man who could give him the training in architecture he wished and he journeyed to New York when he was twenty years old with the fixed purpose of entering Mr. Goodhue's office. It was, however, two years before Mr. Goodhue would take him on, and in the meantime he worked in the various architectural offices in New York and for a time in Cleveland, O. For the past seven years Mr. Whittlesey has been with Mr. Goodhue, excepting the time he spent in the army and in traveling abroad. He won the Le Brun Traveling Scholarship in 1916 and elected to go to Spain and North Africa to study.

Both in San Francisco and in New York, Mr. Whittlesey belonged to ateliers, following the course of the Beaux-Arts Institute of Design. The example and criticisms of a number of his artist friends in California aroused in Mr. Whittlesey an interest in sketching out of doors, a practice which he has continued more or less intermittently, and with results that are suggested by the repro-

duction of the example of his pencil to be seen in this issue.

* * *

Y.M.I. Building.

Architects Shea and Shea, Chronicle building, San Francisco, have completed plans for a \$100,000 annex to the Young Men's Institute building on Oak street, San Francisco. The same architects are preparing working drawings for a new Elks building in Santa Rosa, to cost \$250,000. The structure will cover ground area 200 x 150, and will have steel frame, concrete walls, and pressed brick and terra cotta exterior.

* * *

Apartment House and Residence.

Plans have been completed and bids taken for the construction of a three-story frame apartment house at Larkin and Geary streets, San Francisco, for Dr. Weiss. Mr. John K. Branner is the architect, and he has also made plans for a residence in Palo Alto for Mr. Jesse Whitehead and a house at Stanford University for Mr. C. F. Hoiman, Jr.

* * *

Architect to Build Apartments.

Architect Henry C. Smith will build a five-story class C apartment house for himself at Green and Taylor streets, San Francisco, at a cost of \$100,000. Monson Bros. will be in charge of construction. This same firm has the contract to build a three-story telephone exchange at Stockton, to cost \$86,000; also a brick warehouse on Presidio avenue, San Francisco, for the Independent Oil Company.

* * *

Branch Bank Building.

Architect Herbert Schmidt has completed plans for a class B reinforced concrete and brick branch bank building, to be erected at Clement street and Seventh avenue, San Francisco, and to be known as the Park Presidio branch of the San Francisco Savings and Loan Society. The structure will cost approximately \$130,000.

* * *

Partnership Formed.

Architect Albert Farr, Foxcroft building, San Francisco, has taken into partnership for the practice of architecture, Mr. J. F. Ward, formerly of New Zealand, and a member of the Institute of Architects there. The firm name will be known as Albert Farr, architect, and J. F. Ward.

* * *

Granted Certificates to Practice.

At the meeting of the California State Board of Architecture, held June 6th, the following were granted certificates to practice architecture in this state:—Mr. Andrew T. Hass, 2124 Eagle avenue, Alameda; Mr. Lester W. Hurd, 3125 Arkansas street, Oakland.

Pennsylvania Academy Prizes.

The board of directors of the Pennsylvania Academy of Fine Arts announce the following major awards and prizes:—The Stewardson prize in sculpture was awarded by a jury of sculptors, composed of Messrs. Albert Laessle, Maxwell Miller, and Samuel Murray, to Mr. Victor V. Slocum; honorable mention to Miss Evelyn Peabody; the Stimson prize in sculpture was awarded by a jury of sculptors, composed of Messrs. Albert Laessle and Frederick Roth, to Miss Mildred Sartelle; honorable mention to Mr. Benjamin Kurtz. The Ramborger prize was awarded by the faculty for the best drawing in black and white of a head from life by a student of the academy who has not been under instruction for over two years to Mr. William Schulhoff. The Thouron prizes in composition are awarded as follows:—The prize, decided by the vote of the faculty, for a group of three compositions upon subjects given to the class during the current year, to Mr. Joseph Mielziner; the prize, for a similar group, decided by the vote of the students of the composition class, to Mr. Ralph Taylor.

* * *

Lodi High School.

Working drawings are being completed by Architects Wright and Saterlee, of Stockton, for a group of high school buildings at Lodi, to cost \$250,000. All the buildings will be of brick construction, and the group will include an auditorium, science building, domestic and manual training shops, and a wooden grandstand.

* * *

San Francisco Business Building.

Plans are being prepared by Architect N. W. Sexton, Chronicle building, San Francisco, for a three-story and basement mill construction office and loft building for the Collins-Hencke Candy Company. The location is the north line of Folsom street, between 2nd and 3rd streets, and estimate of the cost of the work is placed at \$100,000.

* * *

Santa Monica Hotel.

A class A reinforced concrete hotel is being designed for Santa Monica by Architects John and Donald B. Parkinson, Title Insurance building, Los Angeles. The owners are Dr. F. J. Wagner and Mr. F. E. Bundy.

* * *

Country School Work.

Architect Chester Cole, of Chico, is preparing plans for an auditorium and four-room grammar school at Los Minos, to cost \$28,000; also a four-room and auditorium frame and plaster grammar school building for the Shasta Union school district, to cost \$40,000.

Schools Use Electric Towel.

Apropos of the many innovations noted in school and college architecture, it is interesting to observe the progress made by Airdry, the electric towel, in the educational field. Many of the most prominent educational institutions of America have already installed this sanitary appliance. Several machines are already in use at the University of California, and contracts have been signed for additional installations in buildings now in course of construction on the Berkeley campus, Harvard, Cornell, Columbia, University of Chicago and Massachusetts Institute of Technology. The Boston city school department have been users of Airdry for some time.

* * *

Removal Notice.

Mr. S. S. Herrick, formerly of the Vulcan Iron Works, San Francisco, and more recently with the Moore Shipbuilding Co., wishes to announce that the steel fabricating shop recently operated by him at the foot of Adeline street, Oakland, has been moved to 18th and Campbell streets, Oakland, and the name of the business has been changed from S. S. Herrick Co. to the Herrick Iron Works. No change has been made in the personnel, which includes S. S. Herrick, general manager; Chas. W. Broyles, manager of sales; and Henry U. Oliphant, engineer.

* * *

Group of School Buildings.

Revised plans are being made by Architect W. H. Ratcliff, Jr., First National Bank building, Berkeley, for a group of school buildings of fireproof construction, and which will occupy a block of ground in Berkeley for the Pacific School of Religion. The first unit will be a library costing \$125,000. Eventually the school will spend \$1,000,000 on the project.

* * *

Frame Apartment House.

Plans have been completed and bids have been taken by Architects Ashley and Evers, 58 Sutter street, San Francisco, for a \$40,000 frame and plaster apartment house for Minna D. Pischel. The building will be located at Pine and Joyce streets, San Francisco, and will contain eighteen two and three-room apartments.

* * *

Architects Going Abroad.

Architect William Arthur Newman of San Francisco, who is first vice-president of the Society of Constructors of Federal Buildings, and Mr. Walter C. Falch, also of San Francisco, sailed June 10 on the White Star liner Majestic for a four months' trip abroad.

With the Engineers

American Association of Engineers Annual Convention

The eighth annual convention of the Association was held in Salt Lake City on June 5, 6 and 7. The following were the important discussions and actions of the meeting:

The reclamation of arid and swamp lands was endorsed and also the Smith-McNary Bill now pending before Congress.

The appointment of an engineer executive on the U. S. Civil Service Commission was urged; and A. B. McDaniel recommended for appointment.

Prompt action by Congress on the bill to aid federal employes (H. R. 8928) was recommended.

An official statement of the policies of the Association to railroad executives was authorized to acquaint them "with the real objects of the A. A. E.; the betterment of the conditions of the engineer, the education of the public as to the dignity and importance to civilization of the profession of engineering, and that the best interests of the profession, as such, call for loyalty to, co-operation with and devotion to the interests of the client or employer, whether corporate or individual."

Action by Congress to relieve the labor shortage in Hawaii was urged and support of Joint Resolution 171 H. D. recommended.

Service to special classes of engineers was recognized and urged by the Association as a whole rather than by action as classes.

Close co-operation with business clubs was urged and provided.

Provision was made for support of work or local units by granting them 40 or 60 per cent of the annual dues, depending on the amount of work undertaken by the local units.

A. N. Johnson, Dean of Engineering, University of Maryland, and George E. Taylor, Consulting Engineer, Charleston, W. Va., were elected respectively president and first vice-president for the ensuing year. * * *

The Engineer as a Salesman

The engineer is making good as a salesman, according to the Industrial Digest, which quotes Mr. George B. Pegram, Dean of the Engineering Schools of Columbia University, as follows:

"From conversations with employers, and from a general discussion of the subject, I am convinced that there is a greater demand now than formerly for men with engineering training in the

sales department. I have no statistics upon which to base this opinion, but I believe it to be true. Business has developed in such a manner that technical training is absolutely necessary to a man who wants to sell certain kinds of goods.

"For instance, it is hard to see how the General Electric Co. could sell its goods at all without the aid of men with technical knowledge. The same is true of all concerns which deal in machinery. A man buys a machine because he thinks it will be the most economical means of obtaining the results he wants. Since the determination of the most economical methods of obtaining a given result is an engineering problem, it is natural that engineers are well equipped to sell goods that are bought on that basis."

Dean Pegram was asked if he thought that an engineer loses any of his professional standing when he becomes a salesman.

"No. Selling is just as professional as any other branch of engineering," he replied. "Salesmanship is a field in which a man can display all the high qualities of an engineer. A good engineer-salesman will co-operate with his customers and not try to put something over on them. He will sell them the goods they really need, instead of unloading his inferior stocks on them. And, as business is done today, there is room for such a man to succeed."

The best field for the technically trained salesman is, of course, a field in which the product is used by other technical men for technical purposes. An engineer is naturally adapted to sell such things as electrical goods, machinery, chemicals, and steel products. But this new type of salesman is not confined to these lines. He is appearing in all trades: selling stocks, office specialties, and even ladies' waists. * * *

Engineer Is Needed

It is estimated that 10,000 engineers and scientists are employed in the classified Government service—nearly all men engaged on highly technical work and selected for technical qualifications. As a large class they are the highest paid employes in the Government service. Purely engineering and scientific expenditures of the Government amount to a considerable part of the budget omitting public debt and national defense.

The civil service commission should have at least one member able to judge accurately of employee qualifications from personal experience in technical work. Moreover, with the proposed reor-

ganization of the Government departments and the probable reclassification of the Federal service the civil service commission will play an important part and will require the service of a technically qualified man. A well qualified technical expert should be appointed to fill the present vacancy on the commission. Growing interest is felt in the recent announcement that President Harding would appoint such a man.

Hints for Job Getting

Some useful suggestions on securing positions are given by the Voluntary Committee of the Employment Service of the American Society of Civil Engineers in the May Proceedings of the Society, the following being some of the more important paragraphs:

1. Decide on what you want.
2. Make sure your qualifications give you an even chance of getting it. Do not think 100 per cent is necessary. Perfection does not exist.
3. Do not go after a job unless you mean business.
4. There are three factors to every job, viz., advancement, experience, salary. Do not ignore the first two.
5. Remember that the job gets the salary, not the applicant's qualifications.
6. Job getting is selling one's services. The successful salesman knows his product thoroughly. Study your goods.

Letter Writing

1. The object of a letter is to get an interview. Letters do not get jobs.
2. Padding of payrolls is a felony. Padding of letters is equally dangerous for the job hunter.
3. A letter must: Arouse interest; create desire; prove the case; and convince the reader that an interview will be profitable. Therefore: Be as brief as is consistent to prove your claims. Make no claims not backed by the experience record. Always include the experience record.
4. Attractive packages improve the sale of goods. Therefore, typewritten letters on plain business stationery are better than long-hand letters on club or personal stationery.

Interviews.

The interview is "the day in court." Getting it is only one-half the battle. When being interviewed:

1. Be confident of your work, but not presumptuous.
2. Be sure you want the job and be ready to prove why you should get it.
3. Ask a fair market price for your goods. Do not profiteer. Do not be a philanthropist.

4. Assay the three elements: Advancement, Training, Salary, and be guided by the sum of the three in accepting or declining.

5. Leave in a pleasant, hopeful manner if the job is not decided then and there.

6. A letter of acknowledgment of the courtesy of an interview is good policy following a promising call.

Finally, maintain the proper mental attitude. Do not let your morale slump. No one wants a grouch or a man who is not sure of himself.

WHAT INTERESTS ENGINEERS?

A study of the kind of meetings members want was made by the Seattle Chapter. Returns from questionnaires asking the preference of members were as follows:—

	Weighted Total.
1. Activities for meetings.	
Civic enterprises	107
Industrial enterprises	93
Power and utility projects	89
Roads, highways, and bridges	85
Railroads and street railways	55
Radio, telephone, and telegraph	48
2. Outside speakers on following classes of subjects:	
Engineering	134
Banking	57
Elements of success	57
Political	50
Efficiency	48
Psychology	43
Chamber of Commerce	22
3. Trips to industrial plants on Saturday afternoons. (Kind of plants preferred.)	
Construction projects	78
Manufacturing plants	71
Electric, steam, and hydraulic	62
University laboratories	31
Highways	31
Buildings	28
Shipbuilding and repairs	24
Newspaper	15
Street railway repair	13
Canning	11
Candy	3
Mattress	3
4. Social affairs.	
Music	81
Dinners	77
Ladies' nights	49
Picnics	42
Trips to other chapters	37
Dances	37
5. Miscellaneous suggestions.	
Other subjects suggested (not in questionnaire).	
Salesmanship—Business for engineers—Mechanical engineering—Extemporaneous talks by members three to five minutes each—Members to speak at noon lunches.	
Two state that all of these activities are desirable.	
Trips good if properly organized so all can see and hear.	
Smokers (several votes).	
Construction management, estimating, and costs.	
Talks on general economic conditions—analysis of engineering field.	
Plants manufacturing construction materials.	
Sports.	
Bridge, whist for those who do not dance.	
"Meetings should start on time."	

A Novel Testing Tower

By DOSIER FINLEY

Director of Research, The Paraffine Companies, Inc.²

THE Paraffine Companies, Inc., at its plant at Emeryville, California, has built a novel tower for the testing of waterproofing materials. The tower is designed to duplicate, so far as possible, the actual conditions to which such materials are subjected and to permit of tests of long duration.

Instead of external water pressure being applied as in a basement wall, the pressure comes from within the tower, thus permitting the observations on the wall structure to be made from the outside. The material under test is built into the wall of the hollow tower and water is admitted to a predetermined height. Several tests may be conducted simultaneously by building in test portions at several points around the base of the tower. Tests under different pressures may be conducted at the same time by building in the test portions at different heights in the side walls.

An interesting feature of the construction is that there is interior illumination. Peep holes covered with heavy plate glass permit of observation on the pressure side of the material while under test.

An important element of waterproofing often overlooked is that many materials are so nearly waterproof that the slight leakage which takes place through them is swept away by evaporation on the dry side of the structure. It is only when such a material is applied in a situation where there is no ventilation, and consequently no opportunity for evaporation, that its failure to give full waterproofing protection is detected. On the tower erected by The Paraffine Companies, Inc., a box-like cell may be placed against the dry side of the portion of the wall under test and any leakage, however slight, may be picked up by absorbent chemicals and the water weighed on a chemical balance. In this way the observer may determine a passage of water too minute to be detected under ordinary conditions.

Among the products which may be tested on the tower are Impervite Waterproofing for cement mortars and concrete, Pabco Membrane Waterproofing Felts, Malthoid Damp-proofing, Floatine and Pabco Bituminous Enamel.

²This department is maintained for the purpose of rendering technical service and giving the benefit of its experience to architects, engineers, chemists, and, in fact, all who desire to avail themselves of its facilities.



NOVEL TESTING TOWER

Built by the Paraffine Co., Inc.

The tower is of great value for long term tests under the pressure which may be obtained under the head of water carried by the structure. For higher heads shorter tests are usually made. Suitable apparatus is in the laboratories of The Paraffine Companies, Inc., for carrying out pressure tests on membrane waterproofing material and all kind of bituminous waterproofing products up to pressures of 300 pounds per square inch, which is far above that usually encountered in service.

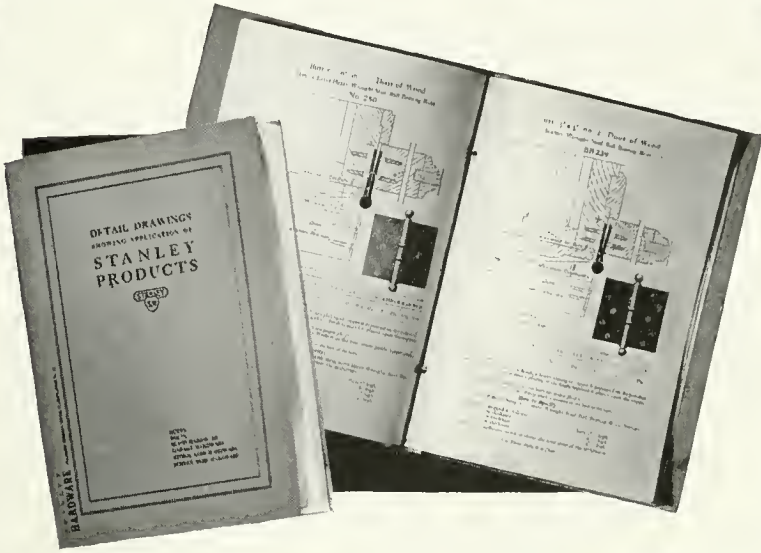

Now Ready!

Detail Manual conforming to the requirements of the American Institute of Architects—in size, copy and general arrangement.

Shows correct application of
**STANLEY Butts,
 Bolts,
 Blind Hardware,
 Storm and Screen Hardware,
 Garage Hardware.**

This Manual is divided into 5 separate sections, each section a complete book in itself.

Can be filed complete, or may be separated and filed under separate classifications.

Drawings, 127 of them, were made by architects, and are drawn to scale.

"How to Specify" is given in every case.

Write Today for Detail Manual No. AE-7



THE STANLEY WORKS

NEW BRITAIN, CONN.

New York Chicago San Francisco Los Angeles Seattle

*Specialists in
 Wrought Steel Specialties*

The Contractor

CONSTRUCTION FORCES UNITED.

HON Franklin D. Roosevelt, formerly Assistant Secretary of the Navy, was formally elected president of the American Construction Council at the end of a two days' session held in Washington, D.C., June 20-22. Mr. John B. Larner, vice-president of the American Bankers' Association and president of the Washington Loan and Trust Company, was elected treasurer.

During the two days' session 200 architects, engineers, general contractors, sub-contractors, construction labor, material and equipment manufacturers and dealers, financial, bond, insurance, and real estate interests, public utility construction departments, Federal, State, County, and Municipal Associations met to consider what should be done to put the construction industry as a whole on a higher plane and to determine ways and means of working together to that end.

The immediate program of action suggested for the new council as a result of these deliberations includes:—

The formation of a code of ethics acceptable to the whole industry and to the public;

The gathering of adequate statistics from all sources and resulting interpretation having all the facts;

The reduction of the national shortage of building trades mechanics and the establishment of the necessary apprenticeship system;

Co-operation in establishing uniform building codes throughout the country;

Co-operation with the railroads in expediting the revision of existing freight rates on construction materials. The establishing and strengthening of local organizations throughout the country to bring about the co-operation of all elements in conformity with the principles of the council;

The mitigation of the evils of seasonal employment and trade migration of labor;

The encouragement of local building shows;

Simplification, standardization, and elimination of waste;

Education of the public to the distribution of its construction and maintenance requirements more evenly throughout the year;

The promotion of health and safety of workmen;

The reduction of loss of life and waste of construction materials from preventable fires;

The study of old buildings in order to establish superior methods of construction;

The education of the public as to the necessity and economy of properly maintaining existing structures.

Mr. Walter Gordon Merritt, attorney in New York City, emphasized the need of the co-operative action that the council will bring about.

"The evils of the construction industry," he said, "are the evils of organizations, not the evils of individuals. These evils have come about because of the

selfish aims of the individual organization. The need is to restrain these selfish aims, and to have each group lay down a code of practice, which must pass the judgment and be in accord with the rules and principles of the American Construction Council."

In stressing the necessity to work hand in hand with labor, he said that the organized labor movement is big enough to meet with and discuss its own problems with any of its critics.

"If we all meet and reason together," he continued, "we shall think, feel, and act together. The relation at the present time between employers and employees in the building trades is one of periodic armistice. This council must work out a plan of common counsel and joint action.

"One of the most important things which the council must work out is a method of arbitration. All contracts should be subject to arbitration in accord with the rules of the council laid down by men of practical standards.

"One of the greatest evils in the industry is the bargaining with corruption for fear that any attempt to uncover that corruption will embarrass future relations."

With reference to jurisdictional disputes, he stated that it is not legal to restrict the construction of metal doors, for instance, to metal workers or any particular work to any particular group of workmen. He held that the employer should be free to hire anybody for any job who can do the work for the wage paid, and that the need was for a broader craftsmanship rather than a more highly specialized one.

"This council," he concluded, "must work out these problems. It must work through common counsel, co-operation, and education. Such collective action will not stifle American individualism, but rather such collectivism will further that individualism. We unite to further liberty, not to restrict it."

Mr. Robert D. Kohn, architect from New York City, in speaking on the necessity of serving the public and industry through local action, stated that the greatest cause of labor problems is the uncertainty of the job of the workman. He described local activities to eliminate such uncertainty in Boston, New York, and Seattle, and emphasized that local effort was necessary to bring about the best man to man relationships in the building trades.

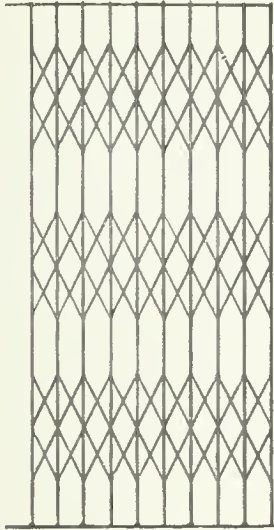

Folding Gates

Ornamental and Miscellaneous
Iron Work

Steel Sash :: Wire Work

Michel & Pfeffer

Harrison and Tenth Streets
San Francisco

Iron Works

Phones { Market 730
Market 731

KENNEDY

RADIATOR VALVES

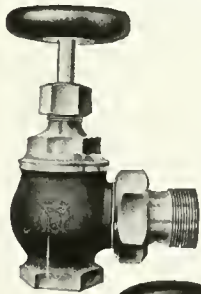

Unfailing reliability of service, reasonable prices and the guarantee of satisfaction that a long established company is able to furnish, make Kennedy Radiator Valves the best buy for steam and hot water service on the market.

We can honestly recommend them for use anywhere, and invite a close scrutiny of those points of design and construction that sets them apart as decidedly superior. They come in every desirable type—straightaway, angle, offset, corner, etc.

Other Kennedy Valves for handling water, steam, oil, acids, gas, alkalis, etc., in more than 500 distinct types and sizes are at your service. Our catalogue illustrates and lists them all. Send for a copy.



THE KENNEDY VALVE
MFG. CO., ELMIRA, N.Y.



Branches and Supply Depots:
NEW YORK, 95 John Street BOSTON, 17 India Street
SAN FRANCISCO, 23-25 Minna Street
CHICAGO, 204-8 N. Jefferson Street

Sales Offices:
Philadelphia Salt Lake City Seattle El Paso

When writing to Advertisers please mention this magazine.

Mr. Henry H. Kendall, past president of the American Institute of Architects, stated that the architects were happy to be among those who are participating in the organization of the council.

"We see in it potentialities far beyond its present capacity," he said, "and we hope soon to see them realized in actual achievements. We shall gladly give to it our best efforts and co-operation to achieve these so much desired results.

"We are to bring together a group of men, vitally interested in different phases of the building industry—an occupation in which, directly or indirectly, almost every trade and industry is represented—and by our counsel and advice solve the many problems which have arisen and will continue to arise between groups and trades; to fix standards and formulate rules of conduct which shall govern our business relations, and promote goodwill, efficiency, and fair play in building and construction."

* * *

Rail Cars and Motor Busses Make Time on New York-New Haven Run.

A DIRECT comparison of the performance of gasoline rail cars, gasoline motor busses, and a regular railroad train was made for the first time, April 21, 1922, when a party of sixty-five automotive engineers journeyed by all three methods from New York to New Haven, and return. The party, consisting of members of the Metropolitan Section of the Society of Automotive Engineers, witnessed this unusual demonstration in attending a joint meeting with the New England Section of the society at the Sheffield Scientific School of Yale University. It was made possible through the co-operation of the New York, New Haven, and Hartford Railroad and the International Motor Co.

The trip from the headquarters of the Society at 29 West Thirty-ninth street, New York, to the Harlem River terminal of the New Haven road was made in two Mack twenty-five passenger motor buses, where the rail cars were waiting. The rail cars were two of the three Mack rail cars, the two Mack busses started system, and took the party from New York to New Haven. The trip from the Harlem River to New Haven, 67.2 miles, was made in two hours and 40 minutes, an average speed of 25 miles per hour. Simultaneously with the departure of the rail cars, the two Mack busses started for New Haven by road, arriving there just 42 minutes later than the rail cars. The distance by road, as given by the Automobile Blue Book, is 70.3 miles, the

time of the busses being three hours and 22 minutes, an average speed of 21 miles per hour. The return to New York was made on one of the fast electric trains of the New Haven road, the return trip being to the Grand Central Terminal at Forty-second street, 72.3 miles. The train schedule called for one hour and 58 minutes for this distance, an average speed of 36½ miles per hour.

A comparison of these performances is interesting, not because the three types of transportation equipment may ever be expected to compete, since each occupies a distinct field, but because it shows the flexibility and adaptability of automotive equipment as applied to passenger transit. The train, of course, was a fast, long-distance express train, consisting of mail, baggage, and express cars, coaches, Pullmans, and a diner, with accommodations for about 350 passengers. The rail cars were provided with seats for 35 passengers and a compartment for their baggage. The busses seated twenty-five passengers. The electric locomotives are capable of pulling such a train as this as fast as 70 miles per hour. The gasoline rail cars can do 40. The busses can be operated safely at 30 miles per hour. The performance of none of the three represents its maximum capabilities, since the train and the rail cars were held down below their maximum speed by their schedules, the busses by speed laws on the highways.

The demonstration did show the flexibility of gasoline equipment, both on the highway and on the rails, however—a flexibility which steam and electric railway equipment both lack. On the particular route covered the density of traffic unquestionably makes the regular steam or electric train the most economical and satisfactory to the public, since frequent service can be given with well-filled trains.

In a short talk given by Mr. W. L. Bean, mechanical assistant to the president of the New York, New Haven, and Hartford Railroad, during the meeting at New Haven, he stated that the railroads were deeply interested in the possibilities of gasoline rail cars in turning operating losses on branch lines into profits, and bespoke the co-operation of automotive engineers in assisting in the greater development of automotive railway equipment. The meeting was devoted to an inspection of an automobile chassis testing dynamometer in the mechanical engineering laboratory of the Sheffield school and an address on power losses in automotive chassis by Prof. E. H. Lockwood.

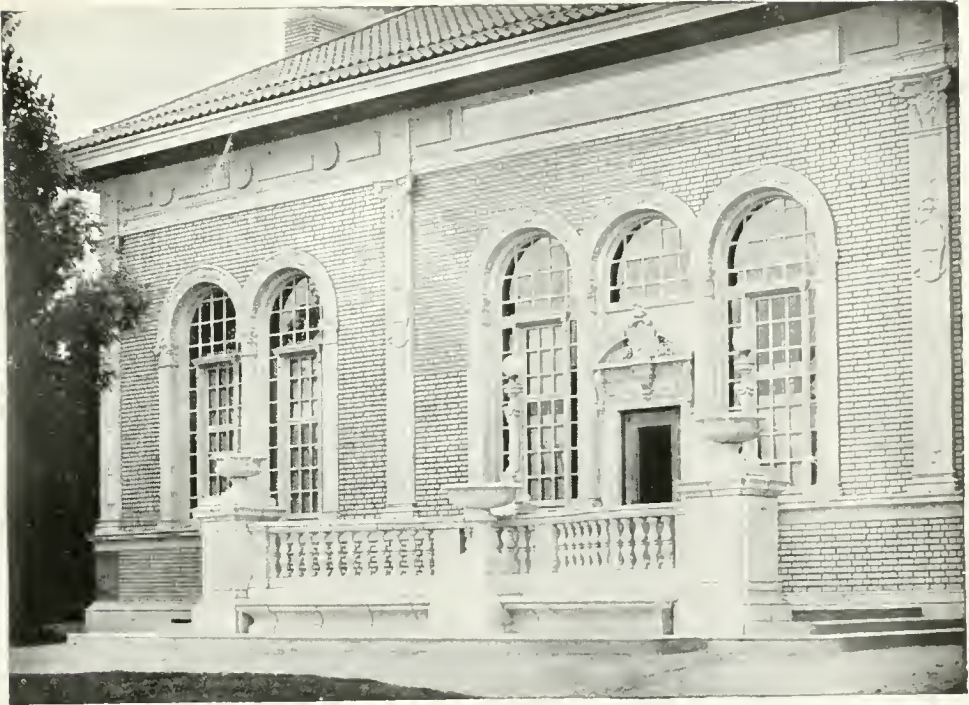

HIGHLAND PARK BRANCH LIBRARY
DENVER, COLORADO
J. B. BENEDICT, Architect

Richness attained economically and with good taste
by the use of Ivory Unglazed Terra Cotta
for all decorative detail

PERPETUATING *an Initial* ECONOMY

FOR expressing ornamental design, Terra Cotta is more economical than any other permanent material.

This results from the fact that repetition of ornament is effected in Terra Cotta by means of molds that are cast from an original model. Thus the costly item of hand-carving on each specific unit is eliminated. And the cost of the original model is distributed, fractionally, among all the repeated units.

The initial economy is perpetuated under all climatic conditions when proper construction and proper relation with other materials have been assured by intelligent design and by competent supervision in erecting. This is attested by numerous examples throughout this country and Europe.

Send for our literature on Terra Cotta showing its wide range of ornamental effect. Address National Terra Cotta Society, 19 West 44th Street, New York, N. Y.

TERRA COTTA

Permanent

Beautiful

Profitable

Modern Skylight Development

As soon as primitive man began to roof his dwellings he was confronted with the problem of securing light and ventilation. Windows and chimneys developed naturally.

When civilized man began to erect temples, workshops and mercantile establishments he found that windows alone could no longer be depended upon for lighting, and began the development of skylights.

Ever since the use of the first primitive skylight, builders have found that glass breakage and leakage were the two chief enemies that had to be overcome.

Breakage is due to deflection of the supporting members and improper methods of separating and cushioning the glass.

Leakage, aside from that due to breakage, is caused by the use of unsuitable materials for separating and cushioning the lights of glass. Because of the expansion of glass it is essential that these materials be of such a character that they will yield to the expanding of the glass under the heat of the sun, and will retain its contact when the glass contracts.

Because of glass expansion and contraction, putty, which was the first material to be widely used as a glass seal, proved unsatisfactory, and designers of skylights turned to metals and other materials.

The use of metals of different compositions has often resulted in electro-couples which quickly corrode the supporting members, resulting in the failure of the skylight. Where materials other than putty have been used they have been successful for a time and then deteriorated, allowing the entrance of moisture, the lights to rest on hard bearing surfaces, and the metal parts of the support to rust and ultimately fail.

In any type of skylight the differences in temperature between the outside and inside of the building cause condensation to form on the lower side—though this is minimized where double glazing is used—and to drip from the supporting metal parts. This has been overcome in certain types by using gutters attached to, or made a part of the supporting members, but this, in turn, has caused corrosion to eat away the supporting members and destroy the life of the skylight.

These defects have resulted in the construction of a skylight supported by rolled steel bars that are always strong and stiff enough to support the skylight load without deflection, the strength of the bars being easily calculated so that architects and engineers are able to quickly prove whether or not they have the right bar for a given span.

The bar, in turn, is protected from corrosion by a condensation gutter resting on the bar, but not a part of it, this gutter being made either of Robertson Process Metal, which is rust proof and prevents electro-couples, or of any other durable metal specified.

To overcome defects encountered in most cushioning members, a special asphalt is used for the glass rests, the lower part of the cushion being in the form of an inverted letter "T," so that the glass is free from contact at all points with the supporting bar and from the next adjoining horizontal light.

The cushion is of a special asphalt that will not flow with the heat of the sun and will not allow the glass to squat down on the metal support, yet will adhere to the glass and allow it to expand and contract without breakage.

To prevent the entrance of moisture from above, an asphalt filler of the same composition is used, being held in place by a metal cap, the filler and cap being formed like an inverted letter "U."

Bolts of brass, or other materials that will better meet special conditions, extend from the filler cap down to the bar, but are separated from the glass by means of the asphalt cushion and filler. As no moisture can reach the inner bearing surfaces of the bolt there is no danger from the creation of electro-couples.

One example of satisfaction resulting in repeat orders of Robertson skylight is indicated by the following: In 1917 the H. G. Prince Company of Oakland installed a 2,000 sq. ft. skylight of the modern type described. The skylight was made of Robertson Process Metal, which has for its base a steel sheet enveloped in turn with asphalt, asbestos felt and waterproofing, which renders the steel immune to the action of steam, gases, acids, salt air, alkali, smoke and fumes. Since its installation not a single drop of rain or moisture has fallen inside the building although subjected to steam conditions within and salt atmosphere without. This resulted in the Prince Company again using over 3,000 sq. ft. of this skylight for their new pea canning factory just completed, Mr. Maury I. Diggs, architect.

A skylight of the design described is also being made with an adjustable bar which overcomes difficulties encountered when skylights are fabricated to meet a specified curb width and when the builders for any reason vary from the specified width.

* * *

NEW ACID PROOF DRAIN PIPE.

A new acid proof drain pipe made of Corrosiron, the well-known acid resisting iron, is announced by the Pacific Foundry Company of San Francisco.

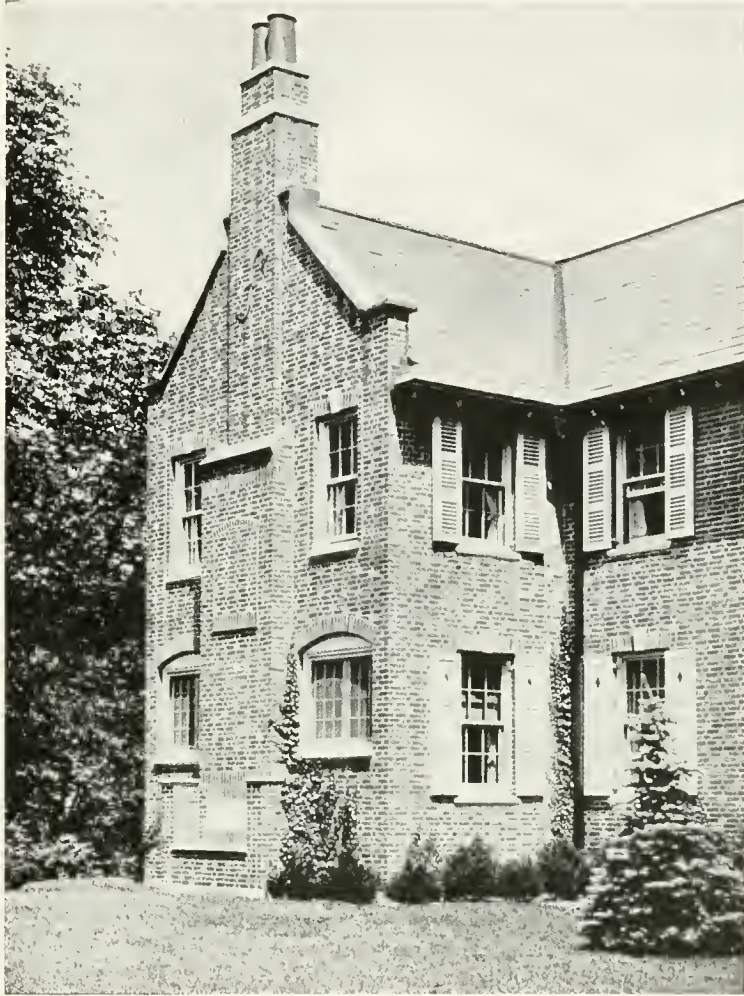

A F. B. A.
USE FACE BRICK
—it Pays

Gable of Residence, West Newton, Mass. Frank Chouteau Brown, Architect

The English type of house lends itself naturally to the genius of brick. The architect here has made the chimney breast the motive of a treatment in brick at once distinctive and beautiful.

Distinctive Treatments of Face Brick Walls

INTERESTING and attractive effects in the Face Brick wall are not necessarily dependent on special forms and sizes. An almost infinite variety of distinctive treatments is possible by the use of standard sized Face Brick—and thus secured at the greatest economy. More than a hundred examples of fine brickwork in standard sized Face

Brick are shown in the portfolio of "Architectural Details in Brickwork." Many architects have expressed themselves as delighted with the beauty of the plates and their richness in suggestions.

A set of these plates, in three folders with printed tabs ready for filing, will be sent to any architect requesting them on his office stationery.

AMERICAN FACE BRICK ASSOCIATION

1759 PEOPLES LIFE BUILDING • CHICAGO, ILLINOIS

Corrosion is practically unaffected by commercial acids and alkalies, as shown by Bureau of Standards tests quoted in the Corrosion bulletin recently published.

This metal was first tested under the most difficult conditions in sulphuric acid and nitric acid plants. Its performance was successful, as evidenced by Corrosion equipment now in use in the largest chemical plants on the Pacific Coast, as well as East.

The purpose of this acid proof pipe is to supply a permanent drainage equipment for high schools, colleges, engraving plants, hospitals, and other public structures where chemical laboratories are included.

San Francisco is the home of Corrosion, and a stock of various sizes of standard drain pipe and fittings is carried. There is also a distinct advantage in being able to secure large quantities or special shapes and lengths through local sources.

A laboratory specification sheet and complete drain line bulletin have been prepared, showing standard specifications and price list. These bulletins and sheets will be mailed upon request, and any inquiries should be addressed to Pacific Foundry Company, Harrison and 18th streets, San Francisco.

* * *

Ventilators for the Kitchen.

None of us would consent to being confined for even a few brief moments in a room which we knew to contain thousands of germs. Yet, despite the good sense that causes humanity to fight shy of contact with contagious maladies, thousands of housewives are suffering the discomfort of poorly ventilated kitchens, where the grease, steam, and smoke permeate the air and make cooking a drudgery.

With a very small expense, a kitchen ventilator will make the kitchen a joy spot. They can be installed in the upper panel of the window or set in the wall over the stove. It costs less than one cent an hour to operate, easy to install, and runs quietly.

Every housewife knows that even with the doors closed it is difficult to keep out of the other rooms the oppressive fumes and cooking odors which lay an invisible film of grease and smudge over the walls, curtains, and decora-

tions, necessitating frequent cleaning, redecorating, and causing material damage to household appointments.

The Tiltz Engineering and Equipment Company, Monadnock building, San Francisco, western representatives of the Ilg Electric Ventilating Company of Chicago, will be glad to show architects and contractors and their clients the advantages of installing kitchen ventilators in the home. The Ilg Electric Ventilator Company also manufacture ventilators, fans, and blowers for offices, stores, factories, public buildings, restaurants, theatres, etc.

* * *

New Heating Supply House.

Messrs. W. J. and F. Burt Hulting and S. G. Hurst have combined, and will hereafter conduct business under the firm name of Hulting, Hurst, and Hulting. The Hulting Brothers were formerly with the Ilg Ventilating Co., and Mr. Hurst represented several lines of plumbing supplies. They will represent manufacturers of plumbing, heating, and ventilating supplies in the Pacific Coast territory.

Among the various lines they now represent are:—Jas. P. Marsh and Company, of Chicago, manufacturers of heating specialties, air valves, traps, and gauges; New York Blower Company, fans, blowers, and air washers; Harrisburg Boiler Corporation, high and low pressure steel boilers; Peerless Heater Company, gas fired C.I. sectional L.P. boilers; Vulcan Brass Company, makers of the Paragon line of brass goods; and the Sturgis Company, manufacturers of showers.

Offices have been established in the Monadnock building, San Francisco.

* * *

"Covered by Insurance"

Newspaper accounts of fire invariably conclude with the statement, "The loss is fully covered by insurance." We take it for granted that this means there is complete compensation for all waste and destruction caused by the fire. There is no greater fallacy. The losses resulting from a fire extend in so many directions that they can never be fully covered by insurance.

Insurance, at the most, can be collected only for the goods and property actually destroyed. Where the fire has been in a shop or industrial plant, no matter how fully the buildings and the contents may

A. QUANDT & SONS

ESTABLISHED 1880

PAINTERS AND DECORATORS

SAN FRANCISCO
LOS ANGELES

Office and Shop
374 GUERRERO STREET
San Francisco
PHONE MARKET 1709

"100% Sanitation—60% New Economy"

AIRDRY

Registered U. S. Patent Office.

"The Electric Towel"

Wherever Perfect Sanitation Is Needed

In Schools and Colleges— just as in stores, office buildings and banks—AIRDRY, "The Electric Towel," provides the everlasting cleanliness desired today. A perfect dryer—no towels, no littered washrooms.

The list of users in educational fields includes the most prominent Schools, Universities and Business Colleges of America. New installations on the Coast include:

*University of California
Martinez High School
Palo Alto High School
Northern Pacific Dental College
Wilson Modern Business College*

Two Models—Pedestal and Wall

AIRDRY CO. OF CALIFORNIA

Pacific Coast Distributors

155 Montgomery Street, San Francisco

Specify
AIRDRY
and bring this
100% sanitation
and 60%
economy to
your clients.
Comparisons
of cost and re-
sult upon re-
quest.

have been insured, there is no adequate compensation to that firm for the time lost from production while seeking a new location or rebuilding. There is no insurance on the unfilled business orders which may go to a rival concern and mean a permanent loss of trade. There is no insurance for the loss of employment suffered by the employees, many of whom may be compelled, temporarily, at least, to accept employment in other branches of industry at lower wages. There is no insurance for the loss of production suffered by the public as a result of the plant being put out of operation. Anything which reduces production and makes commodities scarcer necessarily influences higher prices. And yet these are the invariable results attendant, either directly or indirectly, on almost every shop and factory fire.

And what do statistics show in regard to these fires? That in the vast majority of cases they occur immediately following the departure of the employees for their homes. It means that in the rush of quitting time there has been carelessness. Some one forgot to shut a fire door. Some one failed to turn off some electric switches, some one neglected to remove a heap of inflammable rubbish. Some hurrying worker ignored the rules, lighted his pipe or cigarette before he passed out of the building and carelessly threw the smouldering match on the floor. It is the history of almost every big fire—indifference and carelessness. And the public pays the cost.

* * *

Piping for Concrete Houses

(Valve World.)

THE use of concrete houses, according to the Scientific American, is becoming common in various sections of the country. In connection with the general programme for the investigation and improvement of housing conditions now being carried out by the Bureau of Standards, several trips of inspection have been made by members of the staff of that Bureau to study improvements in the building of concrete houses.

The trip recently made included many projects in the vicinity of Pittsburgh, Cleveland, Chicago, and Minneapolis. Great improvements, both in the ordinary use of concrete and in the architectural and ornamental effects obtained, were noted on this trip. It seems certain that some style of concrete house will become very common in the near future.

With the growing popularity of the concrete house the problem of service piping becomes increasingly important. In the modern home very little of the service piping shows at all. Most of it—practically all of it above the basement—

SERVICE

TESTING
INSPECTION
CONSULTATION
PRODUCTION

Structural and Engineering
Materials



ROBERT W. HUNT & CO.

ENGINEERS

Chemical and Physical
Testing Laboratories

New York Chicago Pittsburgh
St. Louis San Francisco Mexico City
London Montreal

MEESECO WAGON LOADER

For Handling Sand, Gravel, and all Kinds of Bulk Material from Ground Storage to Trucks or Wagons.

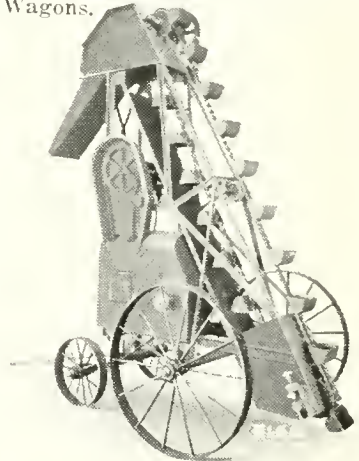

MeeSe & Gottfried Company
ENGINEERS AND MANUFACTURERS
San Francisco Seattle Portland Los Angeles

Metal Lath vs. The Field

RECENT distortion tests conducted in Omaha to show the best possible type of exterior wall construction proves Back Plastered Metal Lath to be the best possible. You will note from the chart that at the greatest number of pounds pressure (3,500) back plastered Metal Lath showed a distortion of one-half inch. At this pressure it had not cracked nor did it show any signs of weakening. From the chart, the tests on other types of construction may be observed.

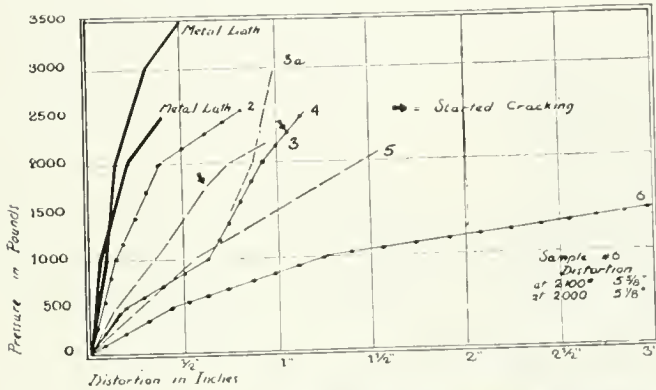

Types No. 3 and No. 4 started to crack at points indicated. The chart proves the success of Metal Lath. As a result the building codes of a great many cities will undoubtedly be changed.

THE picture shows how the test was conducted. Heavy timbers were placed on the scale, which was connected with the lever shown leading to the jack. As the pressure of the jack was increased, the load was registered directly on the scale beam. Maximum pressure was forced against the wall of back plastered Metal Lath but it did not crack.



NOT only this test, but also a test conducted by Armour Institute, shows the superiority of Metal Lath over other forms of construction. The Armour test was to determine what form of wall construction made the best insulator. Again Metal Lath proved that "Metal Lath was against the field." Just as Metal Lath is becoming a means for better and more economical building construction, Herringbone Rigid Metal Lath is becoming THE Metal Lath in great demand today. It has proven its success to many architects and builders as well as being entirely satisfactory to the owner.

The General Fireproofing Co.

20 BEALE STREET

SAN FRANCISCO, CALIF.

**SECO D. F. PUSH
BUTTON PANEL BOARDS
AND SWITCHES**

A high class installation for theaters and public buildings that means efficiency in electrical control.

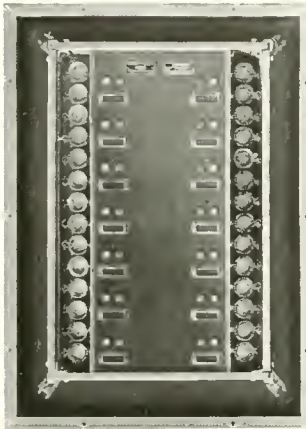

Photograph shows switchboard with door and trim removed

Also Manufacturers of

Safety Panels, Safety Controls, Cut Outs,
Cabinets, Knife Switches, Switch Parts,
Electric Appliances and Specialties

Safety Electric Company

Samuel H. Taylor, *Proprietor*



59 Columbia Square
San Francisco

is buried in the walls and between floors. The necessity for having this piping material, pipe, fitting, etc., of unquestioned quality and carefully installed in the frame building where it is comparatively easy to get at in case of needed repairs, is greatly increased when it comes to the solid construction of the concrete house.

The sanitary and heating engineer will need to be early on the job wherever concrete construction involves piping, for every bit of piping should be thoroughly tested before the concrete is poured around it. Only material of unquestioned quality and dependability should be used and the greatest care should be exercised in putting it together and in testing every joint after it is installed and before it is covered.

The concrete house imposes uncommon obligations on the architect, the plumber, and the heating engineer. The design must contemplate the important buried features, and the nature of the construction material demands unusual care in the selection and installation of these buried features. It is important that piping for the frame building should be of unquestioned quality and installed in a workmanlike manner; but for the concrete building these things are imperative.

A Bad Time to Bid Low

By M. V. AYRES

Statistician Associated General Contractors
of America.

RUMORS come to us that contractors generally are exhibiting a tendency to bid lower on all kinds of construction work than they were willing to do a few months ago. Does the present outlook justify lower prices for construction work?

The general level of prices has been going up, now, for the past two or three months. All authorities agree that the business depression has reached the bottom. There is practically no exception to the rule that prices generally increase somewhat during the period following a detumescence, and we are now on the upgrade. We believe that this is now occurring and will continue probably for at least six months to come. The long time tendency of prices will probably be downward for many years, but for the present, and for some time, they are going up. It is not safe to cut bids on the assumption that prices of materials will be lowered.

Wages in many lines have been reduced rather severely during the past few months. Doubtless, many employers feel that they must come down still more. Unquestionably, in some places and in some industries, where wages are still at the peak, some reduction will be made, but a time of improving business is not a

A Clause That Cancels The Loss of Millions

There are millions of dollars wasted every year in this country through plate glass breakage due to faulty setting. This condition has no right to exist. This great waste of money, this burden borne by merchant and insurance companies alike—and indirectly by everyone—can be prevented, by making the following clause a part of all store front specifications:

GLAZING SPECIFICATION

All Metal Sash, Corner Bars, Division Bars and Self-Adjusting Setting Blocks Used in Store Fronts Must Be Listed by the Underwriters' Laboratories.

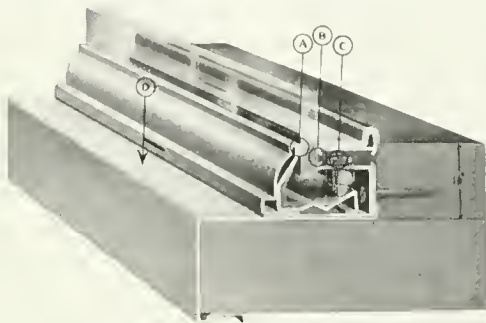

A is the point where the outer member presses against the glass when the delicate watch-like turning of the key at C brings the glass automatically into contact with the rabbet of gutter B sliding on the anti-friction Murnane Self-Adjusting Setting Block.

The Sill Covering D extends from the inner side of the rabbet to the lower edge of the face, eliminating joints—perpendicular screws or nails—positively protecting the wood against deterioration, for leakage is impossible.

Here is the logical answer to the plate glass breakage evil. Give it your hearty support. It will materially reduce the total wastage.

All Zouri Key-Set Sash, Corner Division Bars and Self-Adjusting Setting Blocks have been listed by the Underwriters' Laboratories.

Ask either of the firms listed below for full particulars of Zouri Construction

COBBLEDICK-KIBBE GLASS COMPANY
Oakland and San Francisco

CALIFORNIA PAINT & GLASS CO.
Los Angeles, California

Architects are invited to visit our exhibit at 77 O'Farrell Street, San Francisco

Zouri Drawn Metals Company

Factory and General Office:

1626 EAST END AVENUE

CHICAGO HEIGHTS, ILLINOIS



SPECIFY
**"CALIFORNIA"
 WALL BEDS**

FOR
**BEAUTY COMFORT
 SERVICE**

The time has passed when anything is "good enough" for a wall bed. Concealment must be perfect, of course, but discriminating buyers now consider how the bed is going to match expensive furniture. "California" wall beds please architect, owner and tenant.

We will be glad to send you specifications and prices or if convenient our representative will call.

Send for Circular E

California Wall Bed Co.

714 Market Street, San Francisco
 Sutter 1422

165 Thirteenth Street, Oakland
 Lakeside 1186

time when wages generally can be reduced. Immigration has been restricted in such fashion as to greatly reduce what has in past years been the principal source of recruits for the ranks of common labor. An increase in business prosperity will raise the cost of living and increase the demand for labor. We do not feel that bids can safely be made at lower levels on the assumption that wages are going to be reduced.

Much has been heard to the effect that freight rates must come down, if prosperity is to return. The importance of this factor has been greatly overstressed. Business is improving and freight rates are staying up. Some reductions, it is true, have been made and some more may occur, but the railroads have made only a beginning toward a recovery from a desperate financial plight in which they have been, and they will not willingly submit to any very drastic, or very extensive reduction in their charges. We do not believe that prospective reductions in freight rates are any justification for bidding low on construction projects.

It is perhaps quite as important that a contractor should get his materials when he wants them as that he should get them at the right price. At present, stocks of most things are large, and production capacity is not being used to the full. These conditions are favorable, but how long they will stay so is problematical. Demand is increasing. If the coal strike continues all summer, many industries will not be able to produce up to their normal capacity or perhaps even at their present rates. We do not feel that contracts can be taken with any assurance of prompt deliveries of large quantities of material several months from now.

If business picks up as we hope it will there is going to be a car shortage before the summer is over. The railroads are under-equipped both in cars and locomotives for handling the normal business of the country. Even if their equipment were all in good condition a car shortage would be the hardly avoidable accompaniment of the next period of even ordinary prosperity. But it is not all in good condition. There are nearly 200,000 more cars unfit for service than there ought to be under normal conditions of maintenance. If conditions were such that a car shortage existed of precisely this amount 200,000 cars, it would be a very serious shortage. We do not think that low prices for construction work are justified, if they are based upon the assumption that freight cars will always be available when they are wanted.

SAN FRANCISCO
PUBLIC LIBRARY

The
ARCHITECT &
ENGINEER



AUGUST 1922

Published in San Francisco
50 cents a copy - \$2⁵⁰ a year

**Guaranteed
forever against
any defects in
workmanship or
materials**





THE ARCHITECT AND ENGINEER

CONTENTS FOR AUGUST, 1922

GARDENER'S COTTAGE, ESTATE OF MR. BERNHARD HOFFMANN, SANTA BARBARA, CAL.	<i>Frontispiece</i> <i>James Osborne Craig, Architect</i>
A STEP IN CALIFORNIA'S ARCHITECTURE	47
<i>Irving F. Morrow, Architect</i>	
[With Sixty-four Plates illustrating Mr. Craig's Work in Santa Barbara and Southern California.]	
EDITORIAL	104
WITH THE ARCHITECTS	106
AMERICAN PLAN PRINCIPLES DISCUSSED AT INSTITUTE CONVENTION	108

Published Monthly by
THE ARCHITECT AND ENGINEER, INC.
626-27 Foxcroft Building, San Francisco

W. J. L. Kierulff
President

Frederick W. Jones
Vice-President

L. B. Penhorwood
Secretary

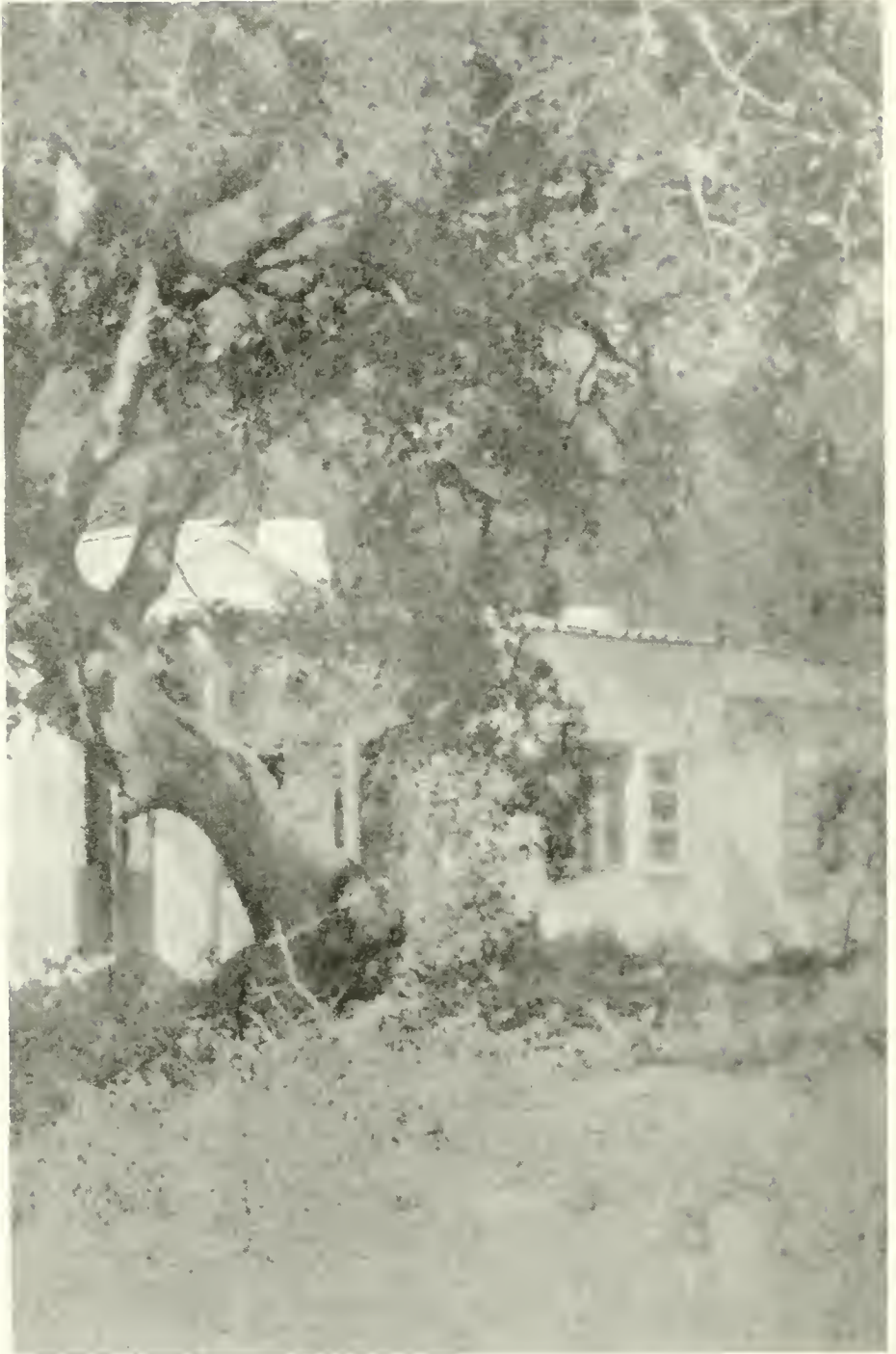

GARDENER'S COTTAGE, ESTATE OF MR. BERNHARD HOFFMANN, SANTA
BARBARA, CAL. JAMES OSBORNE CRAIG, ARCHITECT

SAN FRANCISCO
PUBLIC LIBRARY

THE ARCHITECT AND ENGINEER

AUGUST
1922



VOL. LXX.
No. 2

A Step in California's Architecture

By IRVING F. MORROW*

I.

SPRING at Santa Barbara is a sweep of green and a sweep of blue. Yellow mustard splashes over the hillsides and many-colored bloom flaunts in innumerable gardens. White waves curl along the curving seashore and white clouds strew the sky. With summer a softer haze steals into the atmosphere. Fields and hills mellow into golden and tawny brown. Distances are suffused in blue and violet. People who have grown up with the more insistent contrasts of sterner climates often complain that California enjoys no seasons. Yet here, of a truth, the year's waxing and waning are no less realities for being delicate ones. Definite seasonal episodes mark off the year much as classical musicians divided their compositions into separate movements. To us a change of

*Architect. Member of the firm of Morrow & Garren, Architects.

season comes more as a subtler modulation steals into a freely and continuously flowing music, giving new point or direction to its course. Nobody who longs for a stricter seasonal demarcation, nobody who is depressed under the far-flung gold of late summer and fall, has caught the spirit of the California land. At Santa Barbara the landscape is drawn in broad strokes—bold without aloofness, intimate without pettiness. Over this come colors alternately gay and pensive; but there are always the great hewn wall of mountains tapestried with chaparral, the rolling foothills dotted and patched with oaks, and lines of sycamores following streams toward the sea.



THE PATIO, ORENA STUDIO BUILDING, SANTA BARBARA
James Osborne Craig, Architect

What is more natural than that our earliest civilization should have touched such a place with a caressing hand? The Spanish Padres and the settlers who followed them were people who, for all the exactions of pioneering, refused to allow life to be flavorless, and tasted its flavor as it went. Here was a country breathing at once such calm and kindness and joy and fortitude as made their own lives. It was too precious to dishonor or to remain unenjoyed. It was adorned with among the loveliest of those quiet, simple houses which seem to have taken form under the same natural forces which moulded the landscape's own lines—naïve but confident memorials which a more distracted civilization has treated with shocking disrespect. And its mission is unsurpassed among the structures of Spanish California for poise, nobility and delicate poetry.

When I think of this country, the beauty of its native forms and colors, the aroma of early and lovely traditions which still sensibly persists, and the finer aspects of present culture which cluster around a

nucleus so propitious, it seems to me that it should become a veritable laboratory of California art. I am speaking in particular now, of course, of the art of building in its more personal and humanly significant aspects; of the character which is at the core of a truly popular style of architecture, and which it seems hopeless to seek in the large cities, blighted almost uniformly and increasingly as they are by an unhuman industrialism and a snobbish, provincial cosmopolitanism, both negations of individuality and character. The expression of what is finest in modern life must be worked out in those smaller centers which have had the insight and the courage to refuse to sell their birthrights for messes of up-to-date pottage. I say this not actuated by a futile aestheticism

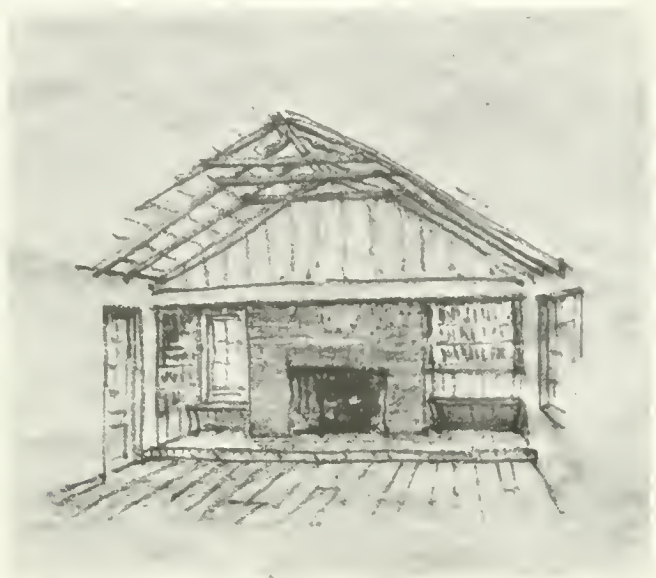

STUDY FOR LIVING ROOM, COTTAGE FOR MR. AND MRS. DANIEL NUGENT,
SANDYLAND, NEAR SANTA BARBARA
James Osborne Craig, Architect

which would seek refuge in a romantic past, but because I believe that some of the main forces of modern life deny human dignity and the joy which should belong to living.

II.

To ask what is to come out of this "experiment station," if I may so call it, would be as futile as making similar inquiries regarding laboratories devoted to physical or chemical investigation. The artist is at one with the scientist at least in living intensely in the present. His art heads toward no finality, but will continue to assume forms ever new and unpredictable as long as the vitality of the human spirit endures. The best service of the future is to make the best use of the opportunities of today. In other words, we are concerned less with where California architecture is going than with where it is beginning.

A fruitful discussion of California architecture must recognize at the outset a conception of style at variance with that which ordinarily obtains. I shall say nothing of the oft-repeated demand for an "American" style of architecture, believing that periodical elections of presidents and of representatives and senators to Congress do not obliterate obvious and significant differences of climate, aspect and manner of life. After all, why should the architectures of Pennsylvania, Kansas and California form a more homogeneous group than did the contemporaneous architectures of Rome, Florence, and Venice? The large cities and those which are ashamed of not being large are achieving a sort of uniformity, but at the sacrifice of character; and I have already indicated that their developments are not necessarily significant because spectacular.

When we look back over the well-defined historical styles of the past—Greek, Roman, Byzantine, Romanesque, Gothic, Renaissance, etc.,—



VIEW FROM THE SEA. COTTAGE FOR MR. AND MRS. DANIEL NUGENT,
SANDYLAND, NEAR SANTA BARBARA
James Osborne Craig, Architect

we note one common trait which seems to characterize the most diverse expressions. Each style confined itself to a more or less circumscribed decorative vocabulary, which was accepted instinctively and as a matter of course by the workers and public of its period. It is this specific decorative apparatus which is today popularly regarded as constituting a style. Looking about us in our present situation it becomes evident that no such unconscious and unquestioned uniformity does or can exist. Whereupon certain theorists have fallen to lamenting that we have no architectural style. Our scholarship, they say, has been our undoing; if we were aware of but one style, we would perforce work in that one, and ipso facto have a style. Away, then, with plates and photographs, and let us exert ourselves to become naive. Aside from the trifling detail of who is to put on the blinders, it seems very simple.

Now it is a pure fallacy to assume that evolution must always be unconscious and undirected, and that because past styles have developed blindly, therefore blindness is of the essence of the process. One thing is certain, that we can not forget by taking thought. It is probably true that, given the continuance of present tendencies, we shall never have a

“style” in the generally accepted historical sense. It does not follow that therefore our architecture must be chaotic and expressionless, or, in other words, without style in the truer sense of the word. We should rather envisage an enlarged conception of style. Our broadened knowledge, far from being rejected as our undoing, should be welcomed as the basis for a more intelligent choice and synthesis. Is it unreasonable to assume that, with other conditions propitious, we might achieve more with all past experience as a conscious basis for our effort than with only the last twenty or thirty years? Is it unthinkable that elements which are historically diverse (of different “styles”) may be fused into a style far more varied and mobile, albeit no less genuine and expressive, than the decorative codes to which the popular application of the word is confined? Style thus conceived is no less a reality than as commonly under-



VIEW FROM THE ROAD, COTTAGE FOR MR. AND MRS. DANIEL NUGENT,
SANDYLAND, NEAR SANTA BARBARA
James Osborne Craig, Architect

stood, though it may require greater insight to recognize and define it. The real enemy of vital architecture today is not knowledge of where we stand and how we got there. Archaeology—an unimaginative, uncreative application of our knowledge—is a deadening influence; and public apathy and lack of appreciation is an incubus which can not be entirely thrown off by the ablest of designers.

There is distinct encouragement for California architecture in the fact that a region whose landscape and culture are congenial to beautiful architecture and whose traditions go back to beautiful architecture, is coming under the influence of a group of designers possessed of a vivid sense of beauty and a fresh and buoyant outlook. The task of these men is a formidable one. In other ages and places architects were charged with the conservation of traditions or the continuance of recognized developments. Our designers are faced with the problem, as I have already

intimated, of establishing a new architecture. This is being accomplished with a unanimity as to fundamentals, combined with a variety and a free play of individuality which leads one to venture that we are indeed witnessing the birth of a California "style" in the larger sense touched upon above.

The fact that the designers who are most recognizably Californian are returning for the greater part to the architecture of Spanish days in no way invalidates the statement that their problem is essentially one of re-creation, rather than of development. Our civilization of today is in no sense a development of that of Spanish California; it has bodily supplanted it. In many of its aggressive lines it is opposed to the easy-going life it has superseded. I am not romantic enough to call for a return to



VIEW FROM THE ROAD. COTTAGE FOR MR. AND MRS. HAROLD CHASE.
SANDYLAND, NEAR SANTA BARBARA
James Osborne Craig, Architect

inefficiency on a plea of picturesqueness. I believe, however, that the older civilization offers us lessons which might profitably be learned. It is worth while recalling that motion is not necessarily progress, that not all systems are efficient ones, and that, after all, the most efficient life is hardly worth while if not enjoyed. Our Spanish predecessors enjoyed life. The reversion to a Spanish attitude or point of view is in the nature of a return to first principles. I say this despite the admission that our culture is not the inheritor of the Spanish one. The present regime came upon the scene about as unembarrassed by architectural preconceptions as can be imagined. It can not complain of infidelity to its traditions, for it had none. The original establishment of the Spanish mode of architectural thought in California, on the other hand, was one of the happiest of historical accidents. I have often speculated on the falsification which might have resulted from a less fortunate historical coincidence. Suppose that the Russians (who actually located on the coast of northern California) had continued southward and established a permanent civilization in central and southern California; or suppose that the English, with well defined but inappropriate architectural traditions, had settled

the country. English colonial houses, of course, are not novelties in California. In their Eastern home, on flat or gently sloping greens, under lofty, large leaved, deciduous hardwoods, they speak in tones of easy dignity and well-bred reserve. Looking out over huddled oaks and tufted chaparral on a brown, rolling California hillside, they are hardly more than prim and dry. It gives one a shudder to imagine the generous, expansive landscape of California dominated by people untouched by its warmth and unrestraint and bent on imposing their own predilections. But the Spaniards came from a land of which this is a counterpart. I shall scarcely admit that there is a site in Spain as beautiful as the Santa Barbara coast; unless it be Granada, in which, indeed, it is not entirely fanciful to imagine an analogy, if green vega be substituted for blue sea.



VIEW FROM THE SEASHORE, COTTAGE FOR MR. AND MRS. HAROLD CHASE,
SANDYLAND, NEAR SANTA BARBARA
James Osborne Craig, Architect

But the spiritual similarity of the two lands can not have escaped anyone who has so much as seen both. When the good old Padres came upon the California coasts and valleys it must have quieted any homesickness which could have survived their ardent labors. Their building traditions and tastes derived from just such a land. They were by nature warm and human tastes, quiet, but not untouched by whimsicality; and this rediscovery of home in exile must have inspired them to tenderness and reverence. The architecture which they produced was of necessity primitive on its structural side; that has proved an inestimable loss to us. Historically and aesthetically it is inevitable; it may be termed indigenous without doing essential violence to the term. Its development was arrested not through internal exhaustion, but because it was stifled under an influx of ignorance and neglect. The men who are today working to create an architecture worthy of California around Santa Barbara (and in the South generally) have shown a sound instinct in beginning where this development was arbitrarily halted. They have indeed gone beyond beginnings. When we speak of the present archi-

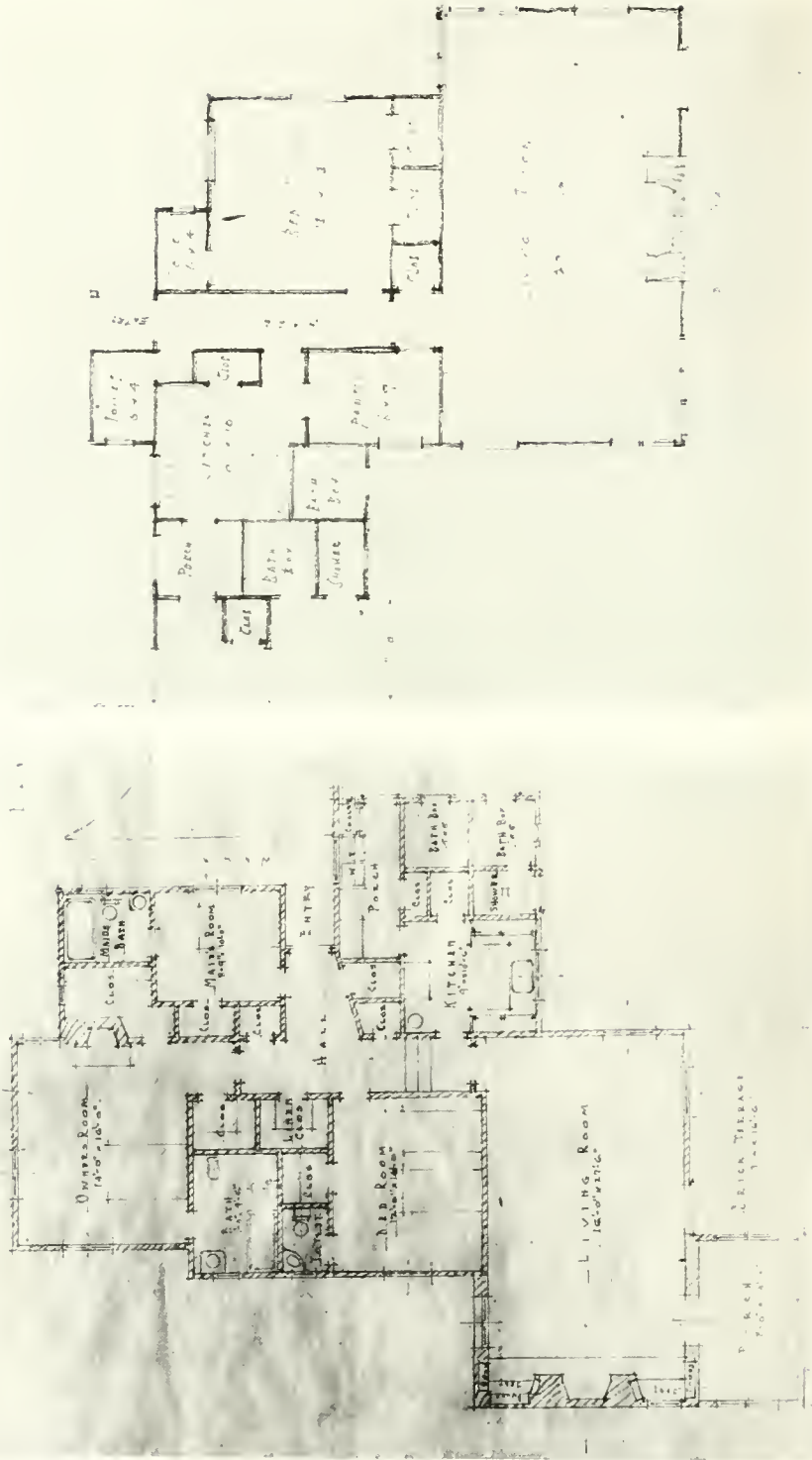

PLANS, COTTAGE FOR MR. AND MRS. DANIEL NUGENT AND COTTAGE FOR MR. AND MRS. HAROLD CHASE SANDYLAND, NEAR SANTA BARRARA, CAL.

JAMES OSBORNE CRAIG, ARCHITECT

(Note. - These two houses are joined by an archway at the center so as to form one building.

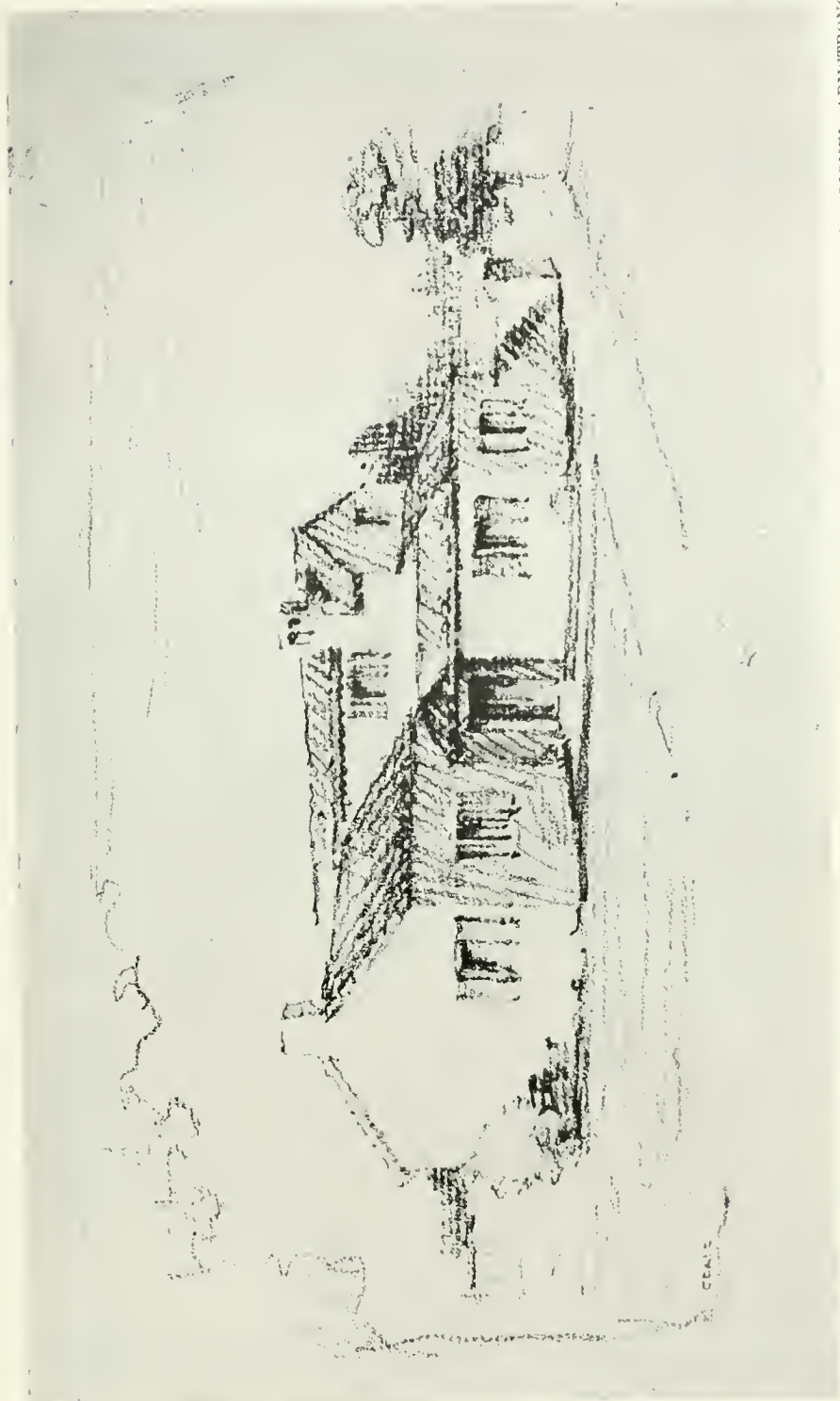

STUDY. HOUSE FOR MR. AND MRS. LIONEL ARMSTRONG
PASADENA, CAL. JAMES OSBORNE CRAIG, ARCHITECT

ecture of Southern California as predominantly Spanish we can not mean to imply that it reproduces anything in Spain or anything the Spaniards did in California. However much its outlook is conditioned by the Spanish point of view, it has already visibly diverged, and will undoubtedly continue to evolve through forms new and beautiful, but unforeseen. And this is only as it should be. We are less concerned in establishing a crystallized California architecture than in setting a living one in motion.

I repeat that I am speaking of those forms of architecture which are close to the lives of the people, in particular of domestic building. Vital-

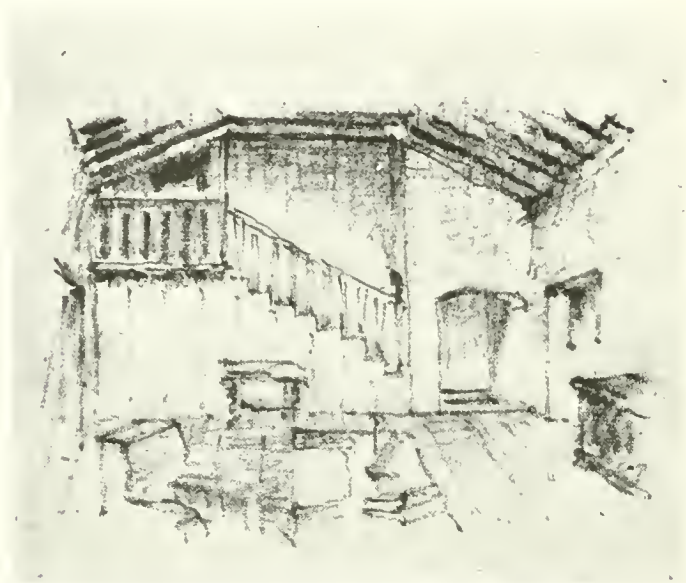

LIVING ROOM, HOUSE FOR MR. AND MRS. LIONEL ARMSTRONG, PASADENA
James Osborne Craig, Architect

ity seems to be squeezed out of railroad stations, court houses and office buildings by an impressive but sterile academicism.

III.

These are days when every sincere effort toward living design is a public service and every achievement a monument. No possible contribution can be spared. The loss of an earnest and sensitive spirit is a calamity; and such a loss the cause of architecture in California has suffered through the untimely passing, early in the present year, of James Osborne Craig.

I question if many people, outside of Mr. Craig's immediate circle of associates, realize the loss sustained. This is by no means because it is an unimportant one, but because the nature of his work was so intimate and the manner of its performance so unassuming that it had missed the attention accorded much work of more blatant but less fine a stamp. My own formal introduction was the inscription at the memorial exhi-

bition of his work held in a studio of the "Patio" at Santa Barbara in mid-spring:

THE WORK OF THE ARCHITECT
JAMES OSBORNE CRAIG
GATHERED BY HIS FRIENDS AND EXHIBITED
IN THIS BUILDING WHICH STANDS AS AN EXAMPLE
OF HIS EFFORTS TO RESTORE TO
SANTA BARBARA ITS HERITAGE



LIVING ROOM, HOUSE FOR MR. AND MRS. LIONEL ARMSTRONG, PASADENA
James Osborne Craig, Architect

Anyone who studied this unpretentious exhibit of sketches and photographs must realize that a talent of genuine achievement and larger promise was cut off in mid-career; as anyone who has heard Mr. Craig discussed by those whom he touched casually or closely in his work will regret the loss of an earnest and sensitive spirit.

Yet although his work is of a personal and reticent nature, unconcerned with the gaping crowd, it is work which will quietly but surely insinuate itself into the spirit of our awakening architecture, and become a potent if unobtrusive influence. To the superficial public it will appear slight and inconspicuous, as natural and inevitable things always do. From the judicious its delicate flavor will never fail to evoke appreciation and affection. It is too much of the soil to miss reacting strongly on our more characteristic architectural thought. Coleridge somewhere, in discussing Shakespeare's technique, makes a profound but often overlooked observation to the effect that the most satisfying art is characterized

more by the fulfillment of expectation than by surprise; and he illustrates his point by citing in example the development of a sunset and the bursting of a storm. In Mr. Craig's architecture there are no surprises (unless it be surprise at realizing that building so subtle and naively beautiful is going on among us today); but expectations of which we were ourselves perhaps unaware are realized. Where he has put a house, it seems as if the landscape must have been incomplete until the house came.

Architecture of this nature, so closely united to the soil on which it rests, or out of which it grows, so intimately bound up with the lives of people who inhabit it, is not always susceptible of adequate illustration. An enthusiasm born of personal contact, of the sensing of a delicate



VIEW FROM THE ROAD, HOUSE FOR MR. AND MRS. WARNER M. LEEDS,
SANDYLAND, NEAR SANTA BARBARA

James Osborne Craig, Architect

texture here or a subtle color there or an elusive pervading sense of scale or personality—such an enthusiasm may seem unwarranted to one who calmly glances over the best of photographs. But houses, after all, are built not to be pictured, but to be lived in; and Mr. Craig's preeminently fulfill this prime function. No sensitive observer can escape the charm; but the photographs may go unappreciated if viewed without an active imagination. In his finer creations it seems as if the outstanding fact were an atmosphere rather than a physical structure. One recalls that elusive relation which the atmosphere of Debussy's compositions bears to their formal musical material.

By this I do not mean to suggest that Mr. Craig's buildings are "scene" architecture, or unstructural in the remotest sense of the word. They are, to be sure, highly unacademic. They start from plans conceived in strict economy, and evolved wholly in the light of the intimate incidents and accidents of daily use and living, rather than of a priori architectonic considerations. The development proceeds logically, unbiased by

prepossessions for "effects." The character and quality of the design derive wholly from massing, fenestration, and the natural (if often unusual) use of real and honest structural materials, rather than from overlays of superfluous matter. In a sense it seems almost incorrect to speak of development; the designs appear to have crystallized and deposited in the mind in a completed state, without subsequent alteration or addition. This, of course, refers only to the effect of inevitableness which they produce, and is not intended as a statement of the actual technique of composition. In any event an unusual power of imaginative projection is attested.

In this connection Mr. Craig's preliminary sketches are highly interesting. They convey the same sense of spontaneous germination as his



VIEW FROM THE SEA, HOUSE FOR MR. AND MRS. WARNER M. LEEDS,
SANDYLAND, NEAR SANTA BARBARA
James Osborne Craig, Architect

architecture. In them we seem to see his thought crystallizing on paper. And it is worthy of note that all the atmosphere and quality suggested in his sketches has been fully realized in the finished structures. They are more like sketches of completed buildings than sketches for projected ones.

Mr. Craig was indeed an exquisite draftsman. The reproduction of his delicate sketches by commercial processes seems almost a desecration. Most of his preliminary studies consist of small scale plans and perspectives dropped irregularly and apparently in haphazard manner, but in reality sensitively arranged, on sheets from around twelve to twenty by fifteen to thirty inches in size. They are generally in pencil on toned paper, with touches of white chalk and more delicate suggestions of color. In many instances they are on tracing paper which fixatiff has crinkled so that satisfactory photographs are impossible. In almost every case the original subtlety of touch has vanished because the paper registers



SECOND FLOOR PLAN, GUEST COTTAGE FOR MR. AND MRS. BERNHARD HOFFMANN,
SANTA BARBARA
James Osborne Craig, Architect



PLAN, HOUSE FOR MR. AND MRS. WARNER M. LEEDS, SANDYLAND, NEAR SANTA BARBARA
James Osborne Craig, Architect
(See Pages 58 and 59)



FIRST FLOOR PLAN



COTTAGE FROM THE SOUTH

FIRST FLOOR PLAN AND PERSPECTIVE, GUEST COTTAGE FOR MR. AND MRS. BERNHARD HOFFMANN, SANTA BARBARA JAMES OSBORNE CRAIG, ARCHITECT

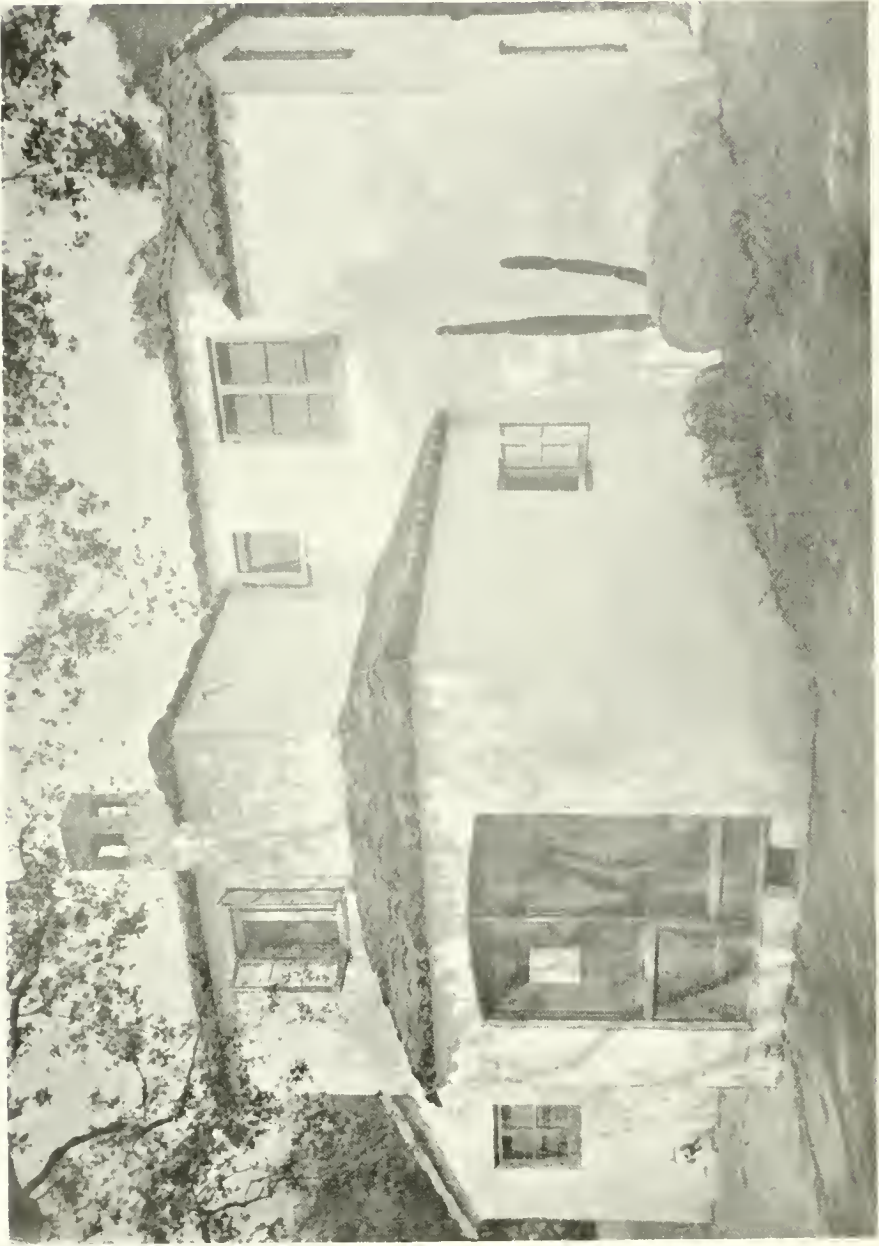

GUEST COTTAGE FOR MR. AND MRS. BERNHARD HOFFMANN, SANTA BARBARA, CAL.
JAMES OSBORNE CRAIG, ARCHITECT



GUEST COTTAGE FOR MR. AND MRS. BERNHARD HOFFMANN, SANTA BARBARA, CAL.
JAMES OSBORNE CRAIG, ARCHITECT



GUEST COTTAGE FOR MR. AND MRS. BERNHARD HOFFMANN, SANTA BARBARA, CAL.
JAMES OSBORNE CRAIG, ARCHITECT



GUEST COTTAGE FOR MR. AND MRS. BERNHARD HOFFMANN, SANTA BARBARA, CAL.
JAMES OSBORNE CRAIG, ARCHITECT



CORNER IN THE PATIO, ORENA STUDIO BUILDING, SANTA BARBARA CALIFORNIA
JAMES OSBORNE CRAIG, ARCHITECT



VIEW IN THE PATIO, ORENA STUDIO BUILDING, SANTA BARBARA,
CALIFORNIA

JAMES OSBORNE CRAIG, ARCHITECT

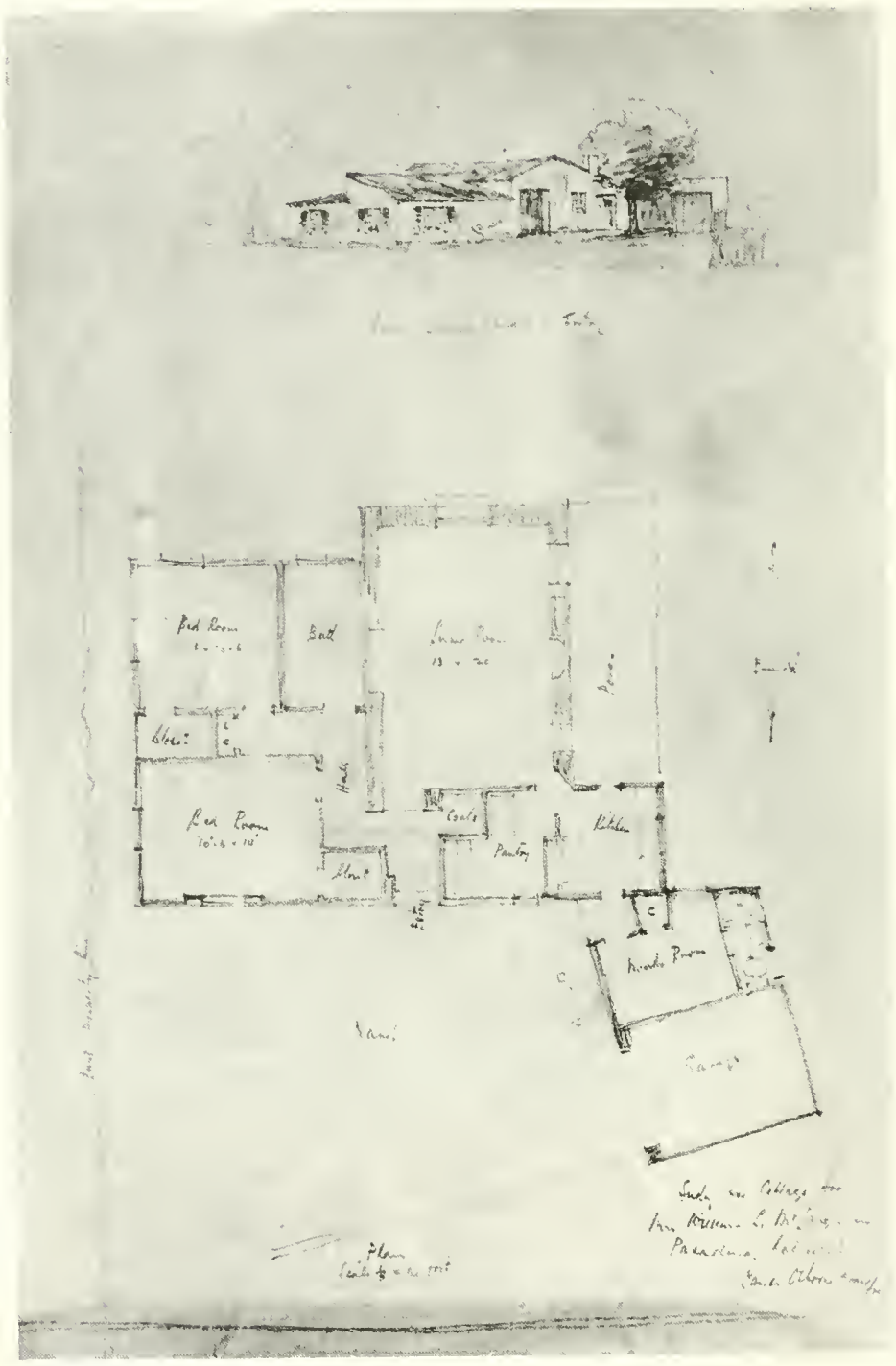

STUDY FOR HOUSE AT PASADENA, CAL.
JAMES OSBORNE CRAIG ARCHITECT



GARDENER'S COTTAGE, ESTATE OF MR. AND MRS. HARRY GANTZ,
MONTECITO, CAL. JAMES OSBORNE CRAIG, ARCHITECT

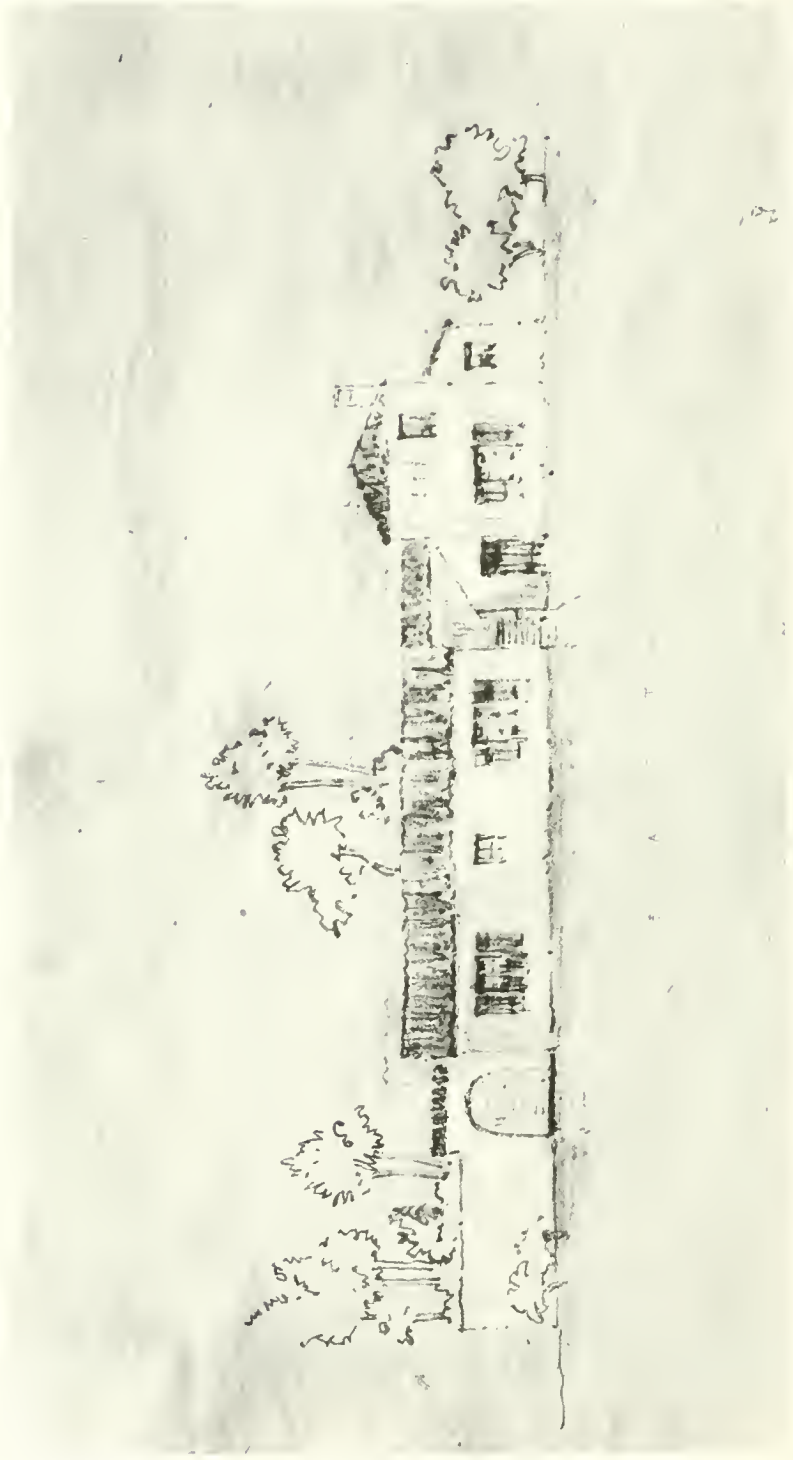

STUDY FOR GROUP OF APARTMENTS
JAMES OSBORNE CRAIG, ARCHITECT



PEBBLE BEACH '12 J.C.

STUDY FOR HOUSE AT PEBBLE BEACH, NEAR DEL MONTE,
CALIFORNIA
JAMES OSBORNE CRAIG, ARCHITECT



HOUSE FOR MR. AND MRS. R. B. QUING, MONTECITO
CALIFORNIA — JAMES OSBORNE CRAIG, ARCHITECT



HOUSE FOR MR. AND MRS. R. B. QUING, MONTECITO,
CALIFORNIA — JAMES OSBORNE CRAIG, ARCHITECT

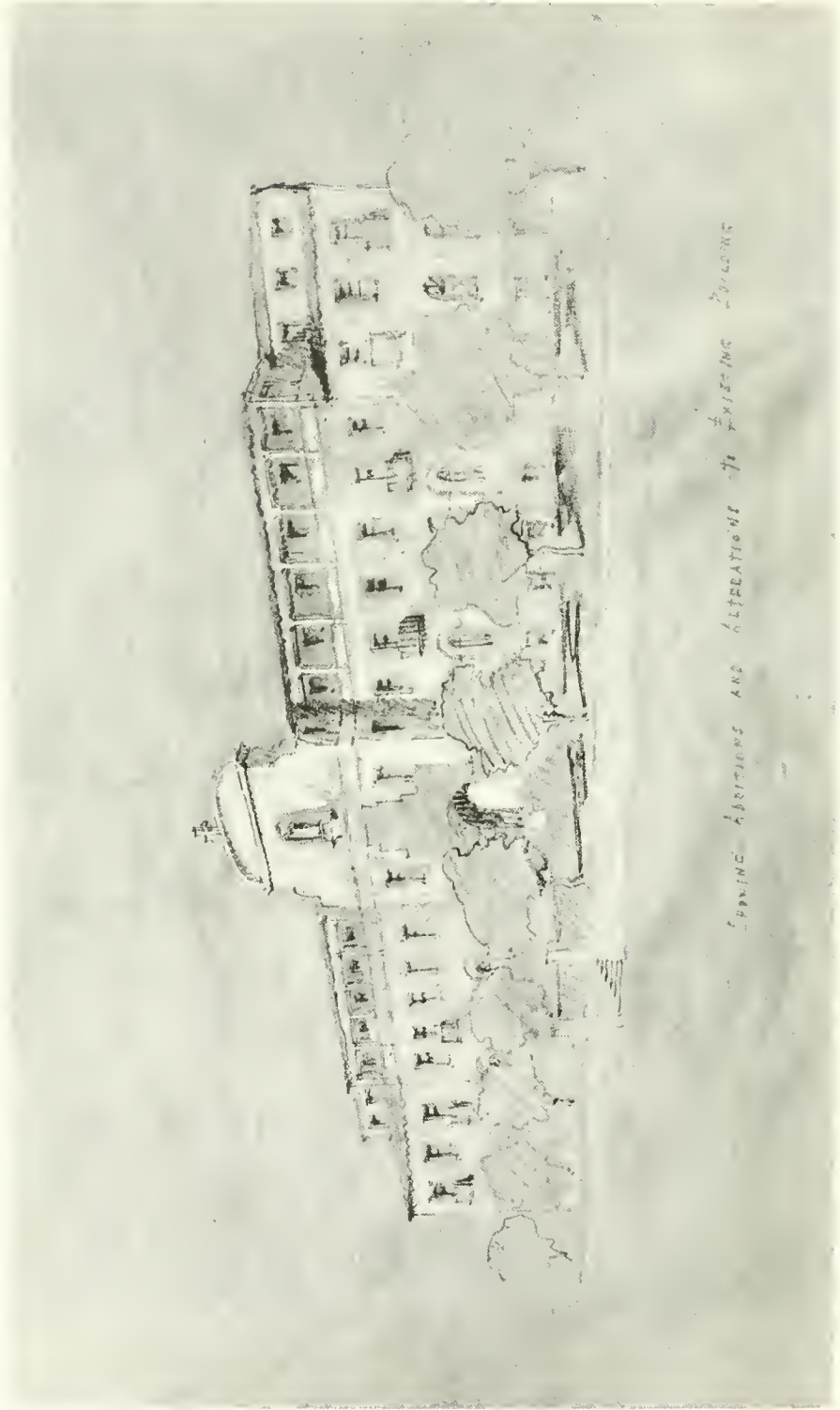

SKETCHING ADDITIONS AND ALTERATIONS TO EXISTING BUILDINGS

PROPOSED ADDITIONS AND ALTERATIONS TO ST. ANTHONY'S COLLEGE
SANTA BARBARA, CAL. JAMES OSBORNE CRAIG, ARCHITECT



PHOTOGRAPH OF MODEL, HOUSE FOR MR. AND MRS. BERNHARD HOFFMANN
JAMES OSBORNE CRAIG, ARCHITECT
SANTA BARBARA, CAL.



PHOTOGRAPH OF MODEL, HOUSE FOR MR. AND MRS. BERNHARD HOFFMANN
SANTA BARBARA, CAL.,
JAMES OSBORNE CRAIG, ARCHITECT



PHOTOGRAPH OF MODEL, HOUSE FOR MR. AND MRS. BERNHARD HOFFMANN
JAMES OSBORNE CRAIG, ARCHITECT
SANTA BARBARA, CAL.



PHOTOGRAPH OF MODEL, HOUSE FOR MR. AND MRS. BERNHARD HOFFMANN
SANTA BARBARA, CAL.
JAMES OSBORNE CRAIG, ARCHITECT



PHOTOGRAPH OF MODEL HOUSE FOR MR. AND MRS. BERNHARD HOFFMANN
JAMES OSBORNE CRAIG, ARCHITECT
SANTA BARBARA, CAL.

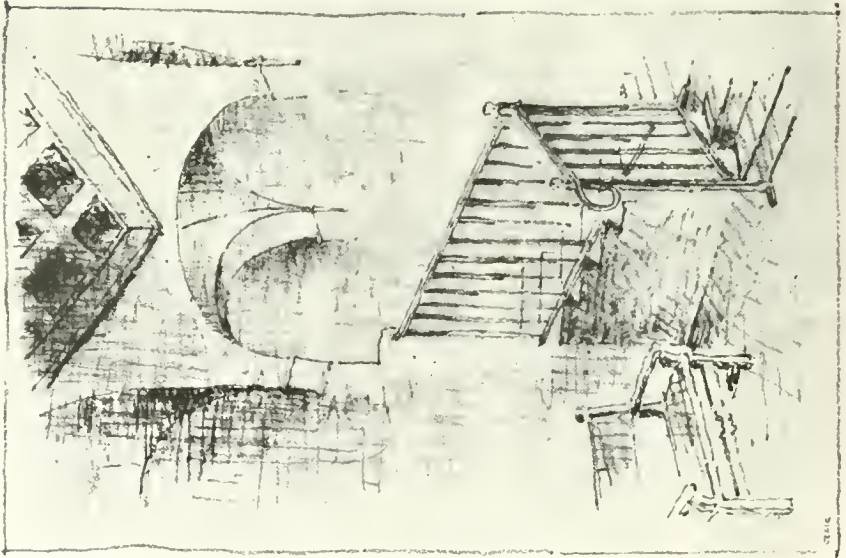
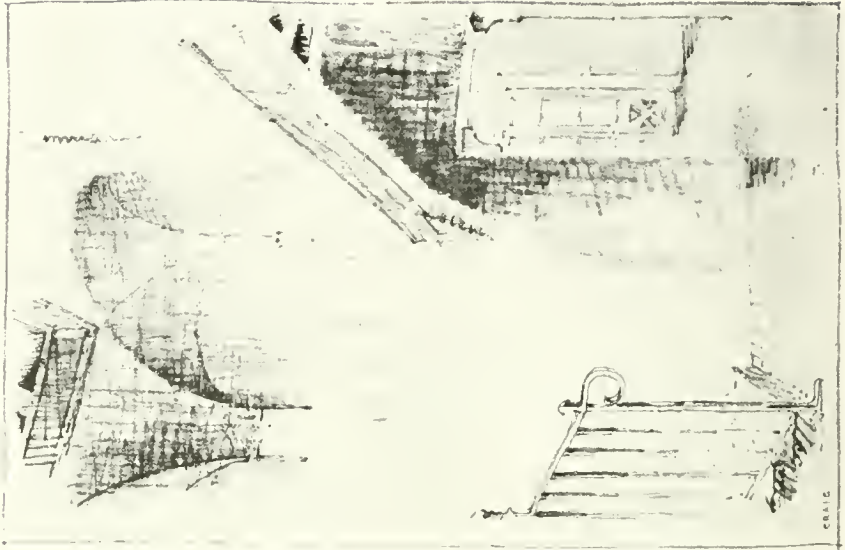

STUDIES FOR HALL AND STAIRWAY, HOUSE FOR MR. AND MRS. BERNHARD HOFFMANN
SANTA BARBARA, CAL.
JAMES OSBORNE CRAIG, ARCHITECT

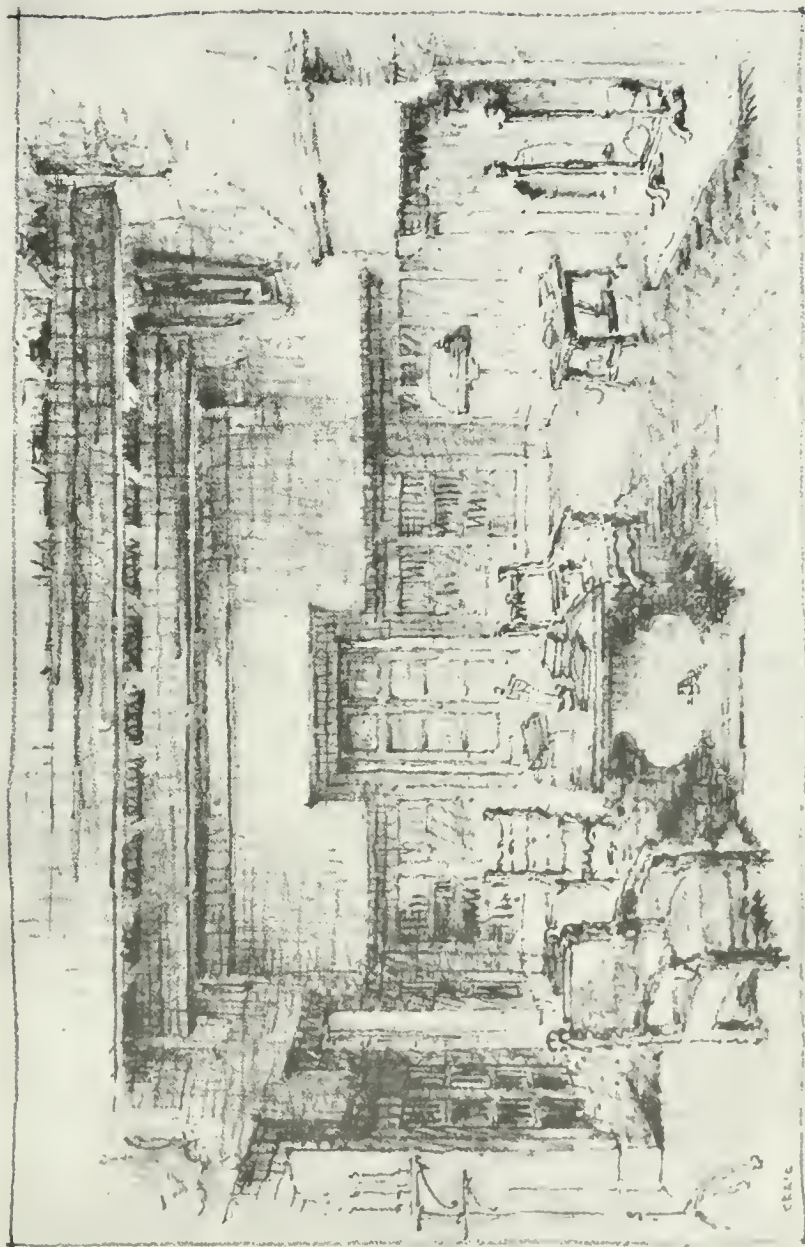

STUDY FOR LIBRARY. HOUSE FOR MR. AND MRS. BERNHARD HOFFMANN
JAMES OSBORNE CRAIG, ARCHITECT
SANTA BARBARA, CAL.

CC 216

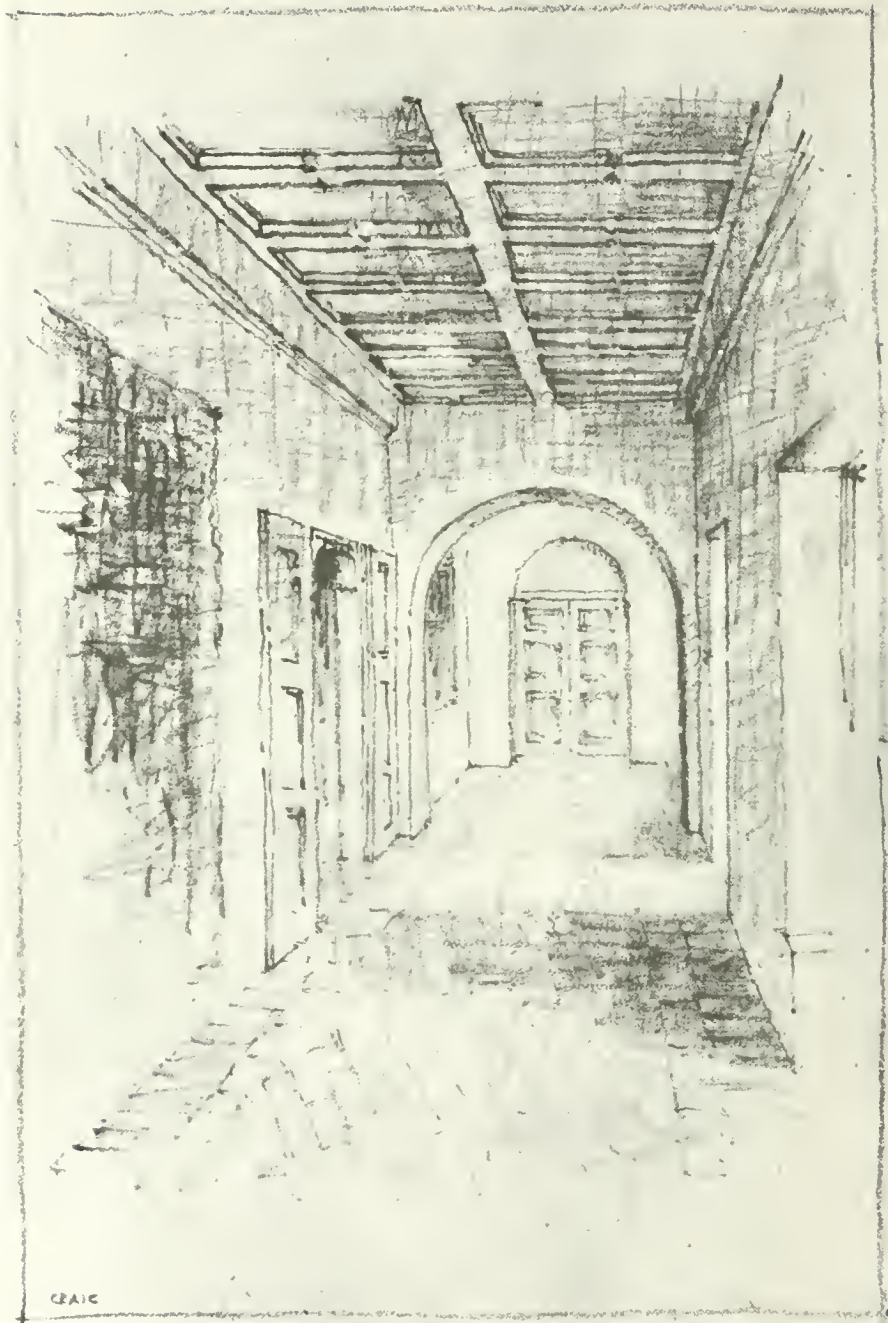

CRAIG

STUDY FOR HALLWAY, HOUSE FOR MR. AND MRS. BERNHARD HOFFMANN
SANTA BARBARA, CAL. JAMES OSBORNE CRAIG, ARCHITECT



HOUSE FROM SOUTH, SHOWING ENTRY

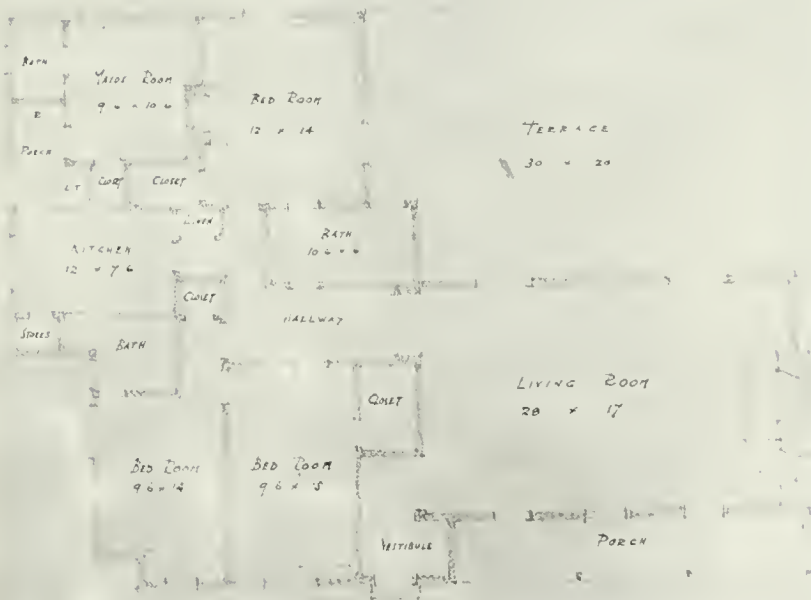

PLAN
SCALE 1/4" = 1'-0"

HOUSE FOR MR. AND MRS. J. B. ALEXANDER, MONTECITO,
CALIFORNIA
JAMES OSBORNE CRAIG, ARCHITECT



DOORWAY, HOUSE FOR MR. AND MRS. J. B. ALEXANDER, MONTECITO
CALIFORNIA
JAMES OSBORNE CRAIG, ARCHITECT



HOUSE FOR MR. AND MRS. J. B. ALEXANDER, MONTECITO
CALIFORNIA
JAMES OSBORNE CRAIG, ARCHITECT



HOUSE FOR MR. AND MRS. J. B. ALEXANDER, MONTECITO,
JAMES OSBORNE CRAIG, ARCHITECT
CALIFORNIA



HOUSE FOR MRS. THEODORE SHELDON, MONTECITO,
CALIFORNIA
JAMES OSBORNE CRAIG, ARCHITECT



PROPOSED ADDITION TO GARAGE OF MRS. THEODORE SHELDON
JAMES OSBORNE CRAIG, ARCHITECT
MONTECITO, CAL.

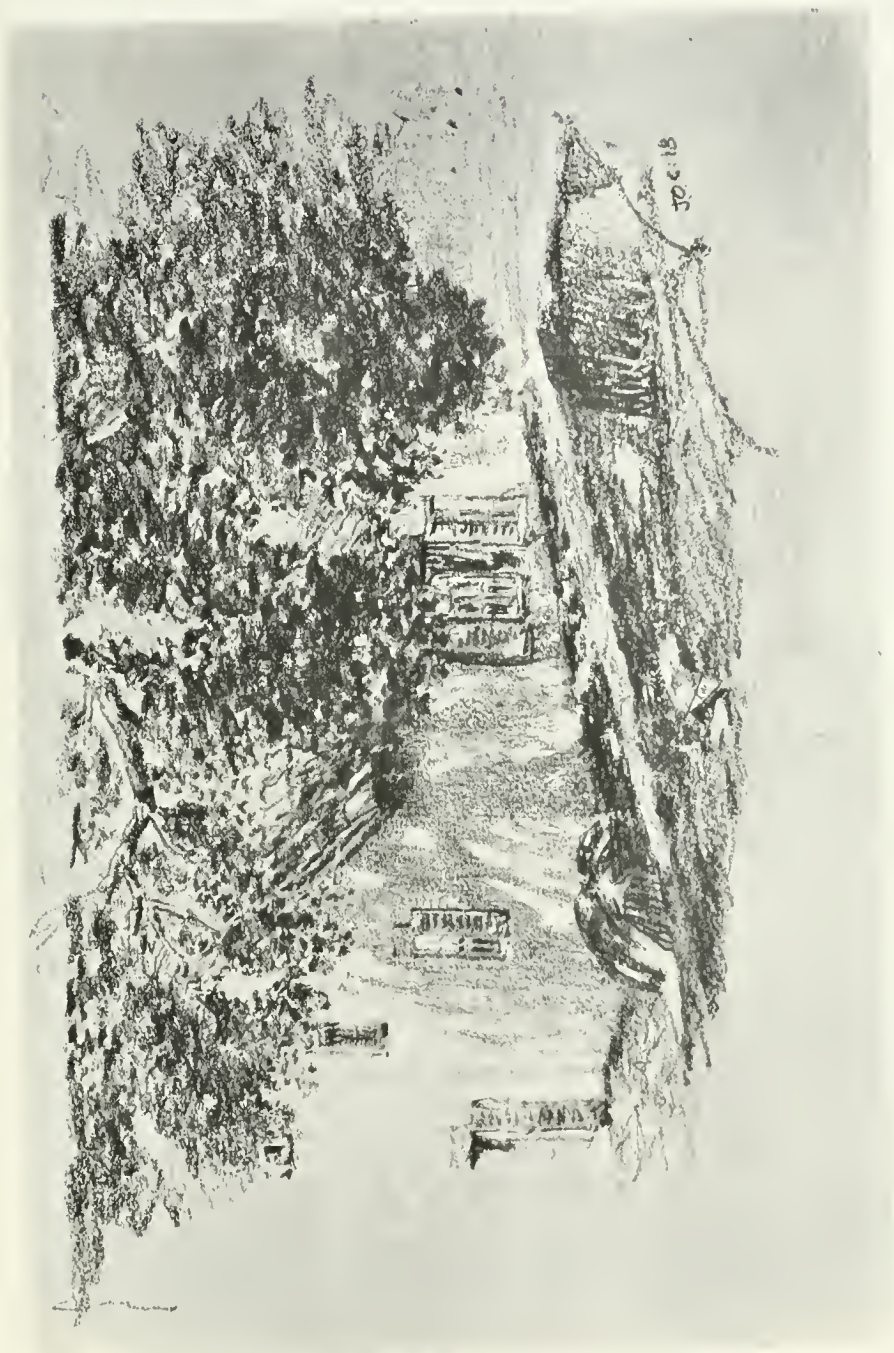

ON THE ESTATE OF MRS. THEODORE SHELDON, MONTECITO,
CALIFORNIA
JAMES OSBORNE CRAIG, ARCHITECT



GARAGE FOR MRS. THEODORE SHELDON, MONTECITO,
CALIFORNIA JAMES OSBORNE CRAIG, ARCHITECT



GARAGE FOR MRS. THEODORE SHELDON, MONTECITO,
CALIFORNIA JAMES OSBORNE CRAIG, ARCHITECT

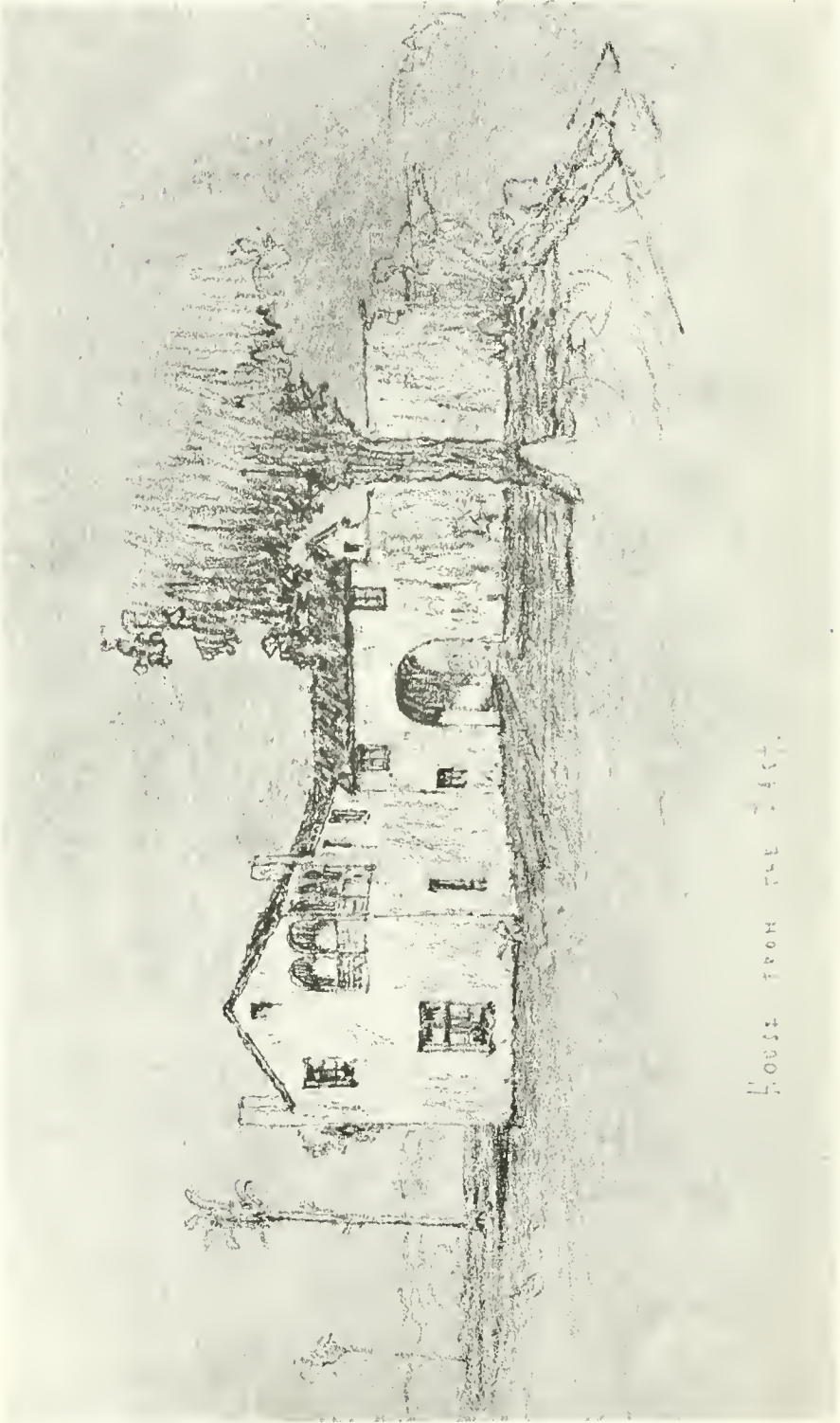

House from the East.

HOUSE FOR MR. AND MRS. DE WITT PARSHALL, MONTECITO,
CALIFORNIA
JAMES OSBORNE CRAIG, ARCHITECT



HOUSE FROM THE SOUTH

HOUSE FOR MR. AND MRS. DE WITT PARSHALL, MONTECITO,
CALIFORNIA
JAMES OSBORNE CRAIG, ARCHITECT

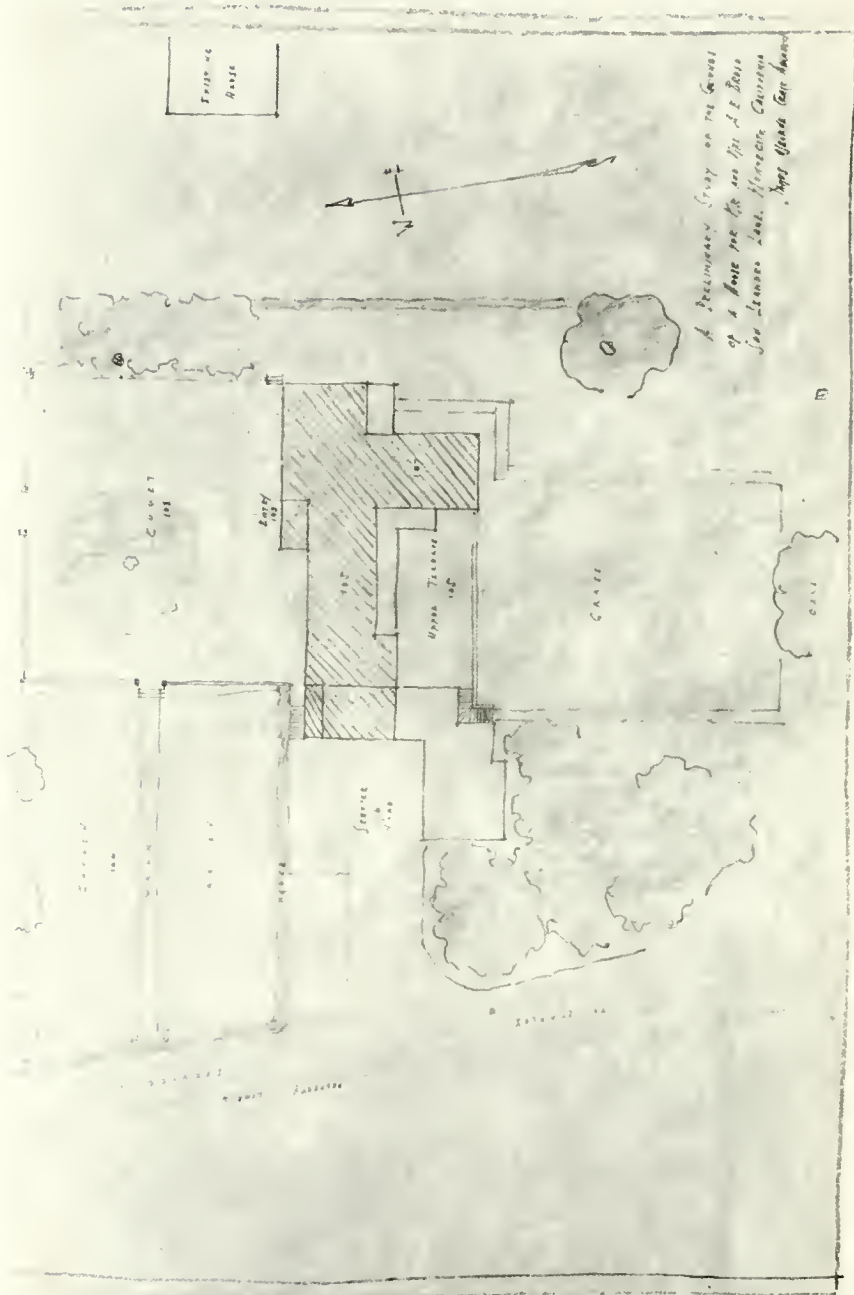

BLOCK PLAN, STUDY OF GROUNDS OF MR. AND MRS. A. E. BRUSH
 MONTECITO, CAL.
 JAMES OSBORNE CRAIG, ARCHITECT



PERSPECTIVE, STUDY OF GROUNDS OF MR. AND MRS. A. E. BRUSH,
JAMES OSBORNE CRAIG, ARCHITECT
MONTECITO, CAL.



STUDY, HOUSE OF MRS. JAMES NELSON BURNES, MONTECITO,
CALIFORNIA
JAMES OSBORNE CRAIG, ARCHITECT

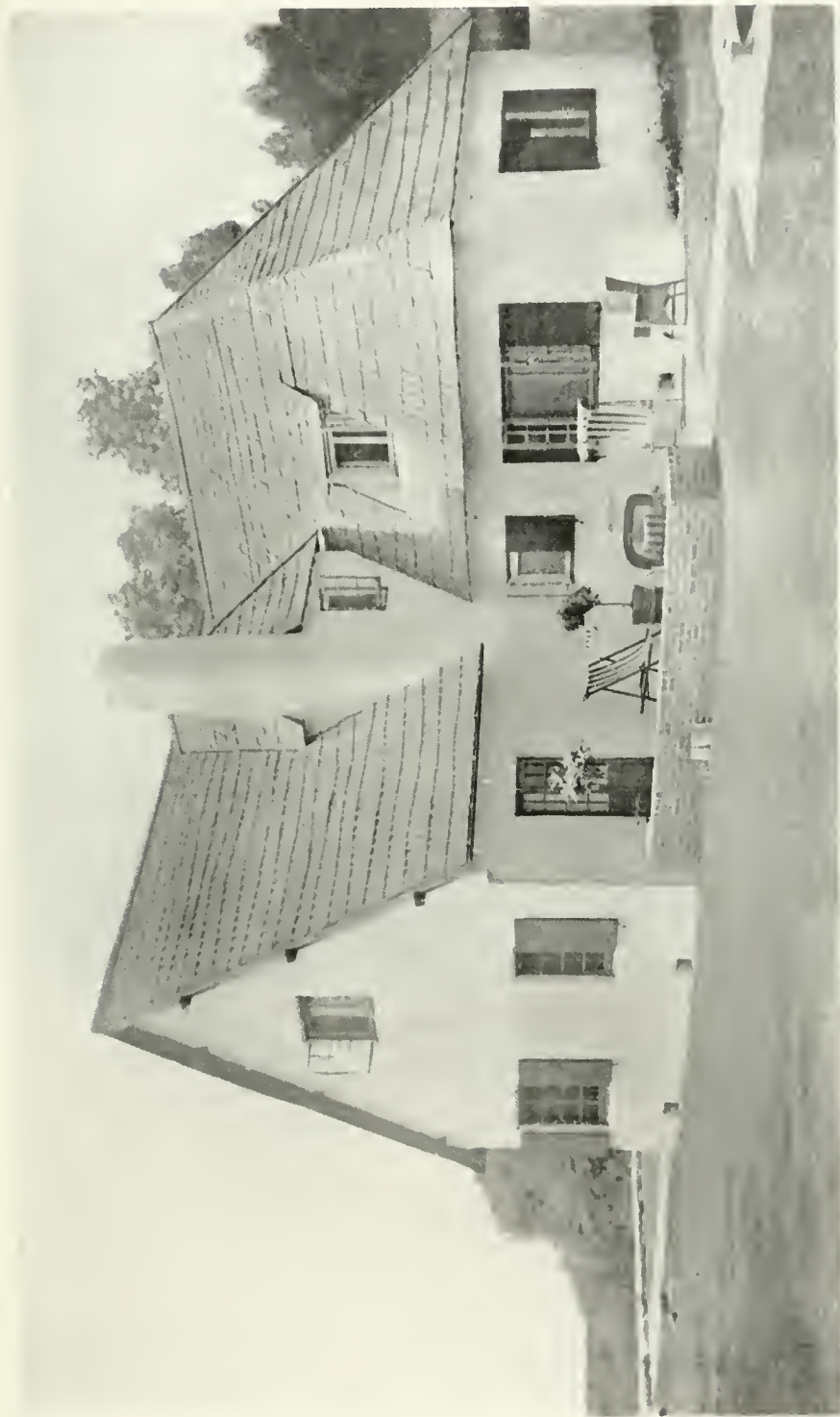

HOUSE OF MRS. JAMES NELSON BURNES, MONTECITO,
CALIFORNIA JAMES OSBORNE CRAIG, ARCHITECT



HOUSE OF MRS. JAMES NELSON BURNES, MONTECITO,
CALIFORNIA JAMES OSBORNE CRAIG, ARCHITECT



GROUND FLOOR

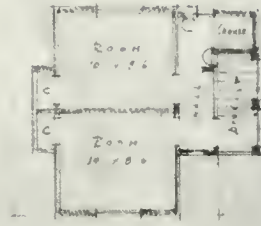

SECOND FLOOR



EAST ELEVATION

WEST ELEVATION



PATIO ENTRANCE FROM DE LA GUERRA STREET.

darker and the chalk lighter than in the drawing, producing cruder contrasts. It has also seemed necessary to do violence to the original compositions in adapting the material to magazine pages. To have reproduced the composite sheets as they stand would have left the individual perspectives unintelligibly small; and the only course open was to cut the drawings arbitrarily into their component members, each of which could be reproduced at approximately its actual size, or with insignificant reduction.

IV.

When I said that Mr. Craig's work was destined to affect the course of architecture in California I did not mean to refer its influence only to an indefinite future. Already his efforts are bearing fruit in a concrete



COURT, DE LA GUERRA HOUSE, SANTA BARBARA
James Osborne Craig, Architect

project for the improvement of Santa Barbara; a scheme which, though it will be executed by other parties, goes back in its essence to his conception.

This scheme is a rather complex and unique development, or rather co-ordination of developments, referred to as the de la Guerra Plaza and the Street in Spain. The undertaking is in part—but probably no outline of the project will seem intelligible without a prefatory explanation of the spirit in which Santa Barbara regards its task.

Santa Barbara is indeed an unusual phenomenon—a city which does not keep one eye fixed on New York. It knows it is small, knows it will probably never have an occasion for being large, and therefore wishes to guide its development along lines not only appropriate to a small city, but proper to its own peculiarities and possibilities. I may be over-zealous in crediting Santa Barbara as a whole with this illuminating intuition. It doubtless harbors individuals who define improvement as cutting down

trees and building waffle-faced buildings. It is, however, the attitude of the Community Arts Association, which has assumed an aggressive and intelligent direction of the city's development, in so far as it can directly or indirectly exert its influence. It is not afraid of charges of provincialism, realizing that the essence of provincialism is the fear of being thought provincial.

One of the first architectural projects to be fostered by the Community Arts Association is the above-mentioned de la Guerra Plaza and the Street in Spain. This is essentially one co-ordinated scheme, a part of which is to be municipally executed (bonds for this purpose having been recently voted) and a part carried out by private enterprise. The



VIEW ON DE LA GUERRA STREET, SANTA BARBARA
Sketch by James Osborne Craig

layout can be understood by reference to the outline sketch plan on the drawing on page D following page 103. It consists of clearing the present paltry City Hall out of the de la Guerra Plaza (where it probably stands illegally anyway) and building a worthy structure on the corner of the plaza away from State street. The present Spanish adobes adjoining the City Hall site on the Plaza are to be retained as municipal offices, the private building at the far end of the plaza is to be rebuilt into the scheme (plans for which are already being executed by Mr. George Washington Smith) and the rear facades of the buildings which front on State street are to be given a simple harmonious treatment. I can not refrain from pointing out with unconcealed satisfaction that the City

Hall will be neither on the main street of the town nor on the axis of anything.

The so-called Street in Spain lies across de la Guerra street, at the side and rear of the old de la Guerra house, and touching or embracing the Patio, already so charmingly restored by Mr. Craig. It will consist of a street or alley, and a court behind the de la Guerra house, bordered by shops, studios, and the like, and communicating through to the street at the rear, where it will open upon the old Lobero theatre now being restored by Mr. Smith. The well known de la Guerra house, as well as the other adobe relics remaining on the site, will be incorporated into the scheme.

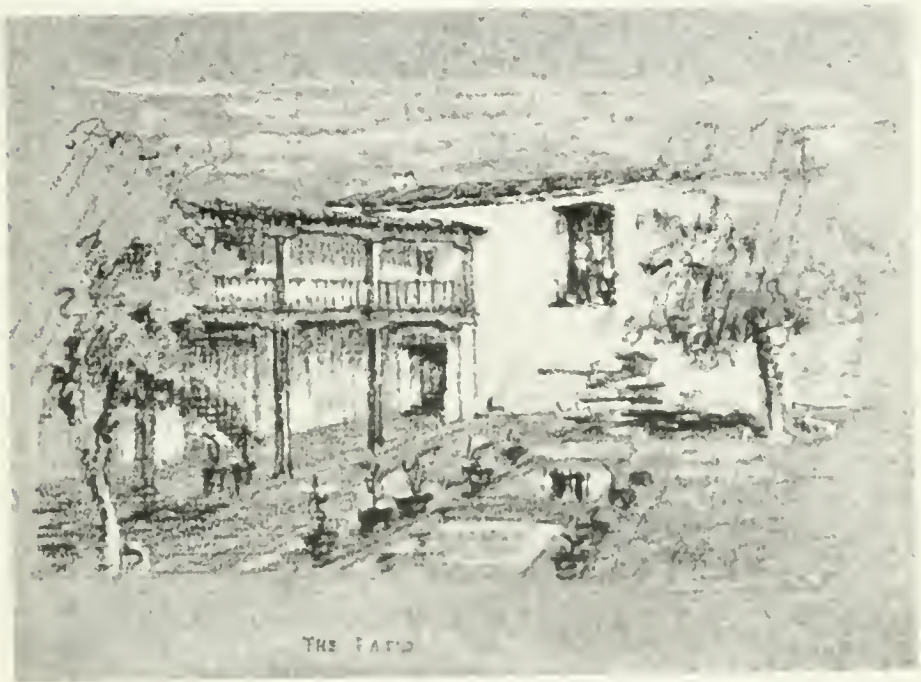

PATIO, DE LA GUERRA HOUSE, SANTA BARBARA
James Osborne Craig, Architect

The execution of this project will give Santa Barbara one of the most beautiful and unique attractions of any Californian—or American—city. Not its least commendable phase is its naturalness, its logic. It is unblighted by the specious “exposition” spirit which so readily invades such undertakings and renders them unsufferable shams. It is not an arbitrary and useless concoction, but a valid restoration. It is to be executed to make the town lovelier for its own inhabitants, not as a useless spectacle for the gaping tourist. Mr. Craig’s friends have recognized his “efforts to restore to Santa Barbara its heritage.” This project, for which he has pointed the way, is one of the most important steps in that direction which the community has taken.

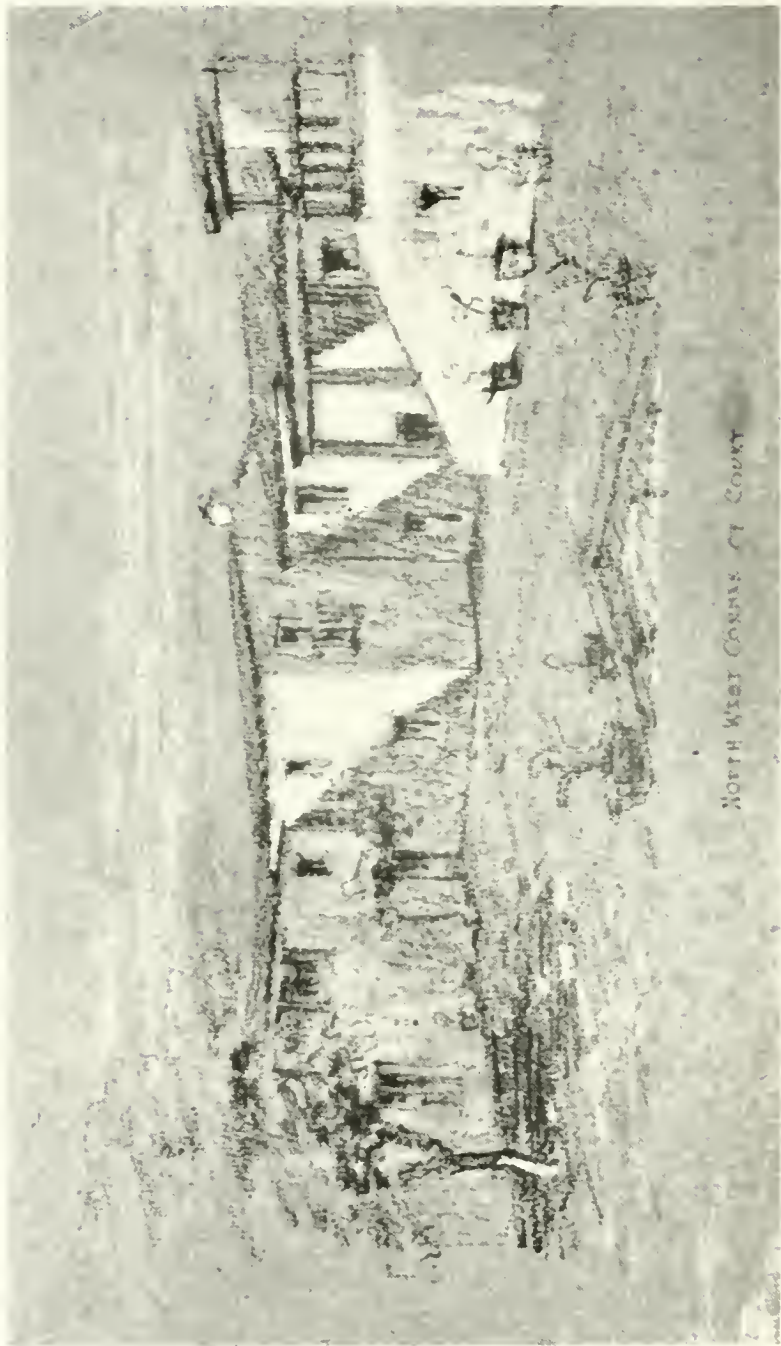

NORTH WYER COURSE CT COURT

COURT, DE LA GUERRA HOUSE, SANTA BARBARA
JAMES OSBORNE CRAIG ARCHITECT

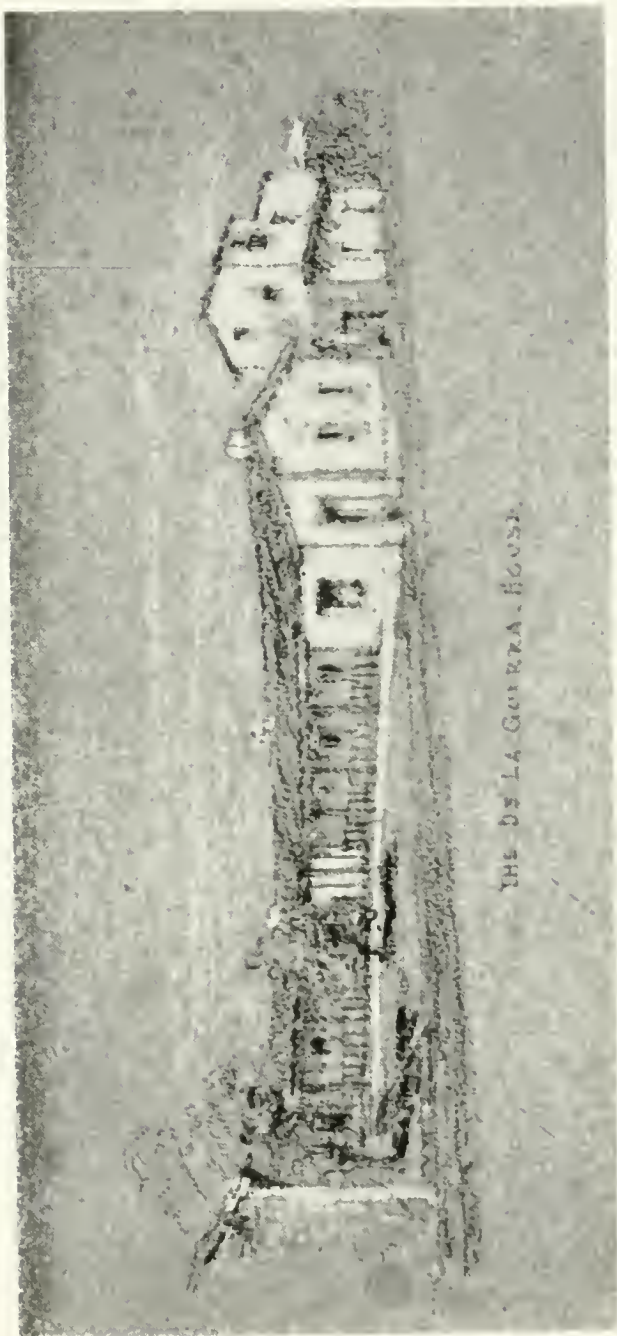

THE DE LA GUERRA HOUSE.

THE DE LA GUERRA HOUSE, SANTA BARBARA, CAL.
SKETCH BY JAMES OSBORNE CRAIG



COURT BEHIND THE CASA DE LA GUERRA, SANTA BARBARA.
JAMES OSBORNE CRAIG, ARCHITECT
CALIFORNIA



CASA DEL M. J. DE LA GUERRA

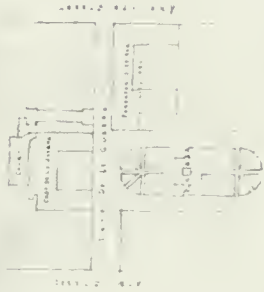

STUDY OF THE DE LA GUERRA PLAZA, SANTA BARBARA,
CALIFORNIA
JAMES OSBORNE CRAIG, ARCHITECT

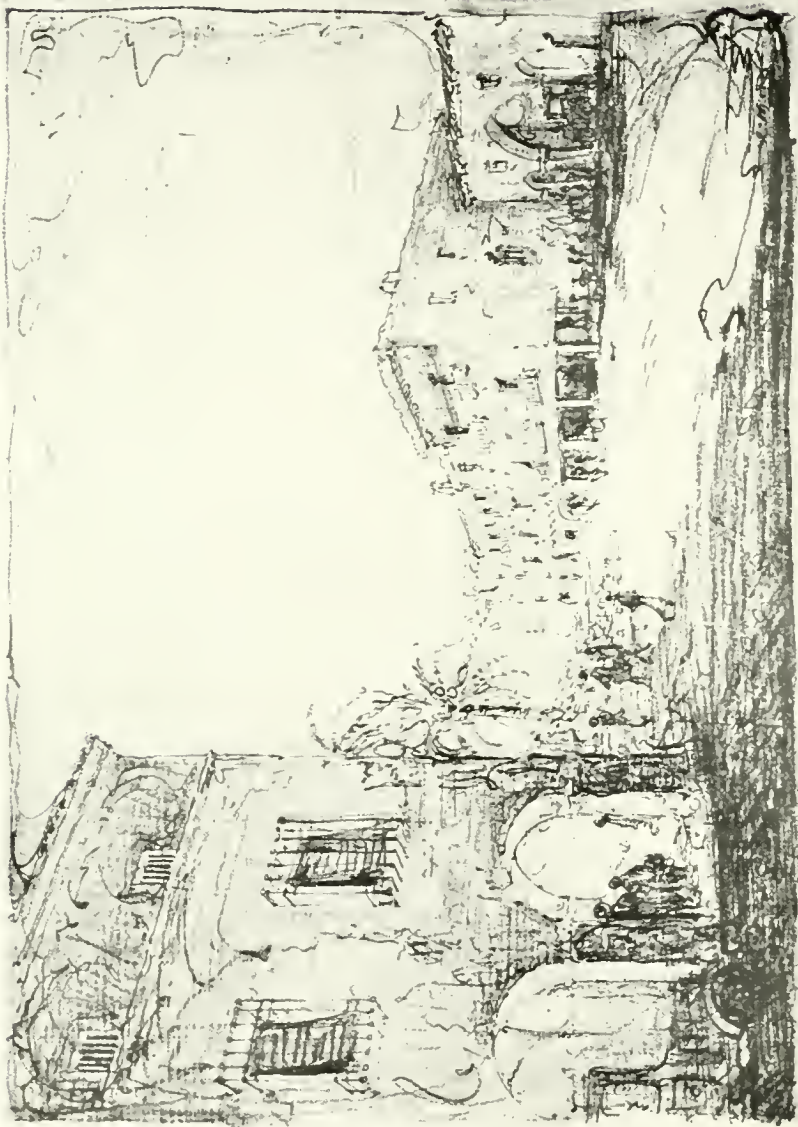

SUGGESTION FOR CITY HALL PLAZA • LOOKING WEST
 SUBMITTED BY AMERICAN ARTISTS ASSOCIATION

STUDY FOR THE DE LA GUERRA PLAZA, SANTA BARBARA,
 CALIFORNIA GEORGE WASHINGTON SMITH, ARCHITECT



SUGGESTION FOR CITY HALL PLAZA - LOOKING EAST.

STUDY FOR THE DE LA GUERRA PLAZA, SANTA BARRERA,
CALIFORNIA GEORGE WASHINGTON SMITH, ARCHITECT



RESTORATION OF OLD LOBERO THEATRE, SANTA BARBARA,
CALIFORNIA
GEORGE WASHINGTON SMITH, ARCHITECT

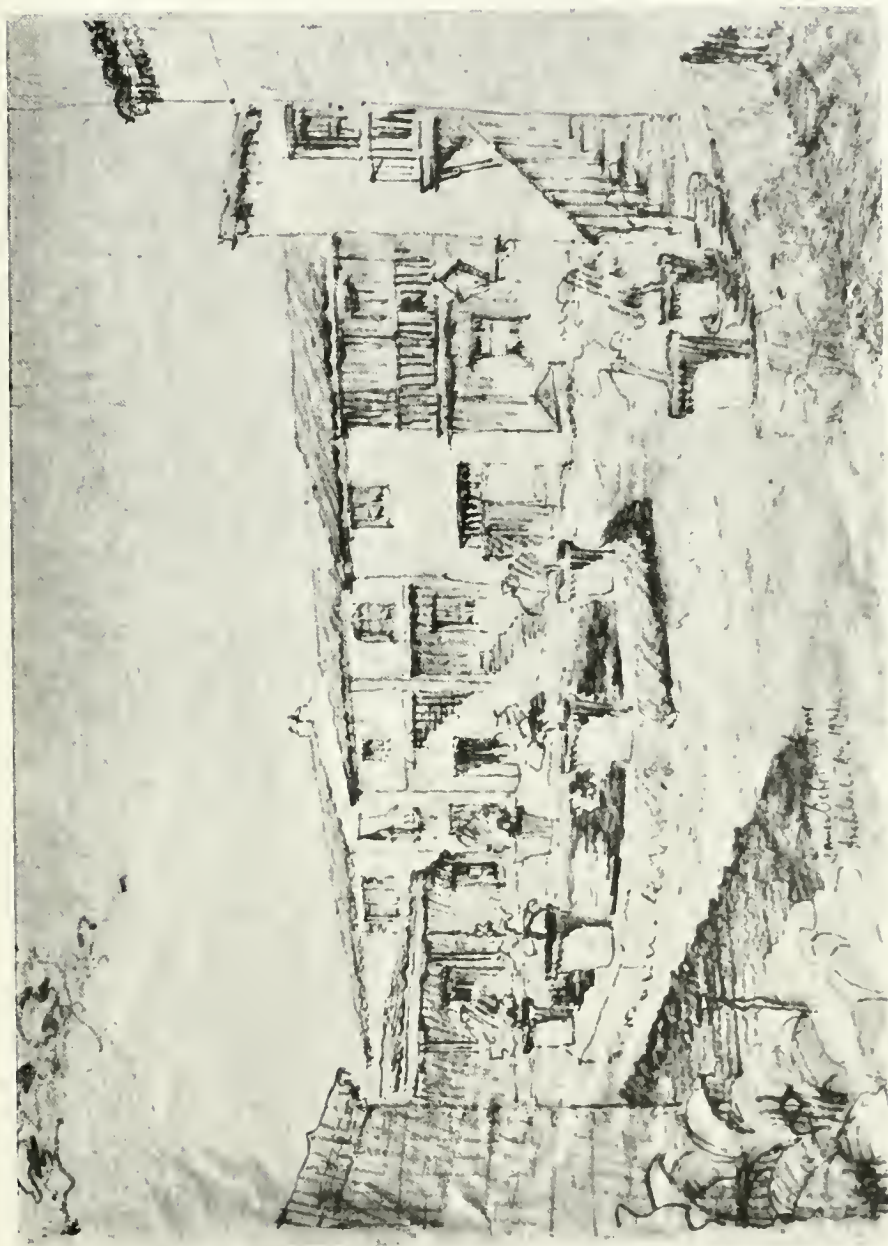

PLAZA BEHIND THE CASA DE LA GUERRA, SANTA BARBARA,
CALIFORNIA
JAMES OSBORNE CRAIG, ARCHITECT

THE Architect and Engineer

Incorporated

Founded 1905 by E. M. C. WHITNEY

W. J. L. Kierulff - President and Manager
 Fred'k W. Jones - Vice-Pres. and Editor
 E. B. Penhorwood - - - - - Secretary
 T. C. Kierulff - - - - - Attorney

Associate Editors

Irving F. Morrow - Architectural Critic
 Chas. H. Cheney - - - - - City Planning
 August G. Headman - - - - - Book Reviews
 Wilbur David Cook - Landscape Architecture
 Wm. B. Gester - - - - - Inspection and Tests
 O. P. Shelley, C. E. { Fireproof Construction
 F. W. Fitzpatrick
 T. Ronneberg, C. E. - - - - - Structural Steel
 W. H. Lowe - - - - - Roofs and Roofing
 Fred'k N. Woods, Jr. - - - - - Rock and Gravel
 Chas. Felix Butte - - - - - Electrical Construction
 J. W. Fricke - - - - - School Equipment
 Will J. French - - - - - Department of Safety

Published Monthly in the Interest of the
 Architects, Structural Engineers, Contractors
 and the Allied Trades of the Pacific Coast by
 The Architect and Engineer, Inc.

PUBLICATION OFFICE:

627-629 Foxcroft Building, San Francisco
 Telephone Douglas 1828

The publishers disclaim any responsibility for
 statements made in the advertisements of this
 magazine.

Terms of Subscription

(Including postage) to all parts of the United
 States, \$2.50 per annum; to Canada 75c
 additional; to all Foreign points \$1 additional

Vol. LXX. AUGUST, 1922 No. 2

TRUE ART PERMANENT

The supreme beauty of the Lincoln Memorial just dedicated in Washington is a reminder of one respect in which we have surpassed Lincoln's time. No architect in America could have designed that structure in the period immediately following Lincoln's death, or if by some miracle of genius it were designed, no committee representing the taste of the time would have accepted it. Whatever could have been produced then would have represented the temporary style of the time—and that the worst style in the history of architecture. The building just dedicated, on the other hand, represents the changeless canons of the ages.

Styles change, but Art is eternal. The State Building at Washington represents the "General Grant

Period." which no other period would have endured. But the Lincoln memorial would have evoked the admiration of Phidias or Michel Angelo—or even of the mediaeval cathedral builders, who might have deplored the classicism but would have praised its simple perfection. It is in a "style" but a style which has lasted already twenty-five hundred years, and is good for twenty-five thousand more.

The styles that last, whether in architecture, poetry, or dressmaking, are those that conform to the permanent canons of art. There are such canons. Jazz music, futuristic painting, free verse, bustled dressmaking and gingerbread architecture do not conform to them. When they go out of style they are out. But Beethoven, Murillo, Petrarch, the Greek robe, and the Parthenon are never in nor out of style. And whatever else is good in any art, no matter how far it may differ from them in form, is good by the permanent standards which they exemplify.

CHESTER ROWELL.

(Copyright by the All Western Syndicate.)

Who Pays for the Bond?

A Southern member of the American General Contractors' Association, with a reputation for skill integrity, and responsibility recently challenged the low bidder on a certain job when he found out that the price of the bond was not included. The low bidder made the statement that he had not furnished a bond in twenty years, and had always been able to satisfy the owner that it was money thrown away. If the bond price had been added, the Association member would have been low.

The opinion sent to him was that the two bids were not comparable—because one complied fully with the specifications, and the other did not; and that in all fairness the owner should allow the cost of the bond to be deducted from the member's proposal, or add the cost to the other. It was added that sometimes an owner designates the company in which he desires the bond to be written and to pay the premium thereon—and that if a bond is required, it must, in the last analysis be paid by the owner, regardless of the method of payment.

Fresno Architects Busy

Fresno is enjoying a building boom and population growth. Sky-scraper office buildings, hotels and apartment houses are going up in all sections of the city and it is safe to predict that by 1925 the Raisin City will have passed the 100,000 mark in population.

Architects R. F. Felchin & Co., Bank of Italy building, are completing working drawings for the eight story hotel which the Sun Maid Hotel Corporation is to build at Van Ness and Kern streets at an outlay of \$750,000. There will be 300 rooms in the new hostelry—all with baths, besides a number of stores, a large lobby and dining room. The mechanical equipment will include a washed air cooling system, steam heat, two passenger and two freight elevators, etc.

The same architects have completed plans for an eight story office building for the T. W. Patterson Estate at Tulare and J streets; also plans are being drawn for a two-story store and loft building adjoining the office building for the same owner; a ten-story office building on J street for the San Joaquin Light & Power company to cost \$600,000; a \$50,000 store and loft building in Stockton for Mr. F. P. Black and a five-story bank and office building in Visalia for the Bank of Italy, estimated to cost \$250,000.

Architects Swartz & Ryland, Rowell building, Fresno, have started construction of the new Parlier grammar school to cost \$110,000 and are now preparing plans for additional buildings at the Tulare Union High school to cost \$150,000, including a main gymnasium, a girl's gymnasium, six additional class rooms and a mechanical arts building, construction to be of brick with tile roof. This firm has also let a contract for a four-room and auditorium school at Biola, a \$15,000 residence for Dr. C. H. Ingram in Fresno, four flats for Mrs. Mamie Donley costing \$18,000 and four flats for Mr. Fred Stevenson, costing \$16,000. Plans have just been completed for the Knights of Pythias building to cost \$90,000.

Architects Coates & Traver have been commissioned by the city of Fresno to prepare plans for an open air concrete swimming pool in Roeding park, Fresno, to cost \$35,000; also for a concrete band stand in Roeding park for the Fresno Park Commission. Cost of both structures, \$53,000.

The Engineer as Specialist or Executive?

There is much talk pro and con about the engineer as an executive. Recently the president of a great railroad said, "Engineering is specialized work and a hard task-master. Engineers in their eagerness to increase their knowledge of engineering become completely absorbed

in their work." Such men are specialists-in-facts, research men, and altruists. They are not executives, nor is it desirable that they should be executives—men who execute, men of action. The very necessary function of the specialist is to prepare the facts for the men of action. The complete divorce of the collection of information and the formulation and execution of plans and policies is probably not only desirable but necessary for true efficiency.

On the other hand, there is a large class of engineers who are men of action dealing with men, machines, and materials. To say that the superintendent of a construction job, or the chief engineer of a railroad or machine shop is not an executive is folly.

Many practicing engineers are by nature and training executives, others are by nature and training specialists-in-facts. To generalize too much is dangerous and may lead to false conclusions. The thing to remember is that a natural executive may have been trained only as a specialist, and has lacked opportunity to exercise his natural gifts.—Editorial in Professional Engineer.

Stanford University Buildings

Contracts have been awarded to George Wagner, 251 Kearny street, San Francisco, for the construction of two large reinforced concrete buildings at Stanford University, Palo Alto, from plans by Architects Bakewell and Brown. One building will be a dormitory and the other a dining hall, the total estimated cost of the two structures being \$600,000.

Form Partnership

Mr. James T. Nabett of Richmond and Mr. George O'Brien of Oakland have formed a partnership for the practice of architecture with offices in Oakland and Richmond. They expect to make a very active campaign for the work of Alameda and Contra Costa counties. Mr. Nabett has extensive school and other work throughout Contra Costa county.

Seventeen Story Office Building

Plans are being prepared by Architect J. R. Miller, Liek building, San Francisco, for a seventeen-story Class "A" store and office building to be erected at Powell and Sutter streets, San Francisco. The building will be especially arranged for physicians and dentists and is expected to cost \$1,500,000.

Seattle Office Building

The Dexter Horton Estate will spend \$2,500,000 in the erection of a Class "A" bank and office building at Third and Second avenues, Seattle, from plans by Architect John Graham of that city.

With the Architects

Building Reports and Personal Mention of
Interest to the Profession

Berkeley Architect Busy

New work in the office of Architect James W. Plachek, 2014 Shattuck avenue, Berkeley, includes a five-story Class "A" bank and office building for the Mercantile Trust Company, formerly the First National Bank, and which is estimated to cost \$160,000; a one-story reinforced concrete addition to the Ford Garage at Shattuck avenue and Durant street and two frame residences at Spruce and Virginia streets for Mr. W. J. Acheson.

American Legion Building

Construction has been started on a Class "A" club building for Golden Gate Post American Legion, at Turk and Polk streets, San Francisco. The building is to cost \$125,000. Messrs. Morrow & Garren are the architects. These architects are also preparing plans for a large residence in Lakeshore Terrace, Oakland, for Mr. Bernard Silverstein.

Extensive Alteration Work

Architect S. Heiman, 57 Post street, San Francisco, reports plans in preparation for remodeling the Poodle Dog hotel and cafe on Bush street at an estimated cost of \$50,000; also alterations to the Altoona hotel on the north side of O'Farrell street, west of Mason and alterations to the two-story store and office building at Bush street and Belden Place, San Francisco.

Store and Loft Building

Architect Arthur G. Bugbee, 26 Montgomery street, San Francisco, is preparing plans for a large store and loft building to be built on Fremont street, San Francisco, for the Bothin Realty Company. The estimated cost is \$75,000. Exterior will be brick veneer.

To Practice Architecture

Mr. Louis Schalk, for a number of years in the office of Miss Julia Morgan, San Francisco architect, is now associated with Mr. Chas. K. Sumner, with offices in the Mechanics Institute building, San Francisco.

Oakland Residence

Architect A. W. Smith has completed plans for a \$16,000 residence to be erected on Hillcrest Road, Oakland, for Mr. F. Armanio of Claremont and Hudson streets, Oakland.

Berkeley Office Building

A four-story and basement physicians' office building is to be erected on the southwest corner of Telegraph avenue and Channing Way, Berkeley, from plans by McWethy & Greenleaf, construction engineers in the Albany building, Oakland. Cost of the improvements are estimated at \$100,000.

Eight Story Apartment House

The Crest View Apartments is the name of an eight-story and basement apartment house which has been designed by Architect Joseph L. Stewart for the northeast corner of Gough and Washington streets, San Francisco. There will be sixty apartments of three, four and five rooms each. Structure will cost \$400,000.

De Luxe Apartments

A twelve-story Class "A" de luxe apartment house will be built on Ocean boulevard, Long Beach, at a cost of \$1,400,000, from plans by Architects Thornton Fitzhugh and Will W. Teall of Los Angeles.

Designing Three Residences

Architect Walter Parker has completed plans for three residences, two in San Anselmo for Mr. L. J. Murray and Mr. James Leach and a third in San Rafael for Mr. Robert Cranston.

Apartment and Residence Work

Architect Houghton Sawyer has completed plans for a \$50,000 frame apartment house at Thirteenth avenue and Lake street, San Francisco, for Messrs. Kline & Krause and a large residence on Highland avenue, Oakland, for Mrs. Annie Hendry.

Fremont Street Building

Architect Sam L. Hyman, San Francisco, has completed plans for a four-story textile building to be erected on Fremont street, near Mission for C. D. & J. B. Weil at an estimated cost of \$85,000. Barrett & Hilp are the contractors.

Will Design Public Library

Architect Bertram D. Goodhue, New York City and Carleton M. Winslow of Los Angeles, have been commissioned to prepare plans for the new Central Public Library building in Los Angeles, for which there is available \$1,500,000.

Architect Kump Has Much Work

Following is a list of buildings under construction in Fresno and vicinity from plans by Architects Ernest J. Kump & Company, Rowell building, Fresno. The list also includes new work in Mr. Kump's office, plans for which are either being prepared or have just been completed:

Four-room Washington Colony Elementary School, Fresno county	\$ 30,000
Four-room Ripperdan Elementary School, Madera county	25,000
Eight-room and Auditorium, Barstow School, Fresno county	63,000
Eight-room and Assembly Hall, Dinuba, Elementary School, Tulare county.....	75,000
Six-room Monroe Elementary School, Fresno county	50,000
Sunnyside Elementary School, Strathmore, Tulare county	10,000
Science Building, West Side U. H. School, Los Banos, Merced county	15,000
Tranquility U. H. S. Machine Shops, Fresno county	15,000
Dinuba U. H. S. Science building, Tulare county	50,000
Lemoore Elementary School, Kings county	60,000
Visalia U. H. School Physical Education building, Arts and Science, Tulare county	100,000
Strand Theatre building, Dinuba, Tulare county	150,000
Dr. A. W. Preston, residence, Tulare county	8,000
Sultana Elementary School, Tulare county, (four rooms and auditorium)	44,000
Pomona, two room building, Fresno county	8,000
Addition, Wilson Elementary School, Dinuba, Tulare county	10,000
Cutler School, two room addition, Tulare county	15,000
One-room addition Alameda School, Fresno county	6,000
Tranquillity H. S. Domestic Science Cafeteria building, Fresno county	20,000
Orosi U. H. S. gymnasium, shops and science building, Tulare county	60,000
One-room addition Pershing School, Madera county	7,000
Two-room Primary School, City of Madera, Madera county	16,000
Science and Arts building, City of Madera, Madera county	26,000
Levy Residence, Fresno, Fresno county.....	10,000
Hotel Dinuba, Tulare county.....	125,000

Architect Robert H. Orr Busy

One of the busiest architects in Los Angeles is Mr. Robert H. Orr, who has offices in the Van Nuys building. Following is a partial list of some of the more important undertakings in Mr. Orr's office:

First Presbyterian Church, Glendale	\$200,000
Hollywood Christian Church	175,000
First Methodist Episcopal Church South of Hollywood	90,000
Hollywood Hospital	225,000
Wilshire Masonic Lodge	70,000
Zoology Laboratory Pomona College	100,000
First Christian Church, Seattle	135,000
Whittier Christian Church	75,000
Calvary Baptist Church, Pasadena.....	90,000
Ventura Christian Church	25,000
Chapel for California School of Christianity	30,000
First Christian Church, Stockton.....	100,000
First Christian Church, Bakersfield.....	75,000
University Church, Seattle	100,000
First Presbyterian Church, San Fernando..	25,000
Melrose Avenue Methodist Episcopal Church, Los Angeles	250,000
Wilshire Boulevard Christian Church, Los Angeles	350,000

Architects Would Disincorporate

The work which it was organized to supervise having been transferred to Architects Dean & Dean, the architectural and engineering commission appointed by the old Sacramento City Commission to have charge of the plans for the new elementary schools, has made voluntary application to the Superior Court for dissolution. It was incorporated by Messrs. George D. Hudnutt, engineer, and Jens C. Petersen and E. C. Hemmings, architects.

Judge Charles O. Busick has fixed September 5th as the date for hearing the application. The action is more or less formal, as the commission transferred all of its obligations in connection with the schools to Messrs. Dean and Dean with the approval of the Board of Education.

Granted Architects' Certificates

The California State Board of Architects granted certificates recently to the following:

Bernard W. H. Scott, 980 Capp street, San Francisco.

Carl R. Schmidts, 2230 Grove street, San Francisco.

Helen E. Findlay, 784 Seventeenth avenue, San Francisco.

Arthur C. Munson, 1103 Story building, Los Angeles.

Hugh R. Davies, Long Beach.

Ilton E. Loveless, San Diego.

DeWitt Mitcham, San Bernardino.

Kemper Nomland, Glendale.

Robert H. Spurgeon, Riverside.

George Birnbach, 333 San Fernando building, Los Angeles.

S. Tracy Hoag, 129 N. Hancock street, Los Angeles.

Joseph J. Kucera, 1040 Worcester avenue, Pasadena.

Prizes for Best Paper

Preliminary announcement of cash prizes for the best paper entitled "Use of Vitriified Clay Pipe in Plumbing Systems" is made by S. E. Dibble, head of the Heating and Ventilating Department of the College of Industries, at Carnegie Institute of Technology. The total amount of prizes is four hundred (\$400.00) dollars. The contest will be open to all practical plumbing and heating dealers, inspectors, etc., as well as to instructors and students in all educational institutions where drainage is taught.

Detail announcements of the rules and regulations of the competition, and the amount of each prize in the various classes, will be made about September 1st, 1922.

Designing School Buildings

New work in the office of Wyckoff & White, San Jose, includes two school buildings in Gilroy, costing \$150,000; a grammar school building at Saratoga, costing \$40,000; and a residence in Hollister for Dr. L. C. Hull, costing \$20,000.

An Equipment Lease Out for Contractors

AN equipment lease that constructors are willing to sign as either lessee or lessor has been issued by the Associated General Contractors of America. Its object being to establish on a basis of common equity those obligations and responsibilities properly involved in renting construction machines, and to provide a simplified rental agreement which will insure absolute fairness to both parties.

The form adopted is the result of investigations and criticism of members of the A. G. C. extending over a period of two years.

Both construction and equipment leasing companies have frequently been subjected to expense and annoyance on account of misunderstandings which arose when equipment is rented by verbal or letter agreement or by an unsuitable form of lease, and it is to overcome such difficulties as these, as well as to eliminate drastic and unreasonable provisions, that the new standard form has been adopted. Misunderstandings frequently arise from the fact that equipment is sometimes rented on short notice when the need arises, and when the main consideration is to get the machine into operation. In such instances, a telephone call, a letter or almost any kind of a lease, may serve to close a transaction, and when the unexpected happens both parties find that the responsibilities are not properly defined or that one or the other is saddled with an unfair obligation.

Situations of this nature can usually be avoided where the construction company has a suitable form of lease, easily filled out and familiar to its officials and executives. When all companies are using the same form the chance of misunderstanding is even more remote, especially when arrangements for leasing must be hurriedly made by letter or wire. This means of consummating an agreement, however, can be safely used by means of the A. G. C. Equipment Rental Agreement. All that is required is an understanding that certain equipment is shipped under A. G. C. terms of lease, and each party will then know definitely his obligations. Final arrangements can be made with a minimum of delay.

The standard form is arranged so that all blank spaces for filling in of dates, rental rates and other stipulations are segregated on the front of a single sheet, and those provisions of general application and requiring no filling in for ordinary conditions are segregated on the back. Thus a concise form of letter size convenient for filing is afforded.

American Plan Principle Discussed at Institute Convention

Southern California Chapter, American Institute of Architects, held its summer meeting at Santa Monica July 18th. Mr. Sumner Hunt, president, submitted his report of the annual convention of the Institute, held in Chicago, June 7th to 9th. Owing to limited space excerpts only are given from Mr. Hunt's resume with special reference to the report of the Board of Jurisdictional Awards:

In making a report on our trip to the recent convention of the American Institute of Architects at Chicago, I am taking up first the matter that seemed to be of the greatest interest to us, and incidentally, one that seemed to arouse more contention on the floor of the convention than any other matter that was taken up; namely the action on the report of the Board of Jurisdictional Awards. This report was made by Mr. Russell of St. Louis, chairman of the Board of Jurisdictional Awards, and was a verbal report, of which I have seen no written record and cannot, therefore, attempt to quote with accuracy. But in general it was to the effect of calling attention to the work that they had done and assuming that the work would continue along the lines that had been carried out during the past year.

It transpired that there was a large number of members of the convention who, like ourselves, felt that while the results accomplished in settling strike disputes were admirable, yet some of the principles in force in the work of this board were vitally wrong, to-wit: what seemed to them and to us a failure to recognize any labor condition except that of organized union labor.

A motion to adopt the report brought out a very general and somewhat heated discussion tending to demand a revision of the present methods of institute participation. In the course of the discussion I made the following remarks:

The Southern California Chapter assumes that you are all familiar with the general principles involved in the jurisdictional award, have read the proceedings of the former convention and know the extent to which the Institute has committed itself to the decisions of a joint board in which the Institute holds but a minority membership.

Contractual and working agreements between the American Institute and other nationally organized bodies interested in building involve the loss of the Institute's identity in amalgamation. Such contractual agreements are basically obnoxious to our Chapter. We do not want to be governed by an amalgamated building trades council.

This is not to say that recommendations, where they are not mandatory, would not be received and welcomed. We realize that most of the jurisdictional awards could be adopted without jeopardizing the "American Plan" principle. All this hangs on the assumption that it is unnecessary to call attention to the fact that certain sections of our country are working on closed shop lines and others on the "American Plan."

The architects who are in sympathy with the

"American Plan" feel that they are fighting for a principle, and that some of the architects who accede to the closed shop movement are merely taking the line of least resistance, while it is recognizing that others feel that a real movement forward is to be accomplished by working out the closed shop principle.

As a result of the fact that the jurisdictional award program had not been properly visualized by our Chapter, our delegates at the Nashville convention, when the matter first came up, found themselves unprepared and uninstructed. Before the date of the next convention, the Southern California Chapter found itself facing a crisis in an "American Plan" community, because of mandatory rulings of the Institute, as a result of which, on June 25, 1920, members of the Southern California Chapter signed a statement addressed to the board of directors of the Institute, in which our position was clearly stated and we feel now that our position must be made clear to the entire membership. The following is a copy of the statement referred to:

"Be it resolved, that the Southern California Chapter of the American Institute of Architects commends the desire of the officers and directors of the American Institute of Architects to bring about amicable solutions of questions that arise in the building trades, and welcomes any recommendation of procedure made by them which does not encroach on the rights of any Chapter member; but it questions the expediency of the adoption in convention or otherwise of recommendations treating with such a complex and important subject as that of jurisdictional awards, without first having referred the matter to the chapters for discussion and vote, and without thus giving the chapters the opportunity to be represented in convention by informed and instructed delegates.

"Therefore, it is with the greatest regret that the Southern California Chapter of the American Institute of Architects cannot endorse or become a party to the action of the American Institute of Architects in this matter of the 'Board of Jurisdictional Awards,' and every member of the Chapter whose name is signatory hereto hereby witters that he must and does refuse to accept as binding upon him any authority, action or decision of the 'Board of Jurisdictional Awards,' or any authority, action or decision arising therefrom. Be it further

"Resolved, that this resolution shall be transmitted to the board of directors of the American Institute of Architects at Washington, and that a copy thereof be sent to every member of the Chapter and to every Chapter of the Institute."

This resolution has been signed by every new man coming into our Chapter and covers our position today. Notwithstanding the fact of this somewhat bold statement of our position, we would like the Institute to feel that even so we are gentlemen and architects, amenable to reason and willing to take orders when they do not conflict with what we conceive to be basic principles."

After my statement as above and some further criticisms from other members, Mr. Ittner of St. Louis moved to the effect that it being obvious that there was a spirit of dissatisfaction in the convention with the present status of the A. I. A. in the jurisdictional award work, and that in view of changed conditions, which I took it, referred to the largely increased number of localities operating under the open shop, or "American Plan" method, that the whole matter of the Institute participation in jurisdictional awards be referred back to the board of directors for study, with a view to revision, to meet these changed conditions. This motion was carried, and speaking again for our chapter, I said that was all we asked, and we would go home happy as a result of this action of the convention.

Thinking of jurisdictional awards logically brings up another important action of the convention along somewhat similar lines, namely the resolution adopted by the convention authorizing the board of directors to take out a membership for the American Institute of Architects in the new American Construction Council. This American Construction Council is a very admirable idea,

endorsed by a number of the best minds in the Institute and in the country-at-large, to bring some sort of order out of the chaos of the building business.

Redwood City Commercial Building

Plans have been completed by Architect G. A. Lansburgh, 140 Montgomery street, San Francisco, for a one-story reinforced concrete commercial building at Redwood City for the California Pacific Title Insurance Company. Mr. Lansburgh has also completed plans for the new Pajaro Theatre at Watsonville, to cost \$60,000.

Sacramento Architects Organize

The Allied Architects and Engineers Club of Sacramento has been organized with an initial membership of over 100. Mr. George Adams of the State Department of Architecture was elected temporary chairman and Mr. D. E. Godfrey temporary treasurer. The following committee will draw up a charter and by-laws: T. E. Stanton, R. A. Herold, Leonard Stark, T. E. Tempest and George Calder.

Honolulu Office Building

Architect C. W. Dickey was called to Honolulu during the month to consult with the Castle-Cooke Company in regard to their proposed new office building. Mr. Dickey has made preliminary plans for two types of buildings costing from \$400,000 to \$800,000. Before returning to California, Mr. Dickey will probably award contracts for the new Queen's Hospital in Honolulu.

Coast to Coast Exhibit

The San Francisco Architectural Club recently enjoyed the honor of housing a number of sketches selected from among those submitted in the Birch Burdette Long Sketch competition for 1921. The exhibition was shipped to this coast from Dallas, Texas, after having been shown in many of the large Eastern cities. Reports indicate unusual interest in viewing the collection.

Woman Architect in Charge

The construction of the newest and largest theater in Boston was supervised by a woman—Miss Ann Dornin, a native of Norfolk, Va., a graduate of the architectural school of Columbia university, and said to be one of the first women in the United States to become a construction supervisor.

Addition to Athletic Club

The proposed addition to the Woman's Athletic Club on Sutter street, west of Mason, San Francisco, is to proceed at once under the superintendence of Mr. A. A. Brown, 120 Market street, San Francisco. The addition will cost in the neighborhood of \$250,000.

Former San Francisco Architect Writes of Eastern Conditions

Editor The Architect and Engineer:

I have to acknowledge the constant receipt and the pleasure gained therefrom of your valuable book, *The Architect and Engineer*. As a further reminder, I have carried your last communication amounting to \$5.00 in my wallet for a longer time than I should have done, and feel sure, for the delay, I have your forgiveness. So it is with pleasure I enclose M. O. for \$5.00 and know that I have unintentionally put to the test of loyalty one of my oldest California friends whose kindness relative to the same I am more than obliged for.

Owing to business conditions since I arrived in New York, I should probably have made my way back to God's Country ere this, if one could have foreseen the constant delays that surround New York's building. Commercial and office buildings and apartment houses, with tearing down of "old" fronts and re-building modern, have been the vogue.

The apartment houses are principally erected by speculative builders, and costing from \$200,000 up, mostly "up." Notwithstanding this influx of the "new" apartments, rentals still remain exorbitantly high. I have to pay \$90.00 per month for four rooms, including as one a kitchenette, which was formerly rented at \$35.00.

Residential architecture is still practically at a standstill here, prices being too high for the would-be "home" owner. Labor troubles are all around us, and as a stimulus to same, the weather for the last two months has been so erratic that one may truly say, that it has rained forty days and forty nights. My experience has led me into the designing of commercial buildings, apartment houses and some residential work.

For the last three months I have been the architect to a well known engineering firm here, the members of which are Cornell graduates in engineering, and I have enjoyed having full control of the architectural department, but work is getting slack and many obstacles loom on the horizon. The building department here is a "maze" and from one day to another, it is difficult to know where you stand. The "zoning" ordinance has to be carefully considered, and the plumbing ordinance varies so much with each different class of buildings, that you have to be more than a plumber to get the system accepted. In several offices they have "specialty men" on this subject.

Masonry in New York is well done, both brick and stone work, and the jointing is a thing of beauty, likewise carving and the ornamental wrought iron grilles.

In all, large and congested as New York City is, there is a peculiar fascination about it. The wonderful Hudson, with its Riverside Drive, and Fifth Avenue, with its numerous fine squares and never-ending traffic, all lend a charm.

Again New York is a very clean city. Constant application of the flooding of streets through the medium of the fire hydrants keeps the streets cleaner than any city I have visited in Europe, not excepting my dear old London.

CHAS. ED. HODGES.

Home Garden Competition

With the object of stimulating interest in the artistic development of the small home garden, the Society of Little Gardens has announced a competition to be judged from photographs of actual small gardens. This competition covers three classes as follows: Class I,—Treatment of space not less than six hundred square feet (20x30), or more than 5,000 square feet (one-eighth of an acre approximately.) Class II,—Photograph of one object of interest in the garden and its setting, as described in Class I. Class III,—Photograph of City Housefront, with artistic arrangement of plants, whether in window boxes, wall vines, or potted plants, as described in Class I. The prizes are as follows: Class I, \$50; Class II, \$15; Class III, \$15.

The photographs will be judged by a jury composed of three experts, Miss Harriet Surtain, chairman, dean of the Philadelphia School of Design for Women; Miss Elizabeth Leighton Lee, director of the School of Horticulture for Women, Ambler, Pa.; and Miss Elizabeth Wilson Fisher, member of the Lantern and Lens Guild of Women Photographers, Philadelphia. The competition closes at noon, October 16, 1922.

Those interested should apply for program of the competition to Mrs. Charles Davis Clark, president of the Society of Little Gardens, 2215 Spruce Street, Philadelphia, Pa.

Will Practice Architecture

Miss Helen E. Findley, youngest of ten women admitted to practice architecture in California, has begun her career as an architect by planning and directing the construction of a two-story dwelling on Fulton street, near Fifteenth avenue, San Francisco, which will be the residence of her parents, Mr. and Mrs. Paul Findlay.

Miss Findlay had her first experience in the office of Mr. Arthur Peabody, state architect of Wisconsin, at Madison. Since coming to California in 1916 she has worked with a number of Los Angeles architects. She will practice under her own name in San Francisco.



THE W. L. HUGHSON FORD SALES AND SERVICE BUILDING

W. L. Schmolle, Architect

Ward & Blohme, Supervising Architects for Mr. Hughson

New San Francisco Home of Ford Agency

COMPLETION of the Wm. L. Hughson Company's Ford sales and service building at Market and Eleventh streets, San Francisco, marks the attainment of a goal set by Mr. Wm. L. Hughson years ago when the automobile industry was in its infancy. The photographs of the various departments of this complete automobile institution speak better than words of the service that the Wm. L. Hughson Company is rendering the Ford owning public.

In adding this chapter to the history of this coastwise organization, it is interesting to review the past of the company since its inception.

Considered the oldest automobile concern in continuous operation, the William L. Hughson Company is one of the biggest factors on the Pacific Coast in the distribution of automotive products, concentrating their efforts at the present time on the Ford car, truck and tractor, and Lincoln. Branches are operated at Seattle, Wash.; Portland, Ore.; San Francisco, Oakland, Los Angeles and San Diego. The building just completed, in addition to being the San Francisco branch, also houses the home office of the entire organization.

Headed by Mr. William L. Hughson who has the reputation in the East of being the best known Western automobile man, this company had its inception in 1903, being known during that period as the Holle Automobile Company. In 1904 when Henry Ford started to build the

Universal car, the agency was secured for it and in spite of changes in other lines, it has been handled continuously since a period of eighteen years, making of this company one of the oldest dealers handling the Ford car today in the country.

In 1906 the Standard Motor Car Company with a capitalization of \$200,000 was incorporated. In 1910 when the Federal motor truck manufacture was started the agency was secured by the Standard Motor Car Company and has been handled continuously since that time.

At about this time a branch was opened in Los Angeles, also one in Oakland. The Stoddard-Dayton line was handled in 1911, 1912 and 1913, until financial reverses made it necessary for the Stoddard-Dayton Company to discontinue manufacturing.

In 1913 arrangements were made to handle the product of the Kissel Motor Car Company. The tremendous growth of the business necessitated an increased capitalization so that a new company known as the Pacific Kissel Car Branch, with a capitalization of \$500,000 was formed. In 1915, a branch was opened in San Diego; a little later in the same year a branch was opened in Portland. In 1917 the Seattle branch was established. For obvious reasons a change of name in June, 1918, was made, the company now being known as the William L. Hughson Company. This did not in the least disturb the personnel, being a

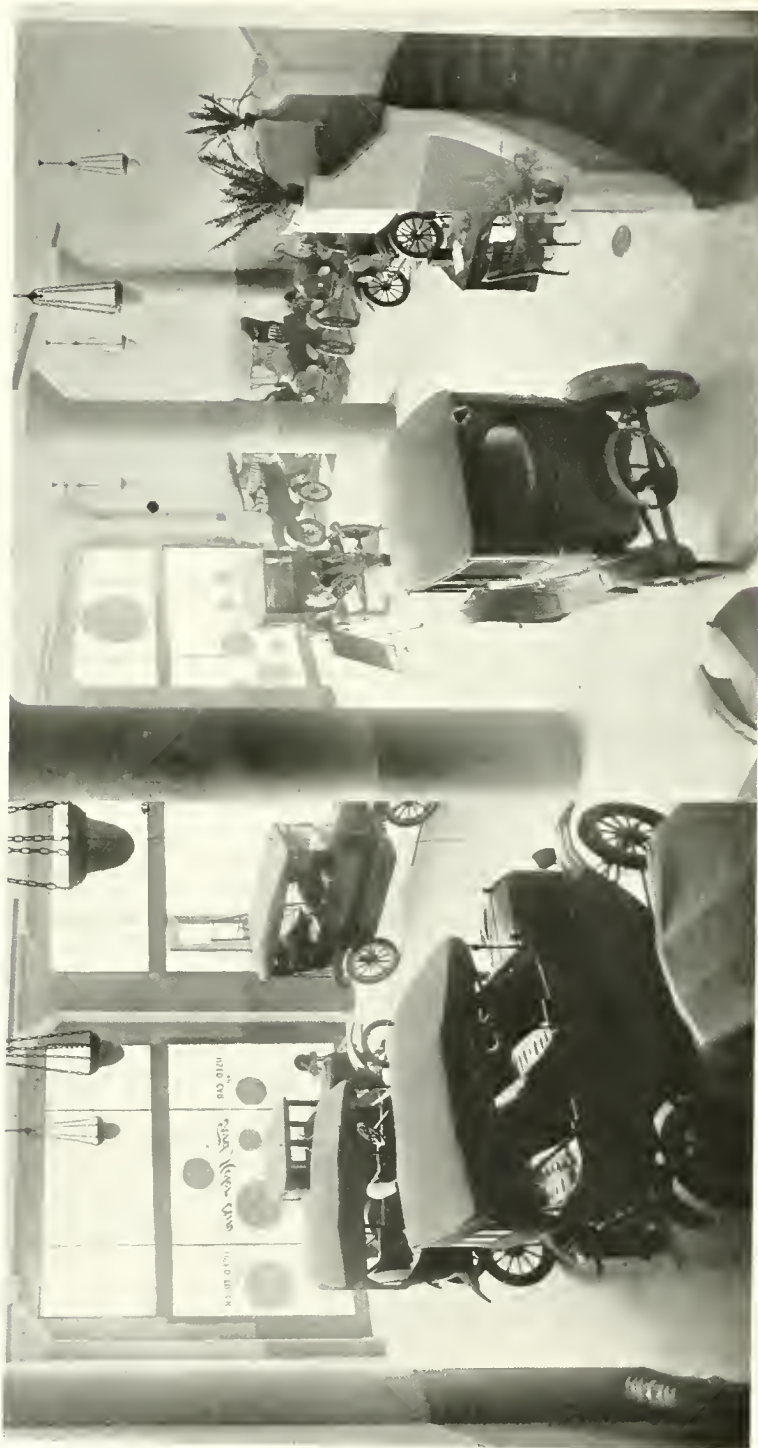

SHOW ROOM, W. L. HUGHSON FORD SALES AND SERVICE BUILDING SAN FRANCISCO

SAN FRANCISCO
PUBLIC LIBRARY

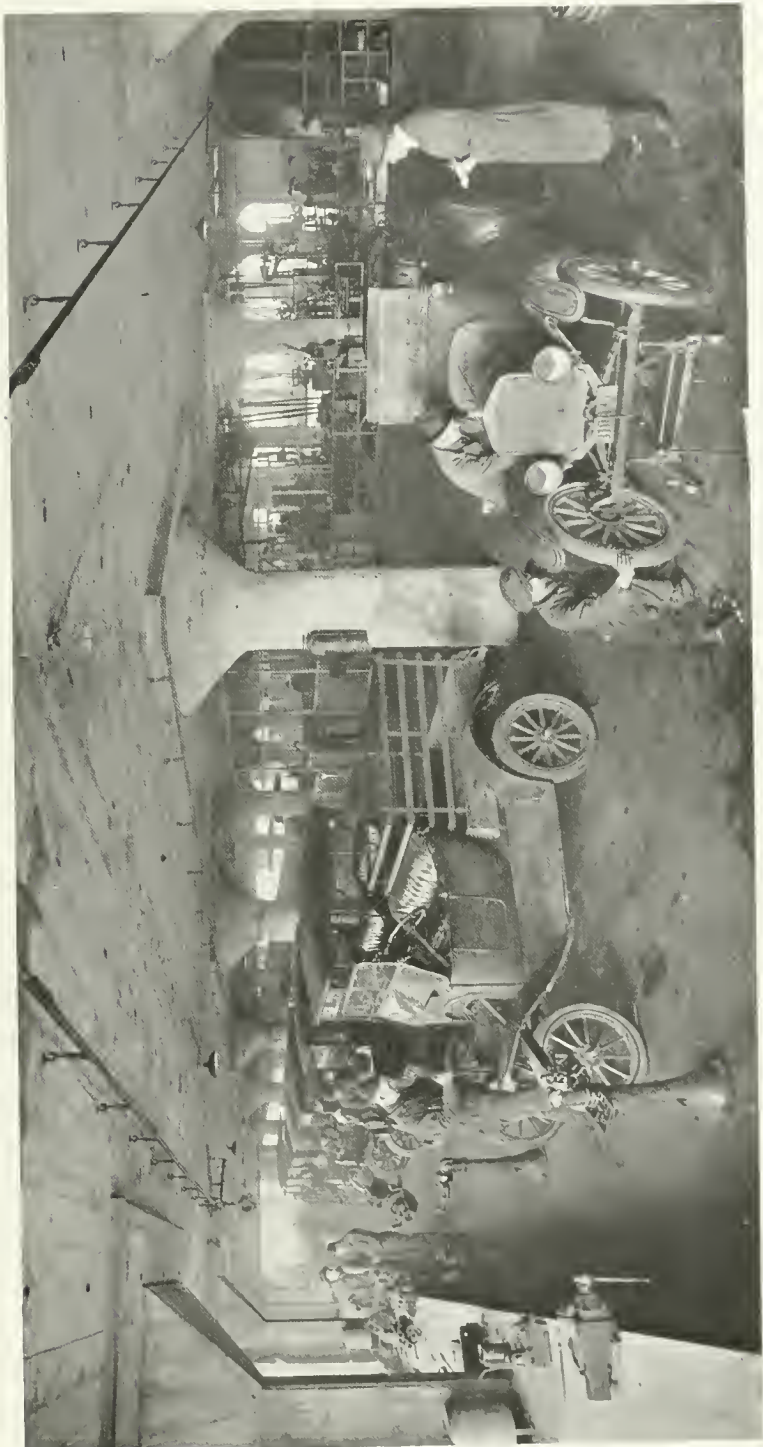

ASSEMBLING PLANT, W. L. HUGHSON FORD SALES AND SERVICE BUILDING SAN FRANCISCO

change in name only, the owners of the business remaining the same as the original organizers in 1903.

The total business done by the company the first year was in the neighborhood of \$35,000; the total business done during the year ending September 30, 1920, was between eight and nine million dollars.

Ever since the inception of the company it has been the aim of Mr. Hughson to put it on the same substantial business basis enjoyed by companies in other successful lines of business. This was no easy task when it is remembered that the automobile business is only about twenty years old. During the early progress of this industry there were a few men who had the foresight to realize the tremendous possibilities ahead of them.

Pioneers among these were Mr. W. L. Hughson and Mr. Geo. W. Emmons, owners of this organization. They brought with them not only the years of experience gained in other lines of business, but also the determination to conduct the automobile business and apply to it the high ideals they had set for their goals in their former lines of endeavor. These two veterans of the automobile business have adhered to certain characteristics that have made for progress and prosperity, and which are considered essentially good for any business. Prominent among these is service to the public, not necessarily free service, but good prompt and efficient service. Price maintenance is another and important consideration.

These two things coupled with a vigorous advertising policy and sales effort and a progressive attitude when new and up-to-date features and appliances were considered, have placed this company at the head of the coast automobile and motor truck selling organizations. Conservative financing and working in close touch and harmony with banking connections, which are of the best in every city where the company has located its branches, has enabled it even in periods of stress and financial discomfort to finance large stocks of goods where stocking up was deemed advisable.

The organization in its desire to benefit those who comprise its force and to offer a protection to those who are dependent upon them has insured all of its employees under the Employees' Group Insurance Plan, which is effective as long as they remain as members of the organization.

Since January, 1920, a "Better Business Policy" has been in effect, through which was established a closer relationship between the members of the organization and the owners of the business. The employees now have a real voice in the operation of their respective depart-

ments, receiving a just remuneration for their efforts in bringing about greater efficiency in the organization. For five years prior to the adoption of this latter policy an annual bonus system was in effect.

It is also a well defined rule of this organization to fill the jobs higher up with men from their own ranks and not to go outside of the organization to find men to fill these positions. An example of this can be found in the fact that each one at the head of a department at the Home Office, as well as all of the managers at the various branches, are men who have risen from subordinate positions in the organization. These are some of the outstanding features which have made of this organization such a successful one. Its policies of conducting business, rigidly adhered to, stand out as an example for younger concerns to follow.

Much of the credit, however, must be given to its directing head, William L. Hughson, for the leading position he takes in all activities relating to the betterment of the automobile industry in general, for aside from being chairman of the executive board of the Motor Car Dealers' Association of San Francisco, one of the strongest organizations of its kind in the country, he was recently elected vice-president of the National Automobile Dealers' Association and president of the Old Timers' Club. He has on many occasions been delegated by the authorities of the city and state to act as chairman of important committees and other activities of a civic and governmental nature.

Owing to the increased volume of its business and the demand for more available space, it was found necessary to provide for larger quarters in San Francisco and plans were immediately made by the organization to build its own building on the principal street of the city at Market and Eleventh.

This brings us to the new building which is spoken of in the first paragraph. In keeping with the organization policy of catering to the comfort and welfare of its employees, the roof holds a novelty in that a regulation size tennis court, two hand ball courts as well as a gymnasium and showers have been built so that the employees and friends of the organization may take full advantage of their recreation period. A unique system of electric lighting will be installed to permit of these sports being enjoyed in the evening hours as well.

The entire basement of the building is devoted to a day and night garage where customers will receive the most courteous and finest service to be found in any Class A garage in the country.

A feature of the Ford service and re-

SPECIFY
STANLEY
GARAGE
HARDWARE

IN SETS

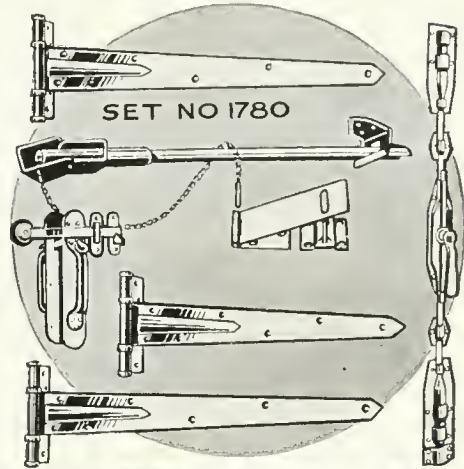

A Set for every type of Garage

And the right kind of a set for
 the right kind of Garage!

There is nothing more incongruous than hardware which is out of harmony with an architect's plans. Realizing this we have designed many sets of Garage hardware so as to be able to match practically every type of Garage, and thus satisfy both architect and client. Each set is complete with everything, and all balanced in size and weight.



Set No. 1780 is recommended for brick and stucco garages. It includes Stanley Ball Bearing Hinges, 26-in. long at top and bottom panels; 24-in. long at center panel; Garage Door Holder (cushion type) Cremone Bolt, which locks door at top and bottom at one operation; and, an Extra Heavy Padlock Hasp.

The quality of hardware on a garage also determines the kind and length of service the garage will give.

May we send you our "Catalog AE-8," which illustrates the plans of 8 types of garages, and suggests the right hardware for each type?

THE STANLEY WORKS

Main Offices and Plant.

NEW BRITAIN, CONN.

New York Chicago San Francisco
 Los Angeles Seattle

When writing to Advertisers please mention this magazine.

pair department is the day and night service, two full crews being employed, making repairs and service at the Ford corner available until 2:30 a. m.

Two large sales rooms as well as the Ford parts and service department are on the main floor. The corner sales room is devoted to the merchandising of the new Ford cars and Ford parts., while the second sales room is devoted to the sale of used cars taken in trade. The home offices, cashier's office, stenographic department, etc., are on the second floor, where the new car service shop is also located. Here we find a department devoted exclusively to the servicing of new Ford cars to insure the purchaser receiving the car ready for the road when it is to be delivered to him. The inspection chart for new cars covers every part of the automobile from putting grease in the rear-end to filling the radiator.

The third floor is devoted to the Ford repair department, the paint and trimming department and the body department; in the repair shop we find the latest type of efficient machinery necessary to give satisfactory service to Ford owners. The paint shop and trimming department have grown tremendously to the extent that all makes of cars are painted here, this being the only department in which anything but Ford products are handled.

A novel and practical installation by Mr. Hughson is the better business policy agreement between the Wm. L. Hughson Company and its employees. This policy is subscribed to by all members of the organization, the key-notes thereof being justice, co-operation, economy, energy and service.

A visit through this big modern automobile establishment is both interesting and educational—and to those who own Fords, very profitable.

Coen Oil Burning System

The Coen System of mechanical oil burning has been installed in a thousand vessels and is the oil burning system most used in our Merchant Marine. This system is now being specially adapted for firing high pressure stationary boilers, and has just recently been specified and ordered for the new San Mateo hospital, W. H. Toepke, architect.

With this system the oil is pumped to the burners under a pressure ranging from 50 to 150 pounds. After leaving the pumps the oil is passed through a

heater where it attains a temperature between 175 and 220 degrees F. At this temperature it enters the burner, which is constructed in such a manner as to cause the oil to take on a whirling motion in the atomizing chamber. The oil in the atomizing chamber rotates at the rate of from 5,000 to 10,000 revolutions and then passes through a small orifice from which it is thrown out by centrifugal force in the form of a hollow cone of "oil fog." This hollow cone of atomized oil or "oil fog" is passed through a special mixing chamber or air register where it is thoroughly mixed with air before entering the furnace. A thorough mixing of atomized oil and air before it is delivered to the furnace is of vital importance, as it is this proper mixture which must be made to insure complete and smokeless combustion.

As no steam is used for atomizing the oil a direct saving of the atomizing steam is made. This saving amounts to from four to ten per cent, according to the efficiency at which the plant has been operated when using steam burners. This saving of atomizing steam also means a corresponding saving in boiler feed water, which in turn means a corresponding saving in the amount of boiler scale. The Coen System is quiet in operation due to the fact that the noisy steam blast is not used to atomize the oil. The flame produced by the Coen burner is soft and uniformly distributed in the furnace, and is therefore easier on tubes than a steam or air atomized burner system, which oftentimes has a blow-torch effect with extremely concentrated hot spots, which are often injurious to the furnace and boiler shells or tubes.

In operation the Coen system is extremely simple, and when fitted with the automatic fire and damper control an even steam pressure is maintained with fluctuating boiler loads and with practically no attention from the firemen.

Coen Company maintains a force of mechanical engineers and oil burning specialists, and is prepared to submit designs and specifications for applying a Coen mechanical oil burning system to steam boilers of 50 H. P. or larger. Special attention is also given to large heating plants where no steam pressure is available and it is desired to operate this system electrically. The executive offices of the Coen Company are at 112 Market street, San Francisco.

Mr. Architect:

We manufacture and install all types and sizes of AUTOMOBILE TURNABLES for public and private garages and will be glad to assist you in preparing your plans and specifications for same.

324 Main Street—EDWARD O. TEALL—San Francisco
TELEPHONE KEARNY 1773

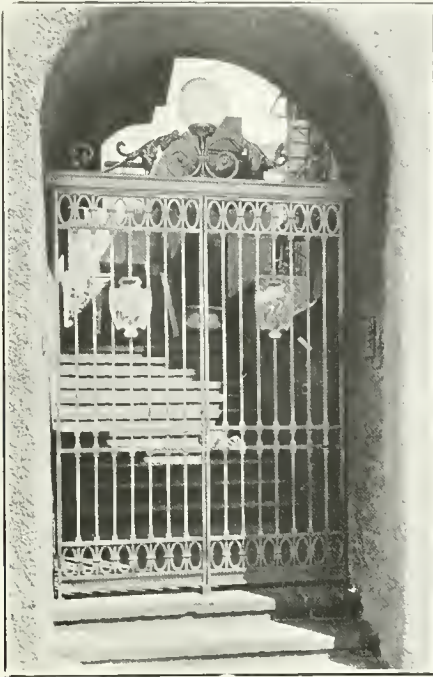

Ornamental Iron

Steel Sash
Wire Work

Michel & Pfeffer
Iron Works

PHONE MARKET 731

Tenth and Harrison Streets
San Francisco, Calif.

Valves for every purpose in the

KENNEDY Valve Book

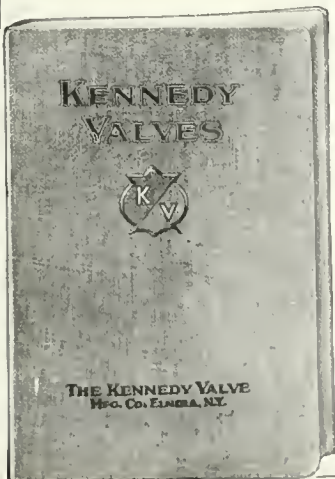

—a practical reference book for all valve users; convenient in size and arrangement. More than 500 different types and sizes are described and listed—a range that covers all usual requirements. If you use valves, you should have the Kennedy Valve Book—it explains the principles of modern valve design, points out the features of construction necessary to assure satisfactory valve service, helps to make an exactly suitable selection for your particular purposes, and gives practical suggestions for the proper installation and care of valves.

170



**THE KENNEDY VALVE
MFG. CO. ELMIRA, N.Y.**



Branches and Supply Depots:
BOSTON, 47 India Street
NEW YORK, 95 John Street
SAN FRANCISCO, 23-25 Minna Street
CHICAGO, 204-8 N. Jefferson Street
Sales Offices:
Philadelphia, Salt Lake City, Seattle, El Paso

When writing to Advertisers please mention this magazine.

ROAD DAY AT CARMICHAEL

Public-Spirited Citizens Show How Local Roads May Be Maintained.

By CHARLES DETERDING

LAST March the residents of Carmichael Colony held a road-making bee. It was a decided success from every viewpoint, and the results should be far-reaching. This accomplishment is an ideal example of what can be brought about in almost any rural community by co-operation between the County Engineering Department, the Farm Bureau, Improvement Club, Chamber of Commerce or whatever body represents the local spirit of progress.

This idea had its inception among the people of Carmichael Colony. They appointed a committee to see Supervisor John Russi, in whose district Carmichael Colony is located. Mr. Russi greeted the idea enthusiastically, assured the committee that he would give them every assistance and ordered the newly appointed County Engineer to work in conjunction with the committee.

The engineer went over the proposed plans of the committee, made a thorough study of the work and developed plans accordingly. In this locality drainage is undoubtedly the most important problem



Making the Horses Dig the Trenches

ical and efficient sizes and locations of culverts. The drainage was considered from two viewpoints:

First: The removal of all water falling on the road as quickly as possible.

Second: The elimination of obstructions in the natural waterways which cause the accumulation of water in the low places. Where water stands the subsoil becomes saturated and its power to sustain the traffic is very limited.

From the result of this study the number and sizes of the culverts were determined, and the Armeo corrugated pipes were delivered at the designated points three days before the road day.

Foresight and Organization

In the meantime the committee met to determine upon a general plan of procedure. The Colony was divided into districts. Each district had a captain who was instructed in the work to be done. As far as possible the men in each district consisted of the residents of that district. This was done in order to make the necessary travel as short as possible and also because residents would be more familiar than others with the bad places in their localities.

Saturday morning, March 25th, all reported to their respective captains, bringing with them such equipment as they believed would prove useful. Throughout the day they worked with a will in order that the roads in Carmichael Colony might be put in first class condition. At the end of the day their efforts had resulted in a most creditable showing. The success of this enterprise is the result of

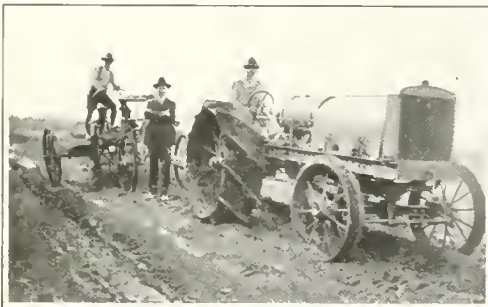

Tractor Grading With Volunteer Crews

in road construction. A detailed examination was made of the district with the object of determining the most econom-

¹ Highway Maintenance Engineer, Sacramento County.

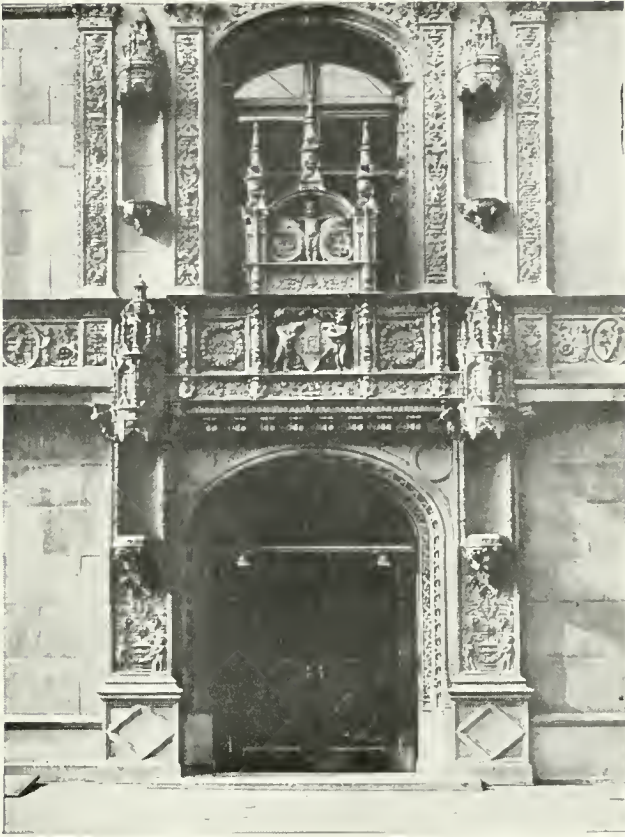

The Harrison Building, Philadelphia, Pa. Messrs. Cope & Stewardson, Architects. For three decades an architectural landmark in Philadelphia illustrating the adaptability and permanence of Terra Cotta.

ADAPTABILITY *and* PERMANENCE

TERRA COTTA presents a greater scope to the designer than any other permanent material because of its ready adaptability of form, texture and color.

Effects of scale impose limitations in the use of Terra Cotta only where the scheme of visible jointing necessitates an economically impracticable size for the individual pieces. Where scale necessitates the latter appearance for certain features of design concealed jointing often offers

a solution acceptable to the designer and manufacturer alike.

To any of the accepted styles Terra Cotta brings the widest flexibility for sympathetic interpretation and the assurance of absolute permanence when intelligently designed and properly installed.

For information and literature address: National Terra Cotta Society, 19 West 44th Street, New York City.

TERRA COTTA

Permanent

Beautiful

Profitable



Horse Power and Gas Engines Saved Bone and Muscle

community spirit. When we consider that 43 men, three tractors, one truck, eight two-horse teams and two four-horse teams, with all the necessary equipment spent the day on the road, it is not surprising that the Carmichael Colony day was such a success.

Getting Results

The day's work resulted in the installation of 19 culverts, repair of one wooden bridge, six miles of grading and the filling in of 12 low places. No work was done on Marconi avenue or Landis avenue. These are to be improved by the county. Likewise the county will do considerable work putting the finish on many of the roads that were worked by the volunteers. This is a fine example of efficient co-operation. At no place had the work of the residents and the County Engineering Department overlapped or conflicted. It was carried out just as planned, resulting in maximum efficiency and economy.

Lessons Learned for Another Year

It takes at least three weeks to plan a road day and get the culverts on the ground, so it is the desire of the County Engineer that another year a great many of the communities in the county begin to plan a road day early in the year. With all the details worked out by the first of March, the County Engineering Department can handle a road day every other day. This would allow one day to move our equipment from one community to the next. If these road days progressed in order from one end of the

county to the other, we could cover most of the territory when the soil conditions were such as to give maximum benefit for the work done.

Road Mileage Too Great for Adequate Maintenance by County Forces

It must not be supposed that these road days would eliminate any of the work that would be done by the county forces. The idea is to attend to some of the details that are so hard to reach with the present road organization. There are approximately 1,800 miles of road in Sacramento county to be maintained in at least a passable condition, if possible. The wear and tear of modern traffic is tremendous, and to reach all of the bad places in this extensive road system is simply out of the question. If a few of the worst places could be repaired by the communities each year, the county doing the general grading, in a very few years the entire system would be in first class condition.

The County Engineer and Supervisor John Russi greatly appreciate the co-operation of the people of Carmichael Colony, and believe that these public-spirited residents have shown the whole county the practical way for local road improvement. And road improvement is not the whole story. There is a growth of neighborliness and public spirit which comes from working together for such ends as this which may in the long run be worth as much to the community as the material results effected.



Installing Armeo Culverts
Carmichael Colony Road Day

SAN FRANCISCO
PUBLIC LIBRARY

The
ARCHITECT &
ENGINEER



SEPTEMBER 1922

Published in San Francisco
50 cents a copy - \$2⁵⁰ a year

This label
protects
you

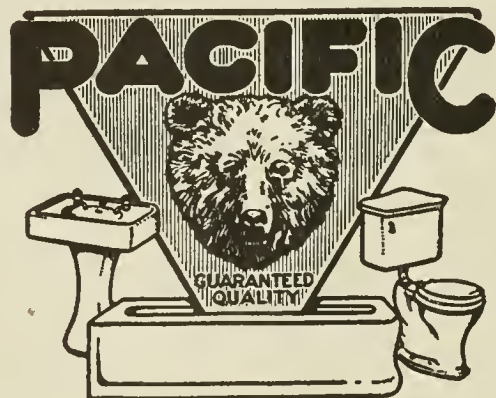

TRADE MARK REGISTERED

Specify

PACIFIC
PLUMBING FIXTURES

Pacific Sanitary Manufacturing Company

Main Office: 67 New Montgomery Street, San Francisco

Factories: Richmond and San Pablo, California



THE ARCHITECT AND ENGINEER

CONTENTS FOR SEPTEMBER, 1922

FRANCESCA APARTMENTS, SAN FRANCISCO	-	<i>Frontispiece</i>
Kenneth Mac Donald, Architect Maurice C. Couchot, Engineer		
APARTMENT HOUSES—SOME RECENT SAN FRANCISCO EXAMPLES	- - - - -	47
THE HIGH COST OF LOAFING	- - - - -	66
COLOR AND TEXTURE EFFECTS IN STUCCO	- - - - -	69
<i>Edwin K. Borchard</i>		
SOME SMALL HOMES IN LOS ANGELES	- - - - -	76
<i>Pierpont and Walter S. Davis, Architects</i>		
THE ARCHITECTURE OF THE WATER TEMPLE AT SUNOL	-	83
<i>Edward F. O'Day</i>		
NEW CALIFORNIA STATE HOUSING LAW	- - - - -	87
<i>William Mosser, Architect</i>		
WHAT DOES ARCHITECTURE MEAN TO THE ARCHITECT?	-	95
<i>W. R. B. Willcox, A. I. A.</i>		
NEW SYSTEM OF LIGHTING SCHOOL ROOMS	- - - - -	98
<i>Louis Cowles</i>		
THE SAN MATEO COUNTY HOSPITAL	- - - - -	101
EDITORIAL	- - - - -	104
WITH THE ARCHITECTS	- - - - -	107

Published Monthly by

THE ARCHITECT AND ENGINEER, INC.
626-27 Foxcroft Building, San Francisco

W. J. L. Kierulff
President

Frederick W. Jones
Vice-President

L. B. Penhorwood
Secretary



FRANCESCA APARTMENTS, SAN FRANCISCO
KENNETH MAC DONALD ARCHITECT
MAURICE C. COUCHOT ENGINEER

THE ARCHITECT AND ENGINEER

SEPTEMBER
1922



VOL. LXX.
No. 3

Apartment Houses—Some Recent San Francisco Examples

MR. ERNEST FLAGG once said, "The apartment house is the result of high priced land." Other things being equal, humanity prefers separate houses. That may have been the case years ago, but in these days of amusement, automobiling, etc., it is not so much the high cost of land that has made the apartment house popular as the convenience which it offers to housewives in search of as little domestic occupation as possible.

The growth of the apartment house has been little short of phenomenal. The apartment house is being designed today to answer the demands of all classes of tenants—the man with the modest income, the semi-well-to-do and the millionaire. It is difficult to say what type of apartment house is most popular. Young couples just embarking upon the sea of matrimony are partial to the two and three-room apartments, because they answer present needs and if they are to be furnished by them may be done so at a reasonable outlay.

Owners have found that the smaller apartments rent more readily if they are furnished by the management. The unsatisfactory feature about this, however, is that the tenants are less apt to be permanent. People who own their own furniture are not likely to want to move when once they are comfortably settled.

Frame houses having from two to four rooms to an apartment are being built in San Francisco and the Bay District for approximately \$1200 per room. Concrete or brick buildings run from \$1100 to \$1500 per room. The rentals from such apartments ranges from \$5500 for two rooms to \$60.00 for three rooms unfurnished.

Architects have found that the question of lighting is a most essential one in designing the present day apartment house. No small amount

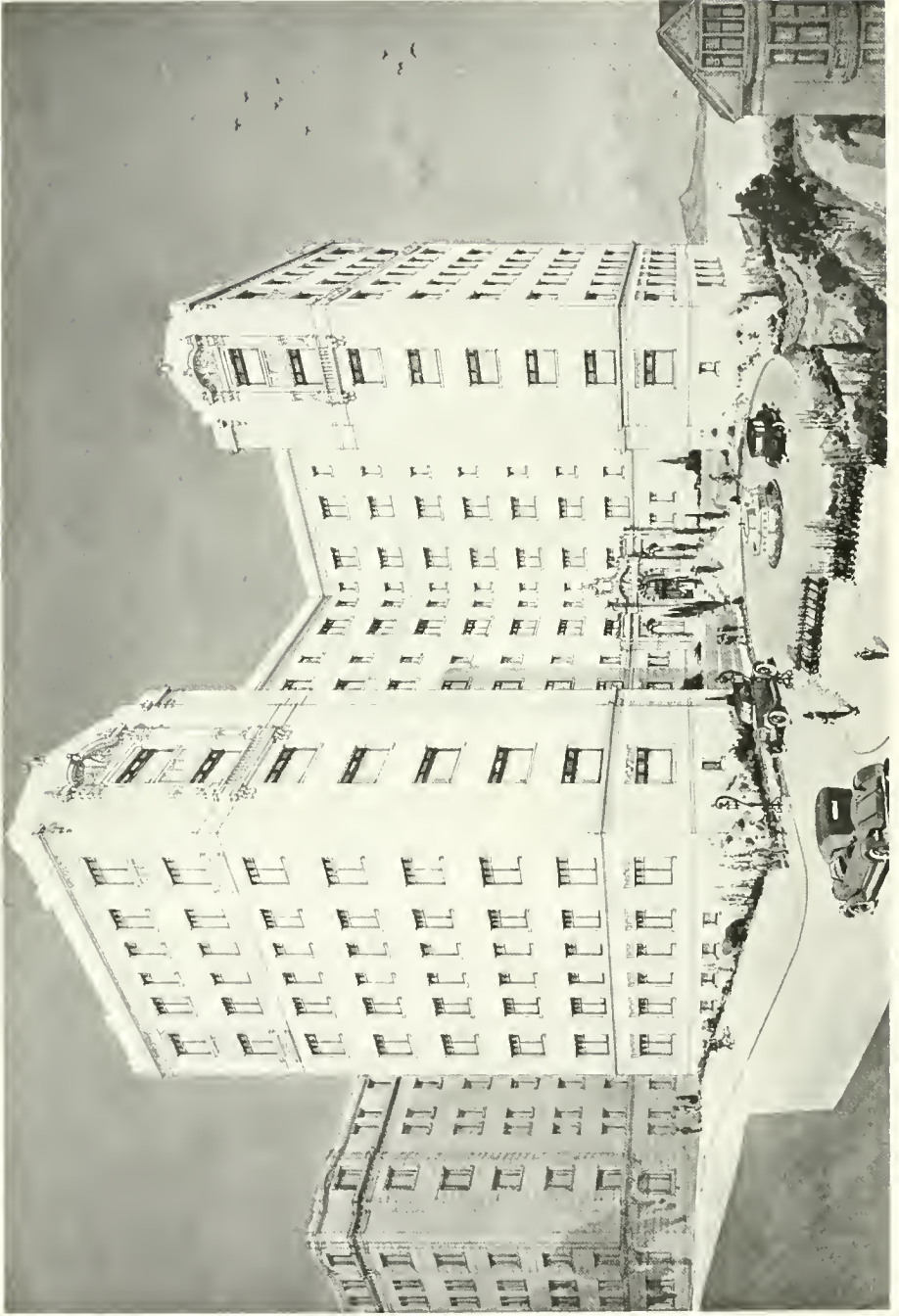

CREST VIEW APARTMENTS, SAN FRANCISCO
JOSEPH L. STEWART ARCHITECT

of ingenuity is necessary on the part of the planner to solve this problem. If not well lighted the building is sure to be a failure, not only from a hygienic standpoint but from an economic standpoint, for dark rooms can never rent if light ones are available. The examples of apartment houses shown in this issue of *The Architect and Engineer* cover a somewhat wide range, presenting the frame apartment house of two and three

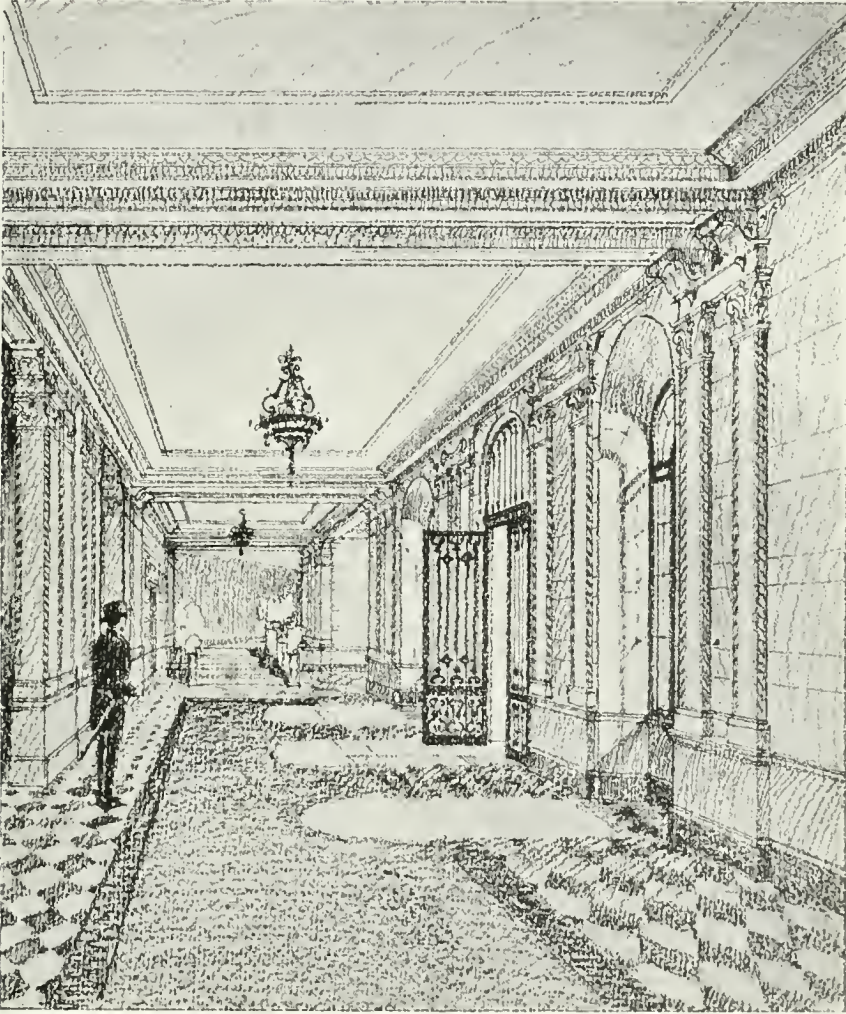

LOBBY, CREST VIEW APARTMENTS, SAN FRANCISCO

Joseph L. Stewart, Architect

rooms; the Class C brick apartment house, having from four to six rooms to an apartment and finally, the more pretentious residence or community apartment house with each floor a home in itself. Some of the community apartment houses recently constructed in San Francisco are larger than the ordinary two-story residence, having from nine to twelve rooms with servant's quarters, four and five baths and garage accommodations for two machines.

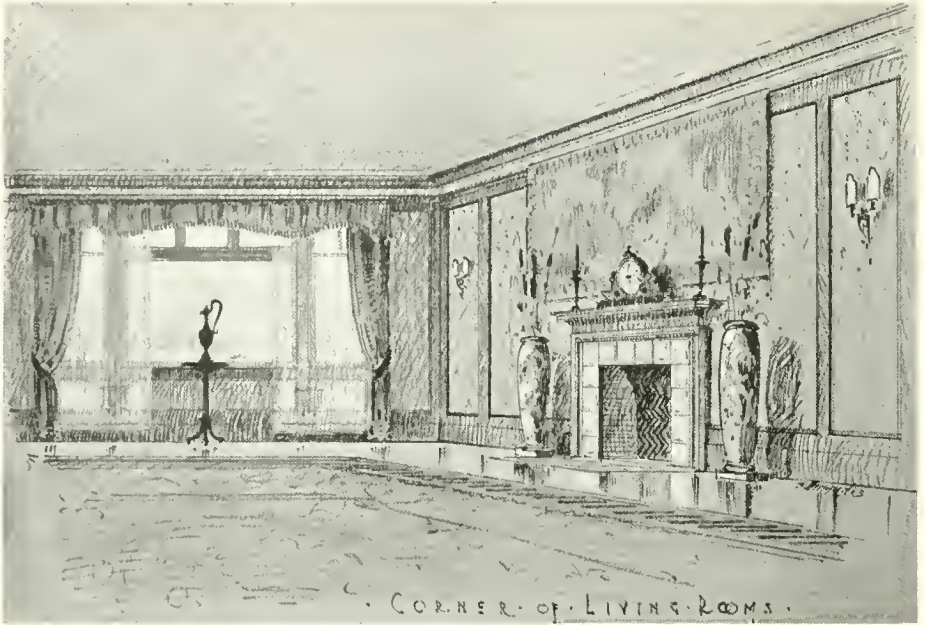

CREST VIEW APARTMENTS, SAN FRANCISCO
Joseph L. Stewart, Architect



CREST VIEW APARTMENTS, SAN FRANCISCO
Joseph L. Stewart, Architect



PINE-JOICE APARTMENTS, SAN FRANCISCO
Ashley and Evers, Architects

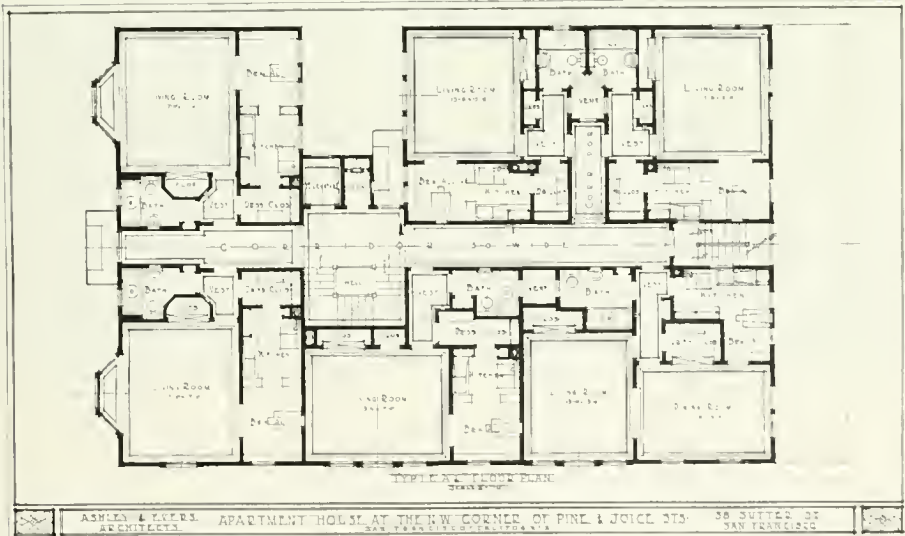

PLAN, PINE-JOICE APARTMENTS, SAN FRANCISCO
Ashley and Evers, Architects



M. H. LEVY APARTMENTS, SAN FRANCISCO
C. O. CLAUSEN
ARCHITECT

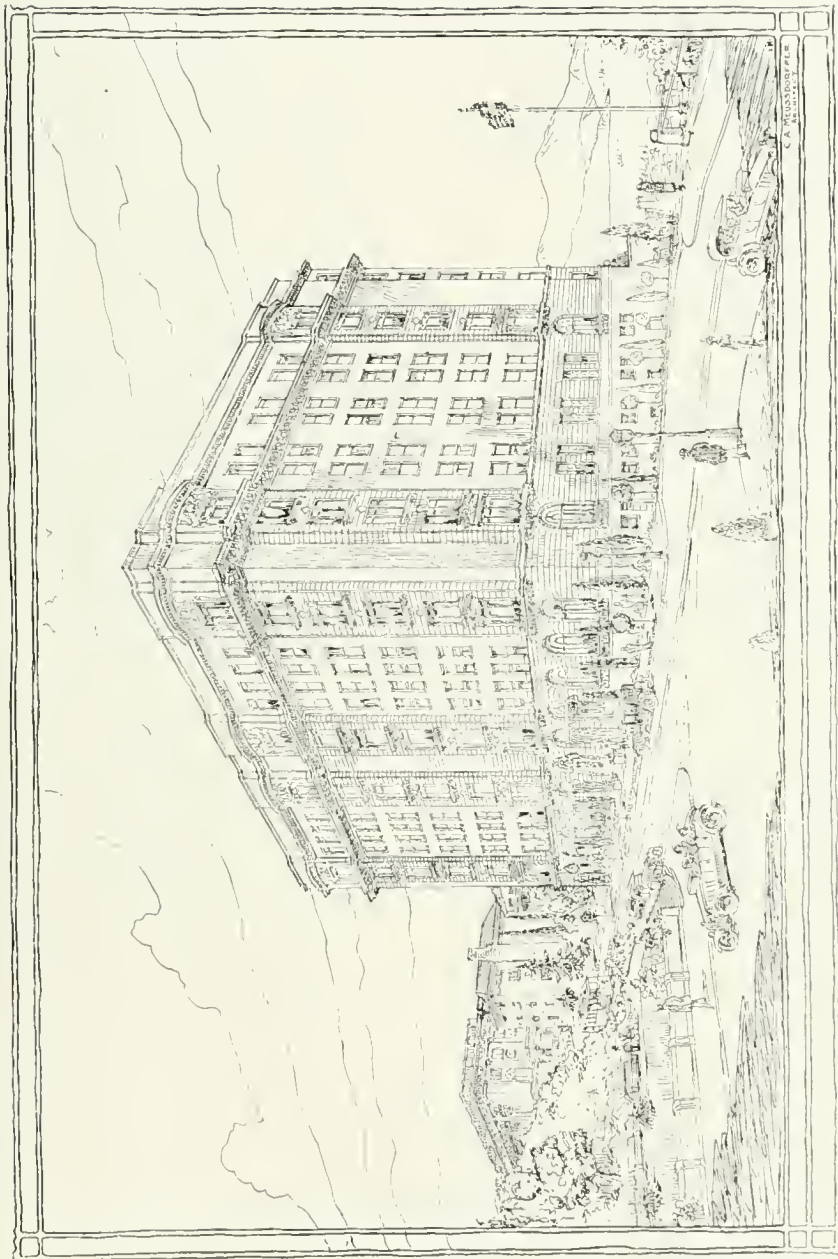

COMMUNITY APARTMENTS, 2000 WASHINGTON STREET, SAN FRANCISCO
C. A. MEUSSDORFFER ARCHITECT

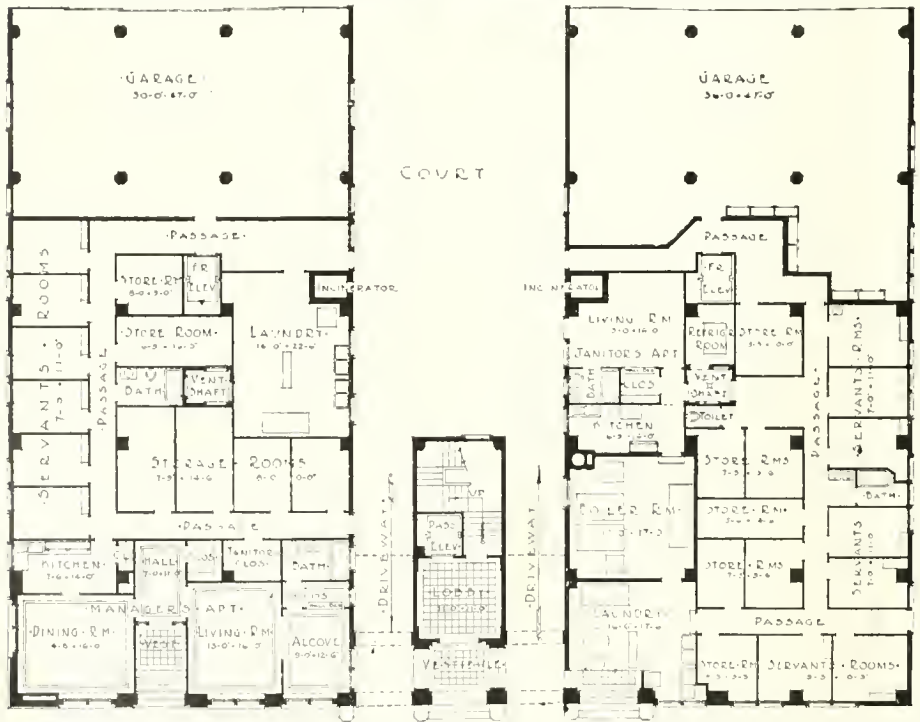
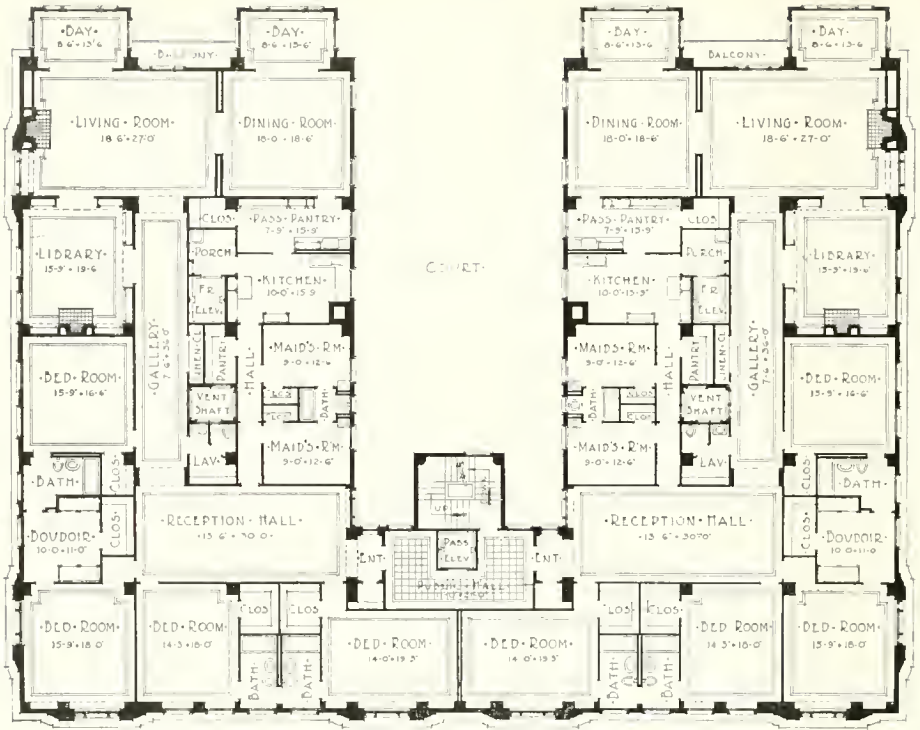

PLANS, RESIDENCE APARTMENTS, 2060 WASHINGTON STREET, SAN FRANCISCO
 C. A. MEUSSDORFFER ARCHITECT



ELEVATION, COMMUNITY APARTMENTS, 2000 WASHINGTON STREET, SAN FRANCISCO
C. A. MEUSSDORFFER ARCHITECT



• C. A. MEUSSDORFFER •
• ARCHITECT •
• HUMBOLDT BANK BLDG. •

COMMUNITY APARTMENTS FOR CALIFORNIA
AND GOUGH COMPANY, INC., SAN FRANCISCO
C. A. MEUSSDORFFER ARCHITECT



C. A. MEUSSDORFFER
ARCHITECT
HUMBOLDT-DANK-BLD'G.

APARTMENTS FOR MR. O. B. MARTIN, SAN FRANCISCO
C. A. MEUSSDORFFER, ARCHITECT
R. McLeran & Co., Contractors

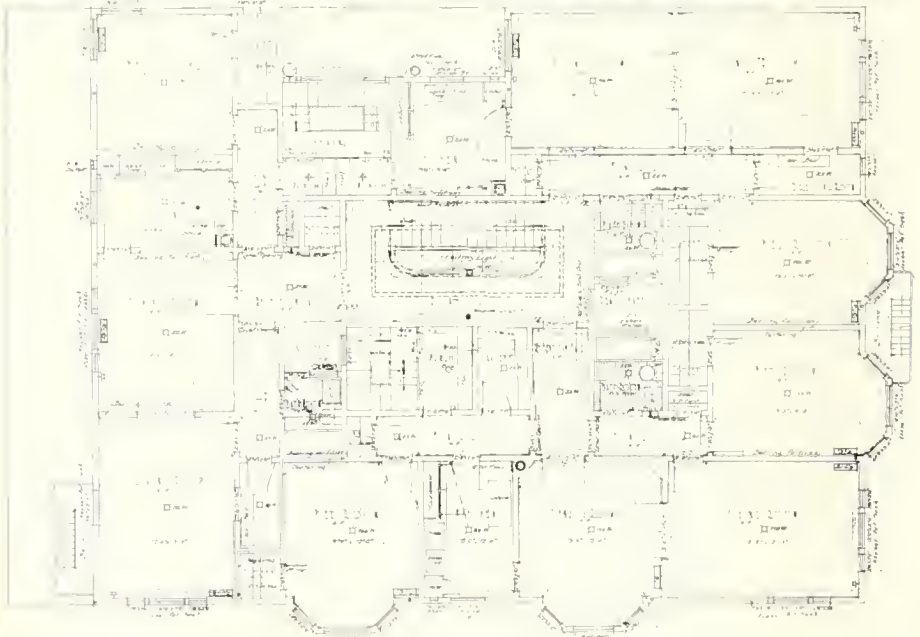

CAMERON AND DISSTON APARTMENTS, SAN FRANCISCO
MEYER AND JOHNSON ARCHITECTS

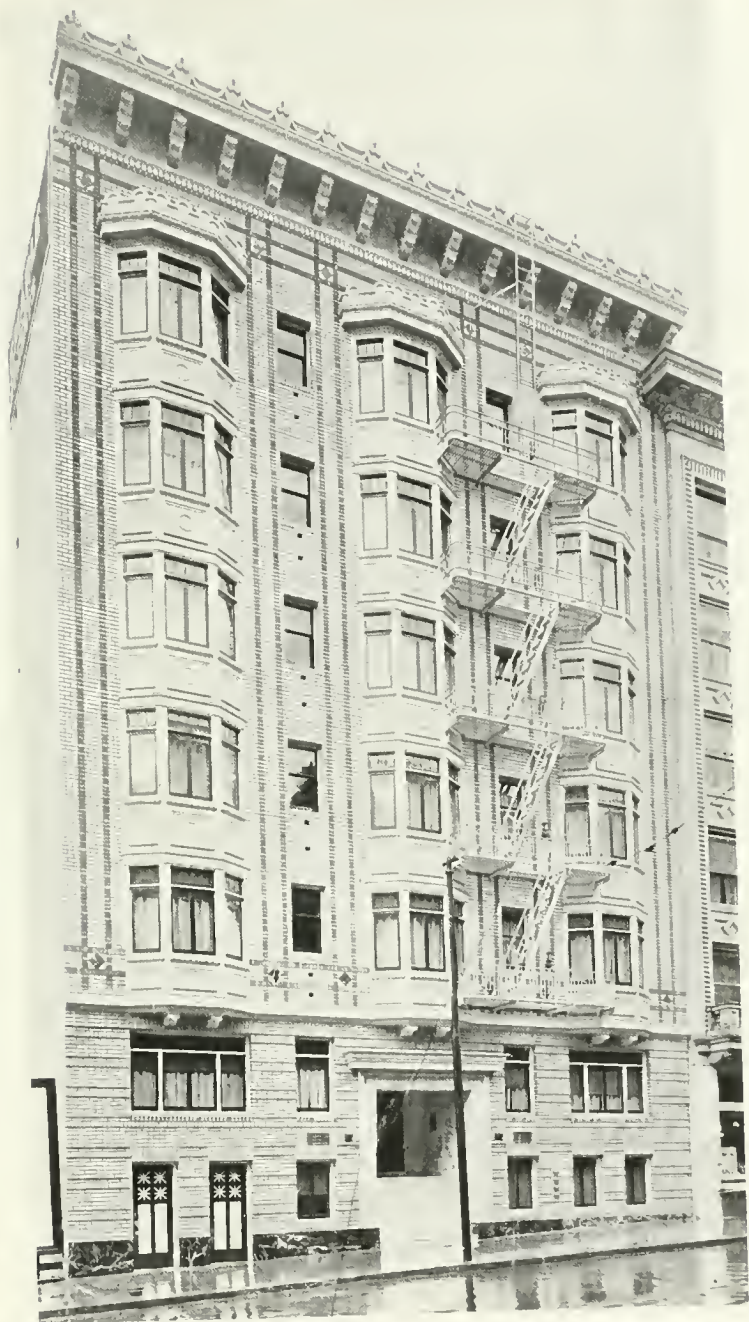

ALBEMARLE APARTMENTS, SAN FRANCISCO
C. O. CLAUSEN ARCHITECT



APARTMENTS AT 969 BUSH STREET, SAN FRANCISCO
C. O. CLAUSEN
ARCHITECT

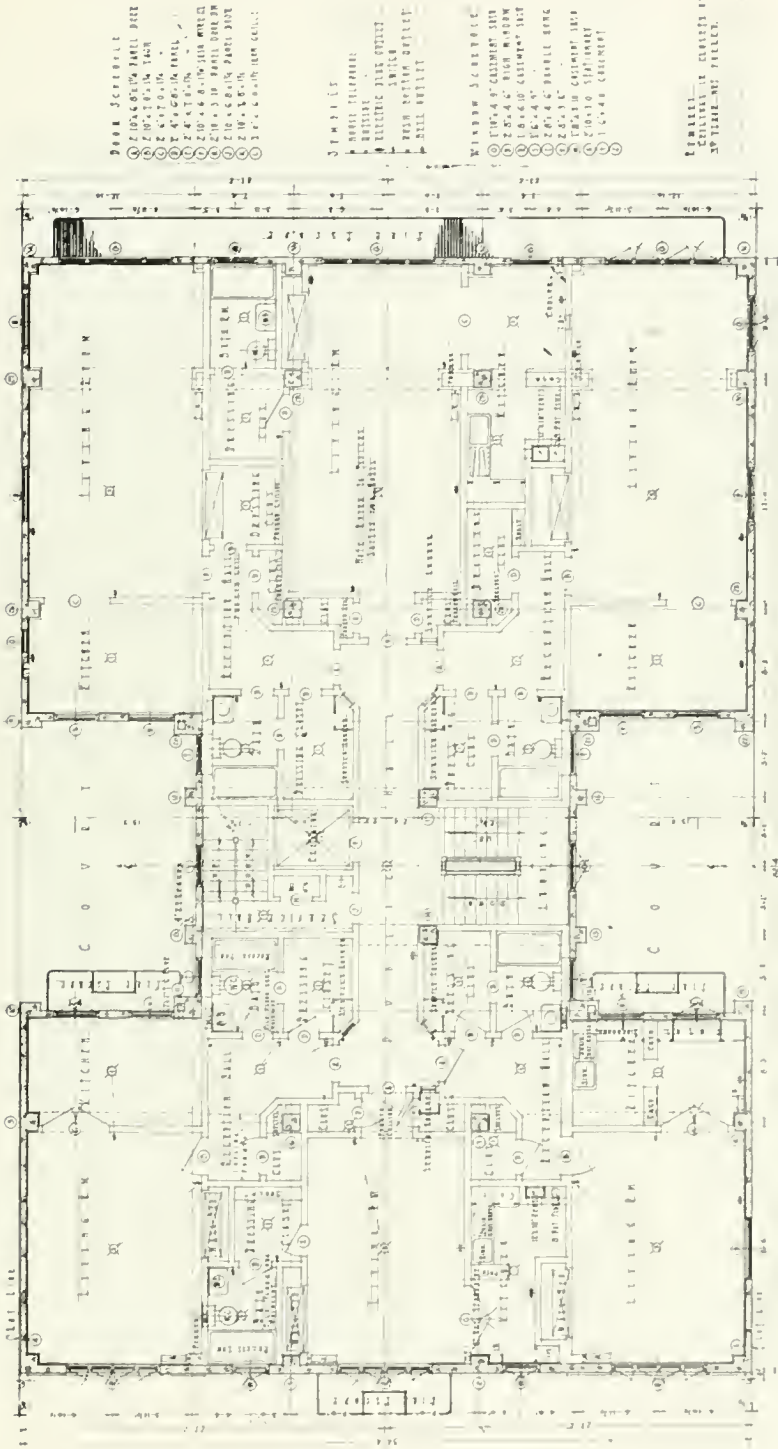

- DOOR SCHEDULE
- 1 1/2" x 6" x 10" OAK DOOR
 - 2 1/2" x 6" x 10" OAK DOOR
 - 3 1/2" x 6" x 10" OAK DOOR
 - 4 1/2" x 6" x 10" OAK DOOR
 - 5 1/2" x 6" x 10" OAK DOOR
 - 6 1/2" x 6" x 10" OAK DOOR
 - 7 1/2" x 6" x 10" OAK DOOR
 - 8 1/2" x 6" x 10" OAK DOOR
 - 9 1/2" x 6" x 10" OAK DOOR
 - 10 1/2" x 6" x 10" OAK DOOR
 - 11 1/2" x 6" x 10" OAK DOOR
 - 12 1/2" x 6" x 10" OAK DOOR
 - 13 1/2" x 6" x 10" OAK DOOR
 - 14 1/2" x 6" x 10" OAK DOOR
 - 15 1/2" x 6" x 10" OAK DOOR

- FIXTURES
- 1 SINK
 - 2 SINK
 - 3 SINK
 - 4 SINK
 - 5 SINK
 - 6 SINK
 - 7 SINK
 - 8 SINK
 - 9 SINK
 - 10 SINK
 - 11 SINK
 - 12 SINK
 - 13 SINK
 - 14 SINK
 - 15 SINK

- WINDOWS
- 1 1/2" x 6" x 10" OAK WINDOW
 - 2 1/2" x 6" x 10" OAK WINDOW
 - 3 1/2" x 6" x 10" OAK WINDOW
 - 4 1/2" x 6" x 10" OAK WINDOW
 - 5 1/2" x 6" x 10" OAK WINDOW
 - 6 1/2" x 6" x 10" OAK WINDOW
 - 7 1/2" x 6" x 10" OAK WINDOW
 - 8 1/2" x 6" x 10" OAK WINDOW
 - 9 1/2" x 6" x 10" OAK WINDOW
 - 10 1/2" x 6" x 10" OAK WINDOW
 - 11 1/2" x 6" x 10" OAK WINDOW
 - 12 1/2" x 6" x 10" OAK WINDOW
 - 13 1/2" x 6" x 10" OAK WINDOW
 - 14 1/2" x 6" x 10" OAK WINDOW
 - 15 1/2" x 6" x 10" OAK WINDOW

- FIXTURES
- 1 SINK
 - 2 SINK
 - 3 SINK
 - 4 SINK
 - 5 SINK
 - 6 SINK
 - 7 SINK
 - 8 SINK
 - 9 SINK
 - 10 SINK
 - 11 SINK
 - 12 SINK
 - 13 SINK
 - 14 SINK
 - 15 SINK

PLAN, APARTMENTS AT 909 BUSH STREET, SAN FRANCISCO
C. O. CLAUSEN ARCHITECT

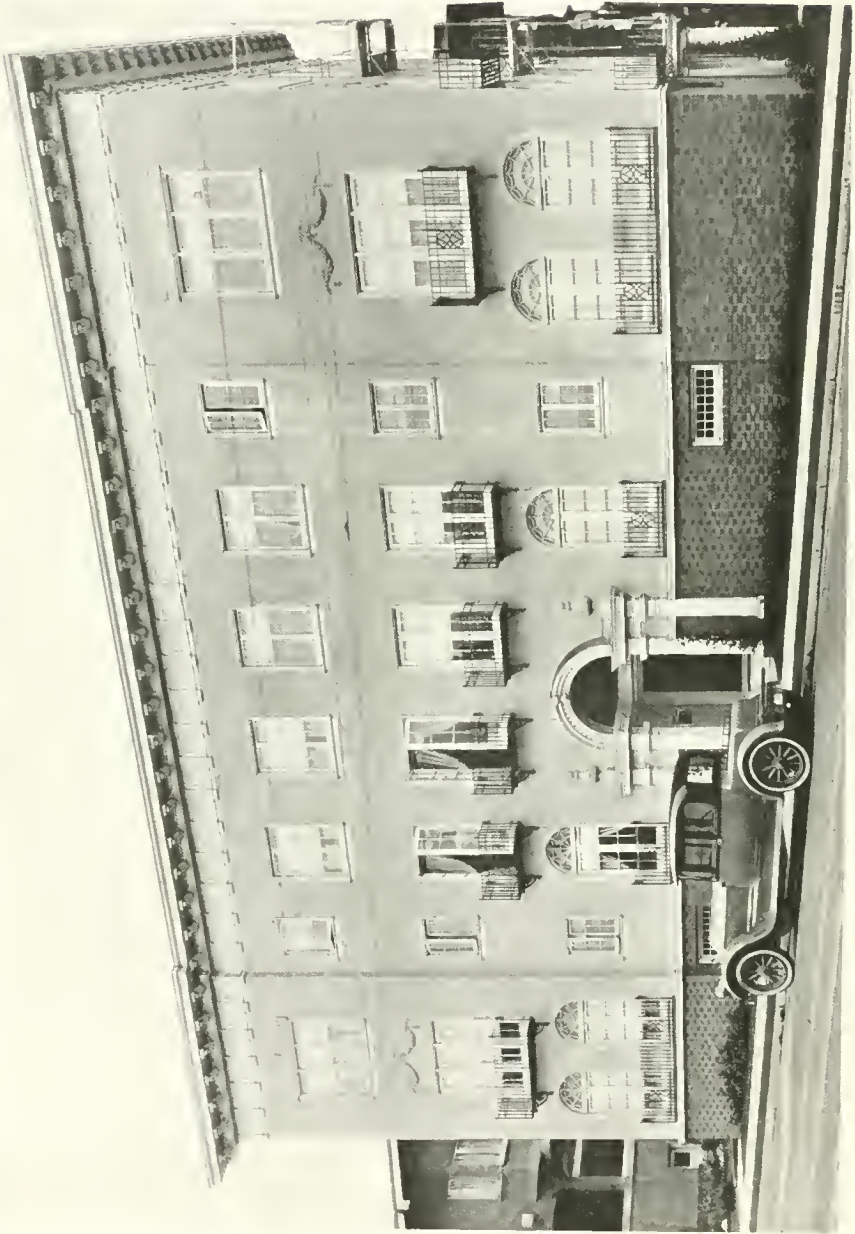

APARTMENT HOUSE FOR MR. CHARLES HELLER, SAN FRANCISCO
C. O. CLAUSEN ARCHITECT

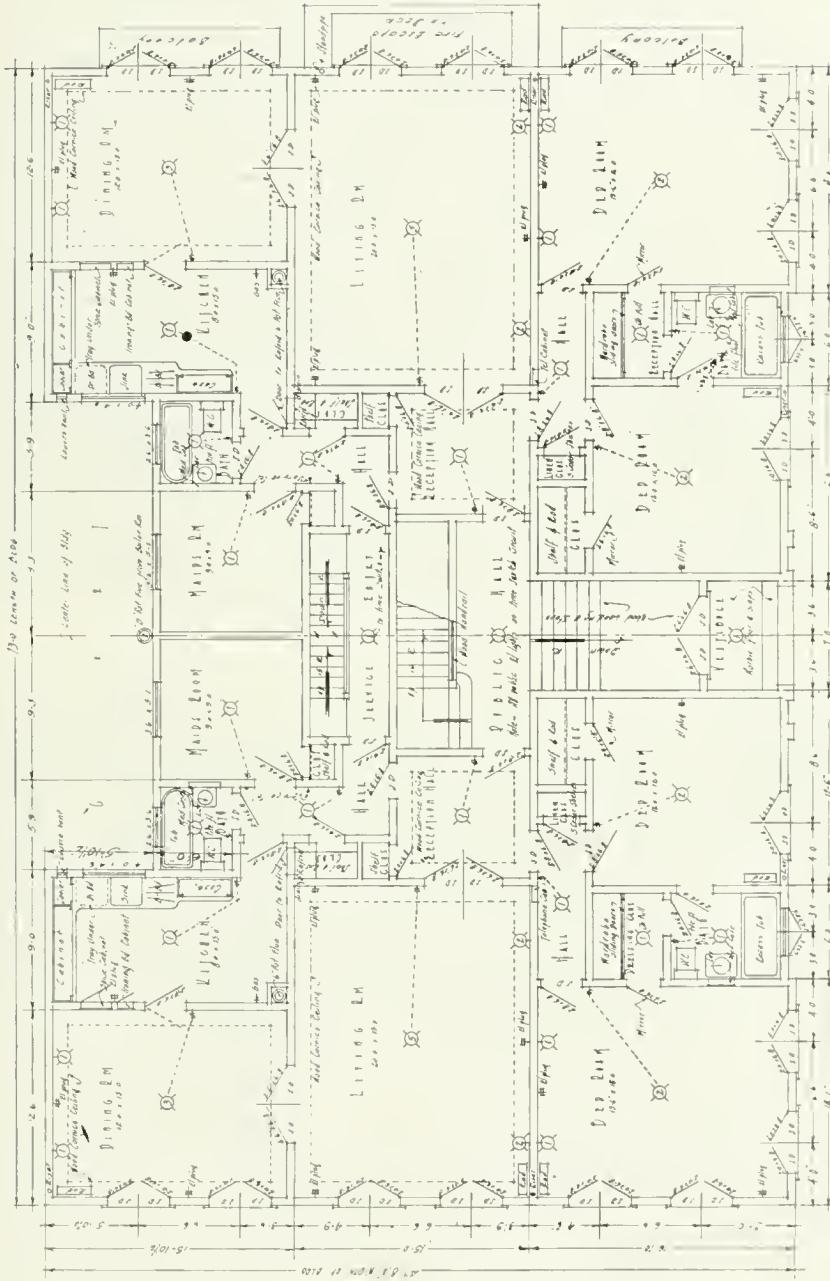

1/20 Scale of Area
 1/20 Scale of Area

PLAN, APARTMENT HOUSE FOR MR. CHARLES L. HELLER, SAN FRANCISCO
 ARCHITECT
 C. O. CLAUSEN



LIVING ROOM, APARTMENT HOUSE FOR MR. CHAS. L. HELLER
C. O. Clausen, Architect



DINING ROOM, APARTMENT HOUSE FOR MR. CHAS. L. HELLER
C. O. Clausen, Architect

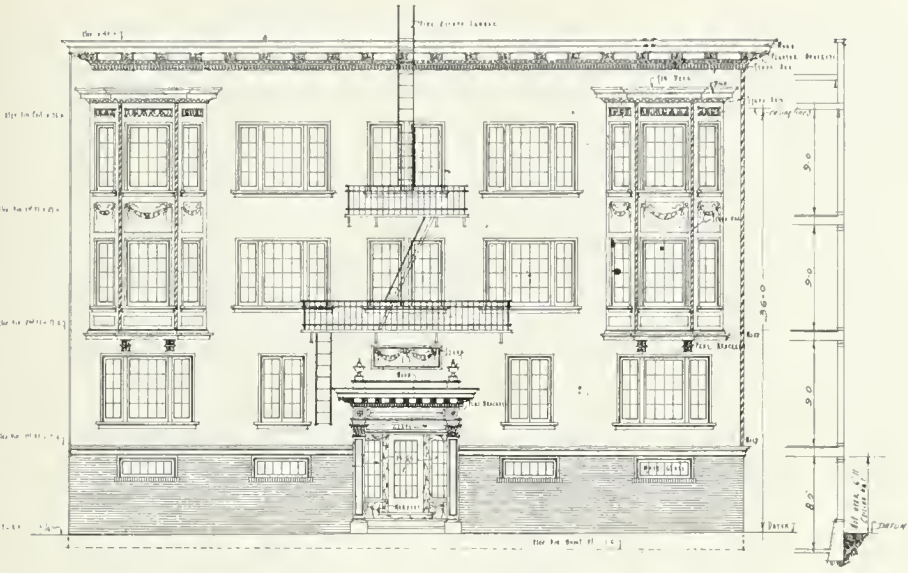

THE FACADE

Scale 1/4" = 1'-0"

ELEVATION, APARTMENT HOUSE FOR MR. C. F. HOFFMAN, SAN FRANCISCO
C. O. Clausen, Architect

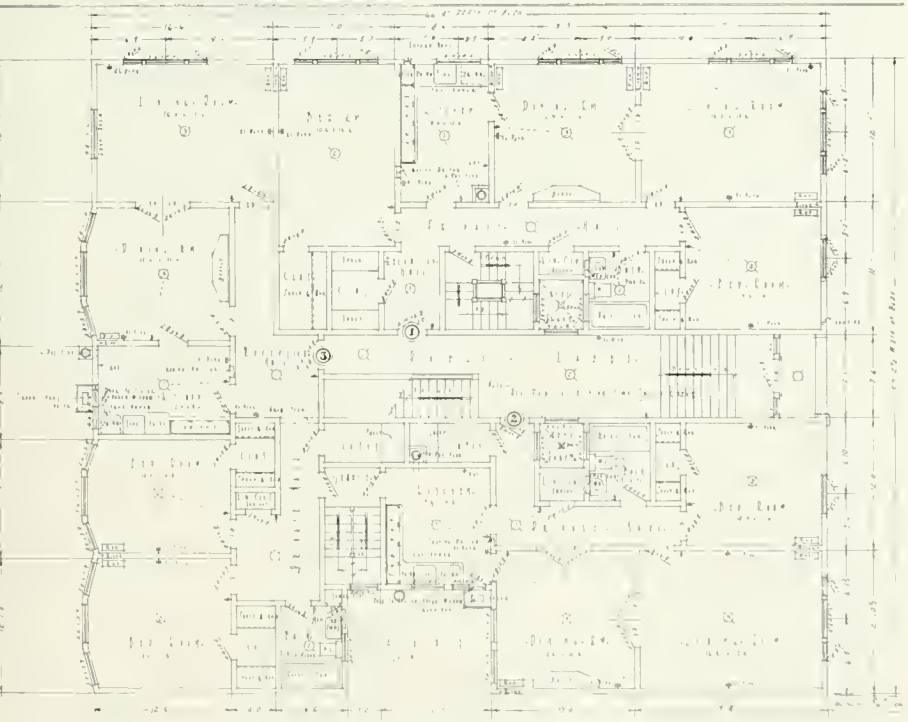

FLOOR PLAN, APARTMENT HOUSE FOR MR. C. F. HOFFMAN, SAN FRANCISCO
C. O. Clausen, Architect

So carefully planned is the apartment house of today that one does not have to build a home to enjoy every comfort. Apartment houses, if designed by competent architects, offer every economic advantage. There is no essential point of planning or layout in the ordinary private house which cannot be obtained by the expenditure of far less capital or rent in a first-class apartment house. Even the desire of certain families to live in buildings of two or three stories can be satisfied in a most desirable manner in apartment houses. Of course the low type of apartment house is hardly practical in the down town section of the city where real estate is high, but they can be built in the residence sections advantageously, and with most tenants owning their own automobiles the distance from the business center is no serious obstacle. Of course, there is one feature about a private house that appeals to many people and that is its "homey" aspect. This may be called sentiment, but whatever it is it remains the strongest kind of a factor, and it should be the aim of architects to give their apartment house that cheery homelike feeling that the public seems to crave.

* * *

The High Cost of Loafing

Workers in This Country Lose \$5,000,000 a Day in Wages on Account of Labor Troubles—Who Pays this Enormous Strike Bill?

OVER all industry—and especially over the building trades—hangs the spectre of labor trouble. Building contractors, in making estimates for a structure, always add a percentage, sometimes as high as 50 per cent, for contingencies; and nine times out of ten the main contingency is a strike, or the threat of a strike.

Other industries also suffer from the same disease—perhaps in a lesser degree, but still they suffer. Strikes are the greatest bogies of modern industry.

Business men know this. Workers know it. The public knows it. Yet strikes multiply.

If the American people—workers, business men, farmers, and all—decide that this condition must stop, they will find the means of stopping it. Evidently they have not so decided. Instead of concerted attempts to end strikes, each month brings forth a new collection of threats. The employers defy the workers. The workers defy the employers. Apparently both sides think they can gain more by a condition of industrial war than industrial peace.

The Industrial Digest submits that no strike is worth its cost. Strikes cost employers and workers more than either side can hope to get out of them. After the anthracite coal workers, some years ago, had won a wage increase by a strike, it was computed that it would take them 15 years, if they continuously saved every bit of the increase they had won, to get back the wages they lost while the strike continued.

A statistician of the National Industrial Conference Board has computed that American workingmen now on strike are losing something like \$5,000,000 a day in wages. The loss to non-striking workmen who have been thrown out of their jobs because of the strike is probably just as large, but no data are at hand from which to compute it.

On September first about 1,250,000 men were on strike. Roughly 80,000 of them are textile workers, who have been out since the early months of 1922; 155,000 are anthracite coal miners, who have been out since April 1; 573,000 are bituminous coal miners, who have also been on strike since April 1; 400,000 are railway shop workers, who have been out since July 1; and the balance are an assorted lot of building-trade workers, clothing workers, etc. One is safe in assuming at any time, year in and year out, that about 20,000 workers in the clothing and garment trades are on strike. Sometimes they are boys' pants makers, sometimes dress workers, sometimes cap makers, sometimes millinery workers, and sometimes another kind of needleworker; but some of them are always out because of a quarrel with employers.

Assuming an eight-hour day, these 1,250,000 strikers represent a loss amounting to 10,000,000 man-hours every day. It would take 100 men, working continuously for 300 days a year, five years to offset a single day's loss at this rate.

This is only one side of the picture. The other is the loss in production to industry, and the loss in profits to employers. These cannot be computed. Figures on the loss of production due to the coal and textile strikes, for instance, cannot be found, for there is no way of telling how much would have been lost in these industries regardless of the strike, because of seasonal shutdowns and lack of business. In the absence of reliable figures all we can say is that the losses are tremendous.

Marshall Olds, in his book "The High Cost of Strikes," has attempted to compute the price which industry and the public pay for industrial warfare. He believes that strikes were the basic cause for the tremendous post-war increase in the cost of living.

The inefficiency due to the strike spirit is most flagrant in the building trades. A grand jury which conducted an investigation into the construction industry in Cleveland not long ago reported:

"We should be remiss in our duty did not we point to a lamentable condition which no doubt has injured the very group (labor) which created it as much, if not more so, than the public generally.

"We refer to the present tendency upon the part of mechanics, artisans and laborers of all trades to do less than a full day's work.

"The testimony adduced before us indicates conclusively that it requires approximately twice as long, with the same number of men, to erect a house today as it did in pre-war times.

"Impartial tests show that it takes twice as many carpenter hours to do carpenter's work on a building as it did five years ago.

"Bricklayers lay less than half the number of bricks; paperhangers, painters and plasterers all do less than half the work in the same time that they did five years ago.

"Manufacturing firms which make and sell building materials prove by their records that while wages have gone up 200 per cent in some instances, labor cost has gone up 400 per cent, indicating that their employees are getting double pay for one-half the work, as compared with the period before the war."

So costs go up, and industry suffers. All this is due to strikes and the spirit of strikes. If we all realized how expensive it is to carry on industrial warfare, would we not devote our energy to stopping it?

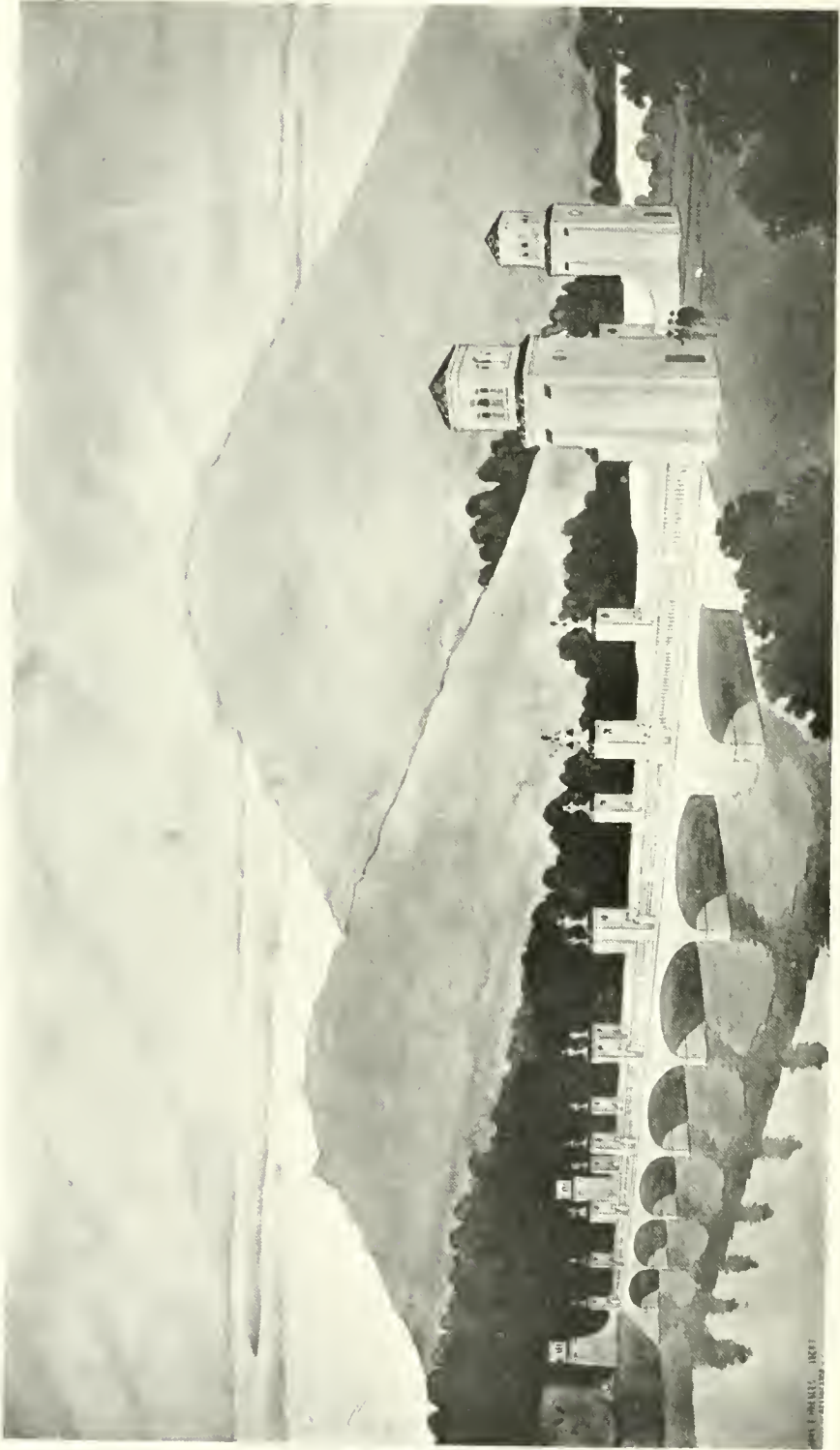

DESIGN FOR BRIDGE IN SOUTHERN CALIFORNIA
NORBERG AND HAYES
ARCHITECTS

WEST. J. PHILLIPS, ARCHT.

Color and Textural Effects in Stucco

Opportunity for Originality in Beautifying House Exteriors

By EDWIN K. BORCHARD, in *The House Beautiful*



ROUGH FLOAT TEXTURE

EVERY lover of beautiful houses has a vivid mental image of each of the few houses which have superlatively pleased; or it may be that he has visualized a "dream house" which is a composite ideal of the best and most perfect details of many houses. And yet, when we see or think of a beautiful house, how often do we analyze our impressions to determine just what it is that excites our admiration? Probably very rarely—and indeed, often it is wiser not to look too closely lest we find some flaws in our perfect gem.

It is safe to say that the architectural treatment of the house, the balancing of proportions, detail and ornamentation contribute a large part to the effect a house makes upon the observer, as do also the surroundings of landscaping and planting. But closely allied to these, in adding to, or detracting from, the appearance, are the colors and textures of the walls. We often see an otherwise passable house made absolutely hopeless by the antagonistic or too-brilliant shades of a poorly chosen color scheme. Picture the most charming country house of the clean white New England cottage type that you have ever seen, in its setting of green lawns—and then try to imagine it painted a barn red or a chocolate brown! An exaggerated example of course, yet it illustrates in a *reductio ad absurdum* how important a part color plays in the appearance of any house.

Properly handled, stucco affords a wide range of colors and yet, because of certain limitations, it does not allow any great errors to be made in choosing the colors. An almost infinite number of shades are available, but because these shades are all soft and subdued they combine well with almost any architecture or setting. Unless a deliberate effort is made to secure brilliant or decided colors, any of the lighter-toned stuccos of today will yield pleasing colors.

To deal specifically with color combinations or to recommend particular shades for one type or another of house is as impossible as specifying or giving advice on the color of a gown or scarf—it really is a field where individuality must have free play. However, there are certain broad general rules to which it is advisable to adhere, though of course like all rules they may be broken.

First of all, a smooth, pure white finish is not advisable for any city or even semi-suburban location where the air is smoke-laden and carries soot and dust to discolor the walls. White is possibly the oftenest chosen color—hence many will not agree to this dictum. It is better, however, frankly to recognize this limitation which is common to all white surfaces, whether of paint, stucco or marble. A pure white stucco wall may be scrubbed or acid-washed to restore the original whiteness, but it is best to avoid this necessity. This does not mean that we must fall back upon a dark gray stucco or some similar smoke-colored shade. On the contrary, we need only substitute for pure white, a delicate cream or warm buff-tone which any reasonable amount of smoke will only mellow without being so glaringly apparent as on a white surface.



SAND FLOATED



SURFACE FINISH



PEBBLE DASH



SPATTER DASH



SAND STRAYED



STIPPLED

In the suburban or country house blessed with pure air and the proper green setting, the white stucco house is at its best. The delightful contrast between white and green, each serving to accentuate the beauties of the other, forms a perfect picture which easily explains the popularity of white houses. The fact that the whiteness is not a matter of a surface coating but is in the wall and hence permanent, in itself is an attractive feature of stucco.

So that an intelligent selection may be made of color combinations and effects in stucco, it is helpful for the owner to have some knowledge



AN INTERESTING TEXTURE THAT SHOWS THE MARKS OF THE TROWEL
Bloodgood Tuttle, Architect

of the technique of obtaining the desired effects. Color in stucco is obtained in two ways: by the natural method and by the artificial. As might be expected, the former method is preferable in almost all cases.

The term "natural" is used because the color is imparted by naturally colored sand, pebbles or stone chips in conjunction with white Portland cement. Some years ago the regular gray cement was used for stucco, but with the advent of white cement, color in stucco was made possible because the background of white permitted the color tones of sand or stone to be exhibited in their full value. For this reason the effects

obtained carry a feeling of freedom from artificiality and a natural variegation that is only possible when Nature contributes the color from her own palette.

Pure white is the simplest of all and merely requires a clean white sand or crushed marble and white cement. Equally simple are the creams, buffs and light browns, for these may be imparted by an ordinary yellow or brownish sand, often available from nearby sources and at a remarkably low cost. Many an owner who has set his heart upon white stucco and found white sand not easily obtainable, has been delightfully surprised by the splendid tone resulting from the use of an ordinary yellow sand. The delicate cream or warm buff resulting has just sufficient color to give the effect of that subtle toning so often contributed by Time.

Reds, pinks, greens and yellows are obtained by the use of stone chips or pebbles of the color sought for, either by a layer of the chips cast-on and pressed into the stucco or else mixed in integrally with the stucco. Pink granite or feldspar chips and yellow pebbles may be employed, or red, yellow and green marble chips utilized—even a mixture of several colors is often desirable for securing a natural variegation and tone-blending.

In the securing of color by natural methods the tones are all subdued and easily adapted for harmonizing with the surroundings. Where a striking, pronounced and more vivid tone is desirable, resort is made to coloring by means of powdered mineral pigment mixed with the stucco.

It is safe to say that the most interesting recent development in the art of beautifying house walls is the use of textural effects in stucco. Like many other artistic treatments, it is a deliberate revival of the older and cruder workmanship of bygone days, when our modern machine-like precision and perfection was not possible. Probably texture as applied to stucco and plastered surfaces originated with the half-timbered type of English country house.

At first, no doubt, the rough marks of trowel and float were due to lack of care or the limitation of tools and materials. When the charming effects resulting began to be appreciated, the treatment became more deliberate, free-hand and informal—fitted for harmonizing with the rugged simplicity of the half-timbered country house. It has, today, developed into a means of decorating wall surfaces at low cost and with no sacrifice of lasting quality or integrity of the wall material.

Wall surfaces of large unbroken area need some type of textural treatment as an aid to architectural ornamentation in avoiding monotony of appearance. This need of texture is recognized in other materials than stucco, as is evidenced by present-day use of rough textured brick, or by rough, uncoursed stone walls. Probably with stucco the charm of texture is explained also by the liking we all have for any piece of work that shows the craftsman's labor. A piece of hand-carved furniture, though perhaps not so sure and perfect in its execution, receives our attention, where one machine-sawed does not attract us even by its mechanical perfections. So a stucco surface showing the marks of trowel and float interests us, while a smooth finish is the usual and uninteresting.

Textural finishes must be used cautiously and with judgment in order to avoid effects merely bizarre or unusual. The surroundings and setting of a house, as well as its architectural style, determine the textural treatment that will be most appropriate. For example, a city house limited in

size of lot, should be finished with one of the more usual surfaces, while a country house may be given practically any texture, with the bolder and more informal ones favored. Again, the distance between roadway and house is an important factor: the greater the distance the rougher may be the texture. In other words, an extremely rough surface that is beautiful at a distance might by the coarseness of its details lose some of its attraction when viewed from a roadway twenty or thirty feet away.

Certain standard textural finishes are the ones best adapted to the average house placed on a moderate size suburban lot, and also where expense is a consideration. Such finishes are known as sand floated, spatter dash, pebble dash and stippled. All can be applied by the ordinarily skillful workman without undue cost. A stippled texture is one of the best for giving a moderate roughness suited to most houses and



SMOOTH TEXTURE APPROPRIATE FOR A SMALL HOUSE
Milton Dana Morrill, Architect

locations. It has also the advantage of being almost "foolproof"—that is, its appearance is almost sure to be pleasing even under the hand of a mediocre workman. In a locality where the very best labor is not obtainable, such a finish is extremely useful.

The underlying motif of all the more unusual texture finishes, is the frank exhibition of the technique of application. The mark of trowel and float is not concealed, but is even accentuated to produce the proper impression. It might be likened to the bold brush-strokes of the painter in oils, who not only does not seek to conceal, but sometimes emphasizes the light and shadow by a lavish use of his pigments. So the strokes of the plasterer's tools are manipulated to give an interesting surface to stucco—to impart character to plain wall areas and to produce that air of informality so desirable in the country house.

At first glance, these finishes look simple of execution because of their seeming lack of careful workmanship, but in reality they require great skill in application. One of the unexpected features is the difficulty of persuading the plasterer to forget his love of true, smooth surfaces and to deliberately produce what to him appears a poor job. In fact, it is a wise precaution to use a small portion of wall in an out-of-the-way part of the house for experimental purposes. The workman then applies, in the presence of the owner, say six square feet of the chosen texture. If it does not meet with approval it is at once scraped off before it has hardened and the effort repeated until a satisfactory finish is secured. This acts as a comparison sample for the whole of the house. In judging texture, it is essential to do so at a sufficient distance to allow proper perspective.

A finish of great possibilities and one much used is one which results from allowing the trowel or float, drawn in a semicircular direction, to form slight ridges in the stucco, these ridges over-lapping or rather joining each other at various angles. This gives a moderately smooth surface broken up by the circular float marking. Especially under oblique light, these markings are thrown into relief and by the contrast of bright lights and shadows impart an effect extremely attractive. This finish forms a splendid background for vines and gives a texture sufficiently rough to afford good support for them.

A rougher and more unstudied finish than the one just described is obtained by depositing with the float mortar in haphazard masses and without any effort toward continuity of surface or level. Practically no limit exists as to the variations possible with this finish. In one the impress of the float is more or less patterned and regular; in another the irregularity is so marked as to give almost the effect of an unfinished surface. This type of texture must be employed with great care to avoid an eccentric or bizarre finish.

New textures may be originated almost at will because of the plastic nature of stucco. One unusual finish consisted of long irregular scorings in the surface—another a roughened surface partly flattened and smoothed with the trowel. On one very unusual house near New York City, the stucco finish is said to have been applied with bare hands, and exhibited the marks of hands and fingers. Surely this is reverting to old methods of construction and might be said to have revived the finishes used in the wattle and daub huts that were the forerunners of our present-day highly perfected and modernized stucco houses.

* * *

“Some People Think They’re Big Guns Until • They’re Fired”

HAVE you seen that clever quip which has been posted in many offices and plants: “Some people think they are big guns until they are fired”? True, isn’t it? Did you ever reflect how quickly the place of even the most important man is filled? This thought came to me the other day on reading that the shares of the American Telephone & Telegraph Company had advanced to the highest price in two years. Theodore N. Vail was universally recognized as the king-pin of the vast Bell Telephone system which he did more than any human being to develop. There were misgivings as to what would happen when he passed. Into his shoes stepped Harry B. Thayer, a man of very different personality, and unknown to the general public; yet those in the

best position to judge declare that the organization is stronger today than ever before, a claim which the increase in the market value of the shares would seem to confirm.

Colonel Samuel Colt was pictured by the public as "the whole thing" in the U. S. Rubber Company; as a matter of fact, there was a man eminently fitted and trained to take his place, namely, Charles B. Seger. The financial world trembled when the original J. P. Morgan became gravely ill. Also when E. H. Harriman was stricken. Yet news of the death of these giants was followed by an advance in the security markets, and things, somehow, went along very much as before.

Ever since Judge Gary came so prominently into the limelight during the steel strike there has been speculations as to who would or could succeed him should he decide to retire—the Judge is in his seventy-fourth year. Some declare that no one within sight possesses all the qualifications requisite for the successful direction of this \$2,000,000,000 enterprise. In its president, James A. Farrell, the corporation is fortunate in having a man of tremendous ability, thoroughly conversant with every phase of the corporation's operations, a man, moreover, whose character and reputation are beyond reproach, who never has been even remotely identified with Wall Street speculation in either the corporation's own stock or in other stocks.

Similarly, one occasionally hears the remark that Bethlehem Steel is a one-man enterprise, and that this must be taken into consideration in viewing the outlook for its securities. But has not Schwab repeatedly declared that the ablest steel man in America is not he but Eugene G. Grace, Bethlehem's president? It is related that on one occasion Mr. Schwab was taking a visitor over the Bethlehem plant when the visitor asked Schwab as to his successor, and that Schwab instantly replied: "There he goes!" pointing to a youngish man walking briskly across the yard, namely Gene Grace.

George Eastman, of Eastman Kodak, told me that he had organized his company in such a way that no fixed duties whatsoever devolved upon him. John H. Patterson recently stepped down from the presidency and general management of the National Cash Register Company; but two young men one under 30 and the other under 40, were ready to fill these offices. No individual could be more closely identified with a business than was Woolworth; yet his death caused not the slightest ripple in the smooth flow of the company's business.—From Forbes.

* * *

Accidents in Building Construction in California

The following tabulation shows the number of fatal, permanent and temporary injuries sustained by workers engaged in building construction in California during the calendar years 1917, 1918, 1919 and 1920:

Industry	Year	Number of Injuries		
		Fatal	Permanent	Temporary
Building construction	1917	47	192	7,917
Building construction	1918	37	107	5,791
Building construction	1919	41	124	5,811
Building construction	1920	42	187	11,020
Total		167	610	30,539

There were 37 fatal injuries in 1921.

There were 12 fatal injuries up to April 15, 1922.

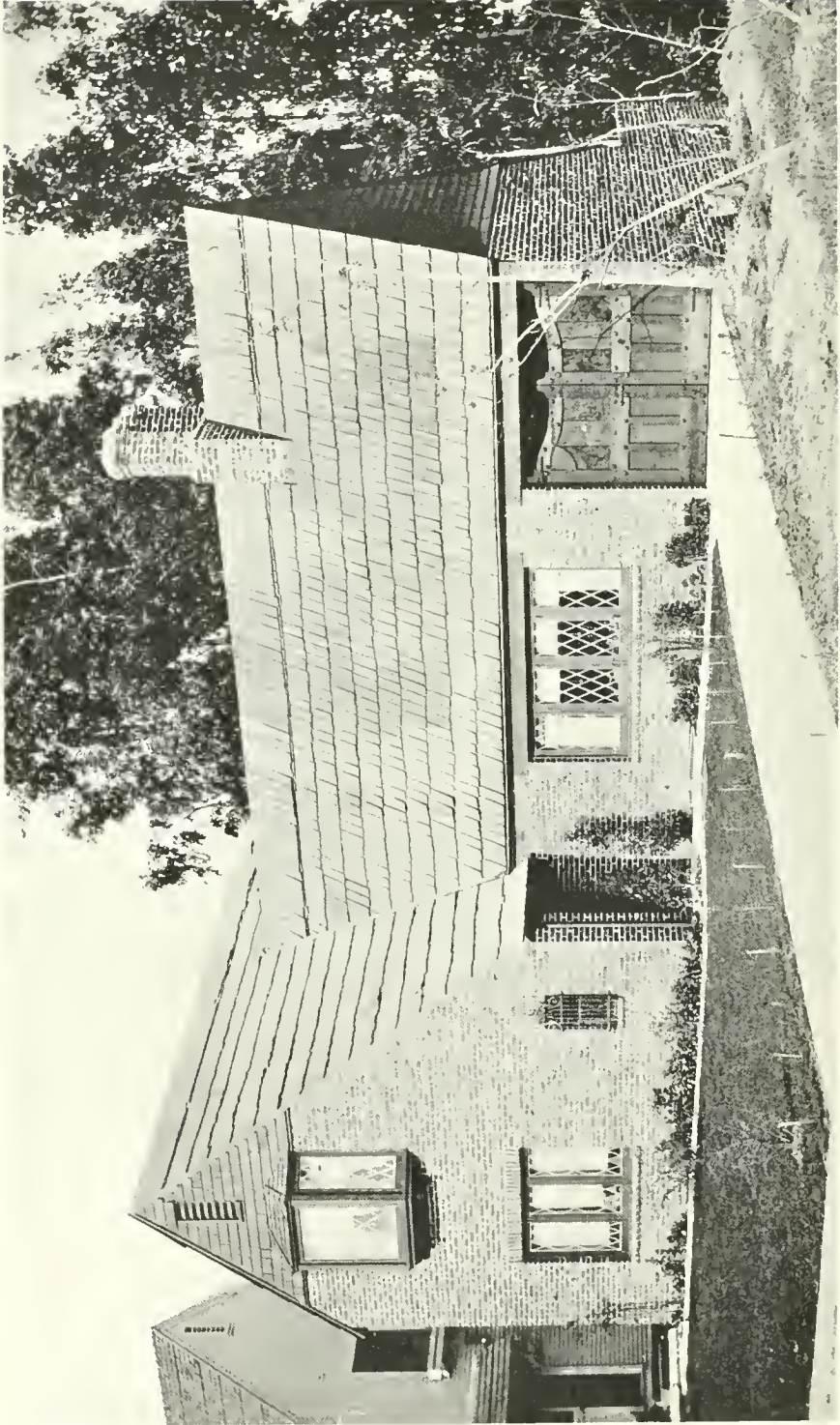

RESIDENCE, ESTATE OF MR. THOMAS NICKOLS, LOS ANGELES
PIERJONT AND WALTER S. DAVIS
ARCHITECTS

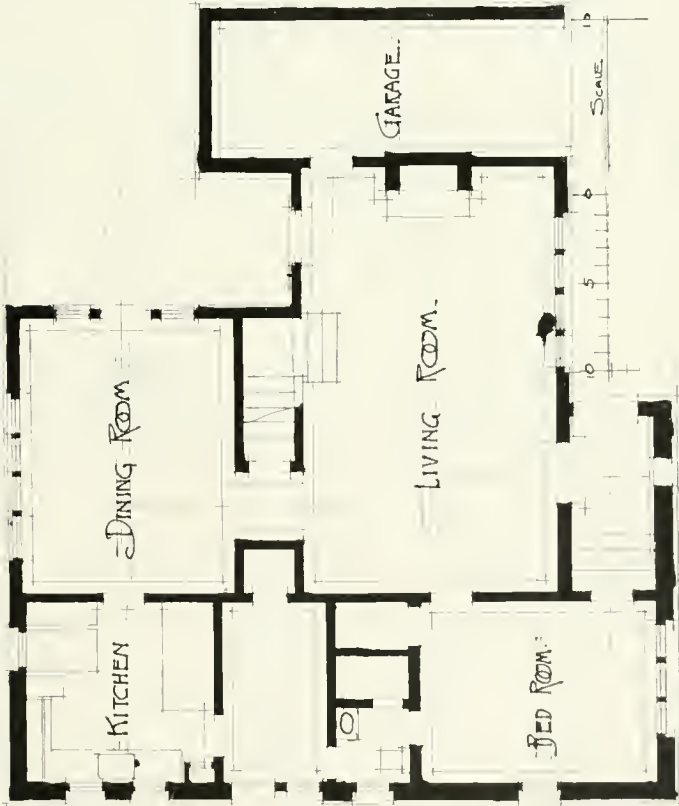
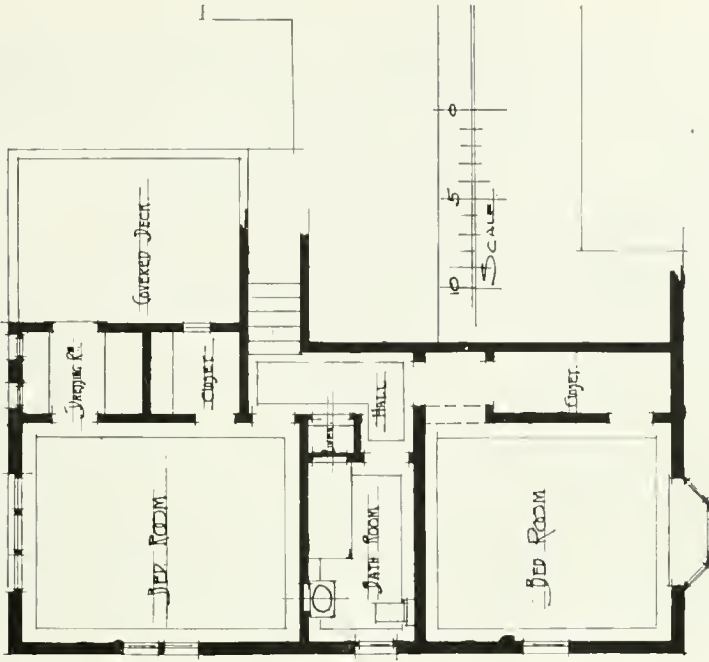

FIRST AND SECOND FLOOR PLANS, RESIDENCE
ESTATE MR. THOMAS NICKOLS, LOS ANGELES
PIERPONT AND WALTER S. DAVIS ARCHITECTS

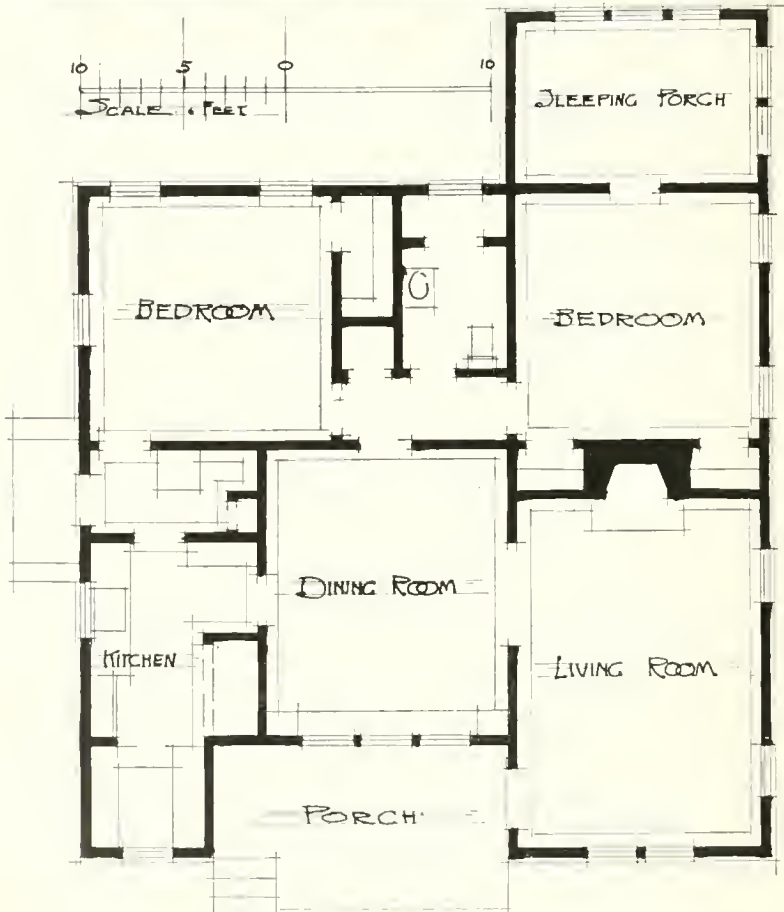

RESIDENCE ESTATE OF MR. THOMAS NICKOLS, LOS ANGELES
PIERPONT AND WALTER S. DAVIS ARCHITECTS

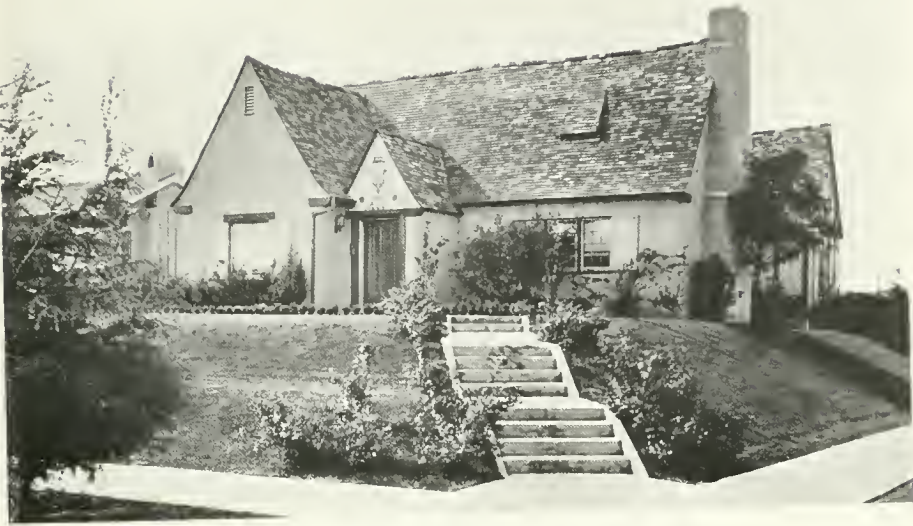

HOUSE FOR MR. MAX CROTINER, LOS ANGELES
Pierpont and Walter S. Davis, Architects

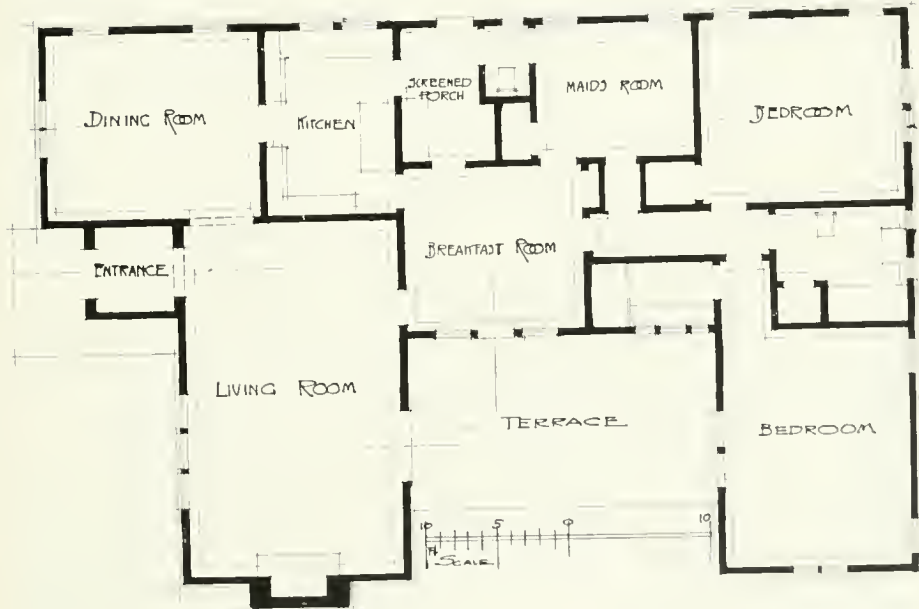

PLAN, HOUSE FOR MR. MAX CROTINER, LOS ANGELES
Pierpont and Walter S. Davis, Architects

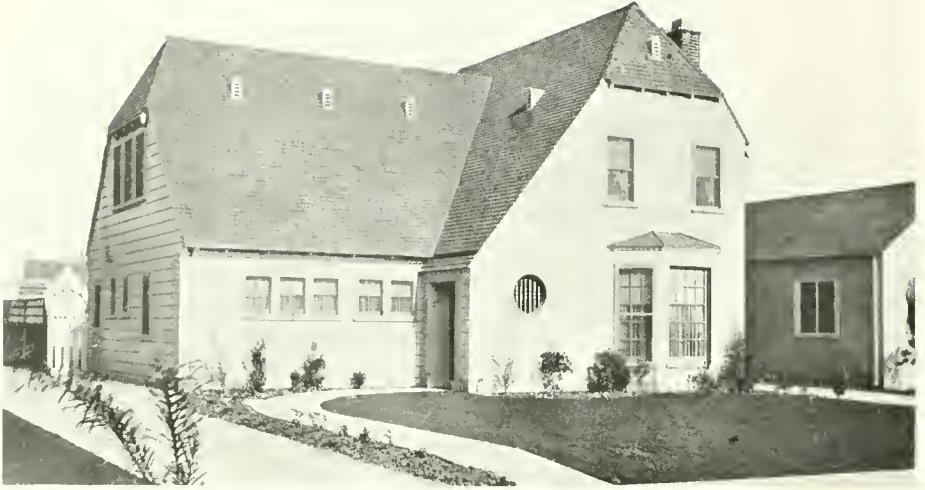

HOUSE FOR DR. JOHN D. McCOY, LOS ANGELES
Pierpont and Walter S. Davis, Architects



ESTATE OF MR. THOMAS D. NICKOLS, LOS ANGELES
Pierpont and Walter S. Davis, Architects

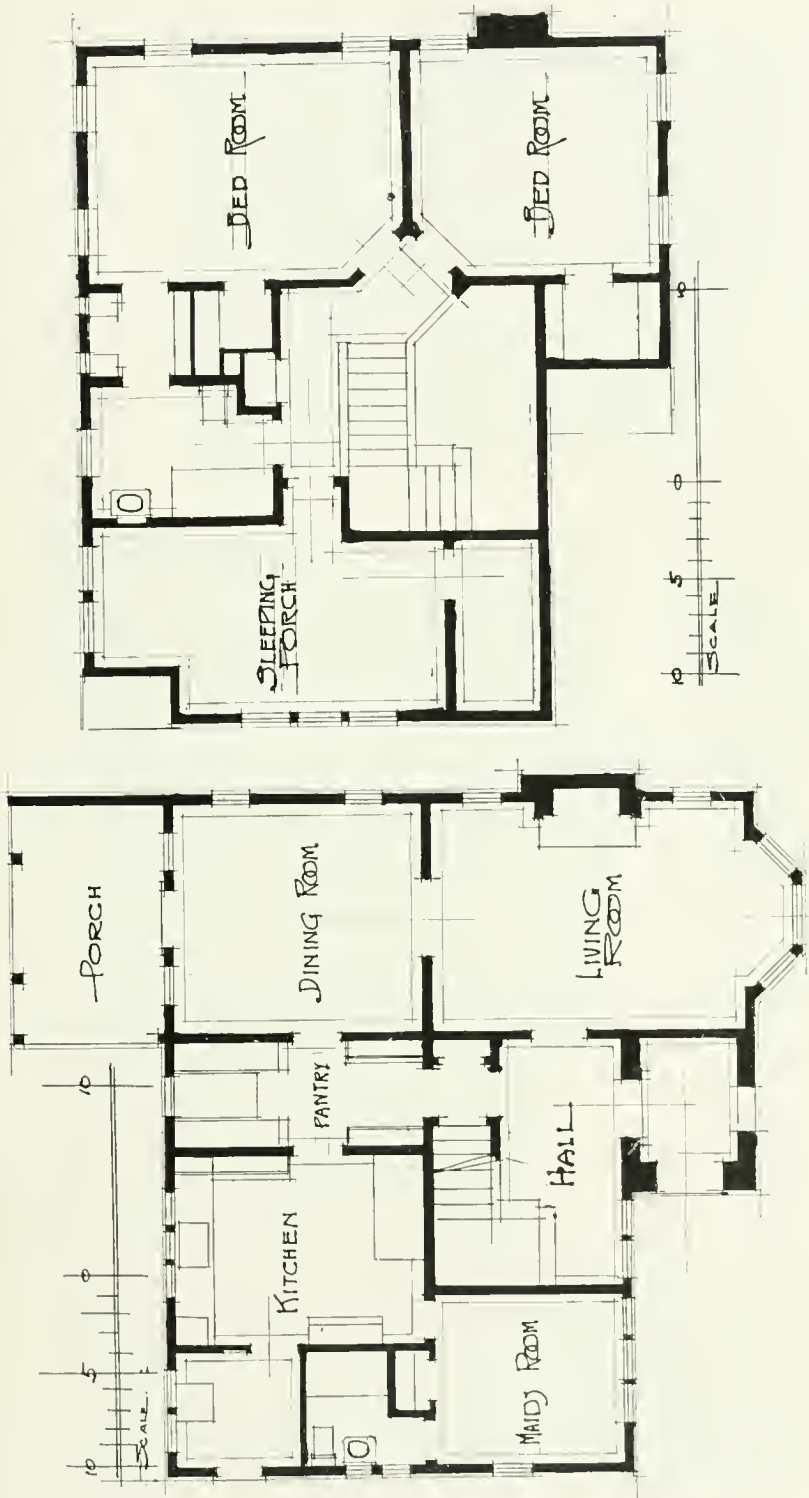

FIRST AND SECOND FLOOR PLANS, HOUSE FOR DR. JOHN MCCOY, LOS ANGELES
PIERPONT AND WALTER S. DAVIS ARCHITECTS

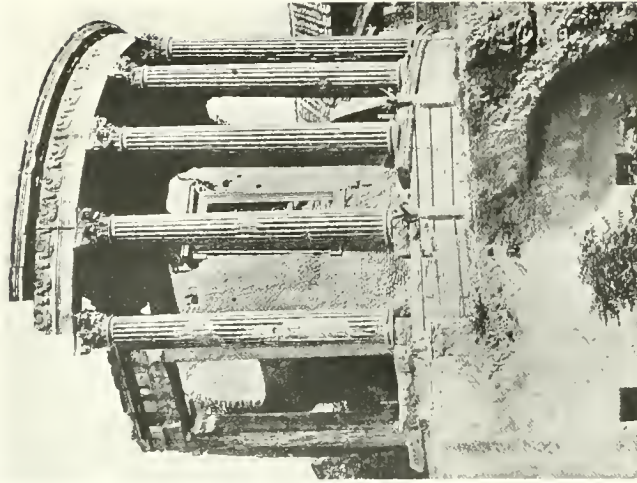

SPRING VALLEY WATER TEMPLE,
SUNOL, CALIF. (On the Left)
WILLIS POLK & CO., ARCHITECTS

THE TEMPLE OF VESTA AT TIVOLI (Above)



The Architecture of the Water Temple at Sunol

By EDWARD F. O'DAY *

SPRING Valley Water Company recognizes "the utility of beauty." This recognition finds distinguished expression in the architectural treatment of important structures, notably the water temple at Sunol in Alameda County, California.

To assume responsibility for the water supply of a metropolis is to acknowledge a solemn obligation, and to be clothed with a special dignity. Whatever expresses that obligation in terms of beauty enhances the dignity of the water company in the minds of all, not only lifting the routine of water supply from the plane of mere business to the higher level of public service, but also enlarging the opportunity for usefulness.

Beauty is the handmaid of dignity, and if dignity be rooted in self-respect it will command the respect of the general public.

Perhaps there is nowhere to be found a more perfect illustration of beauty as an interpretation of public utility service than in the Sunol water temple.

Lands and structures given over to water supply are "dedicated to their highest use," and in the case of San Francisco's water supply the Sunol temple is the most impressive symbol of that dedication.

In the water temple at Sunol all the waters from the Alameda source of Spring Valley Water Company—sources that represent control of six hundred square miles of watershed—meet and mingle for their long journey to San Francisco. The waters that pour into the upper basin of the crypt flow to the temple from artesian wells at Pleasanton. The waters pouring directly into the lower basin come from the natural filter-beds of gravel that underlie Sunol valley, and from the big Calaveras reservoir. From the water temple the mingled waters flow through forty-five miles of conduit, down Niles Canyon, to Dumbarton Point, and thence, through four submarine pipes, across the bay to San Francisco. Half of San Francisco's water supply flows through the water temple every day.

Development of the Alameda sources of Spring Valley Water Company, begun many years ago and still far from exhausting the rich possibilities of this branch of the system, consists broadly in directing the water from its sources through many underground galleries to a central point of confluence, logically located at Sunol. Here the mingled waters form a magnificent cascade, dropping some forty feet into the conduit that "routes" them to San Francisco.

Originally this cascade was housed in a rude shed designed solely to protect the water from contamination. Display of the volume and crystal purity of the water was impossible except by dropping flaming newspapers through the trap-door of the shed.

President Bourn appreciated the desirability of a more dignified treatment of this important point of water control, and the idea of a temple took form in his mind.

The execution of the project was entrusted to Mr. Willis Polk, an architect distinguished for a bold originality disciplined and made delicate by a passionate devotion to Greek and Roman models.

The exquisite design finally produced by Mr. Polk was the fruit of a year's thought and study. The architect rejected plan after plan, a lifelong habit of drastic self-criticism telling him that they did not encompass the ideal he had conceived. Here, as in all works of true art, the

* Editor "San Francisco Water," published by the Spring Valley Water Company.



The evolution of the Water Temple, showing significant steps in the progress of design

final result, though most laboriously achieved, had that quality of inevitableness that leads laymen to regard perfect beauty as the result of a swift and easy inspiration.

Mr. Polk's first design provided a roof supported on twenty-four columns, with a balustrade as a guard-rail surrounding the crypt. This scheme varied but slightly in principle from the final design, but from first to last studies representing some fifty variations of the idea were evolved, only to be discarded.

A natural obstacle to slightly effect hampered the first studies. It was not perceived immediately, but once recognized and surmounted, progress was more rapid. This obstacle was the natural depression of the ground at the site of the water crypt. It was overcome by raising the foundation of the temple some fifteen feet and filling the surrounding ground with about fifty thousand cubic yards of fill, in order to bring the base of the temple up to the ground level of the valley floor.

The most interesting problem, artistically, was the search for "scale"—that is, to find a unit of proportion that would look normal in contrast with nature, a stature that would harmonize with environment. The studies devoted to this element in design led through a series of schemes beginning with twenty-four columns sixteen feet in height, resting on a base forty-five feet in diameter, to a final scheme composed of twelve columns thirty-five feet in height, on a base thirty-six feet in diameter.

A determining factor in this final decision was revealed—but only after many visits to the site—by the noble proportions of a huge cottonwood tree near by. The dimensions and outline of this tree were measured, and its natural proportions suggested the mass of the temple.

In the course of study all the round temples in history were referred to, their proportions and details analyzed for comparison with those under consideration for the projected design.

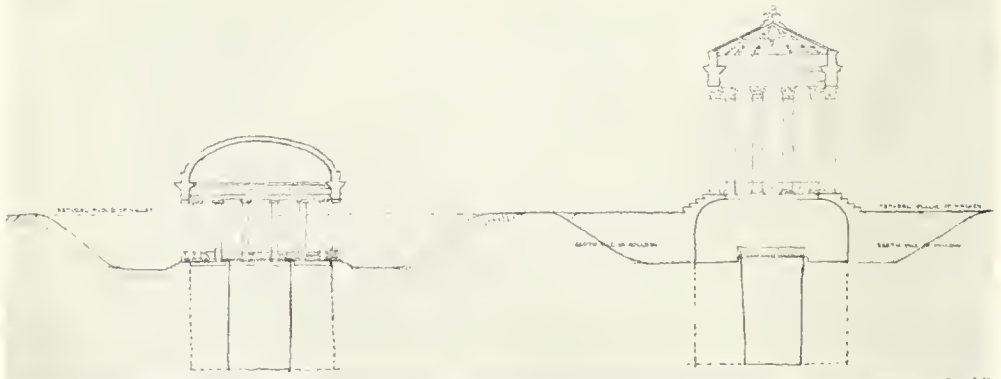

The problem of slightly effect was solved when Mr. Polk raised the base of the Water Temple fifteen feet, bringing it to the general level of the Sunol valley floor.

The final design of the temple in detail was inspired by the famous classic Temple of Vesta at Tivoli, near Hadrian's Villa. This temple, like the Temple at Sunol, rests above a magnificent cascade of crystal-pure water.

* * *

The A. I. A. and the Younger Men

AT THE recent convention of the American Institute of Architects in Chicago, two developments of special interest to the younger men were, the resolution relating to the Junior Class and the proposal regarding graduate fellowships.

The resolution covering the Junior Class provides that any graduate of a school of architecture recognized by the Institute is eligible as a Junior upon submission of proof of his graduation, provided application is made within two years of graduation. This includes the special student whose application carries with it the recommendation of the Dean, or Faculty, of the school in which the student was given his certificate.

It is provided that, Junior affiliation shall expire automatically when the Junior reaches the age of thirty, unless previously terminated by the advancement of the Junior to Membership or Chapter Associateship, or by his resignation, or by the Board of Directors for any cause it may deem sufficient.

The Junior agrees to be bound by the disciplinary rules of the American Institute of Architects.

Application for admission as a Junior is to be submitted on a form authorized by the Board. The annual dues of a Junior are fixed as \$5, of which \$2.50 are to be for one year's subscription to the Journal of the Institute.

It is provided that when an application, in proper form, is received by the Secretary of the Institute, the applicant shall be declared elected a Junior and the membership of the Institute shall be notified accordingly.

It is provided that Juniors shall receive the Journal of the Institute, also the Proceedings of Conventions and such other Institute documents as the Board may direct. Juniors shall be designated by the affix "Junior of the American Institute of Architects," which affix shall not be used in abbreviated form.

The resolution also provides that a Junior shall not be a corporate member of the Institute, nor shall he have any interest in or claim against the property of the American Institute of Architects, nor be entitled to vote in any convention of the Institute except on the sense of the meeting. He shall not be entitled solely on account of his Juniorship to claim affiliation with any Institute Chapter, except that he shall have the privilege of attending meetings. He shall not exercise any privileges granted to members in the By-Laws, except those specifically granted him. It is provided that there shall be no initiation fee for Juniors.

The resolution, the main features of which are given above, provides for the establishment of a relation between the younger graduate in architecture and the Institute that should be a distinct benefit to the former in many ways, and at a nominal cost. It provides a means by which he may have a recognized status in relation to the Institute from his graduation till such time as he may be advanced to Membership or

Chapter Associateship. It bridges the gap between graduation and full recognition. This provision should do much to strengthen the younger men who qualify for Juniorship, both in the eyes of the public and in their sense of their professional relations.

The proposal regarding graduate fellowships, made by the Committee on Education, and, on motion, referred to the Board with power to act, was that ten fellowships of Three Hundred Dollars each for graduate fellows be awarded by the Institute. It is hoped that some of these fellowships may be allotted in two or more schools.—Penal Points.

* * *

Comparative Wage Conditions in the Building Trades

JUNE 1, 1922

PRIMARY CRAFTS	San Francisco	Los Angeles	Salt Lake	Chicago	Minneapolis	Philadelphia	Indianapolis	Pittsburgh
Bricklayers	\$9.00	\$10.00	\$9.00	\$8.80	\$8.00	\$7.20	\$9.20	\$10.40
Carpenters	8.00	8.00	7.20	(Open) 8.00	6.40	10.00	7.40	9.00
Cement Finishers	8.00	8.00	7.00	6.80	6.40	6.40	7.20	7.00
Electricians	8.00	8.00	7.20	8.80	6.40	7.20	8.00	9.00
Lathers	8.00	8.00	8.00	8.00	6.40	7.20	9.00	9.00
Painters	8.00	7.00	7.20	10.00	6.40	6.40	7.20	8.00
Plasterers	10.00	Ave. 12 10-14	9.00	(Open) 10.00	8.00	Ave. 9 8-10	9.00	9.00
Plumbers	9.00	9.00	8.00	7.00	6.40	7.20	9.00	9.00
Sheetmetal Workers ..	8.50	8.00	7.20	(Open) 7.60	6.40	7.20	7.36	8.00
Structural Steel	9.00	6.40	7.20	8.40	6.40	7.20	9.00	8.00
Hodcarriers-Bricklys ..	7.00	6.00	6-7	(Open) 6.30	5.20	6.00	5.60	(Open) 5.60
Laborers—B. T.	5.00	4.00	3-4	5.80	4.00	3.50	2.40	(Open) 2.40
Average Wage	8.12	7.86	7.18	7.77	6.36	7.04	7.53	7.86

THE AVERAGE WAGE OF THE EIGHT REPRESENTATIVE CITIES IS \$7.49

From the above chart, which represents wages paid in the primary building trade crafts in the principal cities of the United States on June 1, 1922, it can be observed that the average wages paid San Francisco building trade mechanics are better than any other city compared. This high wage scale has been guaranteed as a minimum during a year of readjustment, notwithstanding the fact that it was a period of falling prices. Work has been more plentiful, and the building trade mechanic is better off than he has been for many years, as his average annual income is more in actual money and it has more relative buying power. The American Plan is offering no restrictions as to who shall work, as long as he will produce; it is guaranteeing high wages, and the building trade mechanic has more work than he can do.

Note.—Data from wage scales obtained from the Builders' Exchanges and Employers' Associations of the various cities. "Open" means average wage paid craft. No agreed wage scale.

New California State Housing Law

An Analytical Explanation of its Provisions and an Outline History of Housing Legislation.

By WILLIAM MOOSER, Architect *

THE vital importance of the new California State Housing Law does not admit of treating humorously the amusing statements and misstatements made by those who should know better. It is not infrequent to hear these persons tell what the new law will do or will not do and in doing so display an astonishing lack of knowledge. Therefore, there is need of a brief digest explanatory of the new measure, together with a brief history of its compilation and enactment by the Legislature.

The first tenement house law in California and, in fact, all subsequent acts on the subject, were introduced in the Legislature by Senator Lester G. Burnett of San Francisco, and the housing laws are frequently referred to as the "Burnett Housing Act."

The first tenement law, passed in 1909, served its purposes, but because it was modeled after the New York law it was soon found necessary to amend its provisions in order to meet California conditions which differ considerably from those of Eastern cities. Consequently that law was amended at every session of the Legislature until the year 1917. Likewise in 1913 Senator Burnett introduced the first "Hotel and Lodging House Act" which was more or less modeled after the tenement house act, but it was more of a "skeleton" law—in other words its provisions were rather limited.

At each of several sessions of the Legislature the various municipalities sent local officials to lobby for hastily drafted amendments that frequently pertained to their own particular community problems and not infrequently proved grossly detrimental to conditions encountered in other cities. The result was inevitable. Such legislation was a patch-work job; many of its features were unintelligible, ambiguous, conflicting and detrimental to all concerned, and it was not uncommon to find structurally impractical and impossible provisions.

After the 1915 session of the Legislature it was conceded by all concerned that the former method of hastily drafting legislation on an important and technical subject was all wrong. The cities were wastefully spending the taxpayers money and official effort made for destructive rather than constructive results. Therefore, with the approval of Governor Johnson the State Immigration and Housing Commission organized a "State Housing Institute," representative of all interests concerned, to study the entire subject and draft new legislation in a practical manner. The following outline history of the State Housing Institute is self-explanatory: (Page 6, State Housing Manual, published by the Immigration and Housing Commission of California as a report to Governor William D. Stephens, dated October 15th, 1917.)

In order that the public may have confidence in these laws and know that important technical subjects have not been hastily considered and legislated upon, an outline history of the preparation of these laws is herewith given.

The commission, * * made a very careful investigation of housing conditions in the state. This investigation proved the need of amendments to the existing state laws on the subject and the enactment of additional practical and enforceable laws upon the general subject of housing. It, therefore, with the approval of the Governor,

* President California Housing and Building Institute, Member San Francisco Chapter, American Institute of Architects.

invited the fourteen largest cities of the state to participate in a series of conferences for the purpose of studying and discussing all phases of the housing problem, and to draft such legislation as was deemed necessary to solve the problem.

Twelve of the cities responded by naming official delegates—some thirty in number—including supervisors, councilmen, city attorneys, health, housing, building and fire commissioners and inspectors, and other officials of similar rank. These official delegates, together with a large number of semiofficial delegates representing various organizations, such as architectural and engineering societies, city planning and housing associations, public welfare and civic clubs, realty boards and chambers of commerce, apartment house and hotel owners' associations, labor and medical organizations, communal and social workers and similar bodies joined with the commission in a State Housing Institute. The Institute, within the eight months preceding the convening of the 1917 legislature, held four meetings in different parts of the state. At the same time an educational program was carried on through public addresses and press notices. At the institute meetings, the subject of housing was thoroughly covered. A trained and experienced man drew up tentative drafts of the laws. They were printed in convenient pamphlet form and distributed to all the official and semiofficial delegates; also to a large number of people who were interested in the work. At the second and all subsequent meetings, the tentative and revised tentative drafts of the laws were discussed, clause by clause, revised and finally approved.

As a result of the State Housing Institute the three existing housing laws were evolved. The State Commission from the very outset realized that the 1917 laws were not all that was desired and in its official manual said:

The Commission does not regard the laws as ideal, though they contain all that was possible to have enacted at the time.

The task of drafting these laws was rather difficult because of the large field covered and many of those who participated in the work were inexperienced and some were possessed of theoretical pet ideas which, for the sake of harmony, were incorporated in the laws. These untried provisions have since proved impractical. There also crept into the law errors which were not discovered until the laws were passed.

Space does not permit of enumerating the many unsatisfactory and unnecessary features in the existing laws which have made for constant complaint. However, a few of the more important features are worthy of review. To illustrate: Tenement house requirements apply to hotels where entirely different conditions prevail. Some similar provisions also apply to private dwellings for which there is no conceivable justification. It is difficult to understand why in California where we boast of the "Bungalow" type of construction it is unlawful to have a porch that is more than 7 feet deep. In localities, like the San Joaquin, Sacramento and Imperial Valleys, a building without cool porches is practically uninhabitable. Room sizes and tenancy conditions are quite more severe than those in congested centers of population in the East. Even in New York where there have been tenement house laws since 1876, the laws are more lenient than the California laws. A Class "A" fireproof hotel or apartment house is not only limited to 150 feet in height and a given number of stories, but such structures are also limited in height to $1\frac{1}{2}$ times the width of the street they abut. In San Francisco, a building such as the St. Francis Hotel cannot be duplicated because of the street width, and if the St. Francis was destroyed by fire it could not be rebuilt to within 5 or 6 stories of its present height. In Los Angeles, such structures as the new Rosslyn and Clark Hotels cannot be duplicated, and if either of these structures, or a similar structure, was to be destroyed those structures could not be rebuilt. Market street, San Francisco, is the only street in the central part of any California city where it would be lawful to erect an apartment or hotel building to the height limit of 12 stories.

Soon, no doubt, it will be endeavored to apply similar laws to office and mercantile structures. For hotels particularly and as regards some apartment houses the sizes of courts are excessive.

Early in the year 1920 the foregoing mentioned conditions became intolerable and a determined public demand for changes was so manifest that the Governor directed the State Commission to act which it did by sending out a letter, August 26th, 1920, to about 1000 public officials, civic and business organizations, architects, engineers, etc. The opening paragraph of that letter is self-explanatory:

At the direction of His Excellency, William D. Stephens, Governor of California, the Commission of Immigration and Housing is making a study of the changed economic conditions, and experiences had with existing building regulations, with the object of recommending legislation that will make permissive modern methods and new types of construction, curtail high cost of building, encourage and stabilize building and realty values, and particularly to increase housing accommodations consistent with minimum standards for safety and the welfare of the occupants, and provide reasonable safeguards from fire and conflagration hazards. You are cordially invited to join and co-operate with the Commission in this work.

To carry out the work outlined in the foregoing letter the State Immigration and Housing Commission employed expert assistance to re-draft the three existing housing laws into one state housing act under the direction and supervision of the Commission and in co-operation with numerous persons and organizations that participated in the work.

A tentative draft of a state housing law was prepared with the aid of and after discussions were had with public officials, organizations and individuals interested in the subject. The various provisions of this tentative draft of law were discussed by the Immigration and Housing Commission; many changes were made therein, and, likewise, many suggestions for changes that were received by the Commission were written into the law. With the able assistance of Senator Lester G. Burnett, who generously gave of his time and knowledge, the new state housing law was finally drafted in proper shape to be presented to the Legislature. Some changes were made in the act by Senator Burnett and with the approval of the State Immigration and Housing Commission, Senator Burnett introduced the law in the Senate and caused to be printed several hundred copies of the law for distribution statewide so that all interested could study it thoroughly and appear before the Committees of the Senate and Assembly to offer constructive criticism and suggest further changes to better the original act. No objections were made to the law and at the public hearing before the Senate it was unanimously recommended and passed without a dissenting vote. The same procedure followed before the committee of the Assembly where again the law was recommended by that committee and then passed in the Assembly without a dissenting vote. The bill was held in the Governor's office for several weeks after it was passed by the Legislature and no valid objection was presented to the Governor, and he approved the measure May 19th, 1921. The only important suggestion for change in the law that failed approval was to eliminate the provision requiring 25 per cent unoccupied area for tenement houses on interior lots. Particularly in San Francisco, there is merit for this suggestion, but the Legislature refused the change on the theory that it had been the law for some 12 years without serious protest.

Briefly the more important changes from the existing laws are:

1. The new state housing law substitutes the three existing laws regulating the construction and maintenance of tenement houses, apart-

ments, hotels and private dwellings. The new law cuts down the phraseology to less than one-half of the verbiage contained in the three existing laws.

2. The law is very materially simplified; provisions grouped and sections arranged in logical sequence, and made readily understood by layman and technician.

3. The enforcement provisions are simplified, made definite and conflict of authority removed. Permit and certificate requirements, filing of plans, etc., are made easier with unnecessary red-tape omitted.

4. Definitions in the act are greatly elaborated, made clear and in accordance with standard practice.

5. Wherever possible elasticity of interpretation is delegated to local officials in the cities in order that peculiar unforeseen contingencies might be met intelligently.

6. The word "approved" which is frequently used throughout the act is specifically defined so as to permit local officials to approve the use of new kinds of materials, appliances, modes of constructions and other contingencies impossible to be anticipated or foreseen.

7. A "dwelling," "tenement house," "hotel," "fireproof building," "semifireproof building," "wooden building," "occupied area," "yards," etc., are made clearer in the definitions so as to avoid ambiguity and the annoyance that has existed heretofore.

8. Projections into courts and yards—particularly cornices are now clear as to their meaning. In this respect the existing laws are very confusing.

9. Lathing provisions in semifireproof buildings of three and four stories are made to differentiate from those required in a building of greater height. The existing laws discourage this type of popular construction in favor of a wooden building. To say the least, one may kindly attribute the foregoing to an error in the existing laws.

10. The new law permits converting existing buildings to small apartments without having to remove the lath and plaster in hallways and rooms that are not rebuilt, and, consequently, will encourage remodeling of old houses and thereby better them structurally; make them more sanitary and safer and incidentally make them an asset rather than a liability to the owner; relieve shortage of housing and tend to reduce rentals.

11. Rear building and rear lot requirements are modified to make possible the improvement of properties now outlawed due to unnecessary theoretical and utterly impossible provisions that border on foolishness.

12. Height limits of fireproof buildings are removed so that local regulations will govern. This removes the objections heretofore noted and will not only permit but will encourage the erection of high class fireproof buildings without restriction as to height.

13. Height limits of semifireproof buildings are changed to permit that class of buildings to a height of two times instead of one and one-half times the width of street they abut, provided the fixed number of stories is not exceeded. Under the same circumstances, these buildings may exceed two times the width of street, provided the top stories are set back from the facade.

14. Wooden building heights are changed to permit this type of construction on sloping or hillside properties, and the ceiling heights of basements are made practical for use, provided that no more than three stories in the building are used for living purposes.

15. The necessity and importance of the changes in height limits alone suffices to commend the utmost support of the new law regardless of numerous other advantageous changes.

16. "Flats" and the small preferable type of detached dwellings will be encouraged by changes in the sizes of yards and courts. It is nonsensical to require similar stringent provisions for small dwellings that are required for large tenement houses.

17. Court and side yard provisions are simplified and made practical of application. The sizes for yards and courts are consistently differentiated between tenement houses, flats, hotels and private dwellings instead of applying the same conditions to these different types of buildings.

18. Outer court sizes for apartments over eight stories in height are governed by the sizes in effect prior to 1917. Practically no apartment house or hotel of eight or more stories has been erected in the entire state since the existing laws became effective although a number of proposed projects have been abandoned.

19. Outer courts for hotels will no longer be governed as to sizes by limitation of maximum lengths. Moreover, the sizes of outer courts for hotels are reduced as follows: six stories from 8 to 7 feet; seven stories from 10 to 8 feet; eight stories from 12 to 8 feet; nine stories from 13 to 8 feet; ten stories or more from 14 to 8 feet.

20. Inner lot line courts for tenement houses have been reduced to conform to standard practice versus errors made in 1917. The table below is self-explanatory; all figures and wording in italics between parenthesis indicate the requirements of the existing laws and omitted in the new law:

Height of building in stories based on the full number of stories in the building measured upwards from and including the lowest story in which there is an apartment or apartments.	Minimum Width of Inner Court in every part.	Minimum Area of Inner Court in Square Feet.
2 stories	5 feet	60 (<i>75</i>) sq. ft.
3 stories	6 feet	120 sq. ft.
4 stories	7 feet	175 sq. ft.
5 stories	9 feet	225 (<i>250</i>) sq. ft.
6 stories	12 (<i>16</i>) feet	360 (<i>400</i>) sq. ft.
7 stories	15 (<i>20</i>) feet	525 (<i>625</i>) sq. ft.
8 stories or more	18 (<i>24</i>) feet	630 (<i>840</i>) sq. ft.

21. Likewise, the inner courts and inner lot line courts for hotels have been materially changed as will be noted in the two tables that follow. Everything in italics between parenthesis are the requirements of the existing laws which have been omitted in the new law.

22. Recesses from streets, yards and courts are made practical.

23. Intake to courts are required for tenement houses only. The existing laws require these intakes for all buildings except dwellings and the number and sizes required under the existing laws are from 1 of 19½ square feet to 2 or more of from 40 to 60 square feet. The new law requires but 1 intake of 19½ square feet, and if such an intake stops at the second floor line it may be reduced to an aggregate area of 10 square feet and this aggregate area may be divided up into numerous small areas, provided that no such area be smaller than of 12 inches in any dimension.

24. Minimum room sizes have been reduced from 90 to 80 square feet and open sleeping porches are made possible where at present they are practically prohibited.

25. Ceiling heights, room widths and alcove provisions have been entirely rewritten to permit of the proper design of buildings. Incidentally, the phraseology was cut down about 50 per cent.

26. The new law fixes window area provisions on an aggregate of the opening area instead of the present arbitrary sizes which in many instances make impossible of architectural treatment. Windows opening through porches are made lawful provided that the porches abut on a street, court or yard. In other words, it is made possible to design a building of Mission style architecture which is now practically prohibited in California; and this also applies to private dwellings, and a further change fixes a minimum size of aggregate window area for private dwellings regardless of the floor area of rooms.

27. The provisions for hallways and offsets therefrom have been rewritten and an offset from a hallway is permitted of three times instead of one and one-half times the width of public hallway before the offset becomes a public hallway. In a similar manner the skylight provisions have been rewritten and do not apply to two story buildings that contain but three apartments.

28. Water-closet and plumbing provisions remain practically the same with the exception that the local officials are delegated certain discretionary powers when it is found in an existing building that it is impractical to fully comply because of structural reasons.

29. The stairway provisions have been rewritten to eliminate the arbitrary provisions of the existing laws that require two or more stair-

(Inner Courts)

Height of building in stories based on the full number of stories in the building measured upwards from and including the lowest story in which there is a guest room or guest rooms, or dormitory or dormitories.	Minimum Width of Inner Court in Every Part.	Minimum Length of Inner Court.	(Minimum Area of Court)
2 stories	5 (6) feet	9 feet	(75 sq. ft.)
3 stories	7 feet	10 feet	(120 sq. ft.)
4 stories	10 feet	12 feet	(160 sq. ft.)
5 stories	12 feet	16 feet	(250 sq. ft.)
6 stories	14 (16) feet	18 feet	(400 sq. ft.)
7 stories	16 (20) feet	20 feet	(625 sq. ft.)
8 stories or more	16 (24) feet	22 feet	(840 sq. ft.)

(Inner lot-line Courts)

Height of building in stories based on the full number of stories in the building measured upwards from and including the lowest story in which there is a guest room or guest rooms, or a dormitory or dormitories.	Minimum Width of Court in Every Part Measured at Right Angles to Lot Line.	Minimum Length of Court Running Parallel to the Lot Line.	(Minimum Area of Court)
2 stories	4 (5) feet	9 feet	(75 sq. ft.)
3 stories	5 (6) feet	10 feet	(120 sq. ft.)
4 stories	6 (7) feet	11 feet	(160 sq. ft.)
5 stories	7 (9) feet	12 feet	(250 sq. ft.)
6 stories	8 (16) feet	13 feet	(400 sq. ft.)
7 stories	9 (20) feet	14 feet	(625 sq. ft.)
8 stories or more	10 (24) feet	15 feet	(840 sq. ft.)

ways in a building regardless of how small it may be and regardless of how many fire escapes it may have thereon.

30. Likewise, the fire escape provisions have been rewritten to eliminate the same well founded cause for complaint now applicable to the stairway provisions. Furthermore, in a fireproof building the arbitrary provisions requiring fire escapes on the street front have been amended and authority granted the local officials to locate such fire escapes in accordance with design of the building. The use of fire and smoke towers, which are the best possible means for escape of the occupants in case of fire or panic, will be encouraged because in rewriting these provisions they were made practical of construction. Both the allowable areas for fire escapes and stairways were increased.

31. The construction features for elevator, vent and other shafts, inner court walls; and the construction of boiler rooms and garages were rewritten and permit the use of all recognized suitable building materials. Open lot line vent shaft widths were reduced from four to two feet. Likewise, the area of vent shafts were reduced for hotels.

32. The provisions for exhaust draft ventilation in certain rooms in hotels and tenement houses permit of approved systems of ventilation not possible to be installed under the existing laws.

33. A new section regulates the construction of the smaller class of buildings, particularly in smaller cities where there are no building codes; provides a method for computing the factor of safety, schedules for weights and materials, fixes a minimum live load for floors and roofs, etc., in accordance with standard practice.

34. The provisions for the allowable number of persons to occupy a given size of room were entirely changed and the impractical theoretical arbitrary fixing of so many square feet per person and endeavoring to regulate this by the age of the persons was stricken from the act altogether. In lieu of such requirements health officers are delegated authority to meet conditions consistent with prevailing climatic conditions and many other things that only the health officials are qualified to look after when such a necessity arises.

35. The new housing law would have become effective a few months ago had not a few wooden shingle men at the last moment invoked the referendum against the act claiming that one sentence therein was ambiguous and that it might eventually hurt the sale of their products, if not altogether eliminate the use of wooden shingles. However, the law apparently regulates the use of wooden shingles. The act provides that roofs be constructed of **"approved"** incombustible materials or be covered with **"approved"** composition fire resistive materials or a fire retardent material. The word **"approved"** is defined in the law to mean **whatever material** meets with the requirements and approval of the enforcing officials, and, therefore, it merely authorizes the building department to say what is permissible for use of roofings. In other words, the local Board of Works or Building Department, as the case may be, becomes sole judge and if these officials determine wooden roofings are satisfactory in a particular locality, the use of wooden shingles painted or treated to render them fire resistive, or otherwise, may be permissive the same as each city is now empowered to regulate the matter by local ruling or ordinance.

The National Board of Underwriters and National Fire Protection Association endorsed the law and refer to wooden shingles as "the Nation's greatest fire and conflagration hazard." These same author-

ities attribute to wooden roofings millions of dollars loss in fire waste and not infrequently human life. There is more than ample evidence that wooden shingle roofs have been and are the chief contributory causes for innumerable fires and that their use has made for rapidity in spreading of fires. Such incontrovertible facts are worthy of serious consideration.

However, regardless of what one may think of wooden shingles the fact remains that the new law as a whole is in the public interest and far superior to the existing laws, and, therefore, commends the utmost support of the People of California. Every architect, structural engineer and builder in California will find it to his advantage to constitute himself a committee of one to work for the success of the new housing law at the November election.

* * *

225,000 Engineers, Architects and Draftsmen in United States

According to the 14th census in 1920 there were 64,660 civil engineers and surveyors in the United States as compared with 52,033 in 1910. The total number in the professional technical class, according to the census report, was 224,957 made up of the following:

	1920	1910
Architects	18,185	16,613
Designers	15,410	11,788
Draftsmen	52,865	33,314
Inventors	2,376	2,347
Civil engineers and surveyors....	61,660	52,033
Electrical	27,077	15,278
Mining	6,695	6,930
Mechanical (inc. all others).....	37,689	14,514
	<hr/>	<hr/>
Total	224,957	152,817

The above figures for 1920 include 7,842 women for all but 178 of whom were designers, draftsmen or inventors. The total for 1910 includes 6,283 women.

* * *

Fire Losses in a Year

Property worth \$1,416,375,000, the equivalent of 283,275 new houses at \$5,000 each, or more than enough to shelter the total population of a state as large as Connecticut, was destroyed by fire in the United States in the period from 1915 to 1919, as shown by the quinquennial analysis of 3,500,000 adjustments made public by the National Board of Fire Underwriters.

Electricity, the chief cause of fire loss, led with a total of \$84,086,471 for the five years. Matches and smoking stood second with \$73,474,348 and defective chimneys came next with \$56,650,915. Other causes, in their order, were:

Stoves, furnaces, boilers and their pipes, \$55,133,188; spontaneous combustion, \$49,702,886; lightning, \$39,828,489; sparks on roofs, \$2,271,585, and petroleum and its products, \$25,910,434. Incendiarism contributed \$21,596,965 to the damage and miscellaneous unknown causes contemplated the total.

What Does Architecture Mean to the Architect?*

By W. R. B. WILLCOX, A. I. A.

MR. PRESIDENT AND FRIENDS: When we saw upon the programs the subject of the remarks our guests were to make, I am sure our interest and curiosity were at once aroused. I am equally sure that our interest has been justified, even if, because of the brief time available, our curiosity has been too little satisfied.

No such curiosity, or interest, I am aware, can attach to the guess I may make at the answer to the riddle propounded **me**, "What Does Architecture Mean to the Architect?" The answer is too obvious, if not to the architects present, at least to their wives. You may not have mentioned it, and I rather hesitate to do so, lest I scandalize the profession by revealing, thus publicly the mercenary character of its inmost thought, but you have guessed it, it means **JOBS**.

However, having deserved for our souls the good which honest confession is said to be, and since there remain a few minutes of the time so graciously allotted, it may entertain you, as it has me, to consider less obvious answers to the conundrum. For instance, I **might** say that to some architects, architecture means the making of lovely drawings of supposedly beautiful buildings. I don't say it, because, if I did, somebody might think I was "taking a shot" at **him**, and I would not appear unkind.

Then I suppose, the answer might be stated in some high faluting art jargon; but were that attempted, I shudder to reflect upon the nature of your thoughts.

If I should say that architecture meant order, logic, fitness and safety in the planning and designing of buildings, some one would be likely to inquire if "beauty" should not be included in the category; but who knows what "beauty" is? Don't all speak at once.

You see, every last architect has his own pet standards, his own peculiar brand of taste. Fortunately, or otherwise, the tastes of no two exactly agree. What to one architect is the sum of all loveliness, to another is commonplace, or worse; ponderous details which may be the delight of one, are as depressing to the architect whose joy is in that "utmost refinement" we talk about, as are those of the latter, thin and weak, to the former.

For some architects, beauty blooms only in familiar gardens of historic precedent, while for others, it blossoms in strange pastures of quaint or bizarre originality. Architecture's perfect flower is different for different architects, but to the **Genus Architect**, what is its universal and authentic token of beauty? Does anybody really know?

Then, again, were I to say that architecture, in aspect, means form, silhouette, proportion, texture, color, rhythm, grace, virility, dignity, picturesqueness or other similar abstraction, some architects with engineering proclivities, doubtless with difficulty could refrain from contemptuous allusion to my remarks as "high-brow stuff;" while, did I content myself with confining its meaning to "artistic building," the "practical" architect would insist upon it, that it should embrace such delightfully engaging subjects as the proper height of the kitchen sink.

But I am sure I occupy safe ground, in this company, when I say that to the architect, architecture means the **greatest of all the professions**, and the **Mother of all Arts**. And not from **pride** alone—there is more than a semblance of reason for such a view. As a profession, it touches life at more points, perhaps, than any other of the professions.

*An address at the annual meeting of Seattle Chapter, A. I. A.

The **Lawyer** is occupied with the troubles of people. No architect would deny that trouble—his clients'—is his natural element, the atmosphere he breathes; but in addition, he has experience of their pleasures, their happiness.

The **Physician** is occupied with physical ailments of people, and while the architect is brought into contact with the same abnormalities, in the planning of hospitals, sanitariums, medical institutions and similar structures, in the creation of recreational buildings, such as theatres, club-houses, gymnasiums and the like, he ministers, also, to the people who never have been in, or have escaped from, the doctors' care.

The **Engineer** is concerned with problems of safety, strength and convenience, but so, too, is the architect, and beyond that, he takes account of human comforts and aesthetic enjoyments.

The **Clergyman** devotes himself to the spiritual development of his parishoners, in which the architect assists to the extent of subtle suggestion of things religious, in the churches he builds, while, also, he provides both clergyman and parishoner with a respectable—and shall I say, inviting—place for the repose of their mortal frames, when they shall have no further use for them.

The **Teacher** supplies the pabulum of education and strives to inculcate in the young, right habits of thought. The architect builds the schools—sometimes—thus indirectly contributing to the latter. Incidentally, he discovers how nourishing has been the educational fare, and to what extent it has been assimilated. If education has been reasonably beneficial, if a degree of wisdom has dispelled ignorance, it will be evident in the alacrity with which the recipient seeks, later on, the services of an architect for his building operations. I regret to have to note in the appendix that architects are inclined to suspect of low efficiency present-day educational methods.

The **Housewife**, adviser and director-general of our social arts and domestic sciences, shall she not be admitted to the ranks of the professions? Unostentatiously providing those matter-of-course creature comforts, which smooth man's pathway from the cradle to the grave, she finds in the architect both pupil and co-worker, instructing him, free of charge, in the fundamentals of his domestic masterpieces, and modestly yielding him the credit and glory for his successes, insistent only that he shall bear the opprobrium of his failures.

Furthermore, the architect, of necessity, is involved in almost every human enterprise. He is concerned with the sources of supply of the various building materials, of wood, brick, stone and marble; of iron and steel; of glass and fabrics, a seemingly endless list, and he frequents the factories and shops where these materials are shaped and dispensed. He is thrown with men and women engaged in their production, with manufacturers, dealers, salesmen, craftsmen of all sorts, and he has to deal with them quite intimately likewise with artists, sharing their tasks in many instances, the painter, sculptor, actor, and even the musician.

Also is the architect brought into contact with the **Law**, as it pertains to property, to building practice, and to business in general; with certain realms of **Finance**, such as building investments, loans, mortgages, insurance; and in a very particular fashion with the sciences, mechanics, chemistry, electricity, sanitation, acoustics, sociology and economics. I enumerate this partial list of interests simply to illustrate

the many points at which the architect touches human life, not in a superficial way, but in a quite necessary and important manner.

Since architecture encompasses so large a number of human interests, since, in its pursuit, the architect inevitably traverses such varied and such broad fields of human activity, its meaning to him, as the most human, the greatest of all professions, finds complacent justification.

And, the Mother of all Arts! Architecture was born with the human habitation. It is the background, the repository, and, largely, the inspiration of decorative painting, sculpture, pottery and weaving, the stage of the drama, and, from its qualities of rhythm and accent, of composition and motive, is as crystallized music, the "frozen music" of the poets. As none other, is it the art which reveals the progress of the human race. It is the art by which, singly, man interprets to present and future generations the spirit of his time, his race and his nationality.

To the architect it means the **medium** in which, consciously or unconsciously, he **records** the physical and intellectual development and the spiritual enlightenment of man. Also, it means the **record itself**, in which shall be found the story of the life of his own time and his own people, the character of their social and economic habits, the measure of their culture and refinement, their contribution to the perfection of human experience.

* * *

Statistics Show Waning Building Crafts

Those who delight in analyzing statistics will find an interesting study in the census reports giving occupational data. Mr. W. S. Hays, secretary of the National Federation of Construction Industries has compiled from the census reports of 1910 and 1920 a table showing the number of persons registered in various building crafts in comparison with the number in the automobile industry and other lines. An actual decrease is noted in the number of persons employed in five building trades. Nearly a quarter of a million building laborers apparently were absorbed by other industries and the army and navy. These statistics reflect some war time conditions which have since been ameliorated or have disappeared but the situation with reference to the building trades is practically the same today as in 1920. Following are the figures compiled by Mr. Hays:

	1910	1920	Increase	Decrease	Pct.
Structural iron-workers ..	11,427	18,836	7,409	64.5+
Boiler makers	44,761	74,088	29,317	65.6+
Brick and stone masons	169,402	131,264	38,138	23.6+
Electricians	120,241	212,964	92,723	77.2+
Carpenters	817,120	887,379	70,259	8.6+
Building laborers, general ..	869,478	623,203	246,275	28.4-
Iron and steel laborers.....	482,941	729,613	246,672	51.2+
Automobile laborers	15,783	83,341	67,558	428.0+
Petroleum refineries, hrs....	11,215	31,795	20,580	188.6+
Rubber factories, laborers..	13,546	51,467	37,921	280.0+
Painters—building	273,441	248,497	25,944	9.5-
Paper hangers	25,577	18,746	6,831	26.7-
Plasterers	47,682	38,255	9,427	19.8-
Plumbers	148,304	206,718	58,414	39.4+
Roofers and slaters	14,078	11,378	2,700	19.2-
Paint and varnish factories ..	3,920	5,521	1,601	40.8+
Elevator tenders (male) ..	25,035	33,376	8,341	33.4+
Janitors (male)	91,629	149,590	57,961	63.6+
Soldiers, sailors, marines ..	77,153	225,503	148,350	192.5+
R. R. boiler washers	10,409	25,305	14,896	143.0+
Waiters	188,293	228,985	40,692	21.6+
Chauffeurs	45,786	285,045	239,259	522.0+
Population	91,972,266	105,710,620	13,737,354	15.0+

New System of Lighting Schoolrooms

Editor The Architect & Engineer,
San Francisco.

If you will kindly publish the enclosed letter with small diagrams, it will prove very interesting and useful I believe.

The diagrams show my improved system of lighting class rooms, where two sides can be used. The base ventilator may be useful in many kinds of rooms and buildings, with or without special fresh air supply. It eliminates numerous flues and ducts. The carbon monoxide from people's breaths, passing off here, nourishes grass and trees; and these in return give off ozone for the better health of people near.

The cross-section shows in attic, for each chain of rooms, a straight steam supply pipe. For each room there is a branch coil of plain pipe within a duct, to temper the air. A fan for each room or group of rooms, draws air through cornice (both sides) and delivers it into center of ceiling direct, whence it spreads and falls to the occupants. Regulating the fan controls rate of air supply, and vents are automatic.

Yours very truly,

LOUIS COWLES, Architect.

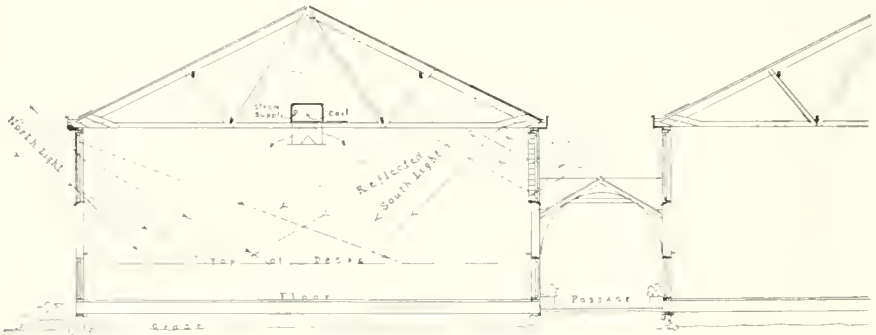

TYPICAL CROSS SECTION OF CLASS ROOMS

Gentlemen:

I have made a very thorough study of natural lighting, and I want to give you, if you want them, the best results available in lighting arrangements.

The main essentials of good lighting are as you know, to have enough for clear easy vision on the work to be done, in all school hours; and avoid all distress to the eyes from glare or cross lights, or any excess that *may come in under the eye lashes*.

The best of clear steady light to work by comes from the north, or from the sky away from the sun.

Yet we need a certain amount of sunshine effect to give warmth and cheer, life and joy, in the pupils' work.

I have an improved plan, system or combination, which gives the best of clear steady light from the north or its equal *all day long* (the usual way is half the time) yet admits sunshine, *reflected to the ceiling first* so being tempered and turned into *top light*.

And *all the light used* comes from well *above* the eyes of pupils, which protects them from all kinds of light coming in on their level.

Numerous valuable advantages will appear in the following notes, taken with drawing shown.

For the high school it is proposed to set class rooms for each department in a double chain east and west, with a passage between, whose roof is low enough to set windows above it.

In this way each room, both sides, can have north windows, to remain open (unshaded) about all the time; avoiding the usual frequent changing of shades or blinds.

Then for sunshine effect, the south side of each room can have similar windows, with shutters having level slats to reflect the light up to ceiling first, then down as top lights to the desks; three times reflected when it reaches the eyes—all glare being subdued.

Superficially, this may appear at first much like "cross lights," which are quite apt to be distressing to weak eyes and must be avoided.

But a little careful discriminating thought, to understand the actual conditions, will allay and dissipate this impression.

Notice that the window sills are about four feet above top of desks, and all the light comes from high up, is diffused and mild, and shadows only quite faint.

Now in an ordinary class room with windows only one side, it is found they must have an area of 20 per cent to 25 per cent of floor area, in order to see well on the back side in dull weather.

But in these class rooms, with windows on opposite sides, this restriction is removed, and the rooms can just as well be made wider.

At say 30 feet wide, the middle of room is still 6 or 8 feet nearer to windows than the back side of a 23 foot room with one side windows.

Assuming 20 per cent of floor area for windows, we get them 4½ feet high, and these set from the top down, take in about double the light the lower part of nine foot windows would do.

So we have here *more light* as well as *better light* all the time, and better distributed besides.

With the south windows having shutters with fixed level white top slats to reflect sunshine to the ceiling, they will not admit direct glare (unless swung open purposely) and do not require watching and adjusting like Venetian blinds, but will do their main work automatically.

This is far simpler and safer than one side windows generally do.

These wider class rooms can be shorter the other way, resulting in a shorter more

SECTION OF VENTILATOR
IN BASE OF ROOMS,
TO LET OFF CARBON MONOXIDE
& COLD AIR.

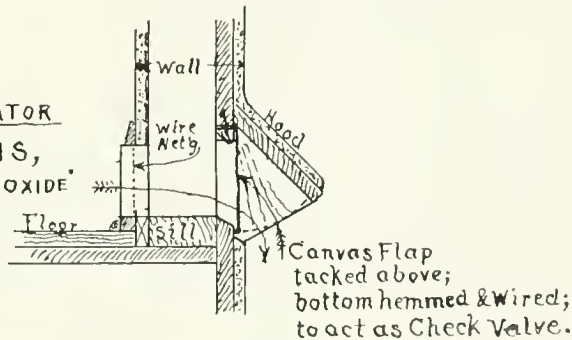

compact building, which is better for economy and convenience.

Also the classes can face the long side of rooms, so that the rear pupils are nearer to the teacher and her blackboard,—better for weak eyes; then both like it better, being in closer touch.

Window sills are about six feet high, so that *if* more blackboards are wanted than two long sides will hold, as is often the case, they can be placed on *four sides*; but in that case, the windows should have opaque roller shades, hung at bottom, to run up over part of windows, to make it safe and comfortable to the eyes in working at the boards.

It is hardly advisable to do work here that is to be seen from back far in the room, where they would face the light; but it is good for work not needing to be seen from far back.

These high windows give a good view of the sky, each side, but are liable to give a shut-in feeling, for lack of a view out onto the ground.

So to provide for this, even much better than is done with ordinary rooms, it is proposed to have on *each side* two or three small low windows *under chalk rails*, looking out right into flower beds or boxes.

These would not reflect much light up into the eyes, but may have curtains to control what there is.

In dull weather when all available light is wanted, the south shutters can be swung wide open, (two to each window), saving electric light, much more than by one side windows.

Each window would have one sash which can be opened any amount, for cross ventilation as a "fresh air room."

If at any time, one side lighting is preferred, either side windows can be closed with roller shades.

No essential values or especially desirable features in the one side lighted rooms are lost or ignored. No variation from usual practice is proposed without first knowing the reasons why any value is there and providing for it in the improved plan.

In fact there is nothing new or not in common use except the combination, its application, and utilizing its results.

Cost of building with short windows both sides, is about the same for class rooms, as with one side lighting, several items costing less being about offset by small increases.

* * *

Copper Nails Best for Shingles

OF interest to the shingle consuming public is a recent development of a copper-bearing, hot-dipped, zinc-coated, steel wire nail, which has rust-resisting properties, guaranteeing the life of a shingle roof for a period equal to the life of the shingle itself, providing the nails are properly used.

While steel wire shingle nails have not been recommended in the past as suitable for applying shingles to roof surfaces because of their lack of rust-resisting properties, the introduction of a small percentage of copper into the steel compound produces a material known as "copper bearing steel" which has a high degree of rust resistance.

To illustrate the practical value of copper bearing steel in a rust resisting shingle nail, the following instance has come under the observation of the American Steel & Wire Company: A church built fifty-two years ago in Portland, Oregon, was only recently re-shingled, and the nails were found to be in surprisingly good condition. However, these particular nails had every possible advantage and they had been used on a three-quarter pitch roof, which drains very rapidly. These nails, when analyzed were all found to contain one-twelfth of one per cent of copper.

Another building built forty years ago was recently re-shingled, and while the nails were not in as good condition as the preceding instance, still they were quite capable of holding shingles on the roof. The nails in both instances were the same, but in the later case, a one-half pitch roof had been used, which probably accounts for the short life of these nails. Tracing the nails back to their origin, it was found that the iron from which they were made came from Eastern Pennsylvania mines, the ore of which had a heavy copper content.

There are several methods of galvanizing steel, but only one which has the real merit of extreme durability. This process, known as hot-dipping, is as follows:

In the particular instance of shingle nails, a batch of nails to be galvanized is tossed into a wire basket, which is then dipped into a hot solution of molten zinc, and the zinc which has an affinity for steel, will coat the entire nail with a relatively thick coating of zinc and lead mixture known as spelter. The nails are then taken out and tumbled to remove surplus spelter. The recent improvement in this process has enabled the manufacturers to produce a practically smooth galvanized nail, which any carpenter may carry in his mouth without any danger of generating canker sores. This has been the aim of most nail manufacturers for years.

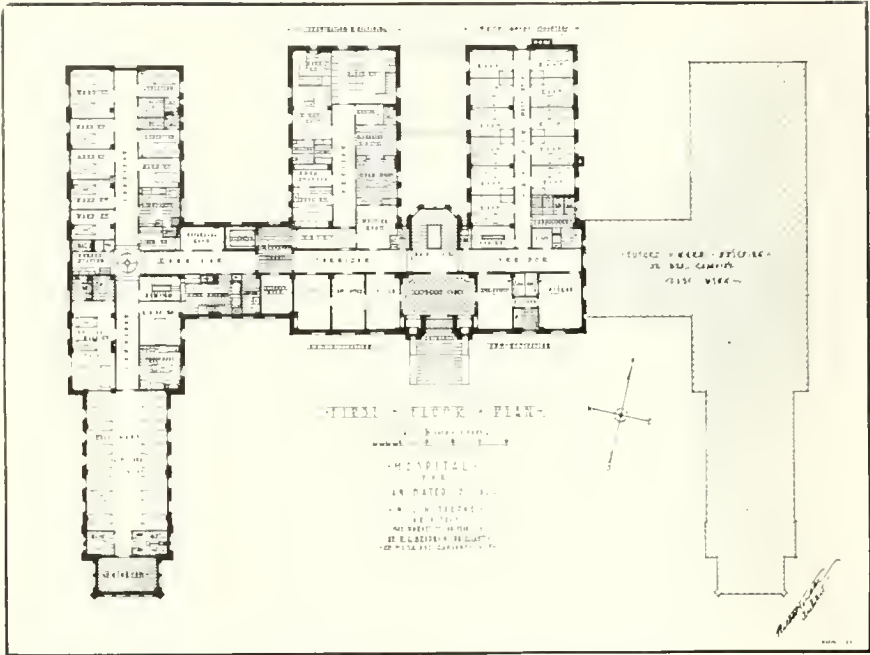

The utilities are centrally located. The nurses' station is in the center, opposite entrance to the ward. The serving pantry, elevator, apparatus room, and janitor's closet extend along the entrance corridor, so that while convenient to the ward, the noises incident to their operations are kept away from the sick. Patients who are seriously ill will be segregated in separate rooms at one end of the ward close to the nurses' station, thus confining the nurses' steps to the smallest possible radius and reducing her work by lessening the time and energy spent in walking corridors.

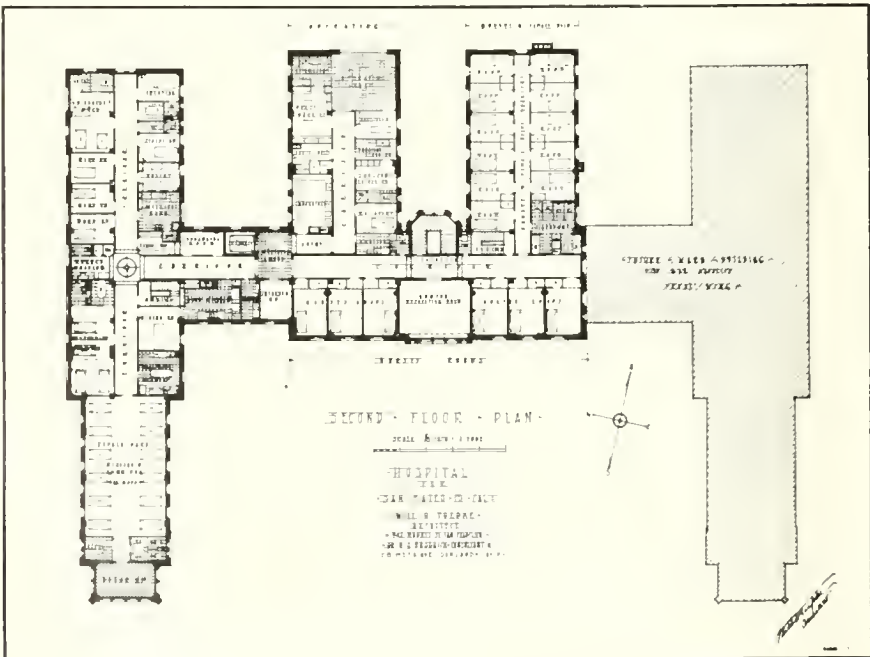

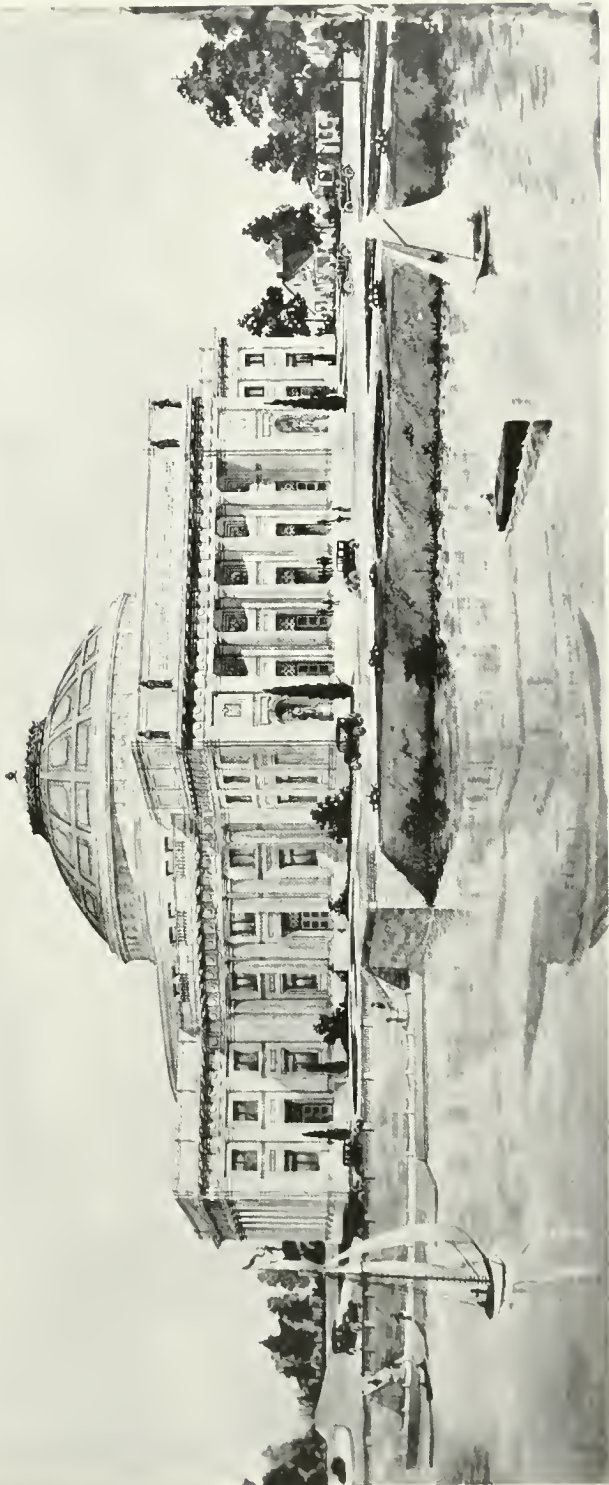

DESIGN FOR MUNICIPAL AUDITORIUM, STOCKTON
CITY ARCHITECTURAL COMMISSION, ARCHITECTS

THE Architect and Engineer

Incorporated

Founded 1905 by E. M. C. WHITNEY

W. J. L. Kierulff - President and Manager
 Fred'k W. Jones - Vice-Pres. and Editor
 L. B. Penhorwood - - - - - Secretary
 T. C. Kierulff - - - - - Attorney

Associate Editors

Chas. H. Cheney - - - - - City Planning
 August G. Headman - - - - - Book Reviews
 Wilbur David Cook - Landscape Architecture
 Wm. B. Gester - - - - - Inspection and Tests
 O. P. Shelley, C. E. { Fireproof Construction
 F. W. Fitzpatrick {
 T. Ronneberg, C. E. - - - Structural Steel
 W. H. Lowe - - - - - Roofs and Roofing
 Fred'k N. Woods, Jr. - - - Rock and Gravel
 Chas. Felix Butte - - - Electrical Construction
 J. W. Fricke - - - - - School Equipment
 Will J. French - - - - - Department of Safety

Published Monthly in the Interest of the
 Architects, Structural Engineers, Contractors
 and the Allied Trades of the Pacific Coast by
 The Architect and Engineer, Inc.

PUBLICATION OFFICE:

627-629 Foxcroft Building, San Francisco
 Telephone Douglas 1828

The publishers disclaim any responsibility for
 statements made in the advertisements of this
 magazine.

Terms of Subscription

(Including postage) to all parts of the United
 States, \$2.50 per annum; to Canada 75c
 additional; to all Foreign points \$1 additional

Vol. LXX. SEPTEMBER, 1922 No. 3

MAKING IT SAFE TO BUILD

Anyone who has tried to figure out just what he should allow for a three weeks' camping trip and then has taken the trip is in a fair position to get some conception of the problems of the estimating department of a building concern. It is not a job for anyone except the most experienced. For remember that unlike the camper who can easily enough make up for the things omitted in his final estimate, there is no such alternative for the building concern, especially if it be one which is operating under a contract which guarantees a predetermined cost. Such an estimate must be accurate and complete and made by men who know not only what things ought to cost but what they will actually cost in the end.

The men who estimate for a big building which as yet is in the preliminary plan stage must be able to conceive of it as a finished structure;—to give to the rough plan and its elevation the necessary third dimension—an idea of the mass of the building as standing on the plan.

There are various methods of getting at the quantities for an estimate which are in common usage. But the most accurate results are obtained when the estimate is made by itemizing all the materials entering the construction. This is called "taking off the quantities." For example to determine the cost of the construction of one hundred square feet of the floor it is possible to arrive at an approximation by using a figure representing the cost of a unit of that type of construction. But a more reliable estimate is made by determining the quantities of material which go into the component parts of the floor—forms for reinforcing, the reinforcement, the concrete, the cement finish, the furring, the plaster and the linoleum or other covering surface. These quantities multiplied by the prevailing unit cost of the material and added together give a reliable estimate and this method is typical of all estimator's work.

Under the ordinary building practice where an owner through his architect or engineer submits plans and specifications to different contractors the quantity survey must be made by each bidder. Only one bidder can be successful and consequently the cost of the job to the owner is higher because of the wasteful duplication in the surveys. For someone must pay for the unsuccessful bidder's time. Thus the unsuccessful bidder on a job accounts for his losses on the jobs he fails to get usually by adding a percentage to each successful bid.

The form of contract used by an organization which handles all

phases of a building operation eliminates this unnecessary expense to the owner. For each owner who employs such a concern pays for the survey of his own building solely. Such a concern is its own contractor and never has occasion to take off quantities unless it has been awarded a contract for a building.—Noble F. Hoggson.

NEW HOUSING LAW

In this issue appears an exhaustive article explanatory of the new California State Housing Law which leaves no doubt but what this law should receive the unanimous support of the voters and particularly the approbation of every person engaged in any phase of the allied building industry throughout the State.

Property owners, architects, engineers, material dealers, manufacturers and building trades craftsmen, can perform a real civic service, with direct beneficial returns to themselves, by voting and working for the new law at the November election. Careful perusal of Mr. Mooser's article is urged of every reader whose interests are in any way allied with the building industry.

The new housing law would have become effective several months ago but for the action of the wooden shingle interests in invoking the referendum against the act, claiming that the attempt to regulate the use of wooden shingles would result disastrously to the industry if enforced. The act provides that roofs be constructed of "approved" incombustible materials. The word "approved" is defined in the law to mean whatever material meets with the requirements and approval of the enforcing officials, and, therefore, it merely authorizes the Building Department of a community to say what is permissible for use of roofings.

The lumber interests say this

leaves a lot of authority up to the local Board of Works or Building Department which may act in favor of certain roofing interests to the injury of all others. However, wooden shingles are not peremptorily barred when painted or treated with a fire resistive coating.

IN BEHALF OF ART

Mr. Willis Polk, San Francisco architect, has addressed the following letter to the editor of Architecture which contains so much fine thought that we feel impelled to print it in full, hoping the suggestions offered may help to bring the United States to the fore as the world's greatest patron of the Fine Arts:

Gentlemen:

Your Editorial (August issue of Architecture) "In Behalf of Art", quoting Dr. Howard Walker's address at the recent Chicago Convention of the American Institute of Architects, suggests that you might advocate a course in Art as a part of the curriculum of all educational institutions, from Grammar Schools to Universities, and beyond that, you might also advocate that divinity students in Theological Seminaries, the world over, be instructed in the elements and principles of Ecclesiastical Architectural Design. Thus might wisely be planted a virulent seed in the field of art cultivation.

The glory of the medieval Cathedrals and the bewildering charm of the Renaissance was mostly due to the patronage of the Church—to the shame of the Church of today (all denominations), Art finds its feeblest expression, in modern church buildings.

The Papal See, the Archbishopric of Canterbury, and even the tented Chataquans of Bryan are all possessed of a potency which if intelligently directed would be productive, so to speak, of sermons in stone. Civilization is after all dependent upon order, and art is the highest expression of order. Art under such conditions never costs anything.

In the days of Rameses, artists had their problems, and art as well as artists languished.

In these days artists have their problems, and art as well as artists continue to languish as usual.

In the course of time—yea, even until the end of time, I opine that art and artists will languish, but that will not prevent the artist from striving. Such

conditions, rather than deterring the artistic spirit, will only urge it on. Art is a domineering mistress—a mistress that never relents, and once one of her votaries falls under her thrall there is no hope, but the hope of success at the expense of sacrifice, a hope that makes a votary renounce all other aims and forever cling to his mistress. Such an act of renunciation is a sacred sacrifice; one that has rarely been commercialized.

But this confession makes me weep, it makes me despondent, it is an abject confession. We can always commercialize the Old Masters—we can always fatten and thrive on the prowess of a dead genius—we can always feel complacent over the hunger cravings of a living artist, and that without feeling a sting of registering a compunction of conscience. We have genius in plenty with us today, but we fail to recognize it in less than 200 years and even then our judgment is doubtful. We have with us at the present time hundreds of artists as good as were Velasquez, Rembrandt, Raphael, Michael Angelo, Phidias & Co., but these living artists have no sales agents—no chambers of Commerce or other avenues of approach to the milk and honey of patronage. The halls of commercialized art are not open to them and will not be unless they die.

All that the living artist has is a mythological winged steed "Pegasus".

Dr. Walker is right, our universities should prepare their students for a proper exercise along these lines, of their prospective powers, then in a short course of time, the men controlling funds and churches, with whom Architects and Artists have to deal, might become sympathetic patrons, rather than skeptical conservatives.

As Mr. Burnham said: "Make no little plans; they have no magic to stir men's blood and probably themselves will not be realized. Make big plans; aim high in hope and work, remembering that a noble, logical diagram once recorded will never die, but long after we are gone will be a living thing, asserting itself with ever-growing insistency. Remember that our sons and grandsons are going to do things that would stagger us. Let your watchword be order and your beacon beauty."

Every country in achieving commercial supremacy has in doing so always become a patron of the Arts. The United States is about to become the greatest patron in history of the Fine Arts.

Maybe these suggestions will speed her up. She will get there anyway, nothing can stop her, for it is by such faith that miracles are done.

Very truly yours,

WILLIS POLK.

Sacramento Architects Organize

Organization of the Sacramento Architects and Engineers Club has been perfected with the adoption of a constitution and election of a permanent board of officers. The club hopes to be settled in its new club rooms in the Meister building very shortly.

Mr. George Adams, of the State Architect's office, is the club's first president. He has been active in the movement for getting the architects and engineers together and acted as temporary chairman of the organization. Mr. George Calder, engineer in charge of the Sacramento filtration plant, is vice president; Mr. J. E. Tempest, assistant city engineer, is secretary, and Mr. Leonard Starks, local architect, is treasurer.

The three directors chosen are Messrs. R. A. Herold, T. E. Stanton, and D. E. Godfrey.

Twenty-two members have signed the underwriting agreement for the \$5,000 which will be used in fitting up the club rooms. In return for the money spent the club will get possession of the headquarters for four years without cost. After that time it will have to pay rent. At present the membership roll has been signed by 134 local architects and engineers. A membership of 300 is the aim of the new organization.

Any engineer or architect living within a radius of fifty miles of Sacramento is eligible to membership. As soon as the new headquarters are finished a program of lectures and study classes will be started along with social activities designed to build up the professions in Sacramento and create a better feeling and higher professional standards among the members.

Sacramento Architect Busy

Architect E. C. Hemmings, Ochsner building, Sacramento, is preparing plans for a group of hollow tile buildings for the Rodome Corporation, Mr. Bert L. Hilborn, Traveler's Hotel, Sacramento, manager. The idea is a new one and is likely to become popular with the motoring public. The buildings will occupy an area 550x250 feet, and will consist of 50 standard one-story tile structures, forming an outer wall, each structure comprising a living room, bed room, kitchenette, bath and connecting garage. There will be accommodations for 420 people and 90 machines. The style of architecture will be Spanish. It is proposed to conduct similar rodomes or road homes in all the large cities on the Pacific Coast.

Other work in Mr. Hemmings office includes an apartment house for Mr. Fred Ankener to cost \$30,000; a school building for the Elder Creek School District to cost \$20,000.

With the Architects

Building Reports and Personal Mention of
Interest to the Profession

Commercial Buildings and Garage

Architect Arthur G. Bugbee reports the following new work in his office, 26 Montgomery street, San Francisco:

Three-story and basement reinforced concrete loft building, leased to the Mono Oil Company, to cost \$20,000.

Two-story and basement concrete and brick loft building on Fremont street, between Howard and Folsom streets, San Francisco, for the H. E. Bothin Realty Company, to cost \$60,000.

Three-story Class B garage for the H. E. Bothin Realty Company on the lot bounded by Hunt, Sherwood and Natoma streets, San Francisco, to cost \$45,000.

One-story reinforced concrete additional floor to the Occidental Hotel, Santa Roca, to cost \$65,000.

Nine Story Apartment House

Architect C. A. Meussdorffer, Humboldt Bank building, San Francisco, has been commissioned to prepare plans for a nine-story Class B apartment house, having nine apartments of eight rooms and four baths each with garage accommodations in the basement, for Messrs. Joseph E. Levin of San Francisco, and S. Levin, of New York. Building will be located on the northwest corner of Jackson and Laguna streets, San Francisco. It is estimated the improvements will cost \$200,000.

Architect W. E. Schirmer Busy

New work in the office of Architect W. E. Schirmer, Thayer building, Oakland, includes a three-story store and apartment building, 40x140, on San Pablo Ave., near Cowper street, estimated to cost \$40,000; a reinforced concrete store building and moving picture theatre on Park Boulevard, Oakland, to cost \$50,000; a residence for Mr. Arthur Clark in Piedmont, to cost \$14,000; and a residence in Piedmont for Mr. Harry Seagrave, to cost \$15,000.

Woman's Athletic Club Addition

Plans have been completed by Architects Bliss & Faville for a six-story addition to the Woman's Athletic Club building on Sutter street, near Mason, San Francisco. Mr. A. A. Brown, construction engineer will supervise the work, which is estimated to cost \$250,000.

Six Story Apartment House

Architect C. O. Clausen has completed plans for a six-story and basement steel frame and concrete apartment house to be erected on the west side of Hyde street, near Sutter, San Francisco, for Mr. Luis Blum. There will be 24 apartments of two rooms each. The building will cost \$65,000. Mr. Clausen has also prepared plans for a \$40,000 undertaking establishment for Mr. Peter Megendie on Golden Gate Avenue, near Fillmore, San Francisco.

Moose Lodge Building

Architects O'Brien Bros., 240 Montgomery street, San Francisco, have been commissioned to prepare plans for a new lodge building for the Loyal Order of Moose. The site is on the south side of Market street, near Brady, San Francisco, lot 67x180, upon which will be constructed a two-story and basement store and lodge building with walls sufficiently strong to carry additional floors later on. The first unit of the building will cost \$120,000.

Church and Apartment House Work

Architect W. J. Wythe, Central Bank building, Oakland, has prepared plans for a \$20,000, frame apartment house to be built on Mather street, off of Broadway, Oakland, also a similar building on Walnut street, Berkeley, for Captain Rideout; a \$30,000 church on Clark Boulevard, Oakland, for St. James Presbyterian Church and a \$12,000 Methodist church at Sonora and a \$7,500 Methodist church at Sunnyvale.

Bank Alterations

Architect S. Heiman, 57 Post street, San Francisco, is preparing plans for additions to the Bank of San Anselmo, to cost \$20,000. Mr. Heiman has also made plans for a \$10,000 home in Ingleside Terrace, San Francisco, for Mr. L. Spiegelman. Preliminary sketches are being made for a six-story Class C apartment house to be erected in the downtown section of San Francisco, at a cost of \$125,000.

Addition to Country Club

Architects Bakewell & Brown are preparing plans for alterations and additions to the Burlingame Country Club.

Oakland Designers Busy

Messrs. McWethy & Greenleaf, architectural designers, with offices in the Albany building, Oakland, recently took figures for the construction of a four-story physicians office building to be built at Telegraph avenue and Channing way, Berkeley, for Mr. Ray F. Jaffe. This firm has recently been commissioned to prepare plans for a pretentious bungalow court, 100x200 on Perry street, near Grand Avenue, Oakland, at a cost of \$50,000. They have also made plans for residences to cost from \$6500 to \$7500 each for Mr. Williams J. Conroy in Northbrae, Berkeley, Mr. Allen C. Cunha in the Lakeshore District, and Messrs. Gurnette & Chandler, two houses on Santa Rey Avenue, near Carlson street, Oakland.

Personal

Architect Niels P. Larsen of Salt Lake City, Utah, has reopened offices for the practice of his profession at 220 Community building at which address he will be pleased to receive manufacturers samples and building material literature.

* * *

Mr. Carl Werner, architect of a number of the recently built Christian Science churches and Masonic Temples in Northern California, has moved his offices from the Humboldt Bank building to the West Coast Life Insurance Building.

* * *

Mr. Fay Spangler, formerly of Santa Maria and later with Architect G. A. Lansburgh of San Francisco and Los Angeles, is now practicing the profession in Santa Ana.

* * *

Mr. Franz Herding, member of the firm of Herding & Boyd, city planners and consulting engineers, of St. Louis, recently called upon some of his old friends and associates in San Francisco and Sacramento. Mr. Herding was at one time chief draftsman in the office of Architect R. A. Herold in Sacramento. Messrs. Herding and Boyd have just made a report to the Holland Investment Company with reference to the feasibility of establishing an ideal town site at Clarksburg, a rural community of much promise twenty miles from Sacramento.

* * *

Mr. Robert H. Orr of Los Angeles announces the removal of his office from 1301 Van Nuys building to Suite 1300-1305 at 724 South Spring street, Los Angeles.

* * *

Mr. W. R. B. Wilcox, architect with offices in the American Bank building, Seattle, has been chosen head of the School of Architecture at the University

of Oregon, Eugene. Mr. Wilcox was at one time a member of the board of regents of the American Institute of Architects and is an architect of national prominence.

* * *

Mr. W. J. Jones, architect, Seattle, has moved his office from 422 New York building to 4078 Arcade building.

* * *

Mr. Claude N. Freeman, architect, formerly of Silverton, Oregon, has moved to Salem, Oregon, and the firm with which he is associated is now known as Freeman & Struble.

* * *

Mr. Roy L. Jones, architectural designer, has moved his office from 5893 Moneta Ave., to 311 S. Western Ave., Los Angeles.

* * *

Messrs. Charlton & Birnbach, architects, have moved from 837 San Fernando building, to room 833 in the same building, Los Angeles.

* * *

Mr. G. E. Strout has opened an office at 201 Braley building, Pasadena. Mr. Strout comes from Boston, Mass., where he practiced architecture for thirty years.

* * *

Mr. Albin Johnson, of the firm of Meyer & Johnson, architects in the Bakers Investment building, San Francisco, has been quite seriously ill at his Oakland home, but his friends will be pleased to learn that his health has improved and he hopes to return to the practice of his profession shortly.

* * *

Architect A. Merrill Bowser is reported to be seriously ill at the Fabiola Hospital, Oakland.

Partnership Formed

Mr. Frank V. Mayo, architect of Stockton, announces the formation of an association for the general practice of architecture and engineering under the firm name of Mayo, Cowell & Bissell, architects and engineers, with Mr. Howard G. Bissell, architect, until recently of New York City, and Mr. Arthur E. Cowell, for many years Engineer of Merced County. Offices have been established in the Bank of Italy Building, Merced, and the Williamson Building, 21 South San Joaquin Street, Stockton.

Elks Building Competition

Architects Charles H. Bebb, James Schack and B. Marcus Priteca, of Seattle, Wash., have been named to represent the Washington State Chapter of the American Institute of Architects in formulating plans for the proposed B. P. O. E. \$1,000,000 building competition.

Architects Granted Charters

The following chapters were granted charters at the annual convention of the American Institute of Architects in Chicago:

Central Illinois Chapter, Peoria, Ill.; Erie Chapter, Erie, Pa.; St. Paul Chapter, St. Paul, Minn.; South Georgia Chapter, Savannah, Ga.; Scranton-Wilkesbarre Chapter, Scranton, Pa.

These chapters are off-shoots from older chapters, and each has been formed, with the approval of the parent body, by members who found it inconvenient to travel the distances necessary to attend meetings of the older groups.

Architectural Jazz

Why shouldn't a "city beautiful" come down from the realm of dreamland into the practical idealism that converts beauty into a commercial asset?

The science of architecture is like Greek to a layman. But the architects have a multitude of different ideals and opinions. The only hope for a real "city beautiful" is to find some coherent architectural standards and stick to them.

Architectural jazz is just as ephemeral, as noisy and as discordant as the jargon of sounds that profane the name of music.

Yet every American city has lapses from the canons of good taste in almost every block of dwellings. Business architecture has suffered less, because the modern skyscrapers era sacrificed everything else to utility. Now that real architecture again shows some signs of renaissance in business structures there may be more danger ahead.—Chicago Daily Journal.

Sketch Competition Open

The announcement of the Birch Burdette Long Sketch Competition for 1922 has been made.

This early announcement is made in order that those who contemplate entering may make sketches during the fall months when the weather conditions and the customary vacations provide the best opportunities for sketching. The competition closes at noon, October 30, 1922. Prizes aggregating two hundred fifty dollars will be given by Mr. Birch Burdette Long to the winners named by the jury of award. The purpose is to encourage sketching, more particularly on the part of draftsmen and students.

The first of these competitions, held last year, aroused a great deal of interest, the response was immediate and large, and a great many interesting sketches were submitted from all parts of this country and some from England and Canada as well. The number of entrants should be even larger this year, for last year's competition set the ball rolling.

Builders Escape Prosecution

Indictments against five persons in connection with the failure of the Knickerbocker theater in Washington, which caused the death of nearly a hundred persons last winter were recently dismissed by the criminal court of the District of Columbia, on the ground that the alleged negligence charged against them was not explicitly set forth in the indictment. An appeal has been taken by the district, but there is little probability that the decision of the lower court will be reversed. There is a wide difference between "a mistake in judgment" and "negligence" and even though there may be evidence of faulty design and construction it may not be possible for the keenest lawyer to write it into an indictment for negligence. The defendants in the case are the architect, the steel designer and fabricator, the building inspector, a sub-contractor and a superintendent.

Honolulu Buildings

Mr. Charles W. Dickey, supervising architect of the Oakland school building program, recently returned from Honolulu, where he supervised the details of two buildings of which he is the architect. One is the Castle and Cook building, costing \$420,000, to be used for steamship offices and plantation business, and the other is the Queen's Hospital, to cost \$375,000. Working drawings have been started for the Castle-Cook building while contracts were let for construction of the hospital.

San Francisco Residence

Architects Ashley & Evers, Holbrook building, San Francisco, are preparing working drawings for a two-story home for Mr. R. H. Hubbell, of the Hill, Hubbell Company. The house will occupy the southwest corner of Locust and Jackson streets, San Francisco, and is being designed in the French style of architecture.

University of California Stadium

Working plans are being made by Architect John Galen Howard, First National Bank building, San Francisco, for the University of California stadium, Berkeley. The design calls for a combination structure of earth and concrete with a seating capacity of 75,000 persons. It is hoped to start construction this fall.

Alterations to Building

Architect V. W. Houghton, 425 Kearny street, San Francisco, has prepared plans for alterations and additions to a six-story building at 250 Stockton street, San Francisco, for the Rudolph Wurlitzer Company.

With the Engineers

The Engineer of Tomorrow
Editor The Architect and Engineer,
San Francisco:

I take pleasure in transcribing for the benefit of your readers the concluding words of the chapter on "Science and Engineering"; the last lecture of a remarkable series bound together under the title, "Mathematical Philosophy" by Mr. Cassius J. Keyser, Professor of Mathematics at Columbia University. The volume is published by E. P. Dutton of New York, and it is undoubtedly one of the great books of this decade, if not this generation.

Yours,

B. J. S. CAHILL.

"And so I propose to define Engineering to be the science and art of directing the time-binding energies of mankind—the civilizing energies of the world—to the advancement of the welfare of man.

"That conception does not represent engineering as it has been in the past nor as it is practiced today. It represents an IDEAL which engineering will approximate more and more just in proportion as it becomes more and more humanized and enlightened. The ideal is an inspiring one; but it ought not to flatter the vanity of professional engineers; it ought rather to give them a feeling of humility. For consider its spirit and its scope.

"Its spirit is not a self-serving spirit nor a class-serving spirit nor any provincial spirit; it is a world-serving spirit—the spirit of devotion to the well-being of all mankind including posterity.

"And what is its scope? Is it confined to the kinds of work done today by professional engineers in the name of engineering? It is by no means thus confined; its scope is immeasurably greater; for, over and above such work, which no one could wish to belittle, it embraces whatever may be intelligent, humane, and magnanimous in the promotion of science, in the work of educational leadership, in the conduct of industrial life, in the establishment and administration of justice—in ALL the affairs of statesmanship big enough to embrace the world.

"I am facing the future, and I say 'in all the affairs of statesmanship' because I do not doubt that the affairs of state—which are the affairs of man—will at length be rescued from the hands of 'politicians' and be committed to a statesmanship which will be an engineering statesmanship because it will guide itself and the affairs of state in scientific light by scientific means.

"Engineering statesmanship will know enough to know that scientific knowledge cannot be applied to the conduct of human affairs if such knowledge does not exist; it will have sense enough to know also that knowledge which does not exist cannot be suddenly called into existence at the moment when it is needed. Engineering statesmanship will, therefore, be sagacious enough to make ample provision in advance for scientific research; not only for technological research, but primarily and especially for that kind of research which does not consciously aim at utility or applications. What kind IS that? It is the kind whose 'only purpose,' in the clear words of President Nichols, is the discovery of new knowledge without thought of any material benefit to anybody'; it is the kind which Simon Newcomb had in mind when he said that 'The true man of

science has no such expression in his vocabulary as 'useful knowledge'; it is the kind of which Henri Poincaré said that, if there can be 'no science for science's sake,' there can be 'no science'; it is, in a word, the kind of research which springs out of pure scientific curiosity—out of wonder, as Aristotle said—and which because it is thus disinterested, just because it seeks the True, is the principal source of the Useful also.

"The subject of such research will be Nature—non-human nature and human nature—the nature of the non-human world and the nature of man—for we can know nothing else. Engineering statesmanship will have sense enough to know that its work cannot be done without scientific knowledge of both kinds of nature; it will, therefore, provide every means for promoting the advancement of the physical sciences and of those biological sciences that deal with the non-human world; and it will especially provide every means for promoting those researches which have for their aim the understanding of Man. I have said 'especially' because engineering statesmanship will have sense enough to know that, of all the things it must deal with, man is the supreme reality, and that, therefore, the understanding of man—scientific knowledge of human nature—is absolutely essential to its enterprise.

"In view of such considerations it is easy to see what the defining marks of a great engineer are destined to be. They will not be the marks of mere 'efficiency' nor of mere technological knowledge nor of technological skill—they will not be mere engineering technique of any kind, whether 'civil' or 'mechanical' or 'marine' or 'architectural' or 'sanitary' or 'chemical' or 'electrical' or 'industrial'; these things will be important, as they are now, they will indeed be indispensable, but they will not constitute, and they will not define, the great engineer. The characteristic marks of the great engineer will be four: Magnanimity Scientific Intelligence—Humility—Action.

"He will be religious and he will be patriotic; 'to do good' will be his religion and his love of country will embrace the world. For he will be the scientific organizer and director of the civilizing energies of the World in the interest of all mankind."

County Surveyors Underpaid

THE American City has recently conducted a country-wide investigation of salaries of municipal and county officials, and has found a county engineer in Idaho who has received an annual salary of \$800 for the last ten years, although the road and bridge work alone amounted to more than \$135,000 in a year. The American City states:

The 1919 Annual Report of this county shows the sum of \$74,285.35 expended on county roads for that year. The total for county bridges was \$61,668.69, making a total of \$135,944.04 for the road and bridge fund. The total expense of the Surveyor's office during the same year was: Salary, \$799.92; stationery and supplies, \$53.16; clerical assistance, \$750; miscellaneous expenses, \$148.82; making a grand total of \$1,751.90. Attention is called particularly to the salary as compared with the sum spent for clerical assistance.

In the Annual Report of 1920 for the same county, the money expended on county roads was

\$103,788.36; on county bridges, \$23,207.82; making a total of \$126,996.18 for roads and bridges. The County Surveyor's expenses for the office for the same year were: Salary, \$89.92; stationery and supplies, \$30.54; clerical assistance, \$900; furniture, \$0.96; miscellaneous expenses, \$153.48, making a total of \$1,974.70. It is interesting to note that in this year the sum for clerical assistance was actually a few cents more than the salary of the County Surveyor, who is the engineer and executive.

A careful examination of these figures shows that there is a rather sad discrepancy in the proportion of salary to expenses in the Surveyor's office, and since the Surveyor does all of the engineering work for the county, his salary is exceedingly small in proportion to the money expended. The total area of this country is about one million acres, one-half of which is national forest. Of the land outside of the forest, 50,000 acres are classified as grazing land, and 250,000 acres are classified as suitable for agricultural purposes. The county lies in the heart of the mountain district, so that all the surveying and the engineering work pertaining to the location of roads and their construction are quite expensive.

If the county were located in a prairie country where surveying was simply a matter of running lines, the salary of \$800 a year might be adequate, but if the work takes the engineering party into mountainous districts and timber where locations are difficult, added salary is justified.

Due consideration should be given to the climate and topography of a county when adjusting salaries for county surveyors and engineers. The arduous labor and technical matters connected with the surveying and laying out of roads in mountainous districts call for a compensation greater than for an engineer who simply has to run a comparatively easy line on level, rolling prairie land.

Civil Engineers to Meet

"Hydroelectric Development," will be the subject of the quarterly meeting of the American Society of Civil Engineers, at San Francisco next month.

Prominent members of the profession from all parts of the country will attend.

Special interest attaches to this meeting because it marks the abandonment by the Society of its time-honored policy of holding but two general meetings during the year, the "annual meeting" held in January at the New York headquarters, and the "annual convention," largely social, held at some selected point. Of the fifty-one conventions that have been held, only four were at Pacific Coast cities, two in San Francisco in 1896 and 1915, and one each in Seattle and Portland, in 1912 and 1920 respectively.

Beginning with the present year, however, the Society has adopted a plan similar to that followed by the other great national engineering societies, and is holding four meetings a year, at various points throughout the country. That San Francisco should be selected as the place for one of the first meetings under the new plan is significant of the growing country-wide recognition of the importance of the Pacific Coast.

All sessions will be held at the Palace hotel. Preliminary meetings of the Board of Direction of the Society will be held Monday and Tuesday, October 2 and 3. The general meeting of the entire

Society will be formally opened Wednesday morning, Mr. John A. Britton delivering the address of welcome. Technical sessions will be held Wednesday morning and evening and Thursday morning. Among the prominent visitors who are expected to deliver addresses are Mr. A. P. Davis, director of the U. S. Reclamation Service and former president of the Society, who will discuss the Boulder Canyon Project, and Mr. F. E. Matthes of the U. S. Geological Survey, who will talk on "Surveying and Map Making by Aeroplane." Local engineers on the program include Mr. F. H. Fowler, district engineer for the U. S. Forest Service, and Mr. John D. Galloway.

Wednesday and Thursday afternoons will be devoted to excursions to nearby points of interest. Thursday evening there will be a dinner and smoker, at which Professor Charles D. Marx, head of the department of civil engineering at Stanford University, will preside.

The remainder of the week will be devoted to an excursion to Hetch Hetchy, leaving San Francisco Thursday evening at the conclusion of the smoker. The party will arrive in the mountains the following morning and will spend Friday and Saturday in going over the various parts of Hetch Hetchy work, visiting also the Don Pedro dam, now being built by the Modesto and Turlock irrigation districts. Those who wish to do so will then continue on to Yosemite Valley, while the others will return to San Francisco, arriving Sunday morning.

Demand for Engineers Back to Normal

A gradual and steady advance in engineering employment in all sections of the country with increased activity in the basic industries is reported by the employment department of the American Association of Engineers. The demand for architectural and structural draftsmen and designers with building, or plant experience has far exceeded the supply in practically all sections of the country.

The total number of positions being received by the American Association of Engineers is over 400 each month, with about 250 of these filled by the Association. This large placement is due to concerted local activity by capable employment representatives. The average monthly salary of all positions filled during June was \$192. A number of positions above the \$500 mark were filled.

University Gymnasium

Preliminary sketches have been approved for the new fireproof women's gymnasium to be erected on the Campus of the University of California, the gift of Mr. William R. Hearst. Mr. Bernard Maybeck is the architect.

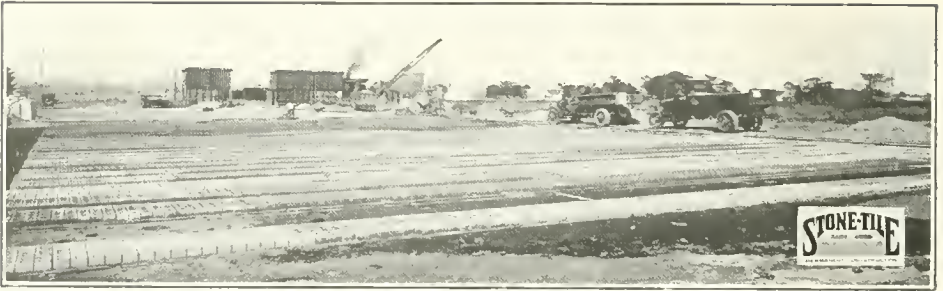

STONE-TILE Plant of Rhodes-Jamieson & Co., Oakland, Calif.

Hollow Concrete Brick Meets Demand for Economical Building Material

By FREDERICK JENNINGS

THE SHORTAGE of building materials and the demand for a thoroughly practical building unit of concrete that can be produced economically and on a large scale has led to the development of Stone-Tile, a new hollow concrete building brick.

The National Stone-Tile Corporation has been organized to manufacture and market this product and distribute the equipment for casting Stone-Tile. The organizers are men of wide experience in the building industry who are thoroughly familiar with the requirements necessary to meet practical building needs.

This company is carrying out at this time plans which will make Stone-Tile universally available and their organization will include plants capable of providing an unlimited supply of Stone-Tile. In doing this their problem has been very much simplified due to the fact that Stone-Tile can be manufactured at any point where sand, rock, gravel and cement are available. The various plants will manufacture in conformance to standard material specifications and will

be provided with all equipment necessary for casting and curing Stone-Tile in such a way as to insure a uniform high quality product.

In casting Stone-Tile the concrete is mixed and poured into the molds in a plastic state, thus insuring uniform density in the finished product. The manufacturing process is accomplished with as little labor as is required in the pouring of concrete sidewalks. No pallets are needed and excessive labor of ramming dry concrete as well as the uncertain results of dry tamp methods are eliminated. The molds are stripped from the newly made brick immediately after the top is surfaced as it is not necessary to wait for the brick to set before lifting the mold and moving it into position for the next pouring. The process is the outcome of years of experimenting and because of its efficiency is attracting widespread attention.

A Stone-Tile plant equipped with ten molds can produce the equivalent of 30,000 common brick in an eight-hour day, and it is expected that the large produc-

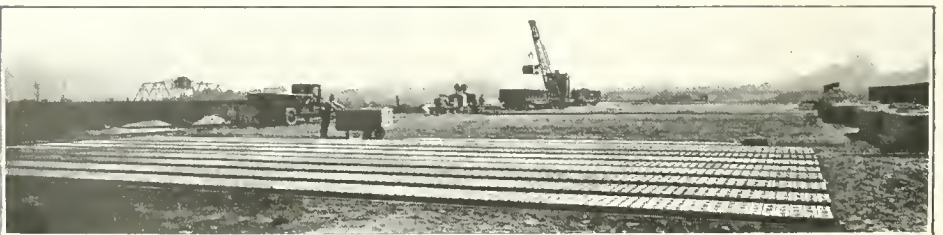

STONE-TILE drying at Rhodes-Jamieson & Co. Plant, Oakland, Calif.



Section of STONE-TILE wall showing colored mortar joint markings and texture of brick surface

tion capacity of the various Stone-Tile plants will do much to overcome the present shortage in building materials.

Made of durable concrete Stone-Tile is unique in the field of building materials and possesses advantages never before combined in one masonry unit. It possesses adaptability comparable to that of common brick at a substantial saving in cost.

Stone-Tile is particularly suitable for the construction of homes, schools, churches, garages, warehouses and fac-

ories, and is fire and weather-proof. Its hard, impervious surface will withstand the action of the weather and retain its pleasing appearance indefinitely.

Stone-Tile masonry gives the advantages of hollow wall construction to the highest degree by combining with this feature satisfactory load-bearing capacity and attractive appearance.

Laid in the same way as ordinary brick masonry, Stone-Tile units are well balanced and convenient in size and

(Concluded on page 114, Second Column)

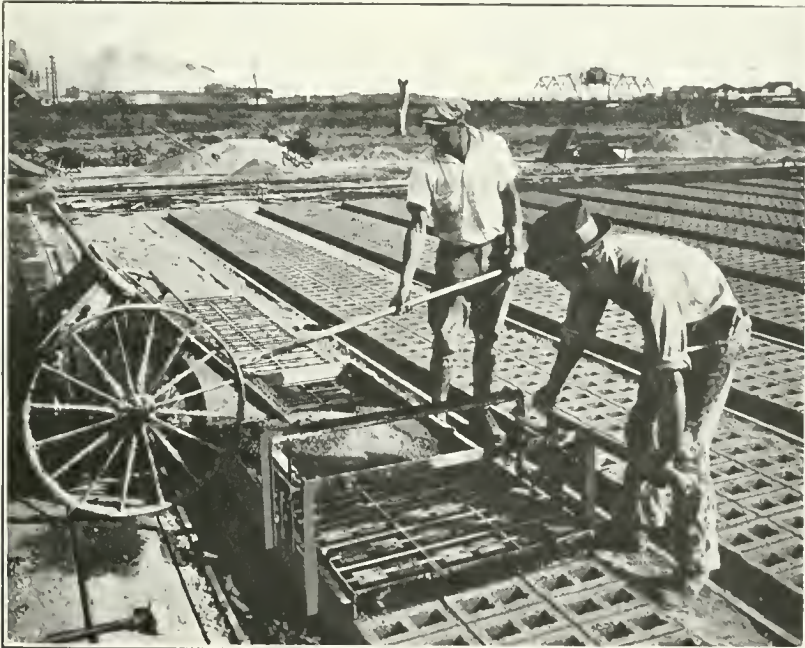

Pouring plastic mix concrete into Stone-Tile Molds.

The Contractor

Continued Higher Prices Mean Resulting Depression

In a letter to the trade associations connected with the construction industry, Mr. Franklin D. Roosevelt, President of the American Construction Council, sends a warning to the effect that the increasing of prices of materials and wages at this time will have a depressing effect.

Mr. Roosevelt's letter, briefly tracing the industrial movement in the last ten years, as a basis for his conclusions, follows:

"The extraordinary post-war era of prosperity which came to a peak in 1920 and was characterized by mounting prices, advancing wages and increasing volume of business, went so far that the slump which followed it in 1921 was inevitable. Again, the great demand for products and especially construction has started us on an era of higher prices and higher wages. Inflation seems imminent; will reaction follow?"

"Railroad ton mileage in 1920 reached a point 5 per cent higher than the record figure of 1918 caused by war-time exertions. Construction undertaken in 1920 exceeded any records previously set. From the spring of 1919 to the peak in 1920, wholesale prices based on 1913 as a level increased from 193 to 247 and building materials from 169 to 300. 'The Buyers' Strike' followed, business entered upon an extreme depression, and wholesale prices dropped back to 138 and building materials to 155.

"The present revival of business activity is just cause for rejoicing. Car loadings, exclusive of coal, for 1922 have so far broken the records of 1920, but this revival is accompanied by disquieting symptoms. Wholesale prices have risen again from 138 to 150; building materials from 155 to 167. Wages did not go up as fast as prices in 1919 and 1920, but they gathered momentum as they went and continued upward after prices began to come down. Some reductions from the peak have been made, but again there is a tendency to advance.

"Expressed in simple terms this means: If we are to keep construction activity steady and stable for the next five years, in view of the volume of work which should be done, we must consciously avoid periods of sky-rocketing either in prices or wages. While the demand for the moment may make possible unusual prices in wages, it will only prove a

boomerang if the public decided to stop buying again. Isn't it better to forego temporary advantage if by so doing industry is kept moving at a steady, stable, healthy pace continuously?"

"I urge your thoughtful consideration of these suggestions and request your cooperation in helping to maintain stability in the construction industry."

Hollow Concrete Brick

(Concluded from page 113)

shape so that masons can lay twice the wall area per day that is possible with common brick.

The soft grey tone and pleasing texture of Stone-Tile is particularly attractive and buildings of this material possess a distinctive individuality. The correctly narrow joint marking produced by the comparatively small size of the units is a particularly popular feature of Stone-Tile masonry.

Stucco finish may be applied most advantageously on Stone-Tile walls as it is not liable to cracks or scaling. The strength of the bond is due both to the texture of the Stone-Tile surface as well as its low absorption which prevents too rapid drying out of the plaster.

Tested under all possible conditions Stone-Tile has received the approval of the engineering division of one of the largest transcontinental railroads and has also been accepted as fully meeting the building requirements of the largest cities.

Architects and builders are showing much interest in Stone-Tile and it is being included in the specifications for schools, homes, warehouses and factory buildings throughout the State.

Trades School a Success

The Industrial Association of San Francisco is receiving wide publicity, most of it of a very favorable nature, for establishing a trades school to encourage more young men to follow the skilled building crafts. "Throughout the country," writes the editor of Stone, published in New York, "the shortage of skilled labor in the building industries is acutely felt. If this was merely a temporary lack of supply, due to conditions that would soon change, there would be no special alarm, though the inconvenience would be none the less marked. But

STANLEY

Storm Sash Hardware

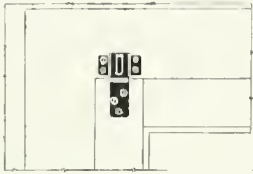

ELEVATION

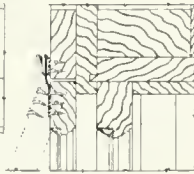

SECTION AT HEAD.



No. 1711

Elevation (Scale $\frac{1}{4}$ full size) Section at Head

No. 1711 Hanger

Holds the window firm, due to the peculiar construction of the eye; prevents jostling; easily taken off and put on.

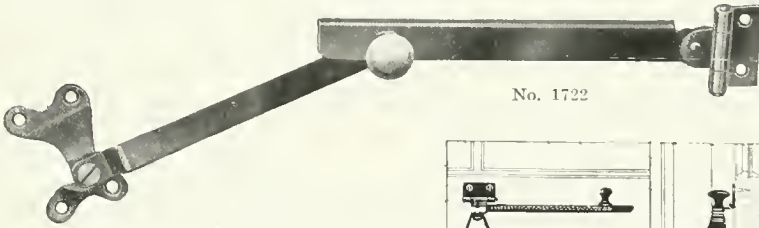

No. 1722

No. 1722 Fastener

An exceptional "take-down" feature; easily taken down without having to entirely un-assemble; holds securely, yet provides ease in manipulation for cleaning, ventilation, etc.

Ask for "Detail Manual, No. AE-9," showing correct application of Stanley Butts, Bolts, Blind Hardware, Storm and Screen Hardware, and Garage Hardware (127 drawings to scale), and telling "How to Specify" in every case.

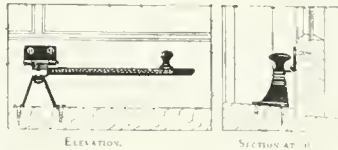

ELEVATION.

SECTION AT H.

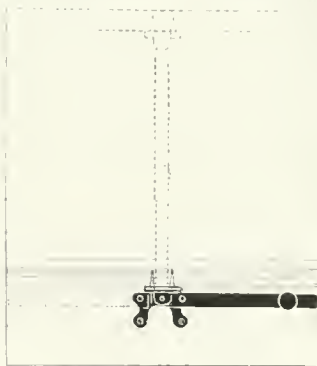

Plan (scale $\frac{1}{8}$ full size)



THE STANLEY WORKS

New Britain, Conn.

New York, Chicago, San Francisco,
Los Angeles, Seattle

TV

A. QUANDT & SONS

ESTABLISHED 1880

PAINTERS AND DECORATORS

SAN FRANCISCO
LOS ANGELES

Office and Shop
374 GUERRERO STREET
San Francisco
PHONE MARKET 1709

the seriousness of it all is that few apprentices are being trained, and there seems to be no way to fill the ranks of the active workers as these become depleted in the natural course of events. It is this that has caused many forward-looking men in the various trade associations connected with the building industry to give an earnest study to the subject, in the hope of devising some adequate remedy.

"As is well known the Industrial Association of San Francisco, which has charge of the labor relations of the section of the building industry operating under the open shop, considered that the direct method of dealing with this shortage was best, and so the trades school was inaugurated.

"There were seventy-five applications for training, but for the start twenty-five were thought sufficient considering the facilities ready at that time. More will be taken in at the beginning of the next term. All enrolled students were required to pass the army "beta" psychological test and physical examination, as it was not thought desirable to waste instruction on persons incapable of profiting by it. An allowance for married men of \$2.50 a day has been provided, but single men are not being paid. Tuition in all instances is free, and buildings and working material have been arranged for by the association. To start the plastering school a structure containing 9,200 feet of floor space was secured. Bays and breasts were constructed in order to provide the maximum amount of wall space, and one competent instructor placed in charge of the first class. Another teacher will be added shortly. The school operates five days a week, eight hours a day. A complete training course of twelve weeks will turn out competent tradesmen, according to the schedule laid down. Apprentices not progressing satisfactorily will be given extra consideration until it is shown that they are not suited to the work, and then they will be

discharged. Of the twelve weeks included in the course, four weeks will be taken up learning to handle tools. Rough brown plaster will be used during this period, and all the various tools in the plasterer's chest will be handled and the students drilled in their use until they become quite proficient.

Honor for Los Angeles Engineer

To fill a seat on the board of directors of a national organization, American Association of Engineers, representing 25,000 technical engineers is considerable of an honor. Such has been the reward in the appointment of Mr. Herbert C. Ferry, first vice-president of Los Angeles Chapter, who has been selected to serve as a national director to represent District Number Two of the American Association of Engineers, which includes California, Nevada and the Hawaiian Islands.

The district failed to elect a director at the recent national election on account of conditions which prevented Mr. Carl A. Heintze, past president of Los Angeles Chapter, from becoming its new officer. The delegates to the national convention, representing chapters within the district, unanimously agreed to the recommendation of Mr. Ferry to fill the vacancy, and as a result he was appointed at the first session of the new board, which took place in Salt Lake.

Mr. Ferry holds the distinction of being both an engineer and a lawyer. After eight years in engineering work with railroads and various branches of civil engineering, in the field and in the office, he took up the study of law, and after completion of his college work was admitted to the bar, now holding a membership in the Los Angeles Bar Association.

He is at present associated with the Union Oil Company of California, in charge of engineering and legal matters concerning easements, franchises, leases and rights of way.

FOR CONVENIENCE—COMFORT—SAFETY

Use **AUTOMOBILE TURNTABLES** in the private garage.

We manufacture all types and sizes.

Write us for specifications and prices.

Telephone Kearny 1773

EDWARD O. TEALL

324 Main Street, San Francisco.

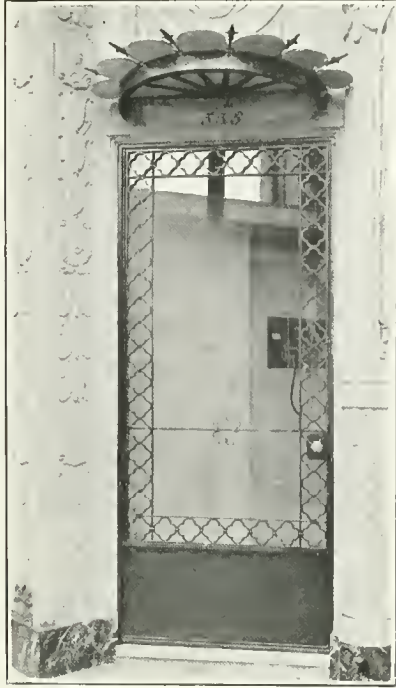

Ornamental Iron

Steel Sash
Wire Work

Michel & Pfeiffer
Iron Works

PHONE MARKET 731

Tenth and Harrison Streets
San Francisco, Calif.

Valves for every purpose in the **KENNEDY** Valve Book

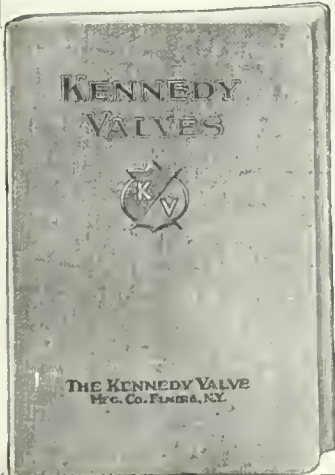

—a practical reference book for all valve users; convenient in size and arrangement. More than 500 different types and sizes are described and listed—a range that covers all usual requirements. If you use valves, you should have the Kennedy Valve Book—it explains the principles of modern valve design, points out the features of construction necessary to assure satisfactory valve service, helps to make an exactly suitable selection for your particular purposes, and gives practical suggestions for the proper installation and care of valves.



THE KENNEDY VALVE
MFG. CO. ELMIRA, N.Y.



Branches and Supply Depots:
BOSTON, 47 India Street
NEW YORK, 95 John Street
SAN FRANCISCO, 23-25 Minna Street
CHICAGO, 204-8 N. Jefferson Street

Sales Offices:
Philadelphia, Salt Lake City, Seattle, El Paso

When writing to Advertisers please mention this magazine.

A New Waterproofing

In this issue appears the initial advertisement of the Barlith Company, who have recently started the manufacture and sale of Barlith Waterproofing on the Pacific Coast.

The composition differs from other waterproofings in that it contains no silicates, cassien or petroleum products, and in that the company's chemists have accomplished the paradoxical feat of getting an insoluble elastic and heat resisting material into an aqueous solution.

Barlith is finding a wide application, not only for exterior and interior damp proofing, where its permanency and the fact that it does not discolor even the lightest colored stones, (such as Manti limestone), constitute strong points in its favor, but also for fabrics, as it possesses the remarkable property of permitting air to pass through treated material but at the same time excluding moisture.

Barlith will not yield to climatic changes, and will stand temperatures up to 700 degrees.

The officials of the company are: Messrs. M. W. Hendrich, President, Lindsay Duncan, Vice President and Manager; J. E. Byrnes, Treasurer, and Kendrick Vaughan, Secretary. The above named, together with F. R. Upton, Jr. constitute the Board of Directors. The company offices are in the Mills Building, San Francisco, and the plant is at West Sacramento, California.

Something About "Universal Exhibits"

By ELFORD EDDY

Of interest to architects and engineers in California and an institution that should be of direct benefit to all, and will be if they will avail themselves of its services, is Universal Exhibits, an exhibition of building materials, equipment and supplies, located in the heart of San Francisco's downtown business district.

Universal Exhibits is not a new idea—there are other such displays—but it is being carried farther than similar exhibits. Its appeal to architects and engineers should awaken a wide interest for the reason that it has features which cater to the needs of such professional men.

Messrs. C. A. and Howard Cady, far-seeing young San Franciscans, are associate managers of Universal Exhibits, which has its home downstairs in the Monadnock building, Third and Market streets, San Francisco. The location is convenient and known to thousands, having been the home of Jules' Cafe, and, more recently, of the National Defenders' Club. Its entrances are by way of the Monadnock elevators, the arcade of the building and No. 20 Annie street, opposite the Palace hotel.



Federal Reserve Bank
Graham, Anderson, Probst & White,
Architects

Federal Reserve Bank

CHICAGO, ILL.

equipped with

FRINK

Bank Screen Reflectors

Our Engineering Department is co-operating with the leading architects in laying out and designing prominent buildings thruout the country. We hope we can be of service to you.

"Specify Frink Reflectors"

I. P. FRINK, Inc.

SAN FRANCISCO, CAL.,

77 O'Farrell Street

21th Street and 10th Avenue,
New York

Chicago, Ill.
Monadnock Bldg.
Boston, Mass.
161 Summer St.
Detroit, Mich.
325 State St.
Cleveland, Ohio
336 The Arcade

Seattle, Wash.
609 Seaboard Bldg.
Philadelphia, Pa.
Franklin Trust Bldg.
Cincinnati, Ohio
17 Greenwood Bldg.
Louisville, Ky.
415 West Main St.

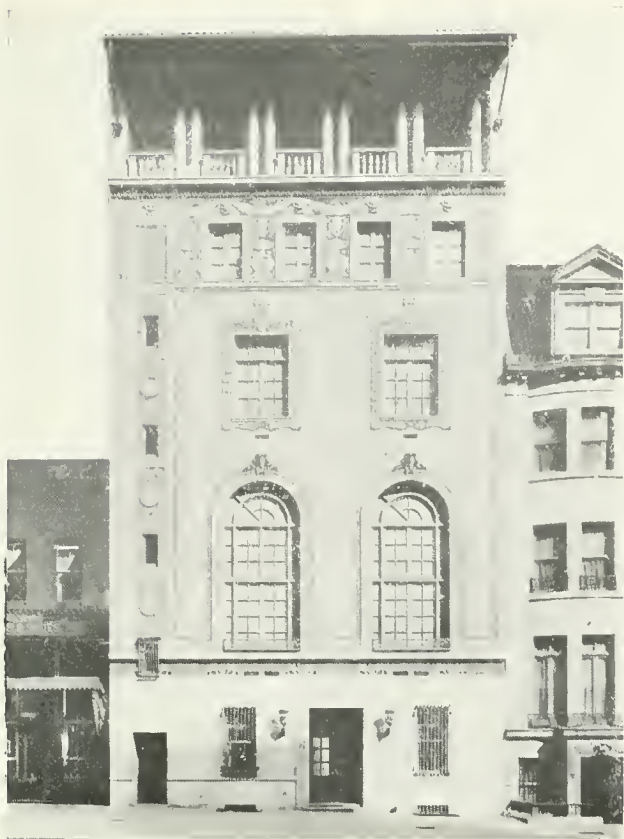

*The Chalif Studios
163 West 57th Street,
New York City, G. A.
& H. Boehm, Archi-
tects, illustrating excel-
lent taste in the hand-
ling of rich polychrome
treatment.*

The USE of COLOR

TERRA COTTA offers a practically unlimited palette for the richest effects in color design.

Developments in modern ceramic chemistry assure the accurate execution of color schemes with only those variations of shade in the individual pieces which enhance the interest of color expression. Rightly viewed these slight irregularities of fire action are an ele-

ment of the greatest charm and artistic distinction.

The Chalif Studios illustrate this and are an example of conspicuous success in the harmonious relation of pale ivory marble and gray manganese brick with polychrome terra cotta for ornamental enrichment. Send for our literature. Address: **National Terra Cotta Society**, 19 West 44th Street, New York City.

TERRA COTTA

Permanent

Beautiful

Profitable

The purpose of Universal Exhibits is to lend assistance to persons engaged or interested in building, whether it be garage or skyscraper, by having assembled and grouped in one place models, samples, materials, suggestions, everything pertinent to construction, so that the man or woman wishing to build will be able to make comparisons and selections and determine what shall be used, from foundation to skylight, without the necessity of tiresome shopping, involving visits to widely scattered places of business.

This is a general appeal. But Universal Exhibits offers a convenient centralized location not alone to the shopper. It is convenient also to the architect and the engineer, and, bearing this in mind, the management has planned special features for those two professions with the idea of being a very real assistance to them, not in exhibiting their wares—models and blueprints, plans, specifications and perspectives—so much as in maintaining for them a library of ready reference of catalogs and samples.

It is not necessary to remind the architect or engineer what a nuisance catalogs and samples are. Every man in the profession knows that if he would accept every catalog and sample that comes to his office and give it room, he soon would have no space for drafting tables, desks or the where to hang his hat.

The plan of Universal Exhibits calls for a comprehensive filing system for catalogs having to do with building—tools, builders' hardware, building materials and the like.

Also, samples of all sorts will be appropriately placed, so that an architect or engineer wishing to examine a special material or fixture will be able to do so here, instead of going to factories or show rooms or having the things he desires to see sent to his office.

By telephoning to Universal Exhibits or dropping a postal, any desired catalog will be delivered to the architect or engineer needing it. When the professional man has been satisfied, has learned what he wants to know, Universal Exhibits will send to his office for the catalog or sample and refile it in its proper place. It is the expectation of Universal Exhibits to have on display as many of these products as is possible.

The Cady brothers solicit the support of architects and engineers for their enterprise. They ask the professions to avail themselves freely and unhesitatingly of the service offered, which is free and without obligation. The more that service is used the greater it will become. They suggest that the architect and engineer might save needless interruption and annoyance by the posting of a notice in his office that any catalog or

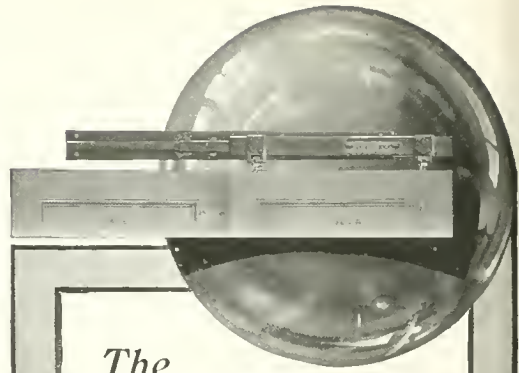

The Ball Means Strength, Economy

The Reliance Ball Bearing principle permits of the most compact, rigid and simple construction. It provides the greatest strength to the exclusion of cumbersome and trouble-making parts.

The action is direct: The balls are not accessory to other rotating parts but themselves support the door and provide easy action irrespective of its weight.

RELIANCE Ball Bearing ELEVATOR Door Hangers

Reliance simplicity means quicker and cheaper installation. This saving permits the use of "Reliance" at an ultimate cost approximating that of the cheaper device.

RELIANCE-GRANT
ELEVATOR EQUIPMENT CORP'N

Park Ave. and 40th St., New York

PACIFIC COAST AGENTS

Waterhouse-Wilcox Co.

San Francisco and Los Angeles, Cal.

Columbia Wire & Iron Works, Portland, Ore.

D. E. Fryer & Co. Seattle,

Spokane, Tacoma, Wash.; Great Falls, Mont.



A F B A
USE FACE BRICK
— it Pays

Details of Residence, South Orange, N. J. Mann & McNeill, Architects

Here is a charming piece of brickwork, surmounted consistently by a heavy slate roof. The brick trim around the door, the soldier and rowlock belt courses, and the simple pattern under the second story window show the possibilities of standard size brick for chaste and distinctive embellishment.

Beautiful Walls, Economically Built

PANELS and pattern work in Face Brick do not necessarily require molded shapes and special forms. Standard size Face Brick are susceptible to a great variety of combinations and treatments. Shades and color tones extend this to an almost infinite field of artistic possibilities. Beautiful walls are thus more a matter of the designer's skill than extravagant cost.

The Portfolio of Architectural Details in Brick-

work shows more than a hundred examples of beautiful brickwork—all in standard size brick. These de luxe half-tone plates are assembled in three series, each in an enclosed folder, with printed tab, ready for filing.

A set of these folders will be sent to any architect requesting them on his office stationery, and his name will be placed on the list for future mailings.

AMERICAN FACE BRICK ASSOCIATION

1759 PEOPLES LIFE BUILDING · CHICAGO, ILLINOIS

sample should be left with Universal Exhibits.

This exhibit is not only designed for the benefit of local professionals, but is to be statewide in scope, and correspondence will be as welcome as personal visits.

Two Useful Booklets

The American Rolling Mill Company of Middletown, Ohio is sending out to its selling representatives, jobbers, and to dealers handling Armeo Ingot Iron products, two interesting booklets dealing with business correspondence.

The story behind the publication of these booklets is interesting. For some time past the American Rolling Mill Company has availed itself of the services of a correspondence advisor, a tactful well-trained educator, who gives his whole time to the supervision of letters which go out from Armeo in order that those letters should be neat in appearance, correct in English, expressive in diction, and be fully representative of the Armeo organization.

The correspondence advisor prepares and sends out weekly bulletins to the Armeo organizations which are read and checked off by every person who has to do with correspondence for the company—stenographers, typists, dictators,

as well as department heads and executives.

As these bulletins began to circulate, requests were received from customers and others outside the organization who were interested in what they had to offer. The demand for back bulletins became so insistent that it was decided to compile each set each year in the form of a pamphlet. This was done and the result has proved highly gratifying.

The work is carried on under the direct mail division of the Publicity Department at Armeo.

\$2,000,000 Los Angeles Hotel

Plans are being prepared by Architect H. H. Whiteley for a Spanish and Italian seven-story apartment hotel to be built on the Brokow property, Hollywood, Boulevard, Los Angeles. There will be 717 rooms, divided into 279 apartments, and 16 studios. The building will cost \$1,750,000, exclusive of furnishings.

Designing School Building

Architects Kuhn & Edwards, Commercial building, San Francisco, are designing a one-story frame and stucco district school building to be erected at Lomita Park, San Mateo County, at a cost of \$45,000. The same architects have completed plans for a \$25,000 store building at Burlingame.

EUGENE SCHULER

J. E. McDONALD

SCHULER & McDONALD

BUILDING CONSTRUCTION

Now building the twenty-story Tribune Building in Oakland
308 TWELFTH STREET, OAKLAND

Res. Tel. Merritt 3600

HERBERT BECKWITH

Building Construction

Formerly with
ARTHUR ARLETT

Everson Building
OAKLAND

Jas. P. Marsh & Company

Founded in 1865 Chicago, Ill.

Manufacturers of Radiator Traps and Specialties—Automatic Air Valves and Vents—Indicating and Recording Gauges—Thermometers—Vacuum and Condensation Pumps.

Catalogues and further information sent upon request

Represented by: HULTING, HURST AND HULTING
Monadnock Building Telephone Sutter 5295

San Francisco, Cal.

MILHAU & VIGNATI

MODELING, ORNAMENTAL PLASTER

SGRAFFITO, CAST CEMENT AND ARTIFICIAL STONE

1126 HOWARD STREET, SAN FRANCISCO

SAN FRANCISCO
PUBLIC LIBRARY

The ARCHITECT & ENGINEER



OCTOBER 1922

*Published in San Francisco
50 cents a copy - \$2⁵⁰ a year*

PUBLIC LIBRARY

The
ARCHITECT &
ENGINEER



1722

San Francisco
1850 a year

Best
by test.
Made in
the West



TRADE MARK REGISTERED

Specify

PACIFIC
PLUMBING FIXTURES

Pacific Sanitary Manufacturing Co.
Main Office: 67 New Montgomery St., San Francisco
Factories: Richmond and San Pablo, California



Door Panel, St. Patrick's Seminary Chapel, Menlo Park, Cal.

CONTENTS FOR OCTOBER, 1922

MISSION CARMEL, MONTEREY COUNTY, CALIFORNIA - *Frontispiece*

	Page
SOME EXAMPLES OF CALIFORNIA'S MODERN CATHOLIC ARCHITECTURE - - - - -	47
<i>Harris Allen, Architect</i>	
THE HERITAGE OF ALL CALIFORNIA - - - - -	63
<i>Mrs. James Osborne Craig</i>	
ELKS TEMPLE, SANTA ROSA, CALIFORNIA - - - - -	67
<i>Frank T. Shea, Architect</i>	
A SMALL COUNTRY HOUSE IN THE ENGLISH COTTAGE MANNER - - - - -	71
<i>Julian Vernalle</i>	
CONSTRUCTION OF MODELS IN LANDSCAPE ARCHITECTURE - - - - -	75
<i>C. L. Flint,</i>	
Instructor of Landscape Gardening, University of California	
MILLION DOLLAR SAN FRANCISCO HOTEL - - - - -	80
MORE LIGHT AND BETTER AIR NEEDED IN HOTEL PLANNING - - - - -	83
SAN FRANCISCO ARCHITECT'S IMPRESSIONS OF A CALIFORNIA INDUSTRY - - - - -	95
<i>Irving F. Morrow</i>	
A REPORT ON BUILDING AND FARMSTEAD ENGINEERING - - - - -	90
<i>Max E. Cook, Farmstead Engineer</i>	
THE ARCHITECT AND ADVERTISING - - - - -	92
<i>Sir Charles T. Ruthen</i>	
EDITORIAL - - - - -	104
WITH THE ARCHITECTS - - - - -	107
WITH THE ENGINEERS - - - - -	110

Published Monthly by
THE ARCHITECT AND ENGINEER, INC.

626-27 Foxcroft Building, San Francisco

W. J. L. Kierulff
 President

Frederick W. Jones
 Vice-President

L. B. Penhorwood
 Secretary



MISSION CARMEL, MONTEREY
COUNTY CALIFORNIA

THE ARCHITECT AND ENGINEER

OCTOBER
1922



VOL. LXXI.
No. 1

Some Examples of California's Modern Catholic Architecture

By HARRIS ALLEN, Architect

IT is altogether appropriate that the Roman ecclesiastic architecture of California should be so largely Romanesque.

To begin with, there are our early Latin traditions and the prevailing Romanesque feeling of our Missions; there is still a decided tinge of Latin blood and Latin atmosphere showing here and there, like the spots of the leopard, apparently ineradicable. And the California climate out-Latins the Latin countries of the Old World in the sparkle of its sunshine, the balminess of its breezes, the temperance of its seasons. No natural impulse arises here for the steep spires and pinnacles of the Goths.

The recent buildings, therefore, which have been erected under the control of diocesan authorities are happily following the well-marked path of tradition, ecclesiastic, historical and natural. With the exception of the Holy Cross Mausoleum, all of the buildings we illustrate are unmistakable in purpose and denomination. Their significance in the architectural development of California may be taken for granted.

The new buildings of St. Patrick's Seminary, Menlo Park, are undeniably monastic, but it is a vigorous, robust monasticism. Memories of Assisi, of Avignon, arise spontaneously. Although this work is far from being a reproduction of those famous piles, nevertheless something exists of their spirit of stern strength, of massive permanence. Here is sheer construction, with little or no ornament.

In a region of dull, overcast skies this architecture would be gloomy and forbidding. But where the bright sunshine casts warm shadows through the arcades, outlines crisply their denticulated archivolts, throws into deep reveal the big arched windows of the clerestory, the results are remarkably effective. How picturesque the vista through

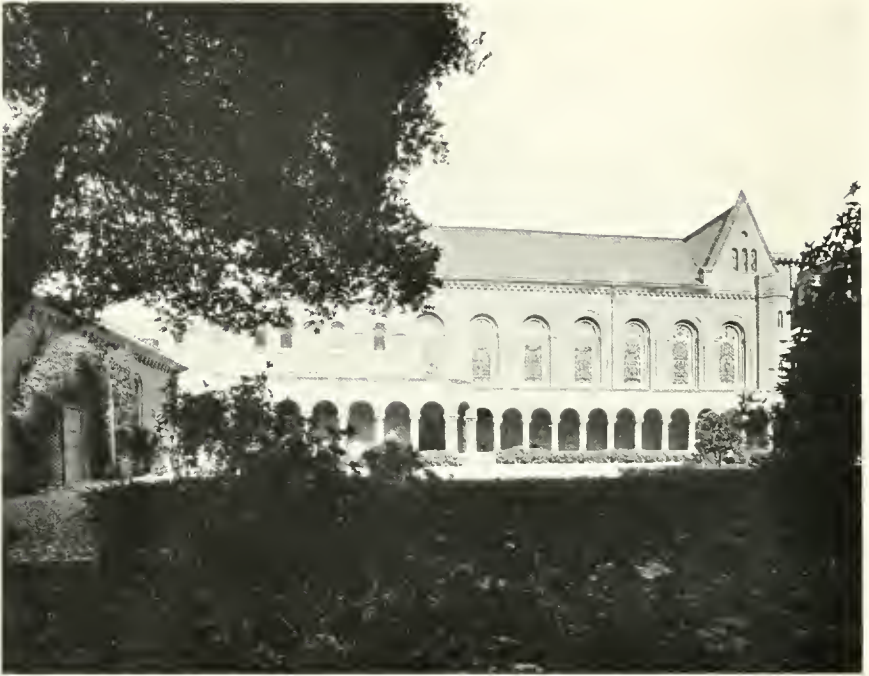

ST. PATRICK'S SEMINARY, MENLO PARK
Shea and Lofquist, Architects



ARCADE, ST. PATRICK'S SEMINARY, MENLO PARK
Shea and Lofquist, Architects

corner entrance arch! High, narrow gable, octagonal stair bay, projecting porch—here is a picture and frame worthy an artist's brush.

The interior of the chapel is elaborately treated with much wooden paneling and carving, a liberal use of stenciled ornament and mural decoration, and the richness of stained glass. Something of the external character is preserved in the free unbroken sweep of the heavily moulded arched ceiling ribs.

The church of Mission Dolores, in San Francisco, Messrs. Will D. Shea and John O. Lofquist, architects, is sympathetically conceived in the spirit of the old Missions. Its mass is bold and well balanced; there is a straightforwardness about it that is pleasing. There is no undue striving for effect; in fact, no one would object to somewhat more of ornament accenting the main facade.

The exterior, then, is quite in line with our loyalty to local tradition, and we believe that age may wither but not make it stale. The treatment inside, however, goes still further back. Here is a jewel of Roman vaulting; barrel vault, groined vault, dome, pendentive and cupola—all in evidence and all combined into a congruous composition.

The succession of arches, of various widths and heights, at various angles and curves, is most interesting. All these arches obviously and easily carry their burden of wall and vault. There is abundance of strength, and yet an effect of grace that is almost airy. The cupola fairly seems to float. The vaulting flows from column and wall so naturally that it appears to be the only possible, or at least the best, form of construction.

Detail is good in scale and form. An effective touch is the placing of sconces at spring line of arch. The main altar is a beautiful, dignified center of interest, with its fine candlesticks and torches outlined against the curving arches of the apse; and the use of mosaic as a background for the side altars is very successful.

The beauty of this church grows on the observer; it has an inspirational quality.

Carmel Mission furnishes a good precedent for the form of the Belmont School Chapel. It is not strange that the application of this treatment should be sculptural rather than architectural in character, as it was designed by John MacQuarrie, who is, of course, also responsible for the sculptural adjuncts to the building.

There is nothing timid or neutral about this composition. It accords with the armed angel on the gable's crest (corresponding with the acroterium of a Roman temple); a masculine, militant conception. This is a Christian fortress, a refuge in time of storm. Such is certainly the impression conveyed by the stark strength and simplicity of this single-arched front with its one deeply-recessed opening. The roof, big in scale though it be, is none too heavy for its massive support.

Back in the shadow of the entrance arch is a doorway quite different in character. Ample in design and ornament, this door offers the suggestion of welcome and succor to the faithful. In short, the building is an example of what may be called "sentimental architecture": it is the expression of an idea, consistently carried out in mass and detail.

One may be permitted to wonder just what part of this meaning is meant to be conveyed by the light standards. Extremely picturesque in silhouette, they seem somewhat Oriental in design—the hint of an alien note which is rather difficult to interpret.

Mr. MacQuarrie has continued his efforts to express meaning in stone, in the mausoleum erected at Holy Cross Cemetery. The Greeks had a



DETAIL OF PORCH, ST. PATRICK'S SEMINARY
SHEA AND LOFQUIST ARCHITECTS



COLONNADE, ST. PATRICK'S SEMINARY
SHEA AND LOFQUIST, ARCHITECTS

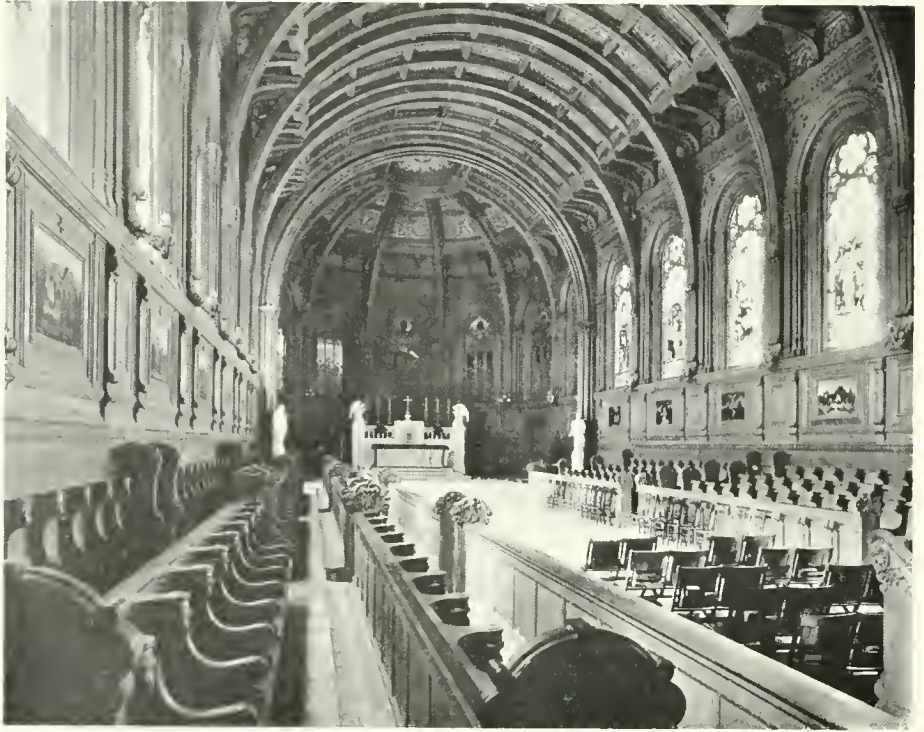

CHAPEL, ST. PATRICK'S SEMINARY, MENLO PARK
Skea and Lofquist, Architects



Interior Detail



Temporary Altar

word "onomatopoeia," by which they meant poetry describing an action and imitating the sound of the act by the pronunciation of the words. This type of architecture is analogous, in a way, like the well-known description of architecture as "frozen music."

A last abiding place, safe and sure, for weary mortals; an abode



MISSION DOLORES, SAN FRANCISCO
Shea and Lotquist, Architects

where thieves enter not, nor worms corrupt; this building assures the believer of rest in peace. This is not to be judged by technical standards nor classic proportions. The forms chosen are those which convey and realize the utmost security and permanence. Whether this is justifiable or not from an academic standpoint, it is clear that a definite idea has been logically executed.



INTERIOR, MISSION DOLORES, SAN FRANCISCO
SHEA AND LOFQUIST ARCHITECTS



INTERIOR, MISSION DOLORES, SAN FRANCISCO
SHEA AND LOFQUIST ARCHITECTS



INTERIOR, MISSION DOLORES, SAN FRANCISCO
SHEA AND LOFQUIST ARCHITECTS



SCHOOL AT BELMONT, CALIFORNIA
JOHN MACQUARRIE DESIGNER



SCHOOL AT BELMONT, CALIFORNIA
JOHN MAC QUARRIE DESIGNER



ELECTROLIERS, SCHOOL AT BELMONT
JOHN MAC QUARRIE DESIGNER



SCHOOL AT BELMONT, CALIFORNIA
John MacQuarrie, Designer



INTERIOR, SCHOOL AT BELMONT
John MacQuarrie, Designer



ENTRANCE ROMAN CATHOLIC MAUSOLEUM, HOLY CROSS CEMETERY
John MacQuarrie, Designer

A simple but beautiful bas-relief over the entrance shows Christ at Emmaus revealing the truth of the Resurrection and blessing his disciples.

This mausoleum will grow in impressiveness when time has marked it with the buffets of weather and vines have clothed it with evergreen drapery. The construction of all of the buildings just described was in charge of Mr. Jas. L. McLaughlin, of San Francisco.

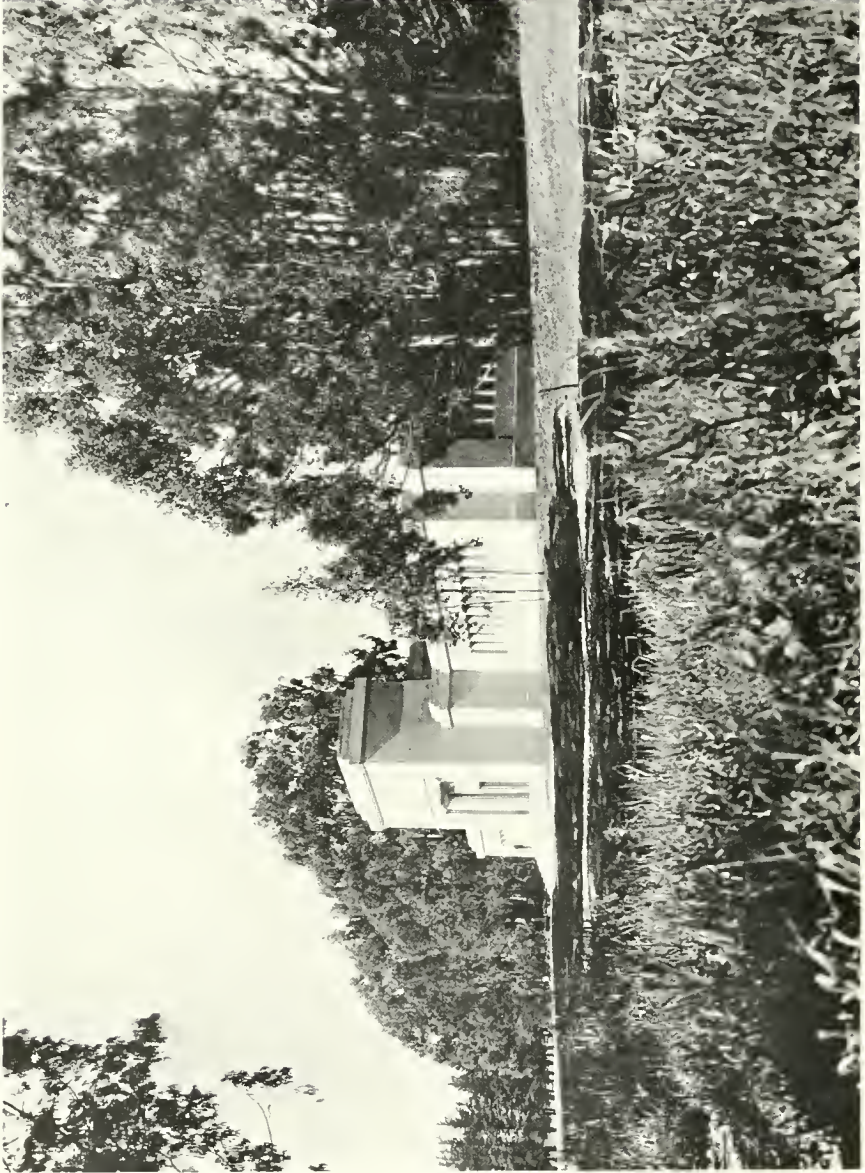

ROMAN CATHOLIC MAUSOLEUM, HOLY CROSS CEMETERY
JOHN MAC QUARRIE
DESIGNER

The Heritage of All California

By MRS. JAMES OSBORNE CRAIG

[This article by Mrs. James Osborne Craig, widow of the brilliant young Santa Barbara architect, whose work in Spanish design was shown in the Architect and Engineer of August last, was published in California Southland, and is a literary contribution to the noble efforts of a group of Southern Californian people who are striving to bring about a permanent restoration of the real old Spanish feeling in architecture.—Editor.]

WHETHER it be the newness of our nation, the pace at which we live, or something inherent in the American people, we seem to have little or no interest in our own traditions. Truly we are a composite group; perhaps we cling to the traditions from whence we came, but once here—though our ancestry originate in the four corners of the globe—we should in every possible way be united in our interest and loyalty to our own country; first, of course, in the broad sense, and secondly (but not least), in the local sense, in preserving all that is finest and most worthy, namely, our traditions. As citizens of the community they are our just heritage.

Should not the greatness of those who labored and perhaps died to make a community bigger, better or more beautiful, have some consideration? Is not respect and emulation of work well done a great thing? In countries where this is most observed we find the greatest culture; for so is the best in each generation preserved and transmitted. But here, do we really care? I think one has only to travel the length of our highway and look at the Missions, for the most part in their deplorable state of decay, to have this question answered. Symbolical of the strength of purpose, simple dignity and restraint of those early padres who first landed on these shores, and by dint of terrific sacrifice made possible a habitation here for the white man, these lovely landmarks of El Camino Real should be the pride and joy of every Californian; instead, they are left for the most part to rats and bats alike—to decay and desolation.

Even though our tradition be limited by reason of our very newness, let this be added reason for conserving every atom of what was here before we came, and cherish each smallest thing that preserves or protects those things which men have carefully striven to pass on to newer generations.

It is a very creditable thing that in Santa Barbara, even though it be in a small way, there is a real concerted action to do this thing—to preserve in a dignified, unaffected manner the architectural beauty that is the heritage of all Californians. Though some may doubt the value of this work, in the last analysis does not architecture express, more than any other art, the life and character of a people, and therefore influence them? It is indeed a great gift, and, like prodigal children, shall we squander our birthright by inertia?

Nature has been so lavish in creating our background: the early Spanish-Californians have left us the beautiful prototype, and we are become an unthinking group if we will not profit by it.

Perhaps you say, "Why should I? I build as my fathers built." But if a people come from England, or Iceland, or the South Seas, there grows up a conglomerate mass without composition or logic. Good architecture depends on many things, but chiefly on adaptation to local condition, climate, habits, needs; and all of these combined to make for comfort, solidity and beauty.

I fear that not a great deal of what we have built in California can stand this test, particularly the last one.

But consider the California prototype as exemplified in the Missions and a few remaining buildings of similar character. It combines all of these assets in a manner fitting to meet the peculiar climatic need of California. Its thick walls preserve the heat in winter and make a cool house for summer. Its many terraces make possible sun or shade. The hand-made tile are about the only material which keeps out California rains, for long, dry summers are disastrous to shakes or shingles; and the simple, dignified lines of these structures, their soft shadows on the uneven plaster, the broken roof lines of red tile, make, in my mind, for an unrivaled architectural beauty.

We of this so-called modern age are so often told to look for architecture in merely utilitarian structures, on the familiar fallacy that beauty is efficiency, and that therefore if a building be efficient it must be beautiful. The example given was a modest building in which the whole front was treated as a gigantic window set in a frame—a characteristic solution to almost every business building in almost every business block in almost every "Main Street" in this country. One does begin to feel that it lacks originality, even though it be selected by the critic as the last word in modern architecture, because it squared with his thesis that the only way for art to advance is by scrapping the past and evolving out of nothing a new and original scheme of graphic and plastic art.

The position is one of some arrogance, inasmuch as it puts the thought of one's own generation above the accumulated attainment of the ages. So many fail to realize the value of all that has gone before. And here our prototype is so clearly defined, shall we utterly disregard it?

As I have said before, Santa Barbara is the one place in California that is working with concerted civic effort to preserve these things. Her Mission is one of the few restored and properly cared for. Very recently many of her old buildings, both public and private, are being restored and occupied; and, of course, the influence on new structures is very great. It will give Santa Barbara unrivaled charm, for fine architecture is like fine literature; its quality is shown in the use of existing means of expression, not in an attempt to invent new ones as long as there are any old ones available for the purpose. Moreover, in architecture as in literature, the underlying trend of old association, not tacked onto the fabric but woven into it, has a charm that nothing else can give.

In almost every city there is considerable activity in the building of large and costly business premises—shops, banks, real estate offices. There is no escaping these buildings in our daily walks, and the question arises, How far do the facades of these buildings justify themselves architecturally? Their internal arrangements are no doubt excellent, but these are of no particular interest to the man in the street, because he seldom sees them. Of course, the tradesman who employs an architect usually insists on this uninteresting and commonplace design—and our only hope seems to be to endeavor with all our might to develop his taste for good architecture, as for all things—not only to increase his capacity for enjoyment but to increase the pleasure of all who may look upon a beautiful thing.

This is the great aim and end of the Community Arts Association in Santa Barbara in what by the short-sighted might be termed meddling with all civic structures, particularly the public buildings—for it is a delightful thing that there are in Santa Barbara a group of men who move steadily toward greater simplicity and reserve in design; they are occupied with construction, proportion, mass and outline, planes and

their relations, rather than concentration on all sorts of inappropriate detail; and generally it is not the architect who is so much at fault as a careless public too apathetic to care what goes in their community. So let us hope that once understood, quality will take the place of quantity and reality the place of sham throughout California.

* * *

\$100,000 Prize Competition

A COMPETITION that is of unusual interest to the profession, not only because of the large amount offered in prizes, but also because of the opportunity it affords to produce a distinctive solution of an interesting problem, has been announced by The Chicago Tribune, which is offering \$100,000 in prizes for designs for a building which is to be the new home of The Tribune. This offer was made on the seventy-fifth anniversary of the founding of that newspaper. The competition opened August 1, and will close November 1, 1922, and will be conducted in accordance with the regulations of the American Institute of Architects. The jury of award will be as follows: Chairman, Mr. Alfred Granger, A. I. A.; Col. Robert R. McCormick, co-editor of The Tribune; Mr. Joseph Medill Patterson, co-editor of The Tribune; Mr. Edward S. Beck, managing-editor of The Tribune; Mr. Holmes Onderdonk, manager of Tribune real estate. Associated with the jury will be an advisory committee comprising two members of the Chicago City Council, two members of the Chicago Plan Commission and two members of the North Michigan Boulevard Improvement Association.

The prize money will be distributed on the basis of the following scheme of honorariums: A prize of \$50,000 will be awarded for the design selected by the jury of award. A prize of \$20,000 will be awarded for the design ranking next in the jury's selections. A prize of \$10,000 will be awarded for the design ranking third. Ten prizes of \$2,000 each will be awarded to ten architects to be especially invited to enter into this project.

The motive which actuates The Chicago Tribune in conducting this competition is to build a monument of enduring beauty which shall be at once a glory to journalism and to the city. The Tribune seeks artistic nobility and business effectiveness in the design of this building.

The conditions of the competition are so liberal in every way and the opportunities to create an interesting design so great that it may well be hoped that the winning design will mark a distinct advance in the architecture of commercial buildings of the highest type.

* * *

Japan Our Best Lumber Buyer

It is interesting to note that although the Pacific Coast is greatly opposed to immigration from Japan, that country is the best foreign patron of the Pacific Coast lumber industry. In recent years Japan has become a heavy buyer of what have come to be known as "Japanese squares." The timber is purchased in large square sticks, which the Japanese resaw to meet their peculiar requirements. During the first three months of 1922 the Japanese took 119 million feet of lumber from the State of Washington and 51,271,000 feet from Oregon. British Columbia contributed 31,263,000 feet in the same period. China is also coming to the front as a buyer of American lumber, and it is expected that it will become a very large buyer in the future. In fact, even now China vies with Australia for second position.



ELKS TEMPLE, SANTA ROSA, CALIFORNIA
Shea and Shea, Architects

Elks Temple, Santa Rosa, California

THE new Elks building at Santa Rosa is being designed by Messrs. Shea & Shea, architects, of San Francisco. The building is one full block long of 200 feet frontage on A street and two frontages of 120 feet on Fourth and Fifth Streets respectively.

In plan it presents 20,000 sq. feet of store floor area, with a possible one 12,000 feet store or a subdivision of one great store, and five elegant shops, which will afford an estimated revenue of \$1000 per month.

Within this structure is to be contained an auditorium with a capacity of 1500 seats, and provision made for all modern appointments in spacious staircases, foyers, reception rooms, kitchen service, and modern stage equipment, all naturally illuminated and scientifically ventilated and heated.

Santa Rosa, in this auditorium, will be provided with the only spacious and well-designed public assembly hall within her limits, and will furnish a long-felt want to the general public. The auditorium is intended to provide, conservatively estimated, a revenue to the Lodge of \$8000 per year. It will figure also as one of the most beautiful and convenient jinks, banquet and social halls that can be found in any Elks building in America. The dancing floor area of this chamber will be 6000 square feet.

The novelty of this auditorium rests in the fact that its floor area is entirely established on the mezzanine level, without intruding on the lodge room planning area.

For the solution of this difficult problem in planning, together with the monumental character of the exterior design without sacrifice of the

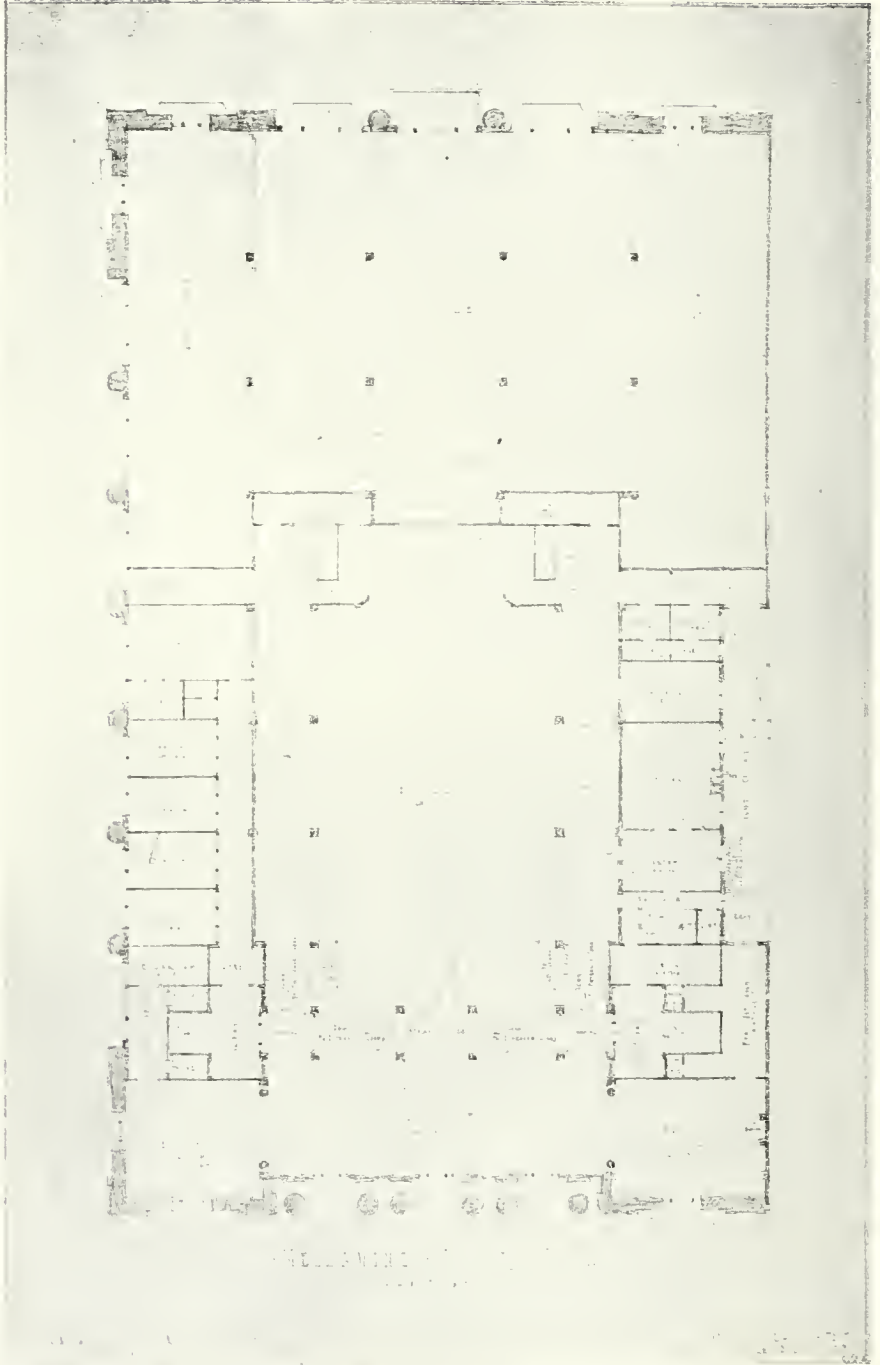

MEZZANINE FLOOR PLAN, ELKS TEMPLE, SANTA ROSA
SHEA AND SHEA ARCHITECTS

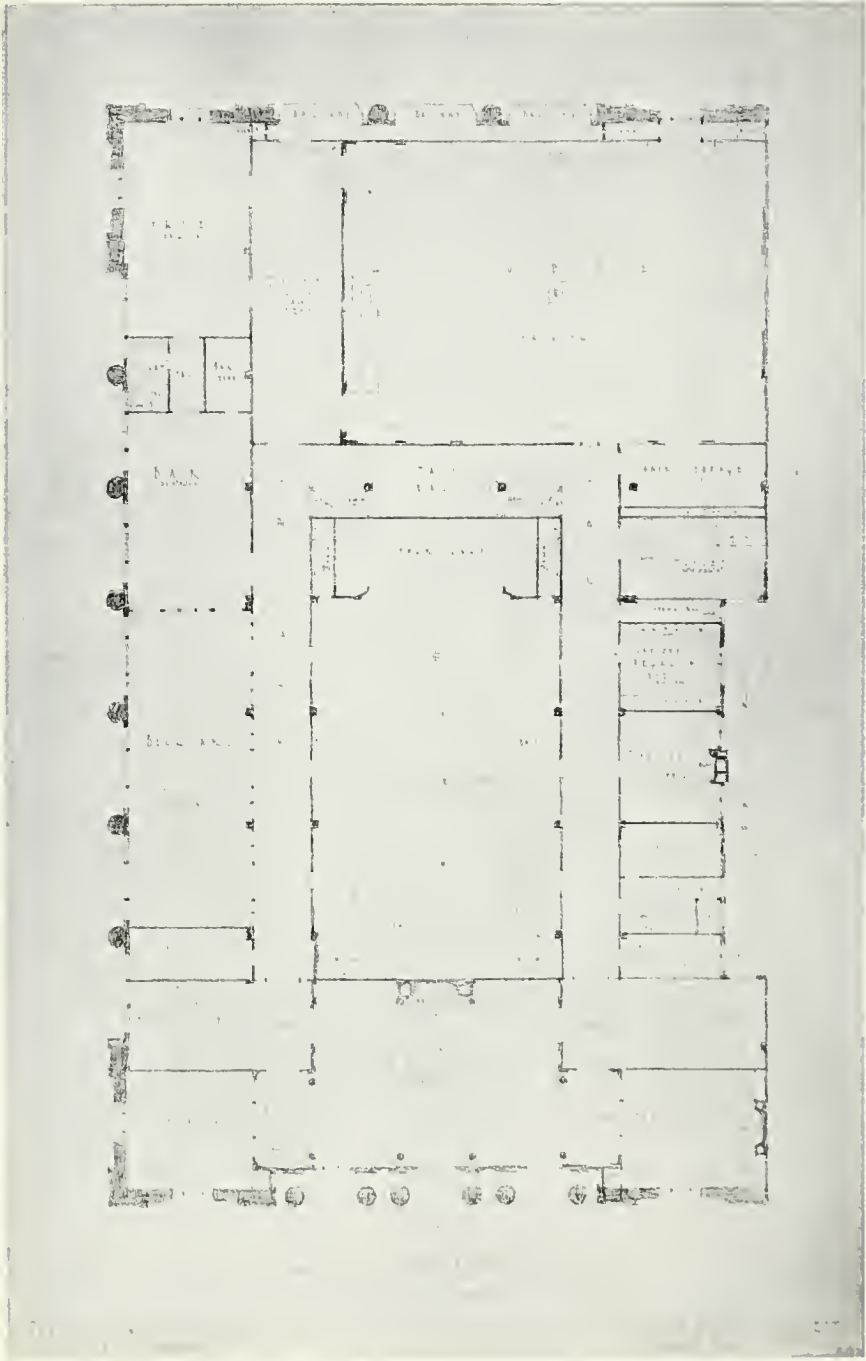

LODGE FLOOR PLAN, ELKS TEMPLE, SANTA ROSA
SHEA AND SHEA ARCHITECTS

commercial features, the award of first place was given the architects now in charge.

The lodge room is situated on the second floor, and is approached without interfering with the occupancy of the auditorium in any way. The lodge floor contains a lodge room, 60 feet by 80 feet, the largest of all Elk's Chambers, with a height of 30 feet, beautifully designed and complete in equipment of ventilation and lighting. The portrait gallery, spacious corridors, billiard rooms, game rooms, lounge rooms, library, dining and kitchen facilities are admirable. No inside rooms exist in the entire plan of arrangement.

The upper floor provides space for the most complete gymnasium arrangement, including handball courts, bowling alleys, small plunge, showers, lockers and well-equipped gymnasium.

This building is the only structure of the entire order with one block of street frontage, well planned, monumental in appearance and more than self-supporting, possessing a possible income of \$20,000 per year, exclusive of the individual lodge revenue of 1500 members.

The building will be constructed along the lines of the most advanced type of reinforced concrete construction, and is estimated to cost \$225,000. Operations towards construction will commence within 30 days and with a view to completion of building by June, 1923.

* * *

Runaway Lumber Market Not Likely

Continuation of the present building activity is generally held to be a primary factor in the attainment and maintenance of general prosperity. In view, therefore, of widespread alarmist reports regarding possibilities of housing construction being retarded by prospects of a so-called run-away lumber market, consequent upon heavy building operations, large demand for lumber, and transportation difficulties occasioned by the coal and railway strikes, the one tending to divert cars from building material to fuel and the other to restrict the volume of transportation, the National Lumber Manufacturers' Association has announced the result of a nation-wide inquiry to ascertain the facts.

The general tenor of the reports received is:

First: That there have been only small changes, ranging from negligible amounts up to 23 per cent, increases and some decreases, in prices at the sawmills of lumber since January 1.

Second: That the increasing wages paid to labor and other items of production cost and, in many instances, fictitious demand caused by excessive anticipatory buying, have accounted for most, if not all, of the price increases.

Third: That in some instances manufacturers have been selling lumber at a loss at the sawmills.

Fourth: That the unusually large volume of orders, together with restrictions imposed on shipments in many localities by transportation deficiencies (and on production by forest fires in the far northwest and elsewhere by local labor shortages) has established a tendency for advancing prices.

Fifth: That the large producers of lumber everywhere are opposed to a rapidly rising market, and are individually pursuing policies designed to avoid it, which include a universal effort to speed up production. No general or concerted action to check price advances at the mills is legally possible, and none, therefore, is being undertaken.

* * *

An Investment in Good Health

The modern bathroom with its sanitation and due consideration for convenience may occupy small space in the home, but it assumes large proportions in the planning of that home. Stinting the bathroom is a costly form of saving. Making it as luxurious and complete as possible is not extravagance, it's simply good sense.



HOUSE OF MR. JOHN STAFFORD WHITE, WALNUT CREEK
John Stafford White, Architect

A Small Country House in the English Cottage Manner

By JULIAN VERNALLE

AS all architects and designers know, and a large number of laymen realize, it is a distinct problem to create a small house, have it livable, satisfying and come within a limited sum of expenditure, the latter qualification being a requisite feature of builders of small homes.

A house to be livable must have the necessary requirements of planning, conveniences, style and general expression to insure to the owner and its inhabitants a certain amount of self-respect.

Within about seventeen miles of the Bay Region, on the Tunnel Road out of Claremont, may be found quite a notable example of this type of small country house, designed by Mr. John Stafford White, Tunnel Road, at Walnut Creek, California, for Mr. and Mrs. Edward Rawson Peck.

While the exterior of this house, done in shingles, with the picturesque, high-pitched shingled roof, somewhat characteristic of the well-known English cottage style, is amply satisfying, it frankly and logically expresses a truly utilitarian and livable plan.

The living-room, within whose four walls the life of the family abounds, is an attractive room of reasonable and satisfying proportions, with a brick open hearth raised twelve inches above an English quarry tile floor of dull Pompeiian red laid in wide black joints with black border. This fireplace is located on the opposite wall from the entrance side and forms naturally the important feature of the room. The walls, together with the beamed ceiling, are done in the natural waxed redwood. The fenestration is particularly attractive, having triple openings to the south and east extending to the floor.

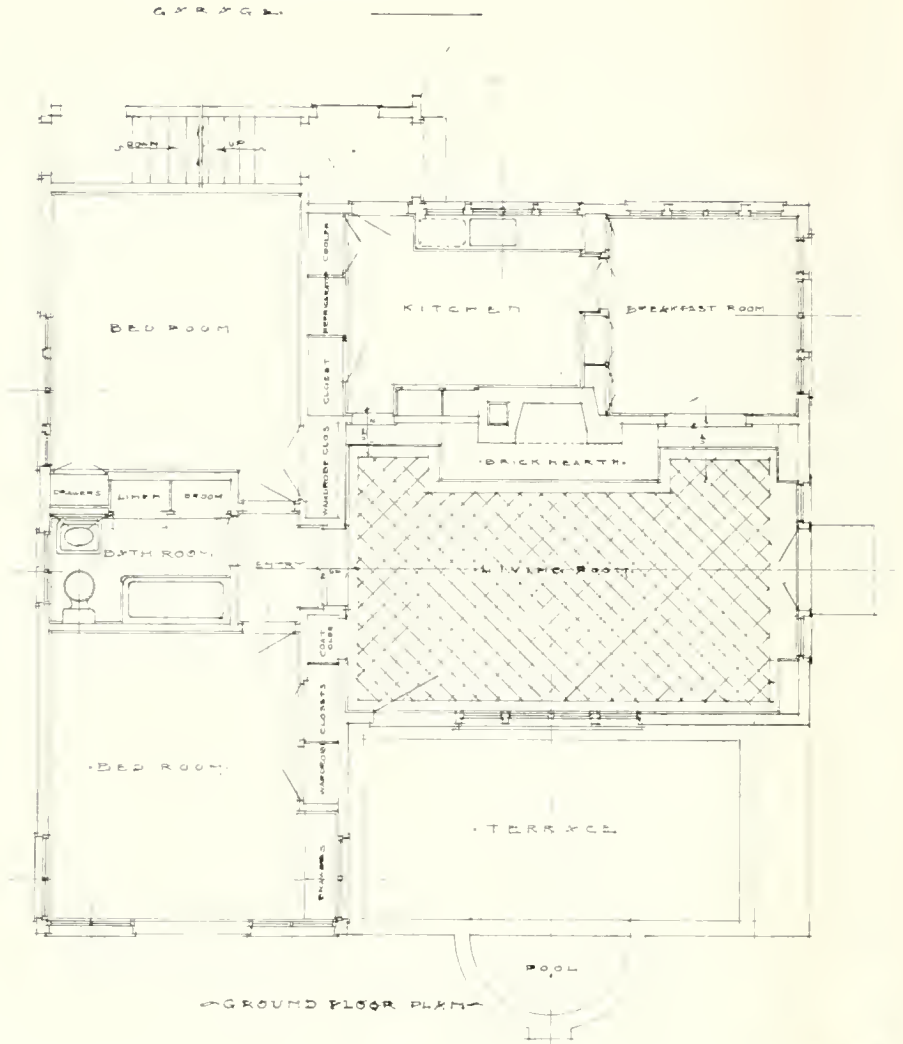

PLAN AND GARDEN VIEWS, HOUSE OF MR. JOHN STAFFORD WHITE

This room is entered directly from a brick-paved terrace, laid in herringbone design, from one side of which springs a semi-circular pool, a veritable "Pool of Enchantment," upon whose waters of limpid stillness float the lovely water lilies, and through its intricacies glide the glittering gold fish—a well-balanced pool for aquatic life. Built-in book shelves flank the triple opening in the east end of this room leading out into the rose garden.

Back of the living room and to the right is located the breakfast room and adjoining it the kitchen; the former with panelled walls from floor to ceiling, both done in white enamel with triple casement windows.

The kitchen is particularly well equipped with many built-in features, such as refrigerator, cooler, ample closet space for culinary utensils, storage of provisions, etc., all behind closed doors. Kitchen sink, laundry trays and electric range and water heater complete the equipment for a model kitchen.

To the rear of the house, with access through the kitchen and rear entry is located the garage. The bedroom above the garage is an attractive room done entirely in natural redwood.

Access to the two family sleeping rooms, as well as the bathroom between, is through an entry leading off from the west end of the living room. These rooms are of ample proportions with triple casement windows, wardrobe closets and finished in white enamel.

The built-in features of the sleeping rooms and bath are to a degree utilitarian and attractive, having wardrobe closets in cedar. The bathroom is amply equipped with linen closet shelves with flaps hinged at the bottom, a closet for toilet articles and medicine, as well as a closet for cleaning utensils, vacuum cleaner, etc.

While here in California we try to convince ourselves that no artificial heat is necessary for comfort, but this house, nevertheless, is well provided for in this respect, having not only a blazing hearth in winter time, but is adequately equipped with a heater in the basement, supplying hot water heat to radiators throughout the house.



FIREPLACE, HOUSE OF MR. JOHN STAFFORD WHITE



GARDEN VIEW, HOUSE OF MR. JOHN STAFFORD WHITE

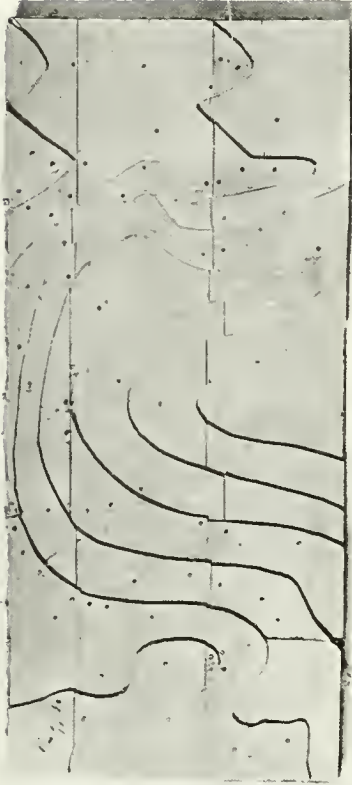

Assembled Contours of Topographical Map for Design of Lot in a Suburban or Country Town

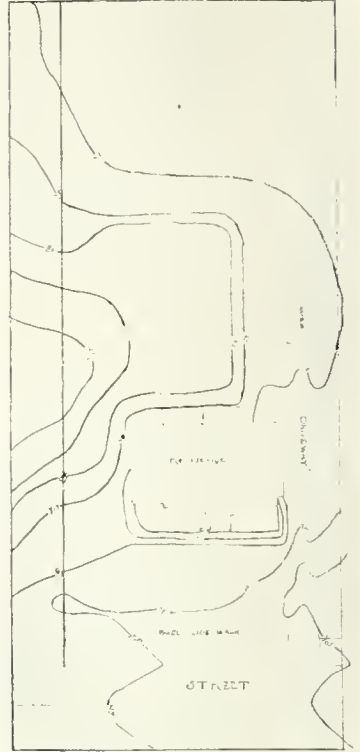

New Grading Plan for Lot for Home in Suburban or Country Town

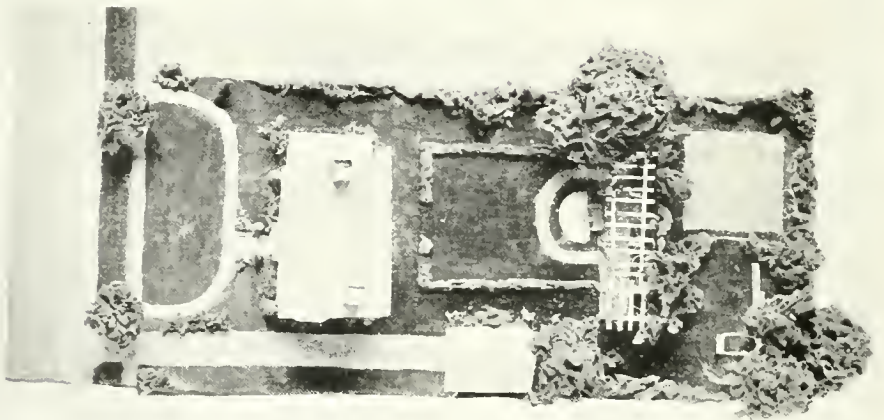

AEROPLANE VIEW OF LOT, AS ABOVE
Problem No. 2



MODEL CONSTRUCTION AS DESCRIBED FROM A TOPOGRAPHICAL MAP

Construction of Models in Landscape Architecture

By C. L. FLINT,

Instructor Landscape Gardening and Floriculture, University of California

VISUALIZING the appearance of a piece of ground from a topographical survey is one of the difficult things for the student of landscape gardening to comprehend, or for the average client of the professional landscape architect. Consequently I have found it helpful to the student to have him graphically illustrate the problem in question by building a model to scale.

The student is first instructed in leveling, and makes a topographical survey of a piece of property and then plots his survey to a definite scale, or a topographical map of some existing property is given him that has previously been surveyed and planned by some eminent landscape architect.

I have used two methods to develop the understanding of the student—to scale and proportion. In the first, the student makes a tracing on alba of a topographical map, places the map in the bottom of a sand box, and then cuts sticks to scale to show the difference in elevation between the different contours. These sticks are then placed in an upright position on the map along the lines of the contours. The plan is then covered with moist sand to the height of the different stakes, and the general plan indicated in dry color of red, green and white. This dry color absorbs moisture enough from the damp sand to cause it to act as a binder, and this holds the model together for some time. Elevations of steps, tennis courts, grades of roads and embankments are some of the important points that are drawn to the students' attention.

The second method is one by which models of a more permanent nature may be constructed. A topographical survey is made as before, and a tracing of it on any thin paper. Cardboard of a proper thickness



FINISHED MODEL, SHOWING EDGES OF CONTOURS, Problem No. 2
Designed and Executed by C. S. Bassett

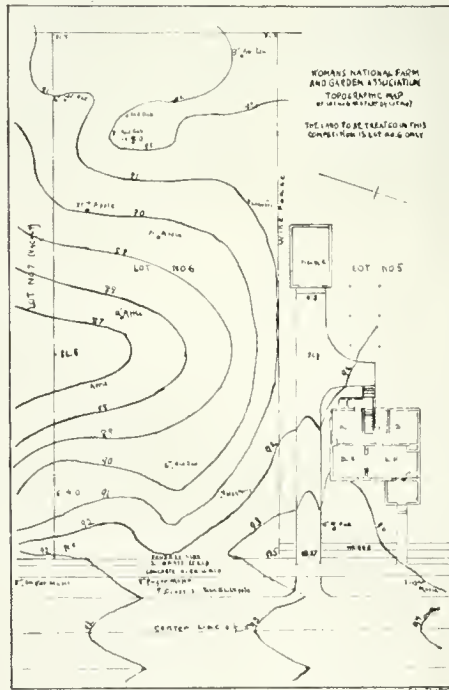

Design for Lot in a Suburban or Country Town
Problem by Frederick Law Olmsted

Use Scale of 100
or 1" = 100'
New Scale 1/4" = 1'

Div of L. G. & F
U of C
Course 104 B C H F

to represent the vertical scale to be used is selected. When there is but a slight difference of elevation, the vertical scale is sometimes used twice that of the horizontal. In the illustrations each contour represents a difference of one foot in elevation, using a scale of $\frac{1}{3}$ of an inch equals 1 foot, and the horizontal scale is the same. Each contour is then traced on cardboard by means of a carbon paper. They should be traced in groups of two's, so that the tracing of each successive contour will act as a guide for its placement when they are assembled. The contours that are to mark the elevations of the model are then cut out and placed one on top of the other, using the second contour line traced as a guide for the placement of the successive contours. The entire model is then covered with modeling clay, and the student is ready to begin his problem of the location of the house and all other visible constructional features.

The problem illustrated is one constructed from a topographical map submitted by Frederick Law Olmsted, in the competition of the Women's National Farm and Garden Association. The grading of such a lot is quite a problem in itself, as it will be noted that the land slopes from the street to a low point near the center of the lot. Consequently the house has been placed upon a slight terrace equal in elevation to that of the street. The lawn slopes towards the steps of the house on practically the natural grade of the lot, providing for ample drainage, and the concave surface of the lawn gives an idea of greater extent than would be obtained by leveling or giving a convex surface of grading. At the rear of the house advantage has been taken of the depression and a formal garden illustrated with a pergola and a seat terminating its main axis.

Such a problem taxes the students' ingenuity and serves the instructor an admirable opportunity for landscape architectural instruction.

All trees and shrubs in the problem were cut from sponges which had previously been dyed green in color and then treated with warm tones of yellows and browns, to relieve the monotony of the green color. Mr. Bassett in his design used green velvet to cover the modeling clay, which gives a very uniform and satisfactory appearance to those areas designated as grass areas.

* * *

South Carolina White Clays

The methods of mining and preparing white clays for market in the vicinity of Langley, South Carolina, are described in Serial 2382 by H. M. Weigel, mineral technologist, just issued by the United States Bureau of Mines. Langley is about nine miles north of Augusta, Georgia. The clays mined in this district are sedimentary kaolins with few impurities. The prevailing color is white; at times the color is smoky grey or pink, and occasionally strong pink to lavender. The lighter colors usually become white on exposure to the air and on drying. The lower parts of the beds are usually the whitest. These kaolins are fine grained in texture and have good plasticity; their tensile strength is from 8 to 36 pounds. They generally slake readily. Their specific gravity is from 2.50 to 2.25. The clays in the district are well adapted for use in paper stock, for which they are mainly used, and in pottery and china ware, without washing. In the district as a whole considerable reserves of clay are yet untouched, hence the industry can be considered fairly stable. Serial 2382 may be obtained from the Bureau of Mines, Washington, D. C.



CLUB HOUSE AND ARENA FOR GOLDEN GATE POST NO. 40, THE AMERICAN LEGION, SAN FRANCISCO

MORROW AND GARREN, ARCHITECTS



HOTEL FOR MR. GEORGE D. SMITH, SAN FRANCISCO
KENNETH MACDONALD, JR. ARCHITECT
MAURICE C. COUCHOT ENGINEER

Million Dollar San Francisco Hotel

SAN FRANCISCO is to have a new fireproof hotel on the northerly line of Sutter street, between Jones and Taylor, and for which a contract recently was let to the Clinton Construction Company for \$1,000,000. The building will rise from the center of the lot, leaving a space 40 by 137 feet on both the easterly and westerly sides. These large open areas will permit the morning and afternoon sun to enter the building during the entire day. The center shaft of the building will rise ten stories and will contain 240 commodious guests' rooms. These rooms, with large dressing rooms and tiled baths and wail beds, have been designed for permanent guests. On each side of the hotel portion of the building there will be three modern stores, which will project half way back on the lot. The remaining space on the easterly side will be beautifully planted with flowers, and will serve as a patio garden opening into the dining room.

The generous lobbies, card rooms, banquet rooms, etc., which are being provided, together with the luxurious appointments of the rooms, are intended to attract high-class permanent guests. The owner, Mr. George D. Smith, who is the present proprietor of the Biltmore Hotel, states it is his belief that the location and general characteristics of this building will make it a very popular residence for permanent guests. The architects are Kenneth MacDonalld, Jr., and Maurice C. Couchot.

* * *

Structural Steel Not a Large Percentage of All Steel or All Building Materials

The Commercial and Financial Chronicle expresses surprise that there should be such great activity in building during 1921 at a time when the steel industry was at such a low ebb. It is not generally realized, even by men engaged in construction, what a small percentage of steel is used in construction.

The output of crude steel in 1919 was 31,671,232 gross tons, and the following were the outputs of the principal classes of finished product:

Rails	2,203,843
Wire rods	2,538,476
Structural shapes	2,614,036
Nails and spikes	606,700
Tin plate	1,150,898
Plates and sheets	7,372,814
Bars, etc.	10,359,543
Pipe and tubes	2,374,931
Total	29,221,241

The output of steel in 1921 was half that in 1919, but it will probably be shown later that the output of structural steel was more nearly normal.

We estimate that the cost of all the structural steel used annually is seldom more than 10 per cent. of the cost of all the materials used in building construction. The tonnage of structural steel usually averages about 8 per cent of the total steel output. Such data explains why there can be very active construction at a time when the steel business is abnormally poor.

Will Supervise Planning of Sesqui-Centennial Exposition

ON recommendation of the Engineers' Club of Philadelphia and the Philadelphia Chapter of the American Institute of Architects, Dr. Paul Philippe Cret and Mr. E. B. Temple have been designated as architect and engineer respectively, to take charge of the preliminary planning of the Sesqui-Centennial Exhibition to be held in Philadelphia in 1926 in celebration of the 150th anniversary of the signing of the Declaration of Independence. In explaining the action of the Committee on Grounds and Buildings, headed by General Atterbury, of the Pennsylvania Railroad, Colonel Franklin D'Olier, President of the Association, said: "The purpose of this move is to work out a tentative plan of grounds and buildings on the Parkway-Fairmount Park site. Mr. Temple, in consultation with the Engineers' Committee, and Dr. Cret, in consultation with the Architects' Committee, and also with the approval of our Association, will select their associate engineers and architects. They will form a small, compact, rapidly-working group of engineers and architects, who will submit this plan at the earliest possible moment. Dr. Cret and Mr. Temple have volunteered their services as a matter of civic pride, and will act without compensation for this preliminary work."

Mr. E. B. Temple is the assistant chief engineer of the Pennsylvania Railway System, which position he held since 1906. He has been with the Pennsylvania since 1901, when he graduated as an engineer from Swarthmore, in the same class with Governor Sproul. He is 50 years of age, a member of the American Society of Civil Engineers, American Railway Engineering Association, the Engineers' Club of Philadelphia. He is also serving, by appointment of the Governor, on the Pennsylvania State Art Commission.

Dr. Paul Philippe Cret is well known as the professor of design in the School of Fine Arts in the University of Pennsylvania, to which he was called in 1903. He is a native of Lyons, France, where he was born in 1876, a graduate of Ecole des Beaux Arts of Lyons, and also Ecole des Beaux Arts of Paris, and the recipient of numerous prizes and honors in the French salons. His best known architectural works in this country are the Pan-American Building in Washington and the Public Library at Indianapolis.

* * *

Deterioration of Stored Cement

Deterioration of cement stored in bulk is less than in bags, owing to the smaller area exposed, states the United States Bureau of Mines, as the result of an investigation to determine the cause of deterioration of Portland cement during storage and transportation. Hydration takes place only at the exposed surface, and the bulk of the cement is unaffected. Cement transported in bulk must be shipped in a tight, closed car, and must be protected from moisture during loading, shipping, and unloading, preferably it should be used immediately after unloading at the point of destination. This practice is now followed by several manufacturers, and where conditions are suitable it is becoming more common as its advantages are seen. Shipping in bulk effects a saving by eliminating the use of bags, which is an important item in the cost of cement, and it should also permit a saving in freight rates. Details of a study of the storage and transportation of Portland cement, with a bibliography on the subject, are given in Serial 2377, obtainable from the Bureau of Mines, Washington, D. C.



BILTMORE HOTEL, PROVIDENCE, R. I.

An interesting departure in hotel construction because of its unique "V" shape.

More Light and Better Air Needed in Hotel Planning*

AN awkwardly shaped plot—a high building too close for comfort—the necessity of building around a structure that cannot be "bought out"—these and many other factors can often be turned to the hotel's advantage when a degree of ingenuity is used in its construction. The photographs and plans on this and succeeding pages show how some hotel operators have, in collaboration with their architects, laid out their hotels so as to overcome these difficulties and provide for better light and ventilation.

The idea of providing a home-like atmosphere was uppermost in the minds of the owners of the Forest Hills Inn (Page 84) when they came to build. They carried out this plan not only in constructing the Inn itself and its grounds, but also for the railroad station adjoining. These structures have uniform red tile roofs and red rambler roses along the walls. Largely through the activity of the Inn's owners these same restrictions also apply to every private house in Forest Hills Gardens—a village to which the Inn forms the main approach.

The notable features of the Hotel Sorrento's, Seattle, Wash., construction (Page 85) are the artistic way in which an entrance court has been provided—without wasting excessive space—and the ingenious arrangement of the turrets which provide for individual porches with each suite. It is interesting to note also how the incline at the left has been utilized for some of the service departments, which are thus made unobtrusive and out of the way.

Cedar Point, Sandusky, Ohio, is a densely wooded peninsula extending seven miles along the shores of Lake Erie, with the lake on one side and Sandusky Bay on the other. The unique construction of The Breakers

*Illustrations and descriptive matter courtesy of Hotel Management



FOREST HILLS INN

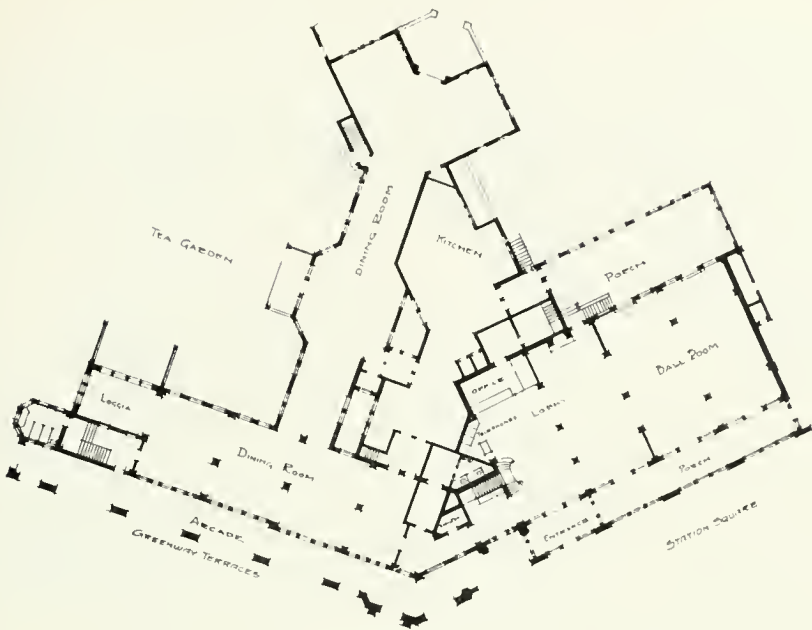

PLAN, FOREST HILLS INN

(as illustrated on Page 89) was decided on in order to conserve the cedar trees, and to make each room an outside chamber.

When plenty of space is available such a lay-out as that of the Wardman Park Hotel, Washington, D. C. (Page 86) is most advantageous. With this plan every room receives sunshine at least once during the day. The spaces between the wings are utilized for tennis courts, a



HOTEL, SORRENTO, SEATTLE, WASHINGTON

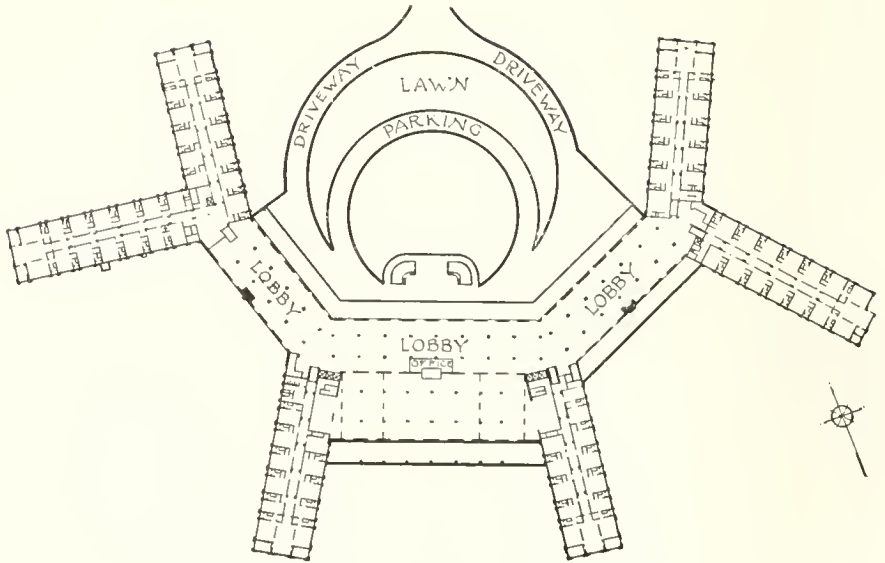

PLAN, WARDMAN PARK HOTEL, WASHINGTON, D. C.

putting green, a swimming pool, and so on. The photograph clearly shows how attractively the shrubbery has been made to fit into the hotel plan.

A floor plan of the Hotel McAlpin, New York, would present the general appearance of three ribs of a fan (Page 89). The establishment's three wings come together at the rear and widen out as they

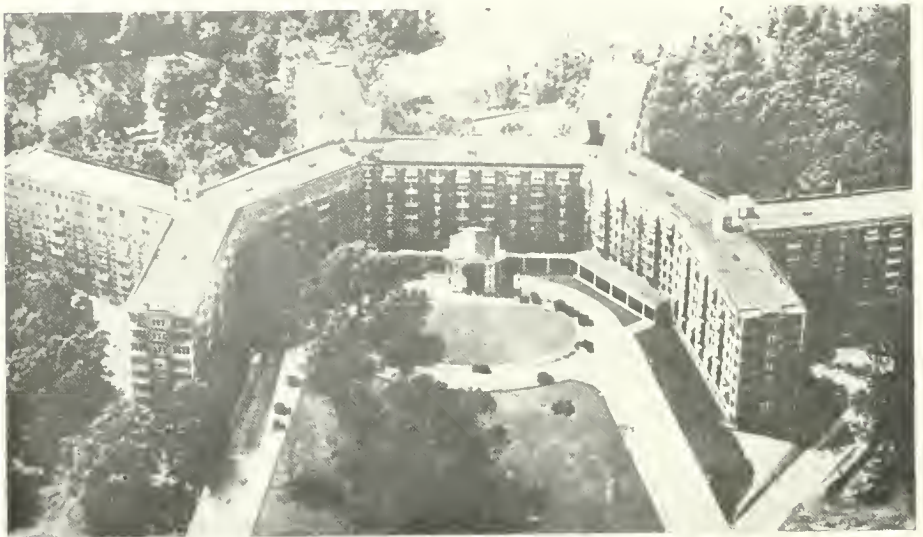

WARDMAN PARK HOTEL, WASHINGTON, D. C.



The Edgewater Beach Hotel, Chicago, has been called "the hotel without a back." Its unique four-wing construction is not only architecturally beautiful, but the facing sides each pair of wings reveal a section of the grounds which has been definitely planned to provide guests with an attractive view.

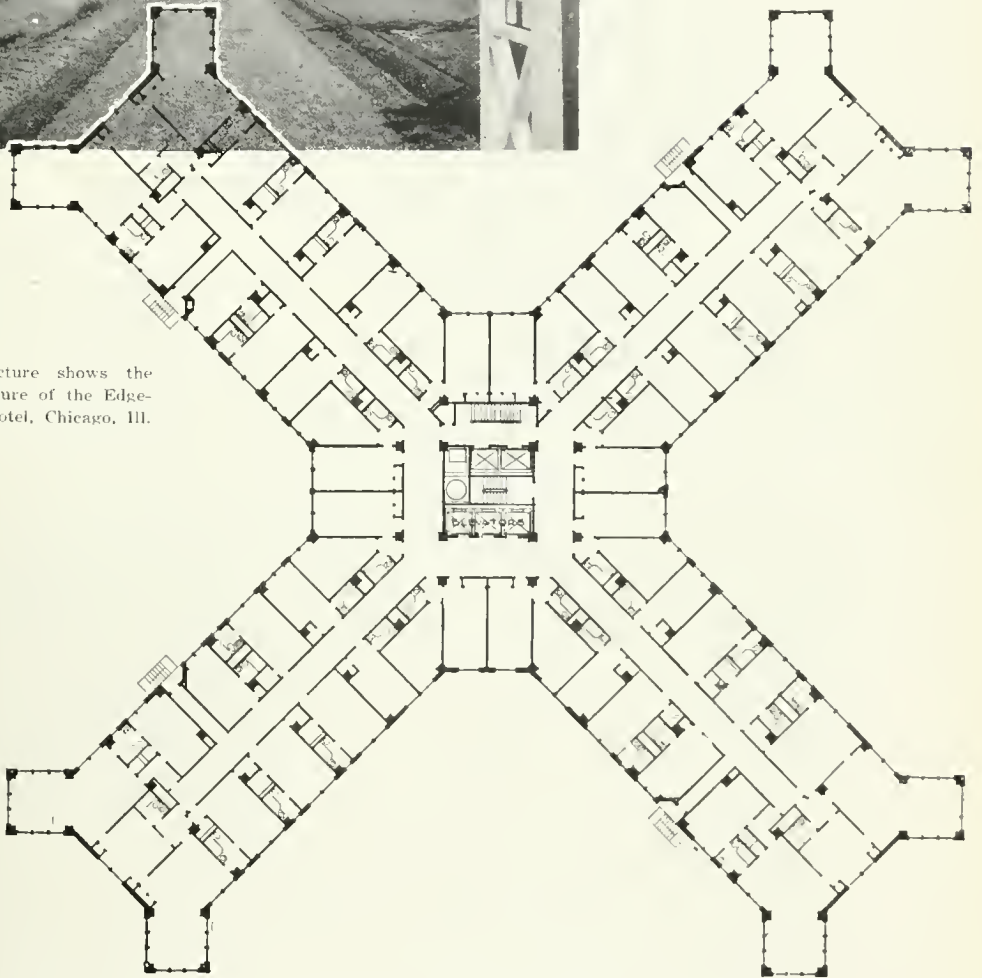

above picture shows the
hern exposure of the Edge-
r Beach Hotel, Chicago, Ill.

PLAN, EDGEWATER BEACH HOTEL, CHICAGO

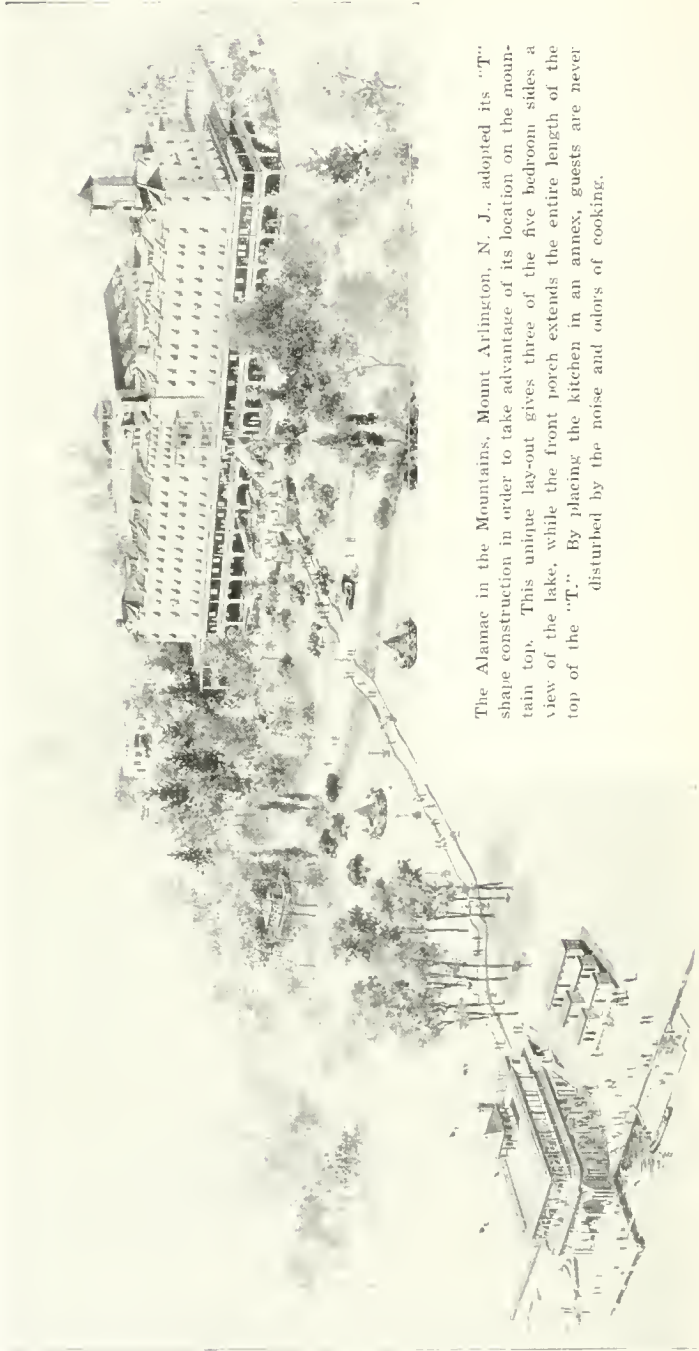

The Almac in the Mountains, Mount Arlington, N. J., adopted its "T" shape construction in order to take advantage of its location on the mountain top. This unique lay-out gives three of the five bedroom sides a view of the lake, while the front porch extends the entire length of the top of the "T." By placing the kitchen in an annex, guests are never disturbed by the noise and odors of cooking.



HOTEL McALPIN, NEW YORK

approach the street. This plan of construction provides not only for outside rooms throughout, but also affords this important feature in the minimum amount of space.

Some such plan was a necessity in the case of the McAlpin, because Broadway cuts diagonally across one side of its plot. As shown in the photograph, the wing in the foreground is rectangular in shape, whereas the other two are slightly angled. This form of construction has resulted in a pleasing variety in the shape of the rooms at the ends of these two wings.



THE BREAKERS, CEDAR POINT, OHIO

A Report on Building and Farmstead Engineering

By MAX E. COOK, Farmstead Engineer—Mem. A. S. A. E.

THE activities of the Building and Farmstead Engineering Department, Delhi State Land Settlement, Delhi, California, embrace not only planning, designing, quantity surveying, obtaining competitive bids, letting contracts, and supervising construction of all classes of farm, townsite, and administrative buildings, but include also making individual farmstead layouts for all settlers, determining location and arrangement of buildings, lanes, corrals, poultry runs, domestic wells, orchards, vegetable gardens, etc. Individual settlers are given unlimited consultation in acquainting them with health recommendations relative to sewage disposal, protection of domestic water supply, insurance rates and hazards, requirements of good practice in plumbing, electric wiring, paint formulas, concrete mixing, chimney construction, carpentry, etc. All buildings are appraised and values set as basis for loans, and all buildings rented are scheduled by this department.

Active interest and support are given to community development, services being extended to school Board and Settlers' Co-operative Association. This included designing and supervising construction of the Community Hall at Delhi, which was recently completed.

The Farmstead Engineering Department is maintained in recognition of the value of planned development. Through this department the settlers' time has been conserved and better buildings have been built at less cost than would have been possible had each farmer been obliged to make repeated trips to town for materials and assistance.

It has been demonstrated beyond question that when buildings are properly designed, planned and built to meet individual requirements, contentment and success are more liable to follow than in cases where no organized effort is at work.

Loans made by the State are more securely protected and appraisals of building improvements are more accurately made with costs and building data amassed by this department as a basis.

In cases where a settler is more or less of a mechanic, and is in a good position to do his own building, he is advised to do so. In all other cases the contract system has proven most satisfactory. In either case a complete set of plans is furnished.

Under the contract system a set of specifications is drawn, and after the plans and specifications have been approved by the settler the work is advertised for bids in the open market in accordance with regulation practice. Sealed bids are received and opened at a predetermined hour in the settler's presence. If accepted, and upon receipt of authorization with accompanying deposit by the settler, a contract is entered into between the State and Contractor, and work proceeds under the supervision of the Farmstead Engineer, acting as agent of settler, until completion and acceptance. The contractors' accounts are audited and the full responsibility is removed from the settler until he accepts the work as complete and satisfactory to him. This service is a complete architectural professional service. The contractor is responsible for accident to his workmen or the public, for loss by fire, and is under bond for faithful performance of the contract.

Where a settler is able to do his own building work, a quantity survey of the materials required is made, and competitive bids taken on these materials in the same way that bids are taken on labor and material contracts. The settler is furnished a copy of the material list to serve

as a guide, the list giving instructions for the cutting and placing of various items thereon.

Wherever it has been possible to purchase building materials in car-load or large quantities by grouping orders, this has been done, to give the settler the benefit of the State's purchasing power.

By a careful system of checking contractors' accounts, and by requiring detailed statements from settlers before loans are made, labor and material men are given positive protection, saving them collection costs and making their business through the State very desirable. This is an important factor in keeping down costs.

Our well-established contract system, with its uniform and well-known methods of procedure, has earned the confidence of local contractors and has created a wide and keen competition.

The first building contract was awarded March 4, 1920. Today there are 454 buildings on the settlement, having been erected at the rate of a building every 1.5 working days. Three hundred and thirty-nine are farm buildings on 132 farms at a cost of \$177,749.00, including domestic wells, or \$1,346.00 average per farm. There are 86 buildings on 51 farm laborer's blocks at a cost of \$51,788.00, including domestic wells, or an average of \$1,116.00 per farm laborer's block. There are 26 administration buildings representing a cost of approximately \$85,000.00. The Wilson Community Hall cost \$10,000.00. The total value of all buildings on the settlement, including domestic wells, amounts to \$325,000.00.

Over \$170,000.00 of this amount was spent under contract; \$81,000.00 was produced by settlers' labor from plans furnished by us; \$72,000 has been spent following settlers' plans, but with construction supervised by this department.

Ten per cent is a conservative estimate of the cost saved by this department in letting the work under contract. Still greater saving is effected through the intelligent planning of buildings and by the utilization of the most suitable materials and of standard sizes that avoid waste.

Where special plans have to be prepared a charge of three per cent of the value of the work is made by the Land Settlement Division. Where stock plans are useable the charge is two per cent, which has made this department self-supporting, considering its contribution to general administration. It has also produced administration buildings at a cost of three per cent of their cost.

As in the case of all other buildings, the determination of the amount to be expended and the type of each dwelling to be erected is based on a personal interview with the individual settler and a thorough knowledge of his requirements. There are three distinct ways of commencing the dwelling program, requiring earnest consideration. A dwelling may be designed with only the ultimate needs in mind, and more or less without regard to cost, being so planned that it may be built in units within reach of available cash.

The shell or skeleton of the dwelling may be built with a view to completing it in installments during winter months and odd times or as capital permits, or a temporary dwelling of a type suitable for converting to some utility use may prove most satisfactory. The latter type is the cheapest, for all of the material within it peculiar to a dwelling may be salvaged for later use in a permanent structure, leaving a higher type of utility building than perhaps could have been afforded otherwise. The complete unit costs the most for a corresponding amount of space, for the reason that it is built with permanency in view.

The Architect and Advertising

By SIR CHARLES T. RUTHEN,
President of the Society of Architects
From The Surveyor, London

DURING the past few years I have been driven to the consideration of the subject of the position occupied by architects and architecture in the social system of today. The general public have little knowledge of the real value of the architect and his craft to modern progress and civilization. Some, but comparatively few, understand the architect and value his work. Many others look upon the architect as a kind of necessary and expensive evil, mainly useful in connection with building matters, in avoiding difficulties in relation to regulations and by-laws; but generally a costly luxury to be avoided whenever possible. Still many more possess the haziest idea about the architect and his work, and are disposed to consider, in any event, that he may be useful to the few but is much better done without by the masses.

In turning these vital matters over and over in one's mind, the fact is very surely borne in upon one that the great public who, unconsciously and in a matter-of-fact way, avail themselves every hour of the day and every hour of the night, of the product, good, bad or indifferent, of the great craft of building, have not the faintest idea of the important part played by the members of the architectural profession in the everyday life of the people.

One wonders whether the architect attaches to himself any share of the blame for this fatal and disastrous ignorance upon the part of the people, or whether he sometimes stops to think, and perchance realizes that this lack of understanding is after all due, if not entirely, in a large measure, to the strange backwardness—perhaps one would be more correct to say selfishness—upon the part of the entire profession—a backwardness or selfishness which is having a very baneful effect upon the fortunes of this great and honorable craft.

Better that the architect adopted the practice—often termed pernicious, but very consistently condemned in our country, extensively and even successively practised on the other side of the Atlantic—of advertising his wares and his services in the manner popular with any great drapery store or furniture emporium. Architects must not advertise, they must not offer their services; this would be a gross breach of professional etiquette; they must remain silent and trust to some piece of good fortune, to the winning of some competition, to the favor of some important or wealthy client to bring them publicity or perchance fame.

That the advertising of one's wares, like some vendor of ordinary or extraordinary soap, or hair restorer, is repugnant and offensive to the sensitive feelings of the architect, brooks no argument; but to lie low and hide the gifts of the Creator under a bushel and to refuse or neglect to let the public learn of the value to modern life of good architecture is a crime. It is wrong to architecture as an art, wrong to architecture as a science, and wrong to the public whom the architect should serve.

The present stand of architects is perhaps agreeable to the few—shall I say even satisfactory to the few? At the top of the professional ladder there is much room, but the lower the rungs the greater the crowd, and the more congested and cramped the accommodation. To the many the present practice is mere false pride, backed by generations of narrow outlook, and love for the profession which forgets its service to the people.

An architectural debating society—one has never heard of such a society, but perhaps the idea is worth cultivating—looking for a fit subject to debate, might adopt one of the following rather amusing titles, which would, I feel sure, provide much food for consideration and debate:

- (a) "What is advertising as applied to architects and their work?"
- (b) "Is advertising that for which payment is made in cash at ordinary advertisement rates?"
- (c) "Is advertising not advertising if no payment is made for insertion, and when the matter appears in that part of the journal usually read by the greatest number of readers?"

One may object "to advertise" oneself or one's own work, in the sense of paying so much per line in the advertisement columns of a newspaper or periodical; but one may not object "to being advertised," or to being written about or of in the ordinary news columns of a newspaper or periodical. This is cheaper, and incidentally more efficacious, but it is nevertheless advertising. It will be generally agreed by those who observe even casually that those highest up the ladder of fame get the most publicity—sometimes called advertisement, and rightly so—and that free, and the lowest upon the ladder, the least publicity, and very possibly have to pay directly or indirectly for that which they get.

* * *

Don't Be a Swizzler!

IN these days of progress and new inventions even new words must be added to our dictionaries to make them more expressive. The latest of these coined words that has come to our attention and one that has a world of meaning is "Swizzler." The story of how this word came about is interesting indeed.

It happened in Oklahoma City. One of the ice cream manufacturers started the manufacture of chocolate coated ice cream bars. He called his bar the "Polar Bar" and advertised it extensively all over his town. Naturally enough a demand was created for his product and people would step up to soda fountains and ask for Polar Bars.

Now it so happened that there were other ice cream manufacturers in this same town, and they saw the goodly business that was being done in the way of Polar Bars, so they started forthwith to make something "just as good." They made chocolate coated ice cream bars and sold them to the dealers a little cheaper than did the manufacturer of Polar Bars, who had done all of the missionary work for that type of product. The result was that if you went into a store and asked for a Polar Bar the clerk would pass you some other chocolate coated ice cream bar if he did not happen to have "Polar Bars." This action came to be more and more pronounced until the manufacturer of Polar Bars decided that it would take further missionary work on his part to put his product in its proper place.

One day there appeared in the papers a large advertisement by the Polar Bar manufacturer. It was headed, "Don't Be a Swizzler," and down in the bottom of the ad was the definition: Swizzler—One who sells you something "just as good." The public caught on immediately. In a very short time it seemed that the dealers were ashamed to offer you anything else when you asked for Polar Bars. The manufacturer of Polar Bars is now reaping the benefit of his original advertising campaign—he has sold his product to the public, and they buy it through the dealers.

This same idea applies to every article that is nationally advertised and sold. When you think of hats you think of Stetson. When you think of collars you think of Arrow. When you think of suits you think of Kuppenheimer or probably Hart, Shaffner and Marx. And so on down the line; certain names mean more to you than others. When you think of buying things for yourself, you think of certain brands that you know better than others. If you are absolutely honest with yourself in diagnosing the matter you will admit that you have more confidence in those advertised articles. If you want a certain article in a store and ask for it by name and the clerk says: "Here is so and so—it's just as good," isn't there some negative reaction in your mind? Especially so if you haven't heard much, if anything, about the brand he is trying to sell you?

Take groceries, for instance. Certain manufacturers advertise their goods nationally and create a public demand for them. The household buyer has definite ideas about what she wants—knows the articles by trade names and wants what she wants when she wants it. And when she goes into a store and asks for Dutch Cleanser she asks for it because she has seen it advertised or because she has used it before. The manufacturer has sold her his product—it isn't salesmanship on the part of the grocer—unless he co-operates with the manufacturer's advertising. If the grocer does not have the product, and offers something "just as good" he is not only doing the national advertiser, who is making business come to him, an injustice, but is beating himself out of good business by not stocking the material that is partly sold before he puts it in stock.

When someone tries to sell you something "just as good" he is trying to sell you what HE wants to sell you and not what you want to buy. This applies as much to one type of article as to another. It is as true of lumber as it is of perfumes or collars.

The manufacturer who advertises nationally is creating a demand for his product in your vicinity. If you handle his product he is creating sales for you—sales you would not otherwise have. People will come to you and ask for his product by name or trade mark. Doesn't it seem entirely logical that this buyer should have what he wants, whether it be collars, hats, flooring or what not? And doesn't it seem logical, too, that if this manufacturer sells his product to the people of your vicinity through you, that you should extend him your co-operation? Then if you agree with this idea "Don't be a Swizzler"—sell your customer what he wants, not something "just as good."—House Organ of the E. L. Bruce Hardwood Lumber Company, Memphis, Tenn.

* * *

Seventy Year Old Wooden Gas Pipe

The common impression is that iron is more durable than wood, but the fact is that under certain conditions wood often outlasts iron. In reconstructing the gas system at Canandaigua, N. Y., which was installed seventy years ago, it was necessary to take up 1800 feet of wooden trunk line pipe. The engineers were amazed to discover that there had been no leakage from it. Although it had been lying submerged in water, it appeared to be as sound as when laid. The inside of the pipe was as intact as the outside. Nevertheless, an iron band which made a joint was so badly rusted that it had to be removed. Not only was this ancient pipe intact, but chips from the borings showed that there had been no seepage of gas, the wood fibre not even being impregnated with gas odor.—National Lumber Manufacturers Association Information Bureau.

Industrial



PLANT OF THE WEST COAST PORCELAIN MANUFACTURERS, MILLBRAE, CALIFORNIA

San Francisco Architect's Impressions of a California Industry

HOW well a California industry can supply a commodity that we used to think could be manufactured only in the East is demonstrated by the success that has marked the comparatively short operation of the West Coast Porcelain Manufacturers of San Francisco. Beginning with a small factory located at Millbrae, San Mateo County, three years ago, the company has enjoyed steady growth, until today it faces an urgent demand for expansion—a condition that undoubtedly will be met early the coming year.

It must be gratifying to the architect to feel that in specifying a high-grade porcelain product he is assured his client will receive material as specified and without delay. Too frequently in the past have deliveries been delayed on account of freight congestion. With complete elimination of this annoyance, an architect need not worry about loss of time through failure of prompt delivery.

The fact that only skilled labor is employed at the Millbrae plant is assurance that the product is high grade, and in design and texture it may be compared with any porcelainware manufactured anywhere in the country. Many of those now connected with the California plant were at one time employed in the Eastern factories, and it is pleasant to know that they have become Californians, have made the Golden State their permanent residence, and are distributing their earnings among us.

Mr. Irving F. Morrow, member of the firm of Morrow and Gerrin, architects, in the Chronicle Building, San Francisco, was asked by the editor of this magazine to visit the Beresford plant and write of his impressions. His description of the methods used in manufacturing porcelain at this factory will be found most interesting, as will the photographs illustrating the successive stages in the manufacture of vitreous china.—Editor.

By IRVING F. MORROW, Architect

THE sight of soft, moist, olive-drab clay takes me back to school courses in modeling, where it is associated with acanthus leaves and Gothic cusps and dissevered hands and arms and more formless fragments clinging quite inexplicably to the ceiling and the far wall. Even later encounters in the more business-like atmosphere of decorative modeling shops have not quite served to eradicate my first impression that plastic clay is an ally now of boredom and now of levity, but always a thing destined to futility. It comes, therefore, as somewhat of a surprise to pass through a pottery—that of the West Coast Porcelain Manufacturers at Millbrae—and see such unquestionably utilitarian objects as vitreous plumbing fixtures being carefully fashioned in lines of hundreds and thousands from mounds and hillocks of what appears no more than the “mud” of youthful memories, and to realize that large numbers of able-bodied men make a living by treating this material seriously.

I say what “appears to be” the modeling clay of youthful memories, because, as a matter of fact, the resemblance is superficial. The ingredients of vitreous ware are selected and prepared with a care unknown to the “mud” which is destined to that peculiarly irresponsible line of endeavor known as “art study.” The mere handling of the material reveals a texture of quite another fineness and smoothness. Many a sculptor and modeler would probably enjoy raiding the clay piles of this pottery.

The clay must be chosen and prepared with a variety of properties in view—its workability, its action in drying and under firing, etc. In fact, no clay in its pure condition presents the necessary combination of properties, but there are added to it quartz, feldspar, etc., in proportions determined by experiment and chemical analysis. The exact formulae are more or less secret. But whatever ingredients find their way into the material of vitreous ware, they must one and all be minutely pulverized. They are first passed between revolving stone grinders, which do the preliminary crushing, and then through the ball mill, which is a revolving steel cylinder, containing flint pebbles of various sizes, which grind the particles in rolling and tumbling about. From the ball mill the material emerges in the form of a dust as fine as flour.

The clay and ground quartzes are then mixed with water and held in large tanks containing mechanical agitators. The liquid must be screened for particles of copper and iron, which produce green and black spots when fired; and it is also passed through a vat containing a magnet to guard against finer particles of iron. When completely screened and thoroughly mixed, the materials must be given a workable, plastic form. It is first passed through the filter press, which squeezes out the free water and leaves the clay in round, flat cakes. These cakes are fed into the pug mill, which expels the air and forces the clay out in small cylinders, ready for delivery to the pressing shops, where it is pressed into the molds. It is soft enough to be readily workable, stiff enough to maintain the forms given it, extremely smooth and homogeneous—the material, in fact, which I described as awakening old memories and new admirations.

In the meantime the molds must have been made ready, and this is often a long and difficult procedure in itself. Anyone at all familiar with the conditions of casting and molding and drawing from molds will realize upon reflection the complications which can arise in making workable molds for, say, a modern toilet bowl with integral trap. In the

first place, the fixture must be completely designed and a plaster model made. From this must be made molds into which the clay can be pressed. It is obvious, however, that clay pressed into a complete mold for even the simplest fixture could never be drawn from the mold. Some scheme must therefore be found for dissecting the fixture into separate units, each of which will give a mold which can be filled and drawn, and all of which can subsequently be assembled with certainty and precision. When a workable scheme of molds has been devised there must first be made a master mold, from which the piece molds can be made in any quantity and at any time. Fixtures are made in large quantities, and many duplicates of any one mold are likely to be in use simultaneously. The molds are of plaster. All of this model and mold work is done at "shrinkage scale," or one-eighth larger than the finished size, to allow for the contraction which the wet clay undergoes in drying and firing.

But whatever skill may be used in devising the piece molds, no system can be evolved in which success does not ultimately rest on the skill of the finishers in the pressing shops. Here the clay is pressed into the molds and the pieces actually take form. Even the simplest mold requires a considerable degree of hand finishing in the way of cutting, smoothing, and the like; and these necessary operations are accomplished with remarkable facility by the well-trained workman. Often an entire edge or rim is given form by a quick rotation of a disk or base on which the work rests, while the hand remains practically still. The pieces from the separate molds are assembled by wetting the edges which are to adjoin and pressing them together, sometimes filling in joints with rolls of clay. The amount of hand work required even on a simple piece would surprise the layman; and for finishing a complicated piece, such as a toilet bowl, a high degree of skill and knowledge of the piece are necessary. The air in the pressing shops is kept humid so that the clay will not dry out while being worked.

After the pressing and finishing there are still many stages before a piece of vitreous ware is completed, although these later stages are probably of less interest to the ordinary observer because they are more purely mechanical. The pieces are first put aside for a week or more to dry out. They are then taken to the kiln for the first firing. The kilns are large cylindrical brick chambers with conical brick roofs. The fire is introduced by oil-burning apparatus through apertures around the circumference at the bottom. The flame must not be allowed to impinge on the piece during firing, and each unit is therefore enclosed in a "sagger." The sagger is in effect a box made of coarse burned clay. The pieces are placed within, and these are piled high throughout the kiln, which is then closed, and the contents are fired at a temperature of 2800 degrees Fahrenheit.

The pieces emerge from the kiln thoroughly vitrified, but with a toothy surface similar to that of the finest sandpaper. They are then carefully inspected for flaws or errors, after which they are dipped into the glaze, again placed in saggars, and subjected to a second firing of 2600 degrees to burn the glaze on. They come from the second firing finished as far as the vitreous china is concerned. They are then removed to the warehouse, where there remains only the fitting or assembling of brass parts. They are then crated and stored awaiting shipment.

Probably few users of plumbing fixtures appreciate the many stages in the process of their manufacture, or the complication of some of these stages, such as preparation of materials, models and molds, and finishing.



The grinding stones. This is the first step in the pulverization of the material

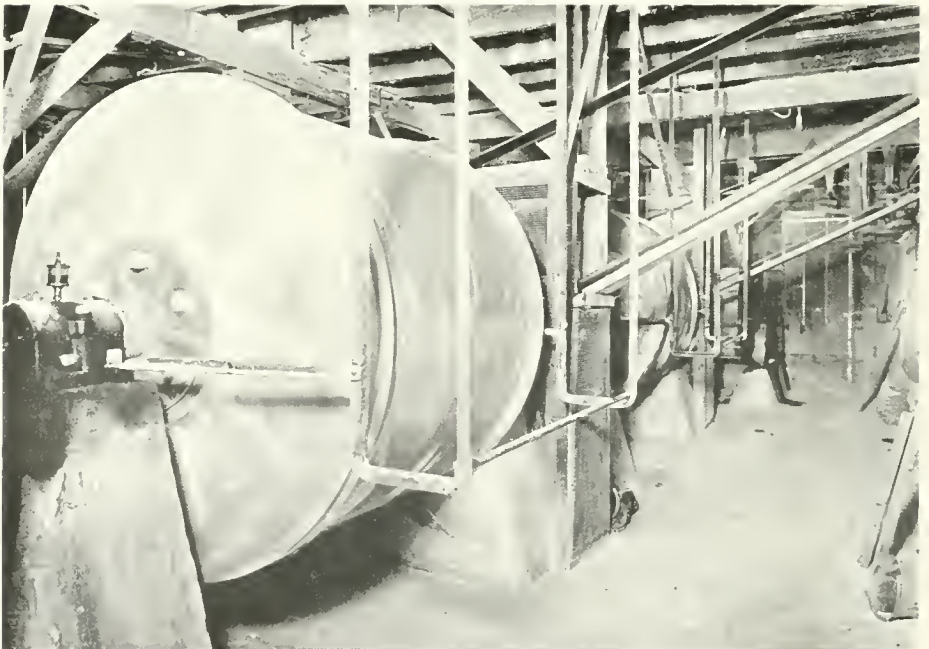

The ball mill. Rotating cylinders containing balls which pulverize the material to a fine powder.



The material bins. The ground materials are stored in these bins and loaded in the necessary quantities on a passing car.

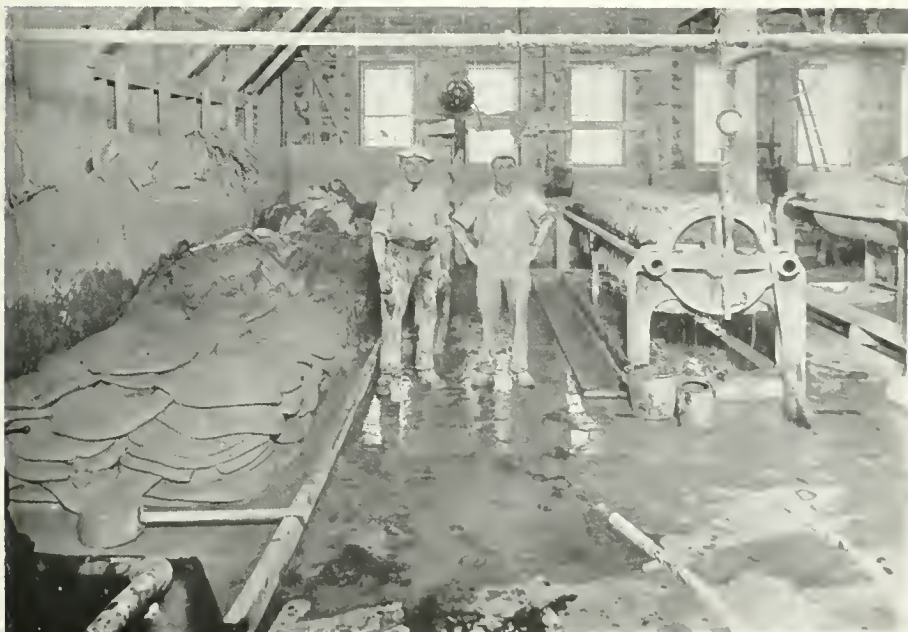

The filter press. After the pulverized clay and quartz have been thoroughly mixed in water, the water is expelled in these presses. Slabs of pressed clay are shown piled at the side.

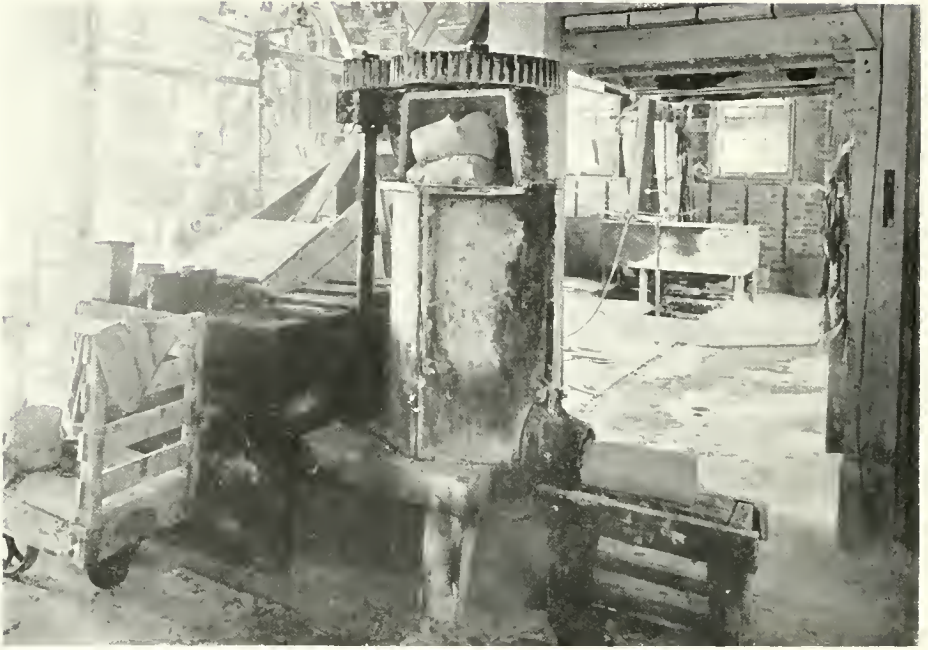

The pug mill. After the water has been expelled in the filter press, the clay passes through this mill, which expels the air. It is then ready for the pressing shops.



The mold shop. Plaster models and molds are made in this shop.



The pressing shops. Toilet tanks in parts.



Pressing shops. Toilet tanks assembled.



Pressing shops. Toilet bowls in parts and assembled.



Inspection room. Pieces here have undergone first firing and are inspected before dipping in glaze for second firing. Dipping room as seen beyond.



Loading a kiln. Suggers are shown piled at side. All pieces are enclosed in these during firing.



Warehouse. Pieces are here given final inspection. Assembling and fitting of brass parts is done, and stock is piled for shipment.

THE Architect and Engineer

Incorporated

Founded 1905 by E. M. C. WHITNEY

W. J. L. Kierulff - President and Manager
 Fred'k W. Jones - Vice-Pres. and Editor
 L. B. Penhorwood - - - - - Secretary
 T. C. Kierulff - - - - - Attorney

Associate Editors

Chas. H. Cheney - - - - - City Planning
 August G. Headman - - - - - Book Reviews
 Wilbur David Cook - Landscape Architecture
 Wm. B. Gester - - - - - Inspection and Tests
 O. P. Shelley, C. E. /
 F. W. Fitzpatrick } Fireproof Construction
 T. Ronneberg, C. E. - - - Structural Steel
 W. H. Lowe - - - - - Roofs and Roofing
 Fred'k N. Woods, Jr. - - - Rock and Gravel
 Chas. Felix Butte - - - Electrical Construction
 J. W. Fricke - - - - - School Equipment
 Will J. French - - - - - Department of Safety

Published Monthly in the Interest of the
 Architects, Structural Engineers, Contractors
 and the Allied Trades of the Pacific Coast by
 The Architect and Engineer, Inc.

PUBLICATION OFFICE:

627-629 Foxcroft Building, San Francisco
 Telephone Douglas 1828

The publishers disclaim any responsibility for
 statements made in the advertisements of this
 magazine.

Terms of Subscription

(Including postage) to all parts of the United
 States, \$2.50 per annum; to Canada 75c
 additional; to all Foreign points \$1 additional

Vol. LXXI. OCTOBER, 1922 No. 1

A LETTER TO A CLIENT

Charles McKim, perhaps in a Pickwickian sense, once said: "There being more renaissance on Fifth Avenue than there is in Italy and France, let us quit imitating and try for an American Renaissance." This observation of McKim's prompts me to think that the Puritanical simplicity and plainness of the New Broad and Wall Street Building typifies in the hearts and minds of people of culture a natural revolt against indiscriminate and thoughtless misuse of renaissance motifs.

In the rush and hurly burly of present day activities, execution of renaissance motifs has in practice fallen so far below high ideals that their use in any way is now thoroughly discredited and strongly discountenanced; but that does not

furnish us with a reason for adhering to a plain and painful Puritanical simplicity.

What we should try to emulate ought to be the grandeur of classic and medieval masterpieces of architecture, including the bewildering charm of their most notable examples. Can we do that if we supinely follow the leadership of Broad and Wall Streets?

After all, would the latter course be anything more than an admission that we lack the ability to constructively interpret, for the improvement of architecture, the lessons of the past? Or do we lack the courage?

Compromise is a deadly leveller; let us not be compromisers, let us be leaders, provided, however, that we lead wisely and conservatively.

The greatest things are simple, but many plain things are not great.

As Mr. Burnham said, when I submitted a design for his consideration: "Make me a tracing of this, with all ornament omitted." I made the tracing, and upon seeing what it meant I was ashamed to submit the new tracing to him. What I am trying to say is, let architects and clients collaborate; the client should not dictate, the architect should not try to dominate.

WILLIS POLK.

OMAHA SOLVES BUILDING PROBLEM

OMAHA has solved in its newly adopted building code a problem that confronts scores, if not hundreds, of other cities in the United States, by extending the permissible uses of certain types of economical construction in building operations in that city.

The National Lumber Manufacturers' Association has been conducting a systematic campaign for the revision of municipal building codes throughout the country with a view to eliminating provisions

that make for unnecessary expense of construction, while at the same time meeting every reasonable requirement of strength and fire resistance. It was instrumental in pointing out to the Omaha authorities that there was very little development in that part of the city included within the fire limits. An investigation demonstrated that with ordinary and mill construction impracticable or prohibited under the building code, real estate men found it more profitable to operate, if at all, outside the fire limits.

Omaha has a very extensive fire limits district, and the restrictions have been such that for practically seven years no wood has been used for structural purposes therein. Since 1915 it has not been possible to erect within that area apartment houses, small stores, factories, warehouses or similar buildings of "ordinary construction," that is, masonry, exterior walls, wood joist floors and wood stud partitions. Nor was it possible to erect in the same district any building over forty feet in height, of heavy timber "mill construction." As practically all buildings within the fire limits are for the purposes mentioned, and as most factory buildings need to be more than forty feet high, and consequently could not be of mill construction, the result was that buildings of both sorts were practically prohibited within the fire limits.

To meet this situation and withdraw the impediments to further building in the central part of the city and elsewhere, a new code was drafted, which permits ordinary construction of buildings not exceeding three stories and of mill construction up to and including six stories. As these two kinds of construction are by far the most popular and most generally economical for the purposes mentioned, it is expected that the new code will result in considerable building in the

central section of Omaha. Another result of the new code is that old buildings, which have been an eyesore and a fire hazard, but which could not be economically replaced with the expensive type of structure hitherto required, will now be torn down and succeeded by new buildings of ordinary or mill construction.

Suburban development is assisted by the new code in that it permits small stores outside the fire limits to be of frame construction. More costly construction of neighborhood stores in new "additions" tended to deprive those sections of adequate merchandising service. Then, too, after a public hearing which developed overwhelming opposition to it the council decided to reject the suggestion that wooden shingles be forbidden.

Another beneficial change in the new code is that wood as a structural material is justly credited with more strength than formerly. The stresses for structural timber have been raised in the new code from 25 per cent to 66 per cent for the various species, as compared with the old code.

These changes mean to lumbermen that Omaha will be on the lumber map again as a consumer of lumber. If only ten medium-sized apartment buildings of ordinary construction are put up in the fire limits within the next year it will mean the sale of at least 300,000 feet in what was heretofore a closed district. One storage building or factory of mill construction would require an equal amount.

Seattle Institute Committee

The following members of the Washington State Chapter have been appointed on the Institute's Committee for the ensuing year:

Mr. Chas. H. Alden—Small House Committee.

Mr. G. C. Field—Structural Service.

Mr. Carl F. Gould—Community Planning.

Mr. D. R. Huntington—Industrial Relations.

Mr. F. A. Naramore—School Building Standards.

"Own Your Home" Presented in Motion Pictures

In various parts of the country, particularly in Ohio and California, model homes have been constructed with the idea in mind of stimulating an interest in home building. These model homes have created a great deal of interest locally, but have done little nationally.

The demand for some method of giving national scope to this movement finally resulted in the Atlas Educational Film Company of Oak Park, Ill., being commissioned to produce a five-reel feature film showing the erection, equipping and furnishing of a modern six-room brick Colonial home.

This film will be shown all over the country under the auspices of and with the co-operation of real estate boards, commercial, advertising, rotary, Kiwanis, Lions and other clubs and organizations; also through official government non-theatrical distribution bureaus (one located in almost every state, usually the State University), through churches, community centers, etc.

A beautiful lot in Glen Ellyn, Ill., has been chosen for the purpose of this film. The scenario is founded on the real facts of human life—things that are happening around us constantly. Converted into motion pictures with real actors it forms one of those heart-gripping, dramatic stories, the kind that make you laugh one minute and cry the next. Woven skillfully through the story runs that thread of romance and appeal to the home instinct that finds response in everyone. The element of romance carried through the film takes the proposition out of the ordinary and places it in the extraordinary.

A number of phases, such as the investment problem, selection of the lot, the contractor, the architect, choice of materials and furnishing the home are prominently featured. Your interest in the proposition lies in the fact that some of the products used in this model house are found in the pages of *The Architect and Engineer*.

The film corrects some of the popular mis-conceptions of building and leaves the beholder with a distinct desire to build.

Will Design City Hall

Messrs. Roland F. Sauter and E. Keith Lockard, architects, of Santa Barbara, have been commissioned to do the architectural work on the new city hall for that city, bonds for which have been sold to the amount of \$150,000. The building will house the city offices, council chamber, building and police departments, and will be under construction in a few months.

United States the Mecca of Architects

The recent war touched America very lightly, and owing to its prosperous condition and the wealth of the country it is able to spend money lavishly on building and developmental works.

For this reason it is becoming the Mecca of architects and engineers, who, if they go to this country, are sure of seeing all the most scientific and up-to-date ideals being applied in the building and engineering world.

Great Britain and France, two leading scientific nations, are the source of a good deal of knowledge in the construction line, which Americans are quick to seize upon and convert to their own requirements. That the nation is invariably up-to-date is due partly to business instinct on the one hand and wealth on the other, for when practical ideas come to light they are never allowed to go to seed, but are made use of just as fast as the almighty dollar can accomplish it.—Building, Sydney, Australia.

Dangers of Removing Forms Too Soon

There is no possibility of stating with precision the time when forms may safely be removed from any piece of construction. This varies entirely with weather conditions and the mass of concrete. Whenever the structure is one which need support no weight but its own, such as a building wall of medium dimensions, all above ground, forms can sometimes be removed in three or four days. There is no advantage, however, in removing forms too early because the forms afford desirable protection to the concrete in preventing it from drying out too rapidly and also prevent a too rapid radiation of the chemical heat generated by the set of the cement. Forms for heavy arches, for floors supported above ground and roofs, must all be left in place from ten days to two, three or four weeks.—*American Builder*.

Granted Certificates to Practice

At the meeting of the State Board of Architecture held September 26 the following were granted certificates to practice architecture in California:

Mr. W. F. C. Gillam, 1228 Paloma Avenue, Burlingame.

Mr. Martin J. Rist, 955 Clayton Street, San Francisco.

Mr. Virgil W. Jorgensen, 406 Balboa Building, San Francisco.

Mr. William Mooser, Jr., Nevada Bank Building, San Francisco.

Mr. Melton V. Mowbray, Jr., 4236 Foothill Boulevard, Oakland.

Mr. W. B. Phillips, 1073 Monadnock Building, San Francisco, was granted a temporary certificate to practice architecture.

With the Architects

Building Reports and Personal Mention of
Interest to the Profession

Designing Many Branch Banks

Architect G. A. Lansburgh, of San Francisco, is preparing plans for thirty or more branch banks which the Mercantile Trust Company proposes to establish in various localities within the city limits of San Francisco. In several instances there will be entire new buildings constructed for the exclusive occupancy of the bank, while in other cases vacant stores will be fitted up. Mr. Lansburgh is also preparing drawings for three high-class residences on Pacific avenue, all in the Spanish type of architecture.

Moose to Have New Home

San Francisco Lodge of Moose will have a two-story and basement steel frame and reinforced concrete lodge building on Market street, between 12th and 13th streets, plans having been completed by Architects O'Brien Bros. A contract has been entered into with Vukicevich and Bagge to erect the building for \$125,000. O'Brien Bros. have also finished plans for a printing plant on Hyde street, near O'Farrell, to cost \$40,000, and a store building on McAllister street, near Franklin, both for Mr. Louis R. Lurie.

Fresno Y. W. C. A. Building

Architect Julia Morgan, of San Francisco, has completed plans for a two-story reinforced concrete gymnasium, to be built at Tuolumne and Fresno streets, Fresno, for the Fresno Y. W. C. A. The estimated cost is \$100,000. Miss Morgan is preparing drawings for an auditorium for the American Legion in Marysville, the structure to be the gift of the Yolo County Supervisors in memory of Marysville soldiers who died in the world war.

Cafeteria Popular in Hospitals

Architect Myron F. Hunt, of Los Angeles, in a talk before the conference of California hospital managers at Pasadena, said the California eating invention, the cafeteria, has taught the hospitals of the country how to get hot food to patients and how to feed their nurses, doctors and employees in the most satisfactory manner. Mr. Hunt said the cafeteria plan in modified form is being used in some of the largest hospitals in the country, and is proving highly efficient.

Designing Los Angeles Skyscraper

Architect S. Heiman, 57 Post street, San Francisco, is preparing plans for a ten-story Class A apartment house to be built on Wilshire Boulevard, Los Angeles, at an estimated cost of \$650,000. Mr. Heiman is representing Roos Bros., lessees of the new Clark building to be constructed immediately on the site of the old Albany building in Oakland, from plans by Architect William Knowles. This structure is to be three stories and basement, and will cost \$350,000.

Physicians' Office Building

Architect W. E. Milwain, of Oakland, has prepared plans for a two-story and basement frame physician's office building to be erected at Grand avenue and Parkview, Oakland, for Drs. L. O. Adams and W. H. Strietmann. Structure will be built in the residence section of Oakland, and the design will be in keeping with the beautiful homes of that district. The improvements will cost \$70,000.

Will Design Building

Mr. W. L. Stoddart, of New York, has been retained by the Tacoma Hotel Committee to design their building. Selection of a local architect to supervise has not yet been announced.

The architect for Seattle's hotel has not yet been selected.

Applies for Chapter Membership

Mr. E. T. Osborne, of Seattle, formerly a member of Royal Institute of British Architects and the San Francisco Chapter, has made application for Institute membership. The application for advancement to Institute membership of Mr. C. H. Keith, of Spokane, was also recently made.

Death of K. G. Malmgren

Mr. K. G. Malmgren, architect, of Spokane, Washington, died a few months ago. He had been an associate member of the Washington State Chapter for three years, and for a number of years a partner of Mr. Kirtland Cutter. At the time of his death he was serving on the Zoning Commission of the City of Spokane.

Personal

Architect De Witt Mitcham, of San Bernardino, who succeeded to the practice of the late Mr. Fred T. Harris, has moved his offices from the Katz Building to suite 205-07 of the new Hutchason Building, San Bernardino.

* * *

Architect Robert H. Orr has moved his offices from the Van Nuys Building to suite 1300-05 Corporation Building, Spring street, between Seventh and Eighth streets, Los Angeles.

* * *

Captain Thomas Harold Messer, C. E., U.S.A., retired, announces that he has resumed private practice as consulting engineer, with executive offices in the Mills building, San Francisco, California.

* * *

Architect W. C. Hays and wife, of San Francisco, will leave this month for Europe, where Mr. Hays will study architecture and travel for eight months.

* * *

Architect Samuel L. Hyman recently enjoyed a trip East with Mrs. Hyman, going to New York by way of the Grand Canyon and returning via Atlanta, Georgia.

* * *

Architect A. B. Rosenthal, of Los Angeles, has moved from the Douglas building to the Junior Orpheum building, Los Angeles.

* * *

Architect Lewis P. Hobart, of San Francisco, has returned from Honolulu, and while there he was instructed to proceed with the working drawings for the memorial natatorium in accordance with his design that was recently awarded first prize.

Oakland Apartment Houses

Mr. L. H. Ford, 306 14th street, Oakland, is preparing working drawings for three brick apartment houses, each building to have 23 apartments of two and three rooms, to be erected on 14th street, Oakland, at a total cost of \$200,000. The buildings will be constructed on the unit plan, each structure covering ground area 60 x 165.

Architect to Build Flats

Architect C. O. Clausen is the owner and architect of a \$14,000 residence flat building to be built on 19th avenue, south of Cabrillo street, San Francisco. Mr. Clausen is also designing some residence flats for Mr. S. T. Fisher, to be built in the same locality.

Branch Bank Building

The Bank of Italy will erect a \$40,000 branch bank building at Telegraph avenue and 49th street, Oakland, from plans by Architect H. A. Minton.

San Francisco Chapter Banquet

The regular meeting of the San Francisco Chapter A. I. A. was held at the Architectural Club rooms, Thursday night, September 21st. Being the first meeting after the summer vacation, it took the form of a dinner in honor of Mr. Wm. B. Faville, who was recently elected president of the American Institute of Architects. About sixty members were present, including a few guests.

Mr. Ernest Coxhead presided as toastmaster and chairman, in the absence of the president of the local Chapter, Mr. G. A. Applegarth. A congratulatory speech was made by Mr. Harris Allen in behalf of the Chapter, to which Mr. Faville responded with a clear and concise statement outlining the program of the Institute for the coming year, and urging the co-operation of all members in the work proposed, all of which is constructive and educational in character. Speeches were also made by Mr. T. Paterson Ross, Mr. W. B. Gray, Mr. Arthur Mathews, to whom was awarded this year the Institute gold medal for his mural decorations; Mr. George B. McDougall, State Architect; Mr. John Reid, Jr., City Architect; and Mr. James Reid.

Mr. George W. Kelham was nominated for President of the Chapter for the incoming year.

Has Much Residence Work

Architect George E. McCrea, 369 Pine street, San Francisco, has quite a little residence work under way. Plans have been completed for a new home in the Lakeshore District, Oakland, for Mr. Donald Robertson, also for alterations and additions to the residence in Edgewood road, San Francisco, of Mr. C. H. Sooy, and a large country house near Watsonville. Mr. McCrea has just completed plans for a convent and parochial school to be erected on Lakeshore avenue, Oakland, for the parish of Our Lady of Lourdes.

Apartment House

Architect Albert Schroepfer, Nevada Bank building, San Francisco, has completed plans for a three-story frame apartment house to be built at 15th and Dolores streets, San Francisco, at an estimated cost of \$30,000. Mr. Schroepfer has also completed drawings for extensive alterations to a lodge building for the Soo Yuen Benevolent Association.

Astoria Hotel

Architects Tourtelotte and Hummel, of Portland, have completed plans for an eight-story concrete and terra cotta hotel to be built at Astoria, Oregon, at a cost of \$200,000.

Roger Bailey Wins Paris Prize

Mr. Roger Bailey has been awarded the Paris Prize of the Society of Beaux-Arts Architects as a result of the competition at the headquarters of the Beaux-Arts Institute of Design in New York.

Mr. Bailey's home is in Rochester, N. Y. He graduated from Cornell University in 1919 and has been employed in the offices of John Russell Pope and A. L. Harmon in New York. Mr. Bailey worked under Patron E. V. Meeks of the School of Fine Arts, of Yale University.

The program called for a city hall which had the requirements never before demanded in practice. Realizing that important cities in the country were now called upon to receive in a dignified manner frequent visitors of distinction, even kings and queens, the program demanded either a separate building or that a distinct portion of the large building be given to great suites of reception rooms, and that the administration should be housed in close connection with this. The plot was 400 x 800 between important avenues, and half of this space was to be kept free to give a setting to the buildings and place for large crowds to congregate at the times when distinguished visitors were received by the municipality.

Historic Building for California

The remains of the historic Norland Hall, near Halifax, in Yorkshire, England, are being transported to San Francisco, where the castle will be reconstructed on the estate of a local capitalist, according to dispatches received from Liverpool and published in the daily press. The building was shipped on the American-Hamburg steamship Virginian, which sailed from Liverpool, September 7th. The name of the consignee has not been announced. The original hall is nearly five centuries old, being built about 1450. It is a half-stone and half-timbered homestead, and has long given picturesque distinction to the hillside overlooking the Calder Valley in England. In the summer of 1914 the hall was torn down for the purpose of storing the parts away, but the intervention of the war caused the project to be abandoned. Packed carefully into crates on their way to America now are old stones weighing several hundredweight, carved oak panelings, a massive stone fireplace dated 1672, an oak gallery, friezes, pillars, and many other unique and historic features of the old dwelling.

Residence Garden

Mr. Emerson Knight, San Francisco landscape architect and engineer, is preparing plans for the new residence garden for Mr. Edward James Henderson at No. 120 Sea Cliff avenue, in Sea Cliff, San Francisco.

Small House Bureau

The North Pacific Division of the Architects' Small House Bureau, Inc., held its first meeting to perfect its organization on September 12th. The following members of the Washington State Chapter were stockholders at the time of the incorporation: Messrs. B. Marcus Pretica, Herbert A. Blogg, Ernest V. Price, Roy S. Mason and Charles H. Alden.

Officers were elected as follows:

President—Charles H. Alden, Seattle.

First Vice-President—Ellis F. Lawrence, Portland.

Second Vice-President—Ernest V. Price, Spokane.

Secretary—Charles D. James, Portland.

Treasurer—Wm. G. Purcell, Portland.

Addition to Hotel Whitcomb

An additional wing is to be built to the Hotel Whitcomb, and Architect Myron Hunt, of Los Angeles, has been called in by Mr. D. M. Linnard, the lessee, to collaborate with Architect George Rushforth, who, with the late George Alexander Wright, prepared the original plans for this hostelry. It is proposed to change the facade of the hotel to a style that will be more in keeping with the Civic Center buildings.

New Jewish Synagogue

The congregation Emanu-El, of San Francisco, has purchased a site for a new synagogue, school and community center at 5th avenue and Lake street. The present synagogue on Sutter street, between Powell and Stockton streets, is one of San Francisco's landmarks, and was restored after the fire. The original plans for this edifice were made by the late Albert Pissis.

Architects Move

Architect William H. Toepke has moved from 942 Market street, San Francisco, to the Call building.

Architect Paul V. Tuttle has opened an office in Room 25, at 357 12th street, Oakland. He will retain his Pacific Grove connections as a branch office.

Fresno Hotel

Plans have been completed by the R. F. Felchin Company and H. Rafael Lake, associated, for Fresno's new million-dollar hotel, which is to be called the Californian. Contracts for the construction of the building will be awarded during the present month.

New School for Colma

Plans are being prepared by Architect John Reid, Jr., First National Bank building, San Francisco, for a gymnasium, auditorium and classroom building at Colma for the Jefferson Union High School District. Bonds amounting to \$125,000 have been voted.

With the Engineers

CONTRACTOR AND ENGINEER

Understanding Engineers Trust

By HAROLD THACKREY in A. G. C. Constructor

THERE is a recent movement to secure closer relations between the engineer and the contractor. The closer the co-operation, and the better the contractor and the engineer understand each other's problems, the more satisfactory the finished product will be, and, finally, the less the contractor will be forced to bid to cover the uncertainties due to the acts of God and the engineer.

There are two sides to every question. A young engineer just graduated from college is very likely to consider that the only way to handle a construction job is to see that the contractor conforms in every detail to the plans and specifications, with no regard whatever for the changes and modifications that are necessary to make the application of the plans practical. On the other hand, the contractor is very apt, unless he has had long experience and is honestly trying to get a satisfactory product, to disregard the intent of the plans in order to save a little time or money. Neither of these attitudes is conducive to good construction work.

There have been many articles published recently condemning the technical schools for the narrow viewpoint the technical graduate holds when he first emerges from the influence of the classroom. Only a short time ago, at a meeting of the deans of the technical schools, a program was outlined to lengthen the period of education of the engineer, the extra time to be used to give the engineering aspirant a knowledge of cultural studies and business economics that has been impossible with the high standard that the technical courses have been required to maintain. This is the first step in the right direction.

It has long been the custom of practicing engineers to place the recent graduate on a job as the inspector. As a result, the first training the embryo engineer receives is without immediate or adequate supervision, and gives him a great deal of responsibility. Not having had the practical experience necessary for efficient prosecution of construction work, he may get the idea that the contractor is trying to resort to sharp

practices and become suspicious. Unless he is usually more than well balanced, he is not competent to distinguish between practical and theoretical methods of prosecution of the work. His ideas, based on four years of boning in the classroom, are inclined to be theoretical, and, in the absence of competent advice are likely to become set, and there have been instances where the contractor has taken advantage of this inexperience to slip something over that would not have passed a more experienced inspector.

One thing that a young engineer is quite likely to overlook is that a set of specifications is to be used as a guide and not as a text book. Specifications are written airtight, or should be, in order to protect the quality of the work performed, and to give the owner, who is paying the bills, protection from unscrupulous or careless workmanship. They are primarily intended to serve as a guide to the general conduct of the work, and are written to cover the most drastic conditions that may be expected to arise; they are intended to cover any contingency, but must be used with judgment and the full penalty exacted only as a last resort.

The contractor who is honestly trying to do a workmanlike job should be given the full benefit of every doubt. He has a great deal at stake, and small delays due to over-zealous inspection not only cause him unnecessary expense but tend to disrupt the efficiency of his organization, with the consequent lowering of the standard of workmanship on the subsequent part of the work. On the other hand, if the contractor continually tries to cover up mistakes or intentionally lowers the quality of materials used, the sooner he is put off the job and "busted" the better for everyone, including the reliable contractors.

Mutual co-operation is the only way to obtain a good piece of work. The engineer inspector must be able to recognize that a contractor is entitled to profit on every contract if consistent with good workmanship. On the other hand, the contractor must recognize that the engineer has a responsible duty to perform. A frank discussion, with the successful completion of the job always as the ultimate object, will be beneficial, but there must be present the spirit of co-operation and the desire to see the other fellow's side.

Engineers Condemn Proposed Water and Power Act

The San Francisco Chapter, American Association of Engineers, has unanimously voted disapproval of the proposed California Water and Power Act.

This action followed the report given by the special committee appointed last February to make a thorough investigation of the measure. This committee consisted of Messrs. J. J. Rosedale, chairman, construction engineer; E. E. Carpenter, consulting engineer; Chas. H. Lee, consulting hydraulic engineer; George Mattis, consulting engineer; Donald M. Baker, hydraulic engineer.

The report set forth the following conclusions concerning the Act, which were endorsed by the Chapter:

First: That the Act is not needed.

Second: That the State, operating under the proposed Act, could not permanently furnish power to consumers more cheaply than privately owned utilities.

Third: That the workability of the Act is open to serious question.

The report further emphasized the points that the Act would prove a dangerous instrument by creating a "one man power" board, with unlimited opportunities for political activities, and involves the principle of unjust taxation since all the people of the State must pledge full faith and credit for the payment of interest and principal of bonds which would benefit only local areas.

Hospital Competition

To obtain for the typical small community in America a hospital building which is at the same time efficient in arrangement and creditable in architecture, The Modern Hospital, published in Chicago, has recently issued the formal program of a prize competition, open to all architects. Prizes amounting to \$1000 are to be given to successful contestants, and although certain definite requirements are set forth in the program, the avowed intention of the competition is to bring out new thought in hospital construction.

The Illinois Chapter of the American Institute of Architects, to which the general program of the competition was submitted, has approved it as to form and method of procedure. Richard E. Schmidt, of the firm Richard E. Schmidt, Garden and Martin of Chicago, is the architectural adviser. The jury of award is to be composed of two architects, two hospital superintendents and a graduate nurse, who has had experience as superintendent of a small general hospital.

The competition calls for a set of plans of a general hospital of from 30 to 40 beds. Registration for the contest must

take place on or before November 15, 1922, and the final date for submitting designs is January 15, 1923. The general program of the contest may be had by addressing the Chicago office of the Modern Hospital, and mentioning this magazine.

Finding the Right Engineer for the Place

The American Association of Engineers is about to undertake one of the most significant investigations that has to do with engineering training and employment. An analysis is to be made of engineering positions to determine just what qualifications are required, what qualifications the engineer should be expected to obtain in early training, and what he should have gained in practical experience. The practical value of this work is evident. It will help put the right man in the right place. The Association has appointed a committee, and as chairman of this committee has selected Mr. A. B. McDaniel of Washington, D. C., who has made an enviable record in the classification of industrial positions. The committee is assured of the hearty cooperation of Dr. C. R. Mann, who prepared the report on engineering education for the Carnegie Foundation, and who has given so much attention to the requirements of engineering training and of the government departments employing large numbers of engineers. The results of this investigation cannot be other than of the utmost value to those in charge of engineering education, as well as to organizations requiring the services of large numbers of engineers.

Harvey Hubbell Electrical Specialties

Harvey Hubbell, Inc., manufacturers of electrical specialties, Bridgeport, Conn., and represented on the Pacific Coast by Gannett, Young and Co., 612 Howard street, San Francisco, have ready for distribution to architects and others interested in electrical specialties a series of useful booklets or circulars prepared by Rickard and Company, New York. All the leaflets are profusely illustrated, their titles being as follows: "Hubbell Shade Holders," "Hubbell Te Taps," "Hubbell Brass Shell and Candle Sockets," "Hubbell Plugs." Referring to the convenience of Hubbell Te-Slots, one of the circulars reads: "A wiring device equipped with Hubbell Te-Slots is always ready to take any standard attachment plug cap, whether its blades are parallel or tandem. Double springs grip each cap blade on two sides; live contacts cannot be reached except by the cap blades; any spark at make or break is concealed. The Te-Slot is a Hubbell invention—its excellence is typical of all Hubbell products."

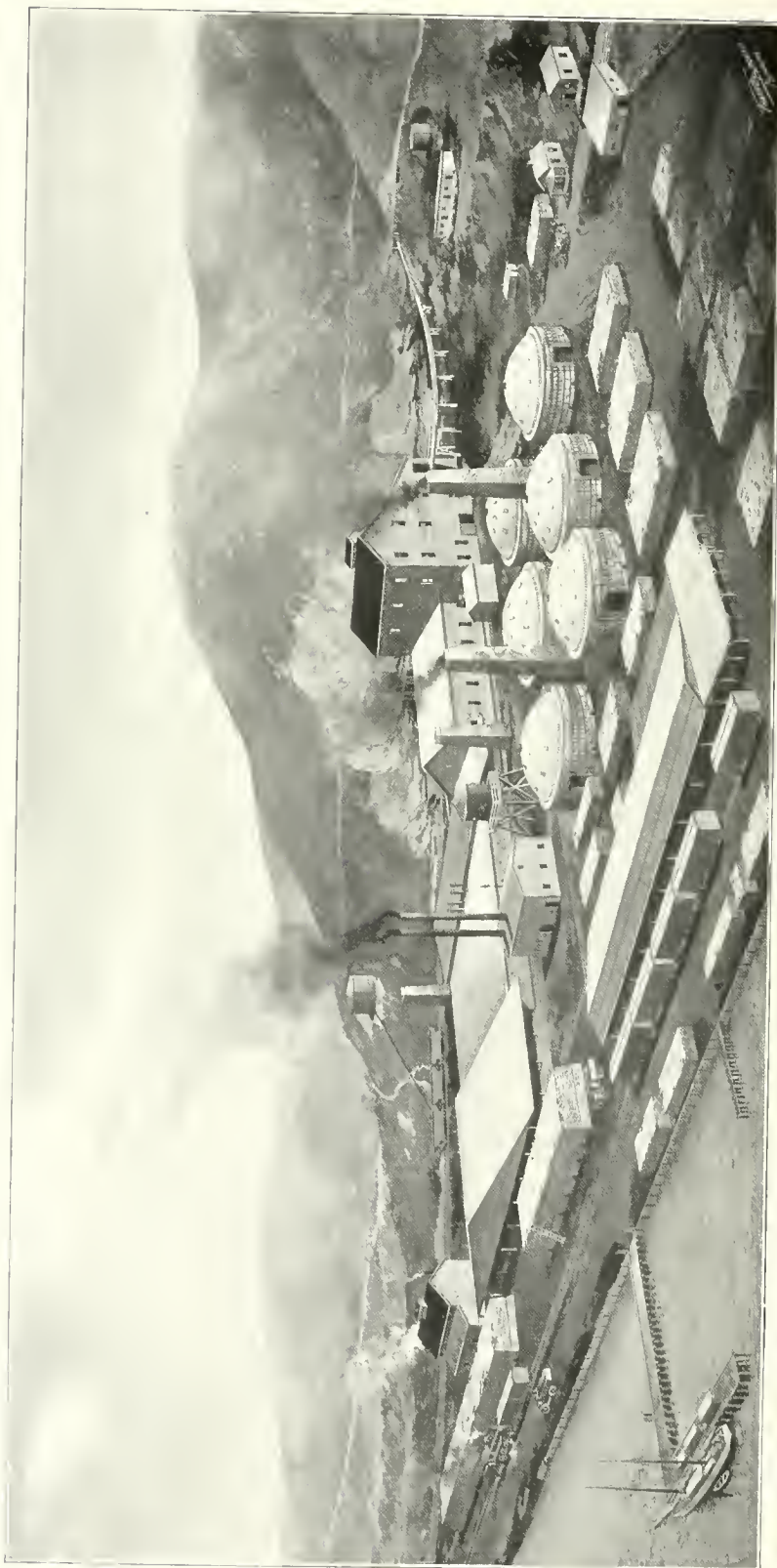

PLANT OF RICHMOND PRESSED BRICK COMPANY, RICHMOND, CAL.

Richmond Pressed Brick Company

Of San Francisco's many thrifty industries probably none has shown greater expansion in the last year or two than the Richmond Pressed Brick Company whose general offices are in the Sharon building, and manufacturing plant at Point Richmond, Contra Costa county. The Richmond yards were originally established as the Northern California branch of the Los Angeles Pressed Brick Company. This was in 1906. Only common brick were manufactured then, the kilns having a capacity of about 10,000,000 brick annually.

In 1910 the plant commenced to make pressed brick and the demand for this material increased so rapidly that the manufacture of common brick was curtailed and the management concentrated its efforts perfecting a high grade face brick. That it has achieved success is evidenced by the continued growth of the company. The business in 1921, despite the general building depression, was the largest in the history of the plant. The present annual output of the company is from 5,000,000 to 10,000,000 pressed, common and fire brick, building tile, etc. The Old Homestead Bakery, Howard and 19th streets, the Hughson garage on Market street and the Rosenberg apartment house at Taylor and Geary streets, San Francisco, are examples of recent Richmond Pressed Brick installations.

Officers of the company which was incorporated in April 1920, are: president, Mr. S. W. Smith; vice-president, Mr. Howard Frost; secretary and treasurer, Mr. W. S. Hoyt.

Larger Show Room

The C. B. Babcock Company have enlarged their display floor at 768 Mission

street, San Francisco, and will have a complete display of modern and efficient gas burning appliances, including Humphrey Radiantfires, Roper gas ranges, gas boilers and practically every kind of merchandise pertaining to the gas industry.

Inspection of this display by architects, contractors and builders is invited.

New Line of Kennedy Malleable Fittings

The Kennedy Valve Manufacturing Company has acquired and equipped an entirely separate and independent plant for the manufacture of Kennedy Malleable Pipe Fittings exclusively. This new plant, known as No. 2, covers 15 acres and has 40,000 square feet of floor space in the main foundry building alone. The new annealing furnaces and tapping machines which have been installed are the very best to be had, and a rigid inspection service will further make sure of uniformity of metal and finish in the product.

Kennedy fittings are therefore made under ideal conditions—in the light of thorough knowledge and 45 years' of experience, and with the very latest and special equipment for the purpose.

Kennedy malleable fittings will be sold through plumbing and steam supply jobbers, who will be able to obtain any particular size and type of fitting on short notice from the well stocked warehouses and supply depots which are maintained at San Francisco and close to other large industrial centers.

This new product helps to round out the big Kennedy line of almost 600 different types and sizes of valves for various purposes, including low and high pressure steam and water lines.

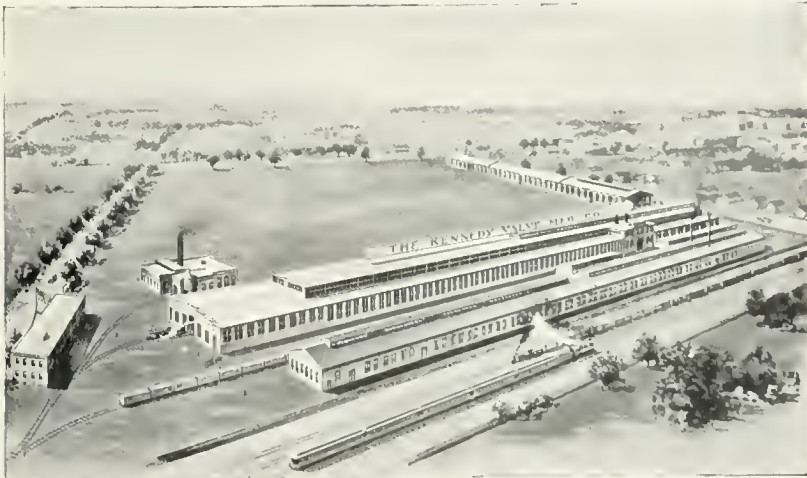

PLANT OF THE KENNEDY VALVE MANUFACTURING COMPANY

The Contractor

Skill, Integrity and Responsibility

*Better Co-operation Between Contractors and Engineers.**

By C. H. McALLISTER.

IT is the aim of the responsible contractor to do reliable, skillful and honest construction, satisfactory to the owner and his representative, the engineer—creditable, as well as profitable, to the contractor himself.

The relationship between the owner and the contractor should be one of mutual responsibility and of close co-operation, by which the interests of both can best be served; and, by the promotion of this co-operation, the responsible contractor (through the work of the A. G. C.) seeks to avoid, as far as possible, differences of opinion, opportunities for misunderstandings, and very often expensive law suits. All of these not only breed suspicion of the contractor in the mind of the engineer, but result in the writing of specifications, so full of one-sided clauses, restrictive beyond reason, that the contractor is encouraged to gamble—if he bids at all—adding an unreasonable amount for contingencies, which he fears may arise in carrying out a contract in which the engineer has reserved unto himself arbitrary authority and has decided in advance questions concerning responsibility, which very often arise through the design of the structure or the written provisions for its construction.

The Associated General Contractors of America knows that the irresponsible contractor is largely to blame for such restrictive clauses in specifications and that this is particularly true of public works contracts. There is in this Association a determination to eliminate conditions which encourage irresponsibility, embracing as it does unfair practises, defective work, deliberate violation of agreements, etc., etc. This Association proposes to set up a plan for the promotion between owner and contractor of that relationship of mutual responsibility which will insure the elimination of unfairness and establish that co-operation which will ultimately result in a saving of time, money and temper to both parties of the contract.

It is this which the Associated General Contractors of America has in mind in presenting this matter to you today for discussion, requesting of

*Paper read at luncheon meeting of the Cleveland Engineering Society, April 14, 1922.

the engineer his co-operation in this important undertaking, believing that the engineer is also vitally interested in the elevation of the construction industry.

The first step is the standardization, as far as possible, of specifications, particularly of those general clauses which either mean so much or so little.

Plans should be clearly drawn and should be complete before they are given out. The opportunity for disputes because of additions, eliminations or deductions should be reduced to a minimum.

Borings or test pit excavations should be made and the results published by the engineer. It is the general practice to make borings, exhibit them, and then disclaim responsibility. There is more trouble in connection with foundation work due to lack of reliable information as to soil conditions than there is with any other class of general construction; and, while we realize that the present hit or miss method of making borings is very unsatisfactory and misleading, we believe that borings can be made or test pits dug which will fairly represent undersurface conditions. This information will in itself tend to eliminate the opportunity to gamble and to prevent unbalancing of bids, saving many times over the cost of the preliminary investigation, besides giving the engineer himself reliable information from which to accurately design the important substructure and save numerous revisions to his plans as originally submitted for competitive bids.

Of course it will be said that the bidder is notified to carefully examine the site of the work and satisfy himself by borings or test pits as to the conditions existing. The time allowed for the preparation of bids is usually of short duration; and, even should the responsible contractor wish to make these borings, it is likely that he would need official permission to make them on public property, particularly on streets and highways. We hold that the furnishing of this information should be as much a part of the owner's duty, as is the furnishing of the plans and specifications governing the construction of the work.

In examining plans and specifica-

STANLEY

Ball Bearing Butts

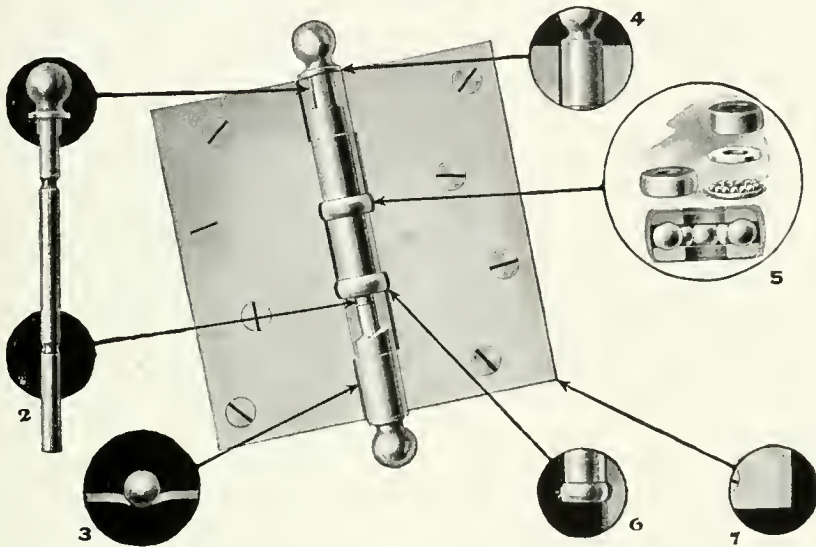

Seven Distinctive Features

1. Non-rising Loose Pins.
2. Self-lubricating Pins.
3. Beveled Edges.
4. Square Shoulders.
5. Stanley Ball Bearing Washers
6. Non-detachable Washers.
7. Square Corners.

The Stanley Works was the original designers and manufacturers of Ball Bearing Butts. In addition to the Seven Distinctive Features the class number is stamped upon the back of each Butt for identification. The letter "Z" stamped on the back of the Butts distinguishes the Stanley Sherardized Finish—an antirust finish recommended for all steel Butts exposed to the weather. When specifying remember The Seven Distinctive Features of Stanley Ball Bearing Butts.

Write for "Detail Manual, AE-10"

THE STANLEY WORKS

NEW BRITAIN, CONN.

New York Chicago San Francisco Los Angeles Seattle

*Manufacturers of
Wrought Hardware and Carpenters' Tools*

San Francisco, Monadnock Bldg.

Seattle, 501 Maynard Bldg.

Los Angeles, 703 Washington Bldg.



A. QUANDT & SONS

ESTABLISHED 1880

PAINTERS AND DECORATORS

SAN FRANCISCO
LOS ANGELES

Office and Shop
374 GUERRERO STREET
San Francisco
PHONE MARKET 1709

tions before the submission of a bid, the responsible contractor generally designs a plant layout for the handling of the work. Of necessity he must use the approximate quantities which are submitted to him as a part of the specifications for the design of a plant layout. Consider how he must necessarily gamble on this large item alone, if he is furnished with quantities which are not approximate. Of course, we realize that a statement of quantities must be approximate, but they should vary only by a small percentage. Many instances could be cited to show the unreasonable expense to which contractors have been placed through the failure on the part of the owner and his representative, the engineer, to give the bidders this information at the time of requesting the bids. When the engineer realizes that the bidder's estimate depends so largely upon the correctness of the quantities given, and that these are not only for the purpose of a comparison of bids but are so essential to the responsible contractor in preparing his bid, we are sure he will then consider it of great importance to himself, as well as to the bidder, to have these quantities as nearly correct as it is possible to get them. Specifications, of course, contain clauses advising the bidder to satisfy himself as to these approximate quantities, some specifications even placing upon the contractor the obligation of checking the plans and specifications and imposing upon him the duty of notifying the engineer of errors of omission or commission. It is unreasonable to expect the contractor with his engineering working force to do in a few weeks what it has taken the owner's engineering force several months to do. If a responsible contractor took cognizance of all such clauses, it would mean the employment by him of an engineering office force, the cost of which, added to his overhead, would mean his inability to compete against the irresponsible contractor for any work at all.

The co-operation of the engineering fraternity is earnestly requested in the standardization of general clauses of specifications. It is our desire to eliminate clauses which are restrictive, indefinite, and which would probably tend to promote serious misunderstandings. It is also our desire to have clauses which definitely restrict the irresponsible contractor from prosecuting his work in an unskillful manner and attempting evasion of clauses covering honest construction. We believe that there is a necessity for intelligent and trained supervision, and realize that a favorite clause in specifications which provides that the contractor shall make good any defects, even though the work has been inspected, could be strengthened to the advantage of both parties by providing that the owner shall furnish competent inspectors, rather than men who get positions because of political influence. An inspector of experience and engineering training who is fair minded is often able to adjust without a wrangle questions, the settlement of which in the hands of an incompetent representative of the engineer in charge would cause trouble between the engineer and the contractor.

Many specifications covering public works construction provide restrictions on the contractor in relation to his employees. These clauses restrict the contractor to the number of hours which shall constitute a day's work and a week's work, and also provide a minimum rate of pay. Despite the fact that such restrictive clauses are made a part of the contract, some contractors are permitted to openly violate them, while others are held strictly to their enforcement. If incorporated communities recognize the law covering such restrictions and embody them in their specifications, it is fair to those contractors who have submitted bids for such work and who intend to live up to these clauses, that these communities should also

FOR CONVENIENCE—COMFORT—SAFETY

Use AUTOMOBILE TURNTABLES in the private garage.

We manufacture all types and sizes.

Write us for specifications and prices.

Telephone Kearny 1773

EDWARD O. TEALL

324 Main Street, San Francisco.

ATLAS WHITE FINISHES

THE success of the stucco house is influenced as much by the permanence as by the beauty of its surface.

Atlas White is a true Portland Cement varying in no way from Atlas Gray Portland Cement except that it is a pure white. In using Atlas White, the architect secures an absolute permanence to whatever texture he chooses. Architects can obtain detailed information about the various types of stucco finish on request. The Technical Department of this company welcomes every opportunity to aid in securing better building practice.

For over a quarter century Atlas Portland Cement has been deservedly known as "the Standard by which all other makes are measured."

The reproduction shows a finish obtained by throwing a rough coat on and smoothing the high parts with a steel trowel. The strength of Atlas White Portland Cement, properly applied, insures the permanence of this pleasing effect.

THE ATLAS PORTLAND CEMENT COMPANY

NEW YORK — BIRMINGHAM
CHICAGO
Boston Philadelphia St. Louis
Dayton Des Moines
San Francisco



When writing to Advertisers please mention this magazine.

act when these clauses are disregarded.

We are pleased to note that several specifications which have recently been issued contain a clause covering arbitration. The American Institute of Architects and the Federated American Engineering Societies recognize the principle of arbitration in their present standard building contract form, and we believe that this is one of the most vital matters which have come to our attention in connection with our study of the relation between owner and contractor. No fair-minded engineer questions the right of the contractor to present his side in a dispute, who would gladly submit his case to a board of arbitration as provided for in a contract, unless he willfully intended to evade his responsibility. We are therefore in favor of embodying in the general clauses of the contract a provision for arbitration which will provide for a settlement, as far as possible, of all disputes which may arise in the interpretation of the specifications or in the execution of the contract.

We believe that specifications covering the proportioning of the aggregates used in mixing concrete should be simplified and strengthened. The responsible contractor bases his estimate on the use of satisfactory material; the irresponsible contractor generally figures on the cheapest material it is possible to buy, regardless of its quality, and hopes by some means to have this material passed if he secures the contract. Because of the conditions existing at different places, as far as variety of materials is concerned, specifications should definitely cover the quality desired by the owner, and there should be no opportunity for the irresponsible contractor to become misled through the specifications. It should be the duty of every reputable engineer to thoroughly investigate the quality of the materials available for his work, so that he may definitely specify what is to be used. The specifications covering the proportioning of the aggregates should be carefully drawn. Many times expensive cement is wasted, because of the indifference of those interested in the proper proportioning of the aggregates. If this was given careful attention, the reputable building supply dealers in the various communities would of necessity have accurate information for the contractor as to the weight of the aggregates per cubic yard, the percentage of voids contained in such commodities as gravel, crushed stone and slag, and would also furnish through their sales department a report on the character and quality of the material.



CLEVELAND DISCOUNT BUILDING

Walker & Weeks, Architects

CLEVELAND DISCOUNT CO.

CLEVELAND, OHIO

equipped with

Frink Reflectors

including

**Continuous Bank Screen Reflectors
Special Concealed Reflectors for
General Illumination**

Our Engineering Department is co-operating with the leading architects in laying out and designing the lighting of prominent buildings thruout the country. We hope we can be of service to you.

"Specify Frink Reflectors"

I. P. FRINK, Inc.

SAN FRANCISCO, CAL.,
77 O'Farrell Street

24th Street and 10th Avenue,
New York

Chicago, Ill.
Monadnock Bldg.
Boston, Mass.
161 Summer St.
Detroit, Mich.
325 State St.
Cleveland, Ohio
336 The Arcade

Seattle, Wash.
609 Seaboard Bldg.
Philadelphia, Pa.
Franklin Trust Bldg.
Cincinnati, Ohio
17 Greenwood Bldg.
Louisville, Ky.
415 West Main St.



Interior, Fidelity Trust and Savings Bank, Chicago, Ill. A. H. Andrews Company, Architects. Wallpanels, pilasters, columns, entablature and counter screens in ivory matt glazed Terra Cotta.

RICHNESS, ECONOMY, DIGNITY

These three essentials are realized in the use of Terra Cotta for interior finish.

Richness of repeating ornament involves no costly hand carving, as each unit is pressed in moulds cast from an original model.

Economy in maintenance is also assured. The impervious surface will not absorb stains and is easily cleaned with soap and water. No repolishing is required under any lapse of time.

Dignity is an imperative need in the interior finish of an important banking institution. Few instances could be more exacting than the example shown.

For information address National Terra Cotta Society, 19 West 44th Street, New York, N. Y.

TERRA COTTA

Permanent

Beautiful

Profitable

Perfect Wall Bed Concealment

San Francisco builders are displaying keen interest in a new device for the perfect concealment of wall beds, developed by the California Wall Bed Company.

In collaboration with the leading architects of San Francisco, the California Wall Bed Company has worked out a system of concealment to the point where one may walk up to the side of a wall, touch a small ornamental fixture, and a portion of the wall swings open as if by magic, displaying the bed ready to lower for a comfortable night's rest.

In a room already crowded with doors and windows, architects and builders have been confronted with the problem of placing an additional opening for a wall bed. The "California" secret installation solves that problem and at the same time conforms to the most modern ideas in wall decoration. It is simple in construction and takes but a depth of 22 inches closet space in a room.

This installation is on display at the enlarged salesroom of the California Wall Bed Company at 714 Market street, San Francisco, and at 165 13th street, Oakland. Architects and their clients are welcome.

The Minwax Protective Products

The desirability of beautifying the exterior surface, the appearance of a structure, and of waterproofing and protecting this surface at the same time is the problem of most architects and engineers.

Minwax products, for standardized structural protection, have for years been popular, and their sales have been increasing steadily. In recent Government tests Minwax proved its superiority over other types of dampproofing and waterproofing.

The Minwax Company has developed a system of protective products for nearly every type of construction, the most important being: Vault light and expansion joint cement, metal coatings, clear waterproofing, brick and cement coating, concrete floor finish, plaster stains and sub-level dampproofing. The basis of these products is Minwax—a mineral wax derived from a naturally occurring asphaltic material, by methods which retain all the natural values. With Minwax itself as a base, the Minwax system of standardized structural protection has been worked out—a series of products each designed to meet specific conditions in the structural world, and each representing a combination of skill and high-grade materials conforming with definitely known factors.

A booklet on Products, Data and Specifications will be sent upon request. The Pacific Coast offices of the Minwax Company are at 22 Battery street, San Francisco, and 653 S. Clarence street, Los Angeles.



*By the Grace of
Window Glass*

THE Architect can be the great physician. His only medicines are sunshine and air, cheap and most wonderful of remedies. Doctors cure human ills but the architect can, in great measure, prevent them.

The liberal use of window glass has made possible a degree of sanitation approaching perfection. Of all rooms in the house the bedroom should have the largest area of glazing in relation to floorage. There is a growing demand for sunshine by day and plenty of air by night.

When drawing up specifications, to insure the utmost satisfaction, specify *American Window Glass* and not just glass. *American Window Glass* is double-inspected and on each box appear the grade markings which identify the quality.

Bear in mind that our grading is higher, our B grade being the equal of other A grades and our A grade correspondingly superior. Clarity, surprising evenness and uniformity are points about *American Window Glass* which make for strength and beauty. Let the sunshine in. Specify *American Window Glass*.



AMERICAN WINDOW GLASS CO.
GENERAL OFFICES: PITTSBURGH, PA. BRANCHES IN PRINCIPAL CITIES

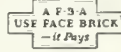

Detail of House, Oyster Bay, N. Y., Carrere & Hastings, Architects

The architects have not been hampered for money in working out their designs for this noble structure, in which the very genius of brick, as the fired clay of the all-supporting earth, has been embodied. Unfortunately the half-tone does not reproduce the exquisite color blending of the brickwork.

Variety of Effects in the Face Brick Wall

THE many beautiful Face Brick walls—in residences, in commercial, industrial and public buildings—that are built every year indicate the infinite variety of effects obtainable by the architect in the use of this plastic material.

The great variety of color tones and textures in the material itself, the arrangement of the units in various bonds, the innumerable patterns obtainable by shifting the headers or stretches in successive courses back and forth,

and the color, texture, and kind of mortar joint, all contribute to extend the artistic possibilities of the Face Brick wall.

The Portfolio of Architectural Details in Brickwork shows more than a hundred examples of beautiful brickwork—all in standard size brick. These de luxe half-tone plates are assembled in three series, each in an enclosed folder, with printed tab, ready for filing. A set of these folders will be sent to any architect requesting them on his office stationery.

AMERICAN FACE BRICK ASSOCIATION

1759 PEOPLES LIFE BUILDING · CHICAGO, ILLINOIS

Opens San Francisco Office

Architects and the plumbing trade in San Francisco will be interested to know that the All-In-One Plumbing Fixture Corporation has opened offices in the Hobart Building. The telephone number is Douglas 8231. The company's factory is in Sacramento, and heretofore all business has been transacted through the Sacramento office in the Osehner building. By establishing San Francisco connections the management will be in position to give better service to customers, making prompt deliveries from stock carried in local warehouses.

Moves to New Offices

Mr. Charles T. Phillips, consulting engineer, has moved from the Pacific building to the Bank of Italy building, 550 Montgomery street, San Francisco. Mr. Phillips' change of location was necessitated by a demand for larger quarters, the result of a constantly growing clientele. Mr. Phillips has been called in as consulting engineer on a number of important buildings, his work embracing the laying out of the electrical equipment, illumination, heating and ventilating in such prominent structures as the Bank of Italy, Matson Office building, and Elks Lodge Hall, Santa Rosa.

Large Reinforcing Steel Orders

One of the largest orders for reinforcing steel to be taken by a San Francisco supply house the past month was a contract for 900 tons of steel bars for the Municipal Filtration Plant, Sacramento, by the Truscon Steel Company, Mr. Charles Holloway, Jr., branch manager, 527 Tenth street, San Francisco. The contract amounts to \$65,180. Mr. Holloway also secured for his company the past month an order for the reinforcing steel on the 18-story Tribune building, Oakland, Mr. Edward T. Foulkes, architect, and the seven-story Providence Security building on Market street, San Francisco, Messrs. Willis Polk and Co., architects. The Truscon Steel Company also has closed a contract to furnish 200,000 square feet of removable steel forms for the new 16-story Matson building, Market and Main streets, San Francisco.

What a Dime Will Do, Electrically Speaking

Some one with a penchant for statistics has figured that a dime's worth of electricity, based on a price of 10 cents per kw-hr., will perform the following services in the household:

Operate a 16-c.p. lamp for about an hour. Operate a six-lb. flat iron for 1½ months. Do a washing equivalent to 20 sheets each week for about 2½ months. Operate a vacuum cleaner long enough to clean about 1/10 of an acre of carpet. Operate a sewing machine for 20 consecutive hours. Drive an electric fan four hours a day for nearly a week. Brew 2½ gallons of coffee in an electric percolator. Operate a heating pad for from ½ to 1 week, depending upon the heat used. Operate a foot warmer five consecutive hours. Operate a water pump long enough to raise 100 gallons 1100 feet. Make 100 slices of toast.

Hoffman Trailer Now Covered by Patents

Mr. C. F. Hoffman of the Golden Gate Iron Works, San Francisco, has recently been granted patents in the United States on a trailer which is expected to revolutionize the trailer industry. The patent consists of a steering and coupling device which keeps the trailer from swaying and whipping from side to side. By overcoming these troublesome features perfect tracking of the trailer is assured. There is said to be no limit to the number of trailers that may be coupled one to another behind the truck and in rounding curves the wheels of the trailers are in perfect line with the wheels of the truck. It is unnecessary therefore for the driver to divert his attention from the highway to ascertain how the trailers are behaving behind. They take care of themselves. Hoffman trailers are built from one to fifteen ton and are manufactured by Mr. Hoffman in his structural steel plant, 1541 Howard street, San Francisco.

Architects Shea and Shea Busy

New work in the office of Architects Shea and Shea, Chronicle building, San Francisco, includes the Santa Rosa Elks building, to cost \$250,000; the Hollister Elks building, to cost \$100,000; the gymnasium for the Young Men's Institute in San Francisco, to cost \$100,000; and a hotel in Yolo county.

**METAL
Store Fronts**

Phone Doug. 3123-1
Oak. 5050-1

GLASS OF ALL KINDS

Mirrors Art Bevel Plate

COBBLEDICK-KIBBE GLASS CO.

175 JESSIE ST.

SAN FRANCISCO, CAL.

WASHINGTON AT THIRD ST.

OAKLAND, CAL.

The ARCHITECT & ENGINEER



NOVEMBER 1922

*Published in San Francisco
50 cents a copy - \$2⁵⁰ a year*

Only one
quality
The
Best

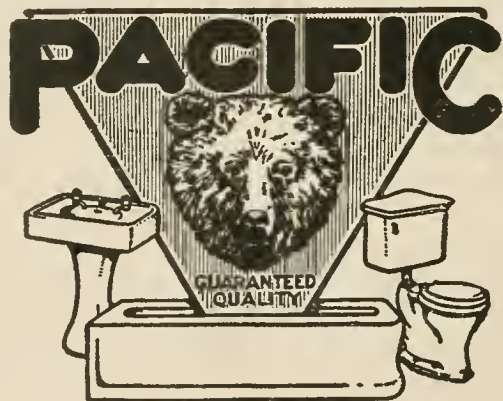

TRADE MARK REGISTERED

Specify

PACIFIC
PLUMBING FIXTURES

Pacific Sanitary Manufacturing Co.
Main Office: 67 New Montgomery St., San Francisco
Factories: Richmond and San Pablo, California



THE ARCHITECT AND ENGINEER

CONTENTS FOR NOVEMBER, 1922

HILL STREET THEATER, LOS ANGELES - - -	<i>Frontispiece</i>
<i>G. Albert Lansburgh, Architect</i>	
RECENT THEATERS DESIGNED BY G. ALBERT LANSBURGH, ARCHITECT - - - - -	Page 47
<i>Harris Allen, Architect</i>	
USE OF STONE IN BUNGALOW CONSTRUCTION - - -	69
FIRE RESISTIVE QUALITIES OF FRAME BUILDINGS PROTECTED BY STUCCO AND PLASTER ON METAL LATH - - -	70
<i>Warton Clay</i>	
TIMBERS FOR JOISTS AND RAFTERS - - - - -	74
ATROCIOUS ARCHITECTURE BEING DONE IN FRANCE -	75
SELECTIONS FROM THE RECENT CALIFORNIA COMPLETE HOMES EXPOSITION - - - - -	77
A HOTEL THAT IS WRONG - - - - -	81
<i>Louis Christian Mullgardt, F. A. I. A.</i>	
SALESMANSHIP AS IT RELATES TO THE PRACTICE OF ARCHITECTURE - - - - -	90
PAINT, ARCHITECTURALLY CONSIDERED - - - - -	91
<i>C. W. Cousins</i>	
POPULATION GAUGES NEW OFFICE SPACE - - - - -	95
<i>E. M. Applegarth</i>	
A SCRAP-BOOK OF ORNAMENT - - - - -	99
<i>William M. Tevis, Jr.</i>	
REINFORCED CONCRETE VAULT REMOVED WITH COMPRESSED AIR "PAVING BREAKERS" - - - - -	101
REFUTES OPINION THAT CONSTRUCTION COSTS WILL DECREASE - - - - -	103
EDITORIAL - - - - -	104
WITH THE ARCHITECTS - - - - -	107
WITH THE ENGINEERS - - - - -	111

Published Monthly by

THE ARCHITECT AND ENGINEER, INC.

626-27 Foxcroft Building, San Francisco

W. J. L. Kierulff
President

Frederick W. Jones
Vice-President

L. B. Penhorwood
Secretary



HILL STREET THEATER, LOS ANGELES
G. ALBERT LANSBURGH ARCHITECT

THE ARCHITECT AND ENGINEER

NOVEMBER
1922



VOL. LXXI.
No. 2

Recent Theaters Designed by G. Albert Lansburgh, Architect

By HARRIS ALLEN

UNLESS you have studied the plans of modern theaters, and then gone over the buildings themselves from top to bottom making a walking interrogation point out of yourself, you can have no conception of the tremendous amount of specialized information an architect must possess to build a successful theater, aside from the surface decoration shown to the public. The wonder is, not that a theater costs a million dollars, but that it can possibly be built for that sum.

Mr. G. Albert Lansburgh, of San Francisco, has had far more experience in building theaters than any other Western architect, and the practical perfection of his latest productions in this line shows the result of his long training. Every one of the countless details of construction and equipment that go to make up the complicated organization of these modern theaters is the last word of its kind; and the arrangement and combination of them all into a compact and convenient ensemble calls for experience, ingenuity, expert knowledge; in short, it requires ability of a high order.

No doubt his Beaux Arts training has done more for him than to give a Parisian touch to all his architectural facades and details; it has given him a facility in planning, a comprehensive grasp of the salient features of a problem. His plan develops logically and expresses clearly the requirements that enter the situation.

One is struck with his thoroughness, in comparing the attitudes of the various theater managers. These men, who with courtesy and genuine interest devoted several hours to showing me their buildings—Mr. Hart of Loew's Warfield, Mr. Work of the Golden Gate, Mr. Piazza of the Hill street—are all keen, competent executives of broad experience. Each one showed the same appreciation for Mr. Lansburgh's ful-

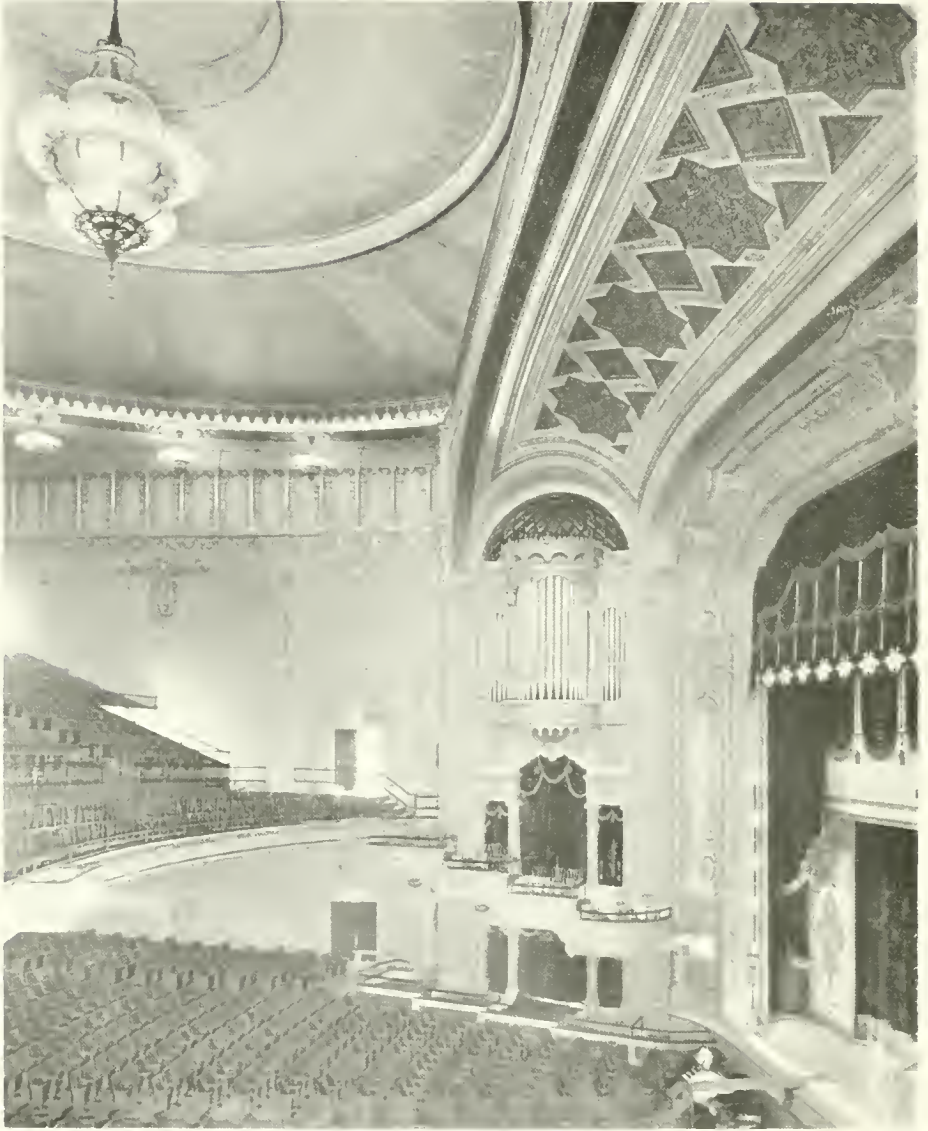

INTERIOR HILL STREET THEATER, LOS ANGELES
G. ALBERT LANSBURGH ARCHITECT

fillment of the manifold problems, and each made the same single criticism, of a minor defect that shows how little there really is to criticise—the use of push buttons to flush urinals instead of an automatic device! Of course, with the sudden rushes of people, the buttons do not get pushed, and this involves some extra work for the attendants.

A complete description of the equipment of these buildings would be too long and too technical; but I think that a brief mention of the main features will throw light on the problems presented to the architect.

First, and most essential from the present viewpoint, are the exits and fire escapes. Not only is the law fully complied with, but the comfort of the audience is exceptionally well provided for. Access from aisles to exits is ample. On each floor level there is complete circulation around house and stage. Openings to streets, alleys and building halls are numerous. The main fire escapes are easy, broad and comfortable, are enclosed in walls, as a rule, and in the Golden Gate Theater are even covered. The balconied openings which mark this particular fire escape have received much favorable comment for originality and artistic merit.

Next, the heating and ventilating system. This is very elaborate and very successful. The well-known Sturtevant method has been used in most of the buildings, in which the air is drawn in by fans, washed and cooled by hundreds of fine jets, warmed when necessary and forced into the large plenum chamber under the auditorium, and into an accessory chamber under the balcony. Large galvanized ducts deflect the current of air, by bends and turns, in order to overcome the noise of the fans. About 65,000 feet of fresh air a minute are sent into the auditorium, through "mushroom" vents in the floor under seats, avoiding any draft. Vent grilles in the ceiling at the extreme top and rear exhaust the used air by fans located on the roof, at the ends of long vertical ducts. In the plenum chamber is a dial automatically registering the temperature on a circular card, which is put each week on the manager's desk. The red line seldom runs far from the 70-degree circle; if it should, the temperature in the office would certainly rise.

Good acoustics are vital in a theater. It is interesting to follow the development of Mr. Lansburgh's studies along this line. His early experiments in improving conditions in the San Francisco Auditorium resulted in a circular cloth canopy, hung below the structural work of the octagonal dome. In the Kinema Theater at Fresno he went a step farther, and put in a coved plaster ceiling, from which was suspended a cloth canopy of dome shape. In the Golden Gate and Hill street theaters he has installed permanent canopies of plaster, preserving the flat dome shape, with painted decoration, provision for concealed lighting, and easy access from the attic space above. The result is marvelous. In the projection booth, averaging, say, 150 feet from the stage, every note of song or orchestra comes clear and true, with no echoes or discords from refracting surfaces.

The electric equipment, needless to say, is most complete and up to date. Both indirect and semi-direct lighting are used in the auditoriums.



PORTION OF MEZZANINE FLOOR, LOEW STATE THEATER, SAN FRANCISCO

Concealed lights around the cornices or canopies of the main ceilings, or behind the beams of the proscenium arches, throw varying combinations of colors during special numbers. For full lighting these throw a flood of white light, in addition to the chandeliers.

In the Hill street theater a blue "moonlight" glow is kept on the cove at outer edge of canopy, which gives ample light for finding seats or exits, and does not interfere with pictures. A similar soft lighting under the balcony comes from behind flat glass panels set in the ceiling, of pleasing shape and pattern.

The stage lighting and wiring deserves a paper to itself. The great switchboards, with, instead of knife switches, large handles colored to match lights, pushing up and down or pulling out, control every possible combination of lights, with ample space behind, screened off, giving access to the wiring. With them one man can do miracles. Wonderful

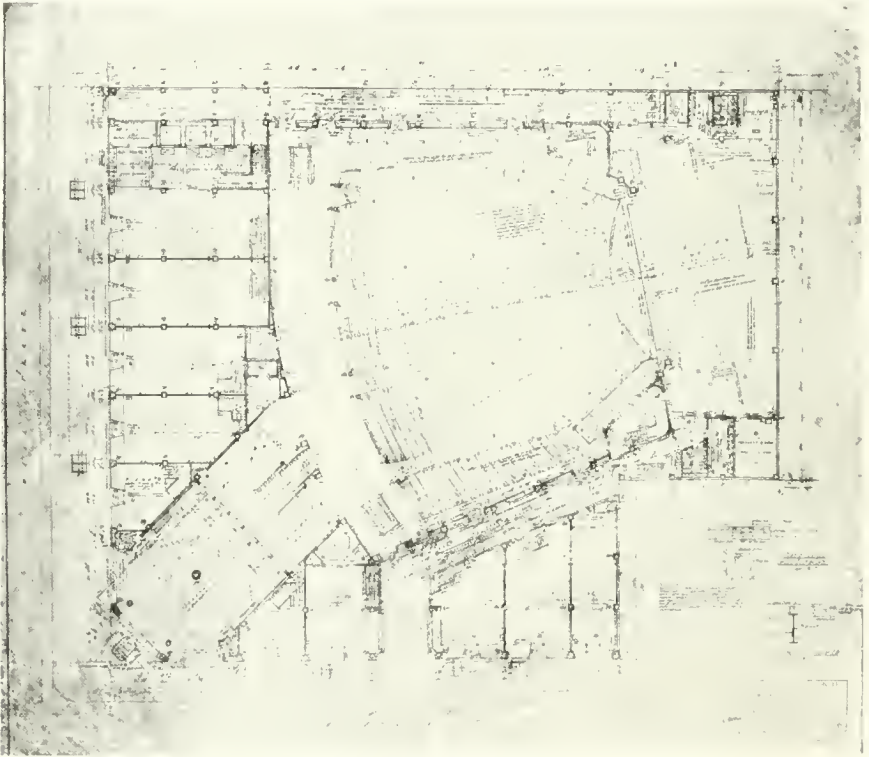

PLAN, HILL STREET THEATER, LOS ANGELES
G. Albert Lansburgh, Architect

color effects are possible now with the 250-watt lamps which transform borders and foots into virtual flood lighting, and with the colored glass that is replacing the fragile old gelatine screens. Spot lights in balcony railing are controlled from this switchboard, but the large moving spots are worked from the projection booth.

The basement room, where wiring panels and meters are contained, is foolproof and fireproof, with every block and fuse easy of access and safe for working purposes. These rooms are immaculate, as, indeed, all the basement apartments are, with the edge on one particular house whose manager was in the navy during the World War—and you ought

to see his engine rooms! Walls, floor, machinery, all are shining with fresh paint and virtue. Those rooms are better than a sermon.

Projection booths are very different now from the hot, stuffy, cramped cubby holes of early days. In these theaters they are large, cool, well ventilated, with indirect light, with adjoining lavatories and store rooms and rheostat rooms, where current from two companies enters and the power from one can be instantaneously switched on if the other fails. There is abundant guard against fire—automatic shut-offs on each projecting machine, fusible links which control the drop shutters at wall openings, direct exits to fire escapes. There are metal reel cases, with automatic re-winds. Instead of telephones, these booths contain dictographs, besides buzzer signals from stage.

There are also dictographs or inter-communicating telephones be-



MEZZANINE FLOOR, HILL STREET THEATER, LOS ANGELES
G. Albert Lansburgh, Architect

tween all important parts of the theaters, and public telephone booths in foyers, mezzanine lounges, smoking and retiring rooms.

And these rooms are many and large and well finished. They are located centrally on each level. A glimpse of the ladies' "beauty" room is interesting—walls lined with dainty individual mirrors and shelves, brilliantly lighted, with maids ready to supply powder and rouge and assistance in the mystic rites of rehabilitation.

The stage itself is in all these houses planned for actual performances as well as for pictures. The old method of working "drops" from overhead "flies" is abandoned. All the drops (up to 67 in one case; the biggest number of sets known is 52, in "Ben Hur") are suspended by



PROSCENIUM, HILL STREET THEATER, LOS ANGELES
G. Albert Lansburgh, Architect



PORTION OF CEILING, HILL STREET THEATER, LOS ANGELES
G. Albert Lansburgh, Architect

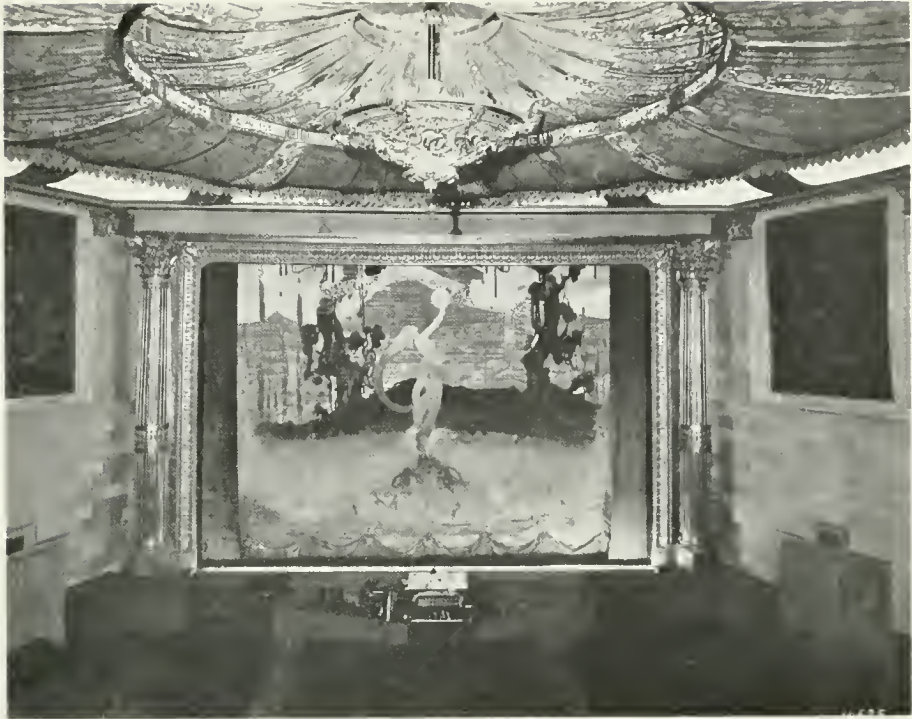

INTERIOR, KINEMA THEATER, FRESNO
G. Albert Lansburgh, Architect



INTERIOR, MUNICIPAL AUDITORIUM, SAN FRANCISCO
G. Albert Lansburgh, Architect

Special Treatment of Stage and Ceiling for Chicago Grand Opera Performances, by Mr. Lansburgh

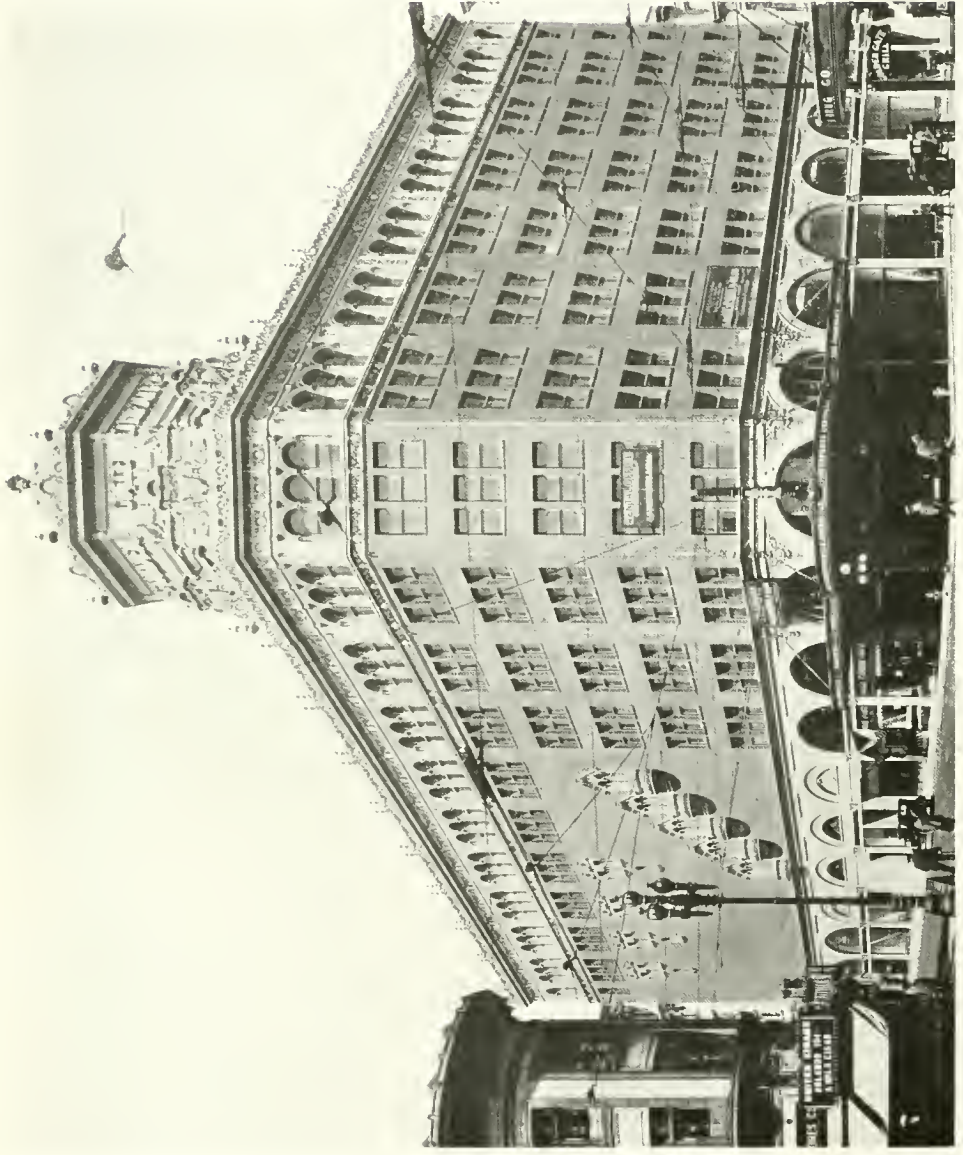

GOLDEN GATE THEATER, SAN FRANCISCO
G. ALBERT LANSBURGH, ARCHITECT

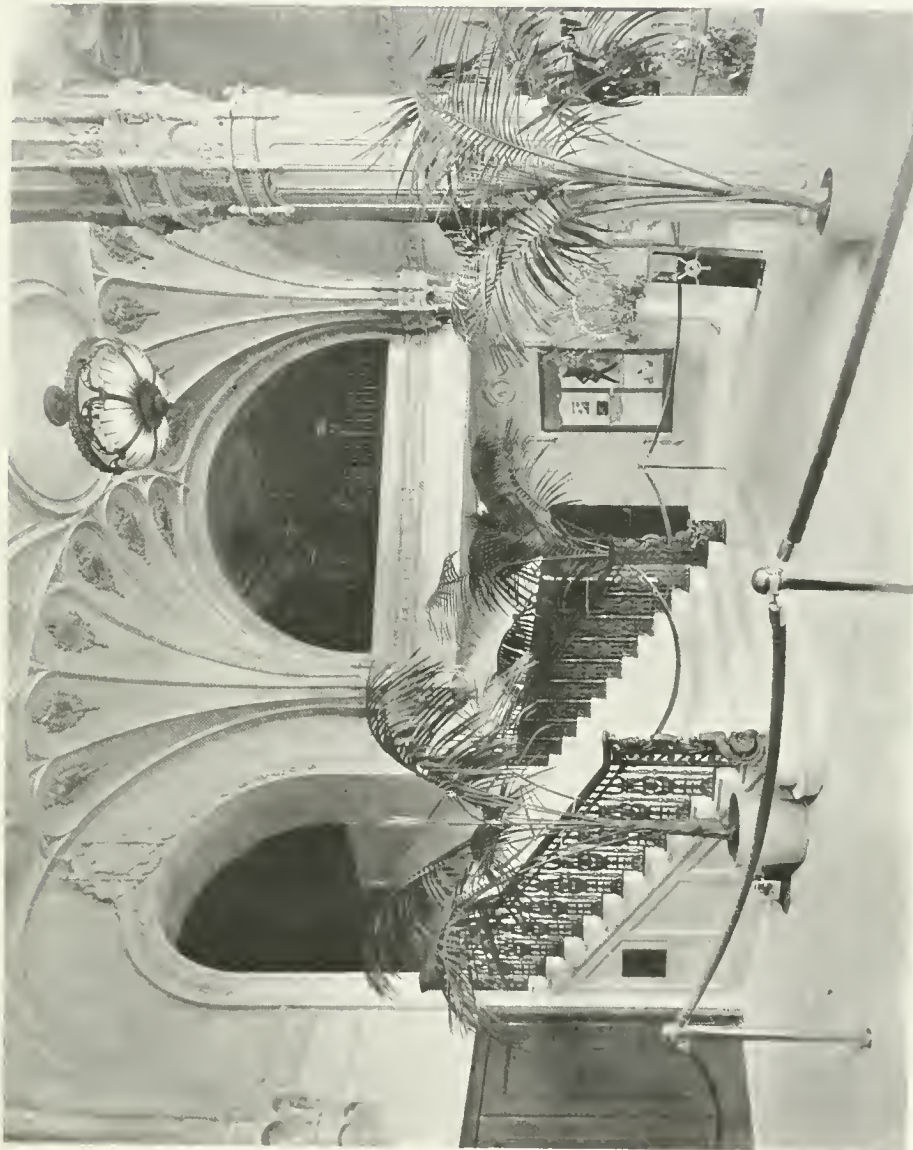

ENTRANCE LOBBY, GOLDEN GATE THEATER, SAN FRANCISCO
G. ALBERT LANSEBURGH ARCHITECT

four steel cables each, which run to a pulley at one side, connected with vertical ropes and counterweights which work easily up and down, like old-fashioned elevators, so that one man can handle two or three at once if need be. The flies are there, but only for use in case of a temporary break.



STAIRCASE, LOEW STATE THEATER,
SAN FRANCISCO

Each house has about 24 large dressing rooms, arranged on several floors at the sides of stage, with a bathroom to each floor. Each room has a wash basin; a buzzer from stage, which warns ten minutes before the actor's entrance cue, with return signal; and individual mirrors, each with hooded top and side lights. In the basements are large and well-furnished rest and practise rooms, animal rooms (wonderfully clean and sanitary), and additional toilet rooms.

The manager's office has been given a commanding location in each case, and where a booking office is also maintained it is placed where business will not interfere with theater patrons. In some cases a play room for children has been provided, with jolly stencils of "Alice in Wonderland" running over the walls, and it is well patronized. It has been found that the special theater elevators are well used, too; people like to ride up to the higher levels, but are willing to walk down.

And attention should be called to the attractive treatment of the main stair-ways to the balconies. It is well known that many people object to balcony seats because the stairs look as though intended for the poorer part of the audience. No such objection holds to these wide, easy stairs placed prominently in the main foyers. Of course there are always plenty of people who insist on orchestra seats.

The architectural treatment of facades and interiors is such as to indicate unmistakably their purpose, with the possible exception of Loew's Warfield in San Francisco. In this strictly conventional office building front, the theater entrance is marked only by a marquis with caryatids above—well done, but hardly striking enough to indicate a theater, from any distance. It was probably felt that more emphasis on this portion of the facade would injure the effect of the main building entrance as a central motif in design.

One notices, of course, the similarity between the Golden Gate and Hill Street theaters. They are practically identical in plan, composition, material and the use of Spanish detail, but by varying the elements of the composition a decidedly different effect is produced.

In the Golden Gate, the basement, shaft and attic are sharply marked by emphatic belt course and cornice lines, and the dome is really a corner turret in effect.

The Hill Street, however, is a solid block, in which the basement (consisting here of two stories) and the attic are enriched but not separated into component parts of the design; and the dome becomes more of a natural terminal to a corner building. To determine this

more clearly, by covering the wings on each side so that each building is apparently an octagonal tower, the comparative results are illuminating.

As regards the general effect, the Golden Gate is more vigorous, but not so coherent. However, the increased length of one wing gave Mr. Lansburgh an opportunity to express his plan with a very interesting blank wall treatment.

The color in both has been kept to a clear buff in both terra cotta and brick, with a touch of richness in gold and color on the domes. This restraint works for dignity, which is praiseworthy considering the location of each, in the heart of the business district.

The Kansas City, St. Louis and New Orleans Orpheums are all strongly French in character. The first two are of a more traditional type, with a basement, an order and an attic. The St. Louis theater shows somewhat more unity in design. Both express, by formality of composition and richness of detail, buildings devoted to

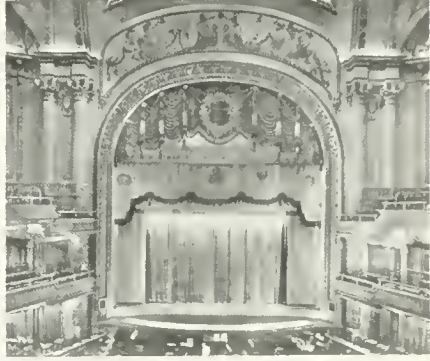

PROSCENIUM, KANSAS CITY ORPHEUM,
KANSAS CITY, MO.

public entertainment. This is especially brought out in the accessory sculpture by Leo Lentelli.

The New Orleans Orpheum conveys the same feeling, and is essentially French in detail, but is much less traditional in spirit. This is really a terra cotta design delightfully carried out in scale, texture, color and form. All the elements of the composition hang together well. The detail is crisp and delicate. The color scheme is charming—a cream and tan tapestry surface with accenting spots of red and blue. It is hard to conceive a more logical use of terra cotta. The Gallicism of this design would seem peculiarly appropriate to the Creole traditions of New Orleans.

In the treatment of their auditoriums, the Golden Gate and Hill Street theaters continue the style of their facades with a profusion of Spanish detail. The Hill Street proscenium arch is carried out to include the boxes, at which point the regular auditorium starts with pilasters, colonnaded and paneled frieze, and ceiling dome. The Golden Gate carries the auditorium treatment in and around the real proscenium arch, using paneled frieze as wall decoration and not cornice.

The color of both rooms is very cool and quiet, in general a greenish tan effect with ornament picked out in dull gold with occasional dull reds and greens and blues. Concealed lighting has been depended upon to produce brilliant flooding of colors over all or parts of the wall and ceiling surfaces.

The organ screens have been made integral parts of the design, in connection with the treatment of boxes. Incidentally the organ chambers are scientifically worked out for proper acoustic results.

In the Loew's Warfield auditorium the plan determined a fan shape, and a very interesting ceiling has ensued, with fanstiek panels radiating from the proscenium arch. The heavily moulded ribs outlining this arch are gradually blended into fluted columns, so that there is a strong structural feeling from floor to ceiling. Over the stage opening, and

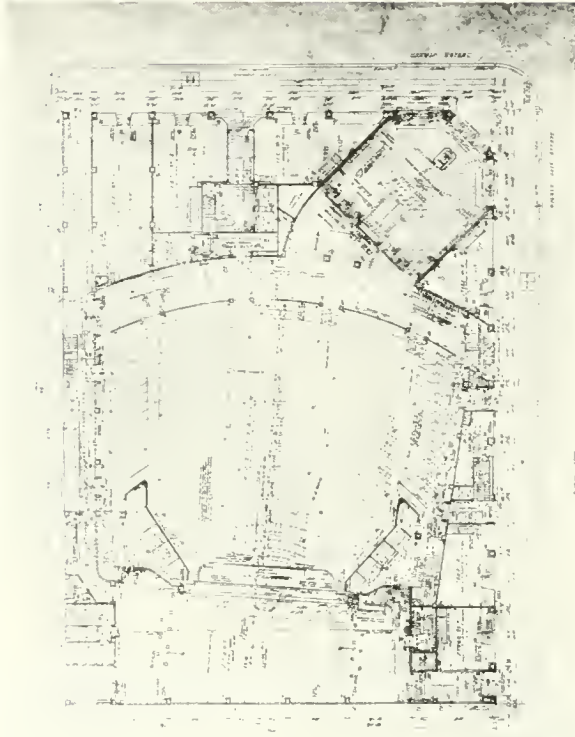

PLAN, GOLDEN GATE THEATER, SAN FRANCISCO
G. Albert Lansburgh, Architect

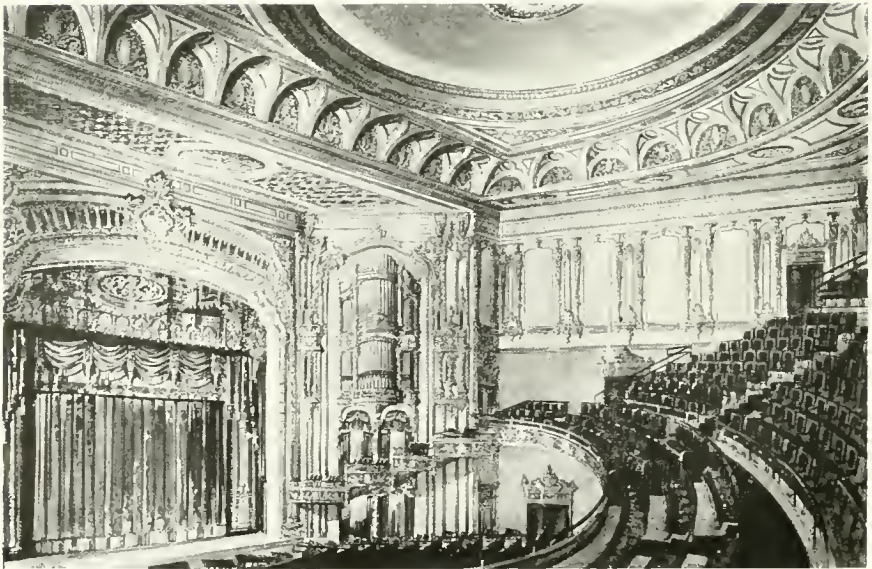

INTERIOR, GOLDEN GATE THEATER, SAN FRANCISCO
G. Albert Lansburgh, Architect

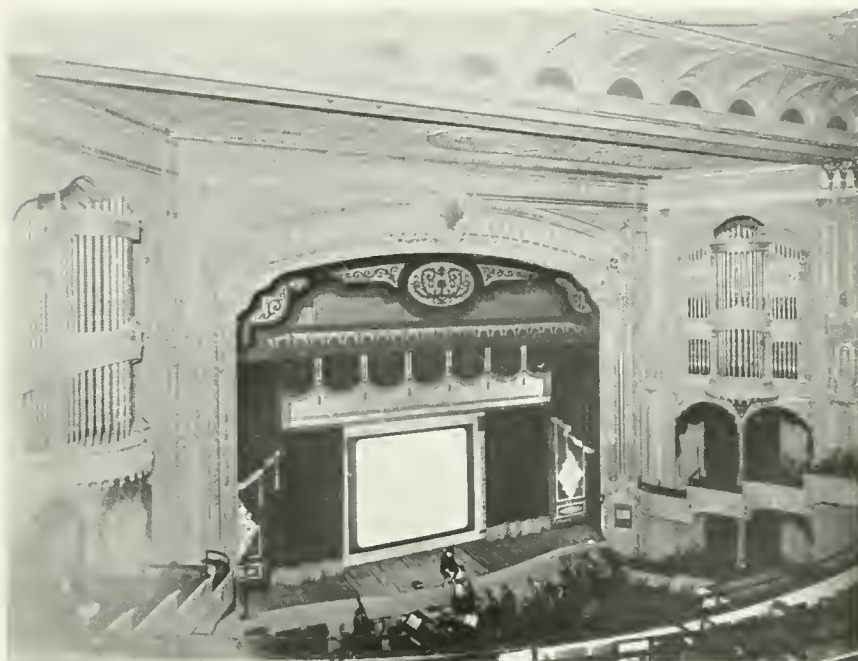

PROSCENIUM, GOLDEN GATE THEATER, SAN FRANCISCO
G. Albert Lansburgh, Architect



GOLDEN GATE THEATER (left) AND LOEW'S WARFIELD THEATER (right), SAN FRANCISCO
G. Albert Lansburgh, Architect



LOEW'S WARFIELD THEATER, SAN FRANCISCO
G. Albert Lansburgh, Architect

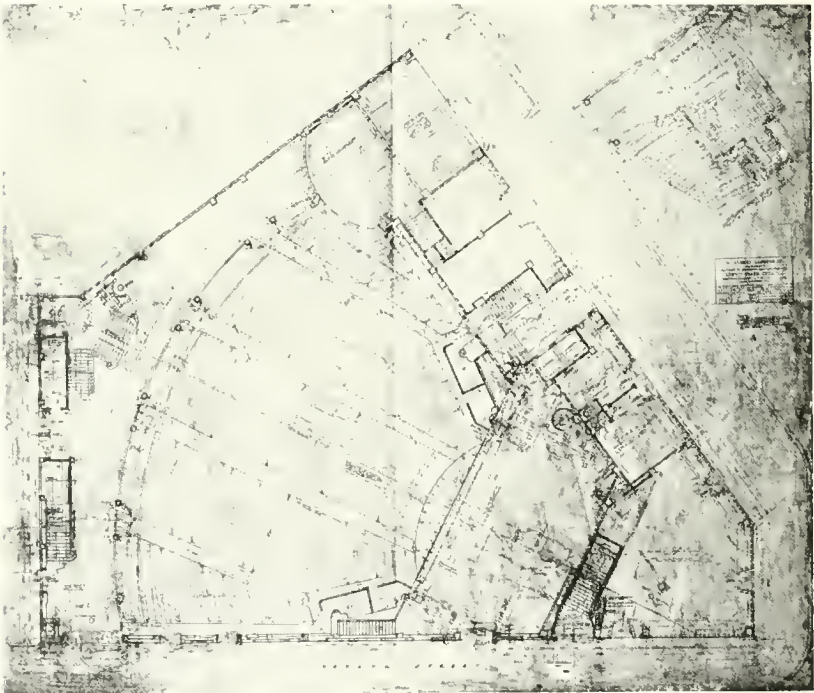

PLAN, LOEW'S WARFIELD THEATER, SAN FRANCISCO
G. Albert Lansburgh, Architect

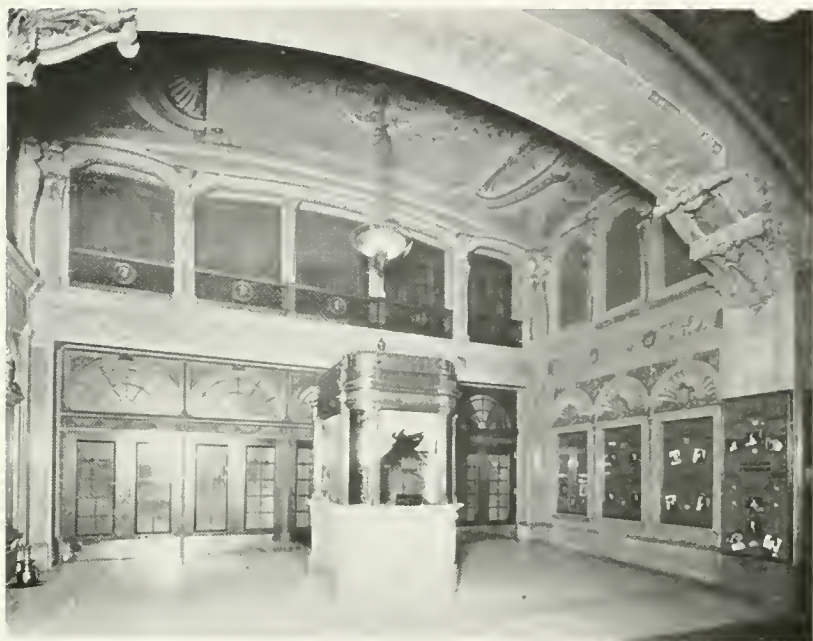

ENTRANCE LOBBY, LOEW'S WARFIELD THEATER, SAN FRANCISCO
G. Albert Lansburgh, Architect



MAIN STAIRCASE, LOEW'S WARFIELD THEATER, SAN FRANCISCO
G. Albert Lansburgh, Architect

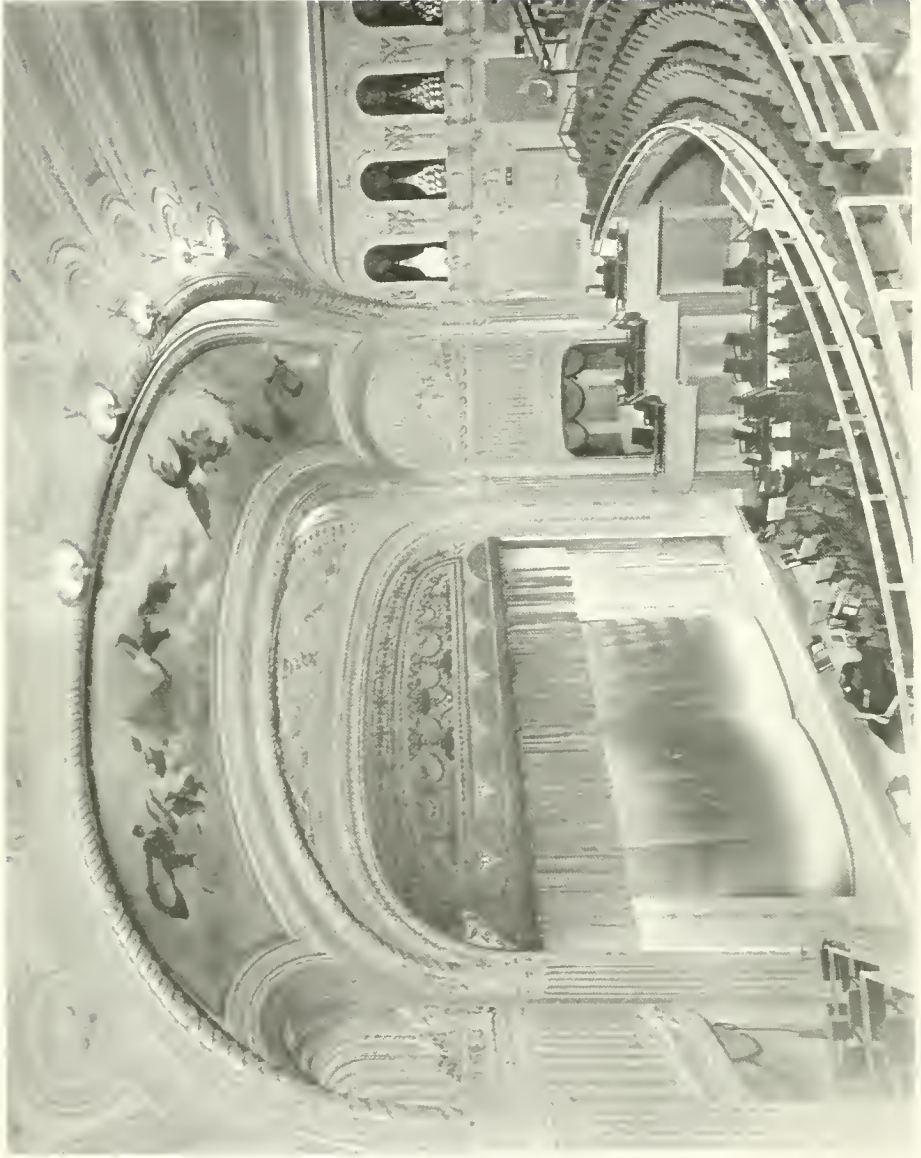

INTERIOR, LOEW'S WARFIELD THEATER, SAN FRANCISCO
G. ALBERT LANSDURGH ARCHITECT

Mural Decoration by Albert Heiter



INTERIOR, STATE LAKE THEATER, CHICAGO
G. Albert Lansburgh, Architect



INTERIOR, STATE LAKE THEATER, CHICAGO
G. Albert Lansburgh, Architect
Kapp and Kapp, Associated Architects

carrying out the fan idea, is a charming decoration by Albert Herter, a fanciful and symbolic setting of Spanish dancers, with the strong colors typical of the country softened into pastel shades. If Watteau had been a Spaniard, one could imagine his having painted just such a scene.

In this theater the clever use of mirrors transforms the auditorium frieze into what is apparently a circular loggia of balconied boxes, a very effective scheme which gives an illusion of added space.



MEZZANINE FOYER,
KANSAS CITY ORPHEUM

Gothic. Mr. Lansburgh cleverly converted a liability into an asset, by making the central column a motif for a fan vault ceiling. This is well adapted to terra cotta, as is also the St. Louis lobby, with its groined and annular vaults and its shell-shape tympani.

The Chicago State Lake Theater is interesting as showing that the soffit of a huge overhanging balcony can be so treated as to overcome a heavy, cramped effect. The huge commercial edifice is a simple straightforward solution of an office building.

The Kansas City and St. Louis Orpheums are examples of the ornate, lofty theater interior which uses generally French detail along approved Parisian lines.

The lobbies of all these theaters are quite successful. Those of the Golden Gate and the Hill Street are an extremely good rendering of Spanish

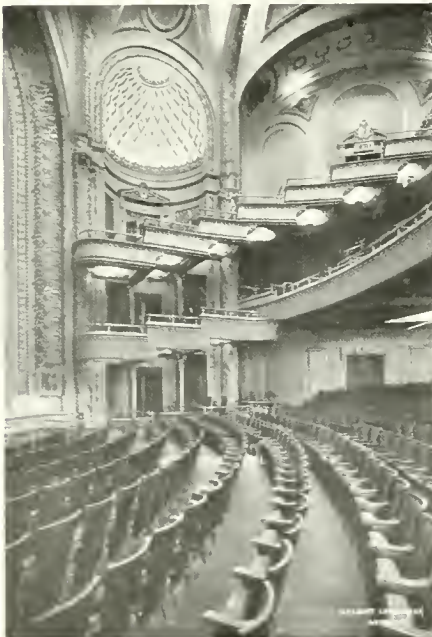

INTERIOR, ORPHEUM THEATER,
ST. LOUIS, MO.

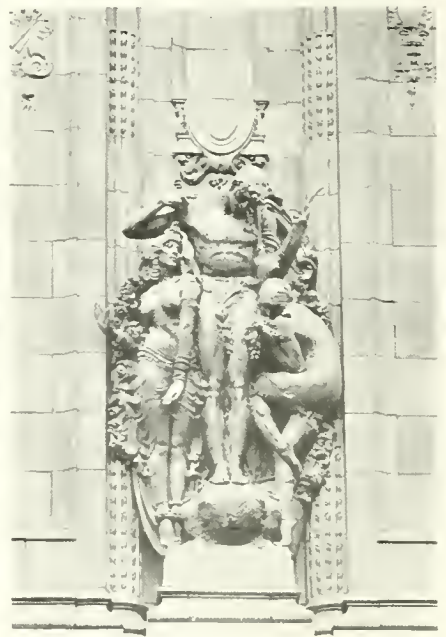

EXTERIOR DETAIL, ORPHEUM THEATER,
ST. LOUIS, MO.



ORPHEUM THEATER, SALT LAKE CITY
G. ALBERT LANSBURGH ARCHITECT



ORPHEUM THEATER, ST. LOUIS, MO.
G. Albert Lansburgh, Architect



LOBBY, ORPHEUM THEATER, ST. LOUIS, MO.
G. Albert Lansburgh, Architect



ORPHEUM THEATRE, KANSAS CITY
G. Albert Lansburgh, Architect

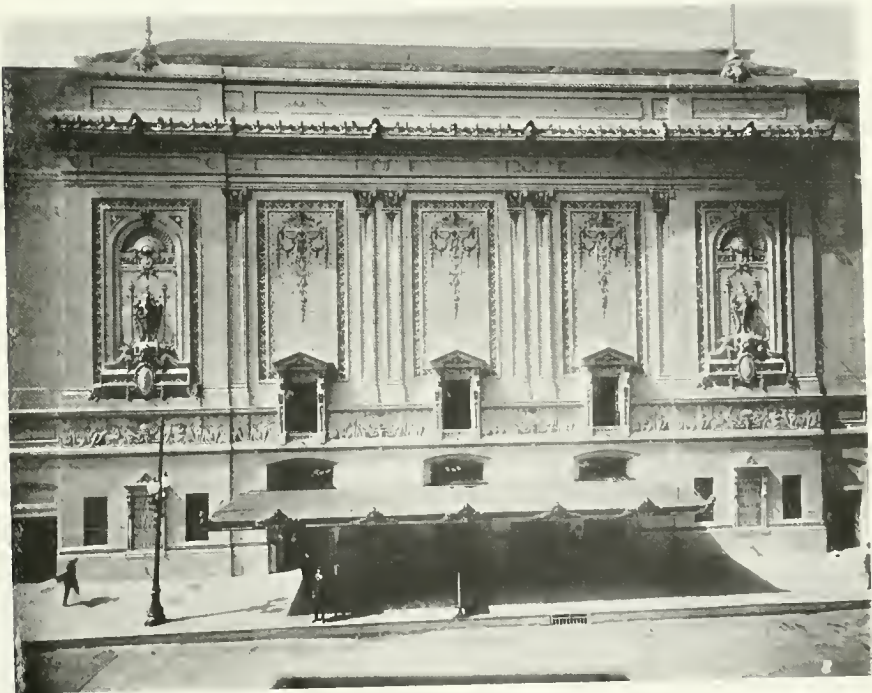

ORPHEUM THEATRE, NEW ORLEANS, LA.
G. Albert Lansburgh, Architect



LOBBY, ORPHEUM THEATER, NEW ORLEANS, LA.
G. Albert Lansburgh, Architect

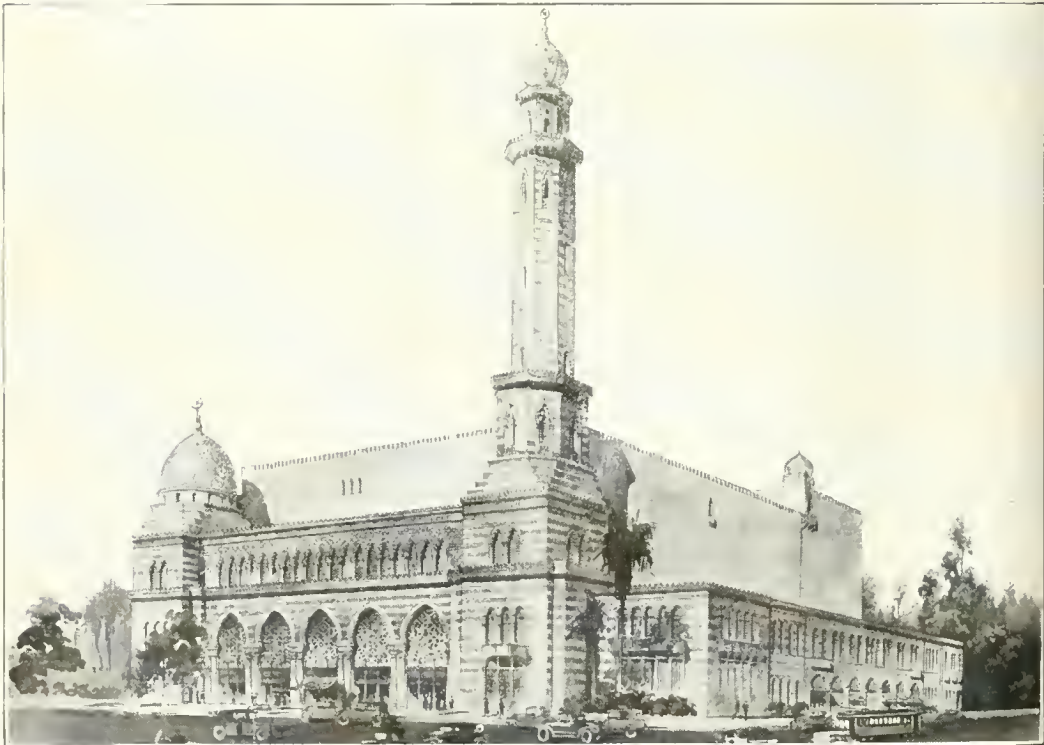

SHRINE AUDITORIUM, LOS ANGELES
G. Albert Lansburgh, Architect
John C. Austin and A. M. Edelman, Associates

The New Orleans lobby is a brilliant terra cotta tour de force. It is really stone design, but carried out in detail that is definitely appropriate to terra cotta. The floor was designed by Leon Solon, and its quiet tile tones and broad pattern form an effective setting for the gay palette of white walls, spots of red, blue, brown and green, and coffered gold ceiling. Altogether a very festive entresol, and quite in character.

The foyers are properly treated in a more sober but still elegant fashion. The stairway at Loew's Warfield is an especially attractive feature, as mentioned previously. Furniture, floor and wall coverings, fixtures, are handsome, in good taste, and fit their purpose.

Mr. Lansburgh has evidently gauged the public taste accurately, and his theaters have the stamp of popular approval.

* * *

Use of Stone in Bungalow Construction

THE popularity of the California type of one-story frame cottage or bungalow has given rise to a marked tendency on the part of builders and architects to adopt the so-called bungalow plans for better grades of smaller homes, and the stone bungalow is becoming frequent and popular in many parts of the country, especially in the Southwest and Far West, says a writer in Stone.

Laying aside all considerations of first cost, the advantage of living within cool non-conducting stone walls in the hot summer months, and within warm non-conducting walls in the cold winter months, is becoming more and more apparent to the man who builds for permanence and comfort, if not for elegance.

The tendency to introduce stone in conjunction with wooden or frame construction has been increasing from year to year, and the enhancing, thereby, of the beauty and elegance of the entire structure, is at once apparent. It may be that only the exposed parts of the chimneys, or of the foundations, may be of stone, or it may be the columns of the front porch, or the front steps, or it may be the gateway or the garden wall, but wherever stone is employed, the improvement in the appearance of the completed structure is evident.

The beauty which stone adds when used in this manner is not transitory, and it is only necessary to glance, by way of comparison, to any nearby frame building, and this difference impresses one more vividly after the lapse of a year or more, the stone retaining its beauty-giving qualities, while the wood ages rapidly.

To one, who is accustomed to count the cost, the slight additional cost of stone is more than compensated for in a few years saving on insurance, and the satisfaction of owning the best is worth more to the man whose home is his pride, than even the saving on the insurance. It is surprising how little more it costs to build a home of stone, a home built to last, and to be enjoyed by one's children and his children's children.

* * *

Greatest Lumber Plant Now Building

Now building on the Columbia river, Washington, is the largest lumber manufacturing enterprise that ever existed in this world. Near Kelso, the Long-Bell Lumber Co. has purchased 70,000 acres of magnificent timber, from which it expects to cut 600,000,000 feet annually, 1,000,000,000 more than the company is now producing in its eleven big sawmills in Texas, Arkansas and Louisiana.

Fire Resistive Qualities of Frame Buildings Protected by Stucco and Plaster on Metal Lath

By WHARTON CLAY, Commissioner Associated Metal Lath Manufacturers

EVER since its advent into the building field thirty years or more ago, metal lath has been recognized as a superior base and reinforcement for plaster. Its original use was for solid and hollow partitions, curved ceilings and a base for ornamental plaster work in fire resistive buildings, but since its crack prevention ability was recognized, and as good quality of wood lath became more and more difficult to secure, it has come to be used with increasing frequency as a base for plaster in wood joisted or frame buildings. In the early days fire prevention was little thought of, and our great national fire waste was not realized by the general public or by the insurance companies, or even by building officials themselves. Years ago, however, building codes began to call for metal lath as a protection over furnaces, behind stoves, around chimney breasts and on positions where the very nature of all other plaster bases made the desirability of metal lath most apparent.

As the fire prevention societies began studying these questions, they immediately took up the recommendation of metal lath and have consistently carried these recommendations out in their writings. However, the dependents upon metal lath, and its relative superiority over other lathing bases was largely a matter of experience in the field where many notable instances were encountered in which metal lath stopped fires. It was also largely based upon "horse sense" from a knowledge of the material itself, its incombustibility and its ability to hold the plaster in place with the minimum of cracking and the maximum of bonding or keys.

As the expense of testing materials for their resistive features is so great, the building fraternity has been denied scientific comparison between materials and even today the published information on tests, is inadequate and there is not anywhere an unbiased list of the actual duration under standard fire test conditions of even the materials which have been tested. It is, therefore, very timely and I am very glad to be in a position to announce for the first time, the results of a series of tests at the Underwriters Laboratories on metal lath and plaster and stucco.

Before going into detailed information on this, however, I wish to make a few observations: Considerations of fire resistive qualities of various constructions are based upon several factors. The insurance company which bases the insurance loss has different considerations to weigh from those of the building official. The building officials' consideration is primarily safety to life and secondarily safety to property. The underwriters must consider first of all the question of minimizing the spread of fire within its place of origin, so that the dollar and cents loss will be low, but they are also just as much concerned with the salvage value of the property. Therefore, they have always given a greater consideration, (by lower insurance premiums), to the masonry wall building than to the frame wall dwelling, even though the interior construction may be identical.

In fact the latest statistics indicate greater percentage of fires in masonry walled than frame walled buildings of the same interior construction. The underwriter has also been justified in this by the factor of communication of fires,—not so much from a question of the actual communication of the fire as from the question of the greater damage

to painted siding than to masonry if a fire be in the vicinity. For if the fire is really severe, it will enter by the unprotected windows anyway. The lower insurance rate on masonry has lead many people to feel greater security from fire in a masonry than in a frame house when, as a matter of fact, they are about equal as regard to safety to life, which is the building official's prime concern.

Perhaps safety from communicating fires is not far from equal, if the masonry walls do not have protected window openings. This has been demonstrated in a very spectacular way in the recent ten million dollar fire in Chicago, where the communication was largely through unprotected openings in heavy masonry walls and finally reached the first-class "fireproof" Burlington office building where the interior damage was about the same extent as it would have been in any other kind of a building.

In fact, the general misunderstanding as to the superiority, from a fire protection standpoint, of masonry walls over other walls, led to a very kindly note of caution to the Brick Manufacturers by Prof. I. H. Woolson, Consulting Engineer of the National Board of Fire Underwriters, at one of their annual conventions. Prof. Woolson said in part:

As usually constructed, I doubt if the average brick building as a whole has a fire resistance of over 10 per cent of that of its walls. This is discreditable to our engineering and architectural intelligence, and productive of shameful economic waste of manufactured resources.

I hope to win your aid in securing the introduction of such proper construction straws into brick buildings as will make them really efficiently fire-resistive.

Let me say, right here, that the defects which I shall criticise are by no means peculiar to brick buildings. They are just as prevalent in hollow tile, stone and concrete buildings

Millions of bricks are used each year in buildings of simple architecture and modest cost. They are undoubtedly less liable to complete destruction by fire than wooden buildings, but are by no means as fire-resistive as they should be, nor are they as safe as the public is taught to believe.

Let us give prompt praise to the brick industry for their co-operation. The Common Brick Association issues a pamphlet with each one of the plans which they sell, stating as follows:

It is not the intent of those advocating brick side walls to give a false sense of safety to the occupants of such a house. The interior partitions, the floors, the roof and basement ceilings are all subject to attack by fire, and the most incipient start in these parts usually results in complete destruction of the interior of the house and all its contents—and too often takes human lives. More than 23,000 persons lose their lives by fire every year in America.

The home builder thoughtful enough to take the first step toward safety by building solid brick exterior walls should know how he may protect the most vulnerable spots inside his home by the use of metal lath.

Once the flames eat through the interior plaster on ordinary bases, wood partitions become flues for the flames. With metal lath as a plaster base, the fire is stopped and cannot get between the two surfaces of the walls or partitions. A wood-bearing partition especially needs good protection, for its failure means the collapse of the floors above.

The Face Brick Association also say in their manual:

Having built a face brick house for your client, as the most substantial and attractive construction to be had, protected on the outside with a roof of permanent material and on the inside with fire-resistive material at the weakest points, you have given him the best possible value for his money, in a structure at once beautiful, enduring, economical and safe against fire.

It is thus recognized that interior construction must be given more attention before ordinary construction can be considered fire-safe. This idea is reinforced by the statistics recently developed by the National Lumber Manufacturers Association in which they analyze the number of fires occurring during the year 1920 in the several types of build-

ings in the eighty-three (83) largest cities in the United States. They found that only 1.1 per cent of all fires extended to the adjoining buildings; that only one-fifth of 1 per cent extended beyond the adjoining buildings, and that 98.7 per cent of all fires were confined to the building or place of origin. Furthermore, the loss by communicated fires was but 7 per cent of the total loss.

I do not believe in one of their principal conclusions however, that because there were more fires in brick and stone buildings than there were in frame buildings in proportion to the number of fires in each, that such information is good evidence to conclude that if people live in masonry houses they are more careless than if they live in frame houses. However, if such a conclusion is true, then the reinforced stucco frame house would be the ideal house, for the occupants would take the greatest precautions for fire safety, and the exterior would provide all the resistance to external exposure that unprotected windows in any type of wall will develop.

We cannot count upon a chain for any greater strength than its weakest link, and we cannot count upon a building wall of any material to prevent fires passing through unprotected windows. However, going back to the actual figures, we find that only 1.1 per cent of the fires are communicated to the adjoining buildings anyway, and we had much better concern ourselves with fire protection to prevent the 98.9 per cent of the fire hazard than concentrate attention upon the communicating fires.

I have always contended that if fire resistance is essential for exterior walls, we should not camouflage the issue and pierce those walls with unprotected openings. If the danger is not great enough to warrant protected openings, it is not great enough to warrant restricting the choice of the prospective builder by law to a masonry wall on the basis of fire protection. If masonry can be proved to be more economical than reinforced stucco in the long run, or more attractive, as it is to many people, it should be chosen on that basis, and as a matter of fact, is chosen on that basis in most cases. However, if the owners wish is for reinforced stucco on frame, he should not be deterred by Ordinances. Officials know that stucco on metal lath has withstood the requirements of the one-hour test, you can feel perfectly safe in permitting this construction for residential occupancy in any location where unprotected windows are permitted. It is customary, however, to restrict the use of such buildings to a space outside the fire limits, and this is not entirely justified.

However, this question of exterior walls is one of small importance when compared to the question of interior fire protection, but I merely wish to register that a frame structure can be made fire-safe from exterior fire exposure by the employment of Portland cement stucco reinforced by metal lath on wood studs.

The interior of all buildings is the prime consideration and the one which is most sadly neglected. When 98.9 per cent of all the fires are confined within the building in which they originate, is it not well for us to give more consideration to interiors than to exteriors, and more consideration to interiors than has been given in the past?

The burning up of thousands of buildings every year is an unnecessary discredit to the economy and efficiency of lumber. One of their most ardent advocates, The American Lumberman, has endorsed and encouraged co-operation between the lumber industry and the metal

lath industry in the use of metal lath in particular points in frame and stucco houses to make them more fire resistive, and the National Lumber Manufacturers Association has jointly sponsored the tests at the Underwriters Laboratories which have proven so successful.

It is well recognized by building officials, fire marshals and others, and confirmed by the statistics on fires that they originate in certain specific locations, over the furnaces, in closets, around flues, etc., etc. It is also recognized that if fires do start, their existence is more dangerous if they involve a staircase, the bearing partitions or the inhabited floors, than if they merely involved non-bearing partitions, attic floors or other unimportant parts.

While no one wishes to make a compromise with safety, yet it is far better to go one step in advance than it is to refuse utterly to move forward. It would be ideal, and it some day may come to pass that all buildings will be required to be entirely of incombustible material, and lumber used only for temporary uses such as packing cases, or artistic uses such as furniture and trim. But that is a long way in the distance and people who are clamoring for this ideal realize that they are playing a long and tedious game. They are making progress, however, and every step is an advance, because here and there is someone who does wish complete fire protection.

While lumber is still an economical material, is it not better to utilize it properly than to place it under the discredit that it is now receiving? Some day all houses will be required to have all lumber adequately protected, but this step is also in the distant future. Let us then look to what is practical, inexpensive, in tune with the times, and possible of early accomplishment. Metal lath can be used in the vulnerable parts of a house at a cost of about 2 per cent—less than the interest charge for four months' occupancy.

As previously stated, metal lath has been considered as a superior material, but how much in advance of other plaster and lathing combinations has never been known. The Associated Metal Lath Manufacturers, therefore, initiated tests at the Underwriters' Laboratories several years ago, intending to develop information as to the resistance of their material with different combinations of plaster and under different conditions of exposure. The war stopped rapid progress of this, but prior to the war, a test had been made on exterior stucco placed directly on the studs, without sheathing, and back-plastered.

A preliminary report from the Underwriters' Laboratories on back-plastered metal lath and stucco construction with Portland cement indicates that:

"This finish can be expected to furnish a substantial barrier to the passage of flame into the hollow spaces back of it for about one hour when exposed to fire of the degree of severity to which stucco buildings are likely to be subjected under average exterior fire exposures.

"This finish can be expected to provide sufficient heat insulation to prevent the ignition of the wooden supports to which it is attached for about one hour when exposed to fire of the degree of severity to which stucco finished buildings are likely to be subjected under average exterior fire exposures."

In our opinion, there is not much difference between the fire resistive value of the back-plastered type of construction and the more common sheathed construction. There is a thicker coat of stucco on the back-plastered type, but the sheathing interposed between the stucco and the bearing studs compensates, in a measure, for the thinner stucco on the sheathed construction. Inasmuch as the windows in either case are

by far the weakest link—the slight difference, if any, between these two constructions is not an essential feature.

Informal tests have been made on common lath and Portland cement stucco and this combination loses its fire resistance in a very short time and the wood is in full flame in 10 to 20 minutes because of the communication of the heat through the thin coat of stucco to any one of the laths which can then communicate the fire on the interior hollow space very rapidly.

* * *

Timbers for Joists and Rafters

MOST people are influenced in their activities by the conveniences available to them. They select and pursue the easiest route to accomplish a certain result. In the building industry that means generally that those responsible for how a new building is erected and of what materials it is to be built very naturally will select the materials most easily assembled, that will involve the least exertion in design calculations, that are most readily available and will produce the most satisfactory building with the greatest economy.

There are many materials that are now about on a par as far as availability is concerned and the structures built of them are generally quite satisfactory. The costs of the different materials in many cases being nearly the same, builders will be influenced to use the materials about which they may have the greatest knowledge and which will require the least tedious mathematical and engineering calculations to determine the sizes required. Realizing this and also that less training to students in technical schools is given on wood as a building material than practically any other structural material, the Architectural and Building Code Bureau of the National Lumber Manufacturers Association, Washington, D. C., has just issued for free distribution a comprehensive series of tables from which can be determined readily the safe lengths of wood joists and rafters with a wide range of load and strength elements.

In many cities ordinances are in effect that require the builder to make the floors of buildings of sufficient strength to support a certain number of pounds per square foot in addition to the weight of the floor itself. Those additional pounds are referred to as the live load and are to provide for the weight of furniture, goods, merchandise, people, etc., that may be on the floor after it is built. This load requirement, taking dwellings for an example, may be 30 pounds in one city and 70 pounds in a city only ten miles distant. To meet these conditions the Bureau has supplied tables for loads of from 30 to 70 pounds for main floors, 20 pounds for attic floors, and 30 and 50 pounds for roofs. It contemplates the issuance of additional tables for greater loads to provide for stores, etc., where heavier loads are encountered and wood joist floors are generally used.

Spans are given in the tables for joist of sizes of 2x6 to 2x14, 3x6 to 3x14, and 4x6 to 4x10, these being the sizes generally encountered in buildings. Spans are given for these sizes spaced 16 inches on centers and also 12 and 24 inches on centers.

As the stresses on which the calculations for the various species of wood are different, spans are given for each joist and each spacing based on stresses of from 900 pounds to 1800 pounds. When spans are to be

limited, to prevent deflection or sagging of the floor, the calculations are based on what is known as a Modulus of Elasticity. Many designers use a modulus of 1,000,000 pounds and apply it to all kinds of wood, which is a mistake as some species are stiffer than others. To provide for this, the tables in addition to the spans for the several stresses, give the spans limited by deflection based on four different Moduli of Elasticity for each size and spacing of joists. Spans for both plastered and unplastered ceilings are given, as well as those for attic floor joists, ceiling joists, roof joists, and rafters.

These tables are meeting with considerable favor among municipal building officials who are using them in checking plans submitted to their departments for permits. Architects are finding them of considerable advantage in the design of buildings as they give the length of span for a certain kind of joist for a certain load. Practically all the other tables in existence in the various hand books give the total load a joist of given size and length will carry which necessitates extra figuring on the part of the designer. These tables go a step farther in service in relation to lumber as a building material. They are of value also to the retail lumberman as an aid in producing safe floors in localities where efficient building designers may not be located.

* * *

Atrocious Architecture Being Done in France

THE following is an excerpt from a letter received by Architect Charles H. Alden of Seattle, Wash., from Mr. W. Marbury Somervell, formerly a practicing architect in Seattle, who is in France:

I just received your good letter, after returning from a wonderful motor trip to Touraine, where I renewed all of the architectural acquaintances of years. It is a funny feeling to be an architect and not an architect, at the same time, and I went through the chateaux like one returned from another life. Somehow they all looked different except a few of the old standbys like Blois and Chambord, but in spite of the unreality I had a bully time and only needed the company of an architect to make things perfect.

I shall probably associate myself with a French architect, M. Closset, a pupil of Laloux' and a fine chap, and between us we will swing a number of villages in one operation. As soon as it is all settled I intend to write a brochure on the subject and will send the findings to the Washington State Chapter if they will be interested. One can have no idea of the difficulties surrounding this reconstruction work, and it has taken me a year of hard work in order to see the light.

I am doing a lot of sketching, in water color and in pen and ink (the latter direct from nature), and am having a perfect orgy of drawing since the weather has changed into spring. This afternoon I have worked for hours over at Samereau, across the Seine, sketching an old farm, which was once a priory in the fifteenth century, although nobody seems to know anything of its history. I am awaiting the return of the Curé, who is away at Sens at present, and then I am going to find out something about it. It is a perfectly bully old thing, and picturesque beyond words. The peasants who inhabit it know nothing about it save that it has been called the Priory ever since the year one, and so for the present we let it go at that.

No matter how good the French School may be, it is certain that the architecture of France has reached the lowest stage in its history. I never in my life imagined anything as atrocious as the work which is being done now, both in public and private. The useless ornament, the useless and meaningless moldings accomplished at great cost, the texture of walls, the brickwork and all of the rest of the bag of tricks, are absolutely disheartening. Why, Seattle has produced in the last ten years more good design than all of France has in a like period. They do excel in workmanship, and when you have said that you have mentioned all that there is to French architecture. The devastated district is the most disheartening of all the areas in France in the design of the new work. Rheims is a fright; Verdun is only a shade better, and as for the poor little villages which have had to depend on the local architects of the district—well, all I can say is that if I do likewise, I hope someone will sneak up behind me and soak me a good one.



DESIGN FOR TWO-STORY STUCCO HOUSE
Miller and Warnecke, Architects

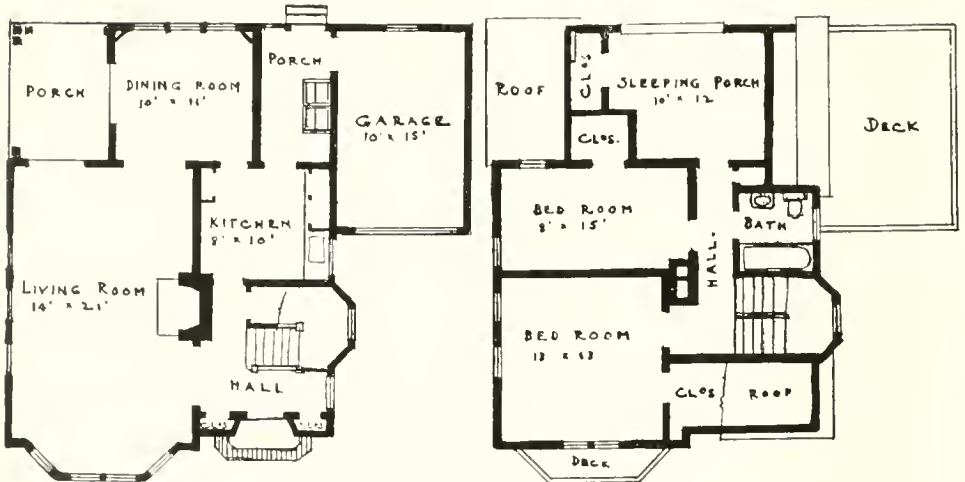

PLAN, TWO-STORY STUCCO HOUSE
Miller and Warnecke, Architects



DESIGN FOR SPANISH BUNGALOW
Reed and Corlett, Architects

Selections from the Recent California Complete Homes Exposition, Oakland

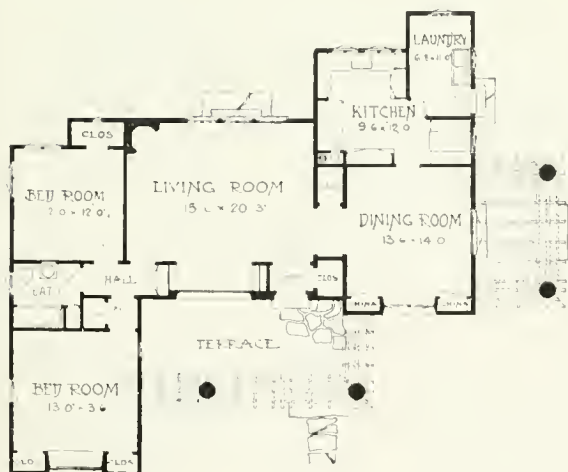

THE FLOOR PLAN SHOWS FIVE ROOMS, WITH BREAKFAST NOOK IN THE KITCHEN. A WIDE, BROAD, OPEN TERRACE, COVERED WITH A PERGOLA, SUGGESTS A CHEERFUL, HOSPITABLE INTERIOR



HOME FOR LAKESHORE HIGHLANDS
Miller and Warnecke, Architects

SIMPLICITY IN DESIGN CONSTITUTES THE REAL CHARM OF THIS HOME. THE PLAIN PLASTERED WALLS AND BLACKENED SHAKE ROOF HARMONIZE WELL TOGETHER. THE ENTRANCE COURT IS AN ATTRACTIVE FEATURE. THERE IS A LARGE LIVING ROOM WITH RECEPTION HALL AND DINING ROOM ADJOINING AND FORMING ONE LARGE ROOM

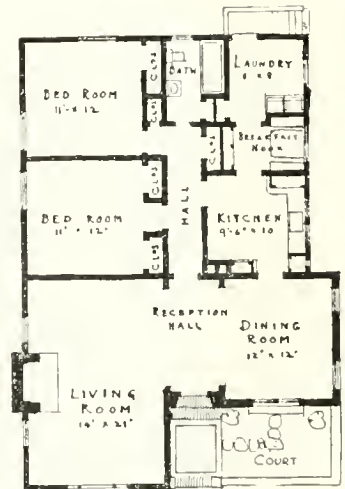



SPANISH TYPE BUNGALOW
Miller and Warnecke, Architects

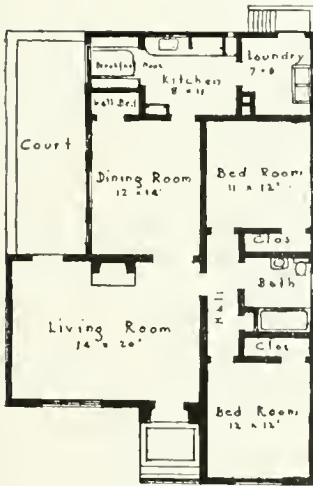

DESIGNED AFTER THE TRADITIONAL SPANISH STYLE, THIS HOME IS SUGGESTIVE OF SUNNY DAYS AND BALMY CLIMATE. THE FLOOR PLAN CALLS FOR FIVE GOOD-SIZE ROOMS AND A BREAKFAST NOOK, BESIDES LAUNDRY AND BATH.



DESIGN FOR FIVE-ROOM HOUSE
Miller and Warnecke, Architects

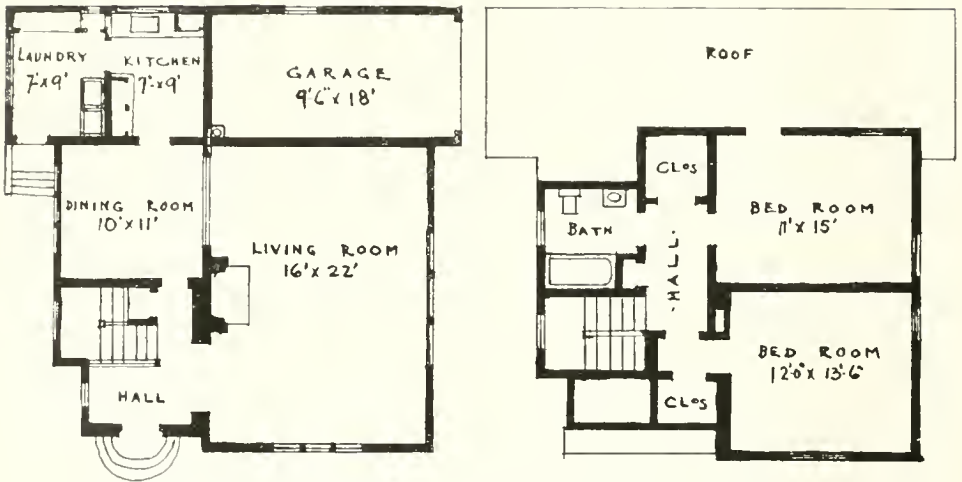

PLAN, FIVE-ROOM HOUSE, WITH ATTACHED GARAGE
Miller and Warnecke, Architects

A Building That Is Wrong

The Imperial Hotel, Tokyo, Japan
Frank Lloyd Wright, Architect

By LOUIS CHRISTIAN MULLGARDT, F. A. I. A.

THE U. S. A. is subject to great diversity of foreign influence—it has groups of unassimilated foreign races whose traits, tastes and thirst for adventure are scrawled across the architectural 'Freedom of one's Country' in sporadic outbursts of eccentric frailty.

Tokyo, Japan, engaged a "foreign" architect to design its brand new Imperial Hotel. It is a monstrous thing of supposedly antique influence, but really prehistoric in plan, design, structure, decoration and state of



Cubes of carved stone, leading a checkered career; a tremendous stone canopy, supported from the face of another stone canopy

decay. It was slipped into the sacred Kujimachi—Ku, near the great avenue approach to the Imperial Palace. Its cost was six million yen, (about three million dollars U. S. A.)

A thoroughly modern hotel of its size, equal to America's best, and appropriate to Tokyo's needs, could have been built for half that amount. Its fantastic, prehistoric character is everywhere in evidence; the accompanying photographs give but a vague impression of it. The super-

ficial observer walks around its streets and court walls, and through its public rooms and hallways and is impressed by the various and sundry things which are commonly called, "remarkably original." Its originality is so antiquated that it embalms and mummifies the brains of the beholder—but not permanently. Recovery and self possession usually return on reaching the coarse gravel hairpin roadway, which serves the rickshas, taxis and pedestrians as a crunching, uncomfortable approach to the main entrance.

Viewing the exterior from any angle, one sees a fortress of buff brick and terra cotta; every facade has been laminated and lambasted



Perforated cornices, with applied copper ornament, overhang every facade. Groups of windows are almost absorbed with brick and stone

with a stone of exceeding rottenness, which has been much carved with patterns of Yucatanese, Aztec and Navajo piffle. The windows are small and inadequate for the 300 bedrooms—the more so because of Tokyo's hot summers. Every facade abounds in elaborated stone embellishments. It is worthy of remark that a glazed window sash can be made the terminating abutment of a stupendous stone string course, and that colossal stone canopies, suspended somehow, are required over entrances to intercept the rays of sunshine and little drops of rain.

Long beams over exterior entrances are of brick, placed horizontally:

the soffits are faced with stone blocks, also suspended, somehow. There are grouped windows, with stone casings and embellishments, so large that the windows are absorbed, as if unnecessary for light and ventilation, but highly essential as an objective for this form of decoration.

The exterior courts and certain large interiors contain huge pedestaled groups of shafts, which look somewhat like families of Arizona desert cactus, hewn into cubistic and ballistic vertebrae, rough, crude, but spineless. There are colossal stone vases and lanterns, some square, some round, made of pieced stones, held together somehow and supported as if on tip-toe—the little toe.



On the roof of the center unit, viewing the rear superstructure, containing the banquet hall and the theater

The cornices are of stone, projecting about five feet. They have panelled perforations to the sky, embellished with perforated sheet copper. Applied ornamental copper also fringes the immense soffits and heavy carved facias. Cornices, like canopies, balconies and beams, have no visible means of support.

The stone quarries near Nikko produced only small stones; hence all of these massive forms are secretly dowelled together, small stones depending mostly upon metal anchorage to support them. Although the structure, at this time, is not entirely complete, it already contains num-

erous large cracks in masonry walls and stone embellishments, which are, in part, due to inadequate foundations and seismic disturbances. Dame Nature allots about fifty earthquakes annually to Tokyo. Every public room has been lavishly decorated with carved Nikko stone, suspended over the heads underneath. The stone is soft and fragile, and literally full of pockets and perforations, suggestive of a well-known cheese. Many of the pockets are filled with loose, disintegrated granules, sufficient in quantity to fill a goblet. No one can forecast when the three factors of inadequate foundation, seismic action and suspended, fragile Nikko stone, will create a tragic sensation; only extra precaution can prevent an otherwise inevitable catastrophe.

The theatre within the Imperial Hotel will seat one thousand people; it is filled with Nikko stone—held in suspension; its balcony railings consist of stone embattlements, twenty inches high; two six-foot-square stone vases impede the balcony entrances. Two great Arizona cacti of stone, fashioned into stacked balls and cubes pierce the solemn atmosphere like spectres. The public would not be admitted to this theatre

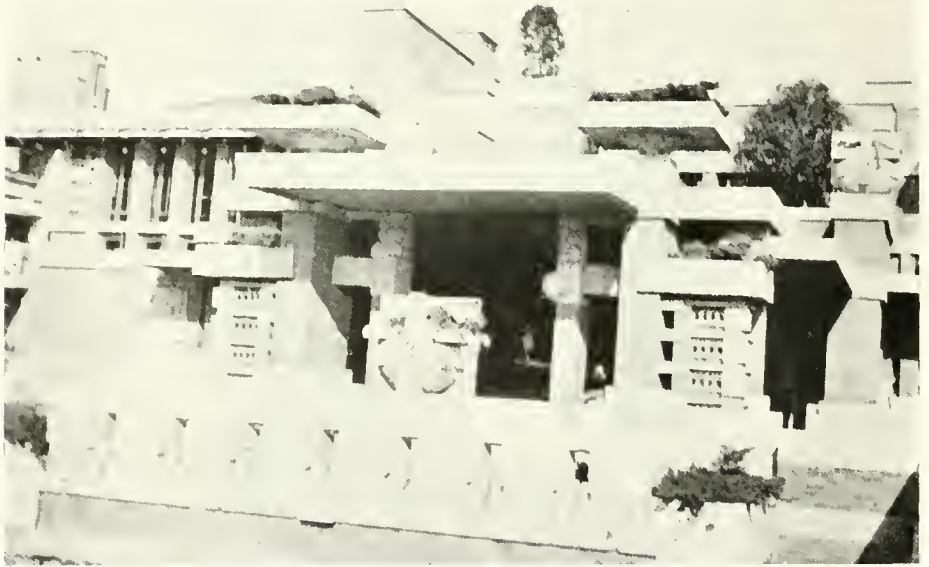

Every facade is laminated profusely with stone, unfit for use—soft, fragile, full of large holes—and carvings of revived prehistoric patterns

if it were outside of Japan; it is devoid of all fundamental essentials whereby human safety is made reasonably secure; it has no secondary exits; a stampede would spell holocaust.

A banquet hall above the theatre will seat eight hundred. Its walls are of brick and stone (all large public rooms of the Imperial Hotel are of brick and stone, corresponding with the exterior elevations). Its long wide balconies of masonry are invisibly supported by cantilever floors, upon which masonry piers are superimposed at a distance of six feet beyond the supporting walls; these piers are designed to receive the ends of a fifty-foot, steep roof span, transferring the roof loads onto the cantilever balconies.

The swimming pool in the basement, under the large central dining room (first floor), is filled to capacity with water which cannot be released without affecting the superstructure—due to a floating founda-

tion; the putrid water in this pool is kept "chemically pure." The swarm of mosquitoes in that hotel leave their mark, as if they had been cultivated under conditions most favorable for producing results that are permanent.

The single bedrooms are thirteen feet square. Twin bedrooms are thirteen by twenty feet. Each has a three-foot alcove leading to a wardrobe closet and to the bathroom, and to connecting room doors. The ceilings are eight feet six inches high. The bathtubs are of concrete, lined with dark brown, unglazed ceramic tile, such as has been applied for wainscot. Bath water discharged from one tub sometimes seeks its level in the tub of an adjoining room—a fact which, coupled with the rough dark tile lining of the tub, makes standing shower baths with flexible hose attachments most popular.

The furniture is all of "special design." The wardrobes have four-fold sliding doors, whose donkey-like stubbornness against coming, or going, leaves the wardrobes conveniently wide open. The writing desk, table and chest contain a flock of sixteen small drawers; these pieces of

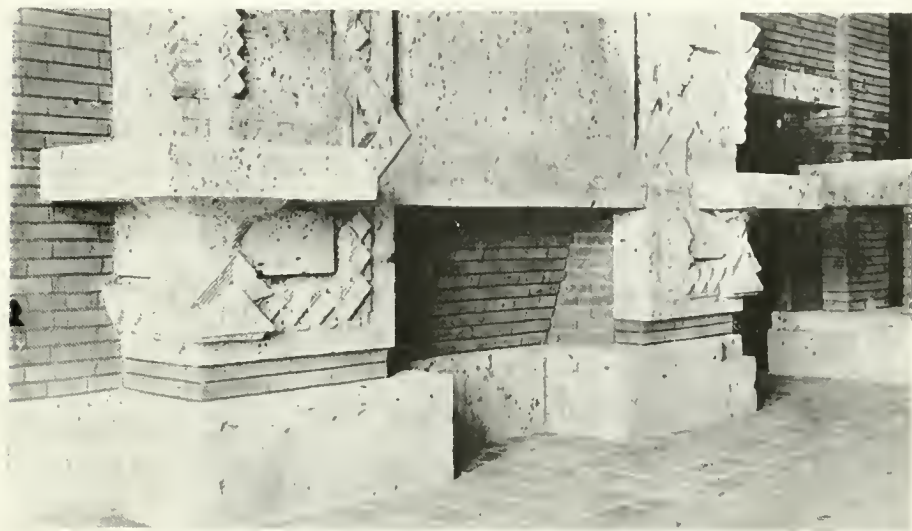

This fireplace is not as innocent as it looks; it smokes! The protruding corner shelves are convenient things to run into. There are many similar fireplaces in this hotel, but the darkness which enshrouded them eluded the camera.

furniture are all of diminutive size. The beds are narrow, the mosquito canopies still narrower; a combination which produces varying conditions of perfect contact between the mosquitoes and choice geographical centers of the earthly bodies which occasionally revolve on their own axis, within the prescribed areas of their nocturnal orbits.

Tokyo summers are not warm, but hot, plus humid—Fahrenheit frequently registers 90 degrees and much more; the bedroom windows are small, the customary pivoted top sash have been carefully omitted from corridor partitions, and there are no screen or louver doors; briefly expressed there is no provision for natural circulation of air. Every room is a box with a few small holes punched into one side, and the annoying, but indispensable electric fan is forever buzzing. Incidentally the corridors are devoid of natural light, and the few electric ceiling lights are made useless by ornamental enclosures. The tunnel-like darkness of the corridors does not hinder one from reading the room numbers, which are carved large, and so placed that one may distinguish

them by sense of touch, or a pocket light. The electric bulbs have been effectually screened with ornamental wood, or, metal, or mostly with Nikko stone and terra cotta, so that the office staff can scarcely detect a departing non-paying guest, after the sun has gone down.

The kitchen is in the basement in the rear. Servants must go up and down stairs for everything which the kitchen provides. The stairs to the private dining rooms are boxed, making complete turns. They are so narrow that two servants with trays cannot pass each other; perhaps a 'block system' may be useful in preventing collisions.

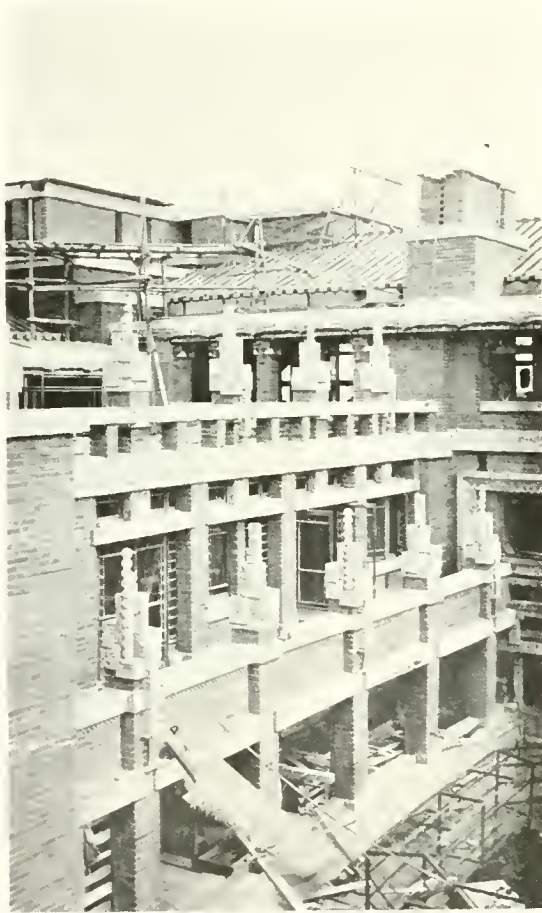

Exterior courts are weird and bewildering in structural motives, scale and ornament of childish conceit

In conclusion, it should be stated that all American citizens will forever regret the inherent mistakes which have been made in the building of the Imperial Hotel. The errors are so numerous and flagrant that it may be said this structure should never have been built. The results are especially unfortunate in most instances because they cannot be remedied. The building was built in accordance with the architect's drawings, which were approved by the owners, or their official

representatives; consequently the responsibility remains with those who were in authority, namely those who prepared the drawings and those who approved them for final execution in brick and stone.

It is frequently true that an architect does not know how his designs will turn out in their final execution. The architect of this building could not have known. It is similarly true that an owner, even more frequently than an architect, cannot foresee by the drawings what the final results are going to be. It is not the fault of draftsmanship. It is most important that both architect and owner should have

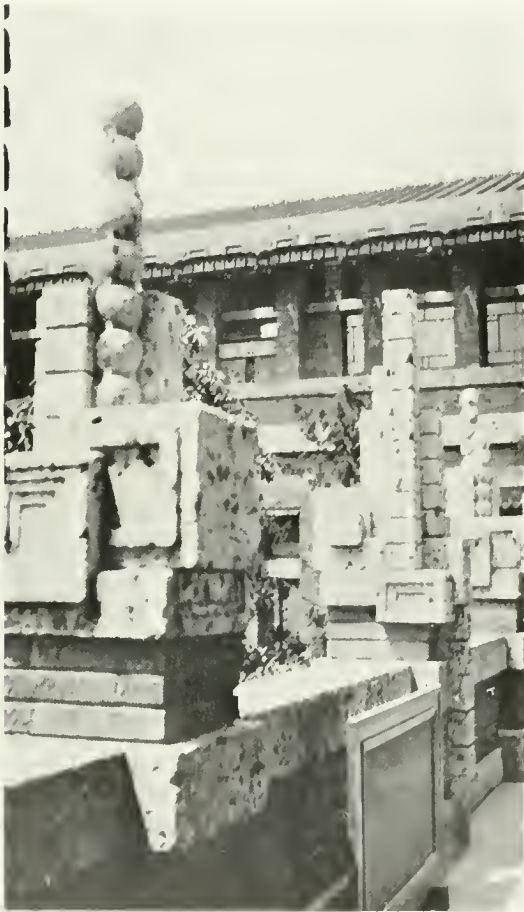

Groups of shafts cut into stacked balls and cubes (which may be conventionalized Arizona desert cactus) constitute a favorite theme of the designer

the capacity clearly to visualize the ultimate results which the drawings and specifications predetermine, or that individuals be engaged who are known to have that capacity, to take their place to insure themselves and others against such unfortunate results as this hotel exemplifies.

Peking, China, September 1, 1922.



An inner court between the left wing and the center unit; the manifestations of this court are repeated between the center units and the right wing



"Peacock Alley" raises its stone feathers fearlessly; its multitude of structural forms and of ornament might have remained a "lost art," if the Imperial Hotel had not revived it



Colossal stone canopies, cornice and vases, suspended by an unseen power, overhang space. A coarse gravel roadway crunches uncomfortably under rickishas, taxis and pedestrians at entrances



The main dining room has stupendous corbels of pieced stones, which profess to support hollow beams filled with electric bulbs. The tons of brick and stone in the music balcony apparently support themselves

Salesmanship as it Relates to the Practice of Architecture

THE following excerpts from a letter written by a prominent business man of Chicago to the Secretary of the Entertainment Committee of the Illinois Society of Architects appeared in the columns of the Bulletin, official organ of the Society:

"It has always seemed to the writer that the question of salesmanship as it relates to architectural service has failed to receive the consideration that its importance to any business justifies.

"Generally speaking, architects appear to have divided themselves into two classes in methods of sales—first, that class closely following the old, established Code of Ethics who are so fortunate that they are able to await the coming of clients to their office, brought there either by their professional reputation or through the good offices of friends or relatives, and—second, that class who scatter sketches and colored perspectives broadcast toward any prospective client who is willing to receive them, without any obligation on the part of the client.

"Towards the first class no criticism may be directed, as their methods in no way detract from the dignity of the profession, but in the writer's opinion, there is a middle ground between the two, not lacking in dignity and bearing a semblance of modern business practice.

"This lies in the approach to prospective clients through dignified and appealing advertising and direct solicitation either personal or written, and both designed to awaken interest in the work and reputation of the architect. This may be followed by consultation relative to the project, but no sketches should be made or intensive study of the problem given without some form of remuneration being arranged for.

"Experience unequivocally demonstrates that the architect is no more required to expend time, money and experience in producing free sketches, than would an attorney be required to prepare a prospectus of a brief in order to demonstrate his ability to a client prior to being retained.

"Unquestionably the requirement of a preliminary fee increases the respect of an intelligent client for the architect, whose opinions are immediately given a tangible value in the client's mind.

"A successful business man never expects to receive something of value for nothing, and many of them are chary of receiving it. When they do accept it it is usually because the architect forces it on them, many times to his own detriment, because the layman, finding himself in possession of a number of different analyses of his problem, all free, promptly becomes confused and thus delays decisions. This means extra expense to each competing architect in keeping himself in evidence and in a number of specific instances which might be cited, the result has been that an architect finally appears who placing some value on his services gains the confidence of the client to such an extent that he eventually secures the commission."

* * *

Higher Buildings for Chicago

The builders of skyscrapers in the Windy City are expecting to be able to hoist their flags to greater heights than ever before if the new zoning and building laws are approved. The new laws figure vertical distances in terms of the cubical contents of the buildings, and the proposed maximum elevation to be permitted in the downtown district will be extended another 20 feet, or to the peak of 280 feet from the street level.

Paint, Architecturally Considered

By C. W. COUSENS, in the *American Architect*

PAIN'T, aside from its use as a vehicle to create pictures, may be regarded by architects from two points. First, as a preservative of the surface to which it may be applied. This use of paint concerns both the architect and the engineer who know the necessity for the proper protection of materials that are to become embedded in the work, or the surfaces of metals in engineering structures that are exposed constantly to the varying temperatures and rigors of climatic changes.

In the present article it will be the endeavor to show how paint,—as color,—may become a very valuable medium, when intelligently used to accent the features of architectural design, not alone on new buildings, but also to rehabilitate, as it were, old structures whose merit of design and proportion have ceased to attract by reason of an unsightly dilapidated appearance.

In travelling about the country in railway trains, it is often noticed that the appearance of cities, or that part of them that may be viewed from car windows, is unsightly. There is a generally down-at-the-heel appearance. The indiscriminating observer is apt to condemn the architectural aspect and, if he has an eye for color, will lament the dinginess that overspreads the whole aspect.

The average building is not as bad architecturally as it seems. Its form is often good, or not all bad, and what it lacks is a proper garb of paint to give it an air of respectability. Probably one of our shortcomings in civic pride is in ignoring the aesthetic value of good painting. A false economy postpones a necessary painting and the result is deterioration of value of buildings through neglect to provide a proper preservative, but also a very marked deterioration in civic pride. Unpainted, slatternly and slovenly neighborhoods are avoided by self-respecting people. A moderate expenditure of paint properly selected as to color and quality, would raise a given section from a purlieu to a desirable neighborhood. The enhancement in rent would be sufficient to pay for the cost of painting, and the attraction of a better class of tenantry would be inevitable. Communities that are striving for civic betterments seem to ignore the value of paint. Civic centers of beauty and good planning are designed, and the visitor in the rapidly moving motor car marks the quick transition from all this fine appearance in the heart of the town, to the squalid, unpainted and generally run down aspect of other localities. To use an old, well worn comparison but one that actually describes these things, there is "a Queen Anne front and a Mary Ann back."

Color in architecture, something every thoughtful architect is striving for, is not solely obtained by color of materials, but particularly as referring to suburban localities, simply a matter of paint.

Every wise man secures an architect to build his house. If his wisdom is broad enough, he will retain him in the matter of his decoration and furnishing. But too often is the idea of decoration confined to the interior of the house. It should be essentially a part of the architect's work not only to specify the quality of the paint to be used on the exterior, but he should be allowed to select the colors and to make sure that the fine elements of his design are not blocked up, or wiped out by an injudicious and inartistic selection of color and its improper application.

Architects should make emphasis in their specifications as to just what tints or colorings should be used for the painting work of exteriors, as well as of interiors. When left to the whims of the new owner or the false notions of the housepainter, many atrocities are committed. Cornices, columns, balustrades, trim and mouldings are eagerly seized upon by the painter as vantage points whereupon to display certain conceits he may have as to color combinations. He seems to feel that each new job presents fresh opportunity for the display of his talent for originality, and, running parallel to this disposition on the part of the housepainter, are the primitive ideas possessed by some new home builders that their houses must be different from any of their neighbors, regardless of rules or canons of taste. Really good lines and classical details of architecture are so maltreated as to give to the average frame house the appearance of a conglomerated mass of gingerbread.

The successful painting of the exterior of a house must depend upon an idea, and it goes without saying that the idea must be simple and consistent in its development.

All well planned exteriors have lines of architectural strength, and where the master hand has created the design, there is absolutely no need for emphasis in the application of paint or color. The creations of the architects demand simplicity of treatment by the painter. The effect produced by the application of surface tints, without the added embellishment of fancy colorings upon a rugged design is at once noble and dignified. The effect of light and shade and of proper background compel admiration, and while so-called imitations of stone work on a frame house are not to be tolerated, a most fitting model in the treatment of the frame house is the stone building. A castle of marble or of granite or any other rugged stone is a creation of beauty simply because of its "oneness," whereas the same design would be a nightmare if it were composed of variegated stones of different hues and texture. A sculptor would create a sensation if he chiseled a masterpiece of highly colored and variegated marble, but after the first shock of surprise his creation would be viewed as a curiosity and not as a work of art.

Some frame houses need help; weak details need emphasis, but such emphasis as is made must be under the supervision of the architect. Good taste demands that projections which need emphasis should be highlighted, and that flat openings should be deepened and thrown into shadow. If tracery and detail are to be emphasized, the body of the house must be neutral and of deeper tint than the tracery.

There may be utilitarian reasons for painting the trim of a house in dark colors, but it certainly destroys the dignity of the design if, for instance, a frame house with body painted French gray, has cornices, mouldings, columns and balustrades painted a slate color. This combination may be serviceable because of wearing qualities, but for artistic effect the French gray house will appear to better advantage if the cornices and mouldings are painted either white or ivory tint.

We are aware that some consideration should be given to utility, and where there is an objection, because of accumulation of dust, etc., on projections, to having white or light colors, a compromise may be effected by having only a shade or two difference between the trim and the body of the house. The effect of severity and plainness will be saved, if the window sashes and frames are painted very dark, almost black.

This will emphasize the shadows and thus give more solidity to the structure.

If the rule of simplicity is carried out to the limit in the painting of exteriors, suburban houses, especially, will show up to better advantage against the background of verdure. A simple color scheme will take into consideration that there are too many features to a house sufficiently prominent in themselves to need undue emphasis of striking color. For instance, we will consider the roof. Too often, this is the most conspicuous feature of the house, because of its vivid color treatment. The prevailing fashion for red roofs should not excuse the painting of roofs of buildings and barns on the farm with metallic red regardless of the color the buildings are painted.

We can readily understand why a red brick house should have red shingles or the new style tapestry effect, but we cannot understand or appreciate that sort of thing on a painted frame house. Rather would we have the old, Colonial white house with green blinds and silver gray shingle roof. In this combination there are refinement, modesty and dignity.

That architect will be serving his client well, beside being a great benefit to his client's community, who insists on simplicity of color treatments of exteriors and depends upon the usefulness of several shades of one color for the general scheme, rather than to permit the ambitious house-painter to use the colors of the rainbow on one job.

In conclusion, it may be stated that color whenever used must be handled with knowledge. The painter selects his frame to fit his picture. The architect has his frame (the surrounding prospect) rigidly provided at the outset. He will, of course, so design the lines of his house as to conform pleasingly to the lines of its background. He will, therefore, need to paint his house, not so it will blatantly proclaim its presence, or set-up a continual war with its adjoining neighbors, but that it may rest quietly in its place and reflect the dignity of domesticity it was sought to secure.

It will, therefore, be seen that color may not be selected haphazard, but must be chosen with knowledge based on good precedent. These precedents are all about us, and it is desirable that they should be carefully studied.

* * *

Color in Architecture

A MATTER that has not been given the careful attention it needs is color in architecture. Towns and cities that are a patch-work of color are, perhaps worse than cities that have practically a dead level uniformity of color owing to the prevalence of some local material, but there need not be either a riot of color or a poverty of color. The monotony of a prevailing material can be relieved by a judicious use of other materials that will give the needed color accent.

Color in architecture, of course, does not necessarily mean spots of brilliant hue, it may mean the general color of the material of the building, pleasing or otherwise. In any case it is a matter that needs more consideration.

In a paper on "Color in Architecture" recently read before the Royal Institute of British Architects, William Harvey presented the subject in a thorough and scholarly manner. Below we quote a few paragraphs of Mr. Harvey's paper from the report in the Journal of the R. I. B. A.:

"In some way or another color is bound up in the appearance of all architectural works, and when not formally invited it is rude enough to intrude its presence unasked. The color of materials available at certain sites controls the finished effect of many works of architecture."

"In both Jerusalem and Tiberias the same type of design is adhered to in the old domestic architecture; but whereas the one city, built of creamy limestone, is full of charming color harmonies in relation to its surroundings, the architectural appearance of the smaller town is rendered dismal by the use of a local stone of sombre black-blue hue."

"It is the misfortune of England at the present time that some of the most generally useful and economical bricks happen to possess a hard, unpleasant tint of pink, whilst brick of a really beautiful color can only be obtained at much greater cost. Fashion has something to do with our taste in bricks, and the only thing to steady our judgment is to ask ourselves whether the color value of such and such a building material really goes well with the other things in the picture—the sky and clouds and foliage, if there is any in the neighborhood."

"Old London stock bricks, with their varied tints, including some black and red among the yellow, stand well under the gray skies and soot of London, and it is a pity that they were ever improved into dull informity. If anything, a little more variety would have improved them, and in the hands of architects who had an eye for color they were given dressings of richer tint or banded with diagonals of vitrified headers."

"The use of painting on ancient Greek architecture, where an inclement winter must have acted adversely to applied pigment, may have been encouraged by the example of Egypt, where painting had proved successful in a dryer atmosphere."

"Ornamentally-colored terra-cotta seems to have been used at the eaves of some primitive temples. Fragments of architectural painted tilework, supposed to date from the seventh century B. C. were found at the shrine of Artemis Orthia, the goddess of Sparta, in the excavations of 1908, and are described in the Journal of the British School at Athens as 'painted tile; tongue pattern in reddish-brown and a maeander in white paint.'"

Mr. Harvey went on to describe in detail the use of color in the old buildings of Egypt and the Orient, as well as in Great Britain and Western Europe, revealing the rich store of suggestions for the use of color to be found in historic work—a profitable study.—Pencil Points.

* * *

World's Largest Radio Station To Be Constructed in China

Construction of high powered radio stations in China, at a cost of \$13,000,000, will be started immediately by the Federal Telegraph Company of Delaware. The company is jointly owned by the California Federal Company and the Radio Corporation of America. The enterprise will bring the control of wireless communication with the Far East into American hands for the first time and will facilitate commercial communication without any foreign interference of censorship. Under the construction program of the company, main and secondary stations are to be built at Shanghai. This main station will be the most powerful station in the world. In it will be installed duplicate 1000-kw. arc transmitters of the Federal type, which will be constructed in the Federal's Palo Alto plant.

Population Gauges New Office Space

San Francisco Needs Seven Square Feet for Each Inhabitant

President Earle Shultz, of the National Association of Building Owners and Managers, commenting upon the comprehensive report just issued through the efforts of the San Francisco Association and its secretary, Mr. E. M. Applegarth, says that similar surveys will probably be undertaken in most American cities. The complete text, with table, of this report as it appears in the latest Bulletin of the National Association of Building Owners and Managers is given below, Mr. Shultz's interrogations being addressed to members in various cities throughout the United States.

VACANT space is undoubtedly the controlling factor for either making a profit or showing a loss in your building. Some managers say that over a period of years vacant space will average ten per cent; others claim it will not exceed six per cent. But whether vacant space has averaged ten per cent or only six per cent in the past, the important question is how much excess space will be on the market in your city next year? Has your Association taken a survey and compiled figures to show you what you might look forward to next year?

In San Francisco the Association has made such a survey, and the results have been startling, to say the least. When the survey was made a short time ago 190,000 square feet of office space was vacant in the city. And in spite of this condition many new buildings are being erected or have been contracted for. The new space to be added by November, 1923, is estimated to increase the vacancies to 300,000 square feet.

Without doubt there is a definite relationship between the size of a city and the amount of office space required. And the size of a city is gauged by the population. Public utility companies from month to month check up on the current consumption on this basis. So our business might at least follow that plan in estimating the requirements for new office space.

San Francisco has made the first study, so far as is known, to arrive at a definite figure for the office building space required. It forecasts a day when the addition of space will be put on a basis long followed by other classes of business. The packers, the public utilities, the manufacturers and others know their market, know their production requirements, and know their costs.

The business of managing office buildings for the past few years has known production costs. In many of our cost estimates no provision is made for vacancies, but this item is now recognized as important. How much are you planning to use for this item in your 1923 costs? As yet, our market has not been studied thoroughly, and added space for future requirements has been left entirely to promoters and chance.

In order to arrive at the amount of new space required in the city from month to month, figures have been compiled showing the population and the office space occupied each year from 1910 to date. From these data it was found that approximately seven square feet of office space per capita is the San Francisco average. In your city it may be more or less than in San Francisco. Another Pacific Coast city uses a smaller unit which was determined from a local survey. The unit figure for San Francisco was obtained from the table on page 98.

Knowing the relationship between population and office space, it was possible in San Francisco to estimate the new space required from year to year as the city grew. The conclusion is that 142,000 square feet of new space is required each year, an increase of 3.1 per cent of the

present space. And the report shows 190,000 square feet of vacant space in San Francisco.

The increase in population as estimated for the next ten years is shown on Chart No. 1. The population curve for the years 1910 to 1920 represents the estimate by the Pacific Telephone & Telegraph Company of the population of San Francisco, South San Francisco, Daly City and Colma. For the years 1915 to 1922, both inclusive, the total rentable area available and the total occupied area are also plotted on this chart. The shaded portion between the two lines represents vacancies. Attention is called to two unusual factors which distort the normal rise of the "occupied area" line:

First: During the year 1915 in which the World's Exposition was held in San Francisco there existed an unusual demand.

Second: In the year 1916 there was an abnormal depression attributed to the effects of the European War.

The main point brought out is that occupied area rises on the average almost parallel to the rise in the line representing population. From this the conclusion is made that for the area above mentioned the maximum ratio of occupied area to every inhabitant is seven square feet per capita.

Attention is called to the very abrupt rise in the line "rentable area" for the years 1922 and 1923. Because of the very great increase shown in rentable area, Chart No. 2 has been prepared with the hope of forecasting accurately the space that may be available and occupied by the end of 1923.

From January, 1922, to November, 1923, the estimate shows that the office space will be increased from 4,581,709 square feet to 5,426,265 square feet—nearly eighteen and one-half per cent in less than two years. This is shown graphically on Chart No. 2, which covers the calendar years 1922 and 1923. The top line represents the office space available at the beginning of the period, and with successive increases the additions of office space due to the construction of new buildings. Each

Table Showing Relation of Office Building Space to Population

Year	Popu- lation	Gross Rentable Area	Sq. Ft. Rent- able Area Per Person	Occupied Area	Sq. Ft. Occu- pied Rent- able Area Per Person
1910	416,912	2,771,405			
1911	428,100	3,028,613			
1912	442,750	3,181,238			
1913	458,300	3,316,331			
1914	476,000	3,564,158	7.5	3,025,000	6.37
1915	495,500	3,845,166	7.76	3,180,000	6.42
1916	515,850	3,878,032	7.52	3,150,000	6.12
1917	537,000	3,899,168	7.16	3,200,000	5.96
1918	559,900	4,223,618	7.55	3,500,000	6.27
1919	583,000	4,322,618	7.41	3,750,000	6.43
1920	607,000	4,402,819	7.25	4,100,000	6.75
1921	628,000	4,563,943	7.25	4,445,274	7.07
1922	649,100	4,581,709	7.07	4,150,000	6.86
1923	670,000	4,950,921	7.49	4,520,000*	6.75*
1924	690,750	5,325,865	7.7	4,655,000*	6.75*
1925	710,800				
1926	730,750				
1927	750,000				

*Estimated.

increase is designated by the respective buildings with the date on which they have been completed or are expected to be completed.

The lower line illustrates graphically the estimates of the occupied area. Two factors considered in this estimate are:

First: The average requirements of seven (7) square feet of office space to each inhabitant; and,

Second: The unusual expansion expected by reason of the fact that the last four of the large constructions are to be entirely or practically all occupied by the builders.

The point on the lower line for December, 1923, is the estimated occupancy on that date. The expansion allowed here is justified due to lack of normal increase in office space during the war period. No expansion factor is taken for building in 1923 excepting in the case of buildings built specially for the occupancy of a single tenant, and the space to be occupied and the space vacated is known.

Had it not been for the expansion factor, the occupied area based on normal increase in population only would be as shown on the chart by "V" for December, 1923.

The lower line (as shown on the chart) allows over the entire period an occupancy of seven square feet per capita, and in order to graphically show the relative expansion expected at each building the increase in occupancy is shown in the lower line for these respective buildings by a vertical rise at the same end that the rise is shown in the upper line. It is obvious that the expansion will not occur entirely simultaneously with the availability of the space, but in order to visualize this relationship of expansion with the new construction the two factors are shown one under the other in the respective lines.

The normal increase in San Francisco office building space, based on the estimated population increase, is estimated to be 142,000 square feet per year. The actual increase in office space shown by Chart II is now at the rate of approximately 460,000 square feet per year—a rate much larger than the requirements.

The promoters, with elaborate plans and generous estimates of profit to be made from new office buildings, for the first time may have to prove their figures. They have had easy sailing in the past, largely because owners and managers of office buildings did not know about future requirements in their city. The sad results of carrying an excess of vacant space is well known and needs no further description. We hope that this condition is to be changed and we are indebted to the San Francisco Association and to Secretary Applegarth for pointing the way.

* * *

White Paint Made Resistant to Light

Painters like to use lithopone because of its many good qualities. This white pigment is, however, not recommended for outside work, due to the fact that it darkens when the painted surface is exposed to sunlight. A French investigator has determined that it is the ultra-violet rays of light that cause the pigment to darken. To prevent the action of these rays, it is only necessary to surround each particle of lithopone with a layer of material which is insensitive to light and which at the same time does not impair the good properties of the pigment. Such materials are blanc fixe, alumina and oxide of zinc. A lithopone paint made in this way gives most excellent results.—Industrial Digest.

“A Scrap-Book of Ornament

By WILLIAM M. IVINS, JR.,

Curator of Prints, Metropolitan Museum of Art

ALTHOUGH not one of the recognized philosophers of the eighteenth century, Marcel, the great Parisian dancing master, sounded one of its most perfect and, artistically, one of its most pregnant notes when he sighed and said, “Ah, que de choses dans un menuet,” since thereby he summed up pointedly, and with as much intention as one cares to grant him, the attitude toward life of a society which found its greatest happiness in pondered and skillful arrangement of the *menus plaisirs* of life. Conversation was not mere talk or interchange of thought, it was a seriously considered game with rules and points, penalties and rewards, to which all the world turned as during the reign of Henri IV it had turned to the niceties of the fence. But as compared with the more athletic, if not more agile, exercise it offered an infinitude of strategies and situations, delectable and charming in themselves, not least among which was the fact that this game was suitable to the parlor and was to be played habitually with women as well as on occasion in their presence. Its devotees, as one of them so frankly said, loathed war because it interfered with conversation.

Taken seriously by an entire community among which were many of the most intelligent as well as the best-bred people of their time, this game was played not only gravely but at times with consequences so momentous that it were futile to regard it as mere frivolity. As the greatest of all games known to men is that of conduct, so may one not dismiss as unworthy of consideration the manner and the material with which it was played by this group of exceptionally keen intellect and studiously good manners. Light in its touch, skilful in its phrase, the period believed with one of its most disillusioned writers that the day wherein one did not laugh was wasted, and it contained many who thought as Vauvenargues, in the wisdom which was not only worldly but most generous, that one of the noblest attributes of man was his ability so easily to dispense with greater perfection. One took what the world provided, and being grateful made the best of it. Of course it was artificial but, however much the moral zealot may dislike another's artificiality, he must know in his heart that without artifice there can be neither manners nor that quality in conduct which is called politeness, and that to its little politeness life owes its pleasant savor.

These reflections may seem quite far apart from any consideration of art, and yet as we look back to the eighteenth century, past those periods, romantic, impressionist, and post-haste, which have succeeded it, and remember the loud turbulencies of petty self-assertion which have marked them all, their essential rudeness, their gaucherie, their stridency, and all the other unsocial qualities which they have sought to justify on the ground of naturalness, we can see that it was perhaps the last in which the art of living and its kindred arts of decoration received the thought and care which are their due. In design as in conversation they believed with that other later moralist that “la politesse aplaît les rides.”

So little self-assertive was the time that there are almost no surviving records of the life and travels of Jean Pillement, of Lyons who was

in many ways one of the most distinguished and delightful of all its many draughtsmen. We know that he was born at Lyons in 1727, that he died there in poverty in 1808, that he worked in London, Paris, Vienna, Lisbon, and that he held the appointment of painter both to Queen Marie Antoinette and to Stanislas, King of Poland. Five times between 1760 and 1780 he exhibited in London at the annual shows, and between 1757 and 1764 more than two hundred plates after his designs were engraved and published there at the expense of a fashionable master of dancing and deportment. He appears to have played a not unimportant part in the development of English landscape practice during the second half of the eighteenth century and to have spent a great part of his life preparing designs for the Lyons looms.

In his own time possibly most famous for his landscapes, which despite their charm were but little more than pastiches of seventeenth century Dutch painting, he is most valued today by the few who know his work on account of the many designs which he made for the decoration of walls and of textiles. Of all the many men who specialized in the minor arts of decoration during the eighteenth century, Pillement stands out because of the sheer delight which lies in his completely nonsensical work. Groups of flowers or seed pods are arranged in marvelous patterns, which are the more entrancing because they have no apparent rhyme or reason. Barques of flowers and leaves pursue their course in flat defiance of all the rules of physics and experience. Chinamen fish from pagodas perched on ladders rising from most fragile petals. Children play gravely comic games. And everything is beautifully mannered. In its way it is the most perfect illustration of the fact, full comprehension of which seems to be so difficult for so many people, that nonsense is neither bad sense nor half-sense, but like sense itself has its logic and its close reasoning, and that to achieve success in its pursuit requires talent of most uncommon distinction. There is no subject matter, there is nothing with which we are familiar, in any other hands the things would be banal and flat, and none the less as we look at these designs, especially those most charming ones rendered in color by the otherwise unknown English etcher Anne Allen, we are transported to a land and to a realm of thought in which artificiality becomes natural and nonsense serious and close-linked as logic its very self.

Where Moreau le jeune and Fragonard told their many and delightful tales of expensive costumes and court manners, Pillement put on his wishing cap and carried himself, and us with him, over the hills and far away to a country beyond the moon where people were grave because there was no sorrow, where people smiled because of the very solemnity of their farce. Like some inspired clown, impassive of countenance, a little melancholy, and impeccable in pomponed pantaloons, he holds forth to us his magic loop, bidding us break through into the world of pure enchantment that lies beyond; a world of inversions and topsiturvinesses, where nothing is unexpected because nothing is expected, and where delight involved no moral consequences. An older Frenchman said, "Our follies are our wisdom."

There has been added to the ornament collection in the Museum Print Room, Metropolitan Museum of Art, New York City, a group of 360 engravings by and after Pillement, of which two score are printed in color.



SECTION OF VENTURI VAULT BEING DEMOLISHED BY PAVING BREAKERS

Reinforced Concrete Vault Removed with Compressed Air "Paving Breakers".

RECENTLY it was found necessary to remove the side walls and top of a large venturi vault and a section of the west wall of the Filter building in Cleveland, Ohio. Fig. 1 is a general view of the work. This shows a section of the west wall that was removed. The section was 23 feet in length, 20 feet in depth and 24 inches thick. The wall was of concrete, reinforced with $1\frac{1}{2}$ inch to $\frac{3}{4}$ inch rods, spaced on 8 inch centers. This made a very solid formation which was difficult to remove. Three days time was required to completely demolish this wall.

At the start, doing this work by hand method was contemplated. However, Mr. Chas. H. McAllister, general manager of the Lake Erie Construction Company, to whom this contract was assigned, finally decided to try out a recently patented "paving breaker" which consists of an automatic, compressed air operated, pick and chiselling machine, similar to a non-rotating hand-hammer rock drill. It is light, extremely simple and operated by one man when working downward. In this particular case, however, it was found advantageous to use two men to each machine. Until lately "paving breakers" have been principally used by street railways, telephone, electric, power and gas companies for tearing up pavement of all kinds, for the laying and repairing of street railway tracks and the laying of electric cable ducts, gas mains, etc.

It required three days time to demolish the west wall by the use of two CC-25 breakers, which not only broke up the concrete in pieces large



PAVING BREAKERS REMOVING CONCRETE FROM VENTURI VAULT, CLEVELAND, OHIO

enough to be handled by one man, but with the aid of a cutting chisel they also cut off the steel reinforcing side rods. These cutting chisels were similar to those used for asphalt except that the edge was concave so that it would not slip off the bar.

Fig. 2 shows the "paving breakers" at work on the side walls of the venturi vault. These walls are 12 inches in thickness, 51 feet long and 10 feet high. They are reinforced in the same way as was the west wall of the Filter building. These walls were removed in seven days by the use of the breakers. The roof of the venturi vault, which was of the same dimensions and construction as the side, was removed in three and one-half days. This work would have taken many more men a much longer time to do it if hand methods were used, and would of course, have been much more expensive.

* * *

Over 7,000,000 Homes Wired

According to a recent survey completed by the Society for Electrical Development, the number of homes wired with electricity in the United States is 7,636,469. However, the number of homes reached by electric service is 13,000,000. The survey further indicates that there are 8,145,126 homes in the country not reached by electric service and that 13,508,657 homes are not wired. These figures indicate there still is a big field for electrical wiring and development and that there are millions of the people in the country today who do not enjoy the advantages of electricity.

Refutes Opinion That Construction Costs Will Decrease

THAT construction costs will continue to increase to a higher level than at present, and that the demand for construction will continue for some years to come, is the opinion of the Associated General Contractors of America, in a statement made to Mr. James A. Wetmore, Acting Supervising Architect, who is quoted as authority for the statement that within the next 18 months the country may look for a very material drop in the cost of building.

In the United States Advertiser it is reported that \$15,000,000 worth of Federal buildings throughout the country are being held up for a drop in the cost of construction expected within the next 18 months.

Not only has the cost of building been going up for several months, according to the Associated General Contractors, but so has the cost of materials. Wages in the building trades have more recently begun to increase also. The general wages of wholesale prices has been increasing since the first of the year.

"The behavior of all these prices in increasing during a time of recovery from business depression," state the contractors, "is entirely normal. It is a phenomenon which always occurs during like periods. We believe it is a very strong indication that prices in general have been stabilized for the present on a new price level in the neighborhood of seventy per cent higher than that which prevailed in 1913. This means that prices will continue to go up until the present period of prosperity is fully established and will not go down again until the beginning of the next business depression. The next depression will probably be only a moderate one—such as we were familiar with before the War—and will be accompanied by only moderate decreases in prices.

"Instead of expecting that building costs will be materially lower eighteen months from now, we anticipate that they will continue to increase during the greater part of that period, and that they will be at that time, perhaps, at about the beginning of a decrease but at a point higher than the present. We believe, further, that the decrease which may be expected to begin at about that time will not go to a point very much below the figures reached during the past winter."

In explaining their reasons for their opinions, the contractors say that the costs of building materials are going up partly because they are partaking of the general tendency of prices to rise during this part of the economic cycle, and partly because we are experiencing a building boom of unprecedented volume. Wages of building labor are increasing, partly because of the shortage brought about by this same building boom and partly because of a recovery in other lines of industrial activity.

"One important aspect of this phenomenon," they state, "is the shortage of common labor, which is due, in large measure, to the almost complete extinction of immigration for the past nine years, caused first by the Great War and latterly by our present restrictive immigration act. That this shortage of common labor in fields other than the building trades is a very real one is proven by the recent action of the United States Steel Corporation, and a number of the other important steel companies, in making large voluntary increases in their wage scales."

THE
Architect and Engineer

Incorporated

Founded 1905 by E. M. C. WHITNEY

W. J. L. Kierulff - President and Manager
Fred'k W. Jones - Vice-Pres. and Editor
L. B. Penhorwood - Secretary
T. C. Kierulff - Attorney

Associate Editors

Chas. H. Cheney - City Planning
August G. Headman - Book Reviews
Wilbur David Cook - Landscape Architecture
Wm. B. Gester - Inspection and Tests
O. P. Shelley, C. E. { Fireproof Construction
F. W. Fitzpatrick }
T. Ronneberg, C. E. - Structural Steel
W. H. Lowe - Roofs and Roofing
Fred'k N. Woods, Jr. - Rock and Gravel
Chas. Felix Butte - Electrical Construction
J. W. Fricke - School Equipment
Will J. French - Department of Safety

Published Monthly in the Interest of the
Architects, Structural Engineers, Contractors
and the Allied Trades of the Pacific Coast by
The Architect and Engineer, Inc.

PUBLICATION OFFICE:

627-629 Foxcroft Building, San Francisco
Telephone Douglas 1828

The publishers disclaim any responsibility for
statements made in the advertisements of this
magazine.

Terms of Subscription

(Including postage) to all parts of the United
States, \$2.50 per annum; to Canada 75c
additional; to all Foreign points \$1 additional

Vol. LXXI. NOVEMBER, 1922 No. 2

**DENVER GETS RID OF ITS
'TWILIGHT' ZONE**

A new construction classification just announced by the Underwriters' Laboratories of the National Board of Fire Underwriters, opens the way for a considerable extension of economical house construction. The new classification consists of ordinary wood construction with metallic lath and gypsum plaster covering. The engineers have found that such construction will resist an unusually severe fire for longer than an hour, and accordingly have given the high insurance rating of "one hour" to floors and bearing walls so constructed.

A step further in the same direction, which is not improbable, will have a very beneficial effect on the "twilight" zones of many American

cities. The new classification applies only to interior work, gypsum plaster not being adapted to weather exposure. It is hoped that eventually a like ruling will be made for frame construction with stucco exterior surfaces of some sort of plaster on metal lath.

Even limited to interior construction, the new rating is of great importance. Though it does not result in lower insurance rates on frame construction, it contributes greatly to safety and fire-resistance in both ordinary and frame construction, and will justify building codes in broadening the zones within which frame construction is permissible. As about three-fourths of American buildings are of frame, any innovation which increases their resistance to fire is of the utmost importance.

In all American cities lumber is still the most economical material for dwelling construction. Consequently, the undue extension of fire limits into residence quarters often imposes heavier construction costs than property and rental values will bear. This has resulted in the "twilight" zone or no-man's land of stagnation and decay, which is apparent in so many otherwise vigorous American cities. As property owners have found that beyond a certain point within the fire limits it is unprofitable to improve or rebuild in accordance with building code requirements, old structures have not been replaced and have been allowed to deteriorate and become the shelter of shabby businesses and slatternly homes.

**NEED OF BETTER INFORMED
SALESMEN**

Editor The Architect & Engineer,
San Francisco, Calif.

Can you tell me if there is some simple treatise on the architecture peculiar to the different periods? I know of so many elaborate works on the subject but what is desired is something that will give a few fundamentals the average salesman can grasp and thereby make it

possible for him to more clearly comprehend the idea the architect has in mind when he comes in contact with him.

A very deep presentation of the subject would discourage the average salesman unless he had some training in this line, but if there is something simple that would hold his interest for a sufficient length of time to read it through, I believe it would be of immense help to him.

Thanking you for any suggestion, we remain

Yours very truly,
THE ALBERT SECHRIST MFG. COMPANY,
Denver, Colo.
PHIL T. WHITE, Manager.

Mr. Willis Polk suggests that the book, "Apollo" might be of interest to a salesman along architectural and art lines.

There is no doubt but what the average salesman who calls upon the architect lacks proper knowledge of architecture and its allied interests. A poorly informed salesman is apt to do his house more harm than good in his attempt to sell the architect.

Too often the salesman's sole knowledge, if such it may be called, consists of a few dribbling generalities which he has memorized from a talk with his employer.

RETURNING TO THE "POCKET SIZE" MAGAZINE

Another leading technical journal—Engineering and Contracting—published in Chicago, has changed from the cumbersome, ungainly 9x12 size book to the more compact and convenient "pocket size," now so popular with the reading public. The Architect and Engineer and the Architectural Record are among the few architectural periodicals that have persistently refused to be influenced by advocates of the so-called standard size 9x12 page, and now that there appears to be a growing dislike for this ungainly size, the publishers of this magazine are pleased that they have not resorted to a change. The present size of The Architect and Engineer—7x10 inches—has met with general favor

for the past sixteen years and there is some satisfaction in noting the return to this size, or a trifle smaller, by the various publications that have tried out the larger pages. Ease of handling and filing and the fact that the 7x10 size will go into any bookcase, are features that appeal strongly to readers and eventually will most likely result in the general adoption of the "pocket size."

CHURCH ARCHITECTURE

A report, presented at Portland, Ore., before the General Convention of the Episcopal Church, and signed, among other members, by Messrs. Bertram G. Goodhue and Ralph Adams Cram, has been the cause of extended editorial comment in the daily press. "Paying for an altar, a window or a rood screen," states the report "does not give the donor the right to impose his own taste upon posterity." And it continues, "Aesthetic infallibility does not inhere in a bishop."

The statement that "in all parts of the country millions have been unwisely spent" will be unanimously concurred in by architects, says the American Architect, which goes on to quote from the New York Times:

"Clearly the time has come to apply the new principles of self-government to the building of churches. What is needed is not so much a personal dictator—a pictorial Judge Landis, an architectural Will Hays or a sculpturesque Augustus Thomas—as a commission of churchmen and architects that shall improve the taste of the donor, curb the artistic hospitality of wardens and vestry, even direct the feet of the Bishop in the way they should go. Hitherto, folk who have been properly brought up have thought it incumbent upon them not to say out loud what they think, by and large, of church architecture. But, backed by the authority of this report, they may now express a hope that in the future a pair of too aspiring spires shall not give the rude populace occasion to dub the edifice behind them the Church of the Holy Toothpicks; that a sculptured Gabriel, overflamboyant with his trumpet, shall not suggest to the ungodly a Church of the Holy Bean Blower."

The New York Tribune, reviewing this report, goes deeper and more understandingly into the development of church architecture. The rivalry in building so much stressed was not the reason for the artistic excellence of thirteenth century churches. That rivalry might have been as to relative size, or the richness of decorative treatment, but the design of the fabric and the motives of its decoration were in the hands and under the control of the clergy who at that time knew ecclesiastical art better than any other class and had the power to control its development.

SPECIFICATION COVERS

Some enterprising (?) party is distributing to architects' offices in San Francisco bundles of specification covers carrying advertisements. The wording on the covers has been so cleverly put together as to make it appear that any architect using these covers, recommends and approves all the advertisers whose names appear thereon. We question the propriety of this enterprise. Surely the better offices do not use specification covers carrying advertising. It is a cheap way of getting something for nothing.

THE TRIBUNE COMPETITION

It is reported that over 800 American architects and 600 foreign architects have entered the Chicago Tribune Competition. This assures an interesting task for the judges.—Bulletin of the Illinois Society of Architects.

Among the San Francisco architects who have submitted designs are Messrs. Bakewell & Brown, Weeks & Day and Bliss & Faville.

Appointed Harbor Engineer

Mr. J. W. Ludlow, who has been acting engineer for some time of the Los Angeles Harbor Commission, has been appointed permanent harbor engineer at a salary of \$400 a month.

San Mateo County Plan Committee

The Three Cities Chamber of Commerce, believing in the wisdom of planning as far as possible in advance, has asked Mr. Willis Polk to accept the chairmanship of a committee to formulate a comprehensive plan by which the future development of San Mateo County, (the field in which San Francisco must logically expand) may be wisely anticipated.

The object is to find expression through a series of studies covering disposition of industrial zones, traffic lanes, residence districts, parks, parkways, and boulevards; preservation of natural scenic beauties and consideration of all other assets so that in anticipation of its ordinary growth the future of the County can be intelligently planned.

To carry out this work Mr. Polk has advised the employment of Mr. Edward H. Bennett of Chicago to make a survey and report on the problem; his services to include two years study more or less as may be required, including preparation of diagrams, necessary perspective drawings, publication of report in attractive form, incidental expenses, etc.

In collaboration with Mr. Bennett in this work Mr. Polk recommends the employment of Dr. B. M. Rastall, to formulate a report based on an industrial survey.

Registration of Professional Engineers

The council of state boards of engineering examiners representing 16 states in conference October 2 and 3 at Chicago, agreed upon rules for the reciprocal registration of professional engineers. These rules provide that an engineer registered in one state may be permitted to practice in other states which are parties to the reciprocal registration agreement. The articles of agreement prepared by the conference will be sent to the various state boards of engineering examiners and will become operative as rapidly as signed by the various boards.

A resolution was passed by the conference that each state endeavor to have state laws changed where necessary so as to allow an engineer going into another state to practice under reciprocal registration without the payment of another fee.

Reciprocal registration with Canada and Mexico was provided for in the appointment of an investigating committee. At the present time engineers going into Canada cannot practice unless registered in Canada. Mexico has given notice that American engineers will not be allowed to practice in Mexico without equal recognition for their engineers.

With the Architects

Building Reports and Personal Mention of
Interest to the Profession

May Enter Hospital Competition Until December 15

Thirty days have been added to the original registration period for entry in the \$1,000 prize competition for small hospital plans which is being conducted by the Modern Hospital magazine, according to a recent announcement. This advances the final day for registration to December 15, and extends the date for submitting designs to February 1.

Inquiries about the contest from architects in England, European countries and even New Zealand have necessitated an extension of the period for registration. Although foreign interest was scarcely anticipated, owing to the vastly different conditions governing hospital construction abroad, the competition is open to all architects and any such designs will not be excluded.

Seattle Elks Club Competition

The program for this competition is in course of preparation by a special committee appointed for that purpose by President Gould of Washington State Chapter, A. I. A. The program will be issued by the Elks Lodge. Participants in the competition are limited to architects practicing within the confines of the City of Seattle.

The competition will be judged by three judges who will be architects residing outside of Seattle. The first prize will be the award of the commission or \$1,000 in the event that construction is not proceeded with; the second prize will be \$500 and the third prize \$250. The competition will close December 31st.

Five Story Apartment House

Architects Bliss & Faville, Balboa building, San Francisco, have completed plans for a five-story apartment house to be erected on Jackson street, near Franklin, San Francisco, for Mr. Edgar Brownstone at an estimated cost of \$100,000. The same architects have made plans for alterations and additions to the Phi Chi Fraternity House at 2529 Hearst avenue, Berkeley. Bliss & Faville are to be the architects of the new Athens Athletic Club building to be erected at 14th and Franklin streets, Oakland, the ground floor of which is to be occupied by the Southern Pacific Company for its electric car terminal.

Bungalow Court For Berkeley

A bungalow court, consisting of eleven houses with accommodations for twenty-four families, has been designed by Mr. L. H. Ford of the East Bay Planners, 308-14th street, Oakland, and construction on the \$75,000 project is under way. The owner is Mr. E. G. Ogle, of 2033 Virginia street, Berkeley. Mr. Ford is preparing plans for the first unit of three brick apartment houses to be built on Jackson street, north of 14th, Oakland, for the Coit Investment Company. The initial unit will cost \$65,000.

Will Design College Group

Architect William H. Weeks, 369 Pine street, San Francisco, has been appointed architect of a group of college buildings to be built in Modesto for the Modesto Junior College. The first building, an auditorium, will cost \$90,000, and plans will be completed immediately. The entire group will involve an expenditure of \$500,000. Mr. Weeks has also been appointed architect of the proposed new Esparto Union High School building to cost \$95,000, and a new grammar school at Tulare to cost \$100,000.

San Jose Home for Children

Architect Clarence Tantau, 251 Kearny street, San Francisco, has been commissioned to prepare plans for a \$100,000 fireproof building for the Home of Benevolence in San Jose. The structure is to be designed in the California Spanish style with stucco exterior and terra cotta tile roof. There will be accommodations for from 80 to 100 children. Mr. Tantau is also the architect of extensive improvements under way at the country estate of Dr. George B. Somers, in Woodside, San Matco County.

Extensive Alterations Planned

The Balfour-Guthrie Company will make extensive alterations to their two-story building at 350 California street, San Francisco, the work to include an entire new front and rearrangement of offices. Mr. Earl B. Bertz is the architect. Mr. Bertz is also making plans for alterations to the two-story store and loft building recently purchased by the United Cigar Store Company at Grove and Market streets, San Francisco.

Orange County on the "Build"

Mr. Fay R. Spangler, formerly of Santa Maria, now practising architecture in Santa Ana, California, writes that Orange County is forging ahead and every city and hamlet is enjoying a veritable building boom. Labor is plentiful and the bonus evil is fast disappearing, he says. Building material deliveries are satisfactory, Mr. Spangler says, except for terra cotta, manufacturers of the latter being taxed to capacity. Mr. Spangler recently let a contract to N. O. Mellott for \$50,650, plus plumbing \$2883 and blackboards \$287 for a new grammar school building of hollow tile with stucco finish and Spanish tile roof for the Harper-Fairview Union School District at Costa Mesa, eight miles from Santa Ana.

Granted Certificates

The California State Board of Architecture, Southern Division, has granted certificates for the practice of architecture to the following: George Dunderdale, Stock Exchange Building, Los Angeles; Glenn G. McAlister, Santa Monica; Marshall R. Lawson, Long Beach; Norman W. Keleh, 5752 Tenth Ave., Los Angeles; John E. Hopkins, New York City; Rudolph Falkenrath, Jr., 1121 Baker-Detwiler Building, Los Angeles; Isaac J. Knapp, 3801 Wisconsin St., Los Angeles.

Designs Many Apartment Houses

Recent work in the office of Architect C. O. Clausen, Hearst building, San Francisco, includes a \$20,000 apartment house on Fourth avenue, for Mr. F. A. Eskilson; a \$22,000 apartment house on Steiner street, north of Post, for Messrs. J. Halperin and J. Stein, and a \$20,000 apartment house on Fourth avenue, north of Clement street, for Messrs. Roskin and Saroff.

Million Dollar Apartment House

Architect Henry H. Gutterson, of San Francisco, is busily engaged on plans for a million dollar nine-story reinforced concrete apartment house to be erected at Sacramento and Mason streets, San Francisco, the contract for which has been let to the Clinton Construction Company, 923 Folsom street, San Francisco.

Tanforan Race Track Buildings

Architect G. A. Applegarth, Claus Spreckels building, San Francisco, has completed plans for a steel and wood grandstand to accommodate 5000 persons at the new Tanforan race track in San Mateo County; also plans for a club house and paddock. The race track is to be opened next February.

Architect S. Heiman Busy

One of the busiest architects in San Francisco is Mr. S. Heiman, 57 Post street, who has found it necessary to move into larger offices at the same address. Mr. Heiman has completed plans for an office building and warehouse in San Francisco for the Kohler Company. He has designed a one-story store building for Mr. Emil Kahn for the corner of 20th street and Telegraph avenue, Oakland, estimated to cost \$20,000. Mr. Heiman has been commissioned to prepare plans for a \$100,000 community theatre, store and office building at San Anselmo, features of which will be an auditorium to seat 1000 persons and a spacious dancing pavilion. Plans have been completed in the same office for remodeling a six-story store and loft building on Mission street, near First, for Mr. Lester G. Loupe, and also for remodeling the Santa Maria building, an eight-story office building on California street.

Alameda Apartment House

A three-story and basement frame and brick veneer apartment house will be erected at Central and Grand avenues, Alameda, by Mr. L. Keliski. Construction of this building was several times deferred by the City Council of Alameda, which at first went on record as being unalterably opposed to hotels and apartment houses within the city's corporate limits. "We are a home city and prefer permanent residents to transients," is the way one member of the Council put it. Gardens and lawns will surround the house and attractive features will be fountains, fish pond and tennis courts. The owner will invest \$100,000 on the project. Mr. A. A. Cantin is the architect.

Architect Sawyer Busy

Architect Houghton Sawyer, Hearst building, San Francisco, is preparing plans for a large apartment house to be built in San Francisco, at a cost of \$100,000 or more. Mr. Sawyer has completed plans for a thirteen-room residence in St. Francis Wood, San Francisco, for Mrs. G. P. Anderson; also a \$13,000 Spanish home in Piedmont for Lucille Bray; a two-story frame residence in Piedmont for Mr. Hager; and a three-story frame and plaster apartment house on the northeast corner of Funston avenue and Lake street, San Francisco, for Mrs. Kline and Mrs. Krause to cost \$50,000.

\$1,500,000 Veterans Hospital

Bids are to be opened in Washington, December 18th, for the Veterans Hospital at Livermore, from plans by Architect Mathew O'Brien.

Passing of Seattle Architect

Mr. A. Warren Gould, past president of the Washington State Society of Architects, died October 15. He fell dead from heart disease in the Union station at Tacoma, Washington.

Mr. Gould was born in Boston, Mass., and came to Seattle in 1904. He was the architect of many of the most prominent buildings in Seattle and a number outside of the city. He was the first man to use reinforced concrete in Seattle to any great extent, being an enthusiastic advocate of this type of construction.

Mr. Gould was a charter member of the Washington State Society of Architects and one of its most enthusiastic supporters. Governor Hart appointed him a member of the examining board of architects for the State of Washington. Mr. Gould was also at one time a member of Washington State Chapter, A. I. A.

Insurance Company to Build

The Western State Life Insurance Company has decided to go ahead with its long-deferred expansion program, and plans have been completed by Architects Reid Bros. for a fifteen-story Class A addition to the company's office building at Sixth and Market streets, San Francisco. This building was originally known as the Hewes building, designed by Reid Bros., and purchased by the insurance company for its home office several years ago. The proposed improvements will entail an immediate expenditure of \$750,000.

San Francisco Architect Injured

Mr. T. Paterson Ross, well-known San Francisco architect, is reported to be convalescent at the St. Francis Hospital from injuries received while on an inspection tour of the Union League Club building, of which he is the architect. Mr. Ross was struck on the head by a wheelbarrow load of brick falling from the sixth story. He was rendered unconscious and for three weeks following the accident he remained in that condition. Physicians entertain hope for his recovery.

Architect Headman Busy

New work in the office of Architect August G. Headman, Call building, San Francisco, includes six restricted duplex dwellings to cost \$150,000, to be built at Lyon and Green streets, San Francisco, also a reinforced concrete store building on Mission street, near Santa Maria avenue, San Francisco, for Messrs. Cohn & Sutton, and alterations to the brick stable at Pacific and Van Ness avenues, for garage purposes. The last-named piece of property is owned by Mr. A. A. Tiscornia.

Pasadena Architects New Quarters

Architects Marston & Van Pelt, Edgar W. Mabury, associate, Pasadena, have prepared preliminary plans for a two-story brick store and office building to be erected at 25 South Euclid Avenue, Pasadena, for Mr. G. L. Morris. There will be three store rooms on the ground floor and the entire second floor will be occupied by the architectural firm designing the building.

Architectural Club Elects Officers

At the annual meeting of the Los Angeles Architectural Club the following were elected: President, Mr. Clifford A. Truesdell, Jr.; vice-president, Mr. Lloyd Rally; secretary, Mr. Paul W. Penland; treasurer, Mr. R. E. Bowes; director, Mr. Walter Davis.

Mr. Donald B. Parkinson, of the architectural firm of John Parkinson and Donald B. Parkinson, gave a description of the new Los Angeles stadium now nearing completion at Exposition Park, for which his firm are the architects.

More Terminal Buildings

Another unit is to be built to the wholesale buildings at Seventh and Alameda streets, Los Angeles, for the Los Angeles Terminal Company, at an estimated cost of \$500,000. The architects are Parkinson & Parkinson.

Another Hollywood Hotel

Architect J. A. Larralde, 1401 Stock Exchange building, Los Angeles, is preparing plans for a 250-room, nine-story, Class A hotel to be built on the northwest corner of Cherokee avenue and Hollywood Boulevard, for Messrs. George M. Hull and Gordon F. Friedman.

\$250,000 Loft Building

A four-story reinforced concrete loft building will be erected on the northeast corner of Fremont and Mission streets, San Francisco, for the Cebrian Company, from plans by Architect G. A. Applegarth. Structure will cost \$250,000.

Concrete Warehouse

Plans have been completed by Architect H. C. Baumann, 251 Kearny street, San Francisco, for a six-story, Class C warehouse and loft building to be built on Second street, between Brannan and Townsend streets, San Francisco, for the Goodrich Rubber Company. Cost \$150,000.

Oakland Architects Move

Architect W. E. Milwain has moved from the Albany building to 524 Pacific building, Oakland, and Hutchinson & Mills, who were also in the Albany building, are now located at 1214 Webster street, corner of 12th, Oakland.

Architects for Paso Robles School

The Paso Robles Union High School District has engaged Architects Miller & Warnecke, Perry building, Oakland, to prepare plans for a fireproof school building to cost \$200,000. It will have sixteen rooms and an auditorium. Mr. John J. Donovan, Oakland architect, will collaborate with them. The same architects are busy designing a number of new homes in the East Bay District, including a \$10,000 residence for Mr. R. W. Kinney.

Fresno Garage

Architect Eugene Mathewson, Cory building, Fresno, has completed plans for a one-story reinforced concrete auto sales building and garage to be erected at Ventura and Van Ness avenues, Fresno, at a cost of \$60,000, for Mr. Walter N. Murphy, agent for the Lincoln car. Mr. Mathewson has also made plans for a one-story brick store building on Van Ness avenue, Fresno, for Mr. O. J. Woodward, Jr.

Lecturer on Architecture Wanted

The University of Manchester, England, is desirous of having some American architect give a lecture during the winter season. Any of our California, Oregon or Washington architects who are thinking of wintering abroad would doubtless have a most interesting time discussing architecture from the American viewpoint.

Water Company to Build

The Spring Valley Water Company has commissioned Willis Polk & Company to prepare plans for a seven-story reinforced concrete office building to be built on the company's property on the west side of Mason street, between Post and Geary streets, San Francisco. The improvements will cost in excess of \$100,000.

Club Women to Build

The San Francisco City and County Federation of Women's Clubs has purchased the southeast corner of Sutter and Mason streets, San Francisco, as a site for a \$500,000 club building. No architect has been selected as yet.

Claremont Residence

Plans are being prepared by Architects Meyer & Johnson for a \$16,000 residence in Claremont, Berkeley, for Mr. Allen Babcock, electrical engineer for the Southern Pacific Company.

Oakland Apartments

Mr. A. J. Yerrick, 5255 College avenue, Berkeley, has completed plans for an apartment house at Grove and 61st streets, Oakland, for Mr. Newton Shelley. Mr. Yerrick is preparing plans for an apartment flat building in Berkeley and a residence in East Oakland.

A Handbook for Architects

Recent scientific research by its technical departments, the United States Forest Service, fire underwriters regional associations of lumber manufacturers and architects, has practically revolutionized the various forms of wood construction, according to an announcement of the National Lumber Manufacturers Association. To mention only one phase of the progress that has been made, it is calculated that the fire hazard on a frame house of up-to-date construction has been reduced 50 per cent. Nevertheless the majority of frame houses are erected in complete ignorance of recent developments and in the same, unscientific, uneconomical and improvident way that they were generations ago.

To meet this condition of unused knowledge the Association's technical and research department, in collaboration with the Structural Service Bureau of Philadelphia, will issue a series of uniform publications which will be an orderly digest in interesting form comprehending all the available information on this subject. At present there is no one place where a builder, engineer, architect or home owner can find a summary of modern knowledge of wood construction. It is scattered through the technical periodicals, trade brochures, proceedings of societies and associations, etc. The series will be in several parts, of a number of chapters each, under the general title of "Lumber and Its Utilization" and will ultimately appear in book form.

Architect's Mother Dies

Mrs. Elizabeth Williams Champney, mother of E. Frere Champney, died suddenly on October 13th. Mrs. Champney was the widow of J. Wells Champney the well-known artist who died some years ago. Frere Champney has come to San Francisco, where he will be associated with Bakewell & Brown for a time.

Personal

Architects A. M. Edelman and A. C. Zimmerman have discontinued their association and Mr. Edelman will continue the practice of architecture in the offices at 726 H. W. Hellman building, Los Angeles.

Planning Attractive Gardens

Mr. Emerson Knight, landscape architect, San Francisco, is planning and planting gardens for four residences for Allen & Company on 30th avenue, north of Lake street in Sea Cliff, San Francisco.

With the Engineers

A CODE OF ETHICS FOR THE CANADIAN ENGINEER

ENGINEERING bodies for many years back have discussed at great length and at frequent intervals the possibility of developing a code of ethics that will govern the practice of the profession and the conduct of its members. Such codes in a more or less complete form have been part of the constitution of most professional organizations, but their observance has been somewhat a matter of individual concern. In these days, perhaps, more attention than ever before is being given to the status of the engineering profession and to the possibility of enforcing a code of ethics. Canada is the latest country to become interested, and the Engineering Institute has appointed a committee to report on the proposed code recently published by a committee consisting of representatives from the American Society of Civil Engineers, the American Institute of Mining Engineers, the American Society of Mechanical Engineers, the American Institute of Electrical Engineers and the American Society of Heating and Ventilating Engineers. The ten clauses in this proposed code of ethics will bear repetition here:

That the dignity of their chosen profession may be maintained, it is the duty of all engineers to conduct themselves according to the principles of the following code of ethics:

1. The engineer will carry on his professional work in a spirit of fairness to employees and contractors, fidelity to clients and employers, loyalty to his country and devotion to high ideals of courtesy and personal honour.
2. He will refrain from associating himself with or allowing the use of his name by an enterprise of questionable character.
3. He will advertise only in a dignified manner, being careful to avoid misleading statements.
4. He will regard as confidential any information obtained by him as to the business affairs and technical methods of processes of a client or employer.
5. He will inform a client or employer of any business connections, interests or affiliations which might influence his judgment or impair the disinterested quality of his services.
6. He will refrain from using any improper or questionable methods of soliciting professional work and will decline to pay or to accept commissions for securing such work.
7. He will accept compensation, financial or otherwise, for a particular service, from one source only, except with the full knowledge and consent of all interested parties.
8. He will not use unfair means to win professional advancement or to injure the chances of another engineer to secure and hold employment.
9. He will co-operate in upbuilding the engineering profession by exchanging general information and experience with his fellow-engineers and stu-

dents of engineering and also by contributing to work of engineering societies, schools of applied science and the technical press.

10. He will interest himself in the public welfare in behalf of which he will be ready to apply his special knowledge, skill and training for the use and benefit of mankind.

In commenting on this code in his presidential address before the Toronto branch of the E.I.C., says the Contract Record, Mr. Storrie, the branch chairman, stated that we had a duty to perform to the public as well as the public having a duty to perform towards us. "We must honestly and fearlessly show up and endeavor to stamp out everything in the profession that savors of wrongdoing," he said. "Ability and reputation should be the means of securing our individual progress rather than the amount of wire-pulling and so-called influence that is so often brought to bear on the securing of appointments." To substantiate this statement Mr. Storrie cited a number of instances of unethical practice in which the engineering profession, or at least individual members of the profession, were shown in a bad light. In one case, for example, the influence of contractors who had received contracts from a firm of engineers was widely used to secure a certain appointment. Under such circumstances how could this firm be fair and just in their dealings with these contractors? This form of securing the influence of contractors who have received contracts from engineers is a serious affair and one that should not be employed under any conditions. In another case one alderman absolutely committed himself to a contractor to vote for a certain engineering firm before he even knew who were being considered for the appointment, or before the committee investigating the status of the various engineers had brought in a recommendation. Needless to say, this contractor had in the past received several contracts from the engineering firm for whom he was working. In yet another case, the manager of a contracting company approached one of his shareholders, asking him to do his utmost to have the rival firm withdraw its application in order to ensure the continuance of certain contracts that it had been accustomed to receive from the engineering firm they were anxious should secure the appointment. Apart from other considerations, this means of securing certain work is an absolutely unfair situation in which to place any contractor, and stren-

vious means should be taken to overcome such unprofessional conduct.

Mr. Storries' comments on this kind of conduct are such that nothing further need be said. "One can readily understand," he states, "that if this condition of affairs is allowed to continue considerable damage to the profession and loss of prestige will result. The sooner the public realize that when tactics like those mentioned have to be adopted in order to secure work there must be something seriously wrong with the engineering ability of the firm that finds it necessary to adopt them, the better it will be for the engineers as a whole. If we wish to be seriously considered by the public as a profession, let us see to it that we adopt professional conduct in our business affairs. Fortunately for the profession, we have as a whole a fine body of men, but that is all the greater reason for jealously guarding our interests and exposing the few who would seek to lower our ideals. We must purge the profession of that kind of work and set our own houses in order and above reproach before we can expect that recognition from the public to which we are justly entitled, and before legislation, minimum fees or ethics can be of any avail. Let us jealously guard our ideals and show an ever-increasing factor of moral safety and courage in our dealings with the public and our fellow-engineers.

BOOK REVIEWS

Edited by

AUGUST G. HEADMAN, Architect

Sketching and Rendering in Pencil, by Arthur L. Guptill. Two hundred pages. Size 9x12. Price \$5.00 net. Published by the Pencil Points Press, Inc., 1 Madison Ave., New York.

This book will be found useful by the teacher of art, by the architectural student, by the architect and draftsman, and by artists, for the author has kept in mind the needs of all these various classes of readers. Mr. Guptill has drawn upon his long experience as an instructor and upon the practical knowledge of the requirements gained through his work as an architect and architectural illustrator.

Part I of the book is devoted to drawing in general. It takes the reader through the elementary stages, beginning with the statement of first considerations, an explanation of the essential equipment, detailed instructions in object drawing in outline and in object drawing in light-and-shade; also in free-hand perspective, cast drawing, life drawing and in the sketching of animals.

Part II is devoted to the consideration of the subject in relation to the representation of architectural subjects. In addition

to the text matter there are numerous illustrations, including life drawings by H. I. Stickroth, Jules Guerin, Taber Sears, Barry Faulkner, Eugene F. Savage; sketches and renderings by Otto R. Eggers, Birch Burdette Long, Chester B. Price, Hugh Ferriss, Troy Kinney, Kenneth Conant, Frank Vincent DuMont, Albert Kahn, Otto F. Langmann, Schell Lewis, Robert A. Lockwood, C. D. Maginnis, Andre Smith and others. Also sketches and renderings of interior decorations and furniture.

There is a very interesting group of illustrations which show sketches of animals by Charles Livingston Bull, whose work as an illustrator is well known, particularly his drawings of animals.

Steam Heating, 368 pages, cloth bound, 8 in. by 10½ in. 162 pages of data. Price, \$3.25, postpaid. Published by Warren Webster and Co., Camden, N. J.

Steam Heating has been prepared by the technical staff of Warren Webster and Co. to meet a demand for authoritative, practical data which can be applied with good judgment in the design, installation, and operation of steam heating systems.

The scope is closely limited to systems using steam as the heat-distributing medium, and therefore it has been possible to cover a vast amount of detail information which has never been practical for books on the wider subject of Heating and Ventilation heretofore published.

This book is particularly suited for use in the designing department, since special care has been given to the preparation of tables and charts for the proper selection of sizes and quantities. There is sufficient discussion of the principles underlying the design of steam heating systems to make the book practical as a text book for students in colleges and schools.

Part II is devoted to Webster steam specialties and their application in a thorough manner, adding very greatly to the practical value of the work. The book is 8½x10½ inches, contains 367 pages, is well bound in cloth and is fully illustrated. It is a manual of practical data that covers the subject in detail, conveniently arranged for reference, and is well suited in form to be included in the architect's library.

Architects' Specification Handbook. Published by the Truscon Laboratories, Detroit, Mich.

This is an entirely new edition, rewritten and revised, of specifications on integral waterproofings, wood preservative, cement floor hardeners, Mill white paint, and architectural varnishes.

The book is available to architects, maintenance engineers, contractors, factory managers, and superintendents of large public buildings upon receipt of request from them.

The Contractor

When Disputes Arise Between Architect and Contractor

MUCH has been written and said on the subject of co-operation between architect and contractor, and it is a subject which is of vital interest to both. Upon it hangs some of the most important problems of the building industry. In the Western Canada Contractor of recent date appears an article dealing with the relation of owner, architect and contractor. The author says:

"It is only human nature that there should be disputes arise in respect to matters in which the gain to one means a loss to the other," and continues: "In spite of this, however, there is no reason why there should be friction in the relation between owner, architect and builder, any more than in other lines of business where the buyer's interests are more or less in opposition to those of the seller.

"In the ordinary buying and selling of everyday life, the buyer buys at as low a price as possible and the seller sells at as high a price as possible, yet the percentage of disputes, compared to the vast volume of business done, is comparatively unimportant. In the building industry, however, the questions raised as to quality and price is tenfold greater than in any other line.

"So far as actually carrying out the work is concerned, the architect is occasionally somewhat arbitrary. Thus the contractor if often upon the defensive, his interests being diametrically opposed to those of the owner, as represented by the architect. Take the question of extras. The contractor is often obliged to depend upon the architect's sense of fair play as to the extent of his settlements.

"Should a difference of opinion arise between the contractor and the owner, as represented by the architect, the latter is invariably ranged upon the side of the owner as against the builder. Often contractors will take such attitude for granted, and work upon the principle that the architect will give as little in service as possible, and the settlement will be unfairly generous to the owner. A resort to arbitration is often too cumbersome a process to be applied to the many small disputes which often arise during the process of some work, and so the feeling of antagonism is intensified, a condition which does not make for the good of the building industry.

"An architect in Western Canada has a large measure of control on a building job. From the time the subject is broached to him by the owner, he is responsible. He makes suggestions and carries them out in his plans, decides the legal points involved, supervises the terms of the contract and superintends the carrying out of the work. In many cases his opinions are accepted at face value by the owner, who often knows little about the subject; the price that should be paid, and how the work should be done.

"It is such conditions which give rise to the belief that the contractor is in competition with the architect, as representative of the owner. It takes all kinds of people to make a world, and it is true that there are architects who are fair and generous in the treatment of the contractor. It is equally true that other architects can see no other side of the case than that of the owner. Others again seem to see how fine they can cut the contractor's profits, and how much they can get out of him. Before the efforts of the two last named, the contractor is under a heavy stress, and feels he is obliged to wage a continual warfare, if he is to come out at the end with even a reasonable portion of the margin he has estimated will be his profit before taking the job. In such cases, if there are extras of any importance, he stands to make a loss, for it is in the extras that the architect can make it very hard for the contractor if he so wishes, the extras being carried out to the architect's order, and the work settled for by him after the job is completed.

"The changing of plans, so often an incident in the carrying out of a job, is a hardship upon the contractor. By every change he is liable to loss. The architect and owner know just what the changes will cost them, but the contractor knows only what he will be paid, not what the changes will cost him.

"There is, of course, one type of contractor—luckily for the good of the business a small class—who do not carry on business according to ethics, and who would not be above giving the owner as little for his money as possible, if an opportunity arose to do indifferent work or use inferior material. Such men make it difficult for all concerned. They antagonize the architect and render him suspicious, and he retaliates by imposing hardships upon contractors, both the com-

petent and conscientious, and the careless and dishonest ones alike.

"Then there is another class of contractor, who begins operations upon a job with a deep rooted belief that the hand of the architect is against him, and who makes up his mind in consequence that he will give only just what is required of him and no more.

"It would not be a fair and just review of the subject if the several elements described were neglected. There are many instances where the contractor has his share of the responsibility for a condition which places the two sections of the building industry at cross purposes.

"It is recognized by the contracting and building industry that the present status of the contractor, in relation to the owner and his representative the architect, is far from satisfactory. He is sometimes regarded as an outsider, and the fact is lost sight of that he assumes a greater part of the risk in respect to many important elements—the supply and cost of material, the many possible conditions in respect to supply and cost of labor, strikes, weather conditions, and the hundred and one other contingencies which may cause a loss, however great or small.

"No contractor can reasonably be expected to take all these risks, and have his profits infringed upon here and there, in order that some fancied deficiency in material or work may be righted, while the owner gets the benefit of the changes in the way of a better building. Both architects and owners must see that the contractor's interests are heavy; that he has much at stake, and it is equally to his benefit to see that the work is carried to a successful competition as promptly as possible.

"With these conditions existing and acknowledged, even to a small extent, what is the remedy for the state of antagonism which does crop up between contractor and owner or architect? Arbitration would answer very well if the sum involved is large, or in particular cases in which one decision would settle the whole matter. But what of the cases in which a difference of opinion is constantly arising? To arbitrate these would require a board of arbitration in constant session night and day. The solving of the problem of friction between architect and builder obviously then is not wholly a case of arbitration, but it will eventually be found in education; the readjustment of the point of view of both architect and contractor; of teaching each that the other has rights and has many difficulties to contend with. The contractor has risk of loss, the uncertainty of the labor situation, the cost and supply of materials, the necessity of high-class work without too great a sacrifice of his own

interests, and last, but by no means least, the necessity of making a reasonable profit.

"On the other hand, the contractor must recognize the fact that the architect occupies a somewhat difficult position; he has his duty to the owner; the responsibility for the appearance and quality of the undertaking rests upon his shoulders. He has a reputation to maintain, and the finished work will stand a monument to his credit or disgrace. It is a matter of vital moment that both contractor and architect should learn to see the position of the other and act accordingly.

"This requires a much more broad-minded view on the part of the architectural profession as a whole than, it must be admitted, at present exists. Is there any reason why that profession should be deemed to be on a higher plane than the contracting business, or the contractor as being subservient to the architect? It is the plain duty of both to foster a wider spirit of toleration and co-operation between the two important branches of the building industry.

"In justice to the contractors, it might be fair to say that they are probably more open to displaying such a spirit than are many architects, but whether one realizes and practices co-operation to a greater extent than the other the quicker such a spirit becomes more general the more the men behind the building projects of the West will benefit in a financial way. It will be readily seen that working together, instead of at cross purposes, will not only make for a higher quality of work, but the policy of 'live and let live' will put the building industry upon a better paying basis, and mutual good will result from the establishment of closer relations among the various branches and interests each represents.

"To be more specific, it seems quite feasible and right to have the associations representing the architectural profession and the building business meet and mingle more frequently than heretofore. Both branches are fairly closely organized; both are frequently equally affected by conditions which may arise derogatory to the building industry. Thus, what is more natural than the architectural chapters and the builders' exchanges should meet on stated occasions to discuss problems in which the interests of both are involved, or conditions which affect the welfare of either or both?

"There will never be a more opportune time to foster such a spirit of mutual understanding and co-operation than at present."

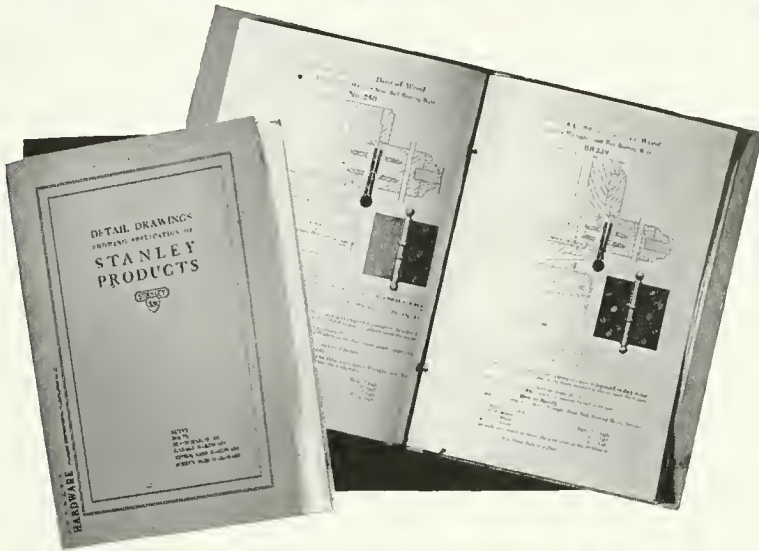

STANLEY DETAIL MANUAL

Shows correct application of
**STANLEY Butts,
 Bolts,
 Blind Hardware,
 Storm and Screen Hardware,
 Garage Hardware.**

This Manual is divided into five separate sections,
 each section a complete book in itself.

Can be filed complete, or may be separated and filed
 under separate classifications.

Drawings, 127 of them, were made by architects, and
 are drawn to scale.

"How to Specify" is given in every case.

Write today for Detail Manual No. AE-11



THE STANLEY WORKS

NEW BRITAIN, CONN.

San Francisco, Monadnock Bldg.
 Los Angeles, 703 Washington Bldg.
 Seattle, 501 Maynard Bldg.

What's Wrong With This?

(From the American Contractor)

"Having failed in their appeal to the journeymen plasterers to help speed up work to relieve congestion in this branch of the building industry, the Contracting Plasterers' Association of Southern California has decided to seek relief from the outside. Advertisements have accordingly been printed in the leading daily papers of the northwest, middle western states and Canada for plasterers to come to Los Angeles. These advertisements set forth the attractive wages being paid and the guaranty of employment."

The above appears in the September 20 Southwest Builder and Contractor. It strikes us that the idea might be made into one of those famous cartoons going the rounds in all daily papers labeled, "What's wrong with this?"

Failing to get the men in Los Angeles, who are making their living by plastering to help relieve the congestion, means that one thing at least is wrong. It seems that plasterers in that particular California city work only five days a week. Their scale is \$10 a day, but in actual practice they are drawing from \$11 to \$15 a day. They have been besieged from every quarter to work five and one-half days a week but they will not. When a trade in this day and age refuses to work five and one-half days a week in order to relieve actual demoralizing conditions, that trade is poorly advised. When contractors rush out with advertisements drawing plasterers from other sections in the face of the present national shortage of that craft, they are committing a wrong to alleviate the effects of another wrong under which they suffer.

Clay Pipe for Plumbing

The College of Industries at Carnegie Institute of Technology, Pittsburg, announces a prize contest for the best papers written on the subject of "The Use of Vitrified Clay Pipe in Plumbing Systems," the contest to be open to plumbing experts, instructors and students. Prizes to the amount of \$250 will be awarded on April 15th, 1923.

According to the announcement, the contest has been arranged to further the interest in reducing the cost of plumbing installations, and to assist the industry to become better acquainted with the development and use of vitrified clay sewer pipe. The money has been made available by the Eastern Clay Products Association.

The contest committee consists of: Professor S. E. Dibble, chairman, College of Industries, Carnegie Institute of Technology; William J. Woolley, manager, The National Trade Extension Bureau, Evans-

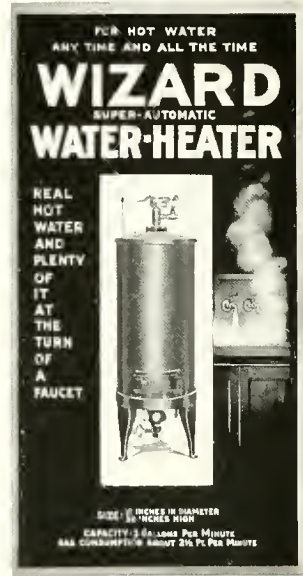

THE "WIZARD" Super Automatic Water Heater is built along scientific principles. It is a new and positive method of heating water, employing the ordinary (or natural) circulation, while hot water faucets are closed and reversing to straight automatic water the lowest price heater on the market. The "Wizard" can be installed in a space fifteen inches wide.

This is the most nearly perfect Hot Water Heater made, and it is the cheapest heater on the market. The "Wizard" can be installed in a space fifteen inches wide.

SPECIFY the "WIZARD" for the residence, flat or apartment house you are designing.

WIZARD SALES COMPANY
833 MARKET STREET
SAN FRANCISCO CALIFORNIA

Telephone Douglas 1203



Ornamental Iron

Steel Sash
Wire Work

Michel & Pfeffer

Iron Works

HARRISON AND TENTH STREETS
SAN FRANCISCO CALIF.

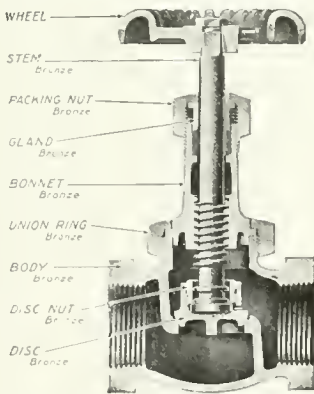

You don't have to
worry about
the inside of

KENNEDY VALVES

they are made to last and they *do* last

Send for Catalog

214

THE KENNEDY VALVE MFG. CO.

Branch Offices and
Warehouses:

NEW YORK, 95 John St.
SAN FRANCISCO, 23-25 Minna
St.
BOSTON, 47 India St.
CHICAGO, 204-8 N. Jefferson
St.

Sales Offices:

Philadelphia, Continental
Hotel Bldg.
Salt Lake City, 503 Dooley
Bldg.
El Paso, 704 Two Republics
Bldg.
Seattle, L. C. Smith Bldg.



When writing to Advertisers please mention this magazine.

ville, Indiana; John T. Morris, director, College of Industries, Carnegie Institute of Technology; Joseph A. Weldon, Weldon and Kelly Company, Plumbing-Sanitary Experts, Pittsburg, Pa.

All communications regarding the contest should be addressed to Professor S. E. Dibble, head of the Heating and Ventilating Department, College of Industries, Carnegie Institute of Technology, Pittsburg, Pa.

"Evidence"

The J. G. Wilson Corporation, 11 East 36th street, New York City, has just published a booklet called "Evidence," which is a rather unique and forceful way of placing before the architect and building industry the merits of Wilson products. The book is prefaced by the following introduction:

"The only proof which is admitted in a court of law is the testimony of those who can speak from their own knowledge, their own observation, their own experience. The only conclusive evidence of the value of a product is that of persons who have used it and put it to the test which can alone determine its merit and quality.

"For this reason it gives us pleasure to devote this booklet solely to letters of commendation from users of Wilson Rolling Steel Doors, Folding and Rolling Partitions, Diffuselite and Awning Blinds, Wardrobes, etc.

"These are a few of many, but they are sufficient to prove beyond doubt or dispute the practical utility of our products and the permanently satisfactory service they render.

"From such evidence as this there can be no appeal. But if the letters printed here fail to cover some special point which arises in the mind of the reader, we shall be glad to send him facts and proof which will be thoroughly satisfactory, no matter what his question may be."

The following letters are reproduced from the long list of evidence presented, and indicate the universal satisfaction which Wilson products have given on the Pacific Coast.

WILSHIRE COUNTRY CLUB
Los Angeles, Cal.

July 11th, 1922.

Gentlemen:

Answering your inquiry regarding the Folding Partitions furnished our Club, wish to state that same have given satisfaction in every way. These partitions are between our lounging room and dining room, and when closed we find that a musical or bridge party in the lounging room does not cause any annoyance to our diners, or interfere in any way with our dining room service. We recommend same with pleasure.

Yours very truly,
WILSHIRE COUNTRY CLUB.
W. G. Boette, Auditor.



First National Bank - Albert Kahn, Architect
Thomas Bruce Boyd, Inc., Equipment Engineers

The First National Bank

Detroit, Michigan
equipped with

Frink Reflectors

including

Continuous Bank Screen Reflectors
Single and Double Desk Reflectors
Polaralite Signs

Our Engineering Department is co-operating with the leading architects in laying out and designing the lighting of prominent buildings throughout the country. We hope we can be of service to you.

"Specify Frink Reflectors"

I. P. FRINK, Inc.

SAN FRANCISCO, CAL.,

77 O'Farrell Street

24th Street and 10th Avenue,
New York

Chicago, Ill.
Monadnock Bldg.
Boston, Mass.
161 Summer St.
Detroit, Mich.
325 State St.
Cleveland, Ohio
336 The Arcade

Seattle, Wash.
609 Seaboard Bldg.
Philadelphia, Pa.
Franklin Trust Bldg.
Cincinnati, Ohio
17 Greenwood Bldg.
Louisville, Ky.
415 West Main St.

CANADA

Associated with Robert Mitchell Co. Ltd.
64 Belair Avenue, Montreal



The Century Club, New York City, McKim, Mead & White, Architects. Terra Cotta used for wall finish of lower story above base and ornamental treatment up to and including parapet balustrade.

GOOD ARCHITECTURE, GOOD MATERIAL

Good architecture implies careful selection of good material. Consistency in this respect characterizes the work of leading architects.

For 33 years the Century Club has stood as among the finest achievements of McKim, Mead & White. It not only shows a fitting selection of Terra Cotta but illustrates its absolute durability when intelligently incorporated with good construction.

Let us assist you in correctly detailing for this result. Address National Terra Cotta Society, 19 West 44th Street, New York, N. Y.

TERRA COTTA

Permanent

Beautiful

Profitable

POINT FERMIN SCHOOL
Point Fermin, San Pedro, Cal.

Gentlemen: June 29th, 1922.
In response to your query of June 20th as to satisfaction from Folding Partitions used in Point Fermin School, will say that they have proven very successful. The partitions are sound-proof, they harmonize with the surrounding construction, and they are very easily operated by any of the teachers or children. I should say they are most successful.

Very truly yours,
MILDRED E. MOGLE, Principal.

FARMERS AND MERCHANTS BANK OF SANTA PAULA, CALIFORNIA

Gentlemen: July 6th, 1922.
Replying to your letter of June 20th, will state that the Folding Doors which you furnished us have been entirely satisfactory.

Yours very truly,
M. N. SHEDENHELM, Vice-President.

**Los Angeles Chapter
AMERICAN INSTITUTE OF BANKING**
Los Angeles, Cal.

Gentlemen: July 7th, 1922.
In reply to yours of June 20th, we will gladly say the partitions, Order No. 36561, have been satisfactory in every way, being easy of operation, sufficiently sound-proof for the purpose of school work and economical. Yours very truly,
(Mrs.) E. B. PUTNAM, Secretary.

A Big Sash Chain Installation

One of the largest orders for metal sash chain received in recent years on the Pacific Coast, was given to the Smith & Egge Mfg. Co. of Bridgeport, Conn., by Messrs. W. J. Dodd and William Richards, architects of the new Pacific Mutual Life Insurance building, Los Angeles, which has recently been completed at a cost of \$1,500,000. The building is equipped with 28,000 feet of No. 2 "Giant Metal" sash chain, which was furnished through the Bennett-Montgomery Hardware company of Los Angeles. The chain was shipped from stock on receipt of a telegraph order from this concern and went forward by express the same day the order was received.

"Giant Metal" sash chain is made of a phosphor bronze mixture controlled by the Smith & Egge Company, and is said to be without an equal. It will be found in many of the large buildings of the country, where it was installed a number of years ago, and is giving the same service and satisfaction as when first put in. The Woolworth building, New York City, contains 50,300 feet of our No. 1 "Giant Metal" sash chain.

"Red Metal" sash chain is second only to "Giant Metal," and is also made of a special composition. This chain is especially recommended to the architect and building trade as one which will give the best of satisfaction and service in any section of the country. Atmospheric conditions are peculiar to certain sections, but the manufacturers have yet to find an instance where "Red Metal" sash chain has been affected by them.

Steel sash chains are made of the best cold rolled steel and can be furnished in various finishes.

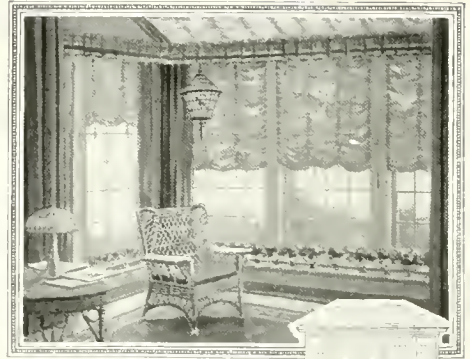

**ARCHITECTURAL
HOME MAKING**

THE attractiveness of home life begins in the drafting room. Long after the fee is paid and forgotten, the thoughtfulness of the architect is remembered.

It is notable how many sun parlors are added to houses long after they have been built. It is but the addition of something which had been forgotten.

There is an ever-increasing trend "sunward," towards the enjoyment of sunshine and air made possible by the judicious but liberal use of better window glass. Cater to the "sunward" movement and reward will follow. Principles of health, sanitation and human happiness will have been recognized.

The Mark on the Box

The long ellipse that appears on every box of genuine American Window Glass is an assurance of quality.

Within the ellipse is the grade mark, A or B. The B glass is of as consistently high quality as the A grade of ordinary glass, and our A grade is correspondingly superior. Demand the beauty, clarity, evenness and strength assured by this mark on every box.

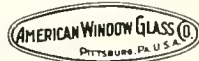

AMERICAN WINDOW GLASS CO.
GENERAL OFFICES: PITTSBURGH, PA. BRANCHES IN PRINCIPAL CITIES



A F B A
USE FACE BRICK
—It Pays

Wing of Public Library, Waltham, Mass. Joseph Leland, Architect

There is distinctive character in this design, as there is in the durable brick and the English Bond in which it is carried out. A century from now this building will have the added mellowness of tradition and age, with its usefulness unimpaired.

Advance in Artistic Brickwork

A COMPARISON of present-day brickwork with that of a generation ago shows a remarkable advance in the handling of this plastic material. The greater skill on the part of designers in the use of bonds, pattern work, mortar colors and the color ranges in the material itself is, in all parts of the country, producing beautiful structures.

Many architects have learned that artistic effects in brickwork are not dependent on special sizes or molded forms, but that they can

be economically obtained by the use of standard size Face Brick.

More than a hundred examples of the artistic possibilities of standard size Face Brick are shown in The Portfolio of Architectural Details in Brickwork. The deluxe half-tone plates comprising the series are assembled in three series, each in an enclosed folder, with printed tab, ready for filing. A set of these folders will be sent to any architect requesting them on his office stationery.

AMERICAN FACE BRICK ASSOCIATION

1759 PEOPLES LIFE BUILDING • CHICAGO, ILLINOIS

Statement of the Ownership, Management, Circulation, Etc., Required by the Act of Congress of August 24, 1912.

Of THE ARCHITECT AND ENGINEER, published monthly at San Francisco, California, for October 1st, 1922.

State of California,
City and County of San Francisco, ss.

Before me, a Notary Public in and for the State and county aforesaid, personally appeared L. B. Penhorwood, who, having been duly sworn according to law, deposes and says that she is the business manager of THE ARCHITECT AND ENGINEER, Inc., and that the following is, to the best of her knowledge and belief, a true statement of the ownership, management (and if a daily paper, the circulation), etc., of the aforesaid publication for the date shown in the above caption, required by the Act of August 24, 1912, embodied in section 143, Postal Laws and Regulations, printed on the reverse of this form, to-wit:

1. That the names and addresses of the publisher, editor, managing editor, and business managers are:

Name of	Post Office Address
Publisher, The Architect and Engineer, Inc., 627 Foxcroft Bldg., San Francisco.	
Editor, F. W. Jones, 627 Foxcroft Bldg., San Francisco.	

Business: Managers, W. J. L. Kierulff and L. B. Penhorwood, 627 Foxcroft Bldg., San Francisco.

2. That the owner is: (If the publication is owned by an individual his name and address, or if owned by more than one individual the name and address of each, should be given below; if the publication is owned by a corporation the name of the corporation and the names and addresses of the stockholders owning or holding one per cent or more of the total amount of stock should be given.)

W. J. L. Kierulff, 627 Foxcroft Bldg., San Francisco.

F. W. Jones, 627 Foxcroft Bldg., San Francisco.
L. B. Penhorwood, 627 Foxcroft Bldg., San Francisco.

3. That the known bondholders, mortgagees, and other security holders owning or holding 1 per cent or more of total amount of bonds, mortgages, or other securities are: (If there are none, so state.)

None.

4. That the two paragraphs next above, giving the names of the owners, stockholders, and security holders, if any, contain not only the list of stockholders and security holders as they appear upon the books of the company but also, in cases where the stockholder or security holder appears upon the books of the company as trustee or in any other fiduciary relation, the name of the person or corporation for whom such trustee is acting, is given; also that the said two paragraphs contain statements embracing affiant's full knowledge and belief as to the circumstances and conditions under which stockholders and security holders who do not appear upon the books of the company as trustees, hold stock and securities in a capacity other than that of a bona fide owner; and this affiant has no reason to believe that any other person, association, or corporation has any interest direct or indirect in the said stock, bonds, or other securities than as so stated by him.

5. That the average number of copies of each issue of this publication sold or distributed, through the mails or otherwise, to paid subscribers during the six months preceding the date shown above is—. (This information is required from daily publications only.)

L. B. PENHORWOOD, Business Manager.

Sworn to and subscribed before me this 29th day of September, 1922.

MARY D. F. HUDSON.

Notary Public in and for the City and County of San Francisco, State of California.

My Commission expires December 22nd, 1924.



Miami Valley Hospital Dayton, Ohio

Architects: Pretzinger & Musselman, Dayton, Ohio
Electrical Contractors: Leshner Electric Co., Dayton, Ohio

Holtzer-Cabot

Signaling and Protective Systems

For Hospitals, Industrial Buildings,
Hotels, Schools, Factories, Etc.

For over forty years leading architects and engineers have specified Holtzer-Cabot signaling and protective systems.

The Holtzer-Cabot Electric Company specialize in the manufacture of "Hospital Signal" and fire alarm systems suitable for all classes of service.

Each system is designed especially for the type of building and the particular service for which it is required.

Holtzer-Cabot installations have been developed and perfected and contain many absolutely exclusive features.

They are simple, safe and reliable.

Architects and engineers are invited to write for brochures published in their interest, "Hospital Signal Systems" and "Signaling Systems for Schools."

The Holtzer-Cabot Electric Co.

Electric Signaling Systems

Home Office and Factory:

125 Amory Street

BOSTON, MASS.

BRANCH OFFICES

Chicago, Ill.: 6161-65 So. State St.

New York, N. Y.: 101 Park Ave.

Philadelphia, Pa.: 807 Otis Bldg.

Detroit, Mich.: 1051 Book Bldg.

Cleveland, Ohio: 517 Union Building

Baltimore, Md.: 1164 Union Trust Bldg.

San Francisco, Cal.: 408 Claus Spreckles Bldg.

Minneapolis, Minn.: 627 Metropolitan Life Bldg.

100% Sanitation — 60% New Economy

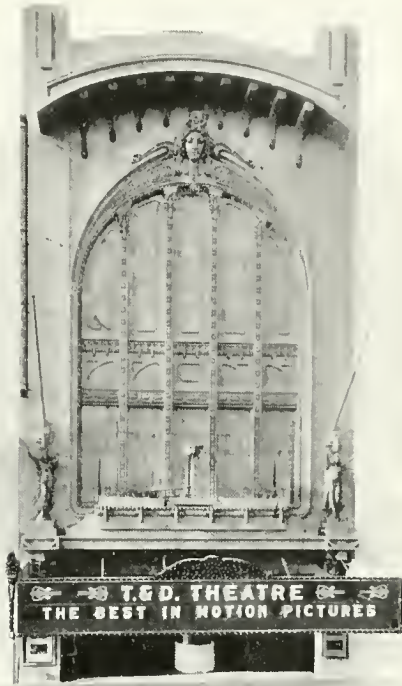

*PARTIAL VIEW OF
T & D THEATRE
OAKLAND, CALIF.
M. V. Politeo,
Archite&*

Oakland's Leading Theatre Installs AIRDRY

In the T & D in Oakland every modern convenience has been installed for the comfort and delight of the patrons. AIRDRY, "The Electric Towel" serves the T & D's continuous stream of visitors with a continuous towel service, ready for use at all times.

*Easily installed, easily operated,
lessens fire hazards, increases sanitation and
lowers overhead. Specify AIRDRY*

AIRDRY CO. of CALIFORNIA

Pacific Coast Distributors

155 Montgomery St., San Francisco

When writing to Advertisers please mention this magazine.

An Automatic Pump for Maintaining Pond Levels

By B. G. MARSHALL

WHEN a cast iron automatic drainage gate was first devised as an attachment to corrugated pipe, the only use in mind was that of draining tidal lands and protecting them from re-flooding. It soon became apparent, however, that such a gate was even more useful among the lowlands of the Sacramento and San Joaquin Valleys and in the Island Country. There great areas of fertile land are protected by dikes and levees. It is necessary to rid them of surface water and equally necessary to guard against back-flow. The device of a sump next the levee over which the water was raised by pumping was cumbersome and expensive. A suitable pump and motor cost several hundred to several thousand dollars according to size; power had to be supplied and a certain measure of supervision. A corrugated pipe through the levee with an automatic valve on the outer end solved the whole problem. Water could flow freely from the land to the river whenever the latter was at low or medium stage, but was effectually prevented from re-flooding the drained areas when the river rose to higher levels.

During the past year or two an application of the exact reverse of this principle has been found decidedly useful in



Automatic Drainage Gate at the Oliver Salt Works, Mount Eden, Calif.

connection with duck ponds, log ponds and seashore lakes. A pipe installed with an automatic gate on the outer end results in ridding land of surface water

and maintaining it in that condition in the face of later rises of the water in the drainage way; but a reversed installation (the gate on the inlet end of the pipe) will work in the opposite way, that is, it will tend to maintain a pond inside the dike at a level corresponding with the high level of the tide or river. Whenever the water rises outside the dike it flows freely into the pond, but as soon as its level falls below that of the pond the gate closes and the water is retained. The advantages are obvious. Ponds, lakes and storage reservoirs can be maintained throughout the year at the highest levels reached by any neighboring body of water save for such losses as occur through evaporation and seepage, and this without any expenditure for power or supervision. At lumber mills, on duck



Automatic Gates on a Tropical Drainage Project

preserves, salt works and at riverside and seaside parks such a device becomes of great practical importance.

Now comes a still further development of the same idea. There are many situations where it is desirable to maintain ponds at certain seasons and at other times to drain the land so that it may be used for other purposes. Sometimes the same areas can be made to serve as duck ponds in the fall and winter months and as cattle pasture in the spring and summer. This can readily be accomplished by having automatic gates at both ends of the corrugated pipes that extend through the dikes. Those on the inner or reservoir ends will serve to establish and maintain the ponds and those on the outer ends to drain them and prevent re-flooding. It is necessary, however, to raise the gates that are not in use and support them in some way so that they will remain open. A simple device for this purpose consists of an eyebolt near the lower edge of the valve, to which is fastened a chain which is worked by a lever above. A practical wooden lever and frame is shown in the accom-

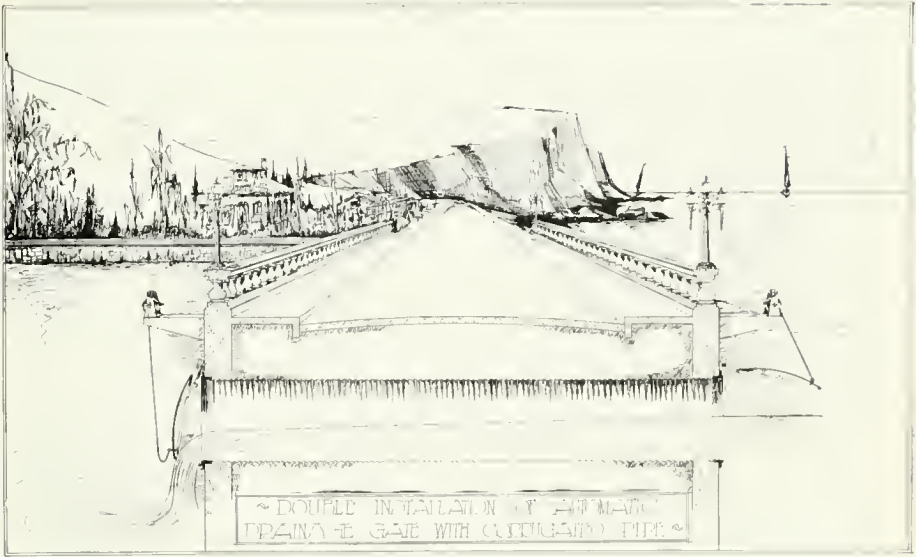

panying photograph. Where a neat appearance is especially desirable (as where the gates are on park lands or other improved property) a concrete control works like that shown in the drawing may be employed.

Such an installation is practically an automatic pump that works without power or attention. It is easily put in place, at very moderate cost, and its construction is so simple that repairs or adjustments are almost never required.

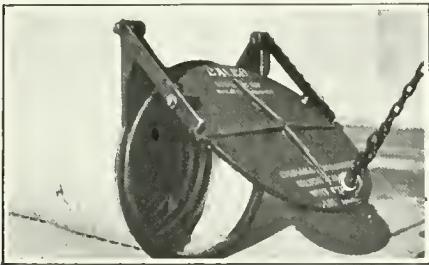

Automatic Gate, Fitted with Eyelet and Chain



Wooden Lever and Stand for Raising Automatic Gate Valve When Not in Use

MOUNT DIABLO CEMENT
 COWELL SANTA CRUZ LIME
 ALL KINDS OF
BUILDING MATERIALS

HENRY COWELL LIME AND CEMENT CO.

Phone Kearny 2095

No. 2 MARKET STREET, SAN FRANCISCO



A Dependable Window Fixture

Hauser Reversible Window Fixtures are made in five types, which may be grouped in any combination desired. Adaptable to wood, hollow metal or steel sash. They provide perfect ventilation, are attractive in appearance, easy to wash and operate, practical, durable, economical

HAUSER WINDOW CO.

157 Minna Street, SAN FRANCISCO

Agencies in All Principal Coast Cities



HAUSER EXHIBIT AT SAN FRANCISCO INDUSTRIAL EXPOSITION

Hauser Window Company has Splendid Year's Business

One of the most popular exhibits at the recent Industrial Exposition held in the San Francisco auditorium, was that of the Hauser Window Company whose factory is at 157 Minna street, San Francisco. The several types of window fixtures manufactured by this company were on display and both Mr. Hauser and his wife, the latter being quite an active member of the firm, were on hand at different periods to explain the operation and merits of the fixtures.

Probably no one similar manufacturer

in San Francisco has been more successful in this line of the building industry, as evidenced by the large number of buildings, both public and private, that have been equipped with Hauser fixtures in recent years. Mr. Hauser is, himself, the inventor of the different types of reversible windows made, all of which are fully protected by patents. As late as June 20th, of this year, patents were awarded Mr. Hauser on two ventilators for metallic sash frames. Simplicity of construction, practical and durable, are embodied in the Hauser products—features that appeal very strongly to archi-

**WIRE
NAILS
FABRIC**

WAREHOUSE AND MILL
SHIPMENT

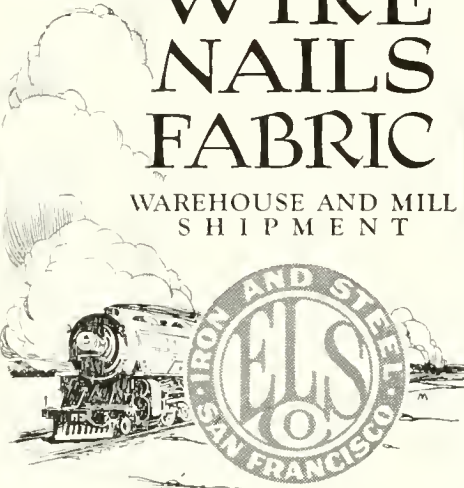

EDW. L. SOULE' CO.
SPECIAL TO BUILDING
SAN FRANCISCO

What Does It Mean to You

—when a manufacturer trade marks his product?

It means this—

He is maintaining **QUALITY** standards—standing squarely behind his products—protecting you and himself from inferior merchandise.

When specifying hardwood, say
"BATAAN" MAHOGANY

Lumber, Veneers, Plywood Panel
Hardwood Flooring

CADWALLADER-GIBSON COMPANY

234 Steuart Street
San Francisco, Calif.

FUEL YOU ARE PAYING TO THROW AWAY

Every large apartment building, hotel, hospital or home where food is prepared and consumed, constantly produces a by-product of fuel in the form of garbage and refuse.

Are you using this fuel or
are you paying to throw it away?

The **KEWANEE** Garbage Burner

Will utilize your garbage to furnish
you **HOT WATER** at all hours
of the **DAY** or **NIGHT**.

Kewanee Boiler Company

216 Pine St., San Francisco
420 East 3rd St., Los Angeles

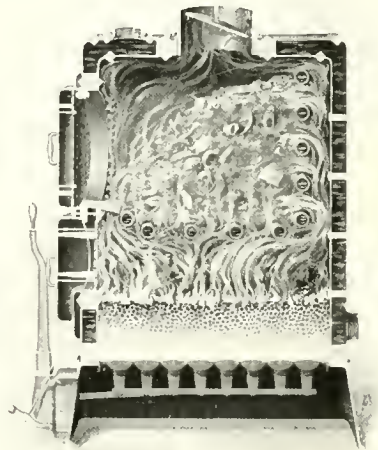

tecis. The fact that the fixtures are easy to operate and do not get out of order like some on the market, also contribute to their popularity.

The new multiple operating window consisting of three separate sashes which may be operated from the lower sash, seems likely to become a favored fixture for school buildings. All Hauser windows operate on single steel extension arms attached to the sash and slide in wooden grooves in the window jambs, allowing the sash to completely reverse. Mr. Hauser's invention does away with all double arms and metal sliding tracks on jambs, experience having demonstrated that the less iron incorporated in the fixture the better the results.

Hauser fixtures have been installed in nearly all of the new San Francisco school buildings, designed by Architect John Reid, Jr., also the West Union High School, Salt Lake City, built at a cost of \$500,000, and containing some 1200 fixtures; Franklin Junior High School, Long Beach, with 800 fixtures; Piedmont High School, Campbell Union High School and numerous other school buildings, designed by Architect William H. Weeks; Petaluma High School, designed by Architect Brainard Jones; Palo Alto Grammar

(Concluded on Page 140)

SERVICE

TESTING
INSPECTION
CONSULTATION
PRODUCTION

Structural and Engineering
Materials



ROBERT W. HUNT & CO.

ENGINEERS

Chemical and Physical
Testing Laboratories

New York Chicago Pittsburgh
St. Louis San Francisco Mexico City
London Montreal

OPERA CHAIRS

for

LOEW'S WARFIELD THEATER

FURNISHED AND INSTALLED

by

WESTERN STATES SEATING CO.

133 KEARNY STREET

SAN FRANCISCO, CAL.

TELEPHONE KEARNY 1047

MEESECO WAGON LOADER

For Handling Sand, Gravel, and all Kinds of Bulk Material from Ground Storage to Trucks or Wagons.

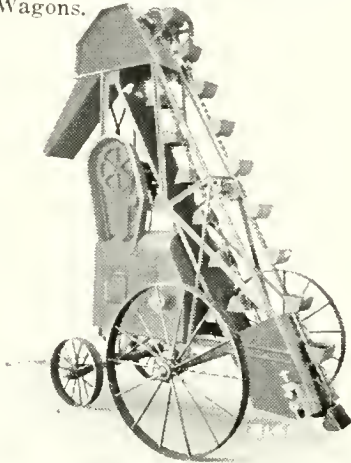

MeeSe & Gottfried Company
ENGINEERS AND MANUFACTURERS
San Francisco Seattle Portland Los Angeles

Sutter 4998

OIL TANK & PUMP CO.

Factory Branch
806 Sharon Building,
55 New Montgomery Street
San Francisco

PETRO WHITE

A Real Rival of
Cold Water Paints

A Snow White Paint in Oil, giving equal opacity of cold water paints. Can be applied with spraying machines at a small increase of cost over water paints for use in factories, warehouses, loft buildings, laundries.

Hill, Hubbell & Co.
TECHNICAL PAINTS

SAN FRANCISCO

Los Angeles Portland Seattle New York



Damp-proofing and Plaster
Bond for the interior of Ex-
terior Walls.

Cures "Tacky" and remains pliable and elastic indefinitely—a tough rubber-like, waterproof skin, bonding securely both to wall and plaster.

Protect your walls
against dampness by
specifying MINWAX
No. 300 DAMPPROOF-
ING.

MINWAX CO., INC.

K. M. HAYDEN
22 Battery St.
San Francisco

W. C. LEA
653 So. Clarence St.
Los Angeles

United States Steel Products Co.

Rialto Bldg., San Francisco

SELLERS of the products of the American Bridge Co., American Sheet and Tin Plate Co., American Steel and Wire Co., Carnegie Steel Co., Illinois Steel Co., National Tube Co., Lorain Steel Co., Shelby Steel Tube Co., Tennessee Coal, Iron and Railroad Co., Trenton Iron Co.

MANUFACTURERS OF

Structural Steel for Every Purpose—Bridges, Railway and Highway—“Triangle Mesh” Wire Concrete Reinforcement—Plain and Twisted Reinforcing Bars—Plates, Shapes and Sheets of Every Description—Rails, Splice Bars, Bolts, Nuts, etc.—Wrought Pipe, Trolley Poles—Frogs, Switches and Crossings for Steam Railway and Street Railway—“Shelby” Seamless Boiler Tubes and Mechanical Tubing—“Americore” and “Globe” Rubber Covered Wire and Cables—“Reliance” Weatherproof Copper and Iron Line Wire—“American” Wire Rope, Rail Bonds, Springs, Woven Wire Fencing and Poultry Netting—Tramways, etc.

United States Steel Products Co.

OFFICES AND WAREHOUSES AT

San Francisco Los Angeles Portland Seattle

HAUSER WINDOW COMPANY

(Continued from Page 129)

School, Chas. S. Sumner, architect; several of the new schools in Sacramento, designed by the City Architects' Commission, composed of Messrs. Hemmings, Peterson & Hudnutt; Ukiah School, Norman R. Coulter, architect; Fresno High School, Coates & Traver, architects; Whittier High School; new Pomona High School, Robert H. Orr and William H. Weeks, architects, and schools in Stockton, Portland, Ore., Seattle, Wash., Honolulu, and thousands of other buildings both public and private.

Alvaline, Cementoline
and other

Jones-Duncan Products

MAGNER BROTHERS
PAINT MAKERS

Telephone: Market 113

414-424 Ninth St. San Francisco

HEATING-PLUMBING

COMPLETE PLUMBING AND HEATING SYSTEMS INSTALLED IN ALL CLASSES OF BUILDINGS — ALSO POWER PLANTS

GILLEY-SCHMID CO., Inc.
198 OTIS ST., SAN FRANCISCO
Tel. MARKET 965

THE TORMEY CO.



General
Painters



Phone Franklin
5 - 5 - 9 - 8

1042 Larkin St., San Francisco, Cal.

Phone Douglas 3224

Hunter & Hudson
ENGINEERS

Designers of Heating, Ventilating and Wiring Systems, Mechanical and Electrical Equipment of Buildings

703 Rialto Bldg., San Francisco, Cal.

Costs less
than

3^C

an hour to
operate

Think of It!
**Steam Heat by
Electricity**

No flame. No odor. No pipes. No furnaces. No danger. No dirt. Just attach cord to a base plug and presto!—the HULBERT ELECTRIC STEAM RADIATOR furnishes you steam heat—real honest-to-goodness Steam Heat by Electricity.

WM. J. SCHWERIN
217 RIALTO BLDG., S. F.
Telephone Sutter 4489

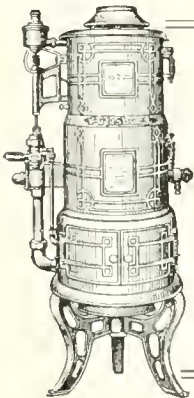

Pittsburg

It Insures
Instant
Hot Water
Service

**PITTSBURG WATER
HEATER COMPANY**

478 Sutter S., San Francisco
Phone Sutter 5025

RUSSWIN

BUILDERS' HARDWARE

JOOST BROS., Inc.

SAN FRANCISCO AGENTS

We Carry Complete Stock:

Fishing Tackle—Guns—Mechanics' Tools—
Paints—Crockery and Glassware—Stoves—
Household Goods. Telephone Market 891.

NO BRANCH STORE

Mazda Lamps

Electric Goods

The
ARCHITECT &
ENGINEER

SAN FRANCISCO
PUBLIC LIBRARY



DECEMBER 1922

Published in San Francisco
50 cents a copy - \$2⁵⁰ a year

The world's best



TRADE MARK REGISTERED

Specify

PACIFIC
PLUMBING FIXTURES

Pacific Sanitary Manufacturing Co.
Main Office: 67 New Montgomery St., San Francisco
Factories: Richmond and San Pablo, California



the
ARCHITECT & ENGINEER
Contents

FOR DECEMBER, 1922

ENTRANCE, HOUSE OF MR. DE WITT PARSHALL, MONTECITO,
CALIFORNIA - - - - - *Frontispiece*
George Washington Smith, Architect

	Page
ARCHITECTURE WITH A PERSONALITY - - - - -	47
Homes by George Washington Smith Around Santa Barbara <i>Irving F. Morrow</i>	
THE PIT RIVER PROJECT OF THE PACIFIC GAS AND ELECTRIC COMPANY - - - - -	89
<i>S. C. Purdee</i>	
THE ARCHITECT AND THE PIPE ORGAN - - - - -	99
<i>Marshall W. Giselman</i>	
SUGGESTIONS FOR MAKING PARTITIONS SOUND-PROOF - -	101
EDITORIAL - - - - -	104
WITH THE ARCHITECTS - - - - -	107
WITH THE ENGINEERS - - - - -	111
THE RIGHT WAY TO DO A GOOD STUCCO JOB - - - - -	112
<i>O. A. Malone</i>	

Published Monthly by
THE ARCHITECT and ENGINEER Inc.

626-627 Foxcroft Building - San Francisco

W. J. Keruff *Frederick W. Jones* *L. B. Penhorwood*
President *Vice-President* *Secretary*



*Artistry and Character too, in
Design Oak Floors!*

Heretofore restricted by high cost to pretentious homes, they are now available to every purse through

BRUCE DESIGN Oak Flooring

Afforded by our newly developed quantity production method. Wide assortment of designs including squares, herringbone and basket weaves — all described in our new catalog. May we send you a copy?

Bruce Design Oak Flooring is obtainable locally through lumber dealers, contractors and floor layers

E. L. BRUCE COMPANY · Manufacturers

MEMPHIS



TENNESSEE



ENTRANCE, HOUSE OF MR. DE WITT PARSHALL, MONTECITO,
CALIFORNIA GEORGE WASHINGTON SMITH, ARCHITECT

Frontispiece
The Architect and Engineer,
December, 1922

THE ARCHITECT AND ENGINEER

DECEMBER,
1922



VOL. LXXI.
No. 3

Architecture With a Personality

Homes by George Washington Smith Around Santa Barbara

By IRVING F. MORROW

WELL-BRED architecture must discriminate between the claims of a building's occupants and of passers-by. Good breeding is an instinctive feeling for propriety, an instinctive gauging of relative values; and by this standard American architecture wants breeding. It is prone to extremes, now contemptuous of everybody, now obsequious before the supposed opinions of outsiders, but all too rarely effacing itself for the quiet and dignified service of the matter in hand. To flout all opinion is boorish; to defer to the approbation of uninterested parties is snobbish and provincial. In architecture (as in conduct), genuine consideration for others is conditioned on scrupulous self-respect. We are all too unfamiliar with the exquisite appropriateness of architecture sincerely, which is to say humbly, dedicated to a purpose or a personality.

Only thus do we achieve that elusive human interest which is the thing that makes an artistic expression worth while, and without which the most respectable forms and procedures are sterile. Traveling in foreign lands enforces the appreciation of this truth. Mere tourists rush headlong from star to star in Baedeker, and return with that austere sense of uplift which attends the self-imposed performance of an irksome task. Those who, heedless of the ubiquitous Thomas Cook, wander

and loiter at the spirit's call, discover that the immeasurable advantage of the European scene is a very human one. It is not so much that its important buildings are all conspicuously superior to our own, as that architecturally the most insignificant hovel which meets the eye is humanly significant. There are buildings which have become objects of pilgrimage which would fare ill under the most casual of architectural analyses. The best-intentioned traveler, once this lesson be learned, can stand unimpressed and unashamed before a masterpiece. Around the corner he may warm to generous enthusiasm over an unimportant building which critics might demonstrate is not architecture, but which is eloquent of the generations of human beings who have fashioned and occupied it. A wall architecturally featureless may, through a subtle texture, deliver a quiet message from a nameless but not forgotten



HOUSE OF MR. HARRY BRAINARD, MONTECITO, CALIF.
George Washington Smith, Architect

craftsman. A colored stain may question the significance of the long succession of seasons. Not until man and his milieu and his handiwork have thus interacted does architecture become a vital force.

Architecture in America is, by and large, not such a vital force. At its worst it is dismal beyond human comprehension. In its better manifestations it is conspicuously respectable, accomplished, even impressive. But since it is an adjunct to be employed or omitted arbitrarily it is a conscious imposition, not a necessity, and hence unvitalized by the human touch. It answers to no inner need of people who use it. It is invoked professionally, as an index of commercial and social aspiration and status. All too rarely is a building conceived solely as a natural and felicitous embodiment of its real reason for being. It is either shock-

ingly neglected, suitable apparently to no conceivable human purpose, or lavished with over-zealous attentions, as if to serve some unreal or ulterior end. It must evoke invidious associations of cost, appearing obviously "cheap" or "expensive." The commonest verdicts of popular criticism are not concerned with a building's appropriateness or beauty, but with its reputed resemblance to ten cents or a million dollars. For a building costing five thousand dollars to look like five thousand is a commercial blunder or a social ineptitude. Thus does American architecture, oscillating between unconcern and over-concern, miss the charming naturalness and inevitability characteristic of countries where simple things can be done in their proper manner and for their own sakes.



HOUSE OF MR. GEORGE WASHINGTON SMITH, SANTA BARBARA, CALIF.
George Washington Smith, Architect

The use of the term "American architecture" must not be interpreted as subscription to the oft-repeated doctrine that there should or can be a uniform, tangible "American style." If the populace errs in relegating the art to the status of herald or handmaiden of prosperity, frequent facile critics are no less vulnerable in demanding a standardized (commercialized) product in the name of "style." Since the histories concisely tabulate Romanesque of the Italian, French, Spanish, and English types, and so on, the same varieties of Gothic and of Renaissance, therefore the exigencies of systematic filing require the continued use of neat classifications by periods and countries. The fallacy becomes apparent when we reject stock phrases to pry into reality. Were there, for instance, four or five distinct varieties of Renaissance? Depending upon

the point of view, there may be said to have been one or a thousand. Certainly the styles did not sharply change at the boundaries of the modern political states. Buildings in the south of France may have more in common with those in the north of Italy or of Spain than buildings in the northern and southern portions of the respective countries. It is convenient to be able to speak of Italian Renaissance, French



WROUGHT IRON GRILLE, HOUSE OF MR. GEORGE WASHINGTON SMITH, SANTA BARBARA, CALIF.
George Washington Smith, Architect

Renaissance, etc., and does no harm so long as we remember that the terms are no more than convenient but artificial groupings without fixed correspondence in the infinite variety of reality. The most significant fact about any of the accepted styles is not that they are uniform, but that their variety is truly infinite. Such diversity is, in fact, the condition of vitality. If the domes of Santa Maria del Fiore, Santa Maria delle Grazie, St. Peter's, and the Salute were all alike except in size; if palaces of Genoa, Siena, and Palermo might be interchanged without

shock to the least sensitive observer, then would the conclusion be inescapable that the Italian Renaissance was decadent, that life had ebbed and left it prone. The glory of Italian architecture is only secondarily that all its cities are "Italian," and primarily that each has its own individual physiognomy. Its vitality is witnessed by its inexhaustible variety.

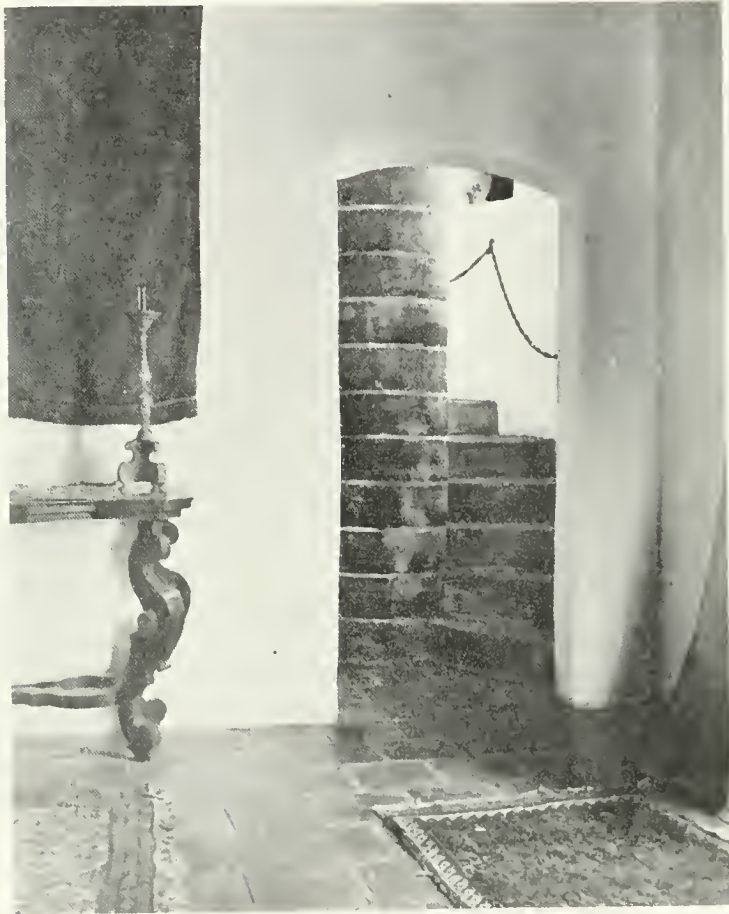

STAIRWAY, HOUSE OF MR. CRAIG HEBERTON, SANTA BARBARA, CALIF.
George Washington Smith, Architect

The ideal of an architecture integrated into one American style, however attractive in a superficial way, is the ideal of decadence. Recall, for instance, the physical and historical backgrounds, the traditions, customs, and outlooks of Massachusetts, Pennsylvania, Louisiana, Illinois, California. What is there to suggest that these diverse physical and social characteristics should express themselves in similar architecture? Reduce the field of survey to a fraction of this vast area, say California. If its many communities enjoy life responsive to their various situations

and needs, what degree of resemblance should we expect between architecture in Eureka, Fresno and San Diego? That standardization has actually been to a large degree achieved is one of the most disquieting aspects of American architecture. When a new office building, Y.M.C.A., railroad station, or factory appears in one of the magazines, one never has the slightest notion, before reading the caption, whether it lies in Dallas, St. Louis, Detroit, or one of the two Portlands.

The most hopeful sign in American architecture today is not the



OLD SPANISH BED, HOUSE OF MR. GEORGE WASHINGTON SMITH, SANTA BARBARA, CALIF.
George Washington Smith, Architect

advent of the heralded "American Style," but the emergence of numerous regional styles. The efficiency expert and booster will forthwith cry provincialism. Yet in truth nothing is more provincial than the stifling of local manners of thought, action, and expression in the effort to assume foreign ones which are neither natural nor appropriate. A community which expresses its individual life in its individual way has vitality. Let us, then, congratulate ourselves that the complacent uniformity of a prospective American Style is compromised in advance by an intrusion recognizably Californian; that the neat simplicity of a "Californian Style" is visibly perturbed by northern and southern aspects;

and that even in these convenient geographical pigeon-holes there are communities which are not abashed at being personal.

The work of Mr. George Washington Smith in and around Santa Barbara is an active force in shaping the course of one of the most distinctive and significant of these local developments. Mr. Smith understands and loves Santa Barbara. He appreciates that it is a place of mellow beauty, made for the leisurely enjoyment of beautiful things. In seeking simplicity, harmony, and quiet good breeding, he has achieved



STUDIO, HOUSE OF MR. GEORGE WASHINGTON SMITH, SANTA BARBARA, CALIF.
George Washington Smith, Architect

the expression of both his own personality and that of his background. Many architects never accomplish either.

His work is of Spanish lineage. There is no need, fortunately to argue the appropriateness of this tradition, esthetically and historically, to the Santa Barbara country. It has amply demonstrated its fitness: all of the designers in the group engaged in working out a serious Santa Barbara architecture have turned instinctively to one or another of its phases; it has received public approbation, even to the extent of lip service from speculating contractors. Mr. Smith's work looks back, not so much to the "Mission" architecture of early California as to the simple work of those parts of Spain which still retain sporadic piquant traces of the Moorish occupation. But it is free from the

archaeological taint, personally conceived, and handled with refreshing freedom.

The country where Mr. Smith works asks for nothing better than simplicity, sobriety, sincerity, quiet taste and good breeding. These he has bestowed in generous measure. When an atmosphere as intensely human as his becomes the rule rather than the exception throughout



STUDIO ENTRANCE, HOUSE OF MR. GEORGE WASHINGTON SMITH, SANTA BARBARA.
George Washington Smith, Architect

our countryside the "See America First" propagandists will have something more valid than patriotism on which to base their pleas. Warm sunshine gleaming on clean white walls between hillside oaks; luminous, transparent shadows across the native stubbly ground and luxuriant garden patches; spacious rooms behind cool gray reveals which temper the summer heat; all of these things have become integral with the country as inevitably as the building of longer standing in the Old World.

The academic critic might be moved to complain that Mr. Smith's

buildings contain no architecture, so uncompromisingly has he dismissed the entire paraphernalia of traditional architectural respectability. Picturesque masses of plain walls in undulating lime-white plaster; windows irregularly, judiciously spotted, but severely plain in generous reveals; tile roofs summarily clipped to a ragged edge almost at the wall line; only here and there a discreet touch of wrought iron or polychrome tile;



ENTRANCE GATE, HOUSE OF MR. GEORGE WASHINGTON SMITH, SANTA BARBARA, CALIF.
George Washington Smith, Architect

no "motifs," no "elements," not even a main axis! Only freedom, warmth, ease, content, repose. Remy de Gourmont, in a penetrating essay on "The Dissociation of Ideas," drops the suggestive remark that the beautiful is what is in its place. A criterion apparently so simple, yet how exacting! Mr. Smith's architecture will stand the test. Every part and detail is inevitably, unerringly in its place. With serenity and a delicate human charm to boot, who can remain insensitive to beauty so mellow?



ENTRANCE COURT, HOUSE OF MR. GEORGE WASHINGTON SMITH, SANTA BARBARA,
CALIFORNIA
GEORGE WASHINGTON SMITH, ARCHITECT



ENTRANCE COURT, HOUSE OF MR. GEORGE WASHINGTON SMITH, SANTA BARBARA,
CALIFORNIA
GEORGE WASHINGTON SMITH, ARCHITECT

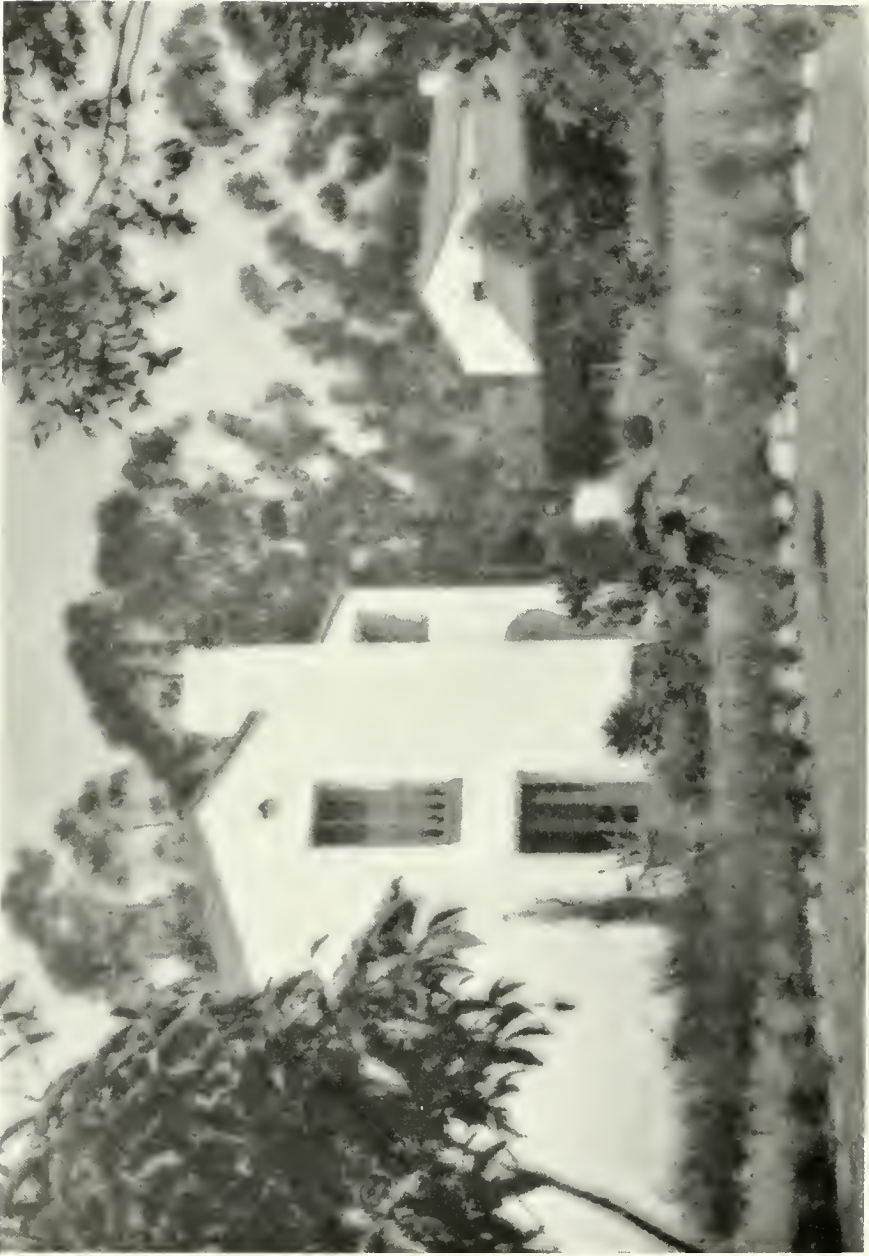

GARDEN VIEW, HOUSE OF MR. GEORGE WASHINGTON SMITH, SANTA BARBARA,
CALIFORNIA
GEORGE WASHINGTON SMITH, ARCHITECT

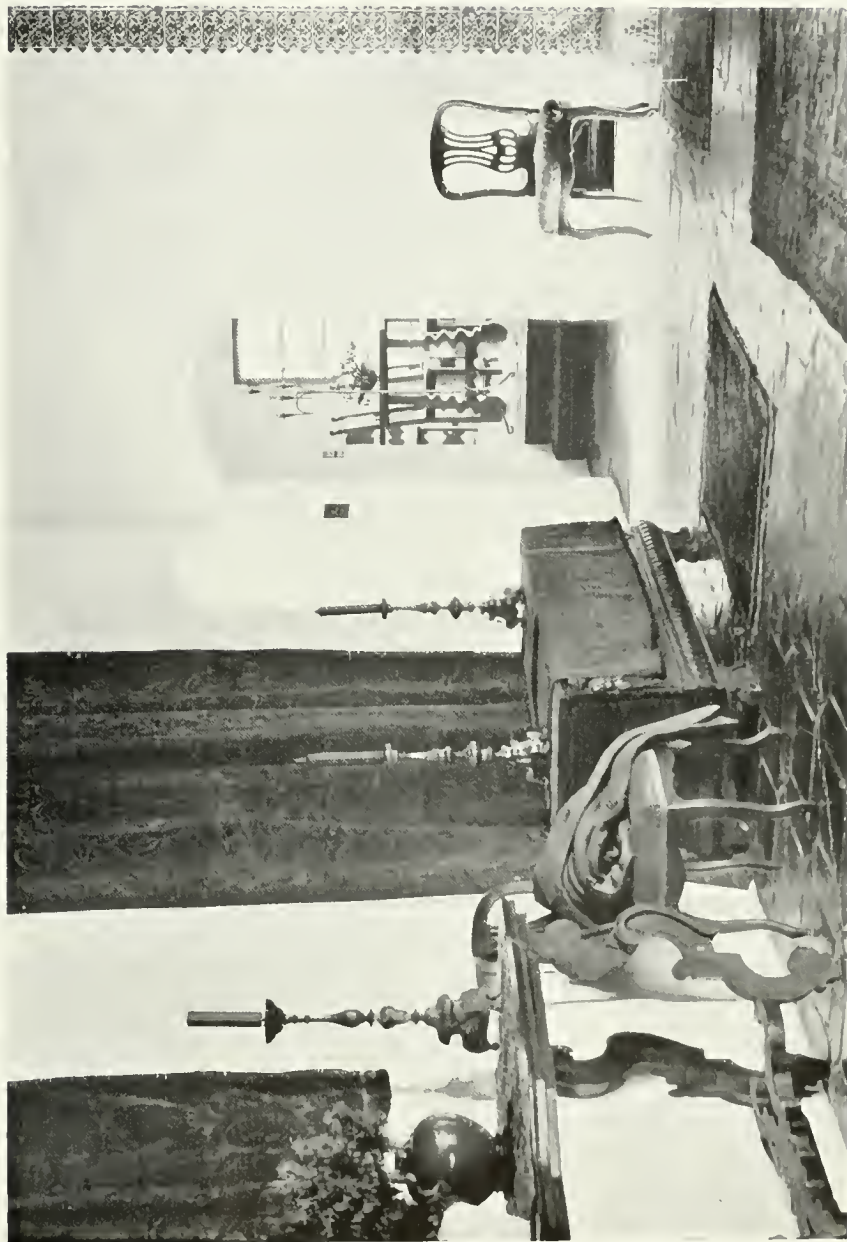

LIVING ROOM, LOOKING INTO DINING ROOM, HOUSE OF MR GEORGE WASHINGTON SMITH,
SANTA BARBARA, CALIF. GEORGE WASHINGTON SMITH, ARCHITECT

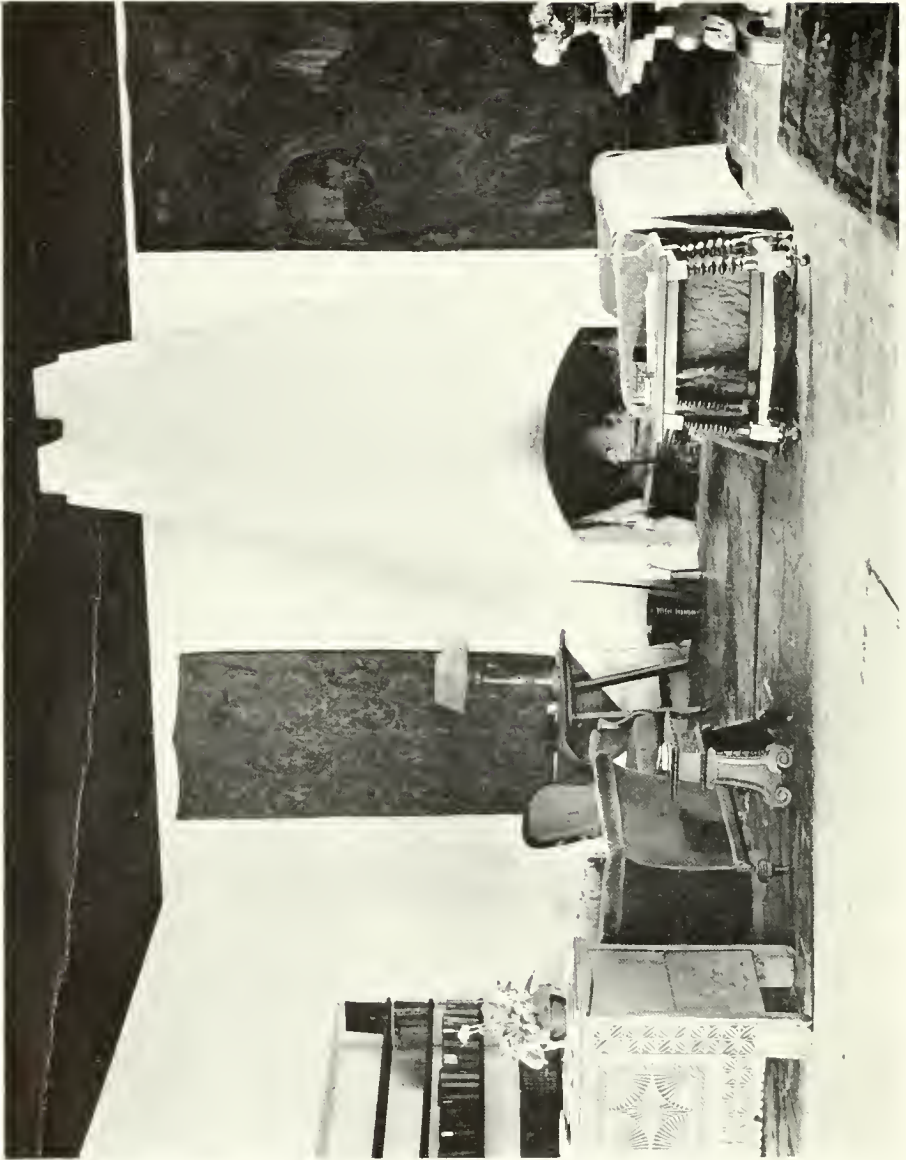

LIVING ROOM FIREPLACE, HOUSE OF MR. GEORGE WASHINGTON SMITH,
SANTA BARBARA, CALIF. GEORGE WASHINGTON SMITH, ARCHITECT

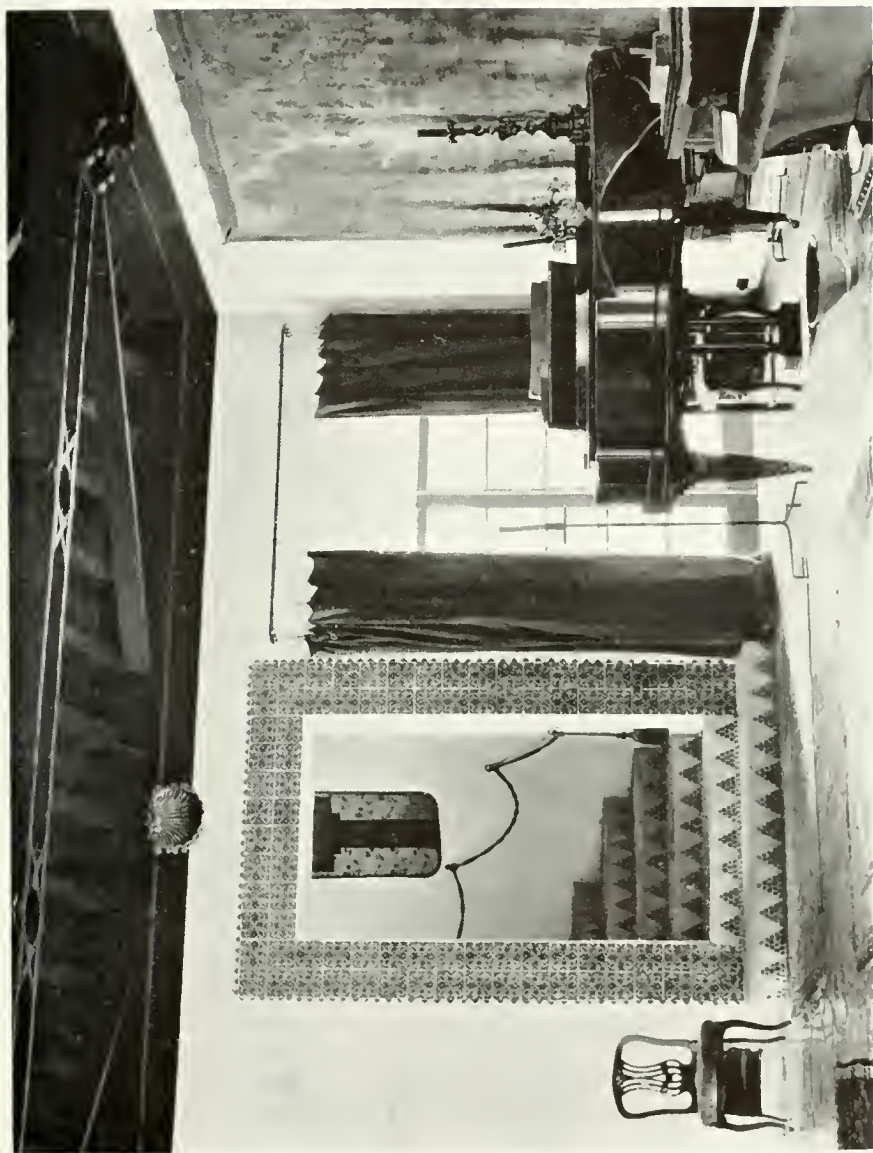

LIVING ROOM AND STAIRWAY, HOUSE OF MR. GEORGE WASHINGTON SMITH,
SANTA BARBARA, CALIF. GEORGE WASHINGTON SMITH, ARCHITECT

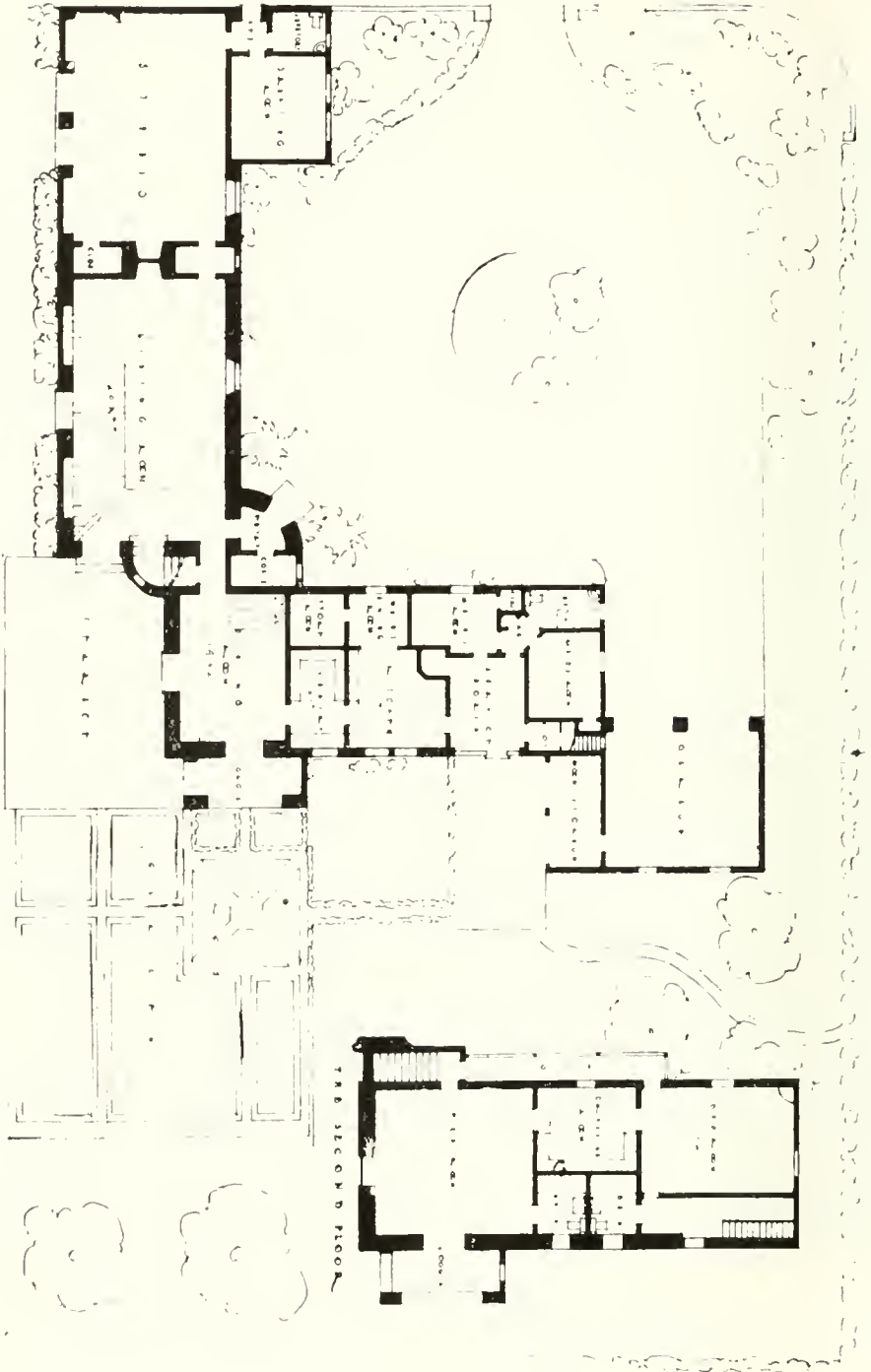

PLAN, HOUSE OF MR. GEORGE WASHINGTON SMITH, SANTA BARBARA, CALIF.
GEORGE WASHINGTON SMITH, ARCHITECT

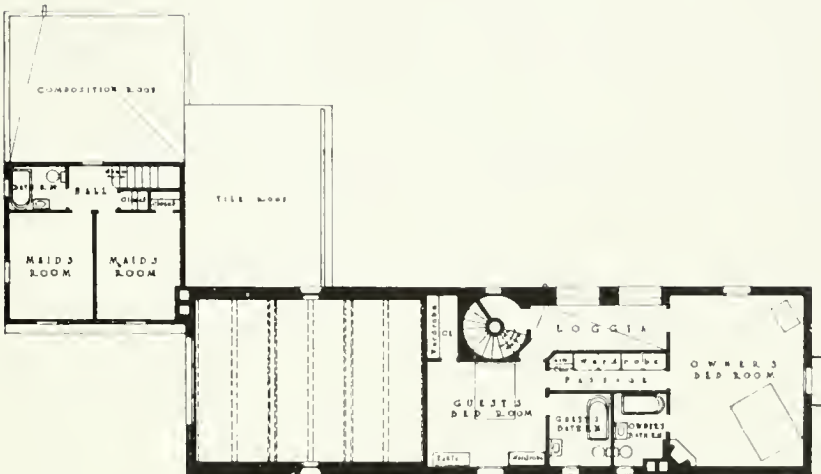

PLAN OF SECOND FLOOR

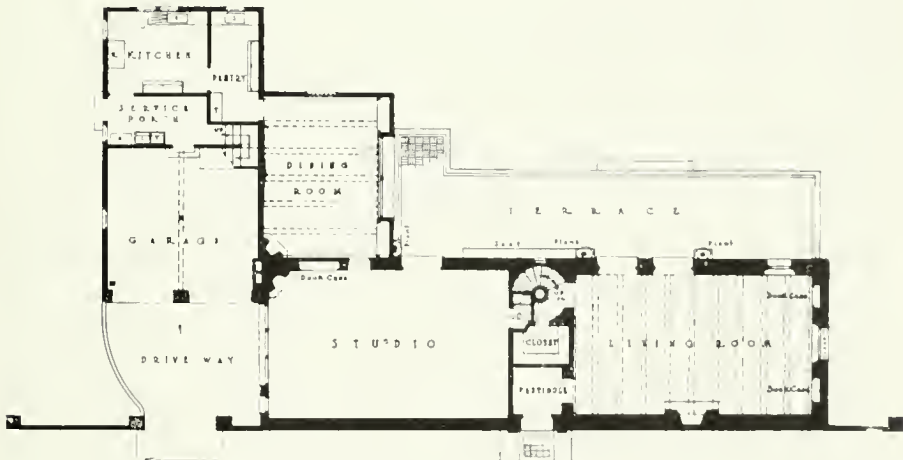

PLAN OF FIRST FLOOR, HOUSE OF MR. CRAIG HEBERTON, SANTA BARBARA, CALIF. GEORGE WASHINGTON SMITH, ARCHITECT

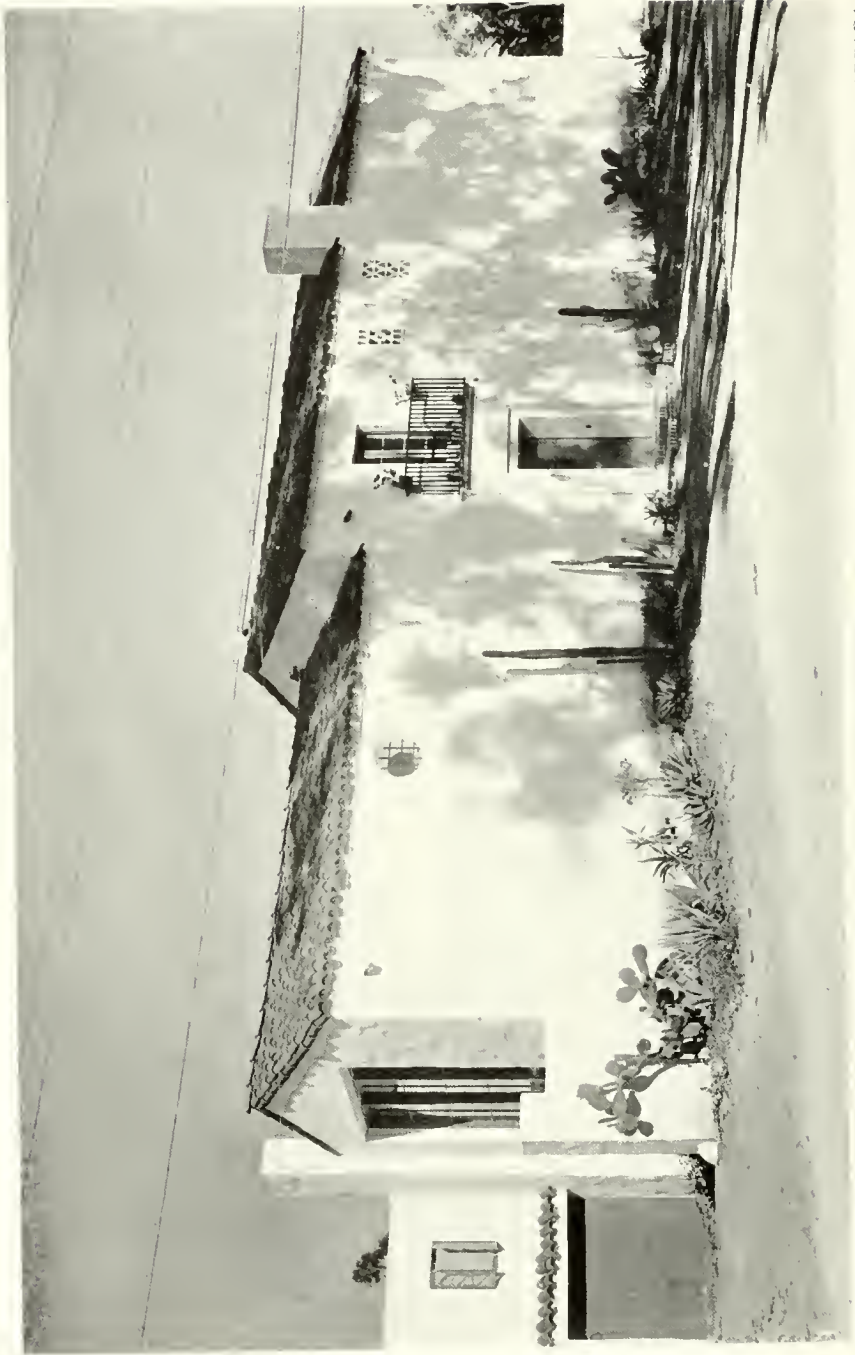

STREET VIEW, HOUSE OF MR. CRAIG HEBERTON, SANTA BARBARA,
GEORGE WASHINGTON SMITH, ARCHITECT
CALIF.



GARDEN VIEW, HOUSE OF MR. CRAIG HEBERTON, SANTA BARBARA,
CALIF. GEORGE WASHINGTON SMITH, ARCHITECT



HOUSE OF MR. CRAIG HEBERTON, SANTA BARBARA, CALIF.
GEORGE WASHINGTON SMITH ARCHITECT



ENTRANCE, HOUSE OF MR. CRAIG HEBERTON, SANTA BARBARA, CALIF.
GEORGE WASHINGTON SMITH, ARCHITECT



LIVING ROOM, HOUSE OF MR. CRAIG HEBERTON, SANTA BARBARA, CALIF.
GEORGE WASHINGTON SMITH, ARCHITECT



DINING ROOM, HOUSE OF MR. CRAIG HEBERTON, SANTA BARBARA, CALIF. GEORGE WASHINGTON SMITH, ARCHITECT

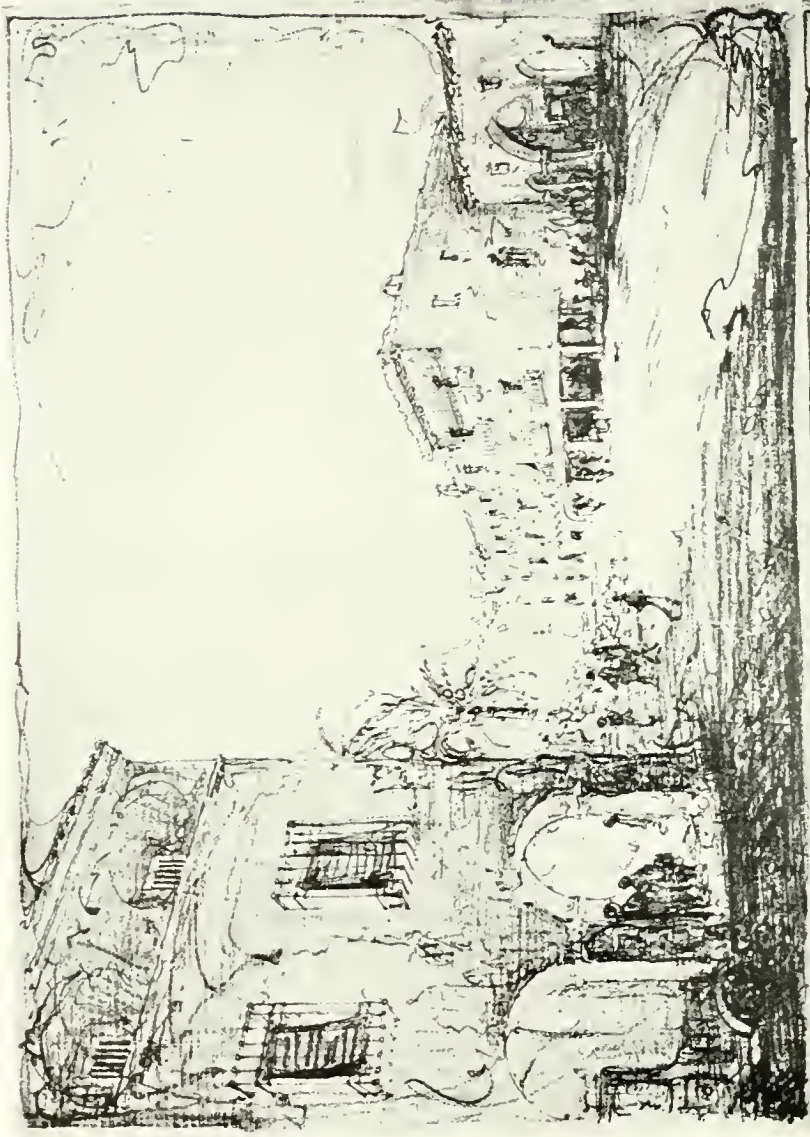

SUGGESTION FOR CITY HALL PLAZA - LOOKING WEST -
SUGGESTED BY ARCHITECTURAL ASSOCIATION

STUDY FOR THE DEVELOPMENT OF THE DE LA GUERRA PLAZA,
SANTA BARBARA, CALIF. GEORGE WASHINGTON SMITH, ARCHITECT

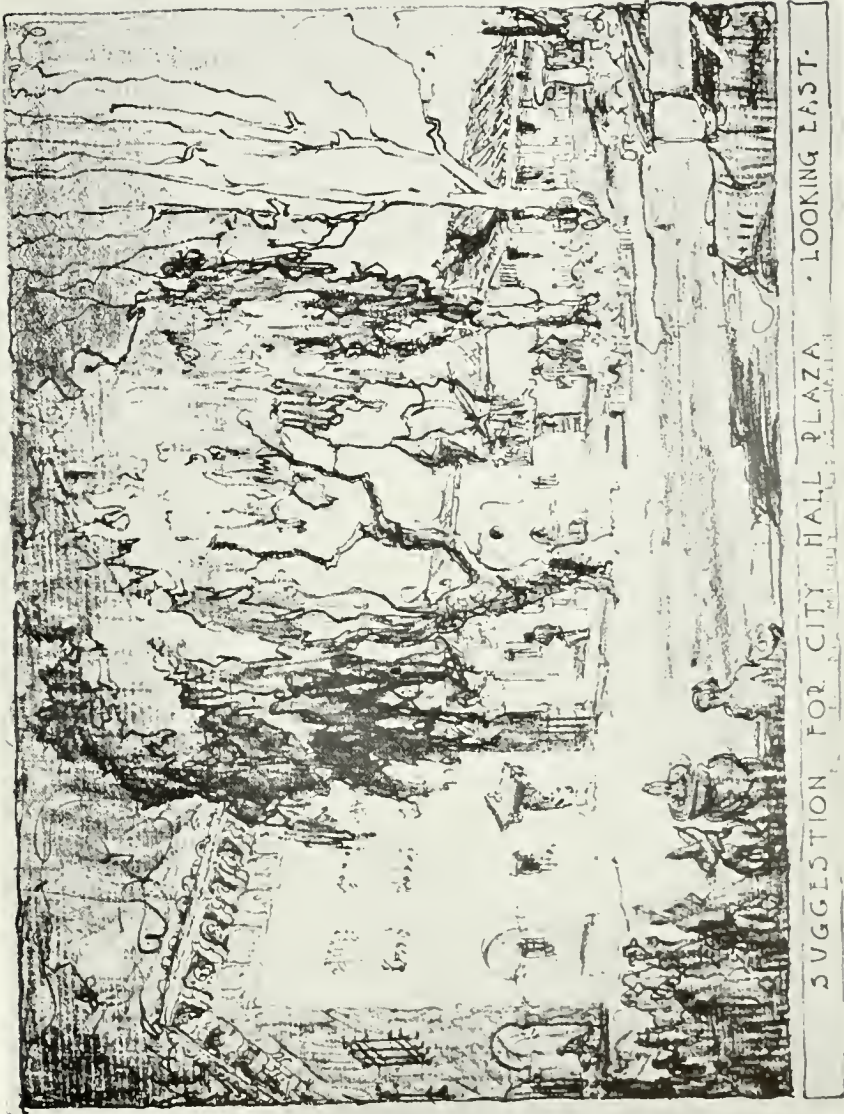

SUGGESTION FOR CITY HALL PLAZA · LOOKING EAST ·

STUDY FOR THE DEVELOPMENT OF THE DE LA GUERRA PLAZA,
SANTA BARBARA, CALIF. · GEORGE WASHINGTON SMITH, ARCHITECT



HOUSE OF MR. R. MUNROE FERGUSON, SANTA BARBARA,
CALIF. GEORGE WASHINGTON SMITH, ARCHITECT

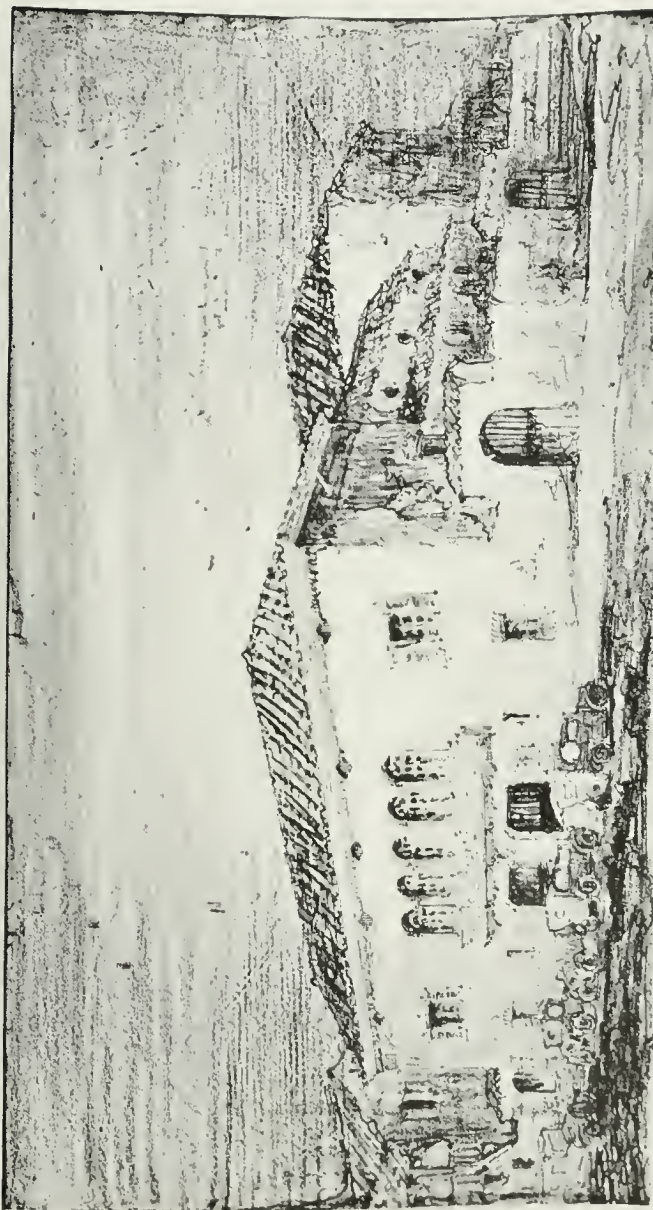

STUDY FOR RESTORATION OF THE OLD LOBERO THEATRE, SANTA BARBARA,
CALIF.
GEORGE WASHINGTON SMITH, ARCHITECT



TERRACE, HOUSE OF MR. DE WITT PARSHALL, MONTECITO,
CALIF. GEORGE WASHINGTON SMITH, ARCHITECT



HOUSE OF MR. DE WITT PARSHALL, MONTECITO, CALIF.
GEORGE WASHINGTON SMITH ARCHITECT



HOUSE OF MR. DE WITT PARSHALL. MONTECITO, CALIF.
GEORGE WASHINGTON SMITH
ARCHITECT



HOUSE OF MR. DE WITT PARSHALL, MONTECITO, CALIF.
GEORGE WASHINGTON SMITH ARCHITECT



ENTRANCE, HOUSE OF MR. DE WITT PARSHALL, MONTECITO,
CALIF. GEORGE WASHINGTON SMITH, ARCHITECT



ENTRANCE, HOUSE OF MR. DE WITT PARSHALL, MONTECITO, CALIFORNIA
GEORGE WASHINGTON SMITH ARCHITECT



PLAN OF SECOND FLOOR

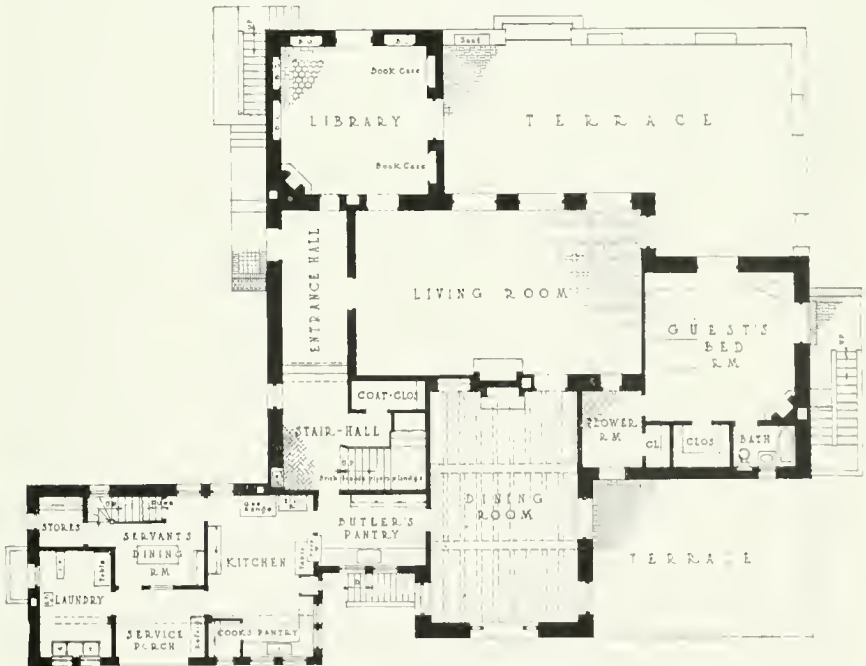

PLAN OF FIRST FLOOR, HOUSE OF MR. WILLARD P. LINDLEY, SANTA BARBARA, CALIF.
 GEORGE WASHINGTON SMITH, ARCHITECT

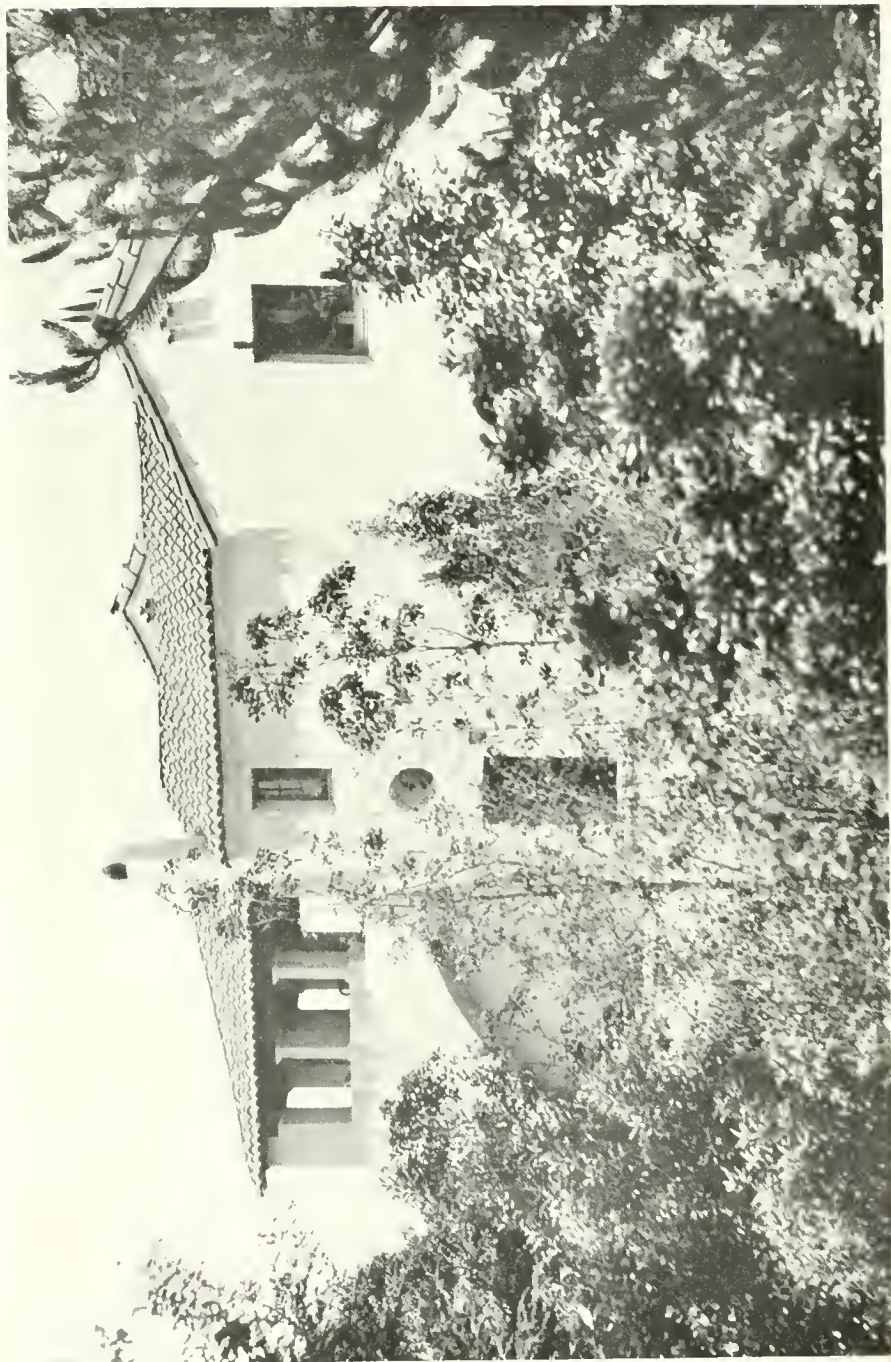

HOUSE OF MR. WILLARD P. LINDLEY, SANTA BARBARA,
CALIF. GEORGE WASHINGTON SMITH, ARCHITECT



HOUSE OF MR. WILLARD P. LINDLEY, SANTA BARBARA,
CALIF. GEORGE WASHINGTON SMITH, ARCHITECT



DRAWING ROOM, HOUSE OF MR. WILLARD P. LINDLEY, SANTA BARBARA, CALIF.
GEORGE WASHINGTON SMITH, ARCHITECT



DRAWING ROOM FIREPLACE, HOUSE OF MR. WILLARD P. LINDLEY,
SANTA BARBARA, CALIF. GEORGE WASHINGTON SMITH, ARCHITECT



ENTRANCE HALL, HOUSE OF MR. WILLARD P. LINDLEY, SANTA BARBARA,
CALIF. GEORGE WASHINGTON SMITH, ARCHITECT



HOUSE OF MR. HARRY BRAINARD, MONTECITO, CALIF.
GEORGE WASHINGTON SMITH ARCHITECT



OFFICE BUILDING FOR PACIFIC GAS & ELECTRIC COMPANY. SAN FRANCISCO, CALIFORNIA
BAKEWELL & BROWN ARCHITECTS



VACA-DIXON SUB-STATION

The Pit River Project of the Pacific Gas and Electric Company

By S. C. PARDEE*

FOR the past few years it has been evident to all men who have studied the situation that the future of California depends to a very large extent on the supply of power that can be made available to take care of the ever-increasing load. Cities all over the state have been conducting active campaigns with the end in view of increasing the membership in their respective Chambers of Commerce, it being the general impression that bodies of this nature are the best fitted to actively encourage eastern manufacturers to establish branch factories in California. In addition, Building and Loan Associations have been active in encouraging the building of homes, and all of these activities must have power in ever-increasing quantities if they are to be successfully carried through.

In the East, hydro-electric power is not, in general, available, and for this reason steam-electric installations have been necessary, the steam being generated by burning either coal or oil. California, however, is much more fortunately situated. It has been authoritatively stated that there is approximately 5,500,000 h. p. of hydro-electric energy economically available for immediate development in this State, while to date only a little over 1,000,000 h. p. has been utilized. The power companies have not, however, been asleep at the switch in any sense of the word. Previous to the war a comprehensive campaign of development was outlined and active construction started on several plants. This construction was halted per force while the more important matter of destroying the German menace was attended to, but immediately after the signing of the armistice the development program was pushed forward with all possible speed.

Several of the immense projects which were undertaken have lately been completed, and among the most notable of these is the Pit River No. 1 Development of the Pacific Gas and Electric Company with an installed capacity of 93,000 h. p. Last September the two Hat Creek plants of this company were placed "on the line" with a combined installed capacity of 33,500 h. p., so that to date the P. G. & E. Company has completed a total of 126,500 h. p. of installed capacity in the Pit River Basin. The map which appears with this article gives a good idea of the profile of the Pit River, and shows the location of the plants recently constructed and those to be put in as the growth of load demands.

*Descriptive data from Report by A. H. Markwart

means of a ditch 2750 feet in length. The total capacity of forebay, ditch and reservoir is 50 acre feet. The penstock is constructed of riveted steel, and has an average diameter of nine feet, its total length being 1600 feet. The maximum drop from head water to tail water is 216.8 feet. Water control is effected by means of motor-operated radial gates at the forebay and a 7 feet 6 inches butterfly valve at the power-house.

The power-house is, architecturally speaking, of simple design and houses a 15,000 h. p. 225 r. p. m. vertical shaft turbine direct connected to a 12,500 kv-a, three phase, 6600 volt generator, together with the necessary switchboard and control equipment. The maximum power which it is expected will be developed by this plant is 8600 kw. when 600 second feet are being delivered to the turbine. The effective head for this condition is 209 feet.

The long penstock required for this plant made necessary the instal-



PLOT PLAN, PIT RIVER POWER-HOUSE

lation of a 48-inch pressure regulator, which is designed to discharge approximately 80 per cent of the full flow.

Hat Creek No. 2

The diversion for this plant located some two miles below Hat Creek No. 1 consists of a pile and timber structure placed diagonally across the stream, thus attaining a spillway length of 282 feet. The water is carried from the diversion to the head of the penstock by means of a timber flume 4469 feet in length, which rests on a bench excavated by means of teams and scrapers. This flume is of such a size as to permit the carrying of 800 cu. ft. of water per second on a grade of 0.7 feet per 1000 feet.

The wooden flume is terminated in a combined flume, spillway and header box of reinforced concrete construction. The concrete section of the flume, 227 feet in length, is built integrally with concrete collector flumes, and is so designed that the water spills on both sides of the main flume, that is over two spillway crests each aggregating 224 feet in length. The water spilling over the uphill crest is carried both ways toward the center of the spillway, and there brought under the main

flume to mingle with the waters spilling over the downhill crests, these being brought to the center of the spillway in a similar manner. The discharge to the river is through a rapid concrete flume 5 feet 9 inches wide, the total capacity of the spillway being 900 cubic feet per second.

The penstock for this plant is of riveted steel pipe approximately the same size as that for Hat Creek No. 1, and is 400 feet in length. The



TYPICAL SECTION OF 220,000-VOLT TRANSMISSION LINE

maximum drop is 197.9 feet from forebay to tailwater. Water control is effected by means of radial gates as at Hat Creek No. 1, but the pressure regulator is omitted, due to the short length of penstock.

The power-house and equipment is practically a duplicate of that at Hat Creek No. 1, but due to the inflow from Crystal Lake more power is available. The maximum power which will be developed at this plant is

9700 kw. with an effective head of 193.5 feet and a flow of 800 second feet.

Pit River No. 1

The construction of the Pit River No. 1 plant of the Pacific Gas and Electric Company has occasioned more than passing interest, inasmuch as the units installed are among the largest in the world, being exceeded in size only by the 45,000 kv-a units installed in the Queenstown Development. The selection of the proper size for these units was dependent to a large extent on the charging current required for the transmission line, the voltage of which is 220,000. This will be further discussed under the head of "Transmission Facilities."

The diversion for the Pit No. 1 plant is located on Fall River, about one mile above the town of Fall River Mills. It consists of a concrete weir 14 feet high and 500 feet long, and does not provide for storage. Radial gates, 20 feet wide and 11 feet 6 inches high, are set in the weir structure, and function so that the entire flow of the river may be bypassed when the plant is not in use. The natural water level of the river is not effected by this development to an extent greater than would be occasioned by the normal fluctuation.

The concrete intake structure is located on the west side of the diversion dam and contains radial gates 20 feet wide by 11 feet 6 inches high, the structure being so designed as to form a highway bridge over the intake canal. The conduit from intake to surge chamber is of 1800 cubic feet per second capacity, and consists of 983 feet of open cut and 10,160 feet of tunnel. The open cut is lined with rip rap on the sides, while the tunnel is concrete lined throughout, the minimum thickness of tunnel lining being 6 inches. This tunnel is mostly of horseshoe construction, and has a cross-section excluding the lining approximately equal to a circle 14 feet in diameter.

The tunnel terminates in a reinforced concrete spillway and surge chamber, from which the two penstocks lead down to the power-house. This spillway is 60 feet in diameter, and is designed to spill 1800 second feet in the event of shut down. An annular shaped collecting conduit passes around the chamber and spills the water through a discharge canal or raceway over the cliff to the Pit River below. The surge chamber is supplied with three 24-inch sluice pipes to facilitate the removal of mud or debris collecting in the bottom.

Two penstock lines, one for each unit, are provided leading from the surge chamber to the power-house, the diameter of each tapering from 10 feet 9 inches at the upper butterfly valve to 8 feet 9 inches at the butterfly valve located at the power-house. The penstock lines are made in two sections the upper being steel riveted and the lower lap welded. The length of the riveted section is 330 feet and of the welded 1027 feet, which makes the total length of the penstock 1357 feet. Water control is obtained by the use of the two sets of butterfly valves mentioned above.

The power-house building, with its vertical lines and terminal towers, is suggestive of the Gothic, and is characterized by good proportions and a straightforward simple treatment. It is a steel frame and reinforced concrete structure of fireproof construction throughout.

This power-house contains two units consisting of a 40,000 h. p. single runner vertical shaft hydraulic turbine direct connected to a 35,000 kv-a 90 per cent power factor lagging 11,000 volt, three phase, 60 cycle generator running at a speed of 257 r. p. m. The units are complete

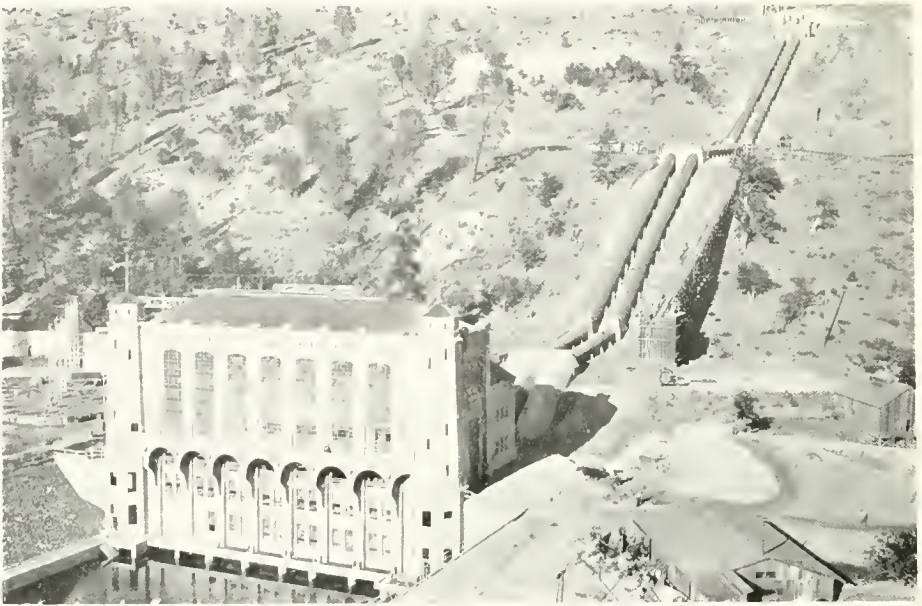

FIT RIVER POWER HOUSE, No. 1

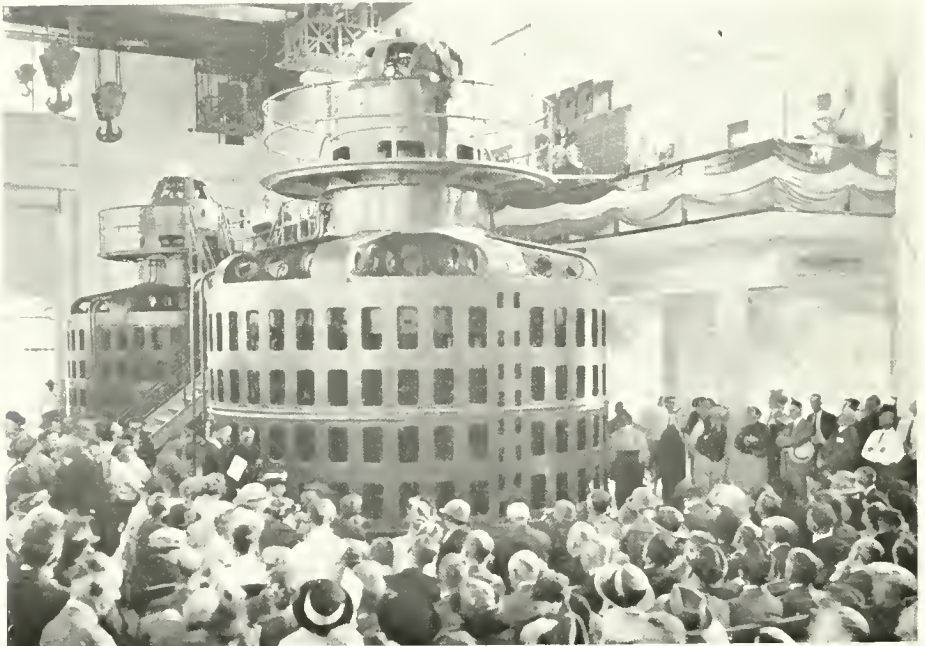

SCENE AT OPENING CELEBRATION, PIT RIVER No. 1 PROJECT, SEPTEMBER 30th, 1922



HAT CREEK POWER-HOUSE, No. 1



HAT CREEK POWER-HOUSE, No. 2



SURGE CHAMBER "SPILLING"



THE CLUB HOUSE, PIT RIVER No. 1 DEVELOPMENT

with integral oil pressure governors and direct connected fly balls, lifting jacks, air-operated braking mechanism, and telescopic draft tubes. The excitation is furnished by 250-volt exciters direct connected to each of the main units. For emergency a 225-kw. motor generator exciter set is connected to a 4-10 r. p. m. single jet overhung impulse turbine to operate under an effective head of 400 feet.

The maximum output of the station is 53,500 kw., obtained with a flow of 1800 second feet and an effective head of 418 feet.

The heavy low tension switching equipment is arranged in the lower part of the building back of the generators, and an elevated switchboard gallery is provided along the downstream wall. The high tension switching equipment is located out of doors, the oil circuit breakers being 220 kv., 400 amperes, grounded neutral, outdoor type, with a rupturing capacity of 2400 amperes at 220 kv.

On account of the remote location of the Pit River Country, the Pit No. 1 Development has been made a sort of community center for the three plants now constructed, and an attractive club house has been erected to aid in making life enjoyable for the men detailed to operate the plant. Company cottages are also provided in which the men and their families are comfortably housed.

On account of the transportation difficulties encountered, the Pacific Gas and Electric Company was forced to construct a railroad into the mountains, having one terminus at Bartle and the other at Pit No. 1. This road is approximately 34 miles in length, and was constructed in the short time of three months in order that the construction might proceed without interruption. The road is so located that comparatively short extensions will fit it for use in the construction of the Pit River No. 2 and No. 3 developments.

Transmission Facilities

One of the most important factors in the development of power in districts remote from the centers of population is the economical transmission of that power to market. The correct voltage at which the Pitt River power should be transmitted was made the subject of exhaustive tests by the engineers of the company, tests that were all the more interesting because they amounted to pioneering. Many interesting and important points were brought out affecting the selection of material as well as voltage, but a discussion of these is outside the scope of this article. Suffice it to say that the voltage selected—220,000—was found to be the most economical and in all ways the most satisfactory for the purpose.

Briefly, the scheme of transmission finally adopted was as follows: A bank of three 4000 kv-a, 6600-60,000 volt transformers was installed at each of the Hat Creek power-houses and the power transmitted over 60-kv. lines to Pit No. 1. Here both Hat Creek lines feed into a bank of 8000 kv-a, 60,000-11,000 volt transformers, the low voltage windings of which are connected to the 11,000 volt bus at Pit No. 1. The Pit No. 1 generators are also connected to this bus, and the combined power fed into two banks of 16,667 kv-a, 11,000-220,000 volt transformers for transmission to Vaca Dixon substation, 201 miles to the South.

A word as to these latter transformers which represent what is perhaps the latest development in transformer design. In 1912 the company purchased some large transformers for its Drum power-house, which at that time were considered as good as any obtainable. The transformers recently installed at Pit (and at Vaca) operate at four times the voltage, have twice the capacity, and yet the weight of the core and coils is only a little over one-third greater than the weight of the same

portions of the old drum transformers. This simple statement gives some indication of the forward strides that are being made in the design of electrical machinery.

The transmission lines from Pit No. 1 to Vaca are for the most part carried on steel towers, the single circuit, "Snow" type tower being used in the mountains from Pit No. 1 to Cottonwood and the twin circuit tower from Cottonwood to Vaca. For the first 28 miles from Pit No. 1 steel cored aluminum cable 1 inch in diameter is utilized, this cable having a conductivity equivalent to 325,000 circular mills of copper. For the remainder of the line 500,000 cm. 7 x 7 copper cable is used, this cable being made up of 49 individual strands of medium hard-drawn copper, each strand being .101 inches in diameter.

The insulators for use on the transmission lines probably received more study than any other single feature of the Pit No. 1 Development. The high-voltage laboratories of several of the insulator manufacturers, as well as that at Stanford University, made detailed investigations, all of which have not as yet been completed. It is, therefore, planned to operate the line at 175,000 volts or less at first, so that advantage may be taken of any improvements in the way of insulator design resulting from these tests, in making the final selection of the insulators for 220,000-volt operation.

The string adopted for present operation at 175,000 volts consists of 13 cap and pin insulators, the first nine of which are "Standard," 10 inches in diameter, the next four "Special," two of which are 11½ inches and two 13½. There is also a "Standard" 10-inch diameter insulator at the bottom, which is enclosed in a copper envelope 16 inches in diameter to fulfill a twofold purpose. It acts as a shield to prevent the formation of Corona, and in addition serves as a splash plate, by means of which the lower side of the insulator above it will become wetted, and thus tend toward a uniform condition of the string as to moisture. This "Corona Shield" does not possess insulating quality, the insulator enclosed in it serving merely as a convenient method of retaining the shield in its proper position with respect to the remainder of the string.

Vaca Dixon Substation

Four miles out of Vacaville, in the Sacramento Valley, is located Vaca Dixon substation, which serves two purposes in the general scheme of transmitting the Pit power to the Bay Regions. In the first place it includes two banks of transformers for stepping the Pit power down from 200,000 volts to 110,000 volts (at which voltage it is fed into the company's system), and in the second the substation building houses two synchronous condensers, whose function it is to regulate the line voltage and thus increase the transmission capacity.

This, then, briefly outlines the work that has been done in harnessing the vast energies of the Pit River and delivering them to the Bay Region for the use of man. As the load warrants, the other four Pit plants will be constructed, and it is confidently stated that those public-spirited citizens who are striving to build up the State of California need have no fear of their activities being curtailed by lack of power. Power there is in great abundance, and one must indeed be lacking in vision who when thinking of the completed Pit River project fails to see the huge factories and the thousands of homes that will be supplied with energy by this vast undertaking. California can develop, is developing, and will continue to do so even more in the future than in the past, and the Pit River project will undoubtedly go down in history as one of the greatest forward strides of this decade.

The Architect and the Pipe Organ†

His Responsibilities in Its Installation

By MARSHALL W. GISELMAN*

THOSE persons who have occasion to visit architects' offices see everywhere evidence of the infinite care taken in every phase of building—samples of cements, tiles, glass—every element that goes to make for artistic and successful building. The same holds good in the intellectual side of the work. Few realize the long hours of concentrated study the architect puts in in his client's interest.

Only the organ and its important problems of installation seem to have been sadly neglected. This is due, no doubt, to the habit of purchasing organs after the building is finished, when the organ builder must make the most of what he finds. Organ builders themselves, however, are largely to blame. Do they take the trouble to visit architects and discuss their wares with them as cement men and glass makers do? They surely do not in the vast majority of cases.

Indeed, the writer has had some very amusing experiences in this connection. Let two of them tell the story: A church is to be built—the pastor did have the foresight to call the writer into consultation with the architects. Oh, yes, they had amply provided for an organ: a trench running completely across the back of the church, 40 feet long and 4 feet wide, and sunk into the floor about one and a half feet. It is hopeless even to remark about this!

I recall another case where a building was especially built to house an organ; yet the building was completed without even the measurements of the organ being known!

Let me hasten to assure the reader that these are in no way exceptional cases; many more equally as astonishing could be mentioned.

This article is a plea for a better understanding of this problem of organ installation. First we must consider the question of space. I say, give the organ space, and plenty of it.

An organ cannot be treated as an after-thought, shoved in anywhere in any old corner under a low arch. Too much of this has been done in the past. Many a splendid instrument has been ruined by this treatment. You can see them any day, in any direction you choose to walk, looking for all the world like old men with stiff derby hats, many sizes too large, pulled down over their ears and eyes, cramping every natural movement, and leaving them only able to mutter, when they might speak as plainly as any one, look the world in the face, and not be ashamed of their existence.

Give an organ height. Height is perhaps the most important element a builder has to deal with.

The average church organ must have 19 feet height for the mere mechanics of building, and this allows nothing for sound. The longest pipe in the average organ is 16 feet, and this pipe must stand upon a wind chest taking about $1\frac{1}{2}$ feet, in all, $18\frac{1}{2}$ feet.

This pipe is now within 6 inches of the ceiling, not enough space to allow it to speak freely; still, if every church would allow a mean height of 19 feet, builders would be happy enough on this score.

Pipes, in endless numbers, exist today with elbows, turns and twists

* Chairman, Technical Advisory Board, The Robert Morton Co., builders of organs, Los Angeles.

† First of a series of special articles relating to the proper installation and arrangement of pipe organs in churches, theaters, and auditoriums.

in them. They start out to lead a straight life, get discouraged when they get near the ceiling, and turn back, or turn to one side, looking at some of their fellow-sufferers and blowing their breath at each other, a most undesirable tonal event, and bear in mind that these deformed citizens of the musical world are much more expensive to build than their straight upstanding brothers. Don't be backward about giving them height!

One stop, played from a manual, contains 73 pipes in a row, the longest of which is usually 8 feet and the smallest about the size of a lead pencil. These standing in a row should occupy a space from 10 to 12 feet long and about 8 inches wide. These manual stops are enclosed in rooms, the front wall of which has a row of what we shall call, for want of a better term, Venetian blinds. These rooms are called swell boxes, and are more or less sound-proof, and the front blinds opening let the tone out, giving the "swell" effect. The walls of these swell boxes when made by a reputable builder are composed of several thicknesses of wood laminated, and with a layer of some sound insulator or air space between. These walls are expensive to build, as they should be very substantial. If built cheaply, they are not likely to be sound-proof, and the "swell" effect is greatly reduced. But to get back to the matter of space. By all means consult some reputable builder, and not the average organist, whose opinions, although sincere, are frequently not catholic enough—he is too often wedded to one make or style of instrument.

In an auditorium of 500 seating capacity, an organ costing \$10,000 should be given 10 feet in depth, 24 to 30 feet in width, and at least 19 feet in height. No builder could complain of this space, and it should provide good sound results. The keyboard or console may be placed anywhere in these days when all organs are or should be electric actions. The console occupies a square floor space six feet each way. This includes the organist.

To sum up, the cardinal considerations are space, acoustic conditions, mechanical attributes and appearance. It is impossible to cover such a wide subject in one writing, owing to limited space, but our hope is that a glimmer may have penetrated the darkness from these few suggestions.

Organs are now being so universally installed in theaters, high schools and auditoriums, and, of course, churches, that the day is not far distant when the architect will surely make this subject one to which he will give as much thought and attention as he does to other seemingly less important problems.

The subject of "space" has been the only one attempted in this article. Other articles relating to the conditions named above, and also the theater organ, will appear in the near future.

* * *

If You Did Not Paint

Talking about the value of paint and its necessity as a preservation of all materials used in building construction, a general contractor made the statement a few days ago that should the city of Chicago be completely evacuated at any one time, and all of its buildings abandoned, that in about fifty years, due to the lack of paint, the buildings would all crumble to the earth. Even the big skyscrapers, which to many would seem to be built forever, he said, would begin to rust just as soon as the paint wore off and rain reached the steel work, and eventually they would rust out and crumble, if not protected by paint.

Suggestions for Making Partitions Sound-Proof

A STUDY of the problems of making partitions sound-proof has been made by the engineering experiment station at the University of Illinois, Urbana, Ill. Because certain principles of sound transmission are overlooked, partitions that would ordinarily be an effective barrier to sound occasionally fail to function as expected, and some of the possible reasons are pointed out in a bulletin (No. 127) reviewing the study of the subject at the experiment station. Sound may be transmitted from one side of a partition to the other in three ways, it is stated in the bulletin. It may progress through continuous air passages, it may pass as an elastic wave through the solid structure of the partition, or by setting the partition in vibration it may originate sound waves on the further side.

"These actions are quite readily understood," according to the bulletin, "by remembering that sound consists of a series of compressions and rarefactions that progress rapidly through a medium without interruption unless they meet new medium with a different elasticity or density. For instance, sound waves in air proceed without hindrance through air passages, such as ventilation openings in a partition. If, however, the passages are small in cross-section, as in the case of a porous material, the progress is hindered and a certain amount of absorption of the energy takes place, due to the friction set up between the vibrating air column and the sides of the pores.

"In case the partition is impervious to air, the direct progress of the waves is interrupted. A third partition is set in vibration, and thus originates new waves on the side opposite the incident sound. For a thicker, more rigid partition, the vibrations are smaller, and a very considerable part of the energy is reflected. The transmission in this case takes place by compressional waves communicated to the solid material of the partition. The amount of energy thus transmitted is usually quite small.

"In view of these considerations, a sound-proof partition should be as rigid and free from air passages as possible. For effective sound-proofing of a group of rooms, the partitions, floors, and ceilings between adjacent rooms should be made continuous and rigid. Any necessary openings for pipes, ventilators, doors, and windows should be placed in outside or corridor walls, where a leakage of sound will be less objectionable.

"In case the sound is generated in the building structure, as the vibrations set up by a motor fastened to the floor, the compressional waves proceed through the continuity of solid materials. In order to stop them, it is necessary to make a break in the structure so as to interpose a new medium differing in elasticity and density. For instance, the vibrations of a motor may be minimized by placing a layer of hairfelt, or similar air-filled material, between the supporting base and the floor. Where the machine is quite heavy, footings may be made of alternate layer of asbestos, lead and leather. Bolting through this material will reduce the insulation, because the vibrations in this case will pass easily through the bolts to the floor. The insulation should thus be left without any bridging over of the discontinuities. Air gaps in masonry will be effective if the air space is not bridged over at any point. A floor floated on sand, sawdust, or hairfelt would approximate this condition. The edges of the floor should be insulated from the walls by felt or similar material.

Especial attention should be paid to the ventilation system. All effective sound-proof constructions either omit entirely a ventilation system or else construct it in some special manner to avoid transmission of sound. In some buildings air is supplied and withdrawn from rooms by individual pipes and are small in diameter and extend without break from the air supply chamber to the rooms. This results in considerable friction between the walls of the pipes and the air, with a resultant weakening of the sound waves. Without some efficient control of the transference of sound through the ventilation system, it is a waste of effort to construct sound-proof walls, double doors, and other contrivances for insulation.

"When sound-proofing a building all details should be considered with respect to the likelihood of transmission of sound. Each room, as far as possible, should be made an insulated unit by means of air spaces or air-filled materials that separate it from surrounding walls. Pipes and ventilators should be so installed as to minimize the chance of transfer of sound. Patent doors are now available that will close the door space at the top, side, and bottom. In case a troublesome sound is generated in the room, it may be minimized by installing absorbing material on the walls.

"The absorption of sound is an essential feature for sound-proofing. Reflecting sound and scattering it still leaves it with energy. It must be absorbed; that is, converted into heat energy by friction before it is eliminated as sound. This means that carpets, furniture, draperies, etc., should be present, or if greater absorption is desired, hairfelt or similar materials must be installed.

"The insulation of sound is a complex problem, and a successful solution is obtained only when all the possibilities of transfer of sound are anticipated and guarded against. While many things may be learned from further experience, and much may be gained from additional theory, enough has been revealed to give encouragement to the belief that sound-proofing may be prescribed in the future with some of the certainty that now attends the acoustic designs of auditoriums."

* * * *

Suspended Ceiling Specifications

After much research in connection with the common practice in the different localities throughout the United States, the following specifications have been approved as being the minimum safe specifications for suspended ceilings.

It is to be regretted that much suspended ceiling work is being erected in a sub-standard manner, and if failure occurs, it will be through no fault of the manufacturers.

Hanger.—The vertical member which carries the steel framework.

The minimum size for hangers shall be No. 8 galvanized wire 1 3-16 inch flats or 7-32 inch round mild steel rods. The wire is to be attached by twisting three times, flats attached by bolting with $\frac{3}{8}$ -inch bolts, rods by twisting twice, or by right angle bends and wiring. They shall be spaced not to exceed 4 foot centers in either direction.

Runner Channel.—The heaviest horizontal member.

Runner channels are to be not less than 1 1-2-inch channels with a minimum of .42 lbs. per lineal foot. They shall be spaced not to exceed 4 feet on centers.

Furring Channel.—The smallest horizontal member, to which the lath is attached.

Furring channels shall be not less than $\frac{3}{4}$ -inch channels, with a minimum weight of .276 lbs. per lineal foot, attached to runner channels by at least three loops of No. 16 galvanized wire at each crossing. They shall be set on various centers, depending upon the lath to be used. A maximum of $11\frac{3}{4}$ -inch centers shall be used for 3 lb. flat lath, $14\frac{3}{4}$ -inch centers maximum for 3.4 lb. flat lath, 19-inch centers maximum for 3 lb. rib lath.

Metal Lath.—The plastering base and reinforcement.

Metal lath shall weigh not less than 3 lbs. per square yard. Metal lath shall be attached to the furring channels by No. 18 gauge annealed galvanized lather's wire every 6 inches along the furring channels.

* * *

Possibilities of Cement Stucco

Few people, even among architects and builders, realize the great possibilities in Portland cement stucco. This adaptable material lends itself admirably to any style of architecture, any color scheme, any ideal which the builder desires to express. Strength or delicacy, warmth or severity, beauty or ruggedness, stateliness or humbleness—these and many other architectural ideals can be given expression in Portland cement stucco better, perhaps, than in any other material. In addition, stucco is easily applied to any sound building, new or old, and will add many years to the life of old buildings.

* * *

What He Can Do

A contractor out in Iowa has taken a contract to move a whole town of over 300 buildings out of the river bottom back a mile and a half into the hills for safety. It will take him two years. Then there comes the announcement that Frank A. Munsey will have an 87-story building constructed in New York City. Another contractor is engaged in sojourning in South America, and meanwhile he is removing a mountain out of Rio de Janeiro. Give an American contractor free rein and he'll put the world itself on the map—or else change the map.—A. G. C. Weekly Letter.

* * *

New Daylight Lamp

An artificial daylight lamp has been developed in England. The lamp is of the regulant incandescent electrical type; the light is reflected from a reflector which is colored with spots of certain shades. The resulting reflection is very much like ordinary daylight. The absorption of the yellow and red rays in the light produces a light of maximum clarity. A park was lighted with 60 of these lights, and the effect was almost the same as if the sun were shining. The new lamps are purchasable on the English market at the present time.—Industrial Digest.

* * *

A Thought for Christmas

Be tolerant, be just, and fear naught. Hide not your face from the light nor cover it in the dark. Deal squarely with an open and even hand. Labor faithfully and in a cheerful spirit. Guard your own Rights no more jealously than those of your fellows. Be steadfast in your loyalty to Right. And the universal reign of Goodwill shall bring Peace on Earth as we journey along the Path of Happiness, through the Pleasant and Fruitful Valley of Service.—Valve World.

THE
Architect and Engineer

Incorporated

Founded 1905 by E. M. C. WHITNEY

W. J. L. Kierulff - President and Manager
Fred'k W. Jones - Vice-Pres. and Editor
L. B. Penhorwood - - - - - Secretary
T. C. Kierulff - - - - - Attorney

Associate Editors

Chas. H. Cheney - - - - - City Planning
August G. Headman - - - - - Book Reviews
Wilbur David Cook - - - - - Landscape Architecture
Wm. B. Gester - - - - - Inspection and Tests
O. P. Shelley, C. E. } Fireproof Construction
F. W. Fitzpatrick }
T. Ronneberg, C. E. - - - - - Structural Steel
W. H. Lowe - - - - - Roofs and Roofing
Fred'k N. Woods, Jr. - - - - - Rock and Gravel
Chas. Felix Butte - - - - - Electrical Construction
J. W. Fricke - - - - - School Equipment
Will J. French - - - - - Department of Safety

Published Monthly in the Interest of the
Architects, Structural Engineers, Contractors
and the Allied Trades of the Pacific Coast by
The Architect and Engineer, Inc.

PUBLICATION OFFICE:

627-629 Foxcroft Building, San Francisco
Telephone Douglas 1828

The publishers disclaim any responsibility for
statements made in the advertisements of this
magazine.

Terms of Subscription

(Including postage) to all parts of the United
States, \$2.50 per annum; to Canada 75c
additional; to all Foreign points \$1 additional

Vol. LXXI. DECEMBER, 1922 No. 3

**BUILDING CONSTRUCTION
OUTLOOK**

In a statement reviewing the building situation and outlook, Mr. Wilson Compton, secretary-manager of the National Lumber Manufacturers' Association, directs attention to the marked increase in labor costs since last spring. Taking Washington, D. C., as an example, Mr. Compton says that building costs have increased 30 per cent and that \$15 a day has become quite customary in Washington for masons, bricklayers and plasterers. In New York as high as \$30 a day has been paid to skilled labor on some building contracts. The statement follows:

"The accumulated housing shortage since 1916 up to the present year was equivalent to approximately two and a half full years of

new building based on the 1910 to 1915 yearly average. At costs of construction prevailing last spring, between five and six billion dollars' expenditure would have caught up this building deficit.

"There is every reason to believe that the fundamental demand for building materials still maintains and that it will continue for several years, with, of course, ups and downs. There will be periods of great building activity alternating with periods of semi-stagnation until the building shortage is substantially caught up. These alterations will probably be due rather to the building trades labor situation than to building materials."

There is no question but that the building industry on the Pacific Coast is facing a very serious labor shortage, and as long as this continues contractors will be forced to pay bonuses. This means high wages and continued high building costs for 1923.

**SHINGLES ELECTED IN
CALIFORNIA**

The defeat of the amendments to the California State Housing Act means that shingles will continue as the popular roofing material in the Golden State. According to a representative of the National Lumber Manufacturers' Association, the recent election was "one of the many interesting phases of the bloodless trade war between wooden shingles and composite roofings, which has been raging throughout the country for some time."

The California legislature of 1921 enacted a "State Housing Act," or building code, of great length and many details, and which contained what the lumbermen called a "joker" that was not noticed until after enactment. This clause provided that the roofs "of every wooden building hereafter erected in any incorporated city shall have the exterior walls

thereof and roofs thereon constructed of the same kind of materials and in the same manner hereinbefore provided for semi-fireproof buildings." When it was too late it was discovered that shingles were forbidden for semi-fireproof buildings. As shingles were not permitted for fireproof buildings, this excluded them from any use in a California city, except by local legislation. Wooden lath was in the same position.

When the shingle men discovered their plight they petitioned for a referendum vote against the act. A lively campaign followed, which attracted more attention in California than most of the personal contests in the election. The West Coast Lumbermen's Association sent out an after-election bulletin stating that the anti-shingle interests spent \$200,000 in the campaign and that the shingle men spent \$25,000. These statements, however, are subject to verification. Los Angeles county polled a majority of 200,000 against the act.

The action of California in sustaining the use of wooden shingles on non-fireproof structures is expected, according to the West Coast Lumbermen's Association, to have a pronounced effect on the controversies now going on in city legislatures and city councils in all parts of the country regarding the use of shingles, which have been precipitated by the propaganda against them.

CONSTRUCTION INDUSTRIES BUILDING WANTED

Down in Los Angeles, where they **do things** in the construction line, they are going to have a Construction Industries Building—an office structure to house the various building organizations, architects' and engineers' societies, and such individual members of the professions and building industry who care to rent offices.

This is the kind of building San

Francisco needs—and should have without further ado. Why don't our Builders' Exchange get behind the movement? In the Southern city the exchange has levied an assessment on its members for one unit of the proposed new building. Another unit will be taken by the Southern California Chapter of the Associated General Contractors of America. San Francisco building interests should get back of this movement for a Construction Industries Building here and put it over with a bang.

OUR CALIFORNIA HIGHWAYS

Much is being said by the press outside California regarding the alleged failure of our California State highways. The fact that many of them are being resurfaced is cited as evidence of their going to pieces. As a matter of fact, however, many of the roads have held up remarkably well, but due to the heavy increase in traffic the highway commission has found it expedient to widen many of the roads, and in doing this shoulders are constructed on either side of the highway and the old portion is then given an additional two or three inches of concrete or asphalt to conform in thickness with the shoulders. This is done oftentimes when the road is in fairly good condition. It is a sensible proceeding, and makes a highly satisfactory highway.

Recently there appeared in the Portland, Ore., Telegram the following statements more or less derogatory to California's highway system:

"Whenever a concrete highway for any good and sufficient reason shows weakness or failure, the black-top interests scent the trouble from afar, as crows scent a carcass. California's 1500 miles of concrete roadway, laid of too thin a slab, is now drawing destructive criticism from the asphalt interests.

"California, it will be remembered, in order to cover its long distances with paved roads, laid 4-inch and 5-inch pavement when 7-inch should have been the minimum thickness."

Yet in spite of this so-called error in engineering, the United States Bureau of Roads, through its chief, Mr. Thomas H. McDonald, has this to say regarding the pavement:

People say that the roads of California have gone to pieces and that they have been gradually giving up the ghost. The Bureau made a very careful survey of 1290 miles of the entire system of 1500 miles of concrete roads which have been built in California since 1909—that is, a period of over ten years. In that ten-year period, of the entire mileage that has been built, less than 13 per cent is all that has shown signs of distress or has broken down; and those roads were 4 or 5 inches thick and 70 per cent of them were laid over clay or adobe soils.

Judges Named for Hospital Contest

Architects Clarence H. Johnston, of St. Paul, and William B. Stratton, of Stratton and Snyder, Detroit, have been named as members of the jury of award of The Modern Hospital's \$1000 prize competition for plans of a small general hospital.

Two of the five judges for the architectural contest are leading figures in the field of hospital administration, two are architects of standing, and the fifth is a graduate nurse who is superintendent of a hospital of the size stipulated in the competition. They are:

Dr. S. S. Goldwater, superintendent of Mount Sinai Hospital, New York, hospital consultant, and former commissioner of health of the city of New York.

Asa S. Bacon, president of the American Hospital Association, and superintendent of Presbyterian Hospital, Chicago.

Clarence Howard Johnston, Minnesota state architect, former director of the American Institute of Architects, former president of the Minnesota Chapter, and designer of the Charles T. Miller Hospital, St. Paul; St. Mary's Hospital, Rochester, Minn.; the City and County Hospital, St. Paul; various hospitals at Minnesota state institutions, and many college and private hospitals.

William B. Stratton, of the firm of Stratton and Snyder, architects of the Detroit General Hospital; the University of Michigan Hospital at Ann Arbor, Mich.; the Municipal Tuberculosis Hospital at Detroit; the Saginaw Women's

Hospital at Saginaw, Mich.; and numerous other hospitals of the Middle West.

Miss Adelaide M. Lewis, R. N., superintendent of the Kewanee Public Hospital at Kewanee, Ill.; graduate of the hospital of the University of Pennsylvania, at Philadelphia; post-graduate of the Presbyterian Hospital, Chicago; former superintendent of the Presbyterian Hospital, New Orleans.

This jury will meet in Chicago to consider the designs immediately following the formal closing of the contest on February 1, 1923. Registrations for the competition closed December 15th.

Winner of Tribune Competition

San Francisco architects who participated in the competition for a new home for the Chicago Tribune have been advised that the jury has awarded first prize of \$100,000 to Mr. John Mead Howells, New York architect, and well known as senior member of the former firm of Howells and Stokes. The winning design is a Gothic expression of the American skyscraper. Second prize was awarded to Mr. Eliel Saarinen, of Finland, and the third prize to Messrs. Holabird and Roche, of Chicago.

The San Francisco architects who participated in the competition were Messrs. Bakewell and Brown, Ward and Blohme, Weeks and Day, and Bliss and Faville.

Seattle Elks Building Competition

The competition committee of the Washington State Chapter of the American Institute of Architects has completed its draft of rules governing a competition among Seattle architects for the new \$1,100,000 Elks building to be constructed on the northwest corner of Fourth avenue and Madison street, Seattle. The A. I. A. committee has submitted the list of rules to the building committee of the B. P. O. E., and the latter body has approved the plans for the competition. It is proposed that only Seattle architects be permitted to enter the competition. A prize of \$1000 will be awarded the best design, with a second prize of \$500 and a third prize of \$250.

Competition for Los Angeles Building

Mr. A. C. Blumenthal has arranged for a competition between several invited architects to design a large building on Mercantile place, Los Angeles. The following architects have been invited to submit drawings: Weeks & Day, G. Albert Lansburgh, MacDonald & Couchot, and S. Hyman, all of San Francisco; Albert Kahn, of Detroit; C. Howard Crane, of Chicago; Curlett & Beelman, Swasey & McAfee, and Myron Hunt, of Los Angeles. Mr. Sylvain Schnaittacher will be architectural advisor.

With the Architects

Building Reports and Personal Mention of Interest to the Profession

Talks to Architects

Mr. R. W. Lawton, an engineer who spent over fifteen years in India and Ceylon in the service of the British Government, was the principal speaker at the November meeting of the Southern California Chapter of the American Institute of Architects. Mr. Lawton spoke briefly of the religious history of India, which has so greatly influenced its architecture. His talk was illustrated with stereopticon views of famous temples and tombs, which were built principally of white marble and red sandstone.

Mr. H. S. Stronach, manager of the industrial department of the West Coast Forest Products Bureau, also spoke, urging co-operation between the architects, mill-men and lumber men to secure a more advantageous use of lumber.

The chapter adopted a resolution requesting Mayor Cryer to fill a vacancy which will occur on the Municipal Art Commission on January 1 by appointing an architect to the position.

Nominations for officers for the ensuing year were made by the nominating committee as follows:—President, Sumner Hunt; vice-president, A. M. Edelman; secretary, Chas. F. Plummer; treasurer, Alfred W. Rea; and director for three years, C. E. Noerenberg.

Approves Mr. Mullgardt's Criticism

Editor The Architect and Engineer, San Francisco.

Let me congratulate you and Mr. Mullgardt upon his most timely criticism of Lloyd Wright's Japanese aberration. Mullgardt for writing it and you for having the "innards" to publish it. Most editors are so blamed fearful of direct adverse criticism.

This was well merited, for it was a flagrant offence and calculated to harm all things American in the eyes of our distant neighbors.

Sullivan deserves credit for getting away from the orthodox styles, doing something original in merely frankly clothing or covering the brute and actual structure with ornament that left the structural intent perfectly evident. He was a master and opened the way to really a new art. His disciples in most part have not proven worthy of carrying on in the way he started, for they have all striven merely for the bizarre, the

grotesquely unusual, an effort to be different, and the results are generally weirdly fantastic, impracticable, dreams induced by cigarettes and absinthe, awful nightmares. And of all those disciples Wright has sinned the most and the worst. And this last sin seems the most sinful of all past sins.

Keep it up. Whenever we do anything worth while proclaim it afar, and whenever we sin architecturally call us down good. That makes a worth-while architectural journal.—Sincerely,

F. W. FITZPATRICK.

Chicago, Ill., Dec. 4, '22.

Weeks & Day Busy

New work in the office of Architects Weeks & Day, California Commercial Union building, San Francisco, includes a \$1,000,000 cathedral for the Scottish Rite Masons, to be built on the site of the Coliseum on Baker street, San Francisco; a theatre and hotel for Mr. George Roos, on Grand avenue, east of Broadway, Oakland; and a group of buildings, including hotel, auditorium, cottages, etc., at Gerlac, Nevada, for the Pacific Portland Cement Company.

School and Store Building

Plans being completed by Architects Kuhn & Edwards, Commercial building, San Francisco, for a one-story frame and stucco school building, having four classrooms and auditorium, to be built near Millbrae, San Mateo County, for the Lomita Park School District. The estimated cost is \$45,000. The same architects have completed plans for a one-story store building to be built in Burlingame at a cost of \$18,000.

Designing Residences

Two large frame and stucco residences have recently been designed in the office of Architect William F. Gunnison, 1666 Golden Gate avenue, San Francisco. They are to be built in the neighborhood of Jackson and Laurel streets, San Francisco, at a cost of \$17,000 each. The owners are Messrs. A. Fala and A. Marx.

Seacliff Garden

Emerson Knight, landscape architect, 704 Market street, San Francisco, is planning and planting a garden for Henry C. Hellwig at 160-30th avenue, in Sea Cliff, San Francisco.

Awarded Scholarship

Otto M. Olsen, a post-graduate student at Carnegie Institute of Technology, Pittsburgh, has been awarded the John Stewardson Memorial Scholarship in Architecture for 1922. In winning this, the most coveted prize for young architects in Pennsylvania, Carnegie Tech. students have won the scholarship for two consecutive years, and three times in the last five years. H. L. Rubin won it in 1917 and Russell F. Simpson was the holder last year.

The scholarship, valued at one thousand dollars, is a memorial established on the basis of a fund donated by John Stewardson, noted architect of Philadelphia, who died 23 years ago. Candidates are restricted to architects, 22 to 30 years of age, who have completed at least one year's office experience and two years in an approved school of architecture, and must have studied or practised architecture in the State of Pennsylvania for the period of at least one year immediately preceding the scholarship award. The scholarship includes a year's travel in Italy, France, Greece, and Spain. More than 120 architects entered the competition this year.

Warehouse and Showroom Building

Architects Julius Krafft and Sons, Phelan building, San Francisco, have completed plans for a two-story and basement reinforced concrete warehouse and showroom building to be built at 8th and Natoma streets, San Francisco, for the Talbot Investment Company. The building has been leased to the George H. Tay Company, now located at Second and Mission streets. The estimated cost of the improvements is \$100,000.

Architectural Exhibit

Arrangements have been made for an exhibition of recent work by Oakland and Berkeley architects in the Municipal Auditorium, Oakland, commencing February 1st and continuing through the entire month. Mr. W. R. Yelland is chairman of the committee of arrangements. Besides drawings and photographs, there will be a display of mural paintings and sculpture. Admission will be free to the public.

Addition to Packing House

Architects Allison and Allison, 1405 Hibernian building, Los Angeles, are completing plans for a packing house to be erected at Santa Paula for the Santa Paula Citrus Fruit Association as an extension of its present building. Dimensions, 150 x 350 feet, one-story and basement; reinforced concrete columns and beams, hollow tile filler walls, stucco exterior, comp. saw-tooth roofing, wood floor, concrete basement; \$200,000.

Personal

Mr. Walter Parker has temporarily closed his office in the Mechanics' Institute building, San Francisco, and is engaged in construction work at the government base hospital in China. Mr. Parker expects to be absent more than a year.

Miss Grace Jewett, who has maintained offices for the practice of architecture in the Mechanics' Institute building, San Francisco, for some time, is in Phoenix, Arizona, for her health.

Mr. Chas. F. Schuetz, engineer, has taken offices with Architect William F. Gunnison, in the Mechanics' Institute building, San Francisco.

Mr. Leonard L. Jones has moved from the Pacific Electric building, Los Angeles, to Suite 602, 603 Gross building, same city. He would be pleased to receive catalogues and samples of building materials.

Mr. A. C. Zimmerman has opened an office for the practice of architecture in Room 400, San Fernando building, Los Angeles.

Mr. John P. Kremple has resumed the practice of architecture in Los Angeles, having returned from a six months' trip abroad. Mr. Kremple gave an interesting account of his travels at the December meeting of the Southern California Chapter, American Institute of Architects.

Mr. Vernon W. Houghton announces that he has opened offices for the practice of architecture, specializing in the scientific designing and planning of commercial equipment of stores, at 275 Post street, San Francisco. He will be pleased to receive manufacturers' catalogues and samples.

Mr. A. L. Haley, recently of Portland, architect and builder, who has had much experience in California and in the Northwest, has located at Kelso, Washington.

Mr. James J. Donnellan has opened an office at 214 Lissner building, Los Angeles. Mr. Donnellan formerly practiced architecture in Chicago and later in San Francisco.

Mr. Earle Russell, formerly structural for MacDonald and Kahn, has opened an office for private practice in the Santa Fe building, San Francisco.

Mr. J. Charles Stanley, architect, Denny building, Seattle, formerly of the firm of Wohleb & Stanley, having charge of the Seattle office of that concern, has

taken offices with Mr. Charles Siebrand in the Northern Life building, Seattle.

* * *

Mr. Otto N. Neher has moved his offices from the Chamber of Commerce building to suite 209 Marsh-Strong building, Los Angeles.

Club Building and Small Banks

Architect and Engineer readers have a treat in store for them in January. The issue will contain the first detailed pictures yet published of the new Los Angeles University Club building, designed by Architects Allison and Allison of that city. Working drawings and plans will accompany the photographs, and Mr. Irving F. Morrow will describe the architecture of the building in detail. Another feature of the January issue will be an article on Small Bank Buildings, with full-page plates of some of the more recent buildings of this type constructed in California.

Designing Large Bakery

Mr. J. Edwin Hopkins, of New York, has recently been granted a certificate to practice architecture in California, and offices have been opened in Los Angeles under the name of the McCormick Company, Incorporated. The New York office is at 41 Park Row. The company specializes in the design of modern baking plants and has recently completed one at Long Beach for the Long Beach Baking Company. Plans are now being drawn for a larger bakery to be built at Hooper avenue and Washington street, Los Angeles, for the Pacific Baking Company.

\$100,000 Berkeley Garage

Plans are being prepared by Architect James W. Plachek, of Berkeley, for a large reinforced concrete commercial garage and automobile sales building to be erected on Shattuck avenue, from Parker to Carlton streets, Berkeley, for Mr. John Havens, of the Berkeley Gazette. The lessees are the Studebaker and Ford agencies in Berkeley. The building will cover ground area 260 by 180, and the improvements are expected to cost \$100,000. Mr. Plachek is also completing plans for a two-story reinforced concrete printing plant to be erected on Center street, Berkeley, for Mr. Lester Hink.

Oakland Apartments

Architect Louis M. Upton, 454 Montgomery street, San Francisco, is preparing plans for a three-story and basement frame apartment house to be built in the Lakeside District, Oakland. Mr. Upton is also making plans for a one-story concrete store and branch bank building on Shattuck avenue, Berkeley.

To Improve Property

Wong Du, a Chinese property owner in San Francisco, is having plans prepared by Architect W. R. Yelland for extensive improvements to his property at Laguna and Geary streets. A chop suey restaurant will be built on the corner and the adjoining two-story building will be extensively altered into apartments. About \$30,000 will be expended.

Bungalow Court

Plans have been completed by Architect Birge M. Clark, of Palo Alto, for a bungalow court consisting of ten, three and four-room apartments, to be built on University avenue, Palo Alto, for Mr. P. L. Wisdom. The same architect has completed plans for five stores to be built in the same town for the Palo Alto Improvement Company.

Los Angeles Office Building

The Milwaukee Building Company, 315 Wright & Callender building, Los Angeles, is preparing plans for a twelve-story Class A store and office building to be built on Hope street, south of Pico, for Mr. K. V. Norswing, of Fullerton. Building will be 75 x 150, and will cost \$750,000.

Return from Europe

Messrs. Walter Falch and William A. Newman, San Francisco architects, have returned from a three months' trip abroad. They report having had a delightful trip. Both architects found considerable new business awaiting their return. Mr. Falch is preparing plans for a large \$100,000 market building, while Mr. Newman is busy on new government work that matured during his absence.

Class A Factory

Architect W. J. Saunders, 227 Laughlin building, Los Angeles, is preparing plans for a four-story Class A factory building at 28th and Main streets, Los Angeles, for Normandin Bros. Co. Reinforced concrete construction, plastered exterior, 56 x 144 feet, steel sash, metal skylights, ornamental iron, freight elevator, etc.

Restaurant and Office Building

Architect Leo J. Devlin, of San Francisco, has completed plans for a three-story restaurant and office building for Comptons, Incorporated, and a contract for its erection has been awarded to Barrett and Hill for approximately \$75,000.

Designing Sanitarium

Architect Julia Morgan, Merchants' Exchange building, San Francisco, is preparing plans for a \$200,000 sanitarium for the Atlas Peak Sanitarium Company of Napa.

Appointed on State Board

Architect Harry H. James, of Seattle, has been appointed by Governor Louis F. Hart, of Washington, to membership on the Washington State Board of Architectural Examiners. Associated with Mr. James on the board will be Mr. Louis Baeder, of Seattle, and Mr. R. J. Russell, of Tacoma. Mr. James is a past president of the Washington State Society of Architects.

Nine-Story Apartment House

Plans have been completed by Architect C. A. Muessdorffer, of San Francisco, for a nine-story reinforced concrete apartment house to be built on the northwest corner of Jackson and Laguna streets, San Francisco, for Mr. J. E. Levin and associates. The building and furnishings will cost in the neighborhood of \$250,000.

Packing Plant

Plans have been prepared by Architects Ward & Blohme, of San Francisco, and a contract has been let to Barrett & Hilp, for approximately \$80,000, for the construction of a two-story reinforced concrete packing plant on Townsend street, east of Fifth, San Francisco. The owners are Roth, Winter & Walsh.

Taft School Buildings

Architect William H. Weeks has completed plans for a group of reinforced concrete school buildings at Taft, Kern County, for the Union High School District. There will be a gymnasium, auditorium and science building. Bonds amounting to \$280,000 were voted some time ago.

Oakland Office Building

Plans are being completed by Architect C. W. McCall, Central Bank building, Oakland, for a seven-story reinforced concrete store and office building to be built on 17th street, for the Ambassador Realty Company, at an estimated cost of \$150,000.

Cement Plant

The Southwestern Portland Cement Company plans to erect a cement plant near Phoenix, to cost about \$1,250,000, according to announcement made by Mr. O. J. Binford, secretary and general manager of the company.

Los Angeles Hotel

Plans are being prepared by Architects Walker & Eisen, Pacific Finance building, Los Angeles, for a four-story Class C brick hotel, having nineteen stores and two hundred rooms, at Temple street and Broadway, Los Angeles, for Messrs. Paulais & Hartfield. Cost, \$300,000.

Eight-Story Warehouse

Architect Albert C. Martin, 430 Higgins building, Los Angeles, is preparing plans for an eight-story and basement Class A warehouse at San Pedro and Commercial streets for the Los Angeles Warehouse Company. The building will be the first of several similar units; offices in first story, one floor for automobile storage, sales offices on eighth floor, remainder for general storage; reinforced concrete construction, 130 x 150 feet, steel sash, metal skylights, steel rolling doors, passenger and freight elevators, gas radiators, track service; \$200,000.

Reinforced Concrete Church

The Clinton Construction Company, San Francisco and Los Angeles, has been awarded a contract at \$135,000, to build a reinforced concrete church at West Adams and Figueroa streets, Los Angeles, for St. John's Episcopal Church. The plans were prepared by Architect Pierpont and Walter S. Davis.

Packing Company to Build

The California Packing Corporation will build a one-story brick and steel manufacturing plant and warehouse at First and Filbert streets, Oakland, from plans being prepared by their engineer, Mr. Phillip Bush. The company is also planning extensions at Modesto and Visalia.

Russian Hill Home

Plans have been completed by Architect John K. Branner, 251 Kearny street, San Francisco, for a large two-story Spanish house on Russian Hill, for Mr. Chas. L. Lewis. Construction will be in charge of George Wagner.

Los Angeles Cathedral

St. Paul's Pro-Cathedral, Los Angeles, will have a new edifice costing \$400,000, from plans recently completed by Architects Johnson, Kaufman & Coate, 608 Union Bank building, Los Angeles.

Oakland Residence

Architects Miller & Warnecke have completed plans for an \$8000 residence in Lakeshore Highlands for Mr. C. W. Smith. The design is Spanish. There will be a terra cotta tile roof.

Architect Moves

Architect John J. Donovan will move his offices from the Pacific building, Oakland, to the new building recently completed at 18th and Broadway, Oakland.

With the Engineers

Appreciation of the Engineer*

It is not often that the engineering profession receives a tribute and there are few records to show an appreciation of what the engineer is, what he is doing, and what are his possibilities, to compare with that offered by Doctor Frank Crane in a recent issue of "The American City." It is hoped that every member of the profession will read this, and while the modesty of the average engineer will forbid it, it affords material for conversation with those not in the profession, and for newspaper publicity, in order that the average man may know better what is owing by him to the engineer. Doctor Frank Crane, whose reputation as a philosopher is growing yearly, says:

The man of the future will be the engineer.

He is the man who can do things, and is better than the man who owns things.

But the official who will forever be indispensable is the engineer.

The time will come when the President of the United States will be chosen as the man who has the greatest talent and skill in organizing public works. There will be no more politics in his selection than there is now in choosing the master mechanic of a railway or factory.

When a nation goes to war nowadays, that is, when it becomes necessary to exert its supreme collective strength, nobody dreams of selecting the most popular politician or the cleverest speech-maker to lead the armies. It is the man who can get the last ounce of efficiency out of men and metal that is wanted.

Some day the nation will realize that it is continually in a crisis, and that in peace as in war we need the highest order of efficiency and organization.

We need the engineer to arrange the transportation of people and goods from place to place, without waste, without competition, without graft, looking only to the public good.

We need the engineer to get meat, bread and milk from farm to citizen, without the present inefficient tangle of trusts and middlemen working at cross purposes.

We need the engineer to turn the profit of public enterprise toward building good roads and bridges, instead of enriching a few shrewd manipulators.

We need the engineer to manage a city as economically and smoothly as if it were a manufacturing plant.

We need the engineer to organize the farmers so that all can work together for each and their products be marketed without being preyed upon at every step of the way from farm to household.

Wealth can be taken away from us; but the power to do things cannot be taken away.

The millionaire could go and not be missed. The engineers we cannot spare.

"What availeth all thy wealth?" said the ancient philosopher. "He that hath better iron than thou will come and take away all thy gold."

Says H. L. Gantt:

"The man who knows what to do and how to do it is preeminently the engineer. The new world which is being ushered in by the great struggle now taking place is one in which the

engineer is destined to be the supreme power, for it is becoming clear that in future the man who owns things will not be as important a factor in the world as the man who can do things."

Reading this panegyric should give a man an added pride in his profession. But that is not sufficient. This is the information that engineers should keep constantly before those in high places, in order that we may not have again conditions as have existed recently. We know thoroughly trained and capable engineers who have been unable to find positions when the country stands in need of the production their training and experience can effect for the benefit of the country. Too long the engineer has been overly modest, and today the whole profession is suffering as a consequence. Undue modesty is a curse which has reacted heavily upon the position and standing of engineers.

If the lesson has not been learned, the outlook is not promising, but if we have learned our lesson it is obvious that we should on every possible occasion do a little shouting on behalf of the profession in order that the world at large may really know what engineers have done and are doing, and of the super-important position they occupy in the development of a country such as this, which at the present time is not even in the slightest degree recognized, as was pointed out at the recent meeting in Vancouver.

"Some" Engineer—This Eskimo

Have you seen "Nanook of the North," a moving picture of Eskimo life? Inquires Engineering and Contracting, and continues: There is one scene particularly interesting to an engineer or architect. We refer to the building of an igloo by Nanook. The house is made of blocks of ice or of compacted snow laid in a spiral and leaning inward, so as to form a dome-shaped structure. In his lecture on "The Far North," Stefansson has paid a great compliment to the original designer of this serviceable residence. He said that although many white men had attempted to build igloos, none had succeeded until taught by an Eskimo. When Peary made his celebrated dash for the North Pole, his party lived in silk tents and almost perished from cold. But when Stefansson made an equally long trip north of the Arctic circle, he built an igloo every night, and slept in comfort at a temperature of 60 degrees.

Consider the igloo as an economic structure. The materials are compacted

(Concluded on Page 116)

* Editorial in the August Journal of Engineering Institute of Canada



A "CALIFORNIA STUCCO" HOME, LOS ANGELES

The Right Way To Do a Good Stucco Job

By O. A. MALONE*

IN order to obtain a good job of stucco, consideration must be given to the structural features of the building to which it is applied. It is not our purpose to go into a detailed description of the items that should and must be considered, as this hardly belongs in a brief of this character. By way of suggestion, though, we would call attention to the fact that care must be taken to see that no rain or other water can possibly get behind the stucco, through cracks around window or door openings; that sufficient overhang must be given the roof to protect the upper edge of the stucco. Thus the first responsibility for good stucco rests upon the shoulders of the designer of the house. The second responsibility rests upon the plasterer, since, no matter what materials are used, it will be impossible to obtain satisfactory stucco unless the utmost care is used in its application. It has been said, and no doubt with truth, that proper workmanship is over fifty per cent. of good stucco. The third responsibility rests upon the material used and the method of application, which we propose to describe.

A frame building should be thoroughly covered with a good roofing felt, start-

ing at the bottom and lapping at least two inches as you go to the top. On this should be applied a metal reinforcement (any good open-mesh metal lath or chicken wire), which should be furred out at least three-eighths of an inch from the roofing felt, and in every instance all joints should be well lapped and tied together, thus creating a continuous reinforcement over the whole surface to be plastered. Then a mortar composed of one part of cement, to which has been added ten per cent of hydrated lime and three parts of clean, sharp sand, should be shoved thoroughly through the reinforcement, so as to form solidly against the roofing felt. Scratch this coat and let dry two weeks, if possible. Then a second coat of the same mortar as specified for the first coat should be put on to a thickness of at least one-half inch over the face of the first coat. If the weather is dry and hot, this coat should be wet down for at least three days, then allowed to become dry before finishing coat is applied.

We now have at least one inch of mortar from face of roofing felt, with reinforcement in center of the slab where it should be. Nothing can destroy a wall built in this manner without first destroying the frame upon which it is constructed.

*Inventor and manufacturer of "California Stucco," Atlas Mortar Company, San Francisco, Sales Agents for Northern California



A LOS ANGELES HOME WITH "CALIFORNIA STUCCO" EXTERIOR

We have been manufacturing California Stucco since 1915, and after closely observing it over that period of time, and seeing it used on all the prominent plastered buildings in California and elsewhere, we believe that it is the best possible finishing coat to apply. It comes in practically any color, and any texture may be made from it, thus eliminating the extra cost of painting, which at best is not permanent. We would warn you that, like all other good proven products, California Stucco is being imitated.

We want to say to those that might object to the slight variation in color ob-

tained in the use of colored stuccos, that the most prominent and greatest artists and architects will not tolerate a one-tone wall, because it lacks interest and the substantial appearance of a wall that must be exposed to the elements.

The so-called waterproofing need not be given any worry, for a wall constructed as described above is mechanically waterproofed, the only way that it can be permanently and successfully done.

Plastering on masonry is not, in our estimation, nearly so important as the

plastering on a frame building, inasmuch as a masonry wall forms a nearly perfect base to plaster on.

It should be stated in conclusion that the above description of a good plastering job is in full accordance with the findings of the Bureau of Standards' investigation on good stucco.

Announcement to Architects

Mr. John J. Donovan, Oakland architect, school building specialist, and author of "School Architecture," announces that Dr. Frank W. Hart, Associate Professor of Educational Administration, and Mr. L. H. Peterson, Associate in Educational Administration of the Department of Education, University of California, are now associated with him for the purpose of providing an enlarged and improved consulting service to School Boards and Architects by closely combining the architect's training and experience with the professional school administrator's knowledge of the modern educational demands upon the school plant.

The enlarged service contemplates preparation of building surveys and school-housing programs in connection with school planning for communities confronted with the problem of increasing their building facilities.

BOOK REVIEWS

Edited by

AUGUST G. HEADMAN, Architect

NORTHERN ITALIAN DETAILS. Drawings and photographs by Walter G. Thomas and John T. Fallon, with an introduction by John Mead Howells. New York: U. P. C. Book Company, Inc., 1922. xxiv, 143 pl., 9 x 12, twenty-four text pages. \$7.50.

It is generally conceded by architects that the better known examples of Italian architecture—in spite of their great charm—have served as "inspiration" to designers until the demand for something less trite is unmistakable.

To fulfill this demand, Messrs. Walter G. Thomas and John T. Fallon, architectural draughtsmen and designers of unquestioned ability, were commissioned to visit Northern Italy to collect material lying off the beaten path; in other words, to secure as large a number as possible of comparatively small and unfamiliar, though none the less meritorious, examples of the work that has made Italy the Mecca of architects for centuries.

The result of their labors is a portfolio of 143 plates representing in the main "architectural bits" such as doorways, windows, stairways, paneling, grills, gates, fountains, knockers, lamps, etc., etc.

Each subject is presented by means of photographs, measured and figured drawings and descriptive text.

ON BEING AN ARCHITECT

Vocashunal Suggestions

By FANATIC FRANCIS

General Fireproofing Co., Youngstown, Ohio

MIRANDY has been a naggin' me considerable a tellin me I should go out and get a regular job with pay attached insted of a settin round the house and i tole her that the biggest successes in the world has been made by them that think, and that while i am a settin there in the cheer mebbly my mind is far away in the gold fields of Alaska or summers else a figgerin on oppertoonities and all she said was that my mind was a blame quick jump home when it was time to eat.

Ive been considerin howsomever and a lookin for a ideal perfeshun to which i can devote my time and at last i struck it. There is nothin so easy or so simple as bein an archyteect. archyteects don't do no work. I been in their offices and i know. You allus see a few young fellers a settin at desks mebbe drawin out diagrams but the archyteet himself if he ain't out to the ball game is a setting down with a fat seegar in his mouth a dictatin to a good lookin stenogerfer and tellin his clients noomerous reasons why their bildins ain't bein completed on time.

If a man wants him a house bilt he knows what kind of a house he wants already and if he don't know his wife does or her relatives will help in desidin. Then he comes to the archyteet and tells him what he wants and the archyteet says verry well and telerfones the kontrakter and tells him to go ahead and bild the house.

I sent to a corispondence school for a course in bein an archyteet and i found it was verry simple. You just learn a standard set of specifications for contractors and get you a book with a lot of houses pictered in it. Then when your customer comes he picks out the kind of a house he wants built, and his wife tells you where she wants the bath room and the closets, and the kitchen sink, which you write down on a piece of paper and then lose it. Then you collect most of the money, go to your contractor and give him some of it and tell him to go ahead, and send all bills to your office ninety days after the work is done. After you turn the plan over to the kontrakter you can go a fishin. All the troubles are his'n not yours.

Them standard specefications was the easist thing i ever saw to learn and i have got them down pat and can rite them out just as easy as anything for a kontrakter.

When i get a job i expcet to look the contractor in the eye and say here are your specefifications, and then i rite this out for him: "INTERPRETATION: The plans and specefereations are to be taken

Confidence and Assurance in Specifying "Stanley"—

For more than three-quarters of a century the Stanley Works has devoted its abilities, energies and vast resources to the manufacturing of products that would meet the highest appreciation of artisan and craftsman.

How well it has succeeded is best exemplified by the unqualified confidence that is everywhere accorded "Stanley Products"—not alone the confidence of the architect, but equal acceptance on the part of consumers into whose structures Stanley Wrought Hardware has so largely entered.

It is, therefore, with no little confidence and assurance that "Stanley Products" are so unhesitatingly specified by the Architectural Profession.

THE STANLEY WORKS



NEW YORK

NEW BRITAIN, CONN.

CHICAGO

San Francisco, Monadnock Bldg.
 Los Angeles, 703 Washington Bldg.
 Seattle, 501 Maynard Bldg.

STANLEY

together. Anything shown on the plans and not mentioned in the specifications and anything mentioned in the specifications and not shown on the plans, is to be considered as both shown and specified, anything wanted by the architect or any of his friends or by anybody else (except the contractor) shall be considered as shown, specified, implied, and required, and shall be provided by the contractor without no expense to nobody but himself.

"If the work has been done without expense to the contractor, the work shall be taken down and done over again until the expense is satisfactory to the architect.

"Anything that is right on the plans is to be considered right; anything that is wrong on the plans shall be discovered by the contractor and shall be made right without a tellin the architect or indicating it in the bills.

"Anything that is forgotten or left out of the plans and specifications, but which is necessary for the convenience of the owner, shall be provided without extra cost to anybody but the contractor.

"The architect reserves the right to change his mind about that which is best.

"Any evidence of satisfaction on the part of the contractor shall be considered as just cause for withholdin' final payment."

Now that shows you what a feller can do when he sets his mind to learn something. Mebbe them specifications ain't just exactly in the precise language as they was written out in the lesson, but they are close enough for practical use, and any contractor can understand them, or not, they generally do as they please anyway.

"SOME ENGINEER—THIS ESKIMO

(Concluded from Page 111)

snow or ice—nothing else. The structure is large enough to house a dozen people comfortably. It can be erected in an hour by three men. Its dome shape makes it not merely self-supporting, but capable of carrying all the snow that may heap upon it. A hurricane will not blow it over. Its walls are comparatively poor conductors of heat, so that the heat from a few pounds of seal blubber serves to maintain a comfortable temperature all night, although the outside air may be 40 degrees below zero.

"Some" structural engineer was the man who designed the first igloo.

Cold Storage Plant

The Arizona Ice & Cold Storage Company will build a \$125,000 ice and cold storage plant at Tucson, Arizona. About \$175,000 will be expended for equipment.



Cut-out and Lowering Device for Electric Light Fixtures

A cut-out and lowering device by means of which cleaning and re-lamping of electric light fixtures can be done in absolute safety is being manufactured by the Westinghouse Electric and Manufacturing Company.

The device, which is called a pulley-socket, is so arranged that a pull on a rope disconnects the electrical parts and the entire fixture comes down dead from the ceiling. The disconnection can be made without first switching off the circuit, for within the pulley-socket wiping contacts are provided of sufficient capacity to make and break the current of a 1000-watt lamp. A second pull resets the fixture in place. An angle reflector can be used, for the device is so designed that the reflector will always come back into its true position and lock into place.

All the parts of this pulley-socket are built in liberal dimensions and are totally enclosed in a cast iron housing, which is galvanized and then painted. The socket is provided with a double lamp-grip, under which the lamp is held so that it can not loosen from vibration.

Some of the advantages of the use of this pulley-socket are that it saves time in cleaning, eliminates the dangerous use of ladders, makes possible a more thorough cleaning of fixtures with less effort, and eliminates the danger of short-circuits and accidental contact with live parts.



Ornamental Iron

Steel Sash
Wire Work

Michel & Pfeffer
Iron Works
HARRISON AND TENTH STREETS
SAN FRANCISCO CALIF.

KENNEDY Radiator Valves

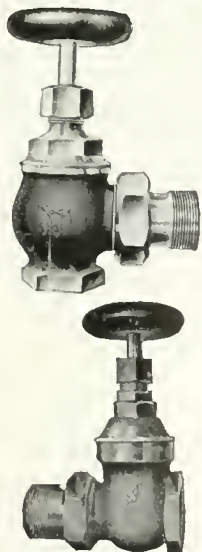

Unfailing reliability of service, reasonable prices and the guarantee of satisfaction that a long established company is able to furnish, make Kennedy Radiator Valves the best buy for steam and hot water service on the market.

We can honestly recommend them for use anywhere, and invite a close scrutiny of those points of design and construction that sets them apart as decidedly superior. They come in every desirable type—straightaway, angle, offset, corner, etc.

Other Kennedy Valves for handling water, steam, oil, acids, gas, alkalis, etc., in more than 500 different distinct types and sizes are at your service. Our catalogue illustrates and lists them all. Send for a copy. 74



**THE KENNEDY VALVE
MFG. CO., ELMIRA, N.Y.**



Branches and Supply Depots:
BOSTON, 17 India Street
NEW YORK, 95 John Street
SAN FRANCISCO, 23-25 Minna Street
CHICAGO, 204-8 N. Jefferson Street
Sales Offices:
Philadelphia, Salt Lake City, Seattle, El Paso

When writing to Advertisers please mention this magazine.

The Pay of County Engineers

Commenting on underpaid engineers and surveyors the Improvement Bulletin says:

"There is not infrequently a rather sad disproportion between the salary paid to county or municipal engineers and the responsibility placed upon their shoulders. There has come to the attention of The Bulletin a number of instances recently in which engineers have resigned from public service because the office did not afford them a satisfactory cash return for the work and the responsibility. An engineer must not only be possessed of professional training and experience, but in addition, if he is to render the highest degree of service, he must be a good business man, experienced in obtaining full value for money expended, and he must be a man possessed of good judgment, able to act quickly and decisively in emergencies.

"Engineers who have recently found it impossible to continue in public service because doing so would entail a financial sacrifice that they felt they could no longer afford, have in a good many instances entered upon private practice of their profession. Others have embarked in other fields of industry. Quite frequently in the last year or two county boards and city councils seeking places in which salaries might be reduced in response to a popular demand, have cut the salaries of engineers. Very often the salaries thus reduced were fixed at a time when the burden of work and responsibility in the engineer's office was not nearly so great.

"Before making such a reduction it would be well for the taxpayers to be sure that they will not lose many times the amount of the salary involved by losing the services of a man who is thoroughly familiar with the public works program, and is able to carry it out efficiently and economically, where as another man would be confronted with difficulties. In one instance, reported recently, the engineer had made plans for a public works program to cost nearly half a million dollars. In line with a policy of retrenchment his salary was reduced. Shortly thereafter he received from a private firm an offer of the original salary to enter their employ. Confronted with the alternative of employing another engineer who was not familiar with the public works program, and had not followed the development of the plans from step to step, the officials wisely determined to restore the original salary and thereby retain the services of the engineer."



HIBERNIA BANK & TRUST CO.
Favrot & Livaudis A. C. Bossom
Architects Associate Architect

Hibernia Bank & Trust Co.

New Orleans, La.
Equipped with

Frink Reflectors

including

Continuous Bank Screen Reflectors
Single and Double Desk Reflectors
Polaralite Signs

Our Engineering Department is co-operating with the leading architects in laying out and designing the lighting of prominent buildings throughout the country. We hope we can be of service to you.

"Specify Frink Reflectors"

I. P. FRINK, Inc.

SAN FRANCISCO, CAL.,
77 O'Farrell Street
24th Street and 10th Avenue,
New York

Chicago, Ill.	Seattle, Wash.
Monadnock Bldg.	609 Seaboard Bldg.
Boston, Mass.	Philadelphia, Pa.
161 Summer St.	Franklin Trust Bldg.
Detroit, Mich.	Cincinnati, Ohio
325 State St.	17 Greenwood Bldg.
Cleveland, Ohio	Louisville, Ky.
336 The Arcade	415 West Main St.

CANADA

Associated with Robert Mitchell Co. Ltd.
64 Belair Avenue, Montreal



Garrick Theatre (formerly Schiller Theatre) Building, Chicago, Illinois. Adler & Sullivan, Architects. Gray unglazed Terra Cotta throughout. Erected 1891. Photograph taken 1922.

A TEST of 31 YEARS

ERECTED in 1891 this building attests the enduring qualities of Terra Cotta under conditions of climatic exposure affording the severest trial. Proper detailing of Terra Cotta and its intelligent relation to other materials will always assure this result.

Note, also, how the size of the individual units of the Terra Cotta is in scale with the general proportions of the building.

Seventy typical plates showing correct detailing for Terra Cotta will be sent on request. Address **National Terra Cotta Society**, 19 West 44th Street, New York, N. Y.

TERRA COTTA

Permanent

Beautiful

Profitable

Builders to Meet in Los Angeles

The national convention of the Associated General Contractors of America will be held in Los Angeles January 30th to February 2nd, 1923, inclusive. It is estimated that about 400 delegates will attend the convention. About 6000 invitations will be sent out from national headquarters to contractors in all parts of the country, not members of the association, to attend the convention.

The program committee hopes to secure Mr. Charles M. Shwab, Judge Gary and former Secretary McAdoo as speakers at the convention. A departure will be made in substituting a program of entertainment for speaking at the annual banquet. Mr. D. A. Garber will be the master of ceremonies. The retiring president, Mr. Arthur S. Bent, will introduce the new president, Mr. W. E. Wood, of Detroit, who will make a response. A trip to Catalina Island and a visit to Los Angeles harbor and Ft. MacArthur, are scheduled. Instead of the customary smoker, there will be a Bohemian night, to include sparring, fencing and broadsword matches, and Mr. Baker will give an exhibition with his famous boxing kangaroo. Theater parties for the ladies at the California and at Grauman's have been promised, and one day will be spent by the ladies at Hollywood, where they will be the guests of the Hollywood Women's Club.

Industrial Booklet

An interesting booklet has just been printed by the H. H. Robertson Company, featuring the Robertson process asbestos protected metal for industrial building construction. This booklet contains much useful data for the architect and engineer who is designing industrial buildings. Copies may be procured from the San Francisco office, 1007 Hobart building.

The Robertson Company announce a price increase of a dollar a square on Robertson Process Asbestos Protected Metal, to become effective January 3rd, 1923.

To Revise Hospital Plans

Bids taken for the construction of the new Mercy Hospital at Merced have been rejected and revised plans are being made by Architect Ira W. Hoover, of Planada. The first unit of this building is to cost \$40,000.

New York Architects Re-register

All architects practicing in New York State are subject to fine if they neglect to re-register before January first.



The finishing touch to a **PERFECT BATHROOM**

BUILT-IN china bathroom accessories not only add greatly to the convenience of a modern bathroom but provide a distinctive note of refinement.

Fairfacts Fixtures are found in many of the finest residences, hospitals, apartment buildings, and hotels in America.

Write for descriptive booklet.

Architects' Service **Department**

WE ARE glad to co-operate with architects in furnishing construction details as well as in suggesting the most convenient arrangement of built-in bathroom accessories.

Fairfacts Accessories are installed by tile contractors and should be included in the tile contract. We do not sell to the plumbing trade.

THE FAIRFACTS COMPANY
Inc.

Manufacturers

234 West 14th St., New York City

Fairfacts
Fixtures

BUILT IN YOUR BATHROOM WALLS

\$1550 in Prizes
for
Best Designs in Face Brickwork
for the Garden

PRIZES

Premiated design will receive	\$500.00
Design placed second will receive	300.00
Design placed third will receive	150.00
Design placed fourth will receive	100.00
The next ten designs will each receive	50.00

*Competition closes at noon,
Monday, February 5, 1923*

For complete program see the November,
December or January issue of Pencil Points, or write
to the American Face Brick Association

AMERICAN FACE BRICK ASSOCIATION

1759 PEOPLES LIFE BUILDING · CHICAGO, ILLINOIS

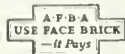

Hot Water Heater Being Manufactured in Northern California

The Wizard is the name of an automatic hot-water heater now being manufactured in San Francisco, and which is meeting with considerable success, being the only heater of its kind on the market at the present time. It is manufactured under new patents, covering important features by which hot water is obtained more quickly and for less money than other heaters of similar size and construction. The heater has been thoroughly tried out for the past two years. According to its manufacturers, it will deliver real hot water, and plenty of it, at the turn of the faucet. The minimum volume is two gallons per minute. The heater can be installed in space less than twelve inches. It is controlled by an automatic valve. No thermostat is used. The mechanical acting parts of the Wizard are so few and simple that any one can readily understand them and may be regulated to work perfectly under all conditions of water or gas pressure by simply turning a thumb screw. There are no mechanical parts to get out of order.

It is claimed that for one half-cent the Wizard will furnish sufficient hot water for a bath, basing the cost of gas at \$1.00 per 1000 cubic feet. The use of a Wizard water heater is recommended, not only for the home, but for hotels, bathhouses, sanitariums, restaurants, etc. The heater is only twelve inches wide and thirty-two inches high.

The following are a few features of the Wizard automatic water heater, as described in the company's latest folder:

Heater is easily cleaned, insuring longer life if kept clean.

Nothing to get out of order.

Method of circulation requires one-third the coil capacity, therefore less than one-third the cost for wear and tear.

Utilizing the heat of the pilot and "left-over" hot water in coils (after drawing), thereby eliminating condensation.

Copper coils last from 12 to 20 years. May be replaced for 80 per cent less cost in 50 per cent less time.

Hot water instantly and continuously.

Temperature of water is held at about 90 degrees, therefore, no loss in radiation and no condensation.

The automatic gas and water control is simplicity itself—nothing to wear out or get out of order.

The "WIZARD" parts are not complicated mechanical devices, and all parts are accessible and standardized.

Hot water day or night. Draw the water for cooking from the hot water faucet—your work half done at the start—and thus save half of the gas wasted in using the gas stove.

The offices of the Wizard distributors are at 833 Market Street, San Francisco.

Burlingame Residence

Architect Chas. E. J. Rogers, Phelan building, San Francisco, has completed plans for a \$15,000 home for Mr. B. F. Hoffacker, at Burlingame.

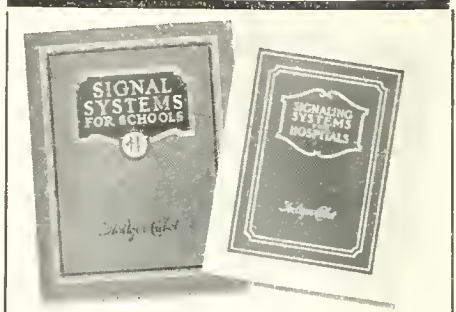

Two brochures published in the interests of Architects and Engineers.

Holtzer-Cabot

Signaling and Protective Systems

For Hospitals, Industrial Buildings, Hotels, Schools, Factories. Etc.

The Holtzer-Cabot reputation of forty years' successful manufacture of electrical equipment is a very real protection.

The leading Architects and Engineers of the country have always recognized this 100 per cent efficiency.

Holtzer-Cabot installations are remarkable for many original features which are absolutely exclusive.

Simplicity, accessibility and low cost of maintenance are reasons why Holtzer-Cabot systems are a valuable investment.

In specifying Holtzer-Cabot products you are specifying service over an indefinitely prolonged period—a period where upkeep is reduced to a minimum and where service is increased to a maximum.

Architects and engineers are invited to write for the brochures illustrated above which give detailed information of the types of signal systems we make.

The Holtzer-Cabot Electric Co.

Electric Signaling Systems

Home Office and Factory:

125 Amory Street

BOSTON, MASS.

BRANCH OFFICES

Chicago, Ill.: 6161-65 So. State St.

New York, N. Y.: 101 Park Ave.

Philadelphia, Pa.: 807 Otis Bldg.

Detroit, Mich.: 1051 Book Bldg.

Cleveland, Ohio: 517 Union Building

Baltimore, Md.: 1104 Union Trust Bldg.

San Francisco, Cal.: 408 Claus Spreckles

Minneapolis, Minn.: 627 Metropolitan

San Francisco, Cal.: 408 Claus Spreckles Bldg.

Minneapolis, Minn.: 627 Metropolitan

Life Bldg.

100% Sanitation — 60% New Economy

For Finished Construction

use the pedestal model

AIRDRY

Registered U S Patent Office.

“The Electric Towel”

The recessed wall model AIRDRY (not pictured) is recommended and widely used for new construction. But for finished jobs, where the same desire for Airdry comfort, cleanliness and economy prevails, we have created the pictured pedestal. This model is stocked here, ready for immediate installation anywhere.



Some noted users are:

*Boston School Dept.
Palo Alto High School
Martinez High School
University of Calif.
Harvard University
Buffalo Public Schools
Chicago Public Schools
Chicago Auditorium
Comfort Stations, Seattle
Merchants' Exchange Bldg.*

*Bank of Italy
Central Savings Bank
Crocker National Bank
Puget Sound Savings
City of Portland
Goodyear Tire Co.
National Cash Register Co.
Crocker Estate Co.
Roos Bros.
City of Paris*

Comparisons of cost, savings and result upon request

AIRDRY CO. of CALIFORNIA

Pacific Coast Distributors

155 Montgomery St., San Francisco

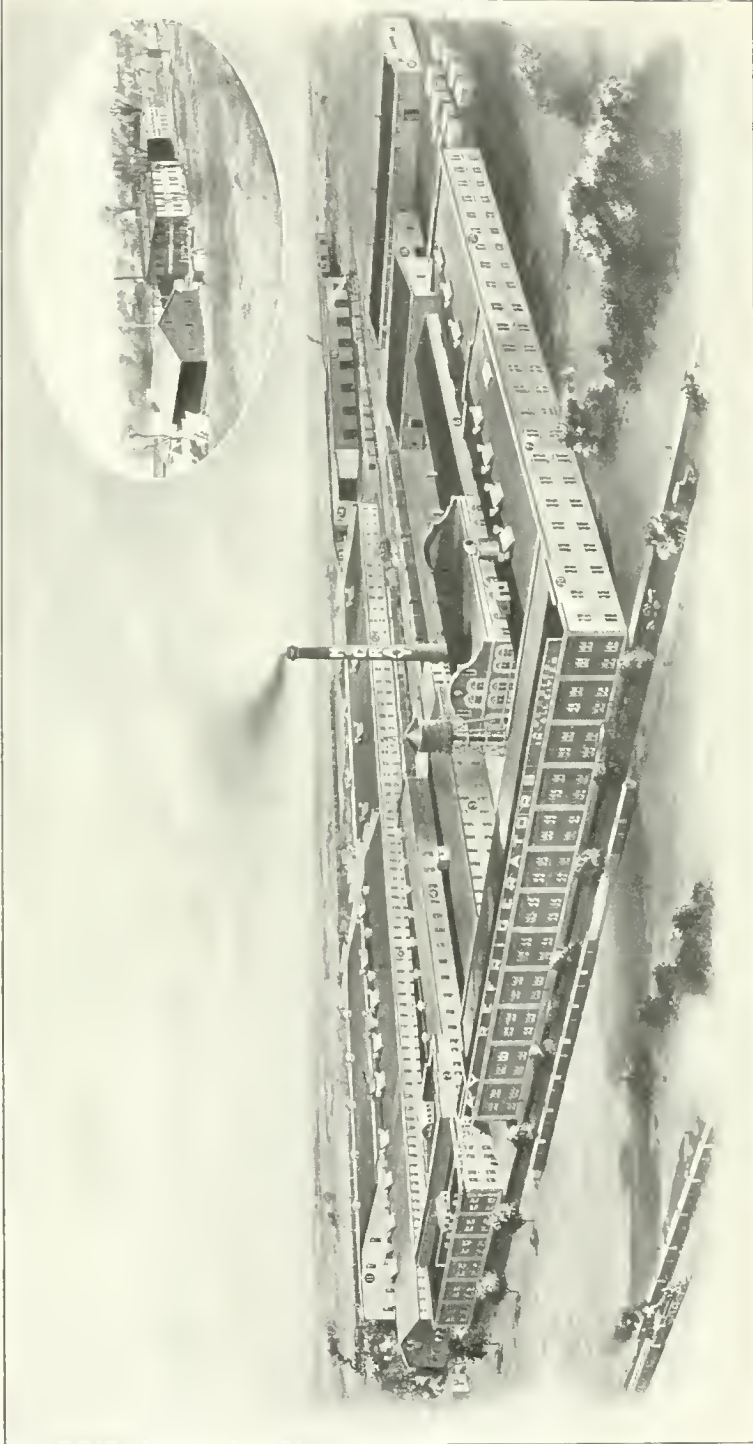

PLANT OF THE McCRAY REFRIGERATOR COMPANY, KENDALLVILLE, IND.
Picture in the oval on the right shows original plant in 1892

Growth of the McCray Refrigerator Company

An industry which has enjoyed exceptional growth in recent years is the McCray Refrigerator Company, of Kendallville, Indiana. Visible evidence of this is found in the views of the plant, one taken in 1892 and the other photographed in 1922, and shown on the opposite page by courtesy of the McCray News, the official house organ of the company.

It is gratifying to note that the Pacific Coast sales of the McCray Company have kept pace with the business in other parts of the country. In California no small credit is due Mr. A. J. Moore, the San Francisco manager, whose energy and enthusiasm have undoubtedly contributed very substantially to the splendid results reported in this territory. The following is a list of some of the recent purchasers of McCray refrigerators in California:

HOSPITALS

St. Elizabeth Hospital, San Francisco.
San Mateo Co. Hospital, San Mateo.
Santa Clara Co. Hospital, San Jose.
Alameda Co. Hospital, San Leandro.
Arroyo Sanatorium, Livermore.
City & County of S. F. Relief Home, San Francisco.

CAFES, GRILLS, MARKETS

Goldman's Restaurant, Merced.
Nick's Cafe, Fresno.
Milligan's Cafe, San Francisco.
Cottonwood Meat Market, Cottonwood.
Hansard Grill, Merced.
Square Deal Restaurant, Reno, Nevada.
Mayflower Lunch, Fresno.
Annex Lunch, Sacramento.
Rosemont Grill, Sacramento.
Moose Cafe, Sacramento.
San Jose Coffee Club, San Jose.
California Restaurant, Santa Cruz.
Jones' Grill, Inc., Modesto, Stockton, Fresno.
Moore & Worth, San Francisco.
Ideal Market (special freezer case), Alameda.
Henry C. Peterson (special freezer case), Oakland.
Nestor Grill, Oakland.
Sutter Market, San Francisco.
J. H. Walter (meat market equipment), Lodi.
Gardner Bros., Alameda.
Nugget (P. J. Cadra, prop.), San Francisco.
14th Street Market, Inc., Oakland.
"Dunhams," San Francisco.

CLUBS

Tulare County Golf & Country Club.
Nate Head (asst. manager Del Monte Hotel), Del Monte.
Mt. Diablo Country Club, Mt. Diablo.
Hotel Lyndon, Los Gatos.
College Shop, Mills College, Oakland.

RESIDENCES

Herbert Edward Law, San Francisco.
Mrs. L. E. Dean, San Francisco
J. E. Bien, Alta Mesa.
Byron S. Rosenblatt, San Francisco.
J. C. Piver, Sausalito.
C. P. Richards, Modesto.
W. S. Martin, Burlingame.
Dr. Robbins, San Francisco.
Mrs. A. A. Moore, Jr., San Francisco.
J. Frank Barrett, San Francisco.
Paul T. Carroll, San Francisco.
Mrs. C. F. Dillman, Sacramento.
E. Reinhart, Elko, Nevada.
Wm. T. Sessnon, San Francisco.
Dr. J. N. Blood, Exeter.
F. H. Young, Ross.
Geo. H. Roos, San Francisco.
J. S. Sublet, Los Altos.

W. D. Duffin, Burlingame.
Rudolph Spreeckles, Burlingame.
Quinto Ranch, Gustine.
Lloyd Conover, San Jose.
C. K. McIntosh, Woodside.
Charles A. Arata, San Francisco.
Mrs. Emma Jane Timms, Dixon.
Bruce C. Kennedy, San Mateo.
W. S. Greenfield, San Francisco.
S. H. Zimmermann, Lodi.
J. C. Grew, San Anselmo.
E. A. Green, Milbrae.
Rev. Father Long, Santa Rosa.
Tayler & Spotswood, San Francisco
Robert Dollar Co., Shanghai, China
Samuel Lightner Hyman, San Francisco
Gouverneur Morris (short-story writer), Monterey

Hardwood Industries Merge

On November 1st the plant, lumber, flooring, goodwill and other assets of the Nashville Hardwood Flooring Co. were sold and transferred by the John B. Ransom Company, of Nashville, Tennessee, to a new corporation, recently organized. The new company will be known as the Nashville Hardwood Flooring Company, and has an authorized capitalization of \$1,000,000, \$250,000 of which is preferred and \$750,000 common.

The ownership of the new company is vested in the Ransom interests of Nashville and the E. L. Bruce Company of Memphis, Tennessee. The change of ownership will not affect the organization and the management of the Nashville Hardwood Flooring Company.

The combined capacity of the Nashville Hardwood Flooring Company, with the two plants of the E. L. Bruce Company located at Memphis, Tennessee and Little Rock, Arkansas, will be over 100,000,000 feet annually. The E. L. Bruce Company is capitalized for \$2,750,000, and has been in business approximately twelve years. Both of their plants are modern, the one at Memphis occupying a tract of twenty acres, and that at Little Rock, with their band saw mill and storage yards, covers fifty-two acres.

The Nashville Hardwood Flooring Company, heretofore operated as a department of the John B. Ransom Company, has been in business eighteen years. Their plant is located in West Nashville, and covers eleven acres of ground. The Nashville brand is known as "Acorn," and bears an enviable reputation over the United States. The Strable Hardwood Company of Oakland are distributors of the "Acorn" brand in Northern and Central California.

Will Design Elks Building.

Architects Frederick H. Meyer and Albin Johnson, of San Francisco, have been commissioned to prepare plans for an eight or ten-story Class A lodge and office building for the San Francisco Lodge of Elks on Post street, opposite the St. Francis Hotel. The structure will involve an expenditure of \$500,000 or more.



Make the home beautiful fireproof

Do you know it is possible to build a house, be it ever so humble, of reinforced concrete for practically the same cost as wood?

Thermo-Wall Construction

will do it, will provide a building that is cold-proof, heat-proof, damp-proof, and fire-proof—walls are concrete with dead air space between.

Thermo-Wall Construction means

permanent buildings with minimum repair bills. Exterior finished in any color desired.

R. O. McCline

REPRESENTATIVE AND BUILDER

1315 Fruitvale Ave., Oakland

Phone Fruitvale 1804

Homes being built
now in Oakland.
Investigate.

