

UC-NRLF



QB 80 178



**LEAVENING AGENTS.**

Published by

# **The Chemical Publishing Co.**

**Easton, Penna.**

Publishers of Scientific Books

Engineering Chemistry

Portland Cement

Agricultural Chemistry

Qualitative Analysis

Household Chemistry

Chemists' Pocket Manual

Metallurgy, Etc.

# LEAVENING AGENTS

Yeast, Leaven, Salt-Rising Fermentation,  
Baking Powder, Aerated Bread,  
Milk Powder

BY

RICHARD N. HART, B. S.

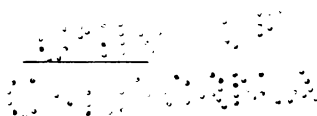

EASTON, PA.:  
THE CHEMICAL PUBLISHING CO.  
1914.

LONDON, ENGLAND:  
WILLIAMS & NORGATE  
14 HENRIETTA STREET, COVENT GARDEN, W. C.

TP460  
H3

**COPYRIGHT, 1914, BY EDWARD HART**

THE  
PUBLISHERS  
OF  
THE  
PUBLISHED



## PREFACE

---

This volume fills a gap in the literature of baking in this country. The baker knows a good deal about his flours and also how they are made, but he knows very little about his yeast and less still about his baking powder. He has been well supplied with literature on the technology and chemistry of flour, but much of the data on his aerating agents has either been aimed over his head or else has been purposely misleading.

**Aerated bread** has been added because of its historical value and because of its possible future. *Dry Milk* is another recent important addition to baking materials.

**Yeast**, which is necessarily a technical subject, has been treated in as condensed and simple a manner as possible. The author acknowledges his indebtedness to an anonymous friend for the section on the manufacture of yeast. This is the first exact and detailed description of yeast manufacture in English, and is an important addition to the literature of chemical technology.

**Baking powder** is a subject on which the bakers and the public have been misinformed. The water has been so badly stirred up by the "baking powder controversy," that the non-technical man has been unable to see beyond the words "alum" and "cream of tartar." This section has been written without personal bias and the facts have been verified.

The author also wishes to express his thanks for the data and valuable criticisms given him by Dr. Edward Hart, the librarians of the John Crerar Library of Chicago, Meek-Barnes Baking Co., of Los Angeles, Lewis C. Merrell and Charles Trefzger, and to acknowledge the assistance of his friends.

R. N. HART.

Peoria, Ill., Aug. 1914.

## CONTENTS

---

	PAGE
YEAST .....	I
Fermentation and Its Cause .....	I
Life and Characteristics of Yeast.....	3
Activities of Yeast—Breathing, Nutrition, Fermentation.....	8
Selection—Hansen's Pure Culture.....	15
Keeping of Yeast .....	16
Tests for Yeast.....	20
Manufacture of Compressed Yeast.....	21
Old Vienna Process—Materials, Disturbances in Fermentation.....	25
Aeration Process—Materials, Disturbances in Fermentation.....	33
Yeast in Bread.....	36
Leaven and Homemade Yeasts.....	43
SALT-RISING FERMENTATION .....	47
BAKING POWDERS .....	51
General .....	51
The Alkali .....	53
The Acid—Cream of Tarter, Phosphate, Aluminum Salts .....	54
Starch.....	58
General .....	58
Kind of Flour.....	60
Care of Baking Powders.....	60
Miscellaneous Substitutes .....	61
Residues in the Bread .....	62
Manufacture.....	63
Analysis.....	64
General .....	67
AERATED BREAD .....	69
MILK POWDER .....	75



## YEAST

---

The study of yeast falls under three heads: (1) Briefly, the discovery of the source and nature of alcoholic fermentation, and a growing knowledge of what yeast is;<sup>1</sup> (2) the characteristics of the yeast plant; (3) yeast manufacture and use. To this is added (4) the action of yeast in bread and (5) Leaven and homemade yeasts.

### FERMENTATION AND ITS CAUSE

Fermentation has always been an interesting and puzzling subject to the physical scientist. The alchemists of old hoped to bring about a fermentation of the base metals to produce gold and silver; the "philosopher's stone" would induce this fermentation. Yeast, of course, is as old as fermentation. But fermentation, until 100 years ago, was thought to be a chemical reaction. For instance, Basil Valentine, a German Monk of the fifteenth century, held with others that it was a purification of the *must*, by which the true nature of the alcohol appeared, and the excrement or baser substances settled as *lees*. When yeast was added to wort "an internal inflammation is communicated to the liquid, so that it raised itself, and thus the segregation and separation of the feculant from the clear, takes place."

Leeuwenhoek opened the book of yeast in 1680, when he discovered the beer yeast globules, by means of his improved microscope; but it did not occur to him that the cells were alive. de Latour, Schwann and Kuetzing turned the first page, with the discovery of a vegetable mass of cells that reproduced by budding. In 1838 Meyer created the yeast genus *Saccha-*

<sup>1</sup> For an excellent treatise on "Fermentation" see *Encyclopedia Britannica*, 1911; Vol. X, p. 275: also "American Handy Book of Brewing, Malting and Auxiliary Trades," Wahl and Henius, Chicago, 1908.

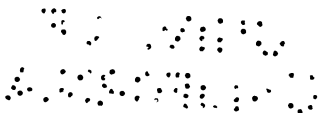

*romyces* of the fungi; because it was now known that yeast breathed oxygen and excreted fermentation products, without secreting chlorophyll (leaf green). In 1870 Dr. Max Rees narrowed the term yeast to those cells which broke up sugar into alcohol, excluding all other bacteria and fungi which produced fermentation.

Taken in detail the history of fermentation research is seen to include the names of the most illustrious chemists since the foundation of chemistry. Liebig, whose deductions were of less importance than the controversy he started, threw the immense weight of his influence in favor of the hypothesis that fermentation was a chemical reaction. He entered this field of research about 1838 and was not successfully challenged until Pasteur published his "Étude sur la Bière" in 1876. Pasteur's work compelled Liebig to modify his own views somewhat. In later years Pasteur's work has been amplified and amended by Traube, Buchner and A. J. Brown.

The present knowledge of yeast and fermentation has come by way of the following theories: (1) *Physical*. Naegeli surmised that the yeast cell transferred its physical activity to the medium within a radius equal to three to six diameters; (2) *Chemical*. Liebig rationalized the ideas of the alchemists coming through Stahl a century before; he presumed yeast to be an unstable albuminoid which produced fermentation by chemical reaction; (3) *Physiological*. Pasteur controverted the first two theories by confirming the vegetable nature and action of yeast. His careful research gave valuable theoretical and practical results; (4) *Enzymic*. Traube, working along the same line, stated in 1858 that yeast secreted substances called enzymes, (see page 9), which had been found independent of yeast in 1833. In 1897 the fermenting enzyme, *zymase*, was separated

from yeast and named by Buchner, who thus confirmed the theory that alcoholic fermentation is the result of the action of an enzyme produced by the yeast cell.

### LIFE AND CHARACTERISTICS OF YEAST

Bread yeasts belong to the *fungi*, the lowest order of the sub-kingdom Cryptogamia or non-flowering plants, without leaves, stems, etc. Specifically, they are the "top yeasts" of the class *Saccharomyces*, order *cerevisiae*. *Top* yeasts, in distinction with *bottom* or lager beer yeasts, become most active at a higher temperature and rise to the top of the fermenting liquor, though they afterwards settle to the bottom of the cold wash water. They are identical with the distillers' yeast and the yeasts of the sweet English beers. *Top* and *bottom*, together with wine and "wild" yeasts, lactic acid and innumerable other bacteria, are found in the floating air dust, in the soil, on vegetation, and very thickly on the skin of ripening fruits.

Bread may be made with *bottom* or brewer's yeast. But its lower temperature of fermentation, its weaker action, its bitter taste and its tendency to darken the bread all tell against it; moreover it keeps poorly in the warm months.<sup>1</sup> For these reasons brewers' yeasts are not held to be bread yeasts in this country.

Yeast breathes oxygen and feeds on albuminoids, substances similar to egg albumen, which have been degraded to amids and peptones, and on organic and inorganic salts. It also ferments sugars into alcohol and carbon dioxid; other products of fermentation, though in almost negligible quantities, are glycerin, succinic acid and higher alcohols. It is believed, though not proven, that leavened bread owes its flavor to these latter organic

<sup>1</sup> "The Technology of Bread Making," Jago and Jago, London, 1911; p. 233.

substances. As it does not secrete chlorophyll, yeast needs no light at any stage in its life, nor is it sensibly affected by electric current, by great pressure (1,800 atmospheres), or by great cold ( $-130^{\circ}$  C., or  $-266^{\circ}$  F.).

Bread yeast has these characteristics: It starts to reproduce below  $10^{\circ}$  C. ( $50^{\circ}$  F.) and is most active in reproduction and fermentation at  $30^{\circ}$  C. ( $86^{\circ}$  F., Maercher and Pedersen), when



Fig. 1.—Healthy yeast cells in the process of budding.  
(Microscopic drawing by W. T. Foster.)

it raises the temperature of the medium to  $33^{\circ}$  C. ( $91^{\circ}$  F.). In a moist condition it will live only an hour at  $44^{\circ}$  C. ( $111^{\circ}$  F.); a moist heat of  $60^{\circ}$  C. ( $140^{\circ}$  F.) will kill it in five minutes. Just as all plants contain much water, so yeast normally carries 72 per cent. This may be reduced to 13 per cent. by slow drying without killing the cells, and with this amount of natural or body moisture they will withstand a heat of  $100^{\circ}$  C. ( $212^{\circ}$  F.), or

may be kept alive in starch, plaster of paris, etc., for years. In this condition yeast ceases to breathe or reproduce by sporulation (forming of spores), it remains dormant, and revives very slowly when it is again restored to normal conditions.

Yeast cells reproduce by budding in a nutrient solution (Fig. 1). Pasteur watched the yeast from the fresh juice

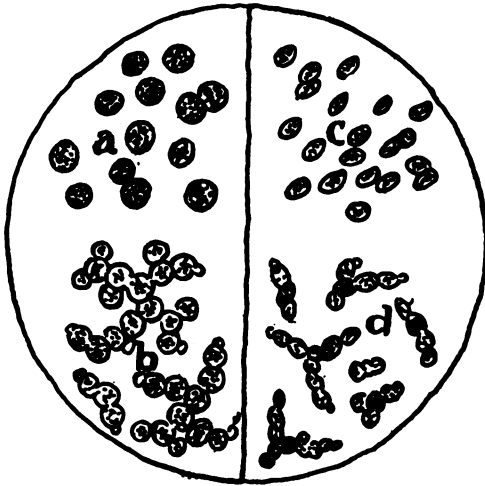

Fig. 2.—*Saccharomyces Cerevisiae* (from Jago, p. 157). *a*—Top yeast, at rest; *b*—Top yeast, actively budding; *c*—Bottom yeast, at rest; *d*—Bottom yeast, actively budding.

of grapes under the microscope:— “in the course of two hours two cellules had furnished eight, including the two mother cells.”<sup>1</sup> Yeast stops budding when it has brought the alcohol of the solution up to a 20 per cent. strength; and budding cells cease to bud when placed in a non-nutrient sugar solution, or when dry. In the latter case reproduction by buds gives place to a slow reproduction through spores unless the yeast is quite dry, as just mentioned.

Yeast will reproduce in nutrient solutions which contain a

<sup>1</sup> “Studies on Fermentation,” Louis Pasteur (Faulkner-Robb), London, 1879; p. 145.

high percentage of lactic acid (the acid of sour milk)—for instance, as much as 3 per cent.; but it is very sensitive to some other organic acids like acetic (the acid of vinegar) and butyric, and even more sensitive to inorganic acids. Since most of the micro-organisms which are detrimental to fermentation cannot resist a high percentage of lactic acid and yeast can, this property is made use of in the manufacture of yeast to get rid of undesirable organisms (see page 26).

Under the microscope the cell, one three-thousandth of an inch in diameter, is seen to be a transparent sphere or oval (Fig. 2). It consists of an outer membrane, a protoplasm or watery interior, and a nucleus or visible center. A *young cell* has thin, transparent walls, a transparent protoplasm, and a nucleus which may be invisible. *Mature cells* have somewhat thicker walls, and occasionally vacuoles or bubbles in the protoplasm; while walls, protoplasm and nucleus are developing granules. *Old cells* become shrunken, with thick walls, and granular structure throughout.

The cells when not well nourished begin to break up and become auto-fermentative, die and melt down, and finally decompose with an offensive odor.

As before stated, normal yeast contains about 72 per cent. water. The 28 per cent. dry matter gives the following proportions of organized substances:<sup>1</sup>

Cellulose .....		37
Protein {	Albumin .....	36
	Protein similar to <u>gluten-casein</u> .....	9
		45
Peptone .....		2
Fat .....		5
Ash .....		7
Extractive matters .....		4
		100

<sup>1</sup> Naegeli and Loewe, from "Manual of Alcoholic Fermentation," C. G. Matthews, London, 1901; p. 41.

AVERAGE ULTIMATE ANALYSIS OF THE ORGANIC CONSTITUENTS OF  
TOP YEAST.<sup>1</sup>

C.....	48.5
H <sub>2</sub> .....	6.8
N <sub>2</sub> .....	11.46
O <sub>2</sub> (+ S).....	30.80
	97.56

ANALYSIS OF YEAST ASH.<sup>2</sup>

Potassium phosphate .....	78.5
Magnesium phosphate .....	13.3
Calcium phosphate .....	6.8
Silica, alumina, etc.....	1.4
	100.00

Or,<sup>3</sup>

K <sub>2</sub> O .....	33.49
MgO .....	6.12
CaO .....	5.47
P <sub>2</sub> O <sub>5</sub> .....	50.60
SiO <sub>2</sub> .....	1.34
SO <sub>3</sub> .....	0.56
Fe <sub>2</sub> O <sub>3</sub> .....	0.50
	98.08

ANALYSES OF YEAST EXCRETIONS.

	Pasteur <sup>4</sup>	Blount & Bloxam <sup>5</sup>
		(100% cane sugar)
Alcohol .....	48.6	51.11
Carbon dioxide.....	46.6	49.42
Succinic acid .....	0.06	0.67
Glycerin .....	3.3	3.16
Cellulose.....	1.0	1.0
Fats, etc .....	0.0	0.0
	99.56	105.36

<sup>1</sup> "Handy Book for Brewers," H. C. Wright, London, 1907; p. 413.

<sup>2</sup> Matthews and Lott, from C. G. Matthews; p. 125.

<sup>3</sup> C. G. Matthews; p. 124.

<sup>4</sup> Wahl and Henius; p. 1070.

<sup>5</sup> "Chemistry for Engineers & Manufacturers," London, 1896; p. 201.

### ACTIVITIES OF YEAST

The activities of yeast are three: breathing oxygen; feeding, and fermentation. Just how closely related these processes are and what their bearing is upon reproduction, are not more clearly understood than is the phenomena of ordinary plant life; but the visible life and activities of the yeast cell are now well mapped out.

**Breathing.**—That yeast needs oxygen is shown: by its ability to turn arterial or red blood blue; by its reduced activity in the fermenting liquid, after the oxygen is absorbed; by its renewed activity after aeration. Gay-Lussac, in 1810, first suggested that oxygen starts fermentation. Later experiments showed that oxygen was not necessary; while Pasteur in 1861 showed that oxygen quickened fermentation.

**Nutrition.**—Yeast foods are:<sup>1</sup>

1. Nitrogenous compounds (Albuminoids as amids, etc.)
2. Carbohydrates (fermentable sugars, starch).
3. Mineral matter.

All of the substances found in the analysis of yeast (page 7) are furnished by the breaking up of the albuminoids, carbohydrates (sugars and starch) and mineral matter (chiefly potash and phosphoric acid). Thus Pasteur raised yeast in a nutrient solution of pure water and sugar, ammonium tartrate and yeast ash.

Yeast as a plant is unable to feed directly on the nitrogenous mash substances which form its food. It must first digest and break up the albumin and albuminoids, and peptones and amids which are more soluble and simple so-called protein or nitrogenous forms. This degradation or digestion of the albuminoids is

<sup>1</sup> "Manual of Alcoholic Fermentation," C. G. Matthews, London, 1901; p. 41.



attributed to what is called the *proteolytic* or digestive action of certain substances, *enzymes*.

*Enzymes*, once called unorganized ferments, are albuminoid substances which are evolved by living cells, and which are thought to act by catalysis. "Under favorable conditions the amount of material which may be changed by a given amount of enzyme is so great as to indicate that the enzyme . . . is not used up by the reaction which it brings about."<sup>1</sup> Recent research in organic chemistry has found them in the saliva, gastric and other digestive juices, in animal tissues, and in vegetable tissue and cells (as in flour). They react commonly at room temperatures, are coagulated at 70° C. (158° F.), and are as a rule unstable.

At least one proteolytic enzyme of yeast, named *endotryptase* by Hahn,<sup>2</sup> has been isolated. It enables yeast to digest nitrogenous foods. Similarly, malt is found, on extraction, to undergo a digestion of its albuminoids to peptones and amids. Though these digestive enzymes have not yet been definitely isolated, their action is seen to resemble that of the animal enzymes, pepsin and trypsin.<sup>3</sup>

The distiller aims to produce as little yeast as possible and is indifferent as to its condition. His strongly saccharine worts give a low yield of an exhausted yeast. On the other hand the yeastmaker aims to produce a wort, rich in peptones and amids and comparatively low in sugars, and he gets many times the yeast that the distiller gets.

We have seen that it is necessary in order to produce a healthy and strong growth of yeast to have a solution which is rich in

<sup>1</sup> "Chemistry of Food and Nutrition," H. C. Sherman, New York, 1911; p. 45.

<sup>2</sup> "Technical Mycology," Franz Lafar, London, 1910; Vol. II, Part 2, p. 549.

<sup>3</sup> Wahl and Henius; p. 1042.

albuminous substances, carbohydrates and mineral matter in a state in which they can easily be assimilated by the yeast. In the practice of fermentation such solutions are produced from various raw materials which form the *mash* or *wort*. The *mash* is the sugar solution which contains the suspended solids of the raw materials; while the name *wort* applies to the clear solution which does not contain any suspended solids.

The mash constituents are malt and several grains—generally corn and rye.

**Malt** is barley or other grain that has been moistened and allowed to germinate, then dried. The following is the approximate composition of barley before and after malting:<sup>1</sup>

AVERAGE COMPOSITION OF BARLEY AND MALT.

	Barley	Malt
Carbohydrates, starch.....	56.0	50.8
Nitrogenous substance.....	12.0	13.0
Sugars { Cane..... 2.8-6.0 <sup>2</sup> }.....	2.3	12.9
{ Maltose..... 1.3-5.0 }.....		
{ Glucose..... 1.5-3.5 }.....		
{ Levulose..... 0.7-1.5 }.....		
Caramel.....		2.5
Fat.....	2.4	2.0
Cellulose.....	12.5	13.5
Ash.....	2.8	2.3
Water.....	12.0	3.0
	100.0	100.0

The main products of the activity of yeast, *carbondioxid* and *ethylalcohol*, (grain alcohol), are the result of the fermentation of sugar; and it was believed until a few years ago that the other products of alcoholic fermentation—higher alcohols, glycerin and succinic acid—were also derived from the fermentation of sugars. But Ehrlich has shown conclusively that products like amyl-alcohol and succinic acid are not so derived, but

<sup>1</sup> C. G. Matthews; p. 162.

<sup>2</sup> After malting; Wahl and Henius; p. 460.

are the products of the action of yeast on albuminous derivatives, especially amino-acids. Following this discovery Ehrlich has isolated new products of yeast fermentation—for instance, *tyrosol*, a new alcohol, derived from tyrosin. The source of the glycerin has not been discovered so far.

While malting increases the sugars to about 15 per cent., the vital change is the production of the enzyme, *diastase*. Diastase converts the gelatinized starch of grain to fermentable sugar and dextrans, by hydration. The converting strength of malt is called its diastatic power. Diastase is partially destroyed at a heat of about 75° C. (167° F.).

**Starch**, ( $C_6H_{10}O_5$ ), is the white, cellular carbohydrate that forms the great bulk of the mash substance. It is insoluble and granular. Boiling it, bursts the cells and forms a gelatinous paste. Diastase hydrates starch to maltose (malt sugar) and dextrans. When starch is converted in this manner in practice by the so-called mashing process, the ratio of maltose to dextrin produced is about 80 per cent. maltose and 20 per cent. dextrin. During the subsequent process of fermentation the maltose ( $C_{12}H_{22}O_{11}$ ) is hydrated by the yeast enzyme, maltose, producing glucose which is readily fermentable.

**Dextrin**, ( $C_6H_{12}O_6$ ), is an amorphous, soluble gum, sometimes used on postage stamps. It is not fermentable, but becomes so if diastase is present.

The **Albuminoids** are protein substances, in other words, those compounds containing nitrogen—the enzymes, gluten, albumin, peptones, amids, etc. The action of the proteolytic enzymes breaks down the albuminoids to the simpler forms for yeast food.

**Cane Sugar** or sucrose ( $C_{12}H_{22}O_{11}$ ), found in the malt in small amount, is inverted by the enzyme invertase to the fermentable sugar glucose, and the less fermentable levulose.

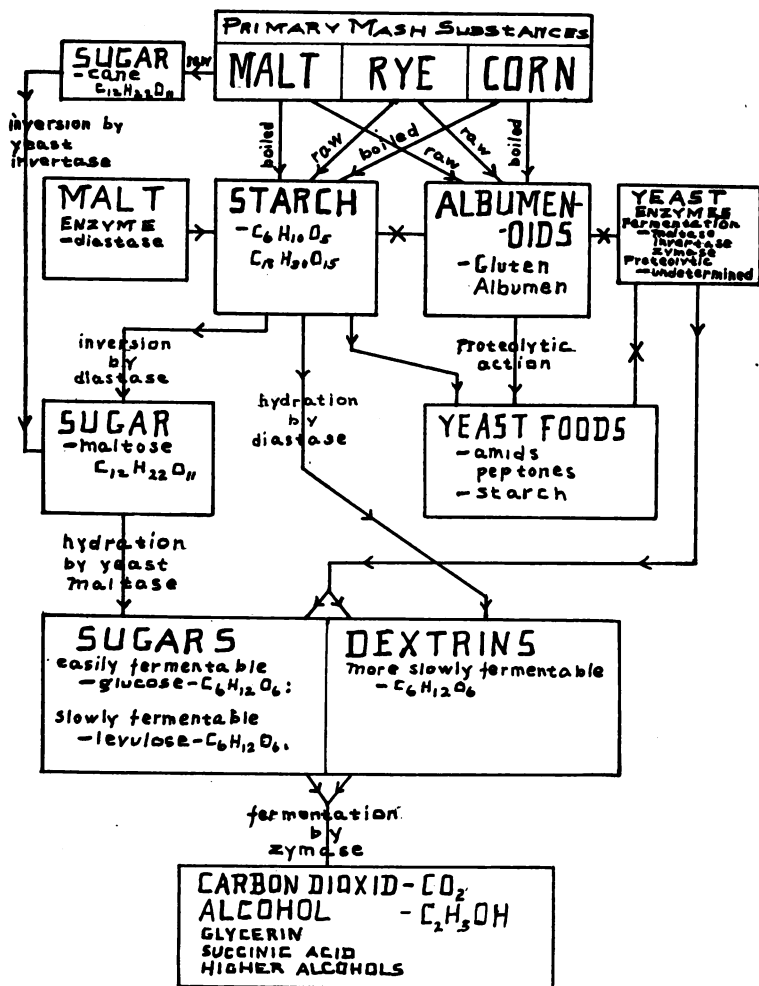

Fig. 3.—Diagram of the enzymic reactions in yeast manufacture.

Glucose, ( $C_6H_{12}O_6$ , called dextrose and grape sugar), is the readily fermentable sugar of grapes. It is less sweet and more soluble than cane sugar.

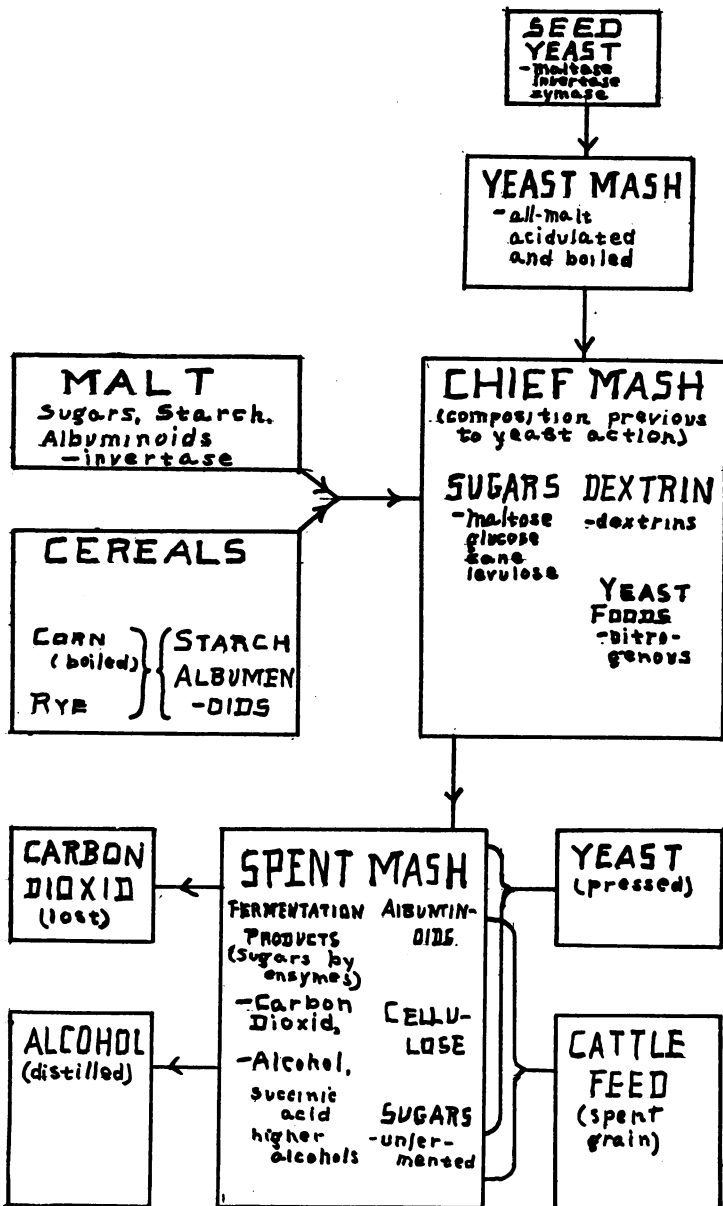

Fig. 4.—Diagram of the mass action in yeast manufacture.

**Levulose**, ( $C_6H_{12}O_6$ , called fruit sugar), is laevorotary to glucose and is less readily fermentable.

Cane sugar and levulose are comparatively unimportant in grain mashes. They become important in the manufacture of yeast from cane or beet molasses. But maltose and dextrin are, together with the hydrated albuminoids, the most conspicuous and also the most important products of the mashing process in the manufacture of yeast from cereals. While the latter (the albuminoids) are the principal sources of the yeast food the maltose and dextrin form the bases for the alcoholic fermentation.

Figs. 3 and 4 show graphically the chemical changes in the mash, due to the enzymic actions of the malt and yeast. The three main reactions are:

(1) The inversion and hydration of starch by diastase, producing maltose and dextrins.

(2) The hydration of maltose, by maltase to glucose

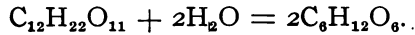

(3) The fermentation of glucose and other sugars and dextrin by zymase, to produce alcohol and carbon dioxid.

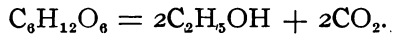

The proteolytic or digestive reactions are too uncertainly known to need a statement here.

YEASTMAKER'S MASH.  
(Approximate.)

	Albuminoids, per cent.	Ash, per cent.	Carbohydrates (sugars, starch), per cent.
Malt .....	11.0	1.60	70
Corn .....	9.50	1.50	66
Rye .....	11.0	2.0	70

The process by which yeast food is released from the mash and assimilated by the yeast is best determined under fermentation.

**Fermentation.**—Lafar's<sup>1</sup> general definition is: "Fermentation is a decomposition or transformation of substances of various kinds, brought about by the vital activity of fungi." At the present time fermentation is charged to the analytic action of an enzyme, called *zymase*, secreted by the yeast cell.

Yeast is found to secrete at least three enzymes—*maltase*, *invertase*, *zymase*. The first two break down the mash compounds into fermentable compounds; the last, *zymase*, carries out actual fermentation. The growth of yeast in Pasteur's solution (see page 8) shows that its enzymes may act by synthesis as well as by analysis.

The empirical formula of fermentation is

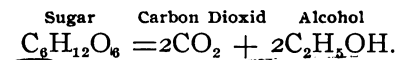

The amount of sugar a yeast can split up in a given time is defined as its *fermentative power*; and is dependent on temperature. The *attenuating power* of yeast refers to the amount of sugar a yeast will ultimately split up. Pasteur obtained 51.11 per cent. alcohol from the 100 parts cane sugar which he first converted to 105.2 per cent. invert sugar; the remaining 48.9 per cent. was carbon dioxid.<sup>2</sup>

### SELECTION AND HANSEN'S PURE CULTURE

Within fifty years it has been found that the uncertainty of fermentation was due to the uncertain yeasts, and that the "diseases" of beer, wine and vinegar could be avoided. The microscope revealed two important facts; that a bread yeast, for instance, besides consisting of different varieties of "wild yeasts,"

<sup>1</sup> "Technical Mycology," London, 1899; Vol. I, p. 24.

<sup>2</sup> C. G. Matthews; p. 96.

was infested by other yeasts and bacteria which caused the "secondary fermentation;" also that the progeny of a single cell differed as much as do the different wheat plants, from seed of a single wheat head. Pasteur apparently rid his yeasts of bacteria by sterilizing his solutions with potassium tartrate or phenol, (carbolic acid)<sup>1</sup> but even then the all-yeast mixture was only less uncertain than the infected yeasts.<sup>2</sup> So the better to avoid the bacteria and wild yeasts and to give the useful yeasts a free field in their solution Hansen originated his pure-culture method in 1879. In Hansen's method, a small portion of Koch's sterile, nutrient gelatin which contains yeast cells is placed on the underside of a watch glass in the moist atmosphere of a bell jar. Those yeast specks which, under the microscope, appear as single cells, are first marked on the top of the watch glass. After a three or four-day sojourn in the moist bell jar the yeast colonies, which have formed from the marked specks, are separated. Each colony furnished the seed for the pitching yeast.

Practically all breweries and many distilleries and yeast factories now start their mother liquor from a single cell according to one of the pure-culture systems.

### KEEPING OF YEAST

Dry yeast cakes made with fine grain or barley meal were used by the Roman bakers.<sup>3</sup> It has been formerly the practice here and abroad to mix about 20 per cent. of starch into the yeast cake, for the alleged purpose of drying and keeping it. The best modern practice regards starch as an adulterant. Pure yeast that is well washed and pressed dry needs no starch and

<sup>1</sup> "Studies on Fermentation," Pasteur (Faulkner-Robb), London, 1879; p. 231.

<sup>2</sup> Wahl and Henius; p. 1085.

<sup>3</sup> "The Modern Baker, Confectioner and Caterer," John Kirkland, London, 1910; p. 3.



will keep in the cake form for several weeks, if kept cool, and still be active and fairly sweet. Slime in yeast is due to imperfect washing and to the action of destructive bacteria.

STARCH IN YEAST.  
(Comparative Tests of Pure Yeast with Yeast and Starch.)

Percentage		Age of Yeast	Time of test	Percentage of CO <sub>2</sub>
Yeast	Starch			
100	.....	.....	.....	100
87½ <sup>1</sup>	12½	1-14 days	24 hours	85
80 <sup>2</sup>	20	.....	.....	91-95
50 <sup>3</sup>	50	.....	.....	77-83

Moufang<sup>3</sup> says that over-washing yeast with pure water will cause it to lose almost all its fermentative power after 12 to 14 days. Washing in dilute phosphoric acid rather increases its power. The yeast foams and dry yeast cakes will keep for months. Their yeast becomes dormant and must be given time to revive. It is believed that the dry yeasts are largely composed of sporulation cells.

Pressed yeast of good quality will keep 10 to 12 days in the winter and half as long a time in summer. The baker is recommended to keep his yeast tied in a bag in a cool place and the bag is occasionally dipped in cold water.<sup>4</sup> Even in the summer, yeast can be economically shipped half way across the continent by express. The yeast, well wrapped in paper, is insulated in thick sawdust and boxed in wood. Such a shipment made from New York to Chicago will be in good condition up to a week after its receipt.

<sup>1</sup> T. J. Bryan, U. S. Dept. Agr., Bur. of Chem., Bulletin 116.

<sup>2</sup> A. Kopper, *Chem. Zeit.*, 1909, 33 : 110.

<sup>3</sup> *Wochenschr. f. Brauerei.*

<sup>4</sup> Kirkland ; p. 83.

The following paragraphs on the "Transportation of Yeast"<sup>1</sup> show how yeast may be prepared for a long voyage:

"While I was employed in India I devoted much attention to the means now in use to make yeast fit to undergo transportation for long distances and retain its fermenting energy in transoceanic shipments. If the yeast is to be kept for a short time only it may be known that the method is first to subject the yeast to a thorough cleaning and then to press it out as thoroughly and quickly as possible in a cold room. The yeast is then packed tight in a tin box and some fresh hops spread between the different layers. After the box is filled, it is closed as tight as can be by soldering and packed in chipped ice in a box with double sides. Where an ice machine can be had it is a good plan to freeze the yeast for about seven hours at a temperature of 13° R. below zero, or 5° F. above zero.

"The above manipulations are not sufficient to keep the yeast for many months together. I have made mixtures with dry yeast which made it possible to preserve it with full fermenting power in a dry condition for more than a year, but the mass with which I mixed the yeast is too much in proportion. I treated the yeast differently before drying and so I succeeded in obtaining a more favorable result. But the researches in this direction are not yet satisfactory to me, but I think I am justified in believing that I shall succeed in so manipulating yeast in the dry state that it can be preserved more conveniently than at present and for an indefinite length of time without losing its fermentative power. Some years ago I sent yeast from India to Capetown, South Africa, and it worked well. The method I pursued was as follows:

"Yeast of sound, vigorous fermenting power was mixed well with the double amount of filtered cold well water, to which

<sup>1</sup> *American Brewers Review*, John Hotz, 1896; p. 277.

was added some salicylic acid dissolved in alcohol. After two hours the water was drawn off and the yeast pressed out hard and dried at a mild temperature, after being sprinkled once or twice with a weak solution of salicylic acid and alcohol. It was dried until the little balls of yeast could be ground into fine powder by stronger pressure. In order to avoid having any larger particles I had it sifted through a fine hair sieve and afterwards mixed the yeast with about three or four times the amount of plaster of paris.

"This mixture should be very intimate, and the whole mixture run through the sieve repeatedly. It is then put into a tin box coated inside with strong paper, the box is filled as tight as possible and soldered up. The box was packed in a double chest, filling the hollow space between the walls with sawdust. I have also mixed yeast with plaster of paris before it was quite dried out, thinking the mixture would become more intimate in that condition, but in that case the yeast requires from four to seven times the volume of plaster of paris and finally does not keep so long.

"Experiments with powdered charcoal were also successful, but I prefer the plaster.

"When the yeast treated in the above manner arrives at its destination it can be used at once, that is, a quantity of the mixture the ratio of yeast and plaster being known—is put into an open one-sixth barrel of sweet wort of 14° R. (64° F.) and the liquid well roused. This is repeated until fermentation sets in, which will not take very long if a sufficient amount of yeast is used. After the wort has begun to ferment and a fine heavy film appears on the surface, the whole liquid is poured into a half-barrel of sweet wort of 13° R. (61° F.). Here it is left until fermentation again sets in and the liquid thus obtained is sufficient to start fermentation in four barrels filled with

sweet boiled wort of 12° R. (59° F.) and from there the fermenting wort or kraeusen beer goes to the big fermenting tun, where fermentation is commenced at 7½° R. (48° F.)."

### TESTS FOR YEAST

Fresh pressed yeast is tasteless and has a faint and agreeable smell of apples, which smell becomes cheesy when stale. It is somewhat granular and crisp under the fingers; a cake is elastic and tears with a faint "cry." Yeast not thoroughly washed, or containing destructive bacteria, becomes soft and slimy. A rye mash makes a pale yellow yeast; a wheat mash, pale pink. The gray color of old yeast is due to the dead cells.

The microscopic test is confined to the factory and the research laboratory. The yeast to be tested is milked with pure water in a burette. A drop of the fluid is put on a glass slide and gently spread out with a glass cover. Under an enlargement of about 400 diameters, healthy cells appear spherical or oval, pale yellow or white, translucent and not granular.

The laboratory test of Adrian J. Brown<sup>1</sup> to give comparative activity, odor, flavor, fermentative and attenuating powers of yeast would not be useful to the baker or yeast manufacturer. Matthews also suggests that his laboratory tests would often be useless; a bottom yeast would give a greater carbon dioxide yield, and yet be nearly useless as a bread leavener.<sup>2</sup>

August Metzler<sup>3</sup> of Australia used the following test:

Weighed yeast was doughed in 100 grams flour and 80 cc. water, in a dish with a spoon, at 30° C. (86° F.) This dough was rolled on a board with 3-5 grams more flour, into a shape 4½ x 1¾ inches, and dropped into a paper cylinder and put in a 500 cc. measuring glass. The first reading is taken as zero. Consecu-

<sup>1</sup> "Laboratory Studies in Brewing," London, 1904; p. 127.

<sup>2</sup> "Manual of Alcoholic Fermentation," London, 1901; p. 274.

<sup>3</sup> *American Brewers Review*, Dec. 1902; Jan. 1903.

tive readings are taken every 30 minutes for two hours, when the dough should be soft and uniform. The table below shows how volume readings for different amounts of yeast may be compared.

FORM FOR METZLER'S YEAST TEST.  
(100 gr. flour, 80 cc. water, 30° C.)

Yeast Hours	1 gr. risen cc.	2 gr. risen cc.	4 gr. risen cc.	7 gr. risen cc.	10 gr. risen cc.
0	.....	.....	.....	.....	.....
½	.....	.....	.....	.....	.....
1	.....	.....	.....	.....	.....
1½	.....	.....	.....	.....	.....
2	.....	.....	.....	.....	.....
2½	.....	.....	.....	.....	.....
3	.....	.....	.....	.....	.....
3½	.....	.....	.....	.....	.....

If a standard flour could be kept, this test would serve to check the yeast for time and quantity. Where the yeast was a standard compressed, the behavior of different flours under fermentation could be roughly estimated.

### MANUFACTURE OF COMPRESSED YEAST

In the previous paragraphs we have seen that to produce yeast it is necessary to prepare a sugar solution rich in albuminous matters which can be easily assimilated by the yeast, and which also contains enough mineral matter for its use. The process of manufacture consists of: (1) The production of a suitable solution for the growth of the yeast; (2) The addition of seed yeast to this solution; (3) Multiplying the seed yeast in this sugar solution; (4) Separating the yeast crop from the solution and putting the yeast in marketable shape by washing and pressing it.

There are two processes of yeast manufacture, which differ

radically in the method of separating the yeast crop from the sugar solution. The older method is called the *Continental* or *Vienna process*. The mash is generally made up of a mixture of equal parts of malt, rye and maize; and the mashing is so conducted that a foam forms during the fermentation. This foam contains most of the yeast, which is separated from the mash by skimming off the foam. The more recent process is called the *aeration* or *wort process*. In this method the manufacturer does not depend on a foam, but allows his yeast to settle out of solution or separates it by means of a centrifugal machine similar to a cream separator.

It is obvious that in the aeration process a clear wort carrying no suspended solids must be used for the growth of the yeast; otherwise these solids would settle with or be separated with the yeast and would make the recovery of a pure product impossible. In the old Vienna process, as before stated, only cereals can be used; and rye is one of the most important ingredients of the mash, because it is necessary to the production of the foam without which no yeast can be produced. But in the aeration process where foam is undesirable other materials can be used—potatoes, molasses, beets or cane-sugar.

Yeast made by the old Vienna process is considered to be of better quality than that produced by the aeration process. However, very good yeast can be made by the aeration process and the latter gives a greater yield of yeast and a small yield of alcohol.

The following approximate figures show the difference:

OLD VIENNA PROCESS.		
Grain	Yeast	Proof spirits
100 pounds .....	12-15 pounds	6½-7 gallons
AERATION PROCESS.		
100 pounds .....	18-22 pounds	5 gallons

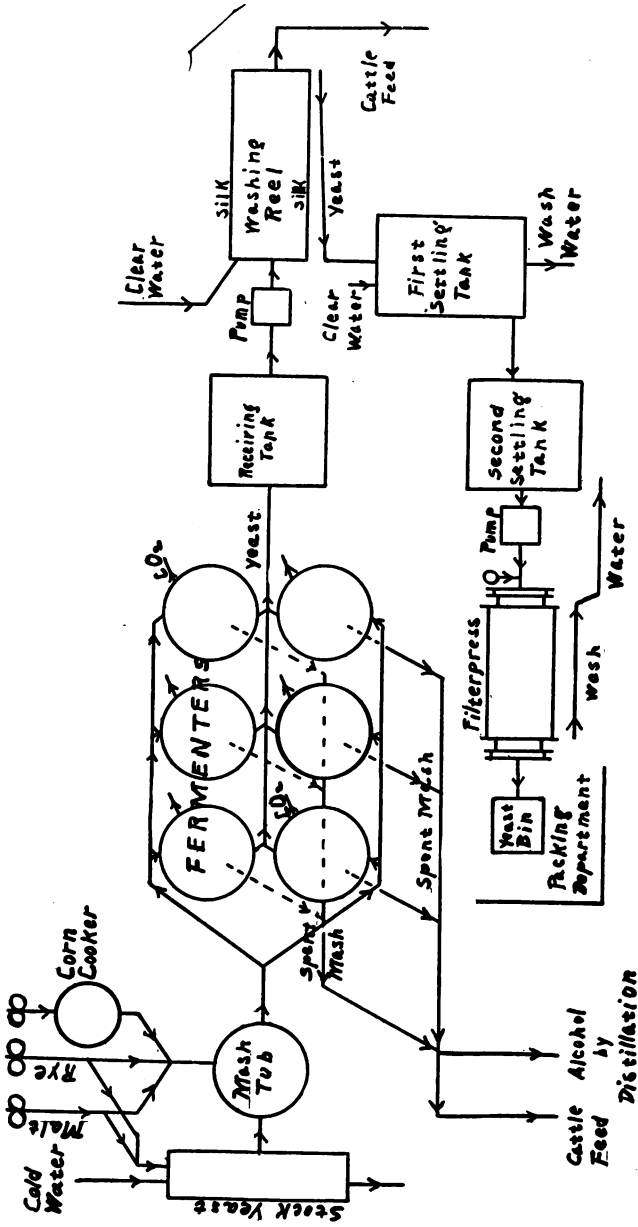

Fig. 5.—Diagram of old Vienna process.

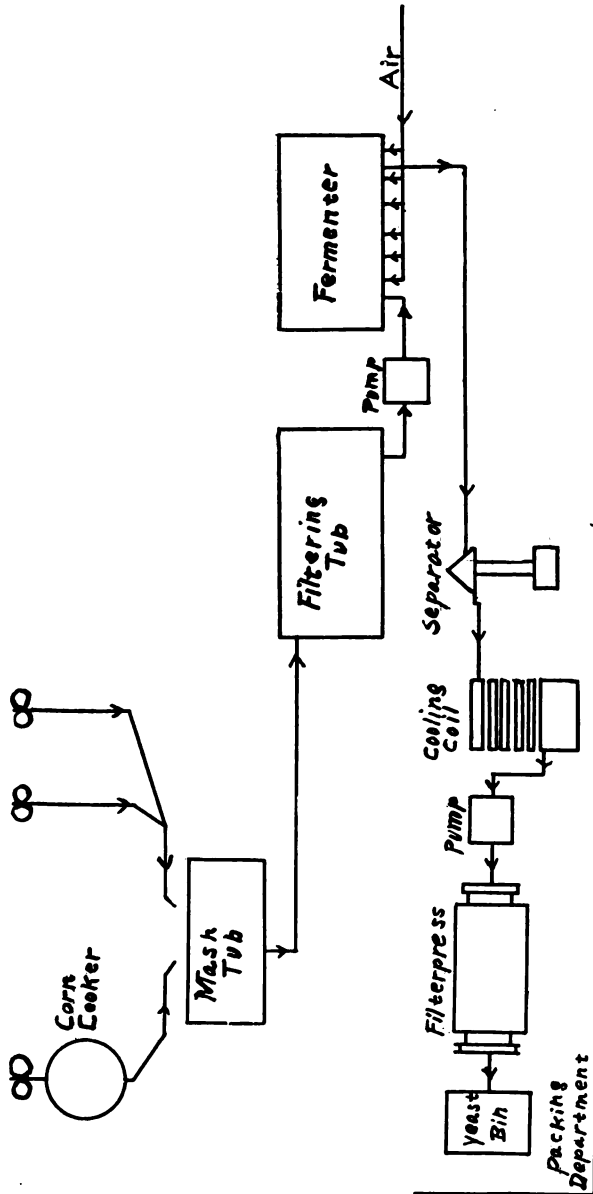

Fig. 6.—Diagram of Aeration process.



In the last few years the aeration process has been considerably improved and the yield of yeast raised as high as 30 and even 35 pounds from 100 pounds of grain, and the alcohol has proportionately decreased.

With the principal differences between the two processes in mind, the common practice in both methods will now be given in more detail. (See diagram, Figs. 5 and 6.)

### OLD VIENNA PROCESS

1. Preparation of the Chief Mash.
  - (1) Cleaning and grinding the grain.
  - (2) Mashing or saccharifying.
  - (3) Cooling.
2. Preparation of the Seed Mash or Seed Yeast.
  - (1) Mashing of seed-yeast.
  - (2) Souring of seed-yeast.
  - (3) Cooling and setting with stock or mother yeast.
3. Treatment of Chief Mash.
  - (1) Adding the ripe yeast-mash.
  - (2) Fermentation.
  - (3) Skimming off the yeast foam.
  - (4) Distillation of the ripe chief mash to recover alcohol (residue, *slop*).
4. Treatment of Foam.
  - (1) Foam cooled by diluting with cold water.
  - (2) Sifting through fine silk to eliminate particles of solids skimmed with yeast.
  - (3) Washing the yeast with water (two or three times).
  - (4) Settling from water.
  - (5) Pressing in filter presses or in bags.
  - (6) Forming into packages, cakes, etc.

**Material.**—800 pounds kiln-dried malt, 800 pounds rye, 800 pounds corn. The corn is ground to a meal and run into a cooler or mash tub (Fig. 7) where it is boiled with direct steam under continuous agitation. It is not customary to cook the corn under pressure—a practice usually observed by distilleries. In a separate mash tub, rye meal and malt meal are mashed with water, and the cooked corn is added to this mixture. The temperature of the three cereals are so regulated that their combined temperature in the mash tub (Fig. 7) is about 63-65° C. (145-148° F.)

The mash is now allowed to stand for about an hour to allow the malt diastase to convert the gelatinous starch to maltose, and is then cooled through the cooling coils in the tub to a temperature of about 20° C. (70° F.). At the same time the mother yeast or seed mash, which has been previously prepared, is added to the mash in the fermenter (Fig. 8) and the fermentation is thus started. It is customary and advantageous to add some *slop* (spent mash from a previous distillation) to the mash in the fermenter. This slop contains valuable nourishment for the yeast and also a certain amount of lactic acid which will retard the reproduction of obnoxious bacteria and will stimulate the yeast.

The yeast mash, already spoken of, is made from 150 pounds rye and 150 pounds malt, both ground and mashed in the smaller so-called yeast tubs, in the same manner as the chief mash. After mashing the yeast mash, it is allowed to undergo a lactic acid fermentation which is induced by the lactic acid bacteria introduced with the malt or rye; or better, by adding a little soured yeast mash taken from a previous yeasting; or by the introduction of pure-culture lactic acid bacteria. The yeast mash sours for 12 to 24 hours, when it will contain from  $\frac{1}{2}$  to 2 per cent. of lactic acid. The function of this lactic acid has been already explained (see page 6).

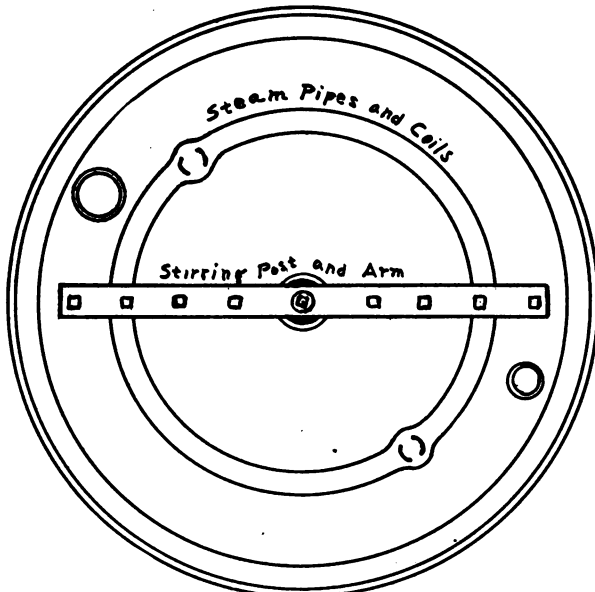
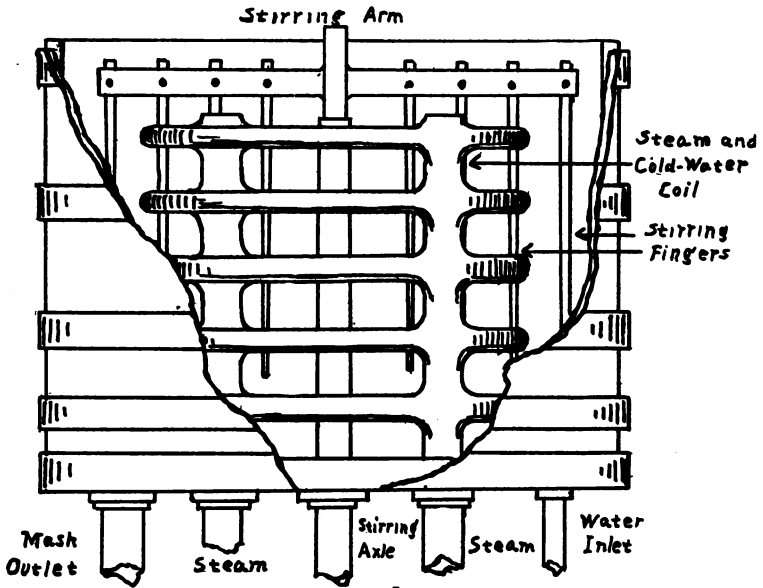

Fig. 7.—Diagram of mash tub.

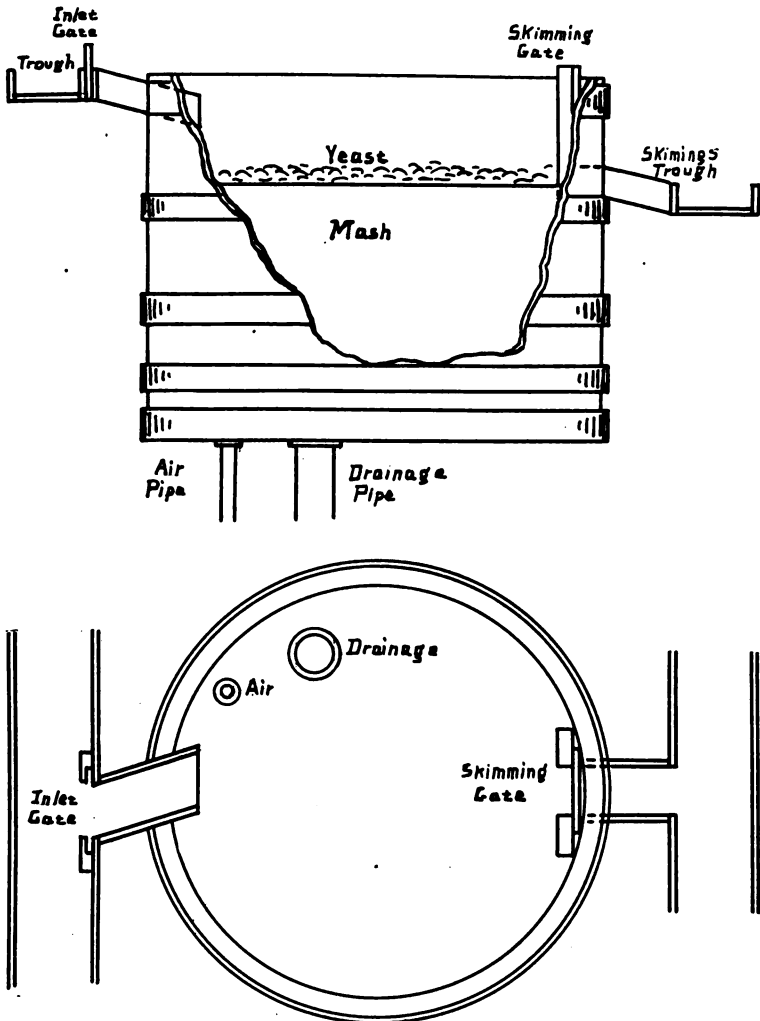

Fig. 8.—Diagram of fermenter.

After souring, the yeast mash is cooled to fermentation temperature and fermentation is started with stock yeast, or with mother yeast from a former fermentation, or with pure-culture

yeast. The fermentation is continued for 10 to 20 hours, or until the yeast cells are fully developed: this depends on the temperature and the amount of stock yeast used. The ripe seed yeast or yeast mash is finally added to the chief mash as already explained.

Fermentation begins in the chief mash, bubbles of carbon dioxide come to the surface and the temperature rises. The increase of temperature quickens the fermentation and the bubbles of carbon dioxide become entangled in the slimy albuminoids of the rye and form a foam several inches thick on top of the mash. At first the foam is transparent, but as the rising gas begins to bring up the newly generated yeast cells from the mash, the foam grows first milky and then to a thick cream. By the appearance of the foam the practical yeast-maker judges when the yeast is ripe for skimming. Ripe cells are rounded and vigorous, and rich in glycogen.

Skimming is done with dippers; or long paddles are used to push the foam to an opening in the top of the fermenter. The skimming is continued as long as foam forms on the surface of the mash, and the foam is at once run into cold water to check further activity of the yeast which may lead to auto-fermentation. For in the absence of fermenting material the enzymes of active yeast attack the yeast protoplasm at fermentation temperatures. As the yeast foam, mixed with cold water, is run over fine screens of metal or silk to separate it from particles of the mash which have also been skimmed off, the yeast and water pass through the fine meshes. The yeast settles to the bottom of the settling tank (Fig. 9), the water is syphoned off and fresh cold wash water added. This process of washing can be repeated several times. After the last washing, the water is completely drained off and the yeast, which looks like thick cream, is ready

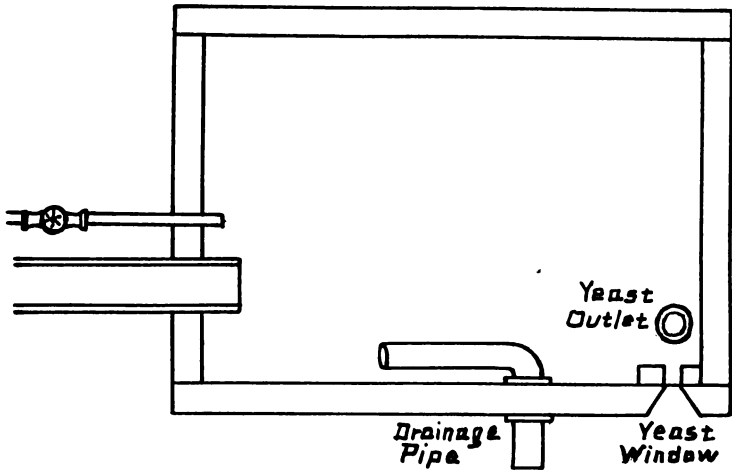
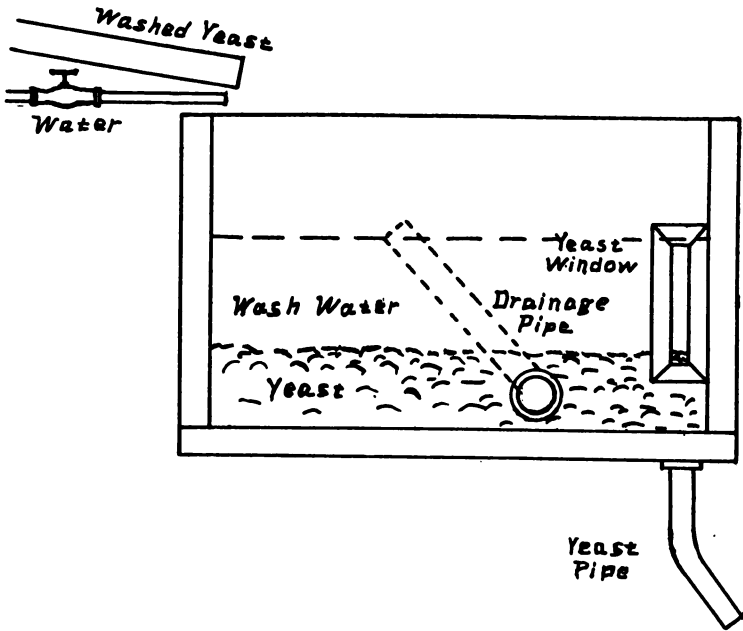

Fig. 9.—Diagram of washing tank.

for pressing. In former times the yeast cream was run into linen bags and the water pressed out in a screw press. Modern factories all use filter presses (Fig. 10) into which the yeast cream is pumped under a pressure as high as 200 pounds to the inch. The yeast remains in the press cloth between the plates and the water runs off by way of the spigots. After the press is full it is opened and the pressed yeast is turned into a trough or bin, from which workmen shovel it into various machines which mold it into cakes or packages for the market.

Yeast is enclosed in paper or tin-foil wrappers for small consumers, or put up in paper-lined wooden boxes for bakers or for express shipment. It must be kept cold during storage and transportation. If good yeast is properly stored it will keep for several weeks; if it is of poor quality or allowed to get warm it will deteriorate very quickly.

We have followed the process of fermentation up to the time when the yeast foam was skimmed off and will now speak briefly of the remaining mash. Not all the yeast can be recovered by skimming; a certain percentage remains in the mash and completes the fermentation of the sugar contained therein. When the fermentation ends, the mash holds about 5-7 per cent. of alcohol, which is recovered by distillation. The residue from distillation is called *slop* or *wash*, used for cattle feed. But some of the slop is clarified by settling and returned to the fermenter as already mentioned (see page 26).

It will be seen that the Vienna or Continental process hinges entirely upon the formation of a foam during fermentation. The composition of the raw material, the treatment of the same in cooking and mashing, the temperature of fermentation, the method of yeasting—all are planned with the object of bringing about the proper kind of foaming.

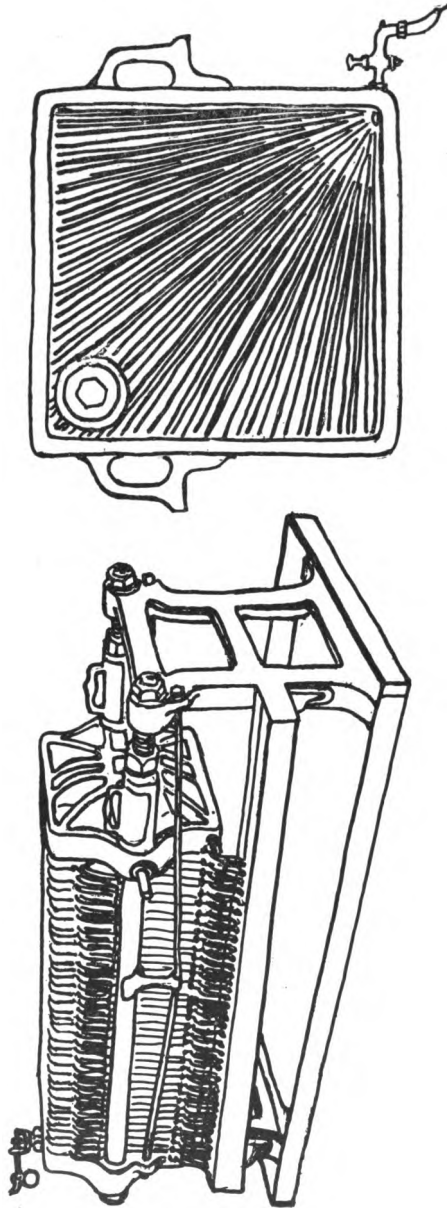

Fig. 10.—Filter press for yeast, and single plate.



**Disturbances in fermentation** may occur at any of the steps in the process. Infected vessels or improper treatment of the foam are most likely to produce bad results, which manifest themselves in a low yield of yeast and alcohol and in a poor quality of yeast. Then there will be difficulties in settling and pressing and the yeast will have a low fermenting power and will not keep any length of time. Sometimes the poor quality of the yeast can be laid to the excessive use of starch, which at the best is an adulterant (see page 16). And the starch may not only unnecessarily dilute the yeast but it may in itself hold bacteria which will decompose the yeast.

### AERATION PROCESS

The aeration process (see diagram, Fig. 6) does not depend on the foaming of the mash; a clear wort is used in this process from which the yeast settles out or is separated by means of a yeast separator made by the DeLaval Separator Co. The wort is commonly prepared from ground grain, or sometimes from molasses. A brief outline of the aeration process:

#### 1. Preparation of Wort.

- (1) Grinding.
- (2) Mashing.
- (3) Souring of mash.
- (4) Filtering for the wort.
- (5) Cooling of wort.

#### 2. Fermentation.

- (1) Setting with seed yeast.
- (2) Fermentation under continuous aeration.
- (3) Separation of yeast by settling or "centrififing."

#### 3. Pressing and Packing the Yeast.

✓ **Material.**—700 pounds green malt, 150 pounds rye, 700 pounds corn, 150 pounds malt sprouts. The rye and malt are ground, not too fine—so as to preserve the hulls for filtering material—and then mashed as in the Vienna process. The corn is first cooked with water before adding to the rye and malt mash. The final temperature of mashing is now about 63° C. (145° F.). The mash is allowed to stand about 15 hours for souring, care being taken to keep the temperature at about 50° C. (120° F.). At or above this temperature, a very pure lactic acid is formed.

In order to insure a pure lactic acid bacteria, a small portion of previously soured mash is prepared with pure culture lactic acid bacteria. The acidifying of the mash, and especially the quality and percentage of lactic acid produced in the mash, is one of the most important operations in the production of a good quality and large yield of yeast by this process. Failures were frequent in the early days of the aeration process, until the yeastmakers learned how to produce the proper conditions and proper acidity for fermentation.

After souring, the mash is heated to about 66° C. (150° F.) and stands until the lactic bacteria are dead. Then the mash is pumped into a tub with a perforated false bottom, like those used in making beer. Here the mash stands long enough to let the solids settle on the perforated bottom; then the mash is drawn off as it filters through the layer of solids. This wort is pumped back and refiltered until it is perfectly clear, then run into a fermenting tub. Compressed yeast for seed is diluted with a little wort or water and mixed with the wort running into the fermenting tub. Pipes lead into the bottom of the tub and a strong current of filtered and purified air is blown through these pipes and up through the wort. After the wort has been run off so that the surface of the grain appears, the latter is sprayed

with hot water to extract the remaining wort. This extract is also run into the fermenting tub, until presently the extract that filters through the grains is almost pure water.

Now the flow of water is stopped and the grain discharged from the filtering tub. This spent grain serves for cattle food. In this process the fermenting tub is filled only half full, because the excessive agitation caused by aeration creates a high foam which would overflow the tubs if they were too full. Excessive foaming is sometimes checked by covering the surface of the wort with a thin layer of pure neutral oil or fat. The temperature of fermentation is kept at an even 29° C. (84° F.) by the cooling coil in the fermenter.

Fermentation goes on rapidly and is over in about 10 hours, for the wort holds only about 4 or 5 per cent. of extract.

The fermented wort is drawn from the fermenting tub and cooled at once to preserve the vitality of the yeast. Then it is either run into settling chambers to separate the yeast or, in the best modern practice, is turned directly into the centrifugal separators. Yeast is separated out in a thick cream, cooled on small surface coolers and pumped into the filter press to further dry it.

The aeration process has been modified and now yields a very high amount of yeast—chiefly because of the lower fermenting temperature, very thin wort, a large amount of seed yeast, and very heavy aeration.

**Disturbances in the fermentation** are due to the same causes as in the old Vienna process. Strong aeration greatly increases the danger of infecting the yeast with *mycoderma* and other fungi which resemble yeast in appearance but have no fermenting power. Aeration greatly stimulates their growth and aeration-process yeast has often been found to contain as high as 50 per cent. of *mycoderma*. However its action in dough is nil.

**YEAST IN BREAD**

## SPONGE AND DOUGH METHODS

There are two general methods of bread making, called the *straight dough* and the *sponge* methods. In the straight dough method all the ingredients, flour, water, salt, shortening and yeast, are mixed together; and after a sufficient length of time the yeast will have caused certain chemical and physical changes in the composition of the dough and the dough will be ready for baking. In the sponge method yeast or barm has been made up with a given amount of slack dough called the sponge which will form say one-half of the batch for baking. After fermentation has proceeded until the slack sponge has risen twice and is swarming with fresh young cells, this sponge is made up with an equal amount of new dough and again set aside to ferment. This second batch represents the entire amount to be baked; it is tighter, and the fermentation begins again from the vigorous yeast cells.

In the first process, the "straight dough," about 1-1½ per cent. by weight of compressed yeast is used. While this is enough, it is not the limit to the amount of sound, fresh yeast that can be used. Very little reproduction or budding will go on. Much yeast will simply cause the fermentation to be complete in a shorter time. As a matter of fact bakers more often use too little yeast. The fermentation goes on slower and other ferments have more chance to begin their action and perhaps introduce bad flavors.

On the other hand, the sponge dough, because it is much smaller than the final batch and because it is made so as to assist budding and reproduction of the yeast, is started with a much less amount of yeast. Some Scotch bakers make their first sponge only one-fourth the final batch, use this first sponge as a

starter for a second sponge and then make their final dough from this second sponge. Of course they must be careful to "take" the sponge each time before fermentation has gone too far. Otherwise other undesired fermentations will have set in and their bread will be dead and have a poor flavor. Jago<sup>1</sup> gives a very graphic description of the results of "taking" the dough at various stages in its fermentation.

"A very useful lesson may be learned by making a batch say of 20 pounds of flour, into a slack dough, with a full allowance of distiller's yeast, say 3 ounces; salt and water in proportion, and working the batch fairly warm. Let a piece be cut off and molded into a loaf immediately the dough is made, and at once baked—the result will be a close, small, very moist loaf, not much bigger than the piece of dough cut off. Next bake a similar loaf from the same piece of dough at the end of every hour from the time of starting, keeping the main mass covered, and in a warm place. An instructive series of changes will be observed in the successive loaves. In boldness the bread improves for some hours, then remains stationary, and finally becomes "runny" and flat. The color of the crust is at first "foxy," then of a golden yellow or brown tint, and finally abnormally pale. The crumb during the first three or four loaves of the series gradually improves, and becomes more bloomy, then changes to a greyish white, losing the bloom, and then "saddens" and darkens, becoming a dull, cold grey, merging ultimately into a brown. At the same time it becomes ragged on the outside edges, and dark when a soft crust has been produced by two loaves being in contact with each other in the oven. In flavor, the first loaf will be sweet, but "raw" and "wheaty," characters which will be lost as fermentation proceeds; at its

<sup>1</sup> "Technology of Bread-Making," London, 1911; p. 433.

best the raw taste will be gone, leaving only a sweet clean-palate flavor. This will be succeeded by a gradual disappearance of the sweetness, the bread being neutral and tasteless; at the same time the loaf will have lost its moisture, and will be harsh and crumbly. As fermentation is pushed still further, the bread commences to be "yeasty" (to taste of the yeast); but this depends somewhat on the original soundness or otherwise of the yeast. This condition merges into one of slight sourness, first of pure lactic acid flavor, accompanied by buttermilk odor; but gradually becoming worse, until, finally, not only is the taste offensive, but so also is the smell, partaking not only of sourness in character, but also of incipient putrefaction and decomposition. During these latter stages the bread again becomes soft and clammy."

**FLOUR, BEFORE AND AFTER FERMENTATION.**

	Flour—dry matter <sup>1</sup>		Fermented dough—dry matter ✓	
	Reducing sugars as maltose	Non-reducing sugars as sucrose	Reducing sugars as maltose	Non-reducing sugars as sucrose
Strong flour.....	1.67	1.05	1.70	Nil
Weak flour.....	1.35	0.24	2.26	0.17

**COMPARATIVE COMPOSITION OF FLOUR AND BREAD.<sup>2</sup>**

	Water	Protein	Fat	Carbo- hydrates	Ash
Flour.....	12.0	11.4	1.0	75.1	0.5
Bread.....	35.3	9.2	1.3	53.1	1.1

When yeast is worked up in the dough it finds the same substances that were in the manufacturer's yeast mash, but in different proportions and in a semi-solid condition. For instance,

<sup>1</sup> Jago; p. 334.

<sup>2</sup> U. S. Dept. Agr., Off. Exp. Sta., Bulletin 28, 1898; p. 28.

the mash was highly saccharine and in a form readily fermentable; but flour contains much less sugar, and the soluble protein is somewhat lower because wheat has more non-soluble protein, as gluten.

Yeast is put in dough for two reasons, the main one being to produce leavening gas; and the other reason is to improve the flavor and to increase the solubility of the gluten—both by chemical action. The reactions brought about by the yeast and, later, by the heat of the oven, are<sup>1</sup>:

1. Fermentation of carbohydrates and production of carbon dioxide and alcohol.
2. Production of soluble carbohydrates, as dextrin, from insoluble carbohydrates; as starch.
3. Production of lactic and other acids.
4. Formation of other volatile carbon compounds.
5. Change in the solubility of the protein.
6. Formation of amid and ammonium compounds from soluble protein.
7. Partial oxidation of the fat.

1. The first is the most prominent reaction—the fermentation of the sugars by the yeast, which first hydrates them to glucose and then splits these up into alcohol and carbon dioxide.

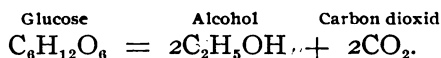

Practically all flours contain more than enough sugars to carry on a satisfactory leavening reaction with yeast. It was early recognized that leavening bread gave off carbon dioxide;<sup>2</sup> and later Girard set at rest the doubt as to the reaction being an alcoholic fermentation, when he found 0.25 per cent. of alcohol in

<sup>1</sup> U. S. Dept. Agr., Off. Exp. Sta., Bulletin 67, 1899.

<sup>2</sup> For method of determining CO<sub>2</sub> in dough, see Exp. Sta. Bulletin 67, 1899; p. 12.

a raised dough. Pohl<sup>1</sup> also found alcohol (0.075 per cent.) in dough, and Birnbaum<sup>2</sup> found it in baked bread (0.314 per cent.). Acidity from lactic and acetic acids may be due, not entirely to bacteria, but to alcoholic fermentation, in case these acids are intermediate products.<sup>3</sup>

Starch itself seems to be eventually drawn into the first reaction; first by the inverting power of the original flour enzymes, and secondly by protein matter altered by the yeast. This will account for the paradox that after fermenting the dough it often carries more sugars than before fermentation.

In ordinary bread making the lost substance is largely divided between about 1 per cent. of carbon dioxide and a little over 1 per cent. of alcohol.<sup>4</sup>

2. The production of soluble carbohydrates from the starch is caused by the oven heat alone and the starch must be gelatinized before this can occur. Gelatinization begins at about 65° C. (149° F.) and the yeast has already died at 60° C. (140° F.).

3. The sourness of bread has received much attention, because it seems not to depend entirely on the actual measurable acidity. Yeast itself does not cause acidity but since compressed yeast often contains lactic acid bacteria, and acetic and even butyric ferments find their way in either through the yeast or the flour or through unclean utensils, secondary fermentations begin just as soon as the yeast fermentation subsides. Jago concludes that "bakers' sourness is accompanied by other changes in the constituents of the bread in addition to the development of acidity;"<sup>5</sup> and he adds that lactic acid makes up about 95 per cent. of the

<sup>1</sup> *Z. angew. Chem.*, 1906, **19**, 668.

<sup>2</sup> Buchner.

<sup>3</sup> "Das Brotbachen," Braunschweig, 1878; p. 252.

<sup>4</sup> *Exp. Sta. Bulletin* 67, 1899; p. 33.

<sup>5</sup> p. 446.



acid and the rest is acetic and perhaps a trace of butyric acid (in case of putrefaction).<sup>1</sup> As is the case in the yeastmaker's mash, none of these objectionable fermentations need be expected where healthy clean yeast is used and the dough is taken in time—before secondary fermentation sets in.

Besides the acid after-fermentation bacteria, one authority<sup>2</sup> charges yeast with having carried "rope" infection into the bread. This so-called potato bacillus is, however, generally believed to come through the flour or from unclean utensils.

4. Some of the distinctive flavor of leavened bread seems to come from the compounds, succinic acid, tyrosin, higher alcohols, etc., which are formed when the yeast feeds on the soluble protein (see page 8). Yet it is a curious fact that in a series of comparative tests in which 18 known and 15 unknown varieties of yeast were used, the resulting breads were alike in flavor and odor.<sup>3</sup>

5. As fermentation progresses the dough "slackens" because its gluten is being slowly dissolved by the small percentage of acids forming. Likely enough the yeast itself has some action on gluten as well as its well-recognized digestive action on the albuminoids; though it is known that dough without any yeast will slowly slacken because the flour enzymes are busy degrading both starch and protein.

6. A small portion of the flour protein is in amid forms which is lost when the yeast converts the amids to ammonia.

7. The breaking up or oxidation of the fat does not depend at all on the yeast, but on the heat of baking.

<sup>1</sup> p. 448.

These volatile bodies caught in sulfuric acid gave carbon sufficient for 0.10 per cent. carbon dioxid, (Exp. Sta. Bulletin 67, 1899; p. 16.

<sup>2</sup> Wisconsin Station Report 1898; p. 110.

<sup>3</sup> Ruth G. Wardall, in *Journal of Home Economics*, 1910; 75.

“Summing up the changes in panification—they are alcoholic fermentation of the sugar, softening and proteolytic action on the proteins, and a limited diastasis of the starch.”<sup>1</sup> The total loss of bread substance has been variously guessed at or estimated, by Daughlish at 3-6 per cent., Vorhees 3-4, Fehling 4.21, Jago 2.5, Heeren 1.57, Graeger 2.14.<sup>2</sup>

In the dough, then, the yeast is given an opportunity to start fermentation, but the tight nature of its new home will not allow it to travel for its food. Hence it must soon begin to want for food and air and soon begin to choke in its own excrement. The tighter the dough the less chance there is for it to bud and reproduce to any extent.

All this explains why a sponge-process batch is started with a slack dough. Here the yeast has much more freedom in its semi-liquid surroundings and can reproduce; when the dough is made from the sponge the latter contains more than enough vigorous yeast cells to be distributed throughout the tighter dough. Each time the dough is pulled over, the yeast within is given a new lease of life. However, at best, yeast does not greatly multiply in either sponge or straight dough.

Lindet's observations showed him that there were more cells in slack dough, but less enzymic action; the reverse held for dense doughs. An increase from 20° to 30° C. (68°-86°F.) favored multiplication and decreased enzymic action. Aeration favored multiplication but was not indispensable. He observed that at 20° C. and for 18 hours time, yeast in dough in the amounts 1/1,000, 2/1,000, 4/1,000 and 8/1,000, increased in the amounts 8.4, 6.4, 3.7 and 1.8. While if too much yeast was used it decreased in amount.<sup>3</sup>

<sup>1</sup> Jago; p. 424.

<sup>2</sup> Exp. Sta. Bulletin 67, 1899; p. 11.

<sup>3</sup> *Compt. rend.*, 150, 1910; 802.

Yeast dies in the dough when the heat goes above 60° C. (140° F.). And the reactions from then on are due to the heat. Thus a baked loaf contains much gelatinized starch in the crumb, and the crust is composed partly of caramel from the sugar and of dextrin from the starch.

### LEAVEN AND HOMEMADE YEASTS

Barley bread four thousand years old, taken from the tombs of Egypt, showed yeast cells under the microscope. This ancient yeast came from the "leaven," which was merely a portion of dough taken from a previous batch, and well crowded with all manner of yeasts, wild yeasts and bacteria. As a result leavened bread contained its full share of lactic and other flavors which these mixed ferments set up. This kind of ferment starter has been standard for centuries. The Scotch barm and the potato ferment are modifications of the leaven, in which the mixed yeasts from an original spontaneous fermentation are so treated that bread yeasts become predominant: lactic acid bacillus, which seems to have its function in giving a buttermilk flavor, is encouraged in the barms. After the bakers began to go to the brewer for his top or bottom yeasts, they found that they could save themselves time and money; and later the industry of compressed yeast making has driven barms and potato mixtures out of progressive regions. Compressed yeasts have also helped to make straight dough and short fermentation recipes more popular.

In some districts bakers and especially housewives still make their own ferment. Potatoes are boiled to gelatinize the starch and dissolve the protein; the boiled potatoes, or preferably the water from their boiling is allowed to ferment spontaneously or is started with a cake of compressed yeast. Hop water, added to the spontaneous or "virgin" ferment, helps markedly to check

troublesome varieties of yeast and bacteria; and raw flour gives added nourishment to the yeast which feeds on its protein. The yeast also appears to convert some of the flour protein into enzymic compounds which hydrolize the potato starch<sup>1</sup> to sugars for the yeast. The mixture of potato water, flour and yeast is used entire by the baker, and one of its virtues is that it is so rich in yeast food that yeast goes on growing in the dough.

Jago<sup>2</sup> quotes the following process for the manufacture of a malt-and-hops yeast: "Forty gallons of water and 2 pounds of sound hops are boiled together for half an hour in a copper, and then passed over a refrigerator, and thus cooled to a temperature of 71° C. (160° F.). The liquor passes from the refrigerator to a stout tub; 1½ bushels (about 63 pounds) of crushed malt are then added, and the mixture thoroughly stirred. The mash is allowed to stand at that temperature for 1½ hours, filtered from the grains, and then rapidly cooled to 21° C. (70° F.). The passage over the refrigerator serves also to thoroughly aerate the wort. Spontaneous fermentation is then allowed to set in, and the yeast is usually ready for use in 24 hours, but is in better condition at the end of two days. All fermenting tubs, and other vessels and implements used, are kept clean by being from time to time thoroughly scalded out with live steam. The result is the production of a yeast of very high quality." Jago and Kirkland both give detailed descriptions of the making of "virgin barm" (a malt-and-hops spontaneous ferment) and "Parisian barm."

Boutroux<sup>3</sup> states that in France a portion of the dough is taken for the leaven of a future baking; it is mixed with equal amounts of flour and water and put away for four or five hours.

<sup>1</sup> Jago; p. 422.

<sup>2</sup> Ibid.; p. 246.

<sup>3</sup> "Le pain et le panification," Paris, 1897; p. 23.

It is again mixed as before and again let stand. Several repetitions of this greatly multiplies the legitimate yeast at the expense of the harmful vegetation. This leaven forms about one-third of the dough for a baking—somewhat more in winter and less in summer.

Compressed yeast is made or expressed to practically all parts of the country. But there always will be regions where yeast can only be obtained at intervals measured by days or weeks. In these cases the baker must either rely on baking powder, or he must make stock yeast that can be drawn on. The following quotation from *Baker's Helper* will cover this contingency :

“When one gets in the western country he finds quite a few jobs where he is compelled to make his own yeast. This recipe works in both high and low altitudes. Here the altitude is seven thousand four hundred and forty feet above the level of the sea. This is the method I suggest :

“Take seven pounds of potatoes, wash them clean then peel ; put the potatoes and peelings on the stove and boil in a pot large enough to keep them covered with water. Boil till the potatoes are soft and tender (the tenderer they are, the easier they are to mash). When they are boiled enough, take them off the stove, take out the potatoes and throw the peelings away, but save the water they were boiled in ; add enough more water to make seven quarts ; put the water back on the stove to boil.

“While the water is boiling, put the potatoes into a bowl and mash ; then add three pounds of bread flour to the potatoes, stirring with the masher until they cool off so that you can put your hands in ; rub this between the hands like pie dough, so that you get the potatoes and flour mixed well. When the seven quarts of water boil, take off the stove and add slowly to the flour and potatoes, stirring continually with an egg whip. After

the seven quarts of water are in, strain the mixture through a sieve or colander; let this mixture set two hours. By that time it will be cooled down to about 90 degrees; then add six cakes of 'Yeast Foam' dissolved in two quarts of water at about 80 degrees. Stir well, then let it set for four hours more, during which time it will form a foam on top and sizzle.

"At the end of four hours add enough water at 75 degrees to make sixteen quarts in all; add about eighteen pounds of bread flour and mix good and smooth. Let this set four hours; in that time it will rise and break. Add sixteen quarts water at 60 degrees, six cakes 'Yeast Foam' dissolved in some of the water, two and three-quarter pounds of sugar, two and three-quarter pounds of lard, one and one-half pounds of salt, and add enough flour to make a good working dough. Let this rest eleven hours and scale out; mold up and pan. Let it prove and bake. This will make 60 three-pound loaves of good fine-eating bread. Here I start my yeast at 8 o'clock in the morning; let it set until 10 o'clock; then mix in the 'Yeast Foam'; then at 2 o'clock I mix in the rest of the water to make the sixteen quarts and the eighteen pounds of flour; at 6 o'clock I mix in the sugar, lard, etc.; set till 5 A. M., and scale out and pan. I hope that this will help some brother baker, as I know it is reliable."

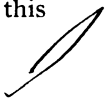

## SALT-RISING FERMENTATION

---

As late as 1898 the Federal Department of Agriculture held the theory that "the fermentation of the dough may also be secured by the enzymes naturally present in the flour. This process of bread-making is known as the salt-rising method. A convenient quantity of wheat meal and corn meal is mixed with a little salt and hot milk and set in a warm place. In the course of a few hours fermentation ensues and the whole mass becomes porous. In this condition it is mixed with the wheaten flour to form a dough, which, when set aside in a warm place, undergoes a fermentation which in many respects is similar to that produced by yeast."<sup>1</sup>

This enzymic theory of salt-rising fermentation was not allowed to stand; for bread made by this process was very uncertain and the fermentation gave symptoms that enzymic action did not explain.

Kohman found that this bread rises best between 40° and 50° C. (104°-122° F.), that it could be made without milk, but that both milk and malt extract were beneficial. Milk seems to quicken the leavening and to increase the amount of gas given off. This bread needs only one rising, and it is wise to mold up the newly-made dough from the risen sponge and put in pans at once. This is probably because the proteolytic (digestive) action of the salt-rising ferment is much more rapid on the gluten than is yeast. The function of the salt seems to be to prevent objectionable fermentation from starting up at the same time, such for instance as lactic and butyric which spoil the flavor of the bread.

<sup>1</sup> Bureau of Chemistry, Bulletin 13, "Foods and Food Adulterants," 1898; p. 1301.

Salt-rising bread is slightly sour, like Vienna bread; it is also very white, fine and evenly grained and has a distinctive flavor and odor not found in yeast bread. But the process is uncertain. One day the dough may rise readily and the next day it may have to be remolded with compressed yeast. Since no yeast nor sour dough is used it is evident that the source of the so-called spontaneous fermentation must be either air, or the flour or milk. It has been the common impression that the salt-rising reaction is most dependable when the dough is mixed in a certain room for a period of time. Mrs. Rohrer has suggested that the reaction seems to fail in a well-sterilized room.

And because this process is both good and uncertain it has been thought worth while to try to isolate the fermenting principle; and to endeavor to put this agent in the hands of bakers in as dependable a form as is compressed yeast. Several investigators have presumed that either yeast spores or bacteria from the air found their way into the dough and set up fermentation just the same as the leaven or "Sauerteig" ferment. Both yeast and bacteria are found in leaven and "Sauertig;" but several scientists, among them Henry A. Kohman,<sup>1</sup> have made salt-rising dough that contained no yeast cells but literally swarmed with bacteria.

These bacteria must enter the dough, either with the milk, the flour, the cornmeal, or from the air of a well-inoculated room. But a series of selective experiments in which first cornmeal, then milk were omitted, while the mixing was done in a sterile atmosphere, suggested that the cornmeal was the source of the bacteria. In fact both flour and cornmeal may carry these ferments, though flour seems less liable to; for good results are gotten with pure flour and cornmeal not too thoroughly cleaned

<sup>1</sup> See the series of papers by this author in *Bakers Review*, beginning August, 1911.



in the milling. But the fact is that air, flour, meal and milk may all supply these ferments.

The next question to solve was, Is the salt-rising bacteria a single variety? To answer this, Kohman made a set of plates from a salt-rising "emptyings," which contained bacteria but no yeast. A number of tubes were inoculated, incubated and a selection made from a tube which showed fermentation. It is not practicable to use sterile flour in baking tests, so Kohman contented himself with enlarging his pure culture colony to the point where it could be used in a dough. Sterile milk was inoculated with his pure culture, incubated 17 hours and the sponge then made with this milk. The sponge dropped in two hours, when it was made into a dough, molded at once and put in pans. It rose well and when baked had all the characteristics of salt-rising bread.

These experiments have settled definitely that the salt-rising organism is a separate variety which it is possible to use from pure culture, and a salt-rising yeast, made from dry batter, was used with uniform success for a month in one bakery. Salt-rising ferment is now manufactured and sold in this country by two separate companies. The ferment produced works uniformly and well.

Kohman carried his research farther. He found that there was no alcohol produced by this process and that the leavening gas was made up of about two parts hydrogen and one of carbon dioxid and no hydrocarbons; so he suspected that the fermentation loss was less than in yeast bread. And his comparative tests confirmed this.

Bread fermented normally from Kansas patent lost 5.15 per cent. in weight, bread put into pans at once on mixing lost 1.81 per cent., and salt-rising bread lost only 0.44 per cent.

Kohman concludes that the ordinary salt-rising fermentation is brought about by bacteria which act principally on the sugars of the flour and milk and especially on milk casein. These bacteria seem to consist of a mixed flora, some of which as spores live through the boiling temperature and would be found in batter from boiling milk. While others, not capable of forming spores, died at a temperature of 77° C. (170° F.). Among these was the variety separated for his pure culture; this was thought to belong to the *coli* group—the same that was called *bacillus levans* by Wolffin and Lehman. None of these varieties kept in liquid media over 24 hours, but could be made up in a dry starchy cake for indefinite future use.

A standard recipe is: Cornmeal, salt and soda are thoroughly mixed and stirred into enough hot milk or water after boiling, to make a batter of the consistency of corn meal mush. This batter or “emptyings” as it is commonly called is kept in a warm place 15 to 20 hours or until it becomes light and shows the evolution of gas, and is then mixed with flour and water to make a slack sponge. The sponge is allowed to come up well, which may take from one to three hours, and is then mixed with the remainder of the ingredients to make a dough of the usual stiffness. The dough is allowed to stand, not longer than an hour, and at times is molded into loaves immediately upon mixing. After it has risen to the degree of lightness desired, it is baked in the usual way.

## BAKING POWDERS

### GENERAL

The name baking powder covers a wide range of substances which are incorporated in a dough to give forth leavening gas in the oven. However, the term may now be limited to this equation:

Acid + alkali + water + heat = carbon dioxide + neutral salt residue.

Kirkland<sup>1</sup> states that the first mention of baking powder in England dates at eighty years ago, as pearlash and alum and later as sesqui-carbonate of ammonia. Baron Liebig, the great German chemist, and the first man to handle the subject scientifically, suggested

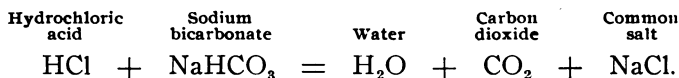

The first patent, by Dr. Whiting in 1837,<sup>2</sup> used the above formula. Thus, from the beginning, sodium bicarbonate appears as the alkali. The subsequent history of baking powder manufacture centers in the endeavors to obtain a satisfactory substance for the acid. The first decided advance was in the use of a solid acid substance. Professor Horsford, of Cambridge, Mass., patented his acid phosphate powder in 1864, and interested his former teacher, Liebig, in introducing and manufacturing it in Germany. Horsford began to advocate phosphate powder in 1861, and Liebig in 1869.<sup>3</sup> The Hoaglands, Fort

<sup>1</sup> "The Modern Baker, Confectioner and Caterer," John Kirkland, London, 1910; p. 239.

<sup>2</sup> Ibid.

<sup>3</sup> "The Theory and Art of Breadmaking," E. N. Horsford, 1861; p. 31.

Wayne, Indiana, druggists, are said to have originated the cream of tartar powder in 1868.<sup>1</sup> They founded the Royal Baking Powder Company. "Alum" powder appeared about 1880.<sup>1</sup> The acid substance "S. A. S.," which now replaces the alums, dates from 1892. The United States, which claims much the largest per capita consumption of baking powders, manufactures the so-called cream of tartar, phosphate and "alum" powders, according to modifications or combinations of the three following general formulas:

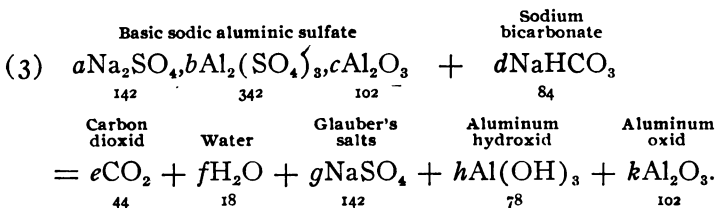
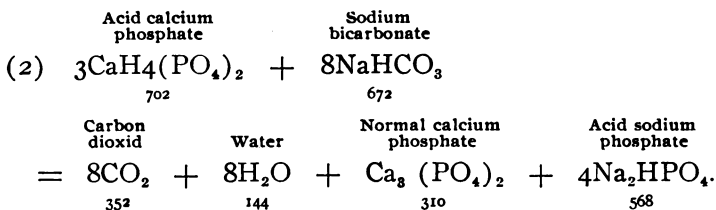
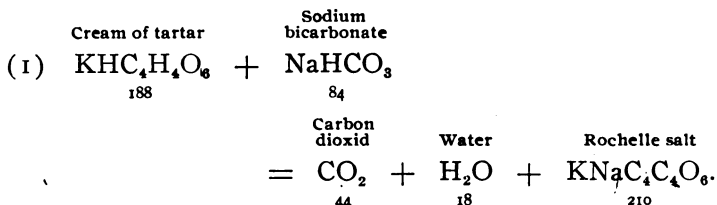

From the standpoint of the consumer, the ideal baking powder (a) gives the most gas for the least volume and weight of

<sup>1</sup> "The Baking Powder Controversy," A. C. Morrison, New York, 1904.

powder; (b) gives the gas slowly when cold and increasingly in the cooking dough; so the dough may be mixed cold and kept standing several hours; begins to generate gas in quantity in the oven and ceases to generate when it would rupture the crumb; (c) leaves a tasteless and absolutely harmless residue in the bread; (d) is cheap; (e) keeps well. The chemicals should not react on one another in the can and thus lose strength.

### THE ALKALI

It will be noticed that sodium bicarbonate appears in all of the foregoing formulas. The aerating gas, carbon dioxide, comes from the reaction of the acid on sodium bicarbonate, which holds the field as the alkali substance.

"Soda" is a white salt with alkaline taste, made chiefly by the ammonia-soda process<sup>1</sup>

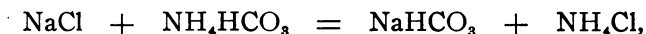

or the Solvay process

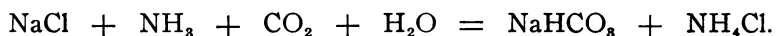

It gives off  $\text{CO}_2$  readily when heated. The resultant  $\text{Na}_2\text{CO}_3$  is a rank tasting alkali that yellows the bread. For this reason "soda," or "saleratus," is not used alone, but is neutralized with an acid principle that will leave a palatable salt residue. The sodium compounds are mostly inoffensive and neutral in the digestive tract.

Other compounds sometimes used for or with soda are magnesium, potassium and ammonium carbonates. The addition of a small percentage of magnesium carbonate is not uncommon. It is cheap, bulks seven times<sup>2</sup> as much as "soda," and is much

<sup>1</sup> "Sulfuric Acid and Alkali," Vol. III, p. 15, G. Lunge.

<sup>2</sup> "Baking Powder," F. S. Foot, New York, 1906.

slower reacting. It supplements the initial reaction of "soda" and makes a better keeping powder. Its salts are harmless but often unpalatable. Potassium carbonate has been rejected because of its bitter residues. Ammonium carbonate can be used alone

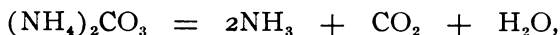

or the sesqui-carbonate, both of which are volatile at oven heat. While these two carbonates, when pure, leave no residue, their odor is not always driven out of the goods.

### THE ACID

**Cream of Tartar.**—While the alkali has always been sodium bicarbonate, many compounds have been used as the acid substance. Cost and availability have been variable quantities, and aerating value, keeping quality, and the character of the residues have been constant quantities, governing the choice of the acid. The aerating value is calculated from the molecular weights in the reaction, according to the proportion

$$100 : X = \text{acid} : \text{sodium bicarbonate.}$$

Tartaric acid ( $\text{H}_2\text{C}_4\text{H}_4\text{O}_6$ ) and its acid potassium salt (cream of tartar), either or both, form the acid of the tartaric powders (Formula 1). Crude cream of tartar is deposited as argols in wine casks. It is obtained in California, and is imported from France, Italy, etc. Cream of tartar ( $\text{KHC}_4\text{H}_4\text{O}_6$ ) is present in the juice of grapes. Fermentation causes it to crystallize out in hard red aggregations, as it is insoluble in alcohol. These argols are purified by double crystallization. One part cream of tartar is soluble in 15 parts boiling water, and in 416 parts water at  $0^\circ \text{C}$ .<sup>1</sup> The red grape color is taken up by pipe clay or egg albumen. Tartaric acid is a by-product in the manufacture of

<sup>1</sup> Encyclopedia Brittanica, Vol. XXI; p. 43.

cream of tartar. Tartaric acid, having two acid radicles compared with one in cream of tartar, will react on more than twice the amount of soda—in other words its aerating efficiency is more than double that of cream of tartar. It is not preferred, however, as its reaction is rapid and complete with cold water, and its keeping quality correspondingly poor. As high as seven per cent. tartaric acid is now used in baking powder, with a gain in the aerating value and apparently no loss in the keeping quality. Cream of tartar forms the bulk of the acid in its powders, with often a small percentage of tartaric acid to give quick initial reaction, or with acid calcium phosphate. Efforts have been made to make tartaric acid available by coating the crystals with egg albumin, melted paraffin, etc. Cream of tartar powders are the most expensive, keep well and aerate well. The residue, sodium potassium tartrate, plus four molecules of water of crystallization, is known as “Rochelle Salts,” a mild, cooling purgative. This residue is slightly greater in weight than the original cream of tartar and the “soda.” The residue from using tartaric acid is normal sodium tartrate. Cream of tartar has an aerating value of 44.7; tartaric acid, 112.0.

√ **Phosphate.**—The acid of the phosphate powders is monocalcium phosphate ( $\text{CaH}_4(\text{PO}_4)_2$ ). “Phosphate” is a deliquescent, transparent, crystalline substance obtained by the sulfuric acid digestion of calcined bones.

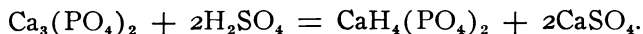

Its principal impurity is calcium sulfate. It has such a strong affinity for air moisture that it will not keep unless specially treated. Phosphate powders were once sold in two packages, keeping the acid separate until mixed in the dough. Coarsely granular structure improves the keeping quality. A recent method of mixing the liquid phosphate with starch and drying

the whole is said to be successful. Phosphate is cheaper than cream of tartar and reacts favorably in the dough. The residue is made up of neutral calcium phosphate which is insoluble, and di-sodium hydrogen phosphate with 12 molecules of water of crystallization.<sup>1</sup> The latter soluble residue is about three-fifths of the weight of the reacting chemicals. This residue is claimed to have a positive food value, supplying the phosphoric acid to replace that milled out of wheat by the roller process. The aerating value of the pure salt is 95.7, according to Formula (2).

**Aluminum Salts.**—These salts, whose baking powders have been called “alum” powders, need a more discriminate naming. *Alum* has the symbol  $K_2Al_2(SO_4)_4, 24H_2O$ . The *alums* are a salt group with the general molecular construction  $M_2N_2(SO_4)_4, 24H_2O$ , in which M is sodium, magnesium, caesium or one of the other monovalent metals, and N is the trivalent element aluminum, or sometimes iron, manganese, etc. The alums are of similar symbol, crystallize in the isometric system, and are soluble in water. They have an astringent taste. When calcined, the water of crystallization is driven off and the salt falls into a fine powder. Alum and ammonium alum so treated are less soluble and astringent and are called “burnt” alums. Sodium alum is a possible salt that is not a commercial substance, as it is very difficult to crystallize. The alums are made by mixing correctly proportioned solutions of the two sulfates and allowing the mixture to crystallize. Aluminum sulfate was formerly made from cryolite and bauxite. It is now made only from bauxite ( $Al_2O_3$ ). Potassium sulfate is mined in a lacustrine deposit which contains it capping rock salt at Stassfurth, Germany. Ammonium sulfate is a by-product from gas and coke works. Sodium sulfate is found in the arid districts

<sup>1</sup> “Qualitative Chemical Analysis,” Fresenius; p. 66.



of our West, and is obtained as a by-product from the manufacture of hydrochloric acid.

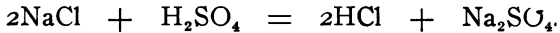

Alum and ammonium alum were first used in the manufacture of alum powders, by manufacturers who bought them under the name "C. T. S." (cream-of-tartar substitutes). The powders made from "C. T. S." were strictly alum powders, and might be illegal in certain territories. In 1892 the *basic sodic aluminic sulfate*, "S. A. S.," was evolved. This substance, either alone or combined, with phosphate or tartaric acid, is now used to the exclusion of the alums. As noted in Formula (3) the symbol of the latter salt calls for indefinite amounts of the two sulfates and for an excess of aluminum in the form of oxid. One analysis of the compound shows it to contain  $70\frac{1}{2}$  per cent. aluminum, and  $27\frac{3}{4}$  per cent. sodium sulfates.<sup>1</sup> This makes no allowance for  $\text{Al}_2\text{O}_3$ . For the reason that sodium sulfate forms a bitter residue the proportion of it is cut low. This compound has an aerating value of about the same as tartaric acid, has first class keeping quality, and is nearly tasteless.

This basic sodic aluminic sulfate is made as follows: Nitre cake ( $\text{Na}_2\text{SO}_4$ ) is dissolved in water and the arsenic is precipitated with a sulfid. The solution is filtered and boiled down with bauxite ( $\text{Al}_2\text{O}(\text{OH})_4$ ), filtered again and evaporated until the salt begins to crystallize out. The thin cakes of the salt are then calcined to nearly red heat ( $560^\circ \text{C}.$ ) in a revolving steel drum. This substance has no fixed symbol and is in no sense an alum.

Supposing that the pure soda were mixed with the pure acid substance so as to exactly neutralize, the following percentage weights of carbon dioxid would be obtained: cream of tartar 16.2, tartaric acid 27.6, basic aluminic sulfate 30.6, ammonium

<sup>1</sup> Gilbert L. Bailey, Los Angeles, 1911.

alum 33.7, calcium phosphate 25.6; ammonium carbonate alone 63.5; tartaric acid and magnesia 14.5.

### STARCH

The starch of baking powder is not only not a filler or adulterant—it is necessary in most climates to keep the acid and alkali from a too intimate contact, and to absorb the moisture of either. Flours, potato and other starches are inferior to corn starch of commerce, which should be of neutral reaction and dried from normal 13-18 per cent. to not less than five of moisture. Starch is used in percentages of 10-50 per cent. Only when used in excess or when made up with inferior starch, talc or "terra alba" (gypsum) is starch objectionable. As with other food products adulteration would not pay even temporarily except through misleading advertising. The alum powders of 1889<sup>1</sup> were notably low in aerating value and high in starch. The present aerating value of all good modern baking powders is approximately the same.

### GENERAL

Eleven per cent. by weight is a normal amount of "available" carbon dioxid.<sup>2</sup> Deterioration may bring this down below 2 per cent. of weight. As before intimated it is quite as important that the powder give off gas according as it is needed in the dough, not too readily when cold and not at all after the crumb begins to form. The full evolution represents the "available," not the total carbon dioxid. Different flours and forms of cake and bread need specially balanced powders.

Egg albumin is used to some extent to increase the efficiency of the CO<sub>2</sub> evolved. The albumen, which is very retentive of the gas, reinforces the same property of the gluten of flour.

<sup>1</sup> U. S. Dept. Agr., Div. of Chem. Bulletin 13, Part V, 1889.

<sup>2</sup> Foot gives 14 per cent., or 50 times its volume of gas.

LEAVENING AGENTS

APPROXIMATE FORMULAS OF SOME LEADING BAKING POWDERS.  
 (Many unimportant constituents are omitted. The authorities quoted do not always state the kind of alum.)

	Royal		Price's		Rumford's		Patapsco		Atlantic & Pacific		Calumet		Crown	
	1906 <sup>1</sup>	1906 <sup>4</sup>	1906 <sup>1</sup>	1889 <sup>2</sup>	1906 <sup>1</sup>	1889 <sup>2</sup>	1906 <sup>1</sup>	1889 <sup>2</sup>	1906 <sup>1</sup>	1889 <sup>2</sup>	1906 <sup>1</sup>	1889 <sup>2</sup>	1906 <sup>1</sup>	1887 <sup>3</sup>
Soda.....	27.5	27	25.5	23.5	28	25.5	19	18.0	25	18.0	28	..	25	18
Starch.....	17.3	20	21.0	18.5	14	26.5	42	44.0	37	37.5	34	..	51	41
Cream of tartar.....	55.3	50	53.5	50.0	..	..	..	..	..	..	..	..	..	..
Tartaric acid.....	..	3	..	..	..	19.0	..	..	..	..	..	..	..	..
Ca(PO <sub>4</sub> ) <sub>2</sub> .....	..	..	..	..	..	18.0	..	2.5	..	3.5	..	..	..	..
H <sub>3</sub> PO <sub>4</sub> .....	..	..	..	..	..	..	..	2.0	..	5.5	..	..	..	..
Mono-calcium phosphate (anhyd).....	..	..	..	..	58	..	20	..	17	..	17	..	..	..
Anhydrous alum.....	..	..	..	..	..	..	19	19.0	21	13.0	20	..	24	15
Available CO <sub>2</sub> .....	..	..	..	11.1	..	12.9	..	8.4	..	7.9	..	..	..	..
Cubic inches of CO <sub>2</sub> in 1 oz. powder.....	..	..	..	134	..	155	..	101	..	95	..	..	..	..
Water of crystallization.....	..	..	..	5.5	..	7.5	..	13.0	..	16.0	..	..	..	..

<sup>1</sup> "Baking Powder," F. N. Foot, New York; p. 41.  
<sup>2</sup> U. S. Dept. Agr., Div. of Chem., Bulletin 13, Part V, (approximate decimals).  
<sup>3</sup> Annual Report Ohio Dairy and Food Commission, H. C. Weber, 1887.  
<sup>4</sup> In bulk.

In warm climates all food stuffs deteriorate more rapidly than elsewhere. The length of time required for proper yeast fermentation as well as the more perishable nature of foods prepared with it and inability of yeast to raise dough rich in eggs, butter, etc., led to the present day widespread use of baking powders. Such powders act at once, the gas therefrom raising the dough purely mechanically without any alteration or semi-digestion of the flour, as is the case when yeast is used. Foods raised with baking powder may be safely used hot from the oven, in fact most of them are so used.

#### KIND OF FLOUR

A test to determine whether the hard or soft wheat flours were better for baking powder biscuits was carried out in the Macdonald Institute, Guelph, Ontario.<sup>1</sup> The flours were two high patent Manitoba, a nearly straight Ontario, a 20-80 blend of a Manitoba high patent and the straight Ontario, and two soft Ontarios, 85 and 35 per cent. respectively. The flours were subjected to a uniform baking test; the recipe called for 300 grams flour, 24 butter, 16 baking powder, (kind not stated) 218-252 milk (the Manitoba patents taking the most milk) and an oven temperature of 232° C. The judges were a committee of three members of the Dominion Millers' district meeting.

The conclusions were that the soft Ontario flours made the best handling dough and the tenderest and cheapest biscuits.

#### CARE OF BAKING POWDERS

**T** All baking powders are naturally in a measure perishable, deteriorating by reason of the gradual loss of gas available. The various powders vary in keeping qualities, those containing aluminic sulfate being the more durable, stronger and much less expensive.

<sup>1</sup> Thirty-fourth Annual Report of the Ontario Agricultural College, 1908.

Any and all baking powders should be kept away from moisture and heat. They should be kept tightly sealed. Nothing should be added to or used in connection with baking powder, of an acid or alkali nature, in any such quantity as to disturb the nice chemical balance existing between these two elements in any well made powder. Baking soda, which is the same as saleratus, also sour milk or fermenting molasses, are the materials most likely to be improperly added in this way. If the baking powder is known to be quite old and must be used notwithstanding age, the use of some sour milk or fermenting molasses in the water, or sweet milk employed to mix the flour with, may restore some of the probably missing acid strength needed to release the gas. (See under "Analysis" for easy method testing for excess alkali). Grocers are especially warned by manufacturers not to place new food stuffs in front of old on their shelves but to sell off senior goods first.

### MISCELLANEOUS SUBSTITUTES

Some of the relatively successful substitutes for a good baking powder are:

✓ Sodium bicarbonate alone. Its residue,  $\text{Na}_2\text{CO}_3$  gives the bread a rank taste and yellow color.

Ammonium carbonate,  $(\text{NH}_4)_2\text{CO}_3$ , ("volatile"). It has six times the aerating value of an aluminic powder. Ammonium carbonate was once under the prejudice of its source of manufacture. However, it is now made from coal. Unless the bread is in small sizes all of the salt is not driven off and the taste and smell remain.

Baking soda and sour milk. Here the lactic acid of the milk neutralizes the soda. Such a mixture must always be by guess, and it is not possible to neutralize sufficient soda with the dilute milk acid.

Baking soda and old fermenting, or "working" molasses. Considerable skill is required to judge of the necessary proportions.

Beating up graham or whole dough and baking quickly in cast iron pans gives a fair bread.<sup>1</sup>

Making up a stiff dough with snow crystals.<sup>1</sup>

Beating eggs into the dough.<sup>1</sup>

Using the volatile property of alcohol by mixing in wine or brandy.<sup>1</sup>

### RESIDUES IN THE BREAD

The first requirement of a baking powder, of course, is that its reaction in the dough, and its residues, shall be harmless to the consumer. If the "baking powder controversy" was of special value to the world it was in showing that there is no record as yet of injurious result from using any baking powder well made by any of the standard formulas. In a baking powder it is not a question of whether "alum" is harmful or phosphate and cream of tartar wholesome, but of whether their residues in bread are deleterious. Using the three primary powders according to recipe, one would have to eat the following number of biscuits to take a dose of their residual salts.<sup>2</sup>

	Biscuits
Cream of Tartar .....	48-96
Phosphates .....	120-240
Alum .....	80-160

The baker and housewife must bear in mind that when a good baking powder is mixed in the dough, it will be a different substance in the baked bread. Neither "alum," phosphate nor cream of tartar will remain.

<sup>1</sup> "Sanitary and Applied Chemistry," L. H. Bailey, New York, 1906; p. 155.

<sup>2</sup> (U. S. and National Dispensatories). "Baking Powder," F. N. Foot, New York, 1906.

Kirkland<sup>1</sup> mentions lead being found in some English cream of tartar. Sulfates may contain small quantities of arsenic.

It seems to be taken for granted that the chemicals of the different powders do not react on the dough substance. Hence in graham and whole-wheat flours baking powders may be used to avoid the degrading action of the flour enzymes during fermentation; or in doughs rich in eggs, butter, etc., in which yeast will not act. A self-rising flour is one which contains a baking powder mixture, usually a phosphate.

### MANUFACTURE

The manufacturing unit consists of receiving bins, drying and grinding apparatus, sieves and a mixer. In the larger factories automatic scales, conveyors, packing machines are necessary. It is to be supposed that the ingredients will vary in purity and hence in reactive value, from time to time; and this will suggest that the amounts by weight of the ingredients must vary and that quantitative tests should play an important part in careful manufacture. Ingredients are tested before mixing for purity and for dangerous impurities, and after mixing for aerating value and keeping quality. A double system of checking the mix day by day will prevent malmixtures getting beyond the factory. It is said that businesses have been ruined by marketing one wrongly made up batch of baking powder.

Besides comparative purity of the chemicals, it is necessary that they be well dried. The starch is dried to about 8 or 9 per cent. of moisture. Phosphate should be protected from moisture. Care in drying the soda prevents its gas being driven off. To prevent intimate contact all but the starch are better in a granular state—especially the phosphate and tartaric acid. As noted before, an artificial coating of paraffin, albumin, starch,

<sup>1</sup> Vol. I, p. 241.

etc., is sometimes added to the acid ingredient. Finally the powders are packed in tins, practically air and moisture proof—a decided improvement over the paper package.

### ANALYSIS

Baking powder analysis falls under two heads: (1) The manufacturer's tests of his ingredients for percentage of purity, freedom from dangerous impurities and his analysis of the finished powder for mistakes in mixing, for available carbon dioxid and keeping quality; (2) The food chemist's (government) tests for freedom from adulterants, poisons, and for available carbon dioxid.

Adulterating with terra alba or excess starch or flour would not pay as it markedly decreases the strength of the powder. The ingredients coming to the manufacturer do not purport to be chemically pure, but contain small quantities of unimportant iron, magnesium, calcium and sodium salts. Arsenic is an occasional impurity in sulfates.

Mistakes in mixing may be easily caught, independent of the check sheets, by dissolving the powder in pure water, boiling to make a complete reaction and testing for marked excess acid or alkali with litmus paper. An exact mixture gives a purple color, which becomes red in excess acid and blue in excess alkali. Theoretically the baking powder is so mixed that the acid and alkali shall exactly neutralize each other. Actually, however, tartrate powders give a slightly acid end reaction and other powders an alkaline reaction. The accuracy of the mixing is tested as follows: One grain of the powder is boiled for several minutes, the solution made acid with five cc. of tenth normal sulfuric acid, then titrated with tenth normal sodium hydroxide. The indicator is phenolphthalein. A correct alkaline powder will require about 4.5 cc. of the hydroxide solution.



Keeping quality is tested briefly as follows:<sup>1</sup>

A given weight of powder is first analyzed for total CO<sub>2</sub>; is then spread on watch glasses and exposed to the air for a stated time. The difference between total CO<sub>2</sub> before and after the exposure indicates the keeping quality under extreme conditions. To approximate an extreme long-time test, the watch glasses of the powder are set for a stated time in a covered bell jar, in the bottom of which is a dish of water. For determination of free and total tartaric acid, cream of tartar, phosphoric acid, ammonia, starch, etc., see Bulletin 107, (1907) Bureau of Chemistry, U. S. D. A.

Available CO<sub>2</sub> is the difference between *total* CO<sub>2</sub> and residual CO<sub>2</sub>.

Available CO<sub>2</sub>: Total CO<sub>2</sub> = x:100 is determined as follows:<sup>1</sup>

"Weigh two grams of baking powder into a flask suitable for the subsequent determination of carbonic acid, add 20 cc. cold water, and allow to stand 20 minutes. Place the flask in a metal drying cell surrounded by boiling water and heat, with occasional shaking, for 20 minutes."

"To complete the reaction and drive off the least trace of gas from the scum and solid mass, heat quickly and boil one minute, aspirate until the air in flask is thoroughly changed and determine the residual CO<sub>2</sub> by absorption, as described."

Knorr's method<sup>2</sup> for total CO<sub>2</sub> is as follows:

"Place some of the baking powder in a perfectly dry distilling flask (Fig. 11). Close the flask with a stopper carrying the tube connecting with the absorption apparatus and also with the

<sup>1</sup> "Baking Powders," C. A. Catlin, Providence, 1899; p. 23.

<sup>2</sup> "Methods of Analysis;" U. S. Dept. Agr., Bur. of Chem., Bulletin 107; pp. 169-178.

funnel tube. Weigh the tubes in which the carbon dioxide is to be absorbed and attach them to the apparatus. In case two Liebig bulbs are employed, one for potassium hydroxid (1.27 or 1.55) and the other for sulfuric acid to absorb the moisture given up by the potassium hydroxid solution, weigh them separately. If two soda-lime tubes are employed, it will be found advantageous

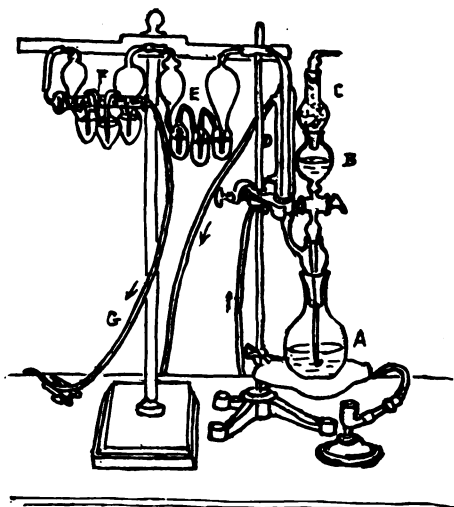

Fig. 11.—Knorr's apparatus for the determination of  $\text{CO}_2$ . A—Distilling flask fitted to condenser by a ground-glass stopper; B—Reservoir containing acid; C—Soda-lime tube fitted to acid reservoir by a ground-glass stopper; D—Condenser; E—Liebig bulb with a solution of KOH for the absorption of  $\text{CO}_2$  and followed by a CaCl tube. An additional guard tube filled with soda lime should follow the tube F, though not shown in the cut. From U. S. D. A., Bur. of Chem., Bull. 107.

to weigh them separately and fill the first tube anew when the second tube begins to increase in weight materially. Nearly fill the tube B with hydrochloric acid (sp. gr. 1.1) and place the guard tube C in position. Then start the aspirator at such a rate that the air passes through the Liebig bulb at about the rate of two bubbles per second. Open the stopper of the funnel and allow the acid to run slowly into the flask, care being taken that

the evolution of gas shall be so gradual as not to materially increase the current through the Liebig bulb. After all the acid has been introduced continue the aspiration and gradually heat the contents of the flask to boiling, the bulb in tube being closed. While the flask is being heated the aspirator tube may be removed, although many analysts prefer, when using ground glass joints, to aspirate during the entire operation. Continue the boiling for a few minutes after the water has begun to condense in D, then remove the flame, open the valve in the tube B, and allow the apparatus to cool with continued aspiration. Remove the absorption tubes and weigh. The increase in weight is due to carbon dioxide."

#### GENERAL

Baking powders are more generally used in this country than elsewhere, and more in the South than in the North. The bulk of the powders are aluminic powders, used in the South especially. Cream of tartar powders are confined largely to the North and the Pacific coast. The following figures are taken from the Memorial of the American Baking Powder Association presented in Congress in 1900.<sup>1</sup>

	Tons used per annum	Manufacturing concerns
Alum .....	50,000	524 (Alum and alum phosphate)
Cream of tartar.....	9,000	10
Phosphate .....	300	1

The Royal Baking Powder Company (trust) was organized in 1899, from the three leading cream of tartar baking powder companies, and the two largest importers of argols. The capital stock is \$20,000,000, half of which is preferred. It is claimed to have a monopoly of the imports of argols. The cream of

<sup>1</sup> "The Baking Powder Controversy," A. C. Morrisou, New York, 1904; Vol. I, p. 54.

tartar interests have long been waging an aggressive war on all powders containing so-called "alum." To meet this aggression the majority of the alum baking powder manufacturers formed the American Baking Powder Association. The cheapness and availability of the aluminic substance made a rival monopoly impossible. This defense Association has successfully warded off prohibitory "pure food" legislation and carried on a campaign of education as to the true nature of aluminic powders. The records of this warfare have been published by the Association in two large volumes.

## AERATED BREAD

---

The first aerated bread patent was taken out in England in 1832 by Luke Wright. In 1856 Dr. John Daughlish brought forth the process which bears his name. He made bread by mixing flour, and water charged with carbon dioxid under pressure. The releasing of the dough in the pans and the heat of the oven expanded the gas in solution and raised the dough. Thus he obtained bread without yeast or fermentation. The primary claims of Dr. Daughlish for his process were that by doing away with the process of fermentation his bread was cheaper and more nutritious. Both his method and the present American method will be here described, more because of their interest and possibilities than because of economic success.

The English method of a quarter of a century ago was described in *Industries*<sup>1</sup> at that time. Carbonic acid was made up to a pressure of 40 pounds; the carbon dioxid was made by dissolving chalk in sulfuric acid and passing it through lime, and was stored in India rubber bags. The mixer was a cast iron vessel, enamel lined. The flour was measured in, the "soda water" turned in, the trap closed and the dough made up under 40 pounds pressure by the churning of the mixing arms. "The bottom of each mixer is provided with several holes, closed by special valves termed 'dough cocks.' These are so arranged that when the handle is turned around, the hollow plug of the cock takes out sufficient dough to speedily expand into a loaf of the shape of the tin \* \* \* " Enameled surfaces and asbestos packed valves kept the dough clean throughout. In 1886 the London Aerated Bread Company made up weekly 1,000 sacks of flour by this process. Flavor, color and texture were brought up

<sup>1</sup> *Scientific American Supplement*, Sept. 25, 1886.

to the necessary high standard for success by using considerable malt or "wine" in the recipe, according to the Childs process.

Aerated bread has been made in Germany and France. It is still made to a limited extent in England by one company<sup>1</sup> and

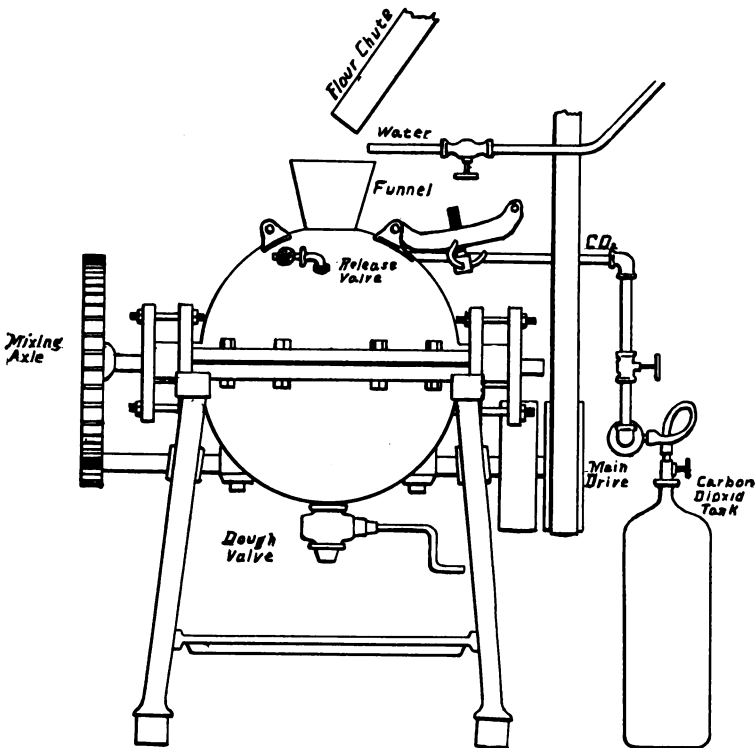

Fig. 12.—Aerated bread machine. (Courtesy Meek-Barnes Baking Co., Los Angeles.)

in America by one company. In this country Mr. Withington of Cincinnati, appears to have been the pioneer. He and Mr. Kohlsaat introduced it in Chicago about 1885, and later Mr. Withington went to Boston and made it there. Mr. Kohlsaat

<sup>1</sup> Courtesy of *The British Baker*, London.

stated that his concern was doing a flourishing business with this bread, selling it in wagons decorated with red banners. During the Haymarket riot the banners were changed to blue. It was a financial success and was liked by his customers, though it did not keep well. At present it appears to be made only in Los Angeles. The following description is given through the courtesy of the Meek-Barnes Baking Co., of Los Angeles.

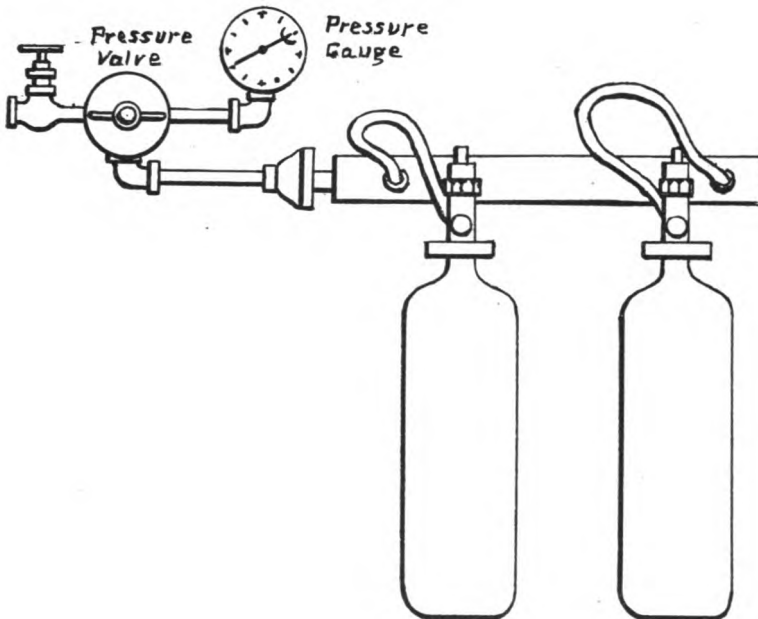

Fig. 13.—Carbon dioxide attachment for aerated bread apparatus.

The mixer (Fig. 12) is a double cast sphere a yard in diameter and three-quarters of an inch thick set five feet above the floor by a trussed frame. The mixing sphere contains the mixing arms mounted on a diametrically placed axle which is geared on the left side to the counter shaft mounted under the back of the mixer.

The mixer sphere has a main charging trap on top which is shown with a funnel. When charged the funnel is taken out, a rubber disc placed over the hole, and then a cast iron disc which is held down by the socketed lever.

The carbon dioxid is introduced as gas through a pipe into the top. Fig. 13 shows how the carbon dioxid cylinders are connected to a receiving drum which allows the gas to warm as it expands. It is released from this drum through a reduction valve carrying a pressure gauge. By connecting two cylinders to the single receiving drum one cylinder can be used to supply the first gas at low pressure while the newer cylinder is reserved to carry the final pressure to 200 pounds.

The mixer sphere has a small blow-off valve above, while in the bottom is the dough cock. It will be noticed that all the packed joints have a wide bearing, so as to dispense with oil and yet prevent leakage.

The operator, having thoroughly cleaned the machine, charges the weighed flour, salt and lard through the trap, and lets in water to make a thin dough, nearly filling the mixer. He starts the motor and mixes the batch for one-half hour and then judges if the dough is of correct consistency. The top trap is now clamped down over the rubber seal, and carbon dioxid is let in at 100 pounds pressure, The mixing continues for 20 minutes longer, the gas pressure running up to 200 pounds. Both power and gas are now turned off. The assistant keeps a stack of empty pans at the left of the operator, who puts one after the other beneath the outlet, turns the cock and lets out a half pan of dough and places the pan on the long peel at his right. The assistant removes the peels and charges the oven—preferably a reel. As the pressure drops from withdrawing the contents, the mixer sphere may be recharged toward the last.



The dough shoots out of the discharge valve with a "cough;" it takes practice to fill the pans evenly. The dough begins to swell at once. The baking takes 40 minutes. The loaf has a rough, irregular top crust, browned in patches and without bloom. The crumb is fine, very even and a very good white.

This apparatus takes two men—one of them skilled,—turns out a batch of 185 two-pound loaves every two hours, calls for power from a two horse-power motor half the time, and exhausts a large carbon dioxid cylinder about every five batches. It will be noticed that compared with the old English "soda water" apparatus, the tanked carbon dioxid is a great convenience.

The advantages claimed for this process are:

(1) A great saving in labor, time and yeast; (2) there is no fermentation change or loss in the dough; (3) the entire process is cleanly, neither handling nor standing of the dough being necessary; (4) the bread is more nutritious and wholesome, not having been fermented; (5) the bread has a white crum and good flavor.

There is no denying the force of the first three arguments. However, it was soon found that the original bread with its unfermented gluten had a raw taste and would not hold the market. The addition of malt extract, etc., to the mix made a much more palatable loaf, whiter and of better texture. This made it a success in England thirty years ago, but defeated the contention that yeast was a harmful leavener. The "wine" or malt performed the work of the fermentation products. The claim of Dr. Dauglish that yeast fermentation causes a loss of 6 per cent. of the dough substance is extravagant. Jago says it is not more than  $2\frac{1}{2}$  per cent. Other recent authorities put it as less than 1 per cent. This loss is of course avoided in this process. The real value of the process would seem to be in its ability to make

sound bread from flour high in bran, flour enzymes and germ substances. Mr. Kohlsaas speaks well of the flavor of aerated bread, and its advertising possibilities, but says that it did not keep. The conclusion is that experimenting may bring this process forward again as a cheap, very quick and cleanly process for large bakeries. Both the flavor and the appearance of the top crust should be improved on.

## MILK POWDER<sup>1</sup>

“The first account of powdered milk is found in Marco Polo’s report of his travels in Tartary in the interior of Asia. In about 1290 he found the Tartars drying milk in the sun, pulverizing it into powder and placing it in sacks to be carried on their excursions into the territory of their enemies.”<sup>2</sup> Powdered milk was again heard of in England about 100 years ago. It has recently come to the front very prominently in this country.

It is quite likely that wholesale milk users will in time use milk powder to the exclusion of the original liquid.

The following table gives average analyses for liquid and dried whole milk:

	Liquid <sup>3</sup>	Dry <sup>3</sup>	Average powder <sup>4</sup>
Fat .....	3.60	29.20	24.30
Milk sugar .....	4.60	37.20	39.20
Casein .....	2.80	22.40	} 24.30
Albumin .....	0.50	4.20	
Ash .....	0.75	6 0	5.90
Per cent. of solids .....	12.25	..	..
Per cent. of water .....	87.60	..	6.30
Lactic acid .....	0.15	1.0	..

To reduce milk to a powder, the water must be evaporated off in such a manner as not to chemically alter these substances, and to leave a powder that is again soluble in water to the con-

<sup>1</sup> Much of the data for this chapter was obtained through the courtesy of Lewis C. Merrell, of Merrell-Soule Co.

<sup>2</sup> *Technical World*.

<sup>3</sup> *Anal. Mitt. Milchw. Ver. Allgäi.*, 21, 1910.

<sup>4</sup> “Economic Reasons for the Reduction of Milk to Powder,” Lewis C. Merrell, *Journal of Industrial and Engineering Chemistry*, Aug., 1910.

sistency of milk. The difficulties that may arise in the stages of the process are:

- (1) Coagulation of the albumen above 149° F.
- (2) Browning, or caramelizing, of the milk sugar much above 212° F.
- (3) Breaking down of the butter fat globules by heat. This destroys the emulsifying power of the powder and would prevent cream and whole milk from being dried.
- (4) Between the percentages of 40 to 10 per cent of water the milk becomes a sticky paste, hard to dry or handle.
- (5) In any slow drying process the lactic acid content is rapidly increased, and this acid begins to act on the milk solids.

Milk can be successfully reduced to powder by removing a portion of its water by agitation in a vacuum pan; the boiling is thus carried on at a temperature below the coagulation point of albumen. This condensed milk is then sprayed into a current of hot air. This reduces the moisture to less than three per cent. It is then sterile to the lactic acid bacteria, and can be kept indefinitely. The albumen has not been cooked and the butter fat has not been broken down, because the rapid evaporation of the milk spray reduces the temperature of each spray drop until dry. The pasty stage (between 10 to 40 per cent. water) has been passed while in the air in a finely divided state. Lewis C. Merrell estimates that each pint of milk has a spray surface of two acres.<sup>1</sup>

In a French process, patented in 1910 by Lecomte and Lainville,<sup>2</sup> the milk is first frozen to a snow powder; the soft, greasy milk solids are separated from the snow by centrifugal action, and then dried. This snow residue, however, must contain a

<sup>1</sup> "Economic Reasons for the Reduction of Milk to Powder," Lewis C. Merrell, *Journal of Industrial Engineering and Chemistry*, Aug., 1909.

<sup>2</sup> *Scientific American*, Nov. 12, 1910.

large percentage of solid residue; such a process would be wasteful.

One pound of dry milk powder is the equivalent of about seven pounds of cream or 11 pounds of skimmed milk.

Summary of advantages of milk powder:

(1) It keeps an indefinite time. Two-thirds the annual milk supply comes between April and September, while great areas of potential dairy lands are too far removed from market for liquid milk. Hence both producer and consumer become independent of these two limitations. The milk of any region and any period of time can be made up for a steady market.

(2) The ratio of freight charges on liquid and dry milk are about as 14 to one. You do not have to pay freight on the water; also, the advantages of easy handling and stability bring a lower proportional rate to the dry milk.

(3) The retail price is on an average with liquid milk. The cost of the process is about neutralized by the reduced freight.

(4) Milk powder bulks about one-eighth of liquid milk.

(5) It is easier and safer to handle all along the line.

(6) Milk powder can be bought and sold on an accurate guarantee of composition and purity.

Its present market is among the large bakeries, confectioners and the government, and occasionally as a filler in baking powder.

It is sold as cream, whole milk and skimmed milk powders. Bakers may mix the powder with their flour before adding water; but it is recommended to dissolve the powder first and use it as liquid milk.

Milk powder is at present made in the States of California, Illinois, Iowa, Michigan, New Jersey and New York. The State Dairy Bureau of California reports a yearly output of about 600 tons, less than one per cent. of the total milk.<sup>1</sup> There appear to be three companies at present doing business in the United States.

<sup>1</sup> Courtesy of F. W. Andreasen, Secy.

# INDEX

	PAGE
Acetic acid, effect on yeast.....	6
in bread .....	40
Acidity of bread .....	40
Acid sodium phosphate in baking powder formula.....	50
residue .....	56
Adulteration, of baking powder.....	64
yeast .....	16
Aerated bread, advantages of.....	73
first patents .....	69
flavored by Childs' process.....	70
future of .....	74
in America .....	70-73
in England .....	69, 70, 73
in France .....	70
in Germany .....	70
manufacture .....	73
mixer and apparatus .....	71
old English method .....	69
time of baking .....	73
Aeration process, for yeast.....	22, 33-35
material for .....	34
Albumin, as yeast food.....	8
egg, for baking powder.....	58, 63
egg, for phosphate .....	63
egg, for tartaric acid.....	55, 63
yeast .....	6
Albuminoids, as yeast food.....	8
defined .....	11
Alchemy and yeast .....	I, 2
Alcohol, and Basil Valentine.....	1
aeration process, yield .....	22
Vienna process, yield .....	22, 31
from fermentation of sugar.....	15
in yeast excretions .....	7
substitute for baking powder.....	61
Alcohols, higher .....	3, 10
Alum, true .....	56
ammonium .....	57
in leading baking powders.....	59
Alums, general symbol of.....	56
manufacture of .....	56
qualities of .....	56

	PAGE
Alum baking powder .....	51
aerating value of .....	58
controversy .....	68
composition .....	59
first patent .....	51
formula .....	52
keeping quality .....	59
in the South .....	67
present output .....	67
residue in bread .....	62
Aluminum, hydroxid .....	52
Aluminum oxid .....	52
Amids as yeast foods.....	8, 41
Ammonia-soda process .....	53
Ammonia determination in baking powder.....	65
Ammonium carbonate, aerating value.....	58, 61
in baking powder .....	51, 53, 54
odor in bread .....	54
substitute for baking powder.....	61
source of .....	61
Ammonium sulfate .....	56
Ammonium tartrate .....	8
Analysis, of average milk powder.....	75
baking powder .....	64
yeast .....	6, 7, 20
Argols, cream of tartar manufacture.....	54
importers of .....	67
Ash, barley and malt.....	10
yeast .....	7, 8
Attenuating power of yeast.....	15
Auto-fermentation of yeast .....	6, 29
"Baker's Helper," home-made yeast.....	45
Bacteria in yeast .....	16
Baking powder, the acid.....	54
action on the dough.....	60
adulteration .....	64
addition of soda, etc., to.....	61
advantages of .....	63
the alkali .....	53
alum .....	67
analysis .....	64
care of .....	60



	PAGE
<b>Baking powder—<i>continued</i></b>	
composition of leading .....	59
cream of tartar .....	67
deterioration .....	60
first patents .....	51
formulas .....	52, 59
general formula of .....	51
history of .....	51
ideal .....	52
in flour .....	60, 62
in North and South.....	67
in warm climate .....	60
leavening values .....	59
litmus test for .....	64
manufacture of .....	63, 64
packing in tins .....	64
phosphate .....	67
restoring old .....	61
starch in .....	58
substitutes for .....	61
tests for .....	60
tests in manufacturing .....	63, 64
war .....	68
Baking Powder Association .....	67, 68
Baking test for baking powder.....	60
Barley, average composition .....	10
Barm .....	36, 43
Basil Valentine and fermentation.....	1
Beets in yeast mash.....	22
Birnbaum, alcohol in bread.....	40
Biscuits, baking powder residues.....	62
Bottom yeast (see brewers' yeast).....	3
Boutreaux, on French leaven.....	43
Bread, flavor from yeast.....	41
from bottom yeast .....	3
loss from fermentation .....	40, 42
yeast action in .....	36-43
Breweries and pure culture systems.....	16
Brewers' yeasts .....	3
Brown, A. J., and Pasteur.....	2
laboratory test for yeast.....	20
Buchner, isolates zymase .....	2

	PAGE
Budding of yeast .....	1
in nutrient solution .....	5
rate of reproduction .....	5
Butyric acid, effect on yeast.....	6
in bread .....	41
Cane sugar, symbol and qualities.....	11
in yeast mash .....	22
Carbohydrates, in bread .....	39-43
in barley and malt.....	10
as yeast food .....	8
Carbon dioxid, "available," in baking powder.....	58, 59
in aerated bread .....	69
in aerated bread, method of generating.....	69, 72
in baking powder formula.....	52, 57
from fermentation .....	10, 15
in yeast excretions .....	7
Cellulose in barley and malt.....	10
Centrifugal separation, of milk.....	76
of yeast and wort.....	33
Childs' process for aerated bread.....	70
Compressed yeast, long-distance shipment.....	45
Corn, in aeration process.....	34
in Vienna process .....	26
in yeast mash .....	14, 26
Cream of tartar, aerating value.....	55, 58
in baking powder formula.....	52
determination of .....	65
how formed .....	54
in leading baking powders.....	59
manufacture .....	54
Cream of tar baking powder, composition of.....	59
formula .....	52
in the North .....	67
originated .....	52
present output .....	67
"C. T. S.," legality of.....	57
Daughlish, Dr. John, aerated bread.....	67
loss of bread substance.....	42, 73
de Latour, vegetable nature of yeast.....	1
Dextrin, in panification .....	39-43
symbol and qualities .....	11-14

	PAGE
Diastase, production and qualities.....	II, 14
action in mash .....	26
"Diseases" of beer .....	15
Dough, and sponge methods.....	36
growth of yeast in.....	42
Dry milk (see milk powder).....	75
Dry yeast cakes .....	16
Eggs, beaten, a baking powder substitute.....	62
Ehrlich, on fermentation products.....	10
Endotryhtase, isolated by Hahn.....	9
Enzymes, action on flour.....	41
definition .....	9
flour .....	63
proteolytic .....	9
yeast .....	15
Enzymic reactions in yeastmaking.....	12, 14
Eethyl alcohol from fermentation.....	10
Fehling, loss of bread substance.....	42
Fermentation, defined and described.....	15
disturbances .....	33, 35
formula for mash .....	14
in bread .....	37-43
Fermentative power of yeast.....	15
Flavor of bread .....	41, 43
Flour, and bread, composition.....	38
before and after fermentation.....	38
Foam in yeast manufacture.....	29, 31
Gay-Lussac, on fermentation .....	8
Girard, on yeast in bread.....	39
Glycerin, from fermentation .....	10
in yeast excretions .....	3, 7
Glucose, symbol and qualities.....	12
fermentation of .....	14
Graeger, loss of bread substance.....	42
Graham flour, baking powder.....	63
Hahn, and endotryhtase .....	9
Hansen, and pure culture.....	15
Heeren, loss of bread substance.....	42
Higher alcohols, flavor of bread.....	41
Hoaglands, cream of tartar baking powder.....	51

	PAGE
Hops .....	43
Horsford, Prof., and phosphate baking powder.....	51
Hydration formula for yeast mash.....	14
Inversion formula for yeast mash.....	14
Invertase, action on cane sugar.....	12
yeast .....	15
Jago, loss of bread substance.....	42
home-made yeast .....	44
on "baker's sourness" .....	40
on stages of panary fermentation.....	37
Kirkland, first mention of baking powder.....	51
lead in cream of tartar.....	63
on "virgin barm" .....	44
Knorr's test for carbon dioxid.....	65
Kohlsaaf, Mr., aerated bread in Chicago.....	70, 74
estimation of aerated bread.....	74
Kohman, conclusions on salt-rising fermentation.....	50
experiments with salt-rising bacteria.....	49
experiments on salt-rising bacteria.....	47, 48
Kuetzing, vegetable nature of yeast.....	1
Lactic acid, for baking powder.....	61
in Vienna process .....	26
Lactic acid bacteria, in aeration process.....	34
in barm .....	43
effect on yeast .....	6
Lafar, definition of fermentation.....	15
Lead in cream of tartar.....	63
Leaven .....	43-46
Le Comte and Lainville, milk powder.....	76
Leeuwenhoek, discovers yeast .....	1
Levulose, symbol and qualities.....	14
Liebig, chemical theory of fermentation.....	2
on baking powder .....	51
Lindet, on yeast in dough.....	42
Litmus test for baking powder.....	64
Long-distance shipment of yeast.....	17-20
Maercher and Pederson .....	4
Magnesium carbonate in baking powder.....	53
Magnesium phosphate in yeast ash.....	7

	PAGE
Malt, average composition .....	10
defined .....	10
digestion of in its albuminoids.....	9
in aeration process .....	34
in Vienna process .....	26
in yeastmaker's mash .....	14, 26, 34
Maltase, action on maltose.....	11, 15
Maltose, and dextrin in yeast mash.....	14
evolution of in mash.....	26
Manufacture, aerated bread .....	72
baking powder .....	63
compressed yeast .....	21
milk powder .....	76
salt-rising yeast .....	49
Manufacturers' yeast test .....	20
Marco Polo, first mention of milk powder.....	75
Mash, defined .....	10
for aeration process .....	22
for Vienna process .....	22
yeast makers .....	14
Mass action in yeast manufacture.....	13
Meek-Barnes Baking Co. ....	71
Merrell, L. C., on milk powder.....	76
Metzler, A., test for yeast.....	20, 21
Meyer, on yeast .....	2
Milk, analysis of .....	75
Milk powder, advantages .....	77
analysis .....	75
bulk .....	77
difficulties in making .....	76
manufacture .....	76
present output .....	78
uses for .....	77
Mineral matter as yeast food.....	8
Mixer for aerated bread.....	71
Molasses, in yeast mash.....	22
baking powder substitute .....	62
Monocalcium phosphate, aerating value.....	56
liquid .....	55
in leading baking powders.....	59
in phosphate powders .....	55, 63
Mother yeast (seed yeast).....	26, 28, 34
Moufang, on washing yeast.....	17

	PAGE
Mycoderma in yeast .....	35
Normal calcium phosphate, aerating value.....	58
in baking powder formula.....	52
coated with egg albumin.....	63
in leading baking powders.....	59
residue .....	56
in yeast ash .....	7
Normal sodium tartrate, residue in baking powder.....	55
Oven for aerated bread.....	72
Oxygen, relation to fermentation.....	8
Pasteur, "Etude sur la Biere".....	2
budding of yeast .....	5
growing yeast .....	8, 15
pure yeast .....	16
theory of fermentation .....	2
Peptones, as yeast food.....	8
"Philosopher's stone" .....	1
Phosphate baking powder, aerating value.....	54, 59
composition .....	59
first patent on .....	51
formula for .....	52
present output .....	67
residue .....	62
self-rising flour .....	63
in two packages .....	55
Phosphoric acid, determination of.....	65
in baking powder .....	59
yeast washed in .....	17
Pohl, alcohol in dough.....	40
Potassium carbonate in baking powder.....	53
Potassium phosphate in yeast ash.....	7
Potassium sulfate, source of.....	56
Potatoes for yeast .....	43
in yeast mash .....	22
Power for aerated bread making.....	73
Proteins in yeast .....	6
Proteolytic, enzymes .....	9
reaction in yeast mash.....	14
Pure-culture lactic acid bacteria.....	26
Pure-culture yeast .....	16

	PAGE
Reactions of yeast in bread.....	39-42
Rees, Dr. Max, definition of yeast.....	2
Rohrer, Mrs., on salt-rising fermentation.....	48
Roman bakers and dry yeast.....	16
"Rope" in bread .....	41
Royal Baking Powder Co.....	51, 67
Rye, in aeration process.....	34
in Vienna process .....	26
in yeast mash .....	14
Saccharomyces cerevisae .....	I, 3
Saleratus (see sodium bicarbonate).....	53
Salt-rising bacteria, characteristics .....	50
in cornmeal and flour.....	48
experiments of Kohman .....	49
in the air .....	48
isolation .....	49
products of fermentation .....	49
Salt-rising bread, "emptyings" .....	50
flavor and structure .....	48
loss in fermentation .....	49
recipe for .....	50
Salt-rising fermentation, enzymic theory.....	47
function of salt in.....	47
milk in .....	47
products .....	49
"S. A. S." (see basic sodic aluminic sulfate).	
"Sauerteig" .....	48
Schwann, vegetable nature of yeast.....	1
Scotch bakers .....	36
Secondary fermentation .....	16
Self-rising flour .....	63
Separator for yeast manufacture.....	33
Slop, from yeast manufacture.....	31
Soda (see sodium bicarbonate).....	53
Sodium bicarbonate, addition to baking powder.....	61
in baking powder formula.....	52, 53
drying .....	63
in leading baking powders.....	59
residue in bread .....	53, 61
substitute for baking powder.....	61
Sodium sulfate, in baking powder formula.....	57
source of .....	56

	PAGE
Solvay process .....	53
Sour milk, in baking powder.....	61
Sponge dough .....	36
Stahl, theory of fermentation.....	2
Starch, determination .....	65
in leading baking powders.....	59
moisture in .....	58, 63
symbol and qualities .....	11
in yeast .....	17, 33
as yeast food .....	8
in yeast mash .....	26
Straight dough .....	36, 43
Succinic acid .....	7
from fermentation .....	10
flavor of bread .....	41
in yeast excretions .....	3, 7
Sugars, in barley and malt.....	10
fermentable, as yeast foods.....	8
relation to fermentation .....	8-15
Tartaric acid, aerating value.....	55, 58
determination .....	65
in baking powder .....	55, 63
in leading baking powders.....	59
manufacture .....	54
Tests, for baking powder.....	64, 65
yeast .....	20
Theories of fermentation .....	2, 47
Top yeasts, analysis .....	3, 7
Traube, on enzymes .....	2
Tyrosin, flavor of bread.....	41
isolated by Ehrlich .....	10
Vienna process .....	22, 25-33
diagram of .....	23
Voorhees, loss of bread substance.....	42
Water, in baking powder formula.....	52
in barley and malt .....	10
in baking powders .....	59
in Pasteur's experiment .....	8
in yeast .....	6
Whiting, Dr., formula for baking powder.....	63
Whole-wheat flour .....	63



	PAGE
Wild yeasts .....	3, 15
Withington, Mr., and aerated bread.....	70
Wort, defined .....	10
difference between distiller's and yeastmaker's.....	9
in aeration process .....	34
Wright, Luke, aerated bread patent.....	69
Yeast, amount in bread.....	41
analysis, of dry matter.....	6
organic constituents .....	7
ash .....	7
excretions .....	7
auto-fermentation .....	6
in bread .....	36
breathing .....	8
cell .....	6
cellulose in dry matter.....	6
compressed manufacture .....	21-40
dies in dough .....	43
effect of lactic acid on.....	6
electric current .....	4
fermentation .....	8
flavor in bread .....	38
foods .....	8
great pressure .....	4
growth in dough .....	42
home-made .....	43-46
keeping of by bakers.....	17
killed by heat .....	4
long-distance shipments .....	17-20
manufacture, diagrams of .....	12, 13
drying and pressing .....	31
lactic acid in .....	26
skimming .....	29
slop .....	31
washing .....	29
mash .....	14, 22
normal moisture .....	4
nutrition .....	8
percentage of water in.....	6
in plaster of paris.....	5
pure culture .....	16
and "ropy bread" .....	41

	PAGE
<b>Yeast—continued</b>	
rye .....	20
sensitive to acids .....	6
spores .....	5
starch in .....	17
taste and odor .....	20
temperature of reproduction and fermentation.....	4
tests for .....	20
wheat .....	20
yield in manufacture .....	25
<b>Zymase, discovered by Buchner.....</b>	<b>2</b>
properties .....	15

**SCIENTIFIC BOOKS PUBLISHED BY**  
**THE CHEMICAL PUBLISHING CO., EASTON, PA.**

---

<b>ARNDT-KATZ</b> —A Popular Treatise on the Colloids in the Industrial Arts. Translated from the Second Enlarged German Edition. 12mo. Pages VI + 73. ....	\$0.75
<b>ARNOLD</b> —The Motor and the Dynamo. 8vo. Pages VI + 178. 166 Figures .....	\$1.50
<b>BENEDICT</b> —Elementary Organic Analysis. Small 8vo. Pages VI + 82 15 Illustrations .....	\$1.00
<b>BERGEY</b> —Handbook of Practical Hygiene. Small 8vo. Pages 164. .	\$1.50
<b>BILTZ</b> —The Practical Methods of Determining Molecular Weights. (Translated by Jones). Small 8vo. Pages VIII + 245. 44 Illustrations .....	\$2.00
<b>BOLTON</b> —History of the Thermometer. 12mo. Pages 96. 6 Illustrations .....	\$1.00
<b>BURGESS</b> —Soil Bacteriology Laboratory Manual. 12mo. Pages VIII + 123. 3 Illustrations .....	\$1.00
<b>CAMERON</b> —The Soil Solution, or the Nutrient Medium for Plant Growth. 8vo. Pages VI + 136. 3 Illustrations.....	\$1.25
<b>COLBY</b> —Reinforced Concrete in Europe. 8vo. Pages X + 260....	\$3.50
<b>EMERY</b> —Elementary Chemistry. 12mo. Pages XIV + 666. 191 Illustrations .....	\$1.50
<b>ENGELHARDT</b> —The Electrolysis of Water. 8vo. Pages X + 140. 90 Illustrations .....	\$1.25
<b>FRAPS</b> —Principles of Agricultural Chemistry. 8vo. Pages VI + 493. 94 Illustrations .....	\$4.00
<b>GILMAN</b> —A Laboratory Outline for Determinations in Quantitative Chemical Analysis. Pages 88 .....	\$0.90
<b>GRAVES</b> —Mechanical Drawing. 8vo. Pages VI + 139. 98 Figures and Plates .....	\$2.00
<b>GRAVES</b> —Orthographic Projection. 8vo. Pages 89. 75 Figures...	\$1.50
<b>GUILD</b> —The Mineralogy of Arizona. Small 12mo. Pages 104. Illustrated .....	\$1.00
<b>HALLIGAN</b> —Elementary Treatise on Stock Feeds and Feeding. 8vo. Pages VI + 302. 24 Figures.....	\$2.50
<b>HALLIGAN</b> —Fertility and Fertilizer Hints. 8vo. Pages VIII + 156. 12 Figures .....	\$1.25
<b>HALLIGAN</b> —Soil Fertility and Fertilizers. 8vo. Pages X + 398. 23 Figures .....	\$3.50

<b>HARDY</b> —Infinitesimals and Limits. Small 12mo. Paper. Pages 22 6 Figures .....	\$0.20
<b>HART</b> —Chemistry for Beginners. Small 12mo. Vol. I. Inorganic. Pages VIII + 214. 55 Illustrations, 2 Plates .....	\$1.00
<b>HART</b> —Chemistry for Beginners. Small 12mo. Vol. II. Pages IV + 98. 11 Illustrations .....	\$0.50
<b>HART</b> —Second Year Chemistry. Small 12mo. Pages 165. 31 Illus- trations .....	\$1.25
<b>HART, R. N.</b> —Welding. 8vo. Pages XVI + 182. 93 Illustrations.	\$2.50
<b>HEESS</b> —Practical Methods for the Iron and Steel Works Chemist. Pages 60 .....	\$1.00
<b>HILL</b> —A Brief Laboratory Guide for Qualitative Analysis. 12mo. Pages VI + 80 .....	\$1.00
<b>HINDS</b> —Qualitative Chemical Analysis. 8vo. Pages VIII + 266.	\$2.00
<b>HOWE</b> —Inorganic Chemistry for Schools and Colleges. 8vo. Pages VIII + 422 .....	\$3.00
<b>JONES</b> —The Freezing Point, Boiling Point and Conductivity Methods. Pages VIII + 76. 2nd Edition, completely revised.....	\$1.00
<b>KRAYER</b> —The Use and Care of a Balance. Small 12mo. Pages IV + 42. 18 Illustrations .....	\$0.75
<b>LANDOLT</b> —The Optical Rotating Power of Organic Substances and Its Practical Applications. 8vo. Pages XXI + 751. 83 Illus- trations .....	\$7.50
<b>LEAVENWORTH</b> —Inorganic Qualitative Chemical Analysis. 8vo. Pages VI + 153 .....	\$1.50
<b>LE BLANC</b> —The Production of Chromium and Its Compounds by the Aid of the Electric Current. 8vo. Pages 122 .....	\$1.25
<b>MASON</b> —Notes on Qualitative Analysis. Small 12mo. Pages 56 ...	\$0.80
<b>MEADE</b> —Chemists' Pocket Manual. 12mo. Pages XII + 444. 39 Illustrations .....	\$3.00
<b>MEADE</b> —Portland Cement. 2nd Edition. 8vo. Pages X + 512. 169 Illustrations .....	\$4.50
<b>MOELLER-KRAUSE</b> —Practical Handbook for Beet-Sugar Chemists. 8vo. Pages VIII + 132. 19 Illustrations.....	\$1.25
<b>MOISSAN</b> —The Electric Furnace. 8vo. Pages 10 + 305. 41 Illus- trations .....	\$2.50
<b>NIKAIDO</b> —Beet-Sugar Making and Its Chemical Control. 8vo. Pages XII + 354. 65 Illustrations .....	\$3.00
<b>NISSENSON</b> —The Arrangement of Electrolytic Laboratories. 8vo. Pages 81. 52 Illustrations .....	\$1.25
<b>NOYES</b> —Organic Chemistry for the Laboratory. 2d Edition, revised and enlarged. 8vo. Pages XII + 292. 41 Illustrations.....	\$2.00

- NOYES AND MULLIKEN**—Laboratory Experiments on Class Reactions and Identification of Organic Substances. 8vo. Pages 81....\$0.50
- PARSONS**—The Chemistry and Literature of Beryllium. 8vo. Pages VI + 180 .....\$2.00
- PFANHAUSER**—Production of Metallic Objects Electrolytically. 8vo. Pages 162. 100 Illustrations .....\$1.25
- PHILLIPS**—Chemical German. 8vo. Pages XII + 241.....\$2.00
- PHILLIPS**—Methods for the Analysis of Ores, Pig Iron and Steel. 2nd Edition. 8vo. Pages VIII + 170. 3 Illustrations .....\$1.00
- PRANKE**—Cyanamid (Manufacture, Chemistry and Uses). 8vo. Pages VI + 112. 8 Figures.....\$1.25
- SEGER**—Collected Writings of Herman August Seger. Papers on Manufacture of Pottery. 2 Vols. Large 8vo. ....\$7.50 a vol. or \$15.00 a set
- STILLMAN**—Engineering Chemistry. 4th Edition. 8vo. Pages X + 744. 174 Illustrations .....\$5.00
- STILLMAN**—Examination of Lubricating Oils. 8vo. Pages IV + 125. 35 Illustrations .....\$1.25
- TOWER**—The Conductivity of Liquids. 8vo. Pages 82. 20 Illustrations .....\$1.50
- VENABLE**—The Development of the Periodic Law. Small 12mo. Pages VIII + 321. Illustrated .....\$2.50
- VENABLE**—The Study of the Atom. 12mo. Pages VI + 290 .....\$2.00
- VULTE AND GOODELL**—Household Chemistry. 2nd Edition. 12mo. Pages VI + 190 .....\$1.25
- VULTE AND VANDERBILT**—Food Industries—An Elementary Text-book on the Production and Manufacture of Staple Foods. 8vo. Pages X + 310. 78 Illustrations.....\$1.75
- WILEY**—Principles and Practice of Agricultural Chemical Analysis. Vol. I. Soils. Pages XII + 636. 55 Illustrations. 17 Plates .....\$4.00
- WILEY**—Principles and Practice of Agricultural Chemical Analysis. Vol. II. Fertilizers and Insecticides. Pages 684. 40 Illustrations. 7 Plates .....\$4.50
- WILEY**—Principles and Practice of Agricultural Analysis. Vol. III. Agricultural Products. Pages XVI + 846. 127 Illustrations .....\$6.00
- WYSOR**—Analysis of Metallurgical and Engineering Materials,—a Systematic Arrangement of Laboratory Methods. Size 8½ x 10½. Pages 82. Illustrated. Blank Pages for Notes.....\$2.00
- WYSOR**—Metallurgy—a Condensed Treatise for the Use of College Students and Any Desiring a General Knowledge of the Subject. Second Edition, revised and enlarged. 8vo. Pages XIV + 391. 104 Illustrations .....\$3.00



