

AUSTRALIAN
BEE LORE AND
BEE CULTURE

ALBERT GALE

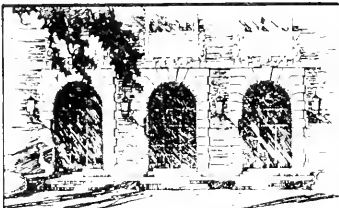

WILLIAM
BROOKS
AND CO.
LIMITED



LIBRARY
OF THE
UNIVERSITY
OF ILLINOIS

595.79
G13a

DEK ST. LIBRARY

Return this book on or before the
Latest Date stamped below.

University of Illinois Library

Jan 10 57

JUN 28 1968

L161-H41

BANKSLOW
BOOKDEALERS
SYDNEY





*Wheeler.
Cattai
Wheeler*

**AUSTRALIAN
BEE LORE AND BEE CULTURE.**





Advance Australia.

AUSTRALIAN
BEE LORE .

AND

BEE CULTURE

INCLUDING

THE INFLUENCE OF BEES ON CROPS

AND

THE COLOUR OF FLOWERS AND ITS INFLUENCE
ON BEE LIFE.

BY

ALBERT GALE

*Late Bee Expert and Lecturer on Apiculture to
N.S.W. Government.*



SYDNEY :

William Brooks & Co., Ltd., Printers,
17 Castlereagh Street.

—
1912.

595.77

G13a

CONTENTS.

CHAPTER I.—INTRODUCTION OF BEES.

Native bees—First hive bees, by Captain Wallace—First advertisement—Controversary from 1822 to 1824—Taken to Jervis Bay in 1840—White-fellow's sugar bag—Honey in the early seventies 1-3

CHAPTER II.—INTRODUCTION OF THE ITALIAN BEE.

First Italian bees—Attacks by bee moth—"Australian Bee Manual," references to, in 1886—Value of Italian queens in 1882, onwards—Bee-keepers' Association—Improvement in hives—Foul brood, great destruction of bees by.. . . . 4-6

CHAPTER III.—BEES' POSITION IN THE ANIMAL KINGDOM.

Classification —Vertebrata —Annulosa — Anthropoda — Lepidoptera, coleoptera, hymenoptera, and apidae contrasted—Genera and species of bees—Honey-producing and wax-producing bees 7-9

CHAPTER IV.—SPECIES AND VARIETIES.

Social bees of commercial value—The bee of the future—*Apis mellifica*, English bee—*Apis ligustica*, Italian bee—Virgil's description—Historical references thereto—Golden and leather coloured—Italian drones, queens and workers—Suitable for warm climates—East Indian bee, *apis dorsata*—Great wax producers—*Apis indica*, description of—*Apis trigona*, our native bee—*Apis florea*, description of—Carniolian bee—*Tunic* or *Punic* bee—Difference between species and variety 10-18

CHAPTER V.—BEES' HOME.

The bees' home—Various hives—Bees bringing home supplies—Bee-glue—Drone and worker cells—Wax-workers—Bees-wax—Brood in various stages—Nurse bees—Uses of bees' legs—The queen and her cell 19-25

CHAPTER VI.—BEE-KEEPING.

Bee-keeping—Ancient history of—Francis Huber—The inmates of bees' home—Queen not royal—The mother bee—Always a widow—Drones and workers always posthumas—Queen's power of reproduction—Queen cells—Neuter, a misnomer—The eggs—Royal jelly—The cocoon—The bee-grub 26-31

10-18-25-31-36-40-45-50-55-60-65-70-75-80-85-90-95-100-105-110-115-120-125-130-135-140-145-150-155-160-165-170-175-180-185-190-195-200-205-210-215-220-225-230-235-240-245-250-255-260-265-270-275-280-285-290-295-300-305-310-315-320-325-330-335-340-345-350-355-360-365-370-375-380-385-390-395-400-405-410-415-420-425-430-435-440-445-450-455-460-465-470-475-480-485-490-495-500-505-510-515-520-525-530-535-540-545-550-555-560-565-570-575-580-585-590-595-600-605-610-615-620-625-630-635-640-645-650-655-660-665-670-675-680-685-690-695-700-705-710-715-720-725-730-735-740-745-750-755-760-765-770-775-780-785-790-795-800-805-810-815-820-825-830-835-840-845-850-855-860-865-870-875-880-885-890-895-900-905-910-915-920-925-930-935-940-945-950-955-960-965-970-975-980-985-990-995-1000

CHAPTER VII.—QUEEN BEE.

Queen's internal anatomy—Power of control of sexes—Selection of the fittest—Golden rule of queen breeding—Emergency cells—Production of honey—Artificial queen cells—Traits of a good queen—Metamorphose from egg to perfect insect—Fecundation of a queen—Her marital flight—Queen from maturity to maternity—Production of drones, its cause—Impregnation of ovary, not the ovum—Productive and non-productive female bees—Change of sexual character of egg—Differentiation of eggs—Egg, embryonic stage to maturity—Circumstances controlling reproduction—inferior queens	PAGE. 32-53
--	----------------

CHAPTER VIII.—THE DRONE.

Drones greatly maligned—Drone cells and their inmates—metamorphose—Food during development—Comparative area, &c., of wings—External anatomy of drone and worker compared—Parthenogenical reproduction of—Not the Ishmaels of bee—Five questions and the various answers from correspondents, re drones—How to obtain high-class drones	54-60
--	-------

CHAPTER IX.—MYSTERIES OF DRONE PRODUCTION.

Not lazy nor idle—Value of males—One mating only—Progeny all female—Drones result of previous mating—Female progeny, result of queen's fecundation—Male progeny, result of queen's mother's fecundation—Atavism—Perfect and complete females—Perfect and incomplete females	61-63
---	-------

CHAPTER X.—THE WORKING BEE.

Working female—Home duties—Foragers—As forest makers—As florists—Novelties in flowers—Orchardists—Nature's workshops and workmen—Swammerdam on fecundation—Development of egg and transformation—Moulting of larvae—Chrysalis stages—Nurse bees, duties of—Wax workers—Care of the young—Huber on nurse bees—Most useful in the division of swarms	64-68
--	-------

CHAPTER XI.—FERTILE WORKERS.

Procreative workers—Drone-laying queens—mysteries of the hive—Superseding queens	69-70
--	-------

CHAPTER XII.—SELECTION FOR STOCK.

Selection of bees for stock purposes—Select the fittest and these survive—Mating uncontrollable—Can select the dam but not the sire—Select so as to excel in gentleness and labour—Resultant characteristics seen only in progeny—There is a barrier to overcome	71-73
--	-------

CHAPTER XIII.—EDUCATING BEES.

Ornamental comb building—How to select bees and hives for the purpose—Results—Successes and failures—Differences in working abilities of bees—Physical energy	PAGE. 74-76
---	----------------

CHAPTER XIV.—WHY DO BEES SWARM?

Nature's reasons—Francoise Huber on swarming—Some errors—Early Spring conditions—Supply of pollen an incentive—Drones on the wing—Hours of swarming—Queen not first to leave—Piping of queens—Swarming not for want of room—Naturalist's errors in regard to swarming—Signs of swarming—Parables—Natural and artificial swarming	77-85
--	-------

CHAPTER XV.—SWARM CATCHING, HIVING, AND TRANSFERRING.

Special call notes—Scouts—Bee-song on settling—Not led by the queen—Origin of beating frying pan when swarming—Queen not first to settle—"Be gentle"—Natural swarms—How to hive—Place of rendezvous—Decoy boxes—Early swarms—To prevent swarming—Vagabond swarms—How to find queen in swarm—An adage—Site for permanent home—Queen handling—Queen's wing should not be clipped—Time of swarming—Swarm removed to permanent home—The next day—Casts	86-100
--	--------

CHAPTER XVI.—TAKING BUSH SWARMS.

Tools and implements—Smoke bellows—Get the bees into a box—Save all brood comb—To secure the queen—Main object: bees and brood-combs not honey	103-107
--	---------

CHAPTER XVII.—HANDLING.

Eyes, ears, fingers—Manipulation—Kindness and gentleness—Docility—Bee knowledge—Length of bee life—Subdued by smoke—Language of bees—Don't stand in their way—When and how to examine—Charging the smoker—How to smoke—Signs of subjugation	108-112
---	---------

CHAPTER XIX.—DIVISION OF SWARMS.

When to divide—Conditions for—The season for—Internal appearances of hive—Virgin queen—Necessity for fertile queens—Summary	113-116
---	---------

CHAPTER XX.—RE QUEENING.

Change necessary—Throw-backs—Mating haphazard—Parentage known by progeny—Life of queen, drone, worker—Early stage of queen to lay—Queen's procreative powers subsiding—Workers' love diminishes—Various ways of re-queening—Caging new queen—Bee-candy—Grafting cells—Chloroforming—Why not always accepted	PAGE. 117-121
---	------------------

CHAPTER XXI.—TRANSFERRING.

Maxim—Subduing—Drumming—Manipulating—Like begets like—Confidenee required—Charging the smoker—Virgil's method—Description of illustration from figure 1 to figure 9	122-131
---	---------

CHAPTER XXII.—THE HISTORICAL BEE-HIVE—ITS EVOLUTION.

Amateur apiarists—Artificial bee-homes—Bible references—India, Egypt, Japanese sun-dried clay-hives—Early experimentors in hive construction—Various styles of hives—Early germ in bar frames—Huber's discoveries—Dzierzon's top-bar—Langstroth movable frame—Evolution of bar frames—Nearing perfection—Value of the bar frame—Spacing—Fixing foundation comb—Correct spacing by bees—Bees and natural comb building—Bar frame, rise and progress—Shape and size—Storing honey—Brace combs—Attachment of comb to frame—Dimensions—Natural heat required—Nature's bee space—Shallows—British Association—Various improvements—Summary of hives—Machine made hives—Hoffman's metal ends—Narrow bottom bar—Antipropolis inventions—Langstroth's 61 reasons for his perfect hive—Materials—Convex and concave bevels, advantages of guide for measurements—Bee-space—Quantity of timber required—Iron gages—Heddon's measurement of—Other hives—Langstroth's simplicity, measurement of ..	132-138
---	---------

CHAPTER XXIII.—MOVABLE BOTTOM BOARDS FOR THE LANGSTROTH SIMPLICITY HIVE.

Measurements of V entrance No. 1—Measurements of No. 2—Alighting board—Measurements of roofs—Quilt—Full-size bar frame measurement—Centre bar—Shallows—Division boards—Frame blocks, measurements of—Description of Shallows—Division boards—Frame block, measurements of—Description of fig. 2—Measurements of	139-150
---	---------

CHAPTER XXIV.—CONCRETE FLOORS.

Superior advantages of—Measurements—Description of diagrams	151-153
---	---------

CHAPTER XXV.—HAWKESBURY AGRICULTURAL COLLEGE
APIARY.

	PAGE.
1, General views—2 shows floor, wire cradle, and sections—	
Various hives in use in college apiary—The kiosk—Removing hives and bees to another site	154-160

CHAPTER XXVI.—ADVANCE OF BEE-LIFE UNDER
DOMESTICATION.

California—Extensive apiaries—Value of apparatus—Honey har- vests—N.S.W. National prizes a hobby—Ornamental apiaries —As an article of diet—Some uses for honey	161-165
---	---------

CHAPTER XXVII.—APPLIANCES AND HOW TO USE THEM.

How to manipulate—Protection—Bee veils—Bee gloves—Other protections	166-169
--	---------

CHAPTER XXVIII.—CHARACTERISTIC SITES FOR AN APIARY.

Make the most of it—Uses for honey—Will it pay?—Flower culture—Gardening—Will it pay?—Bees kept on house roof —Bees at Agricultural Shows	170-175
---	---------

CHAPTER XXIX.—HIVE ARRANGEMENTS.

Success and failure—As a hobby—Semi-circular and straight quincunx plan—Advantages of—Bush-house apiary—Its fit- tings—Berlepsch hive preferable	176-181
--	---------

CHAPTER XXX.—EVOLUTION OF THE BEE-HIVE.

Domestication — Nature's home — Clay-hives — Hollow logs— Hives of the first bee-keepers—Wild honey—Early writers— Destroying bees for the honey—Nutt's supernumary box— The bar frame—Huber's book hive—Langstroth and Dzier- zon—Bees working in the open—Spacing—Bar-frames— Heddon frame, its measurements—Shallow frames—Quinby and other types, measurements of—Bar frames in parts— Langstroth frame, its measurements—Thick top bar—Hoff- man ends—Narrow bottom bar—Gnage for staples—Ready- made bar-frames—Langstroth's 61 pros and cons—Materials —Brood chamber—Half-size super-roof—Quilts—Full-size frame, page 221, and for shallows—Dummy—Section cradle —Sections—Half-size dummy—Section holder—Sections see diagram, page 228—Gale's wire cradle—Berlepsch hive— Hive in parts—The frame—Description of observatory doors —How arranged—The verandah—Advantages and other- wise—The combination hive—Its advocates and its pros and cons	182-234
---	---------

CHAPTER XXXI.—BEE-KEEPING IN BAR-FRAME HIVES.

Beginner's kit—How to get your bees—Transferring from trees	PAGE.
—Foundation comb—Home made foundation comb—Gloves—	
The smoker—Swarm catcher—Uncapping knife—Solar ex-	
tractor	235-241

CHAPTER XXXII.—BEE-WINTERING.

“Apiology”—Climatic changes—Essentials for bee-life and	
health—Winter feeding—Kind of food—Temperature—	
Huber's experiment—Ventilation—Numerical strength of	
colony—Outside protection—Internal dampness	242-249

CHAPTER XXXIII.—NOTES ON HONEY.

Virgil—Honeys from Crete, &c.—Cuban honey—Parramatta	
and Gordon honey—Orange blossom honey—Almond flavored	
—White box, yellow box, and prickly tea-tree honey—	
Uses of honey	250-251

CHAPTER XXXIV.—THE VALUE OF BEESWAX.

Prices for wax—Wax production—Nature's economy—Huber's	
experiments by forced production—Bees lengthen the cells	
—Adulteration—Demand for beeswax—Profits—Alcohol—	
Specific gravity—Cheshire on adulterations—Testing for	
adulterations—Discoloration—Causes—Moulding—Black	
combs—Loss of wax—Solar extractor— <i>Apis dorsata</i>	252-256

CHAPTER XXXV.—THE INFLUENCE OF BEES ON CROPS.

Essential addenda for crops—Nature's reproductive army—	
Flowering and flowerless plants—No bees, no fruit—Butter-	
flies—Cross-pollinisation—Reproductive organs of plant	
life—Nature's use for blossoms—Stamens and pistils—	
Fructification of entomophilous flowers, &c.—Parts of a	
blossom and their uses—Bees and pollen or bee-bread—	
The corolla—The calyx—Daylight and twilight flowers—	
The nectary—Analogy between flowers and insects—Dar-	
win on orchids—Male and female flowers on different plants	
—Pollen for sale—Nature's safeguard against in-and-in re-	
production—Herodotus—Apples and pears—A grain of pollen	
necessary for every grain of seed—Cause of mis-shaped	
fruits—Matrimonial ceremonies—Conjugal traits of plant	
life—Bees gathering pollen—Adaptation of bees' bodies	
for pollen gathering—Ovule receives the “germ of life”—	
Accomplished—How fruit becomes mature—Bees make no	
mistakes—Work of butterfly and bee contrasted—Influence	
of dust and rain storms on fruit crops—Destruction caused	
by insects other than bees—Bees have few enemies—The	
fall of unpollinised fruits.	257-273

CHAPTER XXXVI.—ARTIFICIAL FERTILISATION.

Bees the great fruit producers—Inoculated or cross-pollenised—	PAGE.
Removal of pollen—Sexual flowers—How to effect inoculation of the female flower—How to protect the essential flowers—Instruments to use to effect fertilisation—Hybridisation—Healthy stameniferous and pistiliferous plants necessary—Bisexual blooms—Double flowers—Plants return to earlier forms—Pollen blooms, the cells of life; pistillate blooms, the cells of matter—Hybrid plants, how to perpetuate—"Natural orders," illustrations from the poultry yard—Nature's agents in the production of food for man—Bee par excellence as procreative agents with entomophilous plants—Handicrafts, illustrated in bee-life—Bee-keepers and orchardists' confederates—Don't check bee-life—Color and perfume of flowers—Ants, bees, and wasps—Sir John Lubbock—Inconspicuous blossoms more attractive than highly colored—Lubbock's experiments—Grant Allen's advertisements—Brilliant foliage v. bright colored flowers—Artificial flowers—The agent that attracts bees—Nasturtium—Double flowers not attractive to bees—Bees' various movements in gathering honey and pollen—Turnip blossoms and lucerne flowers—Poppies—English bees with Australian flowers—Australian white flowers more attractive to bees than bright colors—Bright colors fail to attract imported bees—Australian bee-keepers' experiments	.. 274-292

CHAPTER XXXVII.—COLOR OF FLOWERS AND ITS INFLUENCE ON BEE-LIFE.

Entomophilous and anemophilous flowers—Sexes among plants—Locomotive powers in plant-life—Difficulties in the way of cross fructification—Nature of pollen—Bees pre-eminent in storing pollen—Preceptive organs of insects—The native bee—Adaptability of flowers to bees and vice versa—Australian honey plants—Nuptial flight of bees—Refutation of authorities—Lubbock on "Bees, Ants, and Wasps"—Tests inaccurate—Observations in Botanic Gardens—Mr. Baker, Technical Museum—Turnips and lucerne—Darwin on bees' "taste for coloured flowers"—Poppies—Bees neglecting to work on certain flowers—Why?—Sign boards and fingerposts a hasty conclusion—Grant Allen—Nasturtium—Agricultural examination papers—Bees disregard their Old World training when in Australia—Their loss of education after they cross the equatorial line 293-302
---	---------------

CHAPTER XXXVIII.—BEE CALENDAR.

From January to December, inclusive—The work for each month 303-313
---	-----------------

LIST OF ILLUSTRATIONS.

Advance Australia (Frontispiece)	PAGE
Honey Bees	15
Bee Farming (past and present)	21
Queen cages and protectors	25
Queen cages (another type)	31
Queen cells	37
Queen cells on natural combs	39
Queen cells on bar-frames	41
Alley queen nursery (reversed)	53
Nursery cage	60
Comb built in the open air	63
Queen rearing	70
Shallow bar-frame	73
Old straw hives	76
N.S.W. written by bees	76
Catching a swarm	87
Taking a clustering swarm	99
Transferring bees from a log	101
The smoker	104
Introducing queen cages	120
The author transferring bees at the Hawkesbury College	123
“Yes, we believe it”	127
The Heddon Hive	134
Bottom Board, No. 1	140
Bottom Board, No. 2.	141
Alighting Board	142
Descriptive Bar-frame	145
Frame Block, Fig. 1	148
Frame Block, Fig. 2	149
Concrete floors for bee-hives	152
View of Apiary and Kiosk, Agricultural College	155

xii.	LIST OF ILLUSTRATIONS.	PAGE.
Hive and section cradle filled with sections		155
A Bee Farm		173
Hive Arrangements		177
Bush-house Apiary		179
Summer Shelter		185
Colony of bees on Geebung plant		189
Shallow Frame		195
Frame Angles (thick top bar)		198
Measurement of Frame (new comb)		199
Self-spacing thick top bar		200
Staple Gauge		202
Langstroth's Hive and its Fittings		221
Cradles for sections		228
Section		229
Wire Section Cradle (Gale's)		229
Berlepsch Hive and Frame		231
Foundation Comb		237
Honey Extractor (Novice's)		238
Smoker (Pender's)		239
Uncapping Knife		240
Solar Extractor		241
Bee-Wintering		243
Abdomen of worker showing wax pockets and wax scales		256
Essential or sexual organs of a blossom		261
An open blossom showing the organs and floral envelope		263
A deformed apple		268
Bee in the act of fertilising		270
Bee sting in sections		292
Fig. I. showing the combination of the floral envelope		297
Fig. II., Stigma, anthers, stamens, &c.		302
Brood-combs, and developing brood		302

PREFACE.

IN this volume I have collected together some of my published articles, chiefly those that appeared from time to time in the N.S.W. "Agricultural Gazette." One of my reasons for so doing is to make known the history of the introduction into this State, of so valuable an insect as the honey bee. The publication of newspaper and other extracts, herein presented, will prove the historical authenticity of the facts.

A large percentage of the following pages was uttered from public platforms, and what was there voiced was obtained by research and of life-long observation; not as Wisdom learned, but as knowledge gained from the book of Nature. Nevertheless, a well and judiciously selected library is the best of fertilizers to inspire a healthy growth in research and of keen observation.

ALBERT GALE

AUSTRALIAN BEE LORE AND BEE CULTURE.

CHAPTER I.

INTRODUCTION OF BEES TO AUSTRALIA.

As a business to which a man may devote his sole attention, as a subsidiary to farming or fruit-growing, as an addendum, for pocket money for settlers' wives, or as a pastime for persons of leisure in suburban homes, beekeeping has nowadays throughout Australia, so many votaries, that it almost goes without saying some brief account of the inception and growth of apiculture under the Southern Cross will be appreciated.

It is a singular fact that, although both in the American continent and our own, indigenous honey producing flora abounds; the most diligent search by the entomologist and other naturalists, on the discovery of these new lands, was not rewarded by the discovery of any social honey-bee having a commercial value. Certainly there are indigenous bees in America, but the honey-bee was an introduction. In Australia the only social honey-storing insect in any way resembling the true hive bee is the little so-called native bee, *Trigona carbonaria*. The native bee of America does not occur here. Our native bee, *Trogon*, is found in Africa and India, as well as throughout Australia. The honey produced by these native bees is variable in quality, and never equal to that of the hive-bee. It is not so very long ago, however, since "wild" honey was much sought after in our Australian bush as one of the greatest of luxuries. The fact that the *Trogon* has no sting induced many people who would, in those days of crude, ruthless methods have shrunk from an adventure with social honey-bees to wage war against the stores of the "wild bush bees."

In 1822 the first hive bees were brought to this part of the world (Sydney), by a Captain Wallace, or Willis, in the ship "Isabella," according to Haydon. From the bees thus introduced colonies were propagated and distributed inland. In the *Government Gazette*, of 21st June, 1822, there appeared this advertise-

ment:—"Hive of bees for sale by Mr. Parr. Bees imported by Captain Wallace (or Willis)." In a number of the old *Sydney Gazette*, dated Friday, 1st November, 1822, there appears this paragraph:—"We congratulate our readers upon the complete establishment of that most valuable insect, the bee, in this country. During the last three weeks three swarms of bees have been produced from two hives, the property of D. Wentworth, Esq., purchased by him from Captain Wallace, of the 'Isabella,' at his estate, Homebush, near Parramatta."

In the *Sydney Morning Herald*, of 10th August, 1863, it stated that at a meeting of the Acclimatisation Society of New South Wales, bees were first brought to this country by Captain Braidwood Wilson, from Hobart Town, in 1831. This was contradicted in a later issue of the same paper in these words:—"Bees were brought from England to Sydney in the year 1824, in the ship 'Phoenix,' which sailed from Portsmouth in March of that year." This, too, is evidently a mistake, or perhaps another importation, as is evident from the fact that bees were advertised for sale in 1822, which has already been referred to. In 1840, a settler at Jervis Bay purchased two colonies of bees, for which he paid £4, and engaged two aboriginals to carry the hives on their heads a distance of 40 miles. These were the black or English bees, sometimes termed the German bee. For most of these dates and extracts I am indebted to Mr. S. M. Mowle, Usher of the Black Rod, of the Legislative Council, who married the only daughter of the late Captain Braidwood Wilson, R.N.

From the foregoing small beginnings the descendants of these bees soon spread themselves fairly well over New South Wales. Of course, these bees were kept in hives or boxes of any or every shape or style. The bar-frame hive was then unknown. Under the old system anyone could have bees who had the courage to rob them. The stray or escaped swarms of bees took to the bush. The aboriginals soon learned from their white brothers how to subdue bees by means of smoke, and with tomahawk and firestick, aided by strong vines, would ascend the loftiest and smoothest of trees to obtain the "white-fellow's sugar bag." The aboriginals have no word in their own language for the introduced bee. The flavour of the honey from the little native bee was no stranger to them, but they were not long in discovering that both in quality and quantity "white-fellow's sugar-bag" was far superior.

In the early seventies, so plentiful had bees become in the

bush that in the old George-street Markets, dishes and buckets full of it, mixed with dead and dying bees, dead larvae in all stages, broken comb, and rotten wood, were exposed for sale under the cognomen of bush honey. To look at it was anything but appetising. Better samples were bottled and sold under the name of "prime garden honey."

About 1872, our bees met with an enemy that bid fair to almost exterminate them—the bee moth put in an appearance, from whence we know not. Hitherto no skill was required in the management of bees that were kept at that time. New swarms were put into a piece of a hollow log, sawn off evenly at both ends, with pieces of stringy-bark nailed over the openings, and the bees had to obtain ingress or egress as best they could. Gin cases, tea chests, or boxes of other descriptions, were preferred, but in the bush at that time these were not always to be obtained. Manipulation of these hives was as crude as the grotesquely-made hives. There was no consideration given for the lives of the bees. These early beekeepers knew little or nothing of the importance of the queen bee; they did not understand "no queen, no bees," therefore no honey. It was a general destruction. When the bees were robbed, wax, brood, comb, and queen were all sacrificed for the honey, and the waste of the latter was almost as great in quantity as that obtained. This slovenly way of bee-keeping, combined with the ravages of the bee moth, would have set a limit to the days of bee-keeping in this country had not means been devised to check it.

CHAPTER II.

INTRODUCTION OF THE ITALIAN BEE,

UNDER the foregoing adverse circumstances thinking men looked around for something that would be the salvation of the bees. It was long believed that the Italian bee (*Apis ligustica*) was an insect far superior in many ways to the English bee (*Apis mellifica*). Not only was it superior as a honey-gatherer, but it was reported to be far more alert, and more persevering in resisting the attacks of enemies, more especially the bee moth, which in England is known as the wax moth. So great was the onslaught with these moth pests that people owning as many as 200 colonies in a few years found themselves without a single bee. How to contend against this pest was an unsolved problem. The bar-frame style of hive was then little known, and the method of fighting the moth in the gin-case hives was not understood; and so it remains to this day. Not only were the bees kept in the crude methods of the day decimated by this pest, but those that had taken to bush life suffered, perhaps, to a greater extent than those more immediately under the control of man. On the Clarence River, to my knowledge, in the latter part of the sixties, it was not unusual for men to take a horse and dray and go in search of bees' nests, returning with two or three hundredweights of honey. Neither was it an unusual thing to find two or three bees' nests in the same tree. But in later years these, through the ravages of the bee moth, have nearly all disappeared. From the general slaughter among the bees caused by the pest named, some few bee-keepers, with more watchfulness than others, saved a few colonies out of the general wreck. To perpetuate and multiply these was the question of questions. The Italian bee was looked to for overcoming the trouble, and enthusiastic beekeepers were not long in importing the far-famed golden and leather coloured Italian bees.

In the *Australian Bee Manual* by Isaac Hopkins of New Zealand, the introduction of the Italian bee in the Southern Hemisphere is thus referred to:--'It was stated by Dr. Gerstaecker that four stocks of Ligurian bees were shipped in England by Mr. J. W. Woodbury, in September, 1862, and that they arrived safely in

Australia after a passage of 79 days." It does not appear, however, that these stocks succeeded and propagated any more than a colony which Mr. Angus Mackay, Editor of the *Town and Country Journal* in Sydney, subsequently took to Brisbane, at great expense, from America. Mr. S. McDonnell, of Sydney, imported two colonies from America in 1880, and succeeded in raising stocks from them; and, later, Mr. Abrahams (now of Beecroft), a German bee-master, brought some colonies with him from Italy in 1883, settled in Parramatta, and, having succeeded in rearing a pure race of his queens, started an apiary for the Italian Bee-farming Company, of which he is manager and Mr. McDonnell Secretary." The date of the *Bee Manual* from which this is taken is 1886.

In 1882 Mr. C. Fullwood, Brisbane, had sent to him direct from Charles Bianconini, of Bologna, twelve Italian Queens. Of these five arrived alive, and of a second shipment in the following year seven reached their new home safely. In these early years of the introduction of the Italian bee into Australia, the price of pure-bred tested queens, reared in the colony, was from £2 to £3 each; and I have heard that in some cases as high a figure as £5 had been asked. Of late years I have seen three advertised for 7s. 6d.

The inauguration of Bee-keepers' Associations for the assistance of amateurs, and exchange of thought and bee-keeping ideas, followed soon after the introduction of the Italian bee. These Associations were based on similar lines to those established in England, which are acknowledged to have given incalculable benefit to the peasant classes in the rural districts, and the results have been equally beneficial in this State. It was never the intentions of these associations to do more than give instructions to aid people to add luxuries to their own table, in the same way as poultry-keeping, fruit-culture, kitchen-gardening, &c., is carried on, so as to expand the earnings of wage-earners, farmers' wives and daughters, and such-like.

With the pure Italian bees which were at that time expensive, came the necessity for the improvements in hives to permit of their successful and profitable management. The Langstroth simplicity bar-frame hive was welcomed as the very thing for housing these costly insects, and although there are many types of bar-frame hives available, the Langstroth bar-framed hive still holds chief place in the esteem of up-to-date bee-keepers.

Some years ago, a disease, far more destructive to bees than

the bee moth, and now bids fair to be far more serious, made its appearance amongst our bees—*Foul Brood*. On one occasion, at Bombala, I saw over 100 colonies of bees destroyed by this disease. The hives were filled with dead bees and festering foul-brood comb thus spreading the disease far and wide. for the disease is contagious. Districts that were regarded as ideal as apicultural ones were almost swept clear of bees. If keepers of bees, be it but a single hive or an extensive apiary, earnestly set about acquiring a knowledge of the character of the disease and of the causes that are conducive to its spread, and co-operate with their bee-keeping neighbours and the Associations in suppressing it, the bee-keeping industry will be freed from a disaster that threatens to overwhelm it.

CHAPTER III.

THE BEES' POSITION IN THE ANIMAL KINGDOM.

ALL natural objects belong to one of three great divisions—mineral, vegetable, or animal. In classifying any object of nature, the first thing is to find to which of these kingdoms it belongs. These kingdoms are cut up into groups, and are divided and subdivided for the better understanding of the group or division any member of either kingdom may occupy.

Nature is very fond of diversity. She has been very lavishing in the distribution of her infinite resources in all three kingdoms. In the animal world alone she has spread out before us nearly half a million classes of creatures endowed with life which inhabit land or sea. To better understand this vast army, of which the honey-bee is a member, each one is marshalled under eight or nine different heads. This splitting up is for the purpose of narrowing down or limiting any one of them to a known position in the kingdom to which they belong, so that in speaking, reading, or writing of them the meaning will be the more intelligible and comprehensive. Thus, a bee is as much an animal as a horse, cow, or fish, but in their classification there are many grades between them. A horse resembles a fish far more than it does a bee. The horse and fish have internal skeletons and backbones (*vertebrata*), but the honey-bee has neither. Again, the honey-bee resembles a spider, crab, or earth-worm more than it does a horse or fish, but there is a very wide difference between a bee and the first three named. A bee is like a spider or worm in that none of them have an internal skeleton or framework of bones. The framework of bees, spiders, worms, &c., are of the same construction, *i.e.*, made up of external rings. Animals whose bodies are made up of external horny rings are termed *Annulosa*. The organs of locomotion in spiders, worms, &c., have feet. Bees, also, although they fly, walk upon feet. But the feet of a bee differ very much from those of a worm. There are joints in the feet of spiders and bees, but there are none in those of worms. Animals, the framework of whose bodies are composed of horny rings and have jointed feet, belong to that division of the animal kingdom termed *Arthropoda*.

Bees have jointed feet, and are, therefore, separated from

worms, &c., but she still keeps company with spiders. *Arthropoda* are divided into classes. The honey-bee belongs to the class *Insecta*. Here she leaves the company of spiders and crabs, and is joined with butterflies, ants, beetles, &c. The honey-bee is not much like a beetle, but more so than it is like a spider. Compare the body of a spider with that of a bee, you cannot but notice that the spider's body is made up of *two parts* only, head and body, and her *eight legs* are attached to the latter. The bulk of a bee's body is composed of *three parts*—head, thorax, and abdomen. Bees have but *six legs*, and these are attached to the thorax. Again, spiders lay eggs, and so do bees, but the young hatched from spiders' eggs differ greatly from those hatched from bees' eggs. From the spiders' eggs hatch out young spiders as perfect in form as their parents. The young hatched from bees' or butterflies' eggs are as dissimilar as an earthworm is from a butterfly, and in few respects like the bee or butterfly that laid the egg. From the butterfly's egg caterpillars are hatched. At first these young caterpillars are very small; they grow rapidly, and when full grown, they enter another stage of development—a chrysalis or pupa. This third stage is so unlike the caterpillar it developed from, were we not acquainted with the fact, it could not be conceived that it is in any way connected with the parent that laid the egg. In course of time, from this strange-looking chrysalis, a perfected bee or butterfly emerges. Spiders belong to the sub-kingdom *Annulosa*, and to the division *Arthropoda*, but not to the class *Insecta*, because they do not go through those stages in developing to the perfect form or imago, as bees, butterflies, &c., do. Spiders change from egg to imago only. Here the honey-bee must part from the company of butterflies, beetles, &c. These latter are insects as much as bees are, but there is a great difference between them, chiefly in their wings. Butterflies belong to the order of insects termed *Lepidoptera*, *i.e.*, insects having wings covered with feathery scales, and beetles to the order *Coleoptera*, their true wings being protected under horny cases. Bees to the order *Hymenoptera* because their membrane wings are thin, fibrous, and interwoven like network. This order (*Hymenoptera*) contains the largest number of families in the insect world. Some of them are very remarkable for their social habits and wonderful instinctive traits of character. The order *Hymenoptera* is narrowed down into families—*Apidae*. In it are included ants, hornets, wasps, ichneumons, bees, &c. All these are very bee-like in their general form. We have not as yet

reached the particular position in the animal kingdom allotted to true bees. The family *Apidae* is divided into genera. In one of the divisions termed *Apis* honey-bees are placed; accompanying them are mason-bees, carpenter-bees, &c. These latter are short-tongued members of the genus, and therefore are not honey-gatherers. Nevertheless, the habits of the whole of them are extremely interesting. Of long and short tongued bees there are about 2000 varieties. The genus *Apis* is split into species, and the honey-bee belongs to the species *Mellifica*, and here is the exact position assigned to our friend, the harbinger of civilized man—one of the very few insects that have been domesticated for his use, and the only one that he has brought under his subjugation as an auxiliary in supplying him with that highly essential article of diet, honey.

Nevertheless, every member of the species is not equally profitable from a commercial point. Some varieties of this species are profitable only as wax-producers. When we consider the increasing demand in the Home market for Australian bees-wax, the quantity of honey consumed by our hive bees in the production of comb, and our local requirements for the manufacture of that indispensable adjunct to profitable bee-keeping, artificial foundation comb, it at once raises the question:—Would it not be a prudent step to introduce into our State some highly profitable wax-producers?

CHAPTER IV.

SPECIES AND VARIETIES OF SOCIAL BEES.

THE genus *Apis* contains about 16 species and varieties of social bees having a commercial value, and these are the only ones to be dealt with here. A large number of bee-keepers favour crosses, and the cross sought for—the ideal bee of the future—must be one possessing untiring industry, great energy, and unlimited endurance, the queen possessing a docile temper, vigorous constitution, and known for her powers of fecundity, producing workers that are unlimited honey-gatherers and builders of flat, highly-finished combs, in which drone cells are not too numerous, the workers possessing, like the mother, the mildest of tempers. That such a variety of these industrious and interesting workers as the foregoing describes will be produced is only a question of time.

The cat, a descendant of the most ferocious of felines, by years of domestication and association with the human family, has almost forgotten the use of her talons; so also the dog, the ox, and the horse have almost forgotten their powers to injure; therefore it is not unreasonable to suppose the bee of the future, although possessing a formidable sting, will, by careful breeding and selection, refrain from using the power she possesses to inflict injury.

The various races of bees differ greatly, and their geographical distribution is almost as wide as the poles, being found in a state of nature in both the temperate and torrid zones.

Whether the bee of the future, possessing all the qualifications and attributes that we think it ought to possess, will be a pure race or a cross that has not yet been produced time alone can decide.

With the pure races of bees that have already been imported into this State—black, Ligurian, and Carniolan—important steps have been made towards the ideal worker.

Apis mellifica is too well known to need any description, but a chapter on “The Species and Varieties of Bees” would be incomplete without reference to them. Our old friend the black bee was the first variety imported into Australia, and, like the black aboriginal human race of the continent, will be soon superseded by a superior variety.

Whether the black bee was the first variety that was domesticated or not we have now no power of determining. The bees now found where the human race was first cradled are varieties of *Apis ligustica*. Therefore it is more reasonable to suppose that it was the Ligurian rather than the English bee. Be that as it may, it is the black bee that has followed in the wake of civilisation. Wherever the colonist has planted his foot the black bee has followed, but she is now fast making way for another variety that is more fashionable in its attire. Nevertheless, the black bee possesses some excellent traits that it will be well to retain with the incoming race. Her comb-honey is far superior in appearance to that of the Italian bee. This is the only attribute in which she excels her yellow-banded sister.

Apis ligustica, also known as the Ligurian, the Italian, and the yellow Alpine bee, has long been known to entomologists. It is supposed to be the bee that the Greeks and Romans wrote and sang about.

Of the three varieties mentioned by Aristotle it is the one that he speaks of as being "small and round in shape and variegated in colour"—his best variety. Virgil wrote of two varieties, and speaks of the better of the two as being "variegated and of a beautiful golden colour." They appear to have been very fashionable in the time of these ancient historians.

The fashions of this world change. After the lapse of more than 2000 years these yellow-banded bees have again become the favourite variety, not alone on account of their attractive markings and form, but for the many excellent qualities they possess over their old-fashioned black brethren.

In 1805 Spaniola described it, and was the first to call it the Ligurian bee. He found it in the plains of Piedmont. Spaniola gave the variety the name of Ligurian from the old Roman name of the northern shores of the Gulf of Genoa, the district that is hemmed in by the Carnic and Helvenic Alps. The bee of the northern districts of Italy, generally known amongst the bee-keepers as the leather-coloured Italian, differs somewhat from its more southern neighbour.

This southern bee is smaller, more "ladylike," and three of the abdominal rings are of a bright golden yellow. This bee is also found in Asia Minor, the islands adjacent thereto, and in the Caucasus. Its nature is more excitable, and it cannot be depended upon like that of the north. In America, Italian bees are now

being bred for high colour; four-banded, or even five-banded bees have now become a fixed strain. Some time ago, Mr. Abram, of Beecroft, obtained by careful breeding four-banded Italian bees, but did not attempt to fix the strain, being convinced that breeding bees for colour, like breeding fowls for feather, would result in no advantage in their more useful qualities.

Busch in 1855 described the Italian as follows: "The workers are smooth and glossy, and the colour of the abdominal rings is a medium between the pale yellow of straw and the deeper yellow of ochre."

"These rings have a narrow black edge, so that the yellow (which might be called leather-coloured) constitutes the ground."

This description tallies with that of the bee of Northern Italy. Cheshire's pen describes it more accurately. He says "the first abdominal ring on the dorsal side mainly faces the thorax, and may be missed by careless observation; its lower edge only is black. The upper two-thirds of the second is yellow; the upper third smooth and hairless, because this passes beneath the ring above it when the body is contracted. A band of yellow hair covers the second-third and adds much to the beauty of the bee, as the hairs and ground are alike yellow. The lower-third of the ring is glossy black, carrying many microscopic hairs and a minute fringe. The third ring resembles the second, while the fourth and fifth carry yellowish hairs, but are otherwise black; the sixth ring, black also, is nearly hairless." These are the chief points that mark the pure three-banded Italian bee.

This bee readily crosses with *A. mellifica*, and the cross thus produced, as is usual with the crossing of other animals besides bees, will partake of the character of both parents, some of the offspring showing the characteristics of the male stronger than the markings of the female, and others retaining more of the peculiarities of the mother than the father. We often see in the same swarm of crossbrids, bees differently marked.

The drones *Apis ligustica* differ from the workers in having the upper half of their abdominal rings black and the lower half yellow, and they are somewhat smaller than the drone of *A. mellifica*. As compared with the worker the under side of the abdomen is yellower. In colonies where the workers are found to be uniform in markings the queens greatly vary, some are dark and may be mistaken by amateurs for the queens of *A. mellifica*. Other queens are to be met with quite yellow, except a small dark brown dot on each dorsal plate of the abdomen. Most Italian queens have

the abdomen long and beautifully tapering towards the caudal extremity. These yellow queens are very beautiful and have the advantage of being more readily distinguished on the comb when mixed with the workers than their darker compeers, an advantage that should not be lost sight of, especially with those who have not a very observant eye. The advantages that *A. ligustica* have over *A. mellifica* may be summed up as follows:—The queens are extremely prolific, and as soon as one brood emerges from the chrysalis she is ready to refill the brood cells with enormous quantities of eggs. In this respect she greatly surpasses her black sister. It is seldom one finds the brood comb of the latter regular. In the same comb will be found eggs and larvæ in various stages of development. In the brood combs of the Italian bee these irregularities are very rare, the brood in each comb will be as even as sealed honey, every cell having its inmate in the same stage as its neighbours. They recover from spring dwindling early in the season, and as the early honey-bearing flowers expand they have a large army ready to enter upon the labours of the field. The variety as a rule is possessed of a mild temper. Nevertheless I have seen the progeny of some queens far more irritable than any black bee I ever handled. A little smoke will easily subdue the Italian bee, and they bear manipulating well. It is not an unusual thing to see the bees at work while the comb is held in the hand, and occasions have occurred of the queen depositing her eggs in the presence of the observer. They adhere to the comb with greater tenacity than the black bee; the latter can easily be removed by a sudden jerk, whilst the Italian bee has nearly always to be brushed off. They bear artificial swarming much earlier than our old friend the black bee, and to an extent that would soon decimate if not entirely annihilate the latter. They defend their stores with the courage of a British tar, whilst that same attribute makes them marauders and determined robbers of their weaker neighbours. A fairly strong colony is proof against the wax moth. For industry, and as honey gatherers, they have not as yet been surpassed. Mr. Radlkofer says “Not only are Italian bees distinguished by an earlier awakened impulse to activity and labour but they are remarkable also for the sedulous use they make of every opening flower, visiting some on which common bees are seldom or never seen.”

Morawits and Douglas say “The brighter coloured southern bee of Italy is more suitable for hot climates,” whilst Langstroth (speaking of the Italian bees generally) says that “the Italian bees are less sensitive to cold than the common kind” (black). There

is no doubt a good deal of truth in both statements, for bees like other animals adapt themselves to climatic changes more readily than members of the vegetable kingdom. In the warm valley of the Hunter River the leather-coloured bee is the favourite.

Italian drones are far more vigorous than those of the black bee, and as a rule are on the wing much earlier in the day. The virgin queen has also this early rising habit. This habit of the sexes is a great aid in keeping a good strain unmixed, especially in a district where black drones are numerically weak. Dzierzon was under the impression that where both kinds of drones exist in about equal numbers the Italian queens will usually encounter the Italian drones, because both drones and queens are more active and agile than those of the common bee.

The reason of the Italian bee again becoming the favorite after the lapse of so many years was without doubt the beauty of its markings and the mildness of its temper, the latter making it the ladies' bee *par excellence*, and the amount of care and attention that has been bestowed upon it has developed traits and characteristics that could never have been brought out in the black bee. If the same amount of care and attention be bestowed upon it during the next quarter of a century that has been bestowed upon it during the last, the ideal bee of the future will soon become a reality.

Apis dorsata.—This bee is sometimes termed the giant bee of East India. No variety of bees build such slabs of comb as this one. Of ten times under the ledges of rocks, or hanging from the thick branches of trees, combs 6 feet long by 3 feet in width are met with. *A. dorsata* frequently appear to build these slabs of wax for the mere fun of the thing, or for the purpose of keeping their 'prenticed hand in practice, which must be accounted as an advantage in their utility as wax producers. *A. zonata*, of the Philippine Islands, is said to be a larger bee than *A. dorsata*, but it is highly probable that it is a variety of the latter. In constructing their comb, the cells in which drones are reared do not appear to differ in size from that of the worker's cell. Mr. Frank Benton was the first to give any reliable information in regard to these bees. He visited India in 1880-81, and in the jungles obtained colonies by cutting the comb from their original attachments. He placed these colonies in frame hives, and permitted them to have free ingress and egress, and they did not desert these enclosed habitations. They were found not to be so ferocious as had been represented. With proper precautions when hived they



1.

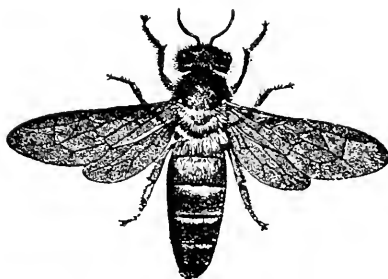

2.

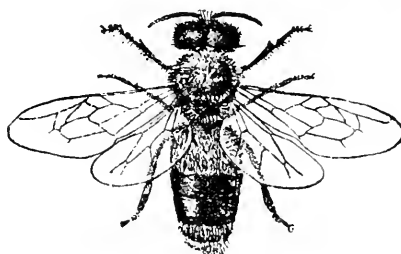

3.

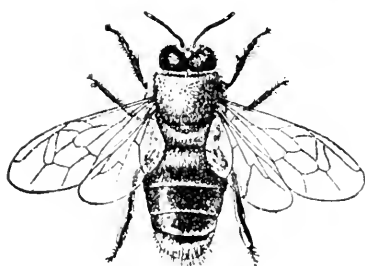

4.



5.

HONEY BEES.

1. Worker, Carniolan Variety of *Apis mellifica*—twice natural size.
2. Giant Honey Bee of East India (*Apis dorsata*), Worker—twice natural size.
3. Giant Honey Bee of East India (*Apis dorsata*), Drone—twice natural size.
4. Drone, Carniolan Variety of *Apis mellifica*—twice natural size.
5. Queen, Carniolan Variety of *Apis mellifica*—twice natural size.

are easily handled, even without smoke. From the quantity of honey and wax present when these bees were obtained, it was evident they are good gatherers. Owing to illness Mr. Benton failed to take these bees to America for the purpose of acclimatisation. He says: "These large bees would doubtless be able to get honey from flowers whose nectaries are located out of reach of ordinary bees, notably those of the red clover, now visited chiefly by humble bees and which, it is thought, the East Indian bees might pollinate and cause to produce seeds more abundantly. Even if no further utility, they might prove an important factor in the production of large quantities of excellent wax, now such an expensive article."

Apis indica is common in Ceylon and the southern parts of Asia. It is domesticated in the East Indies by the Dutch and British settlers, who keep them in habitations made of clay similar to drain pipes, placed in trees and other elevated positions.

The worker of this species of bee is $\frac{3}{8}$ inch long; general colour, a dark brown, almost black, with a yellow shield on the thorax between the wings; each segment of the dorsal plates of the abdomen is tinged with an orange colour. The queen is about one-fourth larger than the workers, and is readily distinguished from them, being of a dark coppery colour. The drones are not much larger than the workers, but differ from them in colour, being of a metallic blue; their wings in the sunlight constantly changing colour—something like shot silk. They are very active, and are said to be very gentle, while the pain resulting from their sting is not so severe as that of *A. dorsata*.

Apis trigona (our native bee) are natives of Australasia, and extend into India. They are something less than our common house fly; colour, black, with dirty white rings on the dorsal segments of the abdomen. They generally build in the hollows of trees, and store their honey in irregularly-formed cells. It has an agreeable flavour, but the storage of it by the bees is so small the insect is not worth domesticating.

Apis florea. The tiny honey bee of India, one of the smallest of the species known, even more slender than our native bee. In colour, they are a blue black, one-third of the abdomen having a bright orange tinge. Like *A. dorsata*, they build in the open air, fastening their single comb to a twig in a bush, and, like all honey-gathering bees, it hangs vertically. The comb seldom contains more than about 20 inches of surface, usually about 7 inches long

by about 3 inches in width. The cells in the comb are extremely small; there are about 100 to the square inch.

Apis mellifica.—There are several varieties of *A. mellifica*, and it is this species, on account of their use to man, that has been in all ages so universally sought for. The black or brown, or, as it is sometimes called, the German bee, is the common well-known hive bee that was introduced into New South Wales by Dr. Wilson, and is now so universally distributed throughout our forests. *The Cyprian* bee, as its name indicates, is a native of Cyprus. The dorsal segments of the abdomen are a golden yellow. They are very irritable, easily angered by rough handling, and susceptible to the least excitement, nevertheless they are valuable as honey gatherers. *The Italian* bees (Ligurians) are natives of Italy. They have golden or leather-coloured segments on the three dorsal plates of the abdomen nearest the thorax. Those having the golden markings are chiefly met with in the southern parts of the peninsula, whilst the leather-coloured are inhabitants of the northern districts of the country. They are supposed to be a fixed strain of a cross between the German and the Cyprian bees. Both these varieties readily interbreed and their progeny are always reproductive. Since the Ligurian bee has become fashionable four and even five banded bees are to be met with. *The Carniolian* bees are natives of Carniola in Austria. The workers are somewhat larger than the common black bee, neither is the abdomen so pointed. They differ in colour in having a ring of silvery-hued hair on each dorsal plate. As honey gatherers they probably rank equally with the Italian bees, and the cross between the two varieties is said to be superior to that between the black and Italian.

The Tunic bee is sometimes named the Punic bee; they are natives of the northern districts of Africa. They are not so valuable as either of the former as honey-gatherers. The best working variety of *A. mellifica* is the pure Italian.

Apis dorsata, *A. indica*, *A. trigona*, *A. florea*, and *A. mellifica* are species of the genus *Apis*; but the German, the Cyprian, the Italian, and the Carniolian bees are only varieties of the species *Mellifica*. Species differ from varieties in that they do not readily interbreed, and where such intercourse takes place the progeny are hybrids or mules, and result in not being reproductive. A species is a conception subordinate to a genus with attributes extending to fewer individuals, whilst a variety is that which varies or differs from others of its kind.

CHAPTER V.

THE BEES' HOME.

NOT the home of the bees—their habitat; that would necessitate my writing of the species *Apis mellifica*, and that would require a description of the habits of *dorsata*, *fasciata*, *mellifica*, and many others having social habits, and also of the varieties these have branched off into—the leather-coloured Italian from the north of Italy; the golden Italian, from the south of that peninsula; the Cyprian, from the island of that name; the Carniolian, from Hungary; and our old friend from England, the black bee.

I was asked some time since, by a lady, what is a bee like? is it anything like a blowfly? I then began to ponder is it possible in the eleventh hour of the nineteenth century that there are people who do not know anything about bees—the hive bee especially. If I had been asked if there are any other bees besides the honey bee, it would not have set me thinking so much. It is not to be supposed that people who eat honey can have any interest in the solitary bees—the mason, the carpenter, the upholsterer bee, &c. Then I thought, well, but everyone are not bee-keepers. What is so very familiar to me and other bee-keepers cannot be universally understood. One time I turned up a school book of object lessons that was written by a lady, and it said “a bee is an insect with two wings,” and I have turned up some of the latest works of natural history and I find they are still perpetuating old theories about the honey bee and its home, and why the cells in the comb have six sides. Most people believe what they read, but that is not always a wise thing to do.

Let us take a ramble to the bees' home and see who and what are there, what they are about, and how long it takes to perfect some of their productions. Turn over some other pages and you will see several patterns or styles of bee-hives. Come out into my garden with me and have a look at some of them in the wood instead of illustrations on paper. There is an old-fashion Langstroth, and here is a very modern Langstroth with all the latest improvements. That one? Oh, that is a Heddon. I don't want you to look at the hives; I want to give you an insight of the interior and what is going on there. Are these bees going in and out of

that hole? Yes. I want to draw your attention to these. You see that one with lumps of yellow clayey-looking material on her hinder legs. Well, that is pollen; they get it from the anthers of flowers. Many people think it is the wax, but it is not. It is the stuff they make bee-bread with. What is bee-bread? When we open the hive I will show you some and tell you all about it. There are some bees going into the hive without, apparently, any load, but nevertheless, they are well laden, but the cargo they are taking in is honey. Look, I will catch one of the bees that is outward bound, and show you; I must kill her or she might sting. Her body (I am not going to use any scientific terms) is formed with six horny rings; these are slightly overlapping each other. If I caught that bee away from her home I should know she was going out to work, because the rings are close together and rather overlapping. Now look at this one; she has just returned from her field labour. Her body is longer, and there is a little whitish mark between each ring; that tells me that her honey sac (she carries that internally) is full of honey. From those markings, if I caught her in the street, I should know she was going to her home. What is that—that one covered all over in yellow dust? That is pollen too. It differs from that carried on the legs. The pollen they carry on their bodies in that way is dry and floury, and they cannot kneed it into little pellets, and stow it away in the pollen baskets on their hinder legs. Pollen from some plants is like damp flour, and from others like dry sand; the former they can kneed into balls, the latter they carry home between the hairs of their bodies. That little furry bee just gone out is a young one; that one there is more shiny—she has not so many hairs over her body; that is the effect of old age and other causes. That big bee just outside that box - is that the queen? No, that is a drone, or male bee. I can catch him alive; he has no sting. You notice he has seven horny rings to form his body. He has larger eyes and longer horns than the workers. Those bees in that hive there are not like those? No, that is the English black bee. These here with four bright golden bands on their bodies are the golden Italian bee. Look, these bees working in this hive have all sorts of markings; some have two yellow rings, others have three. There is one all black, and there is one with four golden bands. These are cross-bred. Yes, all these varieties readily interbreed, one with the other. I thought cross-bred animals would not reproduce? Yes, they will; it is hybrids that do not often reproduce. Is there anything more you would like to know about these bees that are

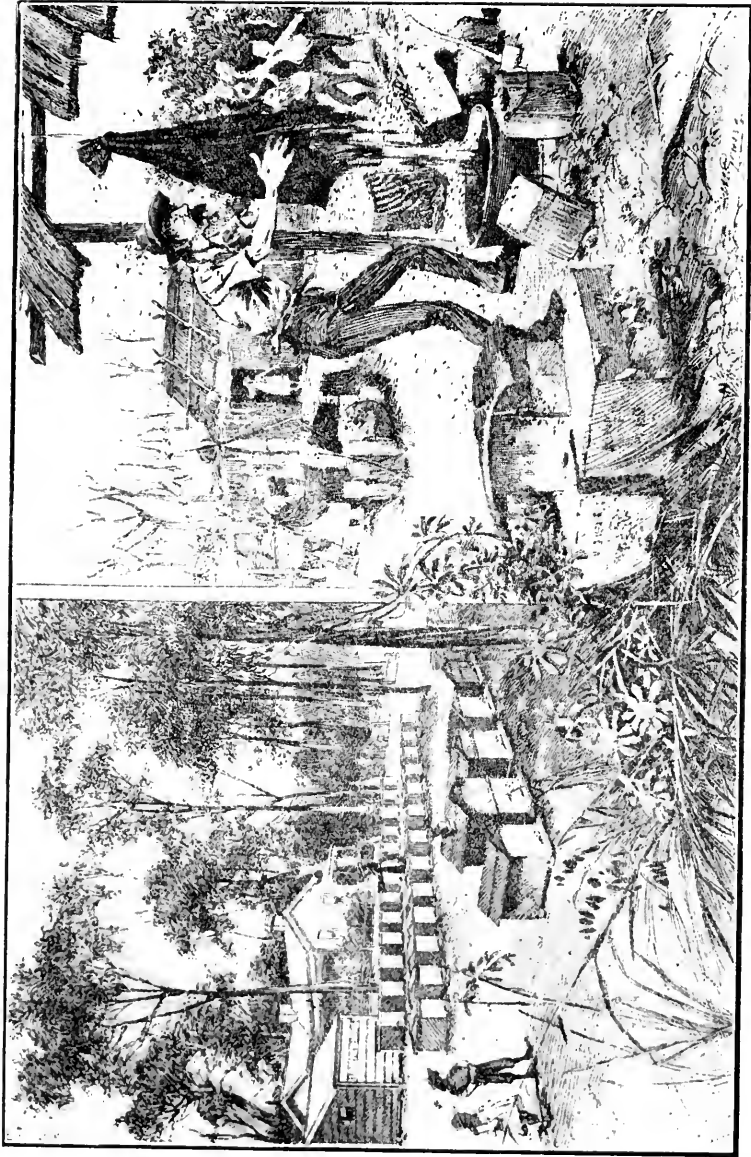

As it is.

Bee-farming.

As it was.



flying in and out of the hive? No; only I notice that some of the bees have much shorter wings than the others. They are old bees, and their wings are much worn with constant use. You must remember the number of trips they make daily, and the many miles they have to travel.

Well, now let us have a look inside at the bee nation, so poetically described by fanciful writers; but it is not a nation—it is only a home where dwells the mother, the father, and the children. No; that is wrong. There is no father. He is dead. Bee progeny are always posthumous. There are drones in here, but they are not fathers. You see, this is a 10-frame hive; it is too large for around Sydney. I will lift the quilt at one corner and blow in a little smoke. You will note the Why and the Wherefore further on. That dark sticky stuff on the top of the frames that makes the quilt adhere so firmly is termed by bee-keepers bee-glue. It is a substance bees procure chiefly from the buds of trees. There is not much in this outside frame but honey. That glistening liquid is the new honey they are just bringing in. Those cells on the top of the frame are filled and sealed over. They will keep that for winter use unless it is required earlier. You will see these cells on the outer parts of the comb are larger than those more in the centre. The larger ones are drone cells and the smaller workers'. There are not many bees on this frame; we shall find more towards the centre of the hive. Here, look! These bees hanging down in a festoon like a chain are wax workers. Oh, beeswax is a secretion that forms in eight little pockets that are found in the under part of the body of all workers, but not in the queen or drone. Let us take a frame from the centre of the hive. I shall find all we want to see there. Yes, just as I expected! Here is brood in all the stages of development. See the little white specks at the bottom of these cells? No? Here, let the sun shine in on them. I thought you would see them then. These are the eggs the queen has laid either to-day or yesterday. These little fat fellows curled around in the bottom of the cell are bee grubs a few days old. These big fellows that almost fill up the whole cell have nearly completed their grub stage. Where the brown caps are on the cells are the young bees in their last stage of development. Here is one that is just eating her way out. That little woolly fellow, after about twenty-one days of imprisonment, has just come out to see what the beehome is like. These light-coloured woolly ones that are running about more nimbly are older. They are now engaged in the duty

of feeding their younger brothers and sisters. They have not been out of the hive yet. They don't go out to work till they are about 14 days old. They then give up their nursing duties and become field labourers. Those capped cells that stand out more prominently? Oh, there are young drones in there, they will remain in the cells about forty hours longer than the worker; you see the cells are more bulky every way than the workers. That dark substance in these cells is bee-bread, made from that pollen you saw the bees carrying in on their hinder legs. That, eaten by the nurse bees, with a little honey and water added, is the material the young bees are fed upon whilst they are in the cells. No, these big bees out there are not queens, there is only one queen. Well, there is very likely to be one or two unhatched queens; these are always more or less present in the spring and also in summer, if the season is good. Why are there so many drones, when there is only one queen! You will learn that further on. That long bee there is the queen? The first you ever saw? Yes; she is easily picked out when you know her. Not much difference, only much larger? To you there may not be, but I can see a vast difference between her and a worker even externally. True, she has six rings to her body, and four wings and six legs, the same as a worker. Those two legs nearest the head of the worker are very similar to those of the queen. They both carry little combs in them for the purpose of cleaning their horns (antennæ). In the hinder legs of the queen there are no baskets to carry the pollen, neither has she those little nippers for removing the wax scales from the pockets that the worker has. The middle pair of legs in the worker contains a crowbar to lever out the pollen from the baskets. This is not so with the queen. The legs of the queen and the drone more nearly resemble each other than those of the queen and the worker. I will pick up the queen by the wing. I must handle her very gently or I may injure her for life, or she may become what bee-keepers term a drone layer. Oh, yes, she has a sting, and a very formidable one too. It is the drone has no sting. No, she won't sting. She can if she wishes to, but as a rule she only uses it on rival queens; her sting is not like that of the worker—that is straight, like a fine needle, but the queen's is somewhat curved. You would like to see the cell the queen lives in? She does not live in a cell. Her home is anywhere in the hive; but usually she is to be found on comb, in the cells of which she is laying. That large knob there, something like a lady's thimble, is a queen's cell; that is the cell from

which one will be hatched. She will be out in a day or so—sixteen days from the time the egg was laid till she emerges from the cell. That cell like an acorn-cup is one from which the queen has emerged. No, they won't use this cell a second time. Well, I think now we had better close them up, they are getting restless. Those bees you hear flying around you, making a sharp, shrill noise, have just returned from field labour, and they cannot understand what we are up to. Further on, you will find the whole theory of this in detailed or in practical and scientific language.

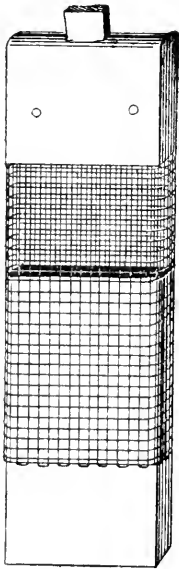

Queen Cage.



Queen Cell
Protector.

CHAPTER VI.

BEE-KEEPING.

THE natural history of bees and their economy are subjects that have attracted the attention of man for many ages. The most ancient writings, sacred and profane, are frequently interspersed with references to bees and their habits. In the earliest Jewish sacred writings both bees and honey are often mentioned. Honey is first mentioned when Joseph was in Egypt. These early people were impressed with the value of honey as food, and also with the wonderful peculiarities in the habits of the bee. Aristotle and other ancient philosophers did not deem the subject of too trivial a nature for investigation. Virgil and other early historians and scientists of that day patiently pursued the same track with a zeal worthy of the men and times. It was not until towards the close of the 17th century that any practical means and appliances were constructed for looking into and observing the bees actually engaged in their domestic duties. Francis Huber, born 1750, and died 1831, was one of the most zealous workers in apiculture that the world had ever seen, notwithstanding that he laboured under the great physical defect of the deprivation of sight. In his labours he was greatly assisted by his wife and man-servant. In more modern days, Dzierzon was an indefatigable investigator of bee-life. Professor Cook says of him:—"As a student of practical and scientific apiculture he must rank with the great Huber." Latterly apicultural societies have been formed in every civilised country—those of Europe, America, and Australia, being in the van.

A hive of bees in the spring and summer time is made up of a mother-bee and her sons and daughters, but late in the autumn it is composed of a mother and *daughters* only. The inmates of a hive are not of "*three* different kinds"—an error of Aristotle and other early historians, and perpetuated by many writers of these modern days. They are all of one sort or kind. They differ only in sexes. There are not *three* sexes—they are males and females. The drone is not a different sort of bee to the queen, neither is the worker a different sort to the queen or drone. Upwards of 2000 years ago, when the honey-bee first began to draw the atten-

tion of the then scientific men to the wonderful economy of the "Bee Nation," there were some wonderful flights of conception written. What could not be discovered by actual observation was filled in by *imaginary* facts. If Aristomachus spent fifty-eight years of his life, and Philiscus the whole of his, in the woods in attempting to unravel the hidden mysteries of bees "at home and abroad," what is there to wonder at that the big bee that was sometimes found in a swarm should be regarded as "the king" of that swarm, or a hive or nest of bees as governed by laws as unalterable as those of the Medes and Persians. In no sense are bees royalists. The so-called queen before her marital flight is not even noticed by the other members of the household. She is one of them. The working-bees pass her with indifference. Those feeding her are supposed royal suite of attendants. In her maidenly days the bees do not take the trouble to feed or even offer her food, but when the queen's maternity arrives they are most solicitous in offering it to her. They follow her wherever she goes, always anxiously anticipating her every want. If in the days of her maidenhood her stomach be microscopically examined no chyle food that has been supplied by the workers will be found therein. Undigested pollen-grains in numbers are always there—nourishment that she has obtained direct from the cells. It is not till she is about to become a mother that she is "carefully watched and tended" by the other inmates, and the attentions they then bestow upon her are not those of courtiers to royalty, but for economical reasons. During the queen's laying period she has not even time for her food to digest to form egg-matter. Her time is wholly taken up in her maternal duties. Bees are not even republicans. The queen (custom compels me to use the term) is in no way chosen by the citizens. "Mother-bee" is the term used by German bee-keepers, and it is far more expressive than that of *queen*. She is destined to be the mother-bee from the laying of the egg.

As our families are composed of a father, mother, and sons and daughters, so a colony of bees is similarly constituted; but with this difference: the mother-bee is *always a widow*, and is such immediately after the consummation of the matrimonial ceremony. The brood in the hive, both drones and workers, are always post-humous children.—*i.e.* have no father.

The mother-bee is a perfect and *complete* female, and is the only female that is so complete and perfect in a hive. In these characteristics she differs from a working-bee—the latter is perfect,

but *incomplete*. The queen, like drones and workers, is also posthumous, and is the only one capable of fecundation. Her one duty is simple, but very exhaustive. It is that of egg-laying. During early spring she is capable of laying 2000 to 3000 eggs a day; that is, if she is one of a strong colony - a colony containing plenty of nurse-bees, and also plenty of foragers. If her daily count of eggs fall short of this there is something wrong with the queen, the other inmates of the hive, or the bee-master.

Shiemenz says, "the queen's body-weight is 100 grammes, the eggs in her ovaries half that weight, and that she produces in eggs her body-weight 110 times in a year." Cheshire says "she lays her own weight (in eggs) daily." To keep up this enormous drain, her system requires a constant supply of very highly-nutritious or egg-producing food. Indeed, during her laying-season she has no time to digest food, to say nothing of the time required to feed herself. Her feeding is done by proxy, and her digestion is largely performed by working-bees.

Schönfeld says "that this queen-food is *produced*, not secreted, in the chyle-stomach of the workers, and is pure chyle-food." Dzierzon calls it *bee-milk*, and Dr. A. von Planta by chemical analysis has proved the truth of the assertion.

The queen-cell, as is seen from the diagram, is in no way even *similar* to the drones' and workers'; the two latter are built of wax, compactly put together, and almost horizontal. Queen-cells are perpendicular, with their openings upwards; and according to Dr. A. von Planta and others, "their sides, as well as their cappings, are porous, and consist of wax and pollen." He also says that this porosity is of physiological importance for the vital functions of the larvæ, and is more pronounced in the *sides* of queen-cells than in the worker and drone cells (of which I shall treat further on); and it is highly essential to be so when "such a precious creature as a queen has to *breathe* therein."

In such cell, in early spring, if there is a fairly good honey-flow, the mother-bee will deposit an egg. All the egg-germs within the ovaries of a queen bee are uni-sexual (males); nevertheless it is within the queen's power, according to season or requirements, to differentiate the sexual character of the egg-germ, by (as it passes through the oviduct) permitting it to receive a germ of spermatozoa before it is deposited in the brood-cell. When thus the sexual character of the egg is changed, it will produce a female—one that is *perfect and complete*, or one that is perfect and *incomplete*. If it is to become a mother-bee, the egg that has

has been differentiated will be laid in a queen-cell, and its inmate will be perfect and complete. If it is to become a worker-bee, the egg will be laid in a worker-cell, and its inmate will be perfect, but *incomplete*. By *perfect and complete* I mean a female that is capable of reproducing a colony of bees—queen, drones, and workers. By *perfect and incomplete* we mean that inmate of the hive which is wrongly termed a neuter.

Nevertheless this *neuter* is equally as perfect as the queen, but is physically incapable of reproducing her species, being deprived by nature of the power of fecundation. To term a working-bee a neuter is scientifically and grammatically wrong.

The eggs laid in the queen and worker-cells must undergo the sexual change above referred to. Sometimes eggs that have not thus been feminised are laid in worker-cells; such eggs always produce drones. They are known by their cappings being much elongated. Working-bees do not appear to discover the queen's error till too late, or they are satisfied to "leave well alone." Working-bees have the power of removing the eggs from one cell to another. This may easily be demonstrated by removing in the spring-time a frame of brood-comb containing eggs from the centre to the sides of the hive. The morning following the eggs will all have been removed elsewhere. When the queen lays a drone-egg in a worker's cell they (the workers) prepare for the development of the masculine inmate accordingly. Not by the removal of the interloper to a drone-cell, but by increasing the capacity of the one it is already occupying longitudinally. What the inmate loses in girth is made up in length.

A bee-egg is cylindrical, rounded at each end, one end being rather larger than the other. The larger end may be termed the head of the egg, as the head of the inmate develops at this point. When an egg is laid in a queen's cell it is attached to the base of that cell, *i.e.*, the part opposite to the cell-mouth, and at first hangs perpendicularly within and parallel to its sides. As the egg develops and advances towards maturity it inclines more and more towards a horizontal position, and some hours before the little prisoner is liberated from its captivity it lies at right angles to the sides of the cell. From the laying of the egg to the hatching usually occupies about three clear days. The newly-hatched grub or larva now becomes the recipient of unceasing feeding. The workers are all attention to supply this new-born babe with "royal jelly" till she literally floats in it. This food termed "royal jelly" has to sustain the young queen during her larval stage. She is

not weaned and fed on more solid matter as is done in the case of both drones and workers. This queen-food is composed of albumen 45.14, fatty substances 13.55, and sugar 20.39.

When the shell of the egg breaks the tiny inmate is seen wriggling backwards and forwards as it enters into the world. It has now entered its larval stage and can be seen slightly curved lying floating in the *royal jelly*. As it grows it will lie more circularly until it forms a complete ring. Very soon the *princess* outgrows the room in which she has been reclining. When thus grown she commences to lift her head above her body, or we had better say lowers her head beneath her body, because as she advances towards perfection her head is downwards and her abdomen upwards. The larval queen is generally fed by the workers for about four or five days.

Just before this well-fed baby-girl changes from a larva to a pupa "a sealing," says Cheshire, "full of minute perforations is added by the never-weary attendants, and the princess weaves within a cocoon of very singular structure." When the weaving of this cocoon is completed she "rests from her labours" for about twenty-four hours; soon her "works follow," and another stage in her metamorphosis begins. She becomes a chrysalis, nymph, or pupa. All these synonymous terms are used for this stage of her development, from the time she has completed her cocoon until she becomes the perfect insect—the imago. The whole time occupied from the laying of the egg till the inmate leaves the queen's cell is about sixteen days, perhaps a little more and sometimes a little less, according to the temperature and other local circumstances.

At the time this "princess" was entering the chrysalis stage the workers were very eager to seal her in while the work of cocoon-building was in progress. As the third transformation nears completion the workers are as anxious to remove the sealing as they were to construct it only a few days or about a week before. The riping queen may always be known (*i.e.*, the queen-cell in which the inmate is preparing to emerge) by the removal of the wax and pollen covering with which she was lately imprisoned and the dark-brown silky cocoon becoming exposed. When this uncovering of the cocoon takes place the enclosed tenant will soon prepare for her escape. With her jaws, like a pair of strong clippers, she will bite through the exposed cocoon (see diagram), twisting around in her cell as she performs the work of self-liberation. Cutting a circular piece from her silken shroud, she

comes forth perfect and in no way resembling the little white grub that was so careful to hide herself behind the delicate but strong lacy fabric that she had constructed to produce this her last or final transformation. It is a miraculous change. The inanimate bee-egg to be transformed into a wriggling footless grub is strange and wonderful. But for this apodal grub to be resurrected in the course of a few days into a beautifully-formed four-winged insect—an insect capable of both terrestrial and aerial locomotion, is infinitely more so.

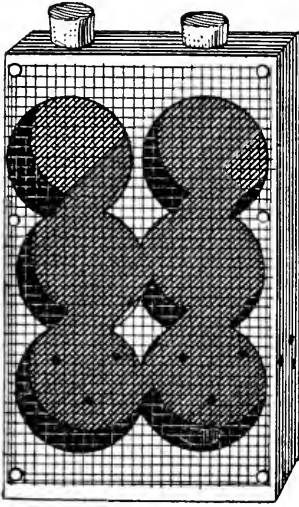

Queen Cages.

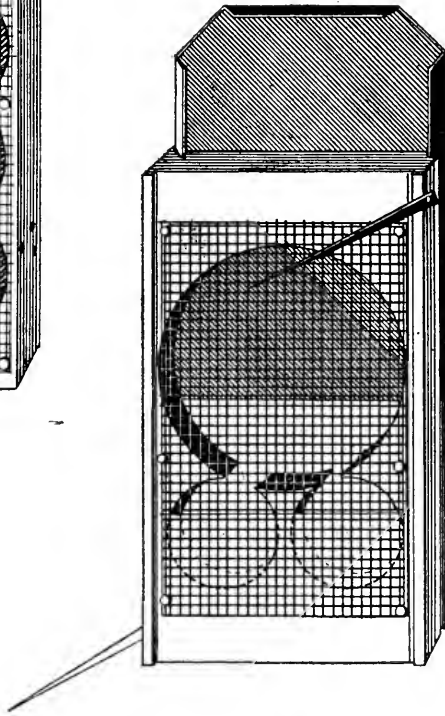

Queens.

CHAPTER VII.

THE QUEEN BEE.

From these diagrams my meaning will be made clearer:—
 A is a portion of the internal anatomy of a mother bee; (*a a*) the ovaries; (*d*) the sac (spermatheca), containing the feminine life germs, that is to differentiate the sexual character of the eggs seen in the ovaries; B is a portion of the same anatomy taken

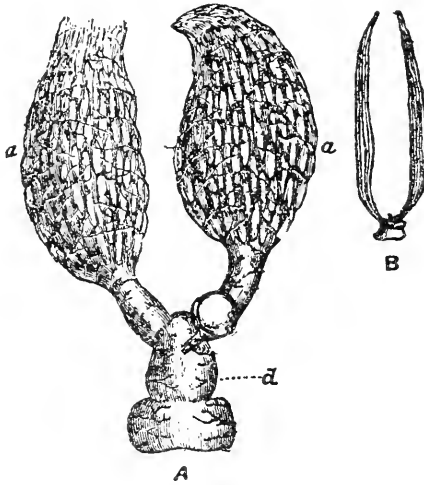

from a working-bee. In A, the mother bee's reproductive organs, the ovaries and spermatheca, are perfect. The former contains developed and developing eggs, and the latter is surcharged with feminine life germs. These constitute her completeness. Thus a mother bee is perfect *and complete*. In B the ovaries and spermatheca (reproductive organs) are as perfect as they are in A, but the eggs are in embryo and not developing, and the sac is void of feminine life germs. Therefore, the working-bee is as *perfect* as a queen, but her reproductive organs are empty. She is incomplete.

Nevertheless, those eggs in A (*a a*) contain a life-germ, but it is masculine. Under certain conditions those eggs may *never be feminised*, notwithstanding they are contained in the ovaries of a

mother bee, a bee that has developed under all the conditions necessary to produce a queen. She may emerge from the cell perfect, but her powers of reproduction may never be completed, as will be seen further on. So with a working-bee. She emerges from her cell with her *ovaries* as complete as those of a queen, and under certain conditions, to be named when treating of the *working-bees*, the embryo eggs contained therein sometimes develop the masculine life-germ, and she becomes what is termed a fertile worker. In her development, nature has stepped in and effectually barred the door against her ever receiving completion.

The queen, when she enters into her new life (the imago) will have her ovaries surcharged with embryo ovules. These will develop under every condition and every circumstance, accidents excepted. She is perfect. She is also perfect in another sense (virginal). Her reproductive and generative organs are fully developed, but the latter, when the final metamorphosis has been completed, is void of the feminine life-germ, that is to transform the male eggs in the ovaries into females—working-bees and queens of future swarms. It is possible for queen bees never to produce females.

Sometimes this happens naturally, and it is possible, artificially, to compel the queen to lay eggs that hatch out male bees only.

In handling frames with queen cells thereon, containing the larva or nymph, the greatest care should always be taken not to injure the inmate, a sudden jerk, or holding the frame so that the developing pupa is removed from her natural position, frequently results in producing a deformed queen, by crippling her wing, so that she is incapable of taking her marital flight, the result being that she is a drone layer from the beginning.

A knowledge of the queen bee is the axis around which revolves successful bee-keeping, and its failure is always more or less caused by a want of that knowledge. By a knowledge of the queen bee I do not mean a scientific knowledge, or a knowledge of her natural history, but a practical knowledge. A knowledge of a queen bee is not the survival of the fittest, but the selection of the fittest. "By their fruits shall ye know them." There is no beekeeper but must have observed that certain of his hives are more profitable than others; not profitable as regards increase in colonies, but profitable in their yield of surplus honey. It has always been so. There is no industry in which immediate

nature has to play an important part, but the success of that industry is the result of careful selection.

The useful and profitable characteristics, both mental and physical, in domesticated animals for ages past have been developed by crossing and selecting of the fittest, and these traits are always in the ascendancy. The injurious mental traits and unprofitable physical forms are being rapidly eliminated.

It is the same in those members of the vegetable kingdom that have become indispensable to man. But to return.

What ones are we to select? "Like produces like." If we find among our colonies of bees a swarm possessing a trait or characteristic more to our ideal than is to be met with in any of the others we should use every effort to perpetuate the valuable qualities thus selected.

In apiaries there are frequently hives of bees that "live into themselves." They pull through winter, throw off a spring swarm, and do well in summer and autumn, but not for the bee-keeper. They have never sufficient honey to extract. It is highly probable the queen is at fault. Destroy her and introduce one from a hive that has the qualities you most admire.

Swarm from your best colonies is a golden rule. Breed your queens from the same is still more golden. The queen of every swarm that is thrown off from a colony whose work is centred in self should be at once destroyed, and one that is a direct descendant from your best of colonies introduced. If this substitution be impracticable unite the workers with some others, the weakest you have, which has a queen from a pet colony. In no way be a party to perpetuate a mental, physical, or industrial deformity.

In artificial queen breeding select your larvæ from your most notable colony for surplus honey storage. Keep a debtor and creditor account, a day-book and ledger of every hive you possess; perhaps a stud-book is the better term to use.

If your new queen is to be the result of grafting a queen-cell on the comb of a queenless colony you must be very careful in your selection. Utilise one that is in a convenient position. Queen-cells are differently situated, sometimes on the edge of a comb, as in C, or on the base or the side of the comb, and again as in D, named an emergency cell. Under no circumstance use an emergency cell. These cells are the result of a last hope of a queenless colony, or of the mother bee from accident or infirmity ceasing to produce worker eggs. Emergency cells are worker-cells transformed into royal quarters. No queen-cell is better adapted for

grafting purposes than the one produced during the swarming season. The inmate of an emergency cell as a rule has advanced too far towards worker development.

An emergency cell may produce a fairly good-looking queen, but her ovaries and other reproductive organs during her worker period of progress, have been greatly checked, and her laying capacity of worker eggs greatly limited or wholly destroyed. Eggs in queen cups are not superior to those in worker-cells; as far as eggs go they are one and the same. But when once that in the worker-cells has reached the limit of maternal development and turns the corner towards perfecting a working-bee, its utility for a queen ceases. It needs no argument to prove the superiority of queens started in normal queen-cells from the egg or before turning the corner *workerwards* over those raised in emergency cells. Promotion from worker larvæ to that of queen larvæ should take place as early as possible after the hatching of the egg.

The chief and only aim of a beekeeper should be the production of honey. Amateur beekeepers, as a rule, lose sight of this. With them the multiplication of colonies is the one thing needful. Of making many swarms there is no end. The increase of colonies is a mania with far too many; too rapid an increase of colonies always ends in a failure of honey storage. Notwithstanding there may be an abundant honey flow, and while a near neighbour is extracting honey and glorying in his success, another will vote beekeeping a failure, because the object of the latter has been to increase his bee crop at the expense of that of honey.

This autumn, as I was passing through Orange, I was informed of a beekeeper with twenty-six colonies of bees who had harvested 5 tons of honey from October to April. A few miles off I met with two beekeepers who had conjointly eleven colonies; both rejoiced in their success of this multiplication in one season. They would have been delighted could they have shown a ton of honey as a result of the summer's work; the fault was in the bees, aided with a want of knowledge on the part of the beekeepers. The judicious selection of queens in the early spring would have given a surprising honey-yield, and the monetary profit would have appeared as a miracle.

The emergency cells are always constructed *over* an egg or a developing larva, generally the latter. In no case are they so selected for the purpose of the queen bee depositing an egg therein. The queen's cell is always the colour of the comb on which it is constructed and that of the other combs surrounding it. The

only cause that I know of for thus simulating the colour of the cells is that the materials of which it is built are scraps removed from those near to, and therefore the most handy for the purpose. Almost any material seems capable of utilization. Bee-larvæ whilst developing, moult frequently—that is, cast off their skins as they increase in size. These skin-casts and also grains of pollen, with the wax scraped from the other cells, are the material from which all queen-cells are made. Worker and drone cells are built with new material, but are used for the rearing of many generations of brood. Queen-cells, on the contrary, are built of old materials, and never used a second time. As a rule the worker and drone-cells are complete when the queen deposits the egg therein; but not until the inmate enters the chrysalis stage is it capped over. The queen-cell is built so as to accommodate the “royal” larva as she grows, and the walls of the cell are enlarged until the inmate enters the third form of development. Workers’ cells are pared down to the utmost limit, and their strength is obtained, as will be seen by referring to the accompanying diagrams, by the form of their construction, and the massing of so many together. Although so fragile in appearance they resist the pressure of the thousands of bees that are continually clustering thereon. The queen-cells, built as they are, semi-detached, are exposed to a much greater strain than those of the workers. During the whole time the queen larvæ are developing the cells are massed about by bees. The object of these clustering bees is the supplying of royal jelly, and to keep a high temperature around the inmate of the cell. If the queen-cells were as fragile as the workers’ they would collapse before the inmates were perfected. To overcome this risk, the constructing bees, so economic in the building of other cells, heap on the material until the queen-cell is forty or fifty times thicker than that of a worker’s. But that the instinct never forsakes them of saving material in all they do is very easily demonstrated by noting both the natural and artificial queen-cells in the accompanying diagrams. In each case it will be observed that the cells under review appear to be a compound of workers’ cells. This appearance is caused by the thick walls scooped out and pitted as to save material without loss of strength. As a rule, queen cells are constructed singly, but not unfrequently are they semi-detached, as in diagrams Nos. 3 and 4. At other times, when an extra good honey-flow is anticipated, as many as seven or eight of these cells will be under construction at one and the same time. Nos. 2 and 3 were taken from a hive

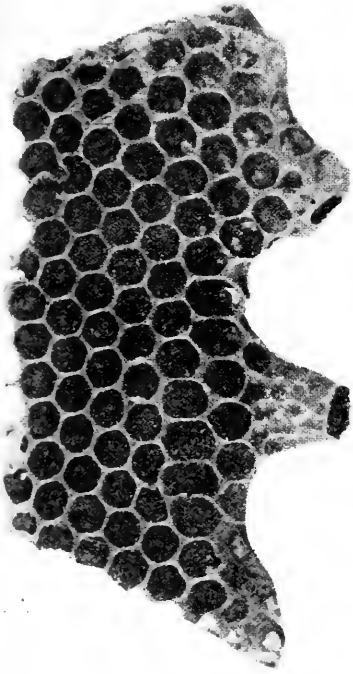

No. 1.

Queen Cells.

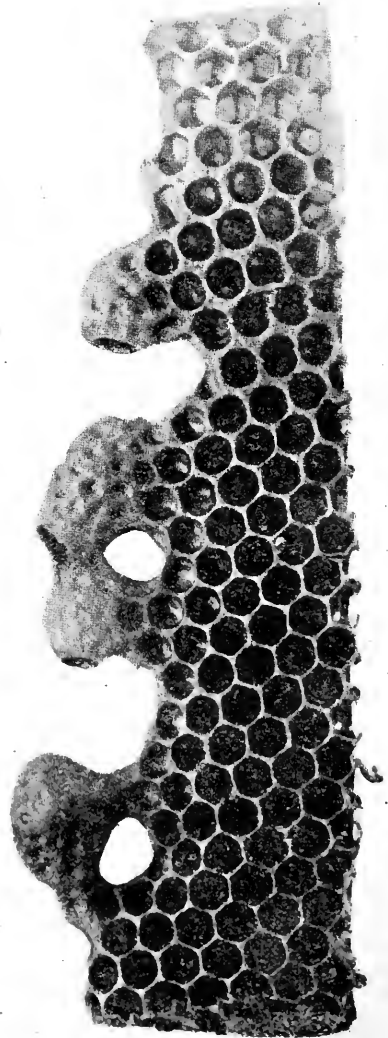

No. 2.

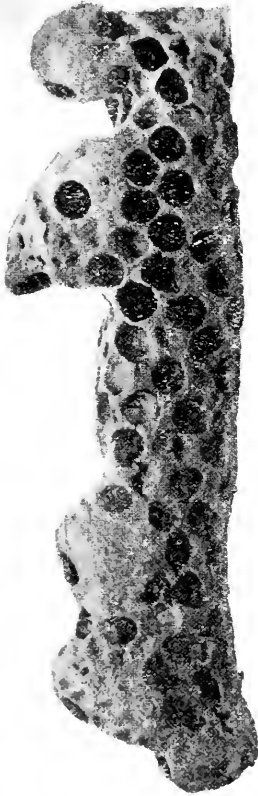

No. 3.



No. 4.

Queen Cells.

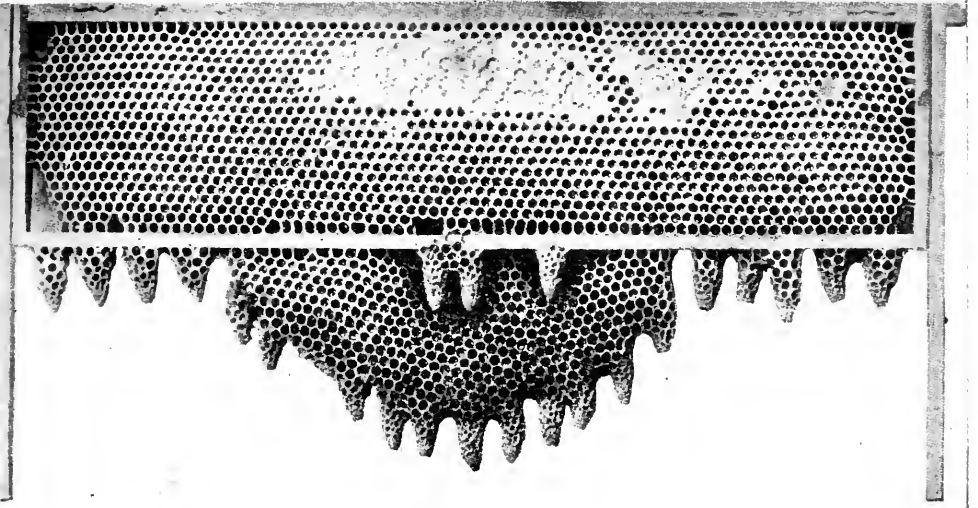

No. 5.

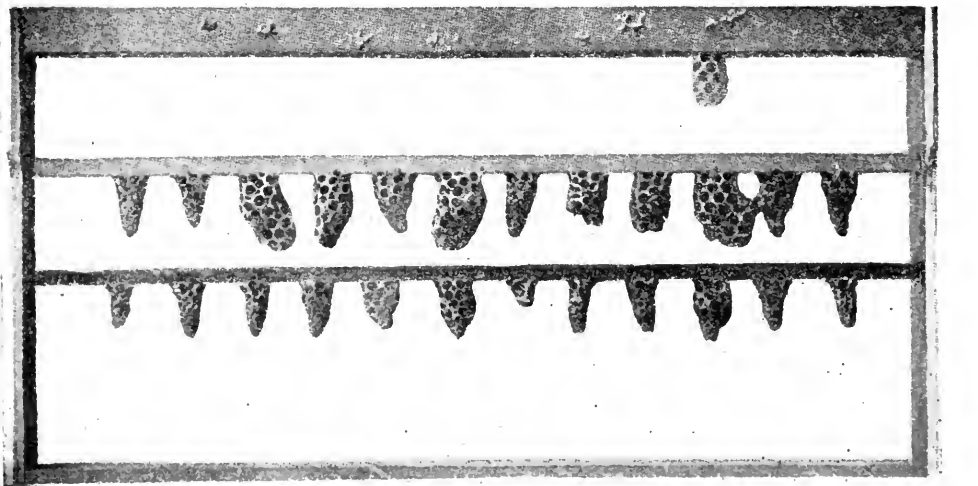

No. 6.

Queen Cells.

in which seven queen larvæ—all about the same age—were developing simultaneously.

Cheshire speaks of as many as thirty of these cells being constructed in succession. There is not much economy in permitting this. It keeps a large number of the bees from field labour, and the secreting of so much royal jelly necessitates the consumption of a lot of material that could be far better utilised in the rearing of brood. When there is such a superabundance of queen-cell building going on they should be destroyed after selecting three or four of the best, or as many as may be required. Of course, these remarks do not apply to nucleus swarms that are kept especially for queen-raising. In addition to the seven cells in the hive referred to, there were other cells hanging here and there in various stages of maturity. The abnormal abundance of developing queens in this hive resulted in four swarms issuing therefrom at intervals of about eight days each. No. 4 shows the vacated cells from which can be judged, approximately, the difference between the ages of its inmates as they emerged therefrom in the order lettered from *a* to *d* respectively. These cells, as before stated, are never used the second time. The thimble-like form, as seen in No. 1, is gradually reduced until it assumes the form of an acorn cup seen in the same figure.

Spring-time is the season when queen-raising is carried on most vigorously. When pollen and honey are coming in abundantly, the bees put forth the whole of their united strength to fulfil the command to be "fruitful and multiply, and replenish the earth." It is also the season when artificial queen-raising is most successful. Nos. 5 and 6 will give some idea of how queens can be raised artificially, and the number that can be produced at one time on the same frame in nucleus hives. These frames were produced by Mr. A. A. Roberts, of Muswellbrook, and resulted in the production of upwards of twenty queens of excellent type and perfect health. No bee-keeper can expect to be successful, no matter how good the season may be, unless he practises queen-raising.

The queen—which to the inexperienced differs in nothing but size from an ordinary worker, although in reality she is differently formed in every part from that of the common herd—when she is laying, which is the only function she has to perform in the domestic economy of bee-life, she moves slowly and gently from cell to cell, followed in her progress by a number of workers who are constantly seen to touch her with their antennæ, but in no way

stopping or impeding her progress or movements, always moving to one side, or backing out of her way, as the movements of the queen may require. As the queen proceeds she puts her head first into a cell, as if for the purpose of satisfying herself that it is not already occupied by an egg. Then withdraws, advances a few steps, clutches firmly the edges of some of the cells surrounding that already inspected. Lifting her body in a graceful curve, she inserts it in the cell until the abdomen is almost entirely hidden from sight. For a moment she is still, then she withdraws and proceeds to another cell in like manner, and so on, from cell to cell. If she is a good laying queen she will attend to each cell in rotation. This is one of the points in a good queen—laying evenly and regularly throughout the whole of one side of a comb. In examining a comb of hatching brood, it is frequently to be noticed that the queen appears to have selected a certain starting-point, and then laid around this common centre, enlarging her sphere of laying as the circle extends, and this process goes on in the same cells year after year.

The queen cell is frequently formed on the base of destroyed workers' cells, by enlarging the walls thereof. The egg that has been chosen from which to evolve a queen, after it is hatched and been fed for a few hours, is thus surrounded by a new building. The position the larva will occupy now differs. Instead of lying on its back horizontally, it will hang pendulously, head downwards. As the little inmate increases in bulk, so the walls of its home will be enlarged to accommodate it, and large quantities of food will be placed therein. When she reaches the nymph or chrysalis stage, the young queen partly enshrouds herself in a cocoon, remaining hidden until she is ready to emerge, which is in about sixteen days.

Having completed her series of wonderful transformations—egg to larva, larva to chrysalis, chrysalis to a perfect insect—she prepares herself for exit. Six or seven days ago the workers were very anxious to make her a prisoner by enclosing her within the cell, now they are as solicitous for her escape. The inmate had spun a cocoon over the entrance to the cell, and the bees had covered it with a mixture of pollen and wax. Now, knowing that her departure from the cradle is at hand, they remove that covering, leaving the cocoon once more exposed. The inmate, freeing herself from her last moult, exercises her powerful serrated jaws as a pair of shears, and works away cutting through the tough covering she had been at such pains to construct a short time since.

As she cuts so she turns in her cell, until she cuts a lid almost clear away, but frequently hanging by a silken hinge, then she is ready to make her escape. But, perhaps circumstances are not sufficiently ripe for her to take charge of the hive. The mother bee may not be ready to quit, the weather may not be what is desired for swarming, or there may be a sudden cessation in the honey flow. In the latter case she is executed without much ceremony, but in the two former cases she is again sealed up and fed where she is by the bees until the conditions that caused her re-imprisonment are removed; then she is permitted to enter the busy home, and ready to commence the journey from maturity to maternity.

The beehive and its inhabitants are like the conjurer's inexhaustible bottle, only there is no trickery about it; nevertheless, they contain a never-ending theme. Dr. Johnson said: "I have often amused myself with thinking how different a place London is to different people," and I have said, if not in so many words, the same in regard to the beehive and its inhabitants. The scientist, from his standpoint, sees only the wonders of the sociality of insects and their wonderful architecture. Both of these, to the uninitiated, are mysterious adaptations to the domestic economy in bee-life. Solomon of old held up the ant as an example of industry—"Consider the ant." The moralist of to-day points the improvident and lazy to the thrift of the hive—"Consider the bee." Paterfamilias takes his text from the same source from which to reprove and improve his share of the coming generation. The commercial man looks upon bees only as a source from which financial profits may be obtained. The school-master refers his class to them (the bees) as one of Nature's greatest object lessons, teeming with incentives for the acquisition of knowledge. I venture to affirm there is not a school-teacher in the Public Service but has given an object lesson to his class on some phase or other of bee-life. If all the good things that have been said in schools about bees were gathered together, what an interesting volume they would make! Every writer on natural history, of course, must say something about bees; but how they let their fancy rove from facts! Neither is there an insect in the whole entomological catalogue that has had so much poetry written about it as the bee. And what wonder-imaginings the poets have taken into rhyme!

The most interesting point of any and everything is the centre from which radiate the facts which give knowledge. By far too many beekeepers "have eyes and see not" beyond the commercial

centre. The axis around which revolves all the interesting facts of the bee-home is the queen. The queen is the centre of success for the commercial beekeeper; she is also the centre of failure. The whole of the domestic economy of the hive is centred in her, and all the interesting lessons given and learned on the subject are as nothing when the queen is absent.

The queen bee has been studied and written about more than any other inmate of the hive, or the female of any other species of insects; nevertheless, the queens of other species of bees are full of interest.

When a young queen first emerges from the cell she does not leave the hive until she is fixed as sole head of the establishment. She remains in what is known as the queen cell till she is fully developed, and ready for all emergencies. Usually she remains in the hive perfectly contented for five or six days after she escapes from the cell. During this period she is treated only as a com-moner by the worker bees. After that period she takes her marital flight. Prior to her leaving the hive for this purpose the air resounds with the deep sound produced by the numerous drones (male bees) that are on the wing. The excursions of the drones are only made on fine days, and immediately around about the hive from which they have made their exit; and the reason of these flights is in quest of queens. When these drones are on the wing, the queen, if she be sufficiently mature, soon follows. If prevented by some of the modern appliances now in use she exhibits the utmost anxiety to escape, by searching in the most anxious manner every available nook that may, perchance, afford her exit. Even if there be no impediment to prevent her from taking her marital flight, she appears to be greatly agitated, as if full of timidity or anxiety. She decks herself in no bridal costume, but, as she is about to sally forth, she is a thing of beauty. She is all aglow in her most beautiful tints. She is small—not much larger than an ordinary worker; it is true, perhaps a little more *lady-like*, but, like all brides, she puts on her most fascinating looks and graces. Among all the drones that are out awaiting her advent there is but one that will be chosen as bridegroom; all the others are to be best men, or perhaps only second and third best, for in this case the race is to the one that is most expert and alert of wing. The bride, full of apparent coyness, advances, circles, and recedes, pursued by a number of the lords of the bee creation. With the most agile the gordian knot is tied. The final matrimonial ceremony is completed mid-air. She that went forth as the

blushing bride returns to her home in the earliest stage of maternity—not like the completion of other weddings, where the bride returns to her home on the arm of her lord, but the queen bee returns alone, leaving her lord not even to follow her. He, poor fellow, dies on the battlefield of love—not killed by his disappointed rivals, but dies as Nature has willed it. I have said elsewhere that all bees are posthumous. No drone that is in the hive, or that is on the wing, has ever been a father. He may become one, but he must pay the penalty his father had to pay before him.

The mother bee returns to the hive a fecundated—a complete female bee, now capable of becoming a mother. Indeed, had she never met with a consort she would nevertheless become a mother, but only to lay eggs that would produce males, and males only.

The fecundation of a queen bee.—With nearly all other oviparous animals, it is the *ovule* that is fecundated; but with bees it is the *animal* herself, and she fecundates the egg according to requirements, and, to a certain extent, regulates their sexuality. The number of eggs the queen bee lays in the cells is in accordance to the strength of the colony. She will not lay more in the cells than there are inmates to cover them. Ofttimes a queen will be so prolific she *will* lay her eggs, although there are not sufficient bees in the hive to cover them. These supernumerary eggs are wasted. This should be an incentive to bee men to keep strong colonies. Langstroth says: “It is most amusing to see how the supernumerary eggs of the queen are disposed of. If the workers are too few to take charge of all her eggs, or there is a deficiency of bee-bread to nourish the young, or if, for any reason, she does not judge best to deposit them in the cells, she stands upon a comb and simply extrudes them from her oviduct, the workers devouring them as fast as they are laid. I have frequently witnessed, in observing hives, the sagacity of the queen in thus economising her necessary work, instead of depositing her eggs in the cells where they are not wanted.”

On her return to the hive after her marital flight she is received by the workers, although not her own children, with all the signs of love and affection that children can bestow upon a parent. You must know there is nothing regal about the queen bee; although she is called such, she is only the mother bee. Before she went out the workers treated her as one of themselves, excepting that the nurse bees occasionally fed her. Now nothing is too good for her. Her every want is attended to with lavish kindness. She is about to become a mother. Yet what a

mother! The only maternal trait she possesses is that of egg-laying.

In two or three days after she returns to the hive the act of laying commences. So eager is she in this duty that I have frequently seen her depositing an egg in cell after cell without even taking the trouble to note if she had not made a mistake now and then—I mean a mistake in not leaving a cell empty. During the earlier months of her laying she uses the workers' cells for worker eggs only. Later on she will lay in both sized cells—drone and workers. Then I have known her make mistakes by dropping a drone egg—that is, an egg that will produce a drone—in a worker's cell; and, as far as I know, neither queen or workers discover the mistake till it is too late, when they rectify it, as far as they can, by elongating the worker cell so as to make up to the little inmate what is lacking in width. Here her motherly instinct ends. All other domestic duties are delegated to the worker. Theirs it is to attend to the egg when hatching, and to the developing larvæ. What a wonderful division of maternal duties! The queen, with the power of being a mother without the power of being able to administer to the wants of her offspring. The worker, with power to attend to, care for, and nourish, even to the supplying of the earliest necessary food—bee milk—but not the power of being a mother—that is, not the power of reproducing her species.

Having taken a cursory glance of the mother bee—not from the cradle to the grave, but from maturity to the first stage in maternity; not from a scientific or a practical standpoint—but with a view to interest those outside the practical and scientific sphere of bee-life, I will now retrace the steps, and go back to the beginning—the egg that hatches out a queen. But is the egg the beginning? Which was first—the egg or the bee? The queen laid the egg and the egg produced the queen; that is a never-ending cycle—writing around and around a ring.

We know that frequently after returning from her marital flight she begins laying after two or three days' rest. Before she took that flight her ovum was surcharged with ovules; these ovules are germs of matter—(a philosopher once said matter was never mind, and mind was no matter);—but her spermatheca was empty. The spermatheca is an internal sac to receive and to retain the life-germs. The object of the flight I have referred to was to get this empty sac charged with these life-germs. You will remember I said the egg was not fecundated, but the queen.

The germs of life received by her in her aerial flight from one, and only one, contact must number thousands upon thousands of these germs. Once becoming fertile this fertility remains for two, three, and sometimes as long as five years, but there is never a fresh supply of life germs from the male. Every seed of a plant requires a grain of pollen to fructify it. In like manner, every ovule of matter produced by the queen requires a germ of life to fecundate it. Every germ that is discharged from the spermatheca so far exhausts the supply. The health and strength of the queen may be such that the whole supply of these life-germs may become exhausted; nevertheless, the queen will still go on laying, and the eggs will hatch out living bees. They are always drones. As the germs in the spermatheca diminish in number, so the male population of the hive is augmented. The first reproductive efforts of a queen result in a progeny of female bees—workers and queens. The final efforts produce males—drones. The line of demarcation between the queen's powers of producing males and females is not a sudden cessation of her power to produce females, but is a gradual one and at first unnoticed. As the numerical strength of workers diminishes, so that of the drones increases. How is it so? Just now I said the virgin's spermatheca was empty, and she went out to get it charged, so that she may be capable of reproduction. Then I said that when these life-germs she has received become exhausted, she still goes on laying, and produces living descendants. Does not this appear to be contradictory? Yes; but it is true, nevertheless. St. Paul said, in referring to a future life, "Behold, I show you a mystery." I am doing the same now in relation to bee-life. How do I know? Because, if from any cause, natural or artificial, the queen bee is prevented from taking her marital flight, the result is the same as if she were an old queen, and in the stages of reproductive decay I have mentioned. But if she be debarred from the power of flight, cannot the same results be produced on terra-firma or within the hive? No. Because the results, of a mid-air meeting, are productive of a male and female progeny; so a queen not having the power of flight, even if she be deprived of that power as soon as she emerges from the cell, produces only males, and it has always been so. "How can these things be?"

You will remember I said it is the queen that became impregnated, and not the egg—the ovary, and not the ovum—a method of reproduction not uncommon in the insect world; but in the higher orders of oviparous terrestrial animals this method

is rare; whilst, on the other hand, aquatic animals, with the fishes especially so, it is the egg that is fecundated, and that, too, in most cases, after extrusion.

Here I propose to deal with the queen from the extrusion of the egg to the mature and perfect insect; nay, in one sense it will be necessary for me to deal with the egg prior to extrusion. We speak of the inmates of the hive as the queen, drones, and workers. There is nothing wrong in it. We also refer to the queen as having the power to lay eggs that will produce these three beings. Drones are male bees; the queen and workers females. The former has power to reproduce her species; the latter have not that power. Nevertheless, these conditions may be, and frequently are, changed—sometimes by the act of the bees themselves, and at other times artificially; that is, at a certain stage in the development of the egg, the queen structure may be advanced or checked, so that the egg shall produce a working bee or a queen, as may be required, either by the bees themselves or by the bee master. Note this transposition for a reproductive female or for a non-productive female takes place after the egg has been deposited in the cell by the queen—that is, the change or transition does not take place *within* the ovary. In the case of the production of the drone, the sexual character of the inmate of the egg is fixed *within* the ovary. The spermatheca of a virgin queen is void of female life-germs; but, notwithstanding this, the ovary is sur-charged with embryo ovules. Each one of these contain a male germ, and each one, if laid by the queen in the same state as it is whilst in the ovary, would produce a male bee. It is immaterial as to where the queen deposits that egg either in a drone, a worker, or a queen cell, the result of development is fixed—it can hatch out nothing but a drone, a perfect male bee. But, for the production of a female bee, all the conditions for the production of the male are followed by Nature up to one point, when under certain conditions the sexual character of the egg changes. This sexual change takes place whilst the egg is in transition from the ovary to extrusion, during its passage through the oviducts of the mother bee. The egg is an elongated sac, one end of which is much larger than the other; in the larger end there is an aperture (micropyle). This aperture is extremely minute; but the minuteness of the opening does not prevent its being continued through the underlying egg membranes, and giving an opportunity of entrance to the spermatozoon (the life germs contained in the spermatheca), whose rhythmic movements, as

though guided by intelligence, conduct it to the micropyle when the egg passes within the fertilising pouch, on its road towards being laid in a worker cell. The wondrous thread enters, coalesces with the germ (of matter within the egg), brings about fertilisation, and affects the resulting sex in a female bee, either a worker or a queen.”* Had not this egg passed within the fertilising pouch, and had not the wondrous thread referred to entered the micropyle of the egg, it would have passed out through the ova-depositor, and its sexual characteristic would have been masculine; but that “wondrous thread” differentiates the whole creature, and an egg is deposited that will produce a queen—a perfect and complete female, capable of sexual intercourse and capable of reproducing its species, but unable to administer in the slightest degree to the wants of its progeny; or a female, a working bee, perfect in all her anatomical parts, but incomplete—that is, the spermatheca is incapable of reception, and the only female instinct she possesses is that of nursing. We know little of the growth of the egg from its embryonic stage to its maturity other than that which differentiates its sex. I have already explained that an egg which is to produce a male bee in whatsoever cell it is laid, the result is the same—a drone. Not so with the egg under review. Contact between that “wondrous thread” and the aperture in the egg does not fix the question whether it shall be a queen or a worker; it only fixes the fact as to gender. The egg that has received the life-germ from the spermatheca will produce a female; but it does not settle the question as to its future destiny. The queen, the workers, and the bee-master have that under control. [The question whether the queen can lay an egg at will that shall produce a male or female bee will be dealt with when treating of drones.] Under ordinary circumstances the locality in which the egg is laid determines the position the bee will occupy in the future domestic economy of the hive. The laying of the egg in the cell in the first instance is controlled by the queen. Circumstances only decide whether it shall be deposited in a worker or a queen cell. If the egg be permitted to remain in the worker cell, it will develop a worker bee; but if it retains its position in the queen cell, a queen bee is the result. The circumstances that control these productions are many; naturally, the seasons; but even these are subject to great variations. An early spring, with an

*Cheshire.

abundance of bee fodder, both in honey and pollen, results in the early development of queens. In fact, queens are bred naturally according to requirements. If there be a prospect of the brood multiplying to the extent that swarming will be necessary, queens are produced to meet this contingency. The brighter the prospects for a large and continuous honey flow, the greater is the eagerness among the bees to rear queens. One fertile queen is required for every swarm that issues forth from the parent hive. But, many queens are developed where only one is required. The reason of this is obvious. When it is remembered that every queen bee is an enemy to every other queen bee, the destruction of queens must be frequent. The fight is always to the finish. No matter what the conditions are; the developing queen larvæ is as much an object of hatred to the reigning queen as is a healthy fertile and fully developed rival.

The cell in which a queen bee is developed differs greatly from that of the worker, not only in form, but in many other respects. The cells in which workers are developed are sexangular tubes. These are arranged horizontally, or nearly so, and form one compact mass. Each of these six walls form a division between any two cells. The arrangement and the massing of these cells form what is familiarly termed brood comb or honey comb. How unlike these are the queen cells. They are circular tubes that hang perpendicularly from the workers' cells. Workers' cells are always built of new material—there are occasional exceptions; but queen cells are always built of old material without exception. The workers' cells are used for two purposes—nurseries and storage; queens' cells as nurseries only. These are detailed contradistinctions sufficient for my purpose. Note, if the queen lays an egg in a worker cell, and within two or three days lays another in a queen cell, naturally we shall have a queen from the latter and a worker from the former cell; but if we apply art, and transpose those eggs, we differentiate the entire creatures that are developed therefrom, checking the evolution of a queen to a worker, reducing the period by about five days by altering its surroundings and other conditions; but we extend the evolution of the worker to a queen by the same time, from the same cause, and the same altered conditions. The queen cells are, as a rule, built on the sides or base of the brood comb. Occasionally a pop-hole—that is the hole frequently seen in honey comb or brood comb to permit the bees passing from side to side of the comb—is enlarged, and the queen cell constructed on the upper edge thereof. And again, it is sometimes met with

as if protruding from a worker cell. These latter are only constructed in cases of emergency. From some cause or other the queen becomes sick, or her laying powers become deranged, or from some other cause she ceases to lay. When the bees make this discovery, their instinct naturally leads them to rectify the queen's omission. The discovery that no eggs are being deposited by the queen causes great anxiety in the hive. Instinctively they know that where there are no eggs there will be no workers, and where there are no workers there will be no food, and thus the continuation of the home must speedily come to an end. The development of queens is entirely left to the workers. After the queen has laid the egg, her duty with it ceases. The workers know that any or every egg or larva is not suitable for queen development. Occasionally, under the stress of the impossible, cases have been known where the bees have chosen a drone egg or larva with the idea of developing a queen therefrom, the reason being that every other avenue of continuing their species had been closed against them. This is bee ignorance, caused by anxiety. Those emergency cells protruding from the workers' are constructed over a larva from a similar cause, it being the best within the hive to select for the purpose of developing a queen therefrom. The queens evolved from such cells are always far inferior to those evolved from cells constructed of the edges of the combs.

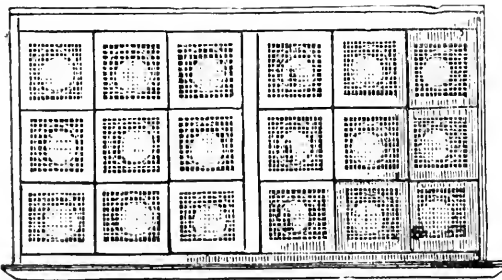

—ALLEY QUEEN NURSERY.

CHAPTER VIII.

THE DRONE.

DRONES, or male bees, as will be seen, differ very much from the queen or other inmates of the hive. Indeed, so much so, as to lead unobservant people into the belief that they belong to a different variety of the same species rather than being male members of the same family in which they are found. On this account drones have been very greatly maligned and looked upon as interlopers rather than factors equal in importance to that of the queen bee. That they exert a pernicious influence in the colony to which they have uninvitedly attached themselves; are dangerous to the well-being of the swarm; militate against its increase and prosperity; and operate against the financial success of bee-keepers, are opinions still held by far too many bee-keepers. The word drone is associated with idleness, worthlessness, and a sponger on, or a vampire of society. It has been borrowed from the supposed uselessness of the drone-bee. A quaint old writer says:—"The drone is a gross, stingless bee, that spendeth his time in gluttony and idleness, for howsoever he brave it, with his round velvet cap, his side gown, his full paunch, and his loud voice, yet is he but an idle companion, living by the sweat of others' brows. He worketh not at all, either at home or abroad, and spendeth as much as two labourers; you shall never find his maw without a drop of the purest nectar. In the heat of the day he flieth abroad, aloft, and about, and that with no small noise, as though he would do some great act, but it is only for his pleasure, and to get him a stomach, and then returns he presently to his cheer."

That drones have "loud voices," and that in the heat of the day they fly "abroad, aloft, and about," is a part of the economy of their nature, and is a factor in the perpetuating of the fittest of their race.

The external anatomy of the male bee (drone) differs very greatly from that of the females (queen or workers). In cell accommodation he occupies a greater space. Drone-cells are only four to the lineal inch, whilst the worker-cells go five to that measurement.

The cappings of drones'-cells are more convex than those of workers, and as in the case of both queen and worker, are porous. They contain not nearly so many pores as those of the former, but far more than that of the latter. When the inmates of these cells have completed their larval stage and are entering upon that of the chrysalides, they are sealed or capped over with a mixture of wax and pollen. The shape and texture of the cappings are such that they are easily thrust off by the mature inmate. The inmates of the cells spin the cocoon by which they are enclosed, but the construction of the cappings is the work of nurse bees. The cappings of brood-cells differ greatly from those of honey cells: these latter are not nearly so convex—in fact, are in the centre slightly concave, so as to more easily resist the pressure of the honey within; they are, moreover, formed entirely of wax, and are therefore air-tight.

In developing, the drone goes through the same metamorphoses as the other inmates, but the time occupied therein is longer. From the laying of the egg to its hatching occupies three days, he remains six and a-half days in a larval form, then changes into a chrysalis and becomes a perfect insect in from twenty-four to twenty-five days. During his larval stage he is fed for about the first four days on 55.91 albumen, 11.9 fatty substances, and sugar 9.57 parts, but as the larva advances in age the two former are decreased and the sugar increased, the average being 43.79, 8.32, and 24.03 respectively.

In the wing he is more expansive, as the following measurements of Cheshire will show:—

	Length of Anterior Wing.	Length of Posterior Wing.	Ratios of United Area.
Worker	38	28	5
Queen	41	29	6
Drone	49	35	9

These measurements are given in one-hundredths of an inch. From this it will be seen that the expansion of a drone's wing is nearly twice that of a worker, and one-third more than that of a queen. Therefore his aerial locomotive power must be greater than either of the females. His antennæ (organs of smell) have also a greater development of olfactory nerves, and are two-thirteenths longer than either that of queen or worker, thus his power of smelling is far superior to theirs. His eyes, notwithstanding he spends a

large portion of his time in the dark, have a far keener power of vision than either female. Bees have both simple and compound eyes. The compound eyes of a queen bee have 4,920 facets, she having to spend the largest portion of her time in the dark. The compound eyes of a worker, who has to spend most of her time in the open air, have 6,300 facets; but those of a drone, although he spends most of his time in the hive, contain 13,090 facets, or nearly three times the number of a queen, and more than double the quantity of the worker; therefore, his power of sight must be far greater than that of the other sexes of the hive. Why has Nature endowed him with these superior aids to sight, to smell, and to locomotion? His paternal duties are always consummated in mid-air. The race is to the swift and fight to the strong. The fleetest, the most dexterous, and the strongest are the successful competitors in the matrimonial race when the virgin queen is on the wing. That is why "in the heat of the day he flieth abroad, aloft, and about, and that with no small noise." Drones are stingless; their abdomen is made up of seven belts, and each belt is composed of two plates—a dorsal and a ventral—the former being the larger, and overlaps the ventral on the lower side of the body. In queen and worker the abdomen has only six belts.

To sum up, the chief external anatomical differences of drones are, as compared with the workers, larger eyes, larger wings, larger body, longer antennæ, an extra belt to the abdomen, and an absence of sting, wax pockets, and pollen baskets.

The life-history of drone bees is a very short one, and, apart from the other inmates of the hive, is not interesting to the bee-keeper, but to the scientist it is fraught with the deepest interest, and is full of scope for research. The Parthenogenical production of male bees; workers becoming fertile without copulation, and producing drones only; queens that have failed in their wedding flight to meet with a consort, or that in their development or in maidenhood have been deprived of the power of flight, also become fertile without copulation, but such fertility is confined to the production of male bees only; that they are rarely produced by a queen in the full vigour of youth, health, and strength, etc., but are always produced as the queen advances in age—the older the queen the greater the abundance of males in the hive. These are subjects in connection with the "inmates of the hive" that I shall deal with later on.

Very little attention has been given to the production of high-class drones. They are the Ishmaels of bee life. Every bee-keeper's hand is against them. They have been given a bad name, and it sticks to them, and all sorts of traps have been invented for their destruction. For the improvement of other domesticated animals a high-class sire is the one most sought after. In the improvement of bees it is otherwise. A high-class dam (queen) is supposed to be the one thing needful. We have the mating proclivities of bees so little under control that breeding by the selection of males appears to be a thing of the future. As we now stand, much can be done to improve our bees by the power we have in our hands. An immediate descendant partakes of the mental, physical, and industrial character of both parents. Traits in parentage can be traced for many generations, and there must be an influence exerted on a descendant from both sides. Parthenogenesis, as it regards drones, has been proved to have exceptions. Bee-keepers have frequently met with cross-bred drones. J. Lowe, in 1867, as recorded in *Trans. Ent. Soc.*, says that fully 20 per cent. of drones bred from the same mother showed the mixed character of the parentage. J. Perez, in 1878 and 1880, in his investigations, obtained similar results, and P. Cameron, in an article on Parthenogenesis, in the *Hymenoptera*, published in the *Trans. Nat. His. Soc. of Glasgow*, 1888, drew bee-keepers' attention to similar facts.

Some time ago we submitted the following series of questions on this point to some of the most observant and practical bee-keepers of the colony:—

1st. Have we hybrid drones?

(The term hybrid to mean a crossbred. Hybrid is a misnomer as applied to a cross between varieties. A hybrid is an intermediate between species, variety is subordinate to species in the same manner as species is subordinate to genus).

2nd. What are the markings of the progeny between the first cross of a pure Italian drone (Ligurian) and a black queen?

3rd. What are the markings of the progeny between the first cross of a black drone and a pure Italian (Ligurian) queen?

4th. A drone two removes from a pure Italian queen. What are his markings?

5th. Through how many generations of drones can you trace Italian blood?

To all these questions we received answers from every one to

whom we applied, and from which we compile the following answers:—

1st. The general opinion is "No," as it regards markings or appearances. The drone progeny from a queen that has mated with a drone of another variety partakes of the *nature* of both parents, but the maternal nature always predominates. Two very striking instances in proof thereof are mentioned. A writer says, "I bred a solid yellow American queen, not a particle of dark colour even at the tip (Sixth dorsal plate). This queen was mated with a Ligurian (Italian) drone. This queen, during the Summer of 1893-94, produced, being young, evenly marked drones, almost yellow (samples of them were forwarded by Mr. Mansfield, Largs, to the Technological Museum, Maitland). During the Summer 1894-95 about 10 per cent. of drones from this same queen varied from the characteristics of the typical Ligurians." In the second case there was a similar result, but the mother bee was one remove further from the American blood by that of Ligurian, in this case there were between 40 and 50 per cent. of the drones showing Ligurian markings.

2nd. The male progeny partakes of the paternal colour and markings, with the exception that the hairs on the abdomen are browner and more dense near the tip.

3rd. The same markings as those from a pure Italian queen, *i.e.*, the three bronze bars on the upper edges of the abdominal segments, each of these bars being somewhat narrower than those of the cross mentioned in No. 2 answer. Occasionally there is a darker patch of bronze extending from the first and second dorsal ring, and partly down each side of the segment. The rest of the abdomen is black. Of the species forwarded to the Maitland Technological Museum the donor says, "Many persons are disappointed in the appearance of these drones, and it would be a good thing to make these characteristics more generally known."

4th. These drones vary in their markings similar to that of the workers, the black blood showing itself more prominently in some of the progeny, and again in others of the same family the Italian markings predominate.

5th. None of our correspondents have traced as yet the Italian blood beyond the third generation. This is a point well worthy of careful investigation.

For breeding purposes the strongest male bees should be used. As stated above, the strongest drone is naturally the selected male,

selected by his own powers of flight, etc. Weak drones, whatever may be the cause thereof, can only perpetuate weakness.

Drones are tolerated in the hive and admitted from others as long as there is a probability of a queen requiring fecundation. But let the honey-flow suddenly cease, and in a few days every one in the hive is banished.

As soon as the honey-flow is no longer abundant the edict is sent forth for the destruction of all the males of the household. There is no mercy shown. The old and the young, egg, larvæ, and chrysalides, must all suffer the same fate. The only crime for which they have to suffer is they are masculine. Those males, that a few weeks before were so active and strong on the wing, when the general order has gone forth for their destruction, offer no resistance. They readily submit to be slaughtered, and those very nurse bees that were so watchful of their well-being at once become their executioners, until the whole of the male sex of that hive is exterminated.

As queen bees mate but once during life, the drones that are required for the following season are the progeny from the same mother, and are full brothers of the slaughtered victims of the previous year.

How often has the question been asked, "Why are there so many drones?" and what queer answers have been given to it. To produce extra heat, to aid in the ripening of the honey, food for birds, etc., are the answers that have been given. It must be remembered, as stated above, that conjunction between the queen and *one* drone takes place but once during the former's lifetime, and such conjunction must take place when the queen is about six days old, although cases have arisen where queens have successfully mated for some time after that period. If there were a scarcity of drones the queen may fail to meet her mate and become a drone-layer. The superabundant number of male bees to one female is analogous to the great number of stamens and anthers in a peach "blossom" or other bloom to the one or few carpels in the flower. One grain of pollen from one stamen is sufficient to fertilise one ovule, then why so many stamens and pollen grains is a question the answer to which has never been doubted. Undoubtedly the same answer as it regards the excessive number of drones applies in this case.

To my mind an excess of useless drones is an argument against the ability of the bee-keeper, or a want of knowledge of the age of his queens. Drone over-production can be minimised by judic-

ious management. Young queens, and closer spacing of brood-comb when necessary, are about the best drone-traps that were ever invented.

For high-class drones, select an old queen, one that has a record of good traits, perhaps the older the better. If she has produced workers up to your ideal standard of usefulness, there is a moral certainty that her drones will be of equal merit. To a certain extent in this way good drones can be selected. "It is not fully true that the drone *is* beyond control," says Cheshire. With care, selected drones can be so secured for the purpose of mating with selected queens. When a queen is 5 or 6 days old, and unmated, close the hive she occupies at night, and remove it to a cool dark room, and keep it there till the afternoon of the second day; return the hive to its original stand. A nucleus hive is the most handy for the purpose. Before returning it to its place, feed all within with heated honey diluted with warm water. Before liberating the queen and other inmates of the hive, be satisfied there are no drones on the wing. This may be done by listening for their deep bass hum, and noticing the entrances of the surrounding hives. It is better to have two nucleus hives for the purpose. One should contain the virgin queen and the other the drones, wherein there is a fertile mother-bee. When the nucleus hives are placed on the stand in the sunlight, it will cause great excitement in both hives. The queen and drones will at once rush out, and there is a moral certainty that the object sought will be attained.

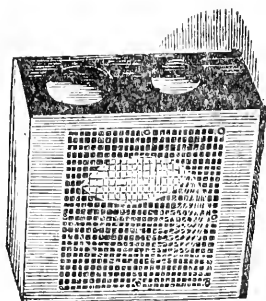

—NURSERY CAGE.

CHAPTER IX.

THE MYSTERIES OF DRONE-PRODUCTION.

ASSOCIATED with the word drone are the terms lazy, idle, and indolent, a ne'er-do-well, one who sponges on society, a human parasite. Sometimes it is used to indicate a low, dull, heavy, monotonous sound. In either case the character of the drone or male bee has given birth to the meaning of the word as now used.

In the latter case the sense attached to the word is very appropriate. In the spring time, those who live near bee-keepers, even if they have no ear for music, cannot fail to be attracted by the low, heavy sound in the air that is so frequently heard about midday when the sun is shining brightly. As it regards the sound emitted by the male bee, the use of the word in that sense is quite justifiable. But as it regards the traits of the male bee being classed with society's drones, there is nothing whatever to justify the assumption, and there is nothing analogous or parallel between the drone bee and the idle and indolent of the human family.

The idea of bracketing everything lazy and idle with the male bee sprang from a want of knowledge in the early history of social bees.

Why should the male bee be so maligned? Why should he be a Cain amongst his brethren, everyone trying to slay him? Why should he be an Ishmael bee that every man's hand is against? Amongst other domesticated animals the males are regarded as of the first importance. Their owners are as proud, and in some cases even prouder of the pedigree of their choice sires than they are of their own genealogical records. Sires always fetch a much higher figure in the market than dams. It is the same in the feathered race. A rooster is worth no more for the table, weight for weight, than a hen. In the yard he is not nearly so valuable. A hen will lay without him, and the eggs are equally good, if not more so, for table purposes. It is the same with other high-class domestic animals. If a man wishes to obtain a name for himself as a breeder of high-class animals, he spares no expense to obtain high-class sires. The dams are looked upon as secondary. Why? The sire is one with many,

and the dam with one. The type of the sire is gradually transmitted through the whole herd. Generations afterwards the throwbacks can be pointed out as carrying the typical form and traits of character of a favourite ancestor. Every care is bestowed upon the sires; it is they that are so advertised. In the show parades it is the sires that are the observed of all observers. When we come to bees the scene changes. We never hear the remark, Where is the drone? but, Which is the queen? If the sire amongst quadrupeds is one among many, transmitting all his good points among the many, how much more so is the case with drones? With the quadruped every descendant is the result of one or more matings between two animals. With bees how different. It is one, and only one, mating between two individuals, as will be seen by referring to the section on the queen bee. But how different the result of that single mating. It produces hundreds of thousands of descendants. More remarkable still, the mating of drone and queen results in a progeny of *all* females. Do not mistake me. I know that queen bees produce a mixture of sexes. But the males are not the result of the mating with *her* consort, *i.e.*, the one that produced the progeny resulting in all females. The male progeny are the outcome of the mating of a previous generation. How can I tell? A golden Italian queen (*a*) mismates—that is, she has come in contact with a black drone (an English bee). What is the result? All the females (workers and queens) are what we should expect them to be, cross-breeds, usually termed hybrids; and if the queen is from a pure stock with Italian blood running in her veins for two or three generations back, the *males* she produces are all pure Italians without a taint of black blood visible or invisible. Again, a pure-bred English queen (*b*) with two or three generations of black blood in her veins mates with a full-blood Italian drone (*b*) resulting in a female progeny of cross-breeds as with the queen (*a*), but the males are full-blood blacks. Now let a perfect and complete female bee (*a2*), being an immediate and direct descendant from the queen (*a*), mate with another black drone. Of course, it will neither be drone (*a*) or drone (*b*), because that would be an impossibility; drone (*a*) and drone (*b*) having died immediately after mating, as is always the case. This was fully explained in a previous page on the queen bee. The result of the fecundation of the queen bee (*a2*) is that all the female progeny have more black blood (three-fourths) in them than their mother;

but the males have the same amount (one-half only). The female progeny from the queen (*a2*) is the result of her mating with the second-named black drone—her consort; but the males are the result of the mating between the first-named black drone and the queen (*a*). Again, let a perfect and complete female bee—a queen (*2 b*)—also being an immediate and direct descendant from the queen (*b*), mate with a full-blood Italian drone. The result of the contact is that all the female progeny have more Italian blood in them (three-fourths) than their mother; but the males—the drones—have the same amount (one-half only); so it goes on with every succeeding generation. The female progeny of every queen is the result of *her* fecundation; but her male progeny is the result of the queen's mother's fecundation. Is this a case of partial parthenogenesis—production without immediate fecundation; or is it a case of atavism—a throwback?

Here is another peculiar thing in connection with the mysteries of drone production. Queen bees are what are termed perfect and complete. They are perfect as it regards their form, and have their sexual organs fully developed—that is, procreatively receptive. Working bees are perfect and incomplete. They are perfect as it regards form; but their sexual organs are undeveloped—that is, they are procreatively non-receptive.



Working in the Open.

CHAPTER X.

THE WORKING BEE.

WORKING bees are the rank and file of the hive; the architects, the builders, the preparers of building materials, the purveyors, the cooks, the nurses, the inspectors of nuisances, the scavengers, the sentinels and the defenders. All and every bee when at home has to fulfil these and many other duties at some time during her indoor life, from the day she escapes from the chrysalis till she goes out to procure home supplies.

"The working female," say Kerby and Spence, "is zealous for the good of the community, a defender of public rights, enjoying an immunity from the stimulus of sexual appetite, and the pains of parturition, laborious, industrious, patient, ingenious, skilful; incessantly engaged in the nurture of the young, in collecting of honey and pollen, in elaborating wax, in constructing cells and the like. Paying most respectful and assiduous attention to objects (queen bees), which, had her ovaries been developed, she would have hated and pursued with the most vindictive fury till she had utterly destroyed them."

Abroad they are foragers, collecting pollen to supply the juveniles at home with bee bread, honey for winter stores, and propolis to glue up cracks, and cementing foreign intruding substances that are too cumbersome to remove bodily or too tenacious to be removed piecemeal. Abroad they are one of the great fertilisers of the vegetable world. They are our forest makers, our orchardists, our florists. As forest-makers, they perpetuate the species of trees and plants upon which they work. As fruit-producers, they are constantly improving their form, their colour, their flavour, and their season. As florists, they are ever varying our flowers in shape, in perfume, in colour, in tint, in streak, and in freckle. They are constantly reproducing odd colours and fashionable combinations thereof, and suffusing them with the most attractive shades to please the searcher for novelties in the floral world.

In the pages on queen-bees I named the workers as incomplete females; we now propose to follow the latter, watching the

changes she undergoes in her transition stages from egg to imago, noting how she performs her various home duties, and following her into the field, the orchard, and the garden, and watching her in Nature's workshops elaborating new varieties of flowers and fruits.

The fecundation of the mother bee by the drone is the first element in differentiating the sexual character of the egg-germ in the ovary of the queen-bee. Swammerdam, an old entomologist, on noting a strong odour, emanating from drone bees, was under the impression that the said odour permeated the body of the queen-bee, and in this way the eggs were fertilised. Francis Huber, experimenting with the theory, confined a number of drones in a perforated box. Placing this box of drones within a hive, from which all drones had been excluded, and confining a virgin queen within the same hive. Needless to say, with our present knowledge of the domesticated bee, she became a drone-breeder.

THE EGGS AND THEIR DEVELOPMENT AND TRANSFORMATION.

The egg, after fertilisation and the treatment it receives after it is deposited in the worker-cell, produces one of the rank and file. While in this cell it is termed a "worker-egg." A misnomer introduced into the bee-keeper's vocabulary before the scientific knowledge of the economy of the hive bee was so well understood as at present.

There are such things as worker-eggs. They are the produce of a fertile-worker, but these eggs always develop drone-bees.

The queen-bee, after she has satisfied herself that the cell she has selected is wholly untenanted and cleaned ready for the reception of an egg, places her abdomen therein, and after it is withdrawn we see fixed at the base of the cell, and parallel to its sides, an elongated pearly-white egg, one end being rather larger than the other.

In the larger end there is a minute doorway (*micropyle*) by means of which the sexual character of the embryo drone-bee contained therein was differentiated. These eggs remain in the position in which they were deposited, and then gradually alter it until they are lying parallel to the base of the cell, which occupies about two days to complete its final position. The heat necessary to hatch these eggs and for their after development should not be less than 70 degrees Fahrenheit.

Draughty hives have much to answer for in preventing early spring swarms. So also has the too common practice of leaving the supers on the brood-chamber without an intervening warm quilt between the two boxes. The more snugly in the brood-chamber the bees are kept during the winter months and early spring, the sooner will early swarms issue, always providing the old stock has been kept numerically strong since the previous autumn. If "the early bird gets the first worm," it is the early swarm that gets the most honey.

When the inmate of the egg hatches, a little whitish worm is seen lying on the bottom of the cell and parallel to it. As soon as the little inmates are liberated from the egg-covering they are supplied with a white semi-transparent fluid by the nursing bees. After receiving this food they grow rapidly and very soon touch the angles on either side of the cell. The little inmates literally float in this milky fluid. Very soon their couch becomes too short to stretch themselves upon. Then they assume a bent or semicircular position. The degrees of these circular segments increases until both ends meet. When there is no further room to coil they stretch themselves along the sides of the cell and parallel to it.

When the larval transformation is nearly completed the organs of locomotion commence developing, first the legs followed by the wings, and so on; this is the beginning of the chrysalis stage. Then the nurse bees begin the work of enclosing the inmates by sealing them in with a brownish mixture composed of wax and pollen, or bee-bread, the same kind of material as the larger cappings of the drone cells and that of the queen-bee are formed with. Under the microscope these cappings are seen to be full of small holes, which freely admit the warm air from the clustering bees to be utilised by the two spiracles in the thorax of the maturing inmate, the ten in the abdomen remaining inactive during the final stage of this transformation.

During the second stage of transformation the larvæ frequently moult or change their skin; this occurs five or six times during growth. After the final moult they are fed for about four days. The inmate is now supplied with no more food, and the work of cocoon-spinning begins as soon as the capping of the cells is completed. The silken threads composing the cocoon are produced from a fluid yielded by a gland, and the work of its construction is exactly similar to that of the silkworm and other cocoon-building insects. Indeed, the bee cocoon may be

described as made of bee-silk. The fluid escapes from spinnerets in the lips of the larvæ, and after its extrusion quickly hardens and becomes fibrous. On the completion of the capping, all further attention from the nurse-bees ceases. The construction of the cocoon occupies about thirty-six hours. While the final development of the chrysalis stages are completing they remain motionless until the twenty-first day is reached, when they emerge from the cell to commence the duty of perpetuating their race, having all the maternal instincts of the mother bee without the sexual appetite and the power of parturition. The queen is one of the most unconcerned onlookers in the hive, as it regards the rearing of the family that is developing from the very eggs she has laid. Not so with the workers. Their one thought is the protection and nurture of the helpless young; an incessant, laborious, patient, and life-long toil; a life cut short by premature death when the family is most numerous; not a death from a ripe old age, but a life worn out by industrious labour, in what should be the spring-time of energy.

NURSE BEES.

The first duty devolving on working bees on entering the world is the care of her brothers and sisters during their infantile lives; a solicitude for their welfare; their cleanliness, their health, always anticipating their every want. Huber was the discoverer of nurse-bees. He speaks of two kinds of workers. One of these is, he says, "In general destined for the elaboration of wax, and its size is considerably enlarged when full of honey; the other immediately gives what it has collected to its companions; its abdomen undergoes no sensible change, or it retains only the honey necessary for its own subsistence. The particular function of the bees of this kind is to take care of the young, for they are not charged with provisioning the hive. In opposition to the wax-workers, we shall call them small bees, or nurses. Although the external difference be inconsiderable this is not an imaginary distinction. Anatomical observations prove that the stomach is not the same; experiments have ascertained that one of the species cannot fulfil all the functions shared among the workers of a hive. We painted those of each class with different colours, in order to study their proceedings; and these were not interchanged. In another experiment, after supplying a hive (deprived of a queen) with brood and pollen, we saw the small bees quickly occupied in nutrition of the larvæ, while those of the wax-working class

neglected them. Small bees also produce wax, but in a very inferior quantity to what is elaborated by the real wax-workers."

There was never a more careful observer of scientific bee life than the physically unfortunate Huber. Since the introduction of the Italian bee, painting and other mechanical aids to observe the various works carried on by the inmates of the hive—the species, class, or kind so named by Huber as wax-workers, nurses and foragers—have dwindled almost into nothingness. That in the hive there are nurse-bees, wax-workers, foragers, etc., is well known to the practical bee-keeper; but that these functions are deputed to various sections of operating bees is now known to be incorrect. Huber must have the credit of the discovery of the division of labour among bees; but that a nurse-bee is *always* a nurse-bee is incorrect. These different functions or classes of labour carried on in the hive are performed by every bee during her lifetime. The first duty of a working bee is that of elaborating chyle food, the nursing of the inmates of the cells, and as she advances in age so she is promoted from office to office until she becomes a breadwinner of the establishment. In this final duty her wings wear out, and she dies in harness, at her post, as the little busy bee.

These nurse-bees are all-important to the bee-keeper. When bees refuse to cluster on the brood comb, or to accept a new queen, or even to rear one, it is because some of the natural conditions of the hive are absent. A want of a sufficient number of nurse-bees is a serious drawback to the prosperity of a colony. In artificial swarming "forced colonisation," if on the brood comb introduced there be not sufficient adhering bees or nurses to feed the larvæ the foragers become dissatisfied at the deserted appearance of the comb, and, refusing to stay, they swarm out or return from whence they came. A constant, regular, and good supply of nurse-bees is the important factor in queen raising. If increase of colonies is the thing sought always note that the combs introduced contain brood in all stages of development, from egg to chrysalis, as well as a good supply of stores.—honey and pollen—this last is indispensable.

CHAPTER XI.
FERTILE WORKERS.

It is not an uncommon thing, from some as yet unknown cause, for a working bee to become procreative. They are usually termed fertile workers. These fertile workers assume all the functions of queens. The workers treat them as such, but I think always with a certain amount of misgiving. They lay eggs, but from these eggs drones are always evolved. Is this power of laying the result of the copulation of the previous generation, or is it a case of parthenogenesis? If parthenogenesis, how is it that it so rarely shows itself? If a virgin queen, through some accident to her wings or any other cause, loses the power of flight, thus preventing her consorting with a mate, she becomes, in bee-keepers' phraseology, a drone-layer. In this respect she stands exactly on the same plane with fertile workers. All unmated queens are always drone-layers; but drone-laying workers (fertile workers) are of rare occurrence. In the case of drone-laying queens, through the loss of the power of flight, she ceases to be procreatively receptive. A fertile worker has, and has always had, the power of flight, but, procreatively, she was never receptive. Yet a drone-laying queen and fertile worker stand exactly upon the same footing.

The mysteries of the bee-hive, what an interesting subject! The reason of this is full of wisdom! In this it is seen no working bee has a brother of full blood. It may appear to be paradoxical. It may even appear to be absurd, seeing that the same mother produced both the males and females of the family; yet, as absurd as it may appear, it is true in fact. It may be asked what relationship exists between the mother bee and the drone she produces, seeing that the father of her own son was the consort of her own mother—a relationship that is not catalogued in the tables of consanguinity?

Thus, if the influence of the drone, both in traits of temperament and working energy (although the drone works not, the energy for such is transmitted by means of the life-germ), is it not of paramount importance that as much, if not more, care should be taken to produce drones of high physique and energetic

will, as is now being done in relation to queen-breeding? If the sire in the higher type of animals is of such vital importance, how is it that the drone bee is not viewed in the same light with bee-keepers? A difficulty stands in the way: We have not the selecting and mating powers in relation with bees that we have over other animals. Nevertheless, we can do much towards the selection of sires among bees. With bee-keepers it is well known that the queen's powers in the reproduction of working bees gradually subsides with age; and as her powers of worker production diminish her powers of producing drones increase until, finally, she ceases to be sufficiently profitable or even capable of continuing her female species. It is usual with bee-keepers to supersede all queens after two seasons' laying. It is also known that the progeny of some queens are 50 per cent. more energetic than that of others. If one or more of these known energetic queens, after they cease to be profitable, owing to the non-production of working bees in sufficient quantities to keep up the numerical strength of the colony, are kept for stud purposes to breed drones, one of the difficulties of selecting is overcome. Further, if the keeping of the drone-laying queen be followed by systematically cutting out or otherwise destroying all young drones in other hives before they emerge from the cells, we shall go a long way in the controlling the selecting powers of mating our bees.

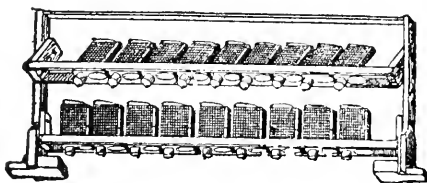

Queen Rearing.

CHAPTER XII

SELECTION FOR STOCK PRODUCING.

CULTURE, farming, rearing, and raising are synonymous terms when applied to any of the members of the vegetable or animal kingdom that are under the fostering care or guiding hand of man. Our chief aim in these matters is the selection of the fittest that may become in one way or the other useful to us. There is no culturist under so great a disadvantage, as it regards the selection of the fittest, as the bee-keeper. Those interested in the culture of members of the animal kingdom other than bees, can select and mate both sire and dam with a reasonable probability of producing a certain ideal or development of an animal more akin to man's requirements than those that were the parentage of the said production. So with the vegetable kingdom. The knowledge we have, and the power we possess as it regards cross-fertilisation, has put such a lever in our hands, that, after having conceived the idea of what may be an improvement either in colour, form, flavour, or bulk, something near thereto is the result. I know that the percentage of failures are far greater than the successes, but from these we select the fittest, and these survive. In these matters the bee-keeper is under one great and lasting hindrance to his success, he cannot select and mate both sire and dam. With him there is no reasonable probability of achieving an ideal type of bee that may suit his fancy. Neither can the bee-keeper ever hope to have the power in his hands to regulate the mating of his stock, so as to change the character of the wild type, either in form or size. Freaks in these matters undoubtedly have occurred that, according to our way of thinking, have produced a bee an improvement on her ancestors. There have been cases of albinos; but even supposing that these cases were more numerous, and still supposing that albino bees would be an improvement on their more sombre brethren, a new variety could not be worked up therefrom, because the cases have always occurred among drones and infertile females (workers), and not fertile females (queens). Again, we occasionally see working-bees extra long in the abdomen; that length not being produced by the surcharged honey sac, and, indeed, some queens seem disposed to produce inmates of two or

three different types. This differentiation in the case of drones is the result of being bred in worker-cells. These drones while in a chrysalid form are easily distinguishable by the capping of the worker's cell being much more elevated than those surrounding it. It is a question with me if these drones bred in worker-cells have the power of pro-creation. Even if it were so, our so far utter inability to mate such an ideal drone with a queen of an unusually long abdomen is debarred by our not having the power to control the mating instinct of bees. A gentleman once said to me, "I have found a method by which I can increase the size of the honey bee." The method was by enlarging the size, ever so little, of the impressions on the foundation comb, and after breeding many generations of this enlarged bee, to again increase the pattern on the foundation, and so on, as the increased size of the bee became fixed. Of course, he knew nothing of practical bee-keeping, and less of its scientific aspect. But when I pointed out that if it were possible to increase the size of the physical structure of bees the whole of the entomophilus flowers would have to undergo a series of new evolutions, so as to fit the enlarged bee, for, according to the Darwinian theory, flowers have evolved to fit the bees, it would appear, according to the creative standpoint, the size and forms of the bees were made to fit the flowers. Be this as it may, we cannot, even if we would, breed bees for a material alteration in form or any increase in size.

From the foregoing it is evident that the object of bee-culture or bee-farming is not for an improvement or an alteration in the physical contour of the insect. Neither can it be for the production of ornamental or fancy varieties as it is with poultry-farming or pigeon-fancying, but to produce a bee that shall excel the wild types in gentleness and in labour.

Elsewhere I have said that I think it possible to produce a type of bee that shall be purely Australian in traits of character, that is, as regards docility and gentleness, activity, and foraging; also in health and in prolification. To obtain these ends there must be the selection of the fittest. The traits of disposition, etc., cannot be traced as coming in any way from the sire's side, for we seldom, nay never know him. His resultant characteristics can only be seen in the progeny, and these traits that emanate from the masculine side cannot be perpetuated for the reasons given in the earlier part of this subject, and that on "From Maturity to Maternity." In breeding other domestic animals, and, indeed,

flower culture and other members of the vegetable kingdom, an ideal can be reached with a greater certainty than is the case with bee culture, because the "fittest" can be selected from both genders. The selection of a typical sire in bee culture is a barrier that seems impossible to surmount.

Thus, then, we must confine our whole attention to the dam, the mother bee, so as to secure those traits of docility, activity, and prolificness so essential in the manipulating of bees, and securing the greatest amount of profit. It is said that females supply the elements of matter, and males those of disposition, activity, etc. Although the queen bee appears to select her consort at random, as a rule it is really the selection of the fittest, for the coveted prize is won by the swiftest of the queen's male attendants. Nevertheless we cannot select the fittest male element of the hive with any degree of certainty; we have the female element almost under positive control. Then how are we to select our queen so as to secure the characteristic traits here enumerated? "By their fruits ye shall know them." Every bee-keeper, practical, amateur, or the most careless amongst them, knows that he has certain colonies that he can walk around about, handle, or move with almost an absolute amount of security from an attack, whilst there are other colonies that he dare not go within coo-ee distance of without having to pay the penalty due to the bees' aggressive temper. Again, in an apiary, no matter whether it be of large or small extent, there are certain colonies that seem to do all the work. Every bee-keeper when he is taking you around amongst his pets will be sure to take you to one particular hive, and inform you "this is the best, or one of the best, lot of workers I have in the place."

CHAPTER XIII.

TEACHING BEES TO WRITE.

Whilst I am now writing, just in front of my study window I have a few hives of bees, one lot as black as any British bees I ever saw. For years past these have given me the greatest amount of section-honey as compared with other hives. It is well known that the honey harvest this season (1900), so far, has been a failure almost all over the State, and Sydney district in that respect stands at zero. Some time ago I conceived the idea of *teaching* my bees to work out certain ornamental designs for the forthcoming Royal Agricultural Show. When everything was ready to *give them their first lesson* in ornamental comb-building, the honey crop suddenly failed. So as to produce the said designs in time for the Sydney Royal Agricultural Show, I was compelled to have recourse to supplying the bees with honey for the purpose. The honey was given in large quantities. I distributed the ornamental designs amongst five colonies. I knew the first thing they would do was to pack away as much as possible of the stores in the brood-chamber. When that work was accomplished I naturally supposed all five of the colonies would commence to work out my ornamental designs, N.S.W. N.B.K.A., 1900, which is now in the Sydney Technological Museum. What was the result? No. 1, after having stowed away as much honey as they could, conveniently in the brood-chamber, absolutely refused to take another drop of that supplied them, notwithstanding there was plenty of room in the designs. For years past this No. 1 has never given me a single section of honey. No. 2 was already well stocked with storage in the brood chamber. These also refused to build comb from fed-back honey. No. 3, in like manner, had plenty of honey in the lower storey, but went to work comb-building in a listless manner, and soon became tired of the work. No. 4 (full-blood Italians) went to work manfully, and in a few days had worked out "0" design, and on the fifth day commenced storing, and as long as I gave fed-back honey to them so they continue to work the designs and have completed the second "0" and capped the greater portion of

the filled cells. No. 5 are real old-fashioned black bees—the bees of my childhood—largely discarded now for the more gaudily-attired Italian. These, too, soon went to work on the design “19,” but, what is most singular, they worked out the curvilinear lines of the 9 in preference to the straight line 1. Undoubtedly, the main cause of apathy with Nos. 1, 2, and 3 was the failure in the natural honey flow; but why should they refuse to build comb when there was an abundance of honey supplied them? I will tell you. Because they are not descendants from an industrious and energetic family. Like produces like; not only in colour, form, and size, but in energy, disposition, and docility. In these respects there is as much difference amongst bees as is the case with other animals. In form and features we can easily trace a family likeness in the human race, and in the same race traits of character and intelligence are as indelibly portrayed. Of course, there are exceptions to the rule—or throwbacks, as cattle breeders term it. And the same thing is met with in bee culture.

Again, go into a large apiary at early dawn, and you will see bees swarming into certain hives almost before sunrise heavily laden with pollen and other stores, whilst in other hives the bees are scarcely on the move. Yes, there are sluggards amongst bees as well as amongst men.

Every bee-keeper in a large way—and, indeed amateurs if they are men of observation—will tell you they have seen, more or less frequently, strong colonies of bees that throw off weak swarms. Some bees, whilst being handled and the comb examined, are as restless as a flock of wild sparrows, others, again, appear to take little or no notice of your interrupting their order of work. I have lifted a comb of brood into the light and seen the queen go on with her egg-laying duties as undisturbed as if the frame had not been touched, and the workers at the same time attending to their occupations.

Now, why all this? Because I want you to see the difference there is in the working abilities and mental powers (may I use such a term? I don't see why!) of bees. What caused the difference in the work accomplished by the bees with the ornamental designs referred to? A difference in physical energy. For energetic workers bred from queens whose progeny exhibit the greatest amount of endurance and working powers. For foraging also these will be on the alert in the early dawn. You can only ascertain the health, the energy, the docility, etc., of a queen by observing these things in the workers of that queen. Then breed

from such queens whose progeny give the greatest number of advantageous points. As yet, we have no means of choosing bees furnishing the superior masculine traits of character; but by constantly selecting queens for stock purposes, possessing the greatest number of desirable peculiarities, a strain of workers will be the result, valuable for all the good qualities required in a domesticated bee. Always select the fittest, and the fittest must survive. Not otherwise.

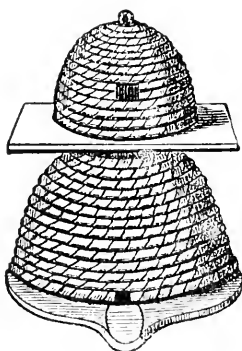

Old Straw Hives.

CHAPTER XIV.

WHY DO BEES SWARM?

'WHY do Bees Swarm?' The answer, stuffed into the proverbial nutshell, resolved itself into this: "It is one out of the many methods Nature has of distributing and perpetuating her species." True, there is a vast difference between Nature's method of distributing bees into new localities and that of other animals whose offspring leave the dam singly, or, seeking a mate, strike off to find pastures new. The offspring of bees leave accompanied by their dam, if it be the first spring swarm, provisioned for the journey, and ready to construct some of the furniture necessary for making a start in house-keeping on their own account. What is the cause of this extraordinary exodus is an effect that is followed from a cause. What is that cause, and how is it brought about? These are two out of many questions that I propose to deal with here—both more or less useful to the inexperienced bee-keeper. For want of such information many a valuable swarm of bees has been lost, whereas, had the signs been properly interpreted, many of them would have been saved.

It is admitted by all, both scientific and practical, bee-keepers that Francois Huber, who wrote his researches on this subject more than 100 years ago, was the greatest inquirer into bee life that ever lived. He is always looked upon as the Solomon of bee-keepers, yet on p. 220 he says: "Therefore, to preserve their race, it is necessary that the old queen conduct the first swarm. But what is the secret means employed by Nature to induce her departure? I am ignorant of it." On p. 240 he again says, "It has been demonstrated that the principal motive of the young females departing when hives swarm is their insuperable antipathy to each other. All the young queens are successively treated alike in hives that are to swarm. But the conduct of the bees towards an old queen destined to conduct the first swarm is very different. Always accustomed to respect fertile queens, they (the workers) do not forget what they owe to her; they allow her the most uncontrolled liberty. She is permitted to approach the royal cells, and if she even attempts to destroy them no opposition is presented by the bees. Thus her inclinations are not

obstructed, and we cannot ascribe her flight, as that of the young queens, to the opposition she suffers. Therefore, I candidly confess myself ignorant of the motives of her departure. No one cause induces the old queen to depart from the hive or the bees to swarm out without her. The same is the case with young or virgin queens." I think if the justly celebrated Huber had looked for the external natural conditions, and had noted how these produced the internal circumstances necessary for what he terms "the formations of swarms," he would have discovered "the motives for her departure." The motives that cause the queen to depart with a swarm from the hive are beyond dispute. Yet there appear to be climatic conditions that are obscure to us, but are, nevertheless, instinctively understood by the bees. The whole rank and file of the hive are not ignorant of the fact that conditions are fast ripening for that all important time; that the hour is at hand when they must go forth and set up a home for themselves. When and how the word is passed from bee to bee that swarming is to take place, and that on a certain day and hour the flight is to be made, appears to largely depend on the age of the maturing queens, and the favourable condition of the weather. In fact, the productiveness of queens largely depends upon the seasons. If in early spring the blooming of honey-bearing flowers warrants a continuity of a few weeks' honey flow, the preparations for swarming are proceeded with. Just at this point is where the skill of the practical (I do not mean professional) bee-keeper aids in the production of early swarming. Here I must repeat that string I have so often harped upon—the numerical strength of the hive carried through winter with a sufficiency of food to induce the queen bee to commence laying, when the first signs of a favourable spring for swarming. If we place ourselves near the hives in early spring, and carefully watch the ingress of the inhabitants, it will soon be apparent that pollen gathering is the chief industry just now. It is one of the chief ingredients in food preparation for the raising of brood. To this end bees are often supplied with artificial pollen to aid in the early maturing of swarms. The eagerness of bees for pollen gathering is the earliest sign of the approach of the first swarm of the spring. On examining the frames of brood combs, if the queen be from 10 to 12 months old, there will be an abundance of worker brood in all stages of development, from the tiny eggs just laid to the emerging young bee. In addi-

tion to these there will be a large number of nurse bees, young downy ones, eagerly engaged in supplying the infantile wants of the younger brood. These are among the first internal indications of swarming. If the bees be a well established colony, and the queen is about completing her first year, there will be indications of the approach of drone laying. In the early part of her life a fecundated queen never lays what are termed drone eggs. When about entering the second year of her existence her drone-laying powers are first developed. The maturing of drones within the cells is the second stage in the order towards swarming. There are no drones wintered with the bees. Of course, it can be done artificially, and perhaps under required conditions it is done when bees are in a state of nature.

As spring advances and bee food becomes more plentiful, the bees seem to realise the conditions necessary for swarming. As queens do not leave the hive, after their return from their marital flight, till they go forth with the first spring swarms, the swarming conditions must be arrived at by the queen observing the abundance of the food supplies brought in by the bees, and the genial warmth of spring. In the first place these auxiliaries conduce to the rapid increase in worker brood, followed, as before stated, by drone production. Drones as their strength and power of flight increase do not remain in the hive like young workers, but are eager to get on the wing. During the warmest parts of spring days their deep hum can be heard mid-air, and if we place ourselves near the hives we shall see them busy at the entrance thereto. This will be a sure indication that queen cells are in progress and young queens are developing. When looking through the hives, these cells are easily distinguishable from the worker or drone cells both by their form and their positions. They are constructed, as a rule, on the edges of the combs. There is no rule as to the number; neither do the number of cells give any indication of the number of swarms that will be cast off during the season from any particular colony. If there are a dozen or more queen cells containing maturing queens, it is seldom that two or more of these are of the same age, that is, it is not probable that any two of them will emerge from the cell at one and the same time, for reasons to be explained further on. The perfecting of these developing queens is another advancing stage in the swarming symptoms. The aversion that queen bees have the one to the other is well known, and also the jealous guard placed over the

cells by the workers; yet a fertile queen, one destined to accompany the first swarm of the season from the hive, is allowed all sorts of latitude. How different is the action of bees towards a laying queen to that of the virgins! Is it caused by filial affection? As soon as all the swarming indications succeed one and the other, that is, the rapid increase of workers, and of worker brood, the advent of drones, and the perfecting of young queens within the cells, if the weather be favourable, the first swarm may be expected on any day, and almost at any hour, generally from 10 to noon. I have known bees to swarm as early as 6.30 a.m., and as late as 5 p.m., but such times are exceptional. No queen, under normal conditions, will go forth with a swarm before depositing eggs in queen cells; but she will leave before the first young queen emerges from her cradle.

There is one symptom of swarming that is infallible, a peculiar sound they emit, and known by most bee-keepers, termed piping. But singularly enough, piping emitted by the bees does not take place prior to the issuing forth of the first swarm, but prior to that of the second. Therefore, it is sometimes contended that the sound is only produced by virgin queens. Be that as it may, it is an unmistakable sound, differing from every other note produced in bee music. It is a high-set, rasping note, likened to "‘peep, peep, peep,’" and hence the word 'piping' has been applied; but 'teet' and 'zeet' have seemed to some to better mimic the *vox regalis** These sounds can easily be distinguished above the ordinary hum of the bees. By placing the ear to the side of the hive after the bees have ceased from outdoor labour the sound of "‘peep, peep, peep,’" will be heard at frequent intervals. Both the young queens imprisoned in the cells as well as those at liberty, produce this challenging cry. Huber says, "What seemed most singular was that this female (virgin queen) emitted a very distinct sound, or clacking, from her prison. It was still more audible in the evening, and even consisted of several monotonous notes in rapid succession." Further on, referring to a newly-emerged queen, he says, "When she approached the other royal cells, the bees on guard pulled, bit her, and chased her away; they seemed to be greatly irritated against her. She twice emitted the sound; in doing so, she stood her thorax against a comb, and the wings crossed on her back; they were in motion, but without being unfolded or further opened. Whatever might have been

*Cheshire, Vol. I.

the cause of her assuming this attitude, the bees were affected by it; all hung down their heads, and remained motionless. The queen confined in the second cell had not yet left it, and was heard to hum several times." Undoubtedly for hum he means pipe, or clack as he terms it. If the piping is heard in the evening, every preparation can be made to receive the swarm next day. There will sure to be a swarm issue forth. I have known, after hearing the piping over night, a swarm to come forth on a bright morning; afterwards, the sky becoming overcast, they again returned to the hive, and issued out on the day following. I have also heard the piping, and on the next morning have seen the swarm rise in the air, and before they alighted re-enter, and not to swarm again during that season. I suppose the cause was a fight to a finish between the rival queens.

Why do bees swarm? Why does a hen sit, rear her chickens, and then leave them to scratch for themselves? Why are the members of the smaller feathered race so solicitous for the safety of their callow nestlings and so anxious to protect them when they leave the nest as perchers, and in a few weeks afterwards, are just as anxious to vent out their rage upon their own offspring, as if they were the greatest strangers, should they approach the old domain? And why do members of the vegetable world bloom, bear seed, and scatter it far and wide? Some seeds are armed with little hooklets, that hitch in the coats of animals that browse upon the parent plants, and are thus carried and dropped miles away; others are coated with adhesive matter which answers the same purpose as the hooklets; other seeds again are bedecked with delicately buoyant down, as in the thistles, and, being thus armed with sails, are wafted far away from the neighbourhood of their nativity. Are not the various methods Nature has adopted to distribute the animal and vegetable kingdom analogous to swarming for the purpose of replenishing the earth? True some go away into a far country singly, others again gregariously. What bee-keeper has not looked at a bed of thistles when the wind is blowing, and, seeing the seeds caught up by their downy attendants, conceived the idea that they rise into the air like a swarm of bees? And what is "to swarm"? An Anglo-Saxon word, meaning to ascend or go up. In some parts of England the word is so used to this day. "Shall I swarm the tree and get that bird's nest?" was an expression used when I was a boy. Now we use the word as meaning a great number, or a great multitude.

Bees swarm because it is one of Nature's ways of distributing and perpetuating their species. All species of bees do not swarm—that is, go away in a multitude—only social bees; and not these in all cases.

What queer notions, past and present, have been given why *apis mellifica* swarm. A every commonly accepted opinion is the want of room. I knew a swarm of bees to enter the gable end of a house and build on the ridge-pole, and therefore had all the space between the roof and the ceiling—room enough to build yards of comb and store tons of honey. They occupied this space for years and regularly swarmed; but on one occasion, making my way under the roof to have a look at the supposed great mass of comb and honey, there was to be seen only a very medium quantity of comb, but a fair supply of honey. In too much space the conditions are not good for wax secretion.

What strange statements are published by entomologists in referring to the swarming of bees—I mean those men who go in for the study, or perhaps I had better say the reading, of general insect life, and not confining their research to a special class. In *Insect Miscellanies* I read: "Bees being confined within a limited space, they cannot there increase and multiply beyond a certain point, and consequently, when the hive becomes too crowded for the population, it is expedient to thin their numbers by emigration (swarming). De Réaumur, the naturalist, says he frequently possessed hives so full of bees that a portion of them were compelled to remain on the outside, conglomerated in a mass, and yet no swarm was sent off to thin their numbers. In other hives, on the contrary, where there was so much spare room, more than one swarm was thrown off." Again, the writer in *Insect Miscellanies* says: "The researches of naturalists, indeed, have discovered many curious facts relative to the proceedings of bees in such cases; but still many things, like the immediate cause of their swarming, remain doubtful and obscure." In the latest work on natural history published, there are some romantic statements given as to the reason the cells in honeycomb are six-sided (hexagonal).

What is the incentive amongst bees that causes the swarming impulse? Chiefly, season or climatic circumstances. But not always these. There are exceptions. A friend of mine in the Old Country informed me that he once found a swarm of bees on a gate post in the depth of winter, when the ground was covered

with snow, no doubt starved out. Not always when bees are short of stores will they leave in a mass as if swarming. I once knew a swarm of bees that had but a small quantity of honey stored for winter use make friends with an adjoining colony where there was plenty of stores, and acted literally up to the text "To him that hath shall be given," the members of the better equipped colony helping to transport the store, the weaker colony gradually intermixing with the stronger. Bees, as a rule, will not permit intruders to enter, but when they bring their own buttered scone, and their own tea and sugar, the visited very much relax that supposed hard and fast rule. Langsworth says: "Bees sometimes abandon their hives very early in the spring or late in summer or fall. Although exhibiting the appearance of natural swarming, they leave, not because the population is so crowded that they wish to form new colonies, but because it is either so small or the hives so destitute of supplies that they are driven to desperation." I have known a starving colony to leave their hive on a spring-like day in December in the old land.

There is no doubt the instinct of swarming is not a sudden impulse, but notwithstanding that, De Réaumur has assured us the immediate cause of swarming remains doubtful and obscure. Practical and scientific observation has robbed it of its doubtfulness and obscurity. The bar-frame hives of to-day have drawn aside the veil of mystery and thrown wide open the door for investigation, so that the merest novice may ascertain the fact that the earlier scientists yearned for but died without the knowledge. The great Teacher said: "Now learn a parable of the fig-tree: When his branch is yet tender and putteth forth leaves ye know that summer is nigh." Now learn a parable of bee life: When the fruit-trees putteth forth their tender blossom buds you know that spring is nigh; and when the bees are seen hurrying home with their thighs packed with spring pollen you know that the swarming instinct is nigh; and when you look into your hives and see queen cells developing you know that swarming is even at your door. Now learn another parable: When the tender grass blade shoots forth, and insects and other poultry food become plentiful, you know that the laying season for your hen is nigh; and when she has been laying for some time, and remains on the nest longer than usual you know that her sitting time is nigh; and after she has been sitting twenty-one days you will expect the chicken at your door.

Are not the parables of the bees and the hen parallel or analogous, the one of the other? The seasons and the local and natural conditions combined were suitable, and these produced the laying conditions, the brooding instinct, and the maternal love of offspring until these latter were capable of shifting for themselves. It was not because the hen-house was too small that the hen commenced to lay, sit, and hatch; that would militate against it. So the seasons and the blossoming of honey and pollen-producing plants, etc., cause the swarming instinct to take hold of the bees. It is Nature's way of guarding against the extinction of the race.

With bee-keepers swarming is always spoken of under two heads—natural and artificial. I am only dealing with the former. I much prefer a natural swarm to one produced artificially. The conditions attending a natural swarm are far more satisfactory. To my mind bee-keeping is robbed of a large percentage of its interest when no swarms issue forth. The delight of witnessing the swarm hurrying pell-mell from the parent hive; the tinkling of the tin kettle, antiquated now in good bee-keeping society, following the vagabonds, the houseless wanderers hither and thither full of expectation as to where they will alight; the joy of listening to the calling of the wanderers home to the alighting bush; the picturesque sight of the increasing and clustering swarm hanging pendulously from the tiny twig of leaflets; the pleasure, at one time highly seasoned with fear, of shaking them into the straw hive for their new home; the frequent visits during the day to see that all is well; at nightfall wrapping them in cloth to carry them home; the placing of them on the stand with care and caution; and the following days of superintendence—are pleasures of my early bee-keeping days that will never be blotted from my memory. Even now such experiences are full of interest to amateur bee-keepers, and give rise to feelings that artificial swarming never produce; but then artificial swarming is for profit and not pleasure.

Who shall draw the line of demarcation between the swarming instinct and the swarming intelligence of bees? They have no infallible rule as to when they shall swarm. The season may be propitious, the swarm may be strong and healthy, the young queens may be in the cells ready to emerge, and the workers' honey-sacs filled for the anticipated journey, but let the weather change to unfavourable conditions, all the preparations will come

to an end and so remain in abeyance until the weather is more suitable for the requirements of swarming. As a rule, on the morning prior to the swarm issuing forth, peace and quietness reigns at home, and there are few bees going abroad foraging. The incentive to swarming are those natural ones herein mentioned.

CHAPTER XV.

SWARM CATCHING, HIVING, AND TRANSFERRING.

PERHAPS the one stage in bee-keeping that requires the least protection and a minimum of courage is "swarm-catching"—that is, taking natural swarms after they have alighted in a cluster on a bush or other object they have chosen for the purpose. To me it is one of the most interesting sights in Nature to watch a swarm leaving the parent stock, rising on the wing, and performing beautiful, mazy evolutions like a country dance mid-air, to the accompaniment of a soft, melodious, gentle hum, so indicative of peace, goodwill, and enjoyment at the prospect of establishing a successful home of their own; the main body keeping up these beautiful movements whilst the scouts are flying hither and thither in search of a suitable spot on which to alight; and then to see them hasten to a bush in thousands, and threading in and out amongst the foliage, now here, then there, until the scouts trumpet forth the call to assemble. I have never yet discovered that call, but it must be well known to the bees: for when the spot on which to alight is found, and the call made, you will see all the bees that are on the wing head towards it, even those that form the most distant circle.

When the place of assemblage is found, what a change takes place in their song! from the gentle, peaceful hum to one of ecstatic delight. Note again, if the bees have made up their mind to go farther afield to form a new home, there will be a change in their movements and in their song. Instead of making easy, graceful movements to and fro, the whole swarm will become agitated, the scouts will be called in, and their song becomes one of great disappointment, not to them, but to you, when you see your cherished hope rising in the air like a solid mass, and with a sharp cry and rapid movement they make for—you know not where. "But," you say, "I was given to understand that bees were always led by the queen—that she gave the call, and directed their movements;—is not that why they beat the tom-tom or ring the frying-pan with the door-key?" Not a bit of it. That is an old superstition, grown out of a custom declaring the ownership

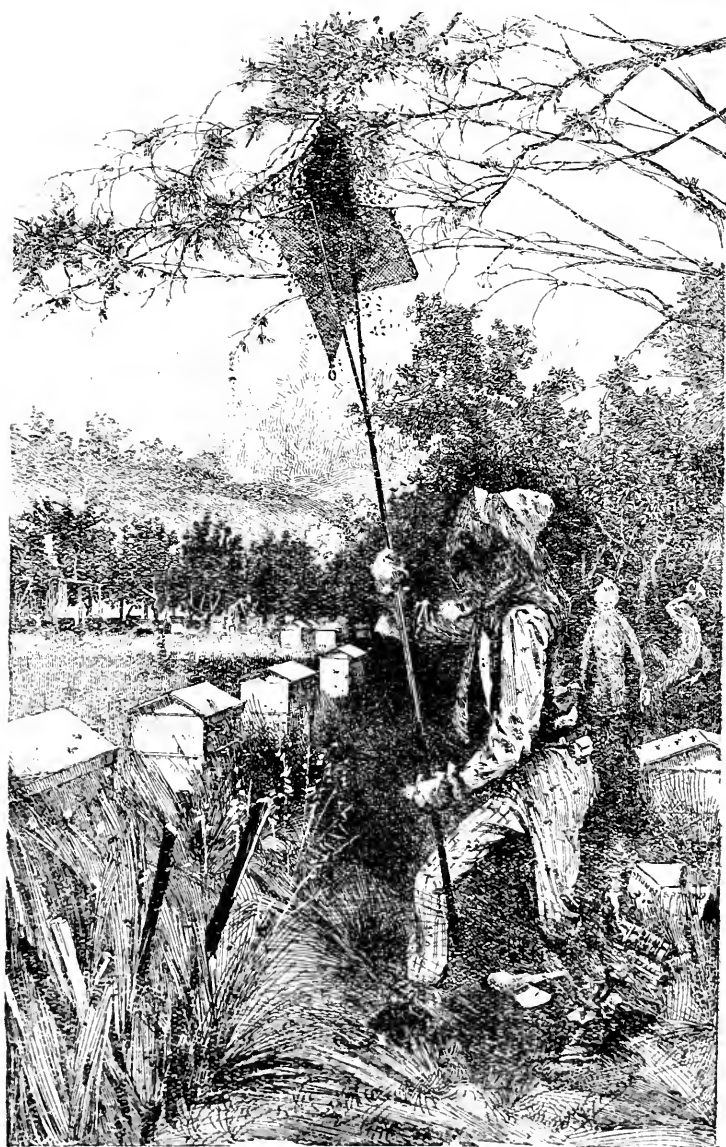

CATCHING A SWARM.

of a swarm of bees when on the wing. It was equal to the ringing of a bell and saying, "This is to give notice these bees belong to me." I have more than once seen the queen on a leaf some feet from where the swarm was clustering. I have seen her parading to and fro on a rail while the swarm was clustering on the post, the bees paying not the slightest attention to her. At other times I have seen her alight on the cluster and burrow in amongst them. Evidently she had been on the wing for some time after the main body had settled.

When bees have once clustered they are in the best of temper; you may do almost what you like with them. Frequently, to prove to onlookers the ease and freedom from danger with which you can handle bees under such circumstances, I have bared my arm and passed my hand through to the other side of them. To do so your movements must be slow and gentle. Try it; but, in doing so, don't forget, "Be gentle."

If bee-keeping be indulged in as a hobby, artificial swarming robs it of one of its most interesting and fascinating features.

As a rule, early spring swarms do not abscond on the day they leave the parent hive. Sometimes they will hang for days to the place where they first settled. Early swarms cluster low. The reason is not far to seek. It is the old, pregnant queen that issues forth with the early swarms. She is heavy, and the workers know it. Sometimes bees cluster in the most inaccessible places; against a wall, in the cleft in a log or stump, in between the forks of trees; from such places you cannot shake them. It is under such conditions as these that the amateur's courage and patience are put to the test. How can they be dislodged and put into a box prior to hiving? Sometimes you may dislodge them with smoke. The most effectual way is to remove them with the hand. Place the receiving-box as near to the bees as you can; on the ground is best. Then scoop them up in handfuls, placing the first few handfuls on the ground. Put the receiver over them, resting on a small stone with room enough to give access; then throw other handfuls near the entrance to the box. When you see those you have placed on the ground freely enter the box, those bees you have left behind will soon follow. But if you are present when the bees are on the wing, all this may be avoided: "Prevention is better than cure." When you see the bees have chosen a place of settlement from which it will be difficult to dislodge them, take a leafy bough and quietly move it up and down

over the site chosen. They will soon forsake it for one better adapted to your purpose; if not, repeat the action.

If they have chosen a leafy bush on which to settle, boxing them is easily enough done. Place the receiving-box directly under the cluster of bees, mouth upwards; give the bough a sudden jerk; the bees will fall in and around the box. Then turn it over, with the bees in it—of course some will fall out—resting on three little stones. The bees will at once begin entering it; but should they return to the bough, wait till about half are clustered, and shake them again.

Sometimes they are so indiscreet as to select a bough high up out of reach. It is then the swarm-catcher comes in very handy, as will be seen by the illustrations. To your swarm-catcher have other portions, so as to lengthen it. These can be made like a jointed fishing-rod, each portion having a ferrule on one end. When the bees are so situated, let them well cluster before you use the catcher. Raise the catcher to the swarm till it surrounds them; then, with a sudden jerk, shake them into it. Let it rest for a while somewhere in the locality where the bees clustered. The bees on the wing will soon join those within the catcher. Having secured your bees in the receiving-box—that is, when a half or two-thirds are settled therein—lose no time in removing the box a few yards away. The bees that have gone back to the o'd spot—and some hundreds of them will be sure to do so—and those that are on the wing, will soon find it and enter it more freely and much sooner than if it be permitted to remain where they were first shaken.

When the bees are well settled in the receiving-box, don't be too particular if a few hundreds are on the wing; it won't matter. Take them to the hive that is to be their permanent home. Always have an untenanted hive, properly fitted up with starters (strips of foundation comb attached to the top bar of each frame), and put in position so that all the frames will hang perfectly plumb. Remove the cover of the hive and also the quilt; space the frames—don't be too particular just now—bring over the bees in the receiving-box, and tumble them pell-mell on top of the frames (you will see how by referring to the illustrations of transferring, p. 101). As soon as they are thrown on to the frames they will begin to descend in a moving mass into the hive. Pick up the quilt, place it over the bees that are resting on the frames—it won't injure them—put four stones, one on each

corner of it, to keep it from blowing away, and then leave them alone for some hours. Don't wait till night, or even the twilight, as is usual, to do all this. There is no advantage in it that I have ever discovered; but, on the contrary, the bees may abscond if not soon hived. If you have not time to attend to all this, that is another thing. In that case remove the box with the bees to the shade of a bush, or in some way protect them from the direct sunlight, and leave them till you have time. Under no circumstances should the bees be allowed to remain in the box too long. As soon as they have taken possession of a place they at once begin to work. I have seen them, when they have been hanging on a bush or elsewhere for a few hours, leave their mark behind them in the form of small bits of comb attached to where they hung. Before turning in for the night, remove the stones from the quilt and replace the lid of the hive; it will protect them from rain should a shower come on.

On the morrow remove the lid of the hive and the quilt, and have a look at the bees. They are just as quiet to-day as they were yesterday when they were clustered. Note how much room they occupy. If you have not bees enough to fill the whole hive, and it is not likely you will, close them in with a division board, and increase their home as required. It is always a disadvantage to you and the bees for them to have too much room to work in; the reason will be given further on.

If the bees do not appear to take to their home, from some cause unknown to you, or perhaps even to themselves, put in a frame of comb with young brood in it. There will be no absconding after that.

For some reason, bees when swarming take a special fancy to alight on the same spot chosen by a former swarm. My neighbour has a stunted lemon-tree trying to grow in his yard, and for years past the majority of swarms have selected that lemon-tree as a place of rendezvous. Undoubtedly bees leave behind them an odour easily recognised by their brethren of another hive. This may be taken advantage of, and provision made to meet your bees at such spots. Knowing this trait in their swarming habits, some bee-keepers have turned it to advantage by putting up one or more boxes to serve as decoys. For this purpose they use an ordinary candle-box with one side removed, the remaining sides being pierced with inch auger-holes; it is then fastened to a long, fairly light rod. When the bees are on the wing, this "decoy-

box" is held up amongst them. If a swarm has once entered it there is not much trouble to induce others to do so again. I have known a German bee-keeper use such boxes with great success, and as an additional attractive inducement pin a dead queen therein. I have not proved that there are any virtues in the latter to attract a swarm.

I have mentioned in these pages several appliances in connection with swarming. You will find that a box to shake them into from the place where they first alight, and to remove them in to their permanent home, the only thing really necessary, and the catcher when the bees settle high in the trees.

The advance swarms of the season are, almost without an exception, numerically strong, and give far more satisfaction to the bee-keeper than late ones. As a rule, fairly early swarms will again throw off swarms late in the season. The only way to obtain strong swarms is to prepare for such in the previous autumn. Put the bees up for the winter with all the adjuncts that will keep that end in view. These adjuncts may be briefly summed up in a few words: hives proof against cold and damp; the swarm strengthened to its uttermost; and food supplied to carry them well on to the spring.

To accomplish this should be the aim of the bee-keeper at all times. The only thing that will mar his success will be the seasons. These he cannot control; but all the adjuncts referred to are in his power.

Last-season's queens are more disposed to swarm, or are more frequently seized with the swarming impulse, than are the second swarms or casts. These are always accompanied by queens of the season. It is these swarms that issue forth from the first swarms of the season technically termed "maiden swarms"—that give the bee-keeper a lot of trouble. It is not far to go to understand the reason of these maiden swarms giving so much trouble. Queens that come forth with the spring swarms are at the least from eight to twelve months old. During the previous season these queens laid eggs that produced female or working bees only. These last year's queens are in a condition to lay drone-producing eggs. The production of drones acts as a stimulus for queen production. Where an old queen is hived in a bar-framed hive where foundation-starters only are used, there will always be found a superabundance of drone-cells constructed. With the second swarms or casts it is not so. The combs built by these are constructed of small-sized cells (workers').

A bee-keeper's ideal should be, as far as possible, to prevent swarming. The building of comb and the preparation for swarming are two luxuries that bees delight to indulge in; but they are far too expensive for the bee-keeper's profits, because both comb-constructing and swarm-producing are carried on at the expense of the honey stores. It must be remembered that these after or maiden swarms, and also casts, are largely made up of young bees that have seen very little field labour, and the withdrawal of these from an established colony is a heavy drain on the labour market of the aforesaid colony; whereas, if they can be kept as inmates of what I may term their own home, they will add to the exchequer of their owner.

A mercantile person would consider cent. per cent. a superb profit for business purposes, and a sheep or cattle farmer would rejoice at a hundredfold as the increase of his stock for the year; and so should a bee-keeper.

As there are mechanical aids to produce swarming, so there are mechanical aids to prevent it. Of course, if the bee-keeper's ideal is in obtaining a large number of hives of bees, then he should husband all casts and after-swarms; but, I must repeat, it can only be done at the expense of his honey profit. True, it is possible, in a very short space of time, to increase an apiary to some hundreds of colonies by means of natural and artificial swarming, providing the locality will carry such a stock as it regards honey-producing plants. Even if some of the colonies of this extensive increase be weak, with proper management they can be brought up to the required strength; but honey must not be expected during the period of strengthening the weak colonies.

Let us see what are the mechanical aids to prevent swarming. We all know, or should do so by this time, that old queens are drone-layers, and the older they become the more drones they produce. Now, nothing will prevent an old queen from becoming a drone layer, any more than we can prevent an old mammal from becoming sterile. You may put in whole sheets of foundation comb, and cut out drone cells by the thousand, but the queen will lay drone eggs in spite of you. If she has nowhere else to deposit them she will put them in the worker cells. Drones are always kept alive at the expense of the storage of honey. They have only one use—one of the aids to reproduction. When that is accomplished the bees themselves get rid of them. During this period they have been occupying valuable room by their superabund-

ance, and devouring food that would be far better used in the rearing of workers. All this can be prevented by getting rid of drone-laying queens. The early spring swarms are always accompanied by a drone-laying queen, and she will very soon commence her drone-laying proclivities. Here you will see the necessity of trying your apprentice hand at queen raising. As early as the season will admit, have an overplus of young laying queens on hand, ready to replace the queen that accompanied the first swarm. This is the first and most important mechanical aid to prevent swarming. The second is like unto it, but not nearly so effective. A queen develops from egg to maturity some five days sooner than the worker; therefore, about every fourteen days take out and examine every comb for constructing queen cell, or developing queens, and destroy them. A keen knife will do it. I always use my finger and thumb and pinch them out.

If, from any cause, you may have been unable to procure young laying queens (although they are always to be procured from dealers in season, and almost out of season), or to examine the combs for queen cells, there are almost sure to be late swarms to deal with. This country is one of the most likely in the world to produce casts and after-swarms, and these are the ones that will give you trouble. In all probability, when they rush from the hive they will go further afield than the spring swarm, before they settle; in fact, it is these swarms that become the vagabonds, and are found hanging on fences and elsewhere about Christmas time. One of the first swarms of bees I ever saw on the wing was one of these vagabonds, high up in the air and hurrying across a meadow. I tried to follow, but a wide and deep brook stopped me. In these early days of my bee-keeping experience, well do I remember tin kettling—ringing them down we called it—the bees attempting to settle first here and there, and, finally, nowhere; while they suddenly took it into their heads to alter their course, rapidly gathered together, were soon lost to sight, and it was good-bye to my swarm. It is this peculiar trait in their character that gives all the trouble. These thousands of bees that escape in this way are so much loss to the colony they came from. If they can be kept in the hive it means more extracting for the bee-keeper. The prevention of these casts means having a strong colony through the winter; and a strong colony through the winter means a strong early swarm in the following spring. How can we keep them at home? Even this cannot always be done.

These casts are too frequently led by a virgin queen. Where these after-swarms alight you will have to go through the same process of hiving, as already described, and return them to the hive. But, you say, will there not be two queens in the one hive? Very probably there will. One must be destroyed. Either you must destroy the one with the cast, or there will be a fight between the two queens in the hive, and then it will be the survivor of the battle that will henceforth reign. But how can we find a queen-bee out of the thousands that are in a swarm? There is a little trouble in doing this. If you are acquainted with the form of a virgin queen, by watching the swarm after it clusters, you may sometimes find her running about on the outside, and occasionally threading her way in and out amongst the crowd. To do so you must have an experienced eye. After you have shaken them out and they have settled into the reception box, by spreading a cloth on the ground and throwing the bees on to it, letting them re-enter the box by crawling towards it, you are often enabled to pick her up. All this requires patience—a commodity no bee-keeper can afford to be without.

One thing worth noting is, that drones are not produced in very early spring, only in a well-conditioned colony. Drones are unnecessary where there are no young queens developing. Nothing retards spring swarming more than badly constructed hives that are cold and damp, and the bees themselves wintered on a too limited supply of stores, and have come through winter on the verge of starvation, and so dwindled in numbers they have not strength enough to hatch out a large number of eggs, these will not swarm early, no matter how favourable the season may be. Conditions the reverse of the above are the ones that will aid the bee-keeper with early swarms, providing the seasonable conditions are favourable. In the West of England they have this proverb: "A swarm of bees in May is worth a load of hay; a swarm of bees in June is not much out of tune; but a swarm of bees in July is not worth a single fly." There is a deal of truth in it.

Be prepared. Have all the required adjuncts at hand and in place for catching your swarms and hiving them. Choose the site on the grounds where you intend to keep them. If it be under natural shade, trim off over-hanging twigs, so as to have head-room. You will find the advantage of this, especially if you are in the habit of wearing a bee-veil. Nothing is more annoying, when you are handling bees, than to find a sudden pull at

your head-gear, and you stand bare-headed with a frame of irritable bees in your hand. Under such circumstances an apprentice at the work would find it hard to follow out the advice I so often give—be gentle and kind in handling your bees. Level the spot where each hive is to stand. Place four pieces of brick on the ground, so they may stand about two inches high. The surfaces of these must be even, try them each way with a spirit-level. On these, place your hives. Before placing the frames in the hives see that the starters (artificial foundation comb, from 1 to 2 inches deep, attached to the top bar of the frame) are securely fastened to the top bar. For hiving purposes I prefer these starters to full sheets. In placing the frames in the hives see that they hang plumb and equidistant from each other. Put a quilt over the frames, and the lid in position. In fact, treat each empty hive intended for the reception of bees as if the colony were in it. You will find an advantage in this when your new swarms issue forth. A swarm-catcher of some description, a bee-veil (always wear one on your hat ready for use), and a queen-cage should be near by, so that you may be able to place your hand on them at a moment's notice. A queen-cage is necessary if you keep your queens with clipped wings. If bees are kept in a town it is an advantage to clip the queen's wings, and also, if your occupation keeps you around about your bees during swarming season, otherwise there is no advantage in it, especially with first swarms. There are a number of other swarming devices, all more or less useful, for which see supply dealers' catalogues.

In Symptoms of Swarming I have mentioned the piping of the queen. By placing the ear to the hive this cry may be heard on the eve prior to swarming. But the absence of the cry is no proof the bees will not swarm on the morrow. On the morning of the day the bees intend to swarm, the inmates of neighbouring hives will be seen issuing forth and returning with all the energy they are capable of, whilst the hive the swarm is expected from will be quiet, and labour will appear to be almost suspended, only a few bees passing in and out. Yet this is not an infallible sign. I have frequently seen a swarm of bees on the wing, and mixed up with them numbers of bees with their pollen-baskets well packed with pollen; evidently they had not received word that swarming was to take place that day.

The time of day for bees to swarm is not well defined. It

is some time between sunrise and sunset. As a rule, it is during the hottest part of the day. It is a pretty and interesting sight to see the bees issuing forth from the hive for the purpose of swarming. They all appear eager to see which will be out first, pushing and tumbling one over the other. Bees with their wings fringed with hard work and old age; middle-aged and baby bees; young, downy fellows, even too young to take part in the general exodus. You will find many of the latter running about outside the hive. If the hive is close to the ground, and of easy access, they are soon inside again; if not, it is as well to pick them up, and put them on the alighting board. A young bee is worth more than an old one.

To any bee-keeper it is pleasant to watch the bees manœuvring in the air; advancing, receding, rising, falling and circling; not looking about for the queen. She is mixed up with them, but she has no allotted place in that busy crowd. Whilst on the wing the hum they emit is a pleasant one, and to them one of joy. We do not know how the information is telephoned from one to the other, when they are on the wing, that a chosen spot has been selected, and it is time to settle. A practised ear can detect a change in the hum. At once, when the sound of the bees change, you will see those bees that have been scattered far around heading for the spot selected. Indeed, there appear to be many spots chosen, for you will see the bees forming little clusters here and there. These are all ultimately abandoned for the central one. Watch the central one. You may see the queen, if she be unclipped, alighting with the rest. Pick her gently up by the wing and cage her for a few minutes. (If the queen is clipped, stand by the hive as the bees issue forth and cage her there.) When a fairly good number of the bees have settled, shake them into a receiving-box, and at once, if you have caged the queen, place her amongst them. If you have not secured the queen, watch the box into which you have shaken the bees. If they persist in returning to the place whence you shook them you must shake again, and repeat the process as often as they return thither. One way of ascertaining if the queen is in the receiving-box is to move it a few yards from the spot in which you first placed it. If the bees follow, you may be sure the queen is there. Nevertheless a large number of bees will continue to hang about the place where they first clustered. If you have secured the queen, these will soon begin to dwindle away. If you have little or no exper

ience in swarm catching and hiving, do not get excited or hurried over the job. It is the quiet, easy movements that will bring success. You have no occasion to be afraid of the bees. When they have the swarming impulse on they are most docile, and put on their best behaviour. You may do almost anything with them if you move and handle them gently. I have seen the most timid ladies, when given to understand this, and shown how to do it, pick bees up by the handful without being stung, and you may do the same. In doing so, put no pressure whatever on the bees.

If the bees settle some distance from the apiary, as soon as about two-thirds of them are in the receiving-box begin to remove them homewards by easy stages—at first say 5 or 6 yards, and increase the distance each removal. As soon as you see that the bees have found the box, give the move-on order, and shift the box nearer home. Do not wait till sundown to take your bees home. The stragglers will follow the box. There will be some few that may not do so; these will return to the hive from whence they came.

Presuming that you have been following all the advice I here tender, and the permanent home for your bees has been “swept and garnished,” and in every way ready to receive its inhabitants, the last stage in the removal of the receiving-box containing the bees should be close to their permanent home. Remove the lid of the hive and its quilt, exposing all the frames to full view. Take your box of bees, and with one jerk tumble the bees in amongst the frames. In a very few minutes they will have descended into the hive, and cluster to the frames. Put the quilt over them, placing a stone on either corner to prevent the wind lifting it. Shortly afterwards remove the stones and put the lid of the hive in its place. The bees will soon find the entrance, and your trouble is over.

Probably next morning you will find them very quiet. They are secreting wax and comb-building. Remove the lid and quilt, and see if all the frames are correctly spaced; if they are not, you know what to do without me telling you. Some on the following day will be seen examining the hive, flying a little way off, and returning. They are learning the geography of the neighbourhood. Within a few days you will see them carrying in pollen. All the danger of their leaving the hive is, perhaps, now over. I say “perhaps,” because bees are such erratic things.

I have known bees, after they have been hived and built combs as large as your hand, take a fad into their heads and clear out.



Why, I cannot tell, and I do not think any one else can. Should they do so, there is nothing for it but to go through the whole work again.

Now, if you have been anything like in luck's way, the whole process from the time the bees made their exit from the parent hive to that when you hive your new swarm will not occupy more than an hour. But to this statement I must make certain reservations. Did the bees settle in an easy accessible place? Did they settle near the apiary?

All here stated has reference to first or early swarms, which are led by a pregnant queen, when there is a certain amount of assurance that they will not abscond. Casts or after swarms—those that come out with virgin queens—may give a little more trouble than here detailed.

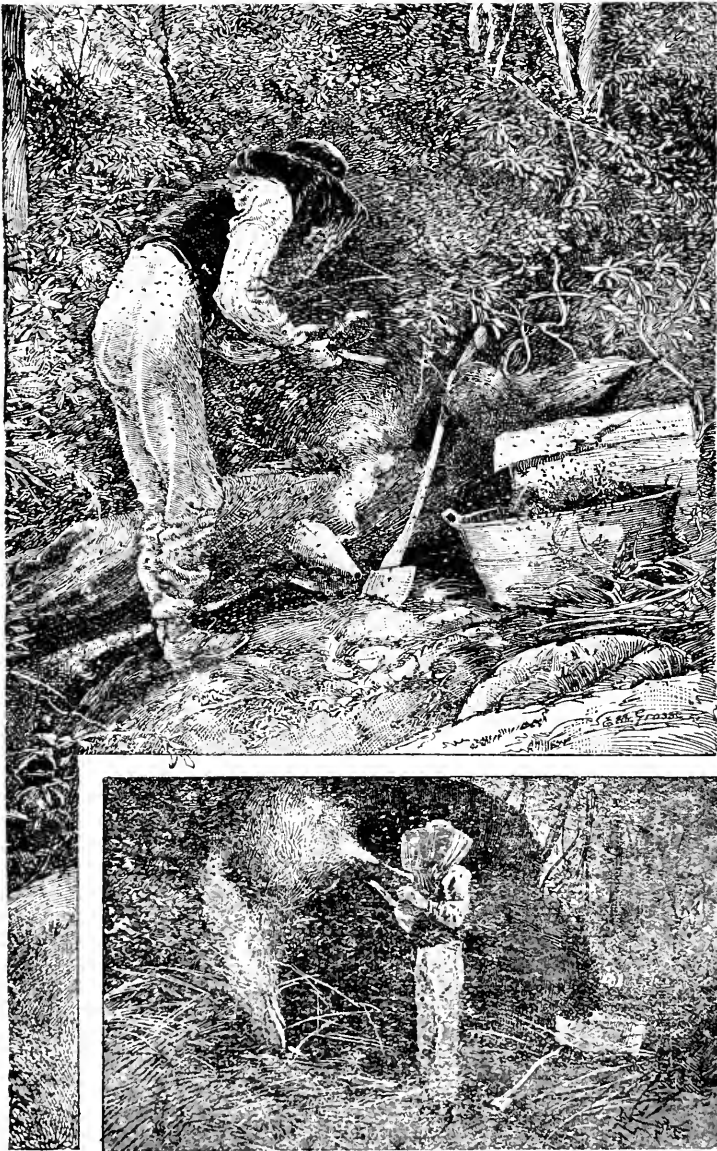

Fig. 1

Transferring Swarm of Bees from Log.

CHAPTER XVI.

TAKING BUSH BEES.

ON the northern rivers of this State, back in the early seventies, bush excursions were frequently made in quest of bees' nests, and oftentimes it proved a very profitable pastime. Armed with a good axe, a knife, and vessels in which to carry home the booty, a party would sally forth, frequently with horse and dray, and come back with 2 or 3 cwt. of honey. True it was bush honey, that is, a mixture of rotten wood and what else the hollow spout contained. But what did that matter? Those who feasted on the luscious delicacy in those days knew nothing of a purer article, excepting that which went under the name of "garden honey." This article differed nothing from "bush honey" only there was no rotten wood in the mixture. More than once I have seen trees felled in which there were two nests, each containing upwards of $1\frac{1}{2}$ cwt. of marketable honey, which was then sold at 2d. per lb. I have also seen a big, old, solid ironbark, the hollow spout of which contained a bees' nest, after a deal of labour bestowed upon it by two axemen, come down with a crash, and that was all the fun and profit got out of it, beyond the discomfiture of the bees, for the nest proved to be a duffer, and the bees were permitted to find new quarters.

The idea of these excursions was to get honey, and nothing but honey. Bees and brood-comb were discarded, the latter always; sometimes the former if they clustered in a come-at-able place, and it was near the house, were taken home and put in the typical gin-case hive, for the purpose of obtaining that better article, "garden honey," with a little less trouble.

Well, that day is fast passing away to be treasured up among the things that have been. The snap-shot illustrations on page 101 are two or three stages towards fitting up an ideal bee farm. The operator has with him some modern bee appliances, notably that indispensable adjunct to bee-keeping, a smoke bellows. By-the-bye, it is an old-fashioned one and if he is not careful to stand it nozzle end up the fire will be choked with its own smoke. One of the newer pattern may be placed on the ground as shown in the

illustration. "Catching a Swarm," on page 87. I prefer the modern bellows of the Pender type (fig. 2).

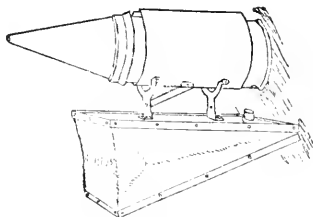

Fig. 2

Now, away in the bush many a good swarm of bees can be obtained in the way our hero with the smoker in his hand is doing. It is evident he is not gone out for honey and honey alone. Note his accompaniments. Nevertheless, by these he appears to be satisfied with two things—the *bees* and the honey. When you are chopping out a bees' nest you must go in for one thing more, the young brood in the comb. The bees are all very well as far as they go; they will do to unite with a weaker colony, or if they are numerically strong lay the foundation for a good colony. But the majority by far are mature bees, and their days are numbered. The life of the youngest of them at the outside will not be more than two months. The brood comb is the most valuable portion of the operator's find; therefore, it will be so to you if you are going to do likewise.

You know the cook's old adage, "first catch your hare." When you have found your bees' nest, if the bees' entrance to the nest be within easy reach smoke the bees as the tree stands. Of course before you do that you will encase yourself as shown. There is no advantage to be obtained in giving them "a regular good dose of it." After three or four good whiffs of smoke have been driven in, rest awhile, and when the smoke has cleared away note the direction the bees are coming out from the entrance; that is, see if they are coming *up* from below or *down* from above. That little bit of observation will save you a deal of chopping. Do not fell the tree till you are sure the nest is out of your reach. If you fell the tree the chances are when it reaches the ground with a thud the comb will break into one conglomerate mass, and when you take out its contents it will be a perfect hotch-potch. By all

means, if it be possible, chop the nest out as the tree stands. In chopping, when you come to the nest, with a little care, you will be able to secure the brood combs without breakage. Remember the young brood in the comb is the most important factor in the nest; that is if you are intending to strengthen your apiary. True, dirty and as full of foul matter as it may be, the honey is useful to feed back to your bees for winter storage. I have seen more than once, in chopping the bees from a log, when the nest is reached, that very few bees were to be seen amongst it or on it. This is one of the most happy acts the bees can accomplish for their own safety and for your success in operating. The bees will leave from timidity as soon as they feel the jarring caused by the chopping process, act precisely the same as they do under the impulse of the tapping that is used in driving when transferring them from a gin-case hive to one of the modern bar-frame type, or as was done when robbing the former makeshift hives. The bees will only do so if there be an additional cavity in the tree by means of which they can escape from their two-footed enemy. In the illustration on page 101, our hero does not appear to have met with a tree with the desired additional cavity, or the bees are extra vigilant, judging from the swarming seen around both man and tub. In chopping do not spare the tree. Remove as much of the timber as will give you full access to the combs, so that they may be removed in as large slabs as possible. Large combs are always easier to adjust in bar-frames than smaller pieces. The latter require a lot of manipulating to fit them. If, when you arrive at the nest, the bees are seen still clinging to the combs, try a little moral suasion to dislodge them therefrom. This can be accomplished by placing a box over the nest. See that one side of the box rests near to where the bees are in the most dense cluster so they can ascend to it with freedom. Remove some of the combs gently. If there are no young brood therein, put it in the honey tub. Hold all empty comb up to the light to see if there are eggs therein. They are as valuable as brood, nay more so. As you take out each bit of comb examine it carefully to see if the queen is thereon. You are more likely to find her between the combs of brood, or where there are the greatest number of bees clustered. Satisfied that the queen is not on it, brush the bees off with a bunch of ferns or leaves, and put it in the receptacle for the honey; have another tub or box for the brood-comb. Do not mix the brood and honey together; it will cause the death of a number of bees. Having removed sufficient comb to get at the

bees, commence to drive them into the box placed over to receive them. This cannot be accomplished with the gentle tapping given in the case of driving them from a box hive. Heavy thuds with the head of the axe will do it. Sometimes even this fails. In that case, disturb them by brushing them rather roughly with a bunch of ferns; at the same time drive in amongst them two or three clouds of smoke. They will very soon begin to travel into the box put to receive them. All the time you are preparing to drive them, and whilst you are doing so, keep a constant watch for the queen. If she is seen moving into the box let her go, all the bees will soon follow. If she is seen moving away from the box, pick her up by the wing or the thorax—do not touch her abdomen, you may permanently ruin her laying powers—and put her in the box. Do not put her in the box unless there is a handful of bees clustered therein. There will now be no further trouble as regards securing the bees. In a little while you may remove the box a little further afield. In a few minutes the bees will be seen making towards it like a flock of sheep. Do not be in a hurry to go to work to get out the comb; it will soon be deserted by the bees. Of course there will be a few stragglers on each bit of comb as you remove it; these brush off near the box. As each bit of comb is removed it will be seen that most of what it contains is both brood and honey. Cut away the latter, dropping it into the tub with the honey. When the brood comb is much besmeared with honey you will find it more difficult to adjust in the frames. So far so good. Now let us see what comes after. You have the box containing the bees; a tub containing the brood; and a tub with the honey. If it be early in the day when you began work there may be a lot of bees still out foraging. In this case it is just as well to leave the box of bees where they are. Of course if it be too far from home you must put up with the loss of the few hundred bees that are away; otherwise you can leave the bees where they are till sundown. Take home the tub of brood and that of honey. I do not care what you do with the latter. Here it is none of my business to say anything about it. I want you to look after the bees and brood. At home you have, or ought to have, a bar-frame hive. If you are only going to transfer the bees to a box-hive, remember it is only one remove from where you took them. You know all about that method of doing things. I want you to become a bee master. There is a wide gap between getting honey out of a log, as you have been doing, and obtaining the comb honey from the one-pound sections taken out of a Lang-

stroth super, or extracting it from the frames; and the gap is just as great in the article you obtain. You have the brood comb, but do not know how to fit in the frame? Take a flat table, or some other flat surface; have a number of pieces of tape cut long enough to tie around a full-size frame, the narrow way; place three or four on the flat surface, parallel and equally distant, according to the size of the comb you are about to fix in the frame; place the frame on the tapes; cut the comb to fit a little tightly in the frame, so that the bottom bar shall grip it firmly; it will be all the better to see that the comb is not put in upside down; adjust each frame in the hive. If not combs enough to fill the hive, put in a division board. Fetch your box of bees, and shake them out on the top of the frames; this is better than throwing them in front of the hive, for in this case they sometimes cluster under the hive, and it takes time to dislodge them therefrom. Cover them over with the quilt, and leave them till morning.

CHAPTER XVII.

HANDLING.

UNDOUBTEDLY the three most important allies to a bee-keeper are eyes that are keen to observe small movements, ears quick to detect the tones and semitones made by the wings of the bees, and fingers, very sensitive to touch, and nimble enough to adjust, swiftly but gently, frames at the required distances, or to change those spaces as circumstances may require. The last-mentioned faculty is, perhaps, the most important of all, and the novice will learn from experience that much of his success will depend upon the dexterity and discretion he is able to exercise in the manipulation of his frames.

Somewhere in his *Complete Angler*, old Izzak Walton says, in referring to putting a worm on the hook, "Handle it gently, as though you loved it." That is the most essential advice I can give to any who want to know how to become a bee-master. Be kind, be gentle. Gentle in all your movements. Kind in moving the bees from place to place. What queer ideas onlookers have as to the reason why a practical bee-keeper is so successful in handling his bees, and the extraordinary notions these onlookers entertain as to the docility of the bees when under manipulation. "Oh, the bees know him," or "He has chloroform about him," or, "He puts something in that smoker (the bee-bellows) that stupefies the bees," are some of the ejaculations that I have overheard again and again when giving practical lectures on "How to handle bees." If I were giving my experience under this head, many amusing and interesting circumstances could I relate that bee-keepers themselves would hardly give credence to. An experienced bee-keeper does not handle his bees with that apparent nonchalance because he is assured of the fact that his bees know him. How can it be so? Look at the thousands of inmates in a hive. How can the individuals in that community become acquainted with their keeper? No, it is not that the bees know their master, but that the master has a knowledge of his bees. He knows by certain of their movements, their appearance, and tone (perhaps I had better say voice), how far he can go, and no farther. We must remember

the duration of the life of a working bee is only about six weeks. We know the length of time required for the most docile of wild animals to become acquainted with their keeper; and the pugnacious nature of the whole race of bees does not except them from the catalogue of the untameable. Nevertheless, the handling of generation after generation of bees, and the breeding from queens of known docility, is telling upon the retaliatory disposition of the bees. That, combined with our increasing knowledge of bee-life, is no doubt having its effect upon their disposition.

I tried chloroform once in my early days, acting on the advice of a chemist. Do not ask me to give my experience. I would rather not. Smoke from the bee-bellows does not act in any way upon their nerves, other than compelling them to gorge themselves with honey.

From the movement and the tones emitted by the bees, the bee-master knows by experience when he can handle them successfully. Again, bees have a language that can be interpreted by a practical bee-keeper as easily as the language of the poultry-yard is understood by the hen-wife. What poultry-farmer does not know the call of a hen when danger is nigh, or when she is looking for a nest, or when she has laid an egg, or when she is about to sit, or when she has chickens, or when she has found a tit-bit for them, etc., etc. So bees have a language that is as distinct to the practical ear of a bee-master as the calls of the farm-yard are to the ears of a farmer.

The joyous, natural note of bees when they are flying from flower to flower, there are very few who cannot recognise it. By that same note the bee-keeper knows when his pets are returning home that they are peaceful and happy. When that note changes sharp and shrill, it is the war cry; then he retires if he has discretion. If, when he has blown a little smoke in amongst his bees, there is a dull, heavy sound, he knows it to be the cry of defeat. He knows, too, their cry of distress at the loss of their queen, and the ecstatic cry of joy when she is returned. Try it with a swarm of bees that is queenless, and without brood, by putting in a frame of brood-comb containing young brood and eggs—at once they change their note to one of joy. What a melodious note they give forth when rising on the wing to swarm; how it changes when they have found a suitable place whereon to alight; then the rallying call to the fugitives as they cluster in thousands one upon the other, and how that cry gradually subsides as the

wanderers return to the cluster. When all the swarm has returned to the alighting spot not a sound is produced. Then, again, listen at a hive at the close of day, when they rest from their out-door labour—the exhaustive labour during the honey harvest. As they stand with their rapidly vibrating wings expanded fanning and ventilating the hive, what a peaceful sound they emit as they sing their evening doxology, “Praise God from Whom the honey flows.” These are sounds that must be learned, and can only be learnt by experience; every bee-keeper knows them. Perhaps not in the order and the language that I have employed, but he knows their change of tone under different circumstances and conditions.

When examining a hive do not stand in front of it. Stand at the side or, better still, behind. In the subject on the arrangement of the hives in the apiary I have already cautioned you to have the hives sufficiently far apart from row to row to give the bees room to enter their home without your presence interfering with their direct line of flight. Stand by a hive of bees and watch them going out to their field labours, and returning with the spoils of the trip. On going out, especially if the honey flow be from trees generally surrounding your homestead, after they emerge from the hive they rise in the air, and make abortive attempts to go in as many different directions in quest of honey or pollen. When they have decided, they at once hie away to where they can get the greatest quantity in the shortest space of time. Watch the returning bees. Each one comes in a straight line from the last flower she rifled of its nectar, when she drops almost suddenly to the hive entrance. There is no hesitation. She enters at once, eager to disburden herself of her load. If they are coming from any point in a direction fronting the hive, their line of flight between the last flower wrought upon and their home is a direct one. Keeping rather high in the air, until near the hive, they gradually descend, forming an inclined plane to the entrance. But, if the foraging ground be somewhere away to the back of their home, they keep at about the same altitude till they get a little beyond their home, when they drop suddenly to the entrance. If bees are interrupted in their line of flight by an animated object near the entrance to their home, they are at once angered. If you stand in front of that line you become that object, and the bees will resent it upon you; but if you take up a position at the rear, the bees, in their homeward flight, pass over you, and you

stand on very safe ground. Now you know where to stand, when you are about to handle your bees, and the reason of it.

The time to examine your bees must be guided by the season and circumstances. In the summer season, any time, if the day be bright; but the middle hours of the day are the best, because there are not the number of bees at home as there are in the earlier or later ones. In the colder seasons never open your hives except under very exceptional circumstances; then select a bright day about noon.

Charge your smoker with anything that will smoulder, and at the same time will throw off a fair volume of smoke, but will not ignite into flame. Old, semi-rotten bagging, old fustian, dry cow-droppings, or cotton-waste that has been used to clean the oiled parts of machinery. There are plenty of other things that are equally good. When the contents of the smoker is lit, see that it smoulders well. First, remove the lid of the hive gently and quietly; next, turn back one corner of the quilt so as to leave a small aperture in that opening; blow in two or three puffs of smoke, keeping the nozzle of the smoker about six inches from it, so that heated smoke shall not reach the bees. I have more than once seen the wings of bees singed for the want of taking this precaution. Wait two or three seconds after this for the bees to well gorge themselves with honey. It is this gorging of themselves with honey that subdues them, not their knowledge of you, nor smoke that stupifies them. After the lapse of a few seconds, gradually and slowly peel off the quilt. You will find it adhering to the frames rather firmly, especially if it be some time since the bees have been examined. As you peel it off follow it up with a good cloud of smoke, still keeping the nozzle well back from the bees. When the whole of the frames are exposed, or as many of them as may be required, just look at the bees, some of them will still have their heads in the cells sucking up the honey; others will be walking rather leisurely over the surface of the comb; others, again, forming little clusters here and there. Those bees on the frame will appear rather longer in the abdomen than those that are coming out of a hive near by that has not been so disturbed. The dorsal rings of the abdomen of bees when surcharged with honey are distended one from the other by a little whitish ring between each of the plates, six in number. When these whitish rings are visible, the bees are on their best behaviour; their hum is peaceful and quiet. No more

smoke will then be needed, except when necessary to drive the bees from one place to another. If, on the other hand, the bees on the comb are restless, some of them standing as if on stilts, their abdomens rapidly vibrating to and fro, occasionally protruding the sting, and those on the wing uttering a sharp, shrill war cry, it is just about as well to leave them alone if you are an amateur. An old, practical bee-keeper would not mind all that; he would very soon bring them to their senses, and go about his work as though they were on their very best behaviour.

CHAPTER XIX.

ARTIFICIAL SWARMING AND DIVISION
OF SWARMS.

THERE is nothing like natural swarming. A natural swarm issues forth with all the conditions demanded by Nature. Every member of the swarm has started from the parent hive in a first-class temper, and with a determination to succeed and to overcome every obstacle. More especially is it so if it be a spring or first swarm from that hive of the season. The ordinary workers, the rank-and-file, are the most numerous. Upon them falls the bulk of the labour—the field-work for the supply of the essential stores for establishing and sustaining the future home. There is also a good supply of nurse bees. Of course, they are only young workers. Although there are no developing brood for them to attend to, there soon will be, because the queen or mother bee accompanying the early spring swarm is in a condition to commence depositing her eggs as soon as the necessary domestic arrangements are sufficiently far advanced to permit of it. A few drones or male bees will also be mixed up in the swarm—that, apparently, disorderly crowd.

A similar multitude of bees, too, are left in the parent hive, with the exception of a fertile queen. Similar and yet dissimilar. Similar in that there are working bees—field-labourers and the nursing bees, and also drones. Dissimilar, because in addition, there are developing bees, *i.e.*, brood in all its stages of development from the eggs that have only been laid a few hours to the bee just emerging from the chrysalis. I said above, *with this exception—a fertile queen*. The parent hive the swarm quitted contains a queen, but she is not fertile. Until the old queen that is fertile has departed, she remains in her cell. She may not become fertile till some days, after the departure of swarm under review. During the tenure of the queen that accompanied the swarm, every day she religiously fulfilled all the conditions that Nature demanded of her—the production of eggs. While in health and strength every day saw hundreds, nay thousands, of eggs deposited, one in each cell. There

was no break in the continuity of her duties till the bees prepare for swarming. From then until the virgin queen that was left behind becomes fertile and becomes a mother, there is a break in the succession to the daily numerical increase to the inmates of the old hive.

All the conditions, too, of Nature are in sympathy with the new swarm. The weather is warm and genial. The gardens, fields, and forests are aglow with blossoms. The air is filled with the odour from the fruit trees, and in the evenings when you stand near the hive the perfume from the stored honey is almost overpowering.

Take a look into the hive the day before the swarm vacates, and you will see the bees densely packed between the brood combs, each comb a perfect slab of sealed brood or otherwise developing, and also eggs. Probably not much honey, but an abundance of bee-bread, and queen-cells containing inmates. If you search for the old queen, the mother of all this immense concourse of bees, this mass of animated insects, you may find her, but it is almost like the proverbial "looking for a needle in a bundle of hay." Take another look a day or so after the swarm has left. How the appearance has changed. Not nearly so many adult bees, but plenty of little, woolly fellows to take the place of those that left. The slabs of sealed brood are gone, and there are plenty of empty cells. There are no eggs. Their place have been taken by little, pearly white bee-grubs, that are seen curling at the base of the cells, where you saw the eggs a few days before. Looking for the queen-cells in which were embryo queens, those you will find to be empty. The "cups" are there, with their edges much frayed. Other of these "cups" may be torn open at the side; but all are tenantless. You look for the queen that has emerged from one of them. Now, you think, I can find the queen, because there are not so many bees to contend with; but if you have had little or no experience in looking for these hidden mysteries, it is more than likely to be a search in vain. Still, she is there somewhere. She is a virgin queen. Here we cannot call her the mother-bee. Virgin queens are not easily distinguished. You must not look for a *big* bee, like the one you saw before they swarmed, but a bee not much larger than an ordinary worker. In form she will be much like her mother, but not in size. All this is Nature's way of propagating her species, distributing them far afield.

What has all the foregoing to do with artificial swarming?

Why, to show you the state of the parent stock, and outside the climatic conditions that are necessary before you attempt to increase the number of your bees by the division of the old stocks, or, as they are frequently termed, swarms.

If all the foregoing conditions are at hand, then you can commence work thus:—Take your strongest and best stocks, ones that are noted for their traits of storing honey. This is the golden rule of bee-keeping that every bee-keeper should paste on his veil, so as to be constantly before his eyes. *Weak and effete queens produce weaklings that are content only to live through the summer when it is all sunshine; in the winter they are content to die.* Operate on one hive at a time. Smoke them well from the entrance. Place an empty hive by the side of the one you are working on. It is as well to have near at hand some frames of empty combs. Take out from three to five of the best frames of brood (those containing the most sealed brood) having plenty of working bees thereon, and be sure to note if the queen is amongst them in the empty hive or empty combs. Place the brood combs in the centre of each hive, the one wherein you place the queen, and the one you leave queenless. If no empty combs be at hand, use division boards, but in that case you had better keep the brood on one side of the hive. Place the hive containing the queen on the new site. It is well to remember that the most bees should go with the queen, because at the time you are dividing, a number of bees will be at work, and these will return to the old site. It would be as well to put some obstacle in front of the removed bees, say a piece of wood leaning against the hive. This will cause the bees, when they come out, to take a survey of their new location, and prevent them returning to their old home. Indeed, both of the divisions may be removed to fresh sites if the foregoing precaution is taken. Of course, the brood comb in the old hive left on the stand must contain eggs from which a new queen can be developed. To develop a queen from an egg in a divided swarm is a round-about way of the division of swarms, and a very great waste of time. No one should keep bees unless he has a few fertile queens on hand, or the means of procuring them at short notice. A colony kept long without a queen is an unprofitable servant. If either of the divisions of a colony do not build up quickly, *i.e.*, in about three weeks, add a frame of brood from a strong colony. But be sure you do not rob Peter to pay Paul.

SUMMARY.

Do not attempt the division of a swarm till drones are on the wing, or at least until there is drone-comb within, and the cells have been sealed for some days.

If we select queens, we should select drones, at least they should come from distinct mothers, if possible.

There should be sufficient empty combs in that portion of a division that are permitted to raise a new queen for themselves, otherwise it is probable that the new combs constructed will consist entirely of drone cells.

Do not have anything to do with the division of swarms in damp or cold weather.

Leave the numerically weakest division on the old stand.

Remember you are not likely to get a good queen from a weak colony.

Do not attempt to divide your colonies unless a fair amount of honey is coming in.

Remember, also, a rapid increase of swarms by dividing, and a good honey production, are not co-equal. Artificial swarming is always done at the expense of the production of honey.

In dividing, keep the brood in both divisions as compact as they were before division, and keep the frames of brood in the same order relatively.

Three or four frames of brood will be enough to form a new colony, be sure you have the old queen with the new colony.

CHAPTER XX.

RE-QUEENING.

THAT is the introduction of a young queen into an established colony. Deterioration of stock is always attributable to the want of new blood. The breeders of horned cattle, whether it be for the butcher or dairying purposes; of horses, for draught, speed, or ornamental use; of sheep, for various classes of wool; and also the breeders of useful and ornamental members of the feathered tribe, recognise the introduction of new blood as the chief factor of retaining special types of animals for special purposes. Nor is the introduction of fresh blood a necessity confined to only the animal kingdom, both domestic and wild. Change of seed is as necessary to the agriculturist and the horticulturist as a change of sires amongst stock-breeders. The very soil itself becomes sick of having to produce a crop of the same class year after year. In the introduction of new breeds and varieties in the foregoing that has been obtained through sports or crosses, how difficult it is to fix and retain an ideal type. Generations after the type is supposed to have been permanently fixed there will appear among the fancied strain a stranger, differing altogether from the paternal or maternal side—a throw-back—a type of generations long gone by—weedy and of little use. This is not the sole reason why we requeen. As yet we have not arrived at that point of breeding special strains of bees and fixing the type to a permanent ideal with only an occasional throw-back. With bees we cannot control the sexes as with other domestic animals or even with members of the vegetable kingdom. The mating of bees is very much haphazard. That is the reason why dealers in queen bees charge so much more for “tested queens” than for untested. They cannot tell the paternity until the resultant progeny has been examined. Bees, too, like all other organisms, have a very strong tendency to revert to the type from whence they sprang.

“Change and decay” is a condition written on all things since the days of creation, and it is this change that is so necessary among the hive bees. The inmate of the hive that has the longest life is the queen. Drones are required only for the season, and

that season is sometimes longer and sometimes shorter, according to climatic circumstances. The life of the workers, too, "from the cradle to the grave," is dependent on the amount of work they have to do. The greater the honey-flow the shorter their lives, and six to eight weeks is their allotted span—longer when there is little or no honey coming in. The queen's life continues for years. She matures rapidly to her apex of perfection, and when that point is reached her reproductive powers gradually diminish. Yet this is not exactly the right way to state decaying powers. Almost to the last she is reproductive; but it is an unprofitable progeny—male bees that have not the power, no matter how good the will may be, to procure the common necessities of bee life. Hence the necessity of regularly and systematically superseding all queen bees. This, to obtain success as a bee-keeper, should be done every alternate year. Some bee-keepers introduce a fresh young queen every season, but I don't know that it is a bad practice. There is more to be gained by it than lost.

There are many methods, ways, or plans, adopted by various bee-keepers for re-queening, all more or less adaptable to obtain the desired results.

"Many fish of many kinds and many men of many minds" is an old aphorism, and as there are many modes of re-queening, I propose here to deal with the most of them. Before doing so I should like to point out to the reader a few little facts in relation to this phase of bee-keeping.

"A new broom sweeps clean" is another proverb that is also very applicable at this point of the subject. Did you ever notice the energy thrown into the work of construction by a swarm that has been newly hived? After they have taken possession of their new home, clustered, and the process of wax-secretion is well under way, the bees having spread themselves out in wax-working curtains and "the foundation of the house is laid," the queen becomes feverishly anxious to commence her duties of reproduction—egg-laying. This anxiety is shared equally by the workers, for they are as eager to be about their maternal duties as the mother bee. Ofttimes, before the cells for worker bees are complete, the queen will deposit her egg therein, and the work of cell-construction proceeds whilst the egg is maturing. At this stage in their domestic economy the zeal of the workers knows no bounds. Before the sun rises they are up and away, and returning again and

again with the fruits of their early excursions. So it goes on all day until the lateness of the hour checks further outside labour. This will continue for the first and well on into the second season if there be out-door labour to be done. After these two seasons the foraging-bees' zeal and energy will begin to wane. They don't rise in such numbers as they did, and their excursions are not so frequent as they were. Why? The queen's procreative powers are subsiding, therefore the workers' maternal duties and love of offspring diminish in like manner. To introduce a new queen, one having all the elements of a queen that has sailed forth with a swarm, is to put new life and energy in the bees that had afortime settled down into the humdrum lassitude of a declining queen. A change may be as good as a rest. But in this case a change means more labour for the bees and extra profit for the bee-keeper.

Again, what pleasure there is in knowing that you are master of your bees, and that you can stimulate a sluggish colony into activity. This activity is a mutual help to both parties.

Let me enumerate the different methods of doing this all-important work:—(a) By destroying the old queen, and letting the swarm take its chance; (b) by grafting a queen cell on the comb of a queenless colony; (c) by the aid of chloroform; (d) by leaving the colony queenless for a given period; (e) by direct introduction. Can these various methods be equally successful? All may be successful, but not equally so. Then why recommend them? Because some of the methods referred to can only be successful in the hands of an experienced bee-keeper. Other methods depend for success upon the season of the year and the abundance or otherwise of the floral season.

By destroying the old queen and letting the colony take its chance.—In the hands of a beginner this is always a success. In the warmer parts of this State there are always eggs and larvæ from which the bees can manufacture a queen. Although a new queen can be thus produced, it is not wise to do so at all seasons of the year, because drones are not always available. If there are no drones the queen will lay only drone-eggs. Spring and summer are the only seasons that should be chosen, and the former one preferable. Look at the waste of time in this method of requeening. There is a loss of about seven weeks during the most important season of the year. No; don't requeen in this way if you can succeed otherwise.

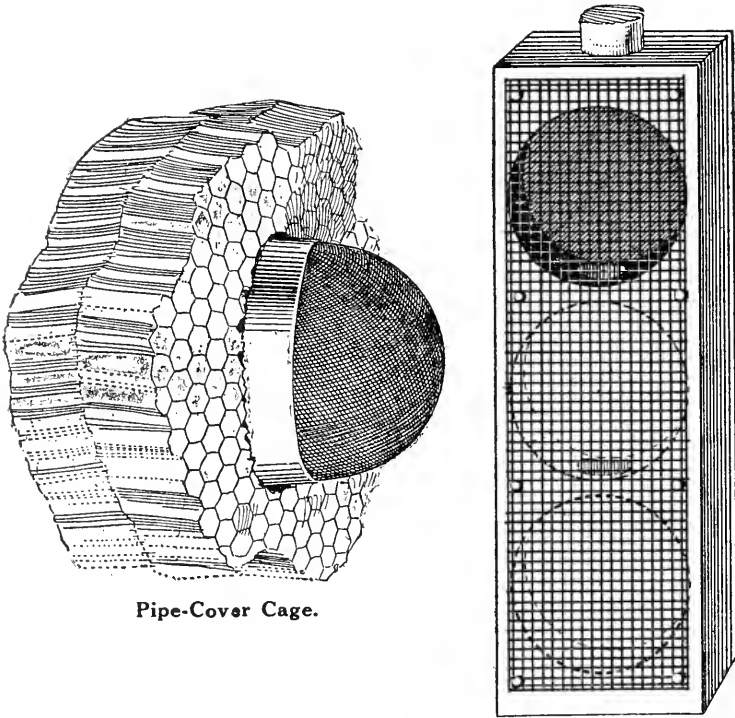

Pipe-Cover Cage.

TO INTRODUCE A QUEEN.

Dequeen and allow the colony to remain queenless for three or four days. During these days search for virgin queens and destroy them. Remove all queen-cells in course of construction and those completed before introducing the new queen. In handling the queen, do it carefully. Pick her up by the wing or thorax. By no means touch her abdomen; you may thereby ruin her procreative powers. Place her in one of the many introducing cages shown on these plates, with about a dozen of her own progeny. If the pipe-cover cage be used, press it into the comb where the honey-cells are capped over. With the other cages use bee-candy in the places allotted for it.

After the introduced queen has been within the dequeened hive for about forty-eight hours, set her at liberty. If the bees take kindly to her they will pay little or no attention to her beyond making an inspection and offering her food. In about an hour after she has been set at liberty have another look at her, and if the inmates appear in any way to molest the queen, recage her, and go through the whole work again. There is no doubt of an introduced queen being accepted during a good honey-flow, and if there be plenty of maturing brood in the cells.

Bee-candy is made by boiling sugar in a little water till it becomes of the consistency of candied honey—*i.e.*, when the boiled sugar has cooled.

By grafting a queen cell on the comb of a queenless colony. You must first make it queenless, and let it remain so for three or four days. Illustrations of this have been given elsewhere. Like the former method, there is no saving of time in this. Its only advantage over the other method is that you introduce a queen from a better strain of bees.

By the aid of chloroform: I have never tried this, but in the *Canadian Bee Journal*, page 390, are these words:—"Drop a dry sponge into the fire-barrel of the smoker, then a sponge wetted with chloroform (a teaspoonful), and another dry one on the top of this in the nozzle, when you are ready for action. Proceed to the queenless colonies, and puff in the chloroform at the entrance (as in the act of smoking), say for a quarter of a minute. Then pass to the next (hive), and so on, for about two minutes. Return to the first hive, give a few more puffs with your chloroform-smoker, and let your queen run in." The writer claims that in this manner you may run in fifty queens in so many minutes, and in each case be successful.

By leaving the colony queenless for a given period. It is well known that if a colony is deprived of its queen that the tone emitted by the bees differs from that previously uttered, and that when their own queen is reintroduced peace seems to reign, and the bees appear to be happy. Huber, in the early days of scientific bee-keeping, demonstrated this; but when he attempted to substitute a strange queen in lieu of their own, they declared war to the knife with her. Now, what was the reason? Most of the lower order of animals recognise each other by the senses of touch and smell. Ants meeting each other touch with their antennæ, their organs of smell, and there is no doubt that bees recognise their queen in the same way. On one occasion I rolled a queen in honey, and introduced her to a colony at the same time as I withdrew the reigning queen. It was a success. At other times I have tried the same plan, and it has been a failure.

CHAPTER XXI.

TRANSFERRING.

THIS is a phase of bee-keeping that falls only to the lot of beginners. A bee-keeper who has had if but a very slight insight into the freemasonry of bee-life should have risen above transferring, other than when he may have bought out a gin case beehive for the purpose of adding to the number of his colonies.

The maxim, "be gentle when amongst bees," never received a better illustration than on the day I transferred a colony at the Hawkesbury Agricultural College, for the purpose of obtaining the illustrations accompanying this article. I wanted the views to be original and true to life. To anyone who has not seen a colony transferred from a common box to an improved bar-frame hive, such illustrations will be extremely interesting, as few can understand how freely and safely these pugnacious little warriors can be handled when we set about it in the right way. Two or three friends left Sydney with us to see that interesting operation. One little fellow who had not been told that he must be gentle and kind when amongst bees, took a stroll amid the hives, but when a bee flew against him he soon quickened his pace, and his cries and tears told that he had not learned the maxim. A number of students of the College had the privilege to be present to watch and take lessons in transferring. At first they were very dubious as to my statement that bees can be handled as easily as you can handle chickens, when you once know how. That you can pick up bees in handfuls as you can pick up handfuls of grain seemed to their ears to savour somewhat of the Rougemont type of phraseology. When the gin case of bees was picked up and carried to the work-table, the bearer discarding all bee protection whatever; and when the manipulator doffed coat, turned up his shirt sleeves, and commenced to break up the old box for the purpose of getting at its contents to put them into bar-frames, it was a picture to see how the uninitiated amongst those students stood back and wondered

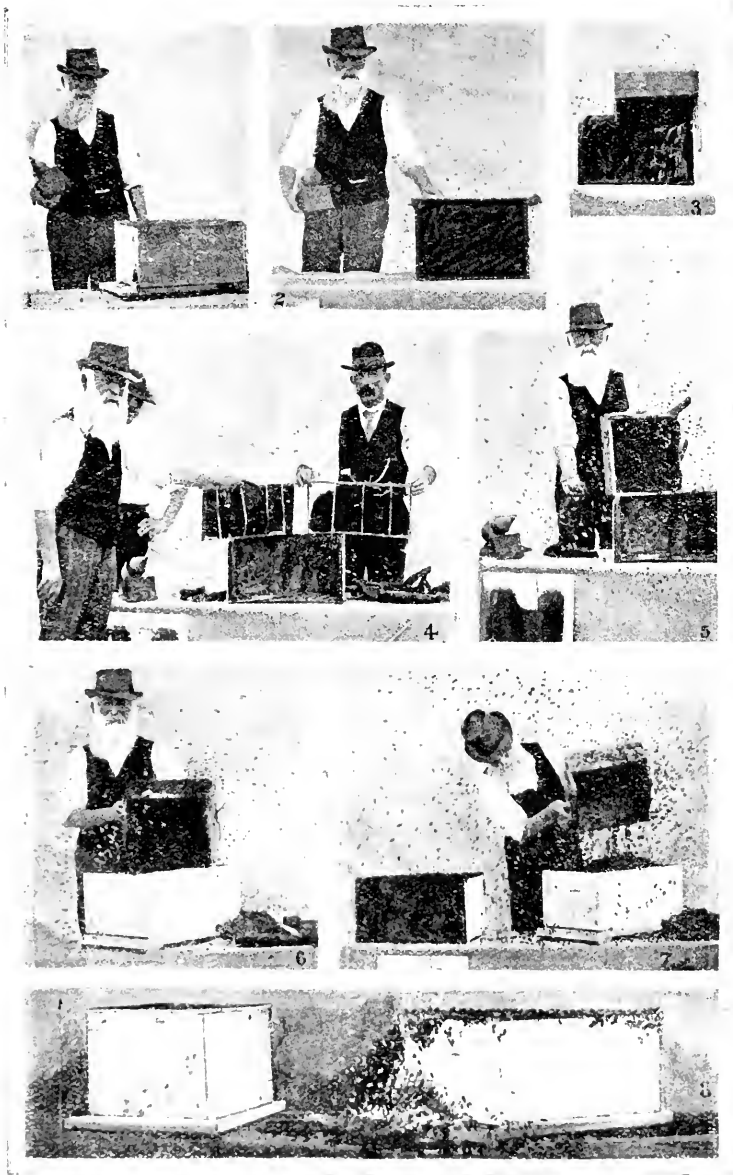

Transferring Bees at Hawkesbury Agricultural College.

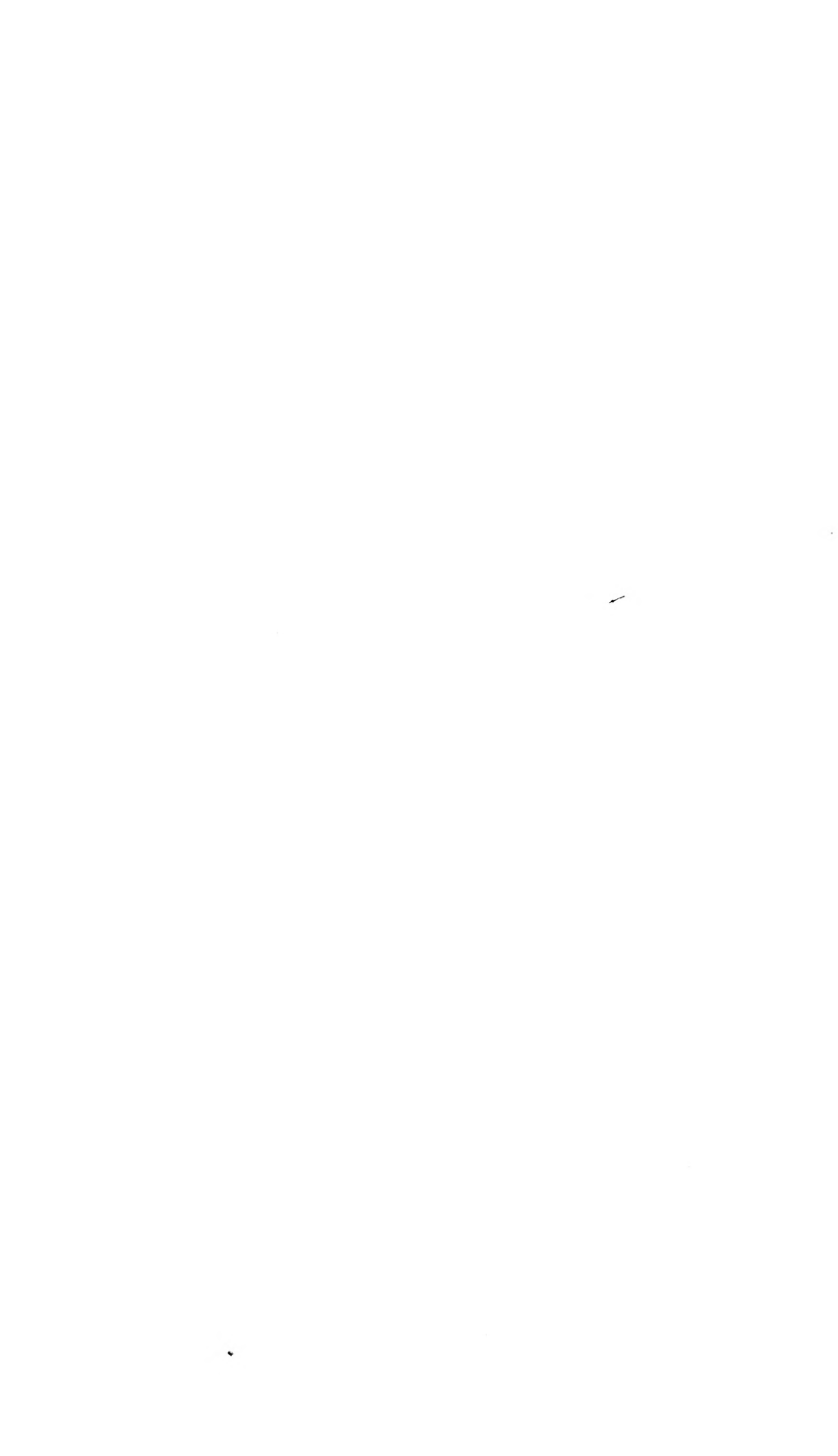

how such liberties could be taken with such a dangerous race of combative insects. More quickly than it takes to write it, when the box was placed bottom upwards prior to *drumming*, the bees came out in hundreds, nay in thousands. The students, by their movements, gave one the idea that a life amid bees was not a happy one, but when the manipulator, with naked hand and bare arms, began to remove the bees that blocked the way to the receiving box the students' surprise ripened into confidence. No matter who the manipulator is, or who the onlookers are, if the former understands the why and wherefore of bee-life it is always the same. I have met timid ladies who would not go within "coo-ee" distance of a bee-hive, because, as they assert, the bees are always in a fightable disposition "when they are near." Yet in a few minutes afterwards I have seen those same ladies come over to the work-table and, removing their kid gloves, handling the bees as freely as the manipulator was doing. And men, too, who have Herculean strength and the courage of a "she-bear robbed of her whelps," but would turn tail and run if a little bee flew against them, converted from the idea that bees cannot be handled, and after one practical illustration, such as we had at the College, become enthusiastic disciples of the physically blind Huber, and develop into enthusiastic followers of Langstroth's method of bee-keeping.

Wherein does the supposed secret lie? Not in any charm, or in the possession of a stupifier, as is too often supposed; but the manipulator has confidence, and, as "like begets like," his confidence stimulates and creates a confidence in the onlookers. It was so when these illustrations were produced. It can be seen when the receiver, made out of an empty candle-box, was put in position how the onlookers stood as far from danger as possible, and how the graduations of confidence expand up to the illustration where the students are gathered around the work-table. These youths are so intermixed with the bees, that if the latter were human beings it would be a difficult task to find the former. All that has ever been written about subduing and handling bees will never convince a sceptic in bee matters half so much as this one bit of practical work. Every onlooker that is depicted around that table is now convinced that bees can be handled, as I told them before I began work, with as little danger as we handle chickens. Count the individuals in the group, note their attire; observe the subdued, patient, movements of those industrious

little bees as they are seen being tumbled about in the various illustrations, and ask how many in that group got stung, and the reply will be, *one*. And why did he get stung? He placed his hand *on* a bee; and if a burly fellow were to come along and put his hand with crushing weight on you, would not you sting? It may not be a sting that would give physical pain, but your stinging rejoinder would give mental pain.

On another page the artist has represented an individual as having "dropped his gun and run." On this occasion he stood his ground well. He had learned the lesson, "Confidence, gentleness, kindness;" a lesson not difficult to acquire, but when once mastered must always be borne in mind and ever acted upon; and as surely as sparks fly upwards, success in transferring and other manipulations in connection with bee-keeping will follow.

Can anyone, ladies especially, transfer bees? If these illustrations and what I have written, do not convince you, what will? Are the implements used in transferring expensive and difficult to obtain? Not a bit of it. Some are in every house, and most of the others can be found in the wood-heap or about the yard. They are all visible in the illustrations; let us take an inventory of them. First there is that ever-indispensable "smoker"; you cannot do without a smoke bellows. Pender's is one of the best we have; that is it you see in my hand. It was charged with a bit of half-decayed bagging. But more on that subject anon. When the old box stood on its original stand a half-dozen strong blasts of smoke were driven in at the entrance. That settled the question "to sting or not to sting" for all the rest of the necessary work in connection with their being transferred to a more convenient (for the bee-keeper) and a better house (for the bees). What did the smoke do? Why, old Virgil understood the use of smoke with bees. Centuries ago he wrote to this effect, "If at any time you would open their narrow cells (to take) the stores of honey from their treasure house, first rinse out your mouth with a draught of water, and hold in front of you clouds of smoke." The smoke does not stupify them, but each inmate takes in about a week's supply of honey. All animals are more docile when they have their stomachs full than when they are empty. Otherwise, you see the bees are removed some distance from their old camping-ground to the protection of an outhouse. Not altogether for the convenience of the makeshift table you see, but the foraging bees returning home will resent



Fig. 9. Yes, we believe it now. Bees to the right of us, bees to the left of us, hummed, buzzed, and bumped us, but none of them stung us.

your intruding on their domain, and the other bees in the apiary may become robbers; and thus being out of their way is being out of danger.

Secondly, there is a broken candle-box with about a third of its side removed. With this the four cleats that hold it in position as seen in Fig. 3 are made. Third is a basin to hold the honey as it is taken from the hive-box, as comb with honey should not be put in the frames when transferring. Fourth, a dinner knife, seen in No. 5, for cutting out the comb from the box, and Fifth, some narrow bits of tape for the purpose of holding the comb in position in the frame as seen in Fig. 4. In front of the table is the bottom board of the old box.

Fig. 1 is the gin case of bees as it was brought from the apiary for the purpose of transferring. It was procured from elsewhere for that purpose. It has many open joints; these are stopped up with old bagging. Such a box fitly illustrates bee-keeping as it was prior to the introduction of the bar-framed system. The open joints are the entrances for bee enemies and dampness and cold draughts of air that foster all manner of bee diseases, and the old bagging is the breeding ground for the bee-moth and the harbour of spiders, etc.

Fig. 2 is the same box on its side, showing the arrangement of the combs within. It will be seen that some of the combs have fallen down. Fallen comb is always a trouble to the bees, and a loss to the bee-keeper. In a Langstroth hive if such a thing happens it can be rectified. It will also be noted that the combs are built diagonally, and in two different directions.

Fig. 3 is the box turned bottom upwards and one of the sides removed. The receiving box is in position and drumming is being done. The bees are driven into the receiving box by rapid and constant tapping at the sides of their old home. Sometimes a puff of smoke or two is driven in between the combs for the purpose of hastening their movements. If the bees should cluster in amongst the combs in the corner of their old homes it is sometimes necessary to remove them. It can be done with the naked hand far better than with a bee-brush. It is quite safe, as can be seen in Fig. 5.

Fig. 4 illustrates the method of fixing the transferred combs in the frames. The largest combs are first taken and cut to fit the frames as near as possible. They are held in position with the narrow tapes, as seen in the frame to the right. The smaller

pieces of comb, seen in the frame to the left, are cut to fit each other as near as possible, and are also held by tapes. Sometimes wires are used in lieu of tapes. I always prefer the latter. These frames are now ready to be placed in the bar-frame hive prior to the bees taking possession of their new home. Care must be taken in transferring the comb to the frames that it is put in correctly, and not reversed, *i.e.*, upside down.

Fig. 5. You see bees are quite harmless under transferring, and can be handled as easily as chickens. After drumming, the box with the driven bees was put on one side out of the way, but is now brought back and is resting on their old home from which all the brood combs have been transferred. To your right is unused comb, some of that which had fallen, drone comb and empty worker comb, for in transferring we never use these, nor the comb with stored honey. The smoke bellows is there, but it has done its work long since, notwithstanding the advice of the ancient Virgil. The bees are now ready to be placed in their new quarters where the frames with the transferred comb have already been placed as in Fig. 6, where thousands of bees are seen still clinging to their old home. Other thousands are in the transfer box ready to be tumbled pell mell, as seen in Fig. 7, where the onlookers' intense interest is plainly seen. Half an hour ago and you dare not handle those bees as here seen. What has made the difference? They have been subdued; we have obtained dominion over them. The manipulator is jerking them from the transferring box, from which they are falling like sand, and are piling up on the top of the frames. Yet not one of them puts on that angry tone so indicative of something sharper to follow. What would our grandfathers have thought of seeing anyone handling bees as the manipulator is here doing? And yet anyone can do it when they have been shown *how*.

Fig. 8. What a transition. Look at it. The past and the present. The old and the new. The old, with its accessories for disease and enemies. A home for bees where they could store honey in its purity for winter consumption, but man in obtaining it for his use had to destroy the bees or the brood comb, or both, with the destruction of the honey-comb, at the same time receiving many a reminder from the bees. And what did he obtain? Honey, mixed with bee-bread, and broken comb and bee-eggs, and crushed larvæ, etc., too numerous to mention. The old, where all the interesting sights in the natural history of the bees that the sages

and naturalists of old desired to look into in vain. The new with its ease of manipulation, giving us an insight into the development of the bees from the egg to the perfect insect, giving us full control of the queen, the centre around which revolves successful bee-keeping at all times, and giving us a food free from those objectionable matters named.



CHAPTER XXII.

THE HISTORICAL BEE-HIVE—ITS EVOLUTION.

“MAKE your cage before you get your bird” is a proverb very applicable to amateur bee-keepers.* I have always advocated that spare hives should be on hand and in position to receive any stray swarm that may chance put in an appearance. No matter how small it may be, it is always more or less valuable if only to strengthen a weak colony. The object of these pages is to give instruction as far as can be on paper, not to professional bee-keepers, but to beginners and would-be bee-keepers of the “back-blocks” and other remote places where carriage and other concomitant troubles are always more or less standing in the way of newly fledged and enthusiastic amateur apiarists.

Artificial homes and habitations for bees, like those of man, have had their periods and architectural developments and changes from the first primitive type to the more or less perfect movable bar-frame hives of almost universal adoption. Like man, too, bees were once “cave dwellers,” and indeed *wild* bees still are. Whilst man led a nomadic life he was content with the “wild honey” that was found “dripping from the rocks.” In those early times there was no occasion to construct artificial homes for the domestication of the bee till man himself became a settler on the soil. The development of an artificial home for bees has been very slow. Some of the earliest history of civilization is silent thereon. Nevertheless, artificial homes for bees “are as old as the hills.” The artificial beehives used in Egypt at the present day are sun-dried earthen tubes, about 4 feet long, similar to unglazed drain-pipes. The same style of hive is said to be the one adopted by the Japanese, and also among the hill tribes of Northern India. From these sun-dried clay-pots of the ancients to the old straw hives of our great grandmothers, architectural progress was very slow.

*He was a sound philosopher who first shaped it and gave it utterance, and the proverb is now as familiar to us as household words.

For obtaining the honey from both the clay-pots and the straw hives, "fire and brimstone" were the persuasive arguments used to induce the little busy bee to yield up its laboriously-gathered winter stores to satisfy the cravings of the sweet-tooth of the bee-keepers of bygone days. How long the common straw hives were annually operated upon with fire and brimstone before some humane individual came to the conclusion that something more than a drain-pipe was needed to save the valuable lives of the inmates I don't know. Notwithstanding that after the applications of the brimstone argument, when every onlooker smelt a little of the torments of the valuable sufferers, all the sympathy of the bee-keeper ended in, "What a pity; only this, and nothing more!" until Nutt invented a straw super. This invention was improved by Neighbour's, Pettitt's, and Taylor's bell-glass supers. Nutt's super straw skip was superseded by Mr. Pettitt's "Temple Bee-hive for the humane treatment of the honey-bee." It was got up in a tasteful and substantial manner, and when placed in a neat and ornamental flower-garden had a very picturesque appearance. "Each hive was furnished with four bell-glasses," he tells us, "from which the drones are effectually excluded, and the temperature of the interior can be so regulated by the use of the ventilators and thermometers, as to prevent the necessity of swarming." only this "necessity for swarming" came off all the same.

About 1864, *The Times* (London) Bee-master, strongly recommended "Pettitt's hexagonal," as improved by himself by the introduction of six slides for the purpose of communication between the brood chamber over the super. But, later on, he discarded it for the Ayrshire box-hive. Pettitt's "Temple hive" seems to have been one of the first wooden structures for bee-keeping having any pretensions to use and ornament used in Great Britain.

In 1846, *The Leipzig Illustrated Almanac*, in a report on agriculture, said, "Bee-culture is no longer regarded as of any importance in rural economy."

In 1848, the Rev. Mr. Dzierzon published his *Theory and Practice of Bee-culture*, wherein he describes his method of removing the combs without the said combs being wholly destroyed. His method was by a movable top-bar to which the bees attached the comb, and also attached it to the sides of the hive from where it had to be removed by the application of the knife. This was the germ from which sprang the movable bar frames

The Rev. L. L. Langstroth constructed a hive on the plan of the folding hives used by the celebrated Huber, for the purpose of verifying some of his (Huber's) valuable discoveries. The use of the Huber hive convinced Langstroth that a hive could be made that should give the bee-keeper a complete control of the combs without enraging the bees. The cutting of the combs from their attachment to the sides and bottom of the hive was the great drawback to Dzierzon's invention, and Dzierzon's movable *top-bar* speedily gave place to Langstroth movable *frame*.

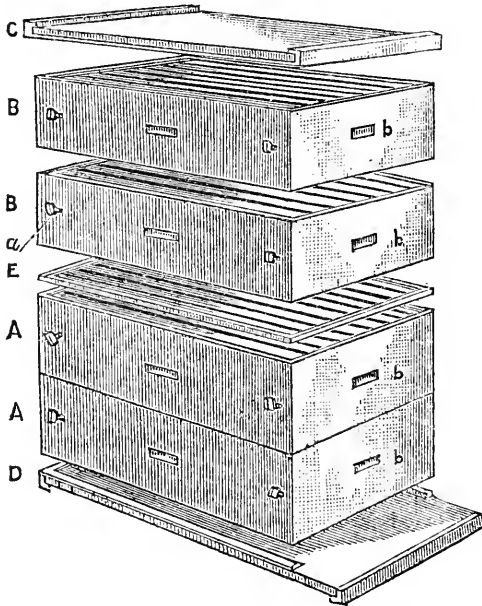

The Heddon Hive.—A, Bodies used as brood-chamber; B, Bodies used as super; C, Cover; D, Bottom board; Slatted wood and zinc honey-board (Queen excluding); a, Wood thumb-screws; b, Handholes for lifting.

Having thus given a short history of the rise and progress of artificial homes for bees, I propose to give a detail description of some of the movable bar-frame hives in general use. The various forms of hives now in use are all more or less modifications of the Langstroth.

Whatever the pattern, model, or size, hive chosen by the bee-keeper who intends to make his own hives, its construction must be simple, and the material most suitable is a soft, porous, light wood. The wood should be well-seasoned, so there may be no

shrinkage with atmospheric changes. Hives should be so made that in the manipulating of them it will not be necessary to injure any of the inmates in the slightest degree.

The hives in use in this State are the Langstroth or Langstroth Simplicity, although occasionally we meet with the Gallup, the Heddon, the Quinby, the Berlepsch, the Long-Idea, etc., or modifications thereof.

The following description is taken from Cheshire's Bees and Bee-keeping, Vol. II.* "The body-boxes (bb) are each $5\frac{3}{4}$ inch deep, by 19 7-8 inch, by 13 inch, outside the ends 7-8 inch, and the sides $\frac{3}{4}$ inch thick. Before nailing together, the inner part of the top and bottom edges is rebated down 3-16 inch, leaving a rim 3-8 inch wide only, so that when the boxes come together they touch only at the 3-8 inch rim, while the 3-16 inch rebate in each make together a full bee-space (bs) of 3-8 inch. This principle of allowing a half bee-space above and below in each horizontal section of the hive, so that the needed 3-8 inch and no more is given in any possible combination, is a salient and new feature in the Heddon hive. The bottom board carries a lath 3-8 inch deep and 3-8 inch wide at its upper edge, upon which the hives rest, so that a larger, but not excessive, bee-space is made beneath. An entrance (e) is thus secured, which is regulated by the Langstroth blocks (lbb). Since the body-boxes are made invertible, Mr. Heddon has felt himself compelled to abandon the hanging Langstroth frame, and adopt a modification of the standing form of Quinby with wide ends. This frame he dove-tails together in the manner of section-boxes. The top and bottom bars are $\frac{1}{4}$ inch by 13-16 inch by 18 1-16 inch, while the end pieces are 3-8 inch by 1 3-8 inch by 5 3-8 inch, *i.e.* (to preserve the before-mentioned bee-space) 3-8 inch shallower than the body-box itself within which the length of the frame has 1-16 inch play. It will be seen that the end pieces of these frames are 9-16 inch wider than the top and bottom bars; hence the space between any two top bars, or bottom bars, will always be 9-16 inch, by which the bees pass freely from section to section of the hive body. To prevent these frames falling through the body-box, the inside measure of which is 1-16 inch greater than their external length, strips of tin are nailed on to the lower rebates of the end pieces. These tin strips project 1-8 inch, and give a resting-place for the frames

* I have given Cheshire's measurements in detail, because they are the sizes now universally adopted.

which stand upon them. As the outside width of the body-box is 13 inches, and the thickness of the sides $\frac{3}{4}$ inch, $11\frac{1}{2}$ inches intervene between the latter. Eight of the frames, each 1 3-8 inch wide, occupy 11 inches of this, so that the $\frac{1}{2}$ inch play provides the additional space required on the outside of the outer combs. To divide this equally, a narrow off-set, $\frac{1}{4}$ inch thick, is nailed into the corner on to the side, and against this the outside frame rests. Wooden thumb-screws (ss), that have been previously boiled in tallow, are now tapped into the sides, so that their ends work on the edges of the wide sides of the frames, squeezing them together until they hold their position securely when the body-box is inverted.

“The stand (st) needs little explanation. The cleats of the bottom board touch its end pieces a trifle before the bottom board itself touches the side pieces, such a bearing causing the weight of the hive to assist the cleats in keeping the bottom board perfectly straight. The honey-board (hb) Mr. Heddon arranges on the ‘break joints’ principle, its slots standing over the interspaces between the frames of the body-box, with the object of preventing the building of brace-combs as they are termed, *i.e.*, strips and irregular extensions of comb introduced between upper and lower frame or frames and section-boxes, filling the bee-space and attaching together, according to bee notions of security, parts that the bee-keeper desires to remain separate. The frame which holds the honey-board together extends in thickness 3-16 inch, both above and below the slots, thus keeping the half bee-space so characteristic of the Heddon system. The honey-board, as supplied, has no further addition, but the inventor recommends, and Mr. Jones actually places, queen-excluder zinc between the slots, which have saw-kerfs made in their edges, so that zinc, wider than their interspace, can be run in and kept in position. Zinc expands and contracts greatly by change of temperature, and would be consequently likely to seriously buckle if given in full sheet; but this is entirely prevented by the arrangement described.

“The section-racks (sr) are constructed on the general plan of the brood-chambers, with which they have the same length but a slightly greater breadth; their edges, however, abut accurately upon the brood-boxes, which is accomplished by giving to the sides a small outside bevel. Since they are intended to hold frames accommodating $4\frac{1}{4}$ inches by $4\frac{1}{4}$ inches section-boxes, they are only 5 1-8 inches deep, which allows $\frac{1}{2}$ inch for top and bottom bars of frames, and 3-8 inch for two half bee-spaces. The sides of the

section-racks are 5-8 inch only (1-8 inch less than that of the brood-boxes), giving 1 foot full of internal width to the section-rack, which thus accommodates seven frames, each carrying four of the sections previously named. The thinning of the side necessitates battening, to give the tightening screw (s) sufficient hold, and the rack itself adequate rigidity. The tin rest and rebates are applied to these racks as to the body-boxes."

These Heddon hives are only suitable for the most experienced bee-keeper. It requires a skilled mechanic to make them, and they are far more difficult in manipulating than the Langstroth. The wooden thumb screws are a serious drawback; notwithstanding they are first boiled in oil, the sides of the hive in which they work always contract in damp weather, and I find it impossible to move them. I have had one in use now for two seasons, and during damp days or after a shower I find it impossible to open them until the sides are again thoroughly dry.

Every bee-keeper of note finds it to his advantage to make certain alterations applicable to his wants and the district in which he lives; but where one of any other name is used in this State there are a hundred of the Langstroth's or the Langstroth Simplicity, and these terms for all practical purposes are synonymous. The Langstroth hive has stood the test of nearly half a century. Professor Cook's remarks many years ago are still applicable. He (Professor Cook) said of it, "It left the hands of the great master (Langstroth) in so perfect a form that even the details remain unchanged by many of our first bee-keepers."

Anyone who has a fair amount of skill—a bush knowledge of the use of tools—can make a Langstroth hive. Winter evenings in the country often hang heavily, therefore those having spare time cannot employ it in more profitable pastime than that of hive-making.

The wood used should be soft and light and well seasoned, and the only thing that is imperative in the construction is that the measurements must be rigidly adhered to, otherwise there will be no end of trouble in the manipulating of the bees. Many a bee-keeper who has been his own carpenter has given up bee-keeping in disgust, because in the construction of his home-made hives there has been a want of care in giving bee-space—quarter of an inch—true bee-space is 3-16 inch.

The wood in kerosene and other packing cases is more or less suitable. They are to be found around about all country stores,

and can always be cut down for the making of bee-boxes. For the colder districts the sides of the first named is too thin. The smell of the kerosene is quickly evaporated by putting the cases in the full glare of the sun. The most suitable thickness is that of one inch, or a little less if it is not to be planed. The ends must always be of inch wood, or of sufficient thickness to admit of a rebate (rabbet) for the movable frames to hang freely. The ends of kerosene cases, although not an inch thick, answer very well for the purpose.

The brood chamber, or body of the hive, is $9\frac{1}{4}$ inches deep if a movable bottom (to be hereafter described) be used, but if the bottom be a fixture (though a movable bottom is always preferable) it should be 10 inches in depth. For an 8-framed hive the ends must be $14\frac{1}{4}$ inches—that is, if the sides are to be nailed to the ends—but if the ends are to be nailed to the sides an allowance must be made for the thickness of the sides. The sides should be 20 inches outside measurement. Therefore, a piece of timber 6 ft. x 10 in. is sufficient to make a brood chamber or a full size super. From such a piece of timber, first cut off $28\frac{1}{2}$ inches (if the sides are to be nailed to the ends, and it is always better so to do) and work a rebate (rabbet) 3-8 in. plus the thickness of the top bar of the movable frame, and the top bar of such frame should be at least $\frac{1}{2}$ inch thick, afterwards cutting it into two equal parts. Of course, each one will be $14\frac{1}{2}$ in. x 10in.

An easier and simpler way of making the rebate, although not so workmanlike, is to plant a strip along the end piece of the frame, and fasten it with fine nails thus:—(A) $\frac{3}{4}$ x 3-8 in. piece planted on (c) to form the rebate, and fastened with fine nails; (B) rebate, which should be $\frac{3}{4}$ in. by not less than $\frac{1}{2}$ in., for the frame to hang on; (c) $8\frac{3}{8}$ in. x 1 in., or a shaving or two less. (aa) $9\frac{1}{2}$ in. if the bottom board be a fixture.

A full-sized super is the same measurements as the brood chamber. It will be noticed that if a movable bottom board be used the depth of the bar-frame (to be hereafter described) will be $9\frac{1}{4}$ inches, thus coming flush with the base of (c), and showing no bee-space—a cleat to form the bee-space is fastened on the bottom board. Half-size supers for shallow frames are the same measurements in all except in depth. This will be explained in the article on Frames, etc.

CHAPTER XXIII.

MOVABLE BOTTOM BOARDS FOR THE
LANGSTROTH SIMPLICITY HIVE.

LIKE all other portions of the hive, the bottom board should be made of well seasoned timber, light and free from cracks. A faulty bottom board is always a nuisance and vexation to the bee-keeper, and alike a fruitful source of trouble to the inmates of the hive. Cracks and badly fitting joints in bottom boards, and indeed in any other part of the hive, are always nurseries for the larvæ of the bee-moth and other enemies. If cracks, etc., cannot be avoided they should be filled in with putty or some such stopping.

For an eight-framed hive the width of a movable bottom must be $14\frac{1}{4}$ inches, plus the thickness of the sides of the hive; that is, if the sides are nailed to the end pieces, but if the end pieces are fixed to the sides, they should not be included in the measurement of the bottom board. In other words, a movable bottom should be the full width of the hive, and no more. In length it should be $2\frac{1}{2}$ inches longer than that of the bottom of the hive, the extra length being used as an alighting board. The wood in thickness should not be less than 1 inch stuff dressed down to 7-8 inch.

There are several patterns of bottom boards, but I have selected two that are the most commonly used. If the hives have been constructed the full 10 inches in depth, with a view of having a $\frac{1}{4}$ -inch space beneath the frames, and a $\frac{1}{4}$ -inch above, it may be constructed in either of those shown in the two following diagrams:—

For this platform, or bottom board, a piece of wood 1 inch thick, 2 feet long, and 16 inches wide (the width of the hive) is needed. It may be made of two or more pieces, but the fewer joints the better. As before stated, joints give great facilities to bee enemies for depositing their ova, and these chinks and cran-ies are difficult places for the industrious bees to dislodge them from. The entrance is cut in the solid wood in V shape, as shown

in the diagram, or in crescent form, shown in the diagram by a dotted line. The first shape named being by far the easier method, especially for amateur carpenters. In marking out the entrance take either 16-inch end and draw a line $1\frac{1}{2}$ inch from each corner to a point 5 inches from the front of the bottom board. Run a saw-cut from the corner points to the centre one 3-8 inch deep. This will save a deal of after labour in chiselling away the superfluous wood. The legs, marked *E F*, should be about 16 inches long, 3 inches wide, and of sufficient substance to securely hold the

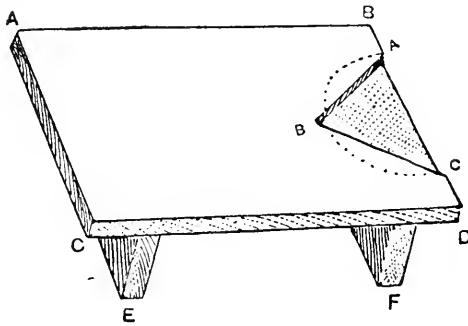

Bottom Board No. 1 for an 8-framed hive, *A B* or *C D* 2 feet, or $2\frac{1}{2}$ in. longer than the full width of the hive. *A B* or *B D* $14\frac{1}{2}$ in., or the full width of the hive. *E F* the legs, 16 in., or the length of the width of the board, and 3 in. wide. *A B C*, the points of the V entrance.

nails when fixed to the bottom board. These legs are for a two-fold purpose; they keep the hive well up off the ground, and also prevent the wood from warping. The underside being invariably damp, and the upper surface dry, the bottoms have a great tendency to twist. Four bricks will answer the same purpose for keeping the hives free from the ground, and have the advantage of preventing the ravages of the white ant. Nevertheless, it is always well to plant strong cleats on the underside of the bottom board. It is a preventive for the warping, and, of course, is absolutely necessary if the bottom is made from more than one piece of wood. The twisting may also be prevented by using grooved cleats. The V-shaped entrance has the advantage of providing for greater or lesser ingress or egress, as may be required according to climatic changes, by sliding the hive forth or back as may be found necessary.

The above diagram is another pattern, and is still more simple in its construction than that with the V-shaped entrance. The wood for its construction is of the same dimensions as that above described; but instead of the entrance being cut out from the solid wood, it is formed by cleats being fixed on three sides, as shown on diagram. The short cleats on the end should be the width of the thickness of the wood in the end of hive (7-8 inch), and of

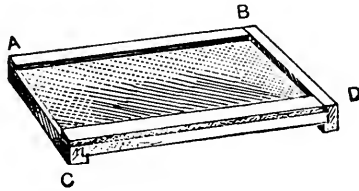

Bottom board No. 2 for an 8-frame hive. A B or C D 2 ft., or $2\frac{1}{2}$ in. longer than the full width of the hive. A C or B D $14\frac{1}{2}$ in., or the full width of the hive.

the same length. So also should the side cleats be the thickness of the side of the hive, and the same length less the width of the end cleats; that is, somewhere about 19 inches. The cleats must be fixed on the surface of the bottom board as shown, and should not be less than 3-8 inch, nor more than $\frac{1}{2}$ inch in thickness. It must be borne in mind that this last-named bottom board is designed for the hives in which the bottom-bar of the frame comes flush with the bottom of the brood chamber or super. The 3-8 inch thickness of the cleats forms the bee space, and is a substitute of the extra depth of the brood chamber, etc., thus permitting the brood chamber to be used as a full super or *vice versa*. This bottom board may be strengthened similarly to the former; or a grooved cleat may be used for that at the end; the grooved cleat aiding in strengthening the board, and doing duty as the end cleat shown in the diagram. To strengthen the forepart of the board a cleat about an inch wide and $\frac{3}{4}$ inch thick is nailed or screwed, the latter being the better method, on the front of the under side similarly placed on bricks for the purpose of keeping it off the ground. In no case should an entrance be made in the end or side of a hive. If such be done it will be found impossible to substitute the super for the brood-chamber, or interchange one for the other. Of course, it will be observed that the bee entrance of this last-named bottom board is the full width, and differs materially from the former or V-shaped entrance. Nevertheless it can be

contracted to any smaller width required, by means of triangular pieces of wood as shown in the Heddon Hive. Or it can be contracted by the means of two pieces of 1-inch thick wood cut in the form of a scalene triangle (three unequal sides), the longest side being half the length of the opening. If so required, the two entrance-blocks will completely close the entrance to the hive. The sides of these triangular blocks being of three different dimensions, offer any degree of contraction or expansion of the entrance to the hive, from that of full width to that of only sufficient for one bee to pass at a time. The longest sides of the entrance blocks being half the whole length of the entrance, the longest sides entirely close it when needed.

THE ALIGHTING BOARD.

THIS may be made separately and detached from the bottom-board, as shown below.

It will be seen that its position is in the front of the hive at the entrance. The inclined plane makes a splendid platform for weary bees to ascend to the hive. By means of these inclined plane alighting-boards the life of many a bee is saved, and many

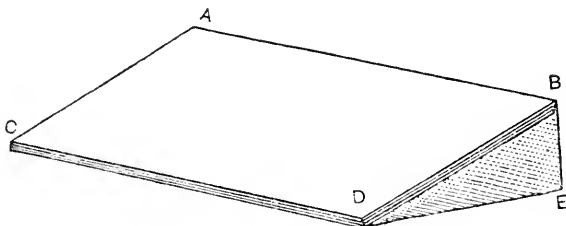

A B or C D, 16 in. ; A C or B D, 10 in. ; B E, 3 in.

a load of honey carried home that would have been otherwise lost. It should be made the length of the width of the hive, thus the platform would be 16 in. x 10 in. It should be so constructed that the upper edge of the alighting-board should come flush with the surface of bottom-board, the lower edge resting on the ground. If a detached alighting-board be used, the bottom-board need not be the full 24 inches.

COVERS OR ROOFS.

NOTHING is more injurious to bees than a leaky roof. I have seen where a drip has penetrated and run down the sealed brood, a space of from 1 to 2 inches of dead larvæ on both sides of the comb; thus causing the destruction of not less than 20 square inches of brood, or about 500 young bees just ready to emerge upon the active labours of life. Far better kill 500 of the old bees that have nearly accomplished the span of life than the developing brood. From the former nearly all the profit has been gathered in, whilst with the latter the whole has to come. A leaky cover is always an irritation to a bee-keeper. As a rule, it is only discovered after wet days when a promise is made to repair, but the day of reparation seldom comes, especially with careless or half-hearted bee-keepers. Nothing can be substituted for a well-made watertight cover. No part of the hive requires to be more carefully constructed. A leaky cover is an abomination alike to the bees and the bee-keeper. The flat top is the easiest to make. It should always be without crack or joint, and of a light, thoroughly-seasoned wood, and so constructed that it should lie evenly, and with as small interstices between it and the hive as possible. Being the most exposed part of the hive, it is liable to expansions and contractions by the frequent changes in the weather, and is more apt to warp than any other portion of the woodwork. Grooved cleats fore and aft are the best preventive to minimise this twisting. In the grooving of these end cleats there is a deal of work for an amateur carpenter; nevertheless, it will pay in the long run. Cleats, 1 inch wide by $\frac{1}{2}$ thick, nailed or screwed to the under side answer fairly well. A piece of wood, 22 inches long, and the full width of the hive, and 1 inch thick, is the thing required for a flat top roof. In the hotter parts of the State the thickness of the cover is an important consideration. The thicker it is, combined with lightness, the better, because it keeps out the heat, thus aiding greatly in keeping a lower temperature during the hotter months of the year, and a thick top is equally valuable in the colder districts, the temperature of the hive being kept more uniform.

Where economy in timber is a consideration, or where thick wood is difficult to procure, the hipped cottage gable-end roof makes a capital cover. In its construction care should be taken that the joint in the ridge is perfectly watertight. This may be accomplished by painting the roof, and, while the paint is still wet,

placing a strip of calico about 3 inches wide over the joint and well rubbing it down till it is evenly stuck to the woodwork by the paint, then again painting the upper surface of the calico. A strip of tin or zinc may be substituted for the calico. In that case no painting will be needed, only for the preservation of the wood, and if the whole hive were so treated it would look better and last longer. Care must be exercised not to split the woodwork in the nailing of the tin ridge-capping. A fall in the roof about 2½ inches and a 1-inch eave will be ample for all weather purposes. Gable-end roofs are great harbours for spiders.

THE QUILT.

PLACE a piece of American leather-cloth between the cover and the top of the frames, the leather side downwards in the summer months, and the cloth side downwards during winter. This leather quilt has many advantages. If it be a flat top cover the quilt prevents the bees glueing the top bar of the frames to the movable roof of the hive. In the case of a cottage roof it prevents the bees going up and building underneath it. In either case the cover is removed with more freedom and without jarring the hive, and thus irritating the bees. Taking the quilt by one corner and gradually peeling off, prevents the light suddenly flashing on the bees. It also subdues the anger of a bad-tempered colony. By the aid of a quilt a bee-keeper can manipulate his bees with far greater freedom and security.

FULL-SIZE BAR-FRAME.

THESE can now be purchased in the flat so cheaply that the home-made amateur article is only used by bee-keepers in the remote corners of the State, or by persons who have a deal of spare time on their hands. In previous pages I have objected to the use of self-spacing bar-frames, and the reasons are there given. Briefly, they are these: These frames can only be made by machinery or practical tradesmen. Of course, if they are purchased that is not a valid objection, but sometimes it is found to be absolutely necessary to space closer than the orthodox bee-space between the frame. Self-spacing bar-frames cannot be so manipulated. This objection is a valid one. Again, any small bit of soft wood can be run out for the construction of frames,

especially where the bee-keeper is so fortunate as to be in possession of a small treadle circular saw, or so clever as to make one out of the remains of a corn sheller and an old sewing-machine. I have seen a very serviceable circular saw so constructed. The following are the dimensions for a full-size standard Langstroth bar-frame :—

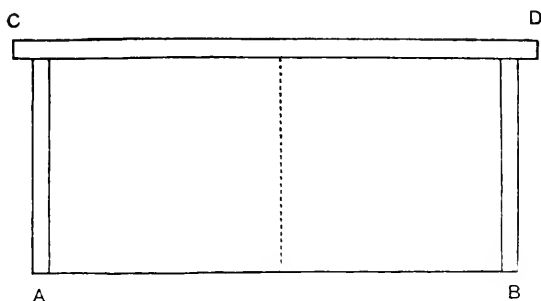

A B, out to out, 9 1-8 inches; C A, out to out, 9 inches. The top bar must be $19\frac{1}{8}$ inches, *i.e.*, out to out of C D, 17 5-8 inches; two bee-spaces, one on either side, $\frac{1}{4}$ inch, equals $\frac{1}{2}$ inch; plus the $\frac{1}{4}$ -inch rebate on each end of the hive equals 1 inch; total, 19 1-8 inches (17 5-8 plus $\frac{1}{4}$ plus $\frac{1}{4}$ plus $\frac{1}{2}$ plus $\frac{1}{2}$ equals 19 1-8 inches).

From these measurements it will be seen no note has been taken of inside measurements. These will be always regulated by the thickness of the bars. It is not imperative that any inside dimensions should be adhered to, but the outside measurements should be scrupulously followed.

The width of the top and side bars should be 7-8 inch, but the bottom bar not more than $\frac{1}{2}$ inch. In fact, the narrower it is the better, so long as there is substance sufficient for nailing purposes is all that is needed. A thin bottom bar has its advantages—bees, in building their comb from the top bar downwards, and no matter in what position the hive stands, will be sure to build their combs plumb. In completing their combs bees always leave bee-space between the base of it and the bottom of the hive. In the construction of comb the mid-wall—that portion of the comb forming the base of the two sets of cells—is the first constructed, and is always kept a little in advance of the construction of the side walls of the cells, giving the comb, as the building advances, the appearance of an axe-edge, being bevelled on both

sides towards the point. If the frames have been hung perfectly plumb, and it is imperative they should be, if only for ease and freedom in manipulation, the wax-working bees are constantly building towards the centre of the bottom bar. From the above it will be seen that the increment of the comb is always making addition to the fine edge of the mid-wall, and as the wax-workers come nearer to the bottom bar, the line of their vision being intercepted by it, they conceive it to be the floor of their home. They thus finish off their comb within the bee-space of the bottom bar. Now, if the bottom bar be narrow, and the narrower the better, the line of vision of the constructing bees is carried over the bar to the floor of the hive. The result is the incorporation of the narrow bottom bar with the comb, leaving bee-space between it and the floor of the hive, culminating in the comb being fixed to the whole of the sides of the frame. This strengthens the comb for extracting purposes, and minimises the trouble of the manipulation thereof. In thickness the side bars should not be less than $\frac{1}{2}$ inch, whilst the top bar should be $\frac{3}{4}$ inch to 1 inch. A thin top bar containing a heavy comb of honey is always liable more or less to sag. Another reason given for the thick top bar is, the queen is less liable to go up in the super and convert it into a brood chamber. The frame of the super, or the brood chamber, may be strengthened by means of a centre bar. It is not absolutely necessary to use a centre bar in brood frames, as in the ordinary honey seasons the little surplus honey in them should never be extracted. If a thick top bar be used, the shoulder should be reduced to the $\frac{1}{2}$ inch, or the rebate in the ends of the hive must be sunk deeply enough to accommodate the extra thickness of the top bar. It will be found much easier to reduce the shoulders of the frame than to form a deeper rebate in the ends of the hive.

CENTRE BAR

(Shown in the diagram by means of a dotted line).

The centre bar should be 3-8 inch square, and slightly longer than the side bars. It should be sprung into its position. It will require no other fixing. As the bees work they will inclose it in the comb, and the bar will be as firm, or firmer than if it had been fixed by nailing. This centre bar entirely supersedes the necessity for wiring, a consideration that should not be over-

looked. It is also much cheaper. Then the contrast in the saving of time between the inserting of the centre bar and wiring is greatly in favour of the former. "Time saved is money earned." For a centre bar nothing but the waste ends cut to length is needed. The wire of a frame, when the foundation is inserted, must be fixed with an embedder, or the bees will not work thereon. The many little tools or implements required in wiring are saved by this little simple perpendicular centre bar.

HALF-SIZE SUPERS OR SHALLOWS.

IN dimension these are exactly the same as the full-size frame, only the side bars are cut half the length—that is, $4\frac{1}{2}$ inches in depth from out to out. It will be noticed that is a 1-16 inch less than a true half. These shallows are now coming very much to the front. They have advantages over the full-size frames. When honey is coming in sparingly, the bees take to them more readily. The honey ripens in them quicker, and the cells are sooner capped. There is an advantage also, in the uncapping for extracting purposes.

THE FOLLOWER, OR DIVISION BOARD.

No hive is complete without a division board. It is a plain piece of board wrought in the form of a full-size frame—length $17\frac{3}{4}$ inches and 9 3-8 inches deep; in length and depth a little more than the frame. The shoulders in followers must be cut to the same gauge as the frames, so that the top of the follower shall be flush with the tops of the frames when they are in position in the hive. The uses of a follower are to prevent the bees scattering too far over the hive, or, in case of a small swarm, to confine them to one side of the hive so that they may build their comb more regularly. Bees should never have more room than they can occupy, without being too much overcrowded. With judicious management a follower is a great help in aiding the bees to fill up the frames with comb more systematically and regularly. It is also of great value in wintering, as by its aid the bees are kept more snugly, and there is not the loss of animal heat as is the case when bees are wintering in a full-sized hive which they cannot fairly well fill, and can roam over at their own sweet will

FRAME BLOCK.

ACCURACY in the external measurements of the bar-frames, independent of the name they bear or of the form or size of their make, is of utmost importance. Whatever may be the design of the hive selected, and the size of the frame adopted, *uniform external measurement* must be continually observed. To facilitate this, many methods have been tried, and many an invention put before bee-keepers all with more or less success, but none perfect. Some of them, perhaps the most, have been cumbersome to handle, and difficult to adjust. Amateur bee-keepers who make their own frames soon discarded them, and fell back on haphazard guesswork, resulting in the discovery that home-made bar-frames are always more or less awry, fail to hang plumb, and if there be a sufficiency of bee space between the top bars, there is too much between the bottom bars, or the bees will persistently build between the side bar and the hive. They try every remedy suggested, and finally come to the conclusion that to be a fairly good practical bee-keeper needs a well-fitted carpenter's shop, plenty of patience, and an apprenticeship to boot.

Now the following very simple contrivance will save an infinite amount of trouble, a deal of vexation of spirit, and amateur carpentering, and bee-keeping by means of its use will be voted an enjoyable and profitable pastime.

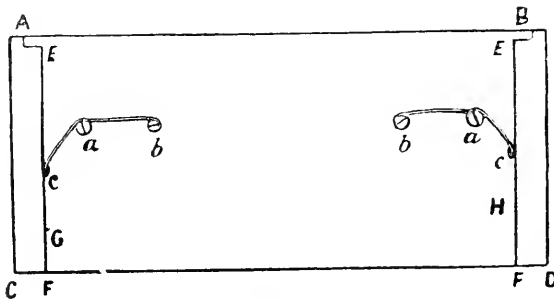

Fig. 1.

Of course, it is constructed of wood. Cedar or redwood is the best kind of timber, on account of its lightness. A piece of $\frac{3}{4}$ -inch stuff 22 in. x 9 in., and two pieces of inch stuff, 9 in. x 2 in. is all the wood that will be necessary. As this bar-frame block will

serve for all time, it should be made from well-seasoned timber, neatly dressed and firmly put together.

The following are the measurements:—A B from shoulder to shoulder in the end pieces, 19 1-8 inches, or the full length of a top bar. C D about 22 inches; A C and B D, 9 inches; E F $8\frac{1}{2}$ inches, or the full depth of the length of one side of a frame; G H, $17\frac{3}{4}$ inches, or the full length of the bottom bar of a frame. *a b* and *b a* are two spiral springs, as shown in diagram No. 2; *b b* the screws fixing the springs to the block; *c c*, the points of contact with the 9-inch side pieces, A C and B D. *a a*, two screws firmly screwed into the frame block, but projecting about 1 inch, around which the spiral spring is coiled in such a manner, so that the portions of the springs *a c* shall have full play and capable of extending to a sufficient width to receive the side bars of any frame. The shoulders at A E and B E must correspond exactly with the projecting shoulder of the frame, both in length and thickness.

This bar-frame block can be made as a duplicate by fixing two additional springs and two other side-pieces. Where a large number of frames are to be made, a double frame block is a great advantage in point of speed. With it a very large number of handlings are avoided.

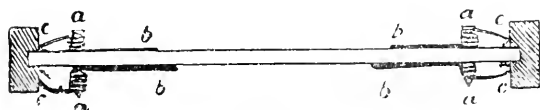

Fig. 2.

Diagram No. 2 is an end of a double bar-frame block—*c a b* and *b a c* are the two sets of spiral springs. The end pieces are shown grooved, and the back tongued into it. It is not necessary to fix the two ends by tongue and groove. Of course, it is both neater and stronger; it also prevents any tendency to warping. If the ends are put on in four lengths instead of two grooved pieces they should be securely fastened with screws. Care must be taken that the side-pieces are at right angles with the edges of the block. This block prevents all twisting in the frames, and the external measurements of frames will be the same without the least deviation.

In putting the frame together prepare the top, bottom, and

side bars, keeping them in three different heaps. It will not be necessary for the side-pieces to be of one uniform thickness. The springs will adjust themselves to any differences that may occur. Fix to the work-bench one or two bottom bars according to whether a single or double block is to be used. Place the bottom of the block so that the fixed bottom bars shall stand in the measurement G H. If it be a double block it will stand without holding. Over the one or two fixed bars, when the block is placed in position, insert the end-pieces for the frame so the springs will grip them firmly to the sides of the bar-frame block. Next, place the top bar in the shoulders A E and B E, shown in diagram No. 1. The side pieces should come flush to the point E. Nail the top bar to each end and three of the four sides will be firmly fixed, then invert the block for the insertion of the bottom bar, and fix it in the ends in like manner to that of the top.

This bar-frame block, besides being applied to the use named, is also a permanent gauge for all portions of bar-frames. In diagram No. 1, A B is the gauge for the top bar; G H that for the bottom bar: and E F, less the thickness of the bottom bar, is the gauge for the end-pieces.

It may be a difficult matter in country places to obtain or make the spiral springs referred to. In that case the main-spring of an old American clock will be found as serviceable as the spiral spring.

The clock spring must be curved, and have sufficient strength in it to keep the end-pieces firmly against sides of the bar-frame block. On more than one occasion when even the clock spring was not obtainable, I have substituted a piece of iron hoop which did remarkably well for the time being.



CHAPTER XXIV.

CONCRETE FLOORS.

THESE are a combination, forming at once both a hive-bottom and a hive-stand. Among bee-men, they have called forth a good deal of comment, oral and written. Some of these comments are adverse, and others complimentary. The objections are:—They are too expensive, too heavy, and too hot. Too expensive! A cask of cement costing 14s. in Sydney will make fifteen of them; that is as cheap as wood, nay cheaper, because they are everlasting. Too heavy! This will depend on the gumption of the maker; if he places the mould on the site where the hive is to stand he will have no occasion to remove it, and the weightiest object to handle will be the mould. Too hot! They were used at the Agricultural College all summer, and were not found so. If this objector had seen them in use, he would have said otherwise.

Their advantages: Being made on the surface of the ground there is no harbour for bee vermin, such as spiders, earwigs, etc. An eight-frame hive covers a superficial area of 280 inches, and that of the concrete floor about 700 inches; being considerably more than twice the area of a hive, it thus prevents weeds etc., overgrowing the hives, and gives free access for the bees at all times. They are fireproof. Of late many a hive of bees would have been saved if these concrete floors had been used; wooden ones soon take fire. They are much cleaner than wood; are not affected by conditions of weather, therefore they do not shrink, crack or warp. They never require painting, and will remain serviceable for generations, improving with age. Can this be said of wood? The bee entrance can be contracted to nil or expanded to $2\frac{1}{2}$ in. x 9 in., so that the bees can fly directly in among the combs if it be so desired. The entrance has a fall of $2\frac{1}{2}$ inches in 9 inches, so no rain can beat therein.

The diagrams are lettered from "A" to "E." "A" is the frame in which "B" was moulded. The bevel of it is 9 in. x 18 in. It gives a full width entrance to an eight-frame or a ten-frame hive, and the first concrete floors used at the Hawkesbury

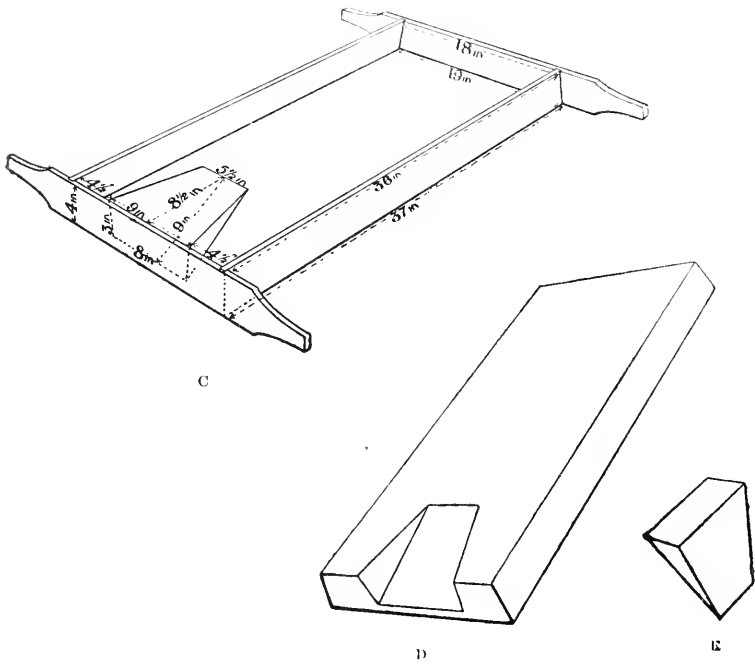
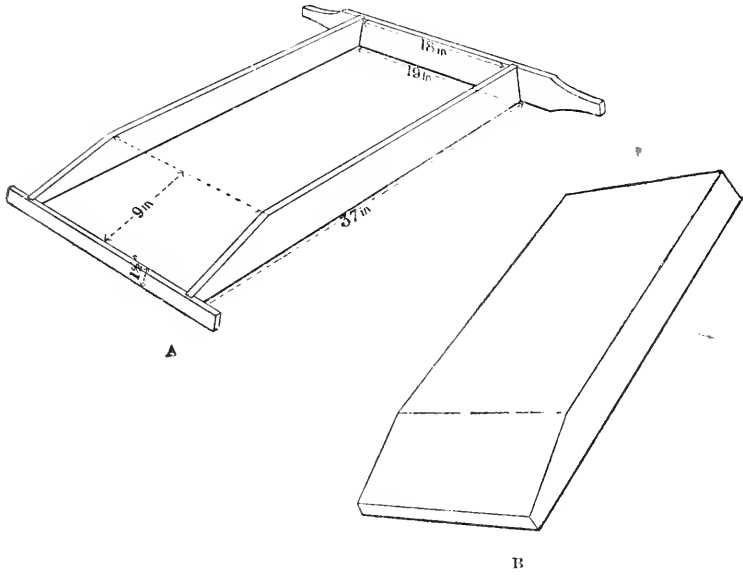

Agricultural College were of this type. "C" is the frame in which "D" was moulded. It will be noted that the difference between "B" and "D" is that the latter has a $4\frac{1}{2}$ inch shoulder on either side. This when the hive is brought fully forward, gives it a more solid foundation to stand on, and at the same time gives protection from cold currents of air sweeping underneath the hive. "E" is the tongue that forms the entrance.

In modelling these floors proceed thus: Select the site, place the moulding frame thereon, first ramming the soil firmly down; try the *frame* with a spirit level; when true, fill in about 1 inch in thickness the full *width* of the frame, and about 10 inches on the end where the shoulders of the floor are, with two of sand and one of cement. Insert the tongue, as shown in "C," then fill in the remaining portion of the frame with concrete, level with the top of the frame. Leave all to stand for twenty-four hours or more. Take out the tongue ("E"), lift the frame ("C") by the handles as shown. The block will appear very rough, but finish it off with a thin coating of a mixture of two of clean sand and one of cement. The more cement is used in this final coating the more impervious to damp will the block be. Put this final coating on with a trowel. When the whole block is coated, if it be rubbed over with a piece of old bagging made very wet, there will be a very good smooth surface.

The concrete can be formed with gravel, sand, and cement, one part of the latter to two of the former; or fill in the frame with broken bricks, stones, etc., and pour in the mixture of sand and cement until the frame is full, when the whole mass may be gently rammed together.

CHAPTER XXV.

THE HAWKESBURY AGRICULTURAL COLLEGE
APIARY.

WITH the object of increasing the facilities for practical instruction in agriculture at the Hawkesbury Agricultural College, the Minister for Agriculture decided some time ago, to have a new apiary laid out on an extended scale, and to equip it with everything calculated to be of educational interest not only to the college students, but visitors. I have had the privilege of superintending this work, and now take the opportunity of affording readers a very full account of what has already been accomplished in the arrangement and equipment of this important branch. The site chosen for the new apiary is about a hundred yards distant from the old one, and to the front of the old honey-house, which is being retained in its present position with sundry alterations. There were too many twists and turns from the old apiary to reach the extracting-room. By referring to the ground plan it will be seen the present apiary is directly in front of the last-mentioned room, and the footpath leading from the one to the other is direct.

In shape this new area is the same as the old one—oblong; but the area is greater, being 120 yards long by 80 yards wide. The site is a little too flat; but by artificial means the drainage can be made fairly effective. It is enclosed by a post and wire fence with a top rail. The site is laid out lawn-like, or, perhaps more correctly speaking, as a parterre, being interspersed with flower beds and flowering shrubs. All these have honey-bearing characteristics. Of course, all beekeepers know the uselessness of planting flowers solely for the honey they produce. Nevertheless, here and on other parts of the college grounds honey-producing plants are and will be planted for experimenting in their honey-yielding value. The apiary is intersected with a series of paths. These are 4 feet wide,



1. General View of New Apiary and Kiosk.

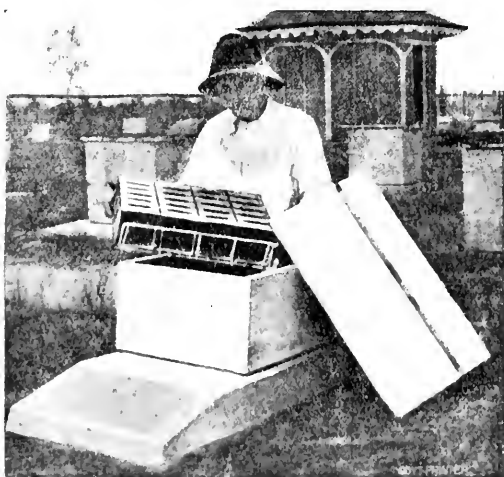

2. Hive and Section Cradle Filled.

and well gravelled, running parallel with sides of the enclosure, and others at right angles thereto.

Among the most useful and novel additions to this new apiary are the concrete floors for the hives; they are the author's improvement upon the old wooden floor. These serve a double purpose, being at one and the same time both stand and bottom-board for the hives. Those shown in the illustration are made from the mould A shown on page 152; those made from mould C are on the other side of the apiary, and do not come into focus; the measurements will also be found on page 152. The advantages of these concrete hive-stands will be at once apparent to every bee-keeper. Being slightly let into the ground, the sloping portion of the stands are on the same plane as the lawn; and the hive, when placed on the stand, is 3 in. higher. There is no wood in connection with the stand or hive bottom, therefore no decay. The stands are solid, having no interstices of any description, and being bedded in sand, there is no harbour for vermin. Being solid, and the superficial area greater than that of the hives, grass and other weeds cannot grow so close to the hives, and so interrupt the ingress or egress of the bees. They are cool and dry, and by moving the hives fore and aft they are easily washed and dried. To accommodate the hives to these stands, it is necessary to add a three-eighth inch depth to the brood-chamber, so as to permit bee-space beneath the frames; thus the brood-chamber is not interchangeable with the supers. By removing the hive towards and over the slope in the stand, any amount of space can be given for ventilating purposes.

The hives in the apiary are of almost every description that is, and has been, in use; the original Langstroth, the Langstroth Simplicity, the Long-Idea, the Heddon, the Berlepsch, the Observation, the Munday, the old straw skip, and even the old box or gin-case hive, are to be seen. But why so many types of hives? And why so many varieties of fowls in the poultry-yard? Simply, to use a vulgarism, "you pay your cash and take your choice." Every variety of poultry has its advocate, either as profitable or ornamental. So with the bee hives. But why go back so far as the old gin-cases; why not go back further to the cave days when bees were kept in clay pots? The main reason for the variety of hives is that in the country districts of this State apiculture is in a transitional state, especially so in the backblocks, and gin-case hives will serve as object lessons in transferring and demonstrating the advantages of modern methods.

The bar-frames are of all patterns. In some the thin top bar, bottom bar and sides of equal width (experience only will teach how to space), the full length, thick top bar, with self-spacing sides and narrow bottom bar, the short thick top bar with staple ends, are all in use. They are all educational, and answer many a student's and visitor's query of "Why?"

The sections, too, in like manner are very diversified; so also are the separators and the section holders or cradles. One section holder or cradle with its separators is unique, as it is only at the Hawkesbury Agricultural College, and at the author's home it is in use. It was exhibited at a Royal Agricultural Show, and called forth the usual amount of comments that are bestowed upon all improvements in bee-keeping or anything else. It is made of wire; two of the sides act with a spring and the sections therefore are self-adjusting. It is Fig. 3 in the illustration, shows 3 spring sides, which are not necessary. There are no thumb-screws, wedges, or other appliances used for keeping them firm in the super. The separators are made from queen-excluding zinc. When the cradle is fitted it is not made secure in the shallows as is usually the case. The burr-comb being removed from the frames of the brood-chamber, the wire cradle, with its contents, is placed thereon, as seen in the accompanying Fig. 2, the frame of the half-size super surrounds it, and the ordinary lid covers it. The two latter are easily removed, and when so removed, the cradle resting on the frames, by pressing open the spring side or end the full sections can be removed, and the empty ones replaced without the slightest trouble. The only drawback to these wire cradles coming into general use is, they are rather expensive; but then they are everlasting. These last remarks will also apply to the concrete hive-stands.

In the centre stands the kiosk. There is nothing new either in design or make, but there is in its use. It is an ornate structure, having a concrete floor. In the centre is an octagon table, and there is ample room for six or eight visitors to sit underneath the shade of its roof, which has an octagonal ceiling. From the centre of this ceiling there is suspended a mosquito net, sufficiently large to envelop the visitors seated around the table. The object is to protect the timid visitor from the too inquisitive bee. A bee flying to near a person unaccustomed to the hum gives rise to the fear that the bee so humming must be bent upon mischief, and accordingly a dive is made for the nearest protection. Some persons once stung remain timid for ever, and ima-

gine that they are the individual object of the hatred of all bees; hence we often hear it said, "I would not go near bees, they have a dislike to me," when the boot should be on the other foot—they have a dislike to the bees. Well, this kiosk and its fittings are for such ones. Underneath, and surrounded by this net, they can examine the marvellous sights to be met with in the domestic economy of the hive, and to my mind it is one of the most interesting—a hive of bees under the control and manipulation of man.

The sides of the kiosk are trellised. There are two openings in the walls, the one for ingress and egress, the other contains two Berlepsch hives. In these, visitors can be shown all that is most interesting in bee life, whilst close to the door are the Langstroth and other hives; the frames from these, containing the queen and brood in various stages of development, can be easily removed and carried within, where they can be examined freely by the most curious of visitors.

From the door of the kiosk to the honey-house is an asphalt path, 4 feet in width. The honey-house is fitted with all the most modern appliances used in the honey industry, and not the least conspicuous amongst them is a four-frame Cowan rapid reversible extractor. This latter has been fitted so as to be driven by treadle-power.

TO REMOVE BEES TO ANOTHER LOCALITY.

It was only the last week in December that the bees were removed from the old site. This was a valuable object lesson for the students engaged in the work. "Being so close won't the bees go back to the old stands?" was the question asked by more than one. On the morrow not 1 per cent. of the bees returned to the site of their old home, although it was in such close proximity. This is the way it was done. All things being in readiness, a moonlight night was selected. At the old apiary the entrance to each hive was closed by means of damp rags, and the hives were placed on hand-barrows and carried to the concrete stands in the new apiary; these were all in place beforehand; pieces of board, two or three bricks, bushes, in fact anything, was placed in front

of each hive; these, when the bees came out for their morning flight, caused them to study the new location, and at the same time to forget the old. A clean sweep had been made of their old homes. Every piece of loose wood, brick, bush, etc., had been removed. There was really nothing left to indicate that an apiary had ever stood there. Any one wishing to remove an apiary to a site near by, if they follow this plan need have no apprehension that the bees will return to the locality whence they came.

There are other additions and improvements contemplated, such as a small pond or fountain, in which floating plants of the duck-weed order are to be placed, where the bees can slake their thirst at pleasure. Such a provision is a great boon to bees. They are thirsty creatures, especially so during the dry warm seasons we have had of late. Every bee-keeper should place a tub or bucket of water in his apiary and if a few aquatic plants are put therein, those of a floating habit being placed amongst them, it will be found to be very advantageous for the bees. The water can be made ornamental by being placed in the centre of a rockery, and trailing plants grown around it.

The Hawkesbury College Apiary is a place worth visiting, and it will be more so when the seasons are better, and the flowering plants, shrubs, and hedges have had more time for establishment.

CHAPTER XXVI.

THE ADVANCE OF BEE LIFE UNDER DOMESTICATION.

THE strides bee-keeping has made of late years have been very great both in Europe and America, more so in the latter than in the former, and the financial result of the enterprise by modern methods has been more surprising than that of almost any other industry that was brought prominently to the fore at or about the same time, and that has marched side by side with it for the same period. The State of California leads in the proportion of honey, and the largest bee-farmers in the world are met with in the southern part of that State.

The amount of capital invested in the industry in Southern California is stated to be £90,000 exclusive of land. The people engaged in the work pay for labour annually £14,000, and circulate no less than £15,000 every year amongst the manufacturers of bee-keepers' supplies. The making of these must supply the means of living to a large number of families. In the same State there are nearly 5,000 bee-keepers, each one averaging 150 colonies, or 750,000 colonies in the Southern State alone. From this State 5,000 tons of extracted honey and a proportionate amount of comb honey was sold in 1896. The price for honey in America is much less than here. In California extracted honey is sold at £16 per ton, and comb honey at double that price. Therefore, the bee industry of the Southern State referred to must have put into circulation not far short of £200,000 that, prior to the inauguration of the bar-frame method of bee-keeping, was permitted to go to waste. Arizona and other places in the States rival the Californias in honey production. These figures were obtained from an article recently published in the *Los Angeles Journal*.

According to the last annual statistical number of the *Californian Fruit-grower* there are in the United States 110 apiarian societies, eight journals devoted exclusively to the bee and honey industry, and fifteen steam factories for the manufacture of hives and apiarian implements. There are 300,000

persons engaged in the culture of the bee, and according to the United States census report, they produced in 1869 14,703,815 lb. of honey, and in 1889, twenty years later, 53,894,168 lb. According to the eleventh census, the value of the honey and beeswax production of the United States at wholesale rates was about £1,458,333, and a conservative estimate of the present annual production is about £4,167,500. As supplementary to these figures, it may be stated that in addition to the fifteen steam-power factories, there is a very large number of smaller factories, using mainly hand and horse power, which are engaged in the production of supplies, such as hives, smokers, honey extractors, and other apparatus.

Bee-keepers in Southern California have as many as 600 or even 1,000 colonies of bees in a single apiary, and secure from 100 to 200 lb. of extracted honey per colony. One bee-keeper in Riverside county reported one year a crop of 10 tons of first quality of extracted honey and 3 tons of the finest comb honey, all from 154 colonies, which, during the season, increased to 196. A report reaches this office of one San Diego county man whose bees this season produced six carloads of honey. Not long ago a Ventura county man had the misfortune to lose 2 tons of honey, which ran down a canyon through an accident, and still had 50 tons remaining for sale. Statistics as to the Californian output of honey are not available, but the crop of 1897 is estimated variously at from 225 up to 400 carloads of 12 tons each, of which San Diego is expected to furnish sixty. California honey is known in nearly all markets.

Bee-keeping in this State has not kept pace in proportion with the population, as is the case in America, neither are we such honey consumers. The Americans are proverbially fond of sweets and our people do not appear to be educated in their tastes to consume a like proportion. Certainly all the honey produced in this State is consumed here, or nearly so, and occasionally we hear of a few tons being imported. In the country places of America nearly everyone is his own bee-keeper, the townspeople consuming the overplus.

In 1891 there were twelve competitors for the National Prize offered by the Government of New South Wales, and in 1892 the increase of competitors was but two. Since then the increase of bee-keepers has been gradually swelling, until this year the dealers in the bee-keepers' supplies have been unable to execute their orders, especially in the supply of foundation

comb; but this demand has been mainly by those who are engaged in the industry as an occupation, or bee-keepers in a large way.

There is no reason why bee-keeping should not be as general as that of poultry-keeping. In our cities, towns, suburbs, and rural districts, wherever there is convenience a few fowls are kept by all, if only for egg-production. Even in the city it is a common thing to see a small space set aside for a poultry-yard. The keeping of fowls in small enclosures is always more or less disagreeable, especially when too near to the dwelling-house. The care, attention, and expense necessary to success in egg-production is in no way a small matter and is generally, when on a small scale, a losing hobby, and if it were not that new-laid eggs of home production were a luxury that can only be depended upon when they are so obtained, few persons would take the trouble to keep fowls. Again, however ornamental, attractive and valuable the *fowls* may be, the enclosures in which they are kept can never boast of the two former conditions. With bees it is otherwise. They add a picturesqueness and a rural appearance to the surroundings of every home, and are adaptable to all grounds, whether they are large or small. The hives admit of any amount of ornamentation, and an observatory hive (*i.e.* one with glass sides), creates an amount of educational interest alike to young and old that it is not open to dispute. Whether kept on a large or small scale, the apiary itself, in addition to the hives, can be made ornate and profitable, and can be so constructed as to be a pleasurable resort, equal to that of the bush-house or garden arbour. Indeed there is no reason why one or more glass hives for the purpose of observation should not be placed in every bush-house. Of course, the idea is that bees will sting, but the hives can be so placed that the dangers from stinging can be entirely avoided, and with ordinary caution in the handling of the bees very little danger need be apprehended. If proper care be exercised in the preparation of the soil for the reception of grape vines, and the annual pruning be systematically followed, an enjoyable vintage as an additional table luxury in the form of grapes will be obtained beyond that given by the bees. If the site for the hives is to be a thing of beauty it will admit of a lavishing expenditure to any extent, enough to satisfy the tastes of the most wealthy. On the other hand, for an individual of frugal means,

the want of capital never stands in the way. Looking at bee-keeping as a hobby, it is not surrounded with the expense and trouble that most other pastimes that are engaged in are. There is no daily attention required, such as feeding, cleansing, etc. No attention from the owner is necessary, as is the case in poultry, during breeding season, and no particular mixture given at regular intervals to ensure the best results in the increase, which is always an important factor with all hobbies. With bees the first expense need be the only one.

It is an industry well adapted to the physically deformed and the weak, and the delicate of both sexes. It is an out-door occupation and, at the same time, an occupation that can only be indulged in during fine weather. It offers a fine field to ladies, of small means to augment their income, or at least, one that will be an addition to house-keeping. I one time met a lady who assured me that the earnings from her bees during the year exceeded those of her husband, who was in regular employment. Not long ago, the daughters of a household informed me that, after attending to their domestic duties, they attended to their bees when it was necessary, and in addition to using honey as a table luxury, they did all their fruit-preserving with it, while the sale of the surplus kept them in clothes. Bee-keeping is valuable where there is a family of children, if only to give them something to do, and to train them to habits of thrift. I before said people keep fowls for the sake of there being a certainty of having new-laid eggs for breakfast. It is equally wise in these days of extensive adulteration to procure all kinds of food in its purest form, and home-procured honey offers one food that can be easily and cheaply obtained in its native purity.

As an article of diet, especially where there is a family of growing children, it should be much more largely used than it is. It is both health-giving and invigorating. Its consumption in these States is behind most of the European nations. We do not appear to have acquired a taste for honey to any extent. The partiality of the Americans for sweet things is proverbial. There honey is placed upon the tables in the hotels and private houses as regularly as butter. The rural districts of United States is a land literally "flowing with milk and honey." We have done wonders during the last few years in making this State "flow with milk," and every possible effort has been made to secure for the butter industry, both for home consumption

and for export, world-wide repute. Why not do the same for honey? The honey crop of New South Wales should be as important as many others that are continually being trumpeted forth. In addition to the quotations I have given *re* the production of honey in California, the *Australian Farm and Home*, referring to the great strides honey-production has made during late years says: "The bee business is evidently destined to expand into one of the greatest of Californian industries, and is already rivalling the production of fruit as a source of profit."

California is constantly being held up to us as a model in fruit-culture, and the newspapers, etc., are constantly inviting us to "go and do likewise," but in the Australian States the value of the bee is little known or, at least, it is greatly underrated. There are those amongst orchardists and other tillers of the soil who still believe that they are a prolific source of scattering the germs of disease that fruit-trees are subject to throughout our fruit districts; nothing can be more fallacious.

As a fruit preservative honey is equal to sugar. In pound for pound it is more economical. In cookery it answers the same purpose as sugar, and, in some sweet dishes, it is even superior. Medicinally it formerly entered largely into various domestic compounds.

What is now required is to educate people in the many uses of honey and the keeping of bees, as universally as that of poultry.

CHAPTER XXVII.

APPLIANCES AND HOW TO USE THEM.

THE advent of the bar-frame system of bee-keeping necessitated the introduction of a number of other appliances, all more or less necessary for manipulation either to avoid the open warfare of the bees or to aid them in their labour, so as to adapt their work to man's better convenience or to obtain their produce with the least possible waste of bee-labour and bee-material. Apart from the poetic side of bee-keeping, there is undoubtedly a phase in it, whether it be indulged in as a hobby or as an industry, which sorely tests the patience of both men and women bee-keepers—not only their patience, but also their courage. Oft-times when the bees have asserted their supremacy and put their enemy to flight, they, the enemy, do not feel the retaliatory courage necessary to renew the attack. Many a one whose heart and soul has been in the idea of bee-keeping, whilst he has been watching veteran bee-keepers handling their bees as if they were so many flowers, has given up that idea when he attempted to do likewise because the bees resented the amateur's interference. Stings from bees are things that no one is desirous to indulge in.

The callous indifference of the practical bee-keeper, and the contempt he has for the little warriors, is all brought about by use—that is, by experience. We are told that we can get used to anything. Proverb hath it that the very eels get used to being skinned, so the practical bee-keepers get used to being stung, *i.e.* their systems become inoculated against the virulency of bee-poison, but in their apprenticing-days all necessary care had to be taken before they could laugh at the danger arising from the action of a bee's sting.

Protection is the starting-point towards the consummation of perfect success in the handling of bees. The first part of the body that a bee tries to attack is the most vulnerable—the eye. Why, I cannot tell you. Perhaps the brightness or the sheen of it, or perhaps the quick movements of the eye and eyelids may suggest to the bee a challenge. At the best of times it is not nice to be stung about the eye. Between the eyes is one of the most

painful points that can be assailed. I say one, because under the tip of the nose is another. I saw a gentleman stung on the last point named and he sneezed nine times in succession. He was a big man, too, and it nearly shook his head off. After he ceased to sneeze, his eyes ran water for about half an hour.

Now in the first place protect the face. A veil is the orthodox thing. Whether veils are necessary or unnecessary is a question for the bee manipulator to decide, and the decision can only be arrived at by experience. To me a veil is always a nuisance. It always more or less obstructs the vision, and as it is always best to look at your bees in the heat of the day a veil prevents the free circulation of the air, and you will feel something like suffocation. Always wear a veil "Bosh!" you say; "I saw in the *Gazette* Mr. Gale handling bees as freely as I can handle cabbage plants!" When you have had the experience that I have you will be able to do the same. Let your veil be large enough to come well down around you. Have a hat with a broad leaf or brim to it. A straw hat if it fits well is cool and comfortable. The veil must be made like a bag open at both ends with an elastic band around one, so that it will draw closely around the crown of the hat, and hang loosely over the brim. Put your veil on and tuck it under your braces, or your vest, or even your coat if you intend to protect the arms. When you have sufficient knowledge of the work, wear your veil thrown back over your head in readiness to cover up the face should occasion require it. American bee books give a list of about a half-dozen different kinds of bee veils; Capeharts', Coggsall's, Martin's, Mrs. Axtell's, Mrs. Harrison's, Mrs. Holm's, etc.; but a piece of silk tulle, mosquito net, or Brussel's net, about $1\frac{1}{4}$ yard long, and sufficiently wide to encircle the shoulders so they may have full play underneath is all that is needed. Whatever the material may be, in colour it should be black. If white be used a square of black should be inserted so as to be worn in front of the face, because black is more easily seen through than white.

One of the most convenient protections for the face is a veil sewn around the rim of a broad leaf hat, and the said hat to be kept in a handy place always ready for use. When the eyes only are to be protected, a pair of close fitting goggles with wire sides and clear glass vision are admirably suited for the purpose.

If the arms are to be protected by a coat, the cuff of it should be tied firmly around the wrist. Many bees will alight on the hand, and crawl up the arm if this be not done; not with the

intention of stinging, but finding themselves imprisoned will retaliate with the only weapon they have available. With experience even this protection will be found cumbersome and unnecessary. Bare arms and the shirt sleeves rolled up above the elbow, will be found a better security against stinging than the protection I have described. If a bee alights on the bare arm, let it alone; it has not gone there for the purpose of stinging, and driving it off may irritate it into action. If a bee intends to sting the only notice it gives is a little sharper tone than usual. If it has made up its mind to sting, it don't go fooling around before the final attack is made, it goes to business at once.

Then again, some people protect the hands; rubber gloves are sold for the purpose. "A cat in gloves never catches mice," so says an old saw. You cannot handle frames, etc., so freely as is necessary with gloves on. Rubber gloves always keep the hands very hot. Better than these bee gloves, and cheaper too, are woollen gloves, with a pair of cotton ones pulled over them and the gloves kept damp whilst you are manipulating. No bee will sting through them if so treated. The only material that appears to be impenetrable to the sting of a bee is rubber or leather, but then the latter must be thick. Kid will not do; they will sting through it. Of course, if the material be so thick that the sting cannot reach through it is right enough. The very first protection to be discarded should be gloves. I never wore a pair of bee gloves in my life, and in my early days came off pretty freely with the stings.

Now there is one portion of protection should not be overlooked. In a hive there are bees that have only just emerged from the cell as well as bald-headed veterans. When inspecting a hive and lifting out the frames there are bees on it of every age. Some of the older ones fly off and return to the hive; others cling to the comb under observation; some of the youngest bees try to imitate the actions of their older sisters to fly home, but suffering from infantile weakness, are unable to do so, and fall to the earth.

If too young to fly, they are not at all times too young to sting. These young bees when under a state of siege are very timid, and become much frightened. When they have fallen to the ground, their first impulse is to return to the hive as quickly as possible. To do so they ascend any elevation within reach, among the most available being the lower extremities of the operator. These disturbed bees will clamber and invade the anatomy of the human form divine, and finding all escape blocked, and

the nether garment pressing upon them, in their turn become besiegers, and apply their tiny bayonet to some purpose, and to the discomfort of the manipulator. There are many ways to check these unpleasant intrusions. Some put on a pair of bike pants; others tie the pants closely around the neck of the foot. When looking at your bees it is not always convenient to run and change your pants, nor is string always available. When a bee-keeper is manipulating he is always fairly well clad, especially on the lower extremities. He should always be adorned with at least boots, socks and pants. Therefore the most handy and convenient way to protect your shins from those little crawling bees is to pull your socks over the leg of your pants; you are then made invulnerable.

Now, what I have advocated so far is protection to be used by the "lords of creation," who are trying to become lords of the bees. But the masters of the lords of creation are as good bee-keepers as their lords, or, if not, many of them are as anxious to become so. Most of the protections I have named are as applicable to lady bee-keepers as they are to men. There are dresses made specially for ladies. I have never seen one worn, and, therefore, I cannot tell if they give sufficient protection. Amateur bee-keepers, both men and women, should be fully protected. But each article of protection should be discarded in turn. First learn to work with unprotected hands, next unprotected arms, followed by working with an unveiled face, that is with the veil thrown back over the head ready to be brought into requisition when required.

CHAPTER XXVIII.

CHARACTERISTIC SITES FOR AN APIARY.

THERE is no country in the world better adapted for bee-keeping than New South Wales, especially in the districts where the whole year through the warmth is sufficient for out-door bee life. Along our coastal districts, especially northwards from Sydney, the winters are better adapted for the bee-keeper than are the central and northerly countries of the old world. After the excessive heat of the summer is over, the remaining seasons of autumn and spring merge one into the other as to exclude almost any signs of Old Father Winter's appearance. And so away on the mountain slopes towards the Western Plains. Along the base of the Great Dividing Range, both towards the coastal districts and where they abut on the Great Plains, in some of our deep valleys running far into the mountains, and on the banks of our mountain rivers and creeks, are bee-farm sites adaptable to the requirements of the industry in every respect. On page 173 is an ideal picture of a bee-farm so realistic of Australian scenery that one or more of our settlers, and one or two of our bee-keepers, may be excused for claiming it as a photograph of their homestead, with bee-hives added, or as their bee-farm as it now stands. No site is better suited for an apiary than is there depicted.

Nestling at the foot of a mountain gorge; protected from the prevailing cold winds by surrounding hills, that are thickly clad with eucalypti, etc., which in seasons are dropping wealth that was lost till the bee-keeper went amongst them, stands the little peninsula taken possession of by the apiarist. The creek, as necessary an adjunct to a bee-farm as to a homestead, both for domestic purposes and also for the wants of the bees—for these, like other animals, always require to be more or less supplied with water—surrounds three-fourths of the tongue of land. Along its banks are alluvial patches, rich in plant-food, well suited for a garden for the cultivation of culinary vegetables. Fruit-trees can be dotted here and there, and patches for the cultivation of pumpkins and maize. The site on which the hives are arranged makes an excellent poultry run, being somewhat sandy, such soil being good alike both for poultry and bees. On such a penin-

sula there is always a sufficiency of natural herbage to supply green-stuff to keep fowls healthy. Poultry in no way interfere with bees, nor bees with poultry. I have heard of a case where a hen developed a taste for them. In such a case she could be converted into a dinner. I one time had a hen that was an excellent drone-trap. When the drones were on the wing she would stand by and obtain many a good meal, but when only workers were out the hen was never present. With such a site converted into a bee-farm, with two or three cows running in the bush for the supply of milk and butter, poultry for eggs and fresh meat, one or two pigs, to fatten with the overplus milk and the refuse from the garden and pumpkin patches, to supply the larder with hams and bacon, an industrious man could do well. The garden could supply a family with health-giving vegetables, and, being in close proximity to the creek, irrigation could be applied to it that would ensure a regular supply of them. The fruit-trees could be so planted that they would receive the benefit of the artificial watering. There would be sufficient surplus fruit to preserve for winter use, either by bottling or jam-making, that would last from fruit season to fruit season. Honey is equal to sugar as a preservative for fruit. A bee-farm with the adjuncts named, with Sydney as a market for the tons of honey that are to be obtained from our native honey-producing trees, and a local township where any overplus of butter, eggs, &c., could be disposed of for ready cash—what more need a family require? Moses' incentive to his flock was that he was leading them to "a land flowing with milk and honey."

There are hundreds of such sites in the districts named awaiting occupiers. There are also numberless individuals looking out to establish a place for a home. A young couple taking possession of one of these sites, starting as above in a small way, so that the adjuncts could be increased or added as requirements occurred, could easily make a comfortable and prosperous home.

Many a settler has already a similar site, occupied only by a few straggling sheep or cattle that are returning at most a precarious living to their owner. It may not be as perfect as the illustration referred to; but, if the hillsides are fairly well clothed with indigenous timber, there is no reason why an acre or so could not be fenced off that would be beneficial, as stated. There is no great outlay needed. One member of the family having ordinary energy and attention could be told off as superintendent. Such an addition would not take up the whole of anyone's time, and, at

the very least, it would supply home luxuries for the table, and thus save the storekeeper's bill.

Will it pay? Yes, if only for home consumption. Any site is more or less adaptable. At Tamworth, a gentleman engaged in business keeps bees on top of his house under a covered turret, and this supplies him with beautiful sections of honey. He is most liberal to his friends in supplying them with similar ones. At Maitland, Mr. Tipper, editor of the *Bee Bulletin*, for years kept bees on the open roof of his office, situated in the principal street, without inconvenience to anyone, and it paid.

In many of our country towns people living in the outskirts could keep bees far more than they do.

Flower-culture and gardening is taking a hold at last on the people living in the bush and away from the city, thanks to the agricultural committees that have added flower sections to their shows. Competition has produced emulation, and, to excel, bush and glass houses have been added to out-door gardens. In country agricultural shows the flower-stalls are among the most attractive sights; but the exhibits that attract the greatest concourse of spectators, apart from the jumping contests, are the apicultural. Those who are in the habit of attending these shows will remember that for some years past, both at Wellington and Muswellbrook, the difficulty has been to elbow your way through the crowd of interested sightseers in the pavilion where the honey and bee appliances are shown. Competition was so keen at a recent show held at Muswellbrook, that the judge was occupied two days in going through the list of exhibits catalogued. The agricultural committee at the last-named town practically let the pavilion committee have a free hand to give the bee section choice of place and almost unlimited space wherein to exhibit their produce.

Flower-culture and bees are hand-maidens. Whatever locality is adaptable for flower-culture is also suited for bees, and it is easy to combine the bush-house for useful and ornamental purposes, the bees adding profit to ornament.

For ladies, the hive placed within the bush-house gives an extra safety from stings. The hives should be placed so that the ferns and other decorations should not interfere with the working of the hive when the supers are placed in position. It is necessary in the construction of the hive that the alighting-board should be made sufficiently wide to protrude some inches beyond the walls of the house. An ordinary sized house could contain ten or twelve

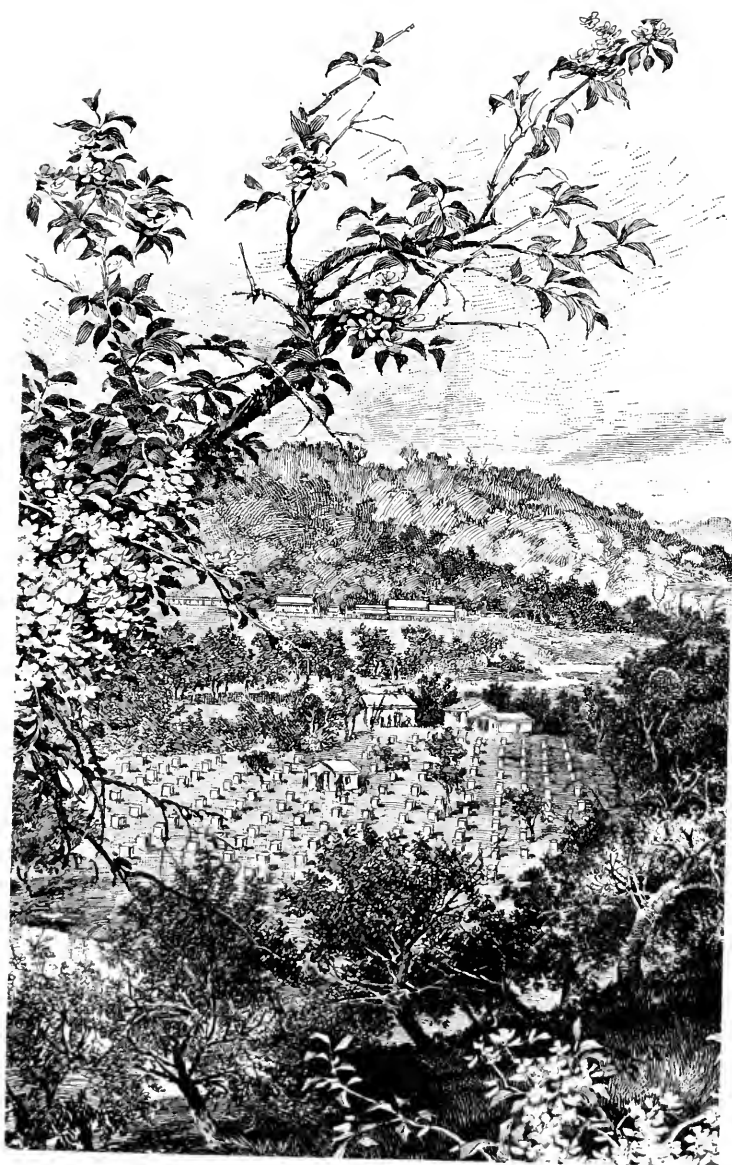

A Bee Farm.



hives. Both bees and bee-keeper are protected alike from the direct rays of the sun.

Gardens, both kitchen and flower, are always the better for a few bees kept therein, especially if fruit-trees are also grown in the former.

The only places that are not suited for bee-culture are extensive plains, and the vicinity of large areas of water. On large plains, because the blooming period of indigenous flowers is short and capricious, and the honey flow does not last so long as in hilly districts; where there are large areas of water, because aquatic flora is not worth mentioning, except in the shallows near the shore, which are well stocked with nymphias, &c. In the neighbourhood of broad rivers and lakes, bees going foraging can cross them readily; but, when returning laden, many hundreds fall victims to the length of the homeward flight, especially in windy weather, and are drowned.

The most important point is to select a site for bee-keeping, no matter if it be on a large or small scale, where there is plenty of native flora within the radius of at most two miles. The nearer these are to the bees the better. Close proximity to fruit orchards and lucerne paddocks is an advantage. The hive should be so placed as to secure the greatest protection from the prevailing cold winds.

CHAPTER XXIX.

HIVE ARRANGEMENTS.

Is it worth while to keep bees? is a question that can only be answered by local surroundings. And the number of hives of bees that can be conveniently kept in any district will depend somewhat on similar circumstances. If the bees are to be kept for experiment and observation only, then the study of locality is unnecessary, because bees can be kept and thrive anywhere if supplied with proper naturally collected food. A person entirely unacquainted with bee life and management, and living in a suitable locality, as before described, should go sparingly to work in the introduction of bees as regards the number of colonies he proposes to manage. It is much better to learn by practice than by theory.

Two neighbours whose gardens are contiguous may start in bee-keeping under precisely the same circumstances. In one case it will be a success and in the other a failure, because the one observes and is interested in his little venture, and the other fails because after putting his bees in position he lets them "take their chance." Nevertheless, failure is not always caused by want of interest. If the site chosen is undulating or falls away, and the low-lying ground is over-shadowed by tree foliage, causing the morning sun to be late in dispersing the dampness that is always more or less associated with shady positions, such a situation is by no means adapted to successful bee-culture. The spot occupied by the bees must be both dry and airy. The apiary protected on all sides from fierce winds by belts of trees is far preferable to an entirely open situation. Damp is undoubtedly one of the greatest of bee enemies. No hobby should be ridden to death, and bees are no exception to that rule. Unnecessary handling irritates bees and causes delay in the work of the hive. On the other hand, if the stocks are only handled when a harvest is anticipated the practice necessary to become a bee-master will be long delayed. The bee-keeper's judgment alone must be exercised in these matters.

The arrangement of the hives is important. They should be

arranged somewhat after the method of laying out an orchard on the quincunx plan, oblong or square according to circumstances. A hive at each corner and one in the centre is the most convenient arrangement. Of course, two of the hives that form the corners of one block will also form the corners of the second series of hives, and so on to the end.

From hive to hive should be about 6 feet, and from row to row 6 feet. These distances are not imperative, more or less can be allowed according to requirements or available space.

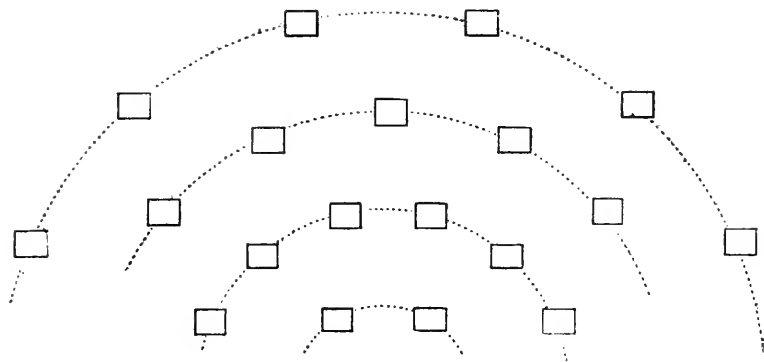

The necessity for such an arrangement is obvious. While operating or manipulating one row, the workman is in no way interfering with the ingress or egress of the bees at work in the

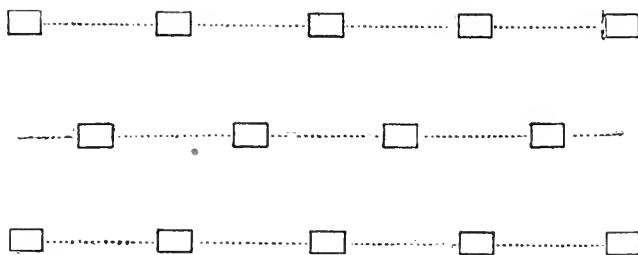

hives directly in front or those immediately in the rear. There are not many worse causes of annoyance to bees than an obstruction in their flight to the entrance of the hive. Bees generally take a *bee-line* from the foraging ground to the hive, and a person stand-

ing in that line of flight is always in danger of being stung. Next in importance to standing behind or at the side of a hive when handling the bees—the former place is preferable to the latter—is that of not standing in the direct line to the entrance to the adjoining hives.

It is not necessary at all times to arrange the hives in straight rows. If the position chosen has a slight incline, with an easterly aspect, it gives a very pretty effect if they are arranged semi-circularly or somewhat in the shape of a crescent. In so doing it is unnecessary to observe the quincunical placing of the hives.

The arrangement of the hives as stated in the foregoing has a double advantage; it gives the bee-keeper a better opportunity of noting the hive requiring attention, and breaks the monotony that is always apparent when the hives are placed in straight lines with the entrance of the one in a direct line with the back of the one opposite. Where all the hives are in the same straight line and of the same colour it is embarrassing to a young queen, when returning from her wedding flight; but the quincunical at once secures a greater variety of surroundings to act as guide-posts for the returning bees.

BUSH-HOUSE APIARY.

An ordinary bush-house can readily be fitted up as an apiary, as shown in the illustration. Some years ago I had such a bush-house erected close to the dwelling. It contained fourteen Langstroth hives. These were about two feet from the ground. Under the hives there grew many varieties of maiden-hair ferns. Other plants suitable for bush-house culture were scattered here and there throughout. In the centre there was a large octagonal table and fixed seats capable of seating sixteen guests. The walls and roof were composed of tea-tree. As an adjunct to the dwelling it formed a grand resort during summer time. When the table and seats were not in use for domestic purposes they formed stands for suitable foliage plants. To visitors it was an endless source of interest, especially when honey was required for the table, and a hive in the house opened, one or more sections taken out, the bees brushed off, and the honey put on the table without the slightest annoyance from the bees. Many timid ladies became courageous and expressed strong desires to look into the hidden mysteries of the bee-home.

It is not essential that the bush-house apiary should be octagonal. Its shape and design should be in keeping with sur-



A Bush-house Apiary.

roundings. The object to be gained is that which will produce the most ornate effect, both with regard to internal fittings and the external parterre.

In practice, I found that the alighting board, if the hives are raised sufficiently above the surface to admit of the cultivation of ferns, &c., underneath, should protrude about 3 inches beyond the wall of tea-tree; but if the plants are grown alternately with the hives, it is better to place the latter a little above the surface of the floor, and openings in the walls made to admit of the full front of the hive as shown in the accompanying sketch. If necessary, the whole of the walls of the house can be utilised for bee-keeping, the centre for pot-culture, hanging baskets for ferns suspended from the rafters, &c. If the space available be circumscribed, and it be found necessary to tier the hives, then the Langstroth hive will be found unsuitable for the purpose. These are always manipulated from the top, and there must be a sufficient headroom allowed for the purpose. Where time and space are of no object, the Berlepsch hive will be found most convenient for tiering. These are worked from the back, and therefore offer greater facilities for stacking. In the commencement the idea of tiering must be taken into consideration and provision made for Berlepsch hives. The stand for the first row should be at the least 2 feet 6 inches from the floor, otherwise it will be found difficult to replace the frames with ease.

In gardens, ornamental or otherwise, in addition to the bush-house for bees, hives may be dotted here and there in out-of-way places that will give a picturesque appearance to the garden site. In placing hives in irregular and out-of-the-way places note the bushes or trees are not so close as to impede the working of the hive, and at the same time see that there is sufficient head room for the manipulator. There are few things more troublesome than having your veil pulled off your head when in the act of examining a frame.

CHAPTER XXX.

THE EVOLUTION OF THE BEE HIVE.

HAVING already described rather lengthily the best localities and the most suitable surroundings for bee-farms in New South Wales, also the situations, the positions, and the arrangements most adaptable for bee-culture both for profit and pleasure, here, it is my intention to write about their habitat, and the rise, development, and progress of their artificial homes.

The domestication of the bee became a thing of necessity, as being one of the sources from which man was to obtain a food supply at once nutritious, healthful, and palatable. The transition of the bee from a state of nature to the care of man is but a grade, and that an easy and simple one. They seem to have been designed more for domestic life than for a wild one. Their social habits, their swarming instinct, the mildness of their temper when leaving the parent stock and whilst on the wing, or clustering, and the ease with which a cluster of bees can be transferred from where they alight to an artificial home, at once stamps them as an ally for a food-supplying force that could not be overlooked.

Their indigenous home appears to have been in Palestine from whence they spread the "wide world o'er." All varieties of social bees have a strongly migratory instinct, and this is greatly assisted by the ease with which they can be transported to places far and near. The only barriers that are placed in their way to a natural distribution over the whole earth are extensive areas of water and expansive treeless plains. They are enabled to live in any climate where there is warmth sufficient for members of the vegetable kingdom to flower and produce honey and pollen. Their natural habitat are trees and rocks wherever they can find cavities sufficiently large for lodgment, the storing of food, and the reproduction of their species. These natural homes are chosen with every regard for health, perfect ventilation, and freedom from drip or other dampness. If, after they have chosen a home, they discover that the rain trickles through, as soon as it is dry they at once set to work to repair the oversight. Quantities of propolis are brought into requisition, and the leak is permanently and effectually stopped. I once, on the banks of the Murrumbidgee, found a

swarm of bees that had taken possession of a small cleft in some rocks, my attention being drawn to them by seeing some clustering on a narrow fissure. On closer inspection I found them at work in stopping the crack. The material used was a resinous matter, obtained from the small cones of some trees near by, and sand thickly intermixed therewith. Some weeks after I revisited the place and found the composition as firmly set as Portland cement. It is said the bees of the Holy Land frequently settle on the face of a rock and construct with mud a dome-like covering around themselves. Here they make their home. The material used is, undoubtedly, the composition I have referred to. The honey seen "dripping from the rock" is from bee-nests so constructed, when such are built where they receive the full force of the noon-day sun which acts upon the resinous wall-material and the delicate virgin comb within.

From the bee-made constructions named to the clayey sun-dried tubular vessels in use to-day by the barbarous or semi-barbarous tribes of Asia and parts of Africa, is but one degree in the transition from the natural to artificial bee dwellings. These artificial drain-pipe hives for the convenience of handling and *robbing* were the first steps in the evolution of the hives we now see. The hollow spout of a tree taken possession of by the bees, broken off and removed nearer to man's dwelling in like manner was the prototype of our wood-constructed bar-frame hives of to-day. In the outlying districts of this State, and in the early days around Sydney, I have frequently seen hollow logs sawn off, pieces of board nailed on either end, with a knot-hole doing duty for an entrance, used for beehives. A knot or swelling of calabash form has been pressed into service for the same use. These semi-natural constructions were the hives used by the first bee-keepers who started the *industry* of bee-farming. How many centuries lapsed before the rude contrivances named were brought into service we don't know. It was some time between the days of the prophets and the Christian era. About the year A.D. 30, a distinction was made in honey that was got from nature's hives and those artificially constructed. In those early times there was "wild honey," however, obtained from natural sources, and from the term "wild" being then in use, there must have been honey to which some other adjectives were employed, perhaps, "garden," or as our American cousins would say, "tame" honey.

The method, or the hives in use when honey was designated by qualifying terms have not been handed down to us. Kitto, in

his "Natural History of the Holy Land," says that "In many parts of that country bees are still numerous, and are reared (kept) with great success." Hasselquist describes the inhabitants of Sepphoris as "breeding a great number of bees to their considerable advantage, and with very little trouble. They make their beehives of clay, 4 feet long and half a foot in diameter, as in Egypt. Ten or twelve of these are placed on the bare ground without anything under them. They are covered with a roof which gives them the appearance of dog kennels. In those in which the bees are at work the opening is closed up, leaving only small apertures through which the bees may pass in and out." The people of these countries are as primitive to-day as they were 2,000 years ago. These clay hives are only a modification of those described by other writers as built by bees with clay against the face of rocks, and must be regarded as one of the very first steps to the hive of the present day. Naturally, wood would be considered superior to sun-dried clay. In China, hollow logs and boxes are still in use for bee-keeping. The boxes have no alighting board. Instead thereof numerous half-inch holes are made in the sides of the boxes to imitate knot-holes, &c. Straw and wooden hives of these primitive patterns, with the addition of an alighting-board, must have remained without further development for centuries. The clay tubes, the straw skips, and the box hive were only an improvement upon the home found by the bees at their own sweet will. They were superior in that they were close at home and the honey could be obtained without searching in the wilds. From all these artificial bee-homes the honey was obtained exactly by the same methods as by the felling of trees or the bursting of rocks. The bees had to be driven from their comb or smothered by sulphur fumes. In either case the destruction of the brood comb (young brood are always the most important part of the inhabitants of a bee community) was inevitable. For the humanitarian part of bee-keeping nothing was done. It did not appear to enter into their calculations that the destruction of the bees was killing the hen that laid the golden egg.

EARLY WRITERS ON THE NATURAL HISTORY OF BEES.

THE natural history of the bee had engaged the attention of scientists from before the days of Pliny and Aristotle down to to-day. England has given us Dr. John Hunter and Dr. Bevan; Switzerland, Bonnet; Holland, Von Swammerdam; France, Reau-

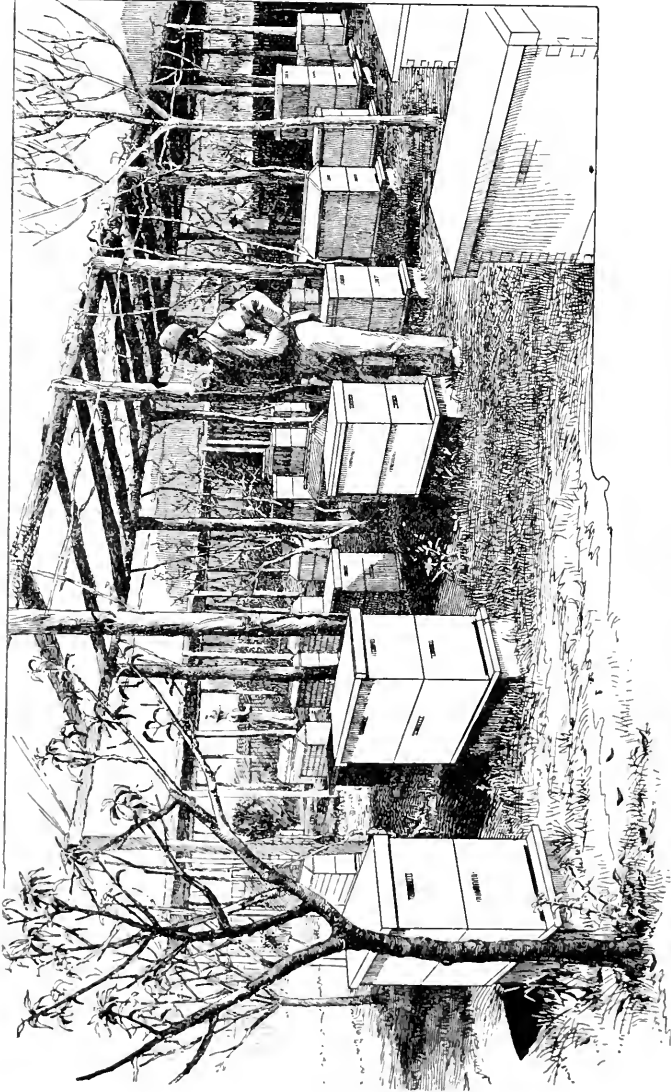

Arrangement of Apiary for Summer Shelter.

mur; Sweden, Linnæus; but the question of the study of bee-life for the purpose of a food supply by the development of hives that could be handled and attended to as other domestic animals did not commence till the latter part of the 18th century or the beginning of the 19th. Thomas Nutt was one of the first Englishmen to condemn the brutal custom of the destruction of the bees for the purpose of securing the honey. The introduction of supernumerary reciprocals to box and skips for the purpose of storing of surplus honey, *i.e.*, honey over and above that required for the bees' winter use, was a step towards a much higher development. Under the old system of bee-keeping the loss entailed upon the bees by the destruction of comb was not understood.

The bar-frame, as we now have it, was not the invention of any one person. The nuclei were narrow bars that rested on rebates on two sides of the hive. To these the bees attached their combs and fixed it to the sides of the hive. Both sides of these combs had to be cut away before they could be removed. There appears to be no record of the person who introduced these movable slots. The very slight advantage obtained by their use never made them general. The knowledge of this slight improvement remained without further development for fully a century, when Francois Huber (Huber the elder) invented his renowned book hive, a hive that worked the same as a book is opened or closed. This invention was not for the purpose of aiding in the saving of bee life, or an increase in the honey supply, but for observation and scientific research. Yet Huber's invention and the one bar or slot already referred to were the parents of the complete frame we now have. Langstroth was well acquainted with both of these improvements. At the time he, in America, was thinking out and perfecting the ideal hive that is now in almost universal use, with practical bee men, Dzierzon, in Germany, was engaged in a similar research. The latter was trying to improve upon the one bar system, where all combs had to be more or less cut away. The main difference in these hives while the two men were engaged in perfecting similar thoughts was Langstroth's hive worked from the top and Dzierzon's from the back. Langstroth's hive, in the earliest stages of its development, was far more workable than Dzierzon's. In the former any comb could be removed singly; whereas in the latter to get at any particular comb all those intervening between the worker and the required comb had to be removed—thus if the tenth frame was required nine others had to be removed, and suspended before the one wanted could be obtained.

After Langstroth had patented his hive, whereby everyone possessing his patent rights were excluded, "Ministers of the Gospel excepted," Baron Von Berlepsch invented frames of a similar character. This was an improvement upon Dzierzon's complete hive, but it did not do away with the inconvenience of removing nine frames to get at the tenth. Still, both these men have their disciples, but the Berlepsch hive is fast falling into disuse.

Since these hives of various complication have been placed before the public, all claiming to have more or less greater advantages over those already referred to, which, perhaps, goes to show that we have not, as yet, arrived at human perfection as it regards bee-keeping, I suppose no industry in so short a period has produced such a host of improvers. "Amateur bee-keepers are great inventors."

BEEES WORKING IN THE OPEN.

The illustration shows a swarm of bees hard at work in the bush on which they alighted. They were discovered in June, 1894, near Sutherland, working on a geebung-bush (*Persoonia linearis*) about 3 feet from the ground, by Messrs. Bloxham Brothers, of Peel and Cheshire Creek Apiaries. It is very rare that bees prefer to work in the open with no other protection than that offered by foliage and twigs. In the Northern District I found a swarm working on the underside of the ledge of an overhanging rock. Although the combs were clearly visible from some distance they were well protected from rain and sunshine. Another I was shown in a hollow log. It was fully exposed to view. The combs were narrow, and the longest about 20 inches in depth. The swarm working on the rock had been there at least two winters. The winter climate of the Clarence is more genial than that of Sutherland. Whether these could have so wintered it is hard to say. I one time saw a swarm in the Goulburn district that had taken possession of the thickest part of a sweet-briar bush. It was late in autumn, and the stores they possessed would not have carried them nearly through the winter months of that bleak district. I have more than once seen bees build underneath gincase hives for want of room above. In one instance in the cold district of Queanbeyan. But, as the cold increased and the stores in the upper part of the hive were used up, the stores underneath were carried above.

The accompanying illustration is the most perfect and visible

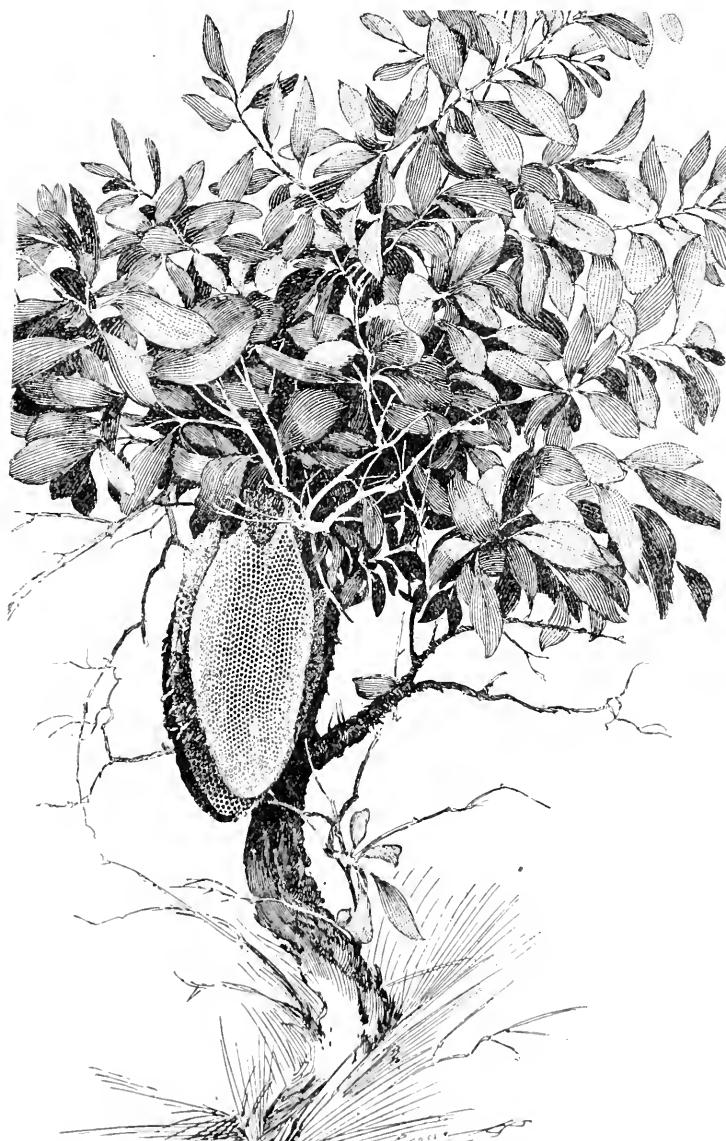

Colony of Bees on Geebung Plant.

I have ever seen or heard of, and the discoverers did wisely in securing a photograph of it.

Bees at work in the open, as there shown, must have been the first step in the direction of the bar-frame hive of to-day. In bee-nests so built the combs are attached to sticks. In some cases these sticks are horizontal, or nearly so, as before shown.

A bee-keeper of keen observation and a little in advance of his brethren finding a comb so constructed, *i.e.*, in the open, and removing it for the sake of its honey, or perhaps to secure the bees, and finding the combs built on parallel sticks could not be otherwise than struck with the convenience of so constructing a hive when removing the bees home on the sticks whereunto the combs were attached, if only for exhibition purposes. Under such circumstances, what great amount of thought would be needed to place them in a box and so work them. The arrangement of other straight sticks would be only a sequence of the first discovery.

The bar-frame, as I have already said, was not the invention of any one person. It has developed stage by stage. The first idea, as I have already pointed out, was revealed to man by Nature. Finding that bees in a state of nature always built their combs parallel, and having discovered honey combs built on sticks, the idea of a top bar would naturally suggest itself. The selection of the straightest sticks for trial purposes was as natural as the removal of the combs found on sticks in a state of nature and carried to an artificial bee home. Finding that these straight sticks arranged parallel on the top of a box, were utilised by the bees for the purpose of fixing their combs thereto, and that the honey could be more readily obtained than when the bees worked in boxes according to their own will—what would be more natural than to follow up this first idea? It is much more simple to obtain straight sticks or slots artificially than to find them in a state of nature. These slots were another step towards perfection, followed by their resting on rebates or grooves, so that the whole, with the bees, could be enclosed as within a box. There was an advantage in this. The bees attached their combs to these slots, but the combs were fixed to the sides of the hive, and both sides had to be cut away before the combs could be removed. There appears to be no record of the person who first removed the combs built on sticks in the open or of the individual who introduced these movable slots. The very slight advantage obtained by their use never became general, and the reason is not intricate to discover. To arrange sticks or slots so true and parallel as is neces-

sary with the frames, so that the bees shall confine themselves to the top bar must have been, nay indeed was, the greatest problem to be solved. If, in the first attempts in the use of slots the bees worked from them in parallel succession, it must have been more by chance than design. We know that the slight improvement obtained by these slots or top bars remained without further development for fully a century. And no wonder, for where one swarm of bees would attach their combs to parallel bars without wax guides of some kind or other, and continue them parallel with the sides of the boxes—a hundred swarms would build at right angles to the bars or diagonally to the box.

Spacing.—So the further development of improvements in beehives, in the direction of the removal of the combs without their entire destruction, remained until the days of Huber. Was it anything to marvel at that it should be otherwise? Yet, with all the advantages we have obtained from the thoughts and experiments of others, we find many beginners in bee-keeping stopping short at the difficulties they find in overcoming the first principles of success, *i.e.*, the knowledge in the correct spacing of the bar-frames, the necessity for the whole of them to be placed parallel to each other, at the same time perpendicularly true, and the securely fixing of the starters or foundation comb. They give up bee-keeping in disgust, and vote it a hobby or an industry that can be successful with but few and a certain failure with the many. But such reasoning is not correct. Patience and observation are the only ingredients necessary for success to cover the difficulties the bee-keepers of last century had to stumble against.

Correct spacing was one of the first and greatest difficulties to be overcome. In a state of nature, brood combs are built 1 3-16 inch from midrib to midrib, or centre to centre. In comb built for storage, it is frequently otherwise, and unless the slots were so placed the bees would build despite them. If eight slots only were so placed in the hive and evenly spaced, and there was room for nine combs, or if there were nine slats used where there was only room for eight combs, the bees would attend to their own spacing irrespective of the bee-keeper's ignorance. This is actually one of the great difficulties of the beginner of to-day, *i.e.*, arranging for the exact bee space between the frames and getting them all parallel to the sides of the hive.

In the early times when slats were in use it was not known that bees always build their combs according to certain guides. The first bee amongst the wax-workers that is ready with her pellet

of plastic wax attaches it to the roof, or something corresponding thereto. No studied direction is chosen. It is fixed haphazard; and whatever direction is taken by the bee for the first comb is the line on which all the other brood combs are constructed parallel with it. Frequently when a swarm takes possession of a new home, natural or artificial, where no bar frames are provided, two or even more wax-workers will start at different points, and all other combs started on either side of these will follow the direction of the one they are nearest to, although at a different angle to others that have been already started, until they gradually approach. Then they are curved and ultimately connected, still maintaining the parallel. This accounts for the bent combs frequently met with when transferring from the gin-case hive to a bar-frame one.

BAR-FRAMES.

The rise and progress of the bee-hive as we now see it having already been dealt with, it is here proposed to treat with the various styles of frames and hives that have been the outgrowth of the keen observation of thinking men. After the first successful steps were taken, difficulties presented themselves and had to be overcome. The form the frames should take, the size most convenient to manipulate, and the number of frames the hives should contain, were some of the problems to be solved. Not only was the convenience of the beekeeper to be considered—he could vary his wants according to circumstances; but would all shapes and sizes be acceptable to the little workers themselves? These were things to be taken into serious consideration when beekeeping was first entered upon, with the idea of obtaining the greatest profit with the least labour, and the smallest amount of suffering from the defensive weapon of the bees themselves. The shape and size of the hives is of paramount importance. Notwithstanding that bees in a state of nature adapt themselves to circumstances, and vary their work according to the home chosen, in an artificial state the requirements are different. In choosing a natural home, bees do not always appear to act with marked judgment, as the queer places selected by them and already referred to proves; but wherever they work, the fixing of the comb securely is always one of the chief considerations of the bees. If the home only admits of securing the comb by the upper edge, then, as a rule, it is built longer than it is deep, and the heaviest part of it (that containing the honey) is close to the attachment. Each comb

tapers off at the edges, wedge shape. The size of the comb depends on the size of the cavity chosen. The brood comb is generally in the centre of the nest, and if the comb is large, it is generally found in the centre of it. If it be the spout of a tree, where it is liable to oscillate, brace combs are built in the bee space between each comb, and the centre of the comb is always better braced than are the sides. Where the combs are long and pendulous they are, of course, more liable to vibrate with the oscillation. Owing to their fragile nature, virgin combs, under such circumstances, would be liable to fracture; and where they cannot be properly and firmly fixed at the sides, and where the superficial area of the combs is great, these brace combs are used in greater numbers. When combs are built where they are not likely to be shaken, few, if any, brace combs are used. From this it will be noted that the shape of combs requires some bee-thought to protect them from injury under different circumstances. In the construction of the hive, and with it the frame, these points must be considered. If the frames are too large every way, the bees will attach the comb only to the top bar; where narrow and deep, they will seldom build down to the bottom bar.

Now, the more insecurely the comb is fastened to the sides of the frame the more liable it is to accident. No matter how great an adept the manipulator may be in technically handling them, the shape of the frame and its attachment have a good deal to do with success.

These matters—*i.e.*, the suitability of the design of the frame for manipulative purposes—have given rise to the many designs or forms of hives brought before the public, each one claiming to have some special advantage to aid in the work of beekeeping. From the very beginning difficulties presented themselves. The cause of these had to be discovered and remedies devised. It is evident the problem as to the proper depth of the frame is still unsettled. The Heddon frame is one of the latest introduced. It has a depth of only $4\frac{1}{4}$ inches and in width is $17\frac{3}{8}$ inches—an area of nearly 74 square inches internal measurements. Of course, in the construction of a frame the outside measurements are the ones that must be adhered to, so that any variations in the thickness of the timber used shall not interfere with the internal measurements of the hives. In the dimensions of a *hive* they are calculated from internal measurements—the opposite to that of the frame. The shallow frames, now so frequently found in use in the supers of the Langstroth hive are internally about $4\frac{1}{8}$ inches x $16\frac{3}{8}$ inches,

the superficial measurement being about 12 inches less than that of the Heddon, that is, about 62 inches.

These shallow frames that are used in the supers of the Langstroth are becoming more and more general every season, and for the reason it is not far to look. The internal heat of a hive has much to do with its success. Roofs that are leaky and sides that are cracked, so as to admit cold draughts of air to circulate within, are always detrimental to early brood development. In the early days of a coming honey flow, bees take more readily to shallow frames than to those of deeper construction. The reason is, the artificial starters are near the young brood. The more compactly both the brood and the workers engaged in comb-building and storage are, the more is the heat generated. It is estimated that from 70° to 80° of heat are necessary for the secretion of wax. Heat ascends; therefore the shallower the space the greater are the conditions for the secretion of wax and the development of brood. These are two important points in successful bee-keeping.

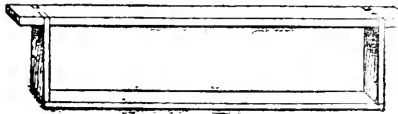

Shallow Frame.

Again, one of the early difficulties with all frames, no matter under what name or what the shape may have been, was that of inducing the bees to attach the comb firmly to all four sides. The more securely the comb within the frame is, the more is the danger of breakage minimised. To overcome this difficulty starters of foundation comb have been used on the bottom bar similar to those on the top one to induce the bees to continue the comb there. Full sheets of foundation are also used towards the same end. Of course the primary use of full sheets of foundation is the saving of labour with the bees. The only alteration that the bottom bar has undergone is that of from the full width to narrow. Bee space, or a little more, must be left between the bottom bar of the frame and the bottom board of the hive. Where the wide bar is used it intercepts the vision of the comb-building bees, for it is directly in a line between the fine edge of the comb in course of construction and the bottom board. In a state of nature there is always bee space beneath every finished comb. The wide bottom bar to the

vision of the bees is virtually the bottom of the hive. The narrower, therefore, this bar is the less is the vision of the comb-building bees obstructed. Shallow frames with narrow bottom bars are great aids in obtaining this consideration—that is in securing all sides of the comb to the sides of the frame. Securing the brood-comb to the bottom bar is not so essential as in the frames used in the supers, the amount as well as the method of handling the frames used in these two portions of the hive differ greatly.

The ends, too, have undergone various modifications with the view of obtaining the greatest amount of ease in working and aiding the bees in their labours, and at the same time giving them man's ideas of what bee comforts and ease should be. At one time we had what was termed Quinby's close-end frames. These were similar to the Heddon frames that are now struggling into use, but differed in measurement. The Heddon ends are $5\frac{3}{4}$ inches long, and full width throughout. The Quinby differs from it only in being nearly double the length (11 inches.) The latter rested on the bottom boards, leaving bee-space beneath the bottom bar, and, like the former, fitted closely to the sides of the hive. The supposed advantage of the close-ends is correct spacing throughout the entire depth of the frame. Oftentimes if frames are not put together correctly they twist, and although they may be correct at the top, they are many degrees out of plumb at the sides. In this manner, although the bars may be properly spaced, the bottom bars frequently touch. Under such conditions bees unite the combs, thus greatly obstructing the free removal of the frames. One of the uses of the closed ends was to mitigate this, but unless the hive stood perfectly level it would fail in that one object.

The Quinby oblong hive differs from the modern Langstroth only in length, being $7\frac{1}{2}$ in. shorter but 2 in. deeper—that is, nearly 48 in. less in superficial measurement. Its depth is the principal objection.

The Adair is another frame of the Langstroth type. In length it is $13\frac{3}{4}$ in., and $11\frac{1}{2}$ in. deep, or superficially about 48 in. less than the Langstroth—the same as between the latter and the Quinby, and, of course, on account of its depth has the same objection.

The Gallup and the American are identical in shape, both square, the latter being 12 in. by 12 in., and the former $11\frac{1}{4}$ in. by $11\frac{1}{4}$ in. What the advantage is in the difference of $\frac{3}{4}$ in. every way is hard to guess.

There is another frame, similar in form to these two latter,

named the Munday. It has a full-width top bar. It has a few advocates in the Hunter River district, where it first saw light.

One of the most queerly-formed frames is Abbott's Standard. The internal measurement of the top bar is $16\frac{1}{2}$ in., the bottom one 15 in., and each side 10 in. long. As will be seen from the diagram, the angles at the top are acute, and those at the base obtuse. It, like many of the others, is now obsolete. However, in all my travels amongst the beekeepers of New South Wales, I never saw one in use. One of the advantages claimed for it was that of causing the bees to attach their comb more securely to the ends.

The British Association standard frame was brought out by the British Beekeepers' Association in 1886. A Mr. Lee is said to have been the inventor. The advantages claimed for it were the simplicity in affixing foundation comb; antipropolising metal ends; the metal ends were also self-spacing. The top bar is two longitudinal pieces of equal size. The foundation was placed between these and secured by clamping the pieces together by means of metal ends. It never came much to the fore. It is too complicated for one thing, and too expensive for ordinary pockets, especially where bee-keeping was carried on in a large way.

The frames of the Combination Hive or the Long Idea differ in nothing from the Langstroth, and will be described under "Hives."

The Langstroth, or Langstroth Simplicity, is the frame that is in universal use in every part of the bee-keeping world. It is $17\frac{5}{8}$ in. by $9\frac{1}{2}$ in., and has a superficial area of 167 square inches. It is made in two forms; the broad, as shown, and the shallow. The former is now always used in the brood chamber. Since it first left its inventor's hands it has undergone several slight modifications. The top bar has been made thicker. The thick top bar has several advantages. In the first place, the queen is not so likely to pass over it into the supers for laying purposes, and it gives additional strength to that part of the frame that has to bear the greatest strain. Improvements have also been made to it for the purpose of facilitating the fastening of the foundation comb; these have been eminently successful. The ends have been so made that when brought close up they give correct bee-space. They may be useful for amateurs, but in the hands of practical men who understand the various requirements under different conditions, there is no advantage gained with them.

BAR-FRAMES IN PARTS.

There was a time when it was as essential for a bee-keeper to be an amateur carpenter as an apiarist; but the construction of hives and frames by machinery has brought them within the reach of all. The very school children, with their pocket and pin-money, can now become the owners of as good, and in many cases better, beehives than their seniors had to work with a few years ago. Not a



decade since there were in use some of the most crudely constructed hives and other bee appliances that we can possibly conceive of. When the National Prizes were in distribution I met with some that were as unworkable as they were grotesque, and the workmanship would cause an outburst of laughter among the members of any of the carpentry classes of our public schools. Not a right-angle in either hive or frame, and the joints were only such in name. Some of the bee-keepers with these crude and most primitive appliances expected to score heavily in the competition. Nevertheless, some of them actually obtained good results, but to do so was a work of love.

But this summary of hives would not be complete without a detailed description of the various parts of both hive and frames. Notwithstanding the accuracy in measurement and uniformity in pattern of the various parts of the bee-home that are constructed from machine-made goods. in some of our distant country districts it is essential that patterns and measurements should be within easy reach when required. Such details will also greatly aid in putting together the various portions when the hives, &c., are bought in the flat.

The diagrams of the various patterns of frames that are and have been in use, and also their measurements, are given.

THE ORIGINAL LANGSTROTH FRAME.

The most simple frame in its construction was the original "Langstroth." "In 1851," says Professor Cook, "Mr. Langstroth

gave a hive to the world that left the hands of the great master in so perfect a form that even the details remain unchanged by many of our first bee-keepers. And up to date the Langstroth frame has undergone no alteration either in form or measurement." The material for its construction should be American red-wood, or any other wood of a light character, well seasoned, and free from knots. These two latter are of importance. If the wood is not properly seasoned, it is very liable to warp or twist and thus throw everything out of plumb. A knot in a thin top or side bar very frequently causes the destruction of a comb by breakage at the knot-hole.

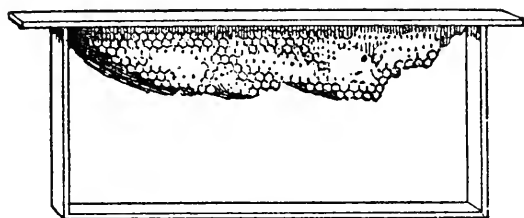

New Comb.

Measurements of a Langstroth Frame.—The wood in all the Langstroth bars was originally of uniform thickness, $\frac{1}{4}$ -inch, and also a uniform width, $\frac{7}{8}$ -inch, *i.e.*, inch stuff was used which, after dressing, reduced it to the required width. Top bar, $19\frac{1}{8}$ inches; each end bar, 9 in.; and the bottom bar, $17\frac{5}{8}$ inches. All these measurements are from out to out, and this will be followed in regard to all other pattern frames, except when otherwise stated. It is almost impossible to put these frames together to the required accuracy excepting with the aid of a frame-block or other gauge.

After the ends are nailed securely to the top bar, there must be a shoulder of $\frac{3}{4}$ inch. This gives bee-space between the side of the hive and the end bar of the frame, and $\frac{1}{2}$ an inch to rest on the rebate in the end of the hive.

Of late years all the original Langstroth bars have undergone modifications. What was said to have "left the hands of the great master in so perfect a form" does not hold good to-day as regards certain details. The top bar has increased in thickness. The thin top bars, especially when used in the supers, were very liable to sag by reason of the weight of the honey. I have known the same result to take place in the frames of the brood-chambers; in this way too much space is left between the top bar of the one

frame and the bottom of the one above it. The bees take advantage of this by building therein, much to the inconvenience of the manipulator. This sagging is prevented by the use of the thick top bar. The top bar is generally $\frac{5}{8}$ inch. I have seen them used a full inch but this is unnecessary. Of course, when the thick top is used, a shoulder must be cut in it on either end one inch long, leaving $\frac{1}{4}$ inch of wood to form it ($\frac{1}{4}$ inch for the thickness of the end piece, $\frac{1}{4}$ inch for bee-space, and $\frac{1}{2}$ inch to rest on the rebate).

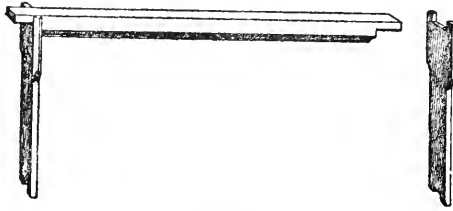

Thick Top,

The thick top bar as now used is vastly superior to that of the Allwood, its superiority being in the tongue for the attachment of the foundation, starters being worked on the bar itself instead of being an independent or a detached tongue. Not only is it a great saving in labour, but the foundation has a greater security, the ends being cut so that the angles, being perfectly square, have the advantage of all the right-angles of the complete frame being sufficiently perfect for all practical purposes. Thus the frame, when in use, hangs plumb, that is if the hive itself rests perfectly level.

The Hoffman ends are self-spacing. They are always preferred by amateurs. One of the greatest difficulties with beginners is correct spacing. They are generally more or less timid in handling bees, and in their hurry to get away from the supposed danger the quilt is placed over before all the frames have been properly adjusted. I have frequently seen, after re-opening a hive that has been closed without due care, the frames in all sorts of angles, and no two of them collateral. Then, again, if the top bars vary in width which is often the case with home-made frames, the discrepancies are seldom taken into consideration. Correct, parallel spacing should be a maxim indelibly fixed on the minds of every bee-keeper. The absence of these precautions causes more annoyance than all other careless acts put together.

Again, it will be noticed that both ends of the Hoffman side-

bars are so cut as to ensure all the angles of the complete frame being correct. The bottom bar dovetails with the side bar, and the thick top also dovetails into the shouldered ends. With these adjuncts connected with each portion of the frame, it forms its own frame-block, and if the frame, when put together, fails to be true, and each frame is a counterpart of the other, the fault lies in the connecting of the pieces. The plain end-bars, or those that have the dovetails on one end only, are far more liable to go awry than the self-spacing or shouldered ends.

The original Allwood top-bar frame was made with metal ends, and the bottom bars secured by means of metal angles. They are still in use with a few. The object of them was twofold; greater ease in fixing the foundation starters and to prevent the gluing with propolis the ends to the rebates in the hive by the bees. A groove in the top bar runs from end to end; there is also a corresponding short groove in each of the side bars. After the frame is put together, a thin strip of wood (tongue) is fitted into the groove; secured in its position by the short grooves in the end pieces to this tongue the foundation is affixed. The foundation can be fixed more readily, and at the same time more securely with a foundation fastener than with molten wax. One of its weak points is the detached tongue, and the loss of time in fixing it in the groove. Another drawback to it is the detached metal end pieces. These can never be so fixed as to carry a frame full of honey. When the frame is full, the ends always more or less give way at the point of juncture. More than once I have seen them do so when lifting out a frame for extracting purposes. The metal corner pieces for fixing the bottom bar to that of the side have no advantage above the old-fashioned nails. The advantage sought to be obtained by the use of these metal ends I have already referred to is antipropolising. These metal ends resting on the fine edge of the metal rebate very materially militates the trouble, and sometimes even the difficulty of removing. Where frames are permitted to remain in the rebate until the bee glue becomes hardened force has to be used to detach them, and they come away with a jerk, which is always annoying to bees. The work of collecting propolis, and its use in any part of the hive, is an unnecessary labour for the bees, and should never be entailed upon them. There is no profit in it either for the bees or their master, and when so engaged, they are neglecting a work that is far more profitable.

The narrow bottom bar, and the reason for its use, has been

called attention to. The narrower it is made consistent with strength, the more readily will the bees attach the comb thereto.

The latest antipropolis invention comes to us from America. Of course, it has not had time as yet to be put into use here. A. J. Root, who brought it out, and has tested it, speaks with the greatest confidence for the merits claimed for it, and, from the diagrams forwarded with the description, very justly so. It has come into my hands since I commenced this part of my subject. It is well known that bees have an aversion to work on metals of any kind; hence the metal rebate and the Allwood metal ends. I have shown wherein the latter failed. This latest cannot be charged with such a weakness. The shoulder of the top bar is reduced in (bee-space) on either end for the purpose of preventing its coming into contact with the woodwork of the hive. After the frame is put together, a staple is driven through the end bar and into the thick top, one on either end, as shown in the diagram. In putting the frame into position the staple comes flush against the elevated portion of the metal rebate, metal against metal, thus the only wood that can be glued

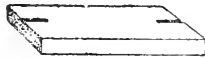

Gauge.

is where the top of the frame rests on the knife edge of the tin rabbet. The staple is driven home within $\frac{1}{4}$ in. A wood gauge, as shown, is used to prevent the staple being driven otherwise than correct, a device that I adopted very successfully when using the Berlepsch frame. These latter frames when put into the hive at the back, were pressed into position, and, to secure the proper space between the frames, flat-headed nails were used. To secure a uniform protruding length, I always used such a gauge.

Notwithstanding Prof. Cook's statement that the bar frame left the hand of its inventor "in so perfect a form," etc., it does not appear as yet, after upwards of forty years being in use, to be past improvement.

Ready-made bar-frames are obtainable from dealers in bee goods very cheaply. They should be purchased in the flat.

LANGSTROTH'S HIVE.

Langstroth, in thinking out the *pros* and *cons* of his valuable system of bee-keeping, appears to have well weighed the various details of the advantages or difficulties that bee-keepers of the future would be most likely to meet with. Judging from what he then wrote it would seem that the *pros* would largely out-balance the *cons*. In studying what both mankind and beekind would require, he has given upwards of sixty necessary requisites that, in his opinion, go to make up a complete hive—a hive that shall be a protection against all climatic changes, and both workable and profitable—*i.e.*, profitable as in labour-saving for the bees and honey production for the bee-keeper.

Out of the sixty odd points he enumerates as the requisites of a complete hive, experience has taught us that the whole of them have not worked as the great bee-master had anticipated. In the majority of his points he is undoubtedly right, and experience has taught that many are wrong, or need to be greatly modified. Let us look at the various points in the order he has given them. He says:—

1. A complete hive should give the apiarian such perfect control of all the combs that they may be easily taken out without cutting them or enraging the bees.

The Langstroth hive of to-day can be so worked by the merest amateur, and with ordinary care with the more docile bees, frequently few, if any, will rise on the wing with that well known sharp note indicative of rage.

2. It should permit all necessary operations to be performed without hurting or killing a single bee.

In removing and replacing frames when examining bees, more are killed by carelessness than in any other way. Hives that are constructed so that the frames come flush with the top of the hive, and where flat covers are used, are one of the causes of the destruction of bees, and another is in placing the quilt over while the top bar is covered with bees. With the bellows drive all the bees below before covering them up.

3. It should afford suitable protection against extremes of heat and cold, sudden changes of temperature, and the injurious effects of dampness.

The hive must be protected from rain, so that there should be no internal moisture. It should be so placed as to admit every ray of the winter's sun. But during the great heat of summer there must be perfect ventilation. For these the hive should be so constructed as to permit a good supply of fresh cool air in summer, and at the same time exclude the chilly winds of winter.

4. It should permit every desirable operation to be performed without exciting the bees.

In point 1 he has said the same thing in other words.

5. Not one unnecessary motion should be required of a single bee.

That will mainly depend upon the bees themselves. Some bees are far more docile than others. To obtain this perfection care and experience must be exercised in selecting breeding stocks. "The motion" of bees also depends on the season; if large supplies of honey are coming in, bees are more tractable than when on the verge of starvation.

6. It should afford suitable facilities for inspecting the conditions of the bees at all times.

Hives as now made afford every opportunity for inspection if proper care is exercised in their construction, and care taken in placing them in position; but bees should not be examined at all times—not during the winter season, or during damp rainy weather, nor when a high wind is blowing.

7. It should be capable of being readily adjusted to either the wants of large or small colonies.

Bees should never have more frames to work on than they can occupy. They should be kept in compact quarters by means of the "dummy" or division board.

8. It should allow the combs to be removed without any jarring.

All jarring and jerking can be avoided by using hives and frames so constructed that the bees will find that *bee glue* is a waste of labour.

9. It should allow every good piece of comb to be given to the bees instead of melting it into wax.

There is no greater waste of profit than the destruction of combs. With care they should last for years, especially in supers. With the modern honey extractors, little or no comb need be broken or destroyed. Brood comb, when too old, should be replaced with comb from the supers, care being taken to observe that it is free from drone cells.

10. It should induce bees to build regular combs.

The bee-keeper is responsible for this. If the advice that I have constantly given on this point be followed, bees will build their combs as true as a railroad track.

11. It should furnish empty comb, to induce bees to occupy more readily the surplus honey receptacles.

Means to furnish empty combs should always be available; but the greatest inducement to bees to occupy surplus honey space is a strong colony, and a good honey flow.

12. It should prevent over-production of drones by permitting the removal of drone-comb from the hive.

One of the best methods of preventing the over-production of drone-comb is whole sheets of artificial comb and young queens. Drone-comb should be permitted in the supers. Bees appear to prefer drone cells for storage purposes. They are more readily constructed, and it is a saving of material; but in the brood chamber a very limited number should be permitted, excepting where a drone-breeding queen is kept for stock purposes.

13. It should enable the apiarian, if too many drones have been raised, to trap and destroy them before they have largely consumed the honey of the hive.

To check the over-production, as mentioned above, comb foundation is a great auxiliary; but by systematically destroying all queens over two years of age, drones will be greatly minimised. To re-queen every hive every season is undoubtedly the best way. This does not refer to queens that are kept as drone breeders for stock purposes.

14. It should enable the apiarian to remove all such comb as are too old. (See remarks on Point 9.)

15. It ought to furnish all needed security against the bee moth.

Strong colonies, Italian bees, and a good honey flow constitute the best security against the bee-moth.

16. It should furnish to the apiarian some accessible place, where the larvæ of the moth, when fully grown, may wind themselves in their cocoons.

This is encouraging the breeding of vermin so as to have the pleasure of destroying them. Prevention is always better than cure. The preventive measures are indicated above.

17. It should enable the apiarian, by removing the combs, to destroy the worms if they get the advantage of the bees.

The worms are the weeds of a bee-hive, and as the weeds in a garden show want of care on the part of the gardener, so worms show the want of care on the part of the apiarian. If by removing the combs, the worms can be destroyed, why have some accessible place, where the larvæ of the bee moth, when fully grown, may wind themselves in their cocoons.

18. The bottom board should be permanently attached to the hive for convenience in moving it and to prevent the depredations of moths and worms.

Experience has taught that a removable bottom-board is far better than a fixed one. The dirtiest part of a hive is the bottom-board, especially in spring time, after a winter's semi-hibernation. It is an easier matter to lift the hives with the bees, remove the bottom-board, and replace it with a clean one than it would be to transfer the bees to another hive. Another thing, the brood is not so likely to be chilled as removing frames to another hive. If the bee-moth should gain the crevices between the hive and movable bottom-board as Langstroth points out, they are much more easily dislodged than when they take possession of the crevices in a fixture.

See my concrete floors on page 152. The concrete floor has all the advantages necessary in 19 and 20.

19. The bottom-board should slant towards the entrance to facilitate the carrying out of the dead bees and other useless substances; to aid a colony in protecting itself against robbers; to carry off moisture, and to prevent rain beating into the hive.

The slight inclination towards the entrance, necessary to keep the rain from driving in would be no aid to the bees in carry-

ing out the dead. One of the best ways to aid a colony to protect itself against robbers is to contract the hive entrance. Moisture in the hive is chiefly caused by condensation. Hives are liable to it in the winter, the cold air on the outside of the hive coming in contact with the warm within. An American leather quilt placed between the top of the frames and the lid of the hive, with the woolly side down in winter, is the best cure. If the frames run fore and aft as in the "Simplicity," the hive may be tilted a trifle forward. This will in no way interfere with the frames lying plumb.

20. The bottom-board should admit of being easily cleansed, in cold weather, of dead bees.

In cold weather, how is the bottom-board to be cleaned without the removal of the bees if it be a fixture? But with a movable one it is easily done.

21. No part of the interior of a hive should be below the level of the exit.

The entrance is most convenient when cut in the solid bottom-board V-shape, having a fall outwards. This will do away with all the trouble Langstroth refers to in connection with the bottom-board.

22. It should afford facilities for feeding bees, both in warm and cold weather.

Honey should never be taken from bees to the extent that they need feeding. Of course there are seasons when there is little or no honey flow. No hive has facilities for feeding of bees better than the Langstroth bar-frame.

23. It should permit the easy hiving of a swarm without injuring any bees or risking the destruction of the queen.

The Langstroth hive, with ordinary care, is so workable that no bees need be injured in hiving.

24. It should admit of safe transportation of the bees to any distance.

An article on the transportation of bees is given elsewhere.

25. It should furnish bees with air when the entrance, from any cause, must be entirely shut.

This can always be done, where there is a movable bottom-board, by lifting the hive, and supporting it with a small nail or other rest.

26. It should furnish facilities for enlarging, contracting, and (or) closing the entrance, to protect the bees against robbers and the bee-moth; and when the entrance is altered, the bees ought not, as in most hives, lose valuable time in searching for it.

Some modern hives are made with a full width entrance; it is contracted by means of two slats, one on either side, and are moved towards the centre, thus the bees never fail in finding it. Where the V entrance is used, the entrance is extended or contracted by moving the hive forward or backward as required, the bottom-board being made sufficiently long to admit it. For this purpose the concrete is admirably adapted.

27. It should give the requisite ventilation without enlarging the entrance so much as to expose the bees to moths and robbers.

Experience teaches that moths, with practical men, are things of the past; and that the best means of ventilation is by means of a wide entrance, providing there is an escape for the heated air near the top. Hot air rises, and the vacuum caused thereby is filled by the cold air taking its place by rushing in at the entrance.

28. It should furnish facilities for admitting at once a large body of air, that the bees may be tempted to fly out and discharge their fæces on warm days in winter or early spring.

Here again experience has taught that a small entrance is best for winter. Warm days will be sure to tempt the bees out for the purpose named. At other times their fæces are discharged on the bottom-board, and in this the movable bottom shows its superiority over fixed one, as it can readily be cleaned any warm day, even in the winter. On warm days in winter, by

lifting the hive from a concrete floor it can be washed, and all traces of fæces removed.

29. It should enable the apiarian to remove the excess of bee-bread from old stock.

Bees always prefer new pollen to old, and if there is new coming in plentifully, it is as well to remove a judicious portion of the old. Nevertheless, "Don't discard the old love till you have safely secured the new one."

30. It should enable the apiarian to remove the combs, brood, and stores (also the bees) from a common to an improved hive so that the bees may be easily able to attach them again to their natural position. A colony transferred to my (Langstroth) hive will repair their combs in a few days, so as to work as well as before their removal.

The method of transferring bees, etc., from a log or a gin case hive is of the utmost importance, especially with beginners, and in the bush. No hive, other than the bar-frame will admit of this. Transferring is dealt with elsewhere.

31. It should permit the safe and easy dislodgment of bees from the hive.

This advice is of the utmost importance, and at once shows the superiority of the Langstroth hive and others of bar-frame construction over the old straw skip and other artificial bee homes. To be able to regulate the numerical strength of the inmates of a hive is the key to success. A frame of brood from a well-to-do hive is not much missed, and in about three weeks is replaced; but the importance of giving a frame of nearly fully developed brood to a weak colony cannot be over-estimated. To do so from other than bar-framed hives is an impossibility.

32. It should allow the bees, together with the heat and odour of the main hive, to pass in the freest manner to the surplus honey receptacles (supers).

If the supers are difficult of access, or are divided from the main hive pierced by holes, as is the case in the Berlepsch hive, this necessary condition cannot be maintained. Thus the importance of the frames of the super being placed directly over

those of the brood chamber is at once realised, and also the advantage of shallows over full size supers. In the supers there must be a sufficiency of heat maintained for the necessary secretion of wax.

33. It should permit the surplus honey to be taken away in the most convenient, attractive, and valuable forms, and without risk of annoyance from the bees.

Undoubtedly "honey in the comb" is the most attractive form in which it can be placed upon the table; but it is at the same time the most expensive way. The reconstruction of the comb is a loss entailed upon both bees and bee-keeper when we consider it is estimated that it requires about 15 lb. to 20 lb. of honey to produce 1 lb. of wax. The invention of the extractors has done away largely with sending honey to market in the comb.

34. It should admit of the easy removal of good honey from the main hive, when in its place there can be supplied to the bees an inferior article.

What Langstroth means here is that good honey should be taken from the bees, and replaced by an inferior article.

In a country like New South Wales, where we have honey in different seasons of such various grades, this is a great advantage. In nearly every part of the State we have an occasional flow of unmarketable honey that is looked upon as a loss; at other times there is a flow of a superexcellent article. We can from bar-frame hives store the unsaleable article, and feed it back to the bees, taking the better article in return.

35. When quantity and not quality is the object sought, it should allow the greatest yield, that the surplus of strong colonies may be given, in the Fall, to those which have an insufficient supply.

To feed weak colonies at the expense of stronger ones is a mistake. Far better to unite two or three weak colonies; it is far cheaper.

36. It should be able to compel the force of a colony to be mainly directed to raising young bees that brood may be on hand to form colonies and strengthen feeble stocks.

A regular supply of brood must be maintained above the

death-rate, not so much for strengthening feeble stocks as to leave a sufficient number of workers on hand for a coming honey harvest. When artificial swarming is necessary strong colonies only will admit of division for the purpose.

37. It ought to be so constructed that, while well protected from the weather, the sun may be allowed in early spring to encourage breeding by warming up the hive.

It is not so much in the construction of a hive as its situation or location. It certainly should be so constructed as to be free from damp, which is one of the greatest drawbacks to early brood production. The site chosen should admit of the morning rays of the early spring sun.

38. The hive should be equally well adapted to be used as a swarmer or non-swarmer.

That is to say, it should be available for natural or artificial swarming. Natural swarming, to my mind is far preferable to artificial; at the same time there are conditions when artificial swarming may be carried out to an advantage. There are now in the market devices for controlling swarming.

39. It should enable the apiarian to prevent a new swarm from forsaking its hive.

For this purpose the bar-frame hive has an advantage over all others. The introduction of a frame of brood in all stages of development, put in the hive before placing the new swarm therein, greatly checks the desire for leaving; or a piece of queen-excluding zinc placed at the entrance so as to prevent the queen from leaving is a certainty.

40. It should enable the apiarian, if he allows his bees to swarm, and wishes to secure surplus honey, to prevent their swarming more than once in a season.

Cent. per cent. is a very fair profit, and no one that is not extra avaricious would wish for more. Some strains of bees seem to have a mania for swarming. When a swarm leaves a colony it carries with it at least a week's supply of honey. The more frequently bees swarm the greater the shrinkage of honey. If the object is to simply multiply colonies, then only should frequent swarming be permitted.

41. It should enable the apiarian who relies on natural swarming and wishes to multiply his colonies as fast as possible, to make vigorous stocks of all his small after-swarms.

This can only be done at the expense of the honey-crop. These after-swarms have young queens, and they occur most frequently during good seasons. If combs containing all the requisites for brood-raising—bee-bread, honey, and developing brood be taken from strong colonies to strengthen weak ones, it must be done judiciously, and as early in the season as possible, otherwise the strong colony may become the weak one.

42. It should enable the apiarian to multiply his colonies with a certainty and rapidity which are impossible if he depends on natural swarming.

As before stated, this should only be done when the multiplication of colonies is required, rather than the production of honey.

43. It should enable the apiarian to supply destitute colonies with the means of obtaining new queens.

Under the old skip and box system of bee-keeping, bees could supply themselves with queens, providing there were eggs or brood of the proper age, but the bar-frame hives opened up a new era in this respect. Prior to this the *manufacture* of queens was not under the control of the bee-keeper.

44. It should enable him to catch the queen for any purpose especially to remove an old one whose fertility is impaired by age.

Colonies die out too frequently through the infertility of the queen either through old age or mismating. In both cases they become drone breeders. With the bar-frame this can at once be remedied, and a fertile queen can be introduced to take the other's place, and thus a colony of bees can be perpetuated indefinitely.

45. While a complete hive is adapted to the wants of those who desire to manage their colonies on the most improved plans, it ought to be suited to the wants of those who, from timidity, ignorance or any other reason, prefer the common way.

There is not nearly the danger to be apprehended from bar-frame as from the skip or box-hive.

46. It should enable a single bee-keeper to superintend the colonies of different individuals.

Bee-keeping has now become an industry. In the large bee-farms of New South Wales it is the work of more than one man to look after his own. One of the principal objects of Bee-keepers' Associations was for the purpose of mutual aid, and these associations are now spread over the civilised world. It is represented in this State by many societies, the central one being the National Bee-keepers' Association, Sydney.

47. All the joints of the hive should be water-tight, and there should be no doors or shutters liable to shrink, swell, or get out of order.

The Langstroth hive, as now constructed—that is to say, if it be made of well-seasoned timber—never suffers from the troubles here catalogued. The hive of to-day differs considerably from those of earlier patterns in this respect.

48. It should enable the bee-keeper to entirely dispense with sheds or costly apiaries as the hive itself should alike defy heat or cold, rain or snow.

In the more temperate zones hives may go without sheds, and, indeed, in the sub-tropics; but the attendant requires some protection from the more direct rays of the sun. The best time to work among bees is the hottest part of the day, when the manipulator requires the protection—not the bees. See "Summer and Winter Protection."

49. It ought not to be liable to be blown down in high winds.

Place the hive low, on bricks, about 3 inches from the ground, so that a current of air can pass underneath the hive.

50. A complete hive should have its alighting-board constructed so as to shelter the bees against wind and wet, thus facilitating to the utmost their entrance with heavy burdens.

The modern Langstroth hive is constructed with a movable bottom-board, and the alighting-boards in most cases, are attached thereto; the entrance is cut into the solid wood, and is an

incline plane, so that all moisture runs away from the hive. This formation also protects the bees against high winds. In this respect the concrete floor is far above all others.

51. A complete hive should be protected against the destructive ravages of mice in winter.

Mice do not appear to trouble bees in this colony to the extent they seem to both in Europe and America. Perhaps the improvements in the bee entrance to the hives has much to do with it. Entrances now are made long and narrow—a little more than bee space; thus, a mouse would find a difficulty in obtaining ingress other than gnawing his way in, when the noise made thereby would surely rouse the anger of the bees.

52. It should permit bees to pass over their combs in the freest manner both in summer and winter.

In Langstroth's original pattern, the combs were arranged parallel with the entrance or front of the hive. Although this may facilitate the manipulation, freedom of ingress and egress was not so easy as in the modern hive, in which the combs run fore and aft, or parallel with the sides of the hive.

53. It should permit the honey, after the gathering season is over to be concentrated, where the bees will most need it.

No honey should be allowed to remain in the supers during winter, and all empty combs should be removed and the winter's supply of honey, when the bees are put up for the season, should be placed as near to the young brood as possible; and if there be not sufficient bees and honey to fill the hive, a division board should be placed so as to keep the whole as compact as possible.

54. It should permit a generous supply of honey to be left in the fall of the year in the hive without detriment either to the bees or the owner.

From 30 lb. to 40 lb. is sufficient for a fairly good colony. If more is left it is not wasted, but rather an advantage. It will be wanted in the spring for brood raising.

55. It should permit the apiarian to remove such combs as cannot be protected by the bees, to a place of safety.

Spare, or over-plus combs, should be placed in a zinc-lined case, the lid made almost air-tight and occasionally fumigated

with sulphur-smoke, to destroy the larvæ, etc., of the bee moth, and other enemies.

56. It should permit the space for spare honey to be enlarged or contracted at will, without any alteration or destruction of the existing parts of the hive.

The space for spare honey (super) of modern hives in no way interferes with the brood chamber. Supers can be expanded or contracted from a single row of one pound sections to one equal to a full-sized hive. Sections as we now have them, were not known till some years after the invention of the Langstroth hive.

57. It should be so compact as to economise, if possible, every inch of material used in its construction.

58. The hive, while presenting a neat appearance should admit, if desired, of being made highly ornamental.

See "Bush-houses as Apiaries," page 179.

59. It should enable an apiarian to lock up his hives in some cheap and convenient way.

This is for the purpose of preventing the honey from being stolen; but I have known cases where thieves have taken honey, bees and hive.

60. It should allow the contents of the hive, bees, combs, and all, to be taken out when it needs any repairs.

Not only when it needs repairs, but everything in a Langstroth hive being movable all the fittings should be occasionally taken out, and the hive thoroughly cleansed, which is an accommodation not to be met with in the old fashioned box, etc.

61. A complete hive, while possessing all these requisites, should if possible, combine them in a cheap and simple form, adapted to the wants of all who are competent to cultivate bees.

In these sixty odd advantages, etc. of the bar-frame hive over every other description of hive that has been in use since the day that bees were first brought under the control of man, Langstroth has not referred to his own particular style of hive, or lauded it to the disadvantage of other bar-frames, but by universal consent, and its general adoption by the bee-keeping pub-

lic it stands at the head of all other bar-frames that have been placed before the bee-keeping world; and therefore it is the first style or pattern hive that demands our attention. The internal measurement of the hive, no matter what name it bears, or of its form, is of the greatest importance—exactness is the one word applicable, so that the fittings or parts may be used with equal facility to any and every hive in the apiary, and not only in those belonging to one bee-keeper but each piece of a hive should be equally adaptable to other hives in the district.

Langstroth hives are generally made to contain eight or ten frames. The ten-frame hive is by no means suitable to all districts. It should only be used in localities where there is a large honey-flow. The eight-frame is handier, and far more fitted for general use, and is conceded by the most experienced bee-keepers to be the easiest workable. A queen-bee must be wonderfully super-excellent that can lay in more than eight frames of the brood chamber; even in these the outer combs of the two extreme frames are seldom seen with brood; and as it regards the supers, there is no advantage in the larger size. Any number of these can be used if the honey is coming in too quickly or time is not available to extract. For brood purposes, the queen confines herself as much as possible to the centre of the lower chamber. If, just at the beginning of the honey harvest the bottom frames are filled with brood—and for profitable bee-keeping, they should be—there cannot, of course, be empty cells in any number; then and only then will the bees be obliged to put their store where the bee-master can most conveniently get at it—that is, in the super; therefore the eight-frame for brood and also eight-frame supers are the ones most strongly recommended.

Material:—Wood, light, well-seasoned, and free from cracks and knot holes, the same as that advised for the frames.

The hives generally supplied by dealers in bee goods are dove-tailed. This makes extra strong corners. There are cheap ones lately put in the market, the corners being mitred and fastened with nails, but the little extra cost of the dovetailed ones makes them cheaper in the long run. The hives obtained from supply dealers are made by steam power. Where only a few hives are required, or there is a difficulty in obtaining machine made ones, home-made, with the corners square cut and put together with nails, will do as well as the best machine constructed, for all practical purposes. If the hive maker is handy in the use of carpenters' tools the corners are much better halved in. It is not only

neater, but, being put together with nails, the joints are more secure than when the wood is cut on the square, and put together flush.

The body of the modern complete hive, other than super and frames is composed of three sections or parts, the hive proper or brood chamber, the floor-board, and the cover. A brood chamber is synonymous with a full-size super, or *vice versa*. These three parts are indispensable. Bees may be kept without super or even without frame, but then that would take us back to the gin-case age of bee-keeping.

The diagrams of the Langstroth hive and the various sectional parts thereof will greatly facilitate the hive maker in constructing home-made hives.

The American measurements, as stated by Root in his "A B C of Bee Culture" are now generally adopted. The body of the hive is $9\frac{1}{2}$ inches deep, $13\frac{7}{8}$ inches wide, and 20 inches long. There are outside measurements. These cannot be followed unless the wood of which they are constructed is of uniform thickness, and that gauge always adhered to. The thickness of the wood of these hives when dressed is $\frac{7}{8}$ inch; therefore, to get the inside measure, which is always best to follow especially in home-made hives, where the wood obtainable is of various thicknesses, $\frac{7}{8}$ inch will have to be subtracted from the dimensions above given—that is, $8\frac{5}{8}$ inches deep, 13 inches wide and $19\frac{1}{8}$ inches long. The modern Langstroth Simplicity Hives are now generally made with bevelled edges, so that the lower edge of the super fits closely over the upper of that of the brood chamber. In this case the floor-board should have a corresponding convex bevel for the lower side of the brood-box to fit thereto, otherwise the space is too great underneath the sides, and is therefore liable to be utilised by the bees for storage purposes when pressed for room. The advantage is that the rain cannot drive in through the connections; but as machinery is necessary for forming correct junctions between the two parts (brood-box and super), home-made hives are excluded from that advantage. Provided they are carefully and accurately worked, there is no reason why the square edges should not be almost as impervious to the weather as bevelled ones. In the Heddon Hive it is so, the one portion of the hive merely resting on the upper portion of the other. The ones I have in use are in no way damper than those bevelled. Where the flat or square edges are used there is not the objection met with where the bevelled edges give extra and unrequired space immediately

between the lower bevelled edge and the bottom board; and what is more to the purpose, a more simply constructed floor board can be used when the edges on the sides are cut on the square. Occasionally there is a little bee-glue used, which certainly is a little extra labour for the bees; but I have more than once found propolis used in the conjunctions of bevel-edged hives.

Elsewhere I have advocated the need of light wood for use in all parts of hives and their adjuncts, but even here we must draw a line of demarcation. Some of our Colonial pine, when it is exposed to the weather, is liable to quickly perish, especially so if it has been lying in the open, when, more or less, the grain opens, and permanent cracks are the result. On one occasion I saw a hive thoroughly collapse when being removed, and the frames, hive, and its contents fall to the ground in one confused heap. And, further, some of our soft timber acts as a splendid hunting ground for white ants. I once saw a large apiary, where sawn hardwood blocks of uniform height were used for hive stands, on which the hives had become a prey to white ants, and their sides were so riddled as to necessitate substitution; and in one case the ants had built a gallery from the side of the hive to one of the frames ready to commence work thereon. The apiary referred to was in the bush, and surrounded by standing and fallen timber. "What has been is likely to be," and I do not think by any means this is likely to be an isolated case. I have always advocated that hives should stand on bricks. In all locations these are not always obtainable, and recourse must be given to a substitute. Where wood is used for a hive-stand, paint it with coal-tar, or, better still, cover it with a piece of tin or sheet-iron; although, if report speaks truly, white ants have been known to eat their way through sheet-lead. I wonder if they would try it on sheet-iron?

Perhaps, after all, the best gauge for carrying out the internal measurements of a hive is to be guided entirely by the frame. If the frames are made true to the standard gauge, and each of uniform pattern and size, the necessary size for a hive is more easily obtained therefrom than in any other way. Allowing bee-space, $\frac{1}{4}$ inch is usual (true bee-space is $\frac{1}{8}$ inch), on all sides between the hive and the frame must be right, also bee-space between the bottom bar of the frame and the bottom board of the hive. The space between the top bar of the frame and the cover of the hive will depend on the construction of the cover itself. "Many men

of many minds" applies to covers or roofs of hives as well as to other matters. In the covering for hives we have many patterns: flat roofs, hip roofs, gable end or cottage roofs, skillion roofs, &c. Whatever their name or pattern, they must be water-tight and afford bee space between the top bar of the frame and cover of the hive. Suitable covers for hive will be described further on.

Perhaps it will be as well, where timber has to be purchased, to bear in mind that a board of inch stuff, 12 feet x 10 inches, will work up into two bodies—*i.e.*, a brood chamber and a full-size super or two half supers; shallow boards, 10 inches wide, are difficult to obtain, unless specially ordered, but 12 feet x 1 foot is a very common measurement, and I strongly advise such a board to be obtained. In the first place, it will allow for shrinkage in seasoning prior to being cut up and put together. The overplus strip that must be cut off comes in grandly for frame-making or for making cleats for bottom-boards, or flanges for covers. In cutting up the board, it is best to cut off the strip, which will be about $1\frac{1}{2}$ inch wide, or a little more, according to the shrinkage; then cut off the four ends in one piece. It will be found more convenient to work out the rabbet in one length than if cut into the four necessary ends. An iron American plough, used by carpenters, is one of the best tools I know of for this purpose.

If the hives are constructed to allow bee-space between the bottom bar of the frame and the bottom board it will save a lot labour in working out the rebate. If bee-space is left between the top bar of the frame and the cover, then the rebate must be $\frac{1}{2}$ -inch deep—that is, bee-space and the thickness of the shoulder of the frame; but if it is intended to work the hive with the frames flush to the top of the hive, which is by far the best, then the rebate should only be $\frac{1}{4}$ inch deep, or sufficient for the shoulder of the frame to come flush with the top of the hive. In this case the cover must be constructed to allow the required space necessary. If metal is to be used in the rebates, due allowance must be made for their reception. A piece of wood (the thicker the better) 13 inches x $19\frac{1}{8}$ inches, all the angles cut perfectly true, will be found very useful gauge in putting hives together. It should be of some very light material. Iron frame gauges, expressly for working hives correctly, are procurable from houses (Pender, Maitland, Lassetter & Co., A. Hordern & Sons), where bee-keepers' supplies are sold. They are true to measurement, and so constructed that all the angles of the hive must be right angles.

If it is intended to dress the timber for the hives (planed wood always takes the paint better than rough), do so in the full length. When the four ends have been cut off the 12 feet board there will be a little less than 7 feet left; from this cut the four sides. Allowing for saw-cuts, the waste from the full-length board will be found to be next to nothing.

Fixed gauges for making the various parts of the hive will be found very useful tools.

Care is the only necessary trait required in putting a hive together. Take nothing for granted; see that every piece of wood is cut to the proper size; all the corners right angles; and when putting the hive together, have a bar frame handy, and see that you have proper bee-space allowed in every place that has been advised. In making a hive, keep this last paragraph before you, and note carefully its axioms.

THE LANGSTROTH HIVE—ITS FITTINGS.

On other pages there are illustrations—Bee hive and its fittings, the details of the hive is also given; therefore the following must be read in connection therewith.

In looking at the illustration it will be seen that it is numbered from 1 to 13, No. 1 being a complete 10-frame Langstroth hive in working order.

2. *The brood chamber* with four full-sized frames, and the dummy or division board with two frames on either side of it.

3. *Half-sized super*, showing five shallow frames, a shallow dummy, and a cradle or section-holder containing four 1-lb. sections. Bear in mind, the half-sized super is half only in depth—that is $4\frac{3}{4}$ inches—sufficient to carry the shallow frame and to allow bee space between it and the top-bar of the brood chamber.

4. *The roof or cover*.—In this case the roof is a gable-end, having a ventilator in either gable formed of perforated zinc. There is one advantage in having the roof raised some 2 or 3 inches above the super or brood chamber. In summer time it admits of a cool current of air passing over the hive. In winter, the space can be occupied by packing to keep out the cold. In the illustration the roof is made of rusticated weather-boards, which form an even surface on the inner side, and are not so liable to crack and split as full-width boards. The roof may be of skillion form. It answers

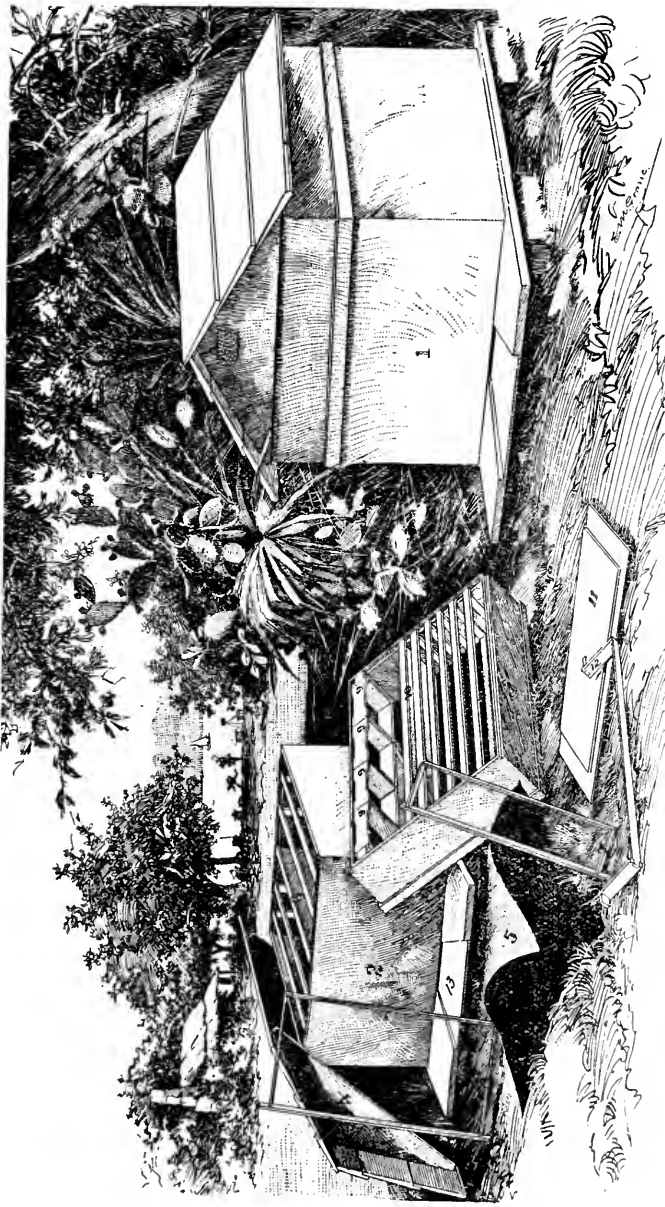

- 1—Hive complete.
- 2—Brood Chamber.
- 3—Shallow Super.
- 4—Roof, or Lid.
- 5—Quilt.
- 6—Full-size Frame.
- 7—Shallow Frame.
- 8—Dummy, half size.
- 9—Sections.
- 10—Dummy, half size.
- 11—Foundation Block.
- 12—Shallow Frames, and also Sections.
- 13—Movable Bottom Board.

precisely the same purpose, and is more easily made; or it may even be flat; but in this latter case it does not throw off the water as in either of the two former styles. Whatever may be the design chosen, it should be of a size to allow eaves of sufficient width to carry the drip well from the sides of the hive. If a flat cover is perfectly water-tight it is equal to either of the two other kinds mentioned, with the exception that there is no cool current of air immediately passing over the top of the frames. It is both easier to make and to handle. It can be overlaid with tin or painted, and whilst the paint is wet a piece of calico put over it, and another coat of paint on the top of that. The paint should be rather thicker than is usually used. If occasionally painted it will last for years, and remain water-proof to the end. A bit of ruberoid, a new material used for roofing purposes, is one of the best water-proof coverings that can be used, and is very cheap.

5. *Quilt of American Cloth.*—The more flexible or leathery the material the better. Of late there has been much discussion on its merits or demerits, some affirming that the bees quickly gnaw through it, others that it creates dampness within the hive. Where there is an imperfect knowledge of how to use this quilt, both arguing, undoubtedly, from experience, if I may be permitted to use an illogical phrase, both were right and both were wrong—right in that the glazed side is for summer use, when, the bees having a sufficiency of storage room, they would not waste their labour in trying to perforate the leathery side, it being too smooth for their mandibles to work upon—*i.e.*, if a material of good substance has been used, but I will not argue the point if a cheap, flimsy article has been chosen. I have quilts that have been in use for about four years, and fairly good to-day, only they are rather thickly covered with bee glue. In the winter, the glazed side being non-absorptive, the stratum of cold air without the hive coming in contact with warm air within, condensation is the result, and produces those globules of moisture seen on the glazed surface in winter months. Wrong, in using the woolly side next to the bees in summer, as they object to a fabric of that nature so near to them. They are always labouring to get rid of it; hence they quickly gnaw through it. The others who argue that it creates dampness, use the glazed sides next to the bees. They therefore, in winter months, find dampness on the underside of the quilt next to the bees. Under these circumstances both were right, and both were wrong; but if the glazed side had been placed next to the bees

during summer and the woolly side in the winter, neither of the two troubles named would have happened. Again, some good practical bee-keepers object to the use of the quilt altogether. That may do for men of exceptional experience, but to my mind no hive is complete without a quilt. The hives with a flat cover are the ones that are so used. Let us see. We cannot make sure of bees being perfectly subdued without the aid of smoke. When the flat cover is placed over the super, or over the brood-box, there is sure to be some space between it and the upper hedges of the hive that the bees object to, and stop up with propolis. This always fixes these two portions of the hive firmly together, and to separate these more or less force has to be applied. The result is that the cover comes away with a jerk, which always greatly annoys the bees, after which a good deal of time is required to subdue them to that frame of mind that will be congenial to the bee-keeper; but where the quilt is used in the manner before described, the cover is easily removed. The quilt is glued to the sides of the hive instead of the cover. One corner of this is easily turned back, the nozzle of the smoker applied to the opening, and the bees are easily driven down. As the quilt is peeled off, so the inmates can be driven away with the aid of smoke. Other material than American cloth may be used. I have used leather, bagging, tin, paper, &c., but I find nothing equal to that advised.

6. For particulars of *full-size Langstroth frame*, see page 221; and also for

7. *Shallow frame* for half-size super.

8. *Dummy or Division Board*. This is similar in form to a full-size frame. It is made of one piece of wood—that is, it is not a frame, neither can it be so used. It is a very important adjunct to all hives, both for full and half-size super, and also for the brood chamber. For the latter it is almost indispensable, especially so when a new swarm is first hived. This is fully treated under "Swarming." Where used in the supers the object of it is, as can be seen in the diagram, to keep the bees well together in the early part of the honey flow or where supplies are coming in slowly. It should be made $\frac{3}{4}$ in. wider and deeper than a frame, so as to prevent the bees from passing under or around it into the unoccupied portion of the line.

9. *A cradle of 1 lb. sections*.—For private use nothing in the form of honey can be more tempting than these sections. They are supposed to hold just 1 lb. The internal measurement is 4 in.

x 4 in. and the outer $4\frac{1}{4}$ in. x $4\frac{1}{4}$ in., the wood being $\frac{1}{8}$ in. thick. They are American-made. As yet no attempt has been made to manufacture them in the States. They are sold in the flat, and are very cheap. Before putting them together, take all that is intended to put into use; hold or tie them firmly together, and pour hot water direct from a tea-kettle over the whole of the V joints. Do not let the water spread further than is necessary, because if you are going to put in the starters at once it will be rather a difficult matter to get the foundation comb to firmly adhere to the wet wood. Under no circumstances let the dove-tails become damped, because if they swell it will be a trouble to put them together, and cause many of them to break. The starters used in them should be of the thinnest grade foundation comb made. A small triangular piece is all that is necessary for the starter. A piece of foundation the full size of the section is frequently used. It is a saving in labour for the bees, but it is not so good for the consumer. Place the starters on that part of the sections that has been cut out for bee-space, and in placing them in the cradle, or whatever appliance is used in the hive for carrying the sections, put the dove-tail joint uppermost; by so doing they are not so liable to come asunder. The side of the section containing the starter should form the upper side of the section.

10. *Dummy or division board for half-size super, see No. 8.*

The little diagram, Fig. 11, is of simple construction, and adaptable for the purposes required. It can be made in one piece or in two; the latter is the easier. When made in one piece, select a bit of cedar or redwood, or any wood that will not warp; the length of the top bar 19 inches, and about 3 inches wide and an inch thick. Put in a saw cut not less than $1\frac{1}{4}$ inch from each end, and $1\frac{3}{8}$ inch deep, and a similar cut lengthwise of the same depth, but only about half an inch from the edge. When the superfluous wood is removed the frame will sit neatly in it. One of more simple construction is made with a strip of $\frac{1}{2}$ inch soft wood not less than 19 inches long, 3 inches wide, and another piece 16 inches long, and $2\frac{1}{4}$ inches wide, nailed together in the form seen in the diagram; this will answer the purpose equally well as that before-mentioned. Before using, soak it in soap-suds, wipe it dry, place the frame on it in position, and lay the foundation starter, so that one edge rests against and along the centre of the top bar. Put some molten wax in a jam tin, to which a lip has been formed; hold the frame, foundation, &c., at an angle of about 45 degrees, and pour the wax along the whole length of the angle formed at

the junction of starter and top bar. The wax will cool in two or three seconds, when the starter will be found firmly attached.

In connection with the Allwood and other machine-made frames, foundation fasteners of other construction adaptable to frame used are obtainable, and will be described under "appliances."

Fig 12, Cradle or Section Holder.—If the brood chamber be the most interesting part of a hive, and the knowledge and manipulation of it be the key to successful bee-keeping, then the knowledge and manipulation of the super and its adjuncts are the most interesting from a commercial and domestic point of view. The surplus honey stored in the super is the just reward of the bee-keeper. To obtain it in its most attractive and purest form should be the aim of both the practical and the amateur bee-keeper. For home consumption the most attractive form in which honey can be sent to table is "honey in the comb," although not the most profitable, and that stored in 1 lb. sections is much neater than that cut from larger slabs or frames. The beautiful white-wood American section to my mind is the apex of perfection.

SECTIONS, ETC., FOR A LANGSTROTH HIVE.

(See diagrams on page 228).

Section-holders are of two forms, as seen in the diagrams. A is worked exactly as the shallow frames, that is, it has shoulders that rest on the rebates in the same manner, and they are handled in the same way. The ends are the full width of the sections (C), *i.e.*, $1\frac{7}{8}$ inch, the bottom bar on which the sections rest is $1\frac{1}{2}$ inch, and is fixed to the ends so as to leave bee-space on each side. The shoulders are the full width of the ends. They are made to fit into the hive with bee-space on either side. But the internal measurement of the cradle is of more importance than the outer. It must hold four sections, that is, it must be 17 in. x $4\frac{1}{4}$ in. The internal measurement of the section is 4 in. x 4 in., external $4\frac{1}{4}$ in. x $4\frac{1}{4}$ in. The closer the sections fit in the cradle, and the closer the cradles fit to each other, the less chance for the bees to use propolis to stop up the interstices; by so working the cradles and sections, the latter are kept cleaner and more attractive. An eight-frame Langstroth hive will take six cradles of four sections each.

K is a separator. One is put between every cradle. Their use is to prevent the bees building their cells so as to project beyond

the walls of the sections, and also to construct a more even surface to the comb. It will be noted in diagram E that there is bee-space (3-16 inch) on the upper and lower sides of the sections; consequently if the starter has been put in the centre of the top side of the section, the cell built on either side of it is $\frac{3}{4}$ inch, or in other words, the completed comb within the section is $1\frac{1}{2}$ inch thick. If these separators are not used, the comb protrudes beyond the distance required, which frequently produces disfigurement. It will be noted that the separator K has four bee-spaces similar to those in the section E. Where home-made tin separators are used, these bee-spaces are not necessary. In home-made appliances tin or other metal is more procurable than the American machine cut. Before putting the sections in the cradle A, carefully fasten the separators, wood or metal, with $\frac{1}{4}$ -inch gimppins; this keeps them in position when completing the fittings of the super. If home-made tin separators are used, they must be cut the full length of the cradle, and not more than 4 3-8 inches wide, and fixed to the cradle so that the bee-space will permit the bees to enter the sections at the bottom only.

Cradle J is more simple in its construction than A. It has no shoulders. Externally it is longer, but the difference in measurement is made up in the thickness of the wood used in the ends. Instead of hanging from the rebates, it rests on two strips of tin. On the underside of the rebatted ends there are strips of tin about an inch wide, and the full length of the end pieces of the super. Strengthen with $\frac{1}{4}$ -inch gimp-pins. These tin strips must protrude about 3-8 inch, so as to form ledges for the cradles to rest upon. Cradle J has eight bee-spaces, four on either side, as shown. The bottom bar may be made one uniform width, as in A.

D is a newly-designed section imported from America by Lassetter & Co. The four sides are of a uniform thickness; there is the absence of bee-space seen in those of the older type. In width, they are $1\frac{1}{2}$ in. throughout. A specially-designed separator (I) has been made for them. It is termed "the fence separator." The uprights are 3-16 in. thick on either side of the rails. This will reduce the thickness of the combs in the sections $\frac{1}{4}$ in. The bees will leave bee-space between the separator and the comb. The only advantage that I can see is that by containing less honey, they will be the more quickly filled.

Metal separators for sections C are best made from queen-excluder zinc, the same length and width as that already mentioned. Indeed, the queen excluding zinc could be used for separa-

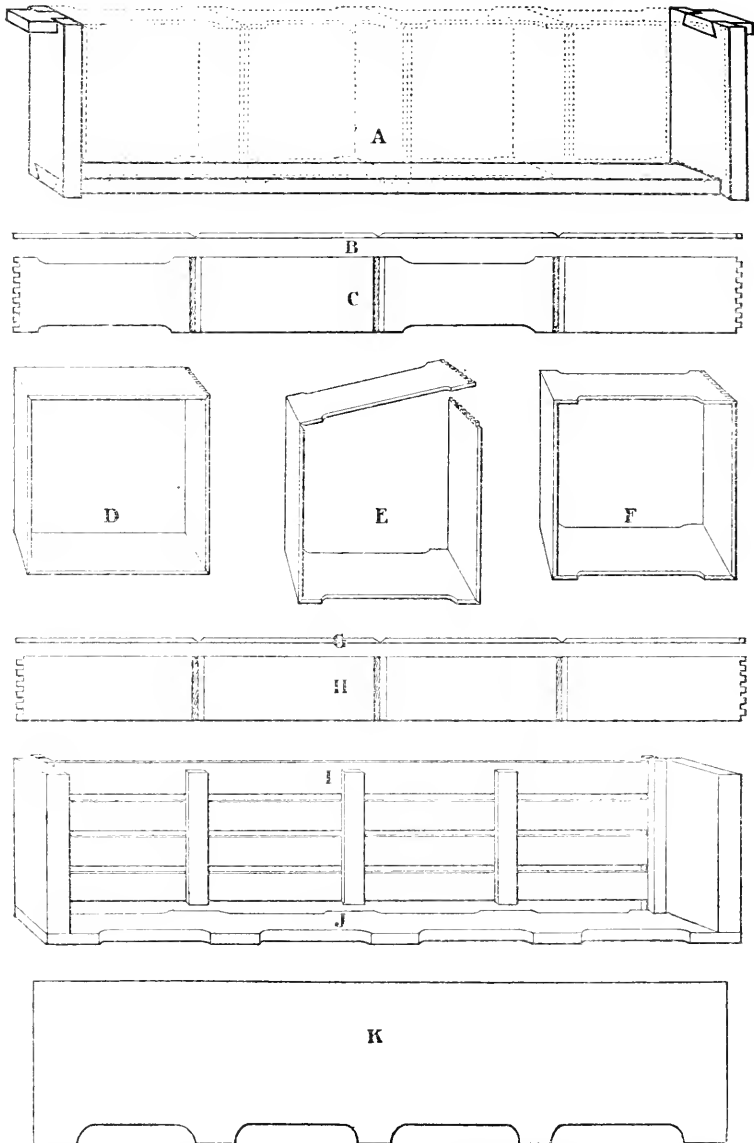

A—Cradle—The dotted lines showing the position of sections when the cradle is fitted for use.

B—Section in flat, showing V grooves.

C—Section in flat, showing dovetails, V grooves and bee-way.

D—The newly-designed section without bee-way.

E—Section showing bee-way and dovetail.

F—Section of the old type, showing bee-way.

G—Section in flat, showing V groove.

H—Section in flat, without bee-way.

I—Fence Separator.

J—Cradle for Sections, without bee-way, and for fence separators.

K—Metal or wooden separator for bee-way sections.

rators to the plain sections D, and answer the same purpose as the fence-separator. I have used them with success. Broken sections cut up into excellent uprights.

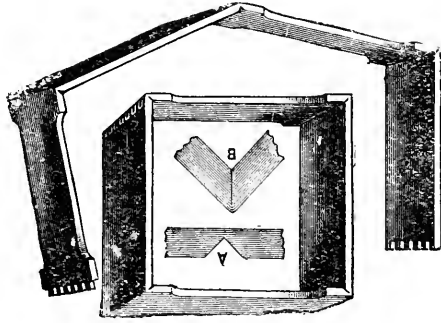

Sections.

The wire cradle is designed to contain six rows of four sections each as in A in the diagram; two of the sides work with collapsible springs, thus the sections are always compact and firmly held together. The writer has used them with marked success. They were first used at the Sydney Agricultural College Apiary.

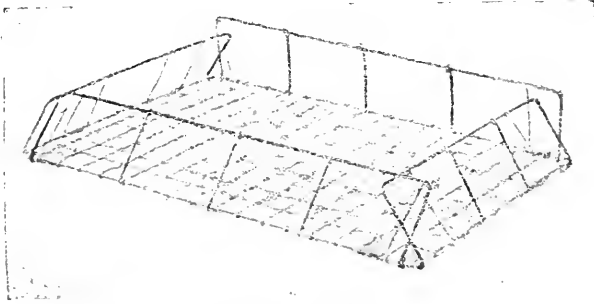

Wire Section Cradle.

THE BERLEPSCH HIVE.

THIS is another make of hive that has still a remnant of admirers even in New South Wales. Men, who in their early bee-keeping days, learned the manipulation of bees with these hives, still cling to them, perhaps for the sake of "Auld Lang Syne," and seem loth to go in for "innovations," notwithstanding that where one Berlepsch admirer is to be met with, there are hundreds of bee-keepers who use the Langstroth hives. Many of the Langstroth devotees can date their bee-keeping days back to the use of the Berlepsch, and were loud in its praise till a new love drew off their

attention, and they are now wedded to the much plainer, simpler, and economical Langstroth. Once having tasted the sweets of the Langstroth, you never hear them even hinting that they are contemplating a divorce, so that they may be in a position to return to the old love.

This hive is named after its inventor, Baron von Berlepsch, of Seebach, Thuringia. The diagram 1 represents the hive closed with the ventilator open, and two of the bar-frames used in connection therewith resting against the side. In diagram 2 the larger is the one used in the lower or brood-chamber, and the smaller belongs to the super or honey chamber. It will be noted that the larger differs but little in form from the Langstroth frame, and from out to out contains about the same superficial measurement. The chief difference in its construction is that the foundation comb is attached to one of the two shorter sides, and its greater length is used vertically, and not longitudinally, as in the Langstroth. The smaller frame is the one used in the honey-chamber, and is half the depth of the larger. The hives are worked from the back, where the manipulator stands. The back is a movable door or shutter; in some cases it swings upon hinges, but more frequently it can be detached and removed, as shown in the diagram 2.

On removing the back for the purposes of operating, etc., two glass-doors are seen, the smaller one in front of the honey-chamber and the larger, which encloses that of the brood. These glass-doors are not a fixture, and are used for a threefold purpose—first, for confining the bees till subdued; secondly, for observation—but like all hives constructed for observation purposes, one side only of a comb is visible, or the end bars of the whole of the frame; thirdly, to keep the frames securely in position. Diagram 2 gives a view of the internal fittings of the hive and of the construction of the frames. The bars of the shorter sides project beyond those of the longer. These shorter bars are not of equal length, the one used for the top being about half an inch longer than the bottom ones. The brood-chamber is separated from that of the honey super by a fixed division board or floor, in which there are one or more holes leading from one to the other for the purpose of giving ingress and egress to the inmates of the hive. In both sides of the brood-chamber, which is made of inch wood, a groove is wrought half an inch wide and three-eighths of an inch deep, so as to allow bee-space between the top bar of the frame and the fixed division-board. These grooves carry the frames in the same way as the rebates in the Langstroth hive; the longer projections of the shorter sides of the frame resting therein, but

instead of being placed in position from above, they are inserted from the back of the hive. Bee-space between the sides of the hive and that of the frames is preserved by the shorter pro-

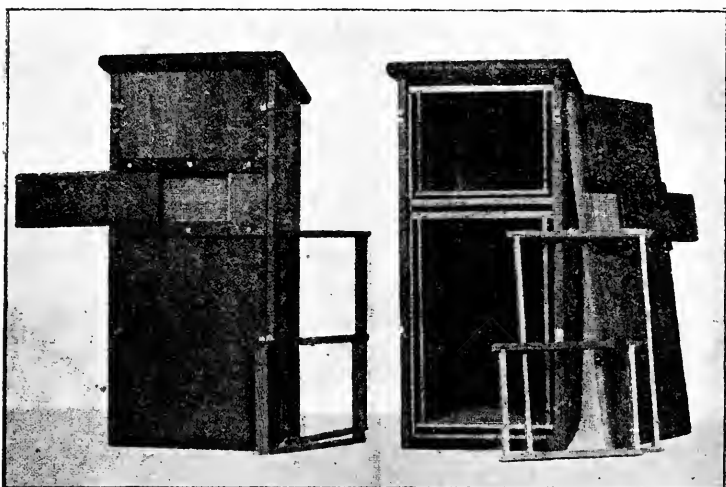

Fig. 1.

The Berlepsch Hive

Fig. 2.

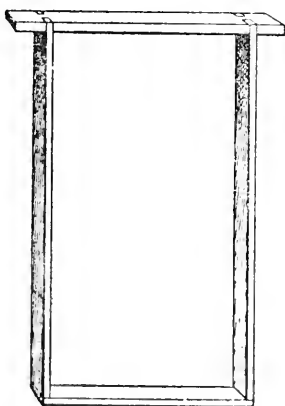

Fig. 3.

jections of the bottom bar of the frames. Space between the frames is secured by four nails, two driven in the top bar on the one side, and the other two in the bottom bar on the opposite side of the frame. The length of the frame is constructed so as to admit bee-space between the frames and the floor of the hive. The glass-

doors are so made as to wholly fill the space, the one of the larger chamber, and the other that of the smaller. They must be so made that they can be inserted or removed without the least jarring, and not so loosely as to allow the escape of the bees, but to easily follow the last frame placed in position.

Thus it is immaterial whether there are only two or the full complement of frames in either chamber. The glass back will, by pressing it against the last frame placed in the chamber, firmly fix the whole in position. Sometimes additional grooves, one on either side of the brood-chamber, are made in each side of the hive, about mid-way between the fixed division board and the floor-board. This is for the purpose of using two half-size or short frames.

The honey-chamber or super is in every respect a counterpart of that of the brood-chamber, only the frames are of a shallower construction.

The only part of the hive proper that is movable is the back. This is pierced for the purposes of ventilation. The piercing is covered with perforated zinc and a sliding shutter, as shown in diagram 1.

The bee entrance is cut in the front of the hive, and is sometimes protected from the weather by a miniature verandah.

The Berlepsch hive is always placed on a stand 2 or 3 feet above the ground, and frequently in two tiers, one above the other. For the reception of these hives a shed is necessary, open on all sides, the tiers of hives occupying the two sides of the shed, so that the manipulator is always under cover.

One great drawback to these hives is the difficulty in manipulating them. If there are eight or ten frames in a hive, and you wish to remove the one nearest the entrance, all the others must be lifted out and placed in a receptacle made for the purpose, and again replaced in the same order as they were taken out, while the bees that have been taken from the hive and have fallen from the comb, must be swept back and gently returned. If twenty hives have to be examined, this receiving-box has to be carried from hive to hive, and the withdrawal and reinsertion of the frames, and the sweeping up of the bees repeated at every hive.

Some of my earliest experiences of bee-keeping in bar-frame hives were with the Berlepsch, but I soon abandoned it for the Langstroth. In my transition stage from Berlepsch to Langstroth, I so altered the honey-chamber of the Berlepsch that I could work the frame for extracting purposes from the top, as in

the Langstroth. I found this alteration a decided improvement, and particularly convenient for working the one-pound sections.

It was this alteration I made in the Berlepsch that convinced me of the drawbacks it had, and in the following season I was soundly converted to the Langstroth pure and simple.

The ordinary Berlepsch hive is made to carry pound sections.

THE COMBINATION HIVE.

This hive was introduced to bee-keepers in 1878, by a Mr. Abbott, whose name it bears. The inventor claimed for it all the requirements necessary for a perfect hive—ease of manipulation, full control of the bees, every facility for the bees to store surplus honey, queen-rearing, and above all “the only hive in the world in which swarming can be positively prevented.” Notwithstanding all that was claimed for it, it reigned but a short time with British bee-men. The diagram shows the general arrangement of the interior of the hive. Brood frames, frames for surplus honey, and broad frames or crates for sections, are all contained in the one chamber. For wintering, the brood-frames can be closed in behind by a tightly-fitting dummy. The frames are the ordinary Langstroth measurements, and are arranged transversely, and not at right angles, as in the Langstroth Simplicity. This hive has a few advocates in this State, and some of the largest yields of honey have been obtained from it.

The Combination hive and the Long Idea are synonymous names for the same hive. Mr. W. T. Seabrook claims to have introduced this hive into New South Wales, and has added several useful improvements to that made by Mr. Abbott. The cover of Mr. Seabrook's improved combination hive is flat, and made in two equal sections. The first section of the cover is placed over the brood, and the second over the honey. With this arrangement the operator, whilst inspecting the honey-chamber, can do so without disturbing the brood. His other improvement is a side entrance in addition to the one in front of the hive. This side entrance acts as a bee-escape. When the honey is to be extracted, the lid covering the brood-chamber is drawn slightly back, a plain division-board or dummy is slipped down in front of the queen excluder. This cuts off direct communication between the honey and the brood; the lid being replaced, the side entrance is opened, and the imprisoned bees gradually escape. These operations are usually done about noon, and the work of extracting begun the following day. When the full combs are

removed, and their places occupied with empty ones, the side entrance is opened, the dummy removed, and the work of the bees again goes on as heretofore. This side entrance does away with the trouble of shaking and brushing the bees from the comb. Mr. Seabrook claims that the Long Idea hive, with his improvements, is far better adapted for raising well-finished sections than any other hive in the market. It is also better suited for wintering than those in general use. In winter the brood-comb is put in the centre of the hive, and a dummy placed on either side of it. The dummy in front of the brood has a bee entrance in it, and a tunnel is made from it to the main entrance; the spare space both in front and rear of the brood is then filled with chaff, and the bees are thus made snug till spring.

CHAPTER XXXI.

BEE-KEEPING IN BAR-FRAME HIVES.

THE BEGINNER'S KIT.

Bees:—Bar-framed hives, bar-frames, full-size and shallows; bar-frame block; bee brush; a few carpenter's tools; foundation comb; gloves; honey extractor; smoke-bellows; swarm catcher; 1 lb. sections; uncapping knife; veil; solar wax-extractor.

The cheapest way, but, perhaps not the best, is to get the so-called wild bees that are to be found in the bush. Bush bees are generally of the common black variety, except those that are found near where some one has gone in for the yellow or golden-banded (Italian) varieties. In such localities cross-bred varieties will be met with. Early in the spring vagrant swarms are to be met with, either on the wing or settled prior to making a start for a fresh habitation. If settled, they will put up with a good deal of handling, and it is almost, if not quite impossible to get them on the wing again. If it is difficult to dislodge them from their temporary resting-place by the ordinary method of shaking, as many as possible should be brushed off into a box placed on the ground, as directed below. If the swarm is on the wing, and they appear inclined to settle in a place awkward to get at for the purpose of hiving, take a small bush or bunch of leaves, and slowly brush it up and down, or backwards and forwards on their chosen settling spot, and they will soon vacate it for one that may be handier and easier to take from. When about a third of them are settled, take your coat off, roll up your shirt sleeves, so that your arms will be bare to the elbow. In your left hand have a candle-box, or one equally light, hold it under the cluster of bees. If they have settled in a bush, or on the bough of a tree, take hold of it near to the bees, give it a quick, sharp, sudden jerk, so that the bees fall into the box you are holding. Be gentle; do not be in a hurry. The bees, if they have not been teased, will not hurt you. Whilst swarming they put on their best behaviour. They are never more docile than when they leave the parent stock to establish themselves as a new colony. If you are of a timid nature, and most novices in bee-keeping are, put on a veil, tie your coat sleeves tightly round your wrists, so that the

bees cannot get underneath it. It is when they are imprisoned, and pressure brought to bear by the coat, that they get angry, and they then draw swords in self-defence. Should you be stung, keep cool, grin and bear it. For if you strike at the bees, and run "with what measure ye mete, it shall be measured to you again," yea, and that ten-fold. As soon as the bees, by means of the jerk, have fallen into the box, lower it to the ground, turn it gently over, mouth downwards, so that the bees roll out on the ground; place the mouth of the box over them, one side of it resting on a small stone or bit of wood, so that they can have ingress and egress. If you have secured the queen, the bees on the wing will quickly gather round the box. If she be not there, they will speedily return to the spot from whence they were shaken. In that case, wait till they have again clustered, and again go through the process of boxing. When you have safely boxed them, take them home, where you should always have a hive properly supplied with frames fitted with foundation comb, ready for their reception. Remove the cover of your hive, take the box containing the bees in both hands, the open end *upwards*, gently shake by swinging the box around, as if washing out a bucket. Do not be rash, and throw them on the top of the bar-frames. Cover them over with the quilt till evening; by that time they will have descended. You may then replace the cover of the hive. If your hive is within 2 or 3 inches of the ground, and it should not be more, you may turn out the bees on the ground in front of the hive, close to the entrance. They will soon find their way in.

If the bees are established in a tree or log, they will have to be cut out by the method known to every bushman. You want the bees, not the honey. Let the bees be primary, and the honey secondary. If you can reach the bee-entrance to their nest, take the smoke-bellows and blow in a fairly good supply of smoke. Sometimes the comb is some distance from the entrance. In such cases more smoke is required than if it be nearer. The smoke and the jarring caused by the axe in cutting into the tree frequently causes the majority of the bees to leave the comb, and retire into some other portion of the hollow, where they will be found clustered, as they are frequently seen hanging on a branch. Ofttimes to dislodge them requires patience. If they are easily reached, lay open the cavity in which they are clustered by cutting away the timber. Place the open end of an empty box over the bees. A few puffs of smoke from the bellows will often cause

them to shift their quarters, and enter the box that has been placed for their reception. If it be found that they cannot be dislodged in the way described, they can be taken out with the hand or a tea-cup. Care must be taken not to crush any of the bees, as it may cause them to lose their temper.

In taking a swarm of bees from a tree, always, if possible, see that you have the queen. She is easily recognised by her size. When you have once seen a queen bee, you will soon learn to pick her out. Should you be so fortunate as to see her, take her up by the wing or the shoulders (she will not sting you), and put her into the box with a few workers. The other bees will soon find out where she is, and follow on like a flock of sheep.

The bee-brush is used for the purpose of removing the bees from the comb when you wish to have the comb entirely free from occupants. A bunch of leaves, especially fern fronds, makes a very good one. With it brush the bees lightly from the comb back into the hive. For the purposes of observation, enough of them can be removed by holding the framè of comb over the hive, and giving it a sudden jerk.

Carpenters' bench tools, not a complete set, will be necessary, only in the case when you prefer to make all the woodwork "on the premises."

FOUNDATION COMB.—This can be bought from dealers at from 1s. 9d. to 2s. per lb. There is what is termed brush foundation. With a little practice this can be home-made. To do so, it will be necessary to obtain from a dealer a plaster cast. Briefly, this

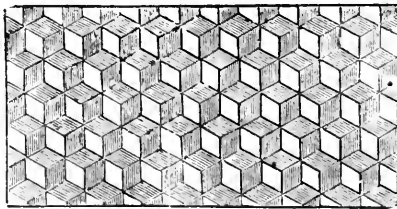

Foundation Comb.

is the way to produce it from the cast: Soak the cast in soap-suds for a few minutes before using. Have a glue pot or other vessel containing molten wax, which should be kept at almost boiling point. A fair sized paint brush, with the bristles not too long, should be kept in the wax during the time it is melting. With this brush paint the molten wax over the plaster slab by one or two rapid strokes. The fewer the strokes made with the brush the

neater and more even will be the foundation. It soon cools, and is then easily peeled from the plaster cast. This brush foundation will answer very well as a substitute for mill-made.

GLOVES.—There are gloves made expressly for the handling of bees. They are seldom, if ever, used by the practical bee-keeper. Nevertheless, timid beginners may be excused for so doing, more especially if they are ladies. Bees can sting through any ordinary wearing glove. Proper bee gloves are made of indiarubber. Nevertheless it is better to handle bees without gloves.

HONEY EXTRACTOR.—There are several different kinds of honey extractors in use, both two and four-frame. Some are reversible, *i.e.*, the comb can be reversed without removing it from the extractor. It will not be necessary to purchase one when you begin bee-keeping. They are rather expensive. When you have



fairly started in the industry, it will pay to buy one. Remember, every time comb is destroyed, it is a loss of profit. Wax is a secretion, and is produced from honey. It is estimated that 1 lb. of wax costs the bees from 15 to 20 lbs. of honey to produce. I have seen some very serviceable extractors made by amateurs.

THE QUILT.—This is a piece of American leather the full size of the top of the hive, and is placed over the frames next to the lid. During summer the enamelled side should be placed immediately over the frames, but in winter the cloth side should occupy that position. In placing it between the cover of the hive and the bees, it has the advantage of confining the bees to the

hive after the cover has been removed until they have been subdued.

THE SMOKE BELLOWS.—There are hot and cold-blast bellows. In the first-named, the air is blown through the fire, and thus becomes heated. Beginners unacquainted with this fact frequently injure some of their bees by holding the bellows too near them. A bellows on the hot-blast principle produces a greater volume of smoke, and therefore more readily subdues the irritability of the bees, but too frequently sparks of fire are carried with the smoke into the bees. The cold blast is the safer, especially in the hands of a novice. No bee-keeper can do without a smoker. The smokers in the market are the “Root” and the “Bingham,”

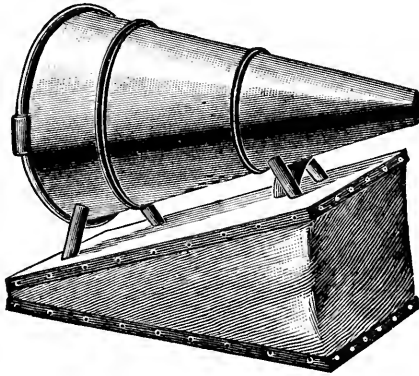

Smoker.

both of which are on the hot-blast method. As a cold blast, the “Clark” has had a good innings, but is rapidly being superseded by the “Pender.” This is also a cold blast, and can be used with the greatest safety by the most inexperienced. The materials used for charging the smoker are various—semi-decayed wood chips, and saw-dust from the wood heap, discarded cotton-waste, old bags, cow droppings, etc. Anything that will smoulder is suitable. The last-named must be perfectly dry, and has the advantage that it is almost impossible to blow it into flame.

SWARM CATCHER.—This is a very useful appliance. A bag made of mosquito net, and sewn to a hoop of about 15 inches in diameter, makes a very good one. It should be fixed to the end of a long, light pole, and at right angles to it. With such an instrument when a swarm settles on a tree out of ordinary reach, they can be secured by such an appliance and brought to the ground.

An open box, the remaining sides having three or four 1-inch auger holes pierced in them, and fixed to a stand of about 10 feet or 15 feet high, in the form of a tripod, is a first-rate appliance for bees to settle in, especially if a dead queen be fixed within. When the swarm is on the wing, this box, stood up in the midst of them, is almost sure to attract them to settle therein, and, if so, it will save a deal of trouble in following them.

ONE POUND SECTIONS.—These can be bought very cheaply. They are, when nicely and evenly filled, very saleable. There is not so much profit in producing sections as there is in extracted honey,—but they are very nice for table purposes. (See page 228).

THE UNCAPPING KNIFE.—These are required only when you have a honey extractor. As the name implies, they are used



for the purpose of removing the caps from the honey cells before placing the frame in the extractor. For uncapping, two knives should be employed. These should be placed in a tin billy of hot water, or some other such vessel, and used alternately. The water can be kept hot by means of a small lamp placed under the tin billy. When uncapping, cut downwards. This will cause the cappings to fall more readily and clear from the comb.

BEE VEILS.—These are a great protection to the face whilst working among the bees. A bag made with mosquito net, and open at both ends, is the usual thing. A broad-brimmed hat, with such a bag sewn to its edge, is the most convenient. Let it be long enough to come well over the shoulders. It will be found difficult to see through the ordinary white netting; therefore, for the face, a small square of black Brussels net should be inserted for the purpose of obtaining a clearer vision of the work. Some veils have gauze wire fronts, others glass. As you obtain confidence, the veil will be discarded.

THE SOLAR WAX EXTRACTOR.—This is a very handy thing—a sort of save-all. A shallow box, with glass lid, is the thing required. A convexed, semicircular false bottom, made of bright tin, is fixed within. The deepest part should not be more than 6 inches from the glass. One end of the false bottom should

be made of gauze wire to act as a strainer, the other of tin. Room should be left at one end of the box to receive a vessel to catch the wax as it drips through the gauze wire. The cover should be easily removed. Place the box at an angle of about 20 degrees, facing the sun. All pieces of waste comb should be thrown into it. Always keep the cover on, night and day. It will soon pay for itself. Waste bits of comb lying about encourages the bee moth.

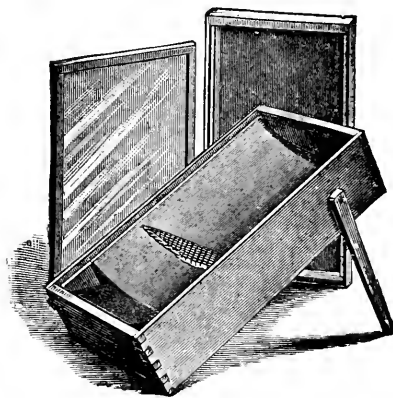

Solar Extractor.

The best time to manipulate bees is when the day is brightest. The best site for your bees will be the most convenient, so long as they are sheltered from the cold winds of winter. Put the hive about 3 or 4 inches from the ground, resting on bricks, with a platform having a gentle slope, inclining from the alighting board to the ground, and be sure to make the roof water-proof. The cement floor as advocated, you will find far better than wood. Bee-keeping will pay if it be properly looked after, if it be only one or two hives to supply honey for your own table.

The principal diseases of bees are foul brood and moth. If the hives are examined occasionally, diseased comb or moth larvæ can be removed and destroyed.

CHAPTER XXXII. WINTERING BEES.

“WHILE the earth remaineth, summer and winter shall not cease” is a Divine promise; but, notwithstanding, New South Wales bee-keepers find, as far as the honey flow is concerned, that, at least, in some parts of this State we have no winter—that is, winter such as necessitates the taking of extra precautions to guard against the severity of the cold. With the bees, “summer and winter” are only relative terms, known to them by the extension or contraction of light and darkness. That is the only sense in which that Scriptural promise to them holds good. They do not know it by the abundance or cessation of the honey flow. Nay, if such were the case, the bees’ winter would be when the sunshine is most intense and the days longest. Often in summer time, in this State of floods and droughts, the little busy bee is put to her wit’s end to find the means of livelihood, to say nothing of a surplus for storage on which to raise the ever-increasing brood. In some years, what other countries would term the best for a honey flow, with us it is the worst. Indeed, in some parts of this State, while some bee-keepers are gloating over their great profits for the season others are entertaining the thought of Jeremiah’s wish, “Oh! that my head were water and mine eyes a fountain of tears that I might weep,” because I have to feed back to my bees, this summer, the profits of last.

“Apiology,” if I may be permitted to coin a word, because it is more expressive for my purpose than apiculture, in this country requires the study of the laws of bee-life far more acutely than that of any other bee-keeping country with which I am acquainted. Other bee countries are not subjected to the great changes, in season and out of season, than we are here. The bee-keeping people in Europe and America have their Spring, Summer, Autumn, and Winter with utmost regularity, the periods differing but little year after year. I do not mean to say that each year or season is equally resultant, but I do mean to say that within a week or so they know what will follow, and can prepare for it accordingly. I have known a midwinter season when the honey-bearing flora were so advanced, the honey flow so good, the brood so plentiful, and circumstances,



Wintering Bees.

both domestic and climatic, that a swarm issued forth at that usually unfavourable season. At other times I have known the floral season so backward that swarming has been delayed till well on to midsummer. In the Old Country I once knew a swarm of bees found hanging on a gate-post when the ground was white with snow; they were starved out.

New South Wales, with climatic districts verging from the torrid zone on the one side, to the frigid, eternal snows on the other—what different adaptations have to be sought and to be found so as to overcome the various necessities and requirements of bees under these circumstances. Cold and hard frosty nights compelling the bees to seek the warmest parts of the hive, followed by a day when the sun shines out with almost summer heat, thus tempting the bees out, not only to bask in the sunlight, which is always a health-giving exercise, but if stores be short tempting them far afield in search of food, when the sudden cold, as the sun drops westward, causes the death of many of the valuable little toilers. Taking this into account, it will be impossible for me to give such an exhaustive article as I should like on this important phase in bee management; therefore each district must glean for itself that which is most suited to its wants. Experience and common-sense are the two most important factors to be used herewith.

What are the essentials most to be observed in prolonging health and life under adverse climatic changes? It matters not whether it be in members of the vegetable or the animal kingdom. Our endemic plants are not all equally proof against the changes of climate any more than are the exotics. The care necessary in our hot-houses and conservatories will best answer this. Nature has given numberless animals, besides bees, the power to guard against the privations of winter. I have no need to catalogue them. How has she instructed others to so guard against the scarcity of winter food, and to provide means whereby they can fight against want, and defy the cold when it is standing below zero? With the herbivorous animals, by laying on an extra accumulation of fat; with some species of squirrels, by storing a winter's supply of food; with some birds, by uniting to build a common home of extra warmth for nocturnal shelter and protection against the pelting rains, and thus they, huddling together, live through the winter; with some, ophidians, by hibernation; with others, by semi-hibernation, awakening in the warmer hours of the day to feast on autumnal gathered stores. Again, some lay-on fat, and construct

huge warm and dry nests, wherein they sleep till the warm days of spring awake them.

Are not these, collectively, analogous of the requirements of bees, and has not Nature taught our bees how to act? Has she not implanted in them an instinctive knowledge how to overcome the obstacles of winter in the various climatic zones of the earth? Nevertheless, they have an instinct that will never leave them—that of storing. In those parts of the State where “never-ending spring abides,” they store with all the energy and prudence as in the northern world, and that trait of storing will never forsake them. If left to their own instinct they will store food sufficient to overcome almost any winter. But the bee-keeper, with that selfish greed for gain, too often extracts the last pound of honey, in the hope that his bees will be able to weather the winter’s storms. By so acting, spring will show him that he has “killed the hen that laid the golden egg.” I do not mean to say that it is always the bee-keeper’s fault that the bees die. Sometimes our summers and autumns are cruel and unkind to our bees, withholding the honey flow, and they die from natural want.

Can you not gather from what I have already said, what are the essentials necessary for wintering bees; a sufficiency of food, perfectly dry quarters, the heat obtained by density of clustering, fresh air and ventilation; for in all the cases mentioned air is to be noted as one of the constituents.

A sufficiency of food; but what kind of food, and what quantity? The quantity of food necessary for a strong colony to pull through winter, and to come out in spring healthy and vigorous, is about 25 lb. This will depend on the length of the winter and its severity. It is far better to leave a pound too much than an ounce too little. The winter’s supply should be of capped comb, and so distributed that the two outer combs on either side should have about equal quantities; and where the winters are most severe, pop-holes should be made through the combs to save the bees the danger of coming in contact with the cold air surrounding the inner side of the walls of the hive.

The kind of food. “What is good for the goose is good for the gander.” What is good for the babe is good for the parent; but not *all that is good for the parent* is good for the babe. No mother would fill the stomach of a week-old babe with corned beef, pickled onions, and boiled cabbage; but where is the adult who would not live and thrive on baby food? Indeed in cases of physical decay, caused by starvation or disease, human sufferers have to return

again to babyhood as it regards food, before the strength of manhood can be regained. Why baby-food for a starving or physically weak man? Because it is the most nutritious. We all, as beekeepers, know the food of young bees differs as their age increases, and that queens, during their baby days, are fed with the same baby-food throughout. Why? I think this is something we have yet to learn. What is this chyle food—this bee-milk fed to young bees. What are its constituent parts? Honey, pollen, water, semi-digested by the nurse bees. This is fed to the young bees in a similar way, and for the same purpose, as young mammals are fed by the dam, or, as St. Paul puts it, "fed by milk that they may grow thereby."

The Americans assert that the only food necessary to bring bees through the winter is honey or sugar, and if pollen be excluded from the bill of fare, dysentery and other abdominal complaints will not occur. I am not so sure of that. In the Old Land, in the days of my youth, when I kept bees in the old straw skip—when we used to smother a certain proportion of the stocks with sulphur, leaving the rest for the next season's increase, I noticed that the bees that came out in the warmer parts of the winter days were those that were starving, and when these were fed on sugar, as a rule, dysentery followed; but the strong stocks that were left with plenty of pollen and honey were the healthiest in the spring, and gave the earliest swarms. All animals know by instinct the most fitting food. Pollen to bees is nothing new. They know their two principal foods, pollen and honey, and how to choose the beneficial and eschew the deleterious. Bees consume honey to produce heat and energy; pollen to build up the waste of nerve and muscle. They know which to select by the dictates of Nature. So in leaving the winter supply of honey see that there is proportionately a sufficient supply of pollen. In this Colony, in winter or summer, I have never lost bees by starvation, because I never interfere with the food supply of the brood-chamber. Do not do it; there is nothing to be gained by it, but frequently a great loss. Your bees will come out better in the spring; they will swarm earlier, all else being equal; there will be less mortality. The old and infirm will be sure to die, but the young will be healthy and strong so as to commence the new season's duties with vigour.

The temperature: Bees can endure great extremes of temperature, even below freezing point. Francis Huber immersed a swarm of bees for three hours in water, and they revived. I once found a gin-case of bees that had been brought down the river during a

flood, and they were as active as if they had just swarmed therein. I cannot tell from whence they came. But with these experiments health is too much interfered with. The question with us is not what extremes of heat, or what extremes of cold, bees can best endure, but how can we best protect our bees by administering to their wants that they may best serve ours. Heat may be produced and conserved in various ways. A full stomach is as good as an extra blanket. That man who has put up his bees for winter, and has given them a sufficiency of food and a little over, has taken the bull by the horns—the first and best step of producing and keeping the required warmth in his hive during the winter months. The hive itself should be free from open joints and cracks. Ventilation in winter is as requisite as in summer, but not to the same extent; but then that ventilation must be systematic and judicious. The bees, by their constant breathing, will keep the oxygen in circulation. There must therefore be a means of escape of the heated air so that the fresh invigorating air may take its place and so benefit the inmates of the hive.

The numerical strength of the colony is another important factor in producing and retaining the warmth of the stock. When bees cluster closely together, they are in a condition to maintain about 65 degrees of heat in winter, and if a closely fitting division board has been inserted so as to keep the bees and their supplies handy and well together, the outer circle of bees will be as warm as those in the centre of the cluster. On the other hand, if the space they occupy be too large, there will be a greater amount of mortality than if they have only sufficient room and no more. Empty or unused combs should be most religiously removed. These absorb heat, and that is so much taken from the inmates. Even if they do not absorb the heat, they will absorb moisture, and mildew, thus militating against the health of the colony.

Paper is a first-class non-conductor of heat; therefore, in our coldest districts, if the hives are lined with cardboard, and sheets of paper placed over the top bars, it would conduce greatly in retaining the natural heat of the bees. Further, outside protection should by no means be neglected, but whatever material be used it must be impervious to rain.

If the hives have flat tops, a sheet of well-trimmed bark half as long and broad again as the hive may be used. It should be well and evenly weighted down, or fastened, to prevent the wind blowing it off. In exposed situations it would be well not to use weights, but drive in a couple of stout pegs at each side of the hive,

and lash the bark with cord. For the purpose nothing could be better than a clothes-line (such as is usually procurable for about 4d.), and for a shilling or two length enough could be obtained to do a great many hives. Where the cover is only an inch or so beyond the top of the hive, water dribbles under. For gable-roofed hives a cover of bagging which has received a coat of paint or tar will do. Cornsacks coated in this way would last for several winters.

Internal dampness must be avoided, and floor-boards kept clean. These are better renewed during the middle part of warm days. By no means attempt to winter weak stocks. Far better carry one strong colony through the winter than half a dozen weak ones; in proportion, they consume far less food.

But, above all, do not be avaricious, and rob your bees of the last ounce of honey, and then expect them to pull through the winter.

CHAPTER XXXIII.

NOTES ON HONEY.

WHEN Virgil said honey was "Heaven's gift, food fit for the gods," he must have meant gods celestial and gods terrestrial. Honey is as essential as salt for a food constituent. It contains both sucrose (cane sugar) and glucose (fruit sugar), not the manufactured article sold under that name, but the pure fruit sugars from Nature's laboratories. "Heaven's gift" is also more or less flavoured with the volatile oils of the flowers upon which the bees work; hence the justly celebrated honeys of Crete, Minorca, and Narbonne are due to the flavour of the volatile oils of rosemary. The ancients loudly sang the praises of the honey from Hymettus; its celebrated flavor was due to the oils of the flowers of thyme. The grateful flavour of the honey of Provens is produced from the flowers of lavender. The delicious flavour and pleasant aroma of Cuban honey is the result of the oil of neroli, which is obtained by the bees from the blossoms of the various members of the citrus family, chiefly that of the orange. Cuba, an island in size one-sixth less than England, in one year exported honey and wax to the value of £130,000. This amount does not include the honey and wax consumed and used on the island.

Large quantities of honey, equally as palatable and containing as an agreeable an aroma as this justly celebrated Cuban article, is produced in this State, notably in that part of the county of Cumberland lying between Parramatta and Gordon, and also in other citrus districts of New South Wales. All that is required to obtain this far-famed honey for the market is a certain amount of care in the management of the hive during the honey-flow from the orange-trees. At the time these trees and other members of the same family are seen in blossom-bud, the bee-keeper should carefully examine every frame in the hive, and remove the winter storage that has not been consumed. It will not be found necessary to remove every cell of unused honey, more especially if the surplus supply is in colour a light amber. The oil of neroli is very penetrative, and its pleasant perfume will soon permeate the unused residue of the winter stock. As soon as the petals of the orange-blossom are seen thickly on the ground, *i.e.*, when the young fruit have fairly set, no time should be lost in securing the harvest of orange-blossom honey. The almond flavour sometimes met with

in the honey obtained from our fruit districts is entirely due to the volatile oils found in peach blossom and other stone-fruit. With care all these favourite flavoured honeys can be stored for market purposes. The worst part of it is, these valuable honeys come in during early spring, when they are largely required by the bees for raising the first brood of the season. Nevertheless, if the bee-keeper has not been over avaricious and extracted too closely before putting his bees up for winter, this drawback will not be there to contend with.

The honey of our native flora that is most appreciated is that from the white box (*Eucalyptus hemiphloia*), yellow box (*E. melliodora*), and the prickly tea-tree (*Melaleuca styphelioides*). Undoubtedly some honey from our native flowers is so strongly impregnated with eucalyptus flavour as to give one the idea that it is a compound medicament for coughs, colds, &c., and was never produced direct from Nature's laboratories. This inferior, strongly-flavoured bush honey is objected to by our brethren in the old country, and indeed by the public of New South Wales; but the honey with the flavours above-mentioned must ultimately become as popular and as much sought after as that of Crete, Minorca, Narbonne, or Cuba.

Honey is not only a valuable article of food, but is at once dietary, preservative, medicinal, and a beverage. As an article of food, cheap as it is, there are few people use it to the extent it should be. As a preservative of fruit and other vegetable substances, it is one of the best mediums we have. It is frequently used in the arts for that purpose. It acts in the same manner as sugar. It is said the ancient Spartans used honey to preserve the dead bodies of their kings. The writer once saw the dead body of a mouse cut out from a jar of granulated honey. Whilst in a liquid state it had served as a medium of suicide for the unfortunate one. The body showed not the slightest signs of decomposition, although it must have been dead over twelve months. Honey diluted with about four times its volume of water, and exposed in an open vessel to the heat of the sun, produces a strong vinegar of a fine flavour. This vinegar is cheaply and easily made, and is equal, if not superior, to the malted article for pickling purposes. Honey, prepared with medicinal ingredients, forms an excellent medicated drink. The metheglen of the ancient Britons was fermented honey. Light or weak mead (another name for metheglen) is an excellent cooling summer drink.

CHAPTER XXXIV.

THE VALUE OF BEESWAX.

BEESWAX is gradually going up in price. The bar-frame system of keeping bees has largely to answer for this. Under the old style, to obtain the honey, the combs were destroyed; that meant there was always a certain quantity of wax to be placed in the markets. Under the old regime beekeepers never required the wax, but under the new, nearly every grain is carefully husbanded for the purpose of converting it into foundation comb. As the new system of beekeeping spreads the less wax there will be in proportion to put to commercial use. Nevertheless the demand for wax is steadily on the increase. It therefore becomes a question: Will the production of wax pay? In this State there are localities where the honey is of a very inferior quality, in fact unsaleable at almost any price; and often times in those localities where good honey is obtainable there are seasons when an inferior article is brought home by the bees. I know that the production of wax is expensive alike to bees and bee-masters. Is it worth while in those localities where only inferior honey is obtained to try the experiment of wax production? Bees can be compelled to produce more wax than they need, and the surplus wax will always find a ready market when such honey as above mentioned will be on hand from season to season. The common class of honey can be bought in Sydney at the present time at $1\frac{1}{2}$ d. per lb. Fair samples of wax are worth from 1s. 2d. to 1s. 3d. per lb. For the former there is really little or no sale, for the latter there is a great demand, therefore always a ready sale. The maxim among merchants is the more frequently a penny is turned over the greater the profit. Wax never remains long on hand, but for this common honey there is no knowing when there will be a sale. There is no denying the fact that wax is more expensive to produce than honey. On the other hand it is not merely so expensive to market. The carriage of a ton of wax is the same as the carriage on a ton of honey. A ton of honey at $1\frac{1}{2}$ d. per lb. is worth £14, and a ton of wax at 1s. per lb. is worth £112. Wax can be sent to market in a bag, and if the bags burst there is none of the wax wasted. This cannot be said of honey. The vessels to market it in are far more expensive than is the case with wax.

WAX PRODUCTION.

Nature is very economic in all her ways, although she sometimes appears to be very lavish in her productions. This may seem contradictory, but it is not so. Where there seems to be a lavish expenditure, Nature's object is, "supply according to demand." Labour and production, with all Nature's tiny workers, go hand in hand, although with some insects occasionally the labour seems excessive in comparison with the article produced, notably is this the case with some of the mason bees. No insect appears to be more saving in the article produced than the hive bee. Every grain of wax is thriftily husbanded; the walls of the cells are always carefully pared down to the thinnest limit compatible with strength. In a state of nature bees use the same combs and cells for years without renewing them. The old box hive was only one removed from Nature's primitive ways. It is the bar-frame hive that suggested such wonderful advancements in the method of bee-keeping; and it is the bar-frame that has given us the courage to take such daring liberties with the internal workings of the bee-hive. Francis Huber's experiments gave insight to the fact that bees may be forced to produce wax in a greater abundance than was necessary for the primary economy of the hive. Nature, which has taught bees so much, has instructed them in the regular preservation of a uniform distance between the combs. But frequently on the approach of autumn the honey cells are elongated so that the comb may contain a much greater quantity of stores. In the old fashion hives the angles of the box sometimes contained comb of abnormal thickness, not unfrequently cell upon cell to more than twice the ordinary dimensions. On the return of spring such cells are reduced to the uniform normal length. Lengthening a cell, as far as the bees are concerned, is the same as constructing a new comb; therefore to produce an extra quantity of wax it is only necessary to place the completed combs sufficiently far apart to give the bees enough room to construct an additional comb in the interstice, and as fast as the new comb is produced to remove it to the melting pot. Of course this can only be done when bar-frames are used.

ADULTERATION OF WAX.

The demand for beeswax has stimulated the dishonest to try all ways and means to adulterate the genuine article and increase the profits of the dishonest. Not long since I was called in to

examine some wax that had been purchased by a tradesman. I found it to be a compound of beeswax and and (I have purposely left the nouns out because I do not wish to educate the ignorant who may feel inclined to be dishonest in such matters). Adulterated wax can generally be detected by the senses—by the touch, by the odour, and by the appearance. But there are other kinds of wax besides beeswax. They are cheaper, and also much inferior. These are sometimes incorporated with genuine beeswax, and when some of these adulterants are used the senses are at fault. Alcohol will overcome this latter difficulty. The specific gravity of beeswax is, as already stated, 965, and that of water, 1,000. Beeswax is lighter than water, therefore it will float in water.

“Wax differs from fat in that it contains no glycerine. The fatty acids united with alkali always liberate glycerine in soap-making, *e.g.*, but if wax be saponified, *i.e.*, converted into soap, no glycerine presents itself, and thus the chemist is furnished with a method of detecting a certain class of adulterations.”—Cheshire, p. 589.

TO TEST WAX FOR ADULTERATION.

There is a very simple test by means of which the adulterated article can easily be detected. Fill a clear glass bottle about half-full of water; place in the water a piece of pure beeswax, add alcohol to the water until the piece of pure beeswax just settles on the bottom of the water. Now take a piece of the supposed adulterated wax, drop it in the bottle with the pure beeswax; if it has been adulterated with other varieties of wax of commerce, I will not name them for the same reason before stated, it will float. The *less* the quantity of genuine beeswax there is in the mixture the lighter will be its specific gravity, or, in other words, the more readily it will float. If the sample of adulterated wax has only had added to it 4 or 5 per cent. of wax other than that of bees, it will sink to the bottom very similar to pure beeswax; but its descent will be slower, and while it rests at the bottom, if the water be slightly agitated, of the two samples resting at the bottom, the pure will remain stationary whilst the sample of mixtures will more or less oscillate according to the percentage of the added adulterant.

DISCOLOURATION—TO PREVENT.

It is not infrequent at our agricultural shows to find competitive samples of wax of more or less a leaden hue, pervading

uniformly, through the whole sample; at other times I have seen it somewhat of the appearance of old-fashioned mottle soap. Such wax is in no way adulterated, but its commercial value is sadly marred. If this discoloured wax be used for foundation comb purposes, I do not think that the bees will reject it. Nevertheless, it is very unsightly even for that purpose. The natural colour of wax is of various yellow or orange shades. Oftentimes colouring matter is used to imitate the natural colour—this deception, too, is detectable by the experienced eye. Rendering wax in a galvanised-iron vessel is answerable for a lot of discolouration. Wax, when melted in a galvanised-iron vessel, has a more or less greenish tinge with it. Copper vessels are the best for wax rendering. To ordinary tin there is no objection, providing no acids have been in the tin. Wax should at all times be extracted by means of steam. Boiling water is detrimental. If appliances for extracting wax by the agency of steam are not available, *rain* water is the next best material for the purpose. Spring water is too often impregnated with lime or other chemicals. It is these mixing with the wax that produces that grey spongy mixture seen underlying wax after it has cooled.

MOULDING WAX.

Almost any vessel is suitable for this purpose, providing it is wider at the mouth than at the base. Glass or enamelware I find to be the best. Wax, after it has been run into the mould and cooled, is frequently found to be full of flaws. This is caused by the molten material being permitted to cool too quickly. As soon as the molten wax has been run into the mould it should be covered over with an old bag or other material, and thus, cooling slowly, these unsightly cracks or fissures will be avoided.

OLD BLACK COMBS.

Some old combs appear to be almost made up of cocoon cases and other cast off material. There certainly is not the quantity of wax to be obtained from these old combs as from the newer ones. Still, while the process of wax rendering is in hand it will pay "to gather up the fragments that nothing be lost." Before putting these old black combs in the melting pot they should be thoroughly soaked. Rain water will be found best for the purpose, because it contains no mineral substances.

LOSS OF WAX.

From Cheshire, 589, vol. II., I quote the following:—"Much wax is wasted through failing to note that lime in water unites with the cerotic acid, forming an insoluble lime soap. . . . Wax should never be melted, nor should combs be rendered in any but rain water or distilled water, unless to the water is added an acid." Vinegar is always procurable, and will answer the purpose as well as anything else. Sulphuric acid is preferable. Two teaspoonfuls of the latter to 1 gallon of water will prevent the formation of lime soap. This soapy material is to be found underneath the cakes of wax when cooled. If this be removed and treated with acid a good deal of the wax can be recovered. These remarks do not apply where a wax-extractor is used. A solar extractor should be in every apiary.

As the arts and sciences advance, the uses of wax are always on the increase. It is still a question if that wonderful wax-working insect, *Apis dorsata*, would not pay to be introduced in this State.

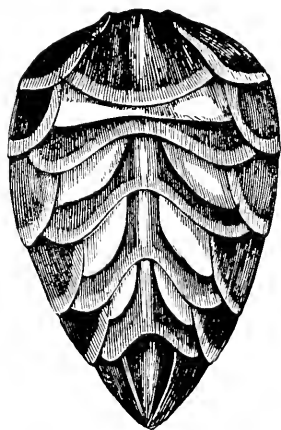

Abdomen of Wax Worker.

Showing ventral plates only, six in number, the four central ones show eight wax pockets containing wax scales. The first and last are without said pockets.

CHAPTER XXXV.

THE INFLUENCE OF BEES ON CROPS.

"You have a splendid crop, thank God!" was once said at a harvest supper in the Old Country. "What do you thank God for?" was the reply; "didn't I put plenty of manure in the ground?" If we were to put the question, "What are the chief necessities in the production of your crops?" to all the agricultural societies in the States, many of them would probably answer, "Deep and frequent ploughing, the loosening of the soil, keeping the surface well open, judicious manuring, good seed, freedom from weeds, and favourable seasons." No matter what branch of soil-culture an individual may be engaged in, or what crops he is growing, if he be market gardener, agriculturist, florist, or orchardist, the answer, perhaps not in as many words, would be tantamount to the same. The florist and orchardist would add pruning to their catalogue of the necessary requirements. There are tiny agents employed by Nature that dwarf into utter insignificance all the modern implements of husbandry that are in use to ensure "an abundant and heavy harvest." They are seldom taken into account. These tiny agents are an absolute and concomitant necessity for the production of a crop from any member of the vegetable kingdom. The wind and insects are the agents employed for the fertilisation of crops. The two mentioned are the chief, but there are many others of a subordinate character that Nature frequently enlists to aid in the reproduction of the various members of her plant life. The members of Nature's great vegetable army, in regard to their method of reproduction, have two distinct characteristics by means of which they perpetuate their species and varieties, *i.e.*, some are termed flowerless and others flowering plants—*cryptogamic* and *phanerogamic* respectively. Ferns, mosses, seaweeds, &c., are included in the former, but this article has nothing to do with the reproduction of these cryptogamic plants.

Flowering plants, "the herb yielding seed and the fruit-tree yielding fruit after its kind, whose seed is in itself," are the portions of the subjects I wish to deal with. How herbs yield seed and

how fruit-trees yield fruit, appears strange, if we take into consideration the too frequent destruction of the very many agents, more especially the honey bee, that husbandmen in their blind ignorance are constantly waging war upon. "Smear the trees with poisoned honey," "Destroy the bees of the bee-farmer," or "Burn down the tree where there are bee nests," is the too constant advice given by well-educated fruit-growers, but whose knowledge of bee life is far below zero. Nature has been very lavishing in the distribution of her varieties of indispensable helpmates for the land culturists. The tiller of the soil, after the necessary preparation of the land and all the mechanical aids he brings to bear in assisting the earth to yield her increase, and to produce her crops of cereals, vegetables, and fruits for our imperative use, is solely dependent on outside agents, over one of which he has little or no control. I refer to the wind. In insect agency—of these the principal ones are members of the bee family—he can to a certain extent regulate the supply and demand.

The chief agent employed in the fertilisation of the seed that supplies us with the "staff of life" is the wind. Seeds that are so fertilised are termed anemophilus. But life's luxuries—cherries, plums, and other drupes or stone fruit generally—are fertilised by insects; so are the pomes and all apple-like fruits, citrus fruits, berries, &c. Insects make the labours of the fruit-grower a great certainty—make "assurance doubly sure." Without them all his labours would end in a wretched and miserable failure. We are entirely dependent on insects for the fertilisation of our fruit. Seeds or fruits that are thus dependent on insects for reproduction are termed entomophilus. It is a true and wise saying, "No bees, no fruit." Nothing can be more fallacious than the idea that bees injure crops. There is no more widely entertained opinion among fruit-growers and florists than this. Let a fruit differ somewhat in form, tint, flavour, or general appearance from that of the same crop on the same tree, the innocent bee is accredited with having "innoculated" that particular member of the fruit of that tree. I have heard it said, when examining the fruit on a navel orange tree, where the characteristic mark in some of the fruit was very prominent and in others almost inconspicuous, that the latter was caused by *bees*; and this, too, from men of prominent positions in the agricultural world. If an ornamental flowering plant produce a bloom differing somewhat from the rest of its kind, or sport, the bee is said to be the culprit.

Jam-makers, during preserving seasons, very frequently, when the bees come to clean up the waste syrup, and perhaps steal a little from that not found in the waste tub, cause, by means of boiling water, the destruction of millions of these tiny and industrious workers. Men do not understand that if they were to carry out this slaughter of the innocents with too high a hand, they would have little or no fruit to preserve. It may be interjected that butterflies, moths, beetles, and other members of the insect world fertilise our fruit crops as well as the bee family. True; but they leave behind them whole armies—well-drilled armies—of caterpillars, grubs, or maggots. These destroy the very fruit their parents fertilised, defoliate the trees, cause sickness inducing disease, and ultimately the destruction of the orchard. This cannot be said of the bee. Butterflies, &c., fly from tree to tree and orchard to orchard, laying a few eggs here and a few there. It is difficult to confine or introduce them to a district, and when once there it is a greater difficulty still to exterminate them. Insect fertilisers, other than bees, are nearly all solitary and houseless wanderers, and it is a work of patience and labour to mitigate their ravages, and the little good they may do as fertilisers is greatly counterbalanced by the great mischief wrought by their offspring. On the other hand, bees are social, are domestic, are under control, can be increased or diminished according to requirements.

The advent of a bee-keeper in a fruit-growing district is not a blessing in disguise, but a blessing so prominent that a traveller passing through a fruit district by express train during fruit harvest can always see the handiwork of the bee. The orchardist cultivates the trees from which the bees get their pollen and the bee-keeper his honey harvest, and the fruit-grower in his turn is almost entirely dependent on the bee-keeper for his harvest of fruit. Between bee-keepers, fruit-growers, florists, &c., there is a mutual provident association so strongly united that to repress the former is to destroy the profits of the latter.

Another interjection: "Have not the bees been the chief agents in the destruction of some of the best varieties of melons, pumpkins, cucumbers, and other members of *Cucurbitaceæ* or gourd order that have been introduced into the State?" If by this it is meant that certain varieties of these very useful vegetables have entirely disappeared, and have been replaced by inferior ones, the result of cross-pollinisation, the bee for a while must plead guilty, because the whole of the order *Cucurbitaceæ* is entomophilous, and the bee plays the chief part in the cross-pollinisation. The fertilisator

of the whole of the gourd order is so easily controlled, that the bee must be acquitted, although he has pleaded guilty, on the ground that the growers have wholly contributed to the result by their indolence, carelessness, or ignorance. A little ignorance in these matters is far more dangerous than the proverbial little knowledge.

The essential organs of plant-life—that is to say, those organs wholly contributing to reproduction—are so prominent in the larger type of blossoms, such as pumpkins, fuchsias, the flowers of most fruit-trees, maize, &c., they can be seen with the naked eye and their functions easily demonstrated by or to anyone having the “observing eye.” There is no necessity for a costly set of microscopic appliances, nor scientifically fitted-up laboratories, nor years of apprenticeship “to boot,” to become an expert in the use Nature makes of the essential organs of flowers. The primary function of flowers, and, indeed, the only use flowers or blossoms are to the trees that bear them, is that of reproducing or perpetuating its species. The most essential parts of a flower are the stamens and pistil. These essential organs are most vigorous, healthy, and free from blemish in the earlier parts of the day. Just after the corolla bursts, these unfurl, the anthers become distributive—*i.e.*, the pollen they contain is sufficiently matured to be wafted by the wind, or gathered by insects or other agencies for fertilising purposes—and later the stigma becomes receptive. The atmosphere during these early hours, in spring time, as a rule, is characterised by a dead calmness, or at the most by gentle breezes. This calmness is most beneficial, and is a highly necessary agent in ensuring successfully the fructification of entomophilous fruits. The more frequently the bees trip to and fro from home to orchard and orchard to home, the greater and better are the results that follow their labours.

I have used the terms bloom, flower, and blossom indiscriminately. They are synonymous. The two former are generally applied to the flowers on ornamental plants, and the last to fruit-trees.

To understand how the all-important work of fertilisation is carried on by bees and other insects, it will be necessary to glance over the accompanying diagram, and have a slight knowledge of the functions each portion of a bloom has to perform.

The pistil (3). Diagram I, is divided into ovary (4), style (2), and stigma (1). The stigma is the end of the style turned inside out. It has four very peculiar characteristics: First, it is skinless;

secondly, it is adhesive—if it be applied to down or a light feather it will adhere to it; thirdly, it is porous; and in the fourth place, it is covered with a lot of hair-like hooklets. These peculiarities in the stigma form important parts in the economy of fertilisation, taken in conjunction with the offices performed by bees in relation to fruit and the reproduction of plant-life. The style is traversed internally by a canal forming a tube, which is the connecting link between the stigma with the ovary.

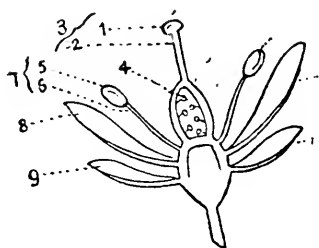

1. Stigma. 2. Style. 4. Ovary. 1, 2 and 4 combined form 3, Pistil, or the female portion of the flower. 5. Anther. 6. Filament. 5 and 6 combined form 7, Stamens, or the male portion of the flower. 8. Corolla. 9. Calyx. 8 and 9 are the floral envelopes, and are for the protection of the Pistil and Stamens.

In this diagram the ovary (4) is said to be *superior*—that is, above or within the parts 8 or 9. Whilst the blossom is in bud-form it is enveloped by the corolla and calyx, and cannot be seen until these parts are mature or fall.

The stamens are the masculine reproductive organs, and, like the pistil, different portions of it receive different terms—the anthers (5) and filaments (6). The filaments are thread-like appendages, and are generally attached to the base of the corolla, and not to the ovary, as in the case of the style; neither is it tubular. Their office is to support the anthers, and to keep them in their proper position. The anthers, generally two in number, are situated at the summit of each filament. They are of different forms, according to the class of fruit borne by the tree—round, angular, elongated, or sometimes twisted. When the blossom first opens, the anther is usually of a bright colour, generally yellow. Its upper surface is a flat, smooth disc. As the day advances, and the anther matures, each one opens with a longitudinal slit its entire length. It can then be seen that each anther is a pocket or sack filled with pollen—a very fine dust-like flour. Pollen is of a variety of colours—white, red, pea-green, &c., are of frequent occurrence—but the predominating colour is some shade of orange. By watching at the entrance of a bee-hive, different bees will be seen to enter with pollen of various shades, although they prefer to work on those blooms that are yielding the greatest quantity. By taking a piece of honeycomb containing bee-bread, and cutting a cell filled with it longitudinally, strata of various colours are always to be seen. In flowers that are fertilised by insects, the pollen is usually of a sticky nature. This property is availed of by the bees. By this they knead it into small pellets, and neatly

pack it in the pollen baskets on their hinder legs. The pollen of pumpkins and other members of that family, on account of its non-adhesive quality, they cannot so treat, but carry home in the hairs of their bodies. The pollen of blossoms fertilised by the wind is also non-adhesive. Pollen grains are of various forms, according to the class of plant it is taken from.

The essential organs of a flower are somewhat akin to one another, and a cursory glance by a casual observer is more than likely to regard the stigma and anther as similar organs and of equal value in the economy of plant-life. Well, in one sense, they are, just as the sexes in animal life are dependent on one another for the continuance of the species of variety. The dissimilarity in the essential organs in a flower is very marked, and their functions wholly distinct. The anthers are the pollen bearers, and the stigma is the receiver. It is highly important that the distinctions should be studied by all engaged in plant culture; and now, as agriculture and horticulture is so spread over the schools curriculum, the attention of all should be drawn to it.

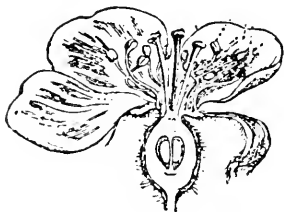

11. The numbers, or parts, are the same as in Diagram 1, but the ovary appears to occupy a different position. In such flowers the ovary is said to be *inferior*—that is, below or without the parts 8 and 9, and whilst the blossom is in bud is *not* enclosed by the floral envelopes. In the early stages of the development of the bud the ovary is always visible. 1. and 11. are bisexual.

The corolla in many entomophilus plants, *i.e.*, plants pollensed by insects, is frequently of an attractive colour, although some are very inconspicuous in that respect. Its office is, while the flower is in bud, protective, guarding the developing essential organs from injury—acting as a blanket. The corolla is composed of petals; these are frequently detached the one from the other; sometimes they are united at the base, the tips only remaining free.

The calyx is the outer protective envelope. If the corolla acts as a blanket, then the calyx is the macintosh. Like the corolla, it is frequently formed of more than one part. Each separate portion is termed a sepal. It is generally, green, but not always.

The beneficial influence of bees on certain crops, and the imperative necessity for their location within a near radius of fruit-trees, demands more than the usual passing glance. The nearer the home of the bee is to the orchard or fruit garden, the more

frequently can they visit the blossoming fruit-trees. The earlier in the morning the bees visit a fruit-tree when in bloom the more certain will be the act of pollenisation and the resultant fertilisation the more effectual. Bees have been seen on their foraging ground beyond the radius of 3 miles, but these long journeys must be undertaken at the expense of the number of trips made during the day.

Blossoms open at various hours both in the day-time and in the night—the majority in the early morning just after sunrise,



III. Maize.—A is the parts 5 and 6 or 7, the male or staminate flower shown in Diagram 1; and B is the parts 1, 2, and 3, and forms the female or pistillate flower.

some at noon, others in the twilight, and a few species after dark. Some species of flowers are very sensitive to light and darkness, and will only open when the sun shines brightly. Those that open in the earlier portion of the day generally close towards sundown and re-open the following morning, especially if they have not been visited by an insect; those that open at twilight or after dark close at dawn. The blossoms of fruit-trees generally remain open the whole day. During a heavy flow of honey, bees will work for some

time after sunset and well on towards darkness. On warm, calm evenings I have more than once seen bees returning home by the light of the moon, when the latter has been shining brightly. Of course, diurnal flowers are visited by diurnal insects. Flowers that open in the twilight or after are visited chiefly by moths.

Anemophilus flowers (those that are fertilised by the wind) do not close after they have once opened. The anthers being attached to the filament so tenderly, the slightest movement caused by a passing breeze is sufficient to shake the pollen to the stigma. It is the soft, gentle breeze that is efficacious in the fertilisation of cereal crops—wind just sufficiently strong to carry the pollen a few feet from the anther that produced it. At the time wheat and other cereal crops are in flower, when the pollen is mature and hanging loosely in the anthers, heavy wind storms are as destructive as late frosts. Many a crop that has appeared promising enough when in blade, has failed to give a heavy yield, owing to strong winds catching up the pollen and wafting it away into the bush, or elsewhere, where its influence is lost.

The arrangement of the reproductive organs in blossoms vary very considerably in different classes of plant life, and the most casual observer must have noticed the many forms of insect life. Those insects that subsist on the honey they extract from flowers are, in many instances, so constructed as to appear to *fit* the flowers they visit. Again, the construction of certain flowers is only adaptable to the wants of certain insects. The nectary is so situated in different classes of flowers that the honey it contains can only be obtained by the insect *designed* to fertilise them. The length of tongue in moths, butterflies, and bees is well-known, and its length plays no inconsiderable part in perpetuating varieties and species of the vegetable kingdom. In Darwin's work, "Fertilisation of Orchids"—a book everyone interested in the subject should read—he mentions one flower as having a spur-like form, from 10 to 11 inches long, with the nectary situated at its base, and for the purpose of obtaining the honey contained therein there must be an insect with a tongue of an equal length. It appears that this particular orchid is a native of Madagascar. Some orchid hunters, in searching that island for specimens, came across a moth with a tongue of corresponding length—evidently the agent employed by Nature to fertilise this particular plant. Some plants are only met with in particular localities; in other localities, having the same conditions of soil, warmth, moisture, etc.,

they are entirely absent. Again, in localities where some species of plants are found, certain species of insects are also to be met with, and *vice versa*. Thus, particular plants are dependent on certain insects, and particular insects on certain plants, for the propagation of their species.

The pollen-bearing organs are not always to be met with in the same flower. In the melon, cucumber, and other plants belonging to that tribe, some of the flowers are male—*i.e.*, possess stamens only, or have no pistil; while others are female—*i.e.*, possess a pistil but no stamens. The pollen of this tribe of plants is comparatively heavy and viscid. It is therefore obvious, as the two sexual flowers are situated at some distance the one from the other, a foreign agent must convey the pollen from the stamen to the stigma of the pistil of the female flower. In some of the Egyptian palm-trees there are what are termed male and female trees—*i.e.*, the sexual flowers are on separate and distinct trees. The trees are often at considerable distances the one from the other, and the pollen can only be transported by insects. The variegated laurel (*Aucuba japonica*) is another of these dioecious sarubs, and of course, like the palm-trees referred to, the male and female flowers are on different trees. It was introduced into England many years ago by the Dutch from Japan. It so happened that the plants first introduced were female plants, or in other words bore female flowers only. There were no pollen-bearing flowers, consequently no seed could be produced, and propagation was carried on by cuttings only. Some years afterwards a Mr. Fortune introduced some male plants. These were planted in close proximity to some of the old Dutch ones that had been perpetuated by means of cuttings. The result was that an abundance of fertile seed was produced the following season.

The pollen of the variegated laurel was an article of commerce in the London Covent Garden market.

The length of time the pollen of some of the palms and laurels retain their vitality is remarkable. The pollen in other varieties of plants must be utilised soon after it is discharged from the anther or its procreative property is lost.

The quantity of pollen grains discharged from flowers is something enormous, especially in those plants where the sexual flowers are on different trees. The flowers on a Chinese laburnum (*Wistaria chinensis*) were calculated to contain no less than twenty-seven billions of pollen grains.

From these illustrations it will be noted the utter impossibility for certain plants to be perpetuated from seeds, or to produce fruit, without aid from an agent outside themselves. Here the bee comes in to play its important part in our fruit-crops.

What I have said in relation to the distribution of the sexual flowers in the variegated laurel, palms, &c., is equally true and holds good in the blossoms of our orchard fruits, with this exception—that they have not separate sexual flowers, but the sexual organs are in one and the same flower. Notwithstanding this, the stamens mature, and the pollen is distributed some time (in some cases days) before the pistil, or rather the stigma, is sufficiently developed to receive it. Thus, while the male organs of some of the flowers have perfected, maturation in others is still progressing, and so with the pistil; so that the fertilisation of the fruit blossom by its own pollen is as impossible as if the reproductive organs were on different plants, or at least on different flowers on the same tree; therefore a foreign agent is as essential to transport the pollen from hermaphrodite flowers as from that of diœcious. The oft-quoted aphorism, “Nature abhors a vacuum,” was reconstructed by Darwin into “Nature abhors perpetual self-fertilisation”; and the various ways Nature has arranged the pollen-bearing organs is Nature’s safeguard against what is termed in-and-in reproduction, and cross-pollination ensured. Cross-pollination has long been recognised in the economy of the reproduction of members of the vegetable kingdom. It was known as far back as the time of Herodotus. He describes the process of the transference (caprification) of the pollen from the male tree to that of the female, by which means a crop of dates was ensured on the Egyptian palms.

Some early-blossoming trees seem to burst forth suddenly, especially pears. In looking through a truss or a bunch of pear blossoms on the same stem that have just opened, it will be noted that the parts perfected are the calyx, the corolla, and the stamen. The pistils are still undeveloped. After the anthers have discharged their pollen, the ripening of the pistils commences; and by the time the stigma is receptive, there is no pollen from the first opening blooms wherewith these early-maturing blossoms can be fertilised. It is obvious that the all-important pollen must be obtained from some other flowers, or there will be a failure in the crops of the tree that has so blossomed. I shall point out further on that the pollen from any source, if the bees were to convey it, will be as great a failure as if the stigma were entirely

deprived of that fertilising influence. Seeds must be fertilised by pollen from their own species. A newspaper clipping—I think from a Brisbane paper that I have now in my possession—says: “If one were to plant 20 acres with Stone Pippin apples, or with Cleopatras, or with Duchess pears, and no other kind of apples or pears within a half-mile, it is not at all likely that there would be any fruit. (*If there were trees within the radius of half a mile, the experiment would not be a failure; if bees were within two or three miles they would carry the pollen, but the crop would be light.*) It is necessary to have a few of some other variety of apple or pear, which bears blossoms at the same, or about the same time, and then they will pollenate each other, so that both varieties will bear fruit. Bartlett pears are fertilised by Duchess d’Augoulême, Easter Beurré, Beurré d’Anjou, and by others. The thing required is to have the flowers of each variety mature at nearly the same time. There is at least one instance in this State where a large block of apples of one kind has been planted for many years, and has never borne any fruit, although the trees are very strong and healthy, and bear perfect flowers every year. The pollen is ripe before the pistils are ready to receive it, and by the time the pistils are mature the pollen is all gone.” The italics in this quotation are mine. I once read in an American paper a similar failure in connection with cherry orchards, where the bees had all been removed because they were accredited with eating holes in the ripe fruit, and thus reducing their market value. After the removal of the bees from the district the trees gave no, or at the most but a slight, crop of fruit. After about three years, the bees were returned to that district, and the trees went on bearing as heretofore. With ignorant men, the poor little bees get the credit of a host of evils they never do. If all orchardists knew the value of bees, apart from that of honey producing, no orchard would be seen without them.

Every grain of seed requires a grain of pollen to fertilise it. By removing the husks from a corn-cob whilst in a green state, a fine silken thread will be seen attached to each maturing grain. It is the organ of reception, and it is absolutely imperative for a grain of the dust from the anther (the flower on the top of the corn-stalk) to fall or be conveyed to the point (stigma) of each silken thread. In a mature cob of corn, misses in the rows of grain are often observable. This is caused by the pistil not having received its necessary grain of pollen; and caused either by an injury to its stigma or an insufficiency of pollen. Deformed fruits

are of common occurrence, more especially with apples and pears. This is caused by imperfect pollenisation. It is clearly observable in the accompanying diagram: a section of an apple showing the five sections of the ovary, with four of the ovules of seeds, marked *f*., perfectly fertilised, and on the sides of the fruit, where the seeds are so fertilised, it is perfect in form. The unfertilised seed in the ovary, marked *u*., has caused the deformation in the fruit. If, in four out of the five sections seen in the ovary of apples and pears, the seeds therein are perfectly fertilised, the fruit is likely to develop, although it will be a deformity; but if only three be so fertilised the fruit seldom comes to perfection. The light seeds, those without kernels, that are frequently met with in pumpkins and other members of that family, are caused in a similar way—*i.e.*, by the bees being prevented by some cause from supplying a sufficiency of pollen to do the whole work necessary in reproduction.

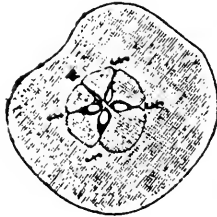

The matrimonial ceremonies—how they marry and are given in marriage—is the portion of the subject I here wish to deal with. The arrangements of the sexual reproductive organs and their various functions have already been dealt with.

There is nothing more interesting in the life-history of the vegetable kingdom than the methods and agencies of its reproduction. Fascinating as it is, it is too often the stumbling-block of amateurs, whose love of plant-life carries them to look into the deeply-hidden mysteries of this absorbing subject. The sexuality known to exist in blossoms, their matrimonial instincts, their marriage ceremonies, their domestic ties, their methods of raising and perpetuating their families and co-relations, the officiating and conjugating priests, and the agreement between the contracting parties, are all more or less like fairy tales than actual facts.

Let us enter into one of the temples of Nature and have a look at the matrimonial instincts of plant life. How their ceremonies are conducted; how species and families of plants live and

perpetuate; who are the conjugating and officiating priests, and how the contracting parties faithfully carry out their marriage vow of for better or for worse, only when Nature performs these ceremonies it is all better and no worse; especially is it so when man has taken in hand the higher development of certain varieties of plant life to be more adapted to his wants and needs.

In the higher members of the plant-world there is a very great difference between pollen cells and the ovules (little eggs) that are joined to form new individuals. The former of these is smaller than the latter, and more active—it is the male; and the latter, of course, is larger than the former, is composed of richer matter, and is passive—it is the female. From the nature of these ovules, these passive eggs, they cannot become seed or plants until they are united with and fertilised by an active or live pollen grain. The essential organs in blossoms known as anthers contain these active cells, the cells of life. The pistillate organs contain the passive cells, the cells of matter. The pistil in apples, pears, or other fruit blossoms is the bride, the stamens seen in blooms of like trees are the bridegrooms, and the honey-bee is the licensed officiating priest who is to perform the connubial ceremony. Let us for a while watch these officials of Nature carry out some of their highly important duties. Bearing in mind, whilst so watching, the table of kindred and affinity wherein it is stated a man may not marry his grandmother or a woman her grandfather, etc., and note how these insects, without a written law, are never parties to close or blood relations intermarrying; neither does their natural instinct permit them to perform unnatural alliances. They will not attempt to marry an orange to an apple, or a pea with a pumpkin, or a pear with a cherry, and so on; neither does Nature permit them to marry the male of a blossom with a female of the same bloom. Such alliances in the higher plants are repugnant to all concerned. Nature's motto in the vegetable kingdom, as well as in the animal, is, especially when aided by the intelligent hand of man, "upward and onward." If the pollen of a blossom were transmitted to the carpels of the same, the result would be degradation, and the loss of some of the choicest varieties of fruit and vegetables we now raise from seed.

The ovary is composed of one or more carpels. The ovary of an apple bloom has five such carpels. In the mature fruit these are termed the core.

In the early spring mornings, when the bees issue forth to go in quest of stores, the first thing they gather is pollen. It is the

first product the blossom yields, even before it secretes its nectar (honey). In their eagerness to be first on the foraging ground, they leave home at about sunrise. If they have selected an orange to gather their stores from, they will keep upon orange or some other member of the citrus tribe during the whole of that peregrination. Tumbling about in the cup of the flower amongst the anthers, they gather up in their fur numberless grains of these life cells, pollen grains. Head, thorax, abdomen are all more or less dusted with it. Whilst gathering it, and whilst on the wing from flower to flower, and tree to tree, they are busily engaged in packing it in the pollen baskets that are situated in the upper part of the hinder legs. As the day warms, the blossoms unfurl; the central whorls develop, and the stigma becomes receptive. The

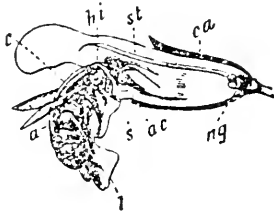

Bee in the act of fertilising.

- a* Anther cell.
- ac* Aborted Cell.
- a* Connective.
- hi* Hinge of filament.
- ca* Calyx.
- st* Style.
- l* Labium.
- ng* Nectar gland.
- s* Stiff attachment of filament.

bee, eager in her duties to supply her home with abundance of food, both for the young brood and winter storage, commences her search for honey. In the early morning there is little or no nectar secreted; but as the warmth increases so the flow of honey advances. Anxious to fill her honey-sac whilst gathering the pollen she enters the blossoms where she will find the greatest abundance of her favourite winter storage, and thrusts her tongue down into the nectaries of the blooms. To get at the honey more readily she lies on the top of the essential organs, and brushes to and fro on the stigma. Whilst thus engaged, the fur on the various parts of her body retains pollen grain; those on her breast come in contact with the stigmas of the flowers. Having commenced working on an orange for pollen she will not go to an apple or aught else for her honey. Citrus fruits supplied the pollen, citrus fruits must provide the honey. Why? Because Nature has endowed the bee with that intelligence—there is no other word so applicable—to know if she were to take the pollen of an orange to the stigma of an apple, as far as fructification was concerned, her labour would be useless. Pollen from one species of the vegetable kingdom can seldom be used successfully, even by artificial means, to

fertilise that of another species. When it is successful the result is a hybrid, the descendants of which cannot be perpetuated by seed, but only by cuttings, graftings, &c. Bearing in mind the characteristics of the stigma, its adhesiveness, and its hairy hooklets, the bee's breast, coming in contact with the latter, it acts as a comb or brush, and aids in detaching the pollen grains from the fur of the bee. These grains fall on the adhesive stigma, and are retained by its viscidly. When this contact takes place—sometimes at once, at other times it may be delayed for hours—the cell of life starts into activity by throwing out a pollen tube, which at once goes in search of the cell of matter contained in the passive ovule. To accomplish this the pollen-tube makes its way down the style which connects the stigma to the ovary. The silky threads that protrude from a cob of corn, delicate as they are, are not too fine or too long for these active tubes to penetrate. The style of the orange, etc., is also easily pierced. The ovule, or young seed in the ovary, contains the embryo of the future plant. The pollen-tube having found its way to the ovule, the union of the respective cells takes place. The ovule thus receiving the “germ of life,” the infantile development of the future orange or other tree, as the case may be, commences.

When the contact of the two cells has been accomplished, the calyx withers; the corolla, with the dead remains of the stamens adhering thereto, falls to the ground; and the pistil in most cases is absorbed in the fruit.

These developments will be better understood by reference to a peach or other stone fruit. When the ovule has thus been fertilised, the seed, or, as it is generally termed, the kernel, is the first to develop, followed by that of the hard shell surrounding it, the stone. At first both kernel and the shell of the stone are in embryo; as they advance in age the shell hardens, and, at the same time the flesh increases and matures with the gradual expansion of the outer skin. We then say it is ripe, *i.e.*, its flesh has become useful as food to man, and the seed capable of reproducing its species.

Now, it must be obvious to the most casual reader that the bee has played the imperative part in the production of these fruits. Nothing else could have accomplished it so effectively and with such beneficial results as the little busy bee. Other insects live on honey and pollen, but no other insect is endowed with the instincts of social bees. Bees work so systematically in cross-pollenisation. They make no mistakes. They will carry pollen

from variety to variety, and sometimes from species to species, but not from order to order. After a foraging excursion they are never seen to return to the hive with different varieties of pollen on their bodies. In examining a cell of pollen in the hive, each stratum is seen to belong to distinct species of the vegetable kingdom (not varieties). With other insects that only feed on pollen grains, they consume it on the anther whereon they alight. It is for immediate consumption for each one's present wants. Where other insects visit one blossom, bees will visit a hundred. Watch a butterfly on a flower and compare its actions with the rapid movements of a bee, and judge for yourself which is the better worker of the two. You must bear in mind that in early spring, flowers, and especially fruit blossoms, mature rapidly. Of the essential organs the anthers in most cases come to perfection first, and are the first to die. The pollen is distributed in a very few hours, and its vitality in most instances is short-lived. The pistil with stigma and its carpels are very delicate organisms, therefore liable to all kinds of accidents. When we remember the chief characteristics of the stigma, it will be seen that a dust storm is capable of clogging it, and thus prevent fructification. A dust storm in early spring has a deal to answer for in the failure of fruit crops; so has heavy rain, wind, or anything else that may bruise these very delicate portions of the flower. From this will be seen the imperative necessity for some rapidly-moving agent to convey the perishable pollen to the highly-sensitive stigma. The numerical strength of these agents must be in proportion to the quantity of work they are expected to do, or the areas under fruit culture they are to visit. If bee-keepers and their bees were banished from Australia there would be fruit, but in what quantities? I have referred elsewhere to the mischief done by butterflies and some other insects, but no such mischief ever follows in the wake of the bee. Fertilisation by agents other than bees would be sufficient to perpetuate species of fruits, and occasionally to produce varieties; but to fertilise heavy crops sufficient to feed mankind they are too inactive, and the mature insects numerically too weak. If adult butterflies, &c., were equal in number to adult bees a famine would follow in the track of their larvæ as disastrous as that caused by the armies of locusts that have been known to sweep over the Holy Land in times past. Numerous insectivorous birds and other animals almost live exclusively on insects, their eggs and larvæ, and thus their injurious ravages are somewhat checked.

How wonderfully has Nature protected this invaluable insect, the bee—valuable not as a honey-storer, but as a fruit-producer. Practically the adult bee has no enemy, if we except the wood swallow, and in the egg and larval stages its home is almost impregnable to invaders. Of course, like the human family and other animals, it is liable to the “ills that flesh is heir to.” In a state of nature bee ova and larva have one arch enemy—the bee moth—and it is as well it should be so. Bees in a state of nature are a great drawback to bee-keepers. The honey, when obtained, is a fourth-rate quality owing to the quantity of foreign matter mixed through it. That same honey, if stored in the frames of the hives of practical bee-keepers, would be worth four times as much as when obtained as bush honey. But this is a digression. To the careful bee-keeper, enemies, not diseases, to the eggs, larva, and young bees are rarely known. The bee-keeper having his stock under control can, with the greatest ease, regulate the supply and demand.

No district can be overstocked with bees, if we regard them as fruit-fertilisers only, but as honey-gatherers it is another matter. The greater number of bees kept in an orchard or fruit district the more rapidly is fertilisation carried on. Once the bee has carried the pollen to the pistil, the act of fructification being successful, the development of the fruit is assured—the fruit has *set*. A few days after the bloom of the trees has disappeared the infant fruit can be seen in the early stages of growth. Standing near an apple, orange, or other tree, when the fruit is in its earliest stage, and a gentle wind shakes the branches, you will sometimes hear the fruit falling in hundreds, or if the tree is shaken the same results will follow. In walking through an orchard in spring-time young fruit just formed are always seen in greater or less numbers scattered on the ground. The premature falling of these fruits is, generally, the result of imperfect fertilisation, caused either by slight injuries to the stigma or an insufficient number of bees to discharge the duties Nature requires of them, *i.e.*, fructification. The same results will follow if the blossoms after pollenisation are frost-bitten, or cutting winds, or the conditions of the growth or its development checked. All these and others will prevent the young fruit progressing to maturity. Sometimes the crop of fruit will be too heavy for the tree to carry, *i.e.*, the sap is insufficient to supply the young with the nourishment required.

CHAPTER XXXVI.

ARTIFICIAL FERTILISATION.

“What man has done man can do,” is a very wise old saw, or a truism that cannot be disputed; and what insects have done, in many instances man can do to his advantage and the advantage of his race. These tiny workers are accredited with unfolding and throwing light upon many a discovery, and man is said to have received some valuable and useful hints by noting the methods or the results of some of their habits and constructions. Science is said to have taught us that insects have played no inconsiderable part in the development of the plant world; how the ocean was the birthplace and cradle of vegetable life, or how the early aquatic forms of it developed their terrestrial representatives, and these again from the lower forms of fruit and grain to the highest types we now enjoy. Whether it was by those disputable points “spontaneous generation” or evolution from “mere specks of green jelly” seen floating in the sea, and the variations, ensuing from their battling and struggling for life, and the “survival of the fittest,” or the ones naturally selected and taken by man under his care and guardianship, matters not, as far as the power we now have in producing variations in the vegetable kingdom, and from these selecting the ones that will administer most to our medicinal and dietary wants, or those having ornamental colours and forms to please the eye and decorate our surroundings, making life worth living, is immaterial to this portion of our subject.

That the bee is, by the part she plays in fertilisation, our greatest fruit-producer, must be conceded by those who have looked into the subject, and she is such an absolute adjunct to the orchardist and others, that to interfere with the bee-keeper would be suicidal to all who are engaged in the reproduction of vegetable life.

I have mentioned that bees have been accredited with the destruction of some of our choicest annual vegetables by inoculation, and that, to a certain extent, they are guilty; but the want of knowledge in men who are engaged in the work of supplying or cultivating such vegetables is the true cause of the disappearance or injury to the varieties referred to. I have said the inoculation of annuals, for it is immaterial how the fruits and seeds of trees and such-like that are reproduced by grafting, budding, cuttings, offsets, &c., are inoculated or cross-pollenised, because the immediate fruit or flower is in no way improved or injured by it,

Cross-pollinisation does not show itself in the fruit or flower that has been so fertilised, but in the plant that is produced from that cross-pollinisation. You may discern an egg that has been laid by a Cochin hen that is running in a yard of mixed fowls by its colour, but from the egg you cannot tell what the cross-bred chick will be; that will only show itself in the progeny resulting from the crossing. So it is in cross-pollinisation—the blossom or fruit does not show it, but the crossing is seen in the succeeding generation.

The way bees transfer the pollen grains from the anther to the stigma has been already described, and the simplicity of the method must be apparent to all.

The action of conveying pollen from place to place is in no way injurious, neither does the instrument used interfere with its vitality. An artificial instrument is as useful to convey it from flower to flower as a natural one, and the action would produce the same result. We have seen that pollen removed from the male flower and placed on the receptive organ of a female flower produce fertile fruit. In members of the pumpkin family the sexual flowers are situated on different parts of the same plant, and the sexuality of the blossom is very readily distinguished. Taking that class of plant for our model, let us see how easily artificial fertilisation can be accomplished. The first step will be to secure in both sexual flowers immunity from visits of bees and other insects. To do this, if the same strain of pumpkin, &c., is to be retained, select two blossoms (male and female) on the same vine whilst in bud form—that is, some days before the flower opens. Enclose them with fine mosquito netting. Gauze-wire is better, because it cannot come into close contact with the opening flower. Care must be taken that the netting is sufficiently large to permit the full expansion of the flower. When the essential organs are mature—that is, in the case of the male flower, when the pollen comes away freely with the instrument used in its removal; and in the female when the central organ has a viscid appearance—remove the net covering from the male bloom first, and with a soft downy feather, or, better still, a small camel-hair pencil (brush), gently brush over the essential organ. If the instrument used be dark in colour it will be noted that a quantity of yellow dust (pollen) is adhering to it. Carry the brush gently to the female flower, remove its covering also, and softly apply the brush with its pollen to its central organ. As soon as the operation is completed be sure to re-cover the bloom that has been artificially fertilised. To

ensure male and female bloom maturing at the same time it is necessary that male buds in various stages of development be selected and treated as above described.

The imperative necessity of artificially fertilising cucumbers, &c., or fruits that are grown under glass or indoor gardens, has long been recognised. In colder latitudes, where early cucumbers, melons, &c., are at a premium, the first morning duty of the man in charge is, as soon as the sun is sufficiently high, to go the rounds of his forcing-pits to overhaul the vines therein, note every female blossom, and taking a male flower in his hand, dust the pollen from it to the stigma of the receptive bloom. Every stigma so treated is morally certain to produce a fruit. But every one neglected is certain to be a failure as far as the production of a fruit is concerned.

What has been said in relation to pumpkin-fertilisation holds good with every other flower that is fertilised by insect agency, only the smaller the flower the greater care must be exercised, and the more patience necessary to ensure successful results. One fact must always be remembered—every seed requires a grain of pollen to ensure a plant from the seed sown; therefore be not parsimonious in the application of pollen, and also remember “enough is as good as a feast.” The care necessary is to apply the brush with its pollen to the receptive organ with as soft and gentle touch as possible.

When hybridisation or cross-fertilisation is required, the same methods must be followed as in the case of pollenising from one variety to that of the same; only whatever species or varieties it is proposed to cross for the reproduction of something new, the selection of the sexes, *i.e.*, the stamiferous and pistiliferous, must be free from disease, vegetable blights, or parasites of every kind. The pollen from the anther must be removed from the one species or variety to the stigmatic portion of the one it is desired to hybridise, and *vice versa*. Nevertheless the results from these crossings are often more successful than where this interchange is not used. The constitution in the sexes of two plants greatly differ; the pollen-bearing essential organs in one plant being far more vigorous than in that of another; and the same differences are met with in the receptive organs of distinct species or varieties.

If hermaphrodite or bisexual blooms are to receive cross-pollenisation, they too must be guarded from the action of insects. The operation is a very delicate one. The flower-buds selected from which to transfer the pollen must be carefully watched, and

as the anthers develop they must be lightly removed without injuring the stigma in the slightest degree, a finely-pointed pair of scissors being used for the purpose. Stamens, as a rule, develop earlier than the pistil.

The pollenisation of double flowers or blossoms is another delicate work, and needs extra patience. The extra number of petals in these is the result of abnormal treatment, which causes the stamens or pistil, and sometimes both, to fall back to flattened leaves.

Botanically speaking, all flowers are modified leaves. When the stamens only have undergone this transformation it is possible to obtain seeds from double blossoms. The petals are removed in the same manner as the anthers from bisexual flowers, and the result is often effective, *i.e.* fertile seeds are produced. Of course, the anthers from a single or semi-double flower supply the pollen; but where both stamens and pistil have undergone the transformation to petals, perpetuation by seeds is altogether out of the question. The reason is very patent—there are no organs of reproduction.

It will need a deal of patience and experience to be successful in the more delicate operations named, and the results will be very disappointing, for, as a rule, not one seed in a thousand or more will be an improvement on the original. Now-a-days the plant world has a tendency to go back to some earlier form.

These final remarks do not apply to the cultivation of pumpkins, melons, cucumbers, &c. The method of artificial fertilisation described will always ensure the best strains of them pure for years to come. To keep any choice strain in health and good heart, a pollen-bearing bloom of the same strain should occasionally be introduced from another district; a plant or seed would be better if the desired strain had also been secured by artificial means. Such plants should be grown away from the main crop, and the anthers and pistils used for reproductive purposes carefully guarded from any chance of the pollen from an undesirable strain being conveyed to the stigma of the plants to be used for seed purposes.

The pollen in all cases contains the cells of life, and ovaries in the pistillate blooms contain the cells of matter. It is the union of these two cells, that of life and that of matter, which produces fertile seeds.

Remember, in selecting for cross-pollenisation purposes, natural orders cannot be used to produce new or fresh orders; nor

genus with genus to produce new genera. Species with species will sometimes produce hybrids, but the result is that these mules are seldom capable of being reproduced from seeds, and when such is the case, they die out after one or two generations of sickly vitality. Nevertheless, hybrids so produced can be perpetuated by grafting, budding, &c. Hybrid annual seedlings seldom last for more than one season. Nature has always a tendency to revert to the original form from whence it sprung. In the ages gone by, whatever may have been the natural law as it regards the "development of species," the law now, in these later times, appears to have been repealed, not only in that of species, but even largely in that of varieties. Hybrids and varieties, both in the vegetable and animal kingdom, when removed from the fostering care of man, degenerate gradually but surely to the prototypes from whence they came.

I notice that I have used the terms "natural orders" to produce new orders, "genus" to produce genera, &c.; this may not be equally clear to all readers. But let us take an illustration from every-day poultry-yard life. Everyone engaged in it knows it is utterly impossible to obtain a hybrid between a duck and a fowl; while a hybrid between a Muscovy and an Aylesbury, or a Pekin duck, are of frequent occurrence, but these mules so produced are never reproductive amongst themselves, because the Aylesbury is a different species to that of the Muscovy. Again, if an Aylesbury duck be crossed with a Rouen, the cross-bred descendants are as reproductive among themselves as their parents would be among members of their own family because they are varieties of the same species. These same rules apply equally well to members of the plant world.

Pollen is the vital agent in the reproduction of all fruit crops, and also the life-cell in the reproduction and perpetuation of all phanerogamic plants, *i.e.*, plants having conspicuous flowers, has already been shown. In this division of the vegetable kingdom it has been pointed out that reproduction is the result of a union between ovules and pollen grains, the former being the cells of matter, and the latter the life-cells. The methods or agents employed by Nature to bring about this union in plant-life are various. In nearly all of them, excepting that of the union that is produced by insects, it is extremely haphazard. Indeed, the union that is brought about by other insects than bees is almost as fluctuating as that of other agencies, such as wind, &c., if we except the bee family, and this family must be gradually narrowed down to the

hive bee as the one *par excellence* in the art of fertilisation in the production of crops that are useful for food or otherwise to man. In the majority of entomophilous plants it is almost impossible for fructification to take place but by contact with an outside agent, and the only agents designed by Nature by their construction, instinct, and their domestic requirements, are members of the bee family. In all parts of the world there are many thousands of species and varieties of insects. Yet out of this vast army of unique and, in some instances, grotesque forms, having peculiarities adaptable for the life they have to lead, and for obscuring themselves from enemies by resembling the plants, etc., upon which they live, the only ones that collect and store pollen are bees. When other insects carry pollen it is entirely accidental. Bees cannot live without it. It is their bread of life. Their young cannot be nursed to maturity so as to perform the active duties they have to follow without it. In the insect world there are artisans in paper-making, in spinning, in weaving, in basket-making, in house-building, in masonry, in sawing, in carpentry, in upholstering, &c., each of them having tools or instruments specially suited for carrying out the work Nature has intended them to perform; but the only ones having instruments and appliances for gathering, carrying and storing pollen are bees. Pollen is removed from the anthers and conveyed to the receptive organs of flowers by every variety of insect that alights on them during the time the pollen is distributive. By reason of the viscid nature of the pollen grains of most entomophilous flowers it adheres to the body or legs of any insect that may by chance walk over it, and is conveyed by them elsewhere. If it were brought in contact with the pistil of a flower of its own variety, the act of fertilisation would be as efficacious as if it were carried by bees; but these cases are purely accidental, and the successes are only "few and far between." Not so with the bee. Every movement of the bee in the direction of fertilisation is a studied one designed purely by Nature to accomplish the perpetuation of the plant it is at work upon. The anthers of some flowers are so situated as to discharge the pollen only on some very particular spot of the external anatomy of the bee—her head, upper surface of the thorax, chest, tongue-sheath, etc., and the stigma is so placed in the flower that only that portion of the bee that has received the pollen would be capable to effect the purpose.

I have used the term bees (*Apidae*) frequently to indicate any member of that extensive family, but all or every variety of bee although both honey and pollen-gatherers, are not capable of gene-

ral fertilisation. It is only the most highly developed bees (humble bees and honey bees) that are furnished with apparatus suitable for collecting and carrying pollen from flowers of *all* forms or designs. Mason bees and leaf cutters (*Osmia* and *Megachile*) have the ventral surface of the abdomen furnished with long stiff retroverted hairs. These hairs by pointing the "wrong" way brush the pollen from the anthers as the insects pass in and out of the bloom. Grains of pollen become entangled among them, and by this means they are transported elsewhere: the hairs on the abdomen of such insects are beautifully adapted for the fertilisation of flowers having a broad and flat corolla, and the reproductive organs being protuberant or conspicuous. If the female organ be hidden low down in the long narrow tube that some blossoms possess, such as clover, etc., they are utterly incapable of performing the uniting ceremony required to produce a fertile seed.

If the hinder legs of one of the hairy bees, a young one especially, because they are more furry than the older ones, be closely examined when returning home, it will be noted that they are thickly bespangled with grains of pollen, to be afterwards transferred to the pollen baskets; it is these stray grains of pollen attached to the hairs that are utilised in pollinating the receptive organs of blossoms. The hairs on the hinder legs of one of the humble bees (*Bombus terrestris*), the arrangement of the pollen-gathering hairs, are carried out with greater perfection, but the hairs are distributed in the same regular manner as in the hairy bee already referred to. In the ordinary honey bee (*Apis mellifica*), the pollen-collecting hairs are much better adapted to their designed use than is the case with the two former. The hairs on the tarsus of the legs are arranged, not in the irregular way as is the case in that of the humble bee, but in eight or nine regular rows. This regularity of the arrangement of the hairs of the pollen-brush enables our domesticated bee to brush the grains of pollen from the anthers far more effectively than is the case with any member of the whole species. Whilst she is at work on the flowers, and also in mid-air, she is constantly transferring those grains to the pollen baskets, but *all* are not stored therein; some escape, and it is these escapees that do the work of fertilisation.

I think I have pointed out clearly that there is no insect so highly developed for carrying the imperatively essential pollen from flower to flower as the hive-bees. Their intelligence, their energy, their social habits, and the ease with which they are kept under control stamp them at once as no mean ally to the tiller of

the soil. The practical bee-keeper in any district is a confederate that should be welcome to all. The indiscriminate destruction of native honey-producing flora should be carefully avoided, because most of the plants that I have referred to in these articles are exotics, and these as a rule bloom in the early spring, and the pollen and honey obtained therefrom is used in the spring and summer for the raising of young brood. The stores gathered from indigenous summer and autumn flowers are to carry them over the severity of the winter. If there be not sufficient storage when the cold and wet season sets in to carry them through till springtime it will cause an insufficiency of bees to do the work Nature has assigned for them, and the result will be a lesser ingathering of the fruits of the tillers' labours. Landowners and others cannot have the remotest idea of the mischief they are doing to the vegetable kingdom, and therefore to mankind, by the wholesale destruction of our native flora. If these are wholly, or nearly wholly, cleared from the land to the extent of giving insufficient winter storage for our bees so as to decimate them to the extent of their numerical inability to carry on the necessary work of fertilisation, the result will be more disastrous than droughts or floods to our fruit trees, because these would cease to yield their crops.

The sons of our agriculturists and others engaged on the land are instructed in pruning, grafting, budding, and other concomitant adjuncts for obtaining a living from the soil, but none of these are more necessary than an acquaintance with bee-management—the practical part of it at least. Apart from the profits from the sale of the honey, or that used in the home (there is no food more healthy and invigorating), the presence of bees on a homestead are as necessary as the implements of husbandry, nay indeed more so.

There is yet another phase of this subject I intend to deal with. I have confined myself to the influence of bees on fruits: here I intend dealing with them as florists.

It has been advocated by the very highest scientific authorities for the Darwinian theory of the development of species in the vegetable kingdom, that colours and perfume of flowers have been produced chiefly, if not entirely, by the visitation of bees and other insects—that our brightest coloured flowers have been developed from progenitors of inconspicuous tints, and the highly attractive shades of the blooms of to-day are the result of the showy character of, as regards colour, a less-favoured earlier race. The same is also said to be the reason of our highly-perfumed

blossoms; and these two qualities of flowers—colour and perfume—remain dominant as attractive agents to insects. It is further said that the development of colour and perfume has had the effect of educating the visual and olfactory nerves of these insects (bees) in their search for flowers of particular colour or perfume to supply them with their daily bread, whilst they pass over those of a less gaudy colouring unheeding. Again, that the markings in the throat or tube of other flowers act as finger-posts or guide-marks to point the bees in the direction they should take to discover where the nectar is situated that contains their food supply. (See "*The Story of the Plants*," by Grant Allen; "*Cross and Self-Fertilisation*," by Darwin and others.)

I am not going to attempt to prove that bees have not had an influence on the plant world; I have already acknowledge it elsewhere. Neither am I going to try to disprove that they are not cognisant of both colour and perfume; but that some colours and some perfumes are more attractive to bees than certain others does not in any way accord with my experience and years of observation.

I know that highly intellectual scientists of undoubted veracity have applied numerous tests, and given the results of their observations to the world, to prove that colours and perfumes are the chief signs that act, like the Southern Cross to the mariner, as indicators for bees to steer by in their peregrinations for the discovery of both pollen and honey. It has been conceded again and again that the tests and their results were unfailing proofs of the correctness of these suppositions, *i.e.*, that flowers of very inconspicuous colours, markings, and shapes have developed into the bright and showy colours and forms they now possess that are so attractive to the cultivated eye of lovers of the plant world.

Sir John Lubbock, in "*Bees, Ants, and Wasps*," referring to the colour sense of bees, says: "The consideration of the causes which have led to the structure and colouring of flowers is one of the most fascinating parts of natural history. Most botanists are now agreed that insects, and especially bees, have played a very important part in the development of flowers. While in many plants, almost invariably with the inconspicuous blossoms, the pollen is carried from flower to flower by the wind; in cases of almost all large and brightly-coloured flowers this is effected by the agency of insects. In such flowers, *the colours, scents, and honey serve to attract insects*, while the size and form are arranged

in such a manner that the insects fertilise them with pollen brought from another plant." The *italics* are mine.

Whilst I am writing I have before me in the garden the white Arum lily (*Arum africanus*). A few weeks ago its white pollen was eagerly sought for by bees. At the same time the broad beans were in full bloom. These, too, were an attractive foraging-ground for the same insects. Since then the peach-trees have burst into flower, with the result that the first-named is entirely forsaken, and the second receiving only an occasional visit. Have the bees gone to the peach-trees because of their attractive colours? Not a bit of it. While the peaches are in flower so are the willows (*Salix babylonica*) just throwing out their catkins. The bees are now bringing in pollen of two colours, one creamy white and the other somewhat of an orange tint. I note that in this (Stanmore) district there are roses, marigolds, Arum lilies, and other attractive flowers in full bloom, but few bees are visiting them. The pollen is coming from the willows and peach-trees. There is also honey from the latter. The flowers (catkins) on the willow are so inconspicuous that a large number of people are ignorant of the fact that they are phanerogamic; yet they are as attractive to the bees as the gaudy peach blooms. A few days ago I visited the Sydney Botanic Gardens. At the time of my visit the most attractive beds of flowers were daisies, pansies, anemones, and the turban ranunculus. Nothing in the Gardens was more showy than these latter, yet no bee visited them. Near was a shrub (*Burns sempervirens*) in which there was a constant hum. What was the cause? Hidden among the foliage there were some small greenish flowers, supplying abundance of bee food. If colour had been their guiding star they would never have found it in the shrub—they would have searched the ranunculus beds; and there they would have searched in vain. But who will say the attractive colour was not there?

When I found the bees had forsaken the Arum lilies and broad-beans for the peach and willow trees, I tried to induce them to return to the first-named by offering them large bribes. I covered the essential organs of the lily with pure honey; but no bee visited them, and finally the bribe was carried away by ants.

It is more than doubtful if bees are attracted to flowers by their colours. Bees can distinguish colours and objects. The tests supplied by Sir John Lubbock on this point are interesting, but do not go to show that the bees are attracted by the colours in flowers. He says "bees have played a very important part in the

development of flowers.” (*Read the whole quotation on previous page.*) “I thought,” he says, “it would be desirable to prove this, if possible, by actual fact. . . . I brought a bee to some honey which I placed on blue paper, and about 3 feet off I placed a similar quantity of honey on orange paper.” [*Note.* his experiments were carried out with paper covered with honey, not with flowers.] “The bee carried away a load of honey and returned to the same blue paper twice.” He then transposed the papers, and she made three more visits to the same coloured paper. On the following day he again transposed the colours. The bee “returned to the old place, and was just going to alight, but observing the change of colours, without a moment’s hesitation darted off to the blue. No one who saw her at that moment could have entertained the slightest doubt about her perceiving the difference between the two colours.” Yes; because she had learned it was the blue paper that gave her food. The bee was working by sight, exactly upon the same lines as the highly intellectual man acts. If there be two cupboards or safes of two different colours in a room—a blue one containing his food, and an orange one his papers—if their positions are frequently changed he goes into the room and looks for the one, by its colour, that contains the food or papers he may require; but if he had been accustomed to find the blue safe in the room in the same position, he would enter the room and would be about to open it, “but observing the change of colours, without a moment’s hesitation,” he too would “dart off to the blue,” and “no one who saw him at that moment could entertain the slightest doubt about his perceiving the difference between the two colours” of the safes. It was not the colour that attracted the bee; it was the food. Notwithstanding the transpositions of colour, as soon as all the honey had been used up, the orange or other colour would have been just as attractive if bee food were placed on it.

On one occasion I saw a bunch of flowers that had been brought from a distance thrown out on a rubbish heap. It was early spring, and at the time bee food was very scarce, especially pollen. There was a good store of honey within the hives; there was also young brood; therefore, pollen was needed. As soon as the bees saw these discarded blooms many of them were “just going to alight,” but observing there was no food they hastened off to the inconspicuous flowers of the couch grass, upon which they had been at work for several days, because there was nothing else at that time supplying them with pollen that was so essential for the young brood.

In "The Story of the Plants," Grant Allen says, "The use of the corolla with its brilliant petals, is to attract insects to the flowers and induce them to carry pollen from plant to plant. That is why they are painted red and blue and yellow; they are there as advertisements to tell the bee or butterfly, "Here you can get good honey"! If the brilliant coloured petals of flowers are so attractive to bees, how is it the single blooms are more attractive to them than double ones of the same variety and species having the same colour? Here is the answer: The single ones produce pollen which is the all-essential food supply for the young bees, but truly double blooms produce no anthers, therefore they produce no pollen. Where bees can get the greatest supply of food in the shortest space of time is the place where they will go. They do not care what colour the corolla is, it may be "painted red, blue, or yellow," the pollen and honey are the advertisements. Neither do they care what colour the pollen is, because they carry home white, yellow, and red pollen indiscriminately, but only one colour at the same time. The cells in the combs that are packed with pollen contain any colour they can get. Food is the advertisement, and not the colour in the corolla or the petals.

In some of our most ornamental plants the flowers are so inconspicuous were it not for their foliage they would be treated as weeds and rooted out. The brilliant foliage is their only recommendation. The carpet beds in our Botanical Gardens during summer are one of the chief attractions to the grounds. They are nothing but leaves. There is no denying their brilliancy. Watch as long as your patience will permit, you will never see pollen or honey-feeding insects alight on them for the purpose of obtaining food. If the clipping or trimming of these carpet beds be neglected, and the tiny flowers be permitted to expand, you will at once see bees and other insects alighting for grains of pollen and sips of honey.

The caladium and the coleus have foliage far more showy than the blooms of scores of plants that are constantly visited by bees, but bright as the foliage may be, the bees are not attracted thereby. When the coleus throws up its spike of pale blue flowers then it becomes attractive to insects, and they are drawn to it, not by the colour of the flower or the leaf, but by the food contained in the former.

In the month of September the peach-trees are in full bloom, so are the bougainvilleas. The brilliant crimson bracts of the

latter, with their small creamy-white flowers, are equally as attractive in colour as the peach-trees, yet where one bee visits the latter a thousand will visit the former.

The manufacturing of artificial flowers has become so perfect of late, and the imitations are so much like natural flowers that when placed amongst natural foliage, the experienced eye of the florist frequently fails to detect the fraud. Even if it be a honey or pollen bearing imitation *bees* are not deceived thereby. If the colour of the flowers or their forms are the advertisements telling them where they could get honey, how is it that bees and other insects are not swarming on the head-dresses of the fashionably attired ladies of to-day? No one can deny that these artificial flowers are as perfect both in form and colour to the sight as the natural ones they are meant to represent, only their essentials of reproduction are absent. The food bees require is wanting, and food, and food alone, is the only advertisement that will induce the bee to search for sustenance even in natural blooms. Their natural intelligence and generations of education have taught them the true sources of wealth. Bees will no more search colours in the expectation of getting food than a gold-miner would go fossicking in a coal-pit for gold.

Botanists and entomologists speak of bees as one of the highest types of insects, and Grant Allen, in "The Story of the Plant," speaks of them thus:—"These higher insects . . . are the safest fertilisers because they have legs and a proboscis exactly adapted to the work they are meant for; and they have also, as a rule, a taste of red, blue, and purple flowers, rather than for simple white or yellow ones. Hence, the blossoms that especially lay themselves out for the higher insects are almost always blue or purple."

Darwin, in "Self-fertilisation of Plants," says:—"Not only do the bright colours of flowers serve to attract insects, but dark-coloured streaks and marks are often present, which Sprengel long ago maintained serve as guides to the nectary," and "that the coloured corolla is the chief guide cannot be doubted." The native daphne (*Pittosporum undulatum*) flower has a creamy corolla hidden amongst its deep green foliage. These trees, both in the Botanic and in private gardens, were in bloom at the same time as the double-flowered peach. In the former the bees were in swarms busily at work, and only an odd bee occasionally visited the latter, and the flowers visited were those containing a few scattered anthers from whence they could scrape together a few

grains of pollen. The bright blooms of the double-flowered peach could be seen hundreds of yards away, but to discover the flowers on the pittosporum you need stand underneath the tree. There is no flower in this State more frequently visited by bees than the simple white or creamy yellow eucalyptus bloom. It is the bee-keeper's most important source of profit.

Again, we are told that markings on certain flowers are finger-posts. "The lines or spots so often found on the petals of highly-developed flowers," says the author of "The Story of the Plants," "act as honey-guides to lead the bee or other fertilising insect direct to the nectary"; he then goes on to describe the "so-called nasturtium." The upper pair (of petals) are broad and deep-lined with dark veins which all converge about the mouth of the spur, and so show the inquiring insect exactly where to go in search of honey. The lower three on the other hand, have no lines or markings, but possess a curious sort of fence running right across the face, intended to prevent other flying insects from alighting and rifling the flower without fertilising it." The nasturtium is bi-sexual (one of those whose stamens develop before the pistil), which is said to be the reason the nectary is situated so far down the spur. In most bi-sexual flowers, in those where the stamens are first to develop, and also in those where the pistil first comes to maturity, the nectary is *not* situated low down, and so far as we know bees find no difficulty in fertilising them. Such flowers, *i.e.*, those whose nectaries are easily accessible, however, produce plenty of seed. How bees must be baffled when they visit unicolour flowers?

What a waste of time it must be for insects to discover the nectary where Nature has been so remiss as not to put up guide posts. In the wild nasturtium of India the two upper petals have these "guide posts," but the three lower ones have not. The cultivated descendants of these have altered wonderfully in their shades of colours and markings. Now before me, I have some blooms that are like the originals, only the three lower petals have markings. The markings on the two upper ones are brick-colour, and in form like the broad-arrow, the apex pointing towards the nectary. The marking on the lower petals are somewhat similar, only the apex points outwards. In blooms of such character are bees much perplexed to discover the nectary? I have also before me a nasturtium unicolour, a pale sulphur-yellow, yet when in the garden I saw the bees were never at a loss which way to turn to find the nectary, and this flower was visited as regularly

as those of brighter colours, and most pronounced markings. George Masee, in "The Plant World," says "that the only use of colour in the flower is that of an advertisement indicating their presence to insects." When stamens lose their character as such, and become petals, the intensity of colour increases and it becomes more attractive to the eye; nevertheless, the more double a flower becomes the less it is attractive to insects.

Mr. R. T. Baker, Curator, Technical Museum, informs me that when botanising in the mountainous districts of New South Wales, near a garden filled with gorgeous-coloured flowers, he observed a specimen of *Panax sambucifolius*, the small, inconspicuous flowers of which were literally swarming with bees in quest of honey and pollen; and those brightly-coloured blooms in the garden were in nearly every case passed over by the bees for the purpose of visiting the specimen named.

Some of the writers I have referred to have given their experience of watching bees searching for the nectary, and the insects' apparent failure to discover it at first sight. When bees are seen searching about the essential organs of flowers it is not the nectary they are in search of, but the gyrations they make are for the purpose of collecting the grains of pollen. If a bee is seen at work on a sunflower or other composite bloom, her movements in gathering pollen differ greatly from those in collecting honey. Every leg is brought into play in the former work, and her motions are as systematic and various as the figures in a country dance. How differently she goes to work in collecting honey. Her head bends towards every expanded flower, and her tongue is thrust into every nectary. At some she pauses momentarily—some insect has been there before her; at others her stay is longer; she has her reward.

Notwithstanding an insect may have rifled the nectary of its honey, and when visited by the bee found to be empty, in a few minutes another or the same bee will revisit it, and this time her stay may be longer, because between the two visits the nectary will have secreted another supply. The indecision of the bee at a flower is no proof that she is looking for the position of the nectary.

To-day bees may be industriously at work upon a flower of certain colour, and to-morrow forsake it for one of less conspicuous shade. "It would appear," says Darwin, "that either the taste or the odour of the nectary of certain flowers is unattractive to hive-bees, or to humble-bees, or to both, for there seems no reason

why certain open flowers which secrete nectar are not visited by both. The small quantity of nectar secreted by some of these flowers can hardly be the cause of their neglect, as hive-bees search eagerly for the minute drops on the glands of the leaves of the *Prunus laurocerasus*."

"The small quantity of honey secreted" is the cause. Within a near radius there were, undoubtedly, flowers that were secreting larger quantities of honey, and both humble and hive-bees always visit flowers where they can gather the greatest quantity in the shortest space of time. When the hive-bees were searching "eagerly for the minute drops on the glands of the leaves of the *Prunus laurocerasus*," the honey flow must have been scarce elsewhere. I have seen bees, in time of a honey famine search the most unlikely places in the hope of getting something to take home. "A drowning man will catch at a straw," and a bee on short allowance will search anything and anywhere to keep the cupboard full.

Some years ago, at Cooma, in a dry season, a bed of turnips ran to flower. They were sown on a sandy, thirsty soil. For three or four days they were besieged by bees. Almost suddenly the bees ceased to visit the turnip blooms, although they were still expanding. The cause of their forsaking the turnips became evident. About one-third of a mile away, on the banks of a creek, a small paddock of lucerne had flowered, and the bees were bestowing their attention on it, because it was yielding a greater supply of food. Their harvest from the lucerne lasted but a day or so. The scythe stopped the honey flow, and the bees returned to the turnips. Was it the dark-blue flower of the lucerne that caused the bees to forsake the creamy yellow flower of the turnip, or the superior quantity of honey contained in the lucerne? Undoubtedly the latter. The whole family of trefoils are well known to be great honey-producers.

Whatever may have been the reason for plants to have brightly-coloured flowers, and to be otherwise decorated so as to attract insects to aid in the work of the development of the vegetable world in past ages, it is evident in these latter times the bees at least have been sufficiently educated to go without leading strings, and have kicked over the traces, and now work according to their own sweet will, or a Higher One.

Darwin himself is not quite sure that the colours and markings of flowers in every case are for the sole purpose of attracting bees.

I have before remarked that bees do not work indiscriminately on every species of flower that comes to hand, notwithstanding they are all honey-producers; but one peregrination is confined to collecting from one species, and in the next ramble they may select another, and so on. Whatever species of flower they may select to gather from, it is not the colour of the bloom that is the attraction. In watching bees at work on a bed of poppies, the brightly-coloured flowers are not chosen in preference to white. Any colour in the bed is as attractive as that of any other.

“Bees repeatedly passed in a direct line from one variety to another of the same species, although they bore very differently-coloured flowers. I observed also bees flying in a straight line from one clump of yellow-flowered *Centhera* to every clump of the same plant in the garden without turning an inch from their course to plants of *Eschscholtzia*, and others with yellow flowers, which lay only a foot or two on either side. In these cases the bees knew the position of each plant in the garden . . . so that they were guided by experience and memory.”* The experience they had gained was that *Centhera* contained more food than *Eschscholtzia*, and Nature had taught them that it would be impossible to impregnate the ovaries of the one with the pollen of the other.

What is our Australian experience as it regards the colour of flowers that are chiefly visited by bees? There is no denying that some of our endemic flowers are as brightly coloured as the exotic; and, before the introduction of foreign plants and the bee (*Apis mellifica*), the chief honey-gathering social insect was the little native bee (*Trigona carbonaria*), one of the chief insect fertilisers in Australia. The chief honey-yielding plants in these States are the *Pittosporum* and the tea-tree (*Leptospermum* family).

The colour of the native flowers named are whitish, with a few exceptions. The chief exotics that have been introduced are fruit-bearing and ornamental flowering plants, which nearly in all cases bear brightly-coloured flowers or blossoms. The exotic, white, flowering fruit trees in the spring-time are very conspicuous by the multiplicity of the blooms they bear; yet our little native bees now as readily find the nectary in them as our introduced bees, and they cannot have had ages of experience to guide them.

On the other hand, it is very singular that the hive-bee, on its introduction into Australia, and before it had been sufficiently colonised, should forsake the highly-coloured garden flowers of

*Darwin, in “Cross and Self-Fertilization of Plants.”

the Old World that were introduced here at about the same time as the bee. These highly-coloured flowers and the hive-bee, as far as Australia is concerned, are coeval. Untold generations of them had learned to work these blooms, we are informed, and their experience had greatly aided in the development of species and the production of showy flowers of the land of our fathers. On the introduction of the bees and the flowers referred to, the former appear to have suddenly turned their attention from the latter, and apprenticed themselves to the work of attending to the whitish native honey-bearing flowers of the Colony—a colour that the writers on the subject say the bees studiously avoid for the more gorgeously-coloured ones their progenitors had been at such pains to produce by erecting those bright-coloured signs for the benefit of the bees of to-day, for the purpose of saving them both time and labour. Nevertheless, the hive bees, when introduced here, after having been educated to the highest standard in the recognition of colours they are said to possess in Europe, have started *de novo*, and worked upon, not our introduced ornamental flowers, nor our showy blooms of “red, blue, and purple,” but upon “simple white or yellow ones”; so unlike the education in colours they had received in the other side of the world. Question—Will our eucalypti and acacias, and other white and yellow flora, in ages to come, develop highly-coloured flowers and of a larger size than at present, and will the bees then forsake the colours they now work upon in the same way they are said to have done in the other parts of the world? It is queer bees should have gone back in their tastes for colours when they crossed the equator in coming to this side of the world.

Some years ago a series of questions were submitted by the Department of Agriculture to the bee-keepers of this State, relative to what plants were visited by bees as regards size and colour of blooms.

In the ranks of the bee-keepers are men of keen observation as to whence honey flow comes. The whole of the answers given are full of interest. Of course, the imported fruit-trees and other exotic flowering plants are named as giving the spring supply of pollen and honey, but the ironbark, grey gum, bloodwood, blue gums, and the eucalypts generally are by far the most remarkable as honey-yielding, and all these have white flowers. In the northern districts, the broad and narrow-leaved tea-tree is stated “to be the largest honey-yielder we have”; therefore its *white*

flowers are the attraction. One bee-keeper states that "one year he grew a plot of *white* poppies for experiments with opium, and found the flowers literally crowded from daylight to dark with bees."

The report concludes by saying, "Regarding the size and colour of flowers most affected by the bees, much diversity of opinion exists among apiarists. . . . It is, indeed, an open question if colour has any effect in the matter." In the report one observing bee-keeper quaintly observes, "The bee is quite indifferent to the size of a flower, provided he can get what he wants"; and, from experience, I can add, quite indifferent as to colour.

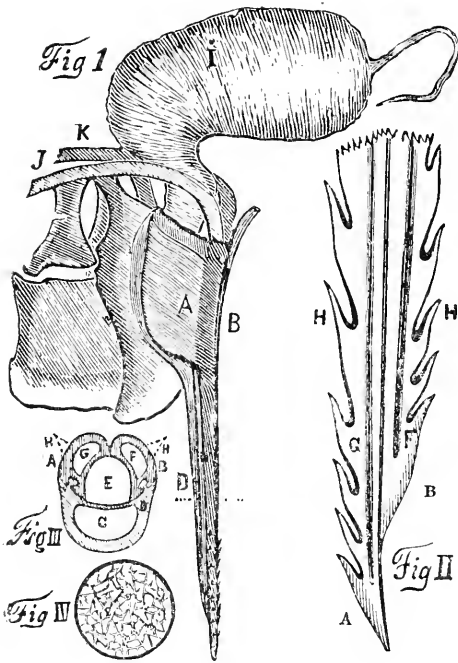

Bee Sting in Sections.

Fig I. — I, Poison sac ; JK, muscles for moving the sting ; A, first movement of sting ; B, second movement ; B, sting sheath.

Fig II. — HH, barbs ; AB, points of sting ; GF, poison ducts.

Fig III. — (Section) HH, barbs ; AB, points of sting ; CEFG, hollow tubes of sting for lightness and strength of sting.

Fig IV. — Poison after crystallisation.

THE BEE STING.

CHAPTER XXXVII.

THE COLOUR OF FLOWERS AND ITS INFLUENCE
ON BEE-LIFE.

(Read before the Australasian Association for the Advancement of Science, Tuesday, 11 January, 1898.)

THE subject that I have chosen for this paper may not, at first sight, appear to be one so fraught with interest as those you have already listened to. That it is in any way directly associated with agriculture may appear somewhat doubtful. Indeed, the title itself is not a very happy one. The matter that I intend to weave into it, both in warp and woof, may not produce a fabric wholly consistent with the *colour* of flowers and its influence on bee-life.

I am dealing somewhat with the essential organs of certain plants, and the agents employed in their reproduction; and I think as I proceed I shall be able to show that bee-life and blossoms are so closely associated the one with the other that to injuriously interfere with either will at the same time militate against both. Animal life—our life—cannot exist without the vegetable kingdom, but some members of the latter can live and propagate themselves without the former; whilst there are other forms of vegetable life which would cease to exist if all animal organisms were excluded from them—indeed, some forms of insect life are an absolute necessity in the reproduction of plants. I know that amongst phanerogamic plants there are those that are anemophilous and other that are entomophilous. The former can continue to multiply without insect aid, but with the latter insects are an imperative necessity. Nearly all insects, more or less, aid in the fertilising of the vegetable kingdom, but the ravages with the foliage caused by some classes of insects far more than counter-balance the good that they may do.

Pollen is the fertilising and vitalising agent in reproducing and perpetuating all classes of vegetables. It is produced in abundance by all flowering plants, both by those of conspicuous and also those of inconspicuous flowers or blossoms. As a rule inconspicuous flowers are anemophilous, and those of more gaudy tints are sought after by insects. It may not be universally understood

that there are male and female elements in the vegetable organisms just as in the animal organism. We know that if the sexes in the latter are always excluded, the one from the other, reproduction is an utter impossibility.

We have control over the sexual intercourse of the domesticated animals. Cattle breeders, sheep farmers, agriculturists, orchardists, horticulturists, and indeed everyone, whether engaged in the culture of the soil or not, thoroughly understand this; but we do not find the same knowledge of the methods of reproduction in vegetable life amongst farmers and others. But agriculturists and those engaged in vegetable culture do not as a rule know that plants are reproduced on precisely similar lines as animals.

Schools of Science are established to unravel the secrets of Nature in the mineral kingdom, anatomical classes are open to students who intend to make a living by operating on other than their own frames, and Veterinary Schools do the same for those who desire to so work on the lower animals. All engaged in the breeding of animals know exactly how to mate so as to produce certain results. Sires are carefully bred, more carefully selected, and most carefully reared. All know, if they take the haphazard chances of permitting animals to breed according to their own will, weedy and valueless ones of no market worth are the result. In cattle they know how to cross-breed their animals so as to obtain the best results for the butcher or the dairyman; or, if it be sheep, they know how to breed for wool or meat; or, if it be horses, they breed for strength or for speed. And all this is done from the knowledge possessed of the procreative powers in both sire and dam. Why is not a similar knowledge applied to fruit or any other crop? Because not one out of a thousand has sufficient knowledge of their occupation to understand that there is a sexuality in plants and that fertilisation is as necessary in plants as in animals.

I said just now that pollen is the fertiliser, and that this substance is possessed by all flowering plants. The one great aim of all vegetable and animal life is to reproduce itself or to perpetuate its species.

Both sexes in all the higher orders of animals possess locomotive powers that enable them to come together at certain seasons for procreative purposes. At other seasons the sexes studiously avoid each other, and in some gregarious animals they separate and form independent flocks, as amongst yellowhammers, chaffinches, wild American turkeys, and deer.

Locomotive powers in plant life are very rare, and where they possess these powers it is more for the distribution of fertilised seeds than for the purpose of fertilisation. There are exceptions, I know—the *Vallisneria spiralis*, for instance.

The higher order of animals are unisexual; occasionally there are malformations termed hermaphrodites; but in the plant world the higher orders are unisexual, bisexual, or hermaphrodites—unisexual when the male and the female blooms or organs are on separate plants; bisexual when the male and female organs are in separate flowers but on the same plant, hermaphrodite when the procreative organs are both in the same bloom (Laurels, 1st; pumpkins, corn, &c., 2nd; apples, pears, &c., 3rd). Yet, nevertheless, no true flower is hermaphrodite—*i.e.*, not hermaphrodite as the term is applied to the animal kingdom. The staminal and pistiline organs are not abnormal malformations, but both organs are perfect and independent of each other, and as a rule in hermaphrodite plants the anthers become distributive before the stigma becomes receptive, or *vice versa*; or, to make it clearer, the receptive and distributive organs do not mature at one and the same time in the same flower.

From this it will be seen how utterly impossible it is, in the great majority of cases, for the anther, when distributive, to come into juxtaposition with the receptive stigma to effect the necessary discharge of pollen to ensure fructification. I am speaking now only of entomophalous plants.

Ofttimes in unisexuals that are entomophalous the staminate plant when in bloom is at a considerable distance from the pistiline; and in bisexuals both genders of flowers mature at the same time but on different parts of the same plants, while in hermaphrodites the sexes may be in close proximity; nevertheless the male and female organs do not mature at one and the same time, then how can these inert beings become impregnated but by an agent other than itself—a foreign agent? In nearly every case the pollen of entomophalous plants is not dry but powdery as in the case with anemophilous blooms, but heavy and highly adhesive. It is this property of the pollen gathered by bees that enables them to stow it away so neatly in their pollen baskets. Its adhesive nature prevents its being blown about by winds, and causes an outside agent necessary to transmit it from the male to the female organs.

Now comes the question, why are bees attracted to blossoms? I mention bees because they are the only insects that gather and

store both pollen and honey. Other insects feed on one or the other or both, but with these it is consumed where gathered—that is, it is consumed on the premises.

I am not ignorant of the fact that the perceptive organs in insects are extremely acute, especially in social bees, and that they can both recognise colour and form. All bee-keepers know that when young bees take their first flights how cautiously they survey the landmarks surrounding their habitations, and where large numbers of colonies are kept, and where every hive is the same pattern and colour, how necessary it is, when the virgin queens are taking their nuptial flights, to place distinguishing marks here and there to ensure the safe return of the young queen to her home. But that bees are led to flowers by the colour they possess, and that certain bright colours—red, blue, purple, &c.—are more attractive to them than paler tints, such as white, yellow, etc., my experience most certainly contradicts. I know that the highest authorities on the subject have written and stated that it is so, and it may appear something like gross presumption on my part to attempt to refute their statements. No doubt some of them have given the experience of observation, but by far too many have been satisfied by stating I was informed by Mr. So-and-So of certain movements in regard to bees and flowers.

Sir John Lubbock, in his work on "Bees, Ants, and Wasps," says: "Most botanists are now agreed that insects, and especially bees, have played a very important part in the development of flowers." . . . "In cases of brightly coloured flowers the pollen is carried by the agency of insects." "I thought," he writes, "it would be desirable to prove this, if possible, by actual fact. I brought a bee to some honey which I placed on blue paper, and about 3 feet off I placed a similar quantity of honey on orange paper." Why he need to place a *similar* quantity I cannot tell, and why he should have *brought* instead of allowing a bee to find it is a problem I cannot solve. Now comes the question—was the bee attracted by the blue paper or the honey food? I have placed honey in a blue campanula, and many other flowers of both conspicuous and unobscure colours. When food is scarce bees will visit any colour; but when it is very plentiful they object to take honey already gathered. Last summer, in my garden, I had a scarlet dahlia in bloom. When it first flowered there was not a stamen present. No bees ever visited it. The plant was afterwards neglected by me, and this neglect caused the stamens to appear, and the

anthers to develop and the pollen to mature. With this bee improvement in the flower it soon became a foraging ground for them. Why did they not visit the early blooms? Because there was no bee-food present. And why did they so visit it when the stamens appeared? The flowers were not nearly so conspicuous as the earlier blooms. But in passing over they saw there was a reward for their labour. Double flowers—I mean flowers in which the whole of the stamens have become petals—are far more showy and conspicuous than single ones, both being of the same variety, and the same colour. Bees abhor double flowers, no matter of what colour, but single ones they love; but it is cupboard love, and cupboard love only.

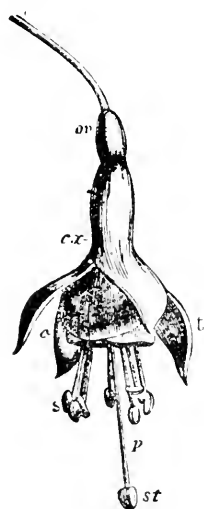

Fig. 1.

Fig. 1.
ov Ovary.
cx Calyx tube.
a Carolla.
p Pistil.
s Stamen and Anthers.
t Calyx.
a and *b* combined are
 the floral envelopes.

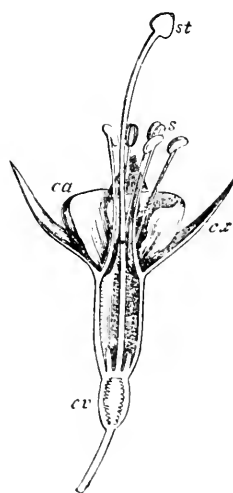

Fig. 2.

Fig. 2.
st Stigma.
 Anthers and Stamens
ca Corolla.
cx Calyx.
ov Ovary.

Early last spring the white Arum lily (*Arum africanus*) was in bloom, and its white pollen was eagerly sought for by bees. At the same time the broad beans were in full flower. These, too, were an attractive foraging ground for the same insects. A little later the peach trees burst into flower, with the result that the first-named was entirely forsaken, and the latter receiving only an occasional visit. Did the bees go to the peach tree on account of their attractive colours? Not a bit of it. While the peaches were in flower so were the willows (*Salix babylonica*) just throwing out their catkins. When these two trees, peaches and willows, were in bloom my bees were bringing in pollen of two colours, one creamy-

white and the other somewhat of an orange tint. At the same time, in the district where I live there were roses, marigolds, arum lilies, and other attractive flowers in full bloom, but few bees were visiting them. The pollen was coming in from the willows and peach trees; there was also honey coming in from the latter. The flowers (catkins) on the willows are so inconspicuous that a large number of people are ignorant of the fact that they are phanogamic; yet they were as attractive to the bees as the gaudy peach trees. During the same spring, and at about the same time, I visited the Botanical Gardens, and the most attractive beds of flowers then in bloom were the English daisies, pansies, anemones, and the turban ranunculus. Nothing in the Gardens were more showy than the two latter, yet no bee visited them. Near these was a shrub (*Burus sempervirens*), in which there was a constant hum from the bees. What was the cause? Hidden among the dark green foliage there were hundreds of small greenish flowers, supplying abundance of food. If colour had been the attractive agent, bees would never have discovered their food in the shrub, and they would have sought the showy beds of anemones, &c., in vain; they were double, and therefore there was no pollen food. But who will dare to say the attractive colour was absent? A short time afterwards I saw the *bougainvilleas* aglow with their showy bracts; they could be seen hundreds of yards away. At the same time the pittosporums were in flower. These latter were so inconspicuous that before they could be detected you need stand directly under them. I visited both—the *bougainvilleas* and the pittosporum; in the former there was not a bee to be seen, notwithstanding their fiery glow, whilst in the latter there was a sound as if a swarm of bees had taken possession of it.’

Mr. Baker, of the Technological Museum, informed me that he observed a specimen of *Panax sambucifolius* swarming with bees, although it bears a small, very inconspicuous flower. A fence divided it from an enclosure of brightly-coloured garden flowers, yet these were passed over unheeded. Why did the bees neglect the garden flowers? Because the yield of food was not equal to that in the *Panax sambucifolius*. In none of the cases I have named were the bees attracted by the colours, but by what they could get in the form of food.

Many years ago, when in Cooma, I had a bed of turnips in flower that from daylight to dark were besieged by bees. Suddenly the bees forsook them. I found the cause to be that a small pad-

dock of lucerne near by had been permitted to flower, and the bees had gone thither. Were they attracted by the purple flowers? Not a bit of it. Lucerne, like other trefoils, produce an abundance of bee food, far more than any of the cruciforms, and the bees had gone where they could get the greatest quantity in the shortest space of time. In about twenty-four hours afterwards the lucerne was cut, and the bees returned to the turnips.

Darwin says: "It would appear that either the taste or the odour of the nectary of certain flowers are unattractive to hive-bees or to humble-bees or to both, for there seems no reason why certain open flowers which secrete nectar are not visited by both. The small quantity of nectar secreted by some of these flowers can hardly be the cause of their neglect, as hive-bees search eagerly for the minute drops on the glands of the leaves of the *Prunus laurocerasus*." The small quantity was the cause, as was the reason my bees left the turnips for the lucerne.

Early one spring I saw bees eagerly working the flower-heads of couch-grass. We all know that the flower of the couch has not an attractive colour. The endemic or native flowers intermixed here and there with them were far more showy. Looking into my bees I found young larvæ were plentiful; pollen for bee-bread was needed. The endemic flowers were producing little or none, but on the couch-grass there was a fairly good supply, and this supply was the cause of their neglecting the brighter coloured blooms for the greenish-yellow flowers of the couch-grass.

Watch a large bed of poppies of mixed colours. No one colour is neglected by the bees. They are as eager to forage in the white as in the red. Poppies are great pollen producers.

Again Darwin says: "Bees repeatedly passed in a direct line from one variety to another of the same species, although they bore very differently-coloured flowers. I observed bees also flying in a straight line from one clump of yellow-flowered *Enthera* to every clump of the same plant in the garden without turning an inch from their course to plants of *Eschscholtzia* and others with yellow flowers, which lay a foot or two on either side." "In these cases," he continues, "the bees knew the position of each plant in the garden, so that they were guided by experience and memory." Their experience was that the *Enthera* contained more food, and Nature had taught them that it would be impossible to fertilise the ovaries of *Enthera* with the pollen from *Eschscholtzia*.

Darwin on "Self-fertilisation of Plants" says:—"Not only do the bright colours of flowers serve to attract insects, but dark-coloured streaks and marks are often present, which Sprengel long ago maintained served as guides to the nectary." If such be the case, how the poor bees must be troubled to find the nectary in self-coloured flowers. I think we have more unicolour flowers than striped ones. If Sprengel maintained it was so long ago, *then* it may have been so; but I maintain, that *now* in these latter days it is not so.

Grant Allen, in "The Story of the Plant," has written some fanciful pictures on the influence of the markings and colours of flowers and their attraction for bees. I know the work is not a text book. He says:—"The lines or spots so often found on the petals of highly-developed flowers act as honey guides to lead the bee or other fertilising insect direct to the nectar." He then goes on to describe the "so-called nasturtium." "The upper pair (of petals) are broad and deep-lined with dark veins, which all converge about the mouth of the spur, and so show the inquiring insect exactly where to go in search of honey. The lower three on the other hand, have no lines or markings, but possess a curious sort of fence running right across the face, intended to prevent other flying insects from alighting and rilling the flower without fertilising it." Now, if any insect, flying, creeping, or crawling, were to enter the nasturtium and rille the flower of its pollen and carry it to one where the stigma was receptive, and the part of the insect's body with pollen on it came in contact with the stigma, fertilisation would be the result. But why do the markings that converge about the throat of any act as guide-posts to them, while we have so many unicolour flowers that are destitute of such markings—to wit, the whole of the pumpkin family, and hundreds of others. Pumpkins, &c., cannot be fertilised other than by insects, and the blooms have no finger-post erected saying, "Here you can get good honey and pollen!"

Yesterday I was watching the bees working the pumpkin flowers, and none of them were at a loss to find the pollen or the nectary. There was no hesitancy. The only finger-post for bees in flowers is the food they contain.

Darwin himself says he is not quite sure that in every case the colour and markings of flowers are for the sole purpose of attracting insects.

I have seen questions something like the following put in agricultural examination papers: "What is the use of colour and perfume in blooms? Such questions should never be put, when we consider that a large majority of the blooms in agricultural crops are anemophilous, and many an observant student can dispute the fact that colour is the attraction.

What is the experience of bee-keepers this side of the equator as it regards the colour of flowers that are chiefly visited by bees? There is no denying that some of our endemic or native flowers are as brightly coloured as the exotics or introduced ones. Before the introduction of our fruit-trees and highly-coloured garden flowers, the chief honey-gathering social insect was the little native bee (*Trigona carbonaria*), and, therefore, it was the chief fertiliser in Australia.

Darwin tells us that it took ages on the other side of the world for the flowers to develop into what they now are in both colour and form, and the bees centuries of training to adapt themselves to the flowers as they developed.

Space will not let me give Darwin's quotations, but all entomologists and botanists are acquainted with the facts.

The chief honey-yielding plants of this continent are the eucalyptus, pittosporum, and tea-tree families, and all these bear whitish flowers. Our introduced fruit-trees and ornamental flowering plants bear brightly-coloured blooms. In spring time our introduced fruit-trees are conspicuous by the multiplicity of their flowers, and our little native bee as readily finds the nectar in them as our introduced bee, and they cannot have had the ages of experience to guide them.

And does it not seem very strange that our hive bee, upon its introduction here, and before it had been sufficiently colonised, should have forsaken the bright-coloured flowers of the Old Land that were introduced here at the same time they were? Our exotics and our hive bee, as far as Australia is concerned, are coeval. Untold generations of bees had been trained to work blossoms in the land of our fathers, and their experience had most, if not all, we are told, to do with the development of species and the production of the showy flowers we now see around us. But when the hive bee crossed the Atlantic and the Pacific, and came here and found they were among their old friends of the gardens, they forsook them and bestowed their attention upon the simple whitish honey-bearing flowers of the State—a colour that the writers on the subject

say they studiously avoid for the more gorgeously-coloured ones, their progenitors had been at such pains to produce by erecting showy flags and sign-boards for the benefit of the bees of to-day, for the purpose of saving them both time and labour.

The hive bee on its arrival here, after having been educated to the high standard it is said to have attained in the old world, works upon, not our introduced flowers of "red, blue, and purple," so much as upon our simple white and yellow ones—so unlike what they ought to have done, according to the education they had received at our antipodes. Is it not queer that our bees should have gone back in their tastes for colours when they crossed over the equatorial line, and came this side of the world?

Some of the facts in this chapter are used to disprove that colour attracts bees, and in the previous one to demonstrate another phase of bee-life.

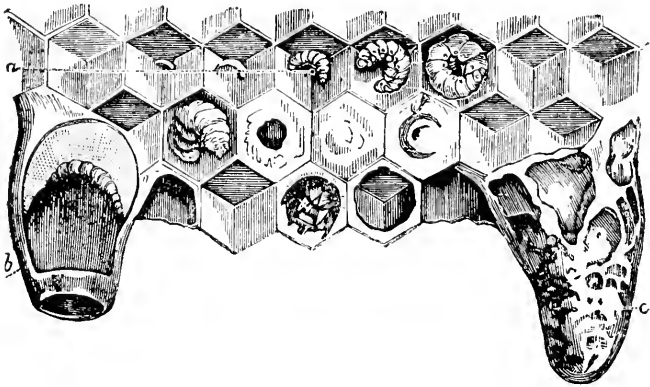

Brood-Comb.

- a.—Larval Workers from egg to period of emerging from cell.
 b.—Queen cell containing larval queen floating in royal jelly.
 c.—Queen cell containing queen.

CHAPTER XXXVIII.

BEE CALENDAR.

January.

With the horticulturist "there is always something to tie, or to stick, or to mend"; so with the bee-keeper. Although there is no delving and digging, still every month brings its allotted work. The hot days of January are very trying to both bees and bee-keepers. The latter is wishing he could work under an umbrella or other sunshade. Well, this autumn, prepare for next summer, unless you have been sufficiently wise to have followed the advice given in the chapter on "Summer and Winter Protection for Bees." In some parts of New South Wales undoubtedly the bees are suffering from the excessive heat—combs are melted, bees suffocated, and honey running to waste, causing an abundance of robbing to be carried on. During this great heat, if you cannot protect yourself, you must protect your bees from such accidents as above recorded. If there be no natural shade, an artificial one must be at once adopted. A sheet of bark sufficiently large to extend about a foot over each side of the hive will answer the purpose splendidly. In the absence of it, a piece of board or an old bag, can be substituted. Permit the bag to hang down on either side of the hive. In the first place, put a couple of pieces of stick across it so as to leave a sufficient space for air to circulate. Weight the covering, whatever it might be, to prevent the wind from blowing it off.

Most of the directions for last month will also apply to this. Prevent swarming, if honey be desired; but if it be intended to increase colonies it is not too late to do so, as there is plenty of time for gathering in the winter's stores. Remove sections as they become capped, and store them for use. Occasionally overlook them for the purpose of keeping the bee moth down. If it gets a footing amongst them great damage will be done. Give all the ventilation possible at the mouth of the hive. It will be noted that all the young brood, perhaps none of them, are sealed over. In very hot seasons bees make it a rule not to seal brood in a chrysalis form. A small hole is left for extra ventilation. The bee-keeper

must aid them as much as possible by removing all obstructions from the entrances. If the bees are seen hanging idly in clusters outside the hive, as they do sometimes before swarming, see that there is plenty room inside for storing.

February.

In some districts gluts of honey will be coming in, and if the supers be not regularly and systematically removed the bees will store in the brood-chamber. It is highly essential that there should be plenty of room, both for brood purposes and for storage. If 1-lb. sections be desired, and honey cannot be put on the table in a more attractive form, they should be overhauled at least once a week, and all that are capped should be removed and stored out of the way of ants and other bee vermin. It is not wise to store sections unless every cell is capped. See that the separators are so placed that the sections cannot be built out. If the section crates only hold one tier, it is well the separators should be sufficiently wide to come to the top of the section and leave only bee space at the bottom. Metal separators are far preferable to wooden ones. Keep the sections as close together as possible; by so doing they are easily removed and are freer from propolis, which is a consideration, because it saves the time of the bees in more ways than one.

Protect the tops of the hive from the direct rays of the sun, or you will find the combs give way with the heat.

Give all the ventilation you can. If all the means in the hive be not sufficient to keep a cool current of air passing through, prop up the hive a little from the floor-board.

Queen-raising should now be over. Nucleus colonies should be united under the best queen among them. In uniting place about eight good frames together and put on a half super. Attend to the instructions given elsewhere *re* uniting.

Ventilation, shade, and the storage of all surplus honey are the important factors for this month.

March.

The order at the close of last month will be the order for the beginning of this—*i.e.*, ventilation, protection from the direct rays of the sun, the uniting of queenless colonies, and the storage of honey.

In the colder districts it will be necessary to prepare for wintering bee stock. If any hive is showing signs of dilapidation, it is better now to replace it with a new one than later on. Select a suitable day for the work. Place the new home in close proximity to the one in occupation. As each frame is removed carefully examine it for any signs of bee enemies and disease. Well scrape the outer edges of the frames to remove all accumulations of burr comb. When replacing the frames slightly increase the interspace between the brood combs; this will admit of more bees clustering between, and thus increase warmth. Where there are movable floor-boards, and they are always to be preferred to fixtures, cleanse them from all debris. Examine all crevices, both in floor-board and body of the hive. Place the supers in the store-room. Invert the quilt—*i.e.*, have the glaze side uppermost; the woolly side will aid in the absorption of moisture caused by condensation. All debris that has been removed should be collected together at once and burnt. The quantity of sealed honey in each hive should be calculated before the bees are put up for wintering. A pound of honey occupies about 16 square inches, more or less, according to its thickness. A fairly strong colony will require about 30 lb. to carry them through. The more honey is left for winter purposes the better will be the spring results. Do not leave any empty or nearly empty storage frames in the hive. The nearer the storage honey is placed to the brood the better. If bees and storage do not occupy the whole of the hive, put in the division or dummy board. Keep all within the hive as compact as possible. With the outside of the hive always anticipate a wet winter and prepare for it. Make the top of the hive waterproof. If old bagging or other absorbent materials are used, and for cold seasons such things are extremely useful, there must be something placed on the top to throw off the rain, otherwise the continued dampness will aid in rotting the hive. Free the surroundings from all weeds. Clear underneath the hives for ventilating purposes.

In the warmer districts, last month's calendar may still be followed.

April.

Winter is close upon us. In the coldest of our districts bees have already retired to their winter quarters, and before the month is out the retirement will be general in the southern and mountain-

ous parts of the Colony. During the warmer portions of the days especially if the sun is bright, the bees will still venture out; but they will not wander far from home if last month's advice has been attended to, *i.e.*, if they are supplied with honey sufficient to carry them on till spring or the coming breeding season. If bees are forced to go foraging on bright winter days, the sudden atmospheric changes prevent the return of many. A good supply of food in the hive is the only remedy. It also forms one of the best methods to keep up the warmth of the hive. On every occasion when the weather is bright and drying remove the wraps, etc., from the hives, and spread them out to dry. External dampness produces internal dampness— which is one of the most prolific causes of disease. Just before sundown return the protectors to the hives.

The evenings are long now and outdoor work among the bees is little needed; there is, therefore, plenty of time in which hives, frames, &c., can be put together and foundation fixed ready for the coming spring.

May.

In our coldest districts both bees and bee-keepers should have retired into winter quarters. The latter will now have plenty of time for thought and preparation for the coming spring. The end of this month will be an excellent time for planting evergreen shrubs for the protection against the cold winds, or, if necessary, as shades against the excessive sun rays for summer time. The long leaf privet (*Legustrum longifolia*), which is used for ornamental hedges will be found the best for the purpose. A trench about 8 inches wide and a foot deep should be opened and the soil made light with the addition of a little sand and manure. In the coming month cuttings from 6 to 12 inches long should be planted at an angle of about 45 degrees, or even more, 6 inches apart, and arranged so that they may overlap one and the other. When sufficiently high they should be kept trimmed to a uniform width of about 8 inches and the length required. If properly managed they will form a green wall almost impenetrable. Such hedges will be found to be both useful and ornamental. Examine all empty combs that are stored, and fumigate for moth and their larvæ. Attend to ventilation to prevent dampness. Do not let the stored combs become mildewed. Make up hives, supers, and frames for the coming season. It is a wise motto to have your cage ready for the bird, and so always have your hives ready for your bees.

June.

This is the month to commence in earnest to establish live break-winds and sunshades. Plant them about 4 feet from the hives, so as to give yourself room to work, and also to take a wheelbarrow or hand-cart, for these are sometimes very useful appliances in a bee farm. Last month I gave instructions for planting, and the best kind of plants for the purpose. As soon as the plants start into growth attend to the necessary. "As the twig is bent so does the tree grow" is an old proverb that is applicable to more than the vegetable kingdom.

Continue to make up hives and frames for the coming season. Fumigate all spare combs that are stowed away. Brush over all spare hives with a solution of carbolic acid, both inside and out; let it run well into the joints and angles. When the weather will permit see that the hives are free from dampness. In the colder districts of the Colony put on additional mats as protection against frost. Mats made of plaited straw are most impervious to cold. If snow is anticipated, cover these with a bit of zinc or tin, for when the thaw takes place they retain the dampness for a long while. If the hives have been painted, and they are always the better for it, the absorbative nature of the wood has been much mitigated, and aids greatly in keeping the inside of the hives dry. In some of the coldest parts of America the bees are housed during the winter, first seeing that they have sufficient stores to carry them through. This is not advisable here, nor even in our coldest parts. In the coldest latitudes of N.S.W. during winter we have frequently bitterly cold nights, but during midday the sun shines out warm and bright. Such days are always taken advantage of by bees for the purpose of flying out and discharging their fæces. The very exercise adds warmth on their return.

In all your work keep the idea of the coming spring constantly before you. The stocks that come out strongest and healthiest in the spring are the ones you will derive your profits from.

July.

Old Father Winter came in upon us at the close of last month in all his strength, and is likely to continue so for some weeks hence. Bee management during winter months differs little; therefore, what was said of last month is also fully applicable to this.

During the warmest part of the brightest days look into the hives, and see if it be necessary to contract the hives with division boards.

Look at the under side of the top of the hives, and note if there be any dampness; find its cause, and cure it. Turn the fluffy side of the quilt down, and overlay with a few layers of newspaper. The fluffy side of the quilt will somewhat absorb the moisture caused by condensation within, and the paper will be an additional protection against the cold and wet from without.

August.

Northwards already there are indications of returning spring, if in a climate where everlasting spring abides it does not appear superfluous to make such a statement. Even here, down south, leaf-buds are developing and blossom-buds are bursting. Pollen is coming in from some of the earliest of blossoming fruit-trees and some of the acacias that are in the more sheltered gullies. Flower gardens are aglow with spring flowers.

On fine days overhaul all hives so as to note what conditions they are in as regards food. If food supply be short, feed as previously advised. Developing brood must be well supplied with both honey and pollen. If there is likely to be a shortage in the latter, supply it artificially; pea meal is a good, perhaps the best, substitute that can be used. If your hives have loose bottom boards, and they are always the best to use, see that they are free from impurities and foreign matter. If the colony has dwindled much, put in a division board. Remove all empty and mouldy combs. See that there are no queenless colonies. If one be found, obtain a queen from a dealer as soon as possible. This paragraph only applies to our warmer districts. On the north and southern tablelands, continue the advice given for July.

It is very possible that on the alighting boards and in front of the hives many dead bees will be seen. Most of these have died from old age. Bees, as a rule, live longer during the winter months than summer. If you have any doubt in your mind as to the cause of death, send along some of the dead, accompanied with some of the symptoms exhibited prior to death.

The Department of Agriculture will at all times gladly give advice as to bee enemies and bee diseases.

September.

In view of the range of climate of the Colony, what may be applicable to apiculture in one district may be quite out of season in another. It is therefore hoped that readers will understand that the advice given is general.

It is scarcely necessary to remind bee-keepers that the first consideration should be to keep the stocks strong. This matter should have been seen to during the final extraction of honey last season. During the winter months, damp and mildew within the hive, cracks and cold draughts, enemies that have been overlooked when the bees were put up for the winter, and many other causes, may have weakened the stocks. During the middle of the warmest days in winter, and more especially as spring advances, dead bees may be seen on the alighting-board, and mortality is due chiefly, but not wholly, to the causes named. If it were possible to keep a record of vital statistics of bees, old age and starvation would show the highest score on the death-roll.

Along the coast districts spring foliage is now becoming plentiful, and increasing in quantity as we go northwards. On the higher tablelands, especially southward, frosts and snow, still prevailing, will retard the spring operations considerably. In our warmer districts there will be more or less young brood in the hives, if the queens are up to the required standard; but not so in colder districts, where, outside the hives, deaths will be more numerous, and the stocks will be correspondingly weaker.

If forage be scarce the bees should be sparingly fed, so as to stimulate the early rearing of brood. Pure honey is by far the best and most easily procurable. But with pollen it is another thing. For this necessary article of bee-diet bees do not confine themselves wholly to the dust of flowers. In the cold district of Monaro I have known them to revel in horse-feed composed of a mixture of bran left in the feed-box, and go home laden therewith. This, to my mind, was evidence that there was plenty of honey in the hive, but a scarcity of pollen wherewith to prepare bee-bread for the coming brood.

There are many artificial substitutes for pollen—rice-flour, oatmeal, and pea-flour are amongst the best of them. There is not the slightest danger to the bees in giving them a fairly good supply of these during warm bright days. Place it in easy access. It must be taken indoors before sundown every day, and not put out in the morning till all dampness is gone. At no time should

artificial pollen be permitted to become damp; it is sure to become mildewed. In that condition bees will refuse it, and if used it will produce dysentery. Treacle must not be used as a substitute for honey, nor wheat-flour for pollen. They act as a purgative, and thereby weaken the young brood.

October.

Nearly the whole of last month drones were on the wing, and, as anticipated, queen-cells were in construction. Indeed, in the metropolitan district, during the latter part of August, my own were hatched, and on the 16th of last month my first spring swarm came out. From the stock they issued, neither in 1895 or 1896, did I get an increase. It was one of those ne'er do wells. Twice I had changed the queens, but nothing good followed. Early in last December I placed in it a strong swarm that half an hour before had issued from a neighbouring colony. There was no fighting; I had killed the queen of the weak colony. With new blood it became one of my best, resulting in giving me my first swarm this season. In the beginning of last month I noticed several small patches of drone blood. As there are numbers of drones on the wing, and swarming has begun here, it should be abundant further north. Speaking of drones, if what I have so often advocated, *i. e.*, old queens that were known by their fruits to have been very prolific and their progeny good workers, have been kept over from last season as drone breeders, the mating of young queens with high class drones will be sure to give the best results.

During last month the summer fruit-trees were aglow with bloom, and pollen stores were plentiful. Before this number of the *Gazette* is in circulation, swarming will be in full swing. If it is the "early bird that gets the first worm," undoubtedly it is the early swarm that gives most profit. The bee-keepers in the old country used to say, "A swarm of bees in May is worth a load of hay; one in June is not much out of tune; but one in July is never worth a single fly." The same rule holds good here, in the corresponding months.

Be careful to see that room in the brood chamber is provided for giving the queen sufficient unoccupied space for laying purposes otherwise she will use the empty cells in the supers.

There will not be much trouble in catching the *first* swarms of the season. It is the fertile queen that leaves with them; she cannot fly far; she is heavy with eggs, and will not proceed a

hundred yards if she can help it from home. As soon as it is noticed that the swarm is issuing from the hive, watch the entrance, and pick up the queen as soon as she is outside. If you fail to find her, look for her in the flying swarm; a pregnant queen never flies very high. If caught place her in a queen cage, and hang her up in a convenient place. As soon as the swarm commences to cluster around her shake a handful or two into a box and liberate her amongst them; it saves a lot of trouble.

If it is intended to re-queen, do not be later than this month. Procure laying and tested queens; it saves a lot of time. Be sure to get them from a healthy apiary. It is a safe rule, whatever goes wrong with your bees, to say it is the queen's fault. Of course there are exceptions.

The principal work in apiaries now is attending to swarming, re-queening where necessary, and queen-raising.

November.

The most necessary traits in the character of all bee-keepers to ensure success are kindness and gentleness, and these powers will require full exercise this month. Physically a bee-keeper requires a pair of good eyes that have been trained to keen observation, and a pair of sensitive ears that are quick to detect the various changes in the sounds that are emitted by bees. They readily inform us of their likes and dislikes. They have a language that is easily translated by bee-keepers of experience, who act according to the requirements indicated. "Watch and listen" is a motto to be kept constantly in view by all engaged in the bee industry.

This month "from the centre all around to the sea," bees will seize every favourable day to swarm if so prepared. Spring food has been fairly abundant all over the Colony so far, and the prospects for a large honey flow are very encouraging. Act upon the principle of strong swarms and quick returns. Where it is not desirable to increase the apiary, check all swarming. There are several ways of so doing. Examining the frames of brood about every fourteen days, and removing all queen cells is one of the best. If the swarms come out, kill one of the queens; of course, keep the best. Search the hive the swarm issued from, and compare the queen left behind with the one on the wing. The former may not have emerged from the cell, or she may not have mated, and in other ways may not be a "tested queen." On the other

hand the one on the wing may possess all good qualities; but, if it be the first swarm of the season it will be an old queen, at the least a last season's one, and if her age be not known she should be superseded by a young tested one. I am presuming there are a few tested queens kept in stock at this season of year. As soon as the swarm has alighted shake them in the usual way, and when they have fairly settled, place them close to the parent hive. Having selected your queen, return the swarm from whence it came, and next morning the combined swarm will set to work equal to a virgin colony. If you wish to make any alteration in the position of your hives, now is your chance. Having put in the new swarm successfully, remove the parent hive to the new position required. On the following day, when the united bees issue to work, not 1 per cent. will return to the former position. The old stock, with the swarm, should be removed to the new position on the evening of the same day the swarm issued forth.

See that there is plenty of room in the brood-chamber for increase. Don't let new swarms hang out in the sun. When hived see that they are well shaded. Give plenty of ventilation. There will be honey to extract. As far as possible keep the various flavoured honeys separate; it will make a deal of difference in the commercial returns.

December.

In some parts of the Colony, where summer is well advanced, the bee-keeper's harvest has fairly begun. On the Northern Rivers it was later than usual, but indications bid fair for a good honey yield. In the warmer districts swarming should now be checked and stocks kept as strong as possible, if honey be the object; if increase of stocks is still needed, of course, go on swarming. In these districts swarms and casts will continue up to the near approach of winter; these should be returned to the parent hive. Where honey is coming in abundantly, extracting should be carried on whenever about three-fourths of the frames are sealed, even the two outer frames from the brood chamber may be extracted in the early season, but don't be too avaricious, especially towards the end of the honey flow. There is nothing to be gained by it; the bees may want the honey, and it will keep in the cells as well as in bottles, and labour of extracting it and then returning it to the hive is done away with. It never pays to extract from the brood chamber except when the honey flow is very good.

In uncapping for the purpose of extracting, hold the frames so that the cappings will fall clear of the comb below the knife. Cut downwards, and take a long-drawn cut; let the action of the knife be towards the operator. By no means saw the cappings off. In putting the frames in the extractor, place them so that the bottom bar of the frame leads in the rotary motion of the machine; in so doing, the honey leaves the cells much more freely than if put in the reverse of that advised.

Don't extract too much unsealed comb, otherwise the honey will have a tendency to ferment. Honey in bulk should occupy a warm position, for the purpose of evaporation; this will cause the honey to ripen and give it a greater density.

Have water in easy access of your bees. The nearer it is to the apiary the better, as it will save the bee a lot of trips to and fro. Bees are fond of brackish water; it aids in keeping them in health. Put some in tins in easy reach. Of course, a little salt added to fresh water will do it. Place some chips in it for the bees to alight on.

Go in for queen rearing, or purchase from a dealer of good repute for healthy bees, for all useless and degenerating queens should be superseded. Remember like produces like, and good healthy queens produce good healthy progeny.

The chronological accuracy of these calendars is only relatively correct, seeing the very extensive climatic ranges existing in the States of Australia, almost from tropic to frigid. The climate of the extreme north when compared with that of the extreme south is greatly diversified; so with the mountain ranges; the arid plains when contrasted with the humid coastal districts. Therefore amateur beekeepers having had little or no experience must be guided by the give-and-take principle. The work with bees glides from one month to another almost imperceptibly. Thus his work must be largely regulated by the climatic changes taking place in his own district.





UNIVERSITY OF ILLINOIS-URBANA



3 0112 068091583