



3 1761 05449611 2

OVERING TO SUCCESS

ROBERT BADEN-POWELL Bt

Walter Gilling

in remembrance of Scouting Days

from C. Clanchester

St. Barnabas Norwich.



Presented to the
LIBRARY of the
UNIVERSITY OF TORONTO
by

Dr. W. J. Gilling

Na 27

Digitized by the Internet Archive
in 2007 with funding from
Microsoft Corporation

ROVERING TO SUCCESS

EXPLANATION OF FRONTISPIECE

This picture-chart of your voyage to success shows some of the bigger rocks that you have to look out for.

They may loom up dark, but don't forget that the sunny spot for which you are aiming lies beyond them, so if you get round them they have got their bright side too.

You will find it if only you don't let yourself be carried on to them, but navigate yourself wisely past them.

By this I mean two comforting things.

There is a bright side to the darkest rock ; and there is a reward for being active in working your own success, instead of passively drifting to ruin—you gain " character " as you round each rock and you gain your goal of Happiness in the end.

N.B.—See that star high up in the sky ? Hitch your waggon on to that. Take the star as your guide. In other words, " Aim high."





PADDLING YOUR OWN CANOE.

This picture is the index to the book.

ROVERING
TO SUCCESS

A BOOK OF LIFE-SPORT
FOR YOUNG MEN BY
SIR R. BADEN-POWELL B^T
WITH 60 ILLUSTRATIONS BY THE AUTHOR

HERBERT JENKINS LIMITED
3 YORK STREET ST. JAMES'S
LONDON S.W.1 Ⓕ MCMXXII

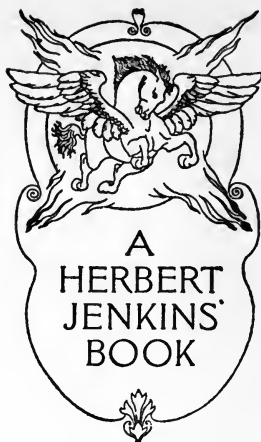

SECOND IMPRESSION



Printed in Great Britain by Butler & Tanner, Frome and London

CONTENTS

	PAGE
PREFACE :	
HOW TO BE HAPPY THOUGH RICH—OR	
POOR	II
Rocks :	
I. HORSES	29
II. WINE	65
III. WOMEN	99
IV. CUCKOOS	133
V. IRRELIGION	173
SUMMARY	201
ROVERING	203

1880

1880

1880

1880

1880

1880

1880

1880

1880

1880

PREFACE

HOW TO BE HAPPY THOUGH RICH—OR POOR

PREFACE

THIS gives you an outline of what the book is about and of what is meant by "Success."

HOW TO BE HAPPY THOUGH RICH—OR POOR.

A canoe trip is like the voyage of life.

An old 'un ought to hand on piloting hints.

The only true Success is Happiness.

Two steps to Happiness are: Taking life as a game and giving out Love.

The Burmese are an example of a happy people.

Happiness is not mere pleasure nor the outcome of wealth.

It is the result of active work rather than the passive enjoyment of pleasure.

Your success depends on your own individual effort in the voyage of life,

And the avoidance of certain dangerous Rocks.

Self-education, in continuation of what you have learned at school, is necessary.

Go forward with confidence.

Paddle your own canoe!

WHAT OTHER FELLOWS HAVE SAID ON THE SUBJECT.

SONG.

BOOKS TO READ.

HOW TO BE HAPPY THOUGH RICH —OR POOR

THIS Preface explains the object of the book.

THE VOYAGE OF LIFE.

I was once caught in a gale when paddling in a birch-bark canoe across a lake in Upper Canada. It was a pretty exciting experience while it lasted, but well worth while.

We had voyaged along rivers and streams, sometimes in the smooth, sometimes through the rapids, but always amid the ever-changing glories of forest scenery.

It was a new experience to come out of our stream on to the wider expanse of the lake and, after starting out in sunshine, to find ourselves presently under a darkening sky involved in a rising gale and a choppy sea.

The frail little canoe, which before we had merely looked upon as a vehicle for carrying us along the river, was now our one hope of life. If she shipped a sea, or if she touched a snag (and there were plenty of them about) we were done for.

Our paddle, instead of being looked on as a mere propeller, became our one means for dodging the attacks of waves and of keeping us going. All depended on the handling of that one implement.

“In a four-hour run across an open bay you will encounter over a thousand waves, no two of which are alike, and any one of which can fill you up only too easily, if it is not correctly met,” writes Stewart E. White, in that delightful book of his, *The Forest*; and he proceeds to tell you exactly how you deal with them.

“With the sea over one bow you must paddle on the

leeward side. When the canoe mounts a wave you must allow the crest to throw the bow off a trifle, but the moment you start down the other slope you must twist your paddle sharply to regain the direction of your course.

“The careening tendency of this twist you must counteract by a corresponding twist of your body in the other direction. Then the hollow will allow you two or three strokes wherewith to assure a little progress. The double twist at the very crest of the wave must be very delicately performed or you will ship water the whole length of your craft.

“With the sea abeam you must paddle straight ahead. The adjustment is to be accomplished entirely by the poise of the body. You must prevent the capsize of your canoe when clinging to the angle of a wave by leaning to one side.

“The crucial moment, of course, is that during which the peak of the wave slips under you. In case of a breaking comber thrust the flap of your paddle deep in the water to prevent an upset, and lean well to leeward, thus presenting the side and half the bottom of the canoe to the shock of water.

“Your recovery must be instant, however. If you lean a second too long, over you go.”

Jumpy work!

The author goes on to tell successively, in similar detail, how to deal with a sea coming dead ahead, from a quarter or from dead astern.

In every case all depends on your concentrated attention, pluck and activity. The slightest slackness and down you go. But the contest has its compensation. “Probably nothing can more effectively wake you up to the last fibre of your physical, intellectual and nervous being. You are filled with an exhilaration. Every muscle, strung tight, answers immediately and accurately to the slightest hint. You quiver all over with restrained energy. Your mind thrusts behind you the problem of the last wave as soon as solved, and leaps with insistent eagerness to the next. It is a species of intoxication. You personify each wave; you grapple with it as with a personal adversary; you exult as, beaten and broken, it hisses away to leeward. ‘Go it, you son of a gun,’ you shout. ‘Ah! you would, would you?—think you can, do you?’

And in the roar and the rush of wind and water you crouch like a boxer on the defence, parrying the blows but ready at the slightest opening to gain a stroke or two of the paddle. You are too busily engaged in slaughtering waves to consider your rate of progress. The fact that slowly you are



PADDLE YOUR WAY THROUGH IT WITH HEAD, HEART AND SINEW.

pulling up on your objective point does not occur to you until you are within a few hundred yards of it. Then don't relax your efforts ; the waves to be encountered in the last hundred yards are exactly as dangerous as those you dodge four miles from shore."

Yes—and it is just the same with a busy life.

THE INTENTION OF THIS BOOK.

The whole thing—the early voyage through the easy-running stream, and then coming out on to the broad lake, the arising of difficulties, the succession of waves and rocks only avoided by careful piloting, the triumph of overcoming the dangers, the successful sliding into a sheltered landing-place, the happy camp fire and the sleep of tired men at night—is just what a man goes through in life ; but too often he gets swamped among the difficulties or temptations on the rough waters, mainly because he has not been warned what to expect and how to deal with them.

I have quoted a few of Stewart White's practical hints from his experiences in paddling through sea-ways : I want

in the following pages to offer you similar piloting hints from my own experiences of dealing with the different snags and waves that you are likely to meet with in paddling through your life-ways.

Among these rocks and breakers are those that can be labelled in the terms of the old toast, "Horses, Wine and Women," with the addition of Cuckoos and Cant. You are bound to come across most of them in your time. In the following chapters I propose to show you there are good as well as dangerous points about these rocks, and also how by "rovering" you may not only get round them, but also derive advantage and make your way to success.

HANDING ON ADVICE.

It always seems to me so odd that when a man dies he takes out with him all the knowledge that he has got in his lifetime whilst sowing his wild oats or winning successes. And he leaves his sons or younger brothers to go through all the work of learning it over again from their own experience. Why can't he pass it on so that they start with his amount of knowledge to the good to begin with, and so get on to a higher scale of efficiency and sense right away?

It is with that sort of idea in my mind that I feel induced to jot down a few of the difficulties that I have come across in my time, and tell how I have found it best to deal with them. I don't say "how I dealt with them," because sometimes I went the wrong way to work, but I saw afterwards through my own mistakes what I ought to have done.

So this book is not intended for experienced men to read. I warn them off. It is for you young men that I write, you who have got the sense to look ahead, anxious to see where you are going and what you are to do in life. And I must say I think that you of the new generation are a bit more level-headed in this direction than your predecessors in the past. The lessons of the war have made many of you men before your time. You don't propose to be the goslings described by B. B. Valentine in the negro ballad in *Ole Marster*:

"Dere is some what 'ssembles goslin's in de way dey march behin'
De ones what goes befo' dem, doh dey don' know whar dey's goin';
Jes' steppin' in de goose-tracks o' de father goes de son,
An' he never does do nothin' dat his daddy didn't done."

HOW TO BE HAPPY THOUGH RICH—OR POOR 15

I suggest that we call this book "Rovering to Success."

You will see the further reason for the term in the last chapter.

By Rovering I don't mean aimless wandering, I mean finding your way by pleasant paths with a definite object in view, and having an idea of the difficulties and dangers you are likely to meet with by the way.

You must expect a good many of these snags.

I have myself tasted some of the bitters and many of the sweets of life, in most parts of the world, so you need not suppose that I am talking entirely through my hat in putting these ideas before you.

Life would pall if it were all sugar; salt is bitter if taken by itself; but when tasted as part of the dish, it savours the meat. Difficulties are the salt of life.

Goethe's mother gave a good principle for life when she said, "I seek no thorns and I catch the small joys. If the door is low I stoop. If I can remove the stone out of my way I do so. If it is too heavy I go round it."

In other words, she didn't butt in, looking for trouble, but took things as they came and made the best of them.

And that is the way to reach success.

THE ONLY TRUE SUCCESS IS HAPPINESS.

What is success?

Top of the tree? Riches? Position? Power?

Not a bit of it!

These and many other ideas will naturally occur to your mind. They are what are generally preached as success, and also they generally mean overreaching some other fellows and showing that you are better than they are in one line or another. In other words, gaining something at another's expense.

That is not my idea of success.

My belief is that we were put into this world of wonders and beauty with a special ability to appreciate them, in some cases to have the fun of taking a hand in developing them, and also in being able to help other people instead of overreaching them and, through it all, to enjoy life—that is, **TO BE HAPPY.**

That is what I count as success, to be happy. But

Happiness is not merely *passive*; that is, you don't get it by sitting down to receive it; that would be a smaller thing—pleasure.

But we are given arms and legs and brains and ambitions with which to be *active*; and it is the active that counts more than the passive in gaining true Happiness.

TWO KEYS TO HAPPINESS.

The rich man has his limitations. He may have two or three houses and dozens of rooms in each, but he can only occupy one of these in turn, since he only has one body.

He is no better off than the poorest in that way. He may look at and admire the sunset, enjoy the sunshine, or the view, but the poor man can do that just as fully.

If the poorer man has the sense to do two things in life he can enjoy it just as well as the millionaire, and probably better.

The first is :

Not to take things too seriously, but to make the best of what you have got, and to look on life as a game, and the world as a playground. But, as Shackleton has said, "Life is the greatest of all games; but there is the danger of treating it as a trivial game. . . . The chief end is to win through honourably and splendidly."

The second is :

To let your actions and thoughts be directed by Love. By Love with a capital "L" I don't mean falling in love and so on. I mean the use of the kindly spirit which you show when you do good turns to other people, when you are kind and sympathetic, and when you show gratitude to others for kindness done to you. That is, Good-will.

A HAPPY PEOPLE.

The happiest people I know as a nation are the Burmese; their brightness and cheeriness are proverbial. Kindness to animals is one of their greatest "weaknesses"; no Burmese will kill an animal even if it is to put it out of pain. He will not eat flesh; and he generally treats animals almost as pets. Men, women and children all seem to enjoy with equal gaiety the beauty of their country, the flowers, the sunshine, and the forests, with smiles, singing

and laughter. They are singularly free from money-grubbing, almost to the extent of being what some people might call lazy. They are content to raise of money or crops just what is sufficient for their wants; and for the rest they merely go in for enjoying life. But that enjoyment is not entirely idle enjoyment. Every young man goes through a period of training as a Phoongyi or monk; however well-off he may be he becomes for the time being penniless in voluntary poverty. He lodges austerely in a monastery, giving himself up to prayer and meditation, and taking up the teaching of boys in the ethics of religious knowledge. And he learns to render help in the best way to those who need it. So that when he comes out into the world he is a man with a sense of service for others and possessed of simple-minded tastes such as will make him a good citizen.

A noteworthy expression of this good feeling can be seen along the roads of the country, where every here and there you come across water-pots set up under shelters where the thirsty wayfarer can quench his thirst; and seats are set up for pedestrians by those who can afford to have them built.

Fielding Hall, in writing of the Burmese in his *Soul of a People*, has said:—

“Wherever else they may succeed or fail as individuals, the Burmese nation will always be the greatest in the world—because it is the happiest.”

HAPPINESS

Happiness is within the reach of everyone, rich or poor. Yet comparatively few people are happy.

I believe the reason for this is that the majority don't recognise happiness even when it is within their grasp.

Did you ever read *The Blue Bird* by Maeterlinck?

It is the story of a girl named Myltyl and her brother Tytyl, who set out to find the “Blue Bird of Happiness,” and they wandered all over the country searching and searching but never finding it, till in the end found that they need never have wandered—Happiness, the Blue Bird, was there where they chose to do good for others, in their own home.

If you think out and apply the inner meaning of the legend it is a help to finding happiness within your reach when you thought it was in the moon.

Lots of fellows look on their work as drudgery, and even their daily journey to and from their work as a grind. And they keep looking forward to their holidays as the time when they will be having some real enjoyment. Too often when the holiday comes it is rainy and cold, or they've got the 'flu and the long-looked-for outing turns out a frost.

The truth is it is, no use putting off happiness for some future day, but the way is to enjoy your life all the time. You may be dead to-morrow, and it will be too late then to think of drinking in draughts of fresh air and seeing the young leaves or hearing the birds. The wise man does not bank on a vague Heaven in the dim future. He realises that he can make his own Heaven for himself here, in this world, and now. The bird in the hand is the thing to go for, especially as it doesn't prevent, but rather leads up to, gathering two more from the bush.

PLEASURE IS NOT HAPPINESS.

Many people think that "pleasure" is the same thing as "happiness." That's where they take the wrong turning.

Pleasure is too often only a distraction. You may take pleasure in looking at a football match or a play, or in reading a good story, or in criticising your neighbours, or in over-eating, or getting drunk. But the effect is only temporary; it lasts but for a time. Indeed, in some cases the reaction is anything but pleasurable—there is the headache next morning!

Happiness is another thing, it sticks by you and fills your life. You find that Heaven is not a vague something somewhere up in the sky, but is right here in this world, in your own heart and surroundings.

Arnold Bennett defines happiness as "satisfaction after full honest effort."

But there is more in happiness than that. For one thing, as he admits himself when he says that "almost any marriage is better than no marriage," there is intense

happiness in the loving comradeship of a mate and the eager trusting companionship of your children.

The late Sir Ernest Cassel, who most people would point to as "a success in life," confessed to failure in the end. He had gained great riches and power and position and had achieved successes beyond the ordinary in his commercial, industrial and sporting activities. But at the end of his life he admitted that the great thing—happiness—was missing. He was, as he put it, "a lonely man."

"Most people," he said, "put too much belief in the theory that wealth brings happiness. Perhaps I, being well to do, may be entitled to say that it is not so. *The things that are most worth having are the things that money cannot buy.*"

There is at any rate some comfort and encouragement in that remark for the man who is poor.

So there is also in the Cingalese proverb, which says, "He who is happy is rich, but it does not follow that he who is rich is happy."

THE POOR RICH.

My wife and I did a queer kind of trip once. We went for a walking-tour on the edge of the Sahara Desert, where it breaks up into the arid stony wilderness of the Aures Mountains. We had with us our two mules to carry our camp-equipment, and two armed Arabs as guides and guards.

In the course of our journey we crossed the road made by the French which runs to the desert town of Biskra, and here in place of the usual strings of camels meandering along, we saw motor-cars tearing across the plain.

Inside were tourists in goggles and veils being rushed to their destination—the big hotel in Biskra—without knowing anything of the joys of tramping it, of finding your own food (even to the spotting of tiny cracks in the soil which told of truffles underneath) and cooking it in the open and bedding down at night under the stars.

As we saw them, with one impulse we both ejaculated, "Poor millionaires"!

Yes, if you have riches you miss a terrible lot of fun.

Hannen Swaffer, writing in the same strain, shows how "poor" Andrew Carnegie, the millionaire, tried to give his

money away in libraries to towns that did not want to have them. "Poor" J. D. Rockefeller, the richest man in the world, is without a stomach, having to live on biscuits and barley water.

Sir Ernest Cassel told him, "There is nothing in the greatest financial successes of life to equal the love of a devoted wife and the delight of a family of happy children"—and he had not got these.

ACTIVE WORK BRINGS HAPPINESS.

But even the happiness of a home would not entirely fill the bill because it does not extend sufficiently far beyond self and therefore risks being selfishness. And selfishness is the root of discontent.

True happiness is like radium. It is a form of love that increases in proportion to the amount that it gives out, and that is where happiness comes within reach of everyone—even the very poorest.

The Rev. Canon Mitchell has written, "Don't ask God to make you happy, ask Him to make you reasonably *useful*, and I think—I really think—that happiness will then come of its own accord."

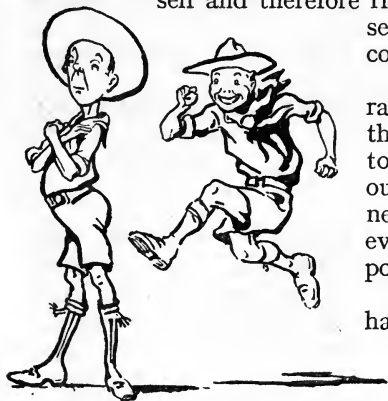

MOTTO: "A SCOUT IS ACTIVE IN DOING GOOD, NOT PASSIVE IN BEING GOOD."

Happiness seems to me partly passive but largely active. Passive, because the appreciation of the beauties of nature, of the glory of the sunset, of the majesty of the mountains, of the wonders of animal life under the scent of the camp-fire, coupled with the joy of a happy home, produce a sense of gratitude to the Creator that can only be satisfied by some active expression of it; the effort to be helpful to others largely supplies the want. It is the active doing of good that counts.

A joyful home coupled with ability to serve others gives the best happiness.

A boy was brought up before the beak lately, as being incorrigible; he urged as his excuse that it was God's fault. "If God didn't want me to be bad, He would save me and make me good."

It reminds me of one of the Boer commanders who, when he was captured by our troops, inveighed bitterly against President Kruger for not having supplied him with sufficient artillery.

He said that when he asked for it the President gave him the characteristic reply: "If God wants us to win the war we shall win it whether we have artillery or not."

To this he had replied, "That is all very well. God has given you a stomach with which to enjoy roast goose, but he expects you to do the plucking and cooking of that goose for yourself."

There is a truth underlying this. God has given us in this world all that is needed to make life enjoyable, but it rests with us to make the most of or to make a mess of it. But we only have a short time to live, and it is essential, therefore, to do things that are worth while and to do them now. One step is not to be content to have your life and ideas wholly wrapped up in bricks and mortar, trade and politics, money-making and other man-made transient things that do not matter.

But look round and learn as much as you can of the wonders of nature, see all you can of the world and its varied beauties and the interests that God offers you. You will soon realise which are worth while and which are not to a life of happiness.

In my own case I had for years past said to myself, "In three years' time I shall be dead. I must therefore get this and that in shape and finished, or it will be too late."

This habit has led me on to hustle and get things done which might otherwise have been put off till to-morrow. Incidentally—and I am very thankful for it—it led me to visit various parts of the world without that fatal waiting for a "better opportunity."

In a sort of day-dream I once saw my arrival, after I had done with this life, at the Gate and St. Peter questioning me. He said to me in a kindly way, "And how did you like Japan?"

"Japan? I lived in England."

“ But what were you doing with all your time, in that wonderful world, with all its beauty spots and interesting places put there for your edification? Were you wasting your time that God had given you to use? ” So I promptly went to Japan.

Yes, the thing that troubles very many men at the end of life is that only then do they see things in their right proportion, and too late they recognise that they have wasted their time, that they have been doing things that were not worth while.

PADDLE YOUR OWN CANOE.

There is a tendency for you as a young man starting out into life to feel that you are but one of a crowd, and so can drift along with the rest and you will be all right, like the lady who, when remonstrated with by her spiritual adviser with the warning that her present life would lead her to hell, replied: “ Well, other people have to bear it. So must I.”

Well, that is a rotten bad tendency. Remember, you are *you*. You have your own life to live, and if you want to be successful, if you want to be happy, it is you who have to gain it for yourself. Nobody else can do it for you.

When I was a youngster a popular song was “ Paddle your own Canoe,” with the refrain

“ Never sit down with a tear or a frown,
But paddle your own Canoe.”

This was meant as giving guidance to going through life—and very good too.

In my picture of you, you are paddling your canoe, not rowing a boat.

The difference is that in the one you are looking ahead and sending yourself along all the time, while in the other you are not looking the way you are going but trusting to the steering of others, and consequently you may bump into snags before you know where you are.

Lots of fellows try to row through life in that way. Lots more prefer to sail passively and to be carried along by the wind of luck or the current of chance; it is easier than rowing—and quite as fatal.

Give me the fellow who looks ahead and actively paddles his own canoe—i.e. shapes his own course.

Paddle your own canoe ; don't rely upon other people to row your boat. You are starting out on an adventurous voyage from the stream of childhood, along the river of adolescence, out across the ocean of manhood to the port you want to reach.

You will meet with difficulties and dangers, shoals and



PADDLE YOUR OWN CANOE—LOOKING AHEAD. IF YOU LET YOURSELF BE ROWED BY OTHERS, WITH BACKS TO THE DANGER, YOU MAY GET WRECKED.

storms on the way. But without adventure life would be deadly dull. With careful piloting, above-board sailing, and cheery persistence, there is no reason why your voyage should not be a complete success, no matter how small the stream in which you make your start.

SELF-EDUCATION IS NECESSARY.

Remember that on leaving school you have not been educated fully to become a man. Mainly you have been shown how to learn.

If you want to win success, you must now finish your education by educating yourself. I suggest that this should take three main directions, viz. :

To make yourself capable for the responsibilities	}	of your profession or trade. as a future father of children. as a citizen and leader of other men.
--	---	---

When I left school I found that I was, as it were, in a dark room, and the education I had been given was as a lighted match which showed how dark the room was, but that a candle was available for me to light with that match and use for my future guidance in the room.

But it was only one room in this world of many rooms. It is well to look into the other rooms, that is into other lines of life in neighbouring centres or other countries, and see how people live there.

You may discover that though your own room seems dark and dismal, there are ways of letting in more sunshine and better outlook if you choose to use them.

But in making your life a success in this way, you will be doing a bigger thing than bringing about your own personal happiness—you will be doing something for the nation!

It may seem odd to you that one single fellow, and one who is not a big bug, can help the nation. But it is a fact all the same.

God made men to be *men*.

On the other hand civilisation, with its town life, tram-cars, hot-and-cold water laid on, everything done for you, tends to make men soft and feckless beings.

That is what we want to get out of.

You often see it said that the Public School education which the more well-to-do boys get is so good. It is good, but not so much for what is taught in the class-room as for what is learnt on the playing-field and out of school.

A boy there learns that clean play and true sportsmanship, straight dealing and sense of honour, are expected of him by his comrades. They discipline him. Until he has earned the right to make his voice heard, he gets very definitely put in his place. In other words, he is "licked into shape." There is a considerable hardening process about it which is all good for him in the end.

In the old days the Spartans put their boys through a very rigorous training in hardness and endurance before they were allowed to count themselves as men, and so do many savage tribes of the present day.

In Central Africa, in the South Sea Islands, among the aborigines of Australia, one still sees it in full swing. I

have known it too with the Zulus and Swazis and Matabele, where the training took the form of sending a boy out alone into the bush, when he arrived at the age of young manhood, in order to prove himself.

He was painted white with bismuth, which could not be washed off and which lasted for some weeks before it wore off.

He was given an assegai or short spear, and that was all, and was turned loose to live as best he could in the jungle.

He had to track, stalk and kill his game for his food and clothing, and make his own fire by rubbing sticks for striking sparks, and to keep himself hidden, since the rule was that if seen by other men while he was still white, they would kill him.

Well, a fellow who came out of that ordeal and returned to his kraal at the end of it was acclaimed as having proved himself no longer a boy and was given his status as a man.

Unfortunately, for the ordinary boy in civilised countries, there is nothing of this kind. We badly need some such training for our lads if we are to keep up manliness in our race instead of lapsing into a nation of soft, sloppy, cigarette-suckers.

That is why I say that if you choose to prepare yourself for success as I suggest in these pages, you will not only be doing yourself good, but you will be doing a good thing for the country, "You'll be a MAN, my son," and you will thus be making one more *man* for the nation.

And what is more, your example will spread and others will make themselves men like you.

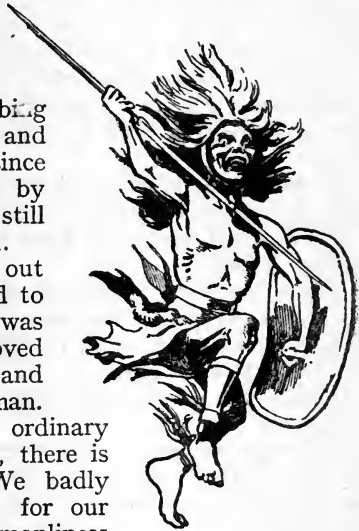

A MASAI LION SLAYER.

The joy of active, healthy manhood.

GO FORWARD WITH CONFIDENCE.

Well, I've indicated to you in outline some of the "rocks" that you will meet with in the course of your voyage through life. There will be others.

But this I can tell you for your comfort, that I have been up against a good many ugly-looking rocks in my time, but in every case I have found that as one got round there was a bright side to them.

Over and over again I have had something bad in prospect, but when I have gone into it the results have been very much better than I expected.

This has happened so often that now I rather welcome a black outlook, as I feel certain that it is going to turn out much better than it appears at first sight.

I have a little totem hanging over my writing-table. I have it there because it is an inspiring little figure.

It helps to tune one up when there's an ugly or a difficult job on hand.

When we were a rich country and used to have real sovereigns to spend, that same figure was to be seen there.

It is a man on a horse, tackling an ugly-looking dragon. St. George is his name.

I have got a lot of drawings, both ancient and modern, of him.

There is one that I like better than the rest, not because it is a better picture, for it isn't; but because in it St. George is shown with a devil of a grin on—he is tackling the dragon with a smile, cheerily, and he means to win. And that is the way to tackle any difficulty however ugly it may look.

In St. George's case it brought about the rescue of the beautiful princess and consequent satisfaction to himself.

So don't be content merely to defend yourself and to ward off the worst of what you may be facing, but go at it with a determination to defeat it and to get advantage out of it some old how.

To sum up this introduction to my subject I can't do better than quote a paragraph from the *Clarion*, written by R. Blatchford:

"I say that in human sympathy and in human service

will man find the most perfect and enduring happiness. And to sympathise with mankind and serve them you must be just and not selfish. All the warfare, all the crime, all the oppression, all that is hideous and hateful and accursed, comes from the unjust deeds of selfish men. All the delights and the blessings of art, of poetry, of literature, of friendship, of peace, and of love are contributed by those who serve and love their fellow-creatures—by the sages, and the poets, and the painters, by the faithful friends, and loving parents, and husbands, and wives."



A PORTAGE.

"Hump your own pack,"
as a man.

WHAT OTHER FELLOWS HAVE SAID

The best way to succeed in this world is to act on the advice you give to others (*Anon.*). (Sounds rather like a hit at myself!)

The great thing in the world is not so much where we stand as in what direction we are moving (*Holmes*).

Success does not depend so much upon external help as on self-reliance (*Abraham Lincoln*).

Be not a shrub but a cedar in your generation (*Sir Thomas Browne*).

We are not what we think we are, but what we think, we are (*Anon.*).

This world is so full of a number of things
That I'm sure we can all be as happy as kings.
(*R. L. Stevenson.*)

He who is happy is rich, but it does not follow that he who is rich is happy (*Cingalese Proverb*).

Hump your own Pack (*Canadian saying*).

Happiness is more than a grin on one's face, it is the glory in one's heart. It is the consciousness that one's machinery is working perfectly at the job for which it was designed (*R. Parlette*).

PADDLE YOUR OWN CANOE

For a man 'tis absurd to be one of a herd,
Needing others to pull him through;
If he's got the right grit he will do his own bit
And paddle his own canoe.
He'll look without dread at the snags on ahead,
Wine, Women and Highbrows too;
He won't run aground but will work his way round,
With a smile, in his own canoe.

Chorus: So love your neighbour as yourself
As the world you go travelling through,
And never sit down with a tear or a frown,
But paddle your own canoe.

[*Parody.*]

HELPFUL BOOKS TO READ

The Strategy of Life. By Arthur Porritt (Morgan & Scott).

The Forest. By Stewart E. White (Nelson & Sons), 3s.

The Pleasures of Life. By Lord Avebury.

Self Help. By Smiles.

Friendship and Happiness. By Arnold Bennett (Hodder & Stoughton), 2s. 6d.

ROCK NUMBER ONE
HORSES

HORSES

THE dark side of this Rock is the loafing and betting at races and football, and prize-fighting.

The bright side the active enjoyment of true sport and hobbies, and earning your own living.

SPORT AND FALSE SPORT.

Horses, their value and their harm.

Boxing is sport, prize-fighting is money-grubbing.

Football, a grand game—for the players, but bad for onlookers.

Money-grubbing is killing true sport.

Helped by Press advertisement.

The harm of betting.

Playing the game is better than paying for the game.

WHAT YOU CAN DO INSTEAD.

Don't loaf!

Go in for clean, true sport.

Take up hobbies.

Earn your own living instead of chancing it, choose your profession well.

Learn responsibility.

Be thrifty in good time.

Do service for others, and you will get all the enjoyment you want.

HORSE SENSE.

KEEP SMILING.

BOOKS TO READ.

MY HORSE COMRADES

DICK was not bad at heart. He was a great friend of mine, and I taught him lots of little tricks. For one thing, he would stand for hours without moving away if I left him with orders to stop there.

On one occasion, on the North-West Frontier of India, this was jolly useful to me. One of the horses of my squadron had broken away from the camp in the night and disappeared. This horse, A44, was one of the best in the regiment, and was ridden by the regimental-sergeant-major, so everybody was in a great stew about his disappearance, especially the colonel.

So I started off on Dick to try and find him. It had been raining and snowing all night, so I soon found his tracks and followed them, sometimes in mud, sometimes in snow. They led me off into wild country among the mountains, often over rocky stony ground where tracking was most difficult.



DICK.

After some hours of work, and after going over some

miles of country, the tracks led straight up a mountain where it was much easier for me to go on foot. So I got off Dick and told him to wait there, and off I went scrambling up the rocks and gullies, until at last I was rewarded by finding old A44, shivering with cold, bleeding from many cuts, having evidently been terrified out of his life. It took a long time to get him down the mountain-side again, but when at last we reached the foot, there was Dick calmly awaiting us—and I was soon riding home in triumph, leading my prize.

Poor A44 never got over it—he was never the same horse again, and at last got a bad fever and died. But the colonel was very pleased with what Dick and I had done in getting him back—and it was jolly lucky for me later on.

It was in this way.

Dick was my "first charger." That is, although he was my own property, I was not allowed to use him for any purpose except for riding on parade or just quiet riding about. I must not drive him in harness, or ride him hunting.

Well, one day when I was riding him near our camp, I saw a fine wild boar scampering across the fields. This was too much for me. I called to my Indian groom to hand me my spear, and off I went on Dick, forgetting all rules and orders, to catch that pig. After a great gallop we got close up to him, and I reached forward to lunge the spear into him, when Dick stopped short and stood up on end. He very nearly sent me flying to the ground by doing so. The reason for this was that among other tricks I had taught him was that whenever I made a low bow to anybody he was to rear up on his hind legs and paw the air. So, when I stooped over to stab the boar, Dick thought I was bowing, and played his part accordingly and stood up.

The pig might easily have escaped us while Dick was playing the ass, but the pig was clever, and he said to himself, "Now's my time to kill those two," so instead of running away he turned and came for us.

As he rushed at us I prepared to receive him on my spear, but as I had to lean over to do this up went Dick again, my spear missed, and the boar got a good cut with his tusks into Dick's hind legs, fortunately missing his

stomach. A second time the same thing happened. But when he came at us yet again I gave Dick such a dig in the ribs with my spurs as made him jump into the air instead of rearing, and as the boar passed under him I jabbed the spear down into his back and killed him.

But the awful thing was how to face the colonel and explain these wounds in my first charger's legs.

"Please, sir," I said, "a boar attacked me, and I *had* to defend myself!"

"Yes, that's all very well," said the colonel, "but how did you come to have a spear in your hand when riding your first charger? Let me see, isn't that the horse that helped you to catch A44 when he ran away? Yes. Well, youngster, don't go riding your first charger after pig again."

HORSES.

I love a horse. A roll of honour hangs on my wall of the different horses I have had as my companions at different times of my life.

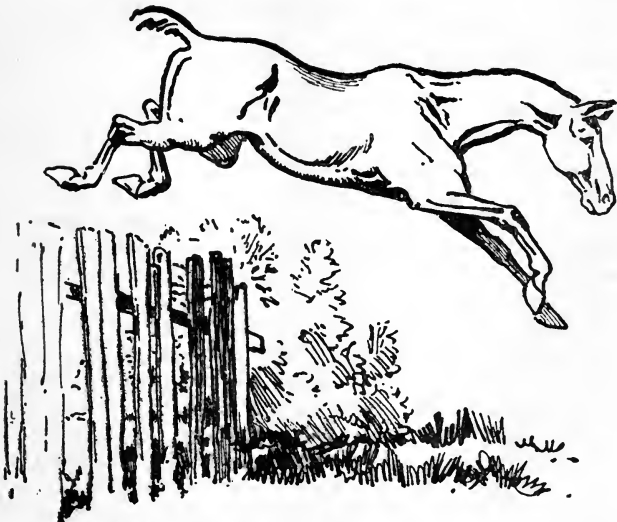

AN EXAMPLE : DOING IT FOR SHEER SPORT.

They have been good friends to me, whether campaigning, hunting, playing polo or racing.

Racing is a truly attractive sport. It stirs the blood to see those splendid animals, the best of their breed, trained to the minute, putting forth all their powers to win under the direction of masters of the art of race-riding.

But like everything else, watching races can pall on one by constant repetition, just as eating good roast beef continually would pall if there were not some salt to savour it.

There are not many regular race-goers who do not savour their racing by having a bit of money on the race. In fact, a fellow who attended meetings without betting would be looked upon as a bit of an eccentric.

It is the chance of winning or losing one's money that supplies the constant attraction rather than simple admiration of the horse.

In fact, a very considerable portion of the racing sportsmen do not bother to attend the meetings, but do their betting comfortably in their own armchair and the telephone.

They thus make themselves the playthings of chance if not the dupes of something worse. They do no good to anybody—unless it is the bookies.

PRIZE-FIGHTING IS BECOMING MONEY-GRUBBING.

Akin to the so-called national "sport" of horse-racing comes that of boxing.

A good boxing competition gives one the sight of fine men in their prime, trained to the ounce, showing the highest skill, pluck and endurance in carrying out their attack and defence under strict rules of fair play and good temper.

I must confess, however, personally to having enjoyed the boxing tournament of Boy Scouts at the Stadium far more than that of a big and much advertised fight of champions at the Albert Hall.

One was the real sporting effort for the sake of sport, the other being a money-making scheme on a large scale.

In the Albert Hall case, each of the performers received a huge fee of some thousands of pounds for a few minutes' hard punching (and a good deal of clinching), while the

onlookers paid heavily for the privilege of seeing them do so, the man who really scored being the financial promoter of the show. The so-called revival of the noble art is rather the awakening of profiteers to the money that can be made out of the public through a well-advertised fight.

And if ever there was an historical example of this it was the great fight in America between Dempsey and Carpentier, where umpteen thousand people paid umpteen thousands of dollars for a few minutes' display of nothing very great in the fistic line, while the promoter of it made a handsome fortune, after deducting umpteen thousands of dollars paid to the Press in advertising the show.

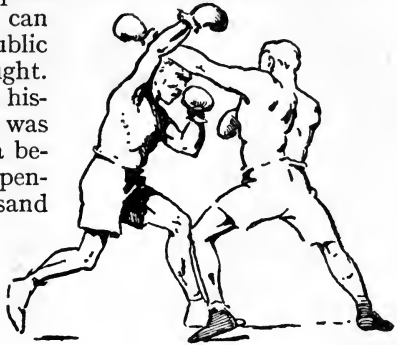

BOXING. A GRAND EXERCISE IN ITSELF, NOW USED AS A MONEY-MAKING DODGE.

This does not compare well with the "good old days" when Tom Spring fought Jack Langan for the championship belt of Great Britain at Worcester in 1824.

The fight ran to seventy-seven rounds before Langan was finally knocked out.

Some sport, and not much money-grubbing about it!

FOOTBALL A GRAND GAME, BUT—

Football was for many years, like cricket and boxing, considered a particularly clean sport. This was before it became a professionals' game.

As an old footballer myself I love the game, as, I expect, you do: you and I look upon it as one of the finest in the world. There is nothing like it for giving health and strength, activity and pluck, discipline and good temper, and above all, the great lesson of playing the game unselfishly for your side and not for your own glorification.

A grand game! and an exciting one to watch, and for this reason it has fallen into the clutches of the profiteer.

Companies now run football grounds, buy and pay the players, excite the public enthusiasm through the Press, and draw enormous "gates."

Instead of playing the game for themselves, our young men are "sucked in" with the rest of the crowd to become lookers on.



PLAY—DON'T LOOK ON.

Looking on becomes tedious without some of that salt of which I have been talking in reference to racing, and so betting becomes the feature of the game.

You will see crowds outside the gates not bothering to go in to even see the match so long as they can get the latest news of its pro-

gress and the variations in the betting. Many more don't even trouble to go near the ground, but do their football in comfort by betting on it from home.

And they call that sport!

MONEY-GRUBBING IS KILLING TRUE SPORT

Then there is card-playing. Nobody would think of playing cards for the sake of playing. It has to be for money.

Golf is fast being lowered into another means of money-grubbing, and there are even signs that cricket may follow suit.

"Professional running and sculling have practically gone under because men who provided the funds found they could not get a straight run for their money."

The journal *Cycling*, commenting on betting, said: "It is rampant at nearly every country cycling meeting. The inevitable result is that the sport has become tainted with discreditable practices."

Thus the look-out for the future of our national sport is generally bad.

Still, if betting and looking on give pleasure to the

majority, let them enjoy it. It may bring pleasure and distraction at the moment, but it certainly cannot bring Happiness; and therefore it is not time or money well spent.

I don't know why it should be so, but when you get mixed up with horses, honesty doesn't seem to have the same value that it has elsewhere. So be on your guard, whether in betting or in buying a horse.

Don't expect every horse-dealer to be honest.

I can remember buying a horse from one honest seller, and he told me exactly its faults and its good points, how much he had paid for it, and that he was now charging me a profit on this because he had since trained and perfected the animal.

As he had the best "hands" of any rider I know, that training was worth something (I am talking of Colonel "Jabber" Chisholme, who was killed leading the charge at Elandslaagte). So much so, that after I had bought the horse at his price and had ridden it, I realised that it was worth more to me than I had paid, so in my turn I followed his example and was honest too, and I sent him a further cheque.

TAKE WARNING.

You may say, "What does it matter whether sport is clean or not so long as one can have a flutter? Everybody does it. It is human nature to gamble, and you can't alter human nature. So why worry?"

I know there is satisfaction in winning, whether by luck or by study of form, but personally I hate to see what used to be true sport prostituted into a money-making concern for a few profiteers who do it at the expense of the mass of young fellows. These are cunningly led on to become gamblers while they are made to believe they are great sportsmen. Under this camouflage a very big number gets sucked in to ruin. As one who has seen a good lot of this humbug I only want to sound a warning to you. It is, then, your look out if you are fools enough to be taken in.

As you get older you can judge better for yourself whether you need that form of distraction when so many other good things are open to you.

But that isn't what the profiteers want; they like to catch you whilst you are young and gullible, and once you get into their clutches you very often can't get out again.

Many a man has made himself rich through betting, that is by being a bookie or a moneylender, but no man has ever done it, to my knowledge, *by* betting, that is by being the dupe of the bookie or moneylender.

The book-makers who have retired into opulence on what they have been pleased to call their "earnings," have really done so because they traded on the fact that most men are fools.

[That reminds me of an address I once gave on "What every woman knows," the theme of which was to indicate that she knows that ninety per cent. of men are fools and the rest are damn fools.]

So, too, at minor race meetings much of the money of the gullible public goes into the hands of those who are in league with masters of their *craft* among the jockeys.



THE REAL AND ONLY
WINNER.

WHAT IS THE HARM OF BETTING?

That is a question you may naturally ask. Well, to begin with, apart from its eating like a disease into the vitals of true sport it is a fools' game for the bettor, because it nearly always means throwing away money in the end.

Very few men, if any, ever made betting pay in the long run. So, unless you are very well off, it is a dangerous game.

The sight of someone winning a pile tempts a fellow to chuck slogging and to try for a turn of luck: it looks like a new way for getting rich quickly, but too often it proves to be the way to get rapidly broke. In almost any case, it breeds in you a nasty trait in character—cupidity. The so-called sportsman wants to win for the sake of the money he is going to get out of the other fellow. Where cupidity comes in, honesty goes out. There is precious little of

true sport about that greasy hankering after some other fellow's money.

Loads of fellows have thought it was an easy way to make money, and have plunged deeper than they could afford; then has come the worse crime, and they have then had to steal or embezzle their employers' or other moneys to pay their debts, or have committed suicide to escape the consequences.

That is the wretched story that one sees repeated over and over again in the papers, but the warning is never heeded by other young fools.

Here is a record compiled of the results of betting losses for the twelve years previous to the war in London alone :

Suicide or attempted suicide	234
Embezzlement and thefts	3,234
Bankruptcies	530

It has been estimated that over 50 million pounds have changed hands between book-makers and their clients in the United Kingdom in twelve months, and that the large percentage went to the bookies.

THE POWER OF ADVERTISEMENT.

For the unhealthy development of betting a certain section of the Press is largely to blame.

A newspaper can take the stand either of leading public opinion on to right lines, or of following the taste of a public, and this may run on to wrong lines.

Unfortunately, there are more who follow the public in our Press of to-day than there were a few years back.

Sunday papers that cater to the morbid taste for murders, divorces, horrors and dirt, are rivalled by evening papers that extol professional football and racing, etc., to an exaggerated degree, as being of higher importance than the things that really matter to the welfare of the nation.

It is true, as the Editor of *The Times*, Mr. Wickham Steed, lately pointed out, that to hold independent views a paper must be independent financially; but it is regrettable that in order to do this many of them have to succumb to the fees that are offered by promoters of prize-fights and cinema stars, so that the public, inflamed by the

Press notices, go quite dotty on performers whom in their own better judgment they would consider very ordinary.

But, and there is no getting over it, the crowd is too often an ass : it doesn't think for itself, nor does it bother to look at both sides of a question. If it did it would not pour its money into the hands of bookies, football company directors, and prize-fight profiteers who are trading on it, but would go in for sport—true sport—for sport's sake, and for the enjoyment and health of it.

I enjoy a good story shown on the film at the cinema (not sinemar, but kineema, I'm told, is the correct way to say it), and some of the acting in those dramas is really wonderful where the actors convey their ideas by expression and gesture.

At the same time their art, good as it is, cannot come up to that of the stage actor who, in addition to these, gives life and soul to the part when he puts it to you in real flesh and blood with human voice and tears.

And yet Molly Mickboard is known to millions for her pretty face and charming acting on the screen, as is Charlie for his funny clowning. The arrival of either of them in a city is foreshadowed days beforehand by carefully prepared paragraphs in the Press, and these gradually boil up in intensity as the day and hour approaches. Advanced greetings are vouchsafed to the nation from the heroine or even from her husband, the hour and place of arrival are fully announced, so that the climax of advertisement is reached when the mob surges to the station to receive the star. They don't do it for an actor, however good he may be. But if you ask any one of the crowd why he does so, not one in a thousand can tell.

Yet into the same city, through the same railway station, have come soldiers and sailors, back from hell, who fought for us and saved their country, but who were allowed to slide in unnoticed and unpraised.

I don't condemn the heart and good will of the people, but the fact that they are so easily sucked in by Press advertisement.

TRUE SPORT.

After reading all this you will think me an awful spoilsport. Years ago bull-baiting was put a stop to by a lot

of people who drew up a petition to Parliament against it.

Their opponents afterwards said of them that they did this not so much on account of the cruelty to the bull, as because they hated seeing other people enjoying themselves.

Well, you may think that it is much the same with me. But it isn't. I have enjoyed true sport and enjoy it still as much as anybody ; indeed, I think I enjoy it more than most people.

And better than any sport I like to see other people enjoying themselves, and the more there are of them doing it the happier I feel.

But such a lot of fellows go off on the wrong tack, imagining they are out after sport when really they are being lured by profiteers, under the name of sport, to put money into their, the profiteers', pocket.

I have no doubt that I should myself have lost a lot of money that way, that is through betting, had I had any to risk. But I hadn't, nor had I enough mathematics in my brain to be able to compute the odds for putting money on when I had any.

Moreover, "once bitten, twice shy." I never forgot that I had once made a bet when a boy at school, and had lost. I am afraid I should be giving away my age if I were to tell you that I backed a horse named Pax for the City and Suburban. I put eighteen-pence on him, and went broke over it ! And that was the end of my looking on and betting at race meetings.

On the other hand, I loved amateur racing when I knew the horses and their riders, or better still, when I had a horse in the race trained and ridden by myself. That was a very different thing to looking on at a lot of strange horses running or to betting on a race from an armchair at home. It was active sport, not passive paying out.

So, too, in football I played in my school team and loved the game. And I still enjoy watching a good match between amateurs, but it is only a very modified joy to me to sit and look on at men playing the game because they are paid to, and to see and hear the vast crowd of onlookers yelling with hysterical frenzy that is largely intensified according as their money is in danger or assured.

What is sport ? To my mind it is the active playing the

game by the individual in place of being merely one of the crowd looking on or having your sport done for you or even helped by a paid hand. As a golfer, for instance, I would not employ a caddie to carry my clubs. It may be that I can't afford the high fees of modern times; it may be that I realise that my language might stun him; it may be that I fear his criticism of my fozzling; it may be that I don't like encouraging boys to take up a work that leads to nothing for them in the end; but my main objection is that I prefer to do my own playing of the game. It is just the same with stalking a stag, or landing a salmon. I don't want a gillie to do the job for me. Why, I don't even have my hair cut by another man; I do it for myself—so far as I have hair!

HOW TO GET FUN AND MONEY HONESTLY

You will say: "It is all very well to criticise looking on at sport; but—

What is a fellow to do with his spare time?

How is he to make money?

How is he to get enjoyment if he doesn't go to races and football?"

Well, it is a bit of a conundrum to lay down any programme that will suit every kind of young man, whether he is rich or poor, or of moderate means, and whether he lives in a town or away out in the country, for winter or summer, singly or in company, indoors or out, day or evening.

Could you suggest an answer yourself?

I guess not. But here is a suggestion in broad principles that may be helpful.

The great secret is to have as your motto these words—**DON'T LOAF.**

To float over a dead calm sea is uninteresting, but it is a very different thing in a nice breeze when there is a bit of a sea on and you always have a wave in front of you to be negotiated, and no sooner are you over that one than another rises before you.

In paddling your way through life you will find the joy of it in always having a fresh wave of work or activity ahead of you to tackle.

So, in answer

To your question of what
to do in the matter of
SPARE TIME,
MONEY,
HAPPINESS.

My suggestion is, go in for
TRUE SPORT AND HOBBIES,
SUITABLE PROFESSION AND
THRIFT,
SERVICE FOR OTHERS.

SPORT.

By *true* sport I mean any kind of game and activity that does you good and which you play yourself instead of looking on. I know that playing-fields are scarce at many centres, and they won't accommodate all the fellows who want to play. Still, there is room for thousands more than those who use them to-day, and also there are playing-fields of a different kind which so far have been little made use of. I could suggest a good many games to meet one condition or another, but I allow it is hard to fit them in to suit all.

The main thing is for you to think out for yourself which sport would best meet the conditions and surroundings in which you find yourself.

But if you can't hit off a line for yourself I can suggest one at any rate that will meet all the above conditions, and you will find it described in the last Chapter, on Rovering.

A TRUE SPORT.

Under the head of a true sport, and one which is open to all alike without much expense, is mountaineering.

"Mountaineering?" you may say. "A lot of mountaineering you can do in England."

Well, you can do a good deal, and I will show you how. To climb a twenty thousand foot mountain is a glorious achievement, but you are not hanging on by your eyelids all the while: the difficulty that tests the climbing powers of your fingers and toes only comes once in a while. If you fall there, you go down two or three thousand feet before you bump. You can get an equally effective fall at two or three hundred feet in climbing an equally difficult rock face at home in your own country. You can get just as much excitement out of climbing on a small mountain, which needs just the same nerve, endurance, and skill, and the same good comradeship on the rope.

At the same time it is a very dangerous practice if you have not been carefully trained for it and have not an experienced climber to lead you.

"It isn't the height of the mountain that counts so much as the difficult bit to be overcome." That is what General Bruce, the leader of the expedition to Mount Everest, said to me in talking of the possibilities of rock climbing for young men in the British Isles. He is enthusiastic about it. The only wonder is that it is not better known and more practised as a sport. This is largely because fellows don't realise that they can carry it out in almost every part of Great Britain.



EVEREST—EVER CLIMBING,
NEVER REST.

If you can't get a mountain you can generally get a group of rocks, a quarry, or cliffs. These all give splendid practice for a team of three or four mountaineers with a climbing rope. Occasionally you hear of a man climbing alone, as in my little outing in the Andes on page

181, but this is all wrong. Once is enough just to give you confidence in yourself, but it does not do to be left helpless from a fall or a sprain. Climbing ought, indeed must, be done in teams, and for that reason it is good. Each

man on the rope has to make himself efficient, so as to be helpful to the others. That is a good practical lesson in itself.

Climbing is the best possible physical developer of nerve and muscle and endurance. A good rock climber cannot be a C3 man. And it is ripping good sport.

Then it needs observation—eye for country and resourcefulness.

I once accompanied the Italian Alpini troops campaign-

ing in the high Alps. These men are trained entirely for mountain work, being all of them recruited from the inhabitants of the mountains. We sighted the enemy on the great snow slopes on the other side of a gorge some two thousand feet deep and two or three miles across. The officers were given the general plan of attack. Then they spread themselves out at intervals in a long line, and sat down and gazed at the opposite slopes and cliffs. They studied them through their glasses, each seeking out a particular line for his detachment to climb, and noticing the landmarks by which he should find it as he worked upwards from below.

The selecting one's line and picking it up as you climb is what gives rock and mountain climbing a never-ending variety and interest and helps one to be successful or to be merely a moderate climber according as you become good at observation.

Then there is the moral effect of learning to face a difficulty, even when it looks like an impossibility, with calm determination and good cheer.

You thus get to face the difficulties of life in the same spirit, and by sticking to it and trying the different ways round or over the obstacle you get there in the end.

Lastly there is your soul. A funny thing to find in rock climbing, but there it is. Climb in company, but when you reach a glorious summit with its vast unearth-like outlook, sit down alone apart and think.

And as you think, drink in the wonderful inspiration of it all.

When you come down to earth again you will find yourself another man in body and mind and spirit.

HOBBIES AND THEIR VALUE.

I find that the habit of doing things for oneself grows upon one and spreads into all branches of one's daily occupation. And a very healthy habit it is; "if you want a thing done, do it yourself" becomes the order of the day.

Even little odd jobs about the house begin to have a fascination, and they teach you a tremendous lot. You get to hammer the nail instead of your thumb with a little practice, and become neat-fingered with the knowledge

of the action of electricity when you re-fit your electric-light plugs.

When war came and deprived us of our supplies of vegetables and fruits, it brought a blessing in teaching many of us to become gardeners and to grow our own food. Allotments have done more harm to the public-houses than any temperance reforms in Parliament, and at the same time more good to the health and contentment of men than any amount of sanitary or political reforms. Your own garden is a grand hobby ground for any man, and the best rest-cure that a hard worker can have. It gives to very many their first real taste of the open air and it has brought to them their first introduction of the growth of plants as well as of bugs and grubs—i.e. Nature Lore.



HAVE A HOBBY OF SOME SORT.

It is the natural bent of every boy to make things with his hands. So many men lose the attraction as they grow older, but where they keep it up this natural form of self-expression and the fulfilment of the natural desire to produce becomes a habit and one which fills many an empty life. A man

with hobbies never has time to waste, time never hangs heavy on his hands, and he is not easily dragged away to other attractions that are boosted in the Press. Hobbies are a safeguard to him.

Hobbies and handcraft lead to skill, for a man who puts his whole thought and spare energy into making things cannot help developing a considerable amount of perfection in his work; and where the mind is applied to the hand, imagination and resource step in, and from hobby work a man often goes on to be an inventor.

When you look around your room or your office or your workshop you will find a hundred articles within sight which

have been the outcome of invention by one man or another. So it comes in your power if you are a hobby man to evolve some invention which may not only help you financially, but which may be a blessing to your fellow-men.

Often, too, through the practise of hobbies a man has found one which, although entirely apart from his present profession, has proved to be the thing for which he was by nature best fitted, and it has shown him a new line and a real career for him to take up ; and if he had previously been a round peg in a square hole he has now found the round hole in which he is properly fitted.

But hobbies, at any rate very frequently, if not generally, can bring in money where a man is in need of it, and although I do not advocate pursuing money for money's sake, I quite recognise the need of a certain amount of it to enable you to carry on and not to be a drag on other people.

In the old hunting book, *Jorrocks*, there is a celebrated character, "Jogglebury Crowdy," whose great hobby was cutting sticks in the hedgerows and woods with a view to making them into walking sticks. I too have that hobby amongst my many others, and though it doesn't sound a very exciting one, yet when you come to practise it it is sufficiently attractive to lead you mile after mile in the hunt for a good stick which would otherwise be untold weariness ; and the satisfaction of securing, of straightening and curing a good stick is very great. I only mention this as showing how the very simplest hobby, one that could be practised by anybody, has its attraction.

Moreover, it has its paying value, and many a boy I know of who has taken up this particular line finds himself able to earn many an honest shilling by it.

But a man who finds out his particular line in hobby can often make it pay well, and thus, instead of trying the impossibility of making money out of betting, you can take the more certain line of doing it in the equally attractive pursuit of hobbies. And the money gained by your own effort is very much sweeter than that filched from somebody else.

Apart from hobbies that bring in cash, there are loads of them to choose from according to what happens to be your taste.

Music, pictures, sculpture and drama, these are all easily available for men in towns, and there is no need for loafing where there are municipal galleries, museums and concerts, etc.

But it is not merely the passive enjoyment of these that I recommend. It is your active self-expression of them that pays.

By self-expression I mean such work as writing poetry, carpentering, playing the fiddle, clay modelling, sketching, and so on. Also there is interest in collecting stamps, coins, fossils, curios, bugs, or any blooming thing.

Nature rambles in the country for studying birds, plants, or animals. You can go in for chicken rearing, fruit growing, jam boiling, rabbit keeping, or making moccasins, or any old thing that you like. There are hundreds of things to choose from ; and when you have found the one that grips you it will repay you, not perhaps in cash but in life-filling satisfaction.

SUITABLE PROFESSION.

As regards money, for most of us an assured income is necessary to save us from being a drag on others, and to put us on the road towards enjoying life and helping others to enjoy it.

So instead of throwing your cash away on the chance of getting more back out of some less lucky fellow let us use the time in making a sure income in return for honest work.

And this means, as a first step, preparing oneself for a profession in life.

I have said I don't like using caddies at golf because it leads the boy on to take up a job which pays him for a time but holds no future prospects for him. He has to drop out when he grows to be a man, and finds himself then not fitted for any special profession. And so in very many cases he becomes a loafer and a waster.

Well, it isn't only the caddie who makes a wrong start in life in this way. A good many boys see a chance of getting a well-paid job or are urged by their parents to take it, but they forget to look at the other end and to see how it is going to benefit them later on.

Too many of these well-paid boys' jobs lead to nothing, and leave the lad stranded just at the important moment

of his life when he should be going up the first steps of a career that will pay in the end.

Then a very usual fault is that even when a young man has found a line that has good prospects in it he takes it up because the job looks like suiting him without first considering whether he is really suited to the job ; and eventually he finds, or his employers find for him, that he is not the right man for it, and out he goes to try and find something else to do. He is a square peg in a round hole, and so he never gets on.

The thing is to find out, while you are being educated, what kind of work you are best suited for, and if at first you take a different job that will give you pay you should still keep your eye on the right line and go for that directly you get your chance.

If you are a square peg keep your eye on a square hole and see that you get there.

“Get the scent in your nostrils and keep your nose to the ground, and don't worry too much about the end of the chase. The fun of the thing is in the run and not in the finish.

When I was a young fellow out of a place, I always made it a rule to take the first job that offered, and to use it for a time till I could catch a better. You can catch a minnow with a worm, and a bass with your minnow. With the bass you can catch an otter, and then you've got something worth skinning.”

That is the advice of *The Self-Made Merchant to his Son*. If that “something worth skinning” is to make a fur coat of comfort for someone else, then you have reached success in your business career ; you have won your way not only to making a living, but also in making your work of service to others.

And that means enjoying your life.

If you should wish to take the suggestion of the pork butcher and find some sort of paid occupation, until you can hit on a congenial opening, you might in many cases do worse than enlist in the Royal Air Force, since the service is not long, is well paid and the work is of intense interest.

But what is more it is actually educative and if taken in that spirit gives a final finish to your school training. You are meantime gaining character, and “a character” such

as will enable you the better to take up a career when you see one open to you.

Similarly, should you be contemplating life in one of the overseas Dominions, by far the best way to gain local experience and friends is to serve for a time in the Constabulary of the country. This similarly is educative and well paid and character building.

THRIFT.

Since the war our critics tell us that the nation has gone very much to the bad. Well, I don't know. I see that the Headmaster of the City of London School says that the boys of to-day are more energetic than those of yesterday, and are getting better every day. That is a promising sign at any rate.

Certainly there are more people who save money now—and fewer who spit. I don't know that the two points have any connection, but they just happen to be facts.

I have suggested in the coming pages that by practice of self-restraint you gain character ; but you also gain another thing—at least sometimes—and that is money. Through checking your use of liquor or tobacco or extra food and of not indulging in things you can't afford you save the cost of these, and, mind you, in the long run that's not a thing to be sneezed at.

I never suggest to people to do what I would not do myself, and I have done a bit of this thrift in my time that I am recommending to you.

I was the sixth of a family of ten and my father was a clergyman who died when I was three. So I was not brought up in what you might call affluence, and when I got into the Army I had to live as best I could on my pay, which was pretty small.

It was a bit of a struggle. It meant among other things no breakfast or midday meal at the Mess, no smokes, no liquor, and it meant earning what I could outside my military duties by drawing and writing.

But I worked hard and enjoyed the struggle. And I "got there" in the end. I had any amount of luck, but I must add, that I snatched a good deal of this for myself. What is commonly called luck is really largely the power to spot your opportunity and to jump at it and seize it. Too

many fellows sit down and wait for luck to come to them and then complain because it never does so.

The curious thing was that I got on faster than I wanted to. I had no real ambition to do anything more than be able to keep myself without drawing on my family to help. If I could do something to help them, so much the better. And I loved my work because it was among the men and horses. I was perfectly content.

But when promotion came to me and I was moved up to higher standing, although the pay was better and the prospects great, I did not like the idea, and I only wanted to be left where I was. I remember well asking my colonel whether I could not decline the promotion, but he laughingly pointed out that that was impossible—and up I had to go. I got on; but it was largely thanks to practising thrift in the beginning.

I was amused a day or two ago in looking through some of my early diaries of journeys and visits to friends; how religiously I kept account of every penny I spent, and how triumphantly I recorded every penny that came in to be available for spending! I could speak, if anybody could, to the truth of the saying, "Take care of the pence and the pounds will take care of themselves."

And I was not only able to help myself in this way but was able to give advice from my own experience and a lead to a lot of my friends among the men in my squadron in the same direction. As a consequence, canteen profits went down, but savings-bank balances went up. The men were healthier and happier, and, on leaving the Service, had money in hand with which to set themselves up in business or in private life.

So too it can be with you who read this. If you have no money, make it—somehow; but make it. A rainy day may come and you ought not then to be a drag on other people's resources. Think of that rainy day, too many fellows forget about it and suffer in the end for their neglect.

If you already have some money, that is no reason for chucking it away; freeze to it. If you have to spend it at all, spend it on other people and not only on your own amusement.

You may be rich, but there is one thing you can't afford—that is if you are a good sort—you can't afford to spend

money on your own luxuries while there are people around you wanting the necessaries of life.

But look here, when I talk of thriftiness I don't mean meanness. Be as mean as you like towards yourself, save from your own expenditure but not from what you would spend on other people.

For myself I enjoyed life just as much as my fellows. I hunted, I played polo, I enjoyed pig-sticking and big-game hunting, but I did not buy high-class-priced animals for the sport, I bought unbroken, untrained ones at little cost and had all the fun and interest of training them myself. Some people buy things almost because they are expensive ; others don't. One man will buy a new coat the moment his previous one shows any sign of dirt or surface wear, another when his coat is worn has it turned and uses the other side of it and so makes it last twice as long. There are ways of getting along with small means quite as enjoyably as with big ones if you only exercise your ingenuity and thrift. Indeed it is a bit of adventure that appeals to a sporting mind. Poor millionaires !

SEIZE YOUR OPPORTUNITY.

A man who had been in my regiment as a soldier came to me not long ago complaining that he was on his beam ends. He said he had served his country faithfully for the best ten years of his life and this was the way a grateful country treated him, letting him down into the gutter. He had no particular trade training, but his brother in Canada was willing to take him into partnership if he went out there. But for his part he didn't think it right that he should be banished because he had served his country, nor had he the money to take him if he had wanted to go.

I asked him how much he had saved during his service. He smiled ironically and said, " You don't save much as a private soldier." But my experience was that most of my ex-men had left the Service with a very fair balance in the savings-bank, and I was bound to say—" You got your food and lodging and clothing and doctor and fuel and light and water all good and all free, and you also had at least 1s. 6*d.* a day clear to spend on yourself—i.e. £27 a year. It would have been possible, therefore, in your eight years to have put by £216, or even allowing yourself beer and baccy

and entertainments, well over £100, which with interest would yield £150 in eight years. This would have fixed you up in Canada, and Canada is not a place of banishment but a jolly good land of promise." But he was one of those who had not used the opportunity when he had got it. The moral of this story is, "Make hay whenever your sun shines ; don't wait for it to shine later on ; clouds may get worse and rainy times may set in."

As John Graham said to his son, "Don't play with the spoon before taking your medicine ; putting off an easy thing makes it hard ; putting off a hard one makes it impossible. . . ."

Old Dick always kept putting things off. When I last heard of him he was ninety-three and just about to die. That was ten years ago—and I'll bet he's living yet."

The thing is to save your money from the very first, especially while you are young and hefty. Mr. Pound, writing on Boy Wage-earners, says that formerly a worker gradually earned higher and higher pay till he was over thirty years of age. Now a lad of eighteen gets good pay and realises his highest at twenty-five, and his earning capacity dwindles rapidly from thirty-five to forty-five. He gets more at twenty than his father did, but very much less at sixty.

Why save up ? Well, you may some day see your opening to better things if you could afford to go overseas, or had a little capital to set yourself up in business. But what is still more certain to come is that one day you'll want to get married ; you will have to think of setting up house with a wife, but there is something more than that which too many men forget. There will be the children. It is playing a low-down trick on them to bring them into the world if you have nothing then to bring them up on.

HOW TO SAVE UP.

The Post Office Savings Bank is as simple a way as any. The postmaster at your post office will take your savings as you hand them in and give you a bank book showing the amount you deposit from time to time, and this money will draw interest and gradually increase of itself.

Another method is to buy National Savings Certificates at a post office or bank with saving enough to buy a few

stamps each week to be attached to your savings card. These savings stamps can be bought at any money order post office.

But another and very popular way is to join with a few other people in forming a "Savings Association" under the National Savings Committee. Under this system you pool your savings each week with the other members and thus they begin to earn interest much sooner than they would do by "lone saving."

Every 15s. 6d. thus collected goes into the Bank and begins to earn at once. Full details can be got from any post office on your asking for a Savings Association Leaflet.

As you get larger sums you can of course invest them in stocks and shares which will bring bigger return though at greater risks. Investing in these requires a certain amount of knowledge of the game, and you should get expert advice. But in the National Savings and Post Office banks your money is absolutely certain and you get a very satisfactory return for it in interest.

CHARACTER FOR CAREER.

I have just been recommending a man for a good business appointment and I gave a short list of his qualifications. When I came to look over them after I had written them down it struck me that if the people who had asked about it had given me a list of the points they wanted in him it would have been just about the same as the list I gave them. You may take it that these qualities are what most employers would like to find in a man. The point for you is have you got them yourself? If not, hie-in and get them and you'll be safe for a good job in any line that you may find best suits you. This is what I said of him—

"He is very capable and energetic, reliable in every way and resourceful; a tactful leader of men—and has a hefty laugh. This last is alone worth his salary, since it comes at the time when things are looking most difficult and infects everybody around him."

Well, that is a good enough character to take you anywhere. "Capable" means skilled and efficient at his work. "Energetic" means active and keen in the enjoyment of it.

Reliable " means sober, punctual, truthful and to be trusted with money and confidential work, and is not likely to do anything foolish or wrong; that he is loyal to his employer as well as to those under him, and will carry on his work whether under observation or not. " Resourceful " means that he will find a way of carrying on whatever the difficulties may be. " A tactful leader of men " means that he is courteous and human, that he leads and does not drive. And the fact that he laughs and takes things cheerily and makes others do the same is a very valuable point in his favour.

RESPONSIBILITY.

One day, in the times when I was the usual silly ass, careless young fellow, my colonel suddenly called me in and told me he was going to make me adjutant of the regiment.

Adjutant ! I was appalled.

The adjutant was the man on whom the whole of the well being and well doing of the regiment to a great extent depended. A glorious work—but what if one failed ?

I couldn't face it.

But the colonel simply said he trusted me to do it. Well, in a few minutes I was a changed being. I was now a man with a big responsibility thrust upon him instead of being a devil-may-care feckless boy with no special aims beyond enjoying himself.

I found myself with a new and serious outlook, with great visions of what I might bring about for the good of the men and for the name of the regiment. I plunged into my work with heart and soul ; and I never looked back. That interview with the colonel, short as it was, was the real starting-point of my career.

And from that lesson in responsibility I was able to go on to higher steps of one bigger responsibility after another.

If you are to do any good towards making a career for yourself you must be able to take responsibility.

To be able to take responsibility needs confidence in yourself and knowledge of your job and practice in exercising responsibility.

In the Royal Navy this fact is fully recognised and they begin it when young. A Midshipman is given responsible

management of a boat with its crew and he gets the whole of the blame or praise according to its doings.

So too in the Boy Scouts. The Patrol Leader is the one authority answerable for the efficiency and behaviour of his six Scouts; and so it is among the Rovers (*see* final Chapter) with the Mate.

Once you are accustomed, from early practice, to take responsibility it makes a man of you. It strengthens your character and it fits you for the higher steps in your profession.

Then too it strengthens your influence for good with others.

IMHLALA-PANZI.

Here is a helpful suggestion from one who has carried it out himself with success.

It is from Marshal Foch, one of the greatest of the French generals in the war.



LAYING CAREFUL AIM FOR A DIFFICULT JOB.

N.B.—The knobs in the water represent the head of a hippo.

He says: "When you have a task to perform consider it carefully.

1. See that you understand exactly what is wanted of you or what it is you want to effect.
2. Then make your plans for bringing it off.
3. Have some good reasons for the plans.

4. Make their execution fit in with the material you have.
5. Above all, have the will, the stubborn will, the determination to carry them through to a successful finish."

I know that the Field-Marshal is right. In my own small way I have always had a weakness for planning things, even unimportant things, before taking them on.

From this I got the name among the Zulus of "Imhlalapanzi," literally "the man who lies down to shoot." That means one who takes care about first getting his aim as correct as possible before loosing off his shot. It is the sure way to success. Take "Imhlalapanzi" as your motto.

You will sometimes have to take risks if you want to succeed; take them, don't shirk them—but take them with your eyes open.

Talking of that, I was once out with another man reconnoitring the enemy's position in Matabeleland.

We had, during the night, managed to get through his outpost lines, and were in rear of his position at day-break.

While we were sneaking about studying it, whom should we meet but a jolly great lion. The opportunity was too tempting. We both nipped off our horses, and regardless of giving ourselves away to the enemy we both fired and between us knocked him over.

But he was up again in a moment, in a shocking bad temper, using awful language, with his hind-quarters partly paralysed by the shot. He couldn't gallop away, but he turned round and round, snarling and looking in every direction for us.

We didn't want to do more shooting than we could help for fear of bringing the enemy down on us, and also for fear of spoiling his skin as a specimen; so I went down into the dry water-course in which he was in order to get nearer and give him his quietus, while my friend stayed on the bank with his rifle ready aimed at the lion in case he tried to turn tables and give me mine.

As the lion saw me approaching he turned on me with his mouth open, lips drawn back, and eyes nearly shut with rage. I fired down his throat and killed him dead.

Then it was that, having taken our risk of being discovered, we kept our eyes open. We took it in turns to

skin the beast (and if you have no gloves it is wonderful how soon a hunting knife can raw your hands when you are in a hurry with a great tough loose hide to deal with). While one man skinned, the other kept a sharp look-out in every direction with the acute feeling that they were looking for us all the time.

Lucky we did so! As we got the skin off, the enemy discovered us, and we just had time to bundle it up and mount our horses before they got within reach of us.

HOW TO PREPARE FOR A CAREER.

A scheme was once made out of what a young man should go in for when educating himself for his career in life. The main points that he should aim at were put in diagram form (*see* page 59).

I was asked to criticise this: so I added another diagram as Part II to it.

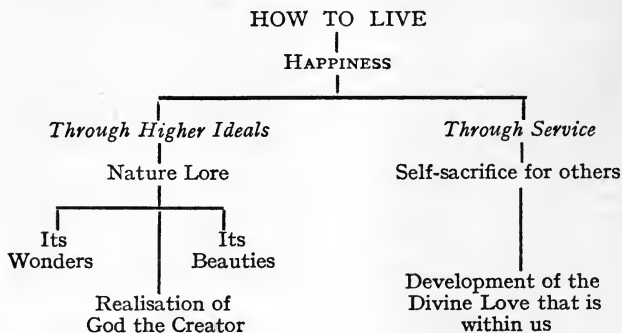

With regard to Part I (page 59) the qualities shown in italics all go to form what is known as *Character*; and it is Character, as much as efficiency or skill, that will help you to success in your career. But I would specially draw attention to *energy* on the one hand and *patience* on the other.

Energy comes partly of good bodily health, but mainly of genuine interest in your work. Some fellows never seem to get interested in their work because it seems to be very limited and running perpetually in the same groove.

HOW TO MAKE A LIVING

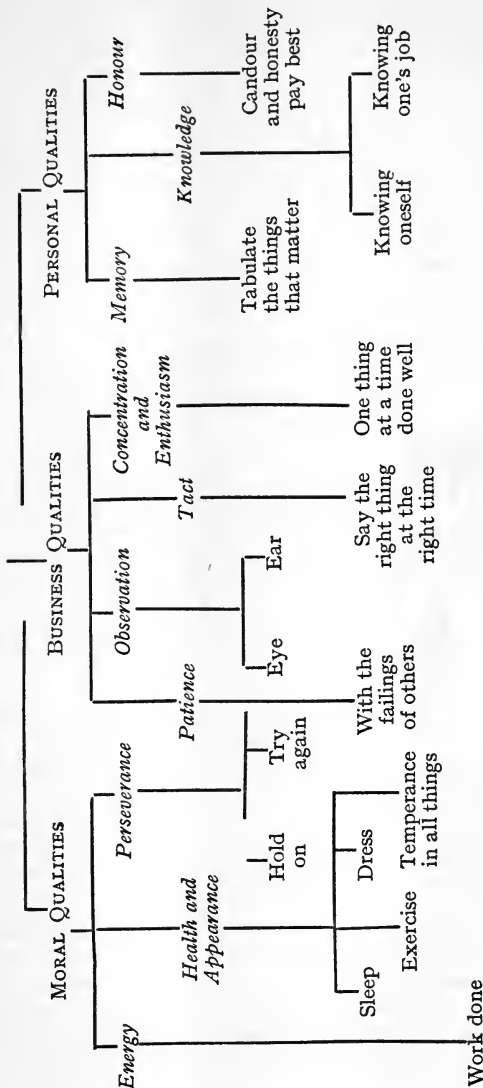

It would be better if they looked around and saw where it fitted in the complete work of the whole ; and if they looked ahead and saw the ultimate value it was going to have when it comes into use beyond the walls of the workshop or office. The best workers, like the happiest livers, look upon their work as a kind of game : the harder they play the more enjoyable it becomes. H. G. Wells, writing on the Peace Conference at Washington, has said : " I have noticed that so-called great men are really boys at heart, that is they are boys in the eagerness of their enjoyment of their task. They work because they like to work, and thus their work is really play to them. The boy is not only father to the man, but he is the man and does not disappear at all."



Ralph Parlette says truly : " Play is **LOVING** to do things, and work is **HAVING** to do things."



MAKE SURE THAT
THE JOB YOU ARE
TAKING ON IS ONE
THAT THROUGH PRE-
VIOUS TRAINING YOU
CAN MANAGE.

There is a good deal in *indispensability*. I was asked this morning why I admired my Indian servant so particularly. The reason was quite simple : it was because he put master first and self second—if self ever came into it at all, which I doubt. Absolutely loyal and to be trusted, always there, ready for any job, silent and hard-working. He was a treasure. But in that country such a character was not exceptional, whatever it might be elsewhere.

Without knowing it, he was *indispensable* ; and I can tell you this, that if you make yourself indispensable to your employer he is not going to part with you in a hurry no matter what it costs him.

Another point that is missed in the foregoing list is that of *being quick* in your work. It may to some extent come in under energy, but it is improved all the more by practice.

If you are quick in all that you do in your play and in your personal actions so that it becomes your habit, you will be equally quick in your work, and there it will count in your favour.

As a matter of practice carry it out in your daily dressing. Don't dawdle ; have everything in its place and ready to your hand ; time yourself at it, and go on and beat your own record.

Other points that should have special attention and receive too little notice in the list are *pluck* and *cheeriness*. I won't dilate upon them here, but will sum them up in the words spoken by Mr. B. B. Valentine's old negro, which I quote at the end of this chapter, p. 62. And there is another asset that you should have for making your career, that is *Hope*. Don't think that because you start low down that it is therefore impossible for you to get up. Hundreds of the big men to-day started at the very bottom of the ladder. But, as I have said before, you've got to do your own climbing. Don't stay in the mud because the others stick there ; look for your stepping-stones and make your way out of it. Get your foot on to the lowest rung and up you go.

I have seen so many men start well in life with all the equipment necessary for making them successful, who then went and failed owing to their lack of *patience* ; when things went against them at the moment they chucked up everything and tried something else ; and if once you get into the habit of chucking up and trying again it becomes a habit and remains a habit, so that your whole life becomes a series of chucking-ups and never getting up.

As regards Part II of the diagram, the question of How to Live, that is how to enjoy life with true happiness and not merely pleasure, is of equal importance with the problem of making a living ; and the two parts into which I have divided it are almost of equal importance with each other, viz. having High Ideals and Serving others. But I think that serving others is the more important of the two because it largely includes the High Ideal and is the main step to Happiness.

That is why I shall go into it more fully in another chapter.

HORSE SENSE

When cupidity comes in, honesty goes out.

A pound in hand is worth two on a horse.

If you are a square peg make for a square hole—and don't be content till you get there.

A coat, like a question, has two sides to it. Both should be exploited before you have done with it.

How your work can become play for you : Play is *LOVING* to do things ; Work is *HAVING* to do things" (*R. Parlette*).

So live that when you die everybody will be sorry—even the undertaker (*Mark Twain*).

Let us all be happy and live within our incomes, even if we have to borrow the money to do it with (*Artemus Ward*).

Most Vice is due to suppressed perspiration (*Dr. W. J. Dawson*).

Self-reverence, self-knowledge, self-control,
These three alone lead life to sovereign power.
(*Tennyson*.)

KEEP SMILING

When you feels a mighty mis'ry an' yer stomach's kinder bent,

And de doctor starts to projec' with the cutting instrument ;
When he lays you on de table, an' a-standin' by yo' side,
He's a-twitchin' an' a-itchin' ter be whittlin' up yo' hide—
DEN remember 'bout the 'possum who was sittin' on de limb,
Wid de gun a-p'inting at him, an' de dorgs a-treein' him ;
How he holler to de hunter an' he holler to de houn' :

" *I'se gwine ter keep a-grinnin'*,—doh I spec' you'll fetch me down."

(" *Ole Marster*," by *B. B. Valentine*.)

BOOKS TO READ

- The Facts of Gambling.* By J. M. Hooge (Melrose), 2s.
Mountain Craft. By G. W. Young (Methuen).
Talks to Boys and Men in the Making. By James Bogan
Scott), 2s. 6d.
The Big Business of Life. By Ralph Parlette.
Value for Money. By Sir W. Schooling (Pitman).

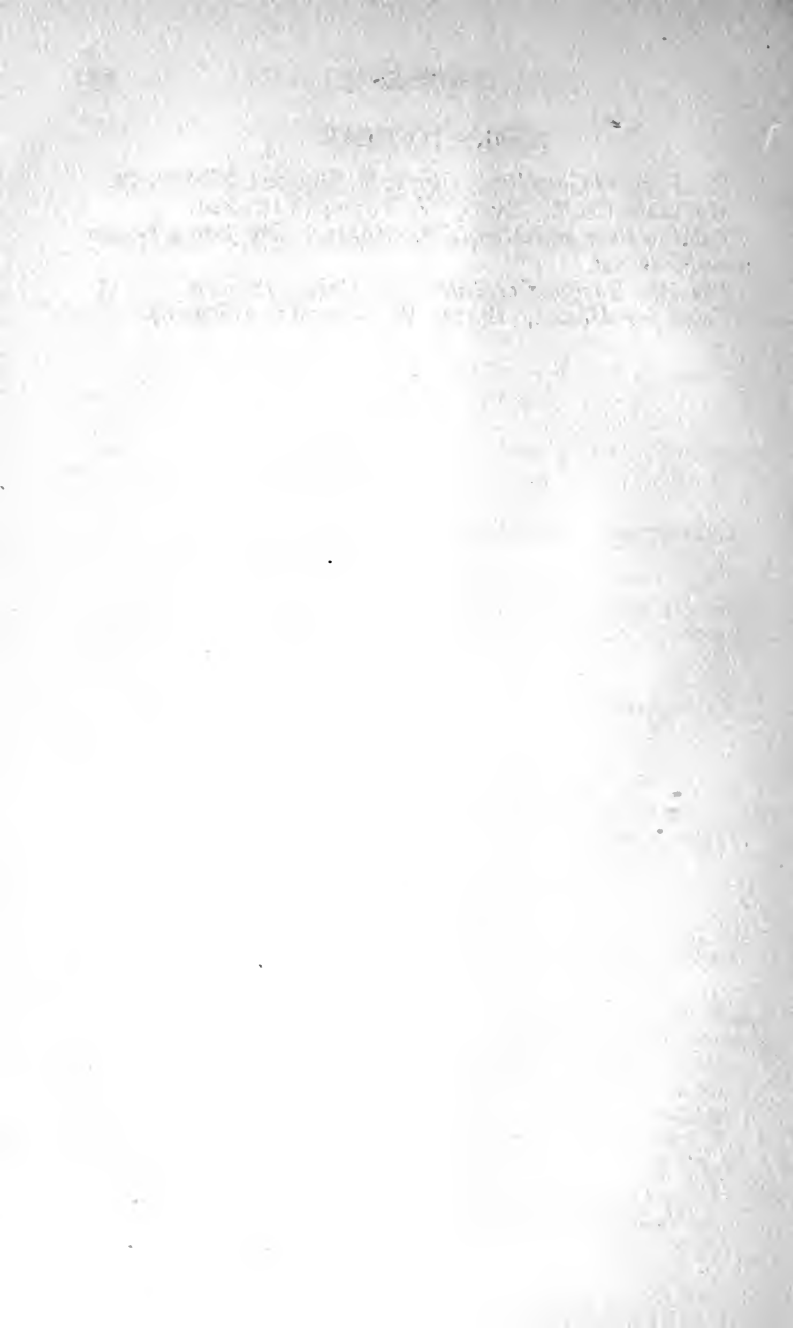

ROCK NUMBER TWO
WINE

WINE

THE dark side of this Rock is the temptation to ruin one's real happiness through self-indulgence.

The bright side is the fact that through overcoming desire you gain strength of character and a higher enjoyment of life.

SELF-INDULGENCE.

A good glass of wine is a pleasure.

The between-meals nip is a dangerous luxury.

The temptation to good fellowship leads to first steps in drinking.

The solitary soaker becomes a waster.

Drinkers are a danger to the State.

Prohibition will not be needed where the nation consists of men of character.

The force of example.

Over-smoking is a danger to health, as are also other forms of self-indulgence, such as

Over-eating.

Over-sleeping.

Over-working.

Physical fitness brings self-control and long life.

Swearing is a sign of weak character.

SELF-COMMAND.

Strength of character is the antidote to self-indulgence.

The example of General Nogi.

Self-control is the biggest item in character.

Habit and thought can be commanded.

Loyalty to yourself is as important in character-forming as is loyalty to others.

Self-respect breeds respect from others.

Shame makes a man an outcaste.

Auto-suggestion can cure temptation to self-indulgence.

How Tommy Tomkins defeated Death.

WHAT OTHER FELLOWS HAVE SAID.

BRUSH AWAY TEMPTATION.

WINE

“WINE ? ”

Colonel Yervers never attempted to be without wine or some sort of alcohol inside him.

On one occasion, when no liquor was to be got, he drank some furniture polish. When the doctor said to him, “But do you mean to say that you could get no water ? ”

The colonel replied, “My good sir, you can't have ever had a real thirst on you or you would know that that's not the time for thinking about having a wash.”

THAT THIRD GLASS.

Wine ? I like a glass of good wine—for its flavour, its colour and refreshment.

And equally I like a glass of beer or cider in its turn. Somehow a second glass seldom appeals to me so much as the first, because the flavour no longer strikes one with its novelty and the first edge of appetite has worn off.

As for the third glass, the man who is wise knows that there is “poison in the cup,” that the sugars and other chemicals contained in the liquor don't in the end do you great good. I suppose, for instance, that few people realise how a fair amount of beer-drinking brings on corns, just as port wine helps to develop gout.

It is the third glass—if not the second—that puts you out of condition for running and exercise ; and a young man will keep his eye on it accordingly.

In my regiment we worked on the principle that officers and non-commissioned officers led their men by example rather than by command, and on this principle I held that one or two of the sergeants were too large round the waist

to be able to nip on to or off their horses as quickly as they should do in showing their men the way.

So I gave out the warning that in three months' time any officer or N.C.O. whose circumference made him too slow for his position would be likely to



STOUT THE CAUSE—STOUT THE EFFECT.

lose it, and that in the meantime he would do well to lose some of his superfluous tissue.

But my criticism was also constructive, as I suggested that the trick might be accomplished by a little more exercise daily and a good deal less porter.

The results were surprising and entirely satisfactory. It was that third glass that had done the harm. But third glasses do worse than this, they lead to fourth and fifth and "sissth glass"—and then the trouble begins, and the imbibor, clinging to the lamp-post, asks, "Is this Christmas Day or Piccadilly?"

THE BETWEEN-MEALS GLASS.

I knew a wonderfully capable engineer, indeed a genius in his way; he would have been famous by now had he not been, as he expressed it, a "twenty minutes' man," that is, he was never less—and never more—than twenty minutes between his drinks.

Which reminds me of a dear old American admiral of my early days, who, when I offered him a glass of something, said, "No, sir; I never drink between my drinks."

And this brings me to my point, that it is the drinking between your eats that does the harm. If fellows only drank liquor at meal-time I believe that there would be no such thing as drunkenness, and certainly they would be twice as healthy.

Reverting to my regiment again (I warn you, you will be awfully bored by "me and my regiment" before you have

done with this book ; but I only want to give you actual experiences towards navigating those "rocks," so you must forgive me), I allowed the men, against all the regulations, to have beer with their dinner and with the hot suppers which were a regimental institution.

As a consequence, drinking at the canteen bar died down to such small proportions that on one occasion I had to present a pair of white gloves to the canteen steward because he had had a blank day when not a man entered the canteen.

TEMPTATION TO GOOD FELLOWSHIP THE FIRST STEP.

A well-wisher was trying to get a drunkard to see the error of his ways and to make a better man of him, but old bottle-nose suddenly interrupted him with the remark, " You talk as if you had never been drunk yourself."

" Drunk ? I should hope not indeed."

" Then what do you know about it ? Don't talk to me. Go and get drunk yourself and learn something of the temptation—and the joy of it. And then talk ! "

Well, there is a certain amount of temptation about it, particularly if you let yourself become one of a herd. I suppose half the men who take to drink get drawn into it in the first place by companionship and supposed good fellowship with a lot of other fellows. A lad first coming out into the world feels that he must do as others do in order to show that he is one of them—" one of the bhoys ! "

Nine out of ten boys begin smoking for that reason—largely out of bravado.

If a boy grew up, say on a ranch, where the men happened to be abstainers, but where tobacco and whisky were available if he wanted them, I don't believe that he would take to them of his own accord. Both are very nasty to the beginner, and taking to either is largely a matter of " because the other chaps do it."

And it is mighty difficult when you are in the company of others round a bar not to join with them in being given drinks and in standing them in return, and this leads to that " sisssth " glass, and to hilarity and row.

Goodness knows I don't object to high spirits and occasional rowdiness. These are natural to young men even without the help of alcohol. I have enjoyed them myself

most heartily, and played the fool to an extent that I should be ashamed of now if I did not recognise that it was all part of the nature of the lad growing into manhood.

To think that I ever played the game of "The Bounding Brothers of the Bosphorous!" Do you know it?

Well, you pile all the furniture in the room into a pyramid, legs of the chairs upwards for choice, and place a good solid table well out in front of it. Then each competitor takes it in turn to run at the table, turn head over heels on it, landing on the pyramid and not forgetting to shout as he does so, "I am a bounding Brother of the Bosphorous."



For the life of me I can't see the fun of it now—but I did then. But that is just the sort of ass a young fellow is.

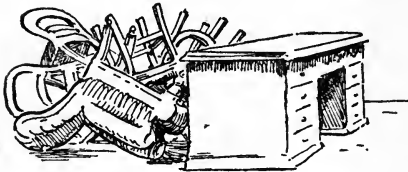

A BOUNDING BROTHER.

The joy of being a Bounding Brother is, however, entirely different from the false hilarity brought about by drink, and drink is not therefore

necessary to make a young man enjoy himself. Indeed, he can do it just as noisily and far more effectively without.

THE SOLITARY SOAKER IS A WASTER.

Apart from the good-fellowship temptation to drink there is also the more potent individual one, that of trying to forget personal miseries of mind or surroundings by "drowning your troubles in the flowing bowl."

Continued bad luck in your dealings, depression from ill-health or disappointment, an unhappy home and drab surroundings, all tempt a man to the easy refuge of a warmed-up throat and stupefied brain.

But it is not good business. The toper may say, "It is all very well to talk, but what is a man to do? After all, if it is a good way out, and if it does give him a spell of some sort of contentment, or at least oblivion, for a short time, why not let him take his dram?"

Well, the objection is, that it is bound to mean ruin, in mind and body, to the poor chap. He loses all control of his will, and he loses his energy ; and these two points are the main things in " character."

Once he has got the drink habit, or what is equally bad—the drug habit, his chance of happiness in this world is done for ; with wrecked health and lessened capability for work, he gives in to other temptations as they come to his weakened character, and he descends to meanness and crime, since he no longer has any hold over himself.

He sinks lower into a sodden existence as a waster and outcast, till death comes and puts him out.

THE DANGER TO THE STATE.

The hard-headed fellow who has character in him will not be carried out of his depth by the herd ; he will know when to stop. It is the fools who form the mass and let themselves be drifted along by the rest or by their ills ; they havenot the grit to "take arms against their sea of troubles."

Where there are numbers of these—and few of our slum public-houses are without them—the example spreads, and it becomes a herd disease. It diminishes the health and earning power, as well as the temper, of a proportion of the population, and so reduces the general happiness and prosperity of the whole.

It makes miserable hovels of the homes for which the men are responsible ; it destroys their individual self-respect, their manliness and thinking powers—in a word, their character.

That means a danger to the State.

A community that contains a number of unthinking feeble-minded fools is prone to be a prey to wild-cat schemes of agitators who can lead such a herd by the nose.

To make a strong nation you must have men of character to form it.

PROHIBITION NOT NEEDED FOR MEN OF CHARACTER.

In certain countries this danger to the State is recognised, and prohibition is brought in to stop liquor altogether.

Considering the enormous waste of money, time, and health, and lost prosperity that is brought about by drink,

there are few people, barring toppers, who do not agree that the temptation should be done away with ; though they do not all agree as to how it should be done.

In Mahommedan countries it is suppressed by a religion that holds the mass of the people. In some countries it is smashed down by law. The worst of this is it leads a lot of people to dodge the law.

This no doubt will die down as the new generation grows up untempted, but a certain amount of harm will have been done, since breaking laws in one direction will presumably encourage their disregard in others.

But prohibition mainly offends the sense of free and manly people who would prefer to reform themselves from within, and who resent the remedy being pressed upon them by reformers, however well meaning, from without.

When Sir Robert Stout recently described liquor as a luxury that we could very well do without, Miss Gaunt replied : " Yes, I suppose we could, just as the Bolsheviks consider night-shirts an unnecessary luxury."

The reform will come and I believe is coming with greater effect, and with greater dignity in many countries through the self-respect and character of the people themselves.

They are not to be ordered about like children, but when they realise it is unmanly, unfitting them for work or play, and that there are plenty of better ways for enjoying life they won't be such fools as to drink to excess.

If one looks back a few years in one's own lifetime one sees a very big difference.

When I first joined the army it was quite usual for the men and even officers to get drunk on festive occasions and nothing was thought of it. To-day if an officer were to exceed the limit in a good regiment he would be told pretty forcibly that " it is not done " and would find himself fired out if he went on with it.

One sees regiments nowadays embarking for foreign service with every man present and sober, just as if turning out for an ordinary parade, where a few years ago numbers would be absent, and half of those present had to be helped, if not lifted, into the train or aboard the transport.

Saturday nights in manufacturing towns used to mean streets full of rowdy fighting drunkards, where now one sees nothing but orderly crowds of happy, sociable people.

Improved character and improved surroundings are doing their work, though there is still an immense field for their development.

I believe in the rising generation of young citizens. The war has done something in opening the eyes of you lads to the more serious side of life.

You have ambition. You want to be manly fellows, you want to be fit to play your part successfully whether in games or in the work of life, or in the service of the community, and you see that if you mean to do it with any success you have no use for drink with its waste of time and money and health.

Taking the pledge is a step, but that is merely a help to weaker characters. The strong-minded fellow will put the case squarely to himself—that he has got to stand up to temptation if it ever comes, and to assert his freedom against its tyranny.

Prohibition will not be needed for a nation of character ; the oncoming generation will see to its own reformation.

THE FORCE OF EXAMPLE.

I have a great respect for the opinion of an honest and simple-minded outside critic, and I have found the uncivilised savage of Africa or the Pacific Islands as simple-minded and honest a critic as one could want, and a very good judge of character.

Among both these people I have heard the same verdict pronounced, " If the English white man says he will pay us we give him the goods. He will pay. But it is not so with all white men."

That is the reputation we hold, and it is one which we ought to uphold.

But even the " English white man " did not, I am afraid, come up to sample in every case. And that is where our missionaries are heavily handicapped in their work.

I remember the old Queen-Mother of the Swazis telling us, years ago, how the missionaries had come and had explained to her and her people the blessings of Christianity and how under its beneficent influence men were honest and straight in all their dealings, sober and truthful, charitable and helpful to others.

So her people welcomed the arrival of white traders and

settlers and gave them land and helped them to build their homes.

Then they found that these men instead of being grateful and helpful to others were helpful to themselves. They took the native cattle, they promised payment but gave it more in the form of kicks than halfpence. They imported whisky in liberal quantities for their own use, and trade gin for the benefit of the natives.

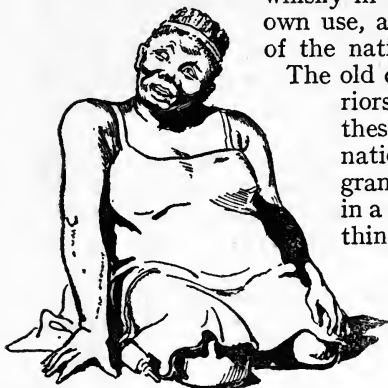

THE FORCE OF EXAMPLE. THE SWAZI QUEEN.

"Missionaries preach sobriety; but white men practise drinking. We support the Missionaries—but—couldn't you give me just one case of gin for myself?"

good our word by presenting her with a case of gin! Such is the force of example.

SMOKING.

I have harped a bit on drink because it has proved to be the cause of so much crime, disease and misery and is therefore the greatest danger to both the individual and the State, and as we are out to seek happiness and success it is a rock most strenuously to be avoided.

But there are some other forms of self-indulgence that a young man will do well to guard against for the reason that they too handicap him in gaining happiness.

There is for the boy the danger of smoking. I should be afraid to say how many letters I have had from lads or their parents, thanking for the warnings that I have given

from time to time of the poisons and other evils that exist for growing lads in tobacco.

Here is one of my latest notes on the subject.

Someone asked me : "What is the order against Scouts smoking?" My reply was that there was no order at all, but every Scout knows that the boy who smokes is a fool, and we have an understanding in the movement that, "A Scout is not a fool."

Why is a boy who smokes necessarily a fool? Well, I have given the reasons in a chapter in *Scouting for Boys*. One of the reasons is this :

"When a lad smokes before he is fully grown up, it is almost sure to make his heart feeble ; and the heart is the most important organ in a man's body. It pumps the blood all through him to form flesh, bone and muscle. If the heart does not do its work, the body cannot grow to be healthy and strong.

"No boy begins to smoke because he likes it : he hates it at first, but he does it out of swank, in order to look manly, as he thinks, whereas really he only looks a little ass."

I have just had a letter from a man who has studied the question from a worker's point of view and he says this : "More than half the present-day discontent, laziness and unmanliness on the part of our young workers is caused by excessive smoking, especially of cigarettes.

"If they could be persuaded not to smoke or drink until they are over twenty years of age, we should have a better race of men. I can prove to you that nearly every growing lad that smokes is discontented, lazy, will not settle to any work, has no interest or ambitions, is nervous and has no pluck.

"This is what the country is suffering from at the present time, and causes nearly all the unemployment among the young workers.

"What I have been telling you shows why a fellow should not smoke—because of himself."

But there is another reason against smoking, even for



grown-up men, which a large number of them forget, and that is how their smoking affects other people.

When you are going to light your pipe (I have no opinion of cigarettes—they are what women and little boys smoke) if you are in a room or in a train or the like, be sure first that it is not going to worry your neighbours.

Many men and most ladies hate tobacco smoke, and, more especially, the smell of it that hangs about their clothes after being in the company of smokers. Naturally they are shy about objecting to it, and have to bear in silence what is hateful to them. A man with any chivalry



THE CAD AND HIS CABBAGE, PERFUMING THE CARRIAGE.

in him will let his pipe wait for a more favourable opportunity.

Cigarettes are to my mind the smoke of the herd, of fidgety, flighty people, while the pipe is that of the individual who quietly sucks at it and calmly thinks for himself.

If you must smoke cigarettes, because they are cheap—remember that to be cheap they have to be made of vile stuff.

Here is what a tobacco dealer has said about it :

“ Out of every 6*d.* paid for ten cigarettes,” he says, “ about 2½*d.* goes to the Government as duty, and about 1½*d.* is the retailer’s gross profit. With the remaining 2*d.* the manufacturer has to pay the cost of tobacco, cutting,

making, packets, carriage, advertising and selling expenses, etc., and still show a profit."

I was a bit of a smoker myself, that is a smoker of pipes, when I came to be associated with some American frontiersmen who had served as scouts in wars with the Red Indians.

None of them smoked and they smiled at me indulgently as a tenderfoot for doing so, when I thought that I was really showing my manliness. They explained that smoking was apt to play Old Harry with your eyesight, wind, and sense of smell; and sense of smell was invaluable to a scout for his work at night. So I chucked smoking then and there, and have never taken to it again, and I am all the better in health and certainly in pocket for the abstinence.

OVER-FEEDING.

When I was in Mafeking we all had to live on a very reduced ration of food, and it was interesting to see how this affected the different people in the garrison. And it affected them in remarkably different ways. Some remained much the same, many were visibly reduced, and I do believe that one or two got fatter on it. But the test came at the end of the seven months, when I called for volunteers to make a sally against the enemy. I asked for those who felt themselves capable of marching five miles, and, though everybody wanted to join in it, we very soon found that only a small proportion of them could stand even this mild test. But it was quite evident that the men who were most capable of doing the required work were those who had been all their lives temperate in eating, drinking and smoking.

The same results were found during an expedition in which I took part on the West Coast of Africa through the swamps and forest of Ashanti—a region that is popularly known as "The White Man's Grave." Those men who had lived fatly and well in their ordinary life went down like ninepins. It was the moderate feeders and the active men who survived. Incidentally on that trip one discovered that meat was not a necessary part of man's food. For a long time I lived on nothing but bananas and plantains, and, though one was buried in a deep, dank forest where you seldom saw the light of the sun, and the scent in the

atmosphere was like that of an old cabbage garden, from vegetation rotting in the swamp, I was never fitter in all my life, and averaged my twenty miles a day marching with a light heart if a thin tummy.

OVER-SLEEPING.

Over-sleeping is another indulgence which people seldom take into consideration, but the Japanese have a theory that every hour of sleep, above what is essential for resting and restoring the energy of brain and limb, is harmful and encourages the growth of fat. So if a man finds he is getting corpulent, he knocks an hour off his sleep each night, and *per contra* if he finds himself too skinny, he sleeps an extra hour or two for a few weeks until he has attained a satisfactory amount of sleekness. If you want to rest your body, read a good book; if you want to rest your mind, play football or go fishing.

OVER-STRENGTH IN LANGUAGE.

Another very common form of self-indulgence, for that is what it amounts to, is *swearing*. For it shows



THE SOLDIER FULL OF STRANGE OATHS.

want of self-control, and though it may relieve the feelings for the moment (and I have found it do so myself), it is

none the less a weakness which is apt to grow worse the more you allow it a free rein. It does you no

good, and if employed against others it does harm. It arouses bad feeling on their part, and in any case it knocks chunks off your own dignity. Pett Ridge suggests swearing is too good a relief to be wasted, and should be kept

for times of crisis. Napoleon once said of General Lannes, one of his most promising leaders, "That devil of a Lannes possesses every quality which makes a great soldier, but he never will be great because he gives way so much to his temper in rebuking his officers. I consider that one of the greatest faults that a general can have."

Lannes was privately told of this by General Marbot, who was a great friend of his and an aide-de-camp of Napoleon. Lannes was eager to be a good general, and from that day on he took himself in hand and kept control of his temper and his tongue. He rose to be a Field-Marshal of France.

How many Lannes in business may have failed to get promotion because they were known to have this failing? A swearer can never hope to be a leader of men, though he may try to drive.

OVER-WORKING is another form of self-indulgence which some people go in for.

Some, I said, not all!

The publisher of this book, Herbert Jenkins, is one of the "some." I have a note of his before me as I write in which he says that he is working thirteen hours a day just now and cannot get away from London for a night. Just now! I have known him some years and I don't remember when it was otherwise with him. He always works thirteen hours a day.

I was a bit amused to hear that a newspaper recently held a competition on the question of who were the three busiest men in the country, and I found that I was bracketed with Mr. Lloyd George and the Prince of Wales.

I no more deserved such implied praise than my hat (indeed less, for my hat has done a lot of overtime in these days of post-war prices).

It is true that I am writing this at a quarter-past five on a bitter winter morning, but if I had not got up early all my life I should never have had time to get half the enjoyment that I have had out of it.

Mind you, if you only take an hour extra per day it means three hundred and sixty-five hours per annum, or three weeks more of waking time than your average neighbour gets.

Personally I reckon to get thirteen months of life into

each year instead of twelve. Some people put in extra time at the other end of the day when body and mind are tired. There is nothing like the early morning for getting over your work.

A man who takes a pride in his work gets a big measure of enjoyment out of it.

I once spoke to a young engineer whom I found working when a strike was on. I asked him how it was, and he said with pardonable pride: "Well, look at that bit of work. Isn't it nobby? I couldn't leave that."

He stuck to it for the love of the thing. What a difference it makes when you work for the love of the thing.

The only danger is for an over-keen worker that he should become a slave to his work and not give himself the right amount of recreation and rest.

By rest I don't mean idleness but change of occupation. My own change of occupation varies pretty considerably. Last week it took the form of wading in a

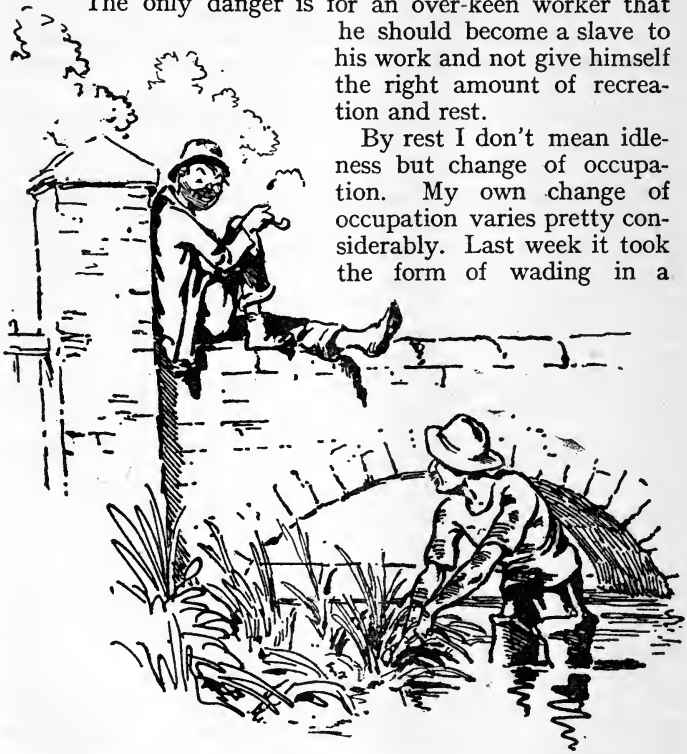

MUCKY JOB, AIN'T IT, MATE ?

muddy stream to clear off the growth of weed. The job had its interest for me, but a greater interest for a loafer who sat on the parapet of the bridge smoking his pipe and watching me with keen enjoyment as I worked.

You know the interest with which the crowd will stand round in a busy street in London and watch men remaking the road with a sort of hot chocolate. Well, he was like that.

At last his curiosity overcame his satisfaction. "Mucky job, seemingly," he murmured. I agreed. I couldn't well do otherwise being plastered, face to feet, with mud.

"Now how much do you get for that shift, mate?"

"Oh, not a tanner an hour," I replied.

"Gor blimey! Well, I'm blinkered if I'd do it!"

And I didn't doubt him.

PHYSICAL FITNESS HELPS SELF-CONTROL.

I had command of a force once where I did away with part of the ordinary equipment of the soldiers—namely their water-bottles.

It sounds cruel and at first the men thought it was so, but as they got into fit condition they found they never needed water, they were relieved of this heavy weight banging on their hips and could march three times as well as other troops.

Moreover, they did not get diarrhoea or typhoid as the others did. The reason for this was that when men had water-bottles they drank them dry within the first hour of marching.

After swilling their insides in this way they found themselves thirstier than ever and filled up their water-bottles from the first stream or pool they came across, and hence disease and sickness.

Any liquid, and especially alcohol, is bad for "condition" if taken between meals. No man in training for running or boxing could possibly keep fit if he drank alcohol except in small quantities with his food, and even then it does him no great good.

It is one of the signs of being "fit" that you seldom feel thirsty. A man gets himself fit for football or other athletic work and could not possibly carry it out otherwise; but he seems to forget this when he is dealing with the work

on which his pay and promotion depend. If he kept himself bodily in condition at all times he would do his work and enjoy his leisure twice as well.

He would take care to keep clear of those between-meals sips, and he would live to a hundred.

UNCLE JOHN SHELL.

“Last year ‘Uncle’ John Shell returned home to find his wife dead. Her relatives took charge of the funeral arrangements, and decided to take his little son, aged seven, to live with them. Uncle John protested strongly, but they took him away. Uncle John thereupon went into the house, got his old flintlock rifle, which he had himself made more than a century ago and mounting on his mule, went in pursuit. He overtook his father-in-law on the road and with his gun forced him to give up the boy.”

“One hundred and thirty-two years old—and hard-boiled!”

Yes. It is not a misprint. According to the authentic account published in the *Landmark*, old John Shell was born in Knoxville on September 3rd, 1788, and is alive and hearty to-day. And the above was his latest exploit, performed last year. The son who figured in the case was only seven, but his eldest son is over ninety, and he has twenty-seven children in between these. The old boy is a farmer, and gives as his recipe for living long :

“Work hard, but don’t over-work. Too much work is as bad as too little. Take the food and sleep that your body needs, and a little fun besides, every day.”

But, he has never drunk anything stronger than water.

AMUSEMENTS.

One little form of “fun” in which I sometimes indulge myself when I have had too long a day in office or at committee work is to go to—for goodness’ sake, don’t tell anyone—a music-hall or a cinema.

I know that I shall be told by respectable folk that this is most degrading. Well, I can’t help it. No man expects to be perfect.

I have been urging ACTIVE change of occupation as your best recreation. I have no defence for this occasional lapsing into being passively amused by others.

At a cinema I get into a restful, half-asleep condition, with a story put up in pictures before my eyes, and if it is a rotten story, as too often it is, I go quietly to sleep.

For a music-hall show I prefer one where there is a tramp cyclist, or the champion smasher of plates or the fellow with a spring necktie. A good dose of laughing is to me like a bath for the brain.

At the same time, I don't deny I get dreadfully bored with three-quarters of the show, with the arch, brazen-voiced, half-stripped lady singer, and the infernal old chestnuts about smelly fish and gin-drinking mothers-in-law, and the nasty little meaning sometimes put into their words by actors who cannot raise a laugh on their merits as humorists.

If it were all clean fun at the halls I believe the audience would like it all the better, and it would pay the management all the better.

It is true that ladies can now come to music halls, where a few years ago it was impossible for them owing to the indecent songs and words employed.

Men of to-day are cleaner minded than they used to be, and it is up to you, the rising generation of young men, to continue that improvement if only for the sake of your own self-respect.

There are many other weaknesses and points of self-indulgence which I have not referred to here, but which you can find for yourself by carefully examining your own character and habits. Many of them may have been unsuspected hitherto, but when you find them for yourself, instead of having them pointed out by others, you may look on them as already well on the way to being cured.

I have indicated some few of these in the last chapter, together with their antidotes.

THE WAY ROUND THE ROCK.

So you see that this rock labelled " Wine " that crops up in your fairway is really that of *self-indulgence*. By that I mean letting your inclination run away with you, whether it be in over-drinking, over-smoking, over-eating, or any other form of luxury. Self-indulgence may spell ruin to the individual and harm to the community. It is largely the result of drifting with the herd around you, with your

back to the danger. But by looking ahead and paddling your own canoe for yourself with *self-control* you can navigate yourself safely round to the sunny side of the rock, thereby acquiring strengthened character that will make you secure against other temptations to weakness.

And so it will help you on your way to success.

SELF-CONTROL.

There are various ingredients that go to make character. The kind of character I mean that practically makes a man a *man*, or, better, a gentleman.

Of these the first is *self-control*. A man who can control himself, his anger, his fear, his temptations—everything, in fact, except his conscience and his shame—that man is well on the way to being a gentleman.

By "gentleman" I don't mean a toff with spats and eye-glass and money, but a "White Man," a fellow whose honour you can rely upon through thick and thin to deal straight, to be chivalrous and to be helpful.

Self-control is the point in which Britishers are particularly strong as a rule. Indeed we are inclined to hide our feelings so thoroughly that foreigners often think we are unobservant and unsympathetic, but they allow that we can be relied upon to keep our heads in an emergency.

Well, that is something at all events; but I believe that we can do a lot more through self-control. It certainly enables us to stand up against many temptations successfully.

It is a thing that can be cultivated and ought to be cultivated by everyone who means to have character.

People often laugh at the Law of the Scouts which says that when a boy is in trouble, danger or pain he should force himself to smile and to whistle and this will immediately alter his outlook.

Yet I do not know anyone who has not approved the idea when once he has tried it for himself.

It undoubtedly has the desired effect, and also the more it is practised the more self-control develops itself as a habit, and therefore as part of one's character.

I once had to crawl into a patch of thick thorn bush after a lion which I was hunting. I was in a mortal funk all the time, but my Zulu tracker was keen on it and planned that

if the lion charged he would cover me with his shield. Though I funked the lion, I funked still more the contempt of my Zulu. So I crawled in—and, I can tell you I was mightily relieved when, after poking about for a time, we found that the lion had bolted out another way.

It came about that later on, in India, I was obliged to repeat the performance with a wild boar. We had been hunting him on horseback, with spears, and had severely wounded him when he got into a thick strip of jungle from which the beaters could not dislodge him.

They went through the covert, making lots of noise, but came out at the far end saying that he was not there.

Well, we knew that he was there, as we had watched all the exits.



THE PLAN WAS QUITE SIMPLE—ESPECIALLY FOR THE LION.

So having cheaply earned the reputation for that kind of game, I had to dismount and go in with the beaters to encourage them in their second attempt.

We found him right enough—or rather he found me. In the middle of the thickest part of the jungle I suddenly heard a crash and a roaring grunt as the great beast charged out at me from his hiding-place. I had my spear levelled for him, so that in his rush he charged straight on to it and got it full into his chest. But the force with which he came threw me over flat on my back. Keeping tight hold of the spear I was able to hold him just sufficiently far back to prevent him from ripping me up the waistcoat with his tusks.

This he was pretty eager to do, and he went at it with

great zest, trying to push me farther down ; but I jammed the butt-end of the spear into the ground behind me and so managed to hold him.

The beaters, stout fellows, vied with each other in getting outside the jungle to tell the other hunters how I had been killed ! These presently came crashing along with their spears and soon put an end to Mr. Boar and relieved me from his attentions.

But, do you know, after a time—nasty as we had thought the job at first—we actually got to rather like the excitement of this method of finishing the fight and so whenever we had a boar badly wounded we dismounted and went at him on foot.

I expect that had there been more dragons around in St. George's time, he would, after getting over his first fear of them so successfully, have probably taken to dragon slaying as a regular pastime.

Yes. If you take yourself in hand and force yourself to face a difficult or dangerous-looking job it will come all the easier the next time.

Self-control not only enables you to master bad habits, but also gives you command of your very thoughts.

And this is a point of vital importance for your happiness.

Force yourself always to see the bright lining that lies behind the darkest cloud and you will be able to face a black outlook with full confidence.

Anxiety is depressed thought, and once you have mastered this, by being able to substitute bright hopefulness, you need never have recourse to drink to give you either Dutch courage or oblivion.

A great boon that comes of the practice of self-control is the ability that you gain to switch your thoughts off any unpleasant subject and to think of something satisfying and jolly.

If you take trouble you can cultivate this habit of switching off a brain cell that is harbouring bad thoughts and opening a fresh cell with good ideals in it.

In this way you may make a new man of yourself.

SELF-DISCIPLINE OF GENERAL NOGI.

The celebrated Japanese general, General Nogi, once explained in my presence how he had trained himself to

self-control and courage. It was a matter of self-discipline. He had begun life as a weakly youth with a nervous disposition, but his will power was such that he recognised his weakness and determined to overcome it.

Whenever he had to face some ordeal which he did not like or which he feared, he forced himself on principle to go through with it, and repeated the performance whenever he could get an opportunity in order finally to subdue his weakness.

He eventually freed himself from the tyranny of fear. He became the boldest leader and the most intrepid soldier of his time.

When his son was killed in action he made no sign lest grief on his part should cause depression among others. But none the less he felt very deeply.

When his Emperor died he felt as a faithful servant that he himself should no longer live : and he killed himself by cutting himself open with his own hand. A wonderful example of self-command over fear and pain.

SELF-CONTROL MAKES THE GENTLEMAN.

“ A London crowd is exceptionally well-mannered. It will stand for hours and watch, in silence, a large safe being hauled up to the top of a high building.

“ In silence, mind you, without offering a word of advice to the men at the job ! A great example of self-control.”

That is what Pett Ridge has to say on self-control and how it contributes to good manners.

Old William of Wykeham declared long ago that “ Manners makyth Man,” and he was right. A real man is courteous ; that is, he shows deference, human sympathy and unbreakable good humour.

It makes him a gentleman, and I have seen it very truly said that it is just as hard for a duke as a bricklayer to be a gentleman.

I used to play polo against a certain team who had a very good back player ; but he had his weak spot, he was not a gentleman, he had a bad temper.

So one only had to bump into him once or catch his stick just as he was about to hit the ball (both allowable in the game) and he lost his temper, and with it his head, for the rest of the game, and was perfectly useless to his side. It

is much the same in discussion or debate ; if your adversary cannot control his temper you have him at your mercy—that is if you can control your own.

One often sees it in the acrimonious correspondence in the newspapers. It is generally the sign of a small mind when an angry man rushes "to write to the papers." He shows the childish spirit of "I shan't play in your yard any more. I'll go and tell mother of you."

Remember this, "If you are in the right there is no need to lose your temper ; if you are in the wrong you can't afford to."

Go ahead on that—behave like a gentleman with politeness and self-control, and you will win every time where your opponent lacks these qualities.

LOYALTY.

Another point that tends to make character (which is the best antidote to drink) is loyalty to others and more especially loyalty to oneself.

Dan Beard, the veteran backwoods boy-man of America, has instituted the order of the "Buckskin Man," namely a man that you can absolutely rely upon as one to turn to in any difficulty, a man full of courage, resource, and above all of loyalty.

Loyalty is an outstanding point in character. Sir Ernest Shackleton, before he went on his last cruise in the *Quest*, told Arthur Mee of the *Children's Newspaper* that once, in the Antarctic, when things were at their darkest and death by slow starvation seemed certain, Shackleton overheard the following conversation between two of his men :

"I don't think we'll get through," said one voice.

"That's the Boss's look-out," came the rejoinder.

It brought home to him afresh, not only the responsibility of leadership, but its loneliness.

"Leadership," he said, "is a fine thing, but it has its penalties. And the greatest penalty is loneliness."

"You feel you must not tell your men everything !"

"You often have to hide from them," he said, "not only the truth, but your feelings about the truth. You may know that the facts are dead against you, but you mustn't say so. One thing only makes Antarctic leadership pos-

sible, and that's loyalty. The loyalty of your men is the most sacred trust you carry. It is something which must never be betrayed, something you must live up to."

"No words can do justice to their courage and their cheerfulness. To be brave cheerily, to be patient with a glad heart, to stand the agonies of thirst with laughter and song, to walk beside Death for months and never be sad—that's the spirit that makes courage worth having. I loved my men."

Personally I can fully endorse every sentence of Shackleton's from the experience of Mafeking, which, though a smaller test in its way, embraced long-continued danger and hardship for the men.

The same practice of cheerful whole-hearted loyalty on their part was the secret of our success there just as it was with Shackleton. In the same way loyalty would be the secret of success in any difficult work, whether it is in business or in the maintenance of the country.

Loyalty is a very precious quality; it should be cultivated and strongly held through thick and thin by any man who has a true sense of honour.

At the same time there is in loyalty that which Shackleton does not particularly point out, although he practised it in a high degree, and it is one which adds enormously to the "loneliness" and to the heavy responsibility of a leader.

The leader needs the loyalty of his men, but equally he must show loyalty to them, and that point is emphasized in the Scout Law where it says that "a Scout is loyal to his employers and to *those under him*."

This side of loyalty often puts the leader in a difficult position when he has in a way to deceive his men, as Shackleton has suggested, by hiding the worst from them. I, too, have known it.

And then, too, he has to be loyal to the *cause* for which he is working. There comes in the most difficult part of a leader's duty.

For instance, few people realise the awful responsibility that rests on a general in the field when, with all the loyalty towards his men, he has to balance the fact that their lives are only a matter of to-day, while the result of a battle may mean everything for the future; and he has therefore to

risk those men whom he loves, and who are trusting him, for the sake of the greater consideration, the safety and welfare of the nation.

These are things that have to be thought on when you are considering what is meant by loyalty and how you are to train yourself for leadership.

But then there is also loyalty to yourself. Temptation comes along, conscience says "No." Inclination says "Yes."

You either rise or let yourself down according to which you obey. If you are loyal to yourself you go up one. If you funk it and give way, down you go, and down goes your respect for yourself.

TRUTHFULNESS.

It was my job at one time to try and detect spies. Of course a very common way of finding out a suspected man's nationality is to stamp on his toe and hear in what kind of language he expresses himself. But a foreign spy-catcher once told me that if he suspected a man of being a British officer in disguise he had one infallible test: he would get him in conversation and take the first opportunity of calling him a liar. Although the officer might be marvellous at generally concealing his true character, if you call him a liar he can't help flaring up at the insult, and so gives himself away.

Yes, it is true. That word "Liar" has a stab in it for an honourable man. I hate to hear the word used, as it often is, by boys or men in an unthinking way, when in arguing some ordinary question they say, "You're a liar."

From hearing it often, I suppose they get accustomed to it, but the man of honour can never accustom himself to it. To him it is always the worst possible insult.

SELF-RESPECT.

Self-respect is an important ingredient in character, and a man who cannot respect himself (and no drunkard or idler or liar or beggar can do this), cannot expect other people to respect him.

It is here that a common little failing comes in, namely tips. A Scout is expected to do his good turns to people out of courteousness and good will and not to accept rewards.

The man who accepts tips lowers himself and puts himself on the level of a beggar accepting charity.

I have been awfully sorry of late years to see tipping creeping in with taxi drivers, hotel porters, waiters and others hungering for a few pence from their patrons.

And yet as men they would be ashamed of being patronised and receiving charity. Tipping leads the way, in better paid positions, to so-called "perquisites," and in still higher places to bribes and corruption.

Hitherto our men have been too manly and self-respecting to lower themselves to this ; long may it be said with truth that " a Briton cannot be bribed."

Samurai are a fifteen-hundred-year-old brotherhood of Knights in Japan, much on the lines of our own mediæval knights. Their guiding ideal is Bushido, which encourages among its members—

Poverty in place of wealth,
Humility in place of ostentation,
Reserve in place of advertisement,
Self-sacrifice in place of selfishness,
Interests of the State in place of those of the individual,
coupled with personal courage, fortitude, loyalty, self-restraint and chastity.

If a Bushi disgraced himself he was invited to commit hara-kiri—that is, on parade, with strict ceremony, to kill himself by ripping his stomach open. These knights were intensely touchy on the subject of their honour and dignity. One, called Gorgorro, in the middle of a battle got an arrow into his eye. This did not stop him, he went on fighting and leading his men in action till the battle was over. A friend then tried to get it out and had to put him down on his back to do it ; but finding that ordinary pulling was not successful, he put his foot on the patient's head to get the necessary leverage. When at last he had successfully prized it out, Gorgorro, instead of being grateful, sprang to his feet and challenged him to mortal combat for having lowered his dignity by placing his foot on his head.

SHAME MAKES A MAN AN OUTCAST.

Do you know what is one of the most tragic sights in this world ?

It is the sight of a man who is ashamed. One feels almost ashamed oneself to look upon it.

I saw it once, for a few moments only, many years ago, but it has haunted me ever since.

I was travelling on a railway extension, in the jungle in a far-off spot, overseas. Our train pulled up at a point where a white ganger and his native crew were at work. Instead of coming up, as these men generally did, full of joy at seeing the train, to get the latest news from the outer world and to speak, if only for a few moments, with other white men, this ganger withdrew himself aside and turned his back upon us, only waiting for the train and its white folk to leave him again.

I asked about him and learned that he had been a cavalry officer, well known in London and generally about the country as a cheery sportsman and a popular fellow.

But the craving for drink had gradually got hold of him and had ruined him, and he was now what we saw him, an outcast, a man who was ashamed.

“YOUNG FELLOWS ARE FULL OF GO, BUT EMPTY OF GUMPTION.”

“Young fellows are full of go, but empty of gumption.”

That is what someone has said of some of you. It reminds me of an occasion when I was out reconnoitring in South Africa with a party of 7th Hussars, and in crossing a dry river bed we came across a lion.

One of us had a shot at him and severely wounded him, but he managed to get away into a patch of thick reeds and rushes, into which it was impossible, or at any rate very unsafe, to follow him, as he had all the advantage of lying hid and had the pull of hearing and scenting anybody coming near his hiding-place.

So we rapidly posted men on the look out at different points round the covert to give information if he should come out. Our plan was, when all preparations had been made and men with rifles had been posted at likely spots, to set fire to the grass and drive him out.

There was considerable delay about this as the reeds to the windward side were green and would not take fire.

I had a good place on a rock for seeing him should he come out in that direction, and was straining my eyes to

catch a glimpse of him in the reeds. Suddenly my vigilance was rewarded. I saw a movement among the rushes, and as they waved to and fro I perceived that the animal was coming in my direction.

My heart thumped with excitement, I spat on my cartridge to bring it good luck, and I waited with my rifle ready at full cock to give him "what for" the moment he showed his nose.

On he came, closer and closer, till he was within a few yards of me. I felt he was mine. I could not miss him at that distance.

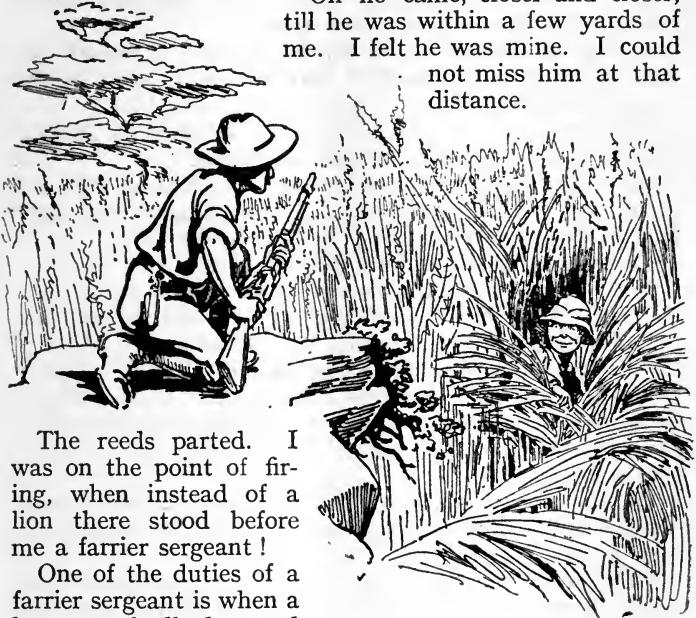

The reeds parted. I was on the point of firing, when instead of a lion there stood before me a farrier sergeant!

One of the duties of a farrier sergeant is when a horse gets badly damaged to take his revolver and put it out of its pain.

So this fellow, having seen that the lion was wounded, supposed that it was his duty to go in and finish it off.

He did not reflect that his revolver would have been about as much good as a peashooter, and that the polishing off would have been done by the lion and not by the farrier.

As it was, he nearly got it in the neck from me. But he was young in the ways of lions. They didn't come his way

PEEP BO! YOUTH IS FULL OF GO,
BUT EMPTY OF GUMPTION.

in Tooting. He had shown splendid go, but little gumption ; and that is what many young fellows do in taking on the lions of real life for which they have had no preparation or warning.

AUTO-SUGGESTION.

Self-control or self-mastery has now become a scientific study, and Dr. Coué, its latest exponent, has established a wonderful record of healing people from pain and illness through the effort of their own mind.

In various directions you will have heard of remarkable cures being effected through " faith healing," that is by the patient believing that the evil will go from him.

I suppose that most of us have at one time or another worked it to some extent upon ourselves.

Say you have a wound in the leg. It hurts all over the limb ; you feel likely to faint ; you can scarcely put your foot to the ground. Ouch ! How it hurts !

Let's sit or lie down for a bit and groan.

Well, there is another way of dealing with it.

" Wound ? So it is, quite a small hole, and the pain can only be just round the wound. No, not all up the leg, that is imagination. No, it is just at that one little spot, quite a small place, and therefore small pain. Hold yourself together, walk on and keep the leg moving so that it won't get stiff. Warm it up and it won't hurt. That's right, better already."

Dr. Coué's idea is that in order to cure yourself of your ailment, whatever it may be, you must use your imagination rather than your will.

He explains the difference thus : If you put an ordinary plank on the ground you can walk along it with perfect ease.

Put the same plank as a bridge between two house-tops, a hundred feet above the street, and you cannot cross it. Your will wants you to go in order to get to the other side, your imagination makes you think you will fall, and defeats your will. And that is their usual relationship to each other. Imagination wins the day.

So if you are suffering you must concentrate your thoughts and imagine to yourself what relief you desire, imagine then that you are gradually getting it and you will presently find that you have got it.

Ninety-nine people out of a hundred are in pain, or ill, or even helpless, because they believe that they are. It is their imagination. But if you can get them to employ the reverse imagination and imagine that they are getting alright and finally *are* all right, they will in almost every case *be* alright.

And Dr. Coué proved the truth of his theory every day in results among the crowds of patients who come hobbling in to him and go away rejoicing.

And he doesn't do it for money or reward.

But the great thing is that not only can auto-suggestion cure illness and pain, it can equally cure bad memory or nervous fear, and more especially—and here lies its importance for young men—it can do away with the desire for alcohol or tobacco, sex temptation, and other forms of self-indulgence.

HOW TOMMY TOMKINS DEFEATED DEATH.

That awful scourge of India, cholera, broke out in the regiment. Tommy Tomkins, a tough old soldier in my squadron, went down with it. In a few hours he was in a bad way.

"Poor Tommy is 'for it,'" was the verdict of the hospital sergeant.

For the next forty-eight hours, however, he held on between life and death, and finally, to the surprise of everybody, he turned the corner.

Later on when I went to see him convalescent in hospital he told me the secret of how he conquered death.

He knew he was dying; the doctor had as much as said so, but told the native attendant that there was just a chance of his living if he could keep his extremities warm. So hot bottles or bricks were to be put to his feet at once.

The doctor went out, and the attendant, instead of bothering about hot bottles, pulled out his hookah from its hiding-place and squatted down in the corner to have a quiet smoke.

This mightily enraged poor Tommy, who, though unable to move or speak, understood all that was going on. He swore to himself that if he could only get well again he would give that native such a rousing up as he would not forget in a hurry. He busied himself thinking what form

of thrashing the punishment should take and how soon he would be able to get out of bed and administer it. He put all thoughts of death on one side in the more absorbing idea of getting a bit of his own back on that fellow.

And so he came to life again.

It was the force of will and imagination that pulled him through.

I had just such another experience in my own case. I was pretty bad in hospital with dysentery when the news came that if I could only be well by a certain date I should get command of a column that was going off after the enemy.

It seemed a hopeless task, but still I hoped. And I imagined to myself what I would do when in command, and I planned plans, while, at the same time, I tried hard to get better.

The harder I tried, the better I got. Day after day passed by and I was convalescent, but when the eventful date arrived I just wasn't fit enough to be allowed to go.

Two days later another man came in, also seriously ill with dysentery. My bed was wanted for him. As I gave it over to him he moaned that he was coming in to die. I told him, "Rot—I was much worse when I came in. Think of what you are going to do when you get out again."

Next day I started out with an escort of three, and after a ride of eighty miles, through a risky country, I caught up the column and took charge of it.

Meantime my successor in the bed imagined himself dying. He got worse and worse, and eventually did what he thought he would do—he died.

SELF-CURE.

Well, this is really the art of auto-suggestion, by which a man can, *if he is determined*, cure himself of many an illness and almost any weakness.

If a man can defeat death by it, surely he can defeat drink or any other temptation. Don't forget it. If things at any time look difficult for you, or even impossible, think of a way by which you might have won success and then figure to yourself your winning it; and when your mind tells you that it is impossible, reply to it, "No, not impossible. I see what might be. I can try. I can win it. I

can. I *can*. I CAN—and I *will*!” And ten to one you will succeed.

Self-indulgence comes of centring your attention in your own sensual desires ; its cure is to divert your interest from self to other things and people. Take up hobbies. Go in for active sympathy and helpfulness to others, and incidentally you will be gainer of new points in building your character.

Amiel says : “ A man who has no refuge in himself . . . is not properly a personality at all. He is one of a crowd, a taxpayer, an elector, but not a man. He who floats with the current, who has no ideal, no convictions, such a man is a mere article of world’s furniture—a thing moved, instead of a living, moving being.”

Individuality over-developed means self let loose, which is the very opposite of what we want. Individuality with character is another thing, it means a man with self-discipline, energy, ability, chivalry, loyalty, and other qualities that go to make a good man. And when these qualities are harnessed into the service of the community he is something more than a good man, he is a good citizen.

WHAT OTHER FELLOWS HAVE SAID

Self-respect, not self-esteem, breeds respect from others.

Character has more value than any other attribute in life.

Self-control is three parts of Character.

Don’t drink between your “ eats.”

You cannot dream yourself into Character. You must hammer and forge it for yourself (*Froude*).

Take advice from the thrush, when he says, “ Stick to it, stick to it, stick to it.”

Consider the postage stamp, my son ; its usefulness consists in its ability to stick to one thing until it gets there
(*Josh Billings*).

ROVERING TO SUCCESS

When everything goes crooked
 And seems inclined to rile,
 Don't kick, nor fuss, nor fidget,
 Just—you—smile!

When someone tries to "do" you
 By taking more than half,
 Be patient, firm and pleasant;
 Just—you—laugh.

But if you find you're stuffy
 (Sometimes, of course, you will)
 And cannot smile, nor grin, nor laugh,
 Just—keep—still.

BRUSH AWAY TEMPTATION

When de drink holler to you, "I'm yo' frien'!"
 Bresh it away!
 When it tell you, "You's as strong as other men!"
 Bresh it away!
 B'fo' you stumble an' you stutter,
 B'fo' you's flung into de gutter,
 B'fo' you lose yo' bread an' butter,
 Bresh it away!

Ef temptation come an' ask you, "How you does?"
 Bresh it away!
 When it say, "I'se been wondering whar you wuz!"
 Bresh it away!
 Tho' a soft, sweet-talking critter,
 Dat's a mighty powerful hitter,
 It's de devil's own man-gitter,
 Bresh it away!

(*"Ole Marster," B. B. Valentine.*)

BOOK TO READ

The Practice of Auto-Suggestion.

By C. H. Brooks (Allen, Unwin). 2s. 6d.

ROCK NUMBER THREE

WOMEN

WOMEN

THE dark side of this Rock is the temptation to forget the reverence due to women.

The bright side is the safe-guarding oneself against temptation through the cultivation of chivalry and of manly protective strength.

SEX INSTINCTS AND THEIR RISKS.

The period of youth is the human "rutting season," which occurs annually in the case of animals and plants.

The coming of manhood causes sexual temptation in the lad. It comes from perfectly natural causes namely, the spread of semen or sap in the system.

The male and female seed join in forming the germ of a new child.

This seed is a sacred trust, handed down to you for carrying on the race.

The importance of care and continence, that is, of not giving in to temptation.

Temptation is much increased by the herd bravado of young fellows talking carelessly among themselves.

If temptation is yielded to, a man loses his self-respect. He also risks venereal disease, which is a danger and a retribution.

Disease is largely due to ignorance, which has brought about many tragedies.

MANLINESS.

True chivalry towards woman prevents a man from falling or from tempting a woman.

It is up to you as an individual to master yourself and to take the right line.

Your mother's influence can help you.

In saving yourself, you will be helping to preserve the race.

How to get health and strength through fresh air, cleanliness, breathing, care of teeth, exercises, etc.

Be a MAN.

MARRIAGE.

Let your love adventures be clean.

How to choose the right girl.

Warnings from a pork-butcher on getting engaged.

Income an important detail.

A man owes duties to his wife on getting married.

The joy of children.

The responsibilities of parenthood, and how to train for them.

Happiness of the home is made complete by rendering service to the community.

WHAT OTHERS HAVE SAID ON THE SUBJECT HELPFUL BOOKS.

WOMEN

THE Danger is the temptation to forget the reverence due to women.

The Bright Side to it is the development of chivalry and manly and protective strength.

SEX INSTINCTS AND RISKS

THE MONARCH OF THE GLEN.

One of the finest sights that you can see of animal life on the moor or in the forest is a full-grown stag in the pride of life. He is the king of the herd—the Monarch of the Glen, as Landseer has pictured him.

He is a type of courage, strength, and virile beauty, as he stands roaring out his challenge to all rivals to “come on.”

In the “rutting” season in autumn it is an exciting sight to watch the stags when they are calling and fighting each other for possession of the hinds. They seem to go off their heads for a time, running hither and thither, restless and excited, for weeks unable to settle down to feed or to sleep till utterly worn out. It is those that best reserve their strength



THE RUTTING SEASON.

The Monarch of the Glen, after Landseer.

which then come out on top. In the combats that follow, with the rattle and clash of antlers and the grunting of struggling combatants, the weaker give in, and are pressed backwards by their more powerful opponents, until they are driven off in craven flight, leaving to the victor the choice of wives as lord of the herd.

And he takes his responsibilities, ready at all times—and able—to protect his hinds and fawns against all aggressors.

The defeated weaklings can then only sneak about trying to get what joy they can among the outcasts of the herd. These poor, under-sized creatures, overdone with rutting, are not thought much of by stalkers, who value rather the finer animals with their greater strength and activity.

The same kind of thing goes on in a greater or lesser degree among other animals of the jungle, among the birds in spring, and even among the fishes in winter.

Even plants, trees and flowers come under the same law of Nature, and in their rutting season, the spring, the sap rises and spreads

itself through every branch, leaf and tendril, and the flowers blossom out, so that the female pistil can receive the pollen dust from the male stamens, which is a small germ that unites with the female germ, and they jointly make the young seed for a new plant.

Even the throwing out of beautiful flowers by the plants in springtime is similar to the habits of animals and birds, which put on their brightest plumage in the mating season, and this we see reproduced again among the young mashers with their pink socks, fancy ties, and well-oiled hair.



IN THE CENTRE OF THE PISTIL (*Female*)

[drawn on enlarged scale and in section], with pollen falling from the stamens (*Males*) into the ovary, or egg-bag of the pistil (*Female*), which contains embryo seeds. These become fertilized by the male pollen.

MANHOOD.

It is the impulse of Nature, and it therefore occurs also with man.

But here the difference comes in, that though the unrest comes to him it does not do so every year, but once in his lifetime—that is when he is just growing from boyhood into manhood. And as with the stag, in some cases he comes out of it a strong, virile “Lord of the Herd,” while in others he deteriorates and becomes the weakling or even the outcast.

This “rutting” season is a very upsetting time, and it troubles some fellows to an alarming amount of depression or excitement, which often lasts for several months.

Indeed in occasional cases it goes on for a few years. I get lots of letters from young fellows who have never been told what to expect when they are growing into manhood, and consequently they have felt worried by finding it an upsetting time for them. They get nervy and unsettled in their mind without knowing why. They can't settle down properly to their work, they get shy of other people and feel miserable, and often think that they are going off their head.

I am only too glad that in their trouble they have thought of writing to me, because in many cases I have been able to reassure them and to help them to take it calmly, and to get over it just as they would get over the measles or any other youthful complaint. There is nothing in it to be upset about. It all comes from quite natural causes.

Psychologists, that is men who study the mind, and writers will give you reasons for it that are connected with the mind, but it is quite enough for most of us to know that there is also a very clear reason for it connected with the body.

When a boy grows into manhood his whole body undergoes a gradual change which anyone can see for himself. His voice becomes deeper, hair grows where it didn't grow before, his muscles become set and hardened, his organs develop, and so on.

SEXUAL TEMPTATION COMES FROM PERFECTLY NATURAL CAUSES, VIZ. SAP.

This change is brought about by a fluid forming within him and ripening from his childhood upwards, and which is

now spreading throughout his body just as sap does in a tree. It gives the vigour of manhood to his frame, and it builds up his nerves and courage. Then it has a further and special use.

It is called *semen*, a Latin word meaning seed, because in this fluid, when it goes into the sex organs, a number of tiny germs or seeds are developed.

THE ACTION OF GERM-SEEDS IN MAKING A NEW CHILD.

The value of these seeds is that when mixed among the female seeds that are possessed in a similar way by women

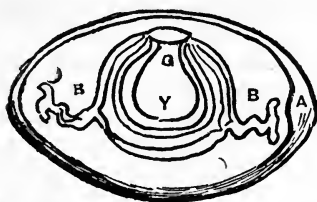

G. The germ born in the hen and fertilized by the cock. Y. Yolk forming. B. Balancers or anchoring cords of strong white jelly. A. Air space.



Three weeks later chick ready to hatch out, with beak, claws, feathers, eyes, etc.

THE MIRACLE OF THE EGG.

ing, breathing creature of flesh, blood and bones, with eyesight, brain and mind, and even with many points of likeness in appearance and character to both of its parents.

THE GERM IS A SACRED TRUST FOR CARRYING ON THE RACE.

And this young creature carries within it again the germs for reproducing further children in its turn, when it has grown to the riper age.

they fertilise them, that is the two seeds become joined together, and between them grow into a larger germ or small egg, which in its turn gradually takes form and life, until in the end a miracle is brought about and it comes into being as a child.

It is just the same miracle that you see carried out daily when your hen lays an egg. That egg contains in its yoke and "white" the future live chicken, and is a result of the seed of the cock bird being joined to that of the hen.

So, in the case of the human being, from the joint germ there emerges a living,

The whole thing is a miracle, a work of God the Creator. The germ from which you were made was passed down by your father just as he came from the germ of his father before him ; and so away back into the Dark Ages.

And you have that germ in you to pass out, when the time comes, to join with that of your wife in making your son.

So it is a sacred trust handed down to you through your father and his fathers from the Creator—the Great Father of all.

Sometimes, when this semen is forming over-rapidly, you may find that you pass some of it out in your dreams while you are asleep. This need not alarm you ; it is the natural overflow. But don't try and bring it on for yourself ; that would be straining and draining it out of your system.

Keeping the organ clean and bathed in cold water every day is the best preventive.

TEMPTATION.

Young men are sensible enough, and are willing, to take advice if they can only get it, and I am certain that if only these things which I have mentioned above were better understood by them they would do their very best to preserve that vigour of manhood that is growing up inside them ; but so many of you have never been warned ; you have never been told what it is that is going on and is exciting you, and you are apt to give way to the temptation to work it off either with women who may tempt you, or, as often happens if you are shy of this, with yourself in "self-abuse."

And if you give in to temptation it is very bad for you in many ways. For one thing, it knocks out your self-respect ; you are doing a thing that you dare not mention to your parents or sisters ; *you are ashamed* ; it is something low and unmanly. A man who is ashamed is no longer a man ; he becomes a conscious sneak.

Also it just checks that semen getting its full chance of making you the strong manly man you would otherwise be. You are throwing away the seed that has been handed down to you as a trust instead of keeping it and ripening it for bringing a son to you later on.

The usual consequence is that you sap your health and

brain just at the critical time when you would otherwise be gaining the height of manly health and intelligence.

HERD BRAVADO.

Young fellows in this rutting stage are apt to get together and to tell smutty stories and look at lewd pictures ; and they think it very fine and manly to talk on the subject when they are really dangerously ignorant about it.

They generally get all sorts of wrong notions into their heads, and with this talking and thinking about it is brought on a feeling of desire, that often seems to the weaker-charactered fellow almost impossible to fight down.

In the ordinary course, the rutting period would pass off in a few weeks or months, but by giving way to temptation, and by keeping up the thought of it in talk and loose companionship, many a fellow gets into the habit of immorality with women or self-abuse with himself, which then goes on after the rutting season is over and when he has grown to manhood.

Once established the habit is then very difficult to break down ; but it can be done if he makes up his mind to it—if he tackles the job, and sticks to it. Each time he succeeds makes success all the more certain.

Sunday is the worst day in the week for vice, because young fellows have nothing to do, and aimless loafing encourages loose talk. If you carry out Rovering (*see* final chapter), you will find lots to do in the way of hiking and enjoyment of the out-of-door and manly activities. To get rid of the bad you must put in something good in its place.

VENEREAL DISEASE.

One almost invariable result from loose talk among lads is that they get to talk filth, and in this way lower their ideals and thoughts to a beastly standard, and one which they will be ashamed of later on when they have grown to be men.

It puts them back on their road to happiness, because they will have so much leeway to make up in getting out of the mud into which they have floundered. And mud always sticks to some extent.

Then lads are apt to joke airily about venereal diseases,

which are sure, sooner or later, to overtake those who indulge their sex desires unwisely.

But these diseases are no joking matter ; however slight their first effects, they are desperately dangerous to a man.

They are very easily caught—even from a kiss or from drinking out of a cup used by an infected person.

There are two principal Venereal Diseases :

Syphilis (" Pox "). Poisonous infection that can be caught by connection or by touch of lips on a cup, pipe, etc. The disease shows itself in a sore at first ; this develops in a few weeks into other sores ; then, in from one to twenty years it causes disease of parts of the body or of bones, and frequently of the heart.

Gonorrhœa (" Clap ").—Caught by connection, or from infected towels, etc. Shown by discharge of matter from the organ and inflammation of the organ itself. Further inflammation likely to follow in the bladder, etc.

Syphilis is often inherited by children from diseased parents, with the result that they are blind, or deaf, or paralytic, or insane. It has been estimated that twenty-five per cent. of people who are blind from infancy are so as the result of parents' syphilis. The sins of the fathers are indeed visited on their children.

When once syphilis has got hold of you, none of the quack medicines as advertised will save you. The only way is to go at once to a good doctor and tell him straight out what has happened. *If he takes you in time*, he will be able to cure you.

But the danger is not one which anyone will joke about once he knows the depth of it, is it ? A visit to any Lock hospital will give you such examples of venereal disease as will persuade you, better than any words of mine, to avoid having anything to do with women of the street if you would save yourself in body as well as soul.

Remember, too, that a man who has once been infected, even though apparently cured, is liable to carry the germ of the disease in him for years, and later on to pass it on to his wife and future children ; and this makes it a crime on his part to marry, for he will ruin innocent lives through his own folly.

The folly of taking such a risk is largely the result of being carried away by the weaknesses of the herd.

It is like drinking or gambling—a disease which you pick up from letting yourself drift too far without thinking, in the company of a lot of other unthinking young fellows.

Many men come to grief from supposing that if they go with a girl who is not a regular prostitute of the streets, there will be no danger of being infected with the disease. But the reports show that the danger is actually greater. The girl who has once been deceived by some blackguard of a man loses her sense of shame and is willing occasionally to go with other men. But in her ignorance she is more liable than the professional to harbour disease, from not knowing what precautions to take. Therefore, she is all the more dangerous to herself, poor creature, and to others with whom she comes in contact.

A man may be continent and resolve to remain so. He may then by chance, or by boon companions, be led to take that fatal "sixssth" glass, and, with brain and senses clouded, do the very things he meant not to do.

That is where so many a good fellow has come to grief and ruined himself not only morally (in his character), but physically (in his body) as well.

THE TRAGEDY OF IGNORANCE.

Last year a young soldier was condemned to death for murdering a woman. He confessed that he had done it with intention. She had infected him with syphilis, she had wrecked his life, and he was determined that, even though he were hanged for it, no more men should suffer as he had done through her instrumentality, and that through the notoriety of this case they would be warned of their danger in time.

Last month a young officer committed suicide, and left this note behind him, addressed to his sister:

"Gertie, dearest of sisters, try and forget what you will never forgive. I should have done what I am about to do three years ago. The disgrace of it all has driven me insane.

"If you should ever have any sons of your own, for pity's sake instruct them fully in the perils surrounding

them. Had I not been so inexperienced I might now be a happy and self-respecting man.

"Mine is yet another tragedy of 'Damaged Goods.'
 "Your unworthy brother,
 "REG."

The play referred to, "Damaged Goods," deals with the venereal question in an open, common-sense way, and is a good education for a young man. It tells of a young man's infecting his wife and child, and the child's nurse, through ignorance. The pathetic cry which there comes in, "If I had only known in time!" is one which is echoed in hundreds of cases every day.

SINS OF THE FATHERS VISITED UPON THE CHILDREN.

When I was writing this chapter a day or two ago a friend asked me whether it was really true that syphilis was passed on by a father to his children to the extent suggested.

I only had to show him a letter that had appeared in *The Times* that morning from a coroner, dated February 21, 1922, in which he said that the loss of life or of reason and the infection of innocent children from this awful disease "is terrible in the extreme."

He quotes as illustration two cases that had recently come under his notice. They were both much alike, and I will merely quote the first one as an instance.

"A woman married some fifteen years ago, and shortly afterwards contracted syphilis from her husband. She was medically treated, and partly recovered, but was again infected with syphilis by him, and she was suffering from it at the time of her death. She had eleven children, of whom five only are living. Five of the other six died from syphilis—the remaining one was accidentally suffocated in bed. All the children living are suffering from syphilis with the exception of the eldest, a girl, fourteen years of age—born before her mother became infected."

MANLINESS

CHIVALRY.

You will, I hope, have gathered from what I have said about this Rock "Women," that it has its dangers for the

woman as well as for the man. But it has also its very bright side if you only manœuvre your canoe aright.

The paddle to use for this job is CHIVALRY.

Most of the points which I have suggested as being part of the right path are comprised under chivalry.

The knights of old were bound by their oath to be chivalrous, that is to be protective and helpful to women and children.

This means on the part of the man a deep respect and tender sympathy for them, coupled with a manly strength of mind and strength of body with which to stand up for them against scandal, cruelty or ridicule, and even, on occasion, to help them against their own failings.

A man without chivalry is no man. A man who has this chivalry and respect for women could never lower himself to behave like a beast, nor would he allow a woman to ruin herself with him by losing her own self-respect and the respect of others. It is up to him to give the lead—and that a right one; and not to be led astray.

I have known such chivalry on the part of a man to give further than this, even to the point of raising a woman who had fallen; where she had expected him to join her in debauchery his courteous respect for her, which overlooked her faults and was given *because* she was a woman, caused her once more to think of her own self-respect and so restored her to her place.

Chivalry, like other points of character, must be developed by thought and practice, but when gained it puts a man on a new footing and a higher one with himself and with the world.

To be chivalrous he must put woman on a pedestal, and see all that is best in her; he must also have sympathy for the weaker folk, the aged and the crippled; and he must give protection to the little ones.

For this he must use his self-control to switch off all that is impure from his mind and ensure that his own ideas are clean and honourable, that his sense of duty is so high that ridicule and chaff will mean nothing to him.

NOT MY JOB.

“Not my job” is usually the camouflage under which a coward endeavours to conceal his want of chivalry. But

for a *man* anything that can be helpful to anyone is his job.

I don't mean by that that he should therefore poke his nose into other people's business, or ask them, "Are you saved?" and so on.

But if he can lend a hand to a woman who is down, or help a young fellow who is trying to keep up and clean, then he can do a great good through his chivalry.

IT IS UP TO YOU TO BE MASTER OF YOURSELF.

The thing is to remember, as I have said before, that you are YOU, and you have got to make your own road for yourself if you mean to gain happiness. Come out of the herd and take your own practical steps towards fighting down the desires that come upon you in the course of Nature.

Keep away from loose companions, whether men or girls; take on lots of other occupation and healthy exercise, such as boxing, walking, hikes, football, rowing, etc. Keep your thoughts off lewdness by taking up hobbies and good reading in your spare time; keep off drink and over-smoking, over-eating, sleeping in too warm or soft a bed, since all these help to make the temptation worse.

Keep yourself clean inside and out by daily washing, and swimming if you possibly can. Constipation and neglect to keep the racial organ cleaned daily are apt to cause slight irritation which leads to trouble.

The temptation has to be fought down mainly during the few months of your changing from boyhood into manhood. If you are past that stage and have unfortunately contracted bad habits it is not too late. You can overcome them if you really try. It is never too late, but at the same time you can't be too early in curing yourself.

Above all don't be alarmed by the awful penalties which quack doctors hold out to you. They do it in order to make you buy their rotten medicines; that is one of the tricks of their trade. But go forward with good hope and trust in yourself.

It will be a struggle for you, but if you are determined to win you will come out of it all the better for the experience; you will have strengthened your character and your self-control; you will have come through clean-minded and

wholesome ; and you will have fortified your body with the full power of manhood.

Remember also that you have done this, not only for your own sake, but because you have a duty to the nation, to the race, that is, to beget strong, healthy children in your turn ; and to do this you have to keep yourself pure.

Some fellows seem to think that if they don't let themselves go now and then, they will not be able to perform when they get married later on. This is absolute nonsense. Continence does not weaken your powers ; quite the opposite ; it strengthens you in every way.

I have had so many letters from young men on the subject that I quote a reply that I have sent them, as it may meet the anxiety of others :

“ I am very glad indeed to hear that you have managed to keep yourself straight in spite of the continued temptation. In reply to your question, I don't think you need have any fear about being able to marry, provided that you go on as you are now doing. Lots of fellows have, to my knowledge, been afraid to marry thinking that they might be impotent, because of their having indulged in self-abuse when young. But they found that they were all right after all, and so I hope and expect it will be in your case.”

AUTO-SUGGESTION.

Imagination runs off into day-dreams, and these may be suggestive ones which bring on temptation.

Yet imagination is the important part of auto-suggestion or self-cure, and therefore the lad who is given to day-dreams is really the one who has the best power for curing himself if he only sets about it on the lines that I have suggested.

THE MOTHER'S INFLUENCE.

A large proportion of the men who have risen to eminence in the world admit that they have owed very much of their character and success to the influence of their mother.

And this is natural, since in any case she has been the one who cared for him and watched over his upbringing from his earliest childhood. She has given of her best for him.

The man owes a debt to his mother such as he can never fully repay. But the best that he can do in this direction is

to show that he is grateful and prove himself worthy of and bring success to her efforts.

She has probably dreamed ambitious dreams to herself of what her boy would do in the world, and disappointment, as bitter as it is secret, will overshadow her where he turns out a waster or a failure.

Boys don't think of this enough. They are cruel without intending it ; they are apt to forget how much she has done for them and how grateful she would be for the smallest return.

I remember Sir Thomas Lipton telling me the story of his life, and I realised how he made his mother a happy woman when, as a shop-boy, he brought her the first week's wages he had earned. "Why, Thomas," she said, "you will be getting me a carriage and pair next !"

That little remark caught his imagination, and on it he built up his ambition. His whole effort was then devoted to the one aim of making enough money to buy a carriage and pair as a surprise-offering to his mother.

He told me that, among the many exciting incidents of his life, the proudest and happiest moment was that when he was able to actually hand over to her the prize that he had gained for her.

So in making your own way to success remember that as you progress it will not be merely a satisfaction to yourself but it will bring a real happiness in a quarter where it is most deserved—in your mother's heart.

And when some of these difficulties or temptations of which I have spoken are troubling you, turn your thoughts to your mother. Think what her wish would be. Act upon it, and it will pull you through.

SAVE YOURSELF AND HELP TO PRESERVE THE RACE.

Now, as I have said before, in giving you these ideas I am only trying to help you to get happiness.

Happiness depends to a large extent on health, though it also depends on knowing that you are aiming to help the general well-being of the country as well as of yourself. It is no use your getting married, indeed in some cases it is a crime to do so, unless you are fit and healthy and able to beget healthy children. And part of your responsibility as

a parent will be to teach your children how to grow up healthy.

Well, there is an awful lot of happiness missed in our country through ill-health, and most of that ill-health could be prevented if fellows only took reasonable care of themselves.

Do you know that only one man in three is really healthy, and that one in every ten is an invalid?

Out of eight million young men—*young men, mind you,*

MAN—A WONDERFUL CO-OPERATIVE
MACHINE.

- A. *Nerve Telephone Exchange* between different parts of the body and the brain.
- B. *Brain* receives ideas and directs the actions of the body.
- C. *Gullet* carries food from mouth to stomach.
- D. *Windpipe* carries air from nose to lungs.
- E. *Heart* pumps purified blood to all parts of body and back to the lungs.
- F. *Lungs* repurify the blood with oxygen from fresh air.
- G. *Stomach* receives food from the gullet and mixes digestive juices into it and passes it into the intestines.
- H. *Liver* helps to collect good juices from food and to expel the bad.
- I. *Intestines*: 20-foot tube through which food passes while being digested. This takes three to four hours. The good juices are taken from food and passed into the blood: the waste part of the food is passed into the rectum.
- J. *Kidneys* extract water and waste matter from the blood and pass it into the bladder.
- K. *Bladder* collects waste water from the body and passes it out.
- L. *Rectum* passes waste food out of body.

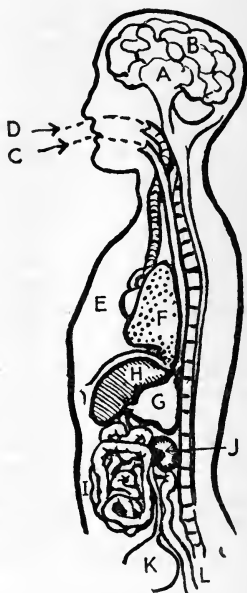

not the old worn-outs—called up for army service in the Great War, one million were found to be medically unfit for service!

A large proportion of these were born healthy, but were allowed by their parents or they allowed themselves to become weak and feeble.

A further proportion were born defective because of the defects in their fathers or mothers—very largely from venereal disease.

If you added up all the working hours that men lose through sickness in Great Britain every year, it would amount to fourteen million weeks. Just think what this means in trade and wages, and yet that loss is largely preventable if fellows only knew how to take care of themselves and had the sense to do it.

If you are an engine driver or car driver you know what tremendous care is necessary in keeping the machinery properly lubricated, fed with adequate head of steam or petrol, gentle use of levers, thorough cleaning of all its parts; constant care and attention are necessary, together with a close knowledge of each particular bit of the machinery, if you are to have it in good working order, running smoothly and efficiently.

But in your own body you have a machine more wonderful than any man-made engine and one that needs still closer attention and better understanding if you are to keep it well. And what is more, you can, by taking care of it, improve it and make it bigger and stronger, which is more than the engineer can do with his engine.

Yet how few fellows understand anything about their inside and its wonderful mechanism: they try to drive an engine that they know nothing about, they give it all sorts of wrong treatment and then expect it to keep sound and to work well!

HOW TO KEEP HEALTHY AND STRONG.

When I was serving in the fever jungles, both on the east and the west coasts of Africa, I noticed that many of us were healthy enough so long as we were on the march every day, but that whenever we had a day's halt and rested some of us were sure to get fever.

I argued it out in my own mind that our blood got cleaned and freshened every day through the daily rear and sweating out of waste stuff in one's system.

A day of rest meant less perspiring and more feeding than usual, and therefore less drainage of one's inside.

So I always made a point of going in for a good bit of exercise on a rest day, and sticking to one's usual small amount of food and drink.

I never had a day's sickness, and at one time averaged

twenty miles a day marching for over a week in a pretty soggy atmosphere. Never felt fitter.

I had one white officer with me, but he had to be replaced five times by fresh men owing to sickness.

Well, I put it down to keeping my blood clean and pure. It is pure blood that makes your body, muscle and fibre grow and keep strong.

And the heart that pumps it through the body is the most important organ that you have. You ought therefore to take the greatest care of it ; but fellows who don't think or who don't know are very liable to over-strain their heart by too much exertion at athletic sports and games, or by forgetting that the heart is liable to be poisoned to a serious extent by over-smoking or too much alcohol. The "Scout's Pace," i.e. alternate running and walking for short spells of twenty or thirty paces, saves men from the heart strain of long-distance running.

FRESH AIR.

The blood needs loads of oxygen—that is fresh air—to keep it fresh. Living indoors without fresh air quickly poisons the blood and makes people feel tired and seedy when they don't know why.

For myself I sleep out of doors in winter as well as summer. I only feel tired or seedy when I have been indoors a lot. I only catch cold when I sleep in a room.

The *British Medical Journal* of February, 1922, reports that living in the open air improved the metabolism (There's a word ! I believe it means your inside heat production) of patients in one hospital to the extent of 40 per cent. above the average.

CLEANLINESS.

I have said clean yourself from inside, but also it is important to clean yourself outside if you want to be healthy.

Cavalry soldiers are noted for their cleanliness, the truth is they have learnt from grooming their horses and cleaning them up at least twice a day how very important it is to health and freshness, to have the skin and parts properly cleaned.

A bath cannot always be got every day, but a wet and

scrubby towel can always be made available and should be used without fail.

BREATHING.

"Shut your mouth and save your life." That is the name of a booklet written by Catlin as the result of his experiences with the Red Indians.

They train their children while they are yet babies to breathe through the nose and not through the mouth. This is partly with the idea of teaching them not to snore and so give themselves away to the enemy in the night, but also because they think that an open mouth reflects on the character of the man.

An Englishman wanted to fight a duel with a Red Indian, but with true idea of fair play he declined to use pistols or other weapons that the Red Indian was unaccustomed to. So he suggested that they should strip and be armed with a knife apiece and fight it out in that way. The Indian smiled and said he would fight if the Englishman still wished it, but that it would go badly with the Englishman.

When asked his reasons for this he said that he had noticed the Englishman habitually kept his mouth half open and he had no fear whatever of a man who did that. It was the sign of a weak character.

We also know that it often produces weak health since, a man who breathes through his mouth sucks in poisonous germs from the air, instead of getting them caught up in the moisture inside his nostrils.

The way to catch 'flu or any other disease that is flying about is to breathe with your mouth open.

TEETH.

An Insurance Company has shown lately that nearly half the ill-health of the nation may be traced to bad teeth.

Although people start with good teeth as children, there are very few that have a sound set after twenty-five, and this is mainly because of their own want of care of their teeth.

Children are not taught the importance of cleaning their teeth THOROUGHLY after meals; and grown-ups don't bother about it. Diseased teeth and gums not only prevent you from properly chewing your food, but may breed little brutes of germs and microbes in your mouth

which go down with your food and give you continual small doses of poison which gradually make you seedy and depressed without your knowing the reason.

If you want to see what you have in the way of germs in your mouth it is an interesting experiment to put some hydrogen peroxide with water in a glass and dip a clean toothbrush into it. Nothing happens.

Brush your teeth over with the toothbrush and dip it again into the glass and you will see myriads of bubbles rising in the water, which means so many germs being knocked out.

I have spoken to you elsewhere in this book on food, on temperance, and smoking, and drinking, and sleeping.

So if you would be strong and well stick to regular daily habits, keeping yourself clean inside and out, give yourself plenty of exercise in the open air, a plain food and not too much of it, moderation in smoking and drinking, breathe through the nose—and you will thank God you're alive.

EXERCISE.

I was asked once by a high authority in education whether I did not think that the cost of erecting gymnasia in every town—though it might amount to millions—would be money well spent because it would develop the health and strength of manhood.



WHEN I TALK OF WALKING
I MEAN SPRIGHTLY WALK-
ING, NOT SLOPPY SLOUCH-
ING.

I replied that the two strongest, healthiest races I happened to know were the Zulus and the Bhutani peasants of the Himalayas; but in neither country had I ever noticed a gymnasium. There was plenty of God's fresh air, and lots of walking and running and climbing to be done in the daily work of these people; and I believed that these were

good enough tonics for any man.

But both fresh air and exercise are absolutely essential to health, both when you are growing and when you have

grown up. I always begin the day with a little bit of body twisting, *in the open*, when I tumble out of bed—but that is only as a start.

Some men go in for physical drill, and some for dumb-bell and other muscle-developing exercises till they come out all over lumps that look fine in a photo when you brace them up, but are not of the slightest practical use to you.

And this work is generally done indoors.

Your exercise must be out of doors in the fresh air, and the very best you can get is at the same time the easiest and cheapest, namely, walking. Week-end walking tours are the very best thing for health of mind as well as of body.

THE RUKSACK.

I know nothing more enjoyable or more cheering and health-giving than a good old tramp every week-end. A knapsack on your back makes you absolutely free and independent. You load it with only the essential things and no luxuries. It is not merely every pound but every ounce of weight that tells on a long march. Nothing can beat the Norwegian type of rucksack

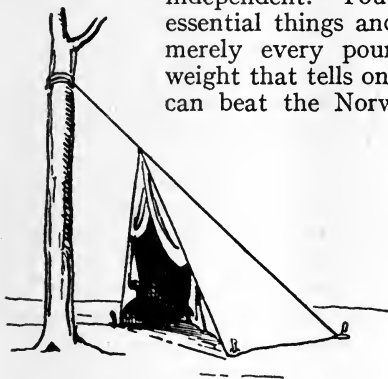

THE GILWELL HIKE TENT. WEIGHT
2 LBS. COMPLETE.

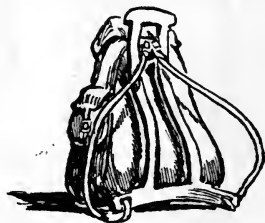

MY RUKSACK, WITH WOODEN
FRAME TO PREVENT GALL-
ING THE BACK.

with its light wooden frame which holds it securely in position without galling or overheating your back. It will take in addition to your clothing a light little tent that can be set up on your staff or on a tree stem, and your sleeping quilt and waterproof sheet. Thus equipped, week-end hikes are possible, and what is more enjoyable all the year round. Weather? Can anything be better

than a good long tramp on a cold blowy day? If it is wet, all the better; you get a very real enjoyment out of a good fire and shelter in a snug farmhouse or inn at the end of the day. I tell you, you get so hardened by practice of the out of doors that you really don't notice the weather very much and you mind it less. Whatever it is, hot or cold, rain or shine, you gain strength, vitality and cheeriness by it.

BE A MAN.

A clean young man in his prime of health and strength is the finest creature God has made in this world.

I once had charge of a party of Swazi chiefs on their visit to England. At the end of their stay, when they had

seen most of the interesting sights of the country, I asked them what had struck them as the most wonderful of all that they had seen.

(They were, incidentally, wonderful sights themselves, having discarded their fine native dress for top hats and frock coats!)

They unanimously agreed that the finest thing in England was the London omnibus. They were so taken with its brilliant colours and the idea of its being entirely for joy-riding!

The next best thing in their judgment was the troupe of gymnastic instructors at the Gymnasium at Aldershot.

When they saw these men performing their various exercises they were tremendously taken with them, but they were not fully satisfied until they had had the men stripped and had examined for themselves their muscular development.

And I must say these gymnasts were magnificent

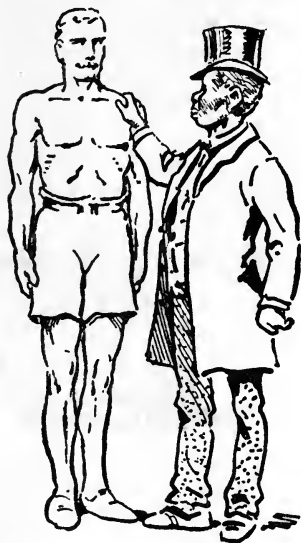

A WHITE MAN AND A MAN.

specimens of what a man should be, and active and alert in mind as well as in body.

And, mind you, a number of these men came originally from poor homes, but had made themselves into what they now were through taking a pride in their manhood. They judged it too good to part with in exchange for philandering after women, swilling beer, and sucking cigarettes. Swazi savages could therefore appreciate manly strength and beauty.

A civilised woman can appreciate all the more a man who is a *man* not only in body, but mind as well, strong and chivalrous.

He is the man for her, and she has no use for the sickly minded, sloppy slacker who talks dirt and has no backbone.

God has given you a body—no, He has lent it to you—to make the best use of ; not to soak it in drink, not to make it limp and weak with debauchery, but to take care of, to strengthen and build up into a really fine figure of a man and a father of children.

You can do this if you like. It is up to you. And what a splendid adventure it can be.

St. George fighting the dragon for the sake of the Princess won't be in it with you, who fight the dragon of temptation and down him so that you may in the end present yourself a *man*, clean and strong and chivalrous to the girl whom you love. You will also have taken a further step towards happiness, and will have fitted yourself bodily for the service of God in carrying on the race on the best lines.

MARRIAGE

You are bound to have your

LOVE ADVENTURES.

I know the difficulty that you are faced with. There is little enough of romance and excitement in the ordinary life of a town or village, and at your particular age, with the rutting season on, woman comes into your thoughts in a new and alluring way.

It is a great adventure, therefore, to a young lad to seek out a girl for himself.

Sometimes he likes to show her off before the others as a

sign of his manliness, in other cases he prefers to get her all to himself. Don't think this unnatural. It is all in the course of Nature. As I have said above, it is in accordance with the law that governs animals as well as man.



THERE ARE WOMEN AND
WOMEN.

But in the case of man there is this difference. He has a mind and intelligence which the animal does not possess; he sees romance in selecting a mate to whom he can give his admiration, love and devotion. These are far above the mere animal instinct. They form human love instead of animal lust; and the higher he raises himself above the animal instinct the less he is of the beast and the more he is of the man.

A main step to happiness in this direction is to select the right kind of girl. There are women and there are dolls
CALF-LOVE.

As a *very* young man you will of course go entirely by her face and figure and you may fall in love with one girl after another—desperately in love; and sometimes will have perhaps two or three on your string at a time.

Probably you may think it the most glorious adventure and most probably a few days later the most disastrous tragedy that ever happened to anyone. It comes to most young fellows about this period to feel like committing suicide over a love quarrel—but they don't do it!

You may comfort yourself by knowing that all this is what comes to every lad, and is known as "calf-love." There is no harm in it, and nothing to be ashamed of nor to be depressed about. Indeed in a short time, when the really right girl has come along, you will laugh at your first ideas of love-making.

But in that calf-love period don't forget you are a man

and not a beast. Behave like a man. Play fair and square with the girl and remember your future son whose germ is in your keeping. Don't tempt her, and don't be tempted by her, and then you will have nothing to feel ashamed of in your after years.

And you will be on the right side if you only take on with a girl whom you can bring to your own home without shame, among your mother and sisters.

Remember that whoever she is, she is someone else's sister; think of him and behave to her as you would wish him to behave to your sister.

HOW TO GET THE RIGHT GIRL.

The right girl will come along sooner or later—if you have kept your head. Your calf-love will have disappeared. You will find a girl whose character you admire and respect, whose tastes are like your own and whose comradeship you long for. It will not be merely her person that attracts you but her personality.

You will find a new, calmer and deeper form of love that links and binds you to her—one which, if you are wise, will never grow less.

And you will expect her to come to you pure and clean, won't you? But what about yourself? Are you going to expect of her what you cannot offer in return yourself?

That would neither be manly nor fair. No, if you are going to enjoy real happiness in life that is the supreme joy of being married to a really good woman from whom you hope for love and respect, you've got to keep yourself clean, while a young man, in thought, and word, and deed, so that you will have nothing to hide—nothing to be ashamed of.

Don't begin your married life with a lie, else you will be lying all through it, and there will be an end to trusting each other.

WARNING FROM A PORK-BUTCHER ON GETTING ENGAGED.

If you have never read a book called *A Self-made Merchant's Letters to his Son* you've got a treat in store for you. It is a most amusing bit of reading, but at the same time full of jolly sound advice.

The merchant is an American pork-packer, writing

to his son who holds a junior post in the business. He hears that his son is hanging about after a certain young lady.

So he says : " I suppose I am fanning the air when I ask you to be guided by my judgment in this matter, because while a young fellow will consult his father about buying a horse, he is cocksure of himself when it comes to picking a wife.

" Marriages may be made in Heaven, but most engagements are made in the back parlour with the gas so low that a fellow really doesn't get a square look at what he's taking. While a man doesn't see much of a girl's family when he is courting, he is apt to see a good deal of it when he is housekeeping.

" Your Ma and I set up housekeeping in one of those cottages you read about in story books, but that you want to shy away from when it is put up to you to live in one of them. There were nice climbing roses on the front porch, but no running water in the kitchen ; there were plenty of old-fashioned posies in the front yard and plenty of rats in the cellar ; there was half an acre of ground at the back, but so little room inside that I had to sit with my feet out of window. It was just the place to go for a picnic, but it's been my experience that a fellow does most of his picnicking before he is married.

" But one way and another we managed to get a good deal of satisfaction out of it, because we had made up our minds to get our fun out of everything as we went along.

" With most people happiness is something that is always just a day off, but *I have made it a rule never to put off being happy till to-morrow.* [I have italicised that.]

" Of course when you are married you've got to make an income, and this is going to take so much time and thought that you won't have a very wide margin left for golf. I simply mention this in passing, because I see in the Chicago papers that you were among the players on the links one afternoon a fortnight ago. Golf's a nice foolish game and there ain't any harm in it so far as I know ; but a young fellow who wants to be a boss butcher hasn't much daylight to waste on any kind of links—except sausage links.

" Of course a man should have a certain amount of play, just as a boy is entitled to a piece of pie at the end of his dinner, but he don't want to make a meal of it.

“Of course your salary isn't a large one yet, but you can buy a whole lot of happiness with fifty dollars a week when you have a right sort of woman for your purchasing agent, and, while I don't go much on love in a cottage, love in a flat with fifty a week as a starter is just about right if the girl is just about right. If she isn't, it doesn't make any special difference how you start out, you're going to end up all wrong.

“Money ought never to be *the* consideration about marriage, but it always ought to be *a* consideration. When a boy and girl don't think about it enough before the ceremony they're going to have to think altogether too much about it after; and when a man is doing sums at home, evenings, it comes kind of awkward for him to try to hold his wife on his lap. . . .

“There is nothing in this talk that two can live cheaper than one. A good wife doubles a man's happiness and doubles his expenses, but it is a pretty good investment if a fellow has got the money to invest. . . .

“A married man is worth more salary than a single one, because his wife makes him work more. He is apt to go to bed a little sooner and to get up a little earlier; to go a little steadier and to work a little harder than the fellow who has got to amuse a different girl every night and can't stay at home to do it.

“That's why I am going to raise your salary to seventy-five dollars a week the day you marry.”

On the other hand, in *Enchanter's Nightshade* you find:

“Men all seem to want to make money directly they get to a city.”

“Well, they must marry.”

“You don't need a deal of money—unless the girl is all wrong.”

INCOME AN IMPORTANT DETAIL.

There is truth in both ideas, but the advice from the old pork-packer is sound, if less romantic, and it is your business before marrying to see that you are in a position to keep a wife and family, otherwise you will be condemning these as well as yourself to a struggle for existence.

Success in business is not a matter of luck or favour or interest, nor even of learning, so much as of ability and

character. Expert skill in your work is bound to tell, but for promotion to higher grades, character—that is absolute trustworthiness, tact, and energy—is essential.

This applies practically to every trade or profession. I was asked the other day what I meant by tact, and I could only reply by quoting the old example of the tactful plumber who, on entering a bathroom which had carelessly been left unlocked by the lady using the bath, promptly said: "I beg pardon, *Sir*. I didn't know you were here," and strolled out again.

I was in a "Rovers' Den" (*see* final Chapter) the other day when congratulations were being showered on one member on his engagement to be married.

"Who is the girl?"

"Oh, she's a Girl Guide."

"Splendid! What a good idea! You couldn't do better."

But immediately two other men chipped in for part of the congratulations, saying that they also were engaged similarly to Girl Guides.

I see promise in this.

You get wives in this way who can be better pals because they have got the same keenness on camping and the out of doors with all the necessary handiness and resourcefulness, health and good temper that comes of such life. I feel certain that if I came to visit you in your home later on, when thus mated, I should find not only a happy home but a clean one; for the premises of campers, who were accustomed to leave their camp grounds as neat as they found them, would not be lumbered up with piles of old tins, scrap-iron, and other rubbish that are a disgrace to so many of our back gardens and waste lands.

A MAN'S DUTIES ON GETTING MARRIED.

Someone once told me my fortune by looking at the lines on the palm of my hand, and he said: "Your line of head is stronger than your line of heart," meaning that I should not be carried off my legs by the first beautiful girl I saw, but that I should think as much about the character of the girl I admired as about her appearance; and that is, I am certain, the way to make your choice. Take care lest, in

making your choice, you think too much of what you would require in your future wife and forget her point of view and *what she would like of you* as a husband. Think of that.

When I got married, an old friend, on giving me his congratulations, also gave me a new vision of my future state when he said : " My dear fellow, I have been married over twelve years and it is still a honeymoon with us. Life has gone on getting happier and happier for us."

And in my turn I too have since found the truth of this.

I should hope that it will be the case with you who read this, but it means using your " line of head " as well as heart ; it means getting the right girl to start with.

Mind you, it is only a little step to ask a girl to say yes, but on that word depends a life-long sentence to both of you, consigning you both to happiness—or hell.

Then, as I said above, " Be wise " ; that is, in taking the girl to be your wife for " better or worse " you are rather apt in the rosy sunshine of it all to forget that " worse."

Clouds may come and you've got to be prepared for them—that's what I mean by being wise.

Have no secrets from your wife and she will have none from you—and all will be plain sailing.

There may be times of trouble, little difficulties in the home which you don't foresee at first. Before you married you only did things for yourself ; now that you are married you've got to chuck your *self* and do things for your wife—and later on for your children. You have got to catch yourself up in little bits of selfishness on your part, such, for instance, as grousing at the food because it isn't exactly to your liking, and that sort of thing. Look at things from her point of view.

Grousing won't mend matters. Give instead some of the little love gifts of your courting days, of admiration and praise ; give and take and SMILE all the time, but most especially at that time when most women get a little off their usual line, just before the first baby arrives. You've got to show your manliness and chivalry as her comforter and protector then.

If she is a little fractious it is through her love for you that she is so. To such attention she will respond. Women are not only more grateful than men, but their character shapes itself according as it is led by their man.

If he be nasty she will nag ; if he be nice then she will be nicer, and then there's love and laughter in the home.

CHILDREN.

Have you ever read Rudyard Kipling's story *They* ? I read it long before I was married, away out in the bush in Africa. The point in that story that went home to me was not the delightful description of English scenery, of the old-world home and garden, etc. ; it was where the man imagined that he felt the clinging of little children's fingers in his hand ; he only imagined it, but it thrilled him to the core.

And I had that imagination in my mind for years as vividly as in the story. But when it came to pass that I actually felt a tiny hand in mine, the hand of my own little child, it gave me something more than a thrill—a feeling that has never worn off with custom, for it still does so—the heart-filling joy of it never grows less. . . .

But, there ! Try it for yourself, in your own home, of your own making—and you will know what happiness is.

There is nothing like it—and it cannot be described, at least not by me.

So, as I have already said before, Heaven is not a vague something somewhere up in the skies.

It is right here on earth, in your own home. It does not depend on riches or position, but rests with you to make it, in your own way, with your own brain, and heart, and hands. And you can do it if only you like to use these aright.

RESPONSIBILITIES OF PARENTHOOD.

But the joy of being a father brings with it a big responsibility. Children learn mainly by the example of their elders.

A grouching, selfish father must not be surprised if one day his son swears at him and goes his own way ; the father will get later on what he gives out to-day. Train your children through Love rather than Fear.

A kindly parent gains a loving daughter and devoted sons. As I have suggested before, you will be happier if

you aim to leave this world a little better for your being in it.

One step in this direction, and one which is within your reach as a father, is to make your boy a better man than yourself, by teaching him all that you know, what to aim for and what to avoid. Especially he will want your helpful advice when he, in his turn, approaches the "rutting season."

Think how much or how little your father did for you and go one better with your son.

You will be the happier for it.

But are you prepared for this? You may have been educated, or you may have educated yourself for your profession in life, which after all can only last a certain number of years, but have you gone through any training for this much more important point, on which depends so much the future lives of your children?

Have you had any practice yourself in the training and upbringing of boys? Of knowing their ways, of judging their temperaments, of developing their character?

This is all of grave importance to you in your responsible position as a parent.

I hope in the concluding chapters to give you a few practical suggestions about it.

Many parents object to their sons being told about sex matters and venereal disease. I have heard men curse their parents for not having told them. Personally I don't think that any parent who has seen something of the effects of ignorance, or of what is worse, the wrong notions which boys pick up all too soon from their fellows, would hesitate about warning his sons.

A FINAL TIP FOR HAPPINESS.

But I warn you that there is still another item needed to make your Heaven complete.

A man came to me this week. He had been a big-game hunter and naturalist in Central Africa; he had been a farmer in British Columbia; he had started a tobacco plantation in East Africa; and he had seen the world in a life of adventure and romance. He had now settled down in an island of his own in the Indian Ocean in a glorious

climate of sunshine amongst beautiful and healthy surroundings. One might well have thought, as he did at first, that this was going to be a heavenly haven after all his strenuous wanderings, but he had now come to discover a fly in the ointment.

He realised that he was living comfortably merely for himself. This conviction had now brought him to give up that *Existence* and exchange it for *Life*—that is, for activity in doing something for others.

I had myself gone through much the same experience when I finished my career as a soldier. It had been a pretty varied and strenuous one, bringing a good deal of the rough along with the smooth, and I had loved every minute of it.

At the end my ambition was to settle down in a little farm in some out-of-the-way corner of the world.

I planned it out, but then the second thought arose which made me realise that idleness and indulgence of self did not mean happiness—that true happiness could only be got through Service.

So there is another chapter to this book.

WHAT OTHERS HAVE SAID ON THE SUBJECT

Men ought to be mighty good to women, for Nature gave them the big end of the log to lift and mighty little strength to do it with (*Abraham Lincoln*).

Have a heart that never hardens, and a temper that never tries, and a touch that never hurts (*Charles Dickens*).

Whoso findeth a wife findeth a good thing and the favour of the Lord (*Proverbs xviii. 22*).

Health is worth more than wealth.

Cleanliness is next to Godliness.

A "Gentleman" is a bloke wot keeps even 'is toenails clean.

Fear of a father does not necessarily mean respect for him.

The cane often makes the coward and the liar.

Men! With the help of God, be MEN (*Heard at St. Gervais Church, Paris*).

As man was created for Health, so was man created for Happiness (*Maeterlinck*).

Let not thy fancy be guided by thine eye, nor let thy will be formed by thy fancy; let thy understanding moderate between thine eye and thy fancy (*F. Quarles*).

HELPFUL BOOKS

Wanted! Men! By Eustace Miles.

Life and Health. By Dr. Shelly (Macmillan). 3s.

Health, Strength, and Happiness. Dr. C. W. Saleeby (Richards).

The Engines of the Human Body. Dr. A. Keith (Williams and Norgate).

1870
The following is a list of the names of the persons who have been admitted to the office of the Secretary of the Board of Education since the first of January, 1870.

1. Mr. J. H. [Name] [Address]
2. Mr. J. H. [Name] [Address]
3. Mr. J. H. [Name] [Address]
4. Mr. J. H. [Name] [Address]
5. Mr. J. H. [Name] [Address]
6. Mr. J. H. [Name] [Address]
7. Mr. J. H. [Name] [Address]
8. Mr. J. H. [Name] [Address]
9. Mr. J. H. [Name] [Address]
10. Mr. J. H. [Name] [Address]

11. Mr. J. H. [Name] [Address]
12. Mr. J. H. [Name] [Address]
13. Mr. J. H. [Name] [Address]
14. Mr. J. H. [Name] [Address]
15. Mr. J. H. [Name] [Address]
16. Mr. J. H. [Name] [Address]
17. Mr. J. H. [Name] [Address]
18. Mr. J. H. [Name] [Address]
19. Mr. J. H. [Name] [Address]
20. Mr. J. H. [Name] [Address]

ROCK NUMBER FOUR
CUCKOOS

CUCKOOS

THE dark side of this rock is the danger of being sucked in by cuckoos, cranks or extremists.

The bright side is the development of self-education and service for the community which counteract the lure of cuckooism.

CUCKOOS.

The cuckoo bird has its imitators in human cuckoos.
The political cuckoo, a persuasive herd leader.
The industrial see-saw.
We need Evolution, not Revolution.
Education badly needed for all.
The danger of becoming an ambitious cuckoo.
Or a snob cuckoo.
Or a gush prig.

SELF-EDUCATION.

The safeguard against being wrecked or sucked in by cuckoos is to educate yourself.
Books and how to read them.
Travel as an education.
Self-expression in art.
Self-expression in speech—with some hints.

SUBJECTS IN SELF-EDUCATION FOR CIVIC SERVICE.

Service should be your aim in taking up any public work.
Civic service and how to prepare for it.
Our national government, how constituted.
The Empire and two sides to it.
What the King is to the Empire.
International relations.
The privileges and opportunities of citizenship open to all.

FOOD FOR THOUGHT.

“THE GLORY OF THE GARDEN.”

BOOKS TO READ.

CUCKOOS

HOW A CUCKOO IMPOSES ITS WILL ON OTHER BIRDS.

HAVE you ever watched a cuckoo at her job? She seems partly profiteer, partly communist. When she wants to lay an egg she doesn't go to the trouble of making a nest, she goes about looking for some other bird's nests, preferably that of the harmless little meadow pippit. When she finds one she goes into it, regardless of any protests on the part of the owner, and she takes up one of the pippit's eggs in her beak and drops her own egg in its place. Then she flies off to a neighbouring tree and eats the egg that she has stolen. The pippit on her part meekly accepts this dictation and does all the work of hatching out the cuckoo's egg among her own. The result is a big ugly nestling which even before its eyes are open at once begins to bully its nest mates and finally heaves them out one by one till it has the nest to itself and the full service of the parent pippits for its feeding, etc.

We all know the insistent voice with which the cuckoo goes about proclaiming himself above all other birds.

But it is not only in bird life that all this happens; we have human cuckoos, too.

THE HUMAN CUCKOO.

The human cuckoo is generally a superior sort of person who sees his own side of a question but nobody else's. He is the self-interested man who wants only his own way in the world; he makes use of the work of other humbler folk for his own benefit, or he pushes others out who may be in the way of his getting the things he wants. You find the human cuckoo in various forms such as cranks, political tub-thumpers, intellectual highbrows, and social snobs, and other extremists.

There are two dangers about these cuckoos. One is that you may be sucked in to follow their lead. The other is that you may become one yourself.

THE PERSUASIVE HERD-LEADER.

Have you ever seen wild ducks being decoyed into a trap? It is done by sending a trained dog to play ridiculous antics

along the bank of the stream which leads into the netted tunnel that forms the trap. The whole flock of otherwise sane birds cannot resist following the lead of this novel animal, and so they willingly and quite unwittingly swim to their doom.

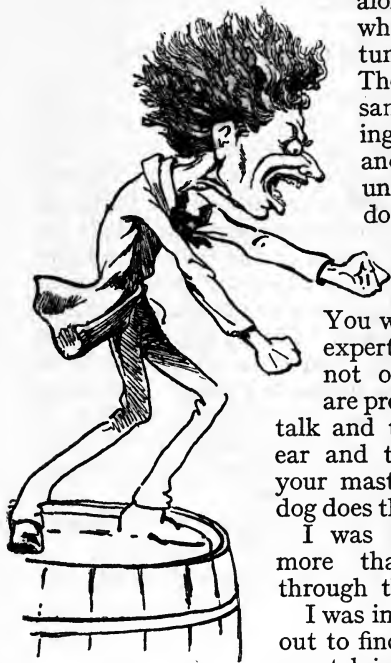

DOWN WITH EVERYTHING
—AND UP WITH ME!

Have you ever been to the Caledonian Market in London on a Friday? You will see there on every hand experts selling goods. They are not ordinary shopkeepers, they are professors at the game. They talk and they hustle, they catch your ear and then your eye and, finally, your mastery of yourself, just as the dog does the ducks.

I was all but taken in their net more than once as I wandered through that busy community.

I was in point of fact merely looking out to find a brass candlestick for my mantelpiece. As near as a toucher I was let in for Lot No. 4. It had nothing to do with candlesticks, but

I was simply hypnotised by the auctioneer to bid for it. This lot contained nothing nearer to my needs than an old saddle, a file, and a pair of partly worn stays.

But such was the power of the tub-thumper that I only escaped by the skin of my teeth and, as it was, I ran into another persuasive man round the corner who was selling a pair of lace curtains. And here I very nearly fell again, not

because I could ever want such things, but because he said he was in a vast hurry and packed up to go, and this lot was accidentally left out, and he would rather sell them for what they would fetch than undo all his packages again ; but he was in a hurry, just off, another minute and the wonderful chance would be gone.

Fortunately I just managed to tear myself off too—in the opposite direction. Happening to pass that way an hour later I found him still at it, selling his curtains like hot cakes because he was in a desperate hurry, and he hustled people to snap them up in a hurry, too—though possibly to repent at leisure later on.

Well—it is much the same with the good loud-voiced political orator ; with the gift of the gab he will bag at one go a whole crowd of open-mouthed wondering lads, who have never troubled to hear the other side of the question about which he is spouting. They fall like ripe plums to his shake, and start forthwith to learn either “ The Red Flag ” or “ By Jingo, if we do,” according as he is preaching red-hot communism or aggressive imperialism. He hypnotises the whole herd. But he cannot mesmerise the individual fellow who doesn't mean to be carried away by the rest.

It is not only the orator that catches unthinking listeners, there are writers too ; and somehow, when you see a thing in black and white, one seems to think it must be true. You naturally take for gospel anything that you read in the papers until you come to enquire into it and to recognise that it is the opinion of one man writing for his living or to back certain views.

There are writers of repute who have studied great questions and who claim to put the matter clearly for those who have not the time or opportunity for going deeply into it.

But even these make their mistakes or take sides, and are apt to colour their pictures rather highly, so it doesn't do to trust them entirely. If they happen to be writing on one side of the question it is well to read what some equally good authority has to say on the other.

And then there are the snakes in the grass, the fellows who get hold of you by chance in conversation, with great ideas, or who lure you through attractive clubs or with well-sounding “ Brotherhoods.” There are lots of them about ; so keep at least one eye open and both ears and all your wits.

Every one of these cuckoos and snakes has his particular aim in getting hold of promising young men. Sometimes the aim is harmless, but more often than not there is some vice underlying it.

THE SEE-SAW.

These are the extreme views that people are apt to give you from opposite ends of the see-saw. That is they are the cuckoos that make the noise in the world and so attract attention of the general flock of birds.

But fortunately for the nation there is a quiet common-sense middle lot of men in between the extremists who

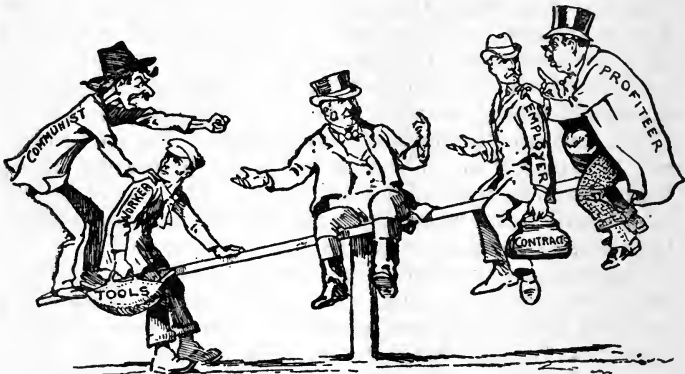

JOHN BULL'S GAME SPOILT BY THE EXTREMISTS AT EACH END OF THE SEE-SAW.

though they don't talk loud, think quietly for themselves: sensible workmen, human employers, and public-spirited benefactors; in other words, a citizenship that is out for fair play and mutual forbearance for the good of the whole. It is this solid element that serves to keep the balance between the extremes.

EVOLUTION AND REVOLUTION.

The right kind of evolution is a very big question, affecting every branch of public and private life, needing the careful study and careful handling of disinterested men if it is going to be a blessing instead of a curse to the mass of the people.

We have had such an object-lesson in Russia of the awful results of hot-heads rushing a revolution, where a whole nation is now dying out through starvation and murder as the direct result.

It is a ghastly tragedy. It may be that the few leaders of the revolution there have done themselves well in the matter of motor-cars and wives, and the amount of jewellery they have got, and they see to it that they are jolly well fed, even if the rest of the people are dying of hunger. One of the Soviet leaders admits their incompetence for ruling a country, and he reports :

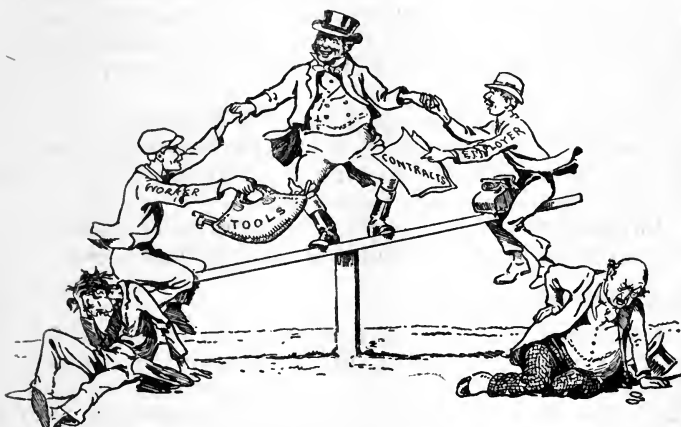

EXTREMISTS AT BOTH ENDS ARE DROPPED, AND J. B. IS SET ON HIS LEGS AGAIN BY MUTUAL CO-OPERATION AND GOOD WILL.

“ Considerably worse conditions prevail in Russia to-day than any yet described in the history of that country. From the consumption of straw the people are passing to eating grass and roots, and they are now suffering from typhus more than they did from cholera in the summer.”

The older men who have had more time in their lives to look round the world to see what has gone on in this direction are inclined to ask what these extremists would put up in place of the existing form of government. They recognise that progress in the right direction is quietly going on all the time ; that is evolution, a natural development ; but

a new constitution built up all in a hurry could only be a jerry-built affair.

Young bloods are too impatient.

Once on a time I lived with a missionary in an unhealthy spot in West Africa. He was the fourth incumbent of the place in four years. His predecessors had died there or been hurried off to healthier climes. I asked him whether he really thought it good enough when one looked round and saw how little real effect the Christianity had upon the natives into whom it had been inculcated at such sacrifice. And he explained that he never expected to see tangible results in his time, but that he felt that the seed sown in the present generation, though it remained underground, would gradually take root and come up in the next generation and possibly blossom forth and bear fruit several generations later on.

Well, that was a fine spirit in which to tackle the job. If more of it were developed in our efforts to bring about better conditions for the country the effect would probably be all the more successful in the end.

But extremists generally prefer to be up in the limelight, instead of working in obscurity at making foundations.

FREEDOM OF THOUGHT.

Freedom of the individual is only right so far as it doesn't interfere with the good of the community as a whole. Every fellow is welcome to have his own opinions, but there has to be a limit somewhere. We are all in agreement with true honest socialism—apart from political adventures posing under that name—in trying to do away with the disgrace which at present hangs over civilisation in almost every country; where human beings, through no fault of their own, are condemned to live through an existence of misery and squalor through bad organisation and faulty conditions. We all want to ensure that every human being who is put into this world by God should have his fair chance of enjoying and making the best of life without being handicapped from the first by man-made circumstances of poverty. But no amount of cuckoo work will put an end to this, any more than will all the Acts of Parliament that may be made. It is a matter for the good will and co-operation of all classes to help our worse-off brothers out of the mire, mainly by

giving them a proper education in character towards career-making.

NATIONAL GOVERNMENT.

I have been in Russia and in most other civilised countries of the world. It doesn't seem to make much difference to the happiness of the people whether the country is governed by a King or a President. In fact, the President of the United States has far more autocratic power in his own hands over his country than our King has in Britain.

During the Peace negotiations, when President Wilson was in France telling the Allies what was the American view of the situation, the story went that he received a cable from Washington saying, "Come back soon, or they will be proclaiming a republic in the United States."

The King, by our constitution, does not rule, but keeps the government running on constitutional lines. He has no power to make war, though he has a high standing for keeping the peace. He is not elected by any particular party of politicians, but comes into the position by succession, trained for it from youth, and without political bias or interest. The main objection raised is that a monarch costs money to the State.

That also is the case with the head of the Government in every country; but in Britain it does not happen to be so true, because our King has private means of his own and uses them to the full.

In some Republics the President is elected by his own political party; in others he gets there by force of arms; and in many he and his Government are out to make hay while the sun shines and to feather their nests while they are yet in power.

In Portugal in the past twelve months (1920-1921) there have been no less than five changes of government, in some cases unfortunately brought about by murder and assassination.

Just now, in almost every country, whether a Republic or Kingdom, there is unrest and poverty as the result of the war. But in none of them does distress come up to the awful misery into which all are plunged under that form of government which is known as the Soviet, or People's Rule, in Russia.

WHERE LABOUR STANDS IN BRITAIN.

In Great Britain, apart from being merely a political party, Labour has gradually and steadily raised itself on its merits as a National institution, through the work of a succession of earnest, far-seeing men. Its members have been handicapped by extremist jackals yapping round them and trying to divert them to more violent methods. But they are British, and that is the point which the jackals, who are mostly from other countries, don't grasp.

The Trades Unions have grown up to be great organisations for safeguarding the workers, and the Co-operative Trading organisations, as well as the Workers' Friendly Societies, are now immense business schemes testifying to big outlook and administrative ability among our working men.

Education is now being seriously encouraged and claimed for the rising generation of workers; because of the need of character, as well as of knowledge, if the majority of our population are going to enjoy the good of life.

Fortunately, the Socialist leaders, as well as the heads of Labour, fully recognise this, as do all men who have to help their country and their kind. Whatever their other differences may be, all seem agreed on this one point, and all treat it as of first importance, namely Education for Citizenship.

It is already in the course of being brought about by mutual good will and co-operation, and in those two qualities lie the key to prosperity and the peace of our people in the future.

But it is well not to sit down and wait for universities to come to you, nor indeed to expect a university to do everything for you when it does come. A very considerable portion of that education can be, and can best be, carried out by every man for himself if he only sets his mind to it.

That is why I am bothering you with this book.

THE AMBITIOUS CUCKOO.

As I have said before, apart from the danger of being sucked in by highfalutin talkers; there is the danger of becoming a highbrow oneself.

Such a lot of fellows, while they are young, think no small

beer of themselves as politicians, or poets, thinkers or orators, artists and the like. I was a real cuckoo myself—equally intent on becoming a red-hot Socialist or a devoted Missionary, and I wore a green tie with forked lightning on it!

In *Enchanter's Nightshade*—which please read if you want a delightful walking-tour-amusing-philosophy-book—J. B. Morton writes of a tourist meeting with a commercial traveller on the road. The C.T. says: "I am contented with my work; there is more in it than touting and braying my wares in the market-place. The market-place itself is sometimes worth seeing. I go about a lot, see new places, meet new people. . . . I don't want to be bounded, caged by my work. I am a traveller, and I often forget the commercial part of it. I shall be sacked one day, and then I shall probably play the piano in a picture show. I've no ambition. All I want is to see life, and to live it, to some extent."

"Ambition is a mixed blessing," said the tourist.

"Have you got ambition?" asked the C. T.

"I have," said the tourist; "my pals have. We all want to make our names by writing."

The C. T. smiled, as a parent might smile at a bright little boy.

"It is a phase," he said. "I have had it. I thought I was Paderewski; wore my hair long; never cut my nails; starved; read morbid books; pined for love. But I got over it as I got older."

"And now you are happy?"

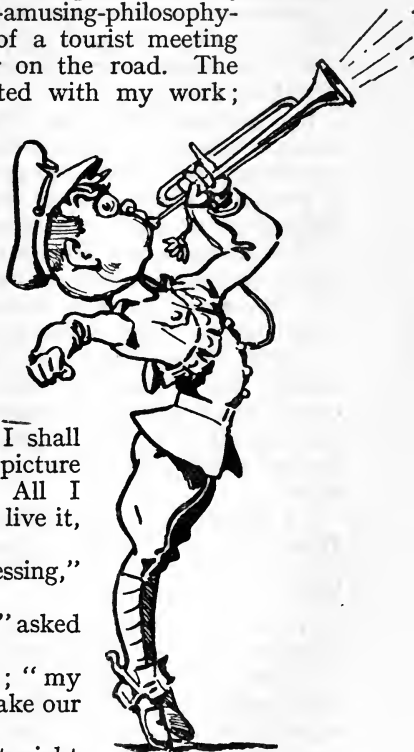

SELF-EXPRESSION—SOMETIMES RUNS TO BLOWING YOUR OWN TRUMPET.

“ I am.”

And he was right. A man who has the cheap ambition to make himself famous or to exalt himself amongst his fellows is laying out for himself disappointment, mingled with envy, hatred and malice, against those who pass him in the race.

Ambition to do the right is the only ambition that counts, and that helps towards happiness.

But the personal ambition to be thought great or exceptional makes prigs.

For instance, it is not difficult to become a Futurist artist. You only need to have a collection of strong colours and a touch in insanity and to fling the result on to canvas. If you have some sanity in you you can only keep up this form of amusement for a time ; it eventually palls.

It is evidently not difficult to be a self-sufficient critic on music, and here is a sample from a book recently published :

“ Few musical critics, *it is safe to say*, and still fewer musicians, have any notion of what they are talking about.

“ ‘ Die Meistersinger ’ is the only opera Wagner ever wrote. The music of ‘ Louise ’ is bosh, absolute bunkum ; that is a fair and unexaggerated statement . . . miserable tootling, which modern instruction in harmony and orchestration would enable Lord Curzon or Lord Northcliffe to write.

“ I have little innate sympathy with Wagner’s music. What do I care for Bach’s prodigious skill ? ”

WANT OF HUMOUR.

G. K. Chesterton has lately pointed to the fact that the average “ cuckoo ” has little sense of humour.

“ Few people,” said he, “ seem to understand the fantastic when it is used logically upon the principle of the *reductio ad absurdum*. For instance, a man says there ought to be no private property of any kind ; that there are none of the things that men have that they should not share. You then say to him, ‘ Your proposal about a communal toothbrush, or a communal pair of trousers,’ and he replies that you are simply making a jest of the discussion. The point to insist upon is that he is the man who has made the absurd remark. He is the man who has made the joke, but the difference is that I can see the joke and he can’t.

Do not think I give you that example merely as indicating partisanship on general political or other matters. Just the same absurdities are uttered on what may be called the reactionary side. For instance, when the ordinary jolly old major, or man in the club, tells you, as a man in a club told me, 'I always like to fight the enemy with their own weapons.' I say to him, 'How long does it take you to sting a wasp?' or 'How do cannibals taste?' or something of that sort. In these circumstances, the man in the club is liable to accuse you of fantasy, but, as a matter of fact, it is he who is fantastic."

WANT OF REVERENCE.

In *The Times* of February 18, 1922, "Lord Morley has lamented the decay of reverence in modern democracy, and Lord Bryce in his recently published work expresses the same anxiety, though he believes that reverence may revive in the future. We trust that such revival will take place. Flippancy, conceit and cynicism render men selfish and contemptuous. They ask 'Who will show us any good?' and, finding no answer to their minds, they cease to believe in goodness. When this happens, reverence dies, and in its death all hope of moral and spiritual progress is destroyed with it." The "cuckoo" has no respect for the views of other people.

I agree with Lord Bryce that reverence may revive, for I am sure it will revive among the improved breed of young men who are coming forward in future. It lies with you fellows to bring it about.

THEN THERE ARE THE SNOBS.

The snobbishness of class against class is one of the causes of the present social unrest that is damaging our country.

You younger fellows can put a stop to it if you only have the will to do so.

It is for the better-off fellows—you who have had the luck to get a better education—it is for you to hold out a hand of fellowship and good will to your less well-to-do brothers. If you are gentlemen—as you profess—you will do it. Indeed, I am glad to believe that the best public schools and universities are already doing it, not in any sense of condescension, but as brother men and fellow-

countrymen. Their elder brothers did it in the war to save the country : they made common sacrifices, and they were comrades together, officers and men.

And you chaps who are not so well off, you would think it pretty low down, wouldn't you, if, when another team had the luck to get the better of you in a game, you turned nasty and booed them. You wouldn't do it. It would be unsportsmanlike.

Don't be unsportsmanlike, then, in the case of a fellow who has had the luck to have more money than you have.

He is your fellow-countryman and fellow-man. He is all right at heart.

Like Chevalier's coster—

“ 'E's all right when yer know 'im,
But ye've got to know 'im fust.”

If you play football with him, man to man, clothed alike and equally muddy, there's not much difference between you.

Yes, your elder brothers, rich and poor, high-born and low-born, got muddy together in the trenches in the late war, they shared together the horrors and the dangers, and in death they were not divided.

There was no snobbishness there. They proved that class difference is skin-deep, they were brothers below the surface and in their hearts.

So it is up to you fellows of the new generation, whether you are rich or poor, to continue that comradeship by being good friends together ; by so doing you can keep up the old country which they saved.

A fellow who has not had the chance of getting a Public School education used to be looked down upon by those who had had it.

I think the present generation of Public School boys are less of snobs in that way than we used to be in my time.

Public Schools now run social and athletic clubs for their worse-off brothers, and the more they can develop better personal acquaintance with the members of these clubs the better it will be for both parties and for the country.

It is not enough for them to give their subscription, they must give their friendship. This step ought to be made by the masters an item of very much higher importance in Public School education to-day.

Every young man ought to make it part of his bit of service for the community.

Good will and co-operation on the part of rich and poor alike is, as I have said elsewhere, the key to the prosperity of all and to the peace of the country.

THE HUMAN ELEMENT.

I once took a very smart young officer of the Life Guards down into the purlieus of South-east London to show him something of the other side of life from that of drawing-rooms and clubs. I had myself, when a youngster, gone into the life of those parts as a plumber.

I thought it would be a bit of an education for him.

It turned out to be a bit of an education for me.

I was glad to see, at all events, that he was not such a snob as to come with his usual spats and starch, and when we got into the bit of a club that I know of down there he fished out a dirty old pipe, ordered his beer, and in a few minutes had the chaps round him roaring with laughter at the yarns he was telling.

On our way home later on I lost my way in the labyrinth of alleys and back streets, and when I confessed, at last, that I was out of my reckoning for Waterloo Bridge, he at once took the lead and said, "This way, up this alley."

I then learnt that my friend was quite accustomed to coming to these parts. He had pals there, just as he had in "Society" circles.

He took people for what they were, not for what their clothes made them.

It was not condescension but human feeling on his part. And that is "good medicine," as Red Indians say—for all of us.

"Superior persons" often seem to think that if a man is in a different line of life from themselves he therefore has not a human heart inside him. A "superior person" is a snob.

THE GUSH PRIG.

A Gush Prig is a fellow who lets himself go in "gush." By gush I mean something that you produce, thinking it brilliant, but which is not the outcome of knowledge or experience.

It may be talk, it may be poetry or prose writing. Self-expression is a good thing, but when it breaks out into gush—well, too often it goes to the head and swells it.

A good many young men find at twenty-two that they know practically all that there is to know—and they want other people to know that they know it.

When they get to thirty-two they find that they have still got one or two things to learn ; at forty-two they are learning hard. (I was still doing so at sixty-two.)

Politicians, especially those of very pronounced views, generally become disappointing to their original supporters as they become older. The reason for this is that they have meantime been learning a lot, their outlook has become broadened by experience, and they have realised the great fact that there is more than one side to a question.

I used to think wonderfully fine thoughts when I was young, and I wrote them down with a poetic fervour that I felt was inspiration. My word, they were tosh when I came to read them later ! I have to-day received a letter of eight sheets from a young man evidently in the same stage.

He talks of—well, it is hard to know what he is talking about when he says : “ People like myself suffered because they saw in the spirit of Scouting a religion and a poetry more dynamic by far than myriads of golden sermons, promises and laws, and because they were willing to follow over the thorny valleys of convention and through the buffeting seas of intolerance and un-imagination that roll and seethe from shore to shore of ordinary mob-psychology.”

Fine !

It reminds me of Browning the great poet. When he was asked what exactly was the meaning intended in one of his earlier poems, he replied : “ When I wrote that poem I, at any rate, knew what it meant—and God knew.

“ Now—God only knows.”

I once heard a Salvation Army officer giving advice to a party of emigrants as they were starting for one of the Oversea Dominions. He said : “ Before you have been there many weeks you will be showing the people there how much better they might do their jobs ; and you will be writing home to tell your people that you never saw such a God-forsaken country and such a rotten lot of people.

“ My advice to you is, Write your letter, but do not post

it for six months or so. Then re-open it and see what nonsense you have written and be thankful that you did not send it."

I think the same advice might be useful to many a young man going out into the world, namely, to write his gush, but to keep it for a few years and then look it over again, and he will doubtless be glad to tear it up before anyone else can see it.

The safeguard is to get your learning first, before you let yourself go, so that you start on right ground, and so don't have to retract or tear up later on.

SELF-EDUCATION

SELF-EDUCATION A SAFEGUARD AGAINST CUCKOOISM.

I have tried in the above paragraphs to show you the dangers of the cuckoo rock, namely those of being led astray by the persuasive call of the cuckoo or of becoming a cuckoo yourself.

The next point is what to do to get past the rock in safety.

Education is one great safeguard. By education I don't mean improved scholarship but education of mind and soul. The one enables you to pass by the danger ; education of soul raises you far above it. If you expand your mind by giving yourself wider knowledge through travel and reading, through learning from the experiences of others, and from the study of nature, you will be safe against the call of the cuckoo ; and if you expand your soul by giving yourself higher ideals and by giving to others your sympathy through good will and helpfulness you can never be much of a cuckoo yourself, or a " highbrow " as it is called in America ; and you will find yourself a better and a happier man.

A prig is generally a prig because he thinks he knows everything when in reality he has often a great deal to learn. He tries to show himself off as more clever than other people while he presumes upon their ignorance. The philosopher Bacon said of old, " Nothing doth hurt in a State more than that CUNNING men should pass for WISE."

The older and wiser you become the less cunning you find yourself, and the more you want to learn. Begin, therefore, by taking in knowledge and experience ; later on will be time enough for giving it out.

When you leave school you have been trained to the general standard of the rest of the class—or herd. But after leaving school some men rise above the average of the rest, many go on among the herd, while some go down into the gutter.

Success or failure largely depends on your own efforts. Those fellows that use their school knowledge to educate themselves further are the ones to get on. That is where books and lectures come in to help you.

But, as Ralph Parlette has said, "If I were to give free tickets for a lecture to men in the street I might as well say 'Small-pox' as 'Lecture.' They have no place to put a Lecture. They don't want to think; they just want to follow their noses through life—and somebody generally leads the nose. The menace of a democracy is the man who will not think for himself and learn to think straight as he learns to walk straight.

"The world can be made safe for democracy, but democracy will never be safe for the world until the mental loafer is saved from himself."

There are mental loafers and wasters just as much as there are physical wasters, fellows who let themselves be guided by cheap newspapers, persuasive orators, and rotten literature and cinemas.

BOOKS AND BOOK-READING.

I have said above that travel and reading and Nature study are all part of self-education. Take reading. With your books around you you have a magic power; when others are fussing and losing their hair over political hopes and disappointments you are sitting content with what you have got. You can at any moment remove yourself and travel through far-off lands, dip into the history of other times, command the wonders of science, amuse yourself with good stories, and see beauty in thought through poetry.

Books are the best friends a man can have. You choose those that you like; you can rely on them at all times; they can help you in your work, in your leisure, and in your sorrow. You have them always around you at your beck and call in your home.

They are not nowadays very expensive if you only buy

one now and then to make up your collection. At any rate, the nearest public library will bring almost any book to your hand without expense. But books of your very own are the better friends and companions. Don't buy a book *because* it is cheap, for very cheap books are often equally nasty. Go for the best while you are about it.

If you have already read books, then you know what sorts you like. If you have never done much reading, let me advise you to begin at once—you will never regret it—and begin with something that interests you.

If you are out to instruct yourself, an encyclopædia in a public library is, as Professor Adams says, a good "first aid" to a subject, and generally gives the names of other books in that particular line. If you are out to read for amusement you can't go wrong in starting with a book like Robert Louis Stevenson's *Treasure Island*, or *Kidnapped*; and Shakespeare's plays are mighty good reading, whether for amusement or instruction. *The Forest*, by Stewart White, and *The Friendly Road* by Grayson, are delightful books in the direction of Rovering.

But when you read, read, don't skim; and if you study while you read, that is, if you worry out the meaning carefully in your own mind, it will stick by you all the longer and be the more useful to you in the end.

If you read with the intention of remembering you will remember.

This is Bacon's advice: "Reade not to contradict and compute: neither to Beleewe and take for granted: nor to finde Talk and Discourse: but to weigh and Consider. Some Bookes are to be tasted, Others to be Swallowed, and Some Few are to be Chewed and Digested. . . ."

"Readinge maketh a Full Man, Conference a Ready Man, and Writing an Exact Man. . . ."

"If a Man Reade little he hath need to have much Cunning so that he may seeme to know that whiche he doth not."

I have found it a jolly useful practice to note down in my diary any good thing that I have read or heard that day. Some fellows do it now on a card-index system, so that you can look up any subject under its alphabetical letter.

At any rate it is as well, after storing as much as you can of good stuff into your mind, to back it up with a written reminder of this sort.

But reading without outlook is no good. You must balance literary knowledge by knowledge of the world, of men, and things. Travel is a valuable step to this, but an observant, sympathetic man can get as much knowledge of his fellow-men in a walk of a mile or so as a stodgy one would get in a thousand miles.

TRAVEL AS EDUCATION.

I was walking through Southampton Docks one day when I struck the scent of spices and coffee coming from one of the warehouses on the quay. I felt impelled to go inside to ask their origin. When the man told me that they were the cargoes of ships sailing from Monte Video, Rio Janeiro, and La Plata my mind went back at once to the great book of my youth, the *Voyage of the "Adventure" and "Beagle."*

The temptation was too great! I then and there took a ticket for South America, though I had to borrow to do it. A few weeks later I was on my way. The voyage, the variety of characters on board, the new countries visited, the insight into new peoples and a new atmosphere, coupled with the sight of the vast pampas and the glorious Andes, opened out my mind and ideas. They did for me in a few weeks what years of study could never have accomplished.

Even if one can't manage to get abroad there is ever so much to see in your own country, and so many sides of life to be investigated when travelling with a push-bike, or even on one's own flat feet. In one's own town or neighbourhood, if one cannot go further afield, there are bound to be relics of ancient history of the place and people whose experiences are worth hearing. But travel of this kind, if carried out with the view to *observing* and finding out all you can of men and things, all comes as an invaluable step in your course of self-education. David Grayson, in his delightful book, *The Friendly Road*, tells how he left his farm and went for a tramping tour, without money and without definite plans, merely to drink in the beauties of the countryside and to meet with other people and to find the best in them. And so it came about that he found great courage in the village minister, human sympathy and simplicity in a millionaire, an awakened spirit in a hopeless farmer, and large outlook in a socialist orator.

I mention this book, not merely on account of its charm

and interest, but because this venture of the author gives exactly an example of what could be done by anyone desiring to educate himself through the open-road method. It is a method that is available to everyone, just as the book, at 3s. 6*d.*, is not beyond the means of most.

I have seen a further system of self-education carried out by students of universities in Canada and America. These lads are not blessed with overmuch money with which to pay their college fees. They did not on that account give up all hope of a 'Varsity training, but during the summer vacation they took service as stewards on board the river steamers, and thus earned enough money to pay their term expenses and at the same time extended their knowledge of men and things and spent their leisure time at work instead of loafing.

SELF-EXPRESSION.

Also if a fellow feels moved to express his thoughts and ideas, whether in poetry or writing, or speaking, or in painting or sculpture, most certainly let him do it. I would only suggest don't be tempted like so many to rush to extreme views before you have seen something of the world. Good self-expression is a virtue, and a virtue of the highest kind.

Every man has what is known as a "gift" of some sort. One of you may be an artist or an actor by instinct, though he may be working in a grocer's shop or as a carpenter; another may be a clever conjurer or a singer, although possibly earning his money as a waiter or a stoker; there are various "gifts" hidden away in almost every man.

Why is it called a "gift"?

Well, because it is a natural quality—a gift from God. That being so the possessor of it ought to make use of it—for God. He can do this by giving out again of that gift to others; let his singing or his acting be employed to cheer others who are downhearted, let his conjuring amuse them, or his pictures open their eyes to what is beautiful. Let him give his talents for the benefit of others rather than of himself, and he will be doing God's work, he will be no humbug, and he will be finding what true happiness means.

PREMPEH'S HINT TO YOUNG TALKERS.

I had the honour, or perhaps better call it the fun, of rounding up King Prempeh, the ruler of the Ashantis on the

West Coast of Africa, when he had exceeded the limit in the direction of human sacrifice—but that is another story.

I merely refer to him here as supplying a hint. Being a savage monarch, he was accustomed to saying what he jolly well thought on the spur of the moment, without any consideration of what might result.

If he got angry he lost his head and let himself go ; and the man with whom he was angry usually lost his head also—in another fashion.

When he was captured he realised that in discussion with the British authorities he might have to adopt a different line of talk. If he spoke without first weighing the effect of his words he might say things that he would afterwards be sorry for.

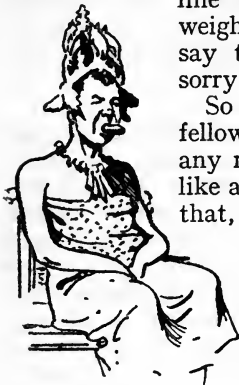

HOW PREMPEH PREVENTED HIS TONGUE FROM RUNNING AWAY FROM HIM.

So he did what lots of impetuous young fellows might well imitate in discussion—at any rate figuratively. He carried a nut, like a big Brazil nut, between his teeth so that, if at any time he felt impelled to blurt out something untactful, he had to pause while he took the nut out of his mouth and so gained time for reflection.

A further hint that I got from this same King Prempeh was—when you have got the better of your opponent don't think that you have entirely done with him or have got him down and out, he may have yet another weapon up his sleeve.

I have a memento of the lesson in the shape of a flint lock of a native gun on my table at this moment, and this is how I learned my lesson.

The King contemplated making a bolt for the jungle during the night when he saw we were likely to arrest him. This I had expected of him, so I had an ambush of my men laid beside the path that he would probably follow.

I hid myself in the ditch a few yards ahead of my men so that I could see, outlined against the stars, anyone who came along, and could give the signal to my men whether to arrest or let him go by.

After a time one of the King's scouts came tiptoeing along very cautiously and quietly, and when he had arrived opposite to me he stopped and peered hard into the darkness ahead.

Something had made him suspicious, and I feared lest he should turn back and give warning of our presence. So being within a yard or so of him with his back towards me I rose up and suddenly grappled with him.

We had a fine old scurry. He got his gun round pointing into my tummy, and I caught hold of the lock. The gun must have been a very cheap one; the lock came off in my hand. We then embraced each other, not exactly in affection; and as we wrestled and rolled over one another my orderly chipped in like a third dog in a dog fight and just grasped my opponent's wrist in time to prevent him from pushing his knife into my liver.

You see he had another argument besides his gun with which to press his case.

I once knew a millionaire who had been a clown in a circus, but even when he had made his pile he continued to work in his shirt-sleeves in his factory. His factory was a wine-making one in one of the South American States, and I saw him working there. He explained the reason for his success was that he insisted on manufacturing the pure juice of the grape where the people had previously had chemical decoctions foisted upon them. He had learnt his lesson in the circus ring. He had found there that second-hand jokes culled from the comic columns of the papers or from jest books did not go down with the public; they wanted genuine original humour. And so it was with wine. Directly he produced pure unadulterated stuff he was overwhelmed with orders and quickly made his pile.

In public schools and 'Varsities and young men's clubs there are debating societies for training young politicians. But the danger about them is that they are rather liable to train prigs because the members are only imitation politicians, speaking what they have read or heard from other men's lips and not the pure outcome of their own understanding.

The imitation article takes no one in. Many of the famous Statesmen only began their political careers when they were middle-aged, that is when they had seen some-

thing of the world and of life. Many notorious politicians began theirs as boys in debating clubs and never got beyond being prigs. (Note.—There's a difference between being famous and notorious.)

But if when you have got experience you find yourself in a position to help the community by taking a part in public affairs, you should do all you can to train yourself for it. As I have said before, rather as a Statesman than as a politician, for the good of the community rather than of a section of it.

One step is to be able to grasp a point readily and its different facets, another is to be able to express yourself well in words. For young fellows who fancy themselves in debate the late Lord Bryce gave a sound word of advice when he said, looking back on his past life, "I can see my teacher in the class-room at school. He stands before me now, addressing his class of boys, and what he tells me is this—'Once you have got a good argument for a course of action, one good and sufficient argument, never look for a second; a second would only weaken the first.'"

For learning how to express yourself well in public there is nothing like taking a part in theatricals; it gives you at once the best practical training in elocution, and in getting magnetic touch with your audience. It teaches you how to express yourself by voice and gesture and it takes away your self-consciousness. Joseph Chamberlain once told me that he owed much of his early success to his practice as an amateur actor.

LISTENING.

Now after all this talk about talking, remember always there is great value and great art in keeping silent. Often you may feel inclined to butt in with your ideas in a discussion, but it is generally best to keep quiet and let the others do the chin-wagging. You learn in this way. Talking gives away many a man to the silent watcher. On every committee there are the men who do all the talking and who get little attention.

It is the silent man, the one who only speaks when he has got something really important to say, is the one they listen to.

He is the Sphinx to them.

"It is the silent men who *do* things."

SERVICE.

As you train yourself in character and efficiency, let your aim all the time be not merely the attainment of position or prospects for yourself, but of the power to do good to other people, for the community. Once you have put yourself in a position to do service for others you have stepped on to the higher rung of the ladder that leads to real success—that is happiness.

Service includes not merely personal little good turns of courtesy and kindness to other people ; these are right and good ; they are what every Boy Scout does every day ; but I mean something higher and bigger than this—service as a citizen of your country.

It does not mean generally that you want to push yourself as a leader in civic affairs or to force your particular political ideas on other people, but to be a good reliable chap and a helpful citizen in the State, a brick in the wall. For that you have to look wide and see what is best for the State as a whole and not merely to be looking for what is best for one particular part of it.

As Rudyard Kipling shows in *The Glory of the Garden* (see page 170), there is a place for every man in serving the common weal—the good of the community.

When you see where you can, according to your particular gifts, be helpful, chip in and help, just as you would when backing up your side in a game of football. In fact a serviceable citizen is very much like a good football player ; he makes himself in the first place efficient as an individual so that he can then play effectively in his place in the team.



PLAY-ACTING GIVES THE
BEST POSSIBLE TRAINING
FOR PUBLIC SPEAKING.

FOOTBALLER.

CITIZEN.

Individual Qualities	{ Keeness, fair play and good temper. Fitness in wind and limb. Skill with the ball.	{ Character and Intelli- gence. Health and Strength. Handcraft and Skill.
Collective Qualities	{ Play for the side and not for self.	{ Service for the com- munity.

If fellows didn't play in their places, if one thought it more amusing to be always offside and another preferred to handle the ball in spite of the rules and another went in for punching every opponent in the stomach, it would no longer be a game of football, but anarchy and the break up of the match.

That is what is going on to-day in some countries owing to the prevalence of extremists and hooligans in the place of good citizens.

CIVIC SERVICE.

The crowning good that you can do for the community as a good citizen is that of taking a share in civic service. By that I mean taking a hand in municipal and local government affairs. But for this it is well to prepare yourself if you want to be successful, just as you would prepare yourself for running a race or for passing a qualifying examination. Too many fellows go in for public work purely because they have the gift of the gab or some half-baked notion of how government should be run, though they have no experience or real knowledge of the matter. A solid grounding is needed in the knowledge of Local Government and its aims, methods and responsibilities.

A useful little book on *Citizenship* is just out, by Edward J. S. Lay (Macmillan, 2s.).

It deals with many of the questions that I touch upon in this book and others besides, all in a simple, clear and popular way with lots of illustrations. A most useful book for a fellow beginning to study citizenship, that is such questions as Wages, Labour, Thrift, Education, Health, Government, League of Nations, and so on. The Labour Party has been criticised as being "unfit to govern" a country. If this is true, why is it?

It could only be so because men have not been educated widely enough in civic or foreign affairs ; that its members have only got so far as being party politicians and not as yet international statesmen. Politicians have to be hum-bugs because they have to pretend to knowledge which they don't possess on almost every subject under the sun, and also they have to see any question only from the side of their own particular party.

When you come to the age of eighteen you have, as a citizen, the privilege of voting for the member to represent your district in Parliament. You ought to make yourself efficient to be able to take this responsibility and to play in your place in the great game of Citizenship. The first steps to making yourself efficient have already been suggested to you as those for avoiding the different "rocks," namely :

Character and Intelligence.

Handcraft and Skill.

Manly Health of Mind and Body.

Now comes the fourth thing, viz., Service, that is, playing the game as a citizen.

In educating yourself for this a great point is to learn the history of your own town and country, both past and present. Much can be learned by reading, but more by travelling and visiting historical points. Then, in order to be able to understand or give a hand in local public affairs you will need to learn all you can about the way in which Local Government is carried out. Study for instance :

Parish Councils—how appointed and what are their duties in Church and other matters.

Urban and Rural District Councils and how they deal with parishes under their direction.

Borough and City Councils—how their officers are elected, such as Mayor, Aldermen and Councillors, and what are their duties in administering poor-relief, health regulations, elementary schools, liquor control, police and fire services, etc.

County Councils—its officers, departments, and its duties over the Borough Councils ; how rates are collected and expended, from duties, licences and taxation upon education, lighting, roads and bridges, hospitals, housing, libraries, markets, parks, waterworks, sewage, etc.

PARLIAMENT.

Apart from the Local Government of Counties each Parliamentary district sends a representative chosen by the people to speak for them in the House of Commons. There are thus 707 representative Members of Parliament, and these men have the power of making the laws for governing the country. Thus every man over 18 and woman over 30 has a voice in the management of the country.

The House of Lords has over 600 members, who sit there by right of succession, but a fair proportion are men who have distinguished themselves above the average in business, or in national service, and are appointed by the King in consultation with the Government.

The duty of the Lords is mainly to discuss any measure proposed by the House of Commons. They have no real power to "down" a question, though they may send it back to the House of Commons with suggestions for amendment. The question thus gets thoroughly ventilated and discussed before it becomes law.

The House of Lords pass it on to the King for his consent. This is a formality, since the King has practically no power to refuse his assent to what the House of Commons has decided upon.

The different sections of political feeling thus come to be represented in Parliament under such names as Liberals, Conservatives, Labour, and so on. The party which is strongest in votes carries on the government and is criticised in all it does by the weaker parties not in power. This is a good thing so long as it doesn't run to excess and break up national unity. A country divided against itself cannot stand.

The Cabinet consists of Ministers under the leadership of the Prime Minister and is the Executive that carries on the administration of the country under the general direction of Parliament. Each Minister has a department of the Administration under his responsible charge, such as Navy, Army, Education, Home Office, Foreign Office, Colonial Office, Ministry of Health, etc. The whole system has gradually grown up from early days, when kings were autocratic rulers, till 1215, when, under the Magna Carta, the power came more into the hands of the people, and was increased by the Habeas Corpus Act, 1679, the Act of Settlement, 1701, and the Parliament Act, 1911.

So Parliament has grown up by steady evolution on good foundations, and as such has earned the title of the "Mother of Parliaments." When you travel in other countries, whether republics or monarchies or embryo States, you will find that they regard the Mother of Parliaments as the nearest approach to the ideal of Government of the People by the People, that is, of pure democratic rule.

A NEW REPUBLIC.

Not long ago I was in a newly established republic talking to the Chief Executioner. He was lamenting the fact that executions were now done away with. I asked him whether they now gave long imprisonment instead of execution. "Oh, no," he replied, "we are a democratic republic now; prisons are done away with."

"Then is there no crime?"

"Yes, there's plenty of that still."

"Then what do they do with the criminals?"

"The soldiers take them outside the gates and shoot them—till they are dead."

(This evidently was not his idea of an execution, since he had been accustomed to do it with a chopper.)

"But what about a small crime? Suppose a man stole a pocket-handkerchief, what would they do with him?"

"Take him outside and shoot him till he was dead."

(I found later that there was a meaning underlying this "till he was dead," because, the soldiers being trained democratically, i.e. on their own initiative, only fired from the hip and not from the shoulder, so it often took them a long time to hit the objective.)

"How awful! And what about women who do wrong? Surely the soldiers don't shoot them till they are dead?"

"Oh, no, no. We shouldn't do that."

"What is done, then, to women criminals?"

"Ah! they are sent to me, and I cut them up into a hundred pieces; but we have no executions for men."

This was where a young nation was endeavouring to run before it had learnt how to walk. There are two or three just now anxious to get away from nurse's apron-strings and to do much the same.

I was at one time staying in a republic where the head

of the government, when sitting quietly at home after his day's work, was visited by the Commander-in-Chief, a close friend of his.

The general came very privately and unostentatiously to see him. He had come, he said, to say good-bye.

"Oh, are you going away?"

"Oh, no. I am going to stay here. It is you who had better go, because to-morrow there is to be a revolution, and I am to be elected in your place—as soon as you have been assassinated."

So, to save trouble, the President went.

That is the way in which the government changed hands in those parts.

TWO SIDES TO THE EMPIRE QUESTION.

One Sunday I was strolling in the Park in Sydney, New South Wales, when I was attracted to listen in turn to two different tub-thumping cuckoos. And here I got two sides of the question on the subject of the British Empire, which may be of interest as an example in that line. But for a fellow who is educating himself to realise that there are two sides to every question I would suggest studying the reports of the doings in the House of Commons and the daily press. And you will here see not merely two, but very often three or even four different views of the same point, and each of them apparently equally well founded. It is good practice, then, to worry them out for yourself and see which is really going to benefit the majority of the nation in the long run, and make up your own mind accordingly. Here are the views which I overheard on the Imperial question. They may not be conclusive, but at any rate they are interesting.

The British Empire is a bumptious institution.

It has been founded on land-grabbing raids by adventurers since early times.

The only reason why we have not grasped the richest part of the world, South America, is that though we made a most dishonest attempt to do so, we were

If it is any excuse, land-grabbing was not confined to Britons. Rome, Carthage, Portugal, Spain, Holland, etc., have all in their turn been equally acquisitive. It was the fashion in old days. If force, or even brutality, were employed, they were generally counter-balanced by benefits in the

chucked out by the stout colonists, who preferred to govern themselves.

That too was the case in North America.

Everywhere we wrested land from the native inhabitants by force and planted ourselves over them, and developed our wealth and trade at their expense.

We have the jingo spirit of aggressive commercialism, which expressed itself a few years ago in the very arrogant popular song :

“ We don't want to fight,
 But, by Jingo! if we do
 We've got the ships, we've got
 the men,
 We've got the money too.”

This is the militarist spirit which is exploited by the capitalist class to keep their pot a-boiling by opening up new markets for themselves.

end to the countries and people conquered.

In the case of British dependencies we have to some extent atoned, and our colonial standing has lasted because the British rule has been generally humane, and has brought about the greater peace and prosperity for the natives as well as for the colonists.

The suppression of the slave trade by Britain cost the country vast sums of money, with no material return, and was accomplished entirely on the score of humanity.

Of late years the suppression of human sacrifice and slavery all over Central Africa has been carried out side by side with the introduction of peaceful industry. No one who has seen it can deny the wonderful benefit done to the people.

In India, as in Africa, we have insisted on peace between warring tribes and given protection for the weaker, and have introduced education and commerce.

Under British protection vast countries have been developed, wildernesses have been turned into fruitful lands, and new nations have arisen to become great, like those of Australia, New Zealand, South Africa,

Canada, etc., and as they become self-sufficing they are given freedom and self-government.

THE FRYING-PAN IS BETTER THAN THE FIRE.

When I was promoted to command a squadron in my regiment, it happened to be my own squadron that I was posted to instead of being transferred to another.

The men did an unauthorised thing—they had a meeting to celebrate the occasion, and the sergeant-major, in addressing me in their name, said, “We all feel it is better to have a devil we know, rather than an angel we don’t know.” I’m not quite sure which way this remark might be taken to mean. Anyhow, it applies equally well to fancy forms of government, which young hot-heads sometimes clamour for.

But they find that the solid lump of Britons prefer the devil of a Government that they know to an angel-vision that they don’t know.

WHAT THE KING IS TO THE EMPIRE.

General Smuts was one of the Boer generals who fought against us, with the greatest persistence, for his own nation in the Boer War. This is what, as a man who sees both sides, he has since said to the British people about the British Empire:

“You talk about an Imperial mission. It seems to me that this British Empire has only one mission, and that is a mission for liberty and freedom and self-development.

“Yours is the only system that has ever worked, in history, where a large number of diverse nations have been living in unity. Talk about a League of Nations. You are the only real League of Nations that ever existed. . . .

“All Empires of the past have been founded on the idea of assimilation, of trying to force the different nationalities into one mould to form one nation. Your whole idea and basis is entirely different. You do not want to standardise the nations of the British Empire, you want to develop them into greater individual nationhood. . . .

“This British Commonwealth of nations does not stand for assimilation or denationalisation, but it stands for a

fuller, a richer, and more various life among all the nations that compose it (under mutual protection and goodwill). . . .

“The question arises, how are you going to keep this Commonwealth together?”

“You have a potent factor in your hereditary kingship. The King is not merely King of England, but he represents every part of the whole Commonwealth of nations. If his place is to be taken by anybody else as President acceptable to the whole of that great republic, then that somebody will have to be elected by a process which, I think, will pass the wit of man to devise!”

“We have a kingship here which is really not very different from a hereditary republic.”

So, though some people object that monarchy is only retained from sentimental reasons, there is also solid, good, democratic reason for keeping it up.

INTERNATIONAL.

In developing our patriotism we must not forget the danger of getting it perverted into a narrow nationalism. It is right to be proud of your country, but not to gas about it to the disparagement of others, or to boost it on to a higher pedestal than it actually deserves. Your best patriotism is to help to raise your country's efficiency so that it can take its place adequately in the team of nations of the world. The Great War has demonstrated a thing to which people were formerly blind, and that is that all countries are now very dependent on each other in the details of their trade and commerce, that only by mutual good will and co-operation can the world be prosperous and happy.

One country may have the raw materials, but another has the means of manufacturing them, while a third can do the finishing process, and a fourth can best utilise the articles when finished. The cotton grown in India is manufactured in Manchester, finished in Belgium, and used in East Africa. This kind of thing goes on in every direction, including the food supply from a producing country, through a supplying country, to a devouring country. Britain produces more coal and iron than it needs, but not sufficient beef and corn, and so it exchanges surpluses with other countries.

Interlocked as they were in this way, a war between two great countries immediately dragged in others, until the greater part of Europe was scrapping in a dogfight. Millions of men were killed, nations ruined, and the whole world put in a state of unrest for years—over what? The assassination of an Austrian by a Serbian. After this ghastly experience, let us hope that there will be greater security in the future, and that better statesmen will be at the head of affairs in all countries.

The League of Nations and the International Court of Law have now been formed to prevent such a thing happening again. But Leagues and Courts and Regulations are of little use if they haven't got the heart and support of the people behind them. You can muzzle and chain up dogs, but there will be no real certainty of peace until they are good pals and contented. It isn't the muzzles that matter so much as the tempers of the dogs.

So the duty of the citizens in each State is to get more into mutual touch and sympathy with those of other States, through interest in their history and doings, and through interchange of visits, etc. Once mutual good will and personal friendship come to be established throughout the citizenship of the various countries, it should be the best guarantee of all against war in the future.

So you see here lies a big opening before you as a citizen, no matter how humble may be your standing.

At eighteen you have the right to call yourself a British citizen. It is up to you to make yourself worthy of the right, and to prepare yourself beforehand to exercise and use it. It gives you the opportunity of service for the community, which, as I said before, supplies the main step to happiness.

To prepare yourself means gaining knowledge and experience, and the practice, to begin with, of small jobs for the good of the public. (*See final chapter.*)

If you then find that you have a gift that way, go on and take your part in civic affairs.

BE WIDE-MINDED.

When I am Prime Minister, I will make it obligatory that before a man can be elected to Parliament he should

have travelled round the world at least once ; and also that his education should have taught him to look at both sides of a question in every case ; and also that he should have learnt leadership, which means as a first step complete mastery of himself, and sinking to-day's minor party or class ideas for the nobler outlook, the greater good of the whole community in the coming years.

So in preparing yourself keep the right object in your mind's visage to start with. If you think of taking up public life with a view to making a great name for yourself or to getting pay and position by it, then I'll have nothing more to do with you !

This is out of my line. You will be getting among a lot of others who are pushing themselves in the same direction, full of jealousy, hatred, and malice towards each other. I want you to go on towards Big Happiness—not towards Big Potiness.

No—if you go into public life with the humble desire to serve the community, to help the whole show along for the good of the greater number, it is a very different thing. Your reward will not lie in seeing yourself go up, but in seeing those around you go up on to a better standard of living as a result of your work. And this will give you more satisfaction than any decorations or awards that can be heaped upon you.

To fit yourself for the team work that is involved in service as a citizen, whether as worker or leader, you will do well to educate yourself, as I have suggested above, by developing your character and opening your mind, especially in regarding both sides of a question and upholding justice and fair play ; and secondly, by practising good will towards your opponents as well as your neighbours and trying to see their point of view, since they are your fellow men.

If the majority of our men and women would really practise these two points, as well as personal thrift that would put them in position to have time to devote to such work, it would largely help to bring about that co-operation and good will in place of friction that is so necessary for the prosperity of the whole community, and on the larger scale, for the peace of the world.

I hope after reading this dissertation on the cuckoo

rock dangers and how they should be avoided, you will not say that another specimen of a cuckoo is the retired general, whose young days were very long ago, and who now sets himself up as a law-giver on what a young fellow should do and what he should not do.

Well, you may see it in that light ; but as a matter of fact the old fellow has this one point of difference from other cuckoos—he has no personal aim of his own, he has no

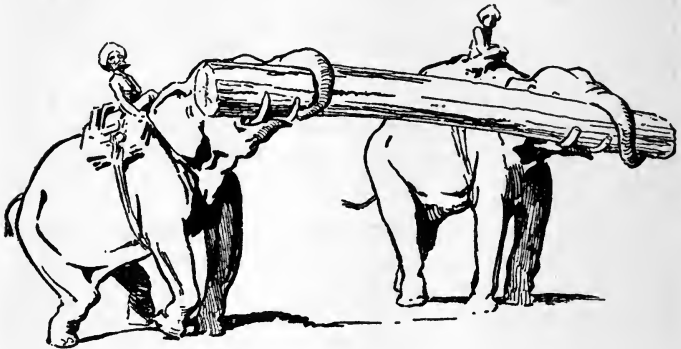

A LESSON FROM BURMAH.

Only mutual good will and co-operation will enable you to tackle the big log successfully

irons in the fire or fish to fry, but he has a great love for his fellow men, he has a very good memory of what he went through as a youngster without a father alive to advise him, and he has a very close sympathy with young men coming out into life. All he wants to do is to offer them any hints from his own experiences that may be of use to them in preventing them from being lured away on to treacherous shoals, and in helping them to live a happier and a fuller life.

FOOD FOR THOUGHT

SOME ANTI-CRANK MAXIMS.

To take yourself too seriously as a young man is the first step to becoming a Prig.

A sense of humour will pull you through this danger as well as through many a bad time.

Let your ambition be not to see how much you can get out of work, but how much you can put into it.

Ambition to do the right is the only ambition that counts.

Cheerful alacrity in doing a thing that is put up to you is the best of recommendations.

A fellow who boosts himself is generally the fellow who needs boosting.

Remember you are a brick in the wall, or a player whose job is to play in his place in the team.

A balanced citizen is worth half a dozen cranks.

Lots of fellows demand their rights before they have ever earned them.

Readiness to serve rather than to dictate shows the best socialist.

Joy cometh to him who serveth, through his brother man, his Father God.

Get out of your own narrow rut if you would widen your mind.

We never fail when we try to do our duty—we always fail when we neglect to do it.

Don't be content with the what—but get to know the why and the how.

Courtesy and Politeness pays not so much for the pleasure it gives to him who receiveth it as for the happiness it gives to him that rendereth it.

A nation gets the Government it deserves.

Young man! Nature gave us one tongue, but two ears, so that we may hear just twice as much as we speak.

It is a great cleverness to know how to conceal our cleverness (*La Rochefoucauld*).

Notoriety is not the same thing as Fame.

Ships, though they be so great, are turned about with a very small helm whithersoever the governor listeth. Even so the tongue is a little member and boasteth great things (*Epistle of St. James iii.*).

There are two kinds of people who never change their opinion, and those are the foolish—and the dead (*J. Russell Lowell*).

THE GLORY OF THE GARDEN

Our England is a garden that is full of stately views,
Of borders, beds, and shrubberies, and lawns and avenues,
With statues on the terraces and peacocks strutting by ;
But the Glory of the Garden lies in more than meets the
eye.

For where the old thick laurels grow, along the thin red
wall,
You'll find the tool and potting-sheds which are the heart
of all,
The cold-frames and the hot-houses, the dung-pits and the
tanks,
The rollers, carts, and drain-pipes, with the barrows and
the planks.

There you'll see the gardeners, the men and 'prentice boys
Told off to do as they are bid, and do it without noise ;
For, except when seeds are planted and we shout to scare
the birds,
The Glory of the Garden it abideth not in words.

And some can pot begonias, and some can bud a rose,
And some are hardly fit to trust with anything that grows ;
But they can roll and trim the lawns and sift the sand and
loam,
For the Glory of the Garden occupieth all who come.

Our England is a garden, and such gardens are not made
By singing, " Oh, how beautiful ! " and sitting in the
shade,

*While better men than we go out and start their working lives
At grubbing weeds from gravel paths with broken dinner-
knives.*

There's not a pair of legs so thin, there's not a head so thick,
There's not a hand so weak and white, nor yet a heart so sick,
But it can find some needful job that's crying to be done,
For the glory of the garden glorifieth every one.

Then seek your job with thankfulness, and work till further orders,
 If it's only setting strawberries or killing slugs on borders ;
And when your back stops aching and your hands begin to harden,
 You will find yourself a partner in the Glory of the Garden.

Oh, Adam was a gardener, and God who made him sees
 That half a proper gardener's work is done upon his knees,
 So when your work is finished, you can wash your hands
 and pray
 For the Glory of the Garden that it may not pass away !
And the Glory of the Garden it shall never pass away !
 (Rudyard Kipling).

(By special permission.)

SOME USEFUL BOOKS TO READ

The Republic. By Plato: The Everyman Library.
 (Dent.) 2s. 6d.

A Short History of the English People. By Green.

Hamlet. By Shakespeare. (With explanatory notes.)
 (Oxford Press.)

Municipal Work. By Rev. Canon Jephson. (Mowbray.)

English Composition. By Nichol. (Macmillan.)

Whitakers' Almanack. 12 Warwick Lane. 6s.

Wealth and Work. By G. W. Gough. 2s. 6d. (G. Philip & Son.)

The Gateway of Commerce. By J. Fairgrave and E. Young. 2s. 6d. (G. Philip & Son.)

England in her Days of Peace. By E. Doorley. 2s. 6d.
 (G. Philip & Son.)

ROCK NUMBER FIVE
IRRELIGION

IRRELIGION

THE dark side of this rock is the danger of atheism and irreligion.

Its bright side is its realisation of God and Service to Brother Men. To this the study of Nature is a direct help.

IRRELIGION.

Atheism is being pressed on young men.

Irreligion is prevalent.

Religion is essential to Happiness.

NATURE LORE.

Safeguards against atheism.

God's work in Nature gives the lie to atheists.

Nature knowledge is a step to realising God.

Humility and Reverence are antidotes to Cant.

These can be gained by commune with Nature :

On the Seas.

In the Forest.

Among the Mountains.

THE HUMAN BEING.

It is not necessary to wander far afield in order to get in touch with Nature.

The Human Frame and its Wonders.

Microscopic Nature.

The Animal World.

The Mind.

THE DIVINE.

The Soul

These all lead to the realisation that God is Love.

GUIDING THOUGHTS FROM VARIOUS SOURCES.

BOOKS THAT MAY BE HELPFUL.

IRRELIGION

ATHEISM.

THERE are a good many men who have no religion, who don't believe in God ; they are known as atheists.

In Great Britain alone there are nine societies of these. They are welcome to have their own opinions in this line, but when they try, as they are always doing, to force these ideas on other people, well, then they are like the Germans trying to force their "kultur" on the world, they become enemies of the worst sort.

Some of these societies directly attack the religious belief of others in a very offensive way, but I believe that by doing so they are, as a matter of fact, doing more good than harm to the religions concerned, since it makes people buck up and sink their own differences in order to combine together to repel these attacks.

Here is a specimen of the gratuitous kind of insult which they offer to the Christian religion. It is one among others which have appeared in the journal of the Rationalist Press Association.

"The chief religious ceremony of Christians, known as the Mass, or Communion, which consists of eating the flesh and drinking the blood of this Jew called Jesus, is a disgust-



THE Highbrow.

ing and degrading superstition, and suggestive of a cannibal feast, which in all probability was its origin.

“Christianity has lowered and perverted the standard of truth in every direction. It is not too much to say that it has debauched the world with falsehood.”

This to every Christian who believed in his religion is an indecent insult. At the same time it is a direct call to him to action. But I am not going into that here.

Apart from the anti-religious there are lots of fellows who, though not violently opposed to religion, are not particularly interested in it. In some cases they have never been shown what it is; in others it has not proved very attractive or inspiring and they have let it slide. Mark Twain said he was averse to discussing religion since it dealt with Heaven and Hell and he had friends in both places.

On the other hand, I have known in the backwoods more than one strongly religious man who as a boy had had no home teaching in religion, but who has realised God for himself through what he has seen of His works and His wonders in the world.

Such a man has come to see that he himself was a part and a member of that wonderful creation, but equipped in higher degree than other living animals by having a mind, the power to appreciate beauty, and the sense of good will towards others, which meant also that he had something of the spirit of God inside him.

God the Creator is recognised by most denominations of religion, but their differences arise over the actual character of the connection of the Creator with the human soul.

In the Christian belief it was held that Jesus Christ came to live among men to interpret and bring home to them the fact that God is Love, and that the sacrifices of offerings to God as practised in the old superstitious religions were not what were wanted so much as the sacrifice of self, and Service for God.

RELIGION IS ESSENTIAL TO HAPPINESS

If you are really out to make your way to success—i.e. happiness—you must not only avoid being sucked in by irreligious humbugs, but you must have a religious basis to your life.

This is not a mere matter of going to church, of knowing Bible history, or understanding theology. Many men are sincerely religious almost without knowing it and without having studied it. Religion very briefly stated means :

Firstly : recognising who and what is God.

Secondly : making the best of the life that He has given one and doing what He wants of us. This is mainly doing something for other people.

That should be your belief, not as a matter of thought for Sundays only, but as one to live up to in every hour and every phase of your daily life.

As steps towards gaining these two points and avoiding atheism, there are two things I would recommend you to do.

One is to read that wonderful old book, the Bible, which, in addition to its Divine Revelation, you will find a wonderfully interesting story-book of history and poetry as well as morality.

The other is to read that other wonderful old book, the Book of Nature, and to see and study all you can of the wonders and beauties that she has provided for your enjoyment. And then turn your mind to how you can best serve God while you still have the life that He has lent you.

THE BOOK OF NATURE.

What I am saying here is for those who have no particular religion or who are in danger of being sucked into this particular Rock of atheism.

The atheists say that they are out against the Christian and other forms of religion because these are superstitions rather than guiding principles of life. They maintain that a religion that has to be learnt from books written by men cannot be a true one. But they don't seem to see that besides printed books, and apart from Revelation, God has given us as one step the great Book of Nature to read ; and they cannot say that there is untruth there—the facts stand before them.

Shakespeare speaks of " Sermons in stones, Tongues in trees, Books in the babbling brooks, and Good in everything." Bacon wrote, " The study of the Book of Nature is the true key to that of Revelation."

The Koran says—" Seest thou not that all in the heavens and all on the earth serveth God ; the sun, the

moon, the stars, and the mountains and the trees and the beasts and many men ? ”

I hope I shall not be misunderstood. I do not suggest Nature Study as a form of worship or as a substitute for religion, but I advocate the understanding of Nature as a step, in certain cases, towards gaining religion.

This way is one that may appeal where other methods have failed, especially to those who are inclined to be atheists or those who have no religious ideals in particular, or who have had them and have lapsed from them. It may help them, by a new path, to find their Church again.

The following words by David Grayson describe what I fancy must be the experience of a very large number of men in the present day.

“ I have been a botanist for fifty-four years. When I was a boy I believed implicitly in God. I prayed to Him, having a vision of Him—a person—before my eyes.

“ As I grew older I concluded that there was no God. I dismissed Him from the universe. I believed only in what I could see, or hear, or feel.

“ I talked about Nature and reality.

“ And now—it seems to me—there is nothing but God.”

NATURE KNOWLEDGE A STEP TOWARDS REALISING GOD.

The Bishop of Winchester held an enquiry during the war among a number of Chaplains at the front, which in the end showed that a very large proportion of our men had little grasp or practice of religion.

Then I read lately that in some cases Faith has been in danger of becoming superstition, and for remedy it was suggested that “ something tangible is needed by the child for building Faith, otherwise he imbibes superstition. This has been largely the result of trying to teach religion on an imaginative basis.” On the other hand, I know that among our young men of to-day there is an earnest desire for religion—a religion that they can grasp and act up to.

During the war I had hundreds of young soldiers anxious to sign on to carry out the Scouts’ Promise and Law (*see* page 221) as something tangible in that direction.

Only yesterday I was told of a group of young working men who have become “ Rovers ” (*see* page 210). There

were some thirty of them, and they asked their officer to hold a Sunday meeting to teach them something of religion. So for such fellows I hope that my suggestions may be helpful.

The spirit is there right enough, but the form is needed when once they have come to realise something of the Divine nature and of His Service.

In the Indian epic, Mahabharata, there is the legend that an energetic priest was dissatisfied with the amount of faith in one of his flock. When charged with irreligion the man explained that he had tried hard but had found that religion was not in his line.

The priest thereupon seized him, and plunging his head under water held him there until he was nearly drowned.

By dint of sheer strength and struggling he managed at last to break loose. When he remonstrated against this violent treatment, the priest replied :

“ If you only strove in a world of difficulties to find God’s help half as hard as you have been struggling to get breath when in the water, you would soon find Him.”

HUMILITY AND REVERENCE.

One antidote to the cocksureness of atheism is Humility coupled with Reverence—as hard a thing to learn as it is to teach. Let me give you an instance or two of how it has been brought about by contact with Nature.

Temple Thurston, in one of his writings, said that he had been looking at a beautiful view, so glorious, in fact, that he thought to himself, “ What would some city dweller say, if he were suddenly taken up out of his grey surroundings and plumped down to see this wonderful sight ? ”

The chances were that he would be so taken by surprise that he would let out some pretty bad language ; no ordinary words would be adequate to express the shock of his delight.

Well, that is just what actually happened in the case of a soldier in the South African War, when, after long and weary marching across the veld, he came suddenly on the tremendous view that spreads itself below you at a point called “ the Devil’s Kantoor,” in the Eastern Transvaal.

“ My God ! ” he cried, “ and some blinking fool said there was no God.”

The wonderful glory of it caught even his stolid imagination, and drew from him an expression which, as Thurston suggests, even if blasphemous, would, for the reason of it, be acceptable to the Almighty.

Anyway, it is not a bad reply to the atheist.

A sailor is often a deeply religious man as a result of his communing with Nature, especially where he has risen to the position of being responsible for his ship. As his vessel surges over the seething mountain of green-grey, death-holding sea—in a howling gale of sleet and spitting spray—he knows the power and appreciates the awesomeness of the forces of Nature against which he is pushing his way.

Standing there alone on his bridge directing things for the safety of the souls committed to his charge he cannot help feeling himself at times in closest touch with the Higher Power on Whom it all depends.

That touch is mainly the acknowledgment of and reverence for a greater Power than himself. He puts himself in the hands of that Power and works with confidence in co-operation with Him.

THE WONDERS OF THE FOREST

If you have never journeyed through the forest of Brazil or West Central Africa you can hardly imagine the curiously haunting sensation that comes of trudging through scenery which on first acquaintance displays the beauty and wonder of a tropical jungle. It recalls to the most unfeeling mind all the grace and majesty of a Cathedral. But despite its attractiveness it hides horror within its dim twilight and soggy vegetation. Through the tangled undergrowth one pushes one's way with trees overhead shutting out the sunshine—and the air. And high above these the giant cotton trees and other monarchs of the forest rear their heads two hundred feet above the ground. But you seldom see these heads when you are groping your way in the ooze and leaf-mould amid the creepers, reeds and bush. As you tramp day after day, and it may be week after week, through this same gloom, its beauty is forgotten in continual repetition, and the confinement becomes a horror from which you know there is no escape and no relief. A sick depression holds

you in its clutch ; in some cases even melancholy and madness come to men.

And then at night as you lie out in the dark, in the soft stillness of the tropical night, the forest is hushed, but there are small voices speaking everywhere. The little chirps of crickets, the song of frogs, the drip and fall of leaves, and the dim whisperings of light breezes playing among the branches away up overhead. Now and again, at long intervals, the stillness is broken by that most impressive of all forest sounds—the roaring, rending crash, as a hoary veteran among the giant trees yields up its long life and falls from its pride of place to be no more seen.

There is a moment of tense and, as it were, respectful silence, and then the little voices of the forest carry on their whisperings again.

Man seems all out of place and a trespasser here. It is mainly a plant kingdom where insects are admitted. And yet in it all there is life and sensation, reproduction, death and evolution going on steadily under the same great Law by which we in the outer world are governed. Man has his Nature-comrades among the forest plants and creatures.

For those who have eyes to see and ears to hear, the forest is at once a laboratory, a club, and a Temple.

ALONE IN THE ANDES

I started out alone before dawn one morning, in the Andes of South America, to climb a mountain-side. The chill gloom of the early dawn was deepened by the depth of the canyon in which I started and the heights loomed round one against the sky, but in the darkness it was difficult to judge of their heights or distance. As I climbed the ascent before me the light gradually opened out, and cliffs and rock-masses stood up more clearly defined. The air was very cold and clear and still, and the great tense silence around one seemed to press itself upon me. Not a murmur of a brook, not a chirp of birds, not a whisper of a breeze. Stillness everywhere. Yet it did not seem altogether a dead stillness ; it seemed rather as if everything—the mountains and the valleys, the peaks and the boulders, were all standing at attention—waiting—looking for the coming of day.

It seemed almost sacrilegious to break that silence with the clicking of one's footsteps among the stones.

Immediately around me the mountain-side was bare. A short distance above me in front was the horizon to which I kept climbing as it continually kept receding. Looking backward behind me a similar horizon was but a few yards below leading down into the gloom I had left. One writer, describing the same climb, has compared the climber to an ant going up a water-butt. And that's what one felt like.

Then above the shoulders of the cliffs that surrounded me there began to arise the crests of higher crags and mountain-tops, like giants standing clearer in the morning light, but all cold and hard, peering at me over the shoulders of their lower neighbours. I was the only moving object in all that immensity of rigid rock and peak. I felt an intruder, and so puny in that solemn domain.

Here the strata and variegated rocks spoke of thousands upon thousands of years, from the time when our earth was being fashioned in the melting-pot.

I was but as a short-lived insect among them.

I climbed higher and higher, and breathing became more difficult, while the sense of loneliness and smallness grew upon me in that intense silence and among those vast gables of the roof of the world.

Suddenly above one of them I saw a great greenish-white peak of eternal snow, stark and clear-cut against the sky; and soon another and yet another on the different sides. It seemed as though the greater giants of the range, on whose steep facets the foot of man had never trod, were standing up to overlook me—cold, stern and pitiless. The stupendous heights, and the ghastly silence, and the loneliness, and the immensity of it all seemed to appal me. I was scarcely myself. There came upon me almost a desire to scream out to break the spell. Yet the loudest human voice would have sounded there as feeble an effort as the piping of a wren as I once heard it among the vast ruins of the Coliseum at Rome.

I tried to shut my eyes to it, when suddenly a strange glow seemed to come in the air above me. Looking back over my shoulder I saw that which made me gasp. One of the great peaks which a moment before had been almost grey-blue now suddenly gleamed at its topmost points a

dazzling orange-pink mass, with its lower parts in opalescent shadows of violet and blue and tinted green, the whole mass standing out with startling distinctness of outline and detail against the darkened sky behind it.

And as one looked around peak after peak took up the rosy radiance of the dawn.

One felt it was too much for one little mortal mind to grasp—one was a trespasser in a holy place. It was something uncanny and beyond one's ken to be up here watching the morning toilet of Nature herself. There was nothing to connect the divine scene with the life of men that I had left down below there in the gloom.

I stumbled on, awed almost to horror by it all, when, at the moment just when I most needed some touch with the human world, over the next rise there stood up before me a figure—the figure “of Christ the Redeemer.”

It was not the usual pathetic body hanging from the Cross, but a big, generous Being with wide flowing robes and with welcoming protective arms outspread.

A fine statue, happily placed for its purpose of marking the boundary and a sign of perpetual Peace between the States of Argentine and Chile, but even more happily placed than its sculptor had designed in giving, at that spot, a tangible link between the human and the Divine—the link which Christ in His time had come on earth to give.

I read somewhere lately :

“One becomes a kind of Yoga in the mountains, where you can only walk and sleep and think.

“I do not know what it is : nine-tenths of the people



CHRIST ON THE ANDES.

who live higher than 1,400 ft. are Buddhists. The mountains almost talk you into it.

“In the quiet of the night you listen to their voices ; you are drawn into the brooding immensity all round you. Then, as the slough of immediate cares and preoccupations slips away, the spirit expands and wider cycles of consciousness are opened out. In warm cities, where men huddle together, one must have something to cling to—a personal Saviour, a lantern in a sure and kindly hand, comforting voices in the dark. But here you do not seek—you know. Self vanishes. There is a mystic purpose in Nature with which you are concerned—remotely not individually.

“You may dream apart, but you are one with all the seeds of the grasses and the little round stones, unprivileged.”

THE GREAT FALLS.

Abraham Lincoln, as he stood and gazed at the Falls of Niagara, said: “It calls up the indefinite past; when Columbus first sighted this continent, when Christ suffered on the Cross, when Moses led the Israelites through the Red Sea, nay, even when Adam first came from the hand of his Maker, then, as now, Niagara was roaring here. . . . Older than the first man, Niagara is as strong and fresh to-day as ten thousand years ago. The mammoth and the mastodon . . . have gazed on Niagara, that long, long time, never still for a moment, never dried, never frozen, never slept, never rested.”

John Wesley Hill, in recording this, writes: “These reflections on Niagara embraced the whole subject of creation, the existence of God, the Mystery and the power of the universe, the history, redemption, and fate of man. . . . From this recognition of God in Nature it requires but a step to a realisation of the Divine in the affairs of men.”

It is very true ; you will understand it if ever you stand on the edge of that stupendous gorge that constitutes the Victoria Falls, in South Africa. Here the Zambesi, half as wide again as Niagara, hurls its waters down 300 ft. into the dark swirling depths below.

Remote from power-stations, trams, and tourists' restaurants, this mighty cataract catches with even greater impressiveness one's imagination.

That roar which one hears some miles away has never

ceased, since time was, to shake the air. The zigzag passage 300 feet deep which the river has cut for itself for forty miles through solid rock speaks to a grinding process not of thousands but of many thousands of years. One learns here something of the littleness of man, and of his transient efforts at fighting and fussing about petty things that matter not. One realises, dimly and inadequately it may be, that there is a bigness around us—that there is the Creator—God.

THE BEAUTY OF NATURE.

Many town-living fellows never get to realise the beauty of Nature because they seldom see it. Their eyes are more trained to looking at shops, advertisements, other people, and "Safety first."

But with those who have to some extent lived with Nature, and have come to recognise its beauties, they can, when they come to town, catch glimpses of it even in the dingy streets.

At one time in my life I had to cross Westminster Bridge every day about sunrise and again at sunset, and scarcely a day passed when I didn't find myself standing to gaze at the scene with the intense pleasure that one gets from the gorgeous colours on the coming or departing of day; and in the pearly grey and lilac tints of the hazy shadows and silhouettes which, thanks to the dear old London smoke, make them particularly prevalent there.

An artist brother of mine actually went to Newcastle to paint the smoke and steam for their wonderful effects under sunlight and cloud.

The clouds themselves make pictures, and sometimes pictures to think upon. Even now I carry in my mind a sunset that I gazed upon over thirty years ago, out on the veld in South Africa.

A gorgeous display as of a blazing gateway leading into brilliant inner halls of gold. The Gateway through which those enter who "Go West."

Has a sunset ever struck you that way?

The man with me was praying.

Why do I love fishing? It is not entirely for the fun of catching fish. I enjoy the day whether I catch any or not. I go to FISH, not to CATCH fish. That means that the surroundings of fishing attract me.

In the rich lush grass of the meadows, with the golden gleam and the scent of the buttercups, the heavy green of shady trees, one is alone with Nature. The humming of the insects, the rippling of the busy water-voles, the weird "drumming" snipe, the blue flashing kingfisher, these and other Nature mates become your companions.

But there are other scenes than this. Shackleton had a different view when he said that country-side scenery was all very well.

"That is all right for getting your butter and roast mutton ; but there's another kind of scenery that challenges the best in a man's soul. I can't tell you what it means to an explorer marching through a fog in a new land when suddenly the fog lifts and he finds himself looking at mountains no human eye has ever seen."



KANCHINJUNGA
UNTRODDEEN BY MAN.

Well, there I agree with him too. I love the homely beauty of the English country-side as I do the vast openness and freedom of the rolling veld in South Africa.

I love the rushing waters and the nodding forests of Canada ; but I have been more awed by the depths and heights of the Himalayas and by the grandeur of

those eternal snows lifting their peaked heads high above the world, never defiled by the foot of man, but reaching of all things worldly the nearest to the Heavens.

HIKING.

You may say " yes, but I can't get to mountains, oceans and primeval forests. How then am I to see and understand the wonders of Nature and her messages ? "

Well, you can do almost as much in your own country if you will come away from the town and suburb and get out into the open, into the woods and meadows.

With your pack on your back and a staff in your hand or

“With your little steel steed between your knees
You can jolly well go wherever you please,”

taking with you your little canvas home, your blanket or your cooking-pot—and FREEDOM. Out in God's open air, preferably “hiking”—that is taking tramps about the country—and drinking in the glories of sky and earth and sea; seeing the colour in the woods and fields, scenting the flowers and the hay, hearing the music of the brooks and birds and the whispering wind, getting to know the animals and their ways, till you feel that you are a comrade with them all and “find yourself” as a part of the great scheme of Nature.

David Grayson writes in *The Friendly Road*: “From time to time it is the custom of these ‘Samurai’ to cut themselves loose from the crowding world of men and with packs on their backs go away far to places in the deserts or on Arctic ice-caps. I am convinced that every man needs such a change as this, an opportunity to think things out, to get a new grip on life, a new hold on God. But not for me the Arctic ice-cap or the desert. I choose the Friendly Road—and all the common people who live along it.”

“Hiking” is a good old Cornish word and means walking with good will.

HUMAN BODY AS AN ITEM IN NATURE STUDY

Apart from woods or fields, you need not go farther than your own self for a beginning in Nature study. What did you come from? A tiny seed no bigger than a pin's point, yet giving you a body formed of flesh and bone and sinew with a likeness to your own father and mother, strong, and able to obey whatever the mind tells it to do.

It has wonderful mechanism in all its parts. Look at your eye, a most delicate and marvellous apparatus beyond anything that man could devise. It gives instantaneous information to the mind of things near or far away, of their

ugliness or beauty, their colours and shapes. It reads this page and from the printed letters upon it puts thoughts and ideas into your brain which the brain packs away into store for use later on when needed.

Touch this book with your forefinger and think, simple as the action is, yet how wonderful.

Eye telegraphs to brain, "there is the book at such and such a distance from you," brain tells sinew to move arm, hand and finger to the spot at once. Nerves in fingertip telegraph back at once to brain that the job has been done and that the book is cold or hot, rough or smooth, and so on.

Ask Mr. Atheist who it was who invented and made that wonderful machine? And not merely one specimen but millions throughout this wonderful world, alike in minutest details, yet no two exactly alike in mind, body or appearance. Put your finger on your pulse, that is the artery on the front of your wrist directly below your thumb. Or feel your heart in the left centre of your chest. There you find the wonderful performance going on of fresh, warmed-up blood being steadily pumped through your arteries.

These lead to all parts of your body, and the blood is then brought back, dirty, by the veins, to the other side of the heart, to be cleansed by the lungs with fresh oxygen from the air.

And that work is going on regularly all the time without your taking any trouble about it yourself; whether you are sleeping or waking, that gallant heart goes on unceasingly at his job.

If he were to go on strike and stop work, even for a minute, you would be dead. He has his telegraph wires in the shape of nerves which give him messages from the brain the moment that your eyes or ears telegraph something out of the way to the brain. Thus, if there is a sudden loud bang near you or your ear tells you in the night that someone is creeping up to stick you with a knife, ear tells brain and brain tells heart, and heart at once increases his rate of pumping.

Also if you go running or doing extra work uphill, more fresh blood is demanded and you suck in greater gulps of fresh air to replenish the blood; and heart has to get on to the job with redoubled vigour.

You owe a great deal to him ; your health, your very life depends on heart doing his duty to you ; and yet thousands of people don't think of their duty towards their heart.

It is not good for him to be artificially forced to work his valves faster than Nature requires. If you force him to do it often the valves get weak and cannot keep the blood freshened and so you get ill. For instance, if you drink alcohol it sets heart going faster than usual and if you keep on doing it it steadily weakens him.

Also if you smoke too much it does the same, especially in the case of growing lads whose heart muscles have not yet gained their full strength for meeting the strain.

The consequence is that thousands of boys destroy their health and strength for the rest of their lives by ignorantly smoking their heart into a bad state.

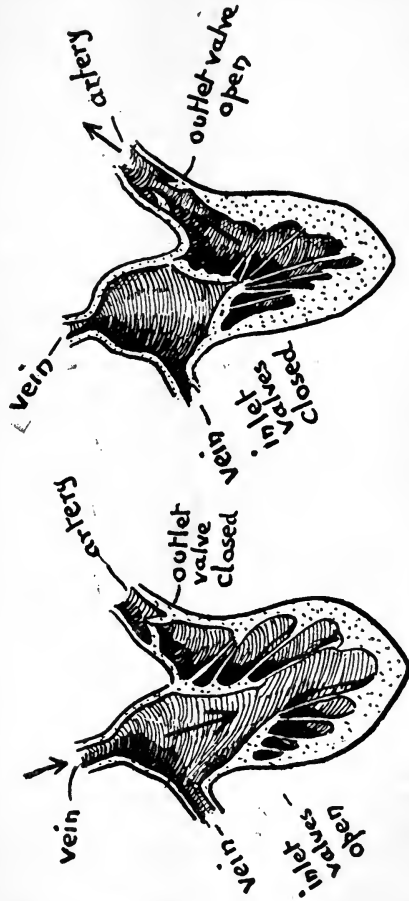

Heart closing big valves to push blood through small outlet valve into arteries.

Heart opening its valves to receive blood from veins.

SECTION OF HUMAN HEART PERFORMING A BEAT

The sketch on the preceding page shows the wonderful arrangement of valves that goes on working in your heart once every second.

I have copied it from Dr. Shelley's book, *Life and Health*, which you should read if you care to see full information put in most interesting form about all the different organs of your body and the work that they do. It is really good reading. He doesn't tell you there, but I can tell you here that an awful lot of fellows who distinguish themselves as young men at running and rowing die before they are very old through heart disease brought on by the strain of their early exertions.

Then there is your ear. Have you ever seen a model of the human ear and the marvellous machinery that it contains for telephoning every sound to your brain?

It would take too long to go into that wonderful apparatus here, but this diagram of the section of an ear will give you some suggestion of what it is like.

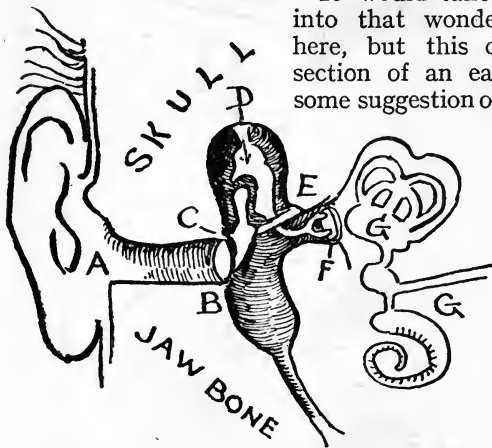

SECTION OF THE INTERIOR OF THE HUMAN EAR—
A WONDERFUL AND DELICATE INSTRUMENT.

Sound enters along the tube A and vibrates the little drum B. This sets "hammer" bone C knocking against "anvil" bone D, and he agitates "stirrup" bone E, who strikes the second drum F. Here there is a sort of snail shell G full of fluid. The vibrations of the drum F set up agitation of this fluid, which in the lower part of its tube touches a lot of minute hairs. These when agitated touch the nerves, which telephone the sound to the brain.

I think if every fellow studied a little of his own body and how it works he would quickly gain a new idea of the miraculous handiwork of God and would realise how He is actually active in your body as well as in your mind.

And when, as some of you have done, you see these wonderful bodies of His with all their complicated, beautifully fitted living mechanisms

smashed, destroyed, or maimed by man-made bombs and shells in man-made battles over man-made villainies, you will feel that there is something wicked and profane about war.

Look at the grain of the skin of your finger-tips, with its many circles and turns, take a print of those with ink upon paper, and examine them with a magnifying glass. You may get thousands of other people to do the same, but you will never find two who have them identically like your own. Consider any part of your body and its wonderful make, sensation, and what it does at your command. You begin to realise what a wonderful living machine has been given to your charge to use properly—and you gain a reverence for your own body.

MICROSCOPIC NATURE.

Take one drop of moisture from your mouth and put it on a glass slide under a microscope and you will see that it contains hundreds of little living animals or germs of delicate form and likeness to each other, endowed with life and action, and with powers of feeding and reproduction.

Go out into the garden or the nearest park and see those plants, pick a single leaf of the thousands on the tree, and study it through a magnifying glass, compare it with another of the same tree or of a tree of the same family a thousand miles away. Both will be exactly alike in form and texture, yet each will have its own little minute difference of individuality. Also each has its own power of breathing and feeling, of feeling warmth or cold, health or illness. Each plant has its birth, life, reproduction and death just as any other animal on earth.

THE POSSIBILITIES OF THE ELECTRON.

Do you know what an electron is? It is a tiny particle of electricity that comes to us from the sun millions and millions of miles away. It is difficult to describe how small it is. Take an atom. An atom is the smallest particle of matter that exists. It is much too small to be seen, but a bubble of hydrogen about the size of a printed letter o contains many millions of atoms.

And an atom is a thousand times larger than an electron.

In the *Outlines of Science*, by Professor Arthur Thomson,

where this is all explained, the author shows that if an atom could be magnified so much as to be the size of St. Paul's Cathedral each electron in it would be about the size of a small bullet!

That begins to make you think there are some small things in this world that you had not noticed before! Yes, and they are pretty wonderful things too.

"An electron," says Sir William Bragg, "can only maintain a separate existence if it is travelling at over 600 miles a second. Otherwise the electron sticks to the first atom it comes across." It may travel at from 10,000 to 100,000 miles per second, or, in other words, it could go round the world half a dozen times in a second! That is a wonder in itself, but another wonder is how the men of science have managed to discover all this. They have gone further and found that a seventieth part of a grain of radium will give out thirty *millions* of electrons per second!

There is all this immense amount of force and energy around us. It has only been discovered lately. It remains for someone to harness it for the use of man, and it will make an immense difference in our conditions of living.

A few years ago we knew nothing of electricity. That has been discovered and used with marvellous results. It has already made possible things that our grandfathers would have said were uncanny works of the devil, such as wireless telegraphy and telephones. But there they are.

The discovery of electrons has shown that even our ideas of the last few years are now out of date as to the nature of electricity. So who can tell what the next few years may bring about?

Sir W. Bragg says, "Atom energy will supply our future needs. A thousand years may pass before we can harness the atom, or to-morrow may see us with the reins in our hands. That is the peculiarity of physics: research and accidental discovery go hand-in-hand."

What a tremendous chance for a fellow who makes atoms and molecules and electrons his hobby! He would be at once the biggest benefactor to the human race that the world has ever seen.

The wonders and mysteries of Nature are unlimited. There are big chances before you fellows of the next generation. So there is material value in studying them—

but the more you study them the more you become humble in the presence of the work of the Creator.

TELESCOPE NATURE.

Look up in the sky. That aeroplane is high, almost out of sight, but what is beyond—far, far above him?

Limitless space. Look at it at night through a telescope, and you will see that those tiny points of light we know as stars are great suns having planets circling round them, just as round the sun we know this earth and half a dozen more like it are continually circling at whirling speed.

Many of those stars are so distant that the flash of light coming from them (and you know how fast a flash travels) takes five hundred years and often much more to reach us.

One of them may have gone to bits in the time of Henry V, after Agincourt, but its light would still be coming to us.

From these tiny microbes and atoms seen through the microscope to those vast worlds as seen through the telescope one begins to realise what is meant by the Infinite, and when one realises that all things, big and little, are working in one regular order in a great set plan, the stars whirling through limitless space, the growth of mountains in the world, the life and reproduction and death in a regular series among plants and germs, insects and animals, one realises that a great master Mind and Creator is behind it all.

THE ANIMAL WORLD.

Animal life is there at hand for you to study if you care to, to give you better insight into the wonders of nature.

There are the birds with their wonderful build of feathers and mechanical arrangements of light bones that enable them to fly, with their nesting ingenuity and their migratory instincts that make them travel half the world over to and from certain spots every year; there are the bees, who are typical of a genuine socialist colony, where all are workers for the common good with a wonderful division of duties and sense of discipline.

Couldn't you get a friend who keeps a beehive to show you something of its wonderful inner life?—so that you could see for yourself how the bees collect and make their wax from the pollen of plants mixed with their own saliva; how the building bees build up cells from it of exactly the

same shape and size, slightly tilted up when they are to hold honey ; how the honey bees come and fill them with the honey from the flowers for the feeding of the community ; how the queen bee lays her eggs in the breeding cells where they are fed by the nursing bees ; how the fanning bees placed in regular lines keep the hive ventilated with their wings ; and how the sentries and guard bees keep out intruders at the door.

THE MIND.

Then among the greater animals you find them sagacious, whether wild or tame, whether seals or panthers, horses or dogs. They all have minds and memories for directing their powers.

It is not only the human mother who loves her children. The tigress is equally fond of her cubs, or the partridge of her chicks.

And so too the male will protect his female, whether he be a monkey or a wild boar, or even a fish, just as bravely and as chivalrously as any knight of olden days.

One has seen animals sacrifice their lives to protect their young as pluckily as any soldier fighting for his home and country.

You have probably owned a dog who would defend you and your possessions with his life, if need be, for no reward but because he loved you.

And you can see from his actions how he enjoys expressing his affection for you. It makes him happy to carry out your wishes and to do little jobs for you.

Man, too, has all these attributes of the animals. He has the mind and the memory, the pluck and the chivalry, the affection and the happiness that animals possess ; but he has them on a far higher scale. He can use them all to greater advantage.

THE SOUL.

As a man you have this pull over the animal—you can recognise and appreciate both the wonders and the beauties of Nature. You can enjoy the golden glory of the sunset, the beauty of the flowers and trees, the majesty of the mountains, the moonlight and the distant views.

But more than this, you can make things, which is more than animals can do, and a good many of you can make

pictures or poetry or render music for yourselves. That is an additional pull that you have towards the enjoyment of life.

But there is bound to come in the thought that something more is expected of you than is expected of rooted trees or animals who have limited powers, something more than merely enjoying the sunshine as they do.

You have all this extra intelligence, with the ability to apply it. But it is wasted if you don't use it or if you spend it badly, as for instance in quarrelling with your next-door neighbour over some potty little question of politics or creed, when all around you is the vast universe and God for you to work for.

The funny thing is that there has been more fighting and quarrelling in the world over religion than for any other cause. It is worse than funny, it is ridiculous, but at the same time true that the more we care for our own religious beliefs the more narrow-minded we seem to become towards the religious ideas of other people.

We forget that we are all sons of the same Father and that we are all striving to do His will, though it may be in different ways.

There is one thing, however, that I feel sure of myself, and that is that God is not some narrow-minded personage, as some people would seem to imagine, but a vast Spirit of Love that overlooks the minor differences of form and creed and denomination and which blesses every man who *really tries to do his best*, according to his lights, in His service.

CONSCIENCE.

How can you best serve Him with the intelligence and power that He has given you? If you are in doubt, ask your Conscience, that is, the voice of God within you. He will tell you at once what is needed of you. And it is generally to give of your good will, and to give it freely.

Animals can quarrel and snarl, "dogs delight to bark and bite, it is their nature to," but they cannot, as a rule, rise to being large-minded, charitable, helpful, and kind. Men can do this when they really mean business. That is where a man attains his proper footing, namely, when he exercises the Divine Love that is in him in service for others.

LOVE.

In India you will often see a fakir who, for a vow, holds one arm aloft and never uses it. That arm withers away and dies. In the same way that spark of Love that exists in every man, if not exercised, wastes away and dies; but if put into practice it grows bigger and stronger and more exhilarating every day.

Service is giving up your own pleasure or convenience to lend a hand to others who need it. Well, if you practise service to others day by day in little things as well as big, you will find yourself developing that spark of Love within you till it grows so strong that it carries you joyously over all the little difficulties and worries of life; you rise above them; you are filled with good will towards men; and Conscience, the voice within you, says "Well done!"

That Love is like Mercy, which Shakespeare describes as having a twofold quality: it blesses him that giveth as well as him that receiveth. That Love is "the bit of God" which is in every man—that is his Soul.

The more he gives out of Love and Charity to his fellow-men so much the more he develops his Soul.

Professor Drummond, in his work *Natural Law in the Spiritual World*, has suggested that it is there that lies man's chance of what is known as everlasting life; he develops his soul from being a little bit to being part of God. It is there that he finds the happiness of being a player in God's team. It is there that he finds the joy of heaven, here and now on earth and not vaguely somewhere later on in the skies.

There is no superstition about all this, as suggested by your atheist. It is a direct fact, and it lies open to every man, whether he be rich or poor, to enjoy, provided he paddles his way towards it.

A step to this end is to read the Bible and trace the history of God's will among men and to carry that will out by your own good will and helpfulness to others, and you will be the better man for it—and safely past the rock of atheism on your voyage to happiness.

Now don't think from all that I have said in this chapter that I am trying to convert you to some new form of religion, because I'm not.

I am only going on the idea that you who read this have

not got any strong religious views of your own, or that you find that atheists are trying to get at you. I only suggest that the better realisation of God may possibly be got through Nature-study rather than through books. I have known it happen in very many cases among woodsmen, seamen, soldiers, and explorers, who had not otherwise grasped any religious faith.

If you find this method does help you, the next step is to talk with a minister of religion, who can then put you on the right line for gaining the truer religious beliefs.

SUMMARY.

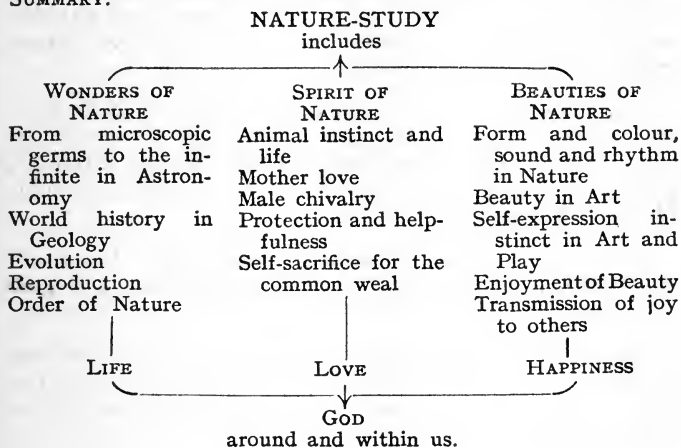

SERVICE FOR GOD
therefore implies under these heads

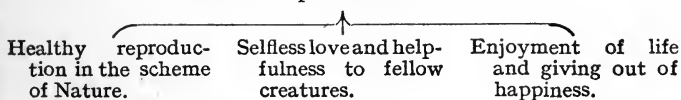

GUIDING THOUGHTS FROM DIFFERENT SOURCES

To be good is one thing, to do good is better.

How many observe Christ's birthday! How few His precepts. It is easier to keep Holidays than Commandments (*Franklin*).

Christ's Death and Resurrection were a call to us to die to our sins and to rise again to a new life—here, in this world and now.

The study of the Book of Nature is the true key to that of Revelation (*Bacon*).

Though I bestow all my goods to feed the poor . . . and have not Love, it profiteth me nothing. Love suffereth long, and is kind ; Love envieth not ; Love vaunteth not itself, is not puffed up, doth not behave itself unseemly, seeketh not her own, is not easily provoked, thinketh no evil ; rejoiceth not in iniquity but rejoiceth in the truth ; beareth all things, believeth all things, hopeth all things, endureth all things (*1 Cor. xiii.*).

God is not a friend who thinks only of our religious side ; on the contrary, we should find it a help and an encouragement if we looked upon Him as a keen friend, interested alike in our games, our work, or our stamp-collecting (*The Heart of a Schoolboy*).

Reverence promises freedom from hasty judgment, friendship towards men, and obedience to the gods (*Marcus Aurelius*).

I can see how it might be possible for a man to look down upon earth and be an atheist, but I do not see how he can look up into the heavens by night and say there is no God (*Abraham Lincoln*).

THE STORY-BOOK.

And Nature, the old nurse took
 The child upon her knee
 Saying, "Here is the story-book
 The Father has written for thee."
 "Come wander with me," she said,
 "Into regions yet untrod,
 And read what is still unread
 In the manuscript of God."

The man who is blind to the beauties of Nature has missed half the pleasure of life.

Be a player in God's team.

Nature is a school where different minds learn different things : one will express his Nature-lore in poetry, another in pictures, but all in peaceful Love.

Lord Avebury says in his introduction to *Marvels of the Universe*: " We live in a wonderful and beautiful world ; a world which it is most important to understand ; and dangerous, if not fatal, to misunderstand. There is no animal or plant which would not well repay, I do not say merely the attention of an hour, but even the devotion of a lifetime. I often grieve to think how much happiness our fellow men lose from their ignorance of science. If anyone is ever dull it is his own fault. Every wood, every field, every garden, every stream, every pond, is full of interest to those who have eyes to see."

Two things fill my mind with ever renewed wonder the more often and the deeper I dwell upon them: the starry vault above me and the moral law within me (*Immanuel Kant*).

Thou shalt love the Lord thy God with all thy heart, and with all thy soul, and with all thy mind. This is the first and great Commandment.

And the second is like unto it :

Thou shalt love thy neighbour as thyself.

On these two commandments hang all the law and the prophets (*Matt. xxii. 37*).

HELPFUL BOOKS TO READ

General Science. By Caldwell and Eikenberry (Ginn).

Outlines of Science. By Professor J. A. Thomson (Newnes).

The Student in Arms. By Donald Hankey.

The Young People's Nature Study Book. By S. N. Sidgwick (Culley).

Nature Stalking for Boys. By P. Westell (Dent), 3s. 6d.

Wild Life in a Southern County. By R. Jefferies (Nelson). 2s. 6d.

Campers' Handbook. T. H. Holding (Simpkin & Marshall), 5s.

The Bible.

TO : [Illegible]

FROM : [Illegible]

SUBJECT : [Illegible]

[Illegible text]

[Illegible text]

[Illegible text]

[Illegible text]

SUMMARY

TO sum up in a few words all that I have said in the foregoing pages.

You want to make a success of your life.

Success does not consist so much in gaining money and power as in HAPPINESS.

Many young men drift along with the rest of the crowd according to chance, and thus never reach happiness: From being *passive* be *active*. Don't drift. Take your own line. Paddle your own canoe. Only, mind the rocks! Avoid them by cultivating other qualities.

THE ROCKS.

(Through herd temptation.)

Horses, betting and looking on at false sport.

Wine, and other forms of self-indulgence.

Women, dangers of a wrong attitude and blessings of the right one.

Extremists in politics, irreligion, etc.

ANTIDOTES.

(Through individual effort.)

Active Hobbies and earning money.

Self-Control and character.

Chivalry and health of mind and body.

Service for your fellow-men and for God.

If you aim for it by practising these safeguards, instead of being stranded among the rocks, you will win success—happiness.

I now offer you, in the next chapter, a practical way by which you can, if you like, carry out the necessary training for yourself.

STIMULUS

1

of the ...
the ...
the ...
the ...
the ...

of the ...
the ...
the ...
the ...
the ...

of the ...
the ...
the ...
the ...
the ...

of the ...
the ...
the ...
the ...
the ...

of the ...
the ...
the ...
the ...
the ...

of the ...
the ...
the ...
the ...
the ...

ROVERING

ROVERING

THIS Part shows how the ideals and theories put forward in the foregoing chapters can be put into actual practice by any young man.

OBJECTS OF THE ROVER MOVEMENT.

Real MEN needed in the nation.
The backwoods the best school for Man-making.

METHODS.

Example of a Rover Scout Training Himself in Manliness.
The aim of the Rover Brotherhood is Service for Others.
Hiking and Camping.
How to become a Rover.
Some of the arts of Rovering.

ORGANISATION.

The Rules for Rover Scouts:
The Object.
The Promise and Enrolment.
The Law.
Forming a Unit.
The Troop.
The Patrol.
The Court of Honour.
Uniform.
Badges.
The Tests.
The "AI Rover."
Rover Dens.
Activities { Service.
 { Recreation.

SERVICE.

An Accident Corps and some sample activities.
Climbing as a sample recreation.
Enjoyment of Life.
Responsibility of a Rover in re-constructing our manhood.
Some weaknesses to be avoided in giving example.
A High Service for Rovers is that of training young boys.

BOOKS OF REFERENCE FOR ROVERS.

"SONGS OF A SOURDOUGH."

SOME USEFUL BOOKS TO READ.

ROVERING

OBJECTS OF THE ROVER MOVEMENT

TOWNIES AND BACKWOODSMEN.

LAST week the newspapers reported a case where a woman was set upon in her shop and robbed by a man.

It was in the street in the middle of the day. As the culprit ran off the woman pursued him and called to passers-by to stop him. One of these asked whether the man was armed, another laughed and urged her to catch him herself, and she certainly tried to do so.

She lost sight of him round a corner, and came on two painters there who, when asked, denied having seen him. Then the plucky woman perceived him hiding close behind them, and she collared him herself.

The magistrate who tried the case had some mighty unpleasant remarks to make to these cowards. One can only hope that they had sufficient self-respect left to feel ashamed.

This case was only on a par with one that happened a few years back, when a poor distraught woman wandered into water up to her waist and deliberately drowned herself before a crowd of men—not one of whom had the pluck to go in and fetch her out.

This is not good hearing. Unfortunately, these are only two more striking examples of what exists on a wider scale in details such as wife-kicking, unkindness to children, and cruelty to animals, that is of want of manliness and chivalry on the part of a proportion of our male population.

It is not confined to one class only; there are thousands of divorce cases where men of good standing are traitors to their wives or to other men, just as there are those who

are led to be traitors to their country at the instigation of agitators.

I know that in the war our men showed up as *true men* in a remarkable degree. Where they were good, they were splendidly good. To read any one of the hundreds of cases of Victoria Cross and Distinguished Service awards is a fine tonic for anyone who feels depressed about the pluck of our race. But as I have constantly said before in this book one has to look at both sides of the picture.

We have splendid material and results that show what men can be if they are only brought up to be manly; and we have on the other side the evidence to show what curs they can be if left to drift among drink shops and rotten surroundings.

For my part I feel that living in towns has a great deal to say to the want of manliness. Go out into the bush of Australia or the veld of South Africa or the backwoods of Canada and you find a different breed. The New Zealander is the bravest man I know. In those lands a man has to fend for himself. If he cannot track the spoor of animals or read signs from the flight of birds, he is going to die of thirst or hunger.

Water isn't laid on in the desert, nor is there a baker's round the corner.

To light his fire and to kill, clean and cook his food for himself is his every-day job.

He has to stand up to the lion or the wolf with the same readiness that he would use to catch a train or to step on to a tramcar at home.

With his axe he does all his carpentry, from sharpening a pencil to felling trees and notching them to interlock in a weatherproof log-house.

I remember away back in Canada the call going round the district that a lady had come to settle there. The next day from ranches twenty miles distant in different directions no less than forty cow-punchers, lumber-men and others turned up; and two days later they rode off their different ways leaving a fine log-house standing, a free gift and ready for the "marm's" occupation.

Though self-sufficing, the backwoodsman is not self-sufficient. He is a rough diamond, but a gentleman, as chivalrous as the knight of olden times.

Deeds that in England would be sent up to the Royal Humane Society for medals pass out there as everyday matters, and excite no comment.

One little incident told by Stewart E. White is typical: "A jam of floating logs had formed in the river and held them up for about three miles back. The men with their peavies were working at the breast of it to break it up and get the logs moving again.

"Presently the jam broke a bit and pulled down-stream a hundred feet or so, and then plugged again.

"Then it was seen that only a small section of the jam had moved, leaving the main body still blocked, so that between the two sections lay a narrow stretch of open water. Into this open water one of the men slipped and fell. Before he could recover, the second or tail section of the jam started to pull.

"Apparently nothing could prevent him from being crushed. A man called Sam—I don't know his last name—ran down the tail of the first section, across a lot of loose logs bobbing on the open water, seized the victim of the accident by the collar, desperately scaled the face of the moving jam, and reached the top just as the two sections ground together with the brutish crash of wrecking timbers.

"It was a magnificent rescue. Any but these men of iron would have adjourned for thanks and congratulations. Still retaining his hold on the other man's collar Sam twisted him about and gave him a vigorous kick. 'There, damn you,' said he. That was all. They fell to work at once to keep the jam moving."

A somewhat similar case occurs in to-day's paper as I write, headed "A Lumberman's Gallantry."

A teamster was driving across Lake Larson with a load of logs when the ice broke, and horses and load plunged into the water. The teamster, instead of thankfully

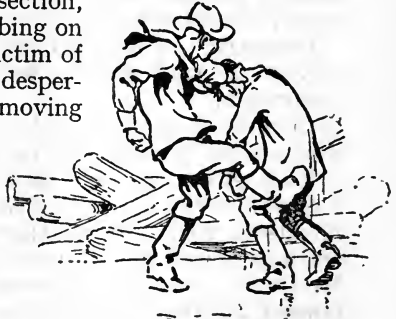

RESTORATION OF THE APPARENTLY DROWNED.

making good his escape, dived into the icy water to a depth of fifteen feet, and after a long and desperate struggle succeeded in rescuing both horses.

When I spoke of townies above, don't think that I therefore despise them. I started life as a townie myself, and some of the best fighting Scouts I have known in South Africa and in France were cockneys. They had with grit and intelligence adapted themselves for their work.

METHODS

A ROVER BACKWOODSMAN.

As I write these lines there is, camping in my garden, a living example of what I hope may be the outcome of this book, on a wider scale.

With all my heart I hope it.

He is a hefty Rover Scout, about seventeen years of age, that is a fellow training to be a man. He has tramped from a distance with his pack upon his back, in which were his light tent, his blanket, cooking pot and food.

He carries on him his axe and lariat. In his hand a serviceable staff with a weirdly carved head, his own handiwork.

In addition to this load he carries a still more important thing—a happy smile on his weather-tanned face.

He slept out last night in bitter wind and rain, although I gave him the choice of living under a roof. He merely remarked, with a laugh, that it had been a hot summer, and a little cold wind was a change and would do him good. He loved the open. He cooked his own meal, and made himself all snug with all the resourcefulness of an old campaigner.

To-day he has been showing our local Scouts how to use the axe with best effects, and he proved to them that he could "rope" his man unerringly with his lasso. He knew the trees by their bark and the birds by their note. And he could climb any tree or crag that he came across. Altogether a healthy, cheery, skilled young backwoodsman. Yet this chap is a "Townie," but one who has made himself a Man.

As he admitted to me, he is in his ordinary life an apprentice in some engineering works in a big city. He enjoyed getting out into the open not merely because it

was a relief from his work, for his work interested him, but because it took him out of the filthy talk and foul language that was supposed by his fellow-workers to be the manly thing to carry on.

He told me he had got a "thick ear" more than once for not taking part in it, and he had managed to deal out a "thick ear" or two on his part in urging cleaner thought.

But he had gone farther than this. His example, rather than his punch, had led two or three of his mates to take an interest in his ideas and his hiking, and they were now becoming Rovers like himself.

Through his own example he was giving to these chaps a new outlook on life and something jollier and higher to live for. So he is doing Service too.

Are you efficient as a man?

Of course you are; you can read and write and so on; and—well, for instance, can you swim?

Yes, of course you can.

And I expect you can box a man of your own weight or hold off an attack by a jiu-jitsu grip?

Can you carry your own golf clubs, can you stalk your own stag, or can you land a big fish single-handed, or do you need a fellow to do it for you?

Can you milk a cow, and light a fire, and cook your own food on occasions; or must you starve because you are dependent on this lady to do these simple things for you?

Can you go beyond yourself and help other people? For instance, do you know how to stop a runaway horse, or rescue a drowning person, or render first-aid in the case of a cut artery?

If you cannot do little things of this kind, you ought to join the Rover Scouts, since there you will learn them and plenty of other useful stunts fast enough.

You have been educated in school, in a class, as one of a herd. You have been taught the general elements of knowledge and you have been taught *how to learn*.



Now it is up to you as an *individual* to go on and learn for *yourself* the things that will strengthen your character and help you to success in life by making you a man.

I will show you one way, at any rate, by which you may do it. It is by becoming a Rover Backwoodsman.

THE AIM OF THE ROVER BROTHERHOOD

Rovers are a Brotherhood of the *Open Air* and *Service*. They are Hikers on the Open Road and Campers of the Woods, able to shift for themselves, but equally able and ready to be of some service to others. They are in point of fact a senior branch of the Boy Scout Movement—young men of over seventeen years of age.

The four main aims of the Scout training in Woodcraft are to develop these points:

Character and Intelligence.

Handcraft and Skill.

Health and Strength.

Service for others and Citizenship.

If you compare these with the "Antidotes" given on page 201 as the bright side of the "rocks," you will see how Rover-Scouting comes in to help you. They are identical.

The Rover brotherhood has been organised all over Great Britain and in the British Oversea States. It has also spread to many foreign countries.

It is not only a brotherhood but a *jolly* brotherhood with its camp comradeship, its badges, its secret signs, its uniform, and its "dens" or meeting-places all the world over.

Since it is a *Brotherhood* of wanderers, you can, as a member of it, extend your travels to foreign countries and there make your friendships with Brother Rovers of other nationalities.

This side of our Movement is not only interesting and educative but is going to make a real step in ensuring the future peace of the world through mutual good will.

If you have already been a Boy Scout you will know pretty much what there is to know about it.

If you have not been a Scout the first things needed are a pair of stout shoes and a stout heart. Then beg, borrow—or get hold of—a copy of *Scouting for Boys*, from the

nearest Scout Troop, or at 2s. 6d. from our Headquarters at 25, Buckingham Palace Road. This will give you the details for hiking and camping for you to go upon.

In a series of "Camp Fire Yarns" it gives the detail of—

1. Scoutcraft and Scouts' work.
2. Campaigning.
3. Camp Life.
4. Tracking.
5. Woodcraft and Nature Lore
6. Health and Strength.
7. Chivalry.
8. Life Saving and dealing with accidents.
9. Duty as Citizens.

And you learn that important duty of a camper, namely :
When quitting your camp-ground leave two things behind :
(1) Nothing to show that you have been there. (2) Your thanks.

CAMPERCRAFT.

I have had the luck to camp out in a good many different parts of the world—in the Canadian backwoods, Central African jungle, Egyptian desert, Norwegian rivers, South African veld, Himalayan mountains, etc.—all have their own particular delights ; but all the same, your own country has a beauty and charm of its own which is hard to beat however far you may travel.

You have there the joys of camping almost at your door, at the least possible cost in money, time and trouble.

Out of the stuffy smoke and second-hand air of the noisy town you have stepped out into the freshening breezes of the open downs and drinking deep of the pure air you gain "new blood in your veins and new life in your brains."

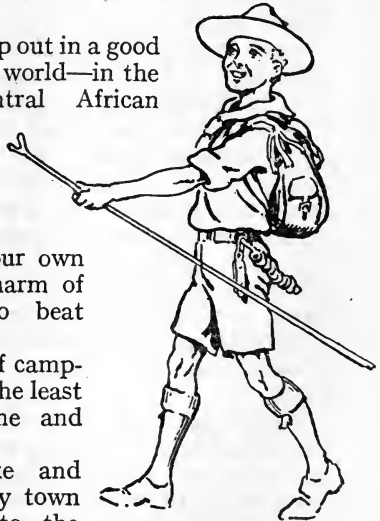

ON THE ROAD TO HEALTH
AND HAPPINESS.

And as you swing along with the untiring stride of perfect fitness you know the joy of living. Over hill and dale, with changing beauties of scenery at every step, you feel a free man. The view is yours to gaze upon, you're free to go and free to stay and free to pitch your lodging where you feel inclined.

Whether you prefer solitary hiking or tramping in company depends on your personal temperament—and temper. In the handbook of the Ramblers' Association one enthusiastic tramp says that he believes in going alone to drink in the wonders of Heaven and earth. He says, "From idle prattlers, improving talkers, serious students of their fellow-men, politicians, golfers, and all observant naturalists—Good Lord, deliver us."

THE JOY OF THE OPEN ROAD.

There is no pleasure that comes near to that of preparing your own meal over your little fire of wood embers at the end of the day, and no scent like the smell of that fire.

There is no view like that from your lair on the woodland hill-side. And there is no sleep like that in the open with a warm blanket or a good thickness of paper beneath you. ("More under than above you" is the tramps' secret for lying warm o' nights.)

The sounds of the night and the companionship of the beasts and the birds make you feel a comrade of them all in the Brotherhood of Nature.

Rain? Cold? Yes, I suppose they come, but you really get to disregard them when you are in the regular swing and habit of week-end camping.

Whether you are a lone hiker or whether you camp with a companion, or in company with a Patrol of pals—it is all good.

"There is nobody under thirty so dead but his heart will stir at the sight of a gypsy camp . . . there is some life in humanity yet, and youth will now and again find a brave word to say in dispraise of riches, throw up a situation to go strolling with a knapsack" (*R. L. Stevenson*).

Then the quaint brethren of the road that you meet, and the freemasonry among out-of-doors men, give you many new ideas and a fresh and widened outlook on life from many a new standpoint.

With this opening up of a new and human side to your character you can, if you will, make your hiking into the wandering of a knight-errant, by being a doer of good turns to all and sundry as you go along.

HOW TO BECOME A ROVER SCOUT.

To become a Rover Scout the best way is to join a Rover Patrol belonging to a Scout Troop in your neighbourhood or a Rover Troop if one exists there.

Any Scoutmaster, local Secretary or other Scouter (i.e. any Scout officer) of the Boy Scout organisation will advise you on the subject and help you in your desire to become a Rover.

If there should be no Scouts or Rovers in your neighbourhood you can become what is called a "Lone Rover Scout." In this case you write to me at our Headquarters at 25, Buckingham Palace Road, London, S.W., where you can be registered as a Lone Rover on the understanding that you will carry out the Rovers' training and the Scout Law to the best of your ability; and you will be entitled to wear the uniform and the badges as you earn them. We have there an equipment store where you can get all you want in the way of camp or hike kit. One way to become a camper, besides being a Rover, is to join the Camping Club of Great Britain. I am a member of it myself, as are a good many members of the Scouting fraternity. It is a joyous company of men and women of the out-of-doors. It runs a valuable and instructive periodical called *Camping*, and has excellent equipment stores of everything that a light camper can need; and it also possesses over 500 camping grounds available for its members in different parts of the United Kingdom.

The cost of membership is only 10s. a year, and it is well worth the money. And there are corresponding Clubs in most other countries.

There are also in very many counties Rambling Clubs, Field Clubs, Antiquarian or Naturalist Societies, etc. These are generally affiliated with the Federation of Rambling Clubs, 25, Victoria Street, of which I am Vice-President.

So I can put you up to knowing about them if you want to. One useful point about this Association is that it

publishes handy guide books of Walking Tours in different localities showing the footpaths and rights of way off the main road and describing the various points of interest that can be visited.

Another way in which it helps its members is by arranging special terms with the Railway Companies and with inns and hotels for accommodation.

We have, in the Rover Movement, a fine camping centre in Epping Forest, and a Woodcraft training school at Gillwell Park, Chingford. Quite handy to London and a ripping place to visit.

There are other camping societies with very alluring names and prospectuses. Several are on the lines of the Scout Movement but intended as traps to catch the unwary and lure them, under the camouflage of Woodcraft, Red Indianism and Hiking, into political adventures of a very questionable nature. They have seen the success which has attended the development of the Scout Movement and the Rover branch of it, and have naturally endeavoured to use the same methods for gaining recruits for their own ends. Keep your eyes open!

As a Rover you will have the joy of picking up the many and varied details that help you to enjoy life and Camp comradeship of the Brotherhood.

Among these will be—

Tracking of men, animals, wheels, etc., and the reading of information therefrom.

Fire-making in the way that a tramp or Red Indian does it and not as you would do for a jubilation on Guy Fawkes Day. A mere handful of red-hot embers will do all the cooking you need.

(By the way, I had letters from more than one ex-Scout who during the war escaped from a German prison and managed to subsist and keep himself concealed largely thanks to what he had learned as a Boy Scout, especially in the matter of hiding his tracks and of cooking his grub over a diminutive fire.)

Cooking, with what the Red Indians call a chiploquorgan, or bent osier, to hold your "billy" over the fire, and a mulquagan, or forked stick, round which you can twist your dough for bread and upon the points of which you fix your slabs of meat for roasting.

Tent, not a canvas tabernacle, but the light-weight bivouac that is now used largely by practical campers, and can almost be carried in your pocket.

Knot-tying, like the use of needle and thread, is a necessary bit of knowledge for a camper.

The axe, and knowing not only how to use it but how to take care of it, is another necessary adjunct.

Map-reading and finding your way by map, land-marks, compass, stars, direction of winds, etc., is as interesting as it is essential.

The Ruksack and its load teaches you how little you can do with and have to do with when hiking.

Eyesight. By practice your eyesight is strengthened to a notable degree, especially if you are town bred and have never had occasion to look more than fifty yards ahead of you.

Hearing is strengthened by practice in listening to sounds by night; and sense of smell is also invaluable for finding your whereabouts or the presence of other people at night.

Judging distance is an art developed by practice when hiking.

Weather knowledge is invaluable to a hiker, who soon gains it by continual observation.

Nature Lore becomes a second nature to the out-door man and gives him a new interest and joy in life.

Camp utensils and apparatus have to be improvised, and this teaches one much handiness and resourcefulness.



INDIAN COOKING-FIRE AND MULQUAGAN.

“ Our young men helped to save Britain and Europe in the war by an exercise of their primitive instincts: the appeal was to the worst rather than to the best in their natures; to anger, pugnacity, to the will to slay.

"The finest work of all remains to be done.

"They can help to save Britain and Europe in the peace by subjugating those same instincts and exercising the highest gifts that civilised man possesses, those of Reason, Tolerance, Amity and Co-operation."

So writes Trevor Allen in *The Young Men who Won the War.*"

I would add to that, that also by using their primitive instincts of open-air living, camping and scouting, they can develop their health, their intelligence, their skill and their helpfulness, and so become better men and better citizens.

WOODCRAFT.

There is a lot in the lore and tradition of the backwoods which naturally comes to be adopted by Rovers.

The gypsies, whether in Britain, Southern Europe or the East, all have their customs, signs and languages.

The Red Indians have their picturesque tradition and ceremonial, and so too have the Arabs, the Maoris, the Zulus, the Masai, and others—all of them interesting and worth studying, since they give romantic suggestions.

I have had to do with most of these peoples; and though the Red Indian has been the most imitated, the present-day specimen is not as a rule the inspiring figure that his forefather was. Excepting the few Indians who still go trapping in the woods, the Arab (of the right kind) is the greater gentleman, the Zulu the braver warrior, the Indian gypsy the better hunter, the Maori the better sportsman, and the Australian black the better tracker. All of them have their points until they come under the deadening influence of civilisation and gin.

A true Woodcrafter loves and adopts much of the picturesque meaning of the savage arts and crafts of all such tribes.

The history and world-wide significance of Totems is a study in itself, and the practical usefulness

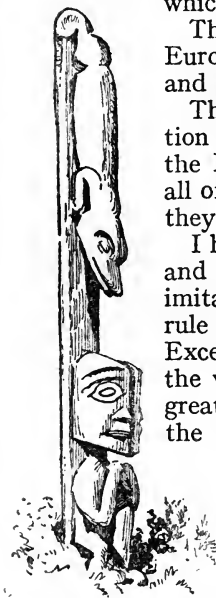

A RED INDIAN
TOTEM POLE.

of the Signs makes a universal language that is adopted and understood throughout the brotherhood of out-door men.

BE PREPARED.

“Be Prepared” is the motto of Scouts and Rover Scouts.

I have only briefly sketched these points in camping and hiking as a general indication, because after all, enjoyable and health giving as they are, they are only steps by which you go on towards your further aim—that is, to *be prepared* for manhood. Of course, if you have the good fortune to be in a newly developed or uncivilised country, they are of direct value to you.

Anyway, through their practice you gain the handiness and knowledge and the self-reliance of the backwoodsman, which makes you the more efficient for your life's work in whatever direction it may lie; you gain the appreciation of the wonders and beauties of Nature; and, more especially, it makes you efficient for doing service for others as a good citizen.

A bad citizen is the man who only looks out for his own good; the good citizen is he who is ready to lend a hand for the community at any time.

I say “ready,” not merely willing; lots of people are willing, but when it comes to the point it so often happens that they have never learnt how, so they are useless.

The Rover's business, therefore, is to learn how to be ready and how to be able to do the right thing in an emergency for the good of the rest.

I will therefore give you the further steps by which the Rover fits himself for this through the organised method of the Rover Scout Movement.

ROVER ORGANISATION

RULES.

The Rover Brotherhood has now grown so big as to require rules for its organisation and conduct.

But these rules are rules—not regulations. That is to say, they are like the rules that you have for football or cricket, necessary to make it a really fair game for everybody.

They are meant to be helpful as giving a line to go upon and not in any sense to be red tape.

Indeed, all the discipline that there is in the Movement is that which comes from freedom, from the desire within each man to "play the game" for his side; and the administration is mainly in the hands of the Rovers themselves.

RULES FOR ROVER SCOUTS

OBJECT: THE AIM OF ROVERING IS BROTHERHOOD AND SERVICE FOR OTHERS.

(N.B.—It should be noted that the Rules given in this chapter are liable to alteration from time to time, and Rover Scouts must therefore keep themselves informed through the Headquarters Gazette, "Trail," and Book of Rules.)

The object of the Rover training is to enable young men to develop themselves as

Happy	}	Citizens
Healthy		
Useful		

and to give each his chance of making a successful career for himself.

It gives the older boy the means of remaining under helpful influences at the difficult time of his life when he is just entering on manhood.

It provides Scouting for young men with its joys of Backwoodsmanship and Nature-craft. (So many men have asked me how they could get the fun of Scouting, and this gives a way for doing it.)

It helps young men of over seventeen years of age, who may desire it, to train for warrant rank of Scoutmasters or Instructors in the Scout Movement.

It gives young men the opportunity of doing useful service for others on a recognised footing.

THE PROMISE.

A promise has to be taken by each member on enrolment.

Where he has already been a Scout, there is no need to take a fresh promise; such old Scout would merely reaffirm his Scout Promise.

But anyone else becoming a Rover, without previous

service as a Scout, is enrolled and takes the Promise as follows :

INVESTITURE OF A ROVER.

The Troop is formed in a horseshoe formation with the Scoutmaster and the Assistant in the gap, with a Union Jack or Scout Flag. The Tenderfoot with his Rover Mate stands just inside the circle opposite the Scoutmaster. The Assistant holds the Thumbstick and hat of the Tenderfoot.

The Rover Mate brings the Tenderfoot to the centre. The Tenderfoot holds a bit of the flag in his hand during this ceremony.

The *Scoutmaster* says: "Do you know what your Honour is?"

Tenderfoot: "Yes. It means that I can be trusted to be truthful and honest in all that I say or do" (or words to that effect).

Scoutmaster: "Do you know the Scout Law?"

Tenderfoot: "Yes."

Scoutmaster: "Can I trust you, *on your honour*, to do your best. To do your duty to God, and the King. To help other people at all times. To obey the Scout Law."

The Tenderfoot then makes the half salute.

The whole Troop also makes the half salute while he says:

"I promise, on my Honour, to do my best. To do my duty to God, and the King. To help other people at all times. To obey the Scout Law."

The salute then ceases, and the *Scoutmaster* then says:

"I trust you on your Honour to keep this promise. You are now one of the great Brotherhood of Rover Scouts."

The Assistant then puts his hat on and gives him his stick.

The Scoutmaster shakes hands with him, with the left hand. The new Rover faces about and salutes the Troop. The Troop salute him in return. The Scoutmaster gives the word "To your Patrol," and the new Scout and his Rover Mate rejoin the Patrol.

When taking the Promise, the Rover will stand holding his right hand raised to the level of his shoulder, palm to the front, thumb resting on the nail of the little finger and the other three fingers upright, pointing upwards.

This is the Scout's Salute and secret sign as well as a reminder of the three points of his promise.

When the hand is raised shoulder high it is called "The Half Salute." When it is raised to the forehead or hat it is "The Full Salute."

ON THE SCOUT LAW.

During the Great War the Boy Scouts subscribed for and maintained several Recreation Huts at the Front for the benefit of soldiers.

On the walls of these, the Scout Law was hung up. It happened that when men were going "up the line" to the trenches at the Front, they felt that they were "up against it."

Many a man realised then, for the first time, that, though he had been taught at school as one of a herd, preached to in church as one of a herd, drilled in the army as one of a herd, he was really a single being having his own existence, his own consciousness, and his own soul, and he might now at any moment have these taken from him by Death.

It disturbed him to feel that he had no exact spiritual comfort to turn to and to take hold of. He knew little of religion or of God—yet he wanted something of the sort—he knew not what.

Then he saw the Scout Law and he read it over, and again he read it over, and thought it out.

Here was something that he could carry out and it looked like doing him good.

So he came and asked if he could "sign on to that." He felt that if he carried out its instructions as far as he could he would at least have the comfort of knowing that before he died he had tried to do his best, and no man could do more than that.

Well, we made it possible for him to sign on; and the consequence was that he whom I describe proved not to be merely one man but men in their hundreds, who came and gave their promise that they meant to the best of their ability to carry out the Scout Law.

It is much the same with you young fellows who read this.

You have largely been educated as one of a herd, you

are going "up the line" into the battle of Life, you will be called away by Death one day—it may be soon or it may be late—but when that moment comes your one thought will be, "Have I tried to do what is worth while, or have I idled away my time?"

So I suggest to you, do as those men did at the Front. Read the Scout Law, think it over, and then "sign on to it" as Rovers.

Here it is.

THE SCOUT LAW

1. A SCOUT'S HONOUR IS TO BE TRUSTED.

If a Scout says, "On my Honour it is so," that means that it *is* so, just as if he had taken a most solemn oath.

Similarly, if a Scout Officer says to a Scout, "I trust you on your Honour to do this," the Scout is bound to carry out the order to the very best of his ability, and to let nothing interfere with his doing so.

If a Scout were to break his Honour by telling a lie, or by not carrying out an order exactly when trusted on his Honour to do so, he may be directed to hand over his Scout badge, and never to wear it again. He may also be directed to cease to be a Scout.

2. A SCOUT IS LOYAL, to the King, his country, his officers, his parents, his employers, or those under him. He must stick to them through thick and thin against anyone who is their enemy or who even talks badly of them.

3. A SCOUT'S DUTY IS TO BE USEFUL AND TO HELP OTHERS.

And he is to do his duty before anything else, even though he gives up his own pleasure, or comfort, or safety, to do it. When in difficulty to know which of two things to do, he must ask himself, "Which is my duty?" that is, "Which is best for other people?" and do that one. He must Be Prepared at any time to save life or to help injured persons. *And he must do his best to do at least one good turn to somebody every day.*

4. A SCOUT IS A FRIEND TO ALL, AND A BROTHER TO EVERY OTHER SCOUT, NO MATTER TO WHAT SOCIAL CLASS THE OTHER BELONGS.

Thus, if a Scout meets another Scout, even though a stranger to him, he must speak to him, and help him in any way that he can, either to carry out the duty he is then doing or by giving him food, or, as far as possible, anything that he may be in want of. A Scout must never be a *S-n-o-b*. A snob is one who looks down upon another because he is poor, or who is poor and resents another because he is rich.

ROVERING TO SUCCESS

A Scout accepts the other man as he finds him, and makes the best of him.

"Kim," the Boy Scout, was called by the Indians "Little Friend of all the world," and that is the name every Scout should earn for himself.

5. A SCOUT IS COURTEOUS, that is he is polite to all—but especially to women and children, and old people and invalids, cripples, etc. And he must not take any reward for being helpful or courteous.

6. A SCOUT IS A FRIEND TO ANIMALS.

He should save them as far as possible from pain, and should not kill any animal unnecessarily, for it is one of God's creatures. Killing an animal for food or an animal which is harmful is allowable.

7. A SCOUT OBEYS ORDERS of his parents, patrol leader, or Scoutmaster, without question.

Even if he gets an order he does not like he must do as soldiers and sailors do, and as he would do for his captain in a football team—he must carry out the order all the same, *because it is his duty*, and after he has done it he can come and state any reasons against it; but he must carry out the order at once. That is discipline.

8. A SCOUT SMILES AND WHISTLES under all difficulties. When he gets an order he should obey it cheerily and readily, not in a slow, hang-dog sort of way.

Scouts never grouse at hardships, nor whine at each other, nor swear when put out, but go on whistling and smiling.

When you just miss a train, or someone treads on your favourite corn—not that a Scout ought to have such things as corns—or under any annoying circumstances, you should force yourself to smile at once, and then whistle a tune, and you will be all right.

The punishment for swearing or using bad language is for each offence a mug of cold water to be poured down the offender's sleeve by the other Scouts. It was the punishment invented by the old British Scout, Captain John Smith, three hundred years ago.

9. A SCOUT IS THRIFTY, that is he saves every penny he can, and puts it into the bank, so that he may have money to keep himself when out of work, and thus not make himself a burden to others; or that he may have money to give away to others when they need it.

10. A SCOUT IS CLEAN IN THOUGHT, WORD, AND DEED, that is he looks down upon a silly youth who talks dirt, and he does not let himself give way to temptation, either to talk it, or to think, or to do anything dirty.

A Scout is pure and clean-minded and manly.

HOW TO FORM A UNIT.

The unit of Rovers is the Patrol of from four to eight members. A Patrol can either be a part of a Scout Troop or an independent unit. The members should be seventeen years of age or over on joining.

A group of two or more Patrols can form a Troop. Patrols belonging to Scout Troops can join an "Association" Rover Troop without severing connection with their Scout Troops.

The Troop.—A Troop should, as a rule, not consist of more than four or five Patrols in number, and should be under the direction of a Scoutmaster and Assistant. A Troop is registered in the same manner as a Scout Troop under the Local Association.

Where its Patrols belong to different Scout Troops an additional Patrol may be desirable for receiving unattached Rovers.

The Patrol.—Each Patrol will be under a Rover Mate elected by the Patrol and approved by the Scoutmaster. He will act as its leader in all games, club arrangements, studies, public activities, etc. He will be assisted by a Second Mate selected by himself.

The Patrol is a gang, and a gang is the natural band of pals into which young men form themselves in all grades of life.

There is, however, this difference in the Patrol, that through the spirit of comradeship runs the thread of higher aspiration and mutual ambition to do good, both to oneself and to others.

Each Patrol should, as far as possible, have its own room or particular part of the Troop Den. It should form the team for games, recreation and work. Where fellows are all working for the honour of the team the standard of achievement is bound to be raised.

Each member of the Patrol should, as far as possible, have his own special duties in the work of the Patrol, such as Keeper of Camp Stores, the Scribe, the Purseholder, Hike Manager, Study Leader, Social Entertainment Manager, and so on. Also, where possible, each member should be assigned a certain day in the week on which he would be "on duty"—ready to take up any specified service or to answer any call.

When the aim of the team is not merely that of winning at games, its members will realise that Rovering is not merely taken up as a pastime for the individual members, but for the opportunity that it gives them of qualifying themselves to do good work and for doing service for their fellow men.

Court of Honour.—The Rover Mates in a Troop form the Court of Honour under the Chairmanship of one of their number elected to the post. This Committee will carry on the Administration of the Troop, including discipline, recommendations for awards, as well as the general business of the Troop, etc., etc., each department being managed by a member responsible.

The Scoutmaster has the right to attend the meetings and to speak, though he does not vote. The admission of candidates to the Troop is a matter for decision in the Court of Honour.

Uniform.—The uniform of a Rover is the same as for a Scout (*see* Rule 23, Policy, Organisation and Rules, 1922) with the following differences:—

Hat.—A Bar with R.S. thereon worn in front, on the strap.

Shirt or Jersey, with green shoulder strap marked "Rovers."

Shoulder Knot.—Red, green and yellow.

Garters.—Red.

Thumbstick.—May be carried in place of staff.

Skean Dhu (optional).—Worn in left stocking.

Service Stars.—On red cloth.

Buttonhole Badges for use in mufti, special R.S. pattern for plain clothes.

Rovers who are Patrol Leaders of Scouts wear the Patrol Leader's Hat-Badge as well as the R.S. Bar, and may wear their Patrol Shoulder Knot.

Sea Rovers' Uniform as for Sea Scouts, but (a) if Jerseys are worn, Sea Rovers' Anchor Badge worn on the right breast of the blue jersey, with cloth Scout Badge on the left breast when in uniform (buttonhole R.S. badge for plain clothes), or (b) if Scout shirts are worn, uniform is as for Land Rovers (except the hat).

The cloth Scout Badge described in Rule 23 must be worn by all Rovers when in uniform.

To qualify to be a Rover Scout a fellow has to pass

this simple test. Until he does so he is considered a "Tenderfoot" or "C3 man."

Examiner: Scoutmaster. (The Handbook *Scouting for Boys* explains the details of the subjects.)

He should know:

1. The Scout Law.
2. Signs and Salute.
3. Right way to fly the Union Jack and what it stands for, and the underlying principles of the Constitution of the British Commonwealth.
4. First-aid as for Second Class Scout.
5. Lay and light a fire and cook a simple meal.
6. Understand the use of a compass, and read a map.
7. Know how to look after his own health in matters of cleanliness, fresh air, foods, clothing.
8. Understand danger of excessive use of tobacco and alcohol, and importance of continence.

AN "A1" ROVER SCOUT.

Here are the points in which you would have to pass tests to win the rank of "A1 Rover." For this you would be tested by Examiners appointed from the Scout Local Association, and on your passing you would receive a Badge to wear which shows you have done so:—

1. Swim 200 yards.
2. Journey, hike, back-packing, 20 miles, taking two days and must sleep out one night in improvised shelter or tent carried in his pack. Make a detailed journey report (on approved lines) with a sketch map of route taken.
3. Pass the competitive standard for First Aid as defined in the St. John's or the St. Andrew's handbook.
4. Pass Campers' Badge (1922 edition Rules).
5. Judge distance, area, size, numbers, height and weight as in Scout test.
6. Thrift—knowledge of management of personal finance, savings bank, investments, and national economy.
7. Local Government and administration of justice.
8. Service for others. To possess a Rover Instructional Badge and to have made use of it by instructing others for a period of not less than six months.

9. Nature Lore—in any one of such subjects as these :—

Astronomy—Knowledge of the stars.

Bacteriology—Germ study.

Botany—Knowledge of plants.

Zoology—Knowledge of animals.

Biology—Knowledge of origin and life of living things.

Geology—Knowledge of rock history, etc., etc.

Chemistry, electricity, etc.

10. Twelve months' service as a Rover.

SPECIAL BADGES

(A) *Rambler's Badge*. The right to wear a bit of bramble $1\frac{1}{2}$ inches long, wired to the right side of the hat-band, may be granted to a Rover who has walked an aggregate of 100 miles, outside of towns, during week-end or holiday hikes.

The Rover must keep a log of his journeys, which he will hand in to the Scoutmaster for information of the awarding authority on completing his total of 100 miles.

This log should give dates, places and distances, and should preferably give information that would be of use to other hikers, such as places of interest to be visited *en route*, good camping places, inns, hints for finding the way at difficult points, etc.

All the better if sketch maps are included, and notes of Nature observed, etc.

(B) *Instructor in Scouting Subjects*. One special Badge shows that the Rover has passed a test in some Scouting subject and has proved himself to be capable of giving instruction to Scouts in that subject. Certificates to be given for each subject passed, but only one Badge.

(C) *Rover King's Scout*. The qualifying badges for Rover King's Badge are the same as for the King's Scout, but the AI test is as given above, and the standard for the qualifying Badges is as given in paragraph (B) above. The Rover King's Scout Badge is distinguished from the King's Scout Badge by a special border.

(D) *Ranger Cords*. A Rover may pass or re-pass the tests for the Ranger Cords.

The following are the qualifications for Ranger Cords. They look a bit formidable at first, but many of them are alternative.

Rover must be a First Class Scout and hold the Camper Badge, together with *either* the Naturalist or Stalker Badge, and also *one* of the following Badges :

Starman, Weatherman, or Woodman.

I give in full the qualifications for the Badges mentioned above taken from the Boy Scout *Rules, Policy and Organisation* (1s.).

Camper must :

1. Have camped out thirty nights, either in bivouac or under canvas, taking an active part in the work of the Camp.

2. Know what minimum requisites in

(a) Kit

(b) Utensils

(c) Rations

are required for seven boys for a week's camp, and have cooked all meals for them for seven days, not necessarily consecutive.

3. Demonstrate what kit he would take on a Tramping Trek by himself, and have taken part in a tramp trek of not less than three days, covering at least nine miles a day.

4. Know how to select and lay out a Camp for

(a) A Patrol

(b) A Troop forty strong
making necessary kitchens, rubbish-pits, latrines, etc.

5. Demonstrate that :

(a) He understands the use and care of an axe.

(b) He has a knowledge of knots as shown in *Scouting for Boys*, and can tie the Tenderfoot's knots blindfold.

(c) He understands lashings.

6. Demonstrate how to pitch and strike a tent capable of holding seven Scouts and carry out ordinary repairs to same.



SHEET BEND.

7. Build a shelter for three Scouts, using only natural materials, or make a suitable Patrol Tent of any old material.

Naturalist must :

1. Be able to explain in his own words :

- (a) The fertilisation and development of a wild flower ;
or
- (b) The development of a bird from an egg ; or
- (c) The life history of an insect ; or
- (d) A month's observation of pond life.

2. Keep unaided a Nature Diary for fifty-two consecutive weeks, illustrated by sketches of the animals, birds,



REEF KNOT.

trees, plants, insects, etc., recorded. This Diary to contain the date and places of :

- (a) First appearance of twelve spring or autumn bird migrants ;
- (b) First flowering of eighteen wild flowers ;
- (c) First appearance of six butterflies or moths.
- (d) The carbon impression of eighteen leaves of common British trees.

In towns one of the following alternatives may be selected in the place of (2). The Commissioners shall decide whether the area may be considered a town for the purpose of this Badge.

Make a collection of the leaves of thirty different trees— or of sixty different species of wild flowers, ferns and grasses—dried and mounted in a book, and be able to name and recognise them correctly.

Or, alternatively—

Make coloured drawings of twenty flowers, ferns or grasses from life, or twelve sketches from life of animals and birds. Original studies, as well as the finished pictures, to be submitted.

Or, alternatively—

Be able to name sixty different kinds of animals, insects, reptiles, or birds in a museum or zoological garden, or from unnamed coloured plates, and give particulars of the lives, habits, appearance, and markings of twenty of them.

Or, alternatively—

Describe the habits and recognise by their songs, calls, or voices thirty different kinds of birds or animals.

Or an alternative Badge to Naturalist is the Stalker.

Stalker. Must take a series of twenty photographs of wild animals or birds from life and develop and print them himself, and must be able to give particulars of their lives, habits and markings.

He must also have one of the following three Badges.

Starman. Must have a general knowledge of the nature and movement of the stars. Be able to point out and name six principal constellations, find the North by means of other stars than the Pole Star in case of that star being obscured by clouds, etc., and tell the hour of the night by the stars or moon.

Must have a general knowledge of the relative positions and movements of the earth, sun, and moon, and of tides, eclipses, meteors, comets, sun-spots and planets.

Weatherman. Must have kept a satisfactory record of air temperature and rainfall for at least two months; also wind, weather, and cloud for a like period; must be able to recognise halos, coronas, and aurora and the principal forms of clouds.

Must be able to read a mercury barometer and understand the action of a barograph; must be able to apply Buys-Ballot's Law, and to read the maps in the Daily Weather Report of the Meteorological Office. Must know the meaning of gale warnings and (if living on the coast) where and during what hours they are displayed. Must know for his own district the wettest month and the wettest day on record, the extremes of temperature and the prevailing winds.

Woodman. Must:

Know how to choose an axe, name its parts, and know the merits of different types and their uses.

Know the safety-first rules of axemanship; grind an axe; fell a tree of at least eighteen inches girth; trim

and log it up ; score and hew ; and split with wedges or axes.

Know how to fell with cross-cut saw and wedges, and understand the theory of the cross-cut and how to sharpen.

Know the different species of trees by their appearance, and the respective uses as timber ; and how to measure timber. Know a well-grown tree (i.e. one useful for timber purposes) from a bad one, and the right time of year for felling. Know generally the principles of levering, hauling, and stacking timber and bark usual in the locality.

Know the best woods for fires.

ROVER DENS.

Special Club rooms, called Rover Dens, should be provided for Rovers apart from Scouts, etc.

These Dens should be under the Rovers' own management and should be open every evening for work or social activity.

Patrols from several Scout Troops might, if desired, co-operate in running one Den between them and a common programme.

It is not possible to run Rovers efficiently without a Den.

One of the most successful Rover Dens—well, it is really almost a Club, because it has over 100 members—is being run in a county town. The subscription is high, 5s. a quarter. But when you compare that with other things fellows spend on, it doesn't seem so much. Five shillings a quarter would not cover their ordinary expenditure on cinemas or dances or going to football matches. Yet here it gives them a jolly good Club of their own, with all its comforts and amusements, outdoor as well as indoor. It is managed entirely by a Committee of members, each one of whom is in definite charge of a department, such as gymnasium, football, ladies' dances, outdoor activities, indoor games, public service, entertainments, Sunday discussions, Study circle, Savings Bank, etc. The expenditure for the first year of its existence amounted to £669, and the receipts came to £667, so they were not far out at their first attempt. This expenditure included rates and taxes, lighting and firing, repairs, papers, food, caretaker, etc. I only mention

it as an example, for what one Club can do others can do also.

OLD SCOUTS' CLUBS.

Clubs, Circles and Associations have been organised in the different Universities as well as in the Navy and the Army, etc., with much the same objects as the Rover Movement has, namely for mutual help in the study of Scoutcraft.

This will enable members ultimately to do helpful service for the community in their spare time, particularly in the direction of training Scouts and Wolf Cubs, conducting camps, etc., in vacation time.

"Clubs" are generally associated somehow with the idea of taking one's ease; in other words, they help minor self-indulgence and loafing.

These Scout Clubs are different they are the breeding-places of the right spirit and the starting-points for useful effort.

Old Scout Clubs are not to be confused with Rover Dens, since they are quite different; in their aims and organisation.

CIVIC SERVICE.

I don't want to alarm you with a big-looking job, but this chart is merely to explain to you the various directions into which you can explore, *if you want to*, as a Rover Scout; and these lead directly to good citizenship and service (*see* overleaf).

You are not expected to do them all, but they are alternatives so that you can take up some or others which happen to suit your circumstances.

ACTIVITIES.

Service is the keynote of Scouting for Rovers.

All Rovers should be encouraged to help in every possible way in the running of their own (or other) Troops, or Wolf Cub Packs: thus gaining the practical experience in training Scouts which helps to fit them for becoming Scoutmasters and fathers in the future: they should be given responsibility for definite departments in helping their Scoutmaster.

Co-operation and inter-patrol activities, by means of

ROVER TRAINING in CIVIC SERVICE

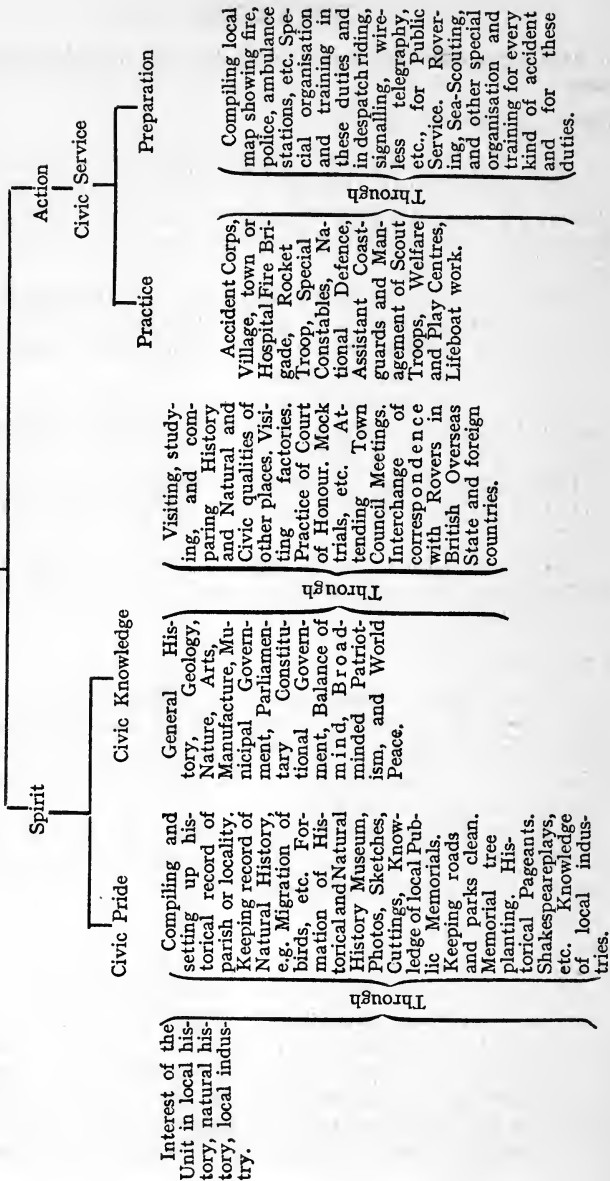

Interest of the Unit in local history, natural history, local industry.

Compiling and setting up historical record of parish or locality. Keeping record of Natural History, e.g. Migration of birds, etc. Formation and Natural History Museum, Photos, Sketches, Cuttings, Knowledge of local Public Memorials. Keeping roads and parks clean. Memorial tree planting. Historical Pageants. Shakespeare plays, etc. Knowledge of local industries.

General History, Geography, Nature, Arts, Manufacture, Municipal Government, Parliamentary Constitutional Government, Balance of mind, Broadminded Patriotism, and World Peace.

Visiting, studying, and comparing History and Natural and other qualities of other places. Visiting factories. Practice of Court of Honour. Mock trials, etc. Attending Town Council Meetings. Interchange of correspondence with Rovers in British Overseas State and foreign countries.

Accident Corps, Village, town or Hospital Fire Brigade, Rocket Troop, Special Constables, National Defence, Assistant Coastguards and Management of Scout Troops, Welfare and Play Centres, Lifeboat work.

Compiling local map showing fire, police, ambulance stations, etc. Special organisation and training in these duties and in despatch riding, signalling, wireless telegraphy, etc., for Public Service. Rovering, Sea-Scouting, and other special organisation and training for every kind of accident and for these duties.

conferences, games and work (e.g. Scouts' Signal Corps) are necessary so that troops may get to know one another, thus encouraging friendships and emulation.

Activities naturally fall under two heads:

(a) Public Service; (b) Scout Service.

(a) Efficient public service to the Community, outside their own troops. Patrols can be formed and trained as "Local Aid Detachments" for service, such as the following:

Accident First Aiders (for dealing with accidents of every kind, crowds, etc.).

Assistant Welfare Officers in factories, play centres, etc.
Coastwatchers or Assistants to Coastguards.

Cyclist Despatch Riders and Motor.

Boy Leaders in Scout Troops, Play Centres, Boys' Clubs, etc.

Defence Signallers.

Pigeon Flying.

Fire Brigade in village, town, factory, hospital, etc.

Rocket apparatus men.

Lifeboat men or launchers.

Special Constables or Assistants to Police.

Scouts' Signal and Wireless Corps.

Sea Scouts.

When a Rover Patrol becomes efficient to the satisfaction of the Police or other authorities concerned, a Certificate (to be obtained from Headquarters) of such corporate efficiency, will be supplied on the application of the District Commissioner and kept by the Rover Mate, to stand so long as the Patrol remains efficient.

(b) Service in their own Troops, as Cubmasters, Secretaries, Games Managers, Instructors, Badge Examiners, Committee Men, Assistant Scoutmasters, etc.

TEAM RECREATIONS

(Corporate, Physical and Moral Health.)

It is important that camping and outdoor games should be carried out to the utmost (and appropriate recreation and rest for Sundays should not be lost sight of). "Parlour Scouting" to be avoided. The following are examples:

Outdoors—

Athletics	Cruises on Canals and Rivers
Walking Tours	Hockey
Coasting Voyage	Hare and Hounds
Football	Swimming
Cycling	Nature and History Rambles
Scouting	Visits of Instruction to Municipal Offices, Courts of Justice, Museums, Factories, etc.
Baseball	Tours abroad to visit foreign Rovers, etc.
Gymnastics Display	
Boating	
Tree and Rock Climbing	
Camping	

Indoors—for mutual improvement, such as—

Lectures by experts on any subject, vocational or social	Orchestral Society
Choral Society	Scouts Own
Dancing	Sing-songs
Debating Society	Social evenings
Dramatic Troupe	Sketching Club
Indoor Games	Study Circles (for Badges, Civic Instruction, etc.)

It is a valuable help to get experts to come and hold informal talks and demonstrations or to conduct rambles.

CLIMBING.

I have mentioned in the above "climbing" as one of the activities for Rovers.

I know no better physical exercise than this, since it not only trains and develops every muscle in the body, but also encourages healthy living, moderation in eating and drinking and smoking, and the development of nerve, endurance and resourcefulness, besides being a most healthy, most enjoyable and manly form of recreation.

It is best done in teams, such as Patrols, working generally with a mountaineer's rope. It includes tree climbing, which in itself becomes a highly interesting sport, mast climbing, rock climbing, cliff climbing and mountain climbing.

There are many more facilities in all parts of the British Isles for this sport than is generally suspected. There is also more danger about it than may be at first thought. It therefore needs careful practice and instruction to begin with. But when once a man is good at it, it has a tremendous attraction, offers never-ending variety, and cannot fail to keep him fit and happy.

SERVICE FOR OTHERS

AN EMERGENCY CORPS.

When in Copenhagen a few years ago I was shown the organisation and working of the Accident Brigade in that city. I believe it is a voluntary organisation that exists in other parts of Denmark also, of which we have no exact counterpart in Britain. It is in the nature of the Fire Brigade and St. Johns Ambulance combined, and it offers to Rovers a particularly valuable form of public service both in towns and villages.

A good instance of the value and variety of its duties occurred at the time when I was visiting its Headquarters in Copenhagen. A call came by telephone to say that a man had been run over by a tram-car and was badly injured. They had not been able to extricate him, and the car was partially derailed. Within a minute three detachments had left the Headquarters for the scene of the accident on motor-cars equipped with all the necessary apparatus for dealing with the situation, including a gin for hoisting the tram-car, ambulance equipment for dealing with the man, and including such details as a wire basket into which to put his remains if he were too far mangled for the ordinary stretcher to be of use.

Also, there were the necessary implements and insulating



MIDDLEMAN'S KNOT FOR CLIMBERS.

gear to enable them to work safely where electric currents had to be dealt with.

The Corps was trained to deal with accidents arising out of explosions of the various kinds of gases, chemicals, etc., suicides by poison, strangulation and so on; ability to track murderers by the smallest signs; knowledge of securing damaged aeroplanes, and dealing with railway accidents, collapse of houses, falling trees, and the many minor accidents to which men are liable through machinery in factories or agricultural work, mad dogs, bulls, etc. In fact, the range of their activities is almost unlimited, varying largely according to the locality and the nature of industry, etc.

But the field for work is wide, and the training for it involves various kinds of study and activities, which are not only interesting, but useful to the men who take them up. He would be a strange man who could not find amongst these varied activities one which at least would prove to be a hobby for him when once he had acquired it. A fellow with hobbies is never likely to find time hang on his hands, or to feel that life has not got some enjoyment in it.

POLICE SERVICE.

“At the recent tragic fire in Newhaven, Connecticut, in which seven persons lost their lives, and more than seventy-five were injured, Scouts did noticeable service.



BOWLINE FOR
SECURITY.

“At three separate street crossings Scouts saw congestion of traffic with no traffic police officer on duty, and in each case stepped out into the street and directed the traffic in the pouring rain for more than two hours.

“Other Scouts did good service in aiding the orderlies in the hospitals in quickly transferring the patients from the emergency wards to the beds, making quicker handling of cases possible.”

This suggests a form of service for which Rovers or Scouts would do well to prepare themselves in co-operation

with the police officers and the Hospital Authorities in their districts.

They can learn the work of controlling the traffic, and of dealing with crowds, where the Scout uniform will give them the necessary authority.

Scouts are not allowed to use police whistles for the Scout work, for fear of creating confusion, but there is nothing to prevent them from carrying a police whistle as part of their equipment, so that on an emergency, where police help is needed, they can at once call for it.

A cyclist scout must of course be always ready to act as orderly or messenger to police officers.

SAMPLE OUTLINE OF ACCIDENT FIELD DAY FOR ROVER TROOP.

Hike or bike, map reading and observing for several miles.

(1) Halt near railway. Imagine railway accident, collision and train smash. Detail patrols to various duties. Each Mate to state how he would carry them out with materials on the spot. Improvising gins to raise wreckage. Extinguish fire. Rescue and First-Aid injured. Policing their property. Sending for help.

(2) Imagine aeroplane crash on landing in south-west gale. Overturms. Aviator pinned underneath and injured. Petrol tank takes fire. Scoutmaster gives duties to patrols. Each Mate describes how he would carry them out with the material available on the spot. Orders should include reporting the accident, and after righting the machine securing it properly, etc., etc.

ENJOYMENT OF LIFE.

A. C. Benson says in *The House of Quiet* :

“A life to be happy must be compounded in due degree of *activity* and *pleasure*, using the word in its best sense.” “I draw from Nature, ever more and more, the most unfailing and the purest joys.” “I have proved by experiment that a life beset by many disadvantages . . . need never drift into being discontented or cold or hard.”

He does not mention there, though he implies it elsewhere, that service for others makes happiness complete.

I agree with the writer of the above, that for sheer enjoyment give me the open air, and the country-side,

even if you cannot get the backwoods and the mountains. Unfortunately, most of us are restricted as regards our holidays and cannot all go far afield. None the less there are week-ends, giving the opportunity for hikes and walking tours which, though they may be short, can yet be arranged to include a great deal of solid enjoyment.

Mr. H. A. L. Fisher, the Minister for Education, has stated some rules for those about to arrange a holiday :

1. Plan your holiday carefully, but be ready to abandon your plan on the slightest provocation.
2. Never go north when you can go south.
3. A change of work is itself a holiday.
4. Never drive when you can walk, and never walk when you can ride.
5. In a cross-country walk there is seldom time for short cuts.
6. A good holiday is like eternity—there is no reckoning of time.
7. One of the best fruits of a holiday is a new friendship.
8. Stay where you are happy.
9. Soak yourself in the atmosphere of a new place before you study the details.
10. The best holiday is that which contains the largest amount of new experience.
11. Holidays come up for judgment before the next term's work.
12. In the choice of holiday books act on the principle that one of the main uses of leisure is to feed the imagination.
13. The principal experts in the art of taking holidays are painters, naturalists, travellers and historians ; the worst person to consult is a golfer.
14. On occasions a very good holiday can be taken at home if you change the hour of breakfast.

THE RESPONSIBILITY OF A ROVER.

Remember that as a Rover, besides making yourself a better man and a better citizen, you are, whether you know it or not, being looked up to by boys in your Troop and your neighbourhood. Boys are awful imitators, and I use the word awful advisedly, because it fills one with awe when one thinks what harm or what good one might be doing for the boys in the examples we set them.

They are very apt to make a hero for themselves of a fellow who is older than them, and who has won their admiration by his own personality, or by something that he has done. I was asked only the other day what it was that induced me to take up football with the energy that I did when I was a boy. I can trace it directly to the

influence of one boy older than myself. He was ultimately a well-known Association player, but at that time, when I had only just come to school, I was his fag and had the honour of holding his overcoat while he played, and of cleaning his boots and his muddy garments and giving him his hot water after the game was over. But I see him now in my mind's eye, running with that easy gait which never seemed to hurry and yet always put him in the right spot for taking possession of the ball. And I remember the fierce contempt with which he stopped a fellow who thought it manly to tell a dirty story.

From the first I longed to emulate him, and, though from that day to this he has never known of the influence he had over me, it was thanks to his example that a good deal of my life at school was fashioned.

So it is that, as a Rover or older boy among your younger brothers, you have a responsibility on your shoulders which at first you may not realise. You may be guiding many a boy to good or to bad according to what you do or say yourself.

"To be good is noble—but to teach others how to be good is nobler—and much less trouble." That is what Mark Twain says, but I am doubtful about the last phrase, since the teaching is largely through personal example; so you have to be careful.

Be careful, if not on your own, at least on their account. You can see for yourself that you have here a tremendous opportunity if you like to use it for doing a great good for your younger brothers. You can set the line for them to follow by your own behaviour in the direction of cheery and manly friendliness and straight living and clean talk.

Think for yourself whether you have any failings which you would not wish others to copy, and try and replace these with something better. Here are a few instances of the more usual weaknesses.

<p>SHORT TEMPER Do you get annoyed when things go wrong or people pin-prick you?</p>	<p>Force a smile and then laugh at the comparative smallness of the irritation. "If you are in the right, you've no need to lose your temper. If you are in the wrong, you can't afford to."</p>
---	--

- SMOKING** . . Remember boys copy you, and smoking is bad for their health. Don't smoke when among them.
- BAD LANGUAGE** Do you use swear words in moments of irritation, or dirty ones in moments of thoughtlessness? Try whistling—and drop it.
- SLACKNESS AND SHIRKING** Are you inclined to "leave it to George," as they say in America? To look on at others doing the work or playing the game, or to anticipate difficulties before they arrive? Sleeves up and lead the way. "Look at the worst, but see the best." Follow *Saint George* and tackle the job.
- BACKBITING** . Are you given to talking of other people's failings and seeing only their bad points? Go on the principle that there is 5 per cent. of good in the worst. The fun is to find it.
- IMPATIENCE** . Do you catch at sunbeams and hanker for the moon—and curse your bad luck when things don't go as you wish? "Softly, softly catchee monkey." Its dogged as does it.
"Stick to it and you'll win through."
"Patience is the secret to success in any career."
- STODGINESS** . Want of humour. As there is at least 5 per cent. of good in everything, so there is also another 5 per cent. of fun. Recognition of this will carry you through many otherwise hopeless troubles. Show your boys how to laugh while you work.
- INTOLERANCE** . Are you a possibly over-keen upholder of your own particular social class, political party or form of religion? These distinctions are sunk in the brotherhood of Scouting. Practise tolerance—teach your boys to study both sides of any question before making up their mind on it.
- SELF-DETERMINATION** This term is often used to cover disobedience, want of loyalty and Develop responsibility and self-discipline in the free spirit of

- lack of discipline. playing the game for your side, not for yourself.
- SELFISHNESS** . Is the worst failing of our race, causes short-sighted outlook and contributes to personal as well as industrial discontent. Practise selflessness, i.e. others first, self second. Look wide.
- DISCONTENT** . Generally the result of self-centredness and taking life too seriously. Make others happy and you will be happy yourself. Recognise the good in what you have got, the fun in life, the glories, wonders and beauties of Nature. Sink personal ambition.
- PESSIMISM** . . Do you let the difficulties or dangers of a venture overshadow its possibilities? "See the worst, but look at the best." Optimism is a form of courage that gives confidence to others and leads to success.
- NARROWNESS** . Do you pride yourself on your view of a question happening to be the right one? Look wider—and then look wider still.
- KNOW ALL** . . Are you convinced that you know Scouting from A to Z? Take in—in both senses of the word—the *Headquarters Gazette*.

Think out other weaknesses for yourself and also their antidotes.

A HIGH SERVICE FOR ROVERS.

Amongst the various forms of service that have been suggested, that of helping to run Scouts or Cubs may seem at first sight to be rather a small one. But when you come to look into it, it is really one of the greatest, if not the greatest among them all. It is the most easy of all to take up, since the opportunities for it lie close to your hand as a Rover, but at the same time it is one in which you can obtain big results in making men out of boys, results which are visible to you as they grow under your hand. And those results can be of the greatest value to your country.

As I have before shown, the Nation badly needs voluntary

help for its Education. There is so much outside the actual reading, writing and arithmetic that is necessary for the boys of to-day to know if they are going to make successes of their lives ; and the shortage of school time and of school teachers is a great handicap to them in learning these things ; so the help of voluntary " elder brothers " is therefore urgently needed.

Rovers, who will lend a hand in the training or management of their Scout troops or Wolf Cub packs, and especially in their camping, will be doing an immensely valuable service. It is one, at the same time, which will bring honest satisfaction to themselves. Everyone who has trained a dog or a horse to be obedient and to perform tricks knows the interest and gratification, but how much greater this is in the case of the young human animal when you see his character changing and forming on right lines for life ! Then you feel indeed that you have done something worth while.

FATHERHOOD.

There is another point to it.

Some day you yourself will be a father. You will be responsible for bringing boys and girls into the world, and for giving them a helping hand to starting successfully in life. If you fail in this and merely let them drift into wastage or misery you will be guilty of a despicable crime.

For other responsibilities in life, such as managing a business, running an engine, or laying bricks, you go through a special training. And yet for this, the greatest and most responsible of all duties, that is the fashioning of the lives and happiness of your own offspring, you do not prepare yourself in any definite way, but leave it to chance. And that is the rule of the herd. Yet what a great thing you could do them had you only the knowledge and practice of the training of the young.

Through Rovering, however, you can get your opportunity of actually practising some of the best and most useful work of a father. You can give out the right aspirations, and the healthy activities that teach the boy ultimately to " paddle his own canoe," and you will be in a position to warn him of the rocks that will lie in his course in his turn.

If men had been trained for fatherhood a few years back, what a very different nation we should have had to-day. The mass, instead of the few, would have been brought up to be steady men of character, healthy fellows, knowing how to enjoy and to make the best of life, and putting the good of others before their own selfish interests. As it was, even without this, Britain, like many other countries, possessed a wonderful proportion of good men in its manhood. But the war came and killed off the flower of these; 860,000 killed and many more maimed, sightless or nerve stricken, all of them from the best of our men, leaving the least fit to carry on the race and affairs of the nation.

RECONSTRUCTION.

In all the after-war unrest and unemployment, it was just the leaven of those best men that was needed to pull things through successfully, and to bring prosperity and happiness to our people.

Still these difficulties are not without their blessings; they open a tremendous opportunity, and a field for young men who are now coming on. You have the glorious opening before you for taking a strong hand towards reconstructing the country on a new and better footing than it ever had before. But it can only be done by the practice of Service, and not through selfish partisan strife.

We old 'uns, who in our time have tried to do our bit for the country we love, we look to you young 'uns, with every hope, to carry on. We believe that you are going to do the right thing for her, and, forgetting your own personal case, you will do your best for her too.

A HOLE IS ONLY MADE TO BE MENDED.

Now if you who read this are one who has bumped on one of the "rocks" already, I want to tell you that I was once voyaging across a lake in Canada, in a birch-bark canoe with another fellow, when we bumped on a snag.

It was not a very serious bump, but birch bark is very thin and the water began to come in through the hole, and to save ourselves we had to paddle for dear life to the nearest islet, having plugged up the hole as best we could with an old hat.

It was a pretty close race. We paddled for all we were worth, and we just got there in time as our craft was sinking.

We hauled her up on a flat, smooth rock, and got our gear out of her and rolled her over, bottom upwards.

We then set to work to repair damages by getting some of the natural gum of some fir-trees and made a little fire in which we melted it. Then, having patched the hole with some old rag and a bit of fresh bark, and the hot gum, we very soon had the boat pretty nearly as sound as ever ; and before long we were on our way again, but with our eyes more cutely on the look out this time, to avoid snags and rocks in future.

Well, that is the same with you, who may have run on a rock in your time.

Don't think that on that account you are done for. Hurry in before you sink and get your bark repaired. It may be hard to do, but put your back into it and you will probably succeed. Use the remedies I have suggested in the foregoing chapters according to the type of rock that you have run upon, mend your ways and resume your voyage with stout heart and a good look out. Having once touched a snag, you will know all the better how to avoid them ; and you can make your voyage just as big a success as any of the other fellows.

Even if you have bumped on more than one Rock, remember how General Foch, at the battle of the Marne, in the Great War, reported to Joffre, his Commander-in-Chief: "My right has been thrown back ; my left is in retreat . . . *I am attacking with my centre.*" And he won !

And so can you. Your right may have been smashed, your left may be in disorder, but you still have your centre ; attack with that and you'll pull through.

ONE WORD MORE

Now I can picture to myself you who are reading this—but you are not the fellow that I want !

You have already been taking an interest in your own future, and you want to know how to "Rove to Success." So my ideas will only come on top of others that you may have already formed. Mine may corroborate yours, or

they may be disappointing to you. In either case I hope you won't feel any the less of a friend to me.

But if you have already prepared yourself for your future, you're not the fellow I really want, as a reader of this book!

I want the chap who has never thought for himself, or planned out his future.

There must be many and many a fine young fellow in our nation being dragged down by bad influences around him, because he has never seen the clearer way; he has not known that by a little effort of his own he can rise above his surroundings and paddle his way to success.

And that is where you come in. Will you help me to get hold of that other fellow? You must know several of him in your circle of acquaintances. If you can get him to read this book I shall be grateful.

Possibly you might even go further and get a study circle of three or four of your friends to go through the book chapter by chapter, one for each evening, and discuss among you the questions I have suggested.

I don't say that you need agree with me, but I do say that the consideration of these ideas, whether you agree with them or not, will at any rate make you think a bit about your future, though I hope it may do more than that. And if you lead others on to join in their study, you will be doing a bigger thing—you will be doing *Service for Others*.

If you should like to write and ask me a few questions at any time, I shall be only too glad to do my best to respond.

If you elect to join the Rovers, as suggested in this chapter, we shall naturally be in closer personal touch; but in any case, I shall be glad if you consider that we are linked by a common bond of sympathy and good will.

For me it is nine o'clock in the evening of life. It will soon be bedtime. For you it is eleven o'clock in the morning—noon-tide; the best part of the day is still before you.



BOWLINE
SECURED BY
OVERHEAD
KNOT.

Like Friendship,
a helpful loop that
never slips nor
comes undone.

For myself I have had a most enjoyable day of it. It has had its clouds and its showers—but it has had also its glorious sunshine.

But for you—what are you going to do with your day? It can be an equally happy one if you only choose to make it so. But not if you are going to laze through it waiting for something to turn up, or are going to sleep away part of it.

Wake up! Get busy! You have only the one life-day to live, so make the best of every minute of it.

You will sleep all the better when bedtime comes if you have been busy through the day.

The fellows who have restless, sleepless nights, are those who have lazed away the sunshine.

Happiness is yours if only you paddle your canoe aright. With all my heart I wish you success, and the Scouts' wish—GOOD CAMPING.

BOOKS OF REFERENCE FOR ROVERS

Scouting for Boys, price 2s. 6d., published by C. Arthur Pearson, Ltd.

Aids to Scoutmastership, price 2s., published by Herbert Jenkins, Ltd.

Policy Organisation and Rules, price 1s., published by Imperial Headquarters.

These three books can be obtained at :—

Boy Scout Imperial Headquarters,
25, Buckingham Palace Road,
London, S.W.

The Boy Scouts' Association Headquarters Gazette, price 3d. monthly, published by C. Arthur Pearson, Ltd., 18, Henrietta Street, London, W.C.

Advice will also gladly be given confidentially on any subject, if you like to apply to me at Headquarters, 25, Buckingham Palace Road.

" SONGS OF A SOURDOUGH "

By ROBERT W. SERVICE

They've cradled you in custom, they've primed you with
their preaching,

They have soaked you in convention through and
through;

They have put you in a show-case, you're a credit to their
teaching,

But can't you hear the wild?—it's calling you.

Let us probe the silent places, let us seek what luck betides
us,

Let us journey to a lonely land I know;

There's a whisper on the night-wind, there's a star agleam
to guide us,

And the wild is calling—calling . . . Let us go.

Have you suffered, starved and triumphed, grovelled down
yet grasped at glory,

Grown bigger in the bigness of the whole?

" Done things " just for the doing, letting babblers tell
the story,

Seeing through the nice veneer the naked soul?

Have you seen God in His splendours, heard the text that
Nature renders?

(You'll never hear it in the family pew)

The simple things, the true things, the silent men who do
things?—

Then listen to the wild—it's calling you.

SOME USEFUL BOOKS TO READ

History of England. By Arnold Forster, 5s.

Elementary Civics. By C. H. Blakiston (Arnold), 2s. 6d.

*Outlines of Local Government and Outlines of Central
Government.* By J. J. Clarke (Sir Isaac Pitman & Sons),
1s. each.

A Primer of London Citizenship (P. S. King & Son), 2s.

THE HISTORY OF THE
CITY OF BOSTON

From the first settlement of the city in 1630 to the present time, the history of Boston is a record of growth and progress. The city has been the seat of government, the center of commerce, and the birthplace of many of the great men of the world.

The city was founded by a group of Puritan settlers who came from England in 1630. They were led by John Winthrop, who gave the city its name, Boston, in honor of St. Botolph, the patron saint of the city.

The city grew rapidly in the first few decades of its existence. By 1680, it had become one of the largest and most important cities in the colonies. It was the center of the Massachusetts Bay colony, and the seat of the colonial government.

The city was the scene of many of the great events of the American Revolution. It was here that the British evacuated the city in 1773, and the Continental Congress fled to Lancaster and then to York in 1776. It was here that the British evacuated the city in 1773, and the Continental Congress fled to Lancaster and then to York in 1776.

The city has been the center of many of the great movements of the world. It was here that the abolitionist movement began, and the women's rights movement was born. It was here that the city became a center of industry and commerce, and a leading city in the world.

The city has a rich and varied history, and it is a city that has shaped the world. It is a city that has been the center of many of the great events of the world, and it is a city that has been the birthplace of many of the great men of the world.

INDEX

- "A 1" Rover Scout, Qualifications for, 225
 A 44, Horse, 31
 Activities for Rovers, 231
 Advertisement, Power of, 39
 Allen, Trevor, quoted, 216
 Alpini, The Italian, 44
 Ambition, 143
 Amiel, quoted, 97
 Amusements, Value of, 82
 Andes, Alone in the, 181
 Animal World, The, 193
 Anti-crank Maxims, 168
 Ashanti Expedition, 77, 153
 Atheism, 175
 Aurelius, Marcus, quoted, 198
 Auto-suggestion, 94, 112
 Avebury, Lord, quoted, 28, 199
 Axe, The, 215

 Backbiting, 240
 Backwoodsman, A Rover, 208
 Bacon, Francis, quoted, 149, 151, 198
 Badges, Special Rover, 226
 Beard, Dan, 88
 Bees, Study of, 193
 Bennett, Arnold, quoted, 18
 Benson, A. C., quoted, 237
 Bet, My First and Last, 41
 Betting, What is the harm of, 38, 41
 "Between Meals" Glass, The, 68
 Bhutani Peasants, 118
 Bible, The, 177, 199
 Billings, Josh, quoted, 97
 Blatchford, Robert, quoted, 26
 Blue Bird, The, 17

 Boar, Adventure with a Wild, 32
 Body, The Human, 115, 187
 Books and Book-Reading, 150
 — to Read, 28, 63, 131, 151, 158, 171, 190, 199, 246, 247
 Bounding Brothers of the Bosphorus, 70
 Boxing and Prize-Fighting, 34
 Bragg, Sir W., quoted, 192
 Bravado, Herd, 106
 Breathing, 117
British Medical Journal, quoted, 116
 Browne, Sir Thomas, quoted, 27
 Browning, Robert, Anecdote of 148
 Bruce, General, quoted, 44
 "Brush Away Temptation"—poem, 98
 Bryce, Lord, 145, 156
 "Buckskin Man," Order of, 88
 Bull-baiting, 40
 Burmese, a Happy People, 16
 Bushido, The, 91
 Busiest Man, The, 79

 Caddies, Golf, 42, 48
 Caledonian Market, The, 136
 Calf Love, 122
 Campercraft, 211, 215
 Camping Club, 213
 Canoe, Paddle your own, 11, 22, 23
 Career, Choosing a, 48, 58
 Carnegie, Andrew, 19
 Cassel, Sir Ernest, quoted, 19
 Catlin and the Red Indians, 117
 Chamberlain, Joseph, 156
 Character for Career, 54

- Chesterton, G. K., quoted, 144
 Children, The Joy of, 128
 Chisholme, Anecdote of Col.
 "Jabber," 37
 Chivalry, 76, 109
 Cholera, Defeating, 95
 Christ on the Andes, 183
 Christian Belief, The, 176
 Cinema, The, 82
 Cingalese Proverb, 19
 Circus Ring, Lessons Learnt in
 a, 155
 Citizen, Qualities of a, 158
 Civic Service, 158, 231, 232
 Cleanliness, 116
 Climbing, Value of, 44, 234
 Clubs, 231
 Conscience, Voice of, 195
 Continenence, 112
 Cooking, 214
 Corinthians i. 13 quoted, 198
 Coué, The Teaching of Dr., 94
 Cuckoo, The, 135
 Cuckooism, A Safeguard against,
 149
 "Damaged Goods," Tragedy of,
 109
 Debating Societies, 155
 Dick, My Horse, 31
 Dickens, Charles, quoted, 130
 Discontent, 241
 Distance Judging, 215
 Drink and Drugs, 71
 Drummond, Professor, 196
 Egg, The Miracle of the, 104
 Electron, The, 191
 Emergency Corps, An, 235
 Empire, The Question of, 162
Enchanter's Nightshade, 143
 Energy, 58
 Englishman, Reputation of, 73
 Evolution or Revolution, 138
 Example, The Force of, 73
 Exercise, Open-air, 118
 Eyesight, 215
 Fatherhood, Training for, 242
 Firemaking, 214
 Fisher, Rt. Hon. H. A. L.,
 quoted, 238
 Fishing, Joy of, 185
 Foch, Marshal, quoted, 56, 244
 Football, 35, 158
Forest, The, 11, 28
 —, Wonders of the, 180
 Franklin, B., quoted, 197
 Freedom of Thought, 140
 Fresh Air, Value of, 116
Friendship and Happiness, 28
 Froude quoted, 97
 Frying Pan, Out of the, 164
 Gambling, 37, 63
 Gentleman, Definition of, 130
 Gillwell Park, 214
 Girl Guides as Wives, 126
 "Glory of the Garden, The"
 (poem), 170
 God the Creator, 176
 —, Realization of, 195, 178
 Goethe's Mother, quoted, 15
 Gonorrhœa, Disease of, 107
 Gorgorro, Anecdote of, 91
 Government, National, 141
 —, Local, 159
 —, One way of changing the, 162
 Graham, John, quoted, 53
 Grayson, David, quoted, 178, 187
 Gush, 147
 Hall, Fielding, quoted, 17
 Happiness, 16, 17, 18, 20
 Healthy, How to keep, 115
 Hearing, 215
 Highbrows, 142
 Hiking, 186
 Hill, John Wesley, quoted, 184
 Hobbies, Value of, 45
 Holes made to be mended, 243
 Holiday, Suggestions for, 238
 Holmes, Edmond, quoted, 27
 Hope, 61
 Horses, 31
 Horse Sense, 62
 Humour, Want of, 144
 Hump your own Pack, 27
 Ignorance, Tragedy of, 108
 Imhlala Panzi, Meaning of, 56
 Impatience, 240
 Income, Importance of, 125
 Indispensability, 60

- Internationalism, 165
 Intolerance, 240
 Investiture of a Rover Scout, 219
 Irreligion, 175
- Jiu-jitsu, 209
 Jorrocks, 47
- Kant, Immanuel, quoted, 199
 "Keep Smiling" (poem), 62
 King, The, 164
 Kipling, Rudyard, quoted, 157
 Knot-tying, 215
 Know all, 241
 Koran, quoted, 177
 Kruger, Anecdote of President,
 21
- Labour, The Position of, 142
 Language, Bad, 78, 240
 Law, Scout and Rover Scout, 221
 —, Scout, at the Front, 220
 Leadership, Loneliness of, 88
 "Liar," The word, 90
 Life, Enjoyment of, 237
 Lincoln, Abraham, quoted, 27,
 130, 184
 Lion Hunt, A, 92
 Lipton, Sir Thomas, 113
 Listening, Art of, 156
 Live, How to, 58
 Living, How to make a, 59
 Loafers, Mental and Physical,
 150
 Love, 196
 Lowell, J. Russell, quoted, 170
 Loyalty, 88
- Maeterlinck, M., quoted, 131
 Mafeking, A Story of, 77
 Mahabharata, an Indian Epic,
 179
 Manhood, 103
 Map-reading, 215
 Marriage and Love, 121, 124
 Matabele, The, 25
 Matabeleland, Adventure in, 57
 Matthew, St., quoted, 199
 Mind, The, 194
 Mitchell, Canon, quoted, 20
 Money Grubbing and Sport, 36
 Motto, Scout and Rover Scouts',
 217
- Mountaineering, Sport of, 43
 Music Halls, 82
- Napoleon and Lannes, 79
 Narrowness, 241
 Nations, British Commonwealth
 of, 164
 —, League of, 164
 Nature, Beauty of, 185, 191
 —, The Book of, 177
 — Lore, 46, 215
 — Study leading to Religion
 and Service, 196, 197
 Nogi, Self-discipline of General,
 86
- Old Scouts' Clubs, 231
 "Ole Marster" quoted (poems),
 62, 98
 Open Road, The Joy of the, 212
 Organisation of Rover Scouts,
 217
 Outlines of Science, 191
 Over-Feeding, 77
 Over-Sleeping, 78
 Over-Working, 79
- Parenthood, Responsibility of,
 128
 Parlette, R., quoted, 28, 60, 150
 Parliament, 160
 Parliamentary Voting, 159
 Patience, 58
 Patrol, A Rover, 223
 Pessimism, 241
 Pett Ridge quoted, 78, 87
 Physical Fitness, 81
 Plant Life, A Lesson from, 102
 Police Service, 236
 Poongyi, The, 17
 Pork Packer, Advice of a, 123
 Prempeh, King, 153
 Prize-fighting, 34
 Profession, Choosing a, 48, 58
 Prohibition, 71
 Promise, The Rover Scout, 218
 Proverbs quoted, 130
- Quacks, 111
 Quarles, F., quoted, 131

- Race, Duty to the, 113
 Racing, The Sport of, 34
 Ramblers' Association, 212
 Rambling Clubs, 213
 Reconstruction, 243
 Recreations, Team, 233
 Red Indians, 216
 Red Indian, Duel with a, 117
 Religion essential to Happiness, 176
 — through Nature, 176
 Republic, A New, 161
 Responsibility, 55
 Roast Goose, Advice on, 21
 Rockefeller, J. D., 20
 Rocks and Antidotes, Summary of, 201
 Rover Brotherhood, Aim of, 210
 — Dens, 230
 — Mate, Duties of, 223
 — Scouts "A 1," 225
 — —, Activities for, 231
 — —, A High Service for, 241
 — —, Books of Reference for, 246
 — —, How to become, 213
 — —, Lone, 213
 — —, Responsibility of, 238
 — —, Rules for, 217, 218
 — —, Special Badges for, 226
 — —, Uniform for, 224
 Rovering, 15, 43, 205
 Ruksak, The, 119, 215
 Rutting Season, 101
- Sahara Desert, Walking Tour in the, 19
 Sailor, Religion of the, 180
 St. George, Example of, 26, 121
 St. James, Epistle of, quoted, 170
 Salute, Rover Scout's, 219
 Salvation Army Officer, Advice of a, 148
 Samurai, The, 91
 Saving up, 53
Scouting for Boys, quoted, 75
 Scout Promise and Law, 178, 221
 See-Saw, The, 138
 Self-Cure, 96
 Self-Determination, 240
 Self-Education, 23, 149
 Self-Expression, 48, 153
 Selfishness, 241
 Self-Indulgence, 83
 Self-made Merchant, Letters of a, 49
 Service Essential to Happiness, 130, 157
 Service the Keynote to Rovering, 231
 Service, Robert W., Poem by, 247
 Service, Suggested Forms of, 235
 Sex Instincts and Risks, 101
 Shackleton, Sir E., quoted, 16, 88, 186
 Shakespeare quoted, 177
 Shame, Effect of, 92
 Shell, Uncle John, 82
 Shelley, Dr., 190
 Silence, The Art of, 156
 Slackness and Shirking, 240
 Smoking, 74, 77, 240
 Smuts, General, quoted, 164
 Snobbery, 145
 Socialist Leaders, 142
 Soul, The, 196
 Spartan Training, 24
 Sport, True, 40, 43
 Statesman and Politician, 156
 Steed, Wickham, quoted, 39
 Stevenson, R. L., quoted, 28, 212
 Stick-cutting, 47
 Stodginess, 240
 "Story Book, The" (poem), 198
 Success, 15, 244
 Summary, 201
 Swaffer, Hannen, quoted, 19
 Swazi Chiefs, The, 120
 — Queen, The, 74
 — Training, 25
 Swearing, 78
 Syphilis, Disease of, 107
- Teeth, 117
 Temper, Keep your, 88, 239
 Temptation, 105
 Tenyson, Lord, quoted, 62
 Tents, 215
 Theatricals, Value of, 156

- Thrift, 50, 52
Thrush, Advice from the, 97
Thurston, Temple, 179
Times quoted, 145
Tips and Tipping, 91
Totem of St. George, 26
Tracking, 214
Trades Unions, 142
Travel, 152, 167
Troop, A Rover, 223
Truthfulness, 90
Tubthumpers, 136
Twain, Mark, quoted, 62, 176,
239
- Unit, How to form a Rover, 223
University Students, Self-Edu-
cation of, 153
- Valentine, B. B., 14, 62, 98
Venereal Disease, Danger of, 106
Voyage of Life, 11
- Ward, Artemus, quoted, 62
Weaknesses, Some Usual, 239
Weather, Knowledge of, 215
Wells, H. G., 60
White, Stewart E., quoted, 11,
13, 28, 207
William of Wykeham, 87
Wine, 67, 83
Women, 101, 122
Woodcraft, 216
- Young, G. W., 63
- Zulus, The, 25, 118

INDEX

1. Introduction
 2. General Principles
 3. Methods of Investigation
 4. Results of the Study
 5. Conclusions
 6. Appendix
 7. Bibliography
 8. Index

1. Introduction
 2. General Principles
 3. Methods of Investigation
 4. Results of the Study
 5. Conclusions
 6. Appendix
 7. Bibliography
 8. Index



AIDS TO SCOUTMASTERSHIP

A Handbook for Scoutmasters on the Theory of Scout Training by Sir Robert Baden-Powell. Crown 8vo. 2s. net.

Scouting is not an abstruse or difficult science; but rather a jolly game if you take it in the right light. At the same time it is educative, and (like Mercy) it is apt to benefit him that giveth as well as him that receiveth.

The term "Scouting" has come to mean a system of training in citizenship. It is complementary to the more scholastic training in the schools.

The principles are the same for both Boy Scout and Girl Guide movements. It is only in the detail that they vary.

The book does not contain a set of definite stepping-stones to complete knowledge; but suggests the line which has been found successful, and gives the reasons for it. Suggestions are more whole-heartedly carried out when their aim is understood.

HERBERT JENKINS, LTD., 3 YORK STREET, ST. JAMES'S, S.W.



- Q The Herbert Jenkins' Wireless is published monthly and it is priceless. In other words it will be sent post-free to all book-lovers—and others.
- Q It tells all about the latest Herbert Jenkins' Books. It also contains many good stories and interesting personalities—in the best sense of the term.
- Q There are facts about authors and fictions about publishers. Above all there is real information about books, not just press-opinions and other people's opinions, but what a book is about.
- Q One enthusiastic reader of The Herbert Jenkins' Wireless writes that it has enabled him to discontinue his subscriptions to Punch and The Times Literary Supplement!
- Q The Star in big headlines refers to The H. J. Wireless as "Gingering up the Book Trade," and goes on to say that "nothing so ingenious has yet been issued in this country." Are you going to send for it to Herbert Jenkins Ltd., 3, York Street, St. James's, London, S.W.1?

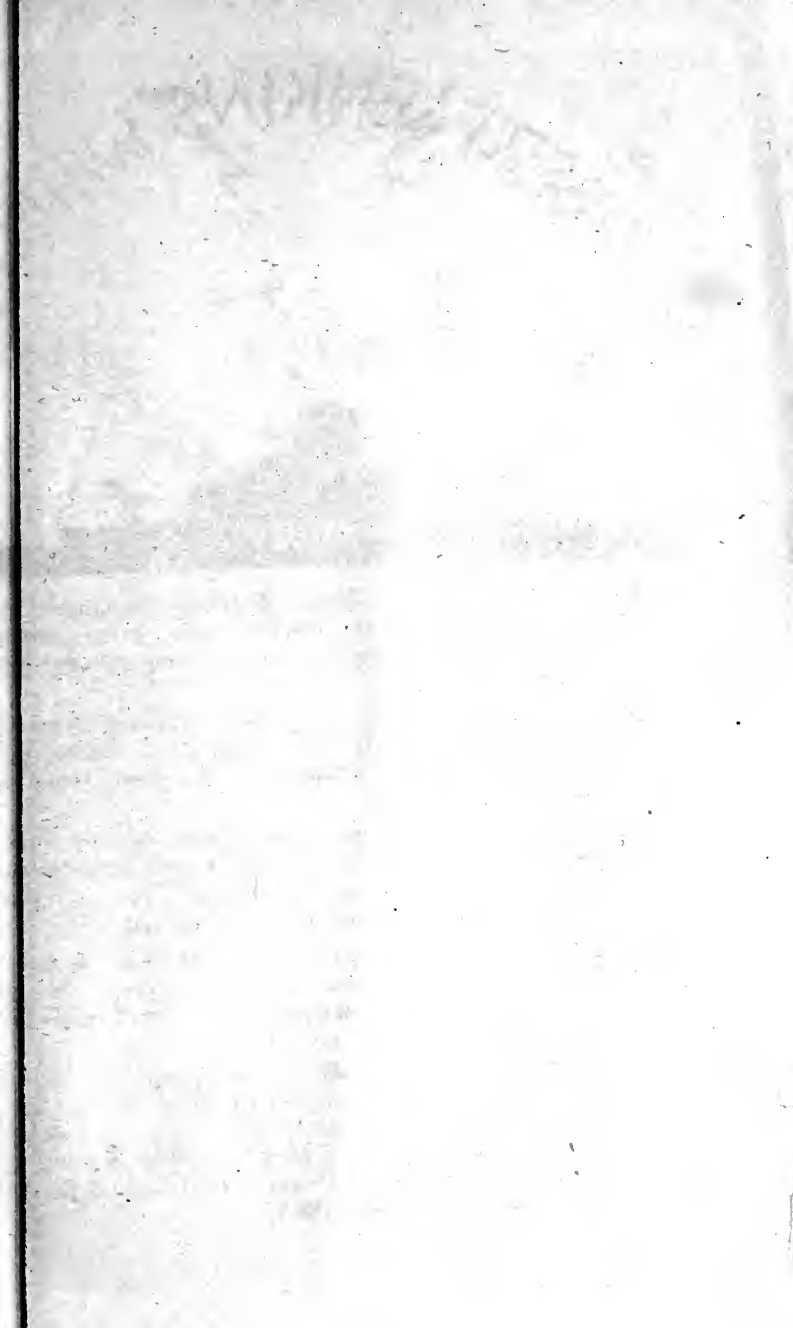



LIBRARY

SEP
29
1987

OF TORONTO

UNIVERSITY

**PLEASE DO NOT REMOVE
CARDS OR SLIPS FROM THIS POCKET**

UNIVERSITY OF TORONTO LIBRARY

HS
3312
B37
1922
C.1
ROBA

