

SF
271
M75
4th ed.



Cornell University Library
SF 271.M75 4th ed.

A. B. C. in cheese-making; a short manual



3 1924 003 012 998

01 1991

ALBERT R. MANN
LIBRARY

NEW YORK STATE COLLEGES
OF
AGRICULTURE AND HOME ECONOMICS



AT
CORNELL UNIVERSITY

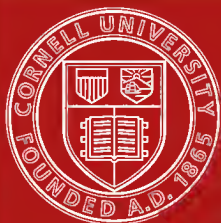

Cornell University Library

The original of this book is in
the Cornell University Library.

There are no known copyright restrictions in
the United States on the use of the text.

The "SWEEPSTAKE" Babcock

MILK TESTER.

**Ball
Bear-
ings**

The bottles
are at the
bottom

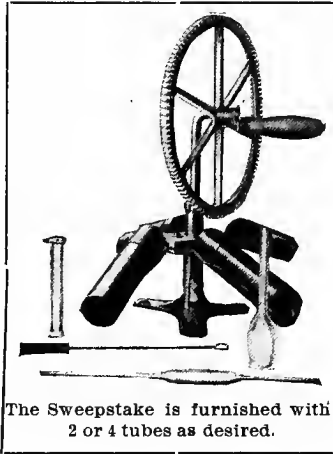

The most
practical,
highest
speeded,
easiest
running
tester
made . . .

**The Best Hand Tester in the World and En-
dorsed by Leading Dairymen as Such.**

GENERAL AGENTS FOR ALPHA-DE LAVAL SEPARATORS

Boilers and Engines.

Rennet Extracts.

Sanitary Ideal Milk Pump.

Farrington Ripeners.

Elgin Style White Ash Tubs.

Parchment Paper, etc.

Simplex Combined Churn.

Refrigerating Machines.

Potts Pasteurizers.

Penn Wood Split Pulleys.

Stearns' Style Spruce Tubs.

Fairchild's Creamery Cleaner.

Wells, Richardson & Co.'s Improved

Butter Color. Climax Heaters.

The Talcott Improved Pasteurizer.

Hansen's Butter and Cheese Color.

Disbrow Combined Churn and Worker.

The Ideal Tester. Victor Engines.

Spruce Tubs. Cadillac Butter Salt.

Lusted Printers. Australian Boxes.

Fairchild's Kno-Germ Odorless Disinfectant.

Creamery Package Manufacturing Co.,

1, 3 and 5 W. WASHINGTON ST., CHICAGO.

BRANCHES: Kansas City, Mo.; Minneapolis, Minn.; Waterloo, Ia.; Omaha, Neb
and Cowansville, Quebec.

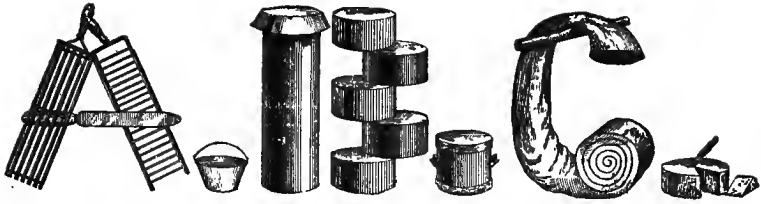

— IN —

CHEESE-MAKING

A SHORT MANUAL FOR FARM CHEESE-MAKERS

— IN —

CHEDDAR, GOUDA, DANISH EXPORT (*Skim Cheese*),

BRIE, FRENCH, NEUFCHATEL AND CREAM CHEESE;

SOUR MILK CHEESE, SUCH AS "HAND" CHEESE,

COTTAGE "SCHMIERKASE," "PULTOST" AND "NIEHEIMER":

ALSO "WHEY CHEESE" (*Norwegian.*)

John H. — BY —
J. H. MONRAD
WINNETKA, ILL.

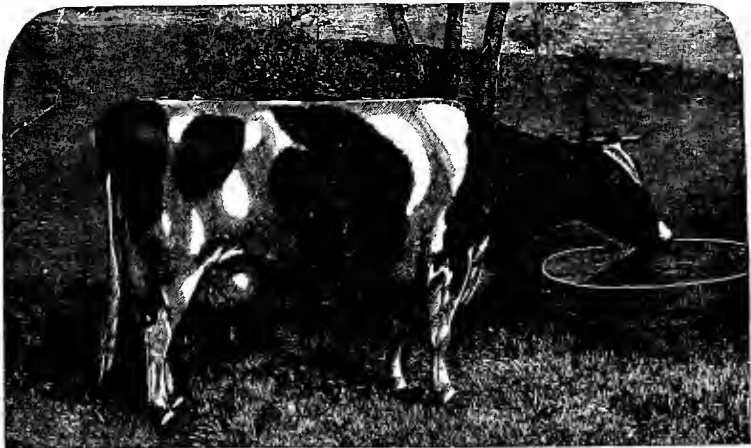

Clothilde 1308

FOURTH EDITION ♡ ♡ PRICE 50 CENTS

myk

SF

271

M75

4th ed

A 127653



EX-GOVERNOR W. D. HOARD,
Editor *Hoard's Dairyman*, Ft. Atkinson, Wis.

No other name is so intimately identified with the Dairy Interest of the United States and in his sermons preached on the text, "Remember, the cow is a mother, the calf is a baby," he has given the keynote to successful dairying.

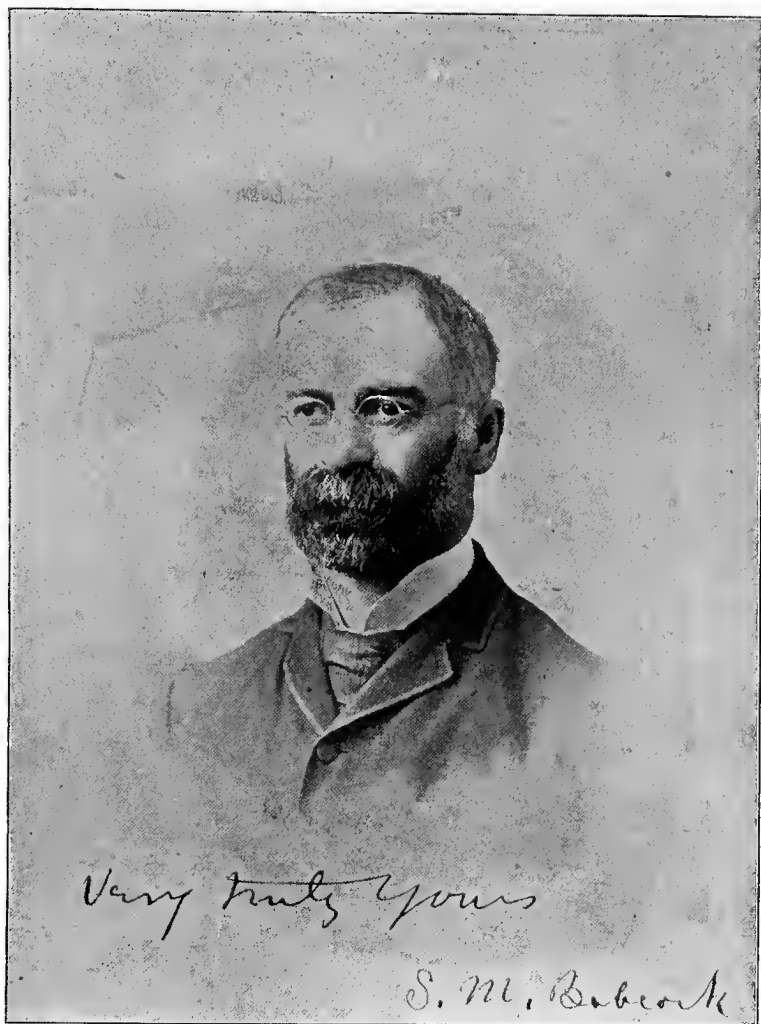

S. M. BABCOCK, PH. D.

S. M. Babcock, Ph. D., was born (1843) and reared on a dairy farm in Oneida County, N. Y. In 1866 he graduated from college and returned to the farm for a few years. In 1870 he studied chemistry at Cornell University, being assistant to Prof. Caldwell from 1875 to 1877, when he went to Germany for two years, studying under Wobler Huebner. After two years' further work at Cornell, he was appointed Chemist at New York Experiment Station, leaving proof of his ability in the annual reports, 1885, 1886 and 1887. Since 1887 Dr. Babcock's name has been connected with the Wisconsin Experimental Station, and his studies of the fat globules in milk, the viscosity of milk, and lately his work on cold curing of cheese, in connection with Dr. Russell, etc., have proved him to be the best milk chemist in America. His milk test has created a revolution in the milk business, the effect of which has hardly yet been realized even by our most advanced dairymen. High tribute as I am bound to give him as a scientist, I cannot close this short biography without paying him just as high tribute as a "teacher." I have several times, when in Madison, sat on the benches with "the boys," and, young and old, they all follow his plain talk with the greatest interest. Good natured, he is always ready to explain over again to the dull ones, and he is certainly an ideal teacher. To know Dr. Babcock is to love and respect him.



MR. JOSEPH HARDING.

Mr. Joseph Harding may be called the father of the Cheddar System, not that he made the first Cheddar Cheese (that was made hundreds of years ago, when the village of Cheddar was "famous for capital Cs—Cliffe and Caverns and Cheddar Cheese"), but he was the first man to systemize it, and to teach rational cheese-making, and his memory is dear to all good cheese-makers. He not only left his mark as a cheese-maker, teacher, and writer, but also left a large family of excellent cheese-makers. One son is the pioneer cheese-maker in New South Wales; another I met in New Zealand, where he operates several factories; one daughter is married to Mr. E. G. Jenkins, who now lives on the old homestead in Marksbury, where I saw a grand-daughter of Harding make cheese. Another daughter is married to Mr. G. Gibbons, of Tunley, who took sweepstakes for cheese at New York Show, in 1878. Thus his good work is going on, and will go on as long as cows give milk and cheese is made.

INTRODUCTION

TO FIRST EDITION, 1889.

IT is not my intention to write an elaborate treatise on cheese-making,—I should but make a failure of it,—but to give a little advice to those farmers who are placed in the same position in which I have been, that is, “as a pioneer farmer, with a few cows, low prices for butter, good prices for cheese among the neighbors, and no cheese factory or maker within convenient reach from whom a few lessons might be had.”

The fact that I did not get further, by the end of two years, than to find out that I did *not* know how to make a really fine cheese, need not, according to many precedents, be an objection to my writing on the subject.

Those who wish to run a factory can only learn their trade by several years' apprenticeship in a factory,* combined with careful study of books and papers.

Though the A B C is written as a guide for farm cheese-making, I cannot abstain from making a few remarks to remove the impression that I should be in favor of general farm dairying—compared with creameries and cheese factories—far from it! While it is quite certain that better butter and better cheese may be made on the farm, where the maker controls the feeding of the cows and the handling of the milk; yet, when this good butter or cheese comes on the market it is drowned in the large quantities of bad and indifferent produce, and sold at a lower price than its intrinsic value entitles it to, unless indeed sold direct to private customers. If a dealer is offered 100 tubs of *uniform* butter, grading in third class, he will pay more for them than for 100 tubs of mixed quality from first class down to fifth or sixth, even though the *average* quality be as high or even higher grade than the 100 tubs of uniform butter. Herein lies the solution of the conundrum of so many hard-working farmers' wives: “Why do my 10 pounds of butter, which in reality are better than the N. N.'s creamery butter, not realize within four cents a pound of his?”

*and, I may add now in 1902, a course or two in a dairy school.

Yes, we live in an age calling for uniformity, and the demand for it extends to all trades, to all manufactures. Thus while hundreds and thousands of farmers, with less than forty cows, may find it to their advantage to make and market their own butter, and exceptionally their own cheese, the creameries and cheese factories are, and always will be, a blessing to the great mass of farmers, especially so in the great Northwest. But to get the full benefit of this system, the farmers must learn to do their share of the work *honestly*.

I do not refer to actual fraud by adulterating the milk, but to honesty in feeding and watering the cows; *honesty* in cleanliness and care of the milk by cooling, and *honesty* in prompt and regular delivery. If the farmers would do this, their reward would come—it may be—slowly but surely in the shape of better returns. A system of *strictly* co-operative factories will be the only way to promote this honesty—to educate, effectually, through the pocket-book. We may have gone too far in our ambition to make large *quantities* in one place, and consequently sacrificed *quality*.

If any young lady (whose father has only from six to twelve cows) is wondering what to do, let her look round among her neighbors who have no children, or only young ones at home, upon whose honesty she may rely, and start a co-operative creamery or cheese factory, *after training for that occupation*, and I venture to say that she will be more happy than in the school room or shop, and make quite as much money.

This kind of small factory should not handle more milk than will make 100 pounds of cheese or 60 to 100 pounds of butter per day, and if we ever get schools for training butter and cheese-makers, we may even thus obtain uniform *quantities* without loss in quality. A strictly co-operative factory is one owned and paid for by the farmers, in proportion to the size of their herd. It is one where the milk is paid for not only in proportion to the *quantity* of milk delivered but to the *quality* as well.

There is plenty of room for both the private and co-operative dairy, and we should all strive to work in unison. I would not have written this lengthy introduction, if I had not feared that this publication might have been understood to encourage a general return to farm dairying.

WINNETKA, ILL., 1889.

J. H. MONRAD.

PREFACE TO SECOND AND FOURTH EDITIONS.

It would be false modesty not to express my satisfaction at the call for a second edition of this little book.

Considering the letters I have received from those who read the first edition, I presume I am right in extending it somewhat. Since 1889 we have been endowed with Dairy Schools in several states, and in some of them the making of several kinds of cheese is taught. Nevertheless there are thousands of farmers' wives and daughters who cannot afford to go to a school and who want to make cheese, and it is to this class that I dedicate this book. Too little cheese is eaten in America and less on the farms than in the cities. There are several reasons for this, notably the making of a lot of poor half or whole skim cheese, which are palmed off by the retailers as full cream at an enormous profit. But I really believe that ignorance of the nutritive value of a full cream cheese is also to blame for it. How many housekeepers realize that—as Prof. Sheldon says—: “Pound for pound cheese contains more nutriment than butcher’s meat, and it may with advantage be used instead of it, and especially so, as they may both be called animal food.” Think of this, you pioneer farmers’ wives who ring the change on bacon and eggs and eggs and bacon, with only an occasional stop for the expensive “butcher’s meat” or the festive chicken. Where creameries take the milk, and are not prepared to make cheese for the patrons and where there is no factory in the community, it will certainly pay some of the farmers to make enough cheese for themselves and their neighbors if not for shipment. Why deprive yourself of one of the cheapest and healthiest luxuries, a well cured, honest, full cream cheese or the still cheaper, equally healthy nourishment, a well made and properly cured skim cheese?

Part of this book does not exactly belong to an “A B C,” but I believe that very often the making of cheese on the farm may develop into a cheese factory by making up the milk from the nearest neighbors at first and thus emphasize the benefit of cooperation in this as in so many other things. When this stage is reached, there will not be found any superfluous information in the reading or the advertising matter.

In publishing the fourth edition, I have only to thank those of my readers who have sent me kind and encouraging letters, and to state that the book has been revised and brought “up to date.”

J. H. MONRAD.

THE BASIS OF SUCCESSFUL DAIRY FARMING.

The testing of each cow at least once a week as to quantity and quality is the basis of all successful dairying, as in only too many cases the poor cows in a herd eat up the profit of the good ones. Better to have six good cows than twelve medium good. The Babcock Test enables any farmer to determine the value of each cow's milk as easily as an expert chemist, and no farmer who owns ten cows or more ought to be without one, unless they belong to a "Test Association." Dealers in Dairy Supplies all keep these testers and give full directions for their use, but I advise always to buy of a responsible firm who will guarantee the exact graduation of the bottles, the proper speed and no vibration, even if it cost a dollar or two more.

I have inserted the picture of Dr. Babcock because the importance of his invention cannot be over estimated, and I want every Dairy Farmer to know him as their best friend.

COMPOSITION OF MILK.

"Milk is an emulsion of butter-fat in a watery solution of albuminous matter (casein or cheese matter and albumen), milk sugar and mineral matter."—*Dr. S. M. Babcock.*

One hundred pounds of milk consists on a rough average of $87\frac{1}{2}$ lbs of water and $12\frac{1}{2}$ lbs of solid matter, namely:

Water	$87\frac{1}{2}$ pounds
Butter fat (making about 4 pounds butter)	$3\frac{1}{2}$ pounds
Albuminoids (casein and albumen).....	$3\frac{3}{4}$ pounds
Milk-sugar and mineral matter.....	$5\frac{1}{4}$ pounds
	100 pounds

While the butter-fat may vary from $2\frac{1}{2}$ pounds up to 7 pounds, the casein and other solids only vary from $8\frac{1}{2}$ to 10 pounds. It will thus be seen that of all the constituents of milk the butter-fat is most variable.

New milk is worth, say, 90 cents per 100 pounds on an average, and skim milk is valued only at 15 or 20 cents per 100 pounds, even if judicious feeding ought to make it worth 25 or 30 cents.

While at the first glance it seems unfair to value milk for cheese-making, according to the butter-fat, as the other solids do not vary nearly as much, yet it has been demonstrated that, practically, the cheese yield varies nearly in proportion as the fat, because the more butter-fat a cheese contains the more water it is able to retain, and its intrinsic value increases with the fat.

COMPOSITION OF CHEESE.

In 100 pounds of good average cheddar cheese (full cream) we find about:

Water	32 pounds.
Butter-fat	35 pounds.
Casein	26 pounds.
Milk-sugar and mineral matter.....	7 pounds.
	100 pounds.

Roughly estimated, full cream cheese consists of one-third each of water, butter-fat and casein. As milk contains about $3\frac{1}{2}$ per cent. each of butter-fat and casein, we should therefore obtain 11 pounds of cheese from 100 pounds of milk, if all of the fat and casein could be got into the cheese. As a matter of fact, however, part of these matters is lost in the whey, and consequently we only get from 9 to 10 pounds of cured cheese from average milk.

WHAT THE CHEESE-MAKER HAS TO DO.

"The extremely fine globules of *butter-fat* are evenly distributed through the whole mass of new milk. If the milk is left to stand for some time, the butter globules will rise to the top, forming with some of the watery solution a layer of cream, whereas the other solids remain dissolved in the water.

"If sweet milk is left to sour, the milk-sugar turning into lactic acid, it will lopper or thicken, the *casein* or cheese matter being precipitated or changing into an insoluble matter. By adding some other acid, as muriatic or acetic acid, the same thickening takes place in sweet milk.

"A similar precipitation or separation of the casein is caused, without the presence of any acid, when *rennet* is added to milk under favorable conditions. We say that the milk curdles or coagulates. But the composition or quality of the precipitate (curd) produced by rennet is different from that formed by acid, and while acid is used for making a few peculiar kinds of so-called cheese, like the German "*Schmierkase*," or cottage cheese, it is only by the help of rennet that regular cheese can be made. When the milk is thickened by rennet, it is at first one uniform mass, but assisted by cutting or gentle stirring, and by heat, the whey in which the albumen, milk-sugar and mineral matters remain dissolved is soon expelled, leaving the casein combined with some water, and

enclosing the butter globules, as a solid matter which forms the cheese.

"In composition *albumen* is very much like casein, but it differs from the latter by not being coagulated by rennet. It may be coagulated by boiling, however, and in Switzerland the so-called Zieger cheese is made by boiling the whey and skimming off the coagulated albumen.

"In ordinary cheese-making the larger part of the albumen, milk-sugar and mineral matters remain in the whey, and do not enter into the cheese."—*J. D. Frederiksen*.

Let us now first briefly consider the main points in the treatment of the milk and curd, before describing each manipulation more fully.

The aim of the cheese-maker is to separate the casein and butter-fat in combination with water, from the other matters in the milk, in such a manner as to obtain the special kind of cheese which he wishes to produce.

The butter fat, being in a state of emulsion, needs no special device to make it separate; indeed, the object is rather to retain it in a fine emulsion (mixture), until the separation of casein takes place, that the fat may be distributed (or encased) evenly in the cheese. The first step, therefore, is to coagulate the casein with rennet.

RENNET

is an extract of the fourth stomach of a calf, that never had anything but its mother's milk (that of a pig or lamb may also be used). The difficulties of getting a uniform home-made rennet preparation are great, and the least taint is highly dangerous, therefore, when Chr. Hansen, of Copenhagen, Denmark, some 37 years ago introduced his liquid Rennet Extract, he was hailed by the Swiss, French and English cheese-makers as a public benefactor; and though there are some equally good extracts in the market now (such as Van Hasselt's), his Extract and Rennet Tablets are justly considered as standard. The little extra cost of using a reliable "commercial" rennet is nothing compared to the advantage of having a pure and uniform rennet.

To obtain the best results, it is important that the milk should be in the right condition and of the right temperature; also that the right quantity of rennet should be used, so as to produce a curd which will develop as desired at the latter stages of the process.

The milk being curdled, the next step is to *cut or break the curd*, so as to allow the whey to escape. In order to further expel the whey, the curd is then heated up towards 100 deg., which is called *cooking or scalding*. Next the *whey is drawn*, and a certain degree of *acidity* is allowed to develop in the curd, or most of the whey may be left on the curd until the proper amount of acid has developed. To check any formation of acid beyond the desired amount, the curd is then *salted*, and finally it is *put to press*. On leaving the press, the cheese is placed in the *curing-room* to ripen.

These are briefly the main stages in the process. Each treatment is destined to assist or check the effect of another, and must be varied according to the condition of the milk or curd.

GUESSWORK NOT ALLOWABLE.

Measuring milk, or, still worse, "guessing" at the quantity should never be done. The only right way is to weigh the milk. A *reliable* thermometer is also highly necessary, and the cheese-makers who, to save a few cents, buy a rennet preparation or cheese color made by incompetent or unreliable manufacturers, deserve their inevitable punishment—that is—a cheese which is not uniform and often off flavored. There are surely enough uncertainties to combat in cheese-making, without wilfully increasing their number. Weigh the milk, measure your rennet extract and color, weigh your salt, and weigh your cheese when taken from press and when sold. Make a memorandum of every little detail, not only in the manufacture, but in the other circumstances, such as the temperature and the moisture of the air, etc., and study the effect on each cheese! If you do this, you will learn twice as quickly as those who neglect it. I give a table (page 13) of Cheese-making Record (also adapted for skim-milk cheese), which I used myself, and which any one may modify to suit himself, inserting of course a column for the per cent. of fat in the milk by the Babcock Test, and the relative moisture in the curing room. While I shall not waste printers' ink on preaching cleanliness, I may say, that unless it is observed in the highest degree, we admit not one but hundreds of uncertainties into the manufacture; in fact, just as many different fermentations, which our lack of cleanliness may breed.

TREATMENT OF THE EVENING'S MILK.

MY FLANNEL STRAINER.

The best strainer I found to be (1) a fine wire one to catch any hairs or straws that might be in the milk, and (2) a piece of white flannel, which I suspended on the four nails that kept four pieces of sticks together. The sticks to be long enough to rest on the can or tub into which the milk is strained, and the flannel to be allowed to sag in the middle. It will astonish some people who think they strain their milk well, if they will try to run it through the flannel afterwards! A new piece must be provided when the old one "felts" so much as to make the straining too *slow*.

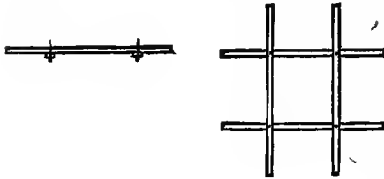

Fig. 1.

The evening's milk should be strained into common shot-gun cans (Fig. 2) or any suitable vessel which in warm weather is placed in cold water or otherwise kept cool till next morning, and it is a good plan to stir the milk well before going to bed, partly to help it cool quickly and aerate, partly to prevent too much cream from rising. Many makers lay great stress on aerating the milk as well as cooling, and if the air in the room is *pure*, it can do no harm; but I confess that I have no belief in the talking and writing about the animal odor, which should be expelled. In nine cases out of ten the animal odor will be found to be "muck," which too often gets into the milk, and which no straining will separate! Aerating in any special manner is not necessary with *pure clean* milk; but, as that is very hard to get, several devices have been constructed for the aeration of milk. This aeration is obtained by causing the milk to run in fine streams through the air before reaching the can and the simplest I have seen is a bucket (with perforated bottom) placed about two feet above the milk can. (Figure 3 represents one sold by D. H. Burrell & Co.) The

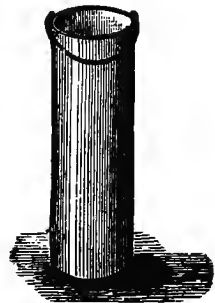

Fig. 2.

milk is then strained into this bucket. I need not warn against setting the cans in any place where the milk may absorb taint from the atmosphere. On an average, it is best to have it cooled down to 70 degrees before going to bed. Most factory cheese-makers maintain that the night's milk should only be cooled slightly or not at all but only aerated by dipping or otherwise as it is desirable to have it ripen to a certain extent; how much, depends on the quality and condition of the milk. Nor can it be denied that such as the average milk delivered to the factories is, the aeration and its following development of Lactic acid bacteria seems to tend to check the development of any taint bacteria, and in so far is desirable, but I must remind the

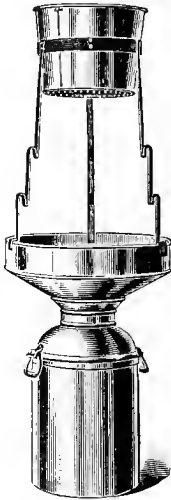

Fig. 3.

that cold also delays the development of bacteria and hence I believe in those combined aerators and coolers. Of these I mention first of all those constructed on the "Lawrence" plan such as the "Star" (Fig. 4), the "Reid" and Vermont Farm Machine Co.'s cooler, and those constructed on the Schmith plan, like the clipper made by Sturges & Burn Mfg. Co. (Fig. 4½).

Where water is scarce and ice has to be used the Champion (Fig. 5), or similar coolers which are constructed on the plan of McPherson's Cooler, may be preferred.

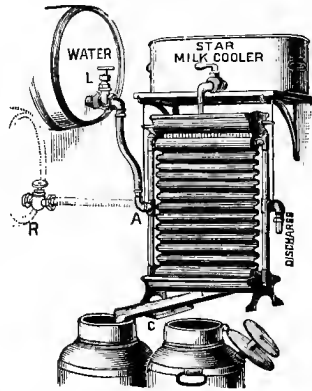

Fig. 4.

PREPARING FOR "SETTING" THE MILK.

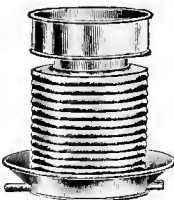

Fig. 4½.

I shall suppose we have 74 lbs. evening milk and 126 lbs. of morning milk (we have set aside milk for the calves and the household from the evening's milk, and only taken new milk for the baby and youngest calf from the morning's milk). After weighing the morning's milk it is at once strained into the cheese-tub, and

covered with a light wooden cover, or with a clean cloth, supported by a couple of sticks laid across the tub (vat). The tub or vat ought to stand in a room *at best* in a temperature of 70 deg., but *never* in a drafty place. I had considerable trouble on stormy days, when I had my vat standing on a veranda. We then skim the cream off the evening's milk, and take along with it enough milk to make, let us say, 30 lbs.; this is put aside in a can to be heated.

For cheese-tub (See Fig. 17) may be used any common tub, or a tight wooden box, not more than 20 inches deep. A whiskey barrel cut in two makes a very good tub, but should be made perfectly smooth, so as to be easy to clean; but the cheapest in the long run is to get a box lined with good tinned steel.

The remainder of the night's milk (44 lbs.) is poured into the cheese tub, and stirred into the morning's milk, and the temperature, when taken, is found to be, let us say, 77 deg. The thirty lbs. of cream and milk is then heated, so that when it is mixed with the other milk the whole mass is 82 to 84 deg. How high the 30 lbs. should be heated *may* be guessed at, and the result will be that if we get it too cold we must dip out some milk and heat again, or if too warm we must cool it, by means which I shall describe later. But the right way to do it is to save manual labor, by a little brain work, and to calculate the exact temperature to which the 30 lbs. should be heated.

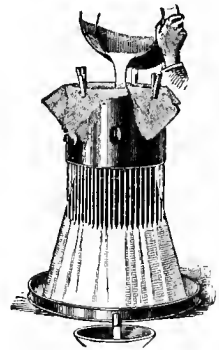

Fig. 5.

We have 170 lbs. of milk in the vat, at a temperature of 77 deg., which we wish to raise to 84 deg., or 7 deg. higher. Multiply 170 by 7 and we get 1190, divide this with the number of pounds of milk (and cream) which we wish to heat—in this case 30 lbs.—and we get 39 2-3 deg., to which the 30 lbs. shall be heated over and above the 84 deg., or 123 2-3 deg. *But* as no portion of the milk should ever be heated above 120 deg., we take 33 lbs. and heat it to 120 deg.

HOW TO HEAT AND COOL THE MILK.

If we have an open boiler, the milk is heated in a shot-gun can or tin bucket placed right in the boiling water, but it must be stirred all the while unless the water is as low as 140 deg., when it may be left alone, though the heating takes much longer if not stirred. This way of heating I have found the best, as it is always necessary to have a large boiler for heating water for cleaning purposes, and is much safer than heating it over a direct fire. The cooling may be done either by placing the can holding the milk in a tub of cold water, stirring the milk all the while, or, if the milk is in a tub, by filling a can, carefully cleaned on the outside, with cold water or ice and stirring the milk with it. If a shot-gun can is hung in a cord over the center of the vat, a child can keep it moving in the milk with one hand, holding the thermometer with the other.

ADDING THE COLOR AND RENNET.

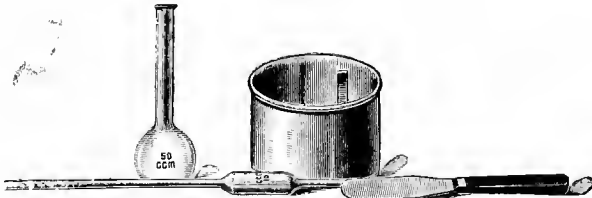

Fig. 6.

We now have the 200 lbs. of milk at 84 deg., and if we are afraid that it is not ripe enough, we may adopt the old cheddar system, used by the late Joseph Harding (the father of systematic cheddar making), and add some sour whey. I do not recommend it, as *it is a dangerous practice*, and may propagate fault from one day's milk to another; yet it has been used by some very good makers. The safest plan is to heat up the milk a little higher and leave it for an hour or two to cool down to 84 deg. while it ripens. Or we may use a starter prepared from the lactic ferment or culture used for cream ripening. But this knowledge of the right condition of the milk for adding the rennet is one of the nice points in cheese-making, which experience only can tell. Mr. R. J. Drummond, of Ingersoll, Canada, who lectured in Scotland and gave practical lessons, used what he calls the rennet test, first introduced by Mr. J. B. Harris, of Antwerp, N. Y. He measured off 4 oz. milk at 84 deg. into a cup, and, from a

very fine measure, added 1 dram Hansen's Rennet Extract. If coagulation commenced in 26 seconds he added the rennet; if it took longer, he let the vat stand. I have suggested a more accurate test for factory makers (Fig. 6) whereby 5cc (cubic centimeters) rennet is diluted with water to 50cc and of this 5cc is added to 160cc milk. In any case it will be more accurate to measure the rennet with a pipette rather than a measuring glass. The later-discovered Marshall Rennet Test (Fig. 6½) is, however, much simpler and should be used in every factory. It consists of a graduated cup (a) in the bottom of which there is a very fine hole. The Rennet extract is diluted in the glass (c) by measuring 1cc with the pipette (b) into the water in the glass previously filled to the mark. 1cc is taken of the diluted extract



Fig. 6½.

and after filling the milk into the cup the rennet is added the minute the milk is run out to the upper mark, and stirred with the spatel (d). The whole is sold in a neat box shown in the illustration. The sweeter the milk is the more will run out before coagulation stops it. Thus if the cheesemaker has found that when the milk stops running at the 3 mark, his milk is in the proper condition to add the rennet, then he wants the test to show 3 every day, and if it shows 4 or more he will ripen the milk more by letting it stand some time warm (with or without the addition of a starter) before adding the rennet, repeating the test at intervals until it shows 3. If, on the other hand, the test shows 2, the maker will know that his milk is already too sour and he will hurry on the manipulations, and take such measures as experience has taught him to be necessary in such cases in order to get a good cheese.

Before adding the rennet we must carefully stir in the coloring; this is essential, and it is safest to dilute the color with water before adding it. Hansen's Color Tablets are very handy as they can be sent by mail. If liquid rennet extract is used, it is then measured off in the graduated glass (Fig. 7)

at the rate of 2 to 4 ounces for 1000 lbs. of milk, or 5 to 10 drams for 200 lbs., according to the quality and condition of the milk. (For farm cheese-making Hansen's Rennet Tablets are very handy to use. The number of tablets required are counted, dissolved in pure water, and the solution is added to the milk). Stir well for four or five minutes, and stir now and then gently on the surface, up to within five minutes of *commencing* coagulation, so as to prevent the cream from rising, but take care to stop in time, that the coagulation be not disturbed.



Fig. 7.

Cover the vat, and if a reliable uniform rennet is used in the right quantity, it may be left for about half an hour without any attention, while we chop a little firewood or otherwise amuse ourselves. After that it must be watched closely, and whenever the curd breaks or splits clean before a finger passed through it, it is time to cut it.

CHEDDAR CHEESE.

DIFFERENT QUANTITIES OF RENNET USED.

When, in the spring of 1887, I visited Mr. D. M. McPherson, of Lancaster, Ont., who controls 66 factories, he used $3\frac{1}{2}$ ounces of Hansen's Extract for 1000 lbs. of milk, but said he should use less later on. With an extract of uniform strength, it depends upon a great many things how much to use. I have heard Prof. Robertson, another Canadian expert, recommend to use as much as 8 ounces, and, if the cheese is to be cured at the modern extreme low temperatures, that may not be too much. Yet I believe that the following rule holds good: "Much rennet—quick ripe and early decayed;" and this balancing of the work of the acid and the rennet is another fine point in cheese-making.

Commencing coagulation shows in about one-third of the time it takes to be ready for cutting. Thus: If *commencing* coagulation shows in 20 minutes, it will be ready in 60 minutes. A cheddar cheese ought to take from 45 to 60 minutes. The tendency in later years has been to commence cutting rather earlier and placing the total as $2\frac{1}{2}$ times longer than the time

in showing commencing coagulation will be nearer the mark. Thus if it shows *commencing* coagulation in 20 minutes, it will be ready to cut in 50 minutes, but of course no fixed rule can be laid down. Always use measuring glass, Fig. 7.

CUTTING THE CURD.

If the curd is left without cutting, it will take hours for the whey to separate and show partly on top of the curd, but by cutting it, the pores of the curd are opened, and the whey escapes. The cutting may be done by any knife long enough, which can be made at home of tin or of hard wood (Fig. 8). The blade should be 20 inches long; if of wood, not more than $\frac{1}{4}$ inch thick and 2 or 3 inches wide, and it should be sharp on both sides, and perfectly smooth. With this the curd is cut crosswise into 6 or 7 inch squares (Fig. 9), taking care that it is cut right down to the bottom of the vat. Having done this it is well to leave the vat covered for five



Fig. 8.

minutes. The next implement to be used is a common skimmer (Fig. 10) with which the curd is gently broken by inserting it slowly and then gently lifting it up, allowing the curd to *break* by its own weight (Fig. 11). When the whole mass is thus reduced to cubes of 2 or 3 inches, it is left again for about 5 or 10 minutes. The next tool used can also be made at home, and consists of 3 pieces of wood (Fig. 12), joined together with 10 brass rods, 10 inches long, $\frac{1}{8}$ inch thick, with about one inch space between the rods. The middle piece of wood is extended into a handle. With this shovel the curd is gently stirred, break-

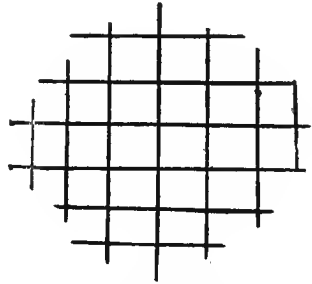

Fig. 9.



Fig. 10.



Fig. 11.

ing up the pieces, until they average only $\frac{1}{2}$ or $\frac{1}{4}$ inch in diameter. If the cheese is inclined to be too dry, do not cut

quite as fine; if too moist, cut finer. This operation should be made carefully, so as to keep the whey clear and not cloudy or milky. An old rule says that you must be able to use the whey as a looking glass, and I suffered agonies by not being able to see my face clearly; but according to what I have seen later at some of the best cheese factories, I believe that standard to be a little too high!



Fig. 12. If cash is available, and the making more extensive, it is well to invest in a vertical (Fig. 13) and a horizontal (Fig. 14) knife. The vertical knife may be imitated at home, as I did, with five pieces of smooth



Perpendicular

Fig. 13.



Horizontal.

Fig. 14.

hoop iron, 20 inches long, riveted together, one or $\frac{3}{4}$ inch apart, in a handle of wood (Fig. 15). When these knives are used, cut the curd with the vertical knife crosswise at right angles, the same as when using the single knife; leave five minutes, and then cut with the horizontal knife, and you have the curd at once in one or $\frac{3}{4}$ inch cubes. This is the triumph of American invention, so far as cheese-making is concerned. When the horizontal knife (Fig. 14) is used, there is no need of the



Fig. 15.

shovel (Fig. 12). Some prominent makers advocate the use of the horizontal knife first, and others claim it does not matter which.

COOKING OR SCALDING THE CURD.

Both these terms are misleading. The object is to heat the curd gradually to a point favorable for expelling the moisture. This is done by dipping off some of the whey, heating it to 140 deg., and pouring it back into the vat. When the curd is fine, as above, it is left to settle, and as soon as possible, part of the whey is dipped off into a can or tin pail. I have found

it very convenient to insert a common large hair sieve into the mass, allowing the whey to get into it, and then dip it out with any cup or can that comes handiest. This will prevent any particles of the curd from getting into the whey, which is heated up to 140 deg. If it takes too long to heat the whey, the curd should meanwhile be stirred up gently to prevent it from matting. In reality there is less damage in keeping it well stirred than in allowing it to mat, as in the latter case, new surfaces will be opened on the little curd pieces, and more butter fat allowed to escape. A common hay rake, with the handle cut short, will do to stir with, or better still (especially for large vats), is McPherson's rake, described later on. For a small round tub, I have found that a wooden handle of same shape as that shown on Fig. 15, with long, round wooden teeth, instead of the hoop iron, will do the stirring satisfactorily. For factory use the Pohl Automatic Curd Agitator is highly recommended by New York state cheese instructors.

When the dipped off whey is 140 deg., enough is poured back into the vat to raise the heat of the whole mass about 2 deg., stirring all the while, and for five minutes afterwards. This is to ensure that every little particle of curd assumes the same temperature. Then more whey is added to raise it another 2 deg., and so on, with five minutes stirring between each addition, until the whole mass is from 96 to 102 deg.

Here is a nice point in cheese-making. The heating of the curd promotes acidity, and acidity promotes the separation of whey, and as a standard cheese should have about 30 per cent. of water, we must, by experience, learn to know how to combine the effect of coarse or fine cutting with low or high "cooking," in order to obtain the desired result.

In my description above, I have followed the old accepted cheddar gospel—to be very slow in raising the heat; as the theory is, that by heating too quickly, the curd pieces contract too suddenly, and a skin forms which keeps the whey enclosed instead of allowing it to escape. But McPherson is of another opinion. He thinks that the skin formed by contraction is enough to hold the butter-fat, but that it allows the whey to filter through; and I saw him heat up a vat 8 deg. in twelve minutes.

He is certainly one of our most successful commercial cheese-makers, making hundreds of tons of *uniform* cheese;

but for the very finest, *slow curing* cheese, perhaps old Harding was right. His daughters and grandchildren, all successful cheese-makers, adhere to the slower cooking of the curd. Perhaps it is a case of "many roads leading to Rome!"

REDUCE THE WHEY IN THE VAT.

During the "cooking," the whey is reduced so as to just cover the curd; this will enable us to draw the balance quickly, when ready for it.

HOT WATER MAY BE USED.

In order to use the first whey dipped off perfectly sweet, for feeding purposes or for making whey cheese, hot (140 deg.) water may be substituted; and it is well to remember that the *value of the whey* depends on its not getting sour. Sweet whey in connection with bran will astonish those who never tried it for pig-raising, or even for calf-raising.

THE "COOKING" PROCESS MUCH SIMPLIFIED.

If we can afford (instead of the plain tub) to get a square tin-lined vat, 20 inches deep, and large enough for our purpose, it will save labor, and if the tin vat is placed in the wooden one,

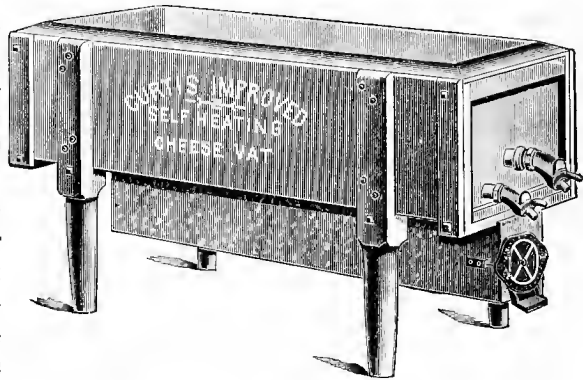

Fig. 16.

so as to leave 2 or 3 inches room for hot or cold water, much labor is saved, and if it is intended to extend the manufacture,

AN OUTFIT FOR CHEESE-MAKING FROM TWENTY-FIVE COWS

may be bought at the following prices:

1 86 Gal. Self-heating Vat (similar to Fig. 16).....	\$45 00
2 Press Screws (Fig. 30).....	5 00
1 Vertical Curd Knife, 6 blades.....	2 00
6 7-inch Cheese Hoops with Followers.....	9 00
(Or 2 14½-inch Hoops with Followers, \$5.00).	
1 Dipper.....	75
1 Curd Rake.....	35
1 Set Stencils ...	1 50
2 Thermometers.....	50
1 4-oz. Measuring Glass... ..	50
Total	\$64 60
	more or less.

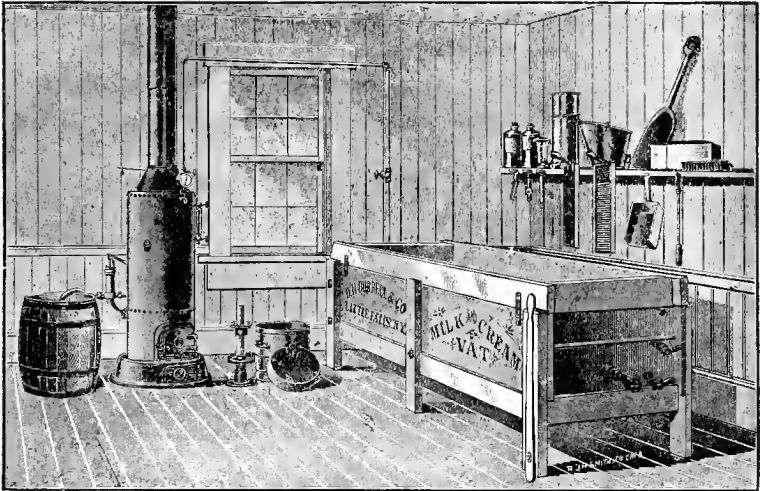

A FARM CHEESE DAIRY.

Or, as steam boilers now are so very cheap and handy for other purposes, it may be found more satisfactory to buy an outfit as illustrated in "a farm cheese dairy," and the following estimate, which may be modified, should be enough for a forty cow dairy will cost about:

1 100 Gallon "B. & W." Steam and Water Cheese Vat.	\$35 00
Improved Upright Dairy Boiler, or Steam Heater.....	35 00
1 8-Blade Perpendicular Curd Knife.....	2 00
1 4-in. Horizontal Curd Knife.....	2 75
Single Y. A. Gang Cheese Press.....	25 00
10 Y. A. Gang Press Hoops, 7 in. diameter.....	13 40
1 heavy Upright Press Screw, with nut complete....	2 50
3 14½ in. Upright Press Hoop.....	5 00
1 1 gallon Dipper.....	65
1 Curd Rake.....	75
1 Set Stencils for 9 months.....	1 50
1 4 oz. Measuring Glass.....	20
2 Thermometers.....	50

\$123 20

Make up your mind how many cows you propose to milk, estimate the maximum milk yield and then write to the various dairy supply houses and get estimates.

At the World's Fair a very simple and cheap outfit (Fig. 18) was shown by Mr. Armstrong, and consists of a square vat with a double bottom, giving a water space, a lamp to heat it, two knives and a simple press; it is all there is needed to make 10 lbs. of cheese.

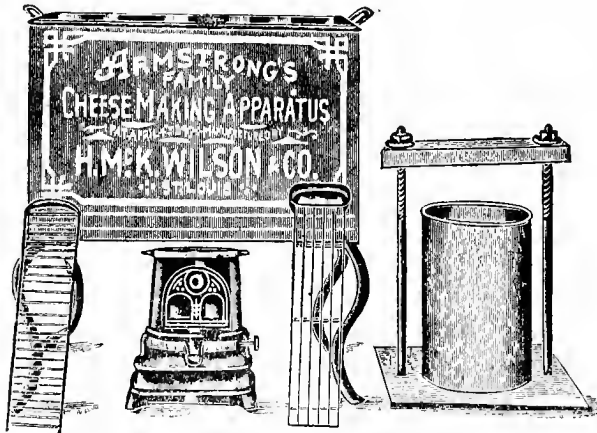

Fig. 18.

STIRRING THE CURD.

The curd is now stirred until it feels "shotty," or is hard enough to rub between the fingers without sticking together. And here again we meet a point which requires experience and careful watching. After this point is reached, the curd is allowed to settle, and the *whey is drawn*, by placing the vat or tub a little slanting (Fig. 17), piling the curd up at one side.

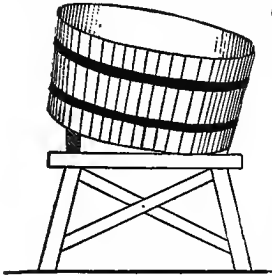

Fig. 17.

A small hole with a plug in may be used to draw the whey, thus saving the trouble of dipping it out. The whey should be got off before any perceptible acid has developed, and the curd is then left to drain, it being kept covered, so as to keep the temperature from falling too much. In one place in Scotland I saw them cover it with several layers of bagging dipped in hot water.

CHEDDARING THE CURD.

While lying thus for about 30 minutes, the curd will mat together, and incisions are made with a knife to promote the draining of the whey. Later it is cut into cubes of about six inches, and these pieces are changed, so that the outside pieces come in the center, and thus an even heat is maintained through it all. Every 30 minutes the pieces are subdivided and turned, keeping them well covered. Acidity develops, the whey drains out (perfectly clear now), and the curd assumes a darker color. The cheese is "cheddaring" or ripening. To decide when it is ripe is the last of the more difficult points.

If a piece is torn with the fingers, it should show fibers like the muscles in a piece of meat. The smell should be—as the late Prof. Arnold aptly described it—like the breath of a healthy cow in pure air, and the feeling should be soft and velvety. This is as near as it can be described, but there is another test, which is very extensively used, though not by ALL good makers; this is the

HOT IRON TEST.

Mr. Norton, the originator of the pineapple cheese, claims to be the inventor; but I have also heard that honor being credited to one of the well-known Scotch cheese-makers, Mc-Adams. Be that as it may, when a little practice is obtained, this test seems to work pretty exactly, *if the circumstances are the same*. It was Mr. Drummond who first drew my attention to the fact that a draught in the room would affect the test; the amount of whey left in the curd will also affect it. Take a piece of the curd, squeeze it in your hand, and apply it with a steady hand to a piece of hot iron (not too hot; just enough to make a drop of water simmer on it); if the curd is ripe it will adhere, and if the curd is slowly pulled from the iron, fine silky threads will form, and the length of these determines the acidity. They should not be less than one inch, and seldom more than two inches. If the curd is not ripe it will not adhere at all, and as soon as the threads are $\frac{1}{2}$ inch long you must watch carefully.

SUBDIVIDING THE CURD.

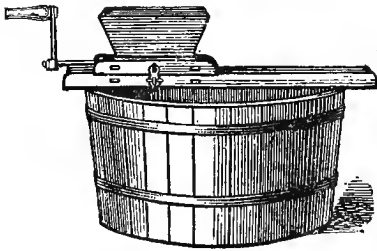

Fig. 19.

When the curd is ripe it is torn by hand into pieces like hickory nuts, put into the "hoop" (described later on), and pressed lightly for about half an hour; taken out again and made as fine as hazel nuts. This work is the greatest objection to the old cheddar system for those

who must do it by hand and cannot afford a curd mill costing from \$15 to \$20. A great many constructions are in the market, but they may be divided into two classes, the peg mills and the knife mills. The peg mills illustrated in Fig. 19, as well as the very popular Pohl's curd mill, Fig. 20, tear the curd apart, while the knife mill cuts it. One of the best-liked knife mills is the Harris mill, Fig. 21, of which several modifications are made. Both kinds have their advantages and admirers, suffice it to remark that the curd from mills which tear it

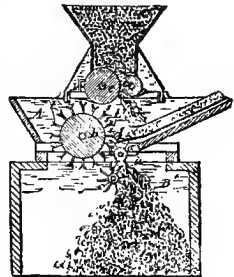

Fig. 20.

apart, closes better in the press. Curd from the knife mill requires more pressure, but it is claimed that it causes less loss of fat.

SALT AND SALTING.

When the curd is "ground," good dairy salt, but not too fine, is added at a rate of 2 to 3 lbs. to the curd from 1000 lbs. of milk. Many cheese-makers seem to think that any salt is good enough but I need not remind the readers that the best is none too good.

I confess that I like a salt with a grain to it, so that when sprinkling it on the cheese it does not mush like fine sugar when sprinkled on berries. I also prefer a salt which does not dissolve too quickly.

The grain should not be hard and sharp, but, taking it between the fingers, it should be soft, smooth and flaky. Chemical purity is of less importance than the physical condition. Most of the salt offered for dairy use are sufficiently pure, while but few are of the proper physical condition, of the most suitable *grain*, so as to dissolve none too quickly. While coarse barrel salt should never be used, a too fine salt is not as good for cheese-making as a coarser grained one which dissolves slower. It should also be remembered that salt takes taint easily, and hence great care should be used in handling it, and dealers who show this care should be patronized.

Of English brands I prefer the "*Ashton*," it has stood twenty-five years' test. Of American brands, the "*Genesee*," and the "*Diamond Crystal*" have years of good reputation, and lately the "*Cadillac*" is also gaining favor.

Too little salt allows the cheese to ripen too fast and too much salt will make the cheese too dry and prevents its curing properly. It goes without saying that the salt must be distributed evenly in the curd.

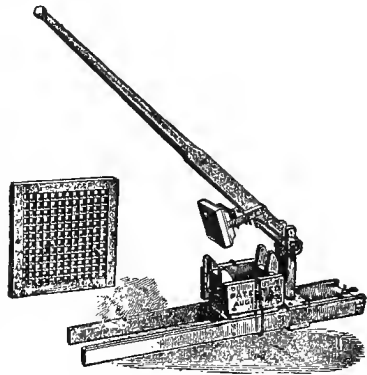

Fig. 21.

The first effect of the salt is to harden the curd, making it "gritty," but later it becomes soft and smooth as before.

After salting, the curd is cooled by spreading it on a table which is set a little slanting, and on which are 4 or 5 laths, covered with a cheese cloth. This table represents the "curd sink" in the cheese factory, and should, if possible, be provided with grooves, that will lead the whey into a bucket at the lower end. When cooled to about 70 or 80 deg., according to season, it is filled into the molds or hoops. If too warm, fat will be pressed out; if too cold, the curd will not be pressed close enough.

THE HOOPS.

The best hoops are made of heavy tinned or galvanized iron, but one can be made of wood by any cooper, if only care is taken to have it perfectly straight and smooth inside (see Fig. 22), and the follower (Fig. 23) made to fit as close as possible without being too tight. For a small farm, one having a diameter of 7 inches and 12 inches deep is best, as the

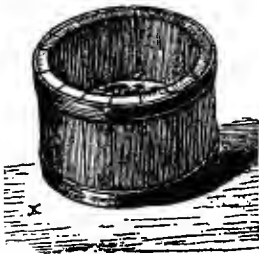

Fig. 22.



Fig. 23.

weight of the cheese will then be from 8 to 10 lbs., so called "Young America." Lately seamless hoops of pressed steel have been introduced by Sturges, Burn & Co.

I have seen a hoop made by simply cutting off a section of a round log, scooping the center out, leaving a rim of only $1\frac{1}{4}$ inch, and with two pieces of hoop iron to strengthen it. Good cheese can be made with such a hoop, but one of tinned steel is not very expensive and is easy to keep clean.

FILLING THE HOOP.

A piece of cheese cloth is carefully placed in the hoop, so as to have the folds as smooth as possible before filling in the curd. When it is full, the edges of the cloth are laid smoothly over, and the follower put on. A splendid invention is the rubber or fibrous "press-rings," which are placed under the follower, as it prevents the curd from crowding out on the

sides, and the consequent paring of the cheese. The price is, I believe, not more than 15c for a 7-inch ring, and it pays for itself in a month.

Cheddars are pressed from 48 to 72 hours, and should be turned after one hour and the cloth changed; then after two hours, and later every twelve hours. In the States I have never seen them in press more than 24 hours.

When pressing in the bandage (which may either be sown at home or bought "seamless") the cloth is not used, and it should be remembered that the unstarched bandages are the best.

AMOUNT OF PRESSURE NEEDED.

For pressing a cheddar cheese the final pressure should be 600 or 700 lbs. for a 10 lb. cheese, and one ton or 2400 lbs. for one weighing 60 lbs. Some makers place the pressure at 18 lbs. for every square inch of the end surface of the cheese; but the first two hours the pressure should be very gentle, and never more than one-third of the final pressure, which should not be applied until after twelve or fifteen hours. Pressure should also be regulated by the temperature at which the curd is put to press. The warmer the curd, the less pressure is needed. It also requires a heavier pressure when a "knife" curd mills is used than when a peg mill, or when torn by hand. As to the press, see later on. If a good close rind does not form, it may help to dip the cheese for a few minutes in water about 150 deg., and put it to press again.

CURING THE CHEESE.

When taken from the press the cheese is only half made—in fact it is no "cheese," it is only a compressed lump of curd; it is then bandaged by sewing a piece of cheese-cloth round it. If the cheese is large, a strong piece of sack-cloth is laced as tight as possible, and some makers (in Scotland) used to iron the ends with a flat-iron, to get a firm and smooth crust. The shelving on which the cheese are cured should be smoothly planed and wider than the cheese. The room should be well ventilated, but without draught; the temperature used to be considered best between 60 and 70 deg., and no one need fear bad results, if they can keep it as low as that, but modern experiments have shown even better results between 50 and 60

deg., and some even believe that 40 deg. will be the ideal temperature. These lower temperatures have no interest for farm cheese-makers and will have the effect (of rather a doubtful value) of necessitating a centralizing of the cheese making industry.

The more uniform we keep the temperature the better it is, and the air must not be too dry nor too damp. The cheese should be turned every day during the first month, and twice a week during the next month; later on, only once a week. When needed they should be rubbed with grease to prevent cracking; for this purpose, the cream raised on the whey (if set in a vat), or butter, or at best the so-called fly-proof grease, may be used.

It is greatly preferable to have two curing rooms, one above ground, the other in a cellar. Indeed the proper curing of cheese is but very little understood and only during the last few years has any attention been paid to this important matter. Thus in Canada ice has been used during the hottest season, and the subearth ducts gained ground in Wisconsin, while lately the experiments in that state by Drs. Babcock and Russell indicate the advantage of actual cold storage for the cheese. It matters not how it is done, but complete control of temperature and moisture should be secured. It is true, as long as cheese-makers ship curd instead of cheese we cannot expect much interest in the matter, yet even if cheese is only kept in the curing room for one short month, it will pay to study not only the best temperature, but also the best degree of moisture. Long and careful experiments should be made in this direction by our Experimental Stations.

A good cheddar cheese is not fit for eating until it is three months old, and should *improve* until it is ten or twelve months old; it should be mellow, and have a rich "nutty" flavor; and, if old, have a sharp, but not "pungent" taste.

THE TRUE CHEDDAR TOO MUCH WORK.

I confess that when working a pioneer farm, I found the true cheddar cheese too much work, and I have described that system chiefly to give the principles in cheese-making, which may be modified in a hundred ways; but, also, because the cheddar is the most prominent cheese in the world!

A MODIFIED CHEDDAR,

or a cross between the true cheddar and the "greased lightning" made American cheddar, seems to be preferable to make on a small farm. It is made exactly the same up to the point when the curd is cooked, when, instead of drawing the whey, the vat is covered and left 30 or 40 minutes, but in no case long enough to let the curd mat together; then stir it up again, and so on until the curd is ripe, which personal experience and the hot iron test show; then the whey must be drawn as quickly as possible, and the curd kept from matting by stirring all the while during the salting and cooling. Instead of loose cloth a sewn bandage, or, better still, a seamless bandage, is placed in the hoop and the curd filled in and pressed into the bandage, which remains on it until it goes on the table. Scale boards (boards as thin as shavings) can be bought to put on the ends of cheese, and when the bandage is pasted on these boards, the cheese is practically protected against flies (these are only sold for large cheese). These are not used now and cloth circles are used instead, the scale boards being used loose in the box to prevent the cheese from sticking.

"MANY ROADS LEAD TO ROME."

This system of keeping the curd in the whey, and by occasional stirring, preventing it from matting, saves the labor of sub-dividing after it is matted together; as the acid develops quicker in the curd, when it is covered by a large quantity of whey, than in the small quantity of whey left in the curd when "cheddaring," it hastens the ripening, and enables the maker to go to press several hours earlier, if he so wishes. On the other hand, it requires to be watched very closely, as too much acid may develop before you know where you are, and the consequence will be a dry cheese with a very poor flavor. The whey must be drawn very quickly, and it is safest to start drawing it a little before the iron shows one inch threads. But whatever system we use, the same (or nearly the same) result may be arrived at with either. It has been a great puzzle to me, all the learned writing and talking about the "sweet curd" system *versus* the acid system. It seems to me, after having seen some first class makers use both systems,

that there is in reality very little difference between the two, *provided* that both makers work with the same aim.

In one case the acid develops slowly, and can easily be controlled, owing to the small quantity of milk sugar (whey) in the curd; in the other case it develops quickly in large quantities of whey *outside* the curd, and communicates itself to that *in* the curd; consequently it is harder to control.

The hurrying of the ripening, which is the fashion, and—may I say it?—the curse of American cheese, is quite another thing; but to get at a certain result with the same milk, it takes a certain heat; a certain quantity of rennet, and a *certain grade of acidity*. Let the latter be developed, either while the curd is in a large quantity of whey, or in little whey left in the curd, it matters not. But, in the first case, the feeding value of the whey is diminished.

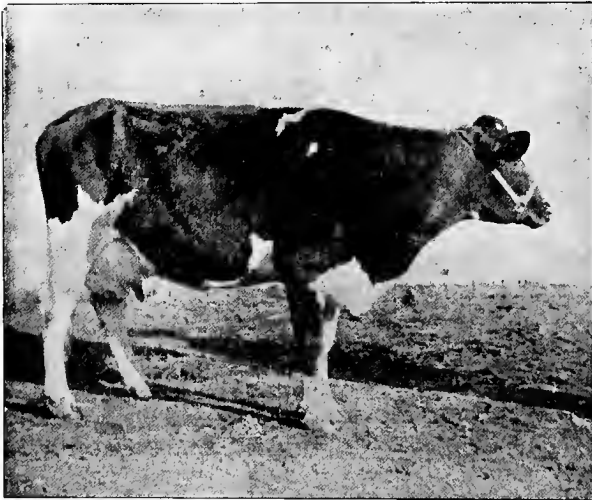

“Topsy.” (Shorthorn dam and Holstein bull), whose yearly average for five years was 10,037 lbs. of milk, with 456 lbs. of butter, at an average cost of 8.6 cents per pound.

POINTS FOR FACTORY CHEESE-MAKERS.

BY PROF. J. A. RUDDICK.

Though written for factory makers I cannot but wish to spread these short and concise rules on cheddar cheese-making, and recommend a careful study of them by *all* cheese-makers:

- ✓ 1. You cannot make strictly fine cheese from milk that is overripe or tainted.
2. If you are a progressive cheesemaker, you will study the causes of tainted milk and seek to apply remedies.
- ✓ 3. Milk may become tainted from:
 - (a) Feed unsuitable for milking cows;
 - (b) Injudicious feeding;
 - (c) An impure water supply;
 - (d) Want of salt by the cow;
 - (e) Absorption of odours;
 - (f) The germs that get into the milk during and after milking.
4. Encourage the patrons to aerate the milk, but
- ✓ 5. Advise them that aeration must be carried out in a place where the air is pure and free from dust or bad odours.
6. Milk will be injured rather than improved if aerated in a stable, barnyard or even alongside a milking yard, from which dust arises.
7. Milk is not prevented from turning sour by aeration, except in so far as the process lowers the temperature.
8. In warm weather the milk should be cooled to a temperature of 70 degrees Fahr. or lower.
9. Attend personally to the taking in of the milk as far as possible.
10. Keep your weighing stand and everything thereon, including your own person, thoroughly clean. You have no right to require the patrons to furnish clean milk unless you set a good example.
- ✓ 11. Make fermentation tests of each patron's milk as frequently as possible. By this means you will often locate taints which are not discernible when the milk is being received.
- ✓ 12. The rennet should be used in sufficient quantity to coagulate the milk, fit for cutting, in not more than 30 minutes, at a temperature of 86 degrees Fahr.
13. The milk should have such a degree of ripeness, or acidity, when the rennet is added, that the whey will be removed in two and a half to three hours from the time the rennet was added.
- ✓ 14. When cutting the curd always aim to make the cubes of uniform size, and follow any course that will secure such a result.
15. A curd that is allowed to get too firm cannot be as well cut as one that is "just right."
- ✓ 16. If the cubes of curd are uneven in size, there will be different kinds of curd in one vat when the whey is removed, because the smaller particles harden first and do not show acid as quickly as the larger and softer ones do.

✓ 17. Stir very gently at first. Many cheesemakers cause more waste at this stage than their wages amount to.

18. The whey should not be removed until the curd has a somewhat firm, elastic character, and is what is generally termed properly "cooked."

19. The curd should be firm, elastic and well "cooked" before there is any appreciable development of acidity.

↘ 20. Failure to have the curd firm before the whey is removed results in tender-bodied, "acid cut" cheese.

21. If difficulty is experienced in getting the curd firm at the proper stage, run off as much as possible of the whey as soon as heating is finished, without tipping the vat, and stir curd vigorously.

22. If difficulty is still experienced in getting the curd firm, the "cooking" temperature should be raised.

23. It is generally advisable to raise the "cooking" temperature several degrees as the season advances, and the milk becomes richer in fat. In some districts it may be raised as high as 105 degrees Fahr. with beneficial results. It should never be raised higher than is necessary at any time of the year.

24. When the whey is removed, the curd should be stirred on racks placed on the bottom of the vat at this stage, or in special "sinks" having rack bottoms.

↘ 25. The cloths used over these racks **MUST BE KEPT CLEAN**. Bad flavours in cheese have been traced to filthy rack cloths.

26. There should be not more than $\frac{1}{4}$ of an inch of acid by hot iron test when the whey is removed.

27. It requires good judgment to determine the amount of stirring the curd should receive before being allowed to "pack." Cheesemakers should study this point carefully, because it has an important effect on the texture and body of the finished cheese.

28. The curd should be protected with a cover while maturing.

29. If a cloth is used it should not rest on the curd.

30. If too much moisture has been allowed to remain in the curd, mill it early. In any case, mill it one hour before salting.

31. The curd should be cut or broken into convenient sized pieces and turned once in twenty minutes while maturing.

32. If the curd shows signs of greasiness, the pieces should not be piled one on top of the other.

✓ 33. A "greasy" curd may with advantage be salted earlier and allowed to stand longer before pressing.

↘ 34. The application of the salt retards but does not stop the changes that are taking place in the curd.

✓ 35. When filling the hoops pack the curd well in the center, so that when pressure is applied the curd will close up in the center first and the air and whey will have a chance to escape.

36. Apply pressure gradually. "A little and often" is a good rule for the first hour.

37. Many cheese are open and loose because not well pressed.

38. A sweet, immature curd will not make a close cheese under any amount of pressure, but no cheese is ever solid and close unless heavy pressure has been applied.

39. Salt gives a flavour to cheese and assists in expelling moisture.

✓ 40. Salt varies greatly in weight owing to its quality of absorbing moisture and giving it off again. It is therefore easier to secure uniform results if the salt is measured instead of weighed.

41. Cheese should be kept in the presses until the next batch is ready.

42. If seamless bandage is used, a half size smaller than the hoop, (15-in. bandage for a 15½-in. hoop, etc.), will give you a neater looking cheese.

43. The best temperature for curing cheese is certainly not over 60 degrees.

✓ 44. There is a marked difference in the flavour and texture of cheese cured between 56 and 58 degrees Fahr. and others of the same batch cured even at 70 degrees. As the temperature is raised the difference increases, especially in the matter of flavour.

45. There is much less shrinkage if the cheese are cured at the low temperature.

46. A cheese cured at 58 degrees begins to "break down" about a week later than if cured at ordinary curing room temperatures, say 70 to 80 degrees.

47. As a cheesemaker you should use all your influence towards securing better sanitary conditions around factories in general.

48. Some attempt should be made to keep flies out of the factory. It is disgusting to see the swarms of them in some places.

✓ 49. Flies are attracted to all kinds of filth with its putrefactive germs. Particles of filth containing germs cling to their legs and bodies, and when they get into milk or whey they are a sure source of infection.

50. A cement concrete floor is the only kind that will ensure perfect draining for the making room. It will help to keep the curing room cool in hot weather, and warm in cold weather.

McPHERSON'S CURD RAKE.

The importance has been shown, all through the description of making cheddar cheese, of keeping the curd moving in the whey while cooking it, and if heated from the bottom with hot water, or steam especially, to prevent it from settling.

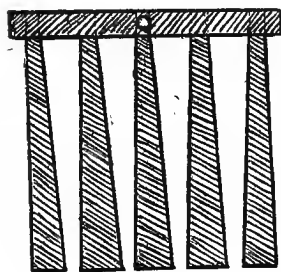

Fig. 24.

Though McPherson's rake is invented by him, and especially adapted for the large square factory vats, I take this opportunity of spreading the knowledge of one of the simplest and withal most effective "stirrers." Fig. 24 represents the head of the rake, and explains itself; the teeth are flat and made of $\frac{1}{4}$ -inch hard-wood, $3\frac{1}{2}$ inches broad at the bottom and $1\frac{1}{4}$ inches at the top, where they are mortised into the head. They are about 20 inches long.

When pulling this rake along in the vat there is created a boiling motion as the whey is forced quicker through the lower and more narrow space between the teeth, and thus the particles of curd are driven from the bottom of the vat. Simple? Yes, all great inventions are.

Try it; any one can make it.

THE CHEESE PRESS—HOW TO MAKE IT.

MY FIRST CHEESE-PRESS.

There was a large stump (K) left just outside my house—indeed the veranda projected over it—and this I used, as shown in Fig. 25. I first levelled the ground and laid a 2-inch

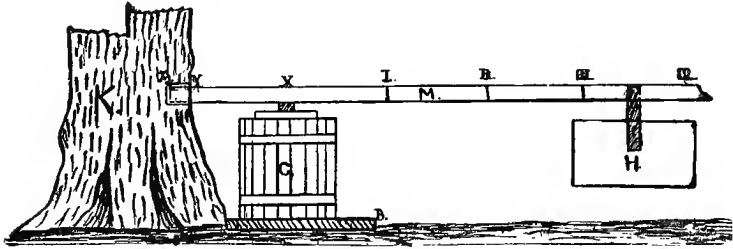

Fig. 25.

plank (B) as close to the stump as possible, then placed the hoop (C), allowing space for the follower and a cross-piece. I mortised a hole (A) in the stump, 3 inches square and 4 or 5 inches deep. When used, a long pole (M) was placed with one end in the hole (A), and, the hoop being in position, a bucket or box (H), filled with stones, was attached at the other end.

To calculate the pressure, the distance from Y to X is measured, and in this case it was 12 inches. If the weight of the bucket is 100 lbs., and it is hung at I, which is 12 inches from X, the pressure is 100 lbs.; if at II, or 24 inches from X, it is 200 lbs.; and if between III and IV, it is 350 lbs.

Such a press can be fixed on any solid wall, by simply spiking a piece of scantling (h) to the wall, as shown in Fig. 26, and putting the end of the lever-pole under it. More convenient still is to have one end of the pole fixed by a very strong hinge to the wall, while the other is hung up by a cord to the ceiling, so that the pole can be hoisted up

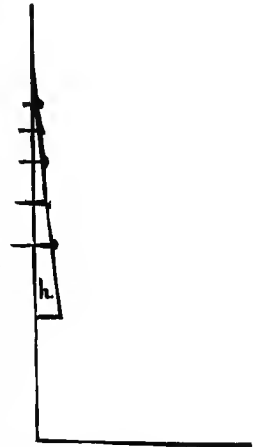

Fig. 26.

out of the way when not in use, but this will not do for heavy pressure.

There is only one drawback to these cheap and yet efficient presses, and that is the fact that unless you watch them very carefully the pole is apt to slant a little one way or the other, and the result is a lop-sided cheese (Fig. 27).

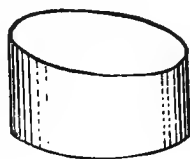

Fig. 27.

MY SECOND CHEESE-PRESS.

Another press which I made on my own farm, more complicated, and requiring more muscle to handle, is shown in Fig. 28, front view and side view.

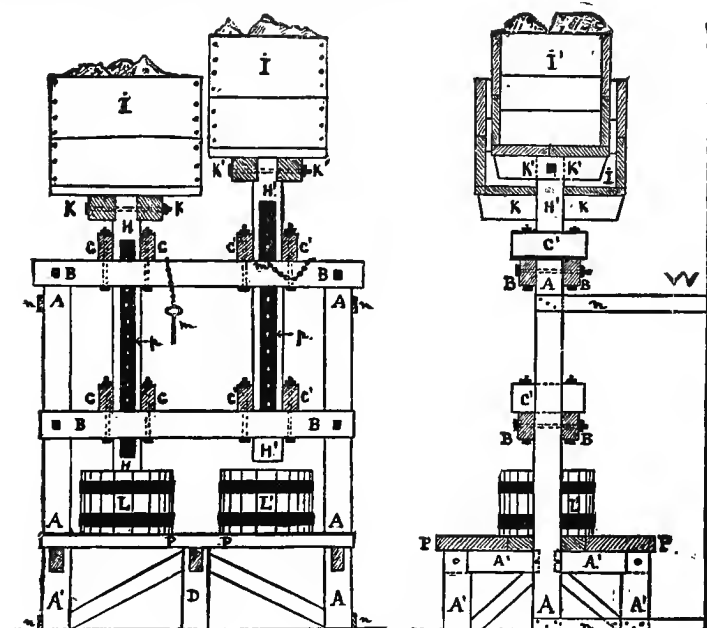

Fig. 28.

Two frames like A-A are made and fixed to the wall (W) by a piece of batten (n) at top and bottom. Across these and a center support (D) the planks (P) are laid, leaving the

posts (A) standing up at each end of the bench so formed. These posts are joined together with four scantlings (B) bolted two-and-two together, the first pair about 16 inches from the planks P, the second pair at the top of the posts. Next eight pairs of cross-pieces (C-C) are bolted to B, as shown in the cut, but it may be enough to screw on pieces of battens, the object being only to form guides for the press poles (H-H) to work up and down in.

The press poles (H-H) consist of a scantling $3\frac{3}{4} \times 3\frac{3}{4}$ inches, with two cross-pieces (K-K) bolted at the top for a support to the boxes (I-I), a piece of iron $2\frac{1}{2}$ in. broad, 34 in. long, and $\frac{1}{4}$ inch thick (p), with holes about 1 or $1\frac{1}{2}$ in. apart, is let into the press pole and firmly screwed on. The holes go right through the press-pole, so as to allow the iron stop-pin (m) to be slipped in above the top bars (B). Holding the pole up (see H'), or taken out (see H). The press-pole, with box full of stones, is worked up and down by a small iron crow bar used as a lever on the lower bar (B). On the drawing are shown two cheese hoops, the full weight of the box I pressing the cheese L, while I' is shown lifted up ready to remove L. Of course many other handier modes may be used for the levering up and down of the weights, but this is one way, and is given here just to give an idea about that kind of press, and if they are built straight there are no better presses so far as a straight continuous pressure is concerned, and that is all there is wanted.

Fig. 29 represents the best of all presses—an English combined lever and screw press.

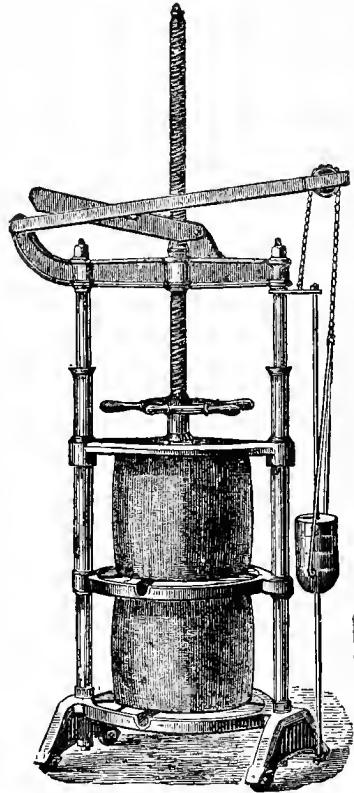

Fig. 29.

THE AMERICAN PRESSES.

American factorymen are never happy unless they can save labor and time; hence the invention of the Gang-press, in which up to twenty cheese are pressed with one single screw!

It is, however, not a safe press, unless you have the curd pretty warm, and it requires continual tightening to keep up the pressure. An inventive genius then added a heavy spring cushion at one end which, however, did not do much good. It remained for the Danes to improve on it and secure a continuous pressure and this has again been improved by Messrs. D. H. Burrell & Co., of Little Falls, N. Y., and no community or person establishing a cheese factory should buy the old gang press, *but be sure* to get the continuous pressure press.

For farm dairies the press screw (Fig. 30) may be bought for \$2 or \$3, and the frame for this screw may be made at home.



Fig. 30.

As shown in front and side views on Figs. 31 and 32 two planks (A) are bolted to crosspieces (C), which forms a foot.

Four planks (B-B) are notched and mortised two and two into (A) edgewise, thus forming a mortise, as shown on the side view, leaving a space (x x x x) between them; on the top of B are nailed planks (P), forming the press-bench on which the hoops (L) are placed.

On top of B and below B, crosspieces I and H are placed and connected with two bolts (D) passing through the middle of the planks B-B, as shown with dotted lines on the side view.

Cross-pieces (K) are bolted below B, and into these pieces are mortised and screwed the nut of the iron press-screws, so as to allow the screw to pass up and down in the space (x x x x) left between the two planks (B).

Material Wanted for a Bench with Two Screws:

A—2	planks	5 feet 3 inches	long,	11 inches	wide,	3 inches	thick.
B—4	“	4 “	10 “	“	“	5 “	“ 4 “ “
C—2	“	2 “				5 “	“ 3 “ “

K—2 planks 2 feet long, 11 inches wide, 3 inches thick.

I-H—2 pieces scantling, not less than 2 inches thick.

P—5½ square feet, 2 in. planks.

D—2 bolts, 48 inches long, ½-inch diameter.

8 bolts, 9 inches long, ½-inch diameter; 4 bolts, 7 inches long, 3-16 inch diameter.

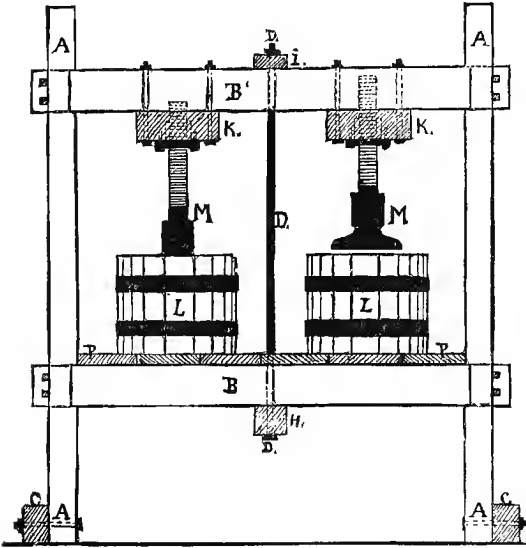

Fig. 31.

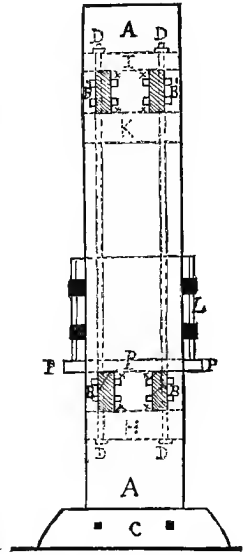

Fig. 32.

Fig. 33 is a cheap combined screw and lever press, sold by Creamery Packing Mfg. Co., Chicago and Kansas City, and Fig. 34 a very neat Dutch lever press with shelves to screw on the wall.

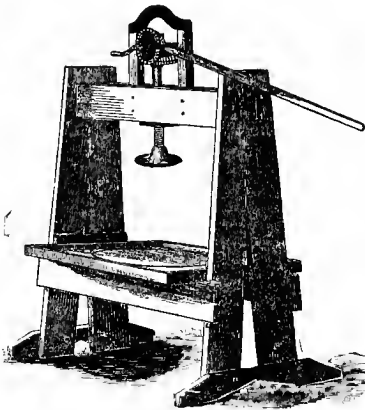

Fig. 33.

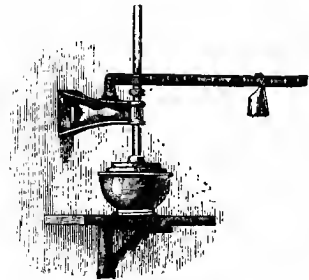

Fig. 34.

THE CURING ROOM IN FACTORIES.

It is always best to have two rooms, one a cellar, and they should, at best, be heated by steam or hot water coils, and cooled by either subearth ducts or an ice chamber, so as to have complete control of temperature.

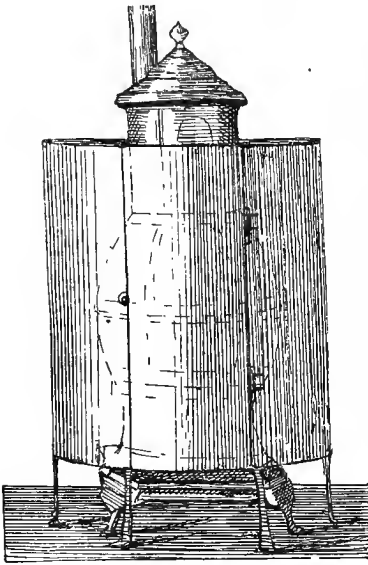

Fig. 25.

If a stove is used at all, it should have a screen as in Fig. 35, and have a water basin for developing moisture when needed. In this connection I mention two devices for ventilating the cellar, one shown in Fig. 36 representing the curing room of Mr. W. Simon, Neenah, Wis., and the other a simple device of a stove pipe turned into the chimney and a lamp placed so as to create an upward draft. Fig. 37.

Whatever system of heating and cooling is used, the more we insulate the walls and ceiling the better and safer

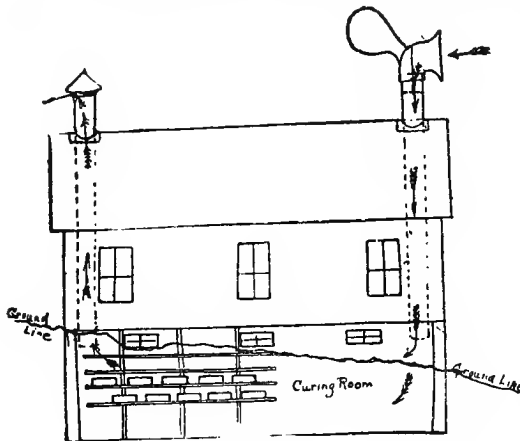

Fig. 36.

it is and not less than four dead air spaces should be provided. Keeping doors and windows closed during the day and open during the night will sometimes help us, and I have heard of a system with cloths (covering

the open windows) kept water-soaked all the time, which of course will cool the air entering the room. As a rule a good dry cellar will suffice.

PARAFFINING THE CHEESE.

One of the great advantages claimed for the subearth-duct curing cellars and for the modern cold curing is the retaining of more moisture and thus preventing shrinkage in weight. This claim has always seemed of small value to me, because the shrinkage is only prevented while in the hands of the manufacturer or jobber and the shrinkage will simply increase while in the hands of the retailer and consumer. Indeed, it seems to me to be an attempt to sell water for cheese. Whatever percentage of water is deemed best in each kind of cheese, it is the duty of the maker to so manipulate his curd that the cheese is at its best when reaching the consumer. If, then, one curing system gives more shrinkage than another, the maker must leave more moisture in his curd as it comes from the press.

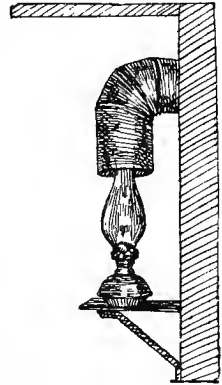

Fig. 37.

Far more practical is the protecting of the cured cheese from evaporation while in the hands of the retailers, especially when sent to hot climes. For this purpose the old English Stilton cheese were covered with a bladder and in the later years, the cheese are covered by a coating of paraffin, this, it is claimed, not only prevents shrinkage, but also mold. On a large scale the best way is to have a steam-heated jacketed kettle covered with asbestos on the outside and then have an iron ring (of the size of cheese to be treated) tied in three equi-distant places with rope connected with a pulley above. The cheese rests on the three knots of rope and is dipped down just for a second and when taken out the three little spots unparaffined are covered with a stroke of the hand. In reply to an enquiry, Prof. J. A. Ruddick writes me:

“We have used wax having a melting point from 118 deg. to 120 deg., and experimented also with a grade that had a melting point of from 114 deg. to 116 deg. As far as our experience goes, the wax melting 118 deg. to 120 deg. is the best. The results are quite as good as with the softer wax, and it hardens rather more quickly and thus facilitates handling. We have experimented with temperatures all the way

from 180 deg. to 215 deg., and have concluded that 200 deg. is a good temperature. It takes about 4 ounces of wax per cheese of 80 pounds weight. I do not think the temperature of the cheese is important. If the cheese are very cold it is possibly better to allow them to remain a few seconds longer in the wax. We leave them about 10 to 15 seconds as a rule, when the cheese are fairly warm. We use a rack that will hold three cheese, made of three bars of iron covered with wood, which prevents the iron, when it gets hot, from melting the cheese."

As to the age when the cheese should be paraffined, theoretically it seems to me the nearer the cheese is cured, the better it should be, but in practice it is preferred to do it as close to the pressing as possible; the concensus of opinion seems to place it at about ten days or two weeks from the press. Prof. Ruddick says: "It appears to me that the cheese should not be paraffined until they are at least one week old. It gives the rind time to form and the surface of the white cheese especially, to take on the amber color that we are accustomed to see. If they are paraffined when they are fresh made the surfaces have an 'acidy' or rather faded appearance."

To do it on a farm is hardly practical, though not impossible. A vessel large enough to allow the dipping of the cheese is set in a larger vessel with water in and this is placed on the range. The paraffin may then be melted and the cheese dipped, but it requires a standing investment in enough paraffin to fill the kettle.

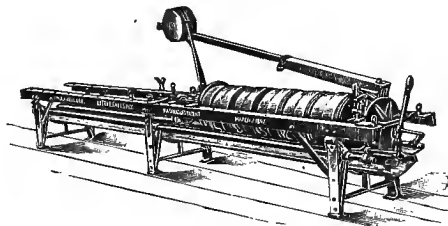

CONTINUOUS PRESSURE GANG PRESS.

"GOUDA"

"MAIKAAS" (MAY CHEESE), "JODENKAAS" (JEW CHEESE), "HEEMRAADSKAAS" (COUNSELOR'S CHEESE), "NIEUWEMELKSCH HOOIKAAAS" (NEW MILK HAY CHEESE.)

Cheddar cheese on a small farm is certainly too laborious, but—as before said—every cheese-maker ought to study its making carefully so as to lay a solid foundation to his (or her) knowledge in cheese-making of all other cheese. I know of none more suitable for making on the farm than the "Gouda."

The city of Gouda in South Holland is the centre for the production of this popular cheese which is imitated in many places in France under the name of "Fromage de Bergues," in Denmark (a modified skim cheese) under the name of "Export Cheese." Gouda is chiefly made from new milk, but, as do most other cheese, its reputation suffers by the making of half skims. The milk is brought into the make-room as soon as possible and strained into a cylindrical barrel on a stand. Color is added and the milk is "set" with rennet at 82 to 90 deg. Fahr. The curd should be ready to cut in 15 minutes,

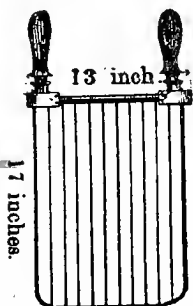

Fig. 38.

and this should be done very carefully and gently, either with a wire cutter, Fig. 38, or with an American curd knife, Fig. 13, page 20, and then left for a while, covering the tub with a cloth. The whey separates and most of it is dipped out. The curd is then stirred up gently and further broken by hand until it is reduced to the size of beans. The temperature is then raised to from 97 to 104 deg. Fahr. either by pouring back some of the whey which has been heated, by adding hot water, or by any other convenient way. The "cooking" temperature depends on the destination of the cheese. The lower the temperature the larger the yield and the finer and softer body (more moisture), but less keeping quality; the higher the temperature the better the cheese will keep and stand transportation.

The hot water or whey which is poured on the curd should not be too hot, not above 120 deg. Fahr., and should be added gradually. Whenever the curd pieces "squeak" between the

teeth, the "cooking" is done and the pieces should then be the size of wheat kernels. The whey is dipped off, and the curd is squeezed and worked with the hands so as to get rid of most of the whey. Many makers salt it at this stage by working it in a box with a double bottom, the upper one being perforated and covered with a cheese cloth. More extensive is the salting in brine.

The salted or unsalted curd is put to press as soon as possible. The hoops (moulds) are deep dishes made of willow wood with a perforated rounded bottom, Fig. 39. In this country they are made of tinned steel. The curd is filled in

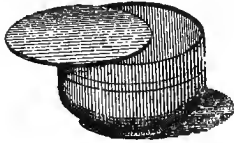

Fig. 39.

a little at a time and pressed firmly and closely with the hands and sometimes with a sort of rammer (potato masher.) The hoop is filled to the edge and then a rounded heap piled on top, and put to press. Sometimes the cheese is taken

from the press after a short time and broken up and then put to press again. The pressure is only about double the weight of the cheese to begin with, but after a few hours it is doubled and kept up for twelve hours. If a longer keeping quality is desired, the weight is doubled a third time and kept up for three hours more. The cheese is turned every hour to begin with and later every three or four hours while in the press. The holes in the mould must be cleaned out. If the salt has not been added to the curd, the cheese are placed in the brine trough, Fig. 40. This trough is filled with a strong

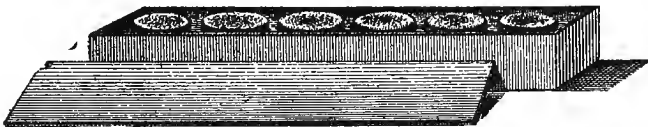

Fig. 40.

brine and the cheese float in it, a little salt being sprinkled on the top surface. They are turned twice a day and the sprinkling of salt is repeated. It takes four to eight days, according to the size of the cheese, to finish the salting. Some makers take them out of the brine after twenty-four hours and dry

salt them by rubbing the salt on, turning them twice a day on the salting table which is provided with grooves for draining. This takes four to five days with a cheese weighing fourteen to sixteen pounds.

When salted, they are washed with warm water, wiped dry with a cloth, and put in the curing room. Here they are turned at first once a day, later twice a week and after three months only once a week. The curing room should be dry and well ventilated and there must be no draughts as that will cause the cheese to crack. If the cheese become greasy (by exudations) they must be washed in warm water and wiped dry again. The curing room is kept dark, and when the cheese are fourteen days old, the rind is colored with a solution of saffron and beer or vinegar, or both. This gives a yellow color and is said to protect against flies. When three or four months old it is as a rule cured, but it is often sold as early as five or six weeks old. The cheese are packed in rows in boxes, with scale-boards between each cheese, and lately neatly painted, pressed cardboard boxes of same shape as the cheese are being used for the export trade. The weight of the Gouda varies from six to sixteen pounds and the shape is shown in Fig. 41.

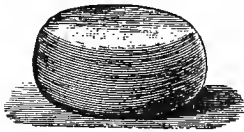

Fig. 41.

A cheese weighing ten pounds will be about nine inches in diameter and four and one-half inches thick. "May Cheese" are made in the spring when the pastures are new, and they are always small.

The system is as described above, but they have a poor keeping quality.

"Jew Cheese" also called "kosher," are salted less than the regular Gouda and have a flat circle in the mould where the stencil of the rabbi, declaring the cheese "kosher," is carved.

"Counselor's Cheese" are made quite small and have a different color. They have a better keeping quality and are chiefly used for presents.

"New Milk Hay Cheese" are those made in winter generally from the milk of fresh-milking cows, but are not considered as good as those made while the cows are on the pastures.

THE FERMENTATION TEST.

In making any kind of cheese, where, as in the Gouda, the rennet is added to the milk just as it comes from the barn, it is even more important than in making cheddar cheese to have perfect milk, and if there is any trouble, it may be necessary to submit each cow's milk to the *fermentation test* and thus find out if the trouble lies in the milk from an individual cow.

The test consists simply of putting a sample of each cow's milk in a tube 1 inch by 5 inches, or a common tumbler with cover, keeping it at a temperature of about 105 deg. Fahr. from 9 to 12 hours and then observe the action of the milk. Dr. Gerber places the shortest time for spontaneous coagulation of good milk at 12 hours, but I have found it (as delivered at cheese factories) to coagulate as quickly as 9 hours. Perfect milk should, when coagulated, show a solid column of curd which, if left undisturbed, should stand quite a time without any whey separating and without any gas bubbles which indicate fermentation. The value of the test depends on having the tubes or glasses and the covers used absolutely sterile and this is done by putting them—when clean—in a pan of cold water and then bringing it to a boil, leaving the glass in until the water cools to about 160 deg., and then placing them in a clean place protected against dust until needed. Dr. Schroth suggested adding a few drops of reliable **Rennet Extract** so as to hasten the coagulation, and at Madison (Wis.) Experiment Station they use a jar of milk, adding **Rennet**, draining whey off and observing the fermentation in the curd. This is called the Wisconsin "Curd Test." The introduction of these tests in our cheese factories would save the country thousands of dollars now lost in poor cheese, and in this matter we must also hope the best from the Dairy Schools.

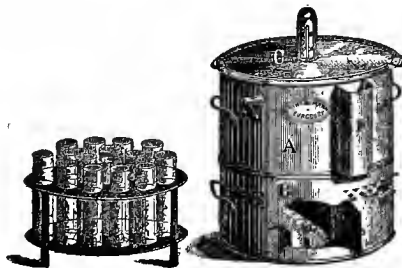

GERBER'S FERMENTATION TEST.

SKIM CHEESE.

These may be made from all kinds of skim-milk, from that only half skimmed to that skimmed perfectly clean in a centrifugal machine. The latter, I presume, produced that cheese which was packed in an iron box and put on board a ship, that when arrived at its destination, the rats had eaten through the box but couldn't get through the cheese! Other skim-cheese seem to be made with the aim of using for leather belting; but, nevertheless, if the patience and economy which hard times have taught the European nations, is brought into play when making skim cheese, a very *cheap*, wholesome, and even palatable food can be produced from skim-milk.

But the great trouble in America is the fact, that while lots of half skim cheese are made, you can never buy it, (as for instance, in Chicago) it all becomes "full cream cheese" in some mysterious manner! It is all right to make a skim cheese, if it be sold as such, and at its right value it is a blessing to poor people; if not, it is a fraud. On the other hand, it is a shame to export these partially skimmed cheese as full cream cheese, as they ruin our reputation in the foreign market.

But on the farm the half skim or even the hard skim cheese should be made and consumed, as it is a most valuable item in the domestic economy.

HALF SKIM CHEESE

may be made either on the cheddar or the Gouda system, but it should always be remembered that, to a certain extent, water may be made to replace fat in the composition of cheese; that is, the *apparent* value and selling quality of a cheese depends, to a certain extent, on the quantity of *fat*, *plus water*, and a cheese containing more fat and less water than another will not always be adjudged to be the best. We must then see to it, that when we make a half skim cheese, *more water* is left in it, hence not cut so fine, not cook too high, and go to press before too much acid has developed.

The curing room temperature should be kept not above 65 to 70 deg.

"DANISH EXPORT CHEESE."

This is a skim-milk cheese introduced by Mr. Busk at the time he introduced the making of sweet cream butter when the milk was allowed to "cream" only for 12 hours set in deep

cans in ice water. The shape of this cheese is the same as that of the Gouda, and may as well be used as an illustration for skim-milk cheese. I may add, that while this cheese was fairly good when made from milk handled as above described, which often had as much as 0.6 and sometimes even 1 per cent. of fat in it, it is not very much of a success when the milk has been through a Separator! Indeed they have in Denmark come to the conclusion that it is a hopeless task to make cheese from separator skim-milk. However, there is

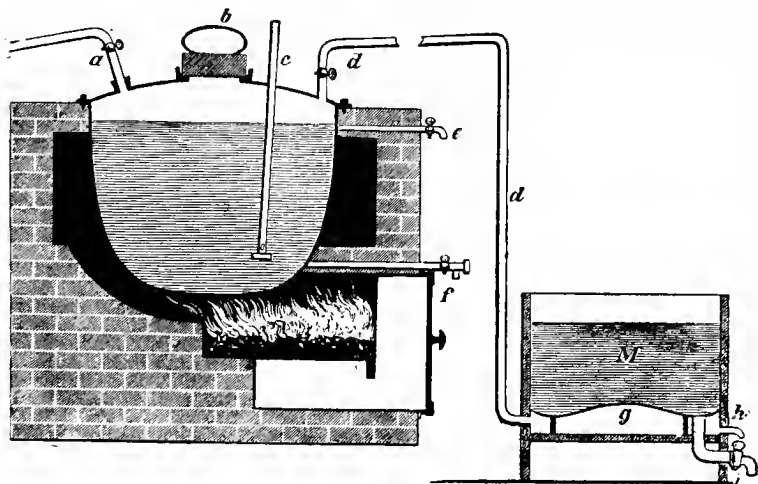

Fig. 42.

nothing to prevent the readers from crowding their separator, so as to leave as much as 0.6 or even 1 per cent. fat in the skim milk and therefore I give a short description written partly from memory, partly from Dairy Councillor Boggild's book on "Dairying in Denmark." As the milk is very sweet, 10 to 20 per cent. of buttermilk may be added after heating the milk to 90 deg. Fahr. The determination of how much buttermilk there should be used may be assisted greatly by testing the milk with the rennet test or the Mann's acid test. The buttermilk will, as a rule, reduce the temperature of the milk to 86 deg. Fahr., at which temperature the rennet is added after having first added the color. I may as well here give an illustration of Prof. Fjord's low pressure farm steam boiler (Fig. 42) which explains itself. A common stationary open

*The cheese-vat shown in illustration is out of proportion small.

boiler is provided with a cast iron cover (for which may be substituted one of wood). The cover must, of course, fit tightly. The boiler is filled through a, and the steam developed passes through the $1\frac{1}{4}$ -inch pipe d d under the tinned copper bottom of the round wooden cheese-vate M. If the cover is made of wood, the steam pipe must be 2 inches, b is a manhole and c is a $\frac{3}{4}$ -inch pipe reaching to within 4 or 5 inches of the bottom of the boiler and 2 to 3 feet above the cover, thus acting as a safety valve, and if the water falls below the lower end, giving warning by allowing the steam to escape. I have wondered why some manufacturer does not put something like this on the market here, meanwhile any handy local mechanic may get up a similar device from the above illustration. However, small feed cookers may be bought for \$35.00 from the Dairy Supply houses, and I cannot lay too great weight on the value of steam on a dairy farm.

The time of coagulation should be between 20 and 30 minutes. The curd is cut rather early, as experiments by Prof. Storch have shown, that less fat is lost in the whey by



Fig. 44.



Fig. 43.



Fig. 45.

cutting before the curd will split clear over the finger. The cutting is done as described for the Gouda cheese and the stirring may either be done with the hands or with the stirrer illustrated in Fig. 12, on page 19. When the curd pieces are about the size of peas they are left to settle and the whey drawn. Enough curd is taken to fill the mould and worked with the hands, pouring off the whey (Fig. 43). The curd is then flattened by pressure of the hand (Fig. 45), the surface scratched up (Fig. 44) half an inch deep, and the hoop is entirely filled with new curd which is worked and squeezed as the first layer, and the top is made round like the lower part.

The whole surface of the cheese used to be rubbed with a little of the curd, previously made greasy by rubbing it between the hands, but this practice is now discontinued as useless.

The cover is put on and a weight of about 20 pounds put on the top. The cheese is turned at short intervals, and after 12 hours it is removed from the hoop and put into strong brine. Here it remains for three days, being turned every twelve hours, and at each turning a handful of salt is put on top.

The cheese is removed from the brine, washed, wiped with a cloth and placed on the shelves in the curing room, where an even temperature of 60 deg. is maintained, while draught and light are carefully excluded. Every day the cheese is turned and wiped with a cloth. When about five weeks old, the cheese instead of being wiped with a cloth, is brushed with a hard brush a couple of times a week.

It is better to have a moist and cool cellar which should be about 52 deg. Fahr. into which the cheese is removed after two or three weeks in the drying (curing) room. The new cheese are placed on the highest shelves and moved lower as they grow older. The poorer a cheese is in fat the more moisture should be left in it and the more time should be given it to cure and get mellow; yet I do not consider that the problem of making an eatable hard cheese from milk containing less than 0.6 to 1 per cent. fat, has been solved, and do not recommend any one to try it. Far better to use such hard skimmed milk for making some modification of the soft cheese which I describe.

CHEESE FROM PASTEURIZED MILK.

Pasteurization of milk deprives it of its sensitiveness to the action of rennet, but late experiments in Germany have shown that this can be restored by the addition of calcium chloride and other salts, yet the state of art is not at present perfect any more than that of adding a culture to separator skim-milk and make a usable cheese, though experiments are carried on at the present time, and the outlook is promising.

WHAT A BAD SKIM CHEESE IS GOOD FOR.

One advantage in experimenting with skim cheese is, that if we fail to get a good cheese, which we don't care to eat ourselves, we have an excellent food for our fowls. Indeed, the adding of a little rennet matter to the skim-milk, before feeding it to young pigs and calves, cannot be overestimated.

And, generally speaking, we have a lesson to learn from Europeans, and that is the proper use of what we are inclined to look upon as "waste products." The wonderful prosperity of France is owing to the fact that the French people don't acknowledge any "waste products"—they utilize *everything*. "Dirt," said Lord Palmerston (I believe), "is a thing out of place. If we put it in the right place, it is dirt no longer."

SOFT CHEESE.

In order to give an idea of this kind of cheese, which may be varied in many ways, I describe a few, commencing with "Brie," which is a kind of "soft" cheese as the Cheddar is of the "hard" ones.

"FROMAGE DE BRIE."

(BRIE CHEESE.)

The "Brie" is undoubtedly the most important French soft cheese, and one which is imitated in most countries. Its production in the Department "Seine et Marne" is said to amount to 10 or 15 million pounds a year, and "Meaux" is the chief market. Unlike other soft cheese, the Brie is not often sold fresh, but is nearly always sold salted and cured. It is made in different qualities from skim milk, from partly skimmed, from new milk and even from new milk with cream added. The sizes of the cheese are as follows:

	Height.	Diameter.	Weight.
Large	0.84 to 1.68 in.	12.6 to 16.8 in.	5.5 lbs.
Medium	0.84 to 1.26 in.	10.5 to 12.5 in.	3.5 lbs.
Small	1.26 in.	5.5	1 lb.

The smallest cheese are called Coulommiers in the market but are made exactly like the Brie. The manufacturer of Brie has always been most precarious and even the most experienced makers have sometimes been baffled. Only during the last years has science stepped in and explained its workings, and of all no one has done more than Prof. E. Duclaux from whose book, "Le Lait," I gather the bacteriological explanations in the following. The illustrations and part of the other matters I owe to Prof. A. F. Pouriau's book.

The buildings used are, as a rule, very simple, and consist of a make room, a drying room, and, in the best factories, a cellar. The rooms are very often kept warm by being built

close to and in connection with the cow's stable, but it is to be supposed that in view of Prof. Duclaux's work, this objectionable custom will be abandoned and all dairies be fitted up, as the best ones are even now, with steam heat. The walls of all the rooms should be plastered and provided with plenty of openings where screens keep out the flies and the draught may be regulated with slides. Thus the air is kept pure by circulation and of a suitable temperature and *moisture*. The object is to obtain a quick curing cheese and one that will cure uniformly. The first is a matter of manipulation, but the latter is a matter of securing the right species of microscopical beings—bacteria and fungi. Quick ripening is obtained by having a curd with less coherency and plenty of water, and to secure less coherency the milk should be "set" with less rennet, producing a slow coagulation. New milk Brie is made as follows: the milk, having been strained, is set just after milking at a temperature of about 90 deg. Fahr. with sufficient rennet to coagulate in two or three hours (seldom four). The rennet is sometimes added to the milk in a large vat from where the milk is dipped or tapped quickly into jars (Fig. 46), or tin buckets holding either 40, 80 or 130 lbs. It is considered best



Fig. 46.

to have each jar hold just enough for one cheese. Often, but not nearly as good, the rennet is added to each jar by itself. Coagulation is considered finished when a finger dipped into the curd does not show any white specks, but simply a little clear whey on being withdrawn. Some makers let it stand until the whey shows on top but it will be seen later on why this may be dangerous.

All curd which has been coagulated slowly will have more or less cream on top, and some makers skim it just before the curdling commences.

The next step is to get rid of the whey without breaking the curd more than necessary and without using any pressure (here is seen the second radical difference in the making of soft cheese from the hard cheese—as represented by the cheddar, slow coagulation being the first one). The object is to prevent the curd from being too dry and thereby delaying the ripening of the cheese, for this reason it is cut gently in horizontal slices with a skimmer (Fig. 47). These slices should be

deposited horizontally without breaking, in the hoop (wood or tin) about 12 inches in diameter and $4\frac{1}{2}$ inches high, which is placed on a wooden plate 14 inches square and one-half inch thick, covered with a straw or rush matting, Fig. 48. Sometimes the hoop is only filled half and left to drain for 12 hours



Fig. 47.

when the other half is filled in with the curd of the next milking. Though Prof. Duclaux does not object to this practice, it seems to me that Dr. Klenze was right in criticising it.

Another thing is not to fill all of the curd in the hoop at once, but to begin and fill one hoop partly, then the others and then come back to the first and fill in more. This seems to me good practice, especially where the milk is allowed to coagulate in a large vat. But to fill in the second half twelve hours later with curd from another milking, is certainly liable to

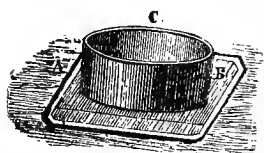

Fig. 48.

make the cheese uneven in its composition. The hoops are sometimes only 2 to $2\frac{1}{2}$ inches high, but have then an additional rim $1\frac{1}{2}$ inches high which is removed when the curd has settled sufficiently. In order to facilitate the draining the room should be kept about

60 deg. Fahr. and a little higher (65 deg. Fahr.) for skim cheese.

The whey runs clear from the hoops which are stacked on the moulding table, Fig. 49. About an hour later, when the curd has settled somewhat, the upper board p with hoop A is placed at the bottom and the order reversed while the hoops are twisted and lifted a little to facilitate the draining. This operation is repeated every hour until the curd has about settled

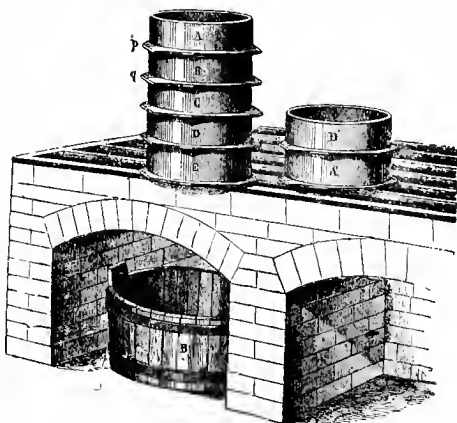

Fig. 49.

settled

to the height desired in the cheese, when the strap, Fig. 50, is substituted for the hoop. It consists of a hoop made of zinc or tin, about $1\frac{1}{2}$ inches high, which is provided with a hook at c and several holes at o, so that it may be made large or small. The strap is

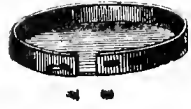

Fig. 50.

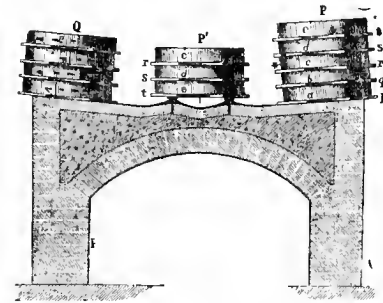

Fig. 51.

laid round the hoop, the latter removed and the strap tightened. The cheese in the straps are then piled up on their boards and mats, 7 or 8 cheese high, on the moulding table. Early the next morning these piles are removed to the draining table (Fig. 51) which is generally made of bricks and covered with slate or sheet lead to protect it against the action of the very sour whey. Every six hours the cheese are turned by placing a mat and a board on top of the strap (Fig. 52) and holding it there with one hand, while the under board is grasped with the other hand, thus the cheese is turned with a gentle movement. Whenever the cheese is turned a clean dry mat is substituted and placed so that the direction of the straw is at a right angle of that of the previous mat, this gives the cheese a chequered surface. Some makers attempt to turn as early as six hours after the curd is filled in, but that is rather risky and it is safer to wait 24 hours. When the cheese is 48 hours old the straps are removed and the cheese salted. This is done with very fine and dry salt which is even sometimes heated to prevent its lumping and to facilitate an even distribution over the surface of the cheese. The salt is rubbed on the sides with the fingers (after having pared off any edge that may project) and sprinkled on the upper end. Some makers replace the hoop after salting the sides for the first time. Twelve hours later the cheese is turned and salted on the other end. If it be too moist when just turned, the salting is delayed a little.

laid round the hoop, the latter removed and the strap tightened. The cheese in the straps are then piled up on their boards and mats, 7 or 8 cheese high, on the moulding table. Early the next morning these piles are removed to the draining table (Fig. 51) which is generally made of bricks and covered with slate or sheet lead to protect it against the action of the very sour whey.

Every six hours the cheese are turned by placing a mat and a board on top of the strap (Fig. 52) and holding it there with one hand, while the under board is grasped with the other hand, thus the cheese is turned with a gentle movement. Whenever the cheese is turned a clean dry mat is substituted and placed so that the direction of the straw is at a right angle of that of the previous mat, this gives the cheese a chequered surface. Some makers attempt to turn as early as six hours after the curd is filled in, but that is rather risky and it is safer to wait 24 hours. When the cheese is 48 hours old the straps are removed and the cheese salted. This is done with very fine and dry salt which is even sometimes heated to prevent its lumping and to facilitate an even distribution

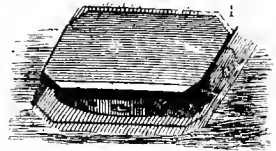

Fig. 52.

Often a mat of wicker-work is now substituted for the one of straw and I have seen wooden splashers used for this purpose. The time will come, no doubt, when the suggestion of a French author of using finely grooved enameled tin plates for this purpose will be adopted.

How long and how much the cheese is salted depends on circumstances. Too little salt lessens the keeping quality and causes them to "run," while too much salt makes them too hard and hurts the flavor. In warm weather the salting is commenced earlier and repeated with only 6 or 8 hours interval.

The cheese is left in the salting room two or three days or more, depending on the temperature, which should be, as said before, about 60 deg. Fahr., never above 65 deg. They are turned and provided with dry mats twice a day.

From the make room they are removed into the "drying" room (curing room), which is kept rather cooler, at a temperature of only 56 deg. Fahr., and with a high degree of moisture (about 95 per cent.) At this stage the cheese is a solid mass, but very crumbly and very sour. There is as yet no sign of mould on it, and the acidity has delayed all ripening fermentations.

But on the other hand the acid is favorable to the growth of a mould which lives on acid rather than casein and after some hours in the drying room a very fine white coat of fungi may be observed, the seeding of these is done either through contact with the mats, or from germs floating in the air. On the regulation of the growth of these fungi, depends the success of the Brie cheese-making. The object is to make them consume as much acidity as possible and yet not develop too much, so as to form a skin over the cheese, that would drain it and dry it too fast. Hence it is important to prevent it from going to seed (forming spores) as this will develop what Prof. Duclaux calls the "dreaded" blue or black fungi. If the temperature is too high it develops the blue ones, if too low the growth increases too much.

The conditions are best when the fungi form a uniform white network all over the cheese. The cheese are placed on the highest (warmest) shelves the first day and are put down a shelf lower every day, turning them twice a day in order to allow the fungi to develop evenly on both sides and also to

check its too rapid growth. The usefulness of this growth of fungi is only temporary and is simply to prepare the ground for another kind which assists in curing the cheese and then disappears.

Under the influence of the white fungi, the acidity disappears gradually, first on the surface, and when this is neutral, there appears under the white layer a reddish one. This is strongest in the little depressions formed by the straws and is formed by a slimy conglomeration of different kinds of bacteria all living on casein. This red coat is always hailed with pleasure if it appears at the right time.

(I may here add that it seems a great many Brie cheese are made, which, according to Dr. Klenze and others, develop the blue fungi after the first white "coat" and then go back to a white one before showing the red spots; this explains the great difference in flavors and shows us how we may regulate them by controlling the condition. The main thing in making any kind of soft curd cheese is to carefully observe the perceptible phenomena and when the result justifies it, see to it that the conditions are always so as to produce them.)

If the red "coat" does not appear or is too slow in showing up, then there is trouble in the camp, and the makers search high and low, without rest, for the remedy. Doors and windows are opened, and closed, the cheese are carried to and fro every place on the farm (even to the rabbitry) in order to find the "best" spot! But all this worry is caused by not understanding the phenomenon. *When the red fungus does not appear, it is nearly always because the acidity has been developed too much originally, either on account of lack of cleanliness with the jars, a too high temperature, a too slow coagulation or a too slow draining.*

When the acid is just right (does not exceed 5 grammes to the quart) 36 hours of white mold in the curing room should—as a rule—render the surface sufficiently alkaline for the red one to thrive, but it seems that, practically, it takes much longer. Thus Dr. Klenze claims it takes 6 to 8 days for the white mould to become bluish which then first becomes yellow and then white again before the red appears in the course of 5 or 6 weeks. It seems, however, that modern improvement in the controlling of the conditions enables the maker

to obtain the red vegetation at once and hence to ripen the cheese much quicker. But of course the conditions must be favorable and the germs must be present in the straw mats in sufficient quantities. The layer of white mould (or bluish if that has developed) is destroyed and separated at the roots by that slimy layer caused by the bacteria of the red one. By turning the cheese it is broken and adheres to the mat.

The white mould is, however, constantly reforming in small quantities and the cheese, as it is sold by the farmer to the merchants, is covered by a red skin with a very fine network of white or grey mould spread over it.

Inside, the original whiteness of the curd becomes gradually transparent. This transformation should take place slowly. If it goes on too fast the outside will "run" (liquidize) before the center is cured. A well made cheese should—after being cut and when pressed on the edges—give a feeling of one thick springy cushion and not of two thin ones on either side of a hard, uncured center. This half-firmness of the cured cheese is evidently the result of evenly balanced conditions rather difficult to obtain.

If a certain proportion of casein, caseone* and water, gives the desired consistency at a certain temperature then the cheese will "run" if the temperature becomes higher without a corresponding loss of water. Hence the cheese is kept in a room (cellar) as dry as possible and having rather a temperature falling gradually to about 47 to 50 deg. Fahr. (8 to 10 C.) The moisture should also be gradually reduced to about 80 per cent. If the cheese are to be kept a longer time it must be done at a still lower temperature.

The yield is from 12 to 15 lbs. from 100 lbs. of milk, and its composition is given by Ducleaux for a premium cheese as follows:

Water	53.84		Water	46.06
Fat	24.60	and an older one	Fat	29.50
Casein	17.40		Casein	19.94
Salt and Ashes	4.16		Salt and Ashes	4.50
	<hr/>			<hr/>
	100.00			100.00

NEUFCHATEL CHEESE.

(Fromage de Neufchatel).

The fresh morning's milk (about 90 deg.) is set in a stone jar, holding about 40 pounds or less, and only rennet enough is added to coagulate it in about 24 hours, when standing in a room of about 60 deg., and "hence it is necessary to use a reliable rennet extract," (says Dr. von Klenze). The jar may be covered with a woolen blanket or the like, to keep the temperature uniform. When coagulated the whole mass is poured into a piece of cheese-cloth, which is either placed in a basket or hung up on four supports fixed for that purpose. Here it is left 12 hours to drain. Then the cloth is gathered together round the curd and placed in a square wooden box, with perforated bottom and sides, and a pressboard put on with weights, say a few stones, and if more weight is needed a small lever press, as described on page 36, is used; it is pressed for 12 hours, and then kneaded by hand *on dry cloth* into a uniform stiff paste; and it requires experience to know the right consistency. If it is too moist, new dry cloths are placed under it, and it is worked until dry enough. But if too dry, it is a sign that either too much rennet has been used, or the curd has been pressed too much. In this case some new curd is added and carefully mixed with the other. When of the right consistency, it is put into the molds (Fig. 53), little tin cylinders of $2\frac{1}{2}$ inches diameter and 3 inches high; as far as that goes, any little empty tin can may be used by unsoldering the top and bottom. After smoothing both ends it is taken out again, and salted on the outside by strewing the salt on both ends and lightly rolling them between the hands covered with salt.

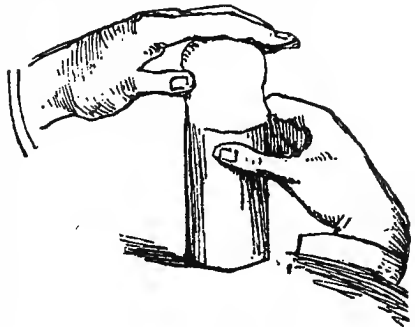

Fig. 53.

They are then placed on a draining board, of any kind which is handiest, and left for 24 hours. In the drying-room are lath shelves, on which smooth dry straw is placed, and the

cheese are laid there without touching each other. They are turned often enough not to lose shape or stick to the straw, and in two or three weeks they are covered with their "first skin," which is, when the white mould showing after five or six days turns into a blue mould. They are now taken to a cellar with similar shelves, where they are placed on end on the straw, and turned every three or four days. After three or four weeks in this place, red spots begin to appear, and the cheese is ready for the market. It takes 6 lbs. of milk to 1 lb. of cheese.

This cheese, like all kindred cheese, is hard to produce uniform, unless special rooms are provided, and I describe the manufacture (part of my information being obtained from Dr. von Klenze), just to give an idea about the principle. Experimenting in the making does not cost much, as 2 or 3 gallons of milk is all that is required, and the outfit need hardly cost anything.

Instead of straw the wooden mats or "splashers" (made of the same kind of wood as matches) may be used for drying the cheese on.

The cheese is also, and, I may say, on this side the Atlantic *chiefly* sold fresh wrapped in tinfoil, like the French cream cheese. I regret to say some very poor ones from skim milk, which are in reality nothing but cottage cheese, are sold under this name.

In large factories special machinery is used for moulding, whereby 1,200 can be formed in one hour.

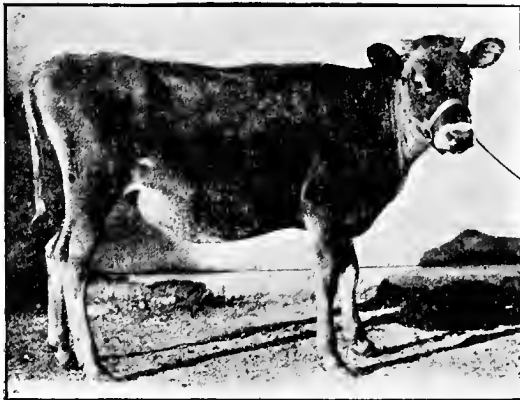

PROF. HAECKER'S "IDEAL" CALF. OMAHA'S POTTY.

CREAM CHEESE.

“While the “Brie” cannot be sold fresh and the “Neufchatel” may only be sold comparatively so (2 weeks), and thus require care and skill in curing, the fresh cream cheese require only neatness and cleanliness.

FRENCH CREAM CHEESE.

(*Fromage a la Creme.*)

Enough rennet is added to the morning's milk, set in a jar at a temperature of 70 deg., to coagulate in two or three hours, and then left for 20 or 24 hours. Instead of any special mould, a common hair sieve may be used. After pouring out the whey gathered on top of the curd, cut it with a skimmer in slices and lay it in the sieve to drain; when this is done,



Fig. 55.

cream in quantities to suit (but not more than that from an equal quantity of milk as was coagulated), is then added, and mixed by mashing with a wooden pestle, like a potato masher, until it is a uniform paste; this is then placed in wicker moulds, lined with muslin, as a rule, heart shaped (Fig. 55), and it is ready for use. It must be kept in ice-box if wanted to keep several days.

DOUBLE CREAM CHEESE.

(*Fromage double creme dit suisse.*)

This is the most popular cream cheese in Paris and it is said that about 40,000 are consumed daily in that city. According to Pourian it is made as follows:

Ten pounds of cream and 64 lbs. of new milk are mixed carefully and brought to a temperature of 55 to 57 deg. Fabr. Enough diluted rennet extract is added to make it coagulate in 20 to 24 hours. The curd is cut in flat pieces with a skimmer and laid on a linen cloth which is folded over it so as to form a sort of press bag. These are laid in a perforated box with boards between each bag and when the first flow of whey stops, then they are loaded with a weight of any kind on top of a board. This pressing takes as a rule 16 to 18 hours.

The curd is then spread on a large table and worked and kneaded by hand, while adding enough cream to give it a uniform smooth consistency, after which it is left on the table some hours to become firmer.

The moulding may be done by taking in the right hand enough curd to make a cheese on a piece of paper and rolling it into a small cylinder. This cannot be recommended for commercial purposes. In Fig. 56 is shown a moulding device which is suitable for a small output. It consists

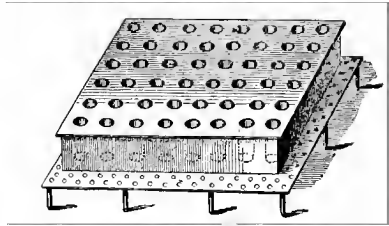

Fig. 56.

of a square piece of perforated tinned steel on low feet (so as to place on a table.) On top of this is square tin box without bottom in the cover of which are soldered a number of cylinders of the desired size. By the aid of a wooden piston the cylinders are lined with a roll of paper. The curd is then dumped on top of the mold and pressed into the cylinders and struck off smoothly with a piece of board. The whole "form" is then lifted carefully, leaving the cheese in their paper wrapping on the perforated tinplate. They are then packed for the market.

An enormous machine, which costs about \$1,000 in France, is used when the cheese is made on a large scale.

The cheese as analyzed by Pourian has 55 per cent. water, 30 % fat and 15 % casein, etc. 1 dozen weigh about 2 lbs.

ENGLISH CREAM CHEESE.

Very thick cream is poured carefully into a linen bag and this hung up, with a basin underneath to catch the whey, in a cool room or cellar. There must be pure air in the room, as the cream easily absorbs odors. When the whey is drained off partly, the bag is twisted tight and bound so as to dry the curd more and after 24 to 48 hours, according to temperature, and the consistency of the cream, the "cheese" is ready to eat, and may be moulded as desired. This is hardly cheese, or should perhaps be called a "sour cream cheese."

MASCARPANI.

In Italy another cream cheese is made, though its title to the name of cheese may be disputed. According to Pourian, it is made from sweet (?) cream skimmed after the milk has been set about 15 hours (shallow setting). It is heated in a water bath to 167 deg., and then coagulated with a little vinegar or lemon juice. The curd is put in a cloth which is twisted more and more to get rid of the whey. When dry enough it is moulded.

CHEESE MADE FROM SOUR MILK.

(Without Rennet.)

SOUR CURD.

Under a great many names, cheese is also made from skimmilk without rennet. The casein is separated from the whey by the spontaneous coagulation of the milk. This coagulation is produced either by leaving the milk in a warm place or by heating it over a fire with the addition of sour buttermilk.

There is, in the manufacture of these cheese, a sad lack of system and the preparation in some cases is very disgusting. Thus the milk will sometimes be left to coagulate in a dirty barrel where a little sour milk is left from day to day and where of course all kinds of fermentations—even that of tyrotoxon or cheese poison—may be started. There is no control, it is all guesswork and the smell of the barrels becomes as bad as any swill barrel.

The proper way is to heat the skim milk to about 90 deg. and keep it there until it is perceptibly sour, then heat it slowly until the curd separates, which, as a rule, happens at 115 deg.; keep it well stirred until the separation is perfect, which generally happens at about 145 deg.; the mass is then drained in a bag of fine linen or cotton, or on cloth stretched on frames, and when dry the curd is worked well, either by kneading like bread with the hands or by mashing in a wooden tub with a potato masher. This rather dry curd forms the basis of the different kinds of cheese, and before going any further, I may give a hint of an improvement which I made while experimenting with Hansen's Dry Lactic Ferment.

PASTEURIZED SOUR CURD.

Take perfectly sweet skim milk and heat in a water bath to 160 deg. Keep it between 150 and 160 deg. for twenty minutes, then cool to 88 deg. and add 5 or 10 per cent. of Startoline (prepared according to directions for use from a reliable "Lactic Ferment") according to the time in which the coagulation is desired. As soon as thoroughly coagulated dip it into bags of fine linen (two layers of cheese cloth may be used) and drain for 12 to 24 hours. Then tie up the bags and press them on a slanting table or plank. The pressure, which may be obtained any convenient way (simply by lay-

ing a board loaded with stones on top) should be increased from, say 2 lbs., for every pound of curd up to 6 or 8 pounds, but experience will soon tell that, by watching the whey coming out. As a rule the curd will be found dry enough after 24 hours pressing and it is then ready for further manipulation.

Curd prepared this way will have the following advantages:

1. It will be free from any deleterious bacteria, such as tuberculosis, etc.
2. It will always be uniform.
3. It will have a more pasty consistency, giving, in fact, the impression of a much richer cheese.

If considered too pasty the curd may be heated before draining and here, as with any kind of sour curd, the dryness (grittiness) will be increased exactly in proportion to the increase of the temperature to which it is heated.

DUTCH CHEESE OR "COTTAGE CHEESE."

One of the most common forms in which these are sold is simply a round hand-formed ball weighing according to the liberality of the maker all the way from $\frac{3}{4}$ to 1 lb., retailing at 5c a ball. These are prepared from the curd, howsoever obtained, by working a little skim milk, new milk, or cream into it, adding sufficient salt and sometimes caraway seed. They are sold fresh and their quality varies greatly according to the care and cleanliness and the quantity of cream used in their make. When my suggestions are adopted the milk or cream should be pasteurized if a longer keeping quality is desired, but a rather finer flavor will be obtained by using perfectly sweet, un-pasteurized cream. It does not take much.

"SCHMIERKASE" OR "BAKER'S" CHEESE.

In the East and elsewhere there is quite a trade for sour curd prepared in a primitive fashion. It is simply drained and then 1 gallon of sweet skim milk is stirred into the contents of a 5 gal. milk can, and the stuff is shipped thus to the cities, where it often arrives in such a fermentative state that it overflows the cans. In the city, it is either sold as it is by the pound or used by bakers for making German "Kase Kuchen" (cheese cake).

The sour curd is, however, manipulated in a great many other ways and sold in the different countries under different

names, and I shall only indicate two, so as to stir up the enterprising dairyman's (maid's) imagination, inducing him to produce some specialty for which a local sale and—who knows, perhaps, in the course of time—a national reputation may be obtained.

“PULTOST” NORWEGIAN.

Though a cheese by this name is also made from sweet milk with rennet, I describe only the one made from sour skim milk. The curd being *produced* as described above, a little buttermilk is added to promote fermentation, and it is then rammed firmly into a mould hoop. This mould—shape immaterial—is then put in a bag, partly to keep the cheese warm and partly to keep the flies out. Sticks are laid across the top of the mould to prevent the bag from sagging and touching the curd.

In one or two days the curd commences to “heat” and becomes yellow. It must then be stirred up again (worked) and replaced in the mould. This is repeated two or three times. When the smell and taste show that the desired fermentation is obtained, the curd is salted and flavored with caraway seed according to taste, and, if a little too dry, a little milk or better still, a little thick cream is added. It may then either be sold as it is, or be packed in boxes or barrels for two or three months whereby the piquant flavor (!) is increased considerably. It stands to reason that this flavor will to a great extent depend on the temperature maintained during the fermentation, especially the one before salting; and after the desired flavor has been decided on (by experiments at different temperatures) the temperature selected should be maintained every day so as to get a uniform result. The heat developed in the curd has been observed to be 86 deg. during the first days and later even as high as 119 deg.

The yield is, as a rule, 16.8 lbs. fresh and 13.1 lbs. fermented cheese from 100 lbs. of skim milk with an addition of 10 lbs. of buttermilk.

“NEIHEIMER” CHEESE.

The home of the world-renowned Westphalian ham is also the home of this cheese. The curd is separated at a temperature between 100 and 120 deg. and drained for 24 hours in a bag. After “working” it into a smooth fine paste it is spread in a layer from 2 to 5 inches thick in a trough (box) and kept in an airy and cool cellar. During the first 3 to 8 days it is

turned daily until it has a uniform light yellow color. Then about 1 to 3 per cent. salt and a little caraway seed is worked into the curd and it is formed by hand into little loaves like French breakfast rolls.

If the curd is too dry to mould it is moistened with beer or milk.

The drying of the loaves is done on mats made of willow work (wooden slats will do) covered with a thin layer of straw which is changed now and then.

When dry they are packed for curing in boxes or barrels with hops which have been used for brewing but have been partly dried again. It is a fine point to have the hops (in making some other kinds of cheese straw or chaff) with the right quantity of moisture, so as to ensure a proper curing of the cheese.

HAND CHEESE.

(*Hand Kase.*)

Dr. F. Stohmann gives a description from articles published in the *Milch Zeitung* of this cheese as made in modern German creameries.

The separator skim milk is set in a heavily tinned vat or kettle and the buttermilk from that day's churning is added; as a rule the temperature will be about 90 deg. Fahr., and the milk is left alone 12 to 18 hours. The next morning the milk is heated to 122 deg. Fahr., while stirring it carefully so that the floating curd does not sink and yet enough to secure a uniform heat in the whole mass. After it has been heated for one to one and a half hour, the curd is left for about 2 hours more, after which the whey is drawn off by a syphon. When the whey is drawn the curd is spread in a large trough to cool, whereby it loses its sticky character. It is next run through a curd crusher (Fig. 57) to reduce it to uniform size.

The crusher or mill has wooden or stone rollers which may be regulated. While it is being ground, salt at the rate of from 3 to 5 per cent. and caraway or other spices are mixed with the curd and this is carried from under the mill by an endless cloth belt to the

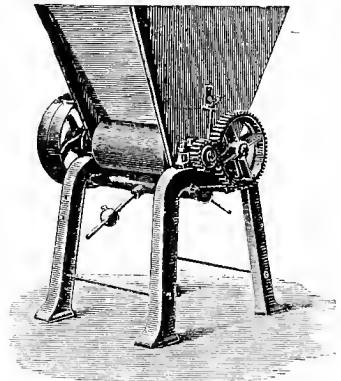

Fig. 57.

press. The press is illustrated in Fig. 58, and consists of a large square box, perforated and lined with slats inside; these are covered with a heavy press cloth and the pressure on the cover is secured by a combination of lever and screw which explains itself. The curd is pressed, as a rule, for one day, but must not become drier than it will stick together again if squeezed to a ball in the hand.

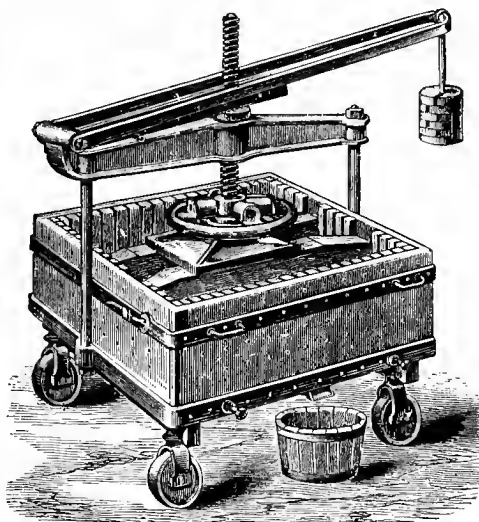

Fig. 58.

The molding of the cheese is done by simply having metal (hoops) rings of the

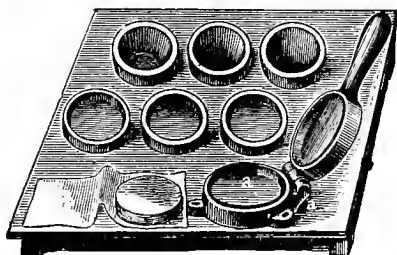

Fig. 59.

desired size and placing these on a board, then filling them with a lump of curd and smooth it off with a wet knife and remove the ring, leaving the cheese on the board. Or, the simple device illustrated in Fig. 59 may be used, but in large factories the machine made by Traiser in Gros Geran, Germany, seems to be labor-saving. With the use of $\frac{3}{4}$ -horsepower the machine forms 3,000 cheese an hour, served by two men only, doing the work of six. It costs \$300.00 in Germany. See Fig. 60.

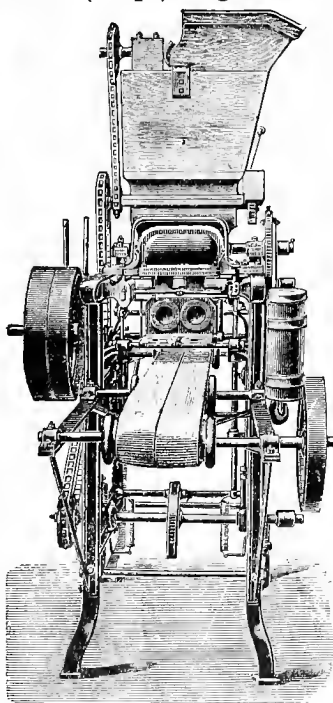

Fig. 60.

“WHEY CHEESE.”

As shown before, there is left in the whey a small quantity of casein and most of the milk sugar and salt as well as what has been called by nearly all scientists the “albumen.” Prof. Ducleaux in his latest book, “Le Lait,” seems to discredit



“MILKING THE GOAT.”

From a photograph obtained from the Swedish Importing and Exporting Company who handle the true Norwegian Whey Cheese and other Scandinavian delicacies, at 17 Dearborn St., Chicago.

this and calls it casein in another form. Be that as it may, this stuff is not recovered by rennet coagulation at the tem-

perature of ordinary cheese-making, but by adding a little sour whey and heating the whole mass to 165 deg. Fahr. (74 C). It is then coagulated and separated from the whey floating on the top. This is skimmed off, cooled and pressed for 24 hours, making what the Germans call "Ziegerkase," but the most renowned whey cheese of this kind is the Norwegian.

"MYSEOST" (OR "PRIMOST.")

This cheese is really condensed whey and may be made from whey obtained either from cheese made of cow's milk or goat's milk, full cream or skimmed.

On a large scale, a regular vacuum pan or a steam jacketed boiler is used, but on the farm any boiler at hand*, large or small, may be put in use, a wood fire being preferable. If there is not boiler-room enough to start all the whey boiling at once, part of the whey should be cooled—or else heated to 180 deg.—to prevent a too great progress in the acidity, while the rest is being condensed. And here I may remark, that the quicker the whey is drawn from the curd the sweeter it is, and the better the whey cheese will be. If more than one boiler is used, it is well to concentrate it on one as soon as it is condensed enough to allow this. When the whey boils, a flecky foam ("zieger") will rise and the best makers remove this by skimming, not only in order not to boil the "zieger" unnecessarily, but also to facilitate the evaporation. Even so will stirring help the evaporation, but it is not essential at this stage when a lively boiling may be maintained. As soon as the mass is condensed so as to be like syrup the "zieger" may be returned and at this stage cream, preferably from goat's milk, should also be added in quantities according to the quality of cheese desired to be made. From this time on, a *constant stirring* should be kept up, and the fire be regulated carefully, so as not to burn the cheese, which will give it a dark color and less fine flavor.

As soon as the mass is about like thin mush, the boiler is lifted from the fire and the contents poured into a large round wooden bowl where it is kept stirred and worked with a wooden pestle (like a potato masher). This may, of course, also be done in the boiler, especially if it is a round one with curved bottom, but on the conscientious performance of this work depends whether the cheese shall be comparatively fine

*Enameled boilers are the best.

and smooth or gritty as if full of sand. Indeed it is such hard work that it takes two persons to alternate at it. Possibly on a large scale a bread kneading machine might be used.

The working is kept up until cool, when the mass is moulded in the shape of bricks, the forms for which anyone can make by nailing narrow boards together. These forms (hoops) are placed on a board and the mass is pressed carefully in with a wooden spatel so that there is no airhole left, and the top side is smoothed nicely. Some makers put a light pressure on. The next day they are taken out by loosening them from the sides of the hoop with a thin knife and in a day or two they are ready to eat or ship to the market packed in wax paper and tin-foil.

This cheese should not be eaten in lumps like Cheddar or Gouda, but sliced thin and eaten on bread and butter, when it will be found to be a relish, especially to children. It is a healthy, nourishing addition to the bill of fare and will be found very useful in preparing sandwiches for school lunches. The open market is, however, limited, and, unless the quality is very good, very risky, as the consumption at present is limited nearly exclusively to Scandinavians. The imported Norwegian cheese retails in Chicago at 25 cents a pound, while a poor imitation may be bought at 5 or 6 cents.

I have now shown how every particle of the milk may be preserved for human food and though I might have written more on the matter, I hope I have given the readers some hints that will be found useful, and that they may not spoil as much milk as I did when I first started making cheese, so to say, from a book. Some milk they must spoil—more or less—as practical experience is indispensable.

I may add as a curiosity that a late patent covers the process of utilizing the whey in another manner by extracting the fat and milk sugar and then making a "milk meat extract" by condensing. I do not take much stock in the invention, and nor can I rejoice in the many ways introduced for making milk powder or dry casein, be it for food use or industrial use. Up to the present time none of these processes have enabled the creamerymen to pay the farmer more than 15 cents a 100 lbs. for the skim milk and at that price we cannot afford to rob the soil by selling instead of feeding it on the farm.

THE FEEDING VALUE OF SKIM MILK AND ITS PRODUCTS.

AS A HUMAN FOOD.

That the farmers who have an abundance of new milk should look with contempt on skim-milk may be forgiven, but when we find that the learned Board of Health of New York actually prohibit its sale under its own name, I more than suspect that this is a case of laziness rather than ignorance as it is easier to compel milk-men to dump the skim-milk, than to enact and enforce regulations compelling them to have the cans properly marked. The result is that the poorer class buy skim-milk as new at 4 to 5 cents per quart.

This reckless waste of a healthy, nourishing food product is a crying shame and it makes my blood boil whenever I happen to pass through the child crowded streets in the poorer districts of any large city. In Chicago I once suggested to a milk dealer that he sell good skim-milk under its own name at a reasonable price (2 or 3 cents a quart), implying that not only would this be a work of philanthropy, but also one of profit to himself. With a meaning smile of pity for my ignorance of "bizz" he said: "That may all be, but there is more money in selling it as new milk! See?"

New milk (average) is considered to have a food value making $3\frac{1}{2}$ lbs. equal to 1 pound of boneless meat. In skimming milk—while we remove the part which has the largest commercial value, the butter-fat—we only deprive it of a small part of its nutritive value, and this can easily be replaced by some cheaper substitute. In reply to an inquiry Dr. Babcock writes me: "In regard to the feeding value, I believe that in the average milk, the fat is worth about one-third as much as the total solids." Based on this a quart of skim milk should be worth 2-3 of whatever new milk is sold for, or, roughly speaking, 5 lbs. ($2\frac{1}{2}$ quarts) of sweet skim milk has the same nutritive value as 1 lb. of boneless meat and 2 or even 3 cents a quart would make it cheap food in our larger cities.

By making a $\frac{3}{4}$ skim cheese and whey cheese the farmer may preserve all the surplus of milk for future use.

FOR STOCK.

It often astouishes me to hear of the small value which patrons of creameries and cheese factories place on skim milk and whey. If preserved sweet—and that can be done by pasteurizing if the new milk is delivered at the factory in good shape—it is certainly worth 25 cents per 100 lbs. on an average. It is true, experiments have been made, where by feeding it to growing animals for a short time (calves for veal) it has been proved worth 50 to 55c for a short period, and even so when feeding young pigs, there are times when the value may be figured at such high prices. I consider 25 cents per 100 lbs. a conservative average estimate when used intelligently in connection with grain, and shall now only mention the result of some experiments. Prof. Henry found that it took 1,430 lbs. of skim milk and 301 lbs. of corn meal to gain 100 lbs. in weight in mature hogs, but only 1,024 lbs. of skim milk and 174 lbs. of corn meal to obtain the same gain in *growing* hogs. The moral is evident! and yet, how many farmers persist in throwing away feed on hogs which ought to have been in Chicago several months ago! Again he found that in feeding skim milk to calves, with hay at \$8 and grain at \$15 per ton, it was worth 25 cents per 100 lbs., when the gain in weight was figured at 4 cents per pound. The same kind of milk first coagulated with rennet was made worth 28 cents based on the same calculations.

Again in another experiment he made skim milk worth 20.6 cents per 100 lbs. feeding it to hogs valued at 4 cents per pound live weight and the grain fed worth \$15 per ton. The hogs were 114 days old when the experiment commenced, and the test lasted 96 days. I venture to say that if the test had been commenced when they were 50 days old, the value of the milk would have been double. *As to whey*, Prof. Henry found that by partly substituting it for grain 758 lbs. of whey saved 100 lbs. of grain. If grain is worth \$12 per ton, whey should then be worth 8 cents per 100 lbs. Whey should never be fed without grain. Shorts, peameal and oilmeal should be used for growing animals with some corn meal added, increasing the latter as the animals mature.

Prof. Fjord came to the result that one pound of barley or rye was equal to five pounds of skim milk or ten pounds of whey, thus he puts the value of whey a trifle higher as compared with that of skim milk than does Prof. Henry.

Write for Prices
of
Apparatus
and
Supplies

—FOR THE—

CHEESE
FACTORY

—OR—

CREAMERY

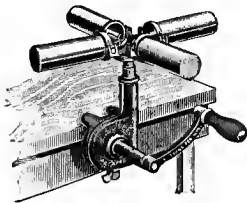

"FACILE JUNIOR."

"SIMPLEX"

Combined Churn and
Butter Worker...

"FACILE"

Babcock Testers.

"B. & W."

Milk Check Pump.

"B. & W."

Double Surface Milk Heater.

SPRAGUE

Adjustable Gang Cheese Press,
Increasing Pressure
Attachment.

CHR. HANSEN'S

Danish Dairy Preparations.

RENNET EXTRACT

Cheese and Butter Colors.

D. H. BURRELL & CO.

LITTLE FALLS,

-

-

NEW YORK.

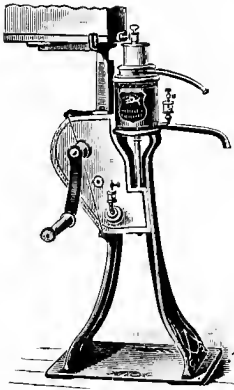

The Two Leaders

U. S. Cream Separators
—AND—
“Agos” Babcock Testers.

Once Used, Always Used.

We handle a complete line of Dairy and Creamery Apparatus.

Write For Illustrated
Catalogues.

Vermont Farm
Machine Co.,

BELLOWS FALLS, VT.

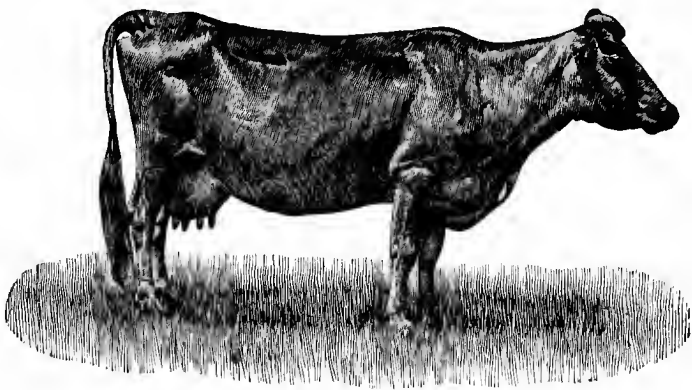
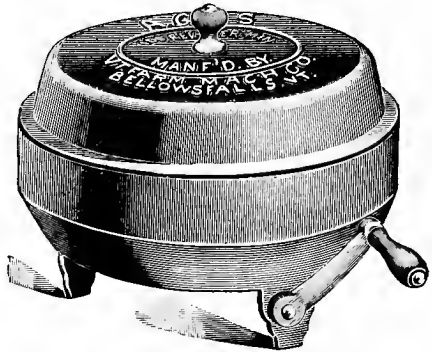



INDISPENSABLE



.. FOR ..

Cheese Making

on the Farm.

Chr. Hansen's Rennet Tablets

—AND—

Chr. Hansen's Cheese Color Tablets.

Send 50c for a box of 24 No. 2 Rennet Tablets, and 30c for a vial of 12 Cheese Color Tablets.

For Factory Cheese Making, use:

Chr. Hansen's Danish Rennet Extract,

—AND—

Chr. Hansen's Danish Cheese Color.

Both liquids, the Standard of the world.

The Marshall Rennet Test

Is a valuable guide for determining the condition of the milk in the cheese vat.

For Butter Making, use

Chr. Hansen's Danish Butter Color,
A pure Annatto Color, or the

Columbian Butter Color,
The Strongest in the Market.

Chr. Hansen's Lactic Ferment
Ripens the cream or the milk to perfection.

Write For Information, to

CHR. HANSEN'S LABORATORY,

P. O. BOX 1010.

LITTLE FALLS, N. Y.

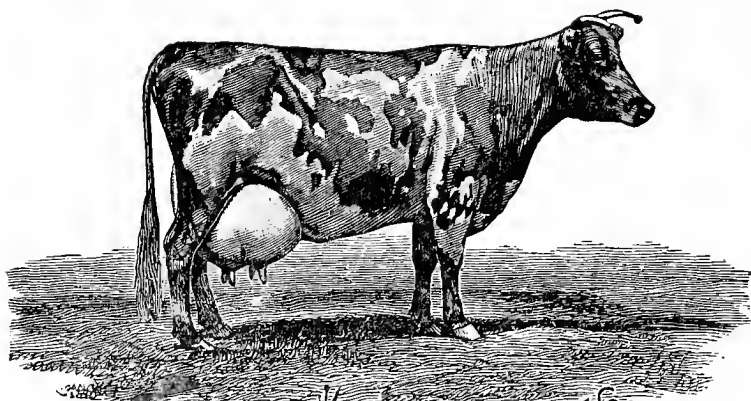

Duchess of Smithfield, 4,256.



STURGES & BURN MFG. CO.,

Chicago, St. Paul, Kansas City.

HEADQUARTERS FOR

...Sturges...

Seamless Cheese Hoops,

Milk Cans, Cheese Presses, Curd Mills, Cheese Boxes,
Bandages, Followers, Rennet, Cheese Color,
Scale Boards.

We have the best stock of

Cheese Factory and ❧ ❧
❧ ❧ Creamery Supplies

In the Country. We can convince you of this
by a trial order. Write for Catalogue.

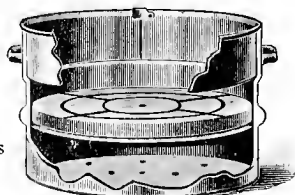

THE CURTIS CHANNEL VAT

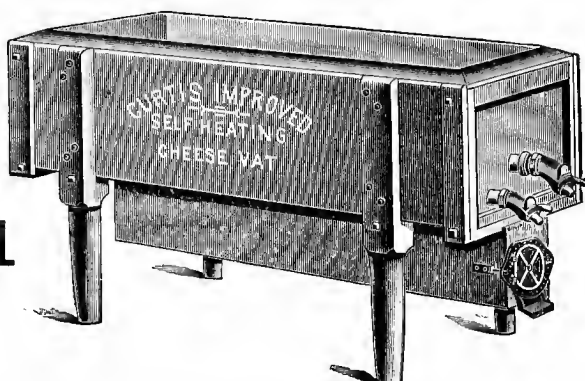

With The Curtis Whey Strainer and The Curtis Curd Rack
IS A COMBINATION FOR CHEESE MAKING
THAT EXCELS ALL OTHERS.

SEND FOR CATALOGUE containing prices of all Supplies necessary for
Cheese Making.

CORNISH, CURTIS & GREENE MANUFACTURING CO.,
FT. ATKINSON, WISCONSIN.

KEITH'S BUTTER and CHEESE CULTURES.

Reliable Pure Liquid Cultures for ripening cream for either pasteurized or raw cream butter, and a *Special Culture for Ripening Milk for Cheese-Making* as recommended by the Wisconsin Agl. Experiment Station.

The numerous premiums that have been awarded users of these Cultures during the past five years, testify as to their sterling quality and to the care used in producing them. I invite your careful investigation. Sample and instructions free by mail.

SIMEON C. KEITH, JR., Bacteriologist.

Successor to O. Douglass Butter Culture Co.

Charlestown, Mass.

Good Salts Must Be Used in Cheese.

The idea that "any old" salt will do has long ago been proved false.

ASHTON'S,
EUREKA,
CADILLAC,

Are the best brands. —————

FRANCIS D. MOULTON & CO.,
New York. Chicago.

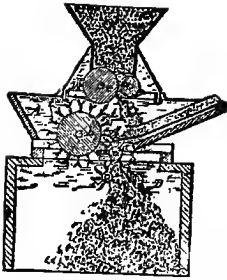

POHL'S . . . SELF-SALTING CURD MILL

Over 2,000 Are in Actual Use
Giving Entire Satisfaction. 

Now the only recognized Curd Mill on the market that works on the true principle. It is the lightest, the easiest to turn. Does not squeeze or injure the curd, needs no sink, grinds and salts at one time; will not clog. It salts every particle of curd evenly, and will grind 8 or 10 cheese in five minutes. For floating curds, this mill is indispensable, and with the salting attachment this is the best and most desirable mill ever made.

It has been put to the severest tests and never found wanting. All first-class factories use it. At the World's Fair it was used in the manufacture of all the cheese turned out in the great competitive test between the breeds, and won for itself the highest commendation from the most critical judges. Every one that uses this mill always speaks of it in the highest terms, as it brings them higher prices for their product. Send for circulars, etc.

POHL'S AUTOMATIC CURD AGITATOR. A machine lately brought out for stirring curd during the cooking process. It will pay you to send for circulars, and get a machine on trial.

STEAM ENGINES AT HARD-TIMES PRICES, For further particulars,
Address

GEO. D. POHL M'FG. CO., Vernon, N. Y.

General Western Agents: Cornish, Curtis & Greene Mfg Co., Ft. Atkinson, Wis., and Creamery Package Mfg. Co., Chicago, Ill.

General Agents for the Pacific Coast: G. G. Wickson & Co., San Francisco and Los Angeles, Cal., and Portland, Oregon.

SUBSCRIBE TO

New York Produce Review.

THE REGULAR WEEKLY

Cheesemaking Department

AND

Market Reports

Are worth twice the subscription price, which is \$1.00 per year in advance.

Subscribers are invited to call for information when needing it.

Send for Sample copy to

173 Chambers St., - New York City

Memoranda.

Memoranda.

DAIRYMEN SHOULD READ

Dairy and Creamery Papers and Books



"Hoard's Dairyman" (weekly), Fort Atkinson, Wis.....	\$1.00
"Chicago Dairy Produce" (weekly), Chicago, Ill.....	1.50
"New York Produce Review" (weekly), New York.....	1.00
"The Dairy Record" (weekly), St. Paul, Minn.....	.50
"Creamery Journal" (monthly), Waterloo, Iowa.....	1.00
"American Cheesemaker" (monthly), Grand Rapids, Mich.....	.50
"Elgin Dairy Report" (weekly), Elgin, Ill.....	1.00
"The Dairy World" (monthly), Chicago, Ill.....	1.00
"Pacific Coast Dairyman" (semi-monthly), Tacoma, Wash.....	1.00
"The Western Creamery" (monthly), San Francisco, Cal.....	1.00
"The Dairy and Creamery" (semi-monthly), Chicago.....	1.00
"The Nebraska Dairyman" (monthly), Lincoln, Neb.....	1.50
"The Dairy Age" (monthly), Topeka, Kan.....	.50
"The Milk Reporter" (monthly), Deckertown, N. Y.....	1.00
"The Milk News" (monthly), Chicago, Ill.....	1.00
"A B C IN CHEESE MAKING," by J. H. Monrad. (Cheddar, Gouda, Skim Cheese, Brie, Neufchatel, Cottage and Whey Cheese.....	Price 50c
"A B C IN BUTTER MAKING," by J. H. Monrad.....	Price 50c
"CHEESE MAKING IN SWITZERLAND," (Swiss, Brick and Lim- burger), by J. H. Monrad.....	Price 50c
"PASTEURIZATION," by J. H. Monrad (second edition)....	Price 50c
"Feeds and Feeding," by Prof. W. A. Henry.....	\$2.00
"A Hand Book for Farmers and Dairymen," by Prof. Woll.....	1.50
"American Dairying," by H. B. Gurler.....	1.00
"Modern Dairying" (Grottenfelt), by Prof. F. W. Woll.....	2.00
"Dairy Bacteriology," by Prof. H. L. Russell.....	1.00
"Cheese and Butter Makers' Hand Book," by J. B. Harris.....	1.00
"Cheese Making," by Prof. J. W. Decker (Cheddar, Swiss, Brick, Limburger, Edam, Cottage).....	1.75
"A Treatise on Cheese Making," by G. E. Newell.....	.50
"The Testing of Milk and Its Products," by Profs. E. H. Far- ington and F. W. Woll.....	1.00
"Indian Corn Culture," by Prof. C. S. Plumb.....	1.00
"Butter Fat and Dividend Calculator," by A. Schoenman.....	2.00
"Milk and Its Products," by Prof. H. H. Wing.....	1.00
"Common Sense Ideas for Dairymen," by Geo. H. Blake.....	1.00
"The Book of the Dairy," (translated) Prof. Fleischmann.	4.00

Mailed direct from publishers, on receipt of price, at buyer's risk, (unless 8 cents extra is remitted for registration).

J. H. MONRAD, Winnetka, Cook Co., Ill.

350,000 MACHINES IN USE

Ten Times All Other Makes Combined

THE STANDARD OF ALL THAT'S BEST IN
DAIRYING IN EVERY COUNTRY IN THE
WORLD. THAT'S THE HISTORY OF THE

DE LAVAL CREAM SEPARATORS

Which possess the patent protected "ALPHA-DISC" and
"SPLIT-WING" IMPROVEMENTS, and are as much super-
ior to other Cream Separators as such other Separ-
ators are to gravity setting methods.

Send for New "20th Century" Catalogue

The DeLaval Separator Co.

Randolph and Canal Sts.

Chicago.

1102 Arch Street
Philadelphia.

217-222 Drumm Street
San Francisco.

General Offices:

74 Cortlandt St.

NEW YORK.

327 Commissioners St.

Montreal.

75 and 77 York Street
Toronto.

148 McDermot Avenue
Winnipeg.

