



NORTH CAROLINA STATE UNIVERSITY LIBRARIES



S02842968 \$

This book is due on the date indicated unless recalled by the Libraries. Books not returned on time are subject to replacement charges. Borrowers may access their library accounts at: <http://www.lib.ncsu.edu/ads/borrow.html>



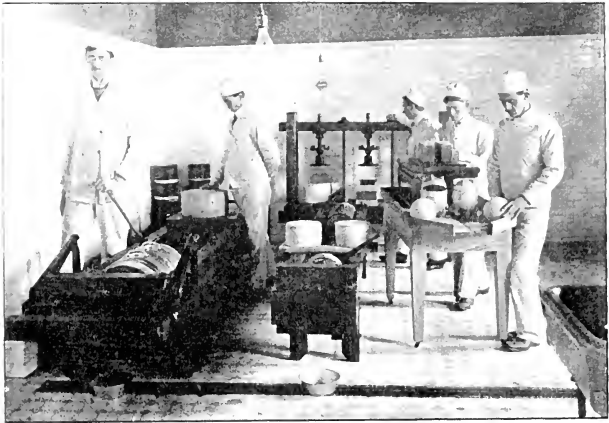

STUDENTS PRESSING CHEESE

CHEESE MAKING

CHEDDAR

SWISS

BRICK

LIMBURGER

EDAM

COTTAGE

BY

JOHN W. DECKER

PROFESSOR OF DAIRYING, OHIO STATE UNIVERSITY; INSTRUCTOR IN
DAIRYING, UNIVERSITY OF WISCONSIN
1890-1899

ILLUSTRATED

COLUMBUS, OHIO
PUBLISHED BY THE AUTHOR
1905

ALL RIGHTS RESERVED

COPYRIGHTED BY
JOHN W. DECKER
1900

PRESS OF
THE BERLIN PRINTING COMPANY
COLUMBUS, OHIO

TO
STEPHEN MOULTON BABCOCK, PH. D.
CHIEF CHEMIST OF THE WISCONSIN EXPERIMENT STATION

WHO, AS A TEACHER, AND LATER AS A CO-WORKER, BY PATIENT LABOR
AND WISE COUNSEL, INSPIRED THE AUTHOR WITH A
GREATER LOVE FOR THE PROFESSION
OF DAIRYING,

THIS BOOK IS INSCRIBED

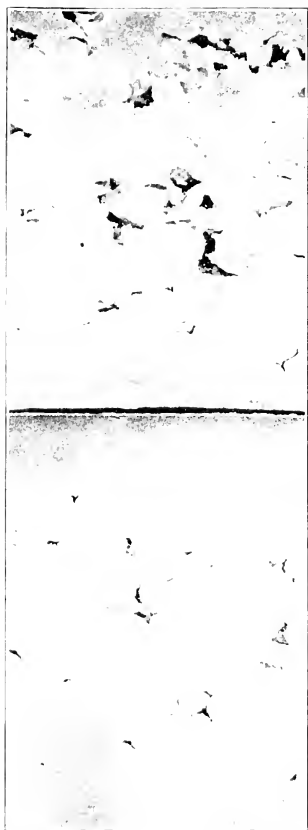

Cold cured cheese, made at the Wisconsin Experiment Station. Upper cheese cured at 60 deg. F., lower at 10 deg. F.
(See page 99.)

PREFACE

The American dairy school is of recent origin, the first one having been started in Wisconsin in 1891.

With the dairy school came the need of pedagogic statements of the subjects taught therein.

It fell to the lot of the author of this book to make such a statement of cheese making. His first attempt was printed in 1893 under the title of "Cheddar Cheese Making." This first attempt met with an encouraging reception and was translated into the French language by Emile Castel for the use of the Canadians in the Province of Quebec. A second and revised edition under the same name was printed in 1895. In 1900 the book was again revised and the scope enlarged to include Swiss, Brick, Limburger, Edam and Cottage cheese, and the title changed to that of "Cheese Making." The edition printed at that time is now exhausted and our knowledge of the subject has increased, requiring a number of important changes to bring the book up to date.

Because of their relation to the subject, milk testing, and dairy bacteriology have been touched upon briefly. An exhaustive treatment has not been necessary as there are text-books treating these subjects.

This is primarily a text-book and not a reference volume. To make the latter out of it would make it unwieldy for the former purpose. An analytical index, a complete table of contents, and references to original matter will, however, assist the busy man, student or instructor to look up references quickly or to find original data.

COLUMBUS, OHIO, January 1, 1905.

TABLE OF CONTENTS.

CHAPTER I.—THE CONSTITUTION OF MILK.

1. Purpose of milk. 2. Composition. 3. Man's use of milk. 4. Albuminoids. 5. Casein. 6. Albumen. 7. Albumose. 8. Ash. 9. Milk sugar. 10. Fat. 11. In emulsion. 12. Creaming of milk. 13. Effect of fat on quality of cheese. 14. Effect of fat on quantity of cheese. 15. Colostrum milk. 16. Curd. 17. Whey. 18. Composition of whey. 19. Losses of fat in whey. 20. Whey from Swiss cheese. 21. Constituents recovered in cheese.

CHAPTER II.—SECRETION AND CONTAMINATION OF MILK.

22. Structure of the udder. 23. Secretion of the milk. 24. Time of secretion. 25. Cause of bad flavors. 26. From food eaten. 27. Flavors; by absorption. 28. Bacterial infection. 29. Varieties of bacteria in milk. 30. How milk is infected. 31. The Wisconsin curd test. 32. Care of milk. 33. Aeration. 34. Varieties of aerators. 35. The barn air. 36. Keep cows clean. 37. Cooling the milk. 38. Covering the cans. 39. Kinds of utensils. 40. Care of utensils. 41. Factory cleanliness. 42. Rubber boots. 43. Scrubbing the floor. 44. Soaps. 45. Scrubbing brushes. 46. Towels. 47. Watch the corners. 48. Shelves for trinkets. 49. How to kill moulds. 50. Antiseptics. 51. To prevent dust. 52. Factory surroundings.

CHAPTER III.—MILK TESTING.

53. Rapid progress. 54. The Babcock test. 55. The bottle. 56. The pipette. 57. The acid measure. 58. The centrifuge. 59. To make the test. 60. Strength of acid. 61. Speed of the centrifuge. 62. Reading the fat. 63. Testing cheese. 64. Quevenne lactometer. 65. Board of health lactometer. 66. Detecting watered milk. 67. Composite samples. 68. Milk thief. 69. Sample jars should be marked to prevent mistakes. 70. Milk samples, how preserved.

CHAPTER IV.—ENZYMES.

71. Two kinds of ferments. 72. Galactase. 73. Rennet extract and pepsin. 74. Rennets, how preserved. 75. How rennet extract is made. 76. Reliable brands to be preferred. 77. Effect of heat on rennet. 78. Rennet does not exhaust itself. 79. Effect of acidity on the action of rennet. 80. Rennet extracts not alike. 81. Rennet action dependent on

three things. 82. J. B. Harris discovers the rennet test. 83. Rennet a powerful agent. 84. Glass graduates for measuring. 85. The Monrad rennet test. 86. Use thermometer to stir milk. 87. The Marschall rennet test. 88. How to use the test. 89. Marschall tests not alike. 90. Errors to be avoided with Marschall apparatus.

CHAPTER V.—THE DEPARTMENT OF RENNET.

91. Experiments in rennet action. 92. Effect of acid and alkali. 93. Effect of water in milk. 94. The effect of salt (NaCl). 95. The effect of temperature. 96. Effect of Anæsthetics. 97. Thermal Destruction point. 98. Effect of strength of rennet solution. 99. Soluble calcium salts required for rennet action. 100. Effect of milk preservatives. 101. Scale pepsin compared with rennet.

CHAPTER VI.—CHEDDAR CHEESE.

102. History of Cheddar cheese. 103. Rise of factory system; in New York. 104. In Ohio. 105. In Wisconsin. 106. Two processes of manufacture. 107. Cheddar system proper. 108. Test for over-ripe milk. 109. Stir milk to keep cream down. 110. Ripening the milk. 111. How to ripen milk to the right point. 112. Definition of a starter. 113. What to use for a starter. 114. Lactic ferment starter. 115. What not to use for a starter. 116. Milk must not be too ripe. 117. Adding the color. 118. Setting the milk. 119. Rennet should be diluted. 120. The use of pepsin. 121. When the curd is ready to cut.

CHAPTER VII.—CUTTING AND HEATING THE CURD.

122. Firming the curd. 123. How to cut a fast working curd. 124. Use horizontal curd-knife. 125. How to insert the horizontal knife. 126. How to take the knife out. 127. How to insert the perpendicular knife. 128. Rapidity of stroke a factor. 129. Keep curd moving. 130. When to begin heating. 131. Cooking an overripe curd. 132. Stirring the curd. 133. Curd rakes. 134. McPherson curd rake. 135. How to tell a proper cook.

CHAPTER VIII.—DRAWING THE WHEY—DIPPING AND MILLING THE CURD.

136. Measuring acid. 137. Threads due to acid. 138. Use of acidimeter. 139. Result of too much acid. 140. Curd rack. 141. Racks, how used. 142. Cutting the curd into blocks. 143. Turning the curd. 144. Pin-hole curds. 145. Washing curds. 146. Use of a curd sink. 147. Proper form of curd sink. 148. How to fill the curd sink. 149. Keep the curd warm. 150. Piling curds. 151. When a curd is ready to mill. 152. Description of curd mills. 153. Pohl mill. 154. Whitlow mill. 155.

McPherson mill. 156. Gosselin mill. 157. The Harris mill. 158. The Fuller mill. 159. The Barnard mill. 160. The Kasper mill. 161. Advantages for and objections to knife mills. 162. Stirring the curd. 163. Time to mill. 164. Effect of dry acid. 165. How to expel gas. 166. Steaming curds.

CHAPTER IX.—SALTING AND PRESSING THE CURD.

167. Condition of a curd for salting. 168. What salt is. 109. Where salt comes from. 170. Impurities in salt. 171. What salt does to cheese. 172. Effect of too much salt. 173. Curds not always salted the same amount. 174. Salt should be evenly distributed. 175. Application of salt. 176. Temperature for salting. 177. Conditions of salted curd for pressing. 178. Removing fat. 179. Curd must not be too warm. 180. Curd must not be too cold. 181. Common packages of cheese. 182. Kinds of bandage used. 183. How the bandage is put onto the cheese. 184. Cheese must be the same size. 185. Tighten the press slowly. 186. Dressing the cheese. 187. The Wilson hoop. 188. How to get cheese dry. 189. Do not pound the hoops. 190. Greasing the cheese. 191. Cracks in cheese. 192. Cheese in cold storage. 193. Cleaning mouldy cheese. 194. Cheese cloth circles. 195. Press cloths. 196. Keep a daily record.

CHAPTER X.—CURING AND SHIPPING THE CHEESE.

197. Changes in curing. 198. Curing at different temperatures. 199. Curing shelves, how made. 200. Arrangement of cheese. 201. Moisture in curing room. 202. The Hygroscope. 203. The Psychrometer. 204. Condition of the curing room air. 205. Supplying moisture. 206. Shrinkage in curing. 207. Central curing rooms. 208. Paraffining cheese. 209. Cheese, how boxed. 210. Scale boards. 211. How cheese are weighed. 212. Marking of weights. 213. Buyer's stencil. 214. How to sell cheese.

CHAPTER XI.—JUDGING CHEESE.

215. Ideal cheese. 216. Flavor. 217. Texture. 218. Salt. 219. Color. 220. Gross appearance. 221. Wisconsin factory cheese makers' scale. 222. Corky cheese. 223. Hard, crumbly or mealy cheese. 224. Weak bodied, pasty cheese. 225. Cracked cheese. 226. Poison cheese. 227. Rusty spots in cheese.

CHAPTER XII.—HINTS ON THE CONSTRUCTION AND OPERATION OF CHEESE FACTORIES.

228. Independent factories. 229. Ontario cheese factories. 230. Good foundations. 231. Dimensions. 232. Store room. 233. Curing room. 234. Sills. 235. Curing-room floor. 236. Vat-room floor. 237. Curing-

room walls. 238. Doors and windows. 239. Joists. 240. Stone cellar. 241. Curing cellars. 242. Cellar, how ventilated. 243. Sub-earth ducts. 244. Use of a well. 245.^b Number and size of tiles. 246. Water motor fans for driving air. 247. Boiler room. 248. Building should be raised. 249. Water supply. 250. Hot water. 251. Septic tank. 252. Sewer trap. 253. Whey tank, how built. 254. Elevating whey. 255. Bath room. 256. Equipment. 257. Water boxes of vats should be lined. 258. Curd sinks. 259. Pressing flats. 260. Sink, how made. 261. Milk, how lifted. 262. Milk testing. 263. Appliances needed. 264. Curing shelves. 265. Cost of factory.

CHAPTER XIII.—ORGANIZATION OF CHEESE FACTORY ASSOCIATION.

266. Plans of operation. 267. By-laws for a cheese factory association. 268. Test committee. 269. Quorum. 270. Rates for making. 271. Figuring dividends. 272. Factory statement.

CHAPTER XIV.—SWISS CHEESE—ITS CHARACTERISTICS.

273. Sweet curd cheese. 274. Switzer, where made. 275. Description of Switzer cheese. 276. Determining quality of cheese. 277. Flavor. 278. Texture. 279. Color. 280. Grades of cheese. 281. How cheese is tried.

CHAPTER XV.—SWISS CHEESE—FROM MILK TO CURING CELLAR.

282. Selection of the milk. 283. Cause of Glaesler cheese. 284. Rennet test should be used. 285. Use of a starter. 286. Test of rennet solution not correct. 287. Swiss kettles. 288. Filling the kettle. 289. Setting the milk. 290. Cutting Swiss curd. 291. The Swiss harp. 292. The wire stirrer. 293. Another method of cutting. 294. Inserting the wooden brake. 295. Cooking the curd. 296. Testing the curd for firmness. 297. Dipping the curd. 298. Pressing drum Swiss. 299. Pressing block Swiss. 300. Marking cheese. 301. Salting the cheese in brine. 302. Salting with dry salt.

CHAPTER XVI.—SWISS CHEESE—WORK IN THE CELLAR.

303. Starting the eyes. 304. Reason for making block Swiss. 305. Handling on the shelves. 306. The second cellar. 307. Handling block Swiss in the cellar. 308. Length of curing period. 309. Boxing drum Swiss. 310. Boxing block Swiss. 311. Whey butter.

CHAPTER XVII.—BRICK CHEESE.

312. Characteristics of brick cheese. 313. Quality of milk required. 314. Milk when received. 315. Quantity of rennet required. 316. How cooked. 317. Testing curd for firmness. 318. Dipping the curd. 319.

Brick cheese molds. 320. Draining table. 321. Draining boards. 322. Filling the molds. 323. Pressing the cheese. 324. Salting the cheese. 325. Curing the cheese. 326. Appearance of gas; remedy. 327. Curing process. 328. How cheese is shipped. 329. Fancy styles.

CHAPTER XVIII.—LIMBURGER CHEESE.

330. Origin of Limburger. 331. Characteristics of Limburger. 332. Kind of milk required. 333. Utensils used. 334. Setting the milk. 335. Cooking Limburger curd. 336. Dipping the curd. 337. Limburger pressing table. 338. Salting Limburger. 339. Curing Limburger. 340. Shipping Limburger. 341. Cause of putrefactive fermentation.

CHAPTER XIX.—EDAM CHEESE.

342. Characteristics of Edam cheese. 343. Origin of Edam. 344. Farming in Holland. 345. Edam cheese in Holland. 346. Treatment of cheese for market. 347. Description of an Edam market. 348. Possibilities of manufacture in America. 349. Market for Edam in America. 350. Methods of manufacture. 351. Quality of milk required. 352. Handling the curd for Edam. 353. Edam molds. 354. Methods of pressing. 355. Hooping the curd. 356. Dressing Edam cheese. 357. Salting Edam. 358. Curing Edam. 359. Shelves for new cheese. 360. Length of curing period. 361. Preparing the cheese for market.

CHAPTER XX.—COTTAGE CHEESE.

362. Utilization of skim milk. 363. Methods of manufacture. 364. Curdling power of acid. 365. Effect of fat on per cent of acid in milk. 366. Abnormal fermentations. 367. Measuring the acidity. 368. Moisture, how regulated. 369. Dipping the cheese. 370. Hydrochloric acid cheese. 371. Marketing the cheese. 372. Soft cream cheese.

CHAPTER I.

THE CONSTITUTION OF MILK.

1. PURPOSE OF MILK.

Cow's milk is given for the primary purpose of nourishing the young calf until it can seek other food in variety.

2. COMPOSITION.

One might therefore expect to find that it contains all the food elements necessary for the building up of the young animal's body. An analysis reveals the presence of water, for the young animal's body is in the largest proportion composed of water; ash for the bones; nitrogenous material in the form of casein, albumose and albumen to nourish the muscles, hair, hoofs and horns; and carbonaceous matter in the form of sugar and fat to maintain the heat of the body.

The following table will give a fair idea of the average composition of milk as delivered to a New York cheese factory; the figures being taken from Bulletin 82, December, 1894, Geneva, New York Experiment Station:

TABLE SHOWING AVERAGE MONTHLY COMPOSITION OF MILK.

Month.	Per cent Water.	Per cent Total Solids.	Per cent of Fat.	Per cent Solids—not Fat.	Per cent Nitrogen Compounds.	Per cent Casein.	Per cent Albumen.	Per cent Albumose.	Per cent Sugar, Ash, Etc.
May	87.40	12.60	3.63	8.97	3.14	2.44	0.32	0.38	5.83
June	87.53	12.47	3.55	8.92	3.07	2.35	0.29	0.43	5.85
July	87.63	12.37	3.59	8.78	3.00	2.27	0.29	0.44	5.78
August	87.51	12.49	3.78	8.71	3.05	2.32	0.31	0.42	5.66
September ...	87.33	12.67	3.75	8.92	3.10	2.41	0.34	0.35	5.82
October	86.87	13.13	4.00	9.13	3.36	2.60	0.36	0.40	5.77

These samples were not fresh when received by the chemist, part of the albumen having been changed to albumose. It is

given in the table as reported by the chemist, but the albumen and albumose may be thought of as albumen.

This table shows that the total solids in the milk varies between 12 and 13 per cent, and the fat varies between 3.5 and 4.7 per cent. These are averages for the milk in the vat at the factory. Individual cows or herds may produce milk varying considerably from these averages. In the table the sugar, ash, etc., are combined. Approximately speaking milk contains 5 per cent of milk sugar and .7 per cent ash.

The following chart shows how the different constituents of the milk are usually grouped with an approximate relation to their use as food in the animal economy. Thousands of milk analyses are on record, but these vary some with conditions of location, etc., so that it would be difficult to give an absolutely correct average, but the figures here given are within the range of usual variation.

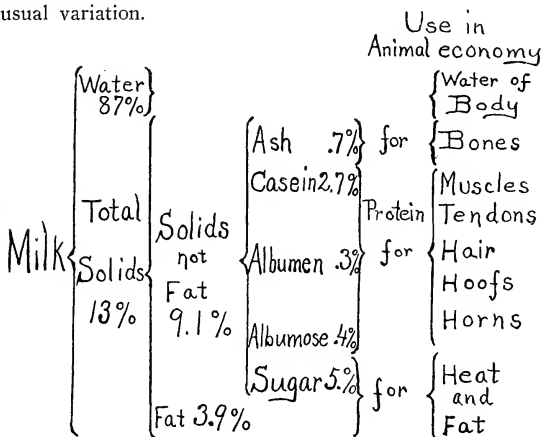

3. MAN'S USE OF MILK.

Man has diverted milk from its normal purpose (the nourishment of the calf) and uses it for a number of food products for himself. The cow normally gives enough milk in quantity and duration to nourish the calf until it can care for itself and then dries up; but by artificial means the cow has been accustomed to the habit of giving milk in larger quantities and for a

longer period, and the cow that has not acquired this habit satisfactorily is not a financial success. Let us examine the several components of the milk.

4. ALBUMINOIDS.

The albuminoids or protein contain the nitrogen of the milk and may be divided into three parts; namely, the casein, albumen, and albumose.

5. CASEIN.

The casein is the part of the milk that is curdled by rennet or weak acids. Commonly speaking it is said to be dissolved in the water of the milk, but this is not strictly true. If milk be filtered through a porcelain filter it will leave a gelatinous mass in the filter. This is the casein; or, if skim milk be revolved for a long time in a separator bowl, a layer of casein will be deposited on the walls of the bowl. Casein is dissolved in solutions of borax, sodium phosphate, and alkalis. It is used commercially as a sizing for paper.

6. ALBUMEN.

By referring to the preceding tables (2) it will be seen that the casein does not constitute all of the protein of milk. When milk has coagulated by rennet the casein is precipitated. If the whey be heated to 180° F. another precipitate will be thrown down. This is the albumen. It is much like the white of an egg which is coagulated by heat. It is in solution until the heat precipitates it. It probably accounts for part of the burnt taste of boiled milk. Albumen cannot be incorporated in Cheddar cheese without giving the conditions of sour cheese.

7. ALBUMOSE.

The albumose is not coagulated by rennet heat. It is derived from the albumen.

8. ASH.

The ash is the bone-forming part of the milk and consists largely of phosphates of calcium and potash, and there are some chlorides. Although the ash is in small proportions in the milk it is of great importance in cheese making. Part of the calcium salts are supposed to be suspended as fine particles in the milk or held in combination with the casein, but a part is certainly held in solution and on this solubility of calcium salts depends the property of coagulation by rennet. If ammonium oxalate be added to milk in sufficient quantity, the soluble calcium salts will

be changed to insoluble calcium oxalate, and the milk will not curdle with rennet. Similar results can be obtained by heating the milk to 180° F. When a soluble calcium salt is added, the rennet will again act—in fact will operate faster as the soluble calcium salt is increased.

9. MILK SUGAR.

The sugar of milk crystallizes in hard crystals, but is not as sweet as the common cane sugar. At high temperature it caramelizes, giving with the albumen to the milk, the peculiar scalded taste. It is separated from milk by evaporating whey in a vacuum pan. Commercial milk sugar is used in lactated foods and medicines.

10. FAT.

The fat of the milk is a mixture of several fats, mainly of stearic, palmitic and oleic acids, in combination with glycerine. With these are a number of fats that are both volatile and soluble. In this latter respect butter fat differs from the fats used in oleomargarine. Filled cheese is made by introducing oleo oils into milk in the place of the butter fat.

11. IN EMULSION.

The fat of milk is in emulsion—that is, it is distributed through the milk serum in the form of very small globules, which can be seen by the eye only by the aid of a powerful microscope. They vary normally in size from 1-40,000 of an inch to 1-2000 of an inch in diameter. Being so very small they must necessarily be very numerous.

Dr. Babcock estimates that in average milk there are 150,000,000 in a single drop. The average production of fat globules by the cows in the Cornell Experiment Station herd has been estimated to be 38,210,000 per second.

12. CREAMING OF MILK.

The fat globules being lighter than the surrounding serum naturally rise, and crowding close together form a layer known as the cream. In the manufacture of cheese it is necessary to get an even distribution of the fat globules at the time of coagulation by the rennet.

13. EFFECT OF FAT ON QUALITY OF CHEESE.

Cheese from separator skim milk is hard and horny; and though undoubtedly possessing food value, is too tough to be eaten.

Each cheese in this lot was made from 100 pounds of a patron's milk delivered at the Wisconsin Dairy School. The per cent. of FAT in each milk and pounds of cheese obtained is marked on each cheese.

The QUALITY of the cheese improves with the increase of fat.



This picture illustrates the fact that as the fat increases, the yield of cheese increases. The fat content of the cheese also increases and makes a richer, better cheese, that should bring a higher price per pound (U. S. Eleventh Annual Report Wisconsin Agricultural Experiment Station, p. 111). The weights given were taken as soon as the cheese came from the press. The cheese was made soft for a local trade.

Cheese made from part skim milk though rather dry, is better than this, and the cheese from full cream milk more mellow and agreeable to the taste. Cheese made from exceptionally rich milk or from milk fortified by addition of cream is still softer and more palatable. This difference in quality is recognized on the market as can be seen by the quotations, full skims ranging from 1 to 4 cents in value, and full creams 7 to 13 cents per pound. Cheese containing less than 50 per cent of fat in the total solids has been made from skimmed milk.

14. EFFECT OF FAT ON QUANTITY OF CHEESE.

About five and a half to six pounds of cheese can be obtained from one hundred pounds of separator skim milk, the amount obtainable depending on the amount of casein in the

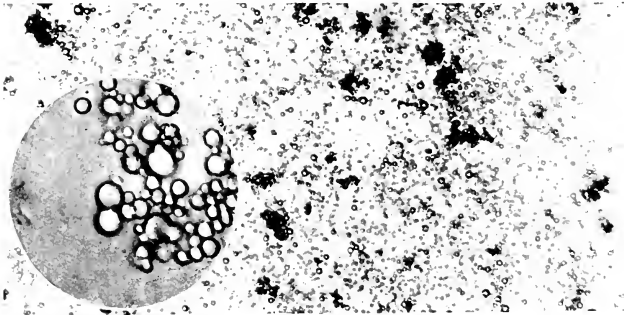

The fat globules as seen through a microscope. The portion included in the circle is more highly magnified. The clotting is due to an albuminous substance (the fibrin according to Dr. Balcock) that collects around the globules soon after the milk is drawn from the udder.

cheese. Perhaps 5.7 lbs. would be the amount of cured cheese obtainable from such milk. Butter fat will carry about a tenth of its weight of water with it into the cheese. A rough way of estimating the probable yield of cheese from a milk of a certain test would be to multiply the per cent of fat by 1.1, and add 5.7—the result being the pounds of cheese obtainable. For instance, from 3 per cent milk there would be obtained $3 \times 1.1 = 3.3$ plus

5.7 equal to 9 lbs.; and from 4 per cent milk, $4 \times 1.1 = 4.4$ plus 5.7 equal to 10.1 lbs.

A little more accurate method is as follows: Cheese on the average contains 37 per cent of water and 63 per cent solids. By dividing 100, the total per cent of solids and water, by 63, the per cent of solids in the cheese, we obtain the factor 1.58. Of the solids not fat, the casein and ash going into the cheese forms about one-third. Some fat goes into the whey so that on the average about 91 per cent goes into the cheese. Then the following formula will give the pounds of cheese obtainable from a given milk:

$1.58 \left(\frac{\text{Solid not Fat}}{3} + .91 \text{ Fat} \right)$ Example solids not Fat 8.92, fat 4 per cent.
 $8.92 \div 3 = 2.74$ or $\frac{1}{3}$ solids not fat. $.91$ of $4 = 3.64$.
 $3.64 + 2.74 = 6.38$ or the total solids $\times 1.58 = 10.08$ pounds of cheese.

No rule can give absolutely correct results on account of varying factors that will be explained later.

The students of the Wisconsin Dairy School who work for dairy certificates are required to report their work each month on blanks furnished them. From 347 of these reports covering 40,900,890 pounds of milk made into 3,800,000 pounds of cheese, Dr. Babcock prepared the following table:

TABLE SHOWING PER CENT OF FAT IN CHEESE FROM MILKS OF DIFFERENT COMPOSITION.

Per cent Fat in Milk.	Yield of Cheese per 100 lb. Milk.	Per cent Fat in Cheese	Pounds of Cheese for one pound of Fat.
3.18	9.19	29.7	2.94
3.38	9.24	32.3	2.73
3.60	9.41	34.0	2.61
3.84	9.81	35.1	2.56
4.09	10.30	35.8	2.51
4.45	10.71	37.8	2.41
Average 3.75		34.1	2.63

It will be observed that the results with the rule given above correspond very closely to the results in actual practice. It also illustrates the difference in the quality of the cheese, for as the fat in the milk increases, it also increases in the cheese, making a mellower cheese which is more pleasing to the consumer.

The yield of cheese per pound of fat, however, decreases with the increase of fat in the milk. If this were not so the

cheese could not become richer in fat with the corresponding improvement in quality.

Dr. Babcock has given a most excellent demonstration in the Eleventh Annual Report of the Wisconsin Experiment Station, that from market quotations the true value of milk for cheese is in proportion to its fat content. He says, in conclusion: "It may be stated as a general rule that it never pays to skim off part of the cream and make both butter and cheese, and further that whenever the price of butter exceeds two and one-third times the price of cheese it will pay better to make butter than cheese, no account being taken of the value of skim milk and whey. If the relative value of skim milk and whey be taken into account butter should pay better than cheese whenever its price exceeds two and one-quarter times the price of cheese. Under other conditions cheese should pay better than butter."

As a compromise between the pooling system and the butter fat method of paying dividends, Prof. H. H. Dean offers a suggestion of adding 2 per cent to the test. Thus, if A's milk tested 3 per cent, add 2 and make it 5 per cent. If B's tested 4 per cent, add 2 and make it 6, thus changing the ratio of 3:4 to 5:6. This would make either patron's butter fat more valuable if water was added to the milk. The method puts a premium on the poorest quality of milk.

In Chapter XIII an illustration of the method of paying for milk by fat test is given.

15. COLOSTRUM MILK.

The first milk given by a cow just after parturition is called colosturm milk, and is much more viscous than normal milk, sometimes being as thick as syrup, and usually of a high color. The components of the milk are not in their normal proportions, the albuminoids sometimes amounting to 15 per cent, and the specific gravity may run as high as 1.085. Under the microscope, cells which have scaled off from the inside of the udder can be seen floating in the milk, and while these dead particles are present the milk is unfit for cheese. After four or five milkings the milk will appear normal, but it should not be used for a week.

16. CURD.

The curd, or green cheese, is the coagulated casein which holds in its meshes most of the fat, some water, and small por-

tions of albumen, milk sugar and ash, plus salt that is added artificially when finished. The water in green cheese is about one-third of its weight. Green cheese and curd are synonymous, for the cheese is simply the curd pressed together.

TABLE SHOWING COMPOSITION OF GREEN CHEESE.

Per cent Water.	Per cent Solids.	Per cent Solids - not Fat.	Per cent Fat.	Per cent Casein, Etc.	Per cent Sugar, Ash, Etc.
36.69	63.51	29.16	34.14	23.44	5.17

In the above table, which was compiled from the Geneva Experiment Station Bulletin 82, the sugar, ash, etc., are grouped together. Our own analyses showed the ash of cheese to vary from 2.38 to 3.85 per cent, of which ash, 2.38 to 2.68 per cent, was the natural ash of the milk, the remainder being salt that was added artificially. Over 40 per cent water makes a poor cheese. Home trade cheese contains 36 to 37 per cent and export 33 to 36 per cent.

17. WHEY.

In the manufacture of cheese, the milk is curdled by rennet, and the curd cut into small pieces from which the liquid portion, or whey, is expelled. It consists of the major part of the water of the milk, which carries with it nearly all the soluble portions; namely, the albumen, milk sugar, ash, and also a small portion of fat, as the globules break away from the surface of the curd when it is cut.

18. COMPOSITION OF WHEY.

The average of analyses of whey for an entire season in a New York State factory was as follows: Water 93.12 per cent, total solids 6.88 per cent, fat .27 per cent, nitrogenous substances .81 per cent, ash sugar, etc., 5.80 per cent.

19. LOSSES OF FAT IN WHEY.

At the Minnesota Experiment Station in 1892 cheese was made from normal milks of different fat content. The following table shows the losses of fat from these different milks:

TABLE SHOWING LOSSES OF FAT IN MILKS OF DIFFERENT FAT CONTENT.

Per cent fat in milk	3.5 to 4	4 to 4.4	4.5 to 5	5 to 5.5
Per cent fat in whey38	.36	.39	.32
Number of trials	28	31	14	4

In another series of experiments where cream was added to milk to make it test 6 per cent, the loss of fat in the whey was no greater than in the whey from normal milks like that to which the cream was added.

In all cases the richer milks made more cheese, which would of course leave less whey from each 100 pounds of milk. It is easily seen from this that the fat in rich milk can be worked into the cheese more economically than the fat from poor milk. What effect could this have in applying the second rule given in paragraph 14?

20. WHEY FROM SWISS CHEESE.

As explained above (17) the fat that goes into the whey is the fat globules that are knocked off from the surface of the curd particles. By using the kind of a knife used in Cheddar cheese making, the fat loss can be reduced to .3 or .4 per cent instead of .7 per cent when the old Swiss harp is used.

By careful operation many makers are reducing the fat test of the whey to .2 per cent.

21. CONSTITUENTS RECOVERED IN CHEESE.

The different parts of the milk have been discussed, together with their relation to recovery or loss in cheese making.

The following table taken from Bulletin 82 of the Geneva Station gives a very good idea of where the different parts of the milk go to:

TABLE GIVING GENERAL SUMMARY OF SEASON'S RESULTS RELATING TO LOSS OF MILK-CONSTITUENTS IN CHEESE MAKING.

	Pounds in 100 lbs. of milk.	Pounds lost in whey for 100 lbs. of milk.	Pounds recovered in cheese for 100 lbs. of milk.	Per cent Lost in Whey.	Per cent Recovered in the Cheese.
Solids in Milk.....	12.52	6.20	6.32	49.52	50.48
Fat in Milk.....	3.66	0.25	3.41	6.83	93.17
Nitrogen Compounds in Milk..	3.07	0.73	2.34	23.78	76.22

In this table it will be seen that 93.17 per cent of the fat of the milk went into the cheese and our rule places the figure of 91 per cent low. (17)

QUESTIONS ON CHAPTER I.

1. What are the food elements which enter into the composition of milk? 2. What is the average composition of milk? 3. What is meant by total solids? 4. Of what do the solids not fat consist? 5. How do we distinguish the difference between casein, albumen, and albumose? 6. What importance is attached to the soluble calcium salts? 7. How much milk sugar in 100 pounds of milk? 8. How does milk sugar differ from cane sugar? 9. What is the nature of butter fat? 10. In what form is the fat found in milk? 11. What is the size of the fat globules? 12. How many fat globules in a drop of average milk? 13. What can be said about the distribution of the globules at the time of adding the rennet? 14. What is the effect of fat in the milk on the quality of the cheese? 15. What is the effect of the fat content of milk on the quantity of cheese obtained therefrom? 16. How much cheese can be made from one hundred pounds of separator skim milk? 17. How much will one pound of fat increase the weight of cheese made from the milk? 18. Give first rule for calculating approximately the yield of cheese from milk of a given fat content. 19. Give second rule for calculating yield of cheese when both fat and solids not fat in the milk are known. 20. What does Dr. Babcock say about the practice of making both cheese and butter from the same milk? 21. What is colostrum milk, and how does it differ from normal milk? 22. What is the chemical composition of green cheese? 23. What is the whey and what elements of the milk does it contain? 24. How do the losses of fat in rich and poor milk compare? 25. How may excessive losses of fat in Swiss cheese making be avoided? 26. What proportion of the various constituents of the milk go into the curd and into the whey?

CHAPTER II.

SECRETION AND CONTAMINATION OF MILK.

22. STRUCTURE OF THE UDDER.

The udder of the cow where the milk is secreted, consists of two glands tied to each other along the median line, and to the posterior part of the abdomen, by fibrous tissue. Each quarter has two openings or teats. The teat is hollow, having an opening at the lower end guarded by a sphincter muscle. The chamber of the teat opens into another chamber in the lower part of the udder just above the teat. From this chamber ducts diverge, dividing and growing smaller. The two halves separated by the fibrous band along the median line are entirely separate. The ducts end in little chambers about a thirtieth of an inch in diameter. These chambers or ultimate follicles are lined with cells. Arteries, blood vessels and nerves surround them and the blood brought by the arteries is changed by the cells into milk.

23. SECRETION OF THE MILK.

While some parts of the blood may be taken into the milk without change, and white blood corpuscles have actually been found in milk, the blood is for the most part changed by the cells. The fat globules are produced in the cells and turned loose into the ducts.

If samples of the fore milk and strippings be analyzed, the solids not fat will be found to be the same. The strippings will, however, be much the richer in fat. This is explained on the ground—first, that the fat globules being lighter there is a natural creaming in the udder, and second, that the fat globules being solids are retarded more by friction in their passage through the ducts.

24. TIME OF SECRETION.

Some authorities believe that milk is secreted to a large extent at the time of milking, for when a cow is excited or



A section through a quarter of a cow's udder. Photographed at Cornell, N. Y., Experiment Station.

disturbed at that time, she may fail to produce as much milk of the same quality as usual.

On the other hand the longer the period between milkings the larger will be the quantity of milk given, and if the udder is not emptied it will become very much distended, and from these facts it is argued that milk production is a continuous process, though the rate of secretion may vary at different times.

25. CAUSE OF BAD FLAVORS.

There are three causes for bad flavors in milk, namely: From strong foods through the blood, by absorption from the air, and by bacterial infection.

26. FROM FOOD EATEN.

Some strong flavored foods like onions, turnips, cabbages, rag weed, etc., put a like flavor into the milk given by the cow. The reader may have observed that when very hungry and faint, a little lunch will renew strength in a very few minutes. This shows how quickly the food is taken into the blood. In like manner when a cow eats strong flavored foods the volatile substances constituting the flavor are taken into the blood and from the blood they go into the milk. Aerating milk (33) will in a measure set these volatile substances free. If strong flavored food is given the cow just before milking the flavor will be sure to be found in the milk. If fed just after milking the flavors will probably pass out of the cow's system before the next milking.

27. FLAVORS BY ABSORPTION.

Milk, especially when warm, will absorb odors through the medium of the surrounding air. It should therefore be kept away from the debasing influence of hog pens, barnyards, swill barrels, and like odoriferous sources. It is very likely that the flavors of food may get into the milk in this way.

28. BACTERIAL INFECTION.

Upon standing, milk becomes sour. The souring is caused by the growth of minute organisms, commonly called microbes or bacteria. They are plants consisting of but a single cell and so small that they can be seen only by powerful microscopes. They increase very rapidly and by their growth produce the changes observed in the milk. Some forms change the milk sugar into lactic acid and the milk becomes sour, other kinds

produce a ropiness of the milk without souring it, and other forms produce gas in the milk and when made into cheese the curd becomes filled with gas holes.

29. VARIETIES OF BACTERIA IN MILK.

The following are some of the more common conditions produced in milk by bacterial growth:

Sour milk; gassy milk; bitter milk; slimy milk; soapy milk, which comes from a germ found on straw in the stable, producing a soapy taste and frothing of the milk; alcoholic fermentation; red milk; blue milk (not skimmed); green milk, etc. A bacillus known as *coli communis* which exists in the colon or large intestine, thriving in the warm conditions there found, finds its way from manure into the milk and causes a large proportion of the gassy curds that our cheese makers have to deal with. At the Cornell Experiment Station this germ was found to exist in the udder for a long time. It found its way through the opening in the teat, got a lodgement, and was there to grow and contaminate the milk until accidentally dislodged and carried out with the milk. Rusty spots in cheese are caused by *bacillus rudensis*.

30. HOW MILK IS INFECTED.

When the milk is drawn from the udder, bacteria floating separately or clinging to particles of dust in the air fall into it. It will readily be seen that if the stable is closed tight and hay has been fed just before milking, a great deal of bacteria-laden dust will be stirred up to fall into the milk. If the cow lies down in the manure, or other filth, at milking time the dust from this is stirred up and falls into the milk. Warm milk is a good place for the germs to grow, and they multiply very rapidly. If the milk is cooled the growth of the bacteria is checked for the time, but on warming up the milk again they will grow and multiply rapidly.

31. THE WISCONSIN CURD TEST.

While associated in dairy work with Drs. Babcock and Russell at the Wisconsin Experiment Station we brought out what is known as the Wisconsin Curd Test for the detection of injurious fermentations. The apparatus consists of pint, or smaller jars, with perforated tops, which set in a frame in a water tank. Samples of the milk to be examined are taken in

the various jars, which are then set in warm water in the water tank and raised to a temperature of 95° to 100° F. Ten drops of rennet extract is added to each sample and when the milk has curdled, the curd is broken up with a case knife. Care should be taken not to transfer the germs from one sample to another by the case knife or thermometer. As soon as the whey separates, it is strained off through the strainer top, leaving the curd behind in the jar. The curd is then under the



A. Uninfected. B. A few gas germs. C. Many gas germs.

The curds here shown were from curds developed in the Wisconsin Curd Test. A sample of good milk was divided into three parts. A was set normally. To B and C a starter of a *Coli communis* a gas germ was added, the larger starter being added to C.

same conditions as a curd in the cheese vat, and the various kinds of bacteria will develop, giving their characteristic results. If the result be gas it will show in the curd, or if it be a taint it will be manifested. Common Mason fruit jars and a washtub can be used for this work, but the regular apparatus for the purpose is much handier.

32. CARE OF MILK.

Having explained the sources of bad flavors in milk, a few suggestions about the care of milk may be in order. It has been seen that one cause of such flavors is the feed that the cows may get. If it is necessary to feed turnips or such foods, they should not be fed to excess, and just after milking, in order

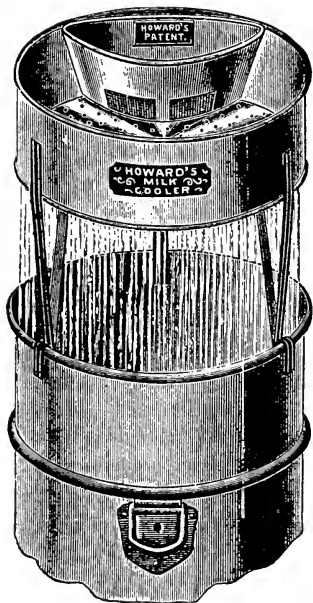

Howard's Aerator.

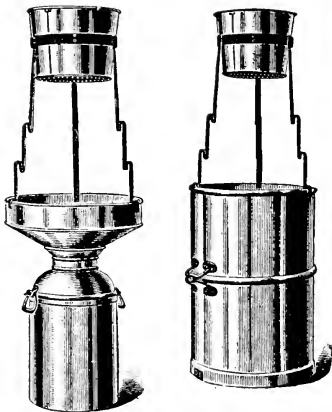

B. & W. Aerator.

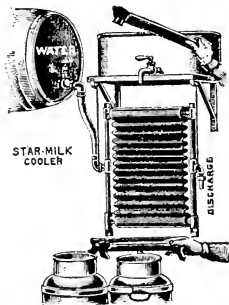

STAR-MILK COOLER

MILK AERATORS.

that the flavor may disappear from the cow's blood before the next milking.

33. AERATION.

Milk should be aerated—that is, it should be exposed in thin films or streams to the air, so that these volatile substances may escape. As milk will absorb odors from the air, especially when the milk is warm, great care should be taken to aerate the milk in a place where the air is fresh and untainted. The barn is obviously a poor place in which to do this.

34. VARIETIES OF AERATORS.

The common aerator is a large tin vessel with fine holes in the bottom. It is held above the milk can by an iron frame. The milk is strained into this, and while the milker is busy milking the next cow, the milk falls through the air in fine streams. The star cooler and aerator is arranged so that the milk flows in a thin film over a corrugated surface, and water flowing through the apparatus cools the milk rapidly as it is being exposed to the air.

35. THE BARN AIR.

The air in the barn should be kept as free as possible from dust, for as previously explained the particles of dust are loaded with bacteria. Danish farmers have a habit of airing out the stables before milking, and hay or dry fodder is not fed until after milking.

The stables should also be kept clean to prevent the milk from being injured by foul odors.

36. KEEP COWS CLEAN.

The cows, if dirty, should be carded the same as a horse. There is absolutely no excuse for having a cow's flanks plastered over with filth. As previously explained, such filth is an incubator for the kinds of bacteria that spoil the milk. At milking time the dust is stirred up and falls into the milk. Just before milking, the cow's coat should be dampened with a rag or sponge to lay the dust and thus prevent its falling. The habit of wetting the teats, however, is a bad one, for with the moisture dirt runs down into the milk.

While a limited number of lactic acid-producing germs in milk may not be detrimental, the germs that come from barn filth are very injurious.

37. COOLING THE MILK.

As soon as the milk has been aerated, it should be cooled to 60° F. or less. At 40° F. there will be little, if any, change in the milk, and if it has to be kept a considerable length of time, this temperature should be approximated as near as possible.

38. COVERING THE CANS.

After the milk has been properly aerated and cooled, it should be covered to prevent evaporation from the cream that forms on the top. This cream can be readily worked back into the milk if it does not become leathery from evaporation.

39. KIND OF UTENSILS.

Wooden pails should not be used for milk for the reason that milk will soak into the wood and ferment, ready to contaminate the next lot of milk.

The seams of pails, cans and dippers should be filled flush with solder so that milk cannot collect and sour.

40. CARE OF UTENSILS.

All strainers, pails and other utensils in which the milk is handled should be rinsed first with lukewarm water, and then with boiling water, and if possible, exposed to a jet of steam to thoroughly sterilize them. Many germs are killed by direct sunlight, and the utensils should be set out in such a position that the sun can shine into them. After scalding they should *not* be wiped out with a dirty rag.

41. FACTORY CLEANLINESS.

No less important than the matter of cleanliness in the barn and manner of milking, is the matter of cleanliness in the factory. Milk may be spoiled in an untidy factory after its delivery there. A few suggestions at this time regarding the care of the factory will be pertinent.

Almost every cheese-maker will keep the inside of the weigh-can and cheese vats clean, but the outside is often sorely neglected. Milk may be spilled on the floor, and not properly cleaned up. Water is slopped on the floor, and the maker wades through it without drying it up; when the whey is drawn from the vat, it often goes on the floor, and in order to keep his feet dry, he wears rubber boots.

42. RUBBER BOOTS

The rubber boots are an injury to his health and the slop unnecessary, to say nothing about the wear on the floor and its nasty appearance. One would think a woman who kept her kitchen floor in such condition, a very untidy housewife, and there is no reason why a factory floor should be slopped over any more than a kitchen floor. If any water accidentally gets onto the floor, it should be mopped up at once. Rotten floors which have to be renewed often, and rheumatism and ill health for the operator, is the price paid for the doubtful privilege of making a mill pond of the make-room floor. The old saying that "a penny earned is a penny saved" applies in a modified form to work in a factory, viz.: Care in preventing dirt will save the labor of cleaning it up.

43. SCRUBBING THE FLOOR.

At the close of the day's work, the floor can be scrubbed, first with lukewarm, and then with hot water, and then dried off with a rubber mop. Hot water will make the floor dry quickly,



Rubber Mop.

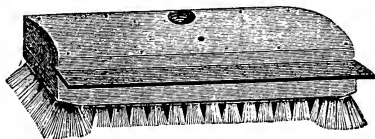

Floor Scrub.

but it should never be used where milk has been spilled, or where milk or whey is on tinware, for heat will scald the milk on.

44. SOAPS.

Powdered soap, such as "Gold Dust," is very effective in taking out dirt, but it is too expensive a form in which to use soap, as it dissolves readily and runs away. Salsoda is much cheaper and just as effective for a great many things, such as cleaning the floor. A mixture of cheap soap and salsoda can be dissolved in hot water and used hot for scrubbing, and then afterward rinsed off with hot water.

Sapolio is a soap mixed with infusorial earth, which may be used for scouring tinware.

45. SCRUBBING BRUSHES.

Several good stiff scrubbing brushes are needed for getting into corners. Brushes are now made in a number of different forms so as to apply to all conditions. There are round brushes on long handles for getting into pipes and tubes, strong brushes with sharp corners and round ends, and extra heavy floor scrubs. All these things make the work easier.

46. TOWELS.

Clean towels and clean cloths for wiping the hands and utensils, it would seem, are so evident a need that it may be thought unnecessary to mention the fact, but the author's experience in finding an absence of them in a large number of factories compels mention to be made.

47. WATCH THE CORNERS.

In scrubbing the floor, the mop board should not be forgotten, nor the doors and other wood work. If the maker is careful in scrubbing the floor every day, a general scrubbing once a week will keep things looking bright.

48. SHELVES FOR TRINKETS.

The windows should be kept as clean as those in a dwelling house, nor should tools and little trinkets be laid on the windowsills. There should be shelves for all such things.

The curing room should likewise be kept in order. It should not be a dumping place for all sorts of material, which properly goes into the store room above.

49. HOW TO KILL MOULDS.

If at the beginning of the season, the walls are sprinkled with water, and the room closed tight while two or three pounds of sulphur is burned in it, moulds will be killed.

50. ANTISEPTICS.

A still better way is to wash the walls with limewater. Limewater is a disinfectant, and should be used wherever it can be applied. Commercial sulphate of iron, or copperas or green vitriol, as it is commonly called, is also a disinfectant, and should be put into drains and places that are likely to smell bad.

51. TO PREVENT DUST.

The boiler room must not be neglected. If coal is used, coal dust can be prevented by sprinkling the coal with water.

The floor should be kept cleanly swept, and should be mopped twice a week, or as often as needed. Tools should have their regular places and be kept there.

The reader may think it a waste of space to talk about all these little matters, but experience has taught the writer that they are the foundation of the business of cheese-making; and makers often fail, because they do not recognize the fact.

It is much easier to keep a clean factory than a dirty one, for the old saying that "an ounce of prevention is worth a pound of cure" is true here, as well as in other cases.

52. FACTORY SURROUNDINGS.

Having got the inside of the factory clean, why not make the outside of it to match? Plant some trees, and in painting the factory, choose white or some light color, that will not absorb but reflect, the heat. A little extra effort may be put into graveling the roadways, to prevent them being cut up in wet weather. Level off the ground for a little space, seed it down, and cut the grass with a lawn-mower. If a dry spell comes we have plenty of water in our well, and can sprinkle the lawn with our steam pump. These things would take but little extra effort, and all will agree, that the result would fully repay the effort.

Why should it not be the rule that a cheese factory is to be kept not only clean, but attractive as well?

QUESTIONS ON CHAPTER II.

1. Describe the structure of the udder. 2. What can be said about the secretion of the milk in the udder? 3. How do samples of the fore milk and strippings compare as to fat content? 4. How is the greater fat content of the strippings explained? 5. At what time is the milk secreted? 6. What are the three sources of bad flavors in milk? 7. How does the flavor of food get into the milk? 8. Will warm milk absorb odors? 9. What are microbes or bacteria? 10. What can be said about the effect of different germs on milk? 11. What can be said about the bacillus known as coli communis? 12. How is milk infected? 13. What is the Wisconsin Curd Test and how is it used? 14. What is the value of the aeration of milk? 15. Describe some of the common aerators. 16. What can be said of the barn air at milking time? 17. Why should the cows

be kept clean? 18. Why should a cow's coat be dampened just before milking? 19. Why should milk be cooled after aerating? 20. Why should the milk cans be covered over night? 21. Why should wooden milking pails not be used? 22. How should utensils be washed? 23. What is the effect of wet floors and rubber boots on a maker's health? 24. How should the floor be scrubbed? 25. Why is a clean towel needed in a factory?

CHAPTER III.

MILK TESTING.

53. RAPID PROGRESS.

When one stops to think that only fifteen years ago, or even less, the only means that a cheese-maker had of determining the quality of milk was the crude test tube, where the milk was set for the cream to rise, and a lactometer that would read good milk when both skimmed and watered, he begins to realize what great progress has been made in milk testing in so short a time. This great change has been brought about by work done at the Agricultural Experiment Stations, and this one line of progress is paying large dividends on all the money that has been invested in them.

As indicated in Chapter I (14) the value of milk for cheese making is dependent on its fat content. "New coins are handled with suspicion," and when the new method of paying for milk according to test came to be advocated, farmers and dairymen were slow to adopt it until they understood it. At the present time, probably 70 per cent of the Cheddar cheese factories in Wisconsin are paying for milk in this way.

54. THE BABCOCK TEST.

The Babcock test was invented by Dr. S. M. Babcock of the Wisconsin Agricultural Experiment Station, and published in Bulletin No. 24, July, 1890, and is now not only in general use in this country, but is also used in the different countries of Europe, and India, New Zealand and Australia. It has literally "gone round the world."

It consists of four parts:

55. THE BOTTLE.

A bottle holding about two ounces and having a long, narrow neck, about the size of a lead pencil. On this neck is a scale covering a volume of two cubic centimeters marked off into fifty divisions. Every five divisions marks one per cent and each division is therefore two-tenths of one per cent.

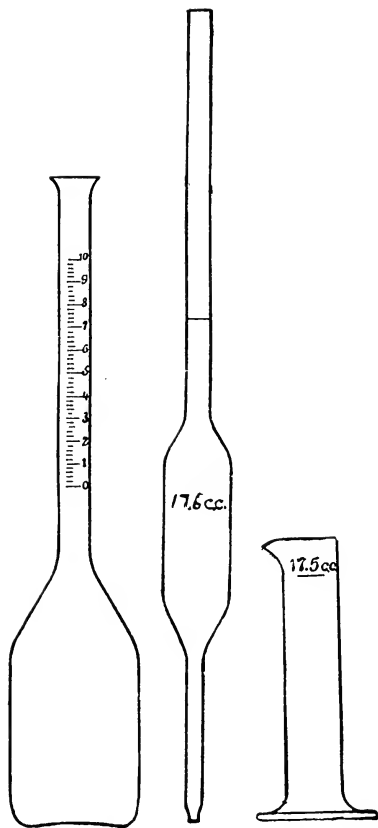

Milk Bottle.

Pipette.

Acid Measure.

Babcock Test Glassware.

56. THE PIPETTE.

The pipette is a glass tube with a bulb in the middle for measuring the milk. There is a mark on the upper narrow stem indicating 17.6 c. c. which volume of average milk would weigh eighteen grams.

57. THE ACID MEASURE.

This is a glass cylinder with a 17.5 c. c. mark on it for measuring the sulphuric acid used in making the test.

58. THE CENTRIFUGE.

This is a machine for whorling the bottles. It consists of a drum about twenty inches in diameter with sockets on the circumference for holding the bottles. The drum is encased in a jacket and is driven by a crank or pulley and gear, or by a steam motor.

59. TO MAKE THE TEST.

The milk to be tested must be thoroughly stirred to get the fat globules evenly distributed. This can be done by pouring from one vessel to another several times. If in the composite test the cream is somewhat hardened, it can be dissolved by warming the milk a little, but this must be done with care as the milk will then churn easily. After the milk is thoroughly mixed draw it up into the pipette by suction with the mouth, and then quickly place the finger over the upper end of it. By letting air in slowly under the finger the milk will run out till it comes down to the 17.6 c. c. mark. Then deliver the contents into the bottle. Next measure 17.5 c. c. sulphuric acid into the bottle, and by a circular motion mix the acid and milk thoroughly till the milk is all dissolved, that is, till no clots are left.

Then put the bottle in the centrifuge and whorl five minutes. At the end of this time the fat will all be on the top of the liquid. Hot water is filled in to bring the fat up into the neck where the amount can be read on the scale. It is whorled another minute to bring the fat all into the neck in a solid mass. It must be read before it gets cold or in a perfectly liquid condition. The bulletin describing the test says 140° F. Better results may be obtained by first filling to the neck and whorling, and then filling into the neck for the final whorling.

Several points of caution should be observed to get uniformly clear readings and reliable tests.

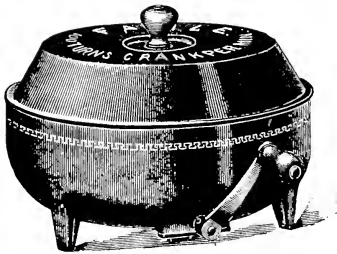

Hand power Centrifuge, covered.

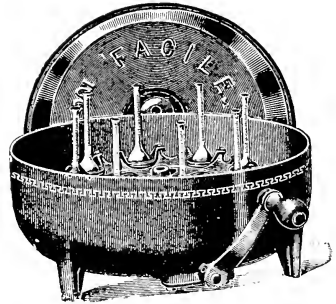

Hand-power Centrifuge, uncovered,
showing position of bottles
in pockets.

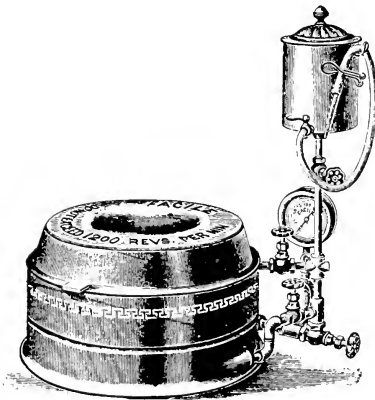

Steam Turbine Test, with steam
gauge and hot water
attachment.

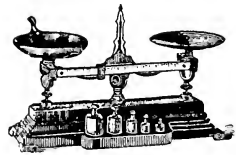

Troemner's Balance, for testing
cheese.

60. STRENGTH OF ACID.

First the acid should be commercial sulphuric acid of a specific gravity of 1.82 to 1.83. If too strong the fat will be charred and there will be black specks in the fat. If too weak, there will be either white curdy matter with the fat or a clear test and not all of the fat. Dairy supply houses now furnish a hydrometer for testing the specific gravity of the acid. If it is 1.81 it is too weak, and if over 1.83 too strong. If the acid is not too much too strong or too weak the difficulty can be obviated by using a little more or less as the case may require. One should observe the color of the fat. It ought to be a deep straw or yellow color. If white or light colored the acid is weak, if black it is too strong. As a general thing there is little difficulty in getting good acid.

Dr. Babcock has invented an automatic acid measure which will fill the bottles with the right amount directly from the acid bottle as fast as the bottles can be shaken. They should be shaken one at a time and not in a tray or in the machine, together, as in that case the milk in some bottles is not thoroughly dissolved.

The acid should go to the bottom of the bottle without mixing with the milk till the final shaking. If it mixes partially and then is allowed to stand, part of milk will get the effect of the acid too strongly, will be charred, and appear in the fat as black specks.

61. SPEED OF THE CENTRIFUGE.

The speed of the ordinary tester, which is about eighteen inches in diameter, should be about one thousand revolutions per minute. The fat is forced to the top of the liquid by the centrifugal pressure, and unless this pressure is sufficient all the fat will not be separated. If the speed is too great the bottles will fly to pieces. Dr. Babcock does not recommend a steam turbine test unless there is a speed indicator attached. A good many of these machines are supplied with steam gauges, but a steam gauge only indicates the pressure applied to the drum, and does not tell the speed.

62. READING THE FAT.

The column of fat should be read from the bottom line, where it meets the water, to the highest point where it joins the

glass. The upper surface is curved, and quite often the test is read low by reading only to the lower part of the curve. It should be read as high as the fat goes. The same thing applies when reading tests of whey. It is quite often read two-tenths when four-tenths is the amount present. A pair of dividers will aid greatly. Open them to the full length of the fat column, then place the lower point on the zero line, and the upper point will show the per cent present at a glance. When reading without dividers errors in subtraction may occur.

Skim milk test bottles with specially narrow necks may be used.

63. TESTING CHEESE.

Cheese may be tested by the Babcock test for fat as well as milk. In making a milk test we take 17.6 c. c., or 18 grams. Cheese contains about one-third fat, so that we cannot take 18 grams; but if we balance the bottle on a small scale, such as druggists use for prescriptions, and weigh in four or five grams of cheese, there will be a convenient amount for the test. The cheese can be cut into small strips which will drop down the neck of the bottle. Then add fifteen cubic centimeters of boiling water and a few drops of ammonia, and shake till the cheese is dissolved into a creamy consistency. When the bottle is *cold* add acid, and test as though it were milk. The reading of the fat is then multiplied by $\frac{18}{a}$, *a* being the weight of the cheese taken. The quotient will be the per cent of fat in the cheese. If we weighed out five grams of cheese, and the reading of the fat is 7.1, we have $(7.1 \times 18) \div 5$, or 25.5% fat in the cheese.

A little balance with weights and a bar, reading to one-tenth of a gram, known as Troemner's balance, is sold by chemical supply houses for about eight dollars.

64. QUEVENNE LACTOMETER.

As has been stated, the Quevenne Lactometer reads specific gravities directly. On the scale are a set of figures reading from 15 down to 40. These figures mean thousandths, that is, 30 means 1.030 specific gravity. If we have a barrel that will hold 1,000 lbs. of water at 60° F., and fill it with milk that reads 30 on our lactometer, we would have 1,030 lbs. of milk in the barrel. Now, if the milk is heated up above 60°, one-tenth of a pound will flow over the top for each degree above 60° F., and

likewise for every degree the milk is lowered, a tenth of a pound more can be put into the barrel. Sixty has been taken as an arbitrary standard of temperature for specific gravity of milk, and we must temper the milk near to that point. If it varies a few degrees, the reading can be corrected by adding or subtracting one-tenth to the reading of the lactometer for every degree of variation in temperature. Thus: if the lactometer reading is 32, and the temperature 65°, add .5 to 32, which would make the corrected reading for 60° 32.5. The best lactometers have a thermometer connected, and it is not advisable to use any other.

65. BOARD OF HEALTH LACTOMETER.

The Board of Health Lactometer has an arbitrary scale reading from 0 to 120; 100 is a specific gravity of 1.029, which corresponds to 29 on the Quevenne scale. This is the lowest specific gravity known for pure milk, the average being about 1.032 sp. g. This scale can be converted into the Quevenne scale by multiplying the reading by .29. By so doing one can use the Board of Health instrument if a Quevenne is not available.

66. DETECTING WATERED MILK.

The solids other than fat make the milk denser and raise the lactometer, while the fat makes it lighter and lowers the instrument. Each per cent of fat lowers it seven-tenths of a degree. If we multiply the per cent of fat found by the Babcock test and add the product to the lactometer reading it will give the reading of the milk if the fat were not present. This is the way to eliminate the effect of the fat. If the specific gravity of the other solids is divided by 3.8, the result will be per cent of solids not fat.

For instance, the lactometer reading is 31.5, the temperature 65°, and the fat 4 per cent, what is the per cent of solids not fat?

$$31.5 + .5 = 32 + (4 \times .7 = 2.8) = 34.8 \div 3.8 = 9.10\%$$

solids not fat.

If the solids not fat run below 8.5 per cent fat it is very poor milk and may be watered.

If 8.5 per cent solids not fat be taken as a basis for pure milk, and we find but 7.00 per cent, the way to get the amount of water added is readily found by proportion :

$$\begin{aligned} 7.0:8.5::x:100 \\ 8.5x &= 700 \\ x &= .832+ \end{aligned}$$

From which 82.3+% is the milk found to be present in the sample or 17.7 per cent water has been added.

When patrons are paid by the fat test it does not pay to go to the trouble of hauling water to the factory.

In paying for milk by test, composite samples are tested as follows :

67. COMPOSITE SAMPLES.

The samples should be saved from each patron's milk every morning by stirring up the milk in the weigh can with a dipper. An ounce cup is then filled with the milk, and turned into the sample jar.

68. MILK THIEF.

A still better way is to take the sample with a milk thief, which is a long tube three-fourths of an inch in diameter, with a valve in the bottom. By lowering this into the weigh can a sample of the milk all the way down runs in at the bottom and the valve is closed by striking the bottom of the can. The tube is then drawn out and emptied through the upper end into the sample jar.



69. SAMPLE JARS SHOULD BE MARKED TO PREVENT MISTAKES.

Each jar has the number of the patron marked on it with asphalt paint, or in some other substantial way.

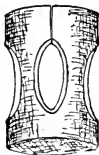

70. MILK SAMPLES, HOW PRESERVED.

A small quantity of potassium bichromate, enough to color a jar of milk a bright yellow, is put into the jar, before any milk is put into it, and this chemical will preserve the milk for a week or more.

Valve end of Scovell's Milk Thief used at World's Fair.

Corrosive sublimate tablets sold by dealers in dairy supplies may possibly give more satisfactory results, but are very poisonous and must be handled with care.

At the end of a week the composite sample of each patron's milk is tested, and the reading of the Babcock test is the percentage of fat in the whole of the week's milk.

For method of making dividends according to test, see Chapter XIII.

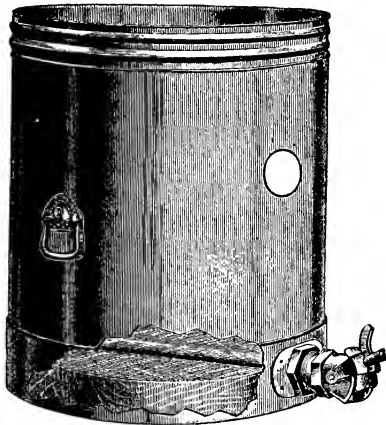

Weigh Can.

QUESTIONS ON CHAPTER III.

1. When and by whom was the Babcock milk test invented?
2. Describe the test bottle.
3. What is the volume included in the scale of the milk bottle and how is it divided?
4. What is the volume of the pipette and what weight of milk will it hold?
5. What is the volume of the acid measure?
6. What is the diameter of the centrifuge drum?
7. How is a test made?
8. What kind and how strong is the acid used?
9. At what speed should the centrifuge be run?
10. Describe how the fat reading should be done.
11. How can cheese be tested with the Babcock test?
12. Describe the Quevenne lactometer.
13. Describe the Board of Health lactometer and state its relation to the Quevenne.
14. How much does each per cent of fat lower the lactometer reading?
15. Give method and rule for detecting watered milk?
16. What is a composite sample?
17. Describe the Scovell milk-sampling tube.
18. How can composite samples be preserved?

CHAPTER IV.

ENZYMES.

71. TWO KINDS OF FERMENTS.

As has been previously described, bacteria are the cause of the breaking up of organic compounds into still other compounds; as for example, milk sugar into lactic acid, or into alcohol and gas. Such changes or fermentations are termed organized ferments because they are the result of the growth of organisms.

There is another class of changes which take place as a result, not of bacterial growth, but of the action of a chemical substance known in contradistinction to the organized ferments, as unorganized ferments or enzymes. Such for instance is a substance found in the saliva known as ptyalin, which has the property of changing starch to sugar. In the stomach is found pepsin which has the property of changing solid proteids to soluble peptones, and in the pancreatic juices is found trypsin, another enzyme with properties similar to pepsin. These enzymes are secreted by the protoplasm of cells which make up the particular glands where these enzymes are usually found. Bacteria have this property of secreting enzymes, and as our knowledge of fermentations increases it may be found that the changes we now suppose to be due to the direct action of the living protoplasm in the cells of plants and animals, are really due to enzymes secreted by the protoplasm. Enzymes have some characteristics in common in the way they behave under changes of temperature. They are most active in the neighborhood of blood heat (100° F.) and cease to act at low temperatures, while at high temperatures (150° to 200°) they are destroyed. The enzymes do not seem to be used up in their action, but will work over and over again.

72. GALACTASE.

Babcock and Russell have recently discovered the presence of an enzyme in milk to which they have given the name galac-

tase. When milk was rendered sterile by chloroform, upon standing it would curdle as though it contained rennet, and then the casein was digested, that is, it was changed to soluble peptones. Galactase is killed at a temperature of 180° F. Its optimum temperature is about 100° F. They have proved that it is at least the major cause of the breaking down of the casein in cheese and its change into soluble peptones; that is, it is the main cause of the ripening of the cheese.

73. RENNET EXTRACT AND PEPSIN.

Since very early times an extract from the calf's stomach has been used to curdle milk in the manufacture of cheese. Such an extract is supposed to contain two enzymes, one rennin, or the lab of Hammersten, having the property of coagulating the milk, and the other, pepsin, which afterward digests the curd.

The city of Copenhagen, Denmark, produces large quantities of rennet. It is said that 5,000,000 rennets are annually consumed in that city. Prof. Alfred Vivian and Mr. Burt B. Herrick, instructors in the Ohio Dairy School, have used scale pepsin in cheese making. Scale pepsin is made by Armour & Co. of Chicago from stomachs of sheep. It both curdles and digests milk and so raises the question whether the curdling and digesting are not really after all two properties of one ferment. Scale pepsin solutions do not curdle very sweet milk as readily as the rennet extracts. Experimentation will probably reveal the cause. In milk containing 2 per cent acid no difference can be observed. In such milk five grams or 75 grains of the scale pepsin is equal to four ounces of Hansen's rennet extract. Pepsin makes cheese of excellent flavor and texture. Enough cheese has been made to establish its value. At the time of the revision of this book experiment stations are at work with it.

74. RENNET—HOW PRESERVED.

The commercial rennet is a calf's stomach which was taken from the calf at the time it was slaughtered, and cleaned, and dried.

The best rennets come from Bavaria. Cheese makers used to buy the rennets and make their own extracts as needed, and the majority of Swiss cheese makers do so now, but extracts, powders and tablets are now manufactured on an extensive

scale, and are much more uniform and reliable than the old homemade extracts, as each new lot of the latter must necessarily be different in strength from the last.

The preparation of rennet powder is too complicated a process for a cheese maker to follow, but one can make his own extract for the season, if he wishes, as follows:

75. HOW RENNET EXTRACT IS MADE.

Prepare a sufficient number of rennets, say five hundred, by splitting them open so that the water can get into them. Then take an oak barrel and put the rennets into it, and fill with water until they are well covered.

Possibly the barrel might be nearly filled with water, but one should not have more water than is necessary to dissolve the ferment.

A little salt should be added to the water, say three pounds of salt to one hundred pounds of water. The rennets should be stirred up and pounded every day, to facilitate the solution of the ferment, and at the end of a week the liquid should be drawn off and the rennets wrung out with a clothes-wringer. They should be put into water again and soaked for another week, and the same operation gone through with. As a usual thing, the ferment has not all been extracted from the stomachs till they have been soaked for four weeks. The liquid that has been obtained by soaking the rennets should be filtered through clean straw, charcoal and sand, and then an excess of salt added to preserve it.

The extract should be clear though of a dark color. The first sign of the decomposition of rennet extract is a muddy appearance.

If extract is ever prepared by the cheese-maker, enough to last the whole season should be made in the spring when the weather is cool, and then it should be kept in a cool place.

76. RELIABLE BRANDS TO BE PREFERRED.

The surest way of getting extract that can be depended on, is to buy some reliable brand.

The practice of preparing extract every few days is wrong, as the strength of each new lot will not be like the last, and if used in about the same quantities the cheese will not cure evenly. The use of whey as a solvent for the rennet is wrong

for reasons that are obvious after considering the subject of organized ferments.

A comparison of extracts and their relative value will be taken up after the rennet test has been explained.

We will now enter upon a study of the properties of rennin, the curdling ferment of milk.

77. EFFECT OF HEAT ON RENNET.

Rennet will not curdle milk at a very low temperature, but as the temperature is raised it will begin to work and act with increasing rapidity until at a point above 100° F. it is injured. By putting cold rennet into warm milk it may work faster up to 120° or 130° F., but when the rennet in weak solutions is heated to 105° F. it begins to be injured. A strong solution may be held at 150° for fifteen minutes without being entirely destroyed, but it will be rendered much weaker. These high temperatures do not destroy the power of the rennet instantly but gradually.

78. RENNET DOES NOT EXHAUST ITSELF.

As has been said concerning enzymes, rennet does not seem to spend its energy, but will act over and over again. If a quantity of milk is coagulated and the whey applied to a like quantity of milk, the milk will be coagulated; this could be done indefinitely, if it were not for getting a larger volume of whey than we have of milk.

79. EFFECT OF ACIDITY ON THE ACTION OF RENNET.

It has been said that the rapidity in the action of rennet is greatly affected by the temperature of the milk, but we will find, if the temperature of the milk is held constant, the more lactic acid there is in the milk the faster the rennet will act, or if any acid be artificially added to the milk in quantities not sufficient to coagulate it, the action of the rennet will be hastened, and on the other hand if alkali be added to the milk, the action of the rennet will be retarded.

80. RENNET EXTRACTS NOT ALIKE.

Another cause for varying rapidity of action is the difference in the strength of the rennet extract used. Rennets vary as to the amount of ferment contained in them, and it is very unlikely that two lots of extracts will be exactly alike.

S1. RENNET ACTION DEPENDENT ON THREE THINGS.

It has been shown that the rapidity with which rennet coagulates milk is dependent on:

1. The strength of the rennet extract.
2. The temperature of the milk.
3. The acidity of the milk.

Now if the same rennet is used at the same temperature of the milk each time, the variation in the rapidity with which it coagulates the milk, must be due solely to the acidity or ripeness of the milk.

S2. J. B. HARRIS DISCOVERS THE RENNET TEST.

About ten years ago J. B. Harris conceived this idea, and used a teacupful of milk from the vat, to which he added a teaspoonful of rennet and noted the number of seconds required to coagulate the milk. When the milk was ripened down to a certain number of seconds, he found that he could foretell approximately the time that it would take for acid to develop.

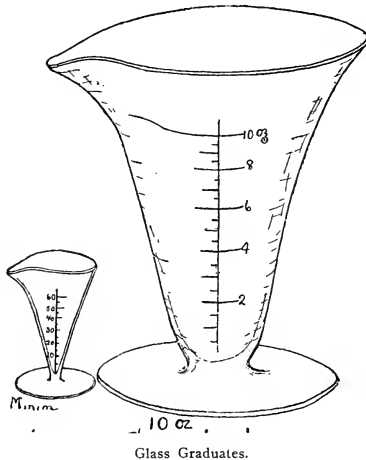
**S3. RENNET A POWERFUL AGENT.**

But if one stops a moment to figure on it, he will see that rennet is a very powerful agent. If one uses four ounces of extract to one thousand pounds of milk, it is one part of rennet

to four thousand of milk, and sometimes the proportion will be as wide as one to sixteen thousand. It will be easily seen that since the rennet is such a powerful agent, it is not likely to be an entirely accurate test where a teaspoon is used for measuring the rennet, for then it would be difficult to measure exactly twice alike. Therefore, in place of the teaspoon, a minim or dram graduate was substituted, and for the teacup an eight-ounce glass graduate such as druggists use. This was much better than the other crude apparatus for making the test.

84. GLASS GRADUATES FOR MEASURING.

But the minim graduate is funnel shaped, and the top being broad in proportion to its volume, the chances for error are still too great in measuring. In actual practice through haste in making the test, two or three drops of extract were likely to be left in the narrow bottom of the minim graduate, and the maker would be confused in not getting the results he expected by depending on it.

J. H. Monrad then proposed a new set of apparatus, which, though not so simple, leaves less chance for error.

85. THE MONRAD RENNET TEST.

The apparatus for the Monrad test consists of a 160 c. c. tin cylinder for measuring the milk, a 5 c.c. pipette, a 50 c. c. glass flask, and a half pint tin basin. By filling the tin cylinder full it always gives the right measure of milk quickly. Measuring the milk in a glass graduate is difficult, as it is hard to get the milk just to the mark, and if the glass is covered with white milk it is difficult to see the mark.

The rennet is first measured with the 5 c. c. pipette. A pipette (as will be seen by reference to the illustration) is a glass tube with a mark on it indicating the volume of 5 c. c., and the rennet can very easily be measured to the mark, and the tube being narrow makes the measurement accurate. The rennet in the pipette is delivered into the 50 c. c. flask, and what little rennet adheres to the inside of the pipette is rinsed into the flask. This is then filled with water to the 50 c. c. mark on the neck, and the solution mixed by shaking. The milk, the temperature of which should be 86° F., measured in the tin cylinder, is emptied into the half pint basin, and 5 c. c. of the dilute extract is measured into the 160 c. c. of milk, and the

number of seconds required to curdle it noted. If a few specks of charcoal are scattered on the milk and the milk started into motion around the dish with a thermometer, the instant of curdling can be noted by the stopping of the specks. They will stop so suddenly as to seem to start back in the opposite direction.

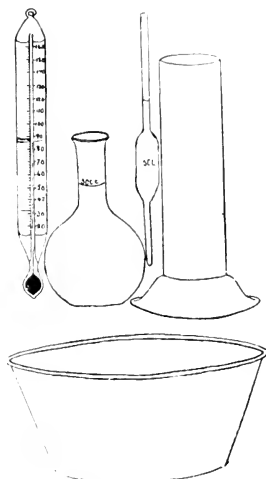

Monrad Rennet Test.

86. USE THERMOMETER TO STIR MILK.

By using a thermometer, the temperature can be constantly watched; and if the temperature should fall, it can quickly be brought back to 86° F. by setting the basin in a pail of warm water for five seconds.

87. THE MARSHALL RENNET TEST.

Another ingenious form of rennet test which is used in a great many factories is the Marshall test, as it keeps its own time. It consists of an ounce bottle with a mark on it to indicate 20 c. c.; and a spatula for stirring the milk; a 1 c. c. pipette is used for measuring rennet into the bottle in which it is diluted up to the mark on the bottle; a test basin, which is a vessel of a little over a pint capacity, on the inner surface of which is a

scale beginning with 0 at the top and numbering by half divisions to 7 near the bottom of the vessel. A hole in the bottom of the vessel is fitted with a cork in which is inserted a glass tube of very fine bore.

88. HOW TO USE THE TEST.

To make a test the vessel is filled with milk at the desired temperature, and when the milk has drained through the little glass tube until the top is at the 0 mark, the diluted rennet is stirred in with the spatula. When the rennet thickens the milk sufficiently no more milk will run out and the operator

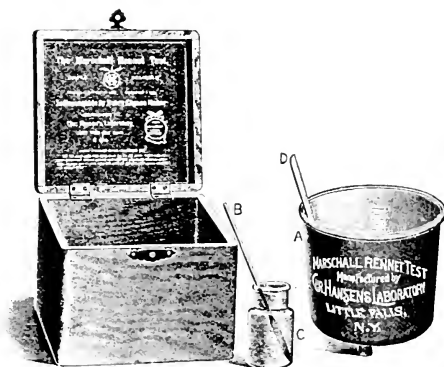

A—Graduated Cup.
 B—1 c. c. Pipette.
 C—Glass in which to dilute the rennet.
 D—Spatula for stirring the milk.

notes the point on the scale down to which the milk has run. The riper the milk the quicker will the milk thicken with a corresponding less reading on the scale.

89. MARSHALL TESTS NOT ALIKE.

Unfortunately the caliber of the glass tubes in the bottom of these tests varies so that varying amounts of milk will run out from different Marshall tests. One may compare results with the same test from one day to another, but a great deal of confusion results from comparing different Marshall tests.

90. ERRORS TO BE AVOIDED WITH MARSCHALL APPARATUS.

1. As there is no thermometer included in the Marschall apparatus the operator is likely to forget that temperature affects the rennet action. One should always temper the vessel before using in cold weather, and should carefully observe the temperature of the milk, both when starting the test and at the time of coagulation. A few degrees in temperature will modify the results very materially.

2. One should exercise great care in running the milk into the vat. Where a large number of tests are made the rennet in the vat may coagulate the milk.

3. Do not compare the results with two pieces of apparatus without first testing them on the same milk.

QUESTIONS ON CHAPTER IV.

1. What are the two general classes of ferments? 2. What are enzymes and where do they originate? 3. What is the effect of temperature on enzymes? 4. Who discovered galactase and where is it found? 5. Describe galactase. 6. What is a rennet? 7. How are rennets preserved? 8. What is rennet extract? 9. Where do the best rennets come from? 10. What is scale pepsin? 11. What is the effect of acidity of milk upon the curdling power of pepsin? 12. How does Armour's scale pepsin compare in strength with Hansen's rennet extract? 13. How is rennet extract made? 14. Why are reliable brands of extract to be preferred? 15. What is the effect of heat on rennet action? 16. What is the effect of acidity on rennet action? 17. On what three factors is the rapidity of rennet action dependent? 18. Who invented the rennet test? 19. Why are glass graduates used in a rennet test inaccurate? 20. Describe the Monrad test. 21. Describe the Marschall rennet test. 22. In what respect are Marschall tests not alike? 23. What errors are to be avoided in using a Marschall test?

CHAPTER V.

THE DEPARTMENT OF RENNET.

91. EXPERIMENTS IN RENNET ACTION.

That the student may better comprehend the department of rennet under different conditions, a few statements are made about the effect of the various conditions to which it may be subjected, together with experiments suggested with the apparatus used in the Monrad test, for demonstrating the truth of the statements made.

92. EFFECT OF ACID AND ALKALI.

Acid in the milk accelerates and alkali retards coagulation.

Experiment (a). Make a test of a sample of milk, observing carefully all conditions as to temperature, strength of rennet, etc. Mark down in a notebook the result. Now add a small quantity of dilute hydrochloric acid to the milk, being careful to stir it constantly while slowly adding the acid. If in a laboratory where decinormal solutions of acid and alkali are available, use about 25 c. c. of acid to a quart of milk, and note the number of seconds required to coagulate when a test is made, carefully observing all of the conditions for making a test properly.

Experiment (b). Repeat the experiment with an increased quantity of acid added to the milk.

Experiment (c). Add slowly a small quantity of dilute soda lye, being careful to stir the milk while adding it, and then make a test as before. Keep careful notes in your note book.

Experiment (d). Make a rennet test of a sample of milk and set it where it will remain warm. Make tests half an hour or an hour later and note that less time is required for coagulation. This is due to the ripening of the milk—or as the scientist looks at it, the bacteria present have been turning the milk sugar into lactic acid.

93. EFFECT OF WATER IN MILK.

Diluting milk with water retards coagulation.

Experiment (a). Make a careful rennet test of a sample of milk. Next take one part of water and three parts of the milk

in question. Mix them and then make a rennet test of the mixture.

Experiment (b). Repeat the experiment with one part of water and two parts of milk.

Experiment (c). Repeat the experiment with one part of water and one part of milk. Can you determine any law governing the rate of coagulation in relation to the amount of water present? Try these experiments with milks of different acidity.

94. THE EFFECT OF SALT (NaCl).

Salt in the milk checks the action of rennet, five per cent stopping it altogether.

Experiment (a). Make a rennet test of a sample of milk, and make a careful note of the result. Now add by weight one per cent of salt and make a careful rennet test. How does the salt affect the test? Try the same experiment with two, three, four and five per cent of salt in the milk.

95. THE EFFECT OF TEMPERATURE.

Raising the temperature hastens, and lowering it retards rennet action.

Experiment (a). Make a rennet test at the standard temperature of 86° F., and write it down in your notebook. Now make tests at 95°, 100°, 110°, 120°, 130° and 140°.

Experiment (b). Make a test at 86° and then try tests at 80°, 70°, 60°, 50° and 40°. If much time is consumed in making the tests, the student should make occasional tests at 86° F. to detect the rate of ripening of the milk.

96. EFFECT OF ANAESTHETICS.

Anæsthetics, like chloroform and ether, suspend protoplasmic action but do not affect enzymes. In this way it is possible to distinguish between organized and unorganized ferments.

Experiment (a). Make a rennet test of a sample of milk and note the number of seconds required. Now add about 3 per cent of chloroform to the sample and shake it in a bottle or cylinder. Next make a test of it. It curdles the milk and rennet is therefore an enzyme.

97. THERMAL DESTRUCTION POINT.

At about 104° or 105° F. rennet in weak solutions is destroyed.

Experiment (a). Make a rennet test of a sample of milk and note the number of seconds required. Next heat the rennet test solution of rennet to 100° for ten minutes and try a test with it on the same milk. Try heating it to 105°, 110°, 115° and 120° for five minutes and make tests after each heating. Do not forget to record results in your notebook.

Experiment (b). Note the length of time required to coagulate 160 c. c. of milk at 86° F. with 5 c. c. of strong commercial rennet extract. Next heat a portion of this strong rennet to 150° F. for five minutes and then note the length of time required for coagulating 160 c. c. of milk at 86° F. with 5 c. c. of it.

98. EFFECT OF STRENGTH OF RENNET SOLUTION.

For a long time it was supposed that as the strength of the rennet solution was increased, the length of time required for coagulation was inversely shortened. This, however, is not true.

Experiment (a). Make a rennet test of a sample of milk.

1. Make up a new solution of rennet, using two 5 c. c. pipettes of rennet in the 50 c. c. flask. This makes the rennet solution double in strength, but the time required for coagulation in a test is what?

2. Make up a solution with three pipettes or 15 c. c. of rennet in the 50 c. c. and make a test.

3. Make up a solution with four pipettes or 20 c. c. in the 50 c. c. What are the results?

4. Try it with 25 c. c. of strong rennet diluted to 50 c. c. It is suggested that the student secure a piece of charting paper and chart out the results here obtained. If the rate of coagulation was diminished inversely in proportion to the increase in strength the results of these tests would when recorded, make a diagonal straight line across the chart, whereas they really make a curved line.

99. SOLUBLE CALCIUM SALTS REQUIRED FOR RENNET ACTION.

It has been previously stated (8) that the soluble salts of calcium must be present in the milk or the rennet will not act.

Take a Babcock pipette of the pepsin solution, add three or four drops of phenolphthalein solution and titrate with $\frac{N}{10}$ alkali. Do the same with rennet extract.

Experiment (a). Make a rennet test of a sample of milk. Add a small quantity of a dilute solution of calcium chloride. (Ca Cl_2) to the milk and make another test. The coagulation will be accelerated. How much?

Experiment (b). Heat a portion of the sample of milk to 190°F . for ten minutes, cool it down and make a test. It will not coagulate for the calcium salts have been rendered insoluble by the heat.

Experiment (c). To a pint of the original sample of milk add 25 c. c. of a strong solution of ammonium oxalate, and make a rennet test. It will not coagulate because the soluble calcium salts have been changed to insoluble calcium oxalate.

100. EFFECT OF MILK PRESERVATIVES.

There is a very pernicious practice among dairymen of using antiseptics to keep milk from souring. Among them are preservaline (boracic acid) and formaldehyde solution sold under the name of freezene, etc. These substances not only check the necessary bacterial fermentations in the manufacture of the cheese, but affect the rennet action.

Experiment (a). Make a rennet test of a sample of milk. Then add 1 per cent of boracic acid to the sample and make a rennet test. Try varying quantities of the boracic acid.

Experiment (b). Make a rennet test of a sample of milk and then add 1 per cent of formaline (formaldehyde solution) to the milk and make a test. Try it with one-tenth of 1 per cent of formaline in the milk.

Question: Should milk doctored with preservatives be received at a cheese factory?

101. Scale pepsin compared with rennet.

101. SCALE PEPSIN COMPARED WITH RENNET.

Dissolve four grams of Armour's scale pepsin in 100 c. c. of cold water. Now make rennet tests with this on milks of varying acidity, at the same time making tests with rennet extract on the same milks for comparison.

QUESTIONS ON CHAPTER V.

1. What is the effect of acid in the milk on rennet action?
2. What is the effect of alkali on rennet action?
3. What is the effect of water in the milk on rennet action?
4. What is the effect of salt in the milk on rennet action?
5. What is the effect of temperature on rennet action?
6. At what temperature is rennet destroyed?
7. What is the effect of anæsthetics on rennet?
8. Is the time of curdling milk inversely proportional to the strength of the rennet solution?
9. What part of the ash of the milk is required for rennet action?
10. What is the effect of boracic acid on rennet action?
11. What is the effect of formaline on rennet action?
12. What is the effect of acidity of milk on the curdling power of the pepsin solution?
13. What do you find the chemical reaction of the pepsin solution and rennet extract to be?

CHAPTER VI.

CHEDDAR CHEESE.

102 HISTORY OF CHEDDAR CHEESE.

For some centuries cheese has been made in the farm dairies in England and Scotland, and the people that came to America continued the manufacture at home of their surplus milk into cheese. The process varied in different dairies and our British cousins have been particularly jealous of their way of making, being careful not to give away any of their secrets as they believed them to be. The term Cheddar came from a town of that name near Bristol.

103. RISE OF FACTORY SYSTEM IN NEW YORK.

The factory system started in America. Jesse Williams, of Oneida County, New York, was the first factory operator. In 1851 he and his sons, located on different farms, brought their milk together and it was made into cheese under his supervision. From this start the factory system developed in New York and was carried into other states and Canada.

104. IN OHIO.

In Ohio the first factory was built by Mr. Budlong, at Chardon, Geauga County, in 1860. The second one was built by Mr. Bartlett at Munson, Geauga County, in 1861. In 1862 John I. Eldridge built the third one in Aurora Township, Portage County. The building is yet standing, but is not in use at this time as a new building close by has taken its place. In 1863 Hurd Bros. built a factory at Aurora Station, which has been in continual operation to the present time. After 1863 the factories multiplied in Ohio very rapidly.

105. IN WISCONSIN.

In Wisconsin the factory system started in about 1864, when Chester Hazen started a factory at Ladoga, Fond du Lac County, and Steven Faville started one near Watertown. At the present time there are about sixteen hundred factories in the state, of which number probably about eleven hundred make Cheddar cheese, the others being brick, Swiss and Limburger.

106. TWO PROCESSES OF MANUFACTURE.

There are two processes of manufacture, one being the granular system, in which the curd is kept in the granular form from the time the whey is drawn until put to press; and the matting system, in which the curd is allowed to mat into a solid mass as soon as the whey is removed, and is afterward milled to get it into a condition for salting before pressing.

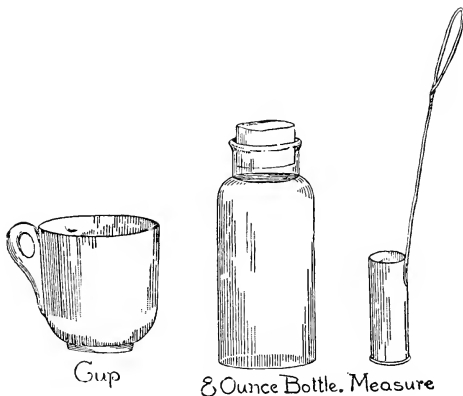

Farrington's apparatus for determining quickly milk of .2 per cent acidity.

107. CHEDDAR SYSTEM PROPER.

The latter system in which the curd is matted is termed the *Cheddar System*. It produces a more meaty texture and uniform grade of cheese and is superseding the granular system.

The Cheddar system as improved in the United States and Canada has been introduced into Scotland and England through Mr. Drummond, an American, in charge of the Kilmarnock dairy school.

The following pages will treat of the best methods as we know them today for making Cheddar cheese. .

FIRST STEPS IN CHEESE MAKING.

108. TEST FOR OVER-RIPE MILK.

Milk that has more than two-tenths of 1 per cent of lactic acid should not be received for cheese making. But as milk will not taste sour until there is three-tenths of 1 per cent of acid in it, it is difficult to know by the taste when to reject such milk.

The Farrington acid test can here be brought into use and the discrimination quickly made. The apparatus consists of a white teacup, an eight-ounce salt mouthed bottle with a cork in it, and a measure made by soldering a wire handle onto a No. 10 brass cartridge shell. Eight Farrington alkaline tablets are dissolved in the eight-ounce bottle of water, which makes a red liquid. A measure of the suspected milk is put into the teacup and then two measures of the red liquid added. If on stirring it, the pink shade remains, there is not two-tenths of a per cent of acid present and the milk can be accepted. If on the other hand the pink color disappears there is too much acid present and the milk should be rejected.

109. STIR MILK TO KEEP CREAM DOWN.

While the milk is being received it should be stirred in the vat to keep the cream down. As soon as the milk has all been received and the quantity figured up, the steam should be turned on and the milk heated to 86° F., and a rennet test made. If the cheese maker is suspicious that the milk may be over-ripe, he should make a rennet test before the milk in the vat is heated up to 86° F., by taking his sample for the rennet test in the basin in which the test is made and warming it up in a pail of warm water.

If the milk is found to be over-ripe, he will have to hurry the process to keep ahead of the fermentation. On the other hand, if he finds the milk very sweet, and that he will have to wait an hour or more for it to ripen down, he should use a starter.

110. RIPENING THE MILK.

If the milk is ripened so as to coagulate in the same number of seconds each day, one can tell very closely the time when the whey can be drawn off from the curd. It should be ripened to a point where in two hours from the time the rennet is added to the milk there will be "one-eighth of an inch of acid" on the curd, as we shall see later on.

With the rennet extract we have been using at the Dairy School, the milk when ripened to thirty seconds works off in about the right time, but the extract is very strong, one ounce being sufficient to coagulate one thousand pounds of milk in twenty minutes. If, however, our rennet extract was so weak

that it would take four ounces of it to coagulate one thousand pounds of the same milk in twenty minutes, it would be only one-fourth as strong as the rennet we have been using, and the milk would then have to be ripened so as to coagulate in one hundred and twenty seconds instead of thirty.

111. HOW TO RIPEN MILK TO THE RIGHT POINT.

Starting in with the season's work the cheese maker has nothing to guide him as to the ripeness of the milk, simply because he does not know the strength of the rennet extract at his disposal. The first day he makes cheese, he must make a rennet test of his milk at the time he sets it and then observe how the milk acts. If the milk is too sweet, he can calculate about how much riper it must be to work just right, and in a few days he will have the matter entirely under his control. Cheese makers should never neglect to use the rennet test, for it enables them to judge definitely the condition of their milk.

When a maker is troubled with tainted milk it is often necessary to ripen a little lower than with good milk, for the bad flavor, as we have already learned, is due to some harmful variety of bacteria which choke out the lactic ferments.

112. DEFINITION OF A STARTER.

A starter is simply a small quantity of milk in which the lactic fermentation has been allowed to develop, and there are therefore millions upon millions of the desired kinds of bacteria in it, and when these are put into the milk in the vat, they increase very rapidly and hasten the ripening of the milk.

113. WHAT TO USE FOR A STARTER.

The starter should be saved from some patron's milk from the morning or evening before, and should always be the best flavored milk, for the whole vat will be made like it.

By adding about half water to the starter milk in the evening it will not curdle so but that it will mix nicely in the vat.

From what has been previously said (30) it will be observed that the milk selected as above is not sure to be the kind of milk desired. If the Wisconsin curd test is used the milk that habitually gives good curds can be selected. Even in that case a bad fermentation may get in. The surest way of getting a good starter is to use a lactic ferment culture.

114. LACTIC FERMENT STARTER.

Lactic ferment is a culture placed on the market by Chr. Hansen's Laboratory, Little Falls, N. Y. It is sold in large and small bottles. The small bottles cost less and are just as good as the large ones, for we can grow the culture ourselves if we once get a start. One or two quarts of milk should be selected as above and heated to 200° F. for fifteen minutes and then cooled to 70° F. The contents of the bottle should be added to the pasteurized milk. In twenty-four hours, if kept warm, the milk will be sour and just at the curdling point.

Another lot of milk, in quantity as much as required for a 2 per cent starter in our vat, should be selected as before and heated to 200° F. for fifteen minutes, and then cooled to 70° F. and the startline added. In twenty-four hours it will be ready to use. A little is saved each day to make new starter. The starter should always be handled in sterile vessels. If care is taken not to contaminate the starter, it can be propagated in a very pure state through a whole season. Carelessness in handling it will infect it with other germs, which will spoil it and it will be necessary to start over again.

115. WHAT NOT TO USE FOR A STARTER.

A starter should not be saved from the vat of milk nor the whey, for the starter will then be likely to contain all sorts of germs, good, bad and indifferent, and these will all be transmitted from one day's milk to the next; in fact, a bad disease might be carried through the milk in this way for a whole season. Thick milk may be used for a starter, if one is hard pressed, but it is better not to let the starter get quite thick. If the starter is thick, it should be strained carefully through a cloth strainer, for if clots of thick starter get into the vat of milk, they will not be colored and may leave white specks in the curd.

Milk should be ripened to a point where in two hours from the time the rennet is added to the milk, there will be one-eighth of an inch of acid on the curd. What is meant by an eighth of an inch of acid will be explained further on.

116. MILK MUST NOT BE TOO RIPE.

Milk should never be allowed to ripen to a point where it will work too fast. In such cases there will be too great a loss of fat in the whey, and a small yield of cheese.

117. ADDING THE COLOR.

Until lately cheese color has been made from the annatto seed grown in South America. Cheaper and stronger color is now being made from aniline, a coal tar product. The public seems to be prejudiced against mineral coloring, but there is so little of it in the cheese that we doubt if it is injurious to health. Personally we like the looks of an uncolored cheese best.

Different markets require different shades. It seems to be a general rule that the further south we go the higher the color that is required. Chicago calls for a straw color. St. Louis wants it higher, and New Orleans higher still.

The color should be added before the rennet. It should be diluted with water and stirred in thoroughly. In the cheese it should not be of a reddish hue.

**BRANCH OF ANNATTO TREE.****118. SETTING THE MILK.**

Having gotten our milk into the proper condition we are now ready to set it. It should be set at 86° F. As sometimes happens, the milk may have accidentally been warmed up to

90°. We would rather set the milk at that temperature than wait to cool it down, for the milk will be ripening while we delay setting it. The only objection to setting milk at 90° is that the curd hardens too fast to cut it conveniently. If it were not for that fact there would be no objection to setting it at 98°.

There is nothing to be gained by setting milk at 82° and waiting for it to curdle. If milk is over-ripe time can be gained by setting it at as high a temperature as it can be readily handled.

For a fast curing cheese we should use enough rennet to curdle the milk in fifteen to twenty minutes; and for a slow curing cheese enough to curdle in thirty to forty minutes.

119. RENNET SHOULD BE DILUTED.

The rennet should be diluted, not with milk (why?) but with a dipperful or pailful of water, and then poured into the vat evenly from one end to the other. The water should be about 90° F. If above 100° F. the rennet will be weakened. The milk should have been thoroughly stirred just previous to adding the rennet, and then the rennet should be thoroughly mixed with the milk. The stirring should be done gently so that the fat will not separate from the milk.

The milk should be kept in motion for several minutes; the surface should then be stirred gently with the bottom of the dipper so that the cream will not rise on the surface, and the milk will set, or coagulate, and hold it down. The movement of the dipper should be kept up for about half the time it takes the milk to coagulate, and then a cover should be put over the vat to keep the surface of the milk from cooling off.

120. THE USE OF PEPSIN.

In substituting pepsin for rennet, only scale pepsin strength 1-3000 should be used. Weigh out at the rate of .5 gram for every hundred pounds of milk in the vat, or for a slow curing cheese at the rate of .4 gram. Dissolve in cold water before adding to the milk. It can be obtained in 1 pound or smaller bottles from Armour & Co., Chicago, or any dairy supply house. A pound is enough for 100,000 pounds of milk.

121. WHEN THE CURD IS READY TO CUT.

The curd is ready to cut when it will break clean before the finger. The index finger is thrust into the curd and pushed

along through it about half an inch below the surface. The curd is first split by the thumb, and when the proper firmness is reached it will break as the finger is pushed along. If the break is clean, that is, does not leave milky but clear whey in the break, the curd is ready to be cut.

QUESTIONS ON CHAPTER VI.

1. State the history of Cheddar cheese.
2. Where and by whom was the first cheese factory operated?
3. When and by whom were the first factories in Ohio built?
4. When and by whom were the first factories in Wisconsin built?
5. What are the two processes of manufacture?
6. What is the Cheddar system?
7. How much acid is allowable in milk for Cheddar cheese?
8. Describe Farrington's rapid acid test.
9. To what point by the rennet test should milk be ripened?
10. How shall a maker determine at what point to set his milk?
11. What is a starter?
12. How should milk for a starter be selected?
13. What is a lactic ferment starter, and how is it prepared?
14. Why should not whey or milk from the vat be used for a starter?
15. From what is cheese color made?
16. Describe the different shades of color required by different markets.
17. At what temperature should milk be set, and why?
18. Why should over-ripe milk be set at a high temperature?
19. Why should rennet be diluted before adding it to the milk?
20. In the use of pepsin, what kind should be used?
21. How does pepsin compare in strength with Hansen's rennet extract?
22. When is the curd ready to cut?

CHAPTER VII.

CUTTING AND HEATING THE CURD.

122. FIRING THE CURD.

Through the work of heat and rennet the curd contracts and expels the whey. In order that this may be more readily done, we cut the curd into small cubes and raise the temperature. The pieces of curd must be of the same size and shape, so that they may expel the whey evenly.

The term "cook" in use for the change brought about in the condition of a curd is not strictly correct, as the curd is not heated hot enough to induce the change ordinarily known as cooking. The term has, however, come into general use by cheese makers and when used by us the firming of the curd by heat is meant.

123. HOW TO CUT A FAST WORKING CURD.

When we have a fast working or over-ripe curd it should be cut finer and heated faster than a normal working curd.

The English cheese-makers used to break the curd, first with their hands, and then with wires, but the curd-knife has entirely superseded that method. There are two forms of knives used in the operation.

124. USE OF HORIZONTAL CURD-KNIFE.

The first is the horizontal knife, which has eighteen or twenty blades. When it is drawn through the length of the vat, it will cut the curd into layers or blankets one-half inch thick, by six inches wide, by the length of the vat long. Care must be taken not to jam the curd, for if it is jammed it will be lost in the whey. The flat sides of the blades should not be forced into the curd to get the knife into a position to cut it, for they will jam the curd in so doing.

125. HOW TO INSERT THE HORIZONTAL KNIFE.

The length of the knife is therefore held in a horizontal position, the upper end of the knife near the handle resting on the top of the end of the vat. The knife is then swung

down into the curd, the edges of the blades cutting into the curd and taking a circular course till the knife has assumed a vertical position parallel with the end of the vat, the lower end of the knife resting on the bottom of the vat. In this movement we have not jammed the curd, but have the knife in a position to move it through the length of the vat and cut the curd into the layers. But these layers are only six inches wide and we will have to cut the whole vat of curd into these layers. Then keeping the knife in the curd we must turn it without breaking the curd, so that we can run the knife to the other end of the vat. Using the side of the knife next to the uncut curd as a center, we turn the knife around through 180° of a circle, and we are ready to carry the knife to the other end of the vat.

126. HOW TO TAKE THE KNIFE OUT.

When we have cut the vat of curd all up into blankets, the knife is taken out in the reverse order to which it went in.



Horizontal Knife.

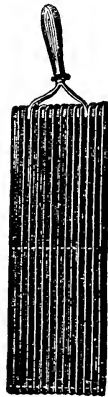

Perpendicular Knife.

The horizontal knife is now laid aside and the operation finished with the perpendicular knife. The blades in this knife run in the direction of the longest dimension of the knife.

Unlike some cheese-makers, the maker should not wait here for the whey to rise over the curd before finishing the

operation, for the pieces of curd will get out of place, and the curd being harder will not be so easily cut.

127. HOW TO INSERT THE PERPENDICULAR KNIFE.

One should next start cutting in the same place as with the other knife, inserting it in the curd in the same way, for it has cross braces which are really horizontal blades, and one must avoid jamming the curd with them. Next draw the knife over the same course that the other knife went, and we have the curd cut into strips one-half inch square and the length of the vat long.

Next cut crosswise of the vat, being careful not to jam the curd, and we then have it cut into half-inch cubes.

If we are making up slow working milk, this amount of cutting may be enough, but if it is necessary to cut finer, it can be done by cutting alternately lengthwise and crosswise. The strokes should be much quicker now, as the curd has been getting harder and finer and will pass between the blades, and a quick stroke is therefore necessary to cut it.

128. RAPIDITY OF STROKE A FACTOR.

When a cheese maker says he cuts a curd a certain number of times, he does not convey the proper idea, for the rapidity of his strokes is a great factor, and if he cuts lengthwise of the vat six times and crosswise six times, and cuts with a slow motion, the curd may not be cut any finer than if it had been cut only four times each way with a quick stroke.

HEATING THE CURD.

129. KEEP CURD MOVING.

As has been said, the curd was cut to allow the whey to escape, but if the curd is not kept moving it will settle to the bottom of the vat and mat together again. Therefore, as soon as the curd has been cut, begin stirring the curd by hand or with a wire basket made for the purpose.

Do not allow the curd to collect in the corners of the vat, and be sure and rub it off from the sides of the vat or it will scald on. The whey should look clear, and be as free as possible from specks of curd floating in it.

130. WHEN TO BEGIN HEATING.

Curd being a poor conductor of heat, one degree in five minutes is fast enough to heat normal working milk. If it is

heated too fast, it will cook the particles on the outside and hold the whey inside of them; and the result will be a mottled whey-soaked cheese. The curd does not expel the whey as fast at 86° F. to 90° F. as it does at a little higher temperature, so that the temperature should be applied slowly at first.

131. COOKING AN OVER-RIPE CURD

If the milk is over-ripe, however, it expels the whey faster, and the curd must be heated faster and higher than normal working curd, or there will be the required amount of acid on the curd before it is hard enough to remove it from the whey. As a usual thing it is not necessary to cook a curd above ninety-

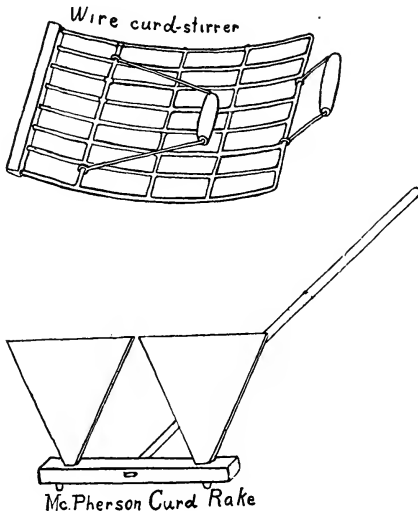

eight degrees, but a curd must be cooked before drawing the whey, no matter if the temperature has to be raised to one hundred and ten degrees to do it. (For definition of cooked curd, see paragraph 135.) It is necessary to cook a fast working curd in that way, and if the curd is taking acid too rapidly for the heating in the whey to be sufficient to firm the curd before the acid is too great, the whey can be drawn and the

remainder of the firming done in warm water, which is run into the vat in place of the whey. (See, however, paragraph 145 regarding this.)

132. STIRRING THE CURD.

To assist the curd in heating evenly and keep it from matting together, it should be stirred from the time it is cut till it is cooked. Some Canadian factories have a steam stirring apparatus which is very handy, but in most factories it is done with a rake.

133. CURD RAKES.

There are two kinds of curd rakes in use, the common wooden hay rake and the McPherson curd rake.

The rake is put into the whey as soon as the steam is turned on, and the curd is started into a rolling motion as though it were boiling. The stirring is commenced with the rake, teeth up, at one end of the vat, and the rake is worked down the length of the vat, making the curd roll on the side of the vat opposite the operator; then back again, making it roll on the side toward him. Care should be taken that curd does not collect in the corners of the vat; nor should it be allowed to roll up into little balls. On the other hand it must not be jammed, or fat will be lost in the whey at the expense of the yield of cheese.

134. McPHERSON CURD RAKE.

The McPherson curd rake has large triangular teeth with the base of the triangle forming the end of the tooth. This form of rake makes it much easier to give the curd a rolling motion. Some rakes have only two large teeth, and others several, but smaller ones. It is well to have two short wooden pins about a half to three-quarters of an inch long, in the back of the rake, to prevent its jamming the curd on the bottom of the vat.

135. HOW TO TELL A PROPER COOK.

One of the most important steps in the process is to know when a curd is cooked enough. There should be one-eighth of an inch of acid on the curd, and then the whey should be drawn. Here it will be seen that our judgment comes into play to know how fast to heat a curd, to have it just firm enough when the acid comes. The rennet test will help us to regulate

this, but if the rennet test indicates that we have a fast working milk it will be necessary to cook faster, and perhaps higher. When the whey is drawn the curd must not be salvy and soft, but when a big double handful is pressed together in the hands, and one hand removed, it should not remain in a mashed-up mass, but should fall apart readily. The particles of curd should be examined from time to time, to see that they are cooking on the inside as well as the outside.

An overcooked curd will give a "corky" cheese, while on the other hand, an undercook will give a salvy, weak bodied cheese that is in danger of souring.

QUESTIONS ON CHAPTER VII.

1. What is meant by firming or cooking a curd?
2. How should a fast working curd be cut?
3. Describe the use of the horizontal and perpendicular knives.
4. What effect has the rapidity of stroke on the fineness to which a curd can be cut?
5. Why do we cut a curd?
6. Why do we heat a curd?
7. How soon after cutting should a maker begin heating a curd?
8. How should an over-ripe curd be heated?
9. Why do we stir a curd?
10. Describe the McPherson curd rake?
11. How can one tell when a curd is properly cooked?
12. What is the effect in the cheese of an overcook?
13. What is the effect in the cheese of an undercook?

CHAPTER VIII.

DRAWING THE WHEY—DIPPING AND MILLING THE CURD.

136. MEASURING ACID.

When there is an eighth of an inch of acid on the curd, the whey should be drawn off.

Strictly speaking, acid cannot be measured by the inch, but the acid seems to act on the curd in some way, so that when a piece is touched to a hot iron and drawn away, it will leave fine, silky threads behind, sticking to the iron. With normal working milk, when the curd is first cooked up, it will not string at all; but when the acid has reached a certain strength, it will begin to string, at first barely sticking to the iron, and as the acid increases, the strings will get longer, till they may be several inches in length.

137. THREADS DUE TO ACID.

That the threads are in no way due to the rennet, but are dependent on the acid, is shown when milk sours naturally. Such a sour milk curd will usually string on a hot iron. If acid is introduced into the milk in sufficient quantity to curdle it, the curd will likely string, in fact, strings of any desired length can be produced, by adding the right quantity of acid to the milk. However, if too much acid is added, it will make a soft, mushy curd, which will not string.

The acid softens the curd so that it readily sticks to the hot iron. About two-tenths of 1 per cent of acid in the whey must be present to make it string an eighth of an inch. As the acid increases the strings get longer. Any solvent of the casein will produce this result on the hot iron. Borax, which is alkaline in reaction, will bring about this result.

138. USE OF ACIDIMETER.

Prof. H. H. Dean of the Guelph Dairy School favors the use of the acidimeter. This is the Manns' acid test. The apparatus consists of a 50 c. c. burette, a solution of phenolph-

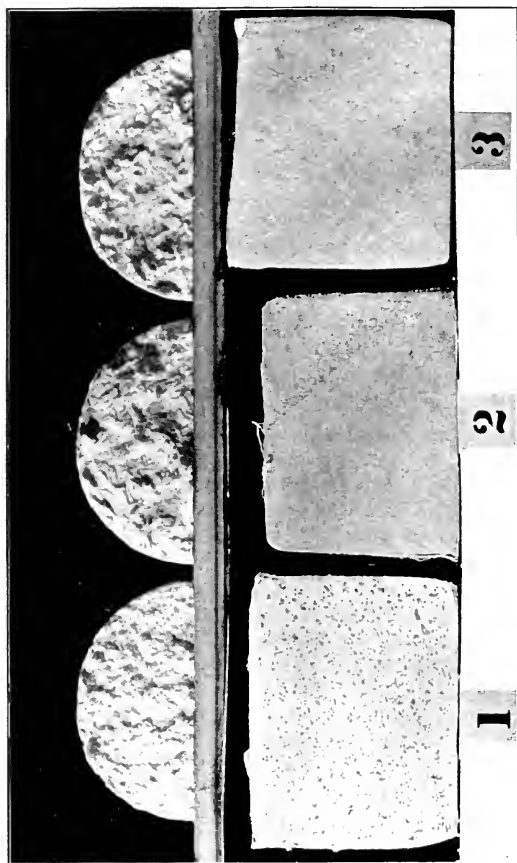

Curd will string on the hot iron when the development of acid in the whey is sufficient to begin to dissolve the casein. This requires about .2 per cent of lactic acid. Any solvent of casein will do the same. This also explains why a closer cheese is obtained by the development of acid, for the half-dissolved particles of curd cement together. No. 1 shows a sweet curd not cemented; No. 2, one cemented by development of acid, and No. 3 cemented by sprinkling borax, an alkaline solvent of casein, on the curd. The upper row shows texture by breaking, and the lower row, texture by cutting.

talein, a Babcock pipette and a tenth normal alkali solution. When a pipette of milk or whey is used 1 c. c. of the alkali used is equal to .05 per cent of lactic acid. The Farrington tablet solution may be substituted for the alkali. Use 19.5 c. c. of water for each tablet. Each c. c. of the solution used will be equal to .01 per cent of lactic acid.

139. RESULT OF TOO MUCH ACID.

When too much acid is developed in the whey, there is also a great loss of fat, as well as of casein. Experience has taught us, that as a usual thing we cannot let the curd take more than one-eighth of an inch of acid in the whey without disastrous results. If we were to wait but a short time after there are strings an eighth of an inch long, we would find perhaps, that they had increased to an inch in length, and our curd would be ruined. It is therefore necessary that one should work nimbly at this stage of the process. Not only should the whey be drawn off from the curd, but the curd must also be thoroughly drained, for whey in the curd will have the same effect as though the curd were still in the whey. Of course the curd must contain its natural amount of moisture, but there must be no pools of free whey in or on the curd.

Dr. Van Slyke has shown that lactic acid acting upon the curd forms a substance which he calls mono-lactic-acid-paracasein. This is dissolved out of the curd by strong brine. This is the substance which makes the curd cement and string. When a double amount of acid unites with the curd it forms di-lactic-acid-paracasein which gives it the characteristics of high acid or sour cheese. The formation of mono-lactic-acid-paracasein affects the subsequent changes in the curing of the cheese.

In the old system of granular cheese making, the curd was stirred over in the bottom of the vat, and then a ditch made in the middle for it to drain. In this stirring, considerable fat was lost, and the curds were not uniform in moisture. The reason of this was, that they were stirred drier one day than another.

140. CURD RACK.

In the Cheddar system, which we follow, the curd is drained on racks, which are placed either in the bottom of the vat or

in a curd sink. The racks are made of hard wood, preferably maple. They are constructed of strips rounded on the top, three-fourths of an inch thick, two inches wide, screwed onto two other pieces two inches high, three-fourths of an inch thick, and four feet long. The slats are three-eighths of an inch apart, and extend crosswise of the vat, and are long enough, so that not more than a quarter of an inch of space is left between each end and the sides of the vat. The racks are usually in two four-foot sections.

141. RACKS—HOW USED.

When the whey is drawn down, so that there is but very little whey left in the vat to interfere with operations, the vat is tipped so that one end is five or six inches lower than the

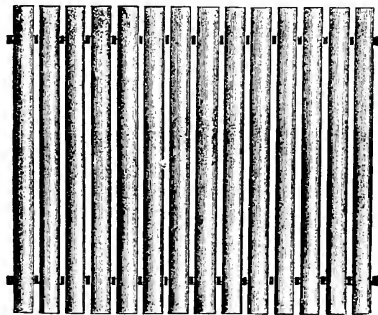

Curd Rack.

other, and the curd is shoved down to the lower end till about five feet of the upper end is cleared. The first section of the rack is then put in, and a linen strainer cloth thrown over it. This strainer cloth should be about twelve feet long, and wide enough (60 inches) to come up over the sides of the vat. The surplus cloth is then tucked under the lower end of the rack, and the curd piled onto it and broken apart to allow the whey to escape.

It should be stirred over several times, and then left to mat evenly about six inches deep. The space, formerly occupied by the curd that has been put onto the racks, is now clear, and the second section of the rack can be placed in the vat. This is put in close to the first section, and the cloth that had

been tucked out of the way, is drawn over it and covered with curd, care being taken, as on the first section, to stir out the whey. The sides and ends of the strainer cloth are then wrapped over the curd, and the vat covered with a heavy cloth cover to keep the curd warm. The temperature must be maintained, to keep fermentation going on.

142. CUTTING THE CURD INTO BLOCKS.

After ten or fifteen minutes, the curd will have matted together, and can be cut into large blocks, which are turned over.

The best instrument for cutting the curd that the author has seen is an instrument invented by Mr. B. B. Herrick, assistant in cheese making in the Ohio Dairy School. It is a trun-

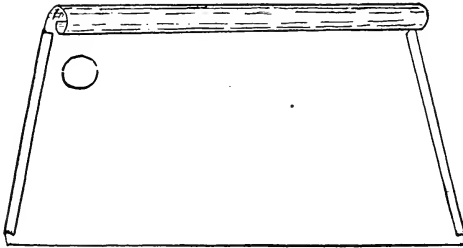

Herrick's Curd Knife.

cated piece of heavy tin or galvanized iron ten inches wide by sixteen inches long. It is folded at the ends and has a bead turned on the back to stiffen it. By taking this in both hands it can be pressed down into the curd cutting it quickly without damage to the strainer cloth.

The curd can be cut once or twice down the length of the vat, and across the vat into pieces eight inches wide.

143. TURNING THE CURD.

Begin at the lower end to turn the curd, for it will be more convenient to place the hands under the curd on the side toward the upper end of the vat, and roll it over. In so doing, it is not necessary to lift the piece, thereby breaking it. Continue turning the other pieces in the same manner, till the last piece at the upper end of the vat is reached, then, by a pull of the cloth, it is turned over. Cover it up and let it stand to mat

still closer. By using racks, the whey runs through when the curd is turned over. Watch the curd, and if whey should collect between the pieces, turn them over and let it run off. The curd should be turned from time to time, but much oftener at first, to facilitate the expulsion of the whey. After a while the curd will begin to get a grain to it, and will tear like the meat on a chicken's breast.

144. PIN-HOLEY CURDS.

If we have what is called a "gassy" or "pin-hole" curd, the gas will begin to form in little holes about the size of a pin head. Through the flattening of the curd, these holes are flattened and the gas escapes. Sometimes these pin holes appear before the curd is taken out of the whey, and, if they are plentiful enough, the curd will float on the surface of the whey, and we have what is called a "floaters." But this does not occur very often, if we draw the whey in time. It used to occur quite often with bad milk, when the curd was left in the granular form, and more acid was run in the whey. The pin holes were not flattened, and consequently appeared in the cheese. Such curds are often accompanied by a bad flavor. They are probably caused from bad ferments, but may be due to bad flavored food. Clover and watercress, when eaten by the cows, have been known to give a curd with pin holes.

Some of the taints are much more persistent than others. As a usual thing, a taint cannot be gotten entirely out of the cheese.

145. WASHING CURDS.

A curd can be greatly improved by washing it. When put onto the racks, and before it has had time to mat, a few pails of water at a temperature of 105° F. will wash out a great deal of the taint.

The author is not now as much in favor of washing curds as he was several years ago. A light washing may improve a curd, but with other substances the lactic acid is washed out and without lactic acid a fine Cheddar flavor cannot be obtained.

We have carried on extensive experiments with this in view. Sweet curd cheese, made from very sweet milk never develops the characteristic Cheddar flavor. Unless two-tenths of a per cent of lactic acid in the whey is developed, this flavor will be

lacking in the cheese. Curds that have an over amount of acid in the whey may appear for the first month to be improved in quality by washing, but after that time, when it is usually beyond the maker's observation and in the wholesale dealer's hands, it will develop a ragged texture and bad flavor like a sweet curd cheese which has been exposed to a high temperature.

At the Wisconsin Experiment Station it has been shown that the lactic acid and milk sugar holds the gas germs in check. If it is necessary to wash the curd very much cane sugar applied at the rate of two and a half pounds to the hundred pounds of curd will keep the undesirable fermentations in check.

146. USE OF A CURD SINK.

It is much easier to get the curd onto the racks and expel the whey, by using a curd sink. Nor is as much fat lost in the operation, for where the curd mats together in the vat before it can be gotten onto the racks, it is necessary to break it apart to let the whey out, and the necessary bruising forces the fat out of it.

147. PROPER FORM OF CURD SINK.

The common form of curd sink, with an opening along the whole length of the bottom, is to be avoided. The sink should be a tin lined box with a channel bottom. There should be racks in it, and the channel under the racks will leave a place for hot water, to keep the curd warm. There should be a faucet at the lower end that can be opened to let the whey drain off, and then closed to keep the water under the curd. If the racks are not used, the curd will not drain sufficiently; and if there is an opening along the bottom, there will be a current of air started up around the curd which will be cooled. Of course this is just what must be avoided, because the fermentation will be checked, if the curd cools down.

148. HOW TO FILL THE CURD SINK.

When the curd sink is used, the whey should be drawn down in the vat till it just barely covers the curd; for while it is covered with whey, it will not mat. The curd sink is then run to the lower end of the vat, and the curd dipped over onto the racks in the curd sink. All the whey runs through, and the curd is left dry to mat properly. If the curd is tainted, it can be more

thoroughly washed, as the curd is not matted together, and the water will wash all around the particles. As the curd is filled into the sink, this can be moved along, and the curd filled into it evenly.

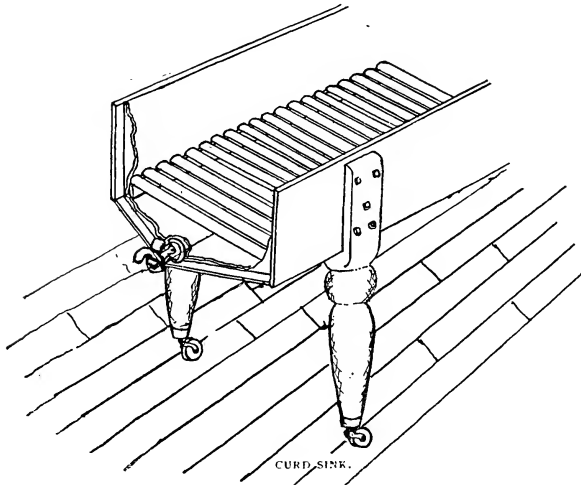

After the curd has been turned several times, the maker can begin piling it. He can pile it two, three, or five or six

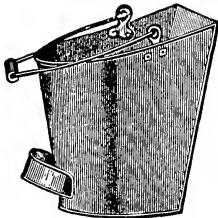

Curd Pail.

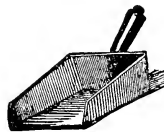

Curd Scoop.

layers deep, but he should keep the pieces pretty well together, so that the curd will not spread too much at first.

149. KEEP THE CURD WARM.

The pieces that have been on the outside of the pile should be placed on the inside, so that the temperature may be kept even. We must not forget the fact, that cheese-making is a process of fermentation, and that heat is a great factor in it.

150. PILING CURDS.

Piling the curd has a tendency to make a fast-curing, soft or "weak-bodied," cheese. If a fast-curing, soft cheese is desired, then the curd should be piled, but if a slow-curing, firm-bodied cheese is desired, we should pile the curd very little or not at all. In many of the best Canadian factories, the curd is not piled at all, but is turned over and over. A curd, from over-ripe milk, should not be piled very much, as such a curd is likely to produce a "salvy" cheese.

MILLING THE CURD.

151. WHEN A CURD IS READY TO MILL.

In the course of an hour and a half from the time the curd has been dipped onto the racks, it will have matted down, and assumed a meaty texture. It will not tear out in chunks, but in strips like the meat on a chicken's breast. There will also probably be half an inch or more, likely an inch, of fine strings, when tried on a hot iron. It is then ready to grind or mill, that is, it is put into a curd mill and cut into small pieces. The acid should be developing well at this stage of the process, but the amount of acid is not so important as that the curd shall be meaty in texture.

152. DESCRIPTION OF CURD MILLS.

The first curd mills were used in England. They consisted of a hopper, in the bottom of which was a roller with iron pegs in it. Sometimes there were two rollers. On the side of the hopper were iron pegs, and when the curd was thrown into it, the pegs in the roller would catch it, and carry it against the pegs, and tear and squeeze it to pieces.

The old Roe mill is made on this principle. The old Elgin mill was also on the same plan, only there was less room for the curd to get between the pegs, and the curd was badly smashed and jammed. It helped to get rid of the fat, and such a mill ought never to have been used.

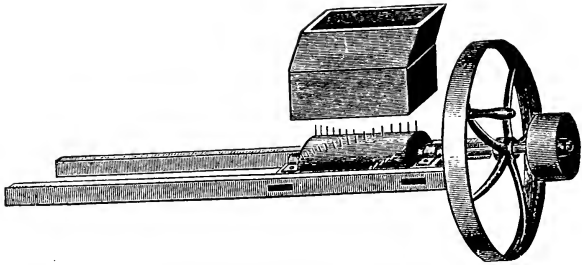

Peg Mill.

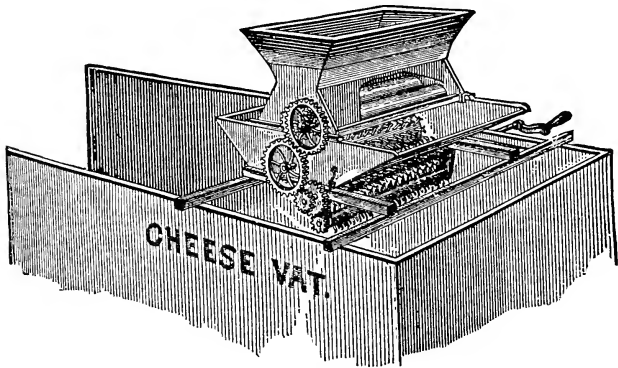

Pohl Mill.

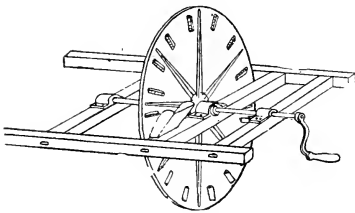

McPherson Curd Mill

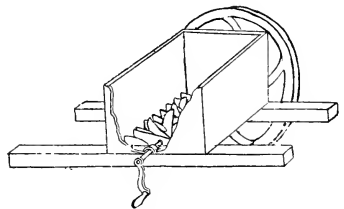

Common Knife Curd Mill

153. POHL MILL.

The next form of peg mill is the Pohl mill, which has sharp teeth on two cylinders, revolving at different velocities, which pick the curd to pieces. The objection to this mill is, that it does not leave the curd in the same size pieces. Some of the pieces will be quite large, while others are small, and when salted the salt will not be evenly distributed. There is a self-salting attachment to the mill, but it is useless, as a curd is never ready to salt when milled.

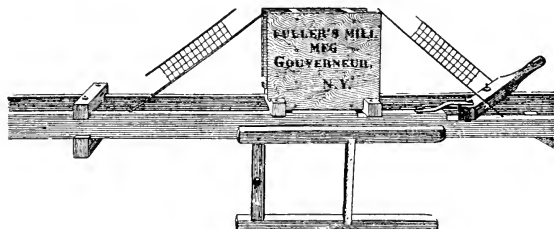

Fuller Hand-Power Curd Mill.

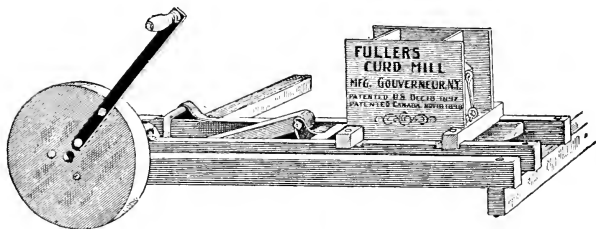

Fuller Power Curd Mill.

154. WHITLOW MILL.

A knife-mill does not jam the curd as much as a peg mill does. It simply cuts it. One of the earliest forms of knife-mills was built after the form of peg-mills, as is seen in the Whitlow mill of Canada. There are a number of knives on a shaft which play between knives in the side of the hopper. When the curd is put into the hopper, it is caught between the knives and cut into small pieces. The B. & W. mill is practically the same mill.

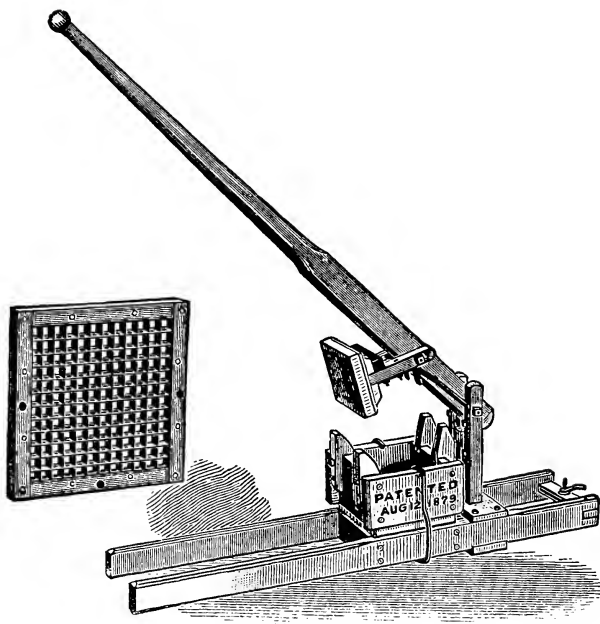

Harris Curd Mill

Barnard Hand Power Curd Mill.

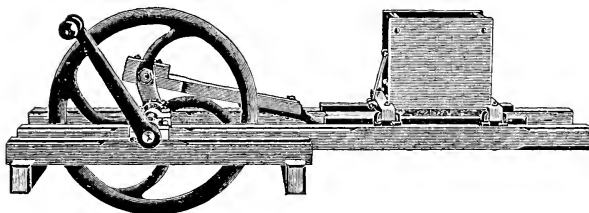

155. McPHERSON MILL.

The McPherson mill, invented in Eastern Ontario, consists of a wheel with knives in it similar to the blade of a plane. A hopper feeds the curd down against the wheel, and as it turns, slices of curd are shaved off. The wheel is apt to make the curd fly.

156. GOSSELIN MILL.

The Gosselin mill is similar to the McPherson, the blade being placed in a cylinder. The curd placed in a hopper rubs against the blades and drops into the cylinder, which being open at the ends, allows the curd to fall out.

157. THE HARRIS MILL.

The Harris mill has a network of knives at the bottom of a hopper. A plunger works by a lever into this hopper, and when a chunk of curd is dropped into this, the plunger forces it through the knives, leaving the curd in pieces one-half inch square, and as long as the piece of curd dropped into the hopper.

158. THE FULLER MILL.

The Fuller mill has two knives with a smaller number of blades than the Harris, placed one on either side of the hopper and the curd is pressed through the knives by a plunger that works back and forth across the bottom of the hopper.

159. THE BARNARD MILL.

The Barnard is similar to the Fuller mill.

160. THE KASPER MILL.

The Kasper mill is like the Pohl except that the pegs on the rollers are replaced by a cylinder of knives. The curd is pressed through the knives by means of a wooden roller. The cylinder is in three sections which open automatically and let the curd fall out.

161. ADVANTAGES AND OBJECTIONS TO KNIFE MILLS.

The other advantage of a knife-mill, besides saving the fat in the curd, is that the curd will not mat together on the racks, but can easily be torn to pieces by hand. An objection offered to such mills is, that the curd will not press together well. It may perhaps be difficult at times, but the trouble in closing the cheese lies somewhere else. It must be remembered that knife-

mills are used, hardly without exception, in factories where the best Canadian cheese is made, and this cheese is shipped to England, where the bandages are often stripped off from them, and they must necessarily be closed.

If the trouble in closing the cheese be carefully investigated it will be found to be in the bandage used, or the temperature of the curd. Some makers let the curd mat together again,

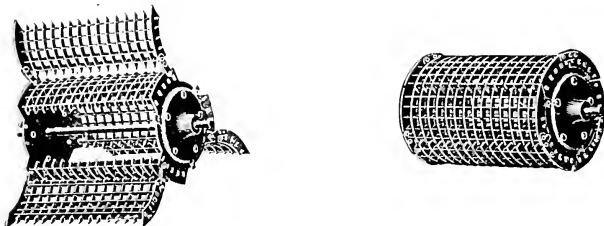

KASPER ROTARY CURD MILL.

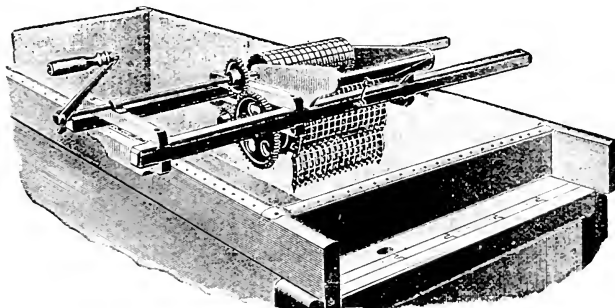

and grind a second or third time, but we do not like so much hacking of the curd. The curd should be piled up to flatten the pinholes, and then stirred every fifteen minutes to give it air.

162. STIRRING THE CURD.

A five-tined fork, with the points turned into little loops to prevent catching into the cloth, or sticking into the sink, is a very handy tool with which to stir the curd. It does the work thoroughly, and with much less labor than with the hands alone.

163. TIME TO MILL.

The grinding should come about half way in time from dipping the curd to salting it. It therefore should be an hour and a half from grinding to salting. During all this time the temperature should be kept up. (Why?)

The curd should take all the acid it will before salting, which is indicated by strings about two inches long on the hot iron.

164. EFFECT OF DRY ACID.

If a fast-curing cheese is wanted, there is all the greater reason for giving it all the acid it will take.

Do not be afraid of getting a sour cheese by giving it all the dry acid it will take. If one has not all the whey out of the

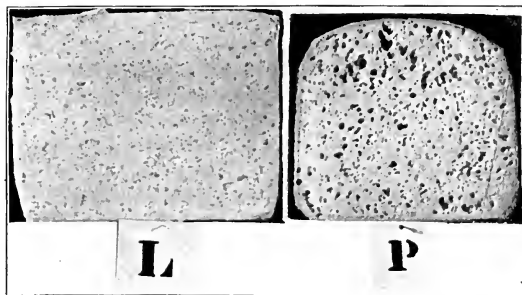

Effect of developing no acid on curd before pressing. The cheese marked L was cut as soon as taken from the press. The cheese P was cut after standing for a week. The small crevices left between the uncemented particles of curd in L, had been expanded by the development of gas, thus making the cheese huff.

curd, there is no danger of a sour cheese. It is acid in the whey that makes a sour cheese.

A tallowy cheese may possibly result from a prolonged matting, but this is seldom the case. If the curing room is not under control in hot weather the cheese is safer if well developed on the racks. If the curing room temperature can be held down to 65° F. it will not be necessary to develop so much acid on the racks.

165. HOW TO EXPEL GAS.

If the pin holes are not all flattened out by the time the maker is ready to salt the curd, it can be put into the hoops and pressed up for fifteen minutes. Then take it out and pull to pieces by hand or with the fork. This, however, is not necessary except in very stubborn cases. The gas can usually be expelled by thorough airing and piling.

166. STEAMING CURDS.

The vat or curd sinks should be covered with a heavy canvas cover. A steam hose can be inserted under it in such a position that the hot steam will not strike the curd directly. A gentle stream of steam will keep the curd warm and the moisture seems to dispose of taints in the curd.

QUESTIONS ON CHAPTER VIII.

1. What is meant by an eighth of an inch of acid on a curd?
2. Why do the threads string out on the hot iron?
3. How much acid must be present in the whey to cause strings one-eighth of an inch in length?
4. What is the effect of too much acid in the whey?
5. How are curd racks used in the vat?
6. Describe the Herrick curd knife.
7. Why and how should the curd on the racks be turned?
8. What are "pinhole" curds and how should they be handled?
9. What can be said in favor of and against washing curds?
10. How may curds be treated to prevent bad fermentations due to too much washing?
11. What is the advantage of a curd sink?
12. How should a curd sink be constructed?
13. How should the curd sink be filled?
14. Why should a curd be kept warm and how may it be piled to accomplish this?
15. What is the effect of high and low piling?
16. When is a curd ready to mill?
17. Describe the old peg mills and what is the objection to them?
18. Describe the Pohl mill?
19. Describe the Whitlow and B. & W. mills.
20. Describe the McPherson mill.
21. Describe the Gosslein mill.
22. Describe the Harris mill.
23. Describe the Fuller mill and the Barnard mill.
24. Describe the Kasper mill.
25. What are the advantages for and objection to knife mills.
26. How should a five-tined steel fork be fixed to stir the curd?
27. What is the effect of dry acid on a curd?
28. How may a tallowy cheese possibly result?
29. How may gas be expelled from the curd?
30. What can be said about steaming curds?

CHAPTER IX.

SALTING AND PRESSING THE CURD.

167. CONDITION OF A CURD FOR SALTING.

The curd, when ready to salt, should, when rubbed on the hot iron, not smell like burnt hair, but like toasted cheese. It should not feel harsh, but soft and silky, and when squeezed in the hand, a mixture of half fat and half whey should run between the fingers.

If it is clear whey that runs out, the curd is not ready to salt. White whey should not run from a curd before salting. In that case it has not been fully freed from whey, and there is a heavy loss of fat. Of course, if the whey is in the curd, it should be gotten rid of, but it ought not to be there. When salted, a clear brine should run from the curd.

Few cheese-makers realize how important a step in the process of cheese making the salting of the curd is, and they salt all their curds according to some fixed rule, learned from their predecessors, without knowing what the salt does.

168. WHAT SALT IS.

Salt is known to chemists by the name of sodium chloride. It is a chemical combination of the metal sodium and chlorine gas, in the proportion by weight, of twenty-three parts sodium to thirty-five and a half parts chlorine.

169. WHERE SALT COMES FROM.

It occurs in beds in the earth, and is either mined, or more commonly obtained from salt wells, in which the salt is dissolved by the water, pumped up to the surface, and evaporated, leaving the salt. But salt does not occur pure in these beds.

170. IMPURITIES IN SALT.

There are associated with it potassium chloride, calcium chloride and sulphates of magnesia and lime. The presence of calcium and magnesium chloride in the salt makes it lumpy and damp, for these chlorides have a great attraction for water, and will take it from the air. Calcium chloride and magnesium give the salt a bitter taste.

These impurities, however, as well as the water contained in salt, are a very low percentage of the whole, and when a salt

dealer talks about his salt being so much stronger or purer than any other high grade salt, it is not so. Do not understand, however, that common barrel salt is just as good as the best salt for cheese making, for it is not. Common barrel salt contains a great deal of dirt, and salt may take up bad odors, which will be imparted to the cheese.

Fine salt that has probably been ground, and the crystals broken, will dissolve faster than a coarser salt, in the natural crystalline form.

Salts can easily be tested as to quality, by dissolving them in pure water, in a glass cylinder, and shaking up to dissolve. Use more salt than will dissolve. The best salt is that which leaves a clear brine with no scum or dirt on the top, nor dirt in the bottom of the solutions. Cheese is an article of food and we do not want any dirt in it, so we should avoid dirty salt. If a few drops of a solution of ammonium oxalate is poured into the salt solution, any lime that may be in the salt will be thrown down in the form of a white precipitate of calcium oxalate. By this means we can form an idea of the amount of lime in the salt. We doubt if a little lime (calcium oxide) is harmful in the salt, but if the calcium is in the form of chloride, it will attract moisture and make the salt lump. Lumpy salt will not be evenly distributed in the cheese.

AVERAGE COMPOSITION OF AMERICAN DAIRY SALTS.

Analyses by F. W. Woll, Wis. Exp. Station.

NAME OF BRAND.	No. of Samples.	Sodium Chloride.	Calcium Sulphate.	Calcium Chloride.	Magnesium Chloride.	Insoluble Matter.	Moisture.
Anchor	3	97.79	1.48	.28	.08	.06	.31
Ashton	3	98.01	1.42	.20	.16	.03	.18
Canfield & Wheeler	4	98.18	1.21	.22	.12	.04	.23
Diamond Crystal	5	99.18	.54	.19	.05	.03	.01
Genessee	8	98.27	1.11	.24	.07	.04	.16
Kansas	3	97.87	1.50	.31	.07	.05	.20
LeRoy	2	98.15	1.31	.39	.08	.01	.06
Vacuum Pan	6	98.00	1.15	.36	.15	.03	.31
Warsaw	3	98.43	.96	.40	.06	.03	.12
Worcester	5	98.57	.92	.25	.07	.02	.17

171. WHAT SALT DOES TO CHEESE.

In the first place, salt gives taste to a cheese. A cheese without salt has an insipid fresh taste. Salt also takes out the moisture, so that fermentation is checked. A cheese without salt will cure very fast, in fact fermentation goes on so rapidly that gas holes are formed.

The same thing is seen in brick and Swiss cheese, in which the fermentation starts in the unsalted state, but the salt, which is applied to the outside, works its way into the cheese before it gets bad. It should be noted, that such cheese has to be cured in a cellar, where there is a constant low temperature. It would otherwise spoil.

172. EFFECT OF TOO MUCH SALT.

If a cheese is salted too heavy, it becomes dry and mealy, and cures very slowly. The flavor is also injured. If we have bad milk, we should salt higher to improve the flavor, for up to a certain point, this is accomplished by heavier salting. We believe this to be due to the fact, that as the fermentation is checked by more salt, the gases formed have a chance to diffuse, and get out of the cheese, without filling it with holes, and the odor of the gases. Salt may also check the action of the enzymes in their work of digesting the casein. (94.)

We would, therefore, if we wanted to make a fine flavored cheese, salt it pretty heavy, say three pounds of salt per one hundred of curd. It must be expected, however, that such a curd will cure slowly. We cannot make the best kind of cheese in a day, a week, nor a month. If one wants a fast-curing cheese, he uses more rennet and less salt, but the product will not be as good a cheese. It will not be as close, nor as fine flavored, for the gases will not have had time to escape from the cheese. If one is making a fine, slow-curing cheese, he need not expect to get as much cheese per hundred weight of milk, as if he were making fast-curing cheese, for the salt expels the moisture and leaves less weight.

In an experiment in the Wisconsin Dairy School, a curd was divided into three equal parts. The first lot received no salt; the second lot one and a half pounds of salt per hundred;

and the third lot three pounds per hundred. The curds were then pressed separately, and the green cheese weighed as follows :

The cheese with no salt.....	10	lbs.
The cheese with one and a half lbs. of salt....	9.75	lbs.
The cheese with three pounds of salt.....	9.50	lbs.

As the cheese cured, they kept their relative weights. Other experiments have borne out this result.

173. CURDS NOT ALWAYS SALTED THE SAME AMOUNT.

But curds should not always be salted at the same rate, from day to day.

A moist curd needs more salt than a dry one, for two reasons: First, the excess of moisture must be expelled by the addition of salt; and second, as the expulsion of moisture takes salt with it in solution, enough must be applied to leave the proper amount in the cheese.

174. SALT SHOULD BE EVENLY DISTRIBUTED.

It is also essential, that the salt should be evenly distributed through the cheese. If there is too much salt in the curd that is put into the hoop last, it will crack the rind of the cheese.

175. APPLICATION OF SALT.

The curd should be spread out evenly in the curd sink, and a part of the salt scattered evenly over it. The curd should then be stirred thoroughly, and again spread out, and the remainder of the salt applied. It ought to be stirred every ten minutes, to keep the salt from settling to the bottom of the pile in the brine.

176. TEMPERATURE OF SALTING.

Before salting, it should have been cooled to 90° F., for if too warm, the fat may be expelled in large quantities with the brine. The curd should not be put to press, till the salt has been thoroughly dissolved and worked into it.

177. CONDITION OF SALTED CURD FOR PRESSING.

It will have a harsh feeling, due to the undissolved salt crystals, and the outside of the pieces of curd are hardened, so that they will not press together readily; but as the salt works into the curd, it will regain its velvety feeling. When this condition has been reached, which is usually in fifteen to twenty minutes, it is ready for the press.

178. REMOVING FAT.

As indicated in paragraph 176 the fat may run over the surface of the curd and prevent the particles cementing. This is especially true of a curd from tainted milk. By throwing two or three pails of warm water (110°) over the curd this fat will be washed off, and then a pail of cold water will harden the curd so that the fat will not run. Of course a little fat is lost in this way. If the curing room is cool enough to permit, salting the curd a little earlier will prevent this.

PRESSING THE CHEESE.

179. CURD MUST NOT BE TOO WARM.

Before pressing, the curd should be cooled to between eighty and eighty-five degrees. If put to press warmer, the fat runs, and large quantities of it are lost. It also runs between the pieces of curd so that they will not close together, and under the bandage, preventing it from sticking. Poorly closed cheese has often been blamed to the curd mill, when the trouble really lay in the temperature at which it was put to press.

180. CURD MUST NOT BE TOO COLD.

Of course, when the curd is much below 80°, it will not close together, but there is a happy medium. This happy medium varies according to the temperature of the press room. If the room is cold, the curd will cool down. A cheese-maker must have some brains in his head, and use them, for he is more than a mere machine to be wound up and run down. A proper temperature for the press room is about 70°.

181. COMMON PACKAGES OF CHEESE

There are four common packages, into which American cheese is pressed, namely, Young Americas, weighing nine or ten pounds, flats and Cheddars, weighing respectively thirty and sixty pounds, and daisies weighing twenty pounds.

The common diameter of flats or Cheddar cheese is fourteen and a half inches, and a flat is half the height of a Cheddar.

There are two kinds of presses used, the gang and the upright. The upright press has the screws in an upright position, and but one screw to a cheese. The gang press has one horizontal screw, which presses anywhere from one to twenty

cheese. The hoops (Fraser) are made a little smaller at the bottom than the top, so that each hoop will fit over the next one in front of it.

It is sometimes claimed for upright presses that the pressure is kept up better, as there is but one cheese under a screw, but they are hard to keep clean and take up a great deal of room.

The Sprague automatic adjustable gang press can be adjusted to fit hoops of different diameters. This press as well as

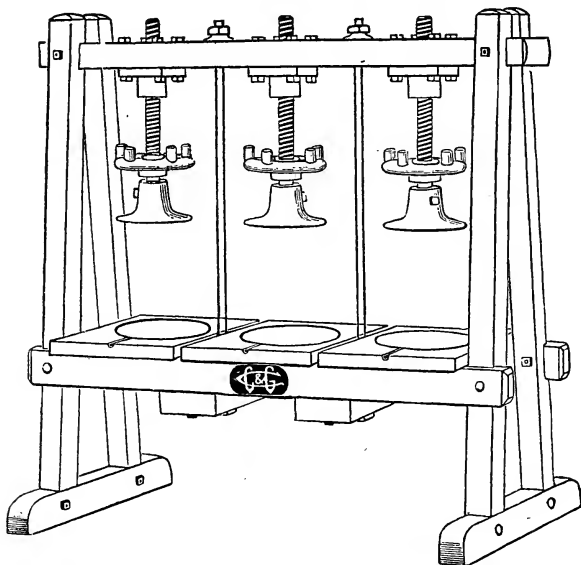

Upright Press.

the Helmer is arranged so that a continuous pressure is kept on the cheese. A new factory should certainly be equipped with one of these presses.

In the Fraser gang hoop, the bandage is held by an iron band, which slips into the top of the hoop. This iron band is called the "bandager."

In pressing the cheese, the maker should aim to turn out a perfect cheese. He should be an artist, and produce an ob-

ject of beauty. The ends should be square with its height, clean, and the bandage turned down evenly at the ends, and closed well on the sides.

182. KIND OF BANDAGE USED.

There are two kinds of bandages used, starched and seamless. The starched bandage is made from the starched cloth, by the cheese maker. The seamless bandage comes in the form of a long tube, from which the required length for the cheese is cut. But the starched bandage will not let the whey out properly, and consequently the cheese does not close on the sides. The cheese closes much better with the unstarched, seamless bandage.

Ready-made unstarched bandages of better quality than the seamless bandage and about the same cost are now in the market.

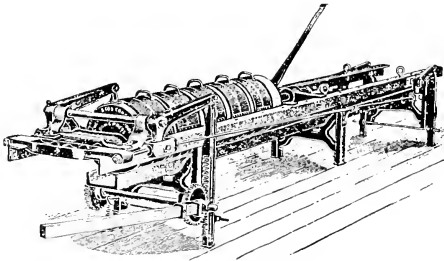

The Helmer Patent Continuous Pressure Press.

183. HOW THE BANDAGE IS PUT ONTO THE CHEESE.

When the bandage is put into the hoop, the edge should be turned in evenly, for about an inch and a half on the bottom, and perhaps dampened to hold its place.

Before putting the bandage in, the bottom cap cloth should be put in. It should be round, and as large as the bottom of the hoop (fourteen and a half inches), and should be soaked in hot water. Square cap cloths lap over onto the sides of the cheese, and make bad looking scars. •

184. CHEESE MUST BE THE SAME SIZE.

Care should be taken to put the same amount of curd into each hoop, so that the cheese will all be the same height.

The hoops should not be filled so full that the cheese comes above the junction between the bandage and the hoop, for in such cases, there will be a little ridge left at the junction, which will disfigure the cheese.

When the curd has been filled into the hoop, the top cap cloth is put on, and the fibrous ring laid around the edge, to keep the curd from pushing out, and then the follower put in. Usually the fibrous ring is tacked onto the follower, and while it

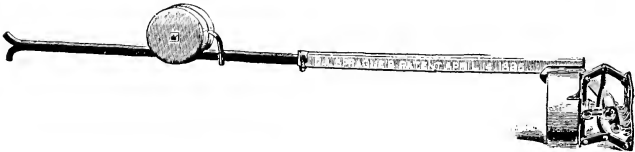

Sprague Pressure Block.

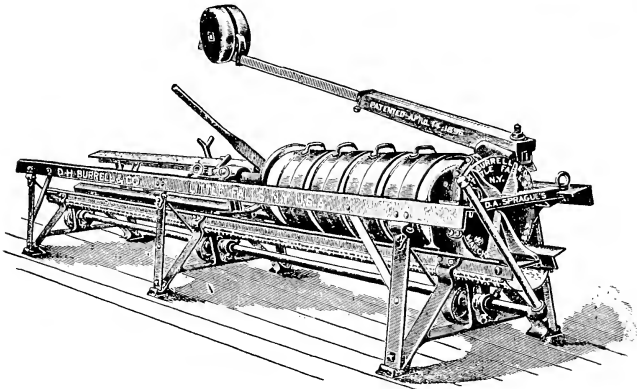

Pressure block in position in the press.

may fit well, it quite often happens that it does not; and the curd will push out at the places where the ring does not come tight against the hoop. There is another point in having the fibrous ring separate from the follower, which will be noticed when we come to it later on. (188.)

185. TIGHTEN THE PRESS SLOWLY.

After the hoops have been slipped into place, the screw should be tightened slowly, to let the whey out gradually. A

small stream of brine should be kept flowing. If too great pressure is applied at first, the fat will be forced out. Curd closes together slowly, as will be seen by squeezing it in the hand. If it be squeezed suddenly, and then the pressure released, it will fall apart, but if pressed up slowly in the hand, it will stick together. The full pressure should not be reached for about fifteen minutes.

In about an hour, the curd will be pressed together, and then the bandage should be turned down around the top of the cheese. This operation is generally called "dressing" the cheese.

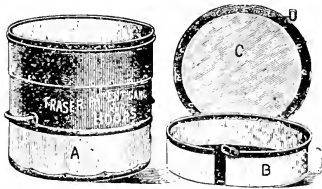

Fraser Gang Hoop.

A, Hoop. B, Bandager. C, Follower. D, Fibrous ring.

186. DRESSING THE CHEESE.

Set the hoops in an upright position, and take out the followers, cap cloths, and bandagers. Pull the bandage gently, to be sure there are no wrinkles in it, and then trim off evenly all around, so that it will lap over onto the end of the cheese about an inch and a half. Soak it down into position with warm water, and put on the cap, after having wrung it out in warm water. Be sure there are no wrinkles in the cap, for they will leave bad looking marks on the rind of the cheese.

Then put in the bandagers to keep the hoops straight in the press, and the fibrous ring and follower, and close up the press, putting on full pressure. Young Americas, however, will not stand as much pressure, for they do not have as much surface as larger cheese, to resist it.

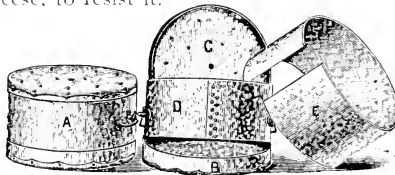

Wilson Cheese Hoop.

187. THE WILSON HOOP.

Another form of hoop used largely in Ohio is the Wilson hoop here described.

DIRECTIONS FOR USING THE WILSON HOOPS.

Each hoop consists of four pieces, as follows:

B. The bottom cover, with the widest flange or rim.

E. The open wide hoop.

D. The closed or tight wide hoop.

C. The top cover with narrow flange or rim.

FIRST—Place the cover with the widest rim (*B*) on the ways in the bottom of the press.

SECOND—Place the Cap Cloth on the bottom of the cover (*B*). Said Cap Cloth should be as large as the bottom of the cover.

THIRD—Place within the bottom of cover (*A*) the open hoop or bandage (*E*).

FOURTH—Wet one edge of the bandage, adjust with the open hoop and turn the wet edge over the top of the hoop.

FIFTH—Put the closed wide hoop (*D*) on top of the open one, letting it lap over about one inch, and fasten the hooks which are provided to keep same from slipping down.

SIXTH—Put in the cheese curd as may be desired, for any thickness the cheese are to be made, but always put in enough so that the outer or tight hoop in slipping over the open one when pressing shall not quite be forced down to meet the edge of the lower cover.

SEVENTH—Put on the top cover (*C*), then unfasten the hooks under the handles, then turn the cheese over, placing the top cover up snug against the head of the press. Proceed in the same manner with the balance of the hoops until all are filled, placing the top cover against the bottom of the previous one, etc. Then proceed to pressing.

EIGHTH—After pressing as usual, or until the time when the bandage is to be turned in or lapped over the edge of the cheese in order to press the bandage down, it is well to remove the cheese from the hoop, and having turned it over, put it back in the hoop with the other face up, and put to press again. This will be found to remove any wrinkles that may have formed in the bandage.

188. HOW TO GET CHEESE DRY.

The idea that we make a cheese dry by pressing it is an erroneous one. The whey has to be gotten out of the curd while it is in the vat, and if it is not gotten out there, no amount of squeezing in the press will expel it, and the cheese will get sour.

If the press is not a continuous pressure one, as is likely the case, the maker should tighten the press the last thing at night, and the first thing in the morning.

In the morning, the cheese should be taken out of the hoops and examined, to see if they are perfect in shape, and all defects remedied. If the bandage does not stick, the cheese should be washed with warm water, and after being tightened in the press, hot water turned on to warm it up. If the edge of the upper end of the cheese is rough, it should be turned end for end in the hoop. In either case, the fibrous ring should be left out, so that the edge of the cheese will come out on the hoop square. Of course, it must be watched, to see that the cheese does not push out beyond the follower, and its last state be worse than the first; but if the pressure is carefully applied, a nice square edge can be put onto a cheese in this way.

189. DO NOT POUND THE HOOPS.

The cheese should slip out of the hoop with very little pounding. Pounding loosens the rivets, and thereby gets the hoops into bad repair, as well as loosens the bandage on the cheese, and sometimes breaks the cheese.

Where a knife is used to loosen the cheese, the bandage is also often loosened. If the cheese does not slip out easily, grease the hoops. The hoops should, of course, be kept clean, and if it is necessary to grease them, clean grease can be applied.

Cheese should never be taken out on the floor, but on a press board. We must remember that cheese is an article of human food. Most people like to have clean food to eat, and we should aim to be just as clean in making the cheese as though the consumers were watching all the time.

Wipe the cheese off with a clean cloth, and then put them on the shelves, marking the date neatly. Cheese with great big marks scrawled over them do not look attractive.

190. GREASING THE CHEESE.

As soon as the rind has dried off, it should be greased with regular cheese grease. The practice of skimming the whey after it has fermented and become full of dirt is nothing less than a dirty trick. Good wholesome cheese, prepared for the purpose, can be bought of regular dealers in dairy supplies, and nothing else should be used.

191. CRACKS IN CHEESE.

If the cheese is left exposed to the air too long before being greased, it will crack. Another cause of the rind cracking is too much acid in the whey. A high acid cheese will, as a rule, crack. A draft of air blowing over the cheese will also cause it to crack. This, of course, is caused by the air absorbing moisture from the rind. We think that, while the question of moisture in the curing of American cheese has gone almost unconsidered, more attention must be paid to this in the future.

192. CHEESE IN COLD STORAGE.

Cheese held in cold storage are very likely to mould. Mould works into the cracks, and for this reason buyers do not want cracked cheese. The rinds of high acid cheese, held in cold storage, will also begin to rot at the middle.

Sometimes the maker leaves the caps, or press cloths, as they are sometimes called, on until a few days before shipping, and then pulls them off and greases the rinds.

Sometimes salt sacks made out of heavy ducking are used for caps. This leaves a hard but very rough rind, and if the cheese is held in cold storage, and mould grows on it, it is almost impossible to get the mould off, and buyers are strongly opposed to using salt sacks for this purpose.

193. CLEANING MOULDY CHEESE.

Cheese that gets mouldy in cold storage is put into a sink of hot water, to which a little ammonia has been added, and scrubbed with a brush. It is put on a shelf to drain and dry, and afterward boxed again.

194. CHEESE CLOTH CIRCLES.

Sometimes a thin "cap" of cheese cloth, called a "cheese cloth circle," is put onto the end of the cheese. The cheese cloth circle does not go on under the bandage where it is turned

down on the end, but over it. In using the circles there is no need of cheese grease till the cheese are shipped. The circle is then pulled off and the rind greased.

The circles make the cheese much cleaner, and buyers generally prefer them, and will pay more money for the cheese, usually an eighth of a cent a pound more. The cost is about one-sixteenth of a cent a pound on flats. Sometimes, by special agreement, buyers want the circles left on the cheese. When the cheese come out of cold storages they are cleaned, the circles being stripped off, leaving a clean bright rind, which is greased.

They should be but twelve or thirteen inches in diameter, as they sometimes do not stick under the edge where they lap over the bandage.

195. PRESS CLOTHS.

The first one is put on inside the "heavy cap" or "press cloth," before the curd is put into the hoop, and the other one is put in when the cheese is "dressed."



196. KEEP A DAILY RECORD.

When the cheese is ready to ship it quite often happens that a maker finds something peculiar about a cheese which he wishes to avoid or reproduce in the future, but he does not remember the circumstances connected with the making of that particular cheese. In the best factories a daily record is kept in a book for the purpose of how the milk and curd act. This gives them a history of each cheese, and by its aid the maker is often able to remedy defects and reproduce the better points.

The following is a blank for the purpose:

Date.....190..

Vat used (Number of vat),
Condition of milk,
Per cent of fat in milk,



Pounds of milk in vat,
 Rennet test for ripeness,
 Temperature set,
 Time set,
 Amount of rennet used,
 Rate of rennet per 1000 pounds of milk,
 Time cut,
 Minutes in curdling,
 Time steam was turned on,
 Time required in raising to degrees,
 Hot iron test when dipped,
 Time dipped,
 Time from cutting to dipping,
 Per cent of fat in whey,
 Time ground,
 Hot iron test when ground,
 Time salted,
 Amount of salt on curd,
 Rate of salt per 1000 lbs. of milk,
 Time put to press,
 Kind and number of cheese made,
 Time dressed,
 Time pressed,
 Weight of green cheese,
 Average weight of milk per pound of cheese,
 Highest and lowest temperature of curing room for last twenty-four hours.

REMARKS—

Under the head of remarks, any important thing not included under the other heads may be noted, such as a gassy curd or washing out the bad flavor, or any way of treatment different from the ordinary way.

QUESTIONS ON CHAPTER IX.

1. What are the conditions of a curd when ready to salt?
 2. What is salt? 3. Where is salt found? 4. What are the impurities in salt, to what extent do they occur, and what are the objections to them? 5. What does salt do to cheese? 6. What is the effect of too much salt? 7. Does salt increase or

diminish the weight of cheese, and why? 8. Should all curds be salted alike? 9. How should salt be applied to a curd? 10. When is a curd ready to press? 11. What prevents cheese from closing, and what is the remedy? 12. At what temperature should curd be pressed, and why? 13. What are the common packages of cheese? 14. How do upright and gang presses compare? 15. How is the bandage held in the Fraser hoop? 16. What are the different kinds of bandage in use? 17. How is the bandage put onto a cheese? 18. How should the cap cloths be cut? 19. How full should a hoop be filled? 20. How fast should the press be tightened? 21. What is meant by dressing the cheese? 22. Describe the Wilson hoop. 23. How is moisture expelled from a cheese? 24. Why should not the hoops be pounded to get the cheese out? 25. Why and with what should cheese be greased? 26. How do high acid cheese behave in cold storage? 27. How can mouldy cheese be cleaned? 28. What is a cheese cloth circle, and how are they put on with reference to the bandage? 29. What is a press cloth? 30. What is the advantage of a daily record?

CHAPTER X.

CURING AND SHIPPING THE CHEESE.

197. CHANGES IN CURING.

When cheese is coagulated by rennet, the coagulum is called paracasein. In curing it undergoes changes into the following products in the order named. Paracasein changes by the action of lactic acid into paracasein-monolactate (lactic-acid-paracasein), para nuclein, caseouses, peptones, amides and ammonia. The first changes are from a substance insoluble in water to substances soluble. These substances do not have much flavor, but as the amides develop the characteristic flavor appears. Dr. Van Slyke has shown by careful chemical analyses, extending over a period of 35 weeks, that the rate of the formation of these decomposition products is dependent upon the temperature.

198. CURING AT DIFFERENT TEMPERATURES.

Cheese will cure slowly at low temperatures and be of fine flavor and texture. At the Wisconsin Experimental Station a cheese was kept at a temperature of 15° F., and was found to have cured perfectly and to be of a very fine quality, with the exception that the freezing had made the texture crumbly. As the temperature is raised the cheese cures faster. At 60° to 65° the most rapid curing takes place at which a good cheese can be obtained. A temperature of 70° for any protracted length of time will injure the texture and flavor, while a temperature of 80° will spoil the best kind of a cheese.

199. CURING SHELVES, HOW MADE.

The cheese should be cured on shelves made of good clear pine, an inch and a half thick by sixteen inches wide, supported every four feet. The point in having the lumber clear is that sap and pitch will be in the knots and color the rinds. The boards should be wider than the cheese, for if the cheese projects over the edge a mark will be left on the face of the cheese. The board ought to be heavy and the supports close together in order to prevent sagging, which might make the cheese, especially Cheddars, crooked. The cheese should be turned

every day, and the shelves wiped with a clean cloth. Pains should be taken not to soil the cheese nor break the corners in turning them.

200. ARRANGEMENT OF CHEESE.

The older cheese should be kept on the lower shelves, and the younger ones on the upper shelves, because of the difference in temperature between the upper and lower portions of the room. The upper shelves being warmer, the younger will cure faster and the month's make of cheese will be evenner than if this rule were not followed.

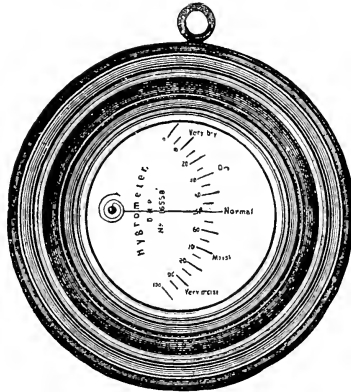

Hygrometer or Hygroscope.

201. MOISTURE IN THE CURING ROOM.

A matter that has not received its proper attention with American or Cheddar cheese is the humidity of the air in the curing room. There are two instruments for measuring the humidity—the hygroscope and psychrometer.

202. THE HYGROSCOPE.

The hygroscope is an instrument consisting of a coil of material very sensitive to moisture. As it takes up from or gives off water to the atmosphere the coil moves a hand around a dial which shows the per cent of saturation.

203. THE PSYCHROMETER.

The psychrometer consists of two accurate thermometers. On the bulb of one is a wick which dips in a cup of distilled

water. When the air is saturated it has all the water it will hold. If the air is not saturated water will evaporate from the wick, and the dryer the air the greater the evaporation. As the water passes from around the bulb into the air it lowers the temperature. The United States Weather Bureau has prepared a table of readings with the corresponding humidity. The following is such a table for use in a curing room.

The thermometer should be fanned briskly with a good fan for three minutes, and then the reading taken quickly. We first find the dry bulb reading on the chart and then find the wet bulb

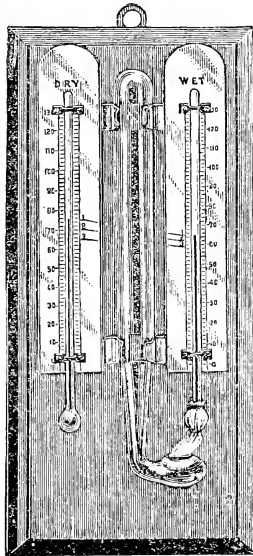

Psychrometer.

reading in the next column, and in the third column, opposite the dry bulb reading, is the relative humidity, or per cent of saturation, by which we mean the per cent of water the air is capable of holding at that temperature.

The psychrometer is not as handy as the hygrometer, but is considered to be more reliable.

HUMIDITY IN THE AIR OF CURING ROOM—CONTINUED.

Dry Bulb.	Wet Bulb.	Rel. Hum.	Dry Bulb.	Wet Bulb.	Rel. Hum.	Dry Bulb.	Wet Bulb.	Rel. Hum.	Dry Bulb.	Wet Bulb.	Rel. Hum.
51	46	68	55	48	59	59	49	47	63	51	42
	47	74		49	65		50	52		52	46
	48	81		50	70		51	57		53	51
	49	87		51	76		52	62		54	55
	50	93		52	82		53	67		55	60
52	41	35	56	44	34	60	48	39	64	56	64
	42	40		45	39		49	44		57	69
	43	46		46	44		50	48		58	74
	44	51		47	50		51	48		59	79
	45	57		48	55		52	58		60	84
	46	63	49	60	53	63	61	89			
	47	69	50	65	54	68	62	95			
	48	75	51	71	55	73	52	43			
	49	81	52	77	56	78	53	47			
	50	87	53	82	57	84	54	51			
51	94	54	88	58	89	55	56				
53	41	31	57	45	36	61	49	40	65	56	60
	42	36		46	40		50	44		57	65
	43	41		47	45		51	49		58	70
	44	47		48	50		52	54		59	74
	45	52		49	55		53	58		60	79
	46	58	50	61	54	63	61	85			
	47	63	51	66	55	68	62	90			
	48	69	52	71	56	73	63	95			
	49	75	53	77	57	78	53	44			
	50	81	54	83	58	84	54	48			
51	87	55	88	59	89	55	52				
52	94	56	94	60	94	56	56				
54	42	32	58	46	37	62	50	41	66	56	40
	43	37		47	42		51	45		53	45
	44	42		48	46		52	50		54	49
	45	48		49	51		53	54		55	53
	46	53		50	56		54	59		56	57
	47	59	51	61	55	64	57	57			
	48	64	52	67	56	69	58	61			
	49	70	53	72	57	74	59	66			
	50	76	54	78	58	79	60	71			
	51	82	55	83	59	84	61	75			
52	88	56	89	60	89	62	80				
53	94	57	94	61	95	64	85				
55	43	33	59	47	38	59	57	41	66	58	61
	44	38		48	43		58	79		59	66
	45	43		47	48		59	84		60	71
	46	49		48	48		60	89		61	75
	47	54		48	48		61	95		62	80

HUMIDITY IN THE AIR OF CURING ROOM—CONCLUDED.

Dry Bulb.	Wet Bulb.	Rel. Hum.	Dry Bulb.	Wet Bulb.	Rel. Hum.	Dry Bulb.	Wet Bulb.	Rel. Hum.	Dry Bulb.	Wet Bulb.	Rel. Hum.			
66	63	85	70	61	60	73	72	95	77	70	71			
	64	90		62	64		72	71		74				
	65	95		63	68		78	72		78				
67	54	41	70	64	72	74	61	47	78	73	83			
	55	45		65	77		62	50		74	87			
	56	49		66	81		63	54		75	91			
	57	53	67	86	64		58	65	62	76	76	95		
	58	58	68	90	65		66	66	65		49			
	59	62	69	95	66		66	67	66		53			
	60	66	58	71	58		45	75	67	70	78	66	53	
	61	71	59		48		68		74	67		78	56	
	62	76	60		52		69		78	68		82	60	
	63	80	61	56	60		52		71	86	69	63		
	64	85	62	60	61		56		72	91	70	67		
	65	90	62	60	62		60		73	95	71	71		
66	95	63	64	63	64	62	47		72	75				
68	55	42	72	64	68	75	63		51	79	73	79		
	56	46		65	77		64		55		74	83		
	57	50		66	81		65		58		75	87		
	58	54	67	86	66		62		76	91	66	50		
	59	58	69	91	67		66		68	70		67	53	
	60	63	70	95	68		70	69	74	68		57		
	61	67	59	72	59		45	76	69	74	80	68	60	
	62	71	60		49		70		78	69		78	69	60
	63	76	61		53		71		82	70		87	70	64
	64	81	62	57	61		53		72	87	71	68		
	65	85	62	57	62		57		73	91	72	71		
	66	90	63	61	63		61		74	95	73	75		
67	95	64	65	64	65	63	48		74	79				
69	56	43	72	65	69	76	64		52	80	75	83		
	57	47		66	73		65		55		76	87		
	58	51		67	77		66		59		77	91		
	59	55	68	82	68		86		66	66	47			
	60	59	69	86	69		91		67	63	51			
	61	63	70	91	70		95	68	66	54				
	62	67	71	95	71		70	69	70	57				
	63	72	60	46	70		74	70	74	54				
	64	76	61	50	71		78	71	78	57				
	65	81	62	53	72		82	72	82	61				
	66	86	63	57	60		46	73	87	64				
	67	90	64	61	61		53	74	91	64				
68	95	65	65	62	57	75	95	68						
70	57	44	73	65	65	77	64	49	80	74	75			
	58	48		66	69		65	52		76	83			
	59	52		67	73		66	56		77	87			
	60	55	68	78	67		60	78		92				
			69	82	68		63	79		96				
			70	86	69		67							
			71	91	70		68							
			71	91	71		69							

204. CONDITION OF THE CURING ROOM AIR.

The air should have as much moisture in it as it will hold without moulding the cheese. Cheese will stand a good deal if the air is kept moving, perhaps as high as ninety per cent. If kept between sixty and seventy per cent it is very fair, but the instruments show that it often gets down to twenty or thirty per cent and the cheese dry out rapidly and crack.

205. SUPPLYING MOISTURE.

Moisture can be supplied by sprinkling the floor, or better still, by hanging up wet sheets that are constantly supplied with water.

To supply a curing room of five thousand cubic feet capacity, at least three cloths thirty inches wide by twelve feet long are needed. These cloths cannot be supplied from a tank by means of wicks, but if there is plenty of running water a pipe with fine holes drilled on the upper side might be arranged to hang the cloths on and water run through the pipe would keep the cloths saturated. A gutter at the bottom would carry off the surplus water.

After a while the cloths will get stiff from sediment from the water. They should then be boiled in water to which a little hydrochloric acid has been added. Do not use enough acid to injure the cloth.

SHIPPING THE CHEESE.**206. SHRINKAGE IN CURING.**

Loss of weight in curing is due to the evaporation of the water of the cheese and to chemical changes. The factors affecting the rate of loss in curing are:

1. Temperature of curing room.
2. Relative humidity of the air of the curing room.
3. Size and form of cheese.
4. Moisture content of cheese.
5. Protection to surface of cheese.

The following table taken from Bulletin 234 of the Geneva Experiment Station shows both the effect of size of cheese and temperature of room on shrinkage:

PER CENT. OF LOSS IN TWENTY WEEKS.

Weight of Cheese.	40 degrees.	50 degrees.	60 degrees.
70 lbs.	2.5	2.4	4.2
45 lbs.	2.7	3.7	5.1
35 lbs.	3.9	5.9	8.5
12½ lbs.	4.6	8.1	12.0

The low temperature cheese was better in texture and milder in flavor than the cheese cured at higher temperatures and the low temperatures therefore returned more money, as shown in the following table:

SHRINKAGE IN TWENTY WEEKS.

Temperature.	Per cent. of Shrinkage.	Scores of Cheese.	Value of 100 pounds at 10c per pound.
40 degrees.	3.8	95.7	\$9.62
50 degrees.	4.8	94.2	9.52
60 degrees.	7.8	91.7	9.22

At the end of twenty weeks the cheese cured at 40° F. was worth 22½ cents more per 100 pounds than that cured at 50° F., and 60 cents more than that cured at 60° F.

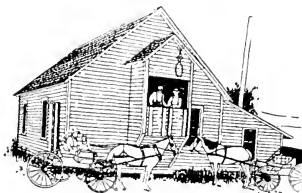

Cheese Factory at Chimney Rock, Wisconsin. The cheese is not cured at the factory but is shipped twice a week to a central curing room at La Crosse.

207. CENTRAL CURING ROOMS.

It seems that central curing rooms will be the most economical method of handling cheese. A small building containing the machinery for making cheese can be erected at little

expense. Once or twice a week the cheese from a number such making rooms can be transferred to the central curing room which can be a more elaborate affair—very likely cooled by artificial refrigeration. It will reduce the labor at the make rooms very materially and an expert can spend his time in the curing work.

The quality of cheese is not only enhanced at low temperatures but the life of usefulness of the cheese is greatly extended.

Combining the improved quality and increased quantity of the cheese cured at 40° for twenty weeks over that cured at 60° for the same length of time according to Dr. Van Slyke the saving will be \$1.08 per 100 pounds of cheese. For a factory receiving 5,000 pounds of milk per day this would mean \$5.40 per day. For ten such factories \$54 per day. Considering the decreased cost of handling at the make rooms and the smaller cost of one good curing building in the place of ten it is quite evident that the central curing room is the most economical way of curing cheese.

208. PARAFFINING CHEESE.

Evaporation of moisture from the cheese can be prevented by applying a coat of paraffine which is practically impervious to moisture. If applied at a temperature of at least 200° F. the cheese will remain bright, as the mold spores are killed at that temperature and the paraffine adheres firmly to the surface of the cheese. Applied hot less paraffine is necessary, thus reducing the expense of coating.

The vat in which the paraffine is melted is similar to a cheese vat but much smaller. A partition three inches from one end does not reach quite to the bottom; the large cakes of paraffine are slipped behind this when introduced to the vat. The paraffine is colored a light yellow with a little cheese or butter color. A frame for holding the cheese hangs above the vat and is counterbalanced by a weight hanging over pulleys. The cheese is placed in the frame over the vat and then immersed for a few seconds in the hot paraffine. Then it is allowed to hang for a few minutes to harden sufficiently to handle.

Dr. Van Slyke makes the following statement regarding paraffine in Bulletin 234 of the Geneva Experiment Station.

“At the end of seventeen weeks, cheese covered with paraffine had lost only .3 pounds for 100 pounds of cheese placed

in storage at 10° F., 5 pounds at 50° F., and 1.4 pounds at 60° F. The saving thus effected, based on the uniform price of cheese at 10 cents per pound, would average about 35 cents for 100 pounds of cheese cured at 40° F., 43 cents at 50° F., and 64 cents



Paraffining cheese in the warehouse of David Muir & White, Fond du Lac, Wisconsin.

at 60° F.; or comparing cheese kept at 40° F., covered with paraffine, with cheese cured at 60° F., not so covered, there would be a difference of 75 cents an hundred in favor of the paraffined cheese."

The objection has been made that by paraffining cheese water is being sold for cheese which is a fraud. Dr. Van Slyke answers the objection by saying that it is retaining not an excess of moisture but the moisture that ought to be kept in the cheese. The English trade has objected to coated cheese and Canadian makers are conservative about adopting the method. Some factories have adopted the method of coating green cheese fresh from the hoop. Some Wisconsin dealers have had trouble with some such cheese turning sour and going off flavor. Most wholesale houses are paraffining all cheese received, but

this is usually two or three weeks old. The cheese-maker should be careful about paraffining cheese too green.

209. CHEESE, HOW BOXED.

Young Americas are shipped four, Cheddars one, and flats generally two, in a box.

Where flats are shipped two in a box they are placed one on top of the other, and are in that case termed "twins." When shipped one in a box they are called "singles."

210. SCALE BOARDS.

That the rinds of the cheese may be well protected "scale boards," or very thin basswood or whitewood boards, are placed in the box. Two or three are placed on each end of the box, and two or three between twins. This number is more than is generally used, but cheese in this way keep better when placed in cold storage. If flats are put together without scale boards, and left for any great length of time, they will stick together so tight that they can with difficulty be pulled apart. The rinds sweat and are easily broken. They therefore need plenty of scale boards. The boxes should be trimmed to one-eighth of an inch less than the height of the cheese, so that it will hold its place and arrive in market in good condition. They should not be more than a quarter of an inch larger in diameter than the cheese; if there is too much room in the box the cheese will be likely to roll around and break the box. On the other hand, the box should not be so tight that the cheese will stick in it.

Boxes that are split or poorly nailed should be thrown aside, for they will be sure to arrive in the market in a dilapidated condition. Cheese makers do not realize that boxes that may be in fair condition may be entirely useless at the other end of the journey.

211. HOW CHEESE ARE WEIGHED.

In weighing cheese nothing but full pounds are counted. For instance, if the weight is $60\frac{3}{4}$ pounds, it is counted but 60, or if the beam barely rises at 61 pounds, it is counted but 60, for in course of transportation it would likely lose weight and be cut down when it is in the hands of the buyer. In the large warehouses, where hundreds of boxes arrive in a single day, they cannot stop to weigh every box, but weigh a few boxes,

and if they fall short the whole lot is docked accordingly. Such weighings are referred to an official weighmaster.

212. MARKING OF WEIGHTS.

The weight should be stenciled, or plainly marked, on the box (not the cover) next to the seam, where it can readily be found. A lead pencil hardly makes a sufficiently plain mark on a cheese box. The brand of the firm to whom the cheese is shipped should be stenciled on the other side of the box.

213. BUYER'S STENCIL.

The buyer generally furnishes a stencil for this purpose. Each stencil, so issued to a shipper, has a distinguishing number on it, which is recorded in the buyer's office, and by referring to the number he can tell who shipped the cheese. This is especially necessary where several factories make up a car load of cheese for a firm.

If a cheese-maker has any cheese that is not first-class he should put a distinguishing mark on such and notify the buyer to that effect, and the buyer will usually deal fairly with him, for he understands that the maker is not trying to take advantage of him.

214. HOW TO SELL CHEESE.

Cheese is sold mostly on the dairy boards of trade. The buyer, after he bargains for the cheese, should be required to inspect the cheese at the factory and accept or reject it. He should then give a draft on a local bank for the amount. The bank then draws on the firm for the amount, at the place of business of the firm, and the cheese belongs to the bank till the draft is honored. This is a strictly cash basis, and is fair to both parties. When the cheese is hauled to the depot the boxes should be covered with blankets to protect it from the dust and the hot rays of the sun.

QUESTIONS ON CHAPTER X.

1. What is the curing process in cheese? 2. At what temperature should cheese be cured? 3. What has been learned by experiments in curing cheese from the same lot of milk at different temperatures? 4. How should the curing shelves be made? 5. How should the cheese be arranged on the shelves?

6. What two instruments are used for measuring the humidity of the atmosphere, and what can be said as to their accuracy? 7. What precautions should be taken in reading the psychrometer? 8. What is meant by relative humidity, or per cent of saturation? 9. What should be the relative humidity of the curing room? 10. How may moisture be supplied to a room artificially? 11. How much cloth surface is required for a room containing five thousand cubic feet of space? 12. How should cheese be boxed? 13. What are scale boards and how should they be used? 14. How should cheese be weighed? 15. How and where should the weights be marked on the box? 16. What five factors affect shrinkage in curing? 17. What are the advantages of low temperature curing? 18. What are the advantages of central curing rooms? 19. What is the purpose of paraffining cheese? 20. At what temperature should paraffine be applied? 21. How does the shrinkage between paraffined and unparaffined cheese compare? 22. What are the objections to paraffining?

CHAPTER XI. JUDGING CHEESE.

215. IDEAL CHEESE.

One trouble that cheese-makers meet with is, that they do not have the proper idea of a perfect cheese in their minds. This arises largely from the circumstances under which they are placed. The cheese are shipped out of the factory as soon as the buyer will take them, the youngest being but a week or ten days old. The cheese may have defects, but the maker does not get a chance to see how it will turn out.

Cheese exhibited at the Wisconsin Dairymen's Convention is scored according to the following scale:

Flavor	50
Texture	30
Salt	10
Color	10
Total	100

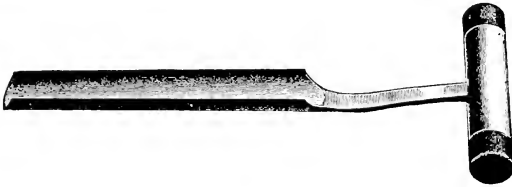

Cheese Trier.

To try a cheese, a plug is pulled from it by means of a cheese trier. The trier should be thin, round and a little tapering, so that it will pull a round smooth plug. A plug should always be taken from the top of the cheese. Never plug it through the bandage.

216. FLAVOR.

Flavor is the most important item in the quality of a cheese. No matter how good the other points may be, if the flavor is bad, the cheese will be condemned. It would be a difficult matter to describe accurately just what the flavor should be like, for

there are different flavors in cheese, which may be equally good. This comes about from the different ferments in the cheese which we cannot as yet entirely control. In another five years, bacteriological research will probably overcome this difficulty for us.

The old saying that "the proof of the pudding is in the eating of it," is true of cheese. If it tastes good and we want more of it, it is just the flavor we should have. It should not be sharp so that it will bite the tongue, but of a mild lasting taste. A great many cheese, in which the flavor cannot be termed bad, are still on the negative side; they do not have that fine lasting aroma, although we can eat them quite agreeably, but do not feel that it is a matter of very great importance, whether we can have more of the same or not.

Where experts are judging cheese, they seldom taste of any. They get the flavor simply by the smell, for if they tasted of every plug they would soon be confused as to flavor.

If a cheese is cold, it should first be warmed up in the fingers, before looking for the flavor.

217. TEXTURE.

While flavor stands first in importance, the texture of a cheese comes next. The plug should be smooth, not fuzzy. If the cheese is not fully cured the plug should bend a little before breaking. When held between the eye and the light it should be slightly translucent. If the light does not come through it, it is a sign that the texture has been injured in the manufacture, probably by too high acid. When a piece is broken from the plug, it should not crumble off, but should show a surface such as flint does when broken, and is therefore termed a "flinty break." When pressed between the fingers it should not stick to them but should mould like wax. Cheese that is tough and will not come down readily between the fingers, is said to be "corky," and is probably due to over-cooking or insufficient quantity of rennet to cure it properly. Cheese should not be mealy, as is the case with high acid or too highly salted cheese.

A cheese with good texture should not have any round, smooth or ragged holes in it; but should be as solid as a board.

Cheese with the round holes, or one that is soft and pasty, will go off flavor on further keeping.

218. SALT.

As was said under the subject of salting the curd, salt gives flavor to a cheese. In fact, the whole subject of flavor is affected by the salt. Cheese that are a little soft and a little inferior in flavor could have been entirely remedied by using a little more salt. It has also been stated that salt may injure both the texture and flavor by using too much. The influence of salt is, therefore, partly considered under texture and flavor.

219. COLOR.

Like salt, the color of a cheese is another way of judging its texture and flavor. A cheese without any coloring matter added to it is improperly termed "white." An uncolored cheese should never be white, but of a light amber color. If it is a dead white, it is so because the acid has cut the color out of it. Of course in a colored cheese, these things would be more easily seen.

The color should be even from one end of the plug to the other. A high acid cheese will give a distinct odor to the trier, the same as when acid attacks steel.

In judging cheese, unless some particular market is in view, the shade of color cannot be taken into consideration. New Orleans requires a very high color, St. Louis less, and Chicago still less, while Boston in this country, and Bristol in England, want no artificial coloring. The tendency toward making uncolored cheese seems to be increasing.

220. GROSS APPEARANCE.

A good judge can usually tell the quality of a cheese from the outside appearance. It should be square, and the rind without cracks, for cracks indicate high acid. When the fingers are run over the surface, it should be springy, that is, it should give readily under the pressure and regain its position. If the finger sinks into a place which does not spring back, it indicates a hole or soft place in the cheese. The rind should not have any white spots on it, as these indicate whey. Sometimes the white spots will disappear in time, but it is a weak point in the quality of the cheese. When the plug has been replaced in the cheese, the place should be greased over, to keep the cheese from drying out, and skippers from getting into the same.

221. WISCONSIN FACTORY CHEESE MAKERS' SCALE.

The scale adopted by the Wisconsin Factory Cheese Makers' Association at Fond du Lac, 1895, is an improvement over the old one. It is as follows:

Flavor	45
Texture	30
Color	10
Make up and general appearance.....	15
	<hr/>
Total	100

In this the salt is judged in flavor and texture where it belongs, while the very important item of the neat way in which the cheese is put up gets proper consideration. Under the old scale a dirty, poorly bandaged, crooked cheese, might get as high a score as a neat square one.

The English scale of points:

Flavor	35
Quality	25
Texture	15
Color	15
Make	10
	<hr/>
Total	100

In the above English scale quality, that considers that the cheese should be mellow, rich, melting on the tongue, applies to an old, well cured cheese. The cheese that goes onto the market in this country would not do that.

222. CORKY CHEESE.

A corky cheese, as its name implies, has a texture resembling that of cork. It does not break down and probably will crumble in the fingers. There are two general causes, over cook and too little rennet. If the cause is the latter the cheese will improve with age.

223. HARD, CRUMBLY OR MEALY CHEESE.

Too much salt will make a hard cheese that will probably be mealy. A high acid cheese will have a similar texture, but the color will be cut and the flavor affected by the acid so that the cause can be distinguished.

224. WEAK BODIED, PASTY CHEESE.

Cheese that has too much whey left in it either by under cook or insufficient stirring when dipped, will be soft, and will not mold properly, but stick to the fingers. Such a cheese will

show mottled spots on the rind. Too much piling on the racks will make a weak bodied cheese. In extreme cases the whey will run out causing what is termed a leaky cheese. The danger of weak bodied cheese is that they may become sour.

225. CRACKED CHEESE.

Cracked cheese are caused either by sour curds or by insufficient closing in the press. The latter probably comes from fat covering the particles of curd and preventing their cementing into one mass. It may also be caused by over cook or by a draft of air blowing over a cheese and drying it out rapidly. Cheese are more apt to crack in a dry curing room in dry weather.

226. POISON CHEESE.

There are occasional reports of people being poisoned by eating cheese. Fortunately these cases are quite rare, but as these cases are isolated it is difficult for scientists to trace the full history of the cheese. Professor Vaughan, of Michigan, some years ago carried on quite an extensive investigation of the chemical nature of such cheese and isolated a poison called tyrotoxinon. This poison causes cramps, acts as a purgative and paralyzes the lower limbs. The author's attention was called to the case of a factory in which some poison cheese had been made. The factory was kept in a neat and tidy manner so that it is not probable the poison resulted from carelessness at the factory. The maker stated, however, that every cheese containing poison had been made where the milk was held several days before making into cheese, and in no case was poison in the cheese where the milk was made up each day. The great majority of cases of ice cream poisoning have been traced to church socials, where the cream was gathered and held several days before freezing. This evidence would indicate that the poison is more likely to occur where the milk is held several days before being made up.

227. RUSTY SPOTS IN CHEESE.

Rusty spots in cheese are caused by *bacillus rudensis*, first discovered by W. T. Connell in 1896 in a Canadian factory. Spots the size of a pinhead or larger can be seen at a distance of several feet. In bad cases the cheese is colored as highly as if by annato, but uneven in distribution. It is more prevalent around gas holes and moist spots. A warm curing room

hastens and a cool room retards them. They usually appear in four to eight days. If they do not appear in ten days there will be no cut in price. There is no injury to texture or flavor, but the consumer objects to the appearance.

It broke out first in 1883 in a mild form in St. Lawrence County, N. Y. In 1884 it was worse, occurring mostly in the fall months. The factory at Hailesboro had it develop in 1892 and the factory had eventually to be abandoned for cheese. Other factories in New York and Canada have been troubled but it has not appeared in other parts of the country. Harding and Smith of the Geneva Experiment Station have carried on investigations which show that the factory is usually the main seed bed, though the bacillus is found in the milk of certain dairies.

If all of the apparatus is put into the cheese vat and covered tightly and a jet of live steam turned in on the utensils for an hour, this operation to be repeated three times a week, the trouble can be practically eliminated.

QUESTIONS ON CHAPTER XI.

1. What are the points in judging cheese and what importance is attached to each?
2. Describe the flavor of a good cheese.
3. Describe a good texture.
4. How does salt affect flavor and texture?
5. Describe a good color.
6. What can be learned from the gross appearance of a cheese?
7. What are the English standards for cheese?
8. What is a corky cheese and its two principle causes?
9. What are the causes of hard, crumbly or mealy cheese?
10. What is a weak bodied or pasty cheese and how is it caused?
11. What are the causes of cheese cracking?
12. What are rusty spots in cheese and how caused?
13. How extensive has the trouble of rusty spots been?
14. What is the method of combating rusty spots?

CHAPTER XII.

HINTS ON THE CONSTRUCTION AND OPERATION OF CHEESE FACTORIES.

228. INDEPENDENT FACTORIES.

In the closing pages of Chapter X the advantage of the central curing room has been set forth. This will apply only where one person controls a large territory or where factories combine. The problem of the single factory still remains and in this chapter the construction and operation of such an independent factory will be presented.

Our factory will be equipped for ten thousand pounds of milk a day, which is small enough.

229. ONTARIO CHEESE FACTORIES.

One secret of Western Ontario's success is in the fact that her factories are large, well built, and properly equipped.

On pages 105 and 109 the plans for a factory are given.

230. GOOD FOUNDATIONS.

In the first place there should be good solid foundations, either of stone piers, or gas pipe, which allows the ground to heave and settle, without raising or lowering the building. The supports should be close enough together to hold the sills in place.

231. DIMENSIONS.

Our plans call for a making room 20x30 feet, with an office ten feet square taken out of one corner of it, and a boiler room 10x16 feet attached, and a curing house 20x40 feet, two stories high.

232. STOREROOM.

The upper story should never be used for curing cheese, but for storing cheese boxes and other supplies.

233. CURING ROOM.

Some Canadian factories have the curing house separate from the rest of the factory, but we can build them together and save the lumber for a second wall, which would be necessary if they were separated.

234. SILLS.

We should have 8x12-inch sills around the outside of both parts of the building. There should be two 6x8-inch stringers, running across the make-room, and one of the same dimensions running through the middle of the long way of the curing

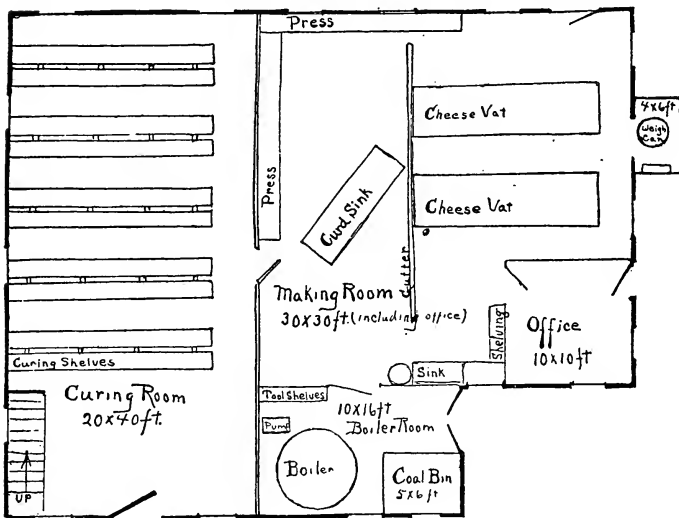

room. Ten-foot joists can be put between the sills and stringers. The dimensions of these joists should be 2x10 inches, and they can be placed eighteen inches apart.

235. CURING ROOM FLOOR.

The joists under the curing room should have rough boards nailed close together on the under side, and a five-inch layer of tanbark put in between them. There will then be a five-inch space left above the tanbark, over which a tight, heavy floor is

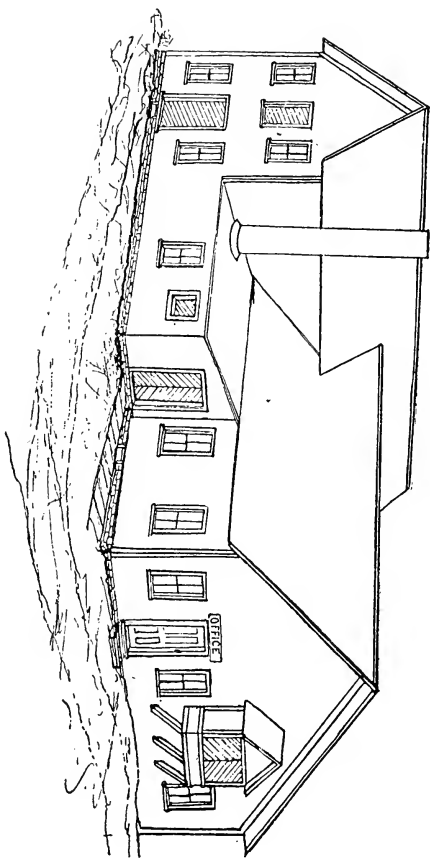

Elevation of Cheese Factory.

to be laid. This may be made, by first laying rough boards, and covering with paper, and then laying the regular flooring. The tanbark, air space and tight floor are to protect from outside temperature.

236. VAT ROOM FLOOR.

The making room should have a heavy two-inch floor, preferably of maple. It must slope at a scale of one inch in five feet, toward a ditch at the lower end of the vats or twenty feet from the front end of the room.

237. CURING ROOM WALLS.

Paper can be put on the studding under the siding, and the walls lathed and plastered. The studding is of 2x4, such as is generally used, and if tanbark can be easily obtained, it can be filled in between the studding. Tanbark is better than sawdust for filling in such places, as mice are not inclined to work in it as much. It is hardly necessary to say, that the top of the room should either be ceiled or plastered.

The curing room must practically be a large box, with walls so constructed that the temperature inside will be affected as little as possible by the temperature outside; some means of introducing cool, fresh air into the curing room is highly desirable.

The walls and ceilings will therefore have to be of several thicknesses, with air spaces between, like the floor which we have already described.

238. DOORS AND WINDOWS.

We must not forget, after we have built such walls, to have the windows fit tight and have shutters on the outside. The doors must be heavy, with air spaces in them, and close tight with a lever latch like a refrigerator door.

To construct our walls, we may put our 2x4 studding two feet apart, which is to be lathed and plastered inside. On the outside, rough boards and paper may be put, and then another row of studding, and paper nailed on with boards on the outside of these. In the spaces in the outer row of studding, tanbark may be filled in.

239. JOISTS.

The joists in the ceiling should be 2x6, ten feet long, eighteen inches apart, supported by 4x6 running crosswise of

the room. If the room is ceiled overhead, tanbark three inches deep can be filled in between the joists, and then a layer of paper put down before the floor is laid. If the room is lathed and plastered, boards must be put in to hold the tanbark. The second story, which is used only as a store room, need not have double walls. A tight-fitting trap door should be made between the store room above and the curing room below, through which to get the cheese boxes down.

240. STONE CELLAR.

A better wall for the curing room in the first story may be made of stone, and built into the side of a hill, for still greater protection from outside temperatures, as in the case with cellars for curing of brick and Swiss cheese. The stone and earth help to keep down the temperature of the air in the room.

241. CURING CELLARS.

In some places cellars made for curing brick cheese have been used with splendid results with Cheddar cheese. Such a cellar is built into the side of a hill, is stoned up on the sides and rises above the ground just far enough for small windows around the top. One trouble with these cellars is that they are sometimes so damp that cheese will mould rapidly.

242. CELLAR, HOW VENTILATED.

This can be obviated by ventilation. At each end of the room is an eight-inch pipe running up through the roof. One of these has a cone above it to prevent the rain coming in through it. On the top of the other is a hood with a tail that keeps the hood always facing toward the wind, and the wind striking into the hood carries a current of air down into the room, while another current of air goes out of the other pipe. Dampers similar to those put into stovepipes can be arranged in these pipes to regulate the flow of air. If the air should get too dry, moisture could be supplied by means of wet sheets. We have seen such curing cellars where the inside temperature did not go above sixty-five degrees, while that outside was eighty-five to ninety. We would have to change the plans of the factory here given for such a curing cellar.

243. SUB-EARTH DUCTS.

In his first edition of "Cheddar Cheese Making," published in 1893, the author advocated the use of sub-earth ducts for

cooling curing rooms. Since then the system has been put into use and is very successful. As one descends into the ground the effect of the sun's heat is left behind. Lower down the internal heat is felt, but in a zone said to be between twenty and eighty feet below the surface there is a constant temperature of 48° to 50° or possibly colder. This is indicated by the temperature of the spring and well water that comes to the surface. By conducting air down into the ground and then through a system of tubes ten or twelve feet below the surface

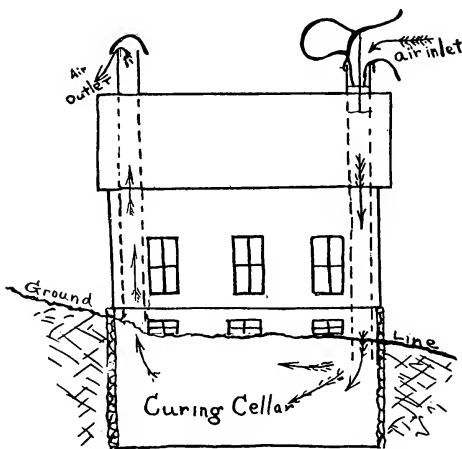

Ventilation of a cellar curing room by means of a cowl and ventilator shaft.

for a hundred feet or more, it can be carried into the curing room at a temperature of not over 60° F. If the curing room is well insulated the air cannot get in at any other place and will be cool. The air is forced into the duct by means of a cowl, which always faces the wind, which is thereby forced down a tube into the duct. An outlet from the top of the curing room allows the warm air to escape. Our curing room if built as described, would be right to use with a sub-earth duct, but we would suggest that double windows and doors be put in to make the room perfectly tight. The illustrations here given of

the construction of the walls of a room and of a duct are taken from Bulletin 70, of the Wisconsin Experiment Station.

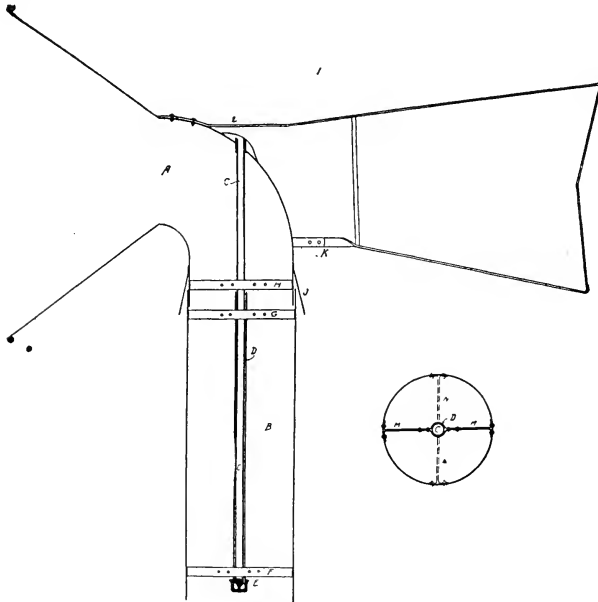

Plate showing how funnel and vane may be mounted. A, funnel; B, shaft of funnel; C, C, C, 1-inch gas pipe; D, D, 1¼-inch gas pipe; E, cap for support of 1-inch gas pipe; F, G, H, and M M and N N are stays of band iron bolted together and to the sides of the shaft to support the axis of the funnel; J, weather collar to turn rain out of shaft. K, L, band-iron to stiffen vane and attach it to funnel.

Diagram for construction of a cowl for a sub-earth duct.

244. USE OF A WELL.

One of our illustrations (page 114) shows how a well was used for cooling the air for a curing room. It is one of the most successful ducts in operation.

245. NUMBER AND SIZE OF TILES.

The first ducts constructed were single tubes and were too near the surface and therefore unsuccessful. The first successful duct was made by placing thirteen rows, one hundred feet long, of six-inch tiles eight to ten feet in the ground. These

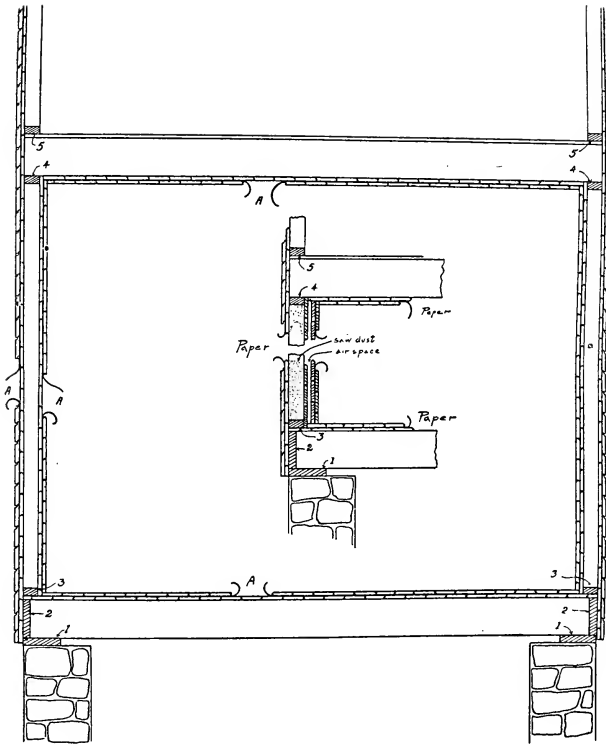

Plate showing the construction of wood curing room. 1, 1, 1, sill; 2, 2, 2, a two-by-ten spiked to ends of joist; 3, 3, 3, a two-by-four spiked down after first layer of floor is laid to toe-nail studs to; 4, 4, 4, a two-by-four spiked to upper ends of studding of first story; A, A, A, A, three-ply acid and waterproof paper. The drawing in the center shows space between studding filled with sawdust and another dead-air space to be used when the best ducts cannot be provided.

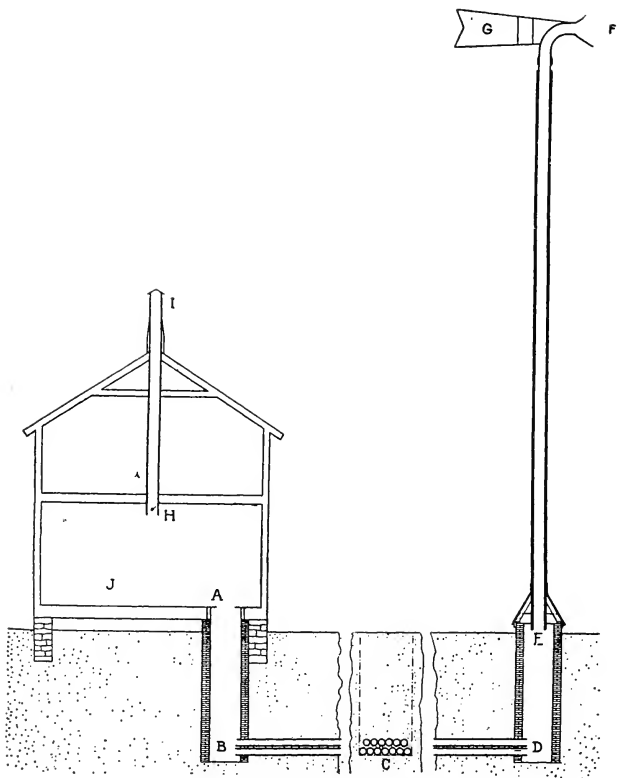

Plate showing section of cheese curing room and horizontal multiple sub-earth duct. A, inlet to curing room; B, end of sub-earth duct in bricked entrance to factory; C, cross-section of the multiple ducts as placed in the factory of A. C. Werth, Neenah, Wis. D, E, bricked entrance under funnel at outer end of sub-earth duct; F, funnel with mouth 36 inches across; G, vane to hold funnel to the wind.

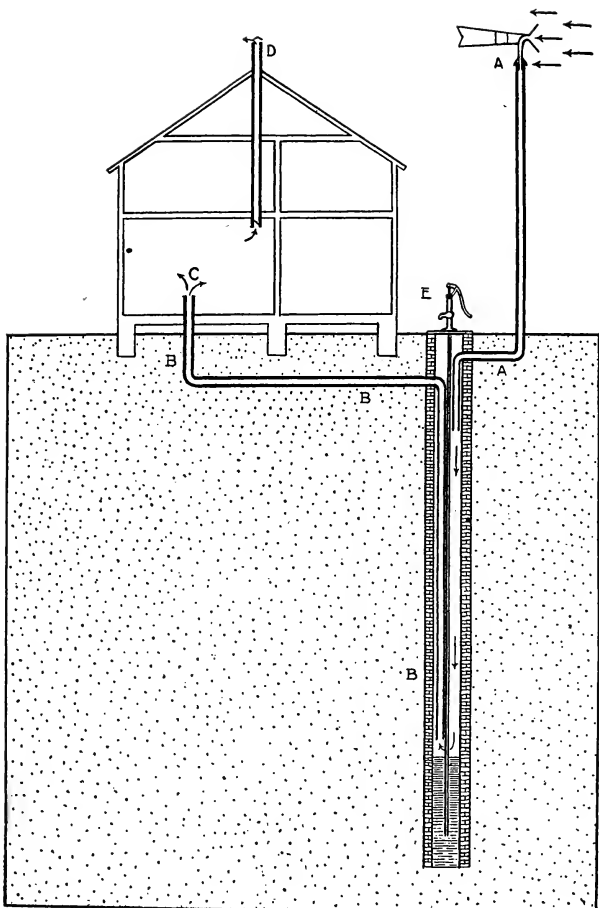

Plate showing vertical section of Mr. J. F. Steinwahn's factory and sub-earth duct in well at Colby, Wis. A, A, funnel taking air into well; B, B, B, duct leading air from well to curing room, C; D, ventilator.

tiles were, however, somewhat small in diameter, and by friction hindered the passage of air on still days when most needed.

Professor King recommends not less than three ten-inch tiles one hundred feet long for a curing room of 5,000 cubic feet of space. Longer tubes and more of them twelve feet down would be better.

246. WATER MOTOR FANS FOR DRIVING AIR.

The weak point in the sub-earth duct is that there may be several days of hot weather with little wind when the cowl will not work. At such a time a water motor driven fan will cir-

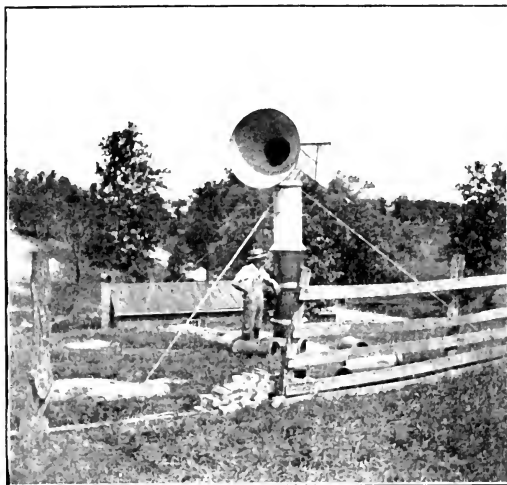

Eighteen-inch cowl to sub-earth duct at B. B. Herrick's factory, Wellington, O. The duct runs down a hill and the factory is seen at the foot of the hill.

culate the air. The Triumph Dairy Co, Triumph, Trumbull County, Ohio, has such a contrivance. A five-barrel tank of water on top of the building will run the fan most of the night. The tank is filled with water by a steam pump.

247. BOILER ROOM.

The boiler room should have a cement floor laid on the ground, and it should be lined with corrugated sheet iron, to insure against fire.

248. BUILDING SHOULD BE RAISED.

The rest of the building should be raised about a foot above the ground, so that air may circulate beneath and keep the sills from rotting.

249. WATER SUPPLY.

A good well is an absolute necessity for a cheese factory. Water can be pumped into a galvanized iron cistern placed above the curing room. This cistern should be set in a drip pan, which will catch any leak or sweat from it, and carry it outside without leaking through into the curing room.

250. HOT WATER.

From the cistern, water may be carried in pipes to the different parts of the building. The water pipes should be galvanized to prevent rusting. There can be a steam pipe running into the water pipe by a T, and the flowing water can be heated by turning steam into it.

251. SEPTIC TANK.

Much difficulty has been experienced in getting rid of the sewage around cheese and butter factories. The blind well has been a source of contamination for the water supply and pollution of streams has been the occasion for law suits and neighborhood quarrels.

The septic tank offers a simple, cheap and efficient means of sewage disposal. It has been presented in a number of dairy papers.

It is two feet deep and above ground, though it may be covered with earth. The factory must therefore be built high enough to empty the drains into the top of the tank. The system of tiles into which the tank empties should not be over one foot below the surface and should be perfectly level.

252. SEWER TRAP

At the mouth of the factory drain there should be a sewer trap, which is simply an  shaped pipe, in which water constantly stands and keeps gas from coming up from the septic tank.

253. WHEY TANK, HOW BUILT.

The whey tank should be lined with galvanized iron, and be placed high enough for a wagon to drive under, and draw off the whey by simply opening a valve. The ground ought

to be paved in such a way that the drip will run off into the sewer. A skim milk weigher will facilitate an equal division of the whey.

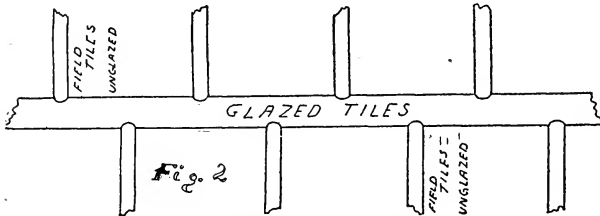
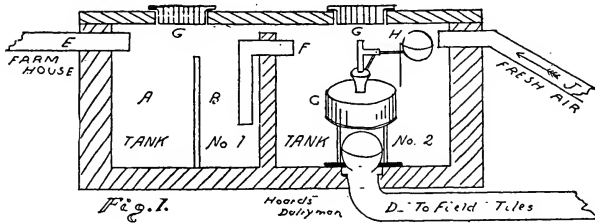

PLAN FOR A SEPTIC TANK.

(As shown in Hoard's Dairyman, January 1, 1904.)

This is a cement tank 8 feet long, 4 feet wide and $2\frac{1}{2}$ feet deep, with a partition reaching nearly to the top and dividing it into two sections. The top has two manholes G opening into the sections. The sewage enters Section 1 through pipe E, into part A, which is separated from part B by a plank partition having 1-inch spaces between the planks, to keep solid matter in part A. Solid matter collects on the top by formation of gas. The liquids flow from the bottom through pipe F into Section 2. When this fills the trap valve is sprung and lets the liquid run out into the underground system of tiles. The tiles should not be more than a foot below the surface of the ground, and should be level. Their volume should be a little more than the volume of the section of the tank emptied into the tile. While the tank is filling again, the liquid soaks into the soil and bacteria near the surface decompose the organic matter.

Prof. John Michels of Michigan has experimented with septic tanks and finds the tanks, without the tiles, to be sufficient to decompose creamery slops.

254. ELEVATING WHEY.

To get the whey from the vat into the whey tank, it can be drawn into a box or barrel, and from there forced by a steam jet into the whey tank. The whey should be scalded to keep it sweet, and after the patrons have gone every morning, the tank should be scrubbed out and steam turned into it to

scald it out. There should be a platform around the tank and steps leading up, so that a person can get into it easily.

255. BATH ROOM.

One thing that a factory should have, though generally unthought of, is a bath room. This can be placed above the curing room. A room, five by eight feet, can have a floor covered with galvanized iron, to catch any drip or slop, and a bath tub put in. Hot and cold water can be connected with it, and a most desirable thing supplied.

256. EQUIPMENT.

For a factory of the capacity we are building, an eight-horse power boiler will be required. A horizontal brick arch boiler is preferable to a vertical one, as it will hold the heat better, and a person can more easily clean the flues.

There should be a good steam pump, and possibly an engine, though that is not absolutely necessary. For ten thousand pounds of milk two vats of a capacity of 5,200 pounds will be needed; these ought to be provided with whey gates for emptying them.

257. WATER BOXES OF VATS SHOULD BE LINED.

It is quite essential also to have the water boxes of the vats lined with galvanized iron, or they will leak, making a bad muss on the floor.

258. CURD SINK.

It will be remembered that a curd sink is a necessary piece of apparatus in getting the curd drained properly; we must, therefore, have a curd sink constructed in the way suggested.

For the curd from 10,000 pounds of milk, two gang presses, and either twenty Cheddar or forty flat hoops will be required.

259. PRESSING FLATS.

One should not attempt, as is quite commonly done, to press two flats in a Cheddar hoop by putting a divider between. Artistic looking cheese cannot be made in that way.

Flat hoops do not cost nearly as much as they did a few years ago, and the expense will be but slightly increased in providing the necessary number of hoops.

260. SINK, HOW MADE.

Another necessary thing, which is seldom found in a factory is a good sink. It should be iron or galvanized iron lined, and plenty large enough—say three feet long, by twenty inches

wide, by twelve inches deep, properly connected with the sewer. At the end of the sink should be a wide shelf or table inclined toward the sink, so that drippings will run off into the sink. This shelf is used to drain tinware on, and a steam jet projecting through it, can be used to sterilize utensils.

We need hot and cold water connections at the sink, and perhaps a hot water barrel beside it. This barrel may be made of galvanized iron, and should be used for a supply of clean, hot water, rather than a place to wash dirty tools. This latter operation ought to be performed in the sink.

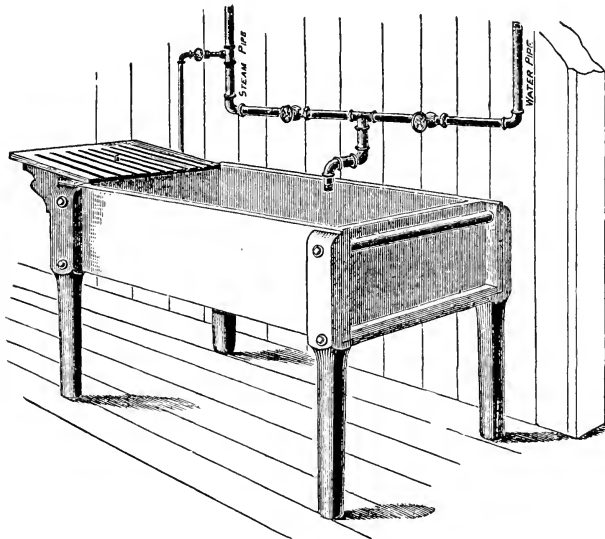

Wash Sink.

261. MILK, HOW LIFTED.

If the roadway is not high enough to empty the milk directly into the weigh can, a large wheel fixed tight on an axle is probably the best appliance for lifting the milk. An endless rope runs over the wheel, and by pulling this rope the wheel turns and winds up another rope on the axle. This rope has tongs on it, which take hold of the milk can.

The weigh can is placed on an 800-pound double beam scale, which stands in a receiving room or covered platform. This platform is built out on brackets in front of the factory. On one side of the room is a shelf for the milk book, and another for the sample jars. The milk is run from the weigh can to the vat, through an open tin conductor.

262. MILK TESTING.

For testing the milk, we should have a thirty-bottle, steam turbine, Babcock test, and a Quevenne lactometer. The Quevenne lactometer gives a direct reading of the specific gravity, and is used in connection with the Babcock fat test for detection of watered milk.

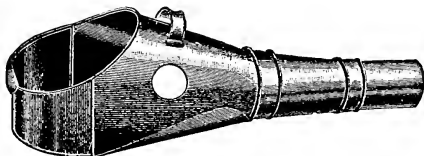

Milk Conductor Head, for running milk from weigh can to vat.

263. APPLIANCES NEEDED.

We will name over some of the minor articles needed in the factory, for some of them are usually found lacking, and sometimes there are not enough of the articles to enable one to work handily.

There ought to be two curd knives—horizontal and perpendicular—and they should be six or eight inches wide and twenty inches long.

A rennet test will be required, and two or three reliable thermometers, for these are easily broken, and we must not run the risk of being without one.

There will also be needed a hair sieve, linen strainer cloth, wash dish, two curd pails, three or four twelve-quart tin pails, several dippers, one of which has a flat side, and a perforated tin bottom, for skimming specks off from the milk.

264. CURING SHELVES.

The shelves in the curing room are supported by cross-pieces, attached to wooden posts. These posts are 4x4s, reaching from floor to ceiling. The cross pieces are 2x4s, set into

the 4x4, to keep them from tilting, and a bolt put through to hold them in place. The shelves are sixteen-foot boards; sixteen inches wide, and one and a half inches thick. They should be the clearest pine lumber obtainable.

The shelving can run crosswise of the room, and if the boards are sixteen feet long, there will be a four-foot passage on the side of the room next to the making room. At the further end of the room from the door to the making room, ten feet of space can be left for boxing cheese.

265. COST OF FACTORY.

The factory we have suggested will cost more than the ordinary run of factories, for it is much better. Nothing that will be a waste of money has been suggested. Certain firms put up factories which are inferior to this, for which they get a third more money than this would cost.

As the cost of material in different localities varies so much, we have not set a price on this factory, but the necessary facts are given, so that anyone can figure on the cost of the building for his own locality, and then reliable firms will furnish machinery at reasonable prices.

QUESTIONS ON CHAPTER XII.

1. What is the necessity of good foundations for a factory?
2. How should the curing room wall be constructed?
3. Why are double windows needed in the curing room?
4. How should the curing room door be built?
5. What is the advantage of a curing room in a cellar?
6. How may such a room be ventilated?
7. What is the principle on which a sub-earth duct works?
8. How many and how large tiles should be used?
9. How deep should the tiles be placed in the ground?
10. How long should a duct be?
11. How may air be forced through the duct?
12. How large should the cowl be and how high should it be placed?
13. How can a well be utilized as a duct?
14. How can hot water be secured?
15. Why should the water pipes be galvanized?
16. What can be said of good sewer connections?
17. What is a septic tank?
18. How

should the whey tank be constructed? 19. How should the whey be drawn off? 20. How can the whey be elevated? 21. Why should the water tanks to the vats be lined? 22. How should the curd sink be constructed? 23. Why should flats not be pressed in Cheddar hoops? 24. How should a wash sink be made? 25. How should the curing shelves be constructed?

CHAPTER XIII.

ORGANIZATION OF CHEESE FACTORY ASSOCIATION.

266. PLANS OF OPERATION.

Cheese factories are operated on two plans, namely, the private and stock company systems. In the first named plan the factory is owned by an individual who furnishes everything in the manufacture, and receives a certain price per pound for such manufacture, the milk and the cheese being all the time considered the property of the patrons. The patrons then have some form of organization for the purpose of selling the cheese and dividing the money, and looking after their interests generally.

Under the other system the farmers' organization goes further and owns the factory, and the officers do all business and hire a cheese maker to manufacture the cheese. Co-operative associations are usually not successful unless a business manager is given full authority to manage the business.

The following by-laws will give a general idea of how to organize such an association:

267. BY-LAWS FOR A CHEESE FACTORY ASSOCIATION.

ARTICLE I. Name—This Association shall be known as the.....
.....Cheese.....Company.

ARTICLE II. Capital Stock—The capital stock of the Association shall be \$4,000, divided into two hundred shares of twenty dollars each.

ARTICLE III. Officers—The officers shall be a president who shall have general oversight of the business of the Association and prosecute any case at law that may arise. A treasurer shall receive and disburse all money and keep a proper set of books which shall be open to inspection of any member of the Association at any time. He shall be the salesman for the Association. He shall receive \$—— per annum for his services. There shall be a secretary who shall figure all milk dividends. He shall be Chairman of the Test Committee.

ARTICLE IV. There shall be semi-annual meetings of the Association on the first Tuesday in March and October, three days' notice of the time and place of meeting to be given by the president. Special

meetings may be called by the president, three days' notice of the time and place to be given, and upon the written request of ten members of the Association the president shall call such a meeting.

ARTICLE V. The division of money for cheese sold shall be determined by the fat test of the milk, after expense of making has been deducted. The remaining amount of money shall be divided by the number of pounds of butter fat delivered during the time said cheese was made, to determine the price per pound of butter fat, and each patron shall receive that price per pound for the butter fat delivered by him during that time.

ARTICLE VI. Test Committee—There shall be a test committee of three members beside the secretary who shall assist the cheese maker in testing the milk.

ARTICLE VII. The price for making cheese shall be one and a half cents per pound.

ARTICLE VIII. The cheese maker may reject any milk that in his judgment will not make first-class cheese.

ARTICLE IX. No milk will be received at this factory that has not been properly strained and aerated.

ARTICLE X. These by-laws may be altered at any legal meeting by a two-thirds vote of the members present, providing there are at least ten members present at such meeting.

The above by-laws can, of course, be changed to suit any particular locality or conditions. The amount of capital stock may be altered, or such articles changed to make them suit a private factory.

268. TEST COMMITTEE.

Article VI, which organizes a test committee, is for the purpose of preventing dissensions. We quite often hear it stated that the maker reads the tests low to get a larger yield, or that he favors one patron more than another. Such statements may be founded on facts, but are generally the results of suspicions. Now if the patrons have a committee of their number to see the tests made, such a committee cannot fail to secure justice.

269. QUORUM.

The matter of the number that shall constitute a quorum has been purposely left out, for in such an association it is not very important, and might hinder in the business of some meetings. The article on the revision of the by-laws contains a clause that practically names a quorum in such a case.

270. RATES FOR MAKING.

In some Canadian stock companies there are two rates charged for making the cheese, a stockholders' rate and a

patrons' rate, which is higher than the former. The patron is not entitled to whey. It belongs to the corporation, to be fed to hogs owned by the association, or disposed of as the stockholders see fit. Each share of milk entitles the owner to have fifteen thousand pounds of milk made up at stockholders' rates, and after that he must either get another share of the stock or pay patrons' rate for all milk made up above that amount. The object of this rule is to make each patron take a financial interest in the factory.

271. FIGURING DIVIDENDS.

Perhaps this is the proper place to speak of figuring dividends. As is indicated in one of the by-laws the price per pound of butter fat should be found, and each patron paid for the pounds of fat delivered by him.

Cheese may be sold each week, but the dividends are made for the month.

The composite samples of milk are saved as described under the head of milk testing, and tested once a week. The pounds of milk delivered by the patron multiplied by the per cent of fat, gives the pounds of fat delivered by him. The amount of money left after paying all expenses is then divided by the total pounds of fat for the month to get the price per pound of fat. And then the number of pounds of fat delivered by each patron, multiplied by the price per pound, gives the amount due him. Theoretically the pounds of milk delivered each week should be multiplied by the weekly test, but the tests from week to week if averaged together for the month, and then the monthly milk multiplied, will give very close to the amount found if each week's fat were found and added together for the month, and a large amount of labor is saved.

If there is a small surplus or shortage of money in figuring, it can be added to or subtracted from the next month's money before determining the price per pound.

For an example of dividing money suppose there are three patrons, and during the month they delivered milk as follows:

A.....	3,000 lbs. milk testing 4.0	%=120 lbs. fat
B.....	2,200 lbs. milk testing 3.5	%= 77 lbs. fat
C.....	1,000 lbs. milk testing 4.5	%= 45 lbs. fat
Total for month.....	6,200 lbs. milk testing 3.90	%=242 lbs. fat

By dividing the pounds of fat by the pounds of milk for the month, and multiplying by 100 we get the average test of all the milk for the month. It is not needed in the figuring of the dividends, but it is interesting to know what the average test is.

Suppose the cheese made from the milk was 620 pounds and sold at 10 cents per pound. We then have \$62.00. The cost of making was \$9.30, and we have left \$52.70 to be divided among the patrons. By dividing this amount by the 242 pounds of fat we get 21.777 cents per pound. Then

A has 120 lbs. fat @ 21.777 cts.=.....	\$26.13240
B has 70 lbs. fat @ 21.777 cts.=.....	16.76829
C has 45 lbs. fat @ 21.777 cts.=.....	9.79965
Total	<u>\$52.70034</u>

We had \$52.70 to be divided. One should always prove his figures to be sure they are correct.

272. FACTORY STATEMENT.

A statement containing all necessary items should be given each patron so that he can figure the dividend himself. There should be a printed form for this. The following may be used:

MUSCODA CHEESE ASSOCIATION FACTORY.

Statement for

Month of19.....

Sales include following dates.....to.....

No pounds of cheese sold.....lbs.

Amount of money received.....\$.....

Average price per pound.....cts.

No. pounds of milk delivered.....

No pounds of fat delivered.....

Average test

Expenses

Money to be divided.....

Which leaves.....cts. per pound of fat

No. pounds of milk delivered by you.....

Your average test.....

Pounds of fat delivered by you.....

At.....cents per pound.....\$.....

Dr. by.....pounds of cheese at.....cts. per pound.....

Money due you.....

No. pounds of fat required for 1 pound cheese.....

No. pounds of cheese from 100 pounds milk.....

.....Sec.

QUESTIONS ON CHAPTER XIII.

1. What are the two general plans on which a factory may be operated? 2. Why are co-operative companies usually not successful? 3. Describe how dividends are figured. 4. Why should a statement be made to each patron when a dividend is declared? 5. What are the important points in such a statement?



Swiss Cheese Factory at Axtel, O., operated by The Diamond Cheese Company.

CHAPTER XIV.

SWISS CHEESE - ITS CHARACTERISTICS.

273. SWEET CURD CHEESE.

It will be remembered that Cheddar cheese was first made in England and was introduced into America by the emigrants from England. In like manner the manufacture of a number of other styles of cheese has been introduced. These styles are what are generally termed sweet curd. The Cheddar is made from ripened milk and a certain amount of acid is developed in the whey. With the sweet curd varieties, however, the milk must be "sweet," the milk being curdled and cooked up as rapidly as possible and then put into the moulds before salting. The salt is nearly all applied to the outside of the cheese by means of dry salt rubbed on the surface or by soaking the cheese in a strong brine.

Among these cheese are "Swiss," of the round and block varieties, brick and Limburger. Swiss cheese has been made in this country quite as long as has the Cheddar and with the brick and Limburger, will soon be, if it is not already, entitled to the name "American."

274. SWITZER, WHERE MADE.

American Swiss, or "Switzer," as it is called, is made to the greatest extent in this country in Green and Dodge counties, Wisconsin; in Wayne, Stark, Summit, Columbiana and Tuscarawas counties, Ohio; and in New York State. The makers are mostly natives of Switzerland, who have emigrated to this country and brought their methods of making with them. These methods can probably be improved upon in a number of ways as will be indicated.

275. DESCRIPTION OF SWITZER CHEESE.

Swiss cheese is known in the old country by the name of Emmenthaler. Its origin is not definitely known, but it has been made in the canton of Bern since in the fifteenth century. In this country it is made in two forms, the round or drum Swiss, and the block Swiss.

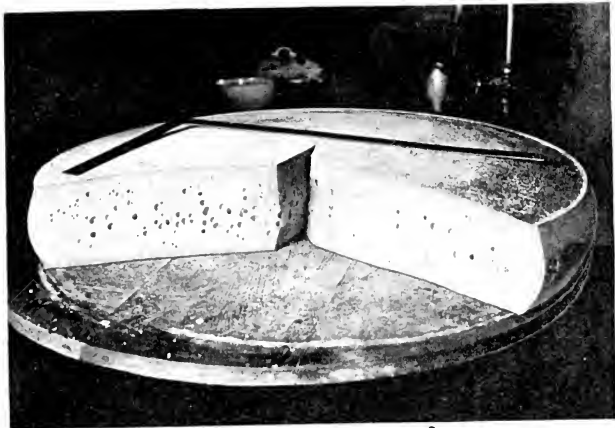

A typical Swiss cheese, cut showing characteristic holes or "eyes." A square on top of it shows its size. The eyes reflect the light, showing that they have a shiny surface.

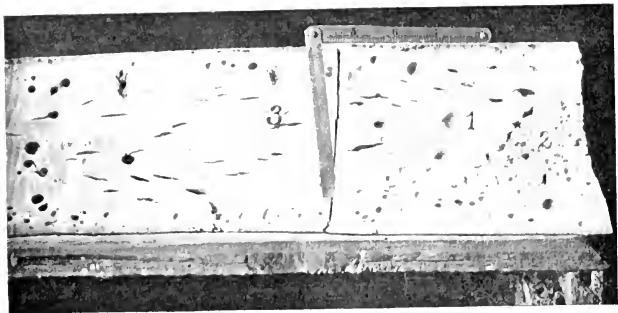

A cut through a Swiss cheese of second quality. The hole next to number 1 is round, but has a dull surface. The holes near the number 2 are small and are typical of a "nizler." The cracks near the number 3 are typical of a glaesler. The rule lying along the side shows the relative sizes of the holes.

The drum Swiss is pressed in large round cakes, twenty-four to possibly thirty-six inches in diameter, and four to six inches in thickness. Such a cheese will weigh, on the average, about 180 pounds. The block Swiss is six inches square by twenty inches long, and weighs twenty-five to thirty pounds. The illustration shows a drum Swiss cheese cut open. On top is laid a square which indicates the size of it. The illustration of two block Swiss on page 139 will give an idea of their proportions.

276. DETERMINING QUALITY OF CHEESE.

In order to intelligently discuss the manufacture of the cheese, we should know what is required in a Swiss cheese to make it of the best quality.

277. FLAVOR.

First as to flavor. We will say that flavor is a hard matter to describe, the same as the flavor of a Cheddar cheese is hard to express in words. It can be said, however, that the Swiss cheese has a slightly salty taste peculiar to itself, a taste that is very pleasing. A cheese that is bitter to the taste is to be condemned.

278. TEXTURE.

A good Swiss cheese should have the right dough, that is, it should not stick to the fingers, nor, on the other hand, be too dry, but should mould in the fingers like wax, or as the term indicates, like dough. It should also have plenty of eyes or holes about a half an inch in diameter, evenly distributed through the cheese, as is seen in the illustration. These holes should have a glossy surface, which is again an indication that the dough is right. If it is too soft, these holes will have a dull surface. In an old cheese a drop of brine may be found in the hole.

279. COLOR.

The color should be white. The native Swiss cheese is very light colored, probably on account of the feed that the cows get, the character of the fat given by the native cows (we know that Guernsey milk is exceptionally yellow, while Holstein milk is light colored), and by the length of time that a cheese has cured. Cheese that are quite yellow will turn white with more age and cannot be distinguished from the native article, and

except for the name "imported" are just as fine. One reason why foreign cheese meets with so much favor in this country is that it does not reach the consumer till it is thoroughly cured, and if the American cheese of the various kinds be allowed to get thoroughly cured it will meet with the same favor.

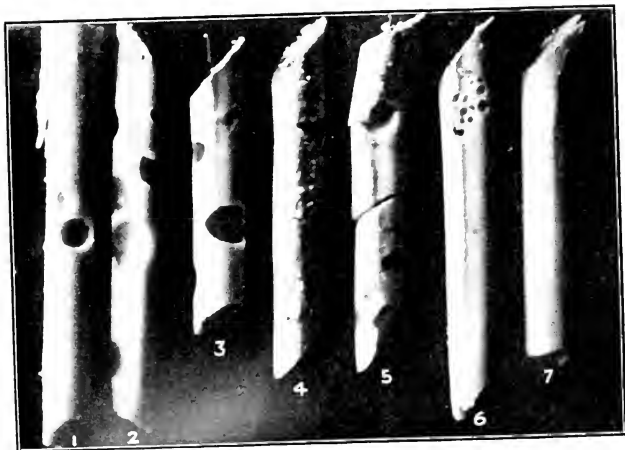

A series of plugs from Swiss cheese of different quality. Nos. 1, 2, 3 would be classed as No. 1 cheese, though 2 has rather too many holes. Nos. 4 and 5 show the cracks of a glaesler and the corresponding pasty appearance. No. 6 at the upper end indicates a niszler, though a typical niszler would have the small holes the entire length of the plug. No. 7 is what would be termed a blind cheese as there are no "eyes" or holes.

280. GRADES OF CHEESE.

There are, however, poorer grades of this Swiss cheese that are not represented by our illustration, for that cheese is an ideal one, a typical article. Cheese are really put into three grades, No. 1, No. 2 and No. 3. Cheese like the one shown on page 129 with the right dough and flavor, and the right kind and distribution of holes is classed as No. 1 cheese. Cheese without eyes or holes is termed blind and classed as No. 2. A cheese with little gas holes (called pin-holes in Cheddar cheese) is termed a niszler, meaning "a thousand eyes." One that is pasty and will stick to the fingers usually has few round holes, and if it does have them they are not glossy on the surface. Such a cheese is

likely to have checks or cracks, running usually in a horizontal direction, through it. These cracks are supposed to resemble the fracture of a piece of glass and hence the cheese is called a *glaesler*. The illustration on page 135 shows a cut through a piece of cheese which presents three different kinds of holes designated by the numbers on the surface. No. 1 shows a round hole, but on close inspection it will be seen that the surface is not glossy as is the case with the holes in the typical cheese shown on page 135. No. 2 shows smaller holes as found in a *niszler*. A *niszler* may have the small holes all through it or in local portions of it. No. 3 shows a characteristic crack of a *glaesler*. The pocket rule hung on the cheese indicates the size of the holes.

281. HOW CHEESE IS TRIED.

When a buyer goes into a factory to buy cheese he cannot, of course, cut any of the cheese open, as shown in the illustrations. He sees the inside of it by drawing a plug with a cheese trier, as is done in buying Cheddar cheese. The picture on page 137 is a photograph of typical plugs of Swiss cheese. Plugs 1, 2 and 3 have the proper kind of holes, though No. 2 has rather too many to be classed as No. 1 cheese. Again, the holes in No. 3 or at least one hole, was too large, for it cut the plug entirely off. It would, however, probably pass for No. 1. Plugs 4 and 5 have the cracks of a *glaesler*, and the little particles of curd roughed up show it to be pasty. Plug No. 6 shows a *niszler* at the upper end, while plug No. 7 is blind.

Now to review the classes of Swiss cheese, the requirements for No. 1 are that:

1. The flavor shall be good.
2. The texture shall have the right dough, i. e., it must not be too dry, neither stick to the fingers, but mould like wax. It shall have the right kind of eyes evenly distributed.
3. The color should be light.

For No. 2 cheese would be included:

1. Cheese of a second rate flavor.
2. *Glæsler* or blind cheese.
3. Cheese with a very uneven or abnormal development of eyes.
4. *Niszlers*.

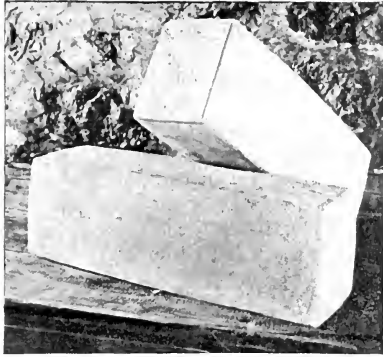

Block Swiss cheese as it appears when of fine quality.

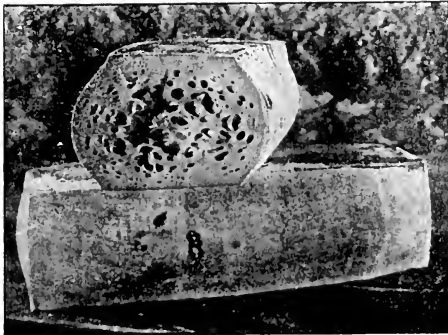

Block Swiss cheese bulged at sides from too rapid formation of gas. The salt did not work to the center fast enough.

No. 3 cheese would include:

1. Cheese of bad flavor.
2. Cheese damaged by rats or mice.
3. Cheese cracked open.

Cheese damaged by rats or mice or cracked are very likely to rot at such points.

The buyer in the presence of the cheese maker determines the grade of the cheese, and marks it on the edge with his trier by gouging out I, II or III marks. He afterwards brands it with a hot branding iron, the brand being usually his initials. When the price of No. 1 is 9½ cents, the price of No. 2 will likely be 8 cents, and No. 3 will sell for from 3 to 5 cents.

Italians like glaeslers better than cheese with the eyes in it, and will often pay No. 1 price for the glaesler and reject a No. 1 cheese. Some makers regularly turn out cheese of No. 1 quality, while others have considerable difficulty in so doing, and the difference in price makes a very large difference in the size of the maker's pocketbook. The criticism that is often heard regarding our Cheddar cheese is, that there is not enough distinction made in price between good, indifferent and bad cheese. That criticism cannot apply to the Swiss cheese markets for the judgment in buying is very rigid.

QUESTIONS ON CHAPTER XIV.

1. What are the two kinds of cheese which are made with reference to the amount of acid developed?
2. Under what class does Cheddar fall?
3. Under what class does Swiss cheese fall?
4. How is the salt usually applied to sweet curd cheese?
5. Where is American Switzer made in greatest quantities?
6. By what name does Swiss cheese go in Switzerland?
7. What are the two kinds of Swiss made in this country?
8. What is a good flavor in a Swiss cheese?
9. What is a good texture in a Swiss cheese?
10. What is meant by the dough of a Swiss cheese?
11. What is meant by the eyes of a cheese?
12. What should be the size of these eyes, how should they appear on their surface and how should they be distributed?
13. What should be the color of a Swiss cheese and what conditions influence it?
14. What are the three grades of cheese and what conditions determine the grade into which a cheese goes?
15. What is a niszler cheese?
16. What is a glaesler cheese?

CHAPTER XV.

SWISS CHEESE FROM MILK TO CURING CELLAR.

282. SELECTION OF THE MILK.

As has been previously explained, Swiss cheese is made from sweet milk. So important does this seem to be that the milk is delivered to the factory twice a day and made immediately into cheese. It is believed by a good many makers that under all circumstances the rennet should be gotten into the milk just as soon as possible.

283. CAUSE OF GLAESLER CHEESE.

Exception may, however, be taken to the opinion that all milk for Swiss cheese should be set immediately when received at the factory, for as may have been observed in the experiment with rennet, a very sweet milk does not curdle rapidly nor is the curd as firm as the curd from riper milk. It takes a certain amount of acid (probably about .17 per cent) to make the rennet expel the whey properly. With too sweet milk, such as is obtained in the cool weather of the fall months, it is hard to get a good cook on the curd and such cheese will have a pasty texture, and a pasty texture will make a glaesler cheese.

284. RENNET TEST SHOULD BE USED.

The milk for Swiss cheese should not be as ripe as for Cheddar cheese, but the rennet test should be used to determine the condition of the milk, and then the milk, if it is too sweet, should be brought to this point each day, by holding or by the addition of a small starter. One of our students reports that with the Marschall rennet test used in his factory, a milk that tests five or six will be sure to give a glaesler cheese, while milk at $3\frac{1}{2}$ will not do so. It should be remembered that Marschall tests vary (89) so that each maker will necessarily have to determine at what point by his particular test the milk should be set.

285. USE OF A STARTER.

Swiss makers very largely use a homemade rennet, which is made up by them each day by soaking strips of rennet in whey.

It is even claimed that commercial rennet extract is not as good as the whey rennet, for they cannot obtain the eyes with it. The explanation for this probably is, that the whey used acts as a starter which supplies the necessary acid in the milk to make the rennet expel the whey sufficiently. At the same time gas germs may be added which will make a niszler cheese (280). Freudenreich has shown that the lactic acid germ is desired in making good Ementhaler. By using a commercial rennet extract, after adding a good lactic acid starter, a cheese with a good development of eyes can be obtained. As this is being done in actual practice it shows that the idea, prevalent among Swiss makers to the extent that it is almost a law, that good eyes cannot be obtained with commercial rennet extract, is incorrect. Of course, the amount of starter required will not be as much as for Cheddar cheese (113).

286. TEST OF RENNET SOLUTION NOT CORRECT.

When a maker makes up his whey rennet, he tries a certain quantity of it on a sample of milk to see that it is of the right strength. If the acidity of the milk were the same each time, as well as the acidity of the whey used, this might be correct, but as a different lot of milk with a difference in acidity is used, it will be seen that this is not a correct way of determining the strength of the whey rennet. It is, therefore, better to use a commercial extract that will be of the same strength each day.

287. SWISS KETTLES.

Swiss cheese is made in large copper kettles that vary in size from a capacity of 600 pounds to 3000 pounds of milk. There are two kinds, the fire kettle and the steam kettle.

The fire kettle hangs on a strong wooden crane and the height of the kettle is adjustable. The adjustment is obtained by means of a strong iron screw on which it hangs, and which passes through a nut in the crane. The kettle hangs over a fireplace. This fireplace is built in a semi-circular form just large enough to receive the kettle, and connects with a chimney for the exit of the smoke. The front of the fireplace is built of sheet iron, and is semi-circular in form, so that when closed it just fits around the front side of the kettle. It is hinged on the brick work on one side (the side opposite the kettle crane) and the further end of it hangs from an iron crane which is also



Swiss kettle in the Raub factory, near Monroe, Wis. The kettle hangs on a heavy wooden crane. The front of the fireplace over which the kettle hangs also hangs on a crane and can be swung out so that the kettle can be swung away from the fire. The opening below the grate will be seen in front of the kettle. The round cover is dropped over the top when the kettle swings forward.

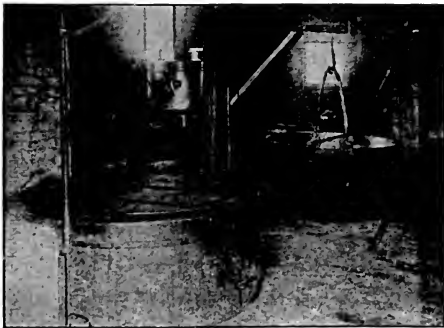

View in the Stearns factory, near Monroe, Wis., showing the kettle swung around in front of the weigh can. The cover to the fireplace has been dropped.

placed on the side of the fireplace opposite the wooden crane. By turning this crane this sheet iron front can be swung out of the way so that the kettle can be swung out into the room. When the kettle is swung out of the fireplace, this front can be closed and a sheet iron lid, hinged against the chimney, can be dropped to cover up the hole for the kettle. A grate is placed in the bottom of the fireplace, and a fire door in the sheet iron front gives a place for the operator to tend the fire on the grate.

The steam kettles are set permanently on the floor. A steam jacket is riveted on the lower part so that steam can be used for heating the milk. A plug in the bottom connects with a pipe for carrying off the whey.



Interior of Swiss cheese factory at Florence, Ohio. Steam kettles are used and the whey is skimmed with a centrifugal separator.

288. FILLING THE KETTLE.

The milk is strained into the kettle the same as into a vat for Cheddar cheese. If a fire kettle is used the kettle may be swung in front of the receiving window. Milk for Swiss cheese should be paid for by fat test, the same as for Cheddar cheese. It is sometimes claimed that rich milk does not give as good eyes as poor milk. This opinion probably comes from the milk

being richer in the fall when the weather is also cooler, which of course, keeps the milk sweeter with the attendant results of very sweet milk. (285.) Rich milk will make more and better Swiss cheese than poor or skimmed milk.

289. SETTING THE MILK.

When the milk is all in the kettle the temperature should be noted. The milk has probably not been cooled at home, though it ought to have been aerated. (33.) It is therefore probably warm enough for setting. If, however, the temperature is found to be below 86° F., the milk should be warmed to that point. The rennet is then added and stirred in with a

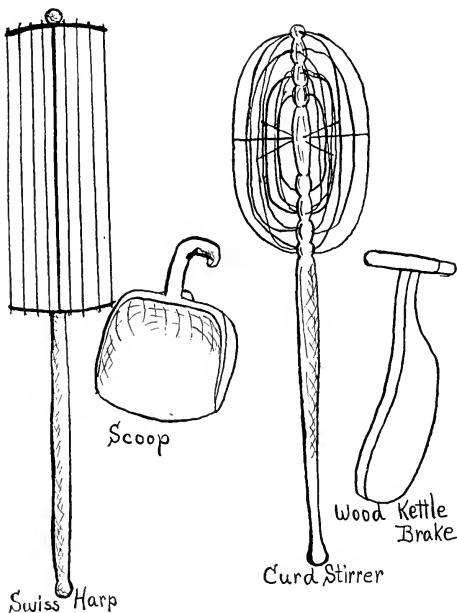

large wooden or tin scoop. The milk is put into a whirling motion in the kettle by this operation, and after stirring for four or five minutes the motion should be stopped, so that the coagulum, when it begins to form, will not be broken by the

force of the current. In the course of twenty to thirty minutes the curd should be ready to cut.

290. CUTTING SWISS CURD.

A Swiss curd when ready to cut should be of about the same consistency as a Cheddar curd. That is, it should make a clean break over the finger when it is inserted (121). There really ought to be a cover for the kettle so that the surface of the milk will not cool off. It will be remembered (95) that rennet will not act as rapidly when the temperature is reduced, and one should aim as far as practical to keep the heat from radiating from the surface. At first the curd is turned over with the scoop so that the surface coming in contact with the lower layers will warm up. After the surface has been turned over very carefully a scoopful at a time, it is ready to be cut with the Swiss harp.

291. THE SWISS HARP.

The Swiss harp is so called, because it is shaped like a harp. It is an iron frame with a long wooden handle. Fine wires are strung lengthways of it about an inch apart. This is carefully inserted in the curd and by circular motions across the kettle the curd is broken into pieces about an inch in diameter.

292. THE WIRE STIRRER.

The wire stirrer is a stick five or six feet long, through one end of which a group of wires are worked into a spherical form. This is next inserted into the curd, which is brought into a circular motion around the kettle. The curd is stirred gently for a few minutes to keep it apart while it firms a little.

293. ANOTHER METHOD OF CUTTING.

By means of the stirrer the curd has become about as fine as Cheddar curd. By using the knives used in making Cheddar cheese (124 and 126) the curd can at once be brought to this condition without breaking and jamming the curd. It is from this cause that so much fat is lost in Swiss cheese making. (19 and 20.)

294. INSERTING THE WOODEN BRAKE.

A wooden brake that is about four or five inches wide, made to fit the side of the kettle closely, is now fastened in. This breaks the current, causing an eddy in the whey as it flows around the kettle and the heat is more evenly distributed.

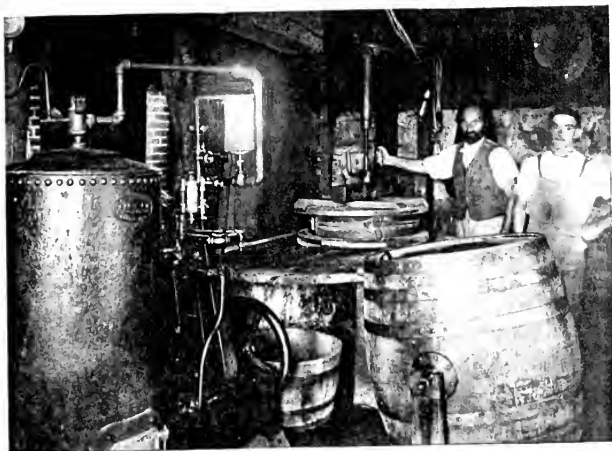

Interior of a Swiss factory, showing a cheese in the press and the means of adjusting the pressure. The small engine and churn are for making whey butter.



Taking the curd out of the kettle. The block and tackle with curd attached is run on a track over to the press.

295. COOKING THE CURD.

The kettle is next moved over the fire, or the steam is turned on if it be a steam kettle. The operator stirs it vigorously with the wire stirrer mentioned above, and the curd breaks and contracts into pieces as fine as wheat. It is stirred until the temperature has been raised to 40° or 42° Reaumur. Reaumur thermometers which start with the freezing point of water as 0° and run to 80° at the boiling point are used almost entirely by Swiss makers. 40° and 42° are therefore equal to 130° and 135° Fahrenheit. After the whey has reached this temperature the kettle is swung away from the fire or the steam is turned off, as the case may be. The stirring is, however, continued until the curd is quite firm, when it is allowed to settle.

296. TESTING CURD FOR FIRMNESS.

A curd is considered firm enough for dipping when it ceases to feel mushy and will squeak between the teeth. Some makers test the cook by squeezing it into a roll in the hand and then noting when it will break short.

This is a point where the maker's judgment is very important. If the curd is not cooked enough it will result in a glaesler, and if cooked too much the fermentations will work so slow that eyes will not form.

297. DIPPING THE CURD.

When the curd is finally firm enough, the wooden brake in the side of the kettle is taken out and the curd is set whirling in the kettle so that when it settles it will settle in a lump in the middle. It is then gathered up into a linen strainer cloth for pressing. The cloth is gathered at one edge in the hand and wet in the whey, and then spread out and rolled onto a flexible iron band. The opposite end is held by an assistant, or if the operator is alone, he holds it in his teeth, and then the iron band is bent into an arch and slid under the lump of curd. The corners of the cloth are then tied together and the whole thing drawn up with a rope and tackle which runs on a pulley and track, like a hay fork, to the pressing table.

It is claimed that if the pieces of curd that are collected at last are put into the center, they will cause it to crack and from the crack a rotten place will start. The curd should therefore be put into the hoop in a lump, and as quickly as possible, so that it will not become cool and brittle and therefore crack.

Where there is curd enough the lump in the kettle may be cut in two and put into two hoops in different dippings.

We have seen that the curd is cooked to 135° F., and it seems a very high temperature for a man to put his arms into as the maker has to do when he scoops the curd into the cloth. Some observations on this point will show that the whey cools down to 115° or 120° before the curd is taken out, and is quite different from the other high temperature which would probably scald him.

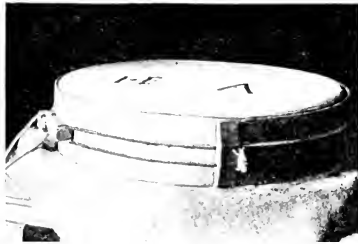

A round Swiss cheese in the hoop. The cheese is made the thickness of the hoop, and the diameter is adjusted accordingly by the rope which runs around it. A round board lies on top and presses the cheese into the hoop.

298. PRESSING DRUM SWISS.

The pressing table is usually on a brick or stone wall and is slightly inclined so that the whey will drain off. The curd cloth with the curd in it is put into a hoop made of a band of elm wood held in circular shape by means of a cord that runs around it. Our illustration shows such a hoop with a cheese in it. The hoop rests on a circular press board while a similar board is placed on the top of it. The hoop is adjusted in diameter by means of the cord so that the curd a little more than fills it.

For the first fifteen minutes it is pressed lightly, then a little more pressure is applied, and in half an hour full pressure is put on. It is turned several times a day, the cloth being taken off and readjusted each time. There are usually two cloths used in the operation, one cloth lying underneath, and the other spread over the top and tucked in between the hoop and the cheese. The last time it is turned the date is marked on it with lamp-black. Dry cloths are put on several times during the day. The

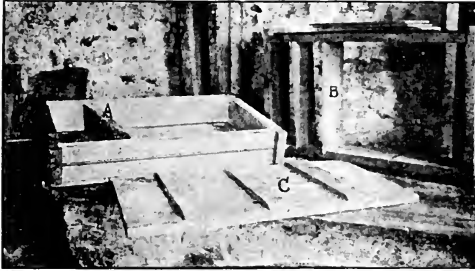

Block Swiss moulds. A, the adjustable end, moved by a screw. B, the partition which fits into the grooves, making the right sized molds after the blocks are cut. C, the cover or follower.



Block Swiss under pressure in individual molds.

cloths should be kept clean by thorough washing and scalding. The press may be worked partially by means of a screw as shown in the illustration, but the main pressure is obtained by placing a post between the cheese board and a heavy beam. The post is close to the fulcrum end of the beam, while the long, heavy end of the beam gives the pressure.

299. PRESSING BLOCK SWISS.

Block Swiss is practically the same as a round Swiss in every way but the form in which it is pressed. It is first pressed into a rectangular cake twenty inches wide and six inches thick. A sliding end regulated by a screw adjusts the volume of the mold to the quantity of the curd. It is turned and pressed in this mold just like a drum Swiss for the first twelve hours. It is then cut into blocks six inches wide and put into another mold with partitions in it just large enough for each piece. Sometimes, however, the curd is pressed from the start in a mold six inches wide by six inches deep and twenty inches long.

300. MARKING CHEESE.

When a cheese has been in the press twenty-four hours it is taken out. It should be perfectly square at the edges with no wrinkles left in it by folds in the cloth. A black paste made of butter and lampblack is used for marking the date on it. It is just as important to keep a record of the way a Swiss curd may act as it is with a Cheddar curd. Such a mark will enable the maker to follow the cheese in the curing cellar.

301. SALTING THE CHEESE IN BRINE.

Most makers salt their cheese in a brine bath. A tank of brine is kept in a cool room, sometimes right in the cellar. The brine is made up by dissolving salt in water until the brine formed is dense enough to float an egg. As cheese are salted in the bath and absorb salt, it is necessary to renew the salt quite often. The cheese is immersed in the brine, turning it over occasionally, as the cheese will float and the top rise a little above the surface. A cheese is kept in the brine for three or four days, according to the amount of salt it is desired to work into it.

302. SALTING WITH DRY SALT.

Some makers do not use a brine bath for salting, but scatter coarse salt on top of the cheese. The cheese is kept on a shelf in the cellar, with a salting hoop around it. This hoop is used



Curing cellar in Five Corners factory, near Monroe. The large drum Swiss cheese are on the shelves. The small boiler supplies steam for moisture when too dry.



Block Swiss cheese in cellar at Stearns' factory, near Monroe, Wis. The large brush B on the post is used for washing drum Swiss cheese. The brine tank A is to be seen.

simply to keep the cheese from spreading while it is soft. The salt draws moisture from the cheese. This moisture dissolves the salt and acts as a medium for the transmission of the salt to the interior of the cheese. No more salt should be applied than can be absorbed over night, so that the cheese will be dry next morning. It is claimed that with the brine method the salt is applied more evenly to all parts of the cheese. A cheese is salted with dry salt from three to five days. If gas shows in a cheese by its huffing or bloating, a little more salt applied to that locality will check the gas.

QUESTIONS ON CHAPTER XV.

1. What is the cause of glaesler cheese?
2. How much acid should milk for Swiss cheese have before setting?
3. How may the acidity of milk for Swiss cheese be determined?
4. Why are makers more likely to have glaesler cheese in the fall months than in summer?
5. What is the effect of whey rennet in regard to the acidity of milk?
6. What is also the possibility with regard to gassy fermentations when whey rennet is used?
7. What is the probable cause of glaesler cheese when commercial rennet is used and how may this be remedied?
8. How much lactic acid starter may be used in milk to be made into Swiss cheese?
9. Why is the test for strength of whey rennet as generally practiced in factories not correct?
10. What are the two classes of copper kettles used?
11. How are the fire kettles arranged?
12. To what other cause than rich milk can glaesler cheese in the fall be attributed?
13. What effect on yield and quality of cheese does the butter fat have?
14. At what temperature should milk for Swiss cheese be set?
15. Why is the current of milk around the kettle stopped in a few minutes after adding the rennet?
16. When is a Swiss curd ready to cut?
17. How much rennet should be used in making Swiss cheese?
18. How is a Swiss curd cut?
19. Describe a Swiss harp.
20. Why is a Cheddar curd knife better for cutting a Swiss curd than a Swiss harp?
21. What is the purpose of the wooden brake placed in the side of the kettle while heating the curd?
22. At what temperature should a Swiss curd be cooked?
23. How do the Raumer and Fahrenheit scales compare?
24. When is a curd sufficiently firm for dipping?
25. What is the effect of an over cook?
26. What is the effect of an

under cook? 27. How is the curd gathered into a lump or cake when firm enough to dip? 28. How is the press cloth put around the cake? 29. How is the curd transferred from the kettle to the pressing table? 30. How is a drum Swiss pressed? 31. How is the hoop or mold adjusted? 32. Why should care be taken in putting the last pieces of curd with the lump on the press? 33. What trouble may result if the curd cracks? 34. How are the cloths adjusted on the cheese? 35. How is a cheese marked? 36. What two methods of salting Swiss cheese? 37. How strong should the brine be made? 38. How long is a cheese left in the brine? 39. How is a cheese dry salted? 40. What advantage is claimed for brine salting over dry salting?

CHAPTER XVI.

SWISS CHEESE—WORK IN THE CELLAR.

303. STARTING THE EYES.

From the salting shelf or brine tank the cheese is taken to the curing cellar. The curing covers two stages and the cheese should be handled in two cellars to secure the proper conditions for a perfect curing. The first curing cellar should be kept at a temperature of about 70° F. At this temperature the gassy fermentations set in and start the eyes. By sounding on the cheese by tapping with the finger, the eyes can be located, for the cheese will begin to sound hollow. Care should be taken to prevent the eyes forming too much in one part. Eyes may be checked by salt, or they may be developed by a little higher temperature and more moisture. As a cheese dries out the eyes are checked. A steam jet in the cellar will provide desired moisture.

304. REASON FOR MAKING BLOCK SWISS.

Block Swiss are handy for cutting. Sometimes where the fermentations are hard to control, block Swiss is made instead of the round variety, for the blocks being smaller, gassy fermentations can be checked quicker, and on the other hand, where the eyes are slow in forming they can be coaxed easier.

305. HANDLING ON THE SHELVES.

The large round cheese is kept on a round cheese board. This is so that the cheese can be handled easier. The cheese is kept free from mold by frequent scrubbing with a long-handled brush made for the purpose. When it becomes necessary to turn a cheese, it is carried on this cheese board to a table, where it is flopped over onto another board of the same kind. The turning at the press is done in like manner.

306. THE SECOND CELLAR.

After the eyes have been well started, the cheese is transferred to a second cellar which is kept at about 60° F. Here the eyes may still develop slowly, but they should not bloat the cheese. If a maker attempts to cure cheese in one cellar, he

will be likely either not to get the eyes started, or if they do start they may develop too far.

307. HANDLING BLOCK SWISS IN CELLAR.

Block Swiss being smaller than drums are more easily handled. They should be washed often enough to keep them clean from mold. Care should be taken, however, not to keep them wet, for in that case the rinds will soften.

308. LENGTH OF CURING PERIOD.

Swiss cheese cures slowly. As described under the paragraph on galactase, this enzyme breaks down the hard curd into soluble peptones. This process takes a number of months and a fine Swiss cheese should be at least eight or ten months old before it is ready for consumption.



A load of three tubs of cheese, weighing a ton and a half, being delivered at Grunert's warehouse, Monroe.

309. BOXING DRUM SWISS.

Drum Swiss are shipped in large tubs. The tub is made a little tapering, and to fit the diameter of the cheese. First a large round scale board is put in the bottom of the tub. A cheese that just fills the tub in diameter is lifted in and pressed tight against the bottom. Another scale board next follows and on top of this another cheese is crowded. In this way probably six cheese are put in a tub. On top of the last a scale board is placed and then the circular cover is forced down on top, by the maker standing on it and gently crowding on all

sides. With this pressure on it the cover is nailed into place. In this way the cheese will be prevented from moving and being injured thereby. Quite often a thousand pounds of cheese will be filled into one tub. If the cheese has to stand in storage a long time, especially if warm, it may sweat some and the scale boards will prevent the cheese sticking together and spoiling the rinds.

310. BOXING BLOCK SWISS.

Block Swiss is put up in boxes six inches deep, twenty inches wide and three feet long. Such a box will hold a row of six cheese. A paper is put in the bottom of the box, scale boards between them, and another paper on top. The method of grading cheese has been explained (281).

311. WHEY BUTTER.

It has been explained that in the methods of making Swiss cheese more fat is lost in the whey than in the manufacture of Cheddar. It is the general practice in Swiss factories to make butter from the whey. In the great majority of factories this butter is little more than grease. The reason for this is that very crude methods are employed in the manufacture of it. The fat as it rises on the whey is soft because it is warm. Under these warm conditions bad fermentations are at work causing poor flavors. The cream obtained is churned without being properly cooled with ice and the grain is therefore soft and greasy. The grease thus obtained sells for about ten cents a pound.

By the use of a separator a much more efficient skimming can be done, and the cream will be thick. With ice and a proper vat for holding it, fat in the cream can be hardened and ripened slowly, and fairly good flavors obtained. Then if churned at a low temperature, an efficient churning will be possible with a good grain and a very fair flavor will be obtained in the butter. If this butter is then held in a refrigerator until shipping, a much better price can be obtained for it. At the present writing a number of factories where the whey is handled in this way are turning out butter that sells for twenty cents per pound, whereas the factories that are making grease in the old way are turning out an article that brings but ten cents. It pays to do things right.

QUESTIONS ON CHAPTER XVI.

1. At what temperature should Swiss cheese be kept to start the eyes? 2. How may the location of eyes in the cheese be determined? 3. How may an over development of eyes in local points in a cheese be checked? 4. What is the effect of a dry atmosphere on the development of eyes? 6. How may moisture be supplied to a cheese cellar? 7. What is the advantage in making block Swiss instead of drum Swiss? 8. How are drum Swiss handled on the shelves? 9. How is a drum Swiss cheese turned? 10. At what temperature should the second cellar be kept? 11. Why should old and new cheese not be kept in the same cellar? 12. How often should Swiss cheese be washed? 13. What will be the effect of keeping the cheese too damp? 14. How long is it necessary to cure Swiss cheese? 15. How are drum Swiss cheese shipped? 16. What is the use of the scale board between the rinds? 17. Why should the cheese be crowded into the tub? 18. How many cheese are placed in a tub and what is their aggregate weight? 19. What is the size of a box for block Swiss? 20. How many cheese are put in a box? 21. How can whey butter be made to bring a much better price than is usually obtained for it?

CHAPTER XVII.

BRICK CHEESE.

312. CHARACTERISTICS OF BRICK CHEESE.

Brick cheese is probably so called because it is made in the form of a brick, and bricks are used for pressure on the mold.

It is of a milder flavor than Cheddar, is moist and suits a large number of people who like mild cheese especially. It can be cut into thin slices which do not crumble and this brings it into favor.

It may have a few small holes in it, but does not have the large eyes of a Swiss. It is softer than Swiss, but not so soft as Limburger. The real difference between brick and Limburger is that it contains less moisture and is cured in a drier atmosphere, which conditions of moisture in and out of the cheese influence the character of the fermentation in it.

313. QUALITY OF MILK REQUIRED.

For brick cheese, the milk should not be as ripe as milk for Cheddar, and on the other hand it should not be so sweet that the rennet will not expel the whey properly, for it will have a tendency toward Limburger in the softness of the texture and gas germs may get more of an ascendancy in the cheese than when the milk is ripened further before setting. If the milk is ripe enough so that the curd will string on the hot iron before it can be gotten out of the whey, a Cheddar flavor will develop. One of the finest Cheddar flavors that the author has ever observed, was in a brick cheese in which an eighth of an inch of acid was developed on the curd at the time of dipping.

314. MILK, WHEN RECEIVED.

It is evident that milk may be received but once a day if it is properly cared for, in fact it will be less liable to develop gas in the cheese if the milk has a few hours age. On the other hand, milk that is over ripe cannot be used without destroying the peculiar character of brick cheese.

The rennet test and the acid test previously described (82 and 108) are of importance in obtaining milk of the proper acidity for brick cheese. If the milk is found to be very sweet, a lactic ferment starter may be added, so that a pure lactic acid fermentation may predominate over the gas forms, and thereby secure a cheese with fewer holes.

315. QUANTITY OF RENNET REQUIRED.

Brick cheese is a quick curing cheese, and a little more rennet is used than for a medium curing Cheddar. The milk will, of course, be a little sweeter than for Cheddar and enough rennet is used to coagulate it in twenty minutes.

316. HOW COOKED.

Brick cheese is made in a steam vat, is set at 86° F., the curd cut and the temperature raised for firming, the same as with Cheddar. The temperature at which the firming takes place depends on the acidity of the milk. With milk nearly as ripe as for Cheddar, 108° F. will do, while 118° or 120° may be required for very sweet milk. The temperature usually employed is about 114° F.

317. TESTING CURD FOR FIRMNESS.

Curd, when ready to dip, should feel as firm as curd for Cheddar cheese. An over cook will make the cheese dry and corky, and an under cook will make a soft cheese approaching a Limburger.

318. DIPPING THE CURD.

When the curd is firm enough, the whey is drawn off so that only enough is left in the vat to keep the curd from matting together. A few handfuls of salt per 1000 pounds of milk are then added to the curd for the supposed reason of checking gas fermentations, but as the salt dissolves in the whey and runs away, this operation can be of little use. Some makers are in the habit of salting the milk by placing salt in the strainer when the milk is running into the vat, to check acid and gas. This, however, is positively injurious to the milk (94) and does not accomplish the object sought.

319. BRICK CHEESE MOLDS.

The brick cheese mold is a rectangular box without bottom or top. The common size is ten inches long by five inches wide and eight inches deep. In some localities they are eight and a half instead of ten inches in length.

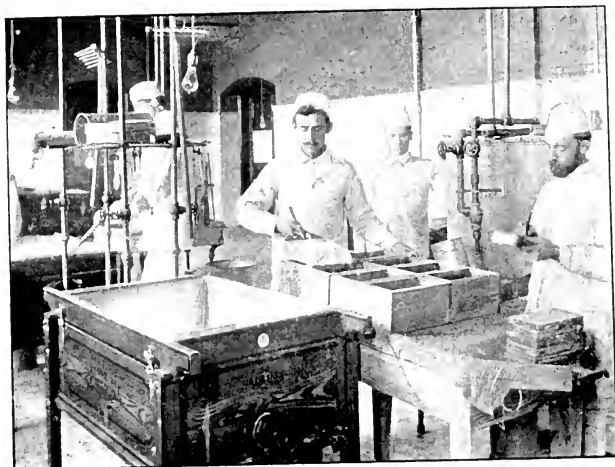

Making Brick Cheese.

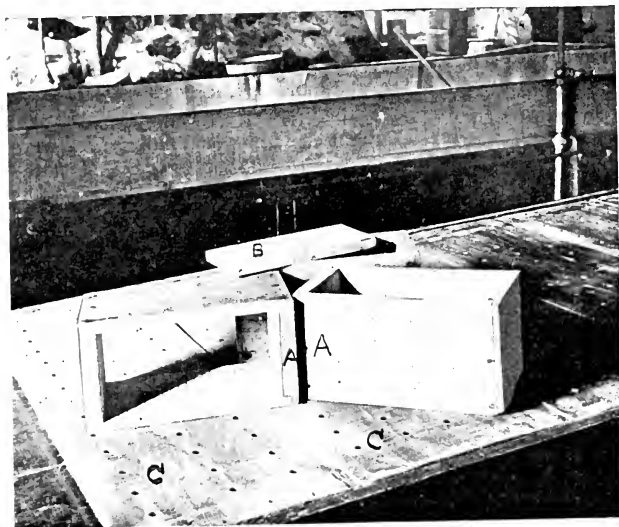

Brick and Limburger cheese molds. A, molds. B, follower. C, draining board.

Slits sawed on the inside enable the whey to more readily escape. Sometimes molds are made of perforated tin, but they do not hold the temperature as well as wood.

320. DRAINING TABLE.

These molds set on a draining table. The table is about thirty inches wide, by six, eight or ten feet long, and inclined toward one end. A guard two inches high is fastened to the upper end and sides. A half-inch strip is fastened along the inside of this guard to rest the draining boards on.

321. DRAINING BOARDS

These draining boards are a foot or sixteen inches wide and have several rows of inch holes bored through them. These boards are laid in the draining table with their ends resting on the aforementioned half-inch strips. A cloth, such as is used on the racks in Cheddar cheese manufacture, is thrown over the draining board, and the molds are set side by side on top of this cloth.

322. FILLING THE MOLDS.

The table sets close to the vat, and the operator stands between it and the vat. With a curd pail he dips the curd out of the vat and fills it into the molds. The whey goes through the cloth, and the holes in the draining boards, and runs down the table and into a whey gutter. Care should be exercised to get just the same amount of curd into each mold so that the cheese, when the curd is all pressed tight together, will be about three or four inches thick, and will weigh six pounds green. Wooden followers that just fit in the molds are then put in on top of the curd.

323. PRESSING THE CHEESE.

One or two bricks are placed on top of the follower in each mold for pressure. In an hour or two the mold is turned over and the pressure applied to the other side. This may be done several times during the twenty-four hours that the cheese is in the press.

324. SALTING THE CHEESE.

At the end of twenty-four hours, the cheese is taken out of the molds and salted. The salting is done in a salting room, which is really a cellar room between the making room and the curing cellar.

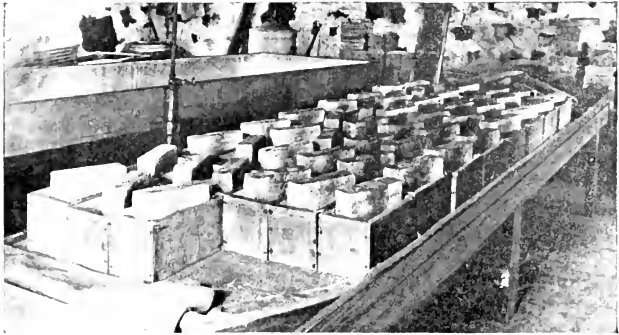

Brick cheese in the molds. A cloth is placed under the molds.



Round brick or imitation Munster cheese in the tin molds.



Brick and Munster cheese in curing cellar.

The salting table is built like the draining or pressing table, with the exceptions that the sides are ten or twelve inches high and there are no draining boards laid on it.

Each cheese is rubbed with salt on all sides of it.

The salt dissolves and penetrates to the interior of the cheese, at the same time expelling moisture which runs off from the table. When the cheese is partially salted, the surface is scraped with a tool which is much like a piece of a saw blade. The small teeth scrape up small particles of the curd which are rubbed into the little crevices left between the particles of curd, and in this way a smooth rind is formed. The salting usually extends over three days, the cheese being turned each day and a little coarse salt being laid on the upper side.

They are piled two or three layers deep, being laid on their broad sides. They may be piled deeper each day.

325. CURING THE CHEESE.

From the salting table the cheese is carried to the curing cellar, where it is laid on tiers of shelves arranged around the room. These shelves are ten or twelve inches apart. The cheese are laid on their broad sides for a week or two until they begin to cure, when they may be laid on their edges.

The cellar should be kept at a temperature of about 60° F. and the relative humidity should be 80 to 90 per cent. This, it will be seen, is a little higher than is best for Cheddar cheese. With such a humid atmosphere the cheese will probably mould, and the maker is kept busy washing the mould off from the cheese. He gets around to wash each cheese at least once or twice a week, and if necessary oftener. The water used may be clear water, or it may have a little salt dissolved in it.

326. APPEARANCE OF GAS—REMEDY.

If gas appears in the cheese it will huff up and bulge out at the ends, sides and edges. Where this occurs to any great extent the value of the cheese is reduced, and the best remedy is to apply the Wisconsin curd test and eliminate the cause. The value of this test was first demonstrated in brick cheese factories.

327. CURING PROCESS.

A plug from a green cheese will be very harsh to the feel, and the plug will bend like rubber. In the course of about two

weeks the harshness begins to disappear, and the cheese will break down in the fingers, and mold like wax, though it is somewhat softer and the plug more elastic than Cheddar.

Brick cheese is usually shipped when it is a month old. If cured slowly, it is better at two months old, but being softer it is not as long lived as Cheddar.

328. HOW THE CHEESE IS SHIPPED.

When brick cheese is ready to ship, it is wrapped in a good quality of Manilla paper and packed in rectangular boxes that are twenty inches wide, five inches deep, and three feet long, the same size as a Limburger box and one inch shallower than a block Swiss box. Each box will hold twenty to twenty-five cheese, and the net weight of the cheese in the box will be one hundred and five to one hundred and twenty pounds. The box weighs about fifteen pounds more.

329. FANCY STYLES.

It has been pointed out that the market calls for odd sizes and shapes of Cheddar at higher prices than for the large Cheddar form. The same thing is true of brick cheese. A round cheese called a Munster is made in every way the same as brick, excepting that the molds are round, and made of tin with holes punched in the sides for the whey to more readily drain out. Being round they are always laid on the flat ends to keep them in shape. The salting and curing is the same as for brick, as is also the method of shipping.

QUESTIONS ON CHAPTER XVII.

1. Why is brick cheese called by that name?
2. What are the characteristics of brick cheese?
3. What quality of milk is required for brick cheese?
4. How often should milk be received?
5. What can be said about the use of a lactic ferment starter in milk for brick cheese?
6. How much rennet should be used to set milk for brick cheese?
7. In what kind of a milk receptacle is brick cheese made?
8. How does the temperature, at which the curd should be cooked, vary with the acidity of the milk?
9. How firm should the curd be for dipping?
10. What would be the effect in the cheese of an over cook?
11. What would be the effect of an under cook?
12. How far is the whey drawn off from the curd before dipping?
13. Describe a brick

cheese mold. 14. Describe a draining table and draining boards. 15. What kind of a cloth is used to cover the draining boards? 16. How is the curd filled into the molds? 17. What are the dimensions and weight of a brick cheese? 18. How is the pressure applied to the cheese? 19. How long is the cheese kept in the molds? 20. Describe a salting table. 21. How are brick cheese salted? 22. How are the little crevices on the surface between particles of curd filled in? 23. How long is the cheese salted? 24. At what temperature should brick cheese be cured? 25. What should be the relative humidity of the air in the cellar? 26. Why and how often should the cheese be washed? 27. What physical change does brick cheese undergo in curing? 28. How is brick cheese packed for shipment? 29. How long should brick cheese be cured? 30. How does the life of brick cheese compare with that of Cheddar and Swiss, and why? 31. What is Munster cheese and how is it made?

CHAPTER XVIII.

LIMBURGER CHEESE.

330. ORIGIN OF LIMBURGER.

Limburger cheese is of foreign origin, having come from the province of Luttick in Belgium. Its manufacture in this country is, however, carried on by the Swiss and German rather than by Belgian emigrants.

331. CHARACTERISTICS OF LIMBURGER.

Limburger is perhaps more generally known by its odor than by anything else. Many people who have never tasted it recognize the odor. But while it is kept cool it does not have such a pronounced odor as when warm. It is found on the market in blocks five inches square and about two inches thick, wrapped in Manilla paper and tinfoil. It has a soft texture of a yellowish color.

332. KIND OF MILK REQUIRED.

Limburger is made from sweet milk. Except where the milk is gassy, very sweet milk is not an objection as with Swiss or brick cheese, for the reason that it is to be made soft and pasty anyway, and if the milk were too ripe the rennet would expel too much moisture.

333. UTENSILS USED.

A steam vat and curd knives, like those used for Cheddar and brick cheese are used in the manufacture of Limburger. A draining table like those used for brick cheese is also used but the molds and subsequent handling are different than for brick.

334. SETTING THE MILK.

As the milk used may be sweeter than for brick it should be set at 90° F., which is a little higher temperature than is used in making brick cheese. It is probably made up twice a day and the temperature of it when received may be a little higher than this. If it does happen to be higher it can be set at the temperature it happens to be without cooling it to 90°. Enough rennet should be used to coagulate the milk in twenty to thirty minutes.

335. COOKING LIMBURGER CURD.

The curd is cut when as firm as for Cheddar and brick, that is, when it will break over the finger with a clean fracture. The curd is stirred and the temperature raised in the same manner as for the above mentioned kinds with the exception that the firming is done at a lower temperature. Ninety-six degrees is the temperature at which it is usually cooked. If the milk is very sweet the temperature must necessarily be a little higher than when some acid has developed. The curd is dipped when a little softer than in making brick cheese.

336. DIPPING THE CURD.

When the curd is firm enough the whey is drawn down so that it just covers the curd as is done in making brick cheese. The Limburger mold is made just like the brick mold with the exception that it is twenty inches long instead of ten. The curd is dipped into these molds and allowed to settle together, brick pressure being applied. After about half an hour it may be turned over. After resting in this position for fifteen or twenty minutes the mold is lifted from the cheese, which is then a block five by twenty inches, and two and a half to three inches thick. It is next divided into four sections so that each section will be five inches square. The cutting may be done with a common large bladed knife, but a better contrivance is a knife with three blades five inches apart. It is made in the following manner: A heavy piece of tin five inches wide and fifteen inches long is reinforced by a strong wire in the edge. Three pieces of heavy tin, four inches wide by five inches long, with the ends turned over to stiffen them, are soldered five inches apart on one side of the large piece of metal. By simply pressing this instrument down on the block of curd, the three blades cut into four equal sized cakes.

337. LIMBURGER PRESSING TABLE.

The cakes are next transferred very carefully to the pressing table. This can hardly be called a press, as the cheese get no pressure beyond their own weight. The table is like the draining table with sides four inches high, but no draining boards are used. A rectangular frame the size of the table fits inside the table. A row of the cakes is placed along one side and are divided by wooden partitions four inches high and five inches long. When the row is completed a long strip, the length of

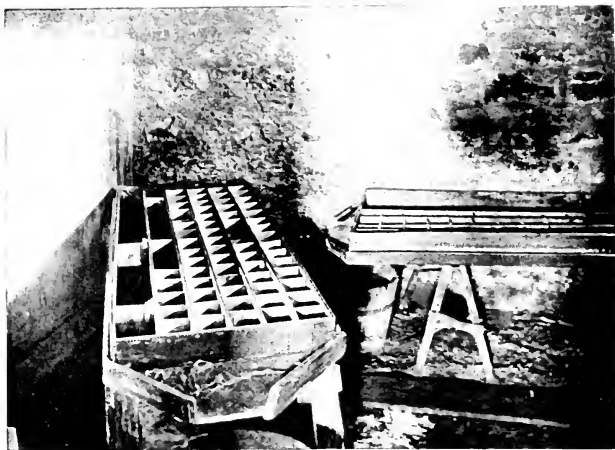

Limburger molds on pressing table, showing the long pieces and the short partitions between.

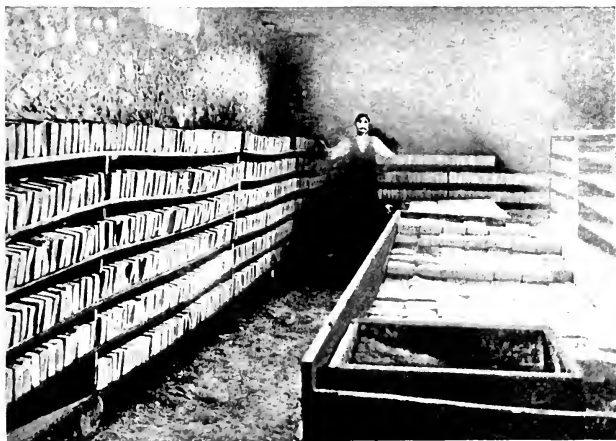

Limburger cellar. In front is the salting table with the cheese in the salt. In the foreground is a box containing salt. The cheese is to be seen on the shelves.

the table, is placed against the row and another row is laid down. In this manner several rows are laid down and the last long strip held in place by several sticks wedged in between the strip and the opposite side of the table. The cakes are turned a number of times in order to drain them and firm the surfaces. The temperature of the room should be about 60° F. In twenty-four hours they go to the salting table.

338. SALTING LIMBURGER.

Limburger is salted in much the same way as brick cheese. First the edges are rolled over in a box of salt and then salt rubbed on the two broad surfaces. It is laid on the draining table in single layers for the first day. The second day it is salted again in the same way and piled in two layers. The third day it is salted again and piled three or four layers deep. Limburger is salted on the average about four days.

339. CURING LIMBURGER.

The curing of Limburger is a putrefactive fermentation. It goes from the salting table to the curing shelves, where the cakes are laid on their broad sides. They are washed every day with water to keep them free from mould and to keep them moist. The atmosphere of the cellar should have a relative humidity of 95 and the temperature should be about 58° to 63° F. Under these conditions the surface soon begins to get shiny and soft and change from white to a reddish yellow. This change works its way to the center, changing the harsh curd to a soft condition. After about ten days the cheese may be set close together on their edges. This change requires from four to six weeks to work to the center, and the cheese is then ready to ship.

340. SHIPPING LIMBURGER.

The cheese is first wrapped in Manilla paper and then in tinfoil and is packed in boxes twenty inches wide, five inches deep and thirty-six inches long. It may be held in storage for a month or two longer before it reaches the consumer, but being so soft it is not long lived.

341. CAUSE OF THE PUTREFACTIVE FERMENTATION.

The main cause of the putrefactive fermentation is the extremely moist condition in which it is kept. It may be brought about in harder cheese like brick and Cheddar, if they are kept

wet, or come in contact with each other or a moist wall, in a very moist atmosphere.

QUESTIONS ON CHAPTER XVIII.

1. Where did Limburger cheese originate? 2. What are the characteristics of Limburger? 3. In what kind of packages is Limburger found in the market? 4. What quality of milk is required for Limburger manufacture? 5. What kind of vat and curd knives are used? 6. At what temperature is the milk set? 7. At what temperature is the curd firmed? 8. What would be the effect of over ripe milk on the cheese? 9. How firm should the curd be when ready to dip? 10. What kind of a mold is used and what are its dimensions? 11. How much pressure is applied to the curd in the molds? 12. What is the treatment of the curd in the molds? 13. Into what sized blocks is the curd cut when the mold is removed? 14. How is the curd cut into blocks? 15. Describe a pressing table. 16. How long is the cheese left on the pressing table? 17. How is the cheese salted? 18. How long is the cheese left in the salt? 19. How is Limburger handled in the curing room? 20. How long is Limburger in curing and what is the physical change that takes place? 21. How is Limburger packed for market? 22. What conditions especially favor the characteristic fermentation of Limburger?

CHAPTER XIX.

EDAM CHEESE.

342. CHARACTERISTICS OF EDAM CHEESE.

In our best grocery stores one sees cheese put up in the form of round balls about six inches in diameter. They are colored a dark red or are of a bright yellow color, or may be wrapped in tinfoil. Each cheese weighs about four pounds and sells for a dollar, or at the rate of twenty-five cents per pound. The texture is perfectly solid and has a flavor much like an old Cheddar excepting that it is a little more salty and is a little harder.

343. ORIGIN OF EDAM CHEESE.

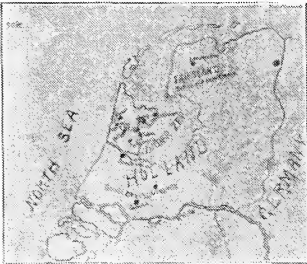

By referring to a map of Holland it will be seen that North Holland is that portion of the country west of the Zuider Zee. Edam is situated on the Zuider Zee, about twelve miles northeast of Amsterdam. Edam cheese, together with Gouda, is made in other parts of Holland, but

that portion north of the North Sea canal on which Amsterdam is situated, and west of the Zuider Zee, is especially devoted to Edam cheese. Every week markets are held at Edam, Purmerend, Alkmaar and Hoorn for the sale of cheese.

344. FARMING OF HOLLAND.

A large part of the country is below the sea level. Shallow lakes or seas like the Zuider Zee have been surrounded by dikes, and the water pumped out, leaving level stretches of country that grow luxuriant crops. The cattle are of the breed known in this country as Holstein Friesian. There are a few cheese factories, but the farmer usually makes his milk into cheese in his own dairy. The utensils are crude, the milk being set in a wooden tub and the necessary rises in temperature



Dutch farmers washing cattle at the canal in Purmerend.

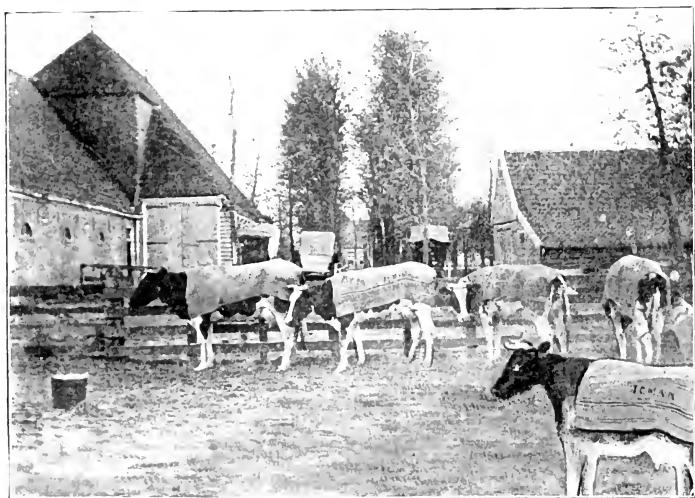

A Dutch farm scene in the Beemster Polder. Cattle in the barnyard just before milking time.

secured by heating a part of the milk or whey in a kettle and adding it to that in the tub. The cheese room, stable, living apartments and tool rooms are usually all under one roof. In May the cattle are turned out in the fields until November, and the stables are cleaned out and usually used for curing rooms. As there is a lack of wood for lumber the houses are built of stone or brick, which holds the temperature, and as the country is surrounded and tempered by the sea, ideal conditions are naturally present for curing cheese.

The factories have vats which are heated by steam as in this country.

315. EDAM CHEESE IN HOLLAND.

Edam cheese has been classed with the sweet curd cheese, but we believe that the best quality of it really approaches very close to the Cheddar. Hollanders have considerable trouble with the gassy fermentations, and use a starter of sour whey which contains a lactic acid germ. The milk is also made up once a day, which gives the night's milk a chance to ripen. The author observed sour Edams in the factories and dairies, and on the markets, which shows that the lactic acid sometimes gets the start of the makers. The purpose of the whey starter is to check the gaseous fermentations.

316. TREATMENT OF CHEESE FOR MARKET.

The cheese is marketed when it is about a month old. It may mould some on the shelves, and is therefore washed and then dried. A coat of linseed oil is rubbed over, which makes the cheese shine. It is loaded into carts without boxing and carried to market.

317. DESCRIPTION OF AN EDAM MARKET.

On arriving at the market, which is a large open space in the middle of the city paved with stones, straw is first laid down on the pavement and the cheese piled on it in pyramidal pile like so many cannon balls. The pile is covered over with a cloth to protect it from the heat of the sun. When the market opens, buyers pass among the piles and try a sample from each pile with a trver the same as is done with other cheese. If the bargain is closed the salesman and buyer shake hands as if they would never let go, but if on the contrary no bargain is made, the buyer goes on and the salesman turns the plugged cheese over and places it in the bottom of the pile, and awaits the next

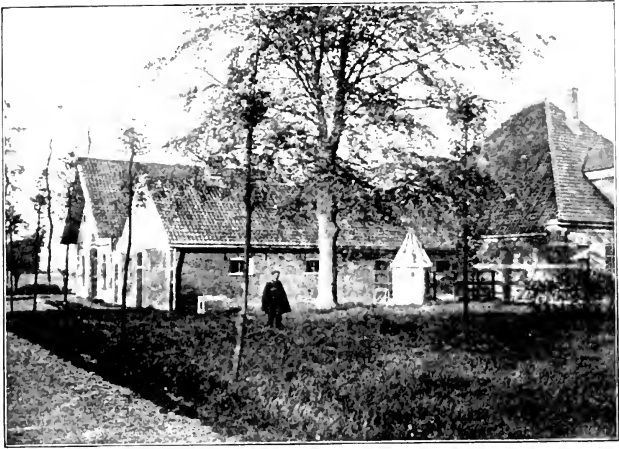

Farm buildings at De Rijp, North Holland.

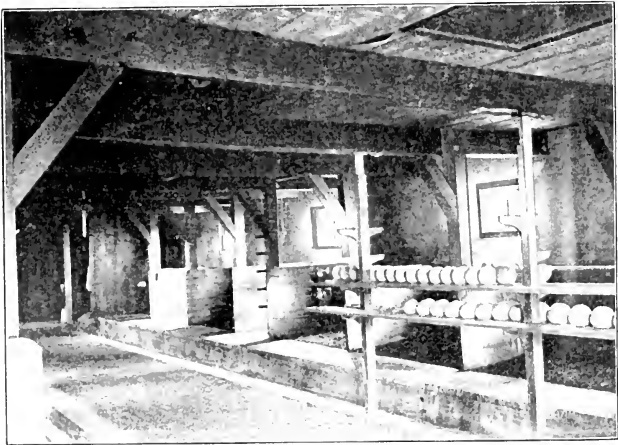

Inside of stable shown above. The cows are now out at pasture. Edam cheese is curing on the shelves.

inspection of his goods. When the cheese is sold, it is placed on skids, which will hold about 150 cheese, and official weighers place it upon large balances in the market building and balance the cheese with official weights. The buyer then takes possession of his cheese. The price paid will probably correspond to the price paid for Cheddar in this country. The best cheese reach this country, but are not consumed until they are eight, ten or possibly twelve months old. The fine characteristic

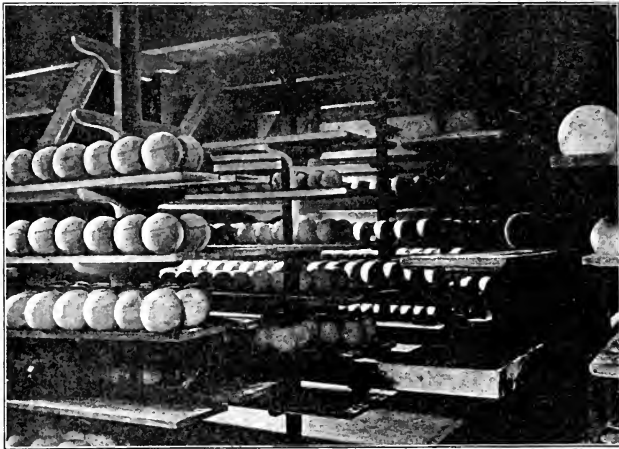

Curing room of an Edam cheese factory at Hoogskarspel in North Holland.

flavor cannot be developed in less time, and it must be developed at a temperature not to exceed 65° F. When it is cured, it may be smoothed down in a turning lathe. The red color is obtained by immersing it for half a minute in an alcoholic solution of carmine.

318. POSSIBILITIES OF MANUFACTURE IN AMERICA.

As the milk in America is generally richer, the sanitary conditions better, and the climatic conditions can be artificially supplied, it is possible to make an Edam in this country that is fully equal, if not superior, to the best imported Edam.



The weekly cheese market at Hoorn, North Holland. The market building where the cheese is weighed is just beyond the statue.

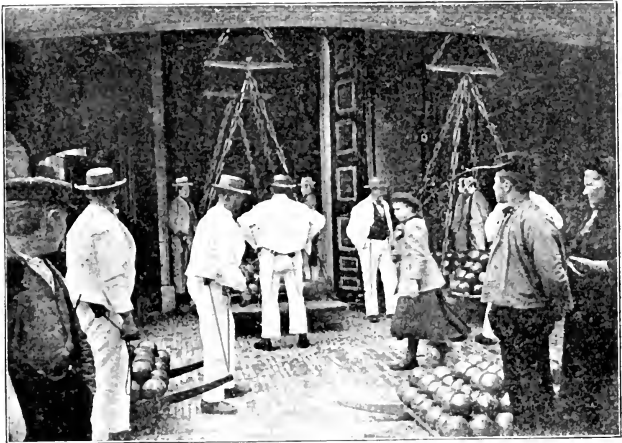

Weighing Edam cheese at the market at Hoorn.

349. MARKET FOR EDAM IN AMERICA.

Edam as sold at wholesale in this country, is packed in cases of one dozen cheese each or about fifty pounds, and sells at about \$1.50 per case. This is fifteen cents per pound, and ought to encourage the manufacture of this kind of cheese. Many wholesale houses are very anxious to buy it in large quantities.

350. METHOD OF MANUFACTURE.

The description already given will give a fair idea of Edam cheese as found in Holland. As the methods of manufacture used in Holland are crude, the method here given will be for practical and scientific conditions as found in America.

351. QUALITY OF MILK REQUIRED.

As has been explained, Edam is really a cheese in which the lactic fermentation is developed. The milk then must be such as is used for Cheddar, and the acidity should be determined by the rennet test in like manner; in fact, the milk should be colored and set, and the curd cut and firmed in the same manner as for Cheddar. When one-eighth of an inch of acid shows on the hot iron, the whey should be drawn and the curd stirred free from whey.

352. HANDLING THE CURD FOR EDAM.

The curd is held for a time in the vat or curd sink in a granular condition, to air and develop acid, until it will string half an inch to an inch on the iron, and then it goes into the molds.

353. EDAM MOLDS.

The molds for Edam cheese, as found in Holland, are mostly made of wood, but manufacturers of dairy supplies in this country have found difficulty in making them of wood, so that they will hold their shape and not check. They are therefore making castiron molds which are turned down and galvanized. Each mold consists of two parts—a bottom part shaped like a bowl with hemispherical bottom; and a top, the interior of which is a true hemisphere that fits into the bottom part, and when pushed into it leaves an interior space perfectly spherical. The two halves have flanges on the ends which make them set squarely against other molds or the press heads. Holes drilled through these flanges enable the maker to insert

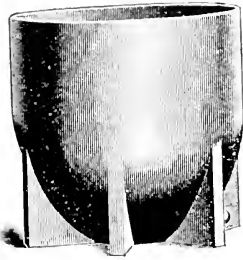

Edam Mold.



Inside of Top.

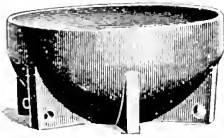

Mold Top.

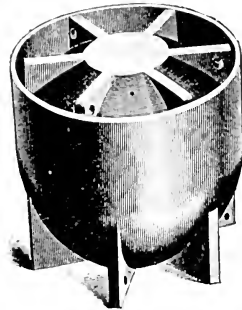

At Press.



Inside.

an iron hook and pull the top and bottom apart. Several small holes through the ends of the halves allow the whey to escape from the imprisoned curd.

354. METHODS OF PRESSING.

In Holland two cheese go in a press together, one mold on top of the other with a brick or wooden 4x1, 3 feet long, above them both for pressure. A Young American gang press is better than this, as it saves both labor and space.

355. HOOPING THE CURD.

The curd is packed in the mold as tight as it can be crowded with the hands, and is rounded off on top. The cover is placed on top and the mold placed in the press. Pressure is applied gradually for a few minutes and full pressure put on in ten minutes. In half an hour the cheese is taken out and dressed.

356. DRESSING EDAM CHEESE.

If just the right amount of curd is placed in the mold, the cheese will be spherical and not much of a paring will have to be taken off where the edge of the two hemispheres meet. A bandage of chees cloth is now wet with warm water and wrapped around the cheese, and a small cap laid on each end. This coming between the iron mold and curd makes the cheese close perfectly. Care should be taken to lap the cloth evenly so that when taken off from the cheese deep wrinkles will not be left. The cheese is pressed for the remainder of twenty hours. It is then taken out, and if desired, the bandage may be taken off immediately, or it may be left until later to prevent cracking. It can, however, probably be taken off more easily when fresh from the mold.

357. SALTING EDAMS.

The cheese is now rubbed with salt and placed in a salting cup. This is a cup slightly larger than the bottom part of the mold. It holds the cheese in shape and allows of a thin layer of salt on the underside. It is salted daily, turning it each time, until it feels hard. It then goes to the curing shelves.

358. CURING EDAM.

The curing process is practically the same as for Cheddar, and the same conditions must be obtained; that is, a temperature of about sixty degrees and a relative humidity of about eighty.

359. SHELVES FOR NEW CHEESE.

The shelves for the new cheese have holes about two inches in diameter cut out, and reamed out on the top side so that the cheese does not get out of shape, setting squarely on its end. After a month or six weeks it can be set on end without injury to the cheese. Of course, each cheese is turned and rubbed every day or two, and if any tendency to crack occurs (which by the way is one of the serious difficulties that will be met) a very little salt scattered on the surface will check this tendency. When the cheese is a month old, a little cheese grease or oil rubbed on the surface will prevent a too rapid drying out.

360. LENGTH OF CURING PERIOD.

This kind of cheese will not be a success unless it is cured at a temperature not to exceed sixty-five degrees for at least eight or ten months. A year of curing will be better. The fine flavor comes from the lactic acid fermentation to start with, and then a slow curing in which the curd is changed to soluble peptones, such as give this cheese and Cheddar their particular flavors.

361. PREPARING THE CHEESE FOR MARKET.

The cheese, when fully cured, should be washed and then scraped or turned down in a lathe. If the fancy requires it, the rind may be colored with an alcoholic solution of carmine, as previously indicated, and then wrapped in tinfoil to prevent further evaporation.

A box 18x24 inches, six inches deep will hold a dozen cheese. Paper should be put in the top and bottom of the box and thin pieces of board placed between them.

QUESTIONS ON CHAPTER XIX.

1. What are the characteristics of Edam cheese? 2. Where did Edam cheese originate? 3. Where in Holland is the city of Edam? 4. What is peculiar about the farms in Holland? 5. What breed of cattle is kept in Holland? 6. Do farm dairies or cheese factories predominate? 7. In what kind of a vessel is the cheese made and how is the temperature regulated? 8. Of what material are the houses in Holland built, and how does this affect the temperature of the curing rooms? 9. What are the climatic conditions in Holland in regard to the conditions for curing cheese? 10. Is Edam a sweet curd or acid curd

cheese? 11. What kind of a starter is used in Holland? 12. What is the purpose of the whey starter as understood by the Dutchmen? 13. How is the cheese in Holland treated for marketing? 14. Describe an Edam cheese market. 15. Where are the principal cheese markets in North Holland held? 16. What kind of Edams reach the consumer in the United States? 17. How are some of the cheese colored? 18. What conditions are necessary to obtain a fine Edam cheese? 19. What are the possibilities for the manufacture of Edam in America? 20. What kind of a market is there for Edam in this country? 21. What quality of milk is required for Edam cheese? 22. How is the milk treated until the whey is drawn? 23. How much acid should there be on the curd at the time of dipping? 24. How long and in what condition is the curd held until ready for the press? 25. Of what material are Edam molds in Holland made? 26. Of what material are they made in this country? 27. Describe an Edam mold. 28. What kind of a press is required for pressing Edams? 29. How is the curd put into the mold? 30. How long is the cheese left in the press before dressing? 31. How is an Edam cheese dressed? 32. How long is an Edam cheese pressed? 33. What particular care should be taken in dressing the cheese? 34. Why is the bandage used on the cheese? 35. When is the bandage removed? 36. What is one of the most serious difficulties to be met with in the manufacture of Edam? 37. How is Edam salted? 38. How long is Edam cheese salted? 39. How may cheese be prevented from cracking? 40. On what kind of shelves should the new cheese be placed and why? 41. How long should cheese be cured? 42. Upon what conditions does the flavor of Edam cheese depend? 43. How are Edams prepared for market?

CHAPTER XX.

COTTAGE CHEESE.

362. UTILIZATION OF SKIM MILK.

A great many city dairies that turn a large part of their milk into the form of cream have skim milk left on their hands, and to make the business pay as well as possible, they naturally look for a means of disposing of this skim milk. Usually there is quite a demand for the sour milk curd, known as Dutch cheese, cottage cheese, or smierkase.

363. METHODS OF MANUFACTURE.

As this has been made probably for centuries, it would seem an easy task, and so it is, if conditions are just right, but as large dairies sometimes have difficulty in obtaining uniform results, a short chapter treating about the manufacture of this cheese from a scientific standpoint may be helpful.

364. CURDLING POWER OF ACID.

As has been explained the casein of milk is precipitated by rennet and dilute acids. Sweet milk can be heated to the boiling point without curdling, but as acid develops, the milk will first be coagulated at the higher temperatures, and then as the acidity increases, the temperature at which it will curdle is gradually lowered until skim milk containing .6 to .7 per cent of acid will curdle spontaneously. At about 70° F. skim milk will not increase in acidity above nine-tenths of a per cent as the growth of the lactic acid germ is inhibited. Dr. Van Slyke found approximately 5 per cent of sugar in milk used by him. When the milk developed .9 per cent acid, the maximum amount, 1.5 per cent milk sugar, or 28 per cent of that originally present had disappeared; 62 per cent of the milk sugar that disappeared was left in the form of lactic acid. The remainder probably disappeared in the form of CO₂ and other volatile substances.

365. EFFECT OF FAT ON PER CENT OF ACID IN MILK.

Fat in milk or cream takes the place of some of the milk serum. Cream containing 35 per cent fat will curdle with about five-tenths of a per cent of lactic acid, and milk containing 5 per cent fat will develop hardly more than seven-tenths per cent of acid. This is because the fat displaces a portion of the serum.

366. ABNORMAL FERMENTATIONS.

When other fermentations than pure lactic acid occur, trouble may ensue, for gas may make the curd froth so that it may be impossible to use it, or the curd may be slimy or the flavor may be impaired. The way out of such a difficulty is to use a lactic ferment starter (112) in the milk.

367. MEASURING THE ACIDITY.

As acidity plays such an important part, it may be desirable to measure the acid. For this a Farrington Acid Test outfit is required. In addition to the apparatus previously described for testing milk for an acidity of two-tenths per cent (108), a graduated glass cylinder of 100 c. c. capacity is required for measuring the water carefully. One tablet is used for each 19.5 c. c. of water, or five tablets for 97 c. c. of water. The titration is then made with 17.5 c. c. of milk measured into the teacup with a Babcock pipette. Each cubic centimeter of the alkali solution required is equal to one one-hundredth of one per cent of lactic acid.

368. MOISTURE, HOW REGULATED.

A very important factor in the manufacture of cottage cheese is the control of the moisture content. Seventy-five per cent of moisture makes a smooth cheese of good texture. More water makes it soft and sticky and less makes it harsh like sawdust. The time and temperature used in firming is the important thing here as in the manufacture of Cheddar cheese. The following rule will usually apply: Set the milk at 70° F. until it coagulates. Cut it fine with a curd knife. Then heat to 90° F. in thirty minutes. In ten or fifteen minutes draw the whey and dip as described in paragraph 369.

Dr. Van Slyke has made careful investigations on this point as shown in the following table:

No. of Experiment.	Temperature at which Milk Coagulated.	Temperature at which Heated to Separate Whey from Curd.	Time in Raising Temperature to Biggest Point—Minutes.	Time After Reaching Highest Temperature to Dipping—Minutes.	Time Required for Curd to Drain Fully—Minutes.	Texture of Cheese.	
						Per cent. Water in Cheese.	
1	60 deg. F.	80 deg.	60	15	135	77.6	good
2	60 deg. F.	90 deg.	20	5	145	78.8	soft
3	70 deg. F.	80 deg.	30	30	150	81.5	mushy
4	70 deg. F.	90 deg.	40	15	10	73.5	good
5	80 deg. F.	90 deg.	20	10	60	74.9	good
6	80 deg. F.	100 deg.	35	5	50	71.8	slightly dry
7	90 deg. F.	100 deg.	20	0	5	71.5	slightly dry
8	90 deg. F.	110 deg.	30	0	5	68.1	tough, hard

369. DIPPING THE CHEESE.

As soon as the curd has settled so that it will not interfere with the whey strainer, the whey is drawn off and the curd is dipped with a curd pail into a cloth strainer. This strainer is made of linen strainer cloth, and is in the form of a tube so that it can be slipped over a wooden frame. The ends of the frame are supported by wooden horses, which are set over a drain to catch the whey. The curd is stirred in this strainer to free it from the excess of whey. Perhaps a little cream or butter may be added to the curd at this time to make it softer and more palatable. Cottage cheese, like other kinds, is more desirable if it contains a good quantity of butter fat. A little dry sage or caraway seed may also be worked into it to give it flavor. Salt to suit the taste, probably about two pounds to the thousand pounds of milk, is also worked in.

370. HYDROCHLORIC ACID CHEESE.

Milk may be coagulated at once by the use of ten ounces of chemically pure hydrochloric acid, spg. 1.20, diluted to ten times its volume. The milk to be used should be at a temperature of 70° to 80° F. The acid is added slowly and stirred in carefully to evenly distribute the acid. Stir until the whey appears clear. The whey is then drawn off and the curd dipped and salted as described in paragraph 369. The yield of cheese in either method of course depends upon the composition of

the skim milk and the water retained, but it will be from sixteen to twenty pounds per 100 pounds of skim milk. The cost of acid is four or five cents per 100 pounds of milk, or one-fourth cent per pound of cheese. The disadvantage of the hydrochloric acid method is the lack of sour milk flavor to the cheese. This can be produced in a measure by adding some sour cream or sour milk to the curd.

371. MARKETING THE CHEESE.

Local conditions may affect the form in which the cheese is put up for sale. It can be put into balls or loaves, which are cut later, or in paper packages, such as are used for oysters and ice cream. It always pays to put up any article in as clean and attractive a form as possible. •

372. SOFT CREAM CHEESE.

Imitation Neufchatel and soft cream cheese is similar to cottage cheese, but made in a slightly different manner. The imitation Neufchatel is made from milk containing three or four per cent fat while the milk for the cream cheese should contain five to ten per cent fat, the higher per cents making the finer quality of cheese. The milk is first treated to a good starter of two to five per cent of its bulk, and then set with rennet at 80° F. When coagulated it is set into a refrigerator or cold water is run around it without breaking the coagulum. It is cooled to 60° F. if possible and left for twenty-four hours. The acid will probably develop to .6 per cent, giving a rich ripened cream flavor. It is then carefully turned into a cheese cloth bag and hung up for twenty-four hours to drain. If too moist, a twisting of the neck of the bag will assist in the expulsion of moisture. After the twenty-four hours draining in the bag it is salted. It can be worked into rolls by filling a tube and pushing it out with a plunger. The rolls are wrapped first in parchment paper and then in tinfoil.

The cream cheese can be printed with a butter printer.

This kind of cheese is perishable as it contains a great deal of moisture and must be consumed within a week. It should be kept in the refrigerator.

QUESTIONS ON CHAPTER XX.

1. What two classes of substances curdle the casein? 2. What per cent of lactic acid must be present in skim milk to

curdle it? 3. What per cent of lactic acid will curdle cream containing 35 per cent fat? 4. Why does it take a higher per cent of lactic acid to curdle skim milk than cream? 5. What effect has temperature on the curdling power of lactic acid? 6. What will be the effect of abnormal fermentations on the quality of the cheese? 7. How may the per cent of lactic acid in the milk be measured? 8. What is the effect of too much acid on the curd? 9. At what temperature should the milk be set? 10. How high is it necessary to heat the curd to get it firm? 11. How is the curd separated from the whey? 12. Describe the strainer into which the curd is dipped? 13. What is the object of adding cream or butter to the curd? 14. How much salt is required for cottage cheese? 15. What substances may be mixed with the cheese for flavor? 16. How should cottage cheese be marketed? 17. How is hydrochloric acid cheese made? • 18. What proportion and what kind of acid should be used? 19. What is the disadvantage of making hydrochloric acid cheese? 20. Describe the manufacture of imitation Neufchatel and soft cream cheese.

BIBLIOGRAPHY.

The following books should be helpful to the cheesemaker:

Dairy Bacteriology..... By Dr. H. L. Russell
Testing Milk and Its Products.....By Farrington and Woll
Principles of Modern Dairy Practice (Grottenfelt).....
.....Trans. from the Danish by F. W. Woll
Handbook for Farmers and Dairymen.....By F. W. Woll
Milk and Its Products.....By H. H. Wing
Chemistry of Dairying.....By Harry Snyder
A. B. C. of Cheese Making.....By J. H. Monrad
Cheese Making in Switzerland.....By J. H. Monrad
Creamery Accounting.....By J. A. Vye
Canadian Dairying.....By H. H. Dean

REFERENCES TO EXPERIMENT STATION REPORTS.

The following list of references are to the bulletins and reports of the experiment stations and the United States Department of Agriculture. The list is not an exhaustive one in the field of experiment station literature, but is intended to be helpful to the student who wishes to follow some of the investigations which have helped to place the art of cheese making on a scientific basis.

-References on:

(1). THE COMPOSITION OF MILK IN GENERAL.

Wisconsin Experiment Station Reports VI, pp. 42-63 and 161-168; VII, pp. 114-119; XI, pp. 205-217; XII, pp. 120-126; XIII, pp. 73-80; XVI, pp. 140-152. Bulletins 15, 16, 18, 61. New Jersey Bulletins 61, 65, 68, 67. Massachusetts Reports 1888, 1889, 1890, 1891, 1892. Minnesota Bulletin 19.

From Different Breeds: New York Experiment Station Report 1891. Michigan Bulletin 68. Nevada Bulletin 16. Cornell Bulletin, How Is Milk Formed? Bulletin 173, The Relation of Food to Milk Fat. Bulletin 169, Studies in Milk Secretion. Bulletin 92, The Effect of Feeding Fat to Cows.

Compositions of Butter Fat as Affected by Food: New Hampshire Bulletins 16 and 18; Texas Bulletins 11 and 14; Alabama Bulletin 25; Pennsylvania Report 1890, Bulletin 17; Maine Reports 1890, 1891, 1893; Iowa Bulletins 13, 14, 16, 17.

The Chemistry of Dairy Products, Ontario Report 1890, pp. 237-241; Bulletin 39.

The Mineral Ingredients of Milk: Maine Report 1890, Part II, pp. 52-67.

Milk Ash Analysis: New Hampshire Report 1888; Minnesota Bulletin 19.

Variations in Milk: Illinois Bulletin 17, pp. 9-16, and Bulletin 24.

Facts About Milk: U. S. Department of Agriculture: Farmers' Bulletin 42.

Variations in Milk During the Period of Lactation: Vermont Report VI.

The Centrifugal Separation of Casein and Insoluble Phosphates from Milk: Wisconsin Report XII, p. 93.

Photographs of Section of a Cow's Udder: Cornell Bulletins 158 and 178.

The Feeding Value of Whey: Wisconsin Bulletin 27; Report VIII, pp. 38-48.

Whey Butter: Cornell Bulletin 85.

(2). FAT GLOBULES OF MILK.

The Fat Globules in Milk: Maine, Report 1890.

The Size and Number of Fat Globules in Milk: Wisconsin, Report VII, p. 238; XI, p. 223. Pennsylvania, Report 1895. Vermont, Report IV.

In Milk From Cows of Different Breeds: New York Experiment Station Reports 1891-92.

In the First and Last Half of Milking: Indiana, Bulletin 24.

The Grouping of Fat Globules: Wisconsin, Bulletin 18, Report XIII, p. 80.

(3). TESTING MILK.

Testing Cream and Milk: Maine, Bulletin 4.

Purchasing Milk by Test: Delaware, Report VII and Bulletin 31.

Babcock and Beimling Tests: Ontario, Report 1890, pp. 183-184.

Short's Milk Test: Wisconsin, Bulletin 16.

Cochran's Milk Test: Cornell, Bulletin 17.

Babcock Milk Test: Wisconsin, Bulletins 24, 31, 36, 52.

Comparison of Milk Tests: West Virginia, Report III.

The Composite Test: Wisconsin Bulletin 36; Iowa, Report XI, pp. 482-484; Bulletins 9, 14, 22; Illinois, Bulletins 16 and 18.

Detection of Adulterations: Wisconsin, Bulletin 31.

Lactometer and Fat Test: Minnesota, Bulletin 27, pp. 55-56; Maine, Bulletin 4 (new series), pp. 6-10.

(4). YIELDS AND LOSSES IN CHEESE MAKING.

The Influence of Fat Upon the Yield and Quality of Cheese—Babcock: Wisconsin, Report XI, pp. 131-146.

The Relation Between Milk Solids and the Yield of Cheese and Between Specific Gravity and Solids of Milk: Wisconsin, Report XII, pp. 100-120.

Cheese Making, Distribution of Ingredients and Loss of Fat: Handbook Experiment Station Work, U. S. Department of Agriculture.

The Composition of Cheese, Milk and Whey and Their Relation to One Another: Ontario, Report 1894.

The Addition of Cream to Milk for Cheese Making: Minnesota, Bulletin 19.

A Series of Investigations in Cheese Making: Geneva (N. Y.), Bulletins 43, 45, 60, 61, 62, 65, 68, 70, 82, 89, 105, 110, 132.

The Loss of Cheese in Curing: Wisconsin, Report XI, p. 144.

Losses in Cheese Making: Vermont, Report 1891, pp. 95-100.

(5). AERATION OF MILK.

Aeration and Aerators: Cornell, Bulletin 39, pp. 90-94; Vermont, Reports 1892, pp. 123-128; Indiana, Bulletin 44, pp. 37-39.

On Flavor of Curds: Wisconsin, Report XII, p. 127.

Absorption of Odors by Milk: Wisconsin, Report XV, p. 104.

Flavor of Cheese Affected by Foods: Wisconsin, Bulletin 115.

(6). ACIDITY.

On Acid Test of Cream: Illinois, Bulletins 32 and 33.

Alkaline Tablets: Wisconsin, Bulletin 52, pp. 8-16.

The Influence of Acid on the Texture of Cheese: Wisconsin, Report XII, p. 129.

The Hot Iron Test: Wisconsin, Report XII, p. 133.

Experiments in Ripening Milk Before Setting: Wisconsin, Report XII, p. 136.

(7). ORGANIZED FERMENTS.

Pure Lactic Cultures in Cheese Making and the Rise and Fall of Bacteria in Cheddar Cheese: Wisconsin, Report XIII, pp. 95 and 112.

The Wisconsin Curd Test: Wisconsin, Report XV, p. 45.

Effect of Digesting Bacteria on the Cheese Solids of Milk: Wisconsin, Report XVI.

Dairy Bacteriology: Bulletin 25, Office of Experiment Stations, U. S. Department of Agriculture.

Invasion of the Udder by Bacteria: Cornell, Bulletin 178.

The Different Species of Bacteria Producing Lactic Acid. Connecticut (Storrs School), Report III.

Blue, Red, Reddish Brown, Bitter Milk: Minnesota, Report 1893.

Tyrototoxic—Cheese Poisoning—Vaughan: Michigan State Board of Health Report, 1886.

The Fermentations of Milk—U. S. Department of Agriculture; Office of Experiment Stations, Bulletin 9.

Souring of Milk: U. S. Department of Agriculture; Farmers' Bulletin 29.

Isolation of Rennet from Bacteria Cultures: Connecticut (Storrs), Report 1892, pp. 106-126.

Sources of Bacterial Infection: Wisconsin, Report XI, pp. 150-165.

Cleanliness in Handling Milk: N. Dakota, Bulletin 21.

Care of Milk on the Farm: U. S. Department of Agriculture, Bulletin 63.

Sources of Gas and Taint-Producing Bacteria: Cornell, Bulletin 158.

Notes on Some Dairy Troubles: I, Fishy Flavor in Milk; II, Bitter Flavor in Neufchatel Cheese; III, Sweet Flavor in Cheddar Cheese; IV, Rusty Spot in Cheese. Geneva, N. Y., Bulletin 183.

Control of Rusty Spots in Cheese Factories: Geneva, Bulletin 225.

Colored Spots in Cheese: Circular No. 24, R. A. Pearson, U. S. Department of Agriculture.

(S). ENZYMES.

Rennet Extracts of Commerce: Iowa, Bulletin 22, pp. 845-851.

The Chemistry of Casein and the Theory of the Curdling Action of Rennet: G. Courant in Exp. St. Record, Vol. V.

Commercial Rennets: Exp. St. Record, Vol. V, p. 100.

Experiments With Rennet: Wisconsin Report XV, pp. 31-35.

A Study of Enzymes in Cheese: Geneva, Bulletin 203.

Rennet Enzyme as a Factor in Cheese Ripening: Geneva, Bulletin 233.

Galactase: Wisconsin, Reports XIV, p. 161; XV, pp. 77-93; XVI, pp. 157-175.

(9). CHEESE MAKING.

Hints to Cheese Makers: Iowa, Bulletin 19, pp. 627-631.

Investigations in Cheese Making: Iowa, Bulletin 21, pp. 735-767.

Experiments in Cheese Making: Minnesota, Bulletin 19, pp. 20-25.

Changes During Cheese Ripening: Iowa, Bulletin 24, pp. 969-984.

Methods of Estimating of the Proteolytic Compounds Contained in Cheese and Milk: Geneva, Bulletin 215.

A Study of Some of the Salts Formed by Casein with Acids—Their Relation to American Cheddar Cheese: Geneva, Bulletin 214.

Some Compounds Present in American Cheddar Cheese: Geneva, Bulletin 219.

The Relation of Carbon Dioxide to Proteolysis in the Ripening of Cheddar Cheese: Geneva, Bulletin 231.

Chemical Changes in the Souring of Milk and Their Relations to Cottage Cheese: Geneva, Bulletin 245.

Conditions Affecting Chemical Changes in Cheese Ripening: Geneva, Bulletin 236.

The Role of the Lactic Acid Bacteria in the Manufacture and in the Early Stages of Ripening of Cheddar Cheese: Geneva, Bulletin 237.

Conditions Affecting Weight Lost by Cheese in Curing: Geneva, Bulletin 207.

Experiments Upon the Curing of Cheese: Cornell, Report 1880, p. 927.

Moisture Supply in Curing Rooms: Wisconsin, Report XIII, p. 156.

Experiments in Curing Cheese at Different Temperatures: Geneva, Bulletin 234.

The Influence of the Temperature of Curing Upon the Commercial Quality of Cheese: Geneva, Bulletin 184.

Shrinkage of Cold Cured Cheese During Ripening: Wisconsin, Bulletin 101.

Curing of Cheddar Cheese, with Special Reference to Cold Curing: Wisconsin, Bulletin 94.

The Cold Curing of Cheese. U. S. Department of Agriculture, Bureau of Animal Industry: Bulletin 49. A combined report of work done for the Department of Agriculture by the Wisconsin and Geneva, N. Y., Experiment Stations.

Cheese Making—Recent Work: Experiment Station Record, Vol. V.

Manufacture and Production of Cheese—Alvord: Year Book, 1895; U. S. Department of Agriculture.

The Manufacture of Some Fancy Brands of Cheese—Luschinger: Minnesota Dairy Association, Report XVI.

The Manufacture of Edam and Gouda Cheese: Minnesota, Bulletin 35, Report 1894, pp. 104-128; New York Experiment Station's Report 1893, pp. 244-269.

Milk for Cheese Making: Ontario, Bulletins 28, 41, 94.

Notes for Cheese Makers: Ontario, Bulletins 40, 43, 44, 47; and Reports 1889, pp. 163-179; 1893, pp. 167-170.

Method of Handling Sour Milk in Making Cheese: Wisconsin, Report XV, p. 42.

Influence of Temperature on the Ripening of Cheese: Wisconsin, Report XIII, p. 194.

Coating Cheese with Paraffine: Wisconsin, Report XVI, p. 153.

Cleaning Milk for Cheese with a Centrifugal Separator: Wisconsin, Report XI, p. 146.

Albumen Cheese: Wisconsin, Report XII, p. 134.

Wisconsin Cheese Makers' Association Reports.

(10). SALT.

Effect of Salt in Cheese: Wisconsin, Report XI, p. 220.

Salt and Its Prevention of the Swelling of Cheese—Freudenreich: Experiment Station Record, Vol. V, p. 91.

Analyses of Salt: Wisconsin, Bulletin 74.

(11). STATISTICS.

The Distribution of Cheese Factories in Wisconsin: Wisconsin, Bulletin 60, Report XIV.

Statistics of the Dairy: U. S. Department of Agriculture, Bureau of Animal Industry, Bulletin 11.

Statistical Data Relative to the Cheese Industry of Wisconsin: Wisconsin, Report XIV, p. 113.

National and State Dairy Laws—R. A. Pearson: Bulletin of U. S. Department of Agriculture.

By-Laws, Rules and Regulations for Cheese Factories: Canada Central Exp. St., Farm Dairy, Bulletin 9.

The Dairy Industry in Wisconsin: Wisconsin, Bulletin 88.

Wisconsin Report XX, pp. 188-240, gives a resume of all cheese investigations conducted at the Wisconsin Experiment Station during the previous ten years.

Statistics of the Dairy: U. S. Department of Agriculture, Bureau of Animal Industry, Bulletin 55, 1903.

ANALYTICAL INDEX.

THE NUMBERS REFER TO PARAGRAPHS.

- ACID.—Effect of on curd, 137, 138, 139, 164. Effect of too much in milk, 116. Effect on rennet action, 81, 92. Farrington's test for, 108. How much required for $\frac{1}{8}$ in. on hot iron, 136. In milk for Swiss cheese, 286. In water for washing cloths, 205. Lactic, source of, 28. Measure for Babcock test, 57. Measuring by hot iron, 136. Sulfuric, for milk test, 60. Threads on hot iron due to, 137.
- ACIDIMETER.—Dean's, 137.
- ACIDITY.—Effect of fat content on possible, 365. In relation to curdling temperature, 364. Measure for, 138, 367. Of milk for brick cheese, 314; for Cheddar, 111-116; Cottage, 364; Edam, 345, 351, 352; Swiss, 285.
- AERATORS.—Kinds of, 34.
- ALBUMINOIDS.—How divided, 4.
- ALBUMEN.—Character of, 6.
- ALBUMOSE.—Character of, 7.
- ALKALI.—Effect on rennet action, 92.
- AMIDES.—Formation of in cheese, 197.
- ANTISEPTICS.—Use of in factory, 50.
- ASH.—Character of, 8. Effect of heat on, 8. Reaction with Ammonium Oxalate, 8. Soluble and Insoluble, 8.
- BABCOCK MILK TEST, 54. Acid measure, 57. Bottle, 55. Centrifuge, 58. How operated, 59. Kind and strength of acid for, 60. Pipette, 56. Reading of fat, 62. Speed of centrifuge, 61. Testing cheese with, 63. Weight of milk samples, 56.
- BACTERIA.—How introduced into milk, 28. In barn air, 35. Varieties of in milk, 29.
- BANDAGE.—How put on cheese. 183. Starched, seamless and ready made, 182.
- BOXES.—For brick, 328; for Cheddar cheese, 207; Edam, 361; Limburger, 340; Swiss block, 310; Drum, 309.
- BRICK CHEESE.—Characteristics of, 312. Curd, how cooked, 316. Gas fermentations in, 326. How pressed, 319-323. Quality of milk for, 313. Quantity of rennet required for, 315. Salting, 324.
- BUSINESS.—By-laws for factory, 267. Factory statement, 272. Test committee, 268. Figuring dividends, 271. Operation of factories, 266. Prices for making cheese, 270.

- CAP CLOTHS.**—183, 184, 192, 194, 195.
- CASEIN.**—Character of, 5. How separated from milk, 5.
- CHEDDAR CHEESE.**—Cheddar system proper, 107. Cleaning mouldy, 193. Cracks in, 190. Greasing, 190. Hoops for, 258. In cold storage, 192. Made from ripened milk, 273. Size of, 181. Two processes of manufacture, 106. Where originated, 102.
- CHEESE.**—Amount of from skim milk, 13. Characteristics of brick, 312. Cheddar, 102. Corky, 222. Cottage, 362. Cracked, 225. Edam, 342. Fancy styles of, 329. Hard, crumbly, 223. Limburger, 330. Poison, 226. Sweet curd, 273. Swiss, 273. Weak bodied or pasty, 224. Yield of per 100 lbs. of milk, 14.
- CLEANLINESS.**—Of cows, 36; factory, 41; utensils, 39 and 40.
- CLOTH.**—Caps, 183, 184, 192. Circles, 194. For supplying moisture to air, 205. Press cloths, 195.
- COLOR.**—From annatto, 117. Of an uncolored cheese, 117. Of Cheddar, 219; Edam, 351, 361; Limburger, 331; Swiss, 279. Requirements of different markets, 117. Source of in commerce, 117. When added to the milk, 117.
- COLOSTRUM MILK.**—Characteristics of, 15.
- COOKING THE CURD.**—Brick, 316, 317. Cheddar, 122. Definition of term, 122. Effect of overcook, 135. Effect of undercook, 135, 188. For an over-ripe curd, 131. Swiss, 295. Test for proper performance of, 135. When to begin, 130.
- CORKY CHEESE.**—Cause of, 135, 222. Described, 222.
- COTTAGE CHEESE.**—Moisture in, 369. Marketing, 371. Method of manufacture, 369. Several names for, 362.
- CRACKED CHEESE.**—How caused, 225.
- CURD.**—Composition of, 16. Condition of for salting, 167. Cutting into blocks, 142. Piling of, 150. Pin-hole, 144. Steaming of, 163. Sweet, 273. Turning on the rack, 143. Washing of, 145. Wisconsin C. test, 31. When ready to mil, 151.
- CURD MILLS.**—Advantages and objections to knife mills, 161. Description of, 152. Kinds—Barnard, 159; B. & W., 154; Elgin, 152; Fuller, 158; Gosselin, 156; Harris, 157; Kasper, 160; McPherson, 155; Peg, 152; Pohl, 153; Roe, 149; Whitlow, 154. Time to mill, 163.
- CURD SINK.**—How constructed, 147. How to fill, 144. Required in factory, 258. Use of, 148.
- CURING.**—Brick cheese, 325, 327. Edam, 358. Effect of different temperatures on, 198. Effect of humidity on, 201. How long a process, 200. Length of period for Edam, 360. Length of period for Swiss, 308. Limburger, 339. Shelves, 264. Shelves for Edam, 359. Shelves, how made, 199. Temperature of room for Cheddar, 197. Chemical changes in, 197.

- CURING ROOM.—Cellars for, 240, 241. Cellars for Swiss, 306. Floor for, 233. How ventilated, 242. Walls for, 237, 238.
- CUTTING THE CURD.—Cutting into blocks on racks, 142. For Swiss cheese, 289-293. How to cut, 123-127. Rapidity of stroke a factor in, 128. Test when ready for, 121.
- DAISIES.—Size of, 181.
- DIPPING THE CURD.—Cheddar, 141. For brick, 318. For Swiss, 297.
- DRESSING THE CHEESE.—Cheddar, 186. Edam, 356.
- EDAM CHEESE.—As found in Holland, 345. Characteristics of, 342. Cheese market, 347. Market for in America, 349. Method of manufacture, 350. Origin of, 343. Treatment of for market, 346.
- EMULSION.—Definition of, 11.
- ENZYMES.—Described, 71. Galactase, 72. Rennet, 73.
- FACTORIES.—By-laws for association, 267. Cost of, 265. Equipment, 258. In Ontario, 229. Plans for, 230-242. Plans of operation, 266. Private ownership, 266. Stock company, 266.
- FACTORY SYSTEM.—History of in Ohio, 104. History of in Wisconsin, 105. How carried to England, 107. Where and when started, 103.
- FAT.—As basis for making dividends, 271. Characteristics and composition, 10-11. Effect of on possible acidity, 365. Effect of on quality of cheese, 13, 14. Effect of on quality of cottage cheese, 369. Effect of on quantity of cheese, 14. How excessive losses in Swiss cheese may be avoided, 20. Removing from curd for pressing, 178. Rule for calculating yield of cheese from fat test of milk, 14. Specific gravity of, 12. Value of for Swiss cheese, 288.
- FAT GLOBULES.—Number and size, 11.
- FERMENTATION.—Gas in brick cheese, 326. How kept up in curd, 141, 149. In curing process, 197. In Limburger cheese, 339, 341. In manufacture of cottage cheese, 364, 366.
- FERMENTS.—Two general classes of, 71.
- FLATS.—Hoops for, 259. How boxed, 206, 207. Pressing in Cheddar hoops, 258. Size of, 181. Twins and singles, 206.
- FLAVOR.—Of Brick cheese, 312, 313; Edam, 342; Limburger, 331; Swiss, 277. Three causes for in milk, 25. In cheese due to amides, 197.
- FRASER HOOP.—Bandage, how held in, 181. Followers and fibrous ring 184.
- GLAESLER CHEESE.—Cause of, 283. Grade of, 280, 281.
- HEALTH.—Effect of rubber boots and wet floors on, 42.
- HELMER.—Automatic pressure press, 181.
- HOOPS—Do not pound, 189. For Edam, 253. For flats, 259. Fraser, 181. Number required, 258. Wilson, 187.
- HYDROCHLORIC ACID.—Use of in Cottage cheese, 370.

- JUDGING CHEESE.**—Color, 219. Corky cheese, 222. Cracked, 225. English standard, 221. Flavor, 216. Gross appearance, 217. Hard and crumbly, 223. How sample is taken, 215. Poison, 226. Salt, 218. Rusty spots, 227. Swiss, 281. Texture, 217. Weak bodied or pasty, 224. Wisconsin Cheese Makers' Standard, 221. Wisconsin Dairymen's Standard, 215.
- KETTLES.**—For Swiss cheese, 287. How filled, 288. Wooden brake, 294.
- LACTOMETERS.**—Board of Health, 65. Quevenne, 64.
- LIMBURGER CHEESE.**—Characteristics of, 331. Curing, 339. Draining curd, 336, 337. Origin of, 330. Quality of milk required, 332. Salting, 338. Setting milk and cooking curd, 334, 335. Shipping, 340. Utensils used, 333.
- MARKETING CHEESE.**—Brick, 328. Cheddar, 208. Cottage, 371. Edam, 361. Limburger, 340. Swiss, 308, 309.
- MILK.**—Absorption of flavors in, 27. Aeration of, 26, 33. Bacterial infection of, 28. Care of, 32. Cause of souring, 28. Composition of, 2. Cooling of, 37. Constituents of in curd and whey, 16. Effect of food upon, 26. Fore and strippings, analysis of, 23. How lifted, 261. Man's use of, 3. Purpose of, 1. Quality required for brick, 313, 314. Secretion of, 23. Specific gravity of, 64. Three causes of bad flavors in, 25. Time of secretion, 24. Varieties of bacteria in, 29.
- MOISTURE IN AIR OF CURING ROOM.**—Brick, 325. Cheddar, 201, 204. Limburger, 339. Swiss, 303. Measure for, 202, 203. Supply, 205. Regulation of, in Cottage cheese, 368.
- NISZLER CHEESE.**—Cause of, 280. Grade of, 281.
- PARAFFINE.**—Use of for coating cheese, 214.
- PARA CASEIN.**—Cheese curing, 197.
- PEPTONES**—197.
- PIN-HOLEY CURDS.**—How caused, 144. Treatment of, 144, 165, 166.
- POISON CHEESE.**—How caused, 226.
- PRESSES.**—Helmer, 181. Required, 258. Sprague, 181. Tightening the, 185. Upright, 181.
- PRESSING CHEESE.**—Block Swiss, 299. Brick, 323. Drum Swiss, 298. Edam, 354, 355. Limburger, 337. Packages used, 181. Temperature for, 179, 180.
- RACKS.**—How made, 140. How used, 141. Turning curd on, 143.
- RECORDS.**—Form for, 196.
- RENNET.**—Action dependent on three factors, 81. A powerful agent, 83. Effect of acid on, 79. Effect of heat on, 77. Extract brands to be preferred, 76; how prepared, 75; not alike, 80, 110. For fast and slow curing cheese, 118. Inexhaustible, 78. Quantity required for brick cheese, 315. Should be diluted, 119. Source of, 74.

- RENNET ACTION.**—Effect of acid and alkali on, 92; of anæsthetics on, 96; of boracic acid on, 100; formaline on, 100; salt on, 94; strength of rennet on, 98; temperature on, 81, 95; of watered milk on, 92. Soluble calcium salts required for, 99. Thermal destruction point of, 97.
- RENNET TEST.**—Discovered by Harris, 82. Errors to be avoided with Marshall test, 90. For Edam, 351. Glass graduates for, 84. Marshall tests vary, 89. Of milk for brick cheese, 314. Practical application of, 110, 111. The Marshall test, 87. The Monrad test, 85.
- RUSTY SPOTS.**—Description of, etc., 227.
- SALT.**—Amount required, 172, 173. Chemical composition of, 168. Considered in judging, 218. Effect upon cheese, 171, 172. How applied, 174, 175. How tested, 170. Impurities in, 170. Where obtained, 169.
- SALTING THE CURD.**—Brick, 318, 324. Condition of curd for, 167. Edam, 357. Limburger, 338. Swiss cheese, in brine, 301; with dry salt, 302. Temperature for, 176.
- SCALE BOARDS.**—For Cheddar cheese, 207.
- SCALE PEPSIN.**—Substitute for rennet, 73, 120.
- SCORE CARDS.**—For Cheddar cheese, 215, 220.
- SETTING THE MILK.**—Brick, 316; for Cheddar cheese, 118; Cottage, 368; Edam, 351; Limburger, 334; Swiss, 289. Temperature for, 118.
- SHRINKAGE.**—In curing, 212. Septic tank, 251.
- SINK.**—For washing, how made, 260.
- SOLIDS OF MILK.**—Not fat, 2; total, 2.
- SPRAGUE.**—Automatic adjustable gang press, 181.
- STARTER.**—Definition of, 112. For Brick cheese, 314; Edam, 345; Swiss, 285. How to select one, 113, 115. Lactic ferment, 114.
- STIRRING THE CURD.**—How done, 132, 292, 295. On racks, 162. Utensils for, 133, 134. Why done, 129.
- SUB-EARTH DUCTS.**—Electric fans for, 244. Number and size of tiles, 245. Principle of, 243. Use of a well for, 244.
- SUGAR OF MILK.**—Character of, 9. Use of in medicine and as food, 9.
- SWEET CURD.**—Kinds, 273.
- SWISS CHEESE.**—Blind, 280. Block and drum, 275. Block Swiss, 304. Boxing, 309, 310. Cellars required, 306. Characteristics, 273. Color, 279. Cutting curd for, 289-293. Description of, 275. Eyes, 278. Flavor, 277. Glæslers, 283. Grades of, 280, 281. Handling on shelves, 305, 307. How tried, 281. Kettles for, 287. Length of curing period, 308. Niszler, 281. Quality, how determined, 276. Rennet test for, 284. Salting of, 302. Selection of milk for, 282. Setting milk for, 289. Starting eyes, 303. Texture, 278. Use of starter for, 285. Where made, 274.

- TEMPERATURE.**—Different degrees of for curing, 198. For cooking—Brick, 316; Cheddar, 131. Cottage, 369; Edam, 351; Limburger, 355; Swiss, 295. For curing—Brick, 325; Cheddar, 198, 199; Edam, 360; Limburger, 339; Swiss, 303, 306. For Rennet test, 85.
- TESTING MILK.**—Apparatus for, 262. Babcock test, 54. Committee for, 268. Composite sample, 67. Detecting watered milk, 66. Rapid progress in, 53. Sampling tube, 68.
- TEXTURE.**—Of Brick cheese, 312, 313, 327; Cheddar, 217; Edam, 342; Limburger, 331; Swiss, 278.
- TYROTOXICON.**—In poison cheese, 226.
- UDDER.**—Structure of, 22.
- UTENSILS.**—Brick cheese draining boards, 321. Draining table, 320. Molds, 319. Curd rakes, 133, 134. Curd sink, 147, 148. Herrick's curd cutter, 142. Horizontal curd knife, 124. Hygroscope, 202. Kind and care of, 39, 40. Perpendicular curd knife, 127. Psychrometer, 203. Scrubbing brushes, etc., 45. Swiss curd stirrer, 292. Swiss harp, 290. Wooden kettle brake, 294.
- VATS.**—Size of, 256. How lined, 257.
- WASHING CHEESE.**—In cold storage, 193.
- WASHING CURD,** 145.
- WEAK BODIED CHEESE.**—Cause of, 135, 150.
- WEIGHING CHEESE.**—Cheddar, 208. Weights, how marked, 209, 210.
- WHEY.**—Butter, 311. Composition of, 17, 18. From Swiss cheese, 20. How elevated, 254. Loss of fat in, 19. Tanks, 253.
- YOUNG AMERICAS.**—How boxed, 206. Size of, 181.

ELEMENTS OF DAIRYING

IS AN ILLUSTRATED BOOK BY THE
SAME AUTHOR AS "CHEESE MAKING"



The subjects treated in the eleven chapters are
as follows:

- I. Historical and Introductory.
- II. The Secretion of Milk.
- III. Water and Solids of Milk.
- IV. Milk Fat.
- V. Milk Solids not Fat.
- VI. The Physical Properties of Milk.
- VII. Butter and Cheese.
- VIII. Contamination of Milk.
- IX. Testing Cows.
- X. Market Milk.
- XI. Dairy Refrigeration.



IT IS PUBLISHED BY THE AUTHOR .

Any Dairy Supply House or Book Dealer can furnish
it (post paid) for \$1.00.

**This book is a preservation facsimile.
It is made in compliance with copyright law
and produced on acid-free archival
60# book weight paper
which meets the requirements of
ANSI/NISO Z39.48-1992 (permanence of paper)**

**Preservation facsimile printing and binding
by
Acme Bookbinding
Charlestown, Massachusetts**



2006

