

PRACTICAL BUTTERMAKING

UC-NRLF

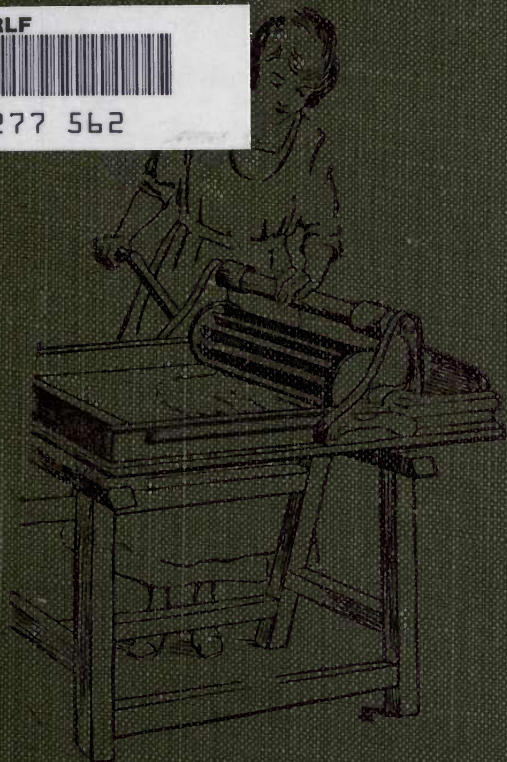

5B 277 562



C. W. Walker-Tisdale, F. C. S.

and

Theodore R. Robinson, F. S. I.

THREE ESSENTIALS

FOR PROFITABLE BUTTERMAKING

THE BEST CREAM SEPARATOR.

THE

SU
I
BON
a
OIL
n

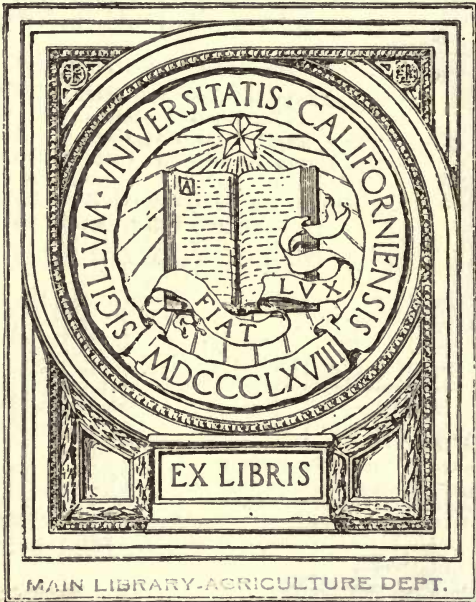

SUPPLY CO. LTD.
LONDON

CHURN.

ON”
fasteners.
Schools, and
buttermaking
competitors.

BU

“C
S

the
ensures even pressure,
is well fitted, simple to
use, easy to clean.

*Illustrated Catalogue Post free
on application.*

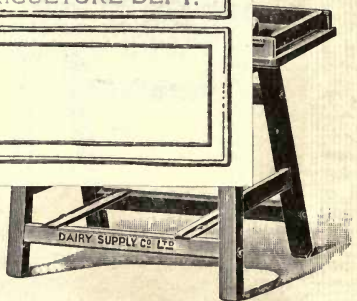

Dairy Supply Co., Ltd., Museum Street, London, W.C.

R. A. LISTER & Co., Ltd.,

DURSLEY, GLOS., Dept. 17,

ESTABLISHED 1867.

MANUFACTURERS OF HIGH-GRADE

Farm & Dairy Machinery & Appliances



"Lister" Cream Separator.



"Lister"
Vertical Petrol
or Oil Engine.



Lister Churn.



"Lister" Butter Worker.

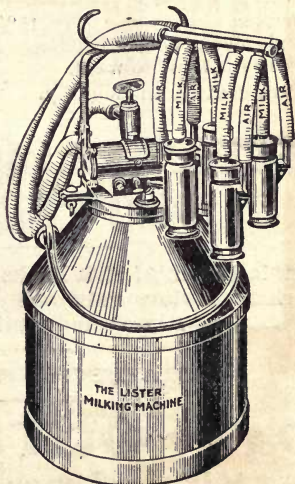

"Lister" Milking Machine.

WRITE FOR PARTICULARS & PRICES.

THE "SUCTION FEED" TUBULAR SEPARATOR.

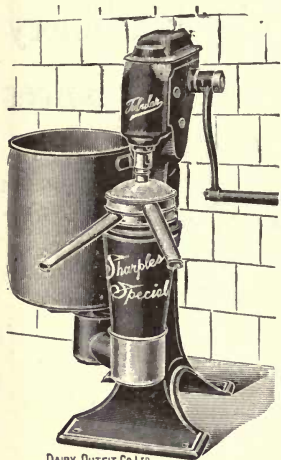

DAIRY OUTFIT Co. Ltd.
KINGS CROSS, LONDON.

Stands on the floor with large milk drum low down. One piece only in the bowl to wash.

It runs easily and silently.

A Revolution in Cream Separators.

THE "SUCTION FEED" takes up the milk into the Bowl as it can deal with it; turn faster or slower it always does perfect work, yielding cream of uniform quality, the thickness of which is controlled as desired.

The "SUCTION FEED" Tubular has no ordinary limit of capacity, the faster you turn the more it will separate—unlike ordinary Separators.

You turn the handle faster and get the job done quicker. The strongest and simplest Separator the world has seen, and it is guaranteed for ever.

The "SUCTION FEED" gives you 15% more cream than other Separators.

EVERY REQUISITE FOR BUTTERMAKING.

Manufacturers of Milk Buckets, Milk Strainers, Pans, Butter Workers, Butter Pats and Prints, Cream Crocks, Butter Papers and Cloths, and Dairy Salt.

CATALOGUES POST FREE.

Dairy OUTFIT Co., Ltd.,
King's Cross, London, N.1.

PRACTICAL BUTTERMAKING

First Published . . . 1903
Revised and Enlarged . . . 1906
Second Revision . . . 1910
Third Revision . . . 1913
Fourth Revision . . . 1919

Indispensable to Dairy Workers.

THE PRACTICE OF

SOFT CHEESEMAKING.

By C. W. WALKER-TISDALE and THEODORE R. ROBINSON.

The most complete guide published to the manufacture of the principal varieties of Soft Cheese and of certain kinds of

SMALL HARD CHEESE.

Brought up to date. Fully Illustrated. Complete recipe for each cheese.

The following varieties of cheese are described, together with information as to the principles of manufacture, utensils required and methods of carrying out the various tests.

Cream Cheese

Cambridge or York

Colwick Cheese

Gervals or Pommel

Point L'evêque

Little Lancashire

Boudon

Camembert

Port du Salut

Coulommier

Little Wensleydale

Goats' Milk Cheese

Sour Milk or Lactic Acid Cheese.

Price **3s.** net; postage 3d.

Published by and procurable from

JOHN NORTH, 98, Fetter Lane, London, E.C.4.

The Wensleydale Pure Milk Society, Ltd.

NORTHALLERTON,

is prepared to take pupils for training in Commercial Dairying. A general all-round experience can be gained in Farm Inspections and Tuberculin Testing; Dairy Management, including Purchase and Sales, Separating, Milk Testing and Cheesemaking, Fitting and Fixing Dairy Machinery, Repairs.

A MODERATE PREMIUM REQUIRED.

The Society provides expert advice on the planning and equipment of small and large Dairies. Plans and Specifications of Buildings and Machinery prepared. Advice on selection of sites, water supply, etc.

Particulars on application to the General Manager

Mr. C. W. WALKER-TISDALE, Consulting Dairy Engineer
to the Agricultural Organisation Society.

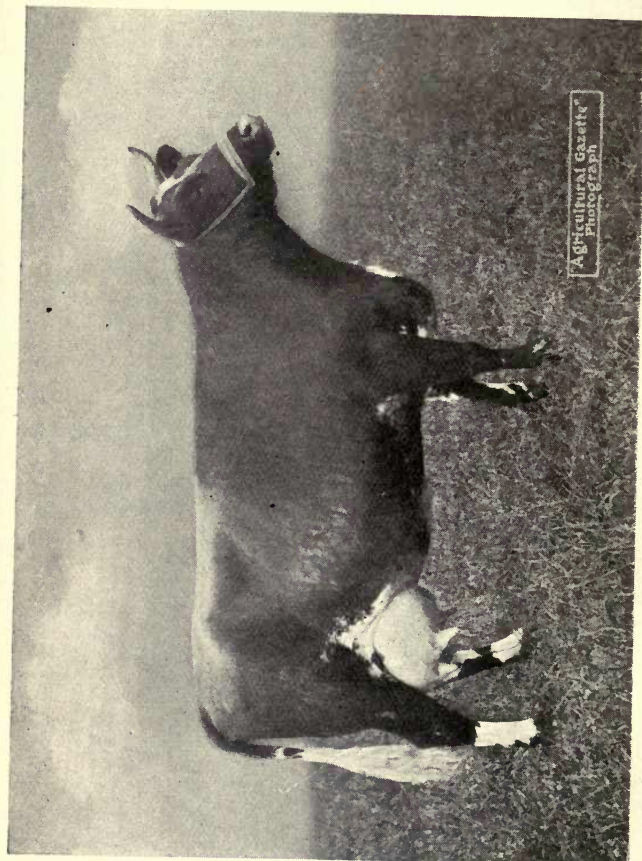

SHORTHORN DAIRY COW.

PRACTICAL BUTTERMAKING

FOURTH REVISION.

A Treatise for Buttermakers and Students.

BY

C. W. WALKER-TISDALE, F.C.S.

*Director of The Wensleydale Pure Milk Society, Ltd.,
Northallerton.*

*Member of the Council of the British Dairy Farmers' Association.
Author of "Milk-Testing."*

AND

THEODORE R. ROBINSON, F.S.I.,

*Late Lecturer in Agriculture, Dairying and Poultry-keeping at
the South Eastern Agricultural College (University of London),
Wye, Kent.*

Joint Authors of

"THE PRACTICE OF SOFT CHEESEMAKING."

All rights reserved.

PUBLISHED BY
HEADLEY BROTHERS PUBLISHERS, LTD.,
72, OXFORD STREET, LONDON, W.1.

Some Press Opinions of "Buttermaking."



Journal of the Bath and West Society :

"The only fault we can find with this little book is that it is so good we should like to have more of it. . . . Buttermakers, however expert, they may be, will not find they have wasted either their money or their time by its purchase and study."

Nature :

"It has the merit of being thoroughly up-to-date. . . . The practice recommended is based on the latest scientific research connected with dairying. . . . It is probably the best of the handbooks on practical buttermaking."

The Standard :

"Thoroughly up-to-date and may be recommended as a trustworthy guide to the making of 'gilt-edged' butter."

The Field :

"May safely be described as one of the best manuals on the subject. The book seems to fill a vacant space, and, in any case, is calculated to be of real service to a pursuit that is still far from being adequately developed in this country."

Agricultural Gazette :

"The authors have succeeded admirably in packing into a small compass a mass of precise information. . . . The instructions given are admirably calculated to enable a buttermaker to place himself or herself in the front rank."

Mark Lane Express :

"The work can be heartily recommended to creamery proprietors, dairy farmers, and the private gentleman who keeps a couple of cows for providing his home requirements."

Farm and Home :

"It is an excellent example of what a practical book written for the practical man ought to be. There is not a single bit of padding in the whole volume. . . . We commend it to our readers who are interested in dairying."

The Dairy :

"No dairy handbook with which we are familiar is more trustworthy."

Farmer and Stockbreeder :

"It is distinctly a very practical volume, and merits the support of practical men who go in for dairy work."

Farm, Field and Fireside :

"The work may be termed a complete guide to buttermaking."

The Scottish Farmer :

"Cannot fail to be of great value to dairy farmers and others interested. It is practical, and this is a great point in its favour."

Irish Homstead :

"May claim to rank as one of the standard works on modern dairying."

Rural World :

"The technical details are excellent : such, indeed, as may be commended to the perusal of both amateurs and professionals."

PREFACE.

FOURTH REVISED EDITION.

THE authors have for the fourth time revised and brought up to date the subject matter of this work, so that it includes the methods found most successful in present time dairy practice.

The aim in this, as in the previous editions, has been to give the information in as few words and in as practical a manner as possible.

Buttermaking still forms a very important part of the Dairy Industry of the United Kingdom, and it is of vital importance that it should be conducted on up-to-date lines.

Whenever butter is made, it is desirable that it should be made of good quality, as it is as easy to make a good article as a bad one. Unfortunately, there is a great deal more bad farm-made butter than good, which, no doubt, is largely due to ignorance on the part of the makers as to what really good butter is like. Time after time we have found makers thoroughly satisfied with the butter they had produced, which was really of very inferior quality. This state of affairs exists merely because such people

are unable to compare their product with butter which is of prime quality.

Great facilities are now offered to buttermakers, who can, if they so desire, soon learn what good butter is like, and, once this knowledge is obtained, it is not a difficult matter to produce it. Instruction in buttermaking is given free by most County Councils, and some of the Agricultural papers now employ an expert to examine, and advise on, samples of butter sent in by readers. Thus those who are unable to leave the farm can learn the merits and demerits of their butter by simply sending a sample for examination to the agricultural paper to which they subscribe.

It is very frequently argued that "buttermaking does not pay." This is undoubtedly true in a great many instances, but the matter cannot be decided generally, as each case needs to be considered in connection with numerous points, including the quality of the article produced, prices obtainable, and marketing facilities, the utilisation of the separated milk and other factors. Under certain conditions buttermaking is undoubtedly a paying business, whilst the keeping of a better class of cattle and the adoption of better methods of manufacture are conducive to make it even more so. In buttermaking the by-product or separated milk has always to be valued. Its utilisation for feeding calves, pigs and poultry gives very satisfactory returns, for at

the present time calves, pigs, poultry and eggs are in good demand, and have never sold better.

This book was previously published under the title of "Buttermaking on the Farm," and comprises the first portion of the complete work entitled "Farm and Creamery Buttermaking," in which buttermaking on a large scale is specially treated.

The illustrations on pages 42, 75, 84, 87, 88, and 95 are loaned from "Cassell's Popular Science," and the Alfa Laval engravings from the Dairy Supply Company

C. W. WALKER TISDALE.

THEODORE R. ROBINSON.

May, 1919.

CONTENTS

(The numbers refer to sections.)

CHAPTER	PAGE
INTRODUCTION - - - - -	13
I.—BUTTERMAKING ON THE FARM - - - - -	15
The Dairy, 1 ; Position and Design of Dairy, 2 ; Materials and Construction, 3 ; Fall in floors, 4 ; Walls, 5 ; Light and Ventilation, 6 ; Roofs, 7 ; Verandah, 8 ; Heating Apparatus, 9 ; Dairy Sewage, 10.	
II.—REQUIREMENTS OF THE BUTTERMAKING DAIRY - - - - -	24
Water Supply, 11 ; A Separator, 12 ; A Churn, 13 ; A Butterworker, 14 ; A Centrifugal Butter Dryer, 15 ; A Temperature Can, 16 ; Ther- mometers, 17 ; Salt, 18 ; Butter Colouring, 19 ; Ice Chest or Refrigerator Chamber, 20 ; Butter Fat Tester, 21 ; Pocket and Sal Methods, 22 ; Test- ing Cream, 23 ; Testing Separated Milk, Skim Milk and Butter Milk, 24 ; Gerber Dirt in Milk Tester, 25 ; Acidimeter, 26 ; Utensils required for a Butter-making Dairy capable of dealing with the milk of twenty to twenty-five cows, 27.	
III. —THE PRODUCTION OF CREAM - - - - -	42
Systems of Creaming, 28 ; Cream Separators, 29 ; Centrifugal Force, 30 ; Efficiency of Separator, 31 ; Varieties of Separators, 32 ; The Separator Bowl, 33 ; Separating Temperatures 34 ; Work- the Separator, 35 ; The Essentials for Successful Separation, 36.	

CHAPTER	PAGE
IV. —CREAM PERCENTAGES FOR CHURNING - - -	59
Percentage of Cream, 37; Cream percentage Calculations, 38.	
V.—CREAM RIPENING - - - - -	62
Cream Ripening or Souring, 39; Natural Cream Ripening, 40; Starters, 41; Ripening Cream with Starter, 42.	
VI.—THE COLOURING OF BUTTER - - - -	67
Artificial Butter Colour, 43; The Natural Colour of Butter, 44.	
VII.—THE PREPARATION OF UTENSILS - - -	70
Methods of Preparation, 45.	
VIII.—THE CHURNING TEMPERATURE - - -	72
Fixing the Temperature, 46.	
IX.—THE PRODUCTION OF BUTTER - - -	75
Churning, 47; Churning Ripened or Loppered Milk, 48; Churning Sweet Cream, 49; Devonshire Clotted Cream, 50; Churning Ripened Cream, 51; Manipulations in Churning, 52; The Finish of Churning, 53.	
X.—SUBSEQUENT TREATMENT OF THE BUTTER -	89
Washing Butter, 54; Brining Butter, 55; Dry Salting Butter, 56; Removing Butter from Churn, 57; Working Butter, 58; Délaiteuse or Butter Dryer, 59; Making up Butter, 60; Washing up Utensils, 61.	
XI.—RESUMÉ OF BUTTERMAKING OPERATIONS -	97
Short Instructions for Butter-making, 62.	
XII.—MARKETING AND THE POINTS OF GOOD BUTTER - - - - -	100
Marketing, 63; Points of Good Butter, 64; Scale of Points for Judging Butter, 65; Points for Judging Butter-making Classes, 66; Points for Judging Butter-making Competitions and Examinations, 67.	

CHAPTER	PAGE
XIII.—THE QUALITY OF BUTTER - - -	105
Ornamental or Fancy Butter, 68 ; Composition of Butter, 69 ; Estimation of Water in Butter, 70 ; Loss of Fat in Buttermilk, 71.	
XIV.—BUTTER RATIO - - - - -	110
Definition of Butter Ratio, 72.	
XV.—RETURNS OBTAINED FROM BUTTERMAKING -	113
Annual Returns, 73.	
XVI.—PRESERVING OR POTTING BUTTER - -	115
Potting Butter, 74.	
XVII.—DIFFICULTIES OF THE BUTTERMAKER - -	117
Sleepy Cream, 75 ; Streaky or Mottled Butter, 76 ; Bad Flavoured Butter, 77.	
XVIII.—ITINERANT OR TRAVELLING DAIRY SCHOOLS	123
Travelling Dairy Schools, 78 ; The Course of Instruction, 79.	
XIX.—THE UTILISATION OF BYE-PRODUCTS OF THE DAIRY AND SURPLUS WHOLE MILK -	127
The Bye-Products, 80 ; Separated Milk as a Food for Human Beings, 81 ; Feeding Calves on Surplus Whole Milk, 82 ; Feeding Veal Calves, 83 ; Rearing Calves, 84 ; Pig-keeping, 85 ; Poultry-keeping, 86.	

LIST OF ILLUSTRATIONS

	PAGE
SHORTHORN DAIRY COW - - - - -	<i>-Frontispiece</i>
SMALL PRIVATE DAIRY - - - - -	16
PLAN OF PRIVATE DAIRY - - - - -	17
SMALL BUTTERMAKING DAIRY	25
BUTTERWORKER - - - - -	26
DELAITEUSE - - - - -	27
MILK TESTING APPARATUS - - - - -	31
GERBER TESTER - - - - -	33
DAIRY ACIDIMETER - - - - -	38-39
SHALLOW PAN - - - - -	42
DIABOLO HAND SEPARATOR - - - - -	44
DIABOLO SECTIONAL CUT - - - - -	45
MELOTTE HAND SEPARATOR - - - - -	46
MELOTTE SECTIONAL CUT - - - - -	47
STANDARD HAND SEPARATOR - - - - -	48
ALFA LAVAL HAND SERARATOR	49
ALFA LAVAL STEAM TURBINE SEPARATOR	51
ALFA LAVAL POWER SEPARATOR - - - -	52
ALFA LAVAL POWER SEPARATOR SECTIONAL CUT	53
ALFA LAVAL POWER SEPARATOR DIRECT DRIVE	55

LIST OF ILLUSTRATIONS

II

		PAGE
TURBINE DRIVEN PASTEURISER AND SEPARATOR	-	59
FRISIAN DAIRY COW	- - - - -	67
MICROSCOPICAL APPEARANCE OF CREAM	- -	75
MICROSCOPICAL APPEARANCE OF CREAM PRIOR TO BREAKING STAGE	- - - - -	84
GARBUTT'S TWO-MINUTE CHURN	- - - - -	85
BUTTER GRAINS IN CHURN	- - - - -	87
MICROSCOPICAL APPEARANCE OF BUTTER	- -	88
GRANULAR BUTTER ON BUTTERWORKER	- -	91
WORKING BUTTER	- - - - -	92
MADE-UP BUTTER	- - - - -	95
ORNAMENTAL BUTTER	- - - - -	103
SAMPLES OF BUTTER COMPARED	- - - - -	106

BUTTERMAKING.

INTRODUCTION.

BUTTERMAKING is an art to which Science lends a ready aid in supplying the reasons for the many operations which milk undergoes from the time it is brought into the dairy until the finished butter is produced.

The manufacture of butter is influenced by external conditions, and where these are not carefully regulated it is almost impossible to produce a first-class article. The regulation of external influences should commence in the byre, or cowshed. Foods that injuriously influence the flavour of milk should be given to the cows only in such quantities and at such times that the flavour or taint will not be transferred to the milk and subsequently to the butter. Thorough cleanliness is essential to prevent milk becoming contaminated before it reaches the dairy. This means that the cowsheds must be clean and airy, the cows and milkers clean and healthy, and the milk always removed from the shed immediately after each cow is milked. As it is absolutely impossible to make the best quality butter unless the milk is delivered to the dairy in a pure and clean

condition, it should be the duty of the buttermaker to see that it is handled and treated in a proper manner up to the time it is delivered into his charge.

Where this is out of the question and a supplier is sending in milk to a creamery in a dirty condition, as indicated by bad flavour and odour, and by particles of straw and dirt being present in it, he should be warned of the defects, and shown the necessity for cleanliness; and, further, if at any future time the milk should be delivered in a like condition, it should be refused altogether.

It is only by adopting strict and careful methods like these that the buttermaker can get a fair start and be able to control properly the further processes of manufacture, and so turn out butter of first-class quality.

CHAPTER I.

BUTTERMAKING ON THE FARM.

(1) **The Dairy .**

DAIRIES may be planned for buttermaking, cheesemaking, milk-selling, or a combination of these. We will treat here of those required for buttermaking only. A buttermaking dairy should contain at least three apartments :—

1. The dairy proper or separating and buttermaking room.
2. A cream ripening or store room.
3. A scullery or covered yard for washing up the various utensils.

Larger dairies have a milk-receiving platform, which is adjacent to a power-driven separator, and the many appliances for heating and cooling milk that are now in such general use.

Provision in these cases must be made for the engine, coal-store, testing-room and office, in addition to the buttermaking and store room already mentioned.

On many farms, sanitary conditions according to modern ideas are altogether neglected, and the following underlying principles should be carefully studied before anything in the way of new buildings or improvements is attempted.

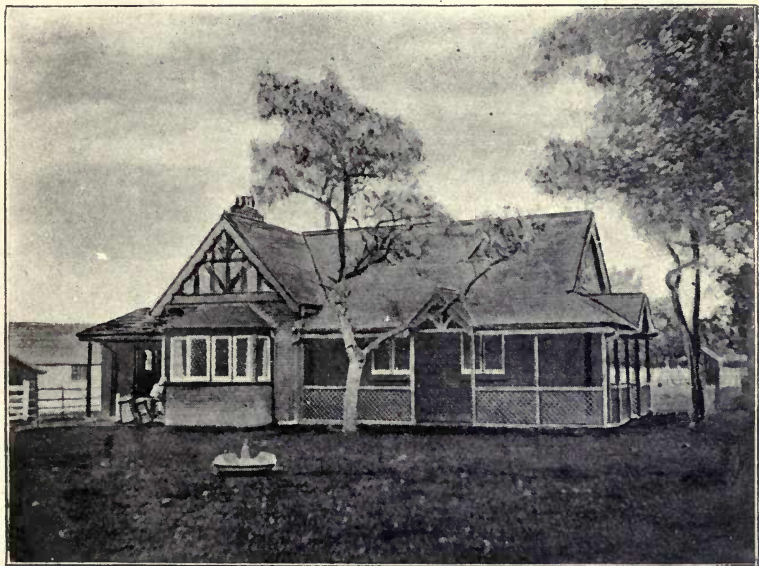

SMALL PRIVATE DAIRY, OF WHICH PLAN IS GIVEN.

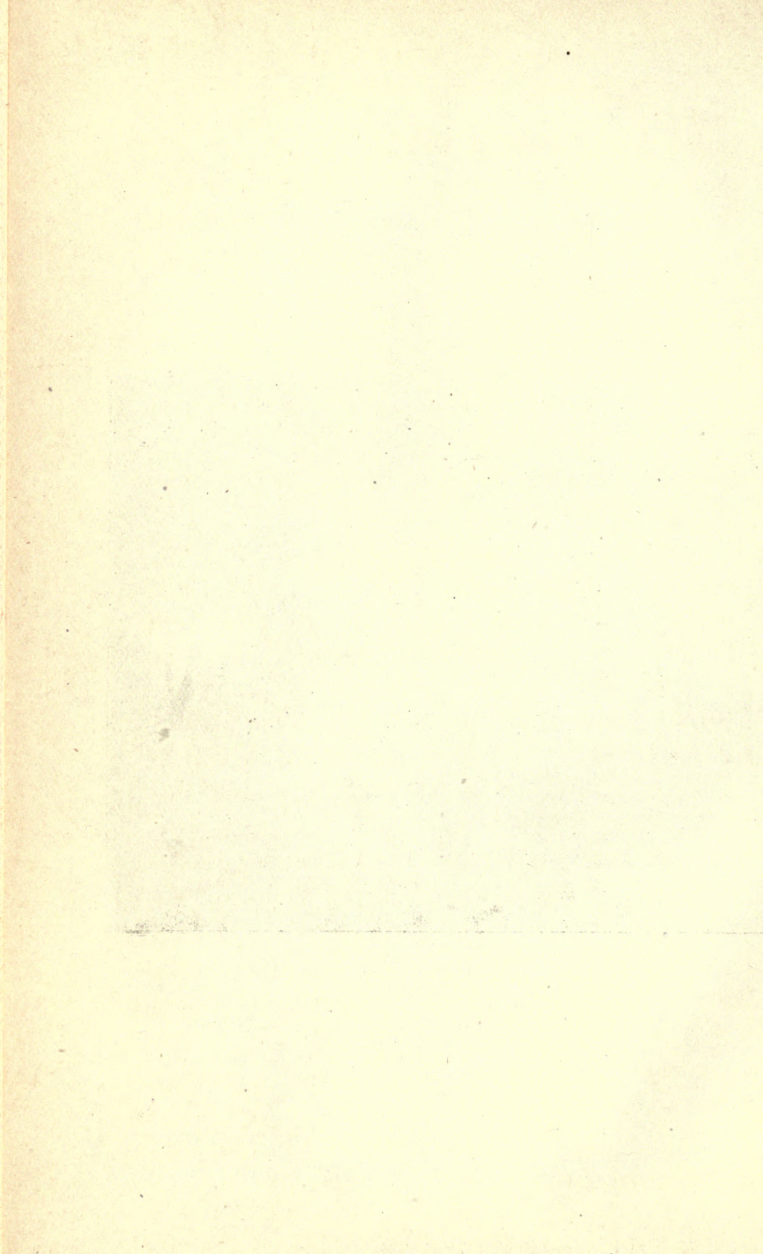

(2) Position and Design of Dairy.

1. Complete separation from the dwelling-house, from cow-byre, pig-styes, or other farm buildings, should be secured; freedom from dust and smell being absolutely essential.

2. A somewhat elevated position is desirable, as this:—

- (a) Prevents contamination by surface water through soakage.
- (b) Allows the buttermilk, etc., to be carried away easily by pipes, if so desired.
- (c) Ensures a circulation of pure air round the entire building. Some dairies are built under or near trees; undoubtedly trees add a charm to the situation, but impede the free circulation of the air. They have, however, their advantages in that they keep the atmosphere moist by means of the water which is given off from their leaves, and they shade and keep the dairy cool.

3. Economy and convenience of working, with every facility for a thorough and rapid cleaning, are requisite.

4. Equability of temperature and perfect ventilation must be secured. The buttermaking room usually has a north aspect.

5. Economy in construction, especially where the business side is of first importance.

6. An ample supply of good water and an efficient system of drainage are of the utmost importance.

(3.) **Materials and Construction.**

Floors may consist of cement, asphalt, red Dutch clinkers, tiles, or flagstones laid on a foundation of concrete.

Cement.—A good substance, and the best for dairy floors when properly laid, but otherwise a failure. If the surface is left rough it does not wear well. The objections to it are :—

- (a) Acids of milk, etc., will in time slightly dissolve this kind of floor, and so wear away the surface.
- (b) It is apt to crack round the sides, especially in frame buildings, thus leaving gaping crevices which get filled with dirt.
- (c) It is difficult to repair, and takes some days to set.

Asphalt.—Val de Travers is the most satisfactory. It is firm and impervious to water ; it is easily laid, very permanent, and can be joined up to fit closely against existing walls. The objections to it are :—

- (a) It softens by heat ; pails and cans containing hot water should, therefore, be placed on wooden racks.
- (b) It is injured by the drippings of oil from machinery.

Red Dutch Clinkers.—These make a first-rate floor, but are expensive.

Tiles, when carefully set in cement, with carefully-fitted joints, form a useful floor. They cannot be kept as clean as cement or asphalt, and take a long time to dry.

Flagstones of Slate or Mountain Limestone wear unevenly, and are apt to crack. It is difficult to get a bedding that will keep them quite solid. Slate absorbs very little moisture and dries quickly.

Wood is quite unsuitable for dairy floors.

(4) **Fall in Floors.**

All floors should be made with a slight fall towards the gutter. Some materials require a greater fall than others, to do the work of drainage effectually. Thus the minimum should be 1 inch in 6 feet for a flag floor; 1 inch in 8 feet for an asphalt floor.

Gutters can be made in asphalt, cement, or in half drain-pipes (glazed), laid flush with the floor, so as to form an open channel leading directly under the dairy wall to the trapped drain outside. The gutter in a large room is placed for convenience down the centre of the apartment instead of round the side. There should be no covered drains inside the dairy, and a shutter or "cut-off" should be placed against the outlet. All underground drains outside should be trapped if they communicate with the building.

(5) **Walls.**

A damp-course should always be inserted immediately against the ground level, and this may consist of a layer of pitch (tenax), two rows of slates bedded in cement or "Bitumen" damp-course. Bricks are preferable to stone, as double walls can be constructed without much difficulty. Two $4\frac{1}{2}$ inch brick walls, with an air space of $2\frac{1}{2}$ inches, give a total of $11\frac{1}{2}$ inches; or a 9 inch inside and $4\frac{1}{2}$ inch outside

brickwork, with air space of $2\frac{1}{2}$ inches, will make a thickness of 16 inches. In hollow walls air bricks should always be inserted both at the top and bottom.

The two portions are bolted together by means of galvanised iron ties or patent bricks. Double walls, although expensive, are of the utmost value for securing equability in the temperature of the dairy. The inside of the walls can be built of glazed bricks or covered with white tiles, and this forms the most suitable interior for a dairy, though it is most expensive. A cheaper plan is to cement the interior walls with Adamant cement, and this is very effective, as it can be washed.

The cheapest interior consists of ordinary lime-washed brick, or stone.

(6) Light and Ventilation.

Plenty of light usually indicates cleanliness. Windows can be placed on one or more sides of the dairy. Fine wire gauze or some similar material can be fixed outside the windows, or to a second window frame, the object being to keep out insects but yet allow air to circulate freely.

Too much sun may be excluded by means of blinds. The simple means of cooling a dairy by merely leaving the door open at night may be mentioned, but the moist atmosphere leaves a wet coating on the walls and ceiling. The air, however, should not be too dry, or a hardened surface will be produced on the cream, due to evaporation of moisture. All buttermaking rooms ought to have

ventilators, preferably both below and above, a great amount of fresh air being absolutely necessary. A usual plan is to have a large air shaft (the opening of which can be regulated) running right up through the roof of the building.

The ideal temperature for a dairy all the year round is from 55° to 60° F.

(7) **Roofs.**

A thatched roof is probably the most effective of all, being warm in winter and cool in summer.

A roof of reeds will last for many years. The chief objection is that shelter is afforded to birds and insects. This drawback can be overcome to some extent by a covering of wire mesh netting. There are other modes of roofing which may be adopted.

Thus, tiles, shingles, boards, felt and laths have been brought into use. These can be arranged in various ways, and it is often advantageous to leave an air space between the upper and lower portions. The essential points of a good roof are that it should be watertight, and that at least one part should be made of some non-conducting substance, in order that the temperature of the rooms below may be kept as even as possible. An excellent roof is formed as follows :—The timber is put on as for an ordinary roof, the spars covered with boards, then tarred felt, and finished with grey slates on the outside.

(8) **Verandah.**

In addition to, or sometimes instead of, double walls, a verandah is built round the dairy. It is

of great service in keeping the dairy cool in summer. The roof of the verandah may be made a continuous slope with that of the dairy, but a verandah which is more effective in keeping the dairy cool is one built with a separate roof jutting out from the wall.

(9) Heating Apparatus.

During certain parts of the year some artificial heating is essential, and this may be done either by means of a slow-combustion stove or, if a boiler is fitted, by steam and hot-water pipes and radiators.

Open fireplaces are not sufficiently reliable for maintaining a uniform temperature, and are not satisfactory for other reasons, though frequently used in small dairies.

Where slow-combustion stoves are used, it is advisable to place pans of water near them, otherwise they make the atmosphere too dry.

(10) Dairy Sewage.

Consists of washings and waste products of the separator, churn, etc. On a small scale it is unimportant, but in large quantities there arises a difficult problem to deal with. Dairy sewage contains a large amount of organic nitrogen and carbon.

The Rivers Pollution Act of 1876 forbids the running of this class of sewage into rivers, neither must it be turned into the town system of drainage.* The following are some of the processes adopted for dealing with it :—

* The Rivers Pollution Act, 1876. The standard adopted is for albuminoid ammonia 36 parts per 100,000 parts of water and no "free ammonia."

A special cesspool or tank is provided, and the contents are utilised as manure on the farm or garden.

Surface irrigation. The crude sewage is run over the land. This is the most natural method, but on some soils the ground soon becomes "sick," and may prove a nuisance unless the sewage can be diverted.

On a large scale, sewage farms. Chemical precipitation or the bacterial treatment of rapid fermentation may be used, but these methods hardly come within the scope of the present work. The cost in adopting any of these schemes is of vital importance to a creamery, the majority of the methods being far too expensive.

CHAPTER II.

REQUIREMENTS OF THE BUTTERMAKING DAIRY.

(11) Water Supply.

A PLENTIFUL supply of hot and cold water is most essential. If a well is the source of the water, generally speaking, the deeper it is the more satisfactory it will be for buttermaking purposes. In such a case the water can always be relied upon to be cold in summer, and its filtration through a considerable depth of strata will ensure greater purity and freedom from surface contamination.

Pure water is an all-important factor in buttermaking, as, if surface or impure water be used for washing butter, the bacteria introduced with the water are a source of many troubles.

The butter produced in a dairy may often have bad keeping qualities and develop a rancid taste. If this results from no apparent mismanagement of the cows, or fault of the buttermaker, such as want of proper ripening of the cream, then the water supply should be investigated. We have frequently found an explanation of rancidity in a defective water supply, and have recommended the boiling and cooling of the water before washing the butter with it. Where this has been done the evil has, as a rule, disappeared. As the water supply is so important it will always pay in the end to submit a sample for analysis and get a

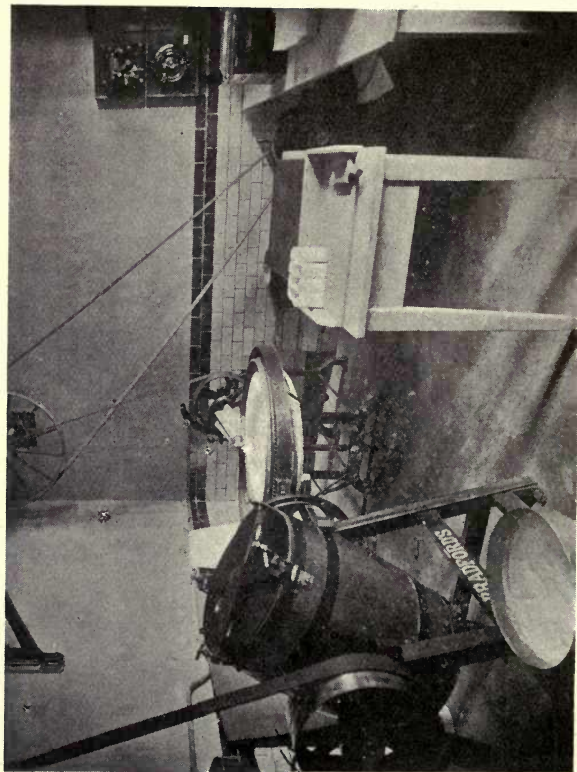

SMALL BUTTERMAKING DAIRY, SHOWING CHURN AND CIRCULAR
BUTTER WORKER DRIVEN BY ELECTRIC MOTOR.

report on its quality. We have known cases where the water used, both in the dairy and for drinking purposes, has been contaminated by drainings from the farmyard. Rain-water, although pure, is of little use for dairy purposes ; it may, however be sometimes stored and used for swilling floors, etc., to economise the much colder and superior well-water, which in dry seasons may run short.

(12) **A Separator.**

For separating the cream from the milk. Milk-setting pans, or pans for obtaining cream on the shallow setting system, may also just be briefly mentioned, though their use now is becoming very restricted, owing to the great advantages as regards economy in time, labour, and efficiency obtained by the use of separators.

By using shallow pans there is, on an average, a loss of $\frac{3}{4}$ of a lb. of butter in every ten gallons of skim milk, so that only those to whom the cost of production of the butter is immaterial can afford to use them.

(13) **A Churn.**

A good churn should embody the following points :

1. It should be simple in construction.
2. It should be made from well-seasoned wood of such a nature as to impart no taste or smell to the butter. Oak is most durable, though some other woods answer satisfactorily.
3. It should have a large opening, so as to facilitate cleaning. A lid (provided with a ventilator and glass window) to fit securely and yet be easily removable is a most important feature.

4. It should supply the greatest amount of concussion in order to make the fat globules coalesce.

There are several devices for quickly fastening down churn-lids now in use which do away with the old-fashioned thumb-screws, that, unless made in bronze or gun-metal, give so much trouble through becoming rusty. The fastenings used in substitution of the thumb-screws consist of quickly adjusted levers and, in the case of small churns, the lid is affixed to the churn by lowering either one or two levers. In the case where one lever rod is used, there is a cam attached at each end of the lid, so that when the swivel links are placed over the cams, a downward movement of the rod fastens the lid. The lever fastenings facilitate the quick opening and closing of the churn, and where the lid and top rim of the churn are reinforced with a metal liner, there is no difficulty in obtaining a tight joint with the usual rubber ring.

(14) **A Butterworker.**

The points of a good worker are :—

1. That it should be made of hard wood which is not easily roughened by salt or scrubbing.
2. It should provide sufficient slope to allow the water to run off easily.
3. The roller should be fitted at a suitable height from the table, so that when in use the water is pressed from the butter without the granular texture being damaged.

Butter-workers should be furnished with the following :—A butter-board of thick, plain wood ;

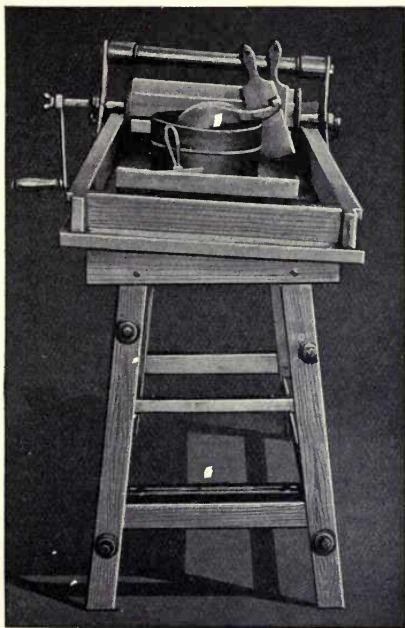

BUTTERWORKER,

WITH ITS ACCESSORIES, SCOTCH HANDS, SIEVE, SCOOP, SQUEEGEE
AND BUTTER BOARD.



1870

Scotch hands of box-wood well fluted and with sharp square corners; a wooden scoop, perforated for preference; a hair sieve; several squares of butter-muslin; hand scrubbing-brush and cream squeegee.

(15) **A Centrifugal Butter Dryer.**

Is sometimes used instead of the butter-worker. The butter must be in a granular condition, as if over-churned, it cannot be dried in this way. In winter, great care is needed to regulate temperatures

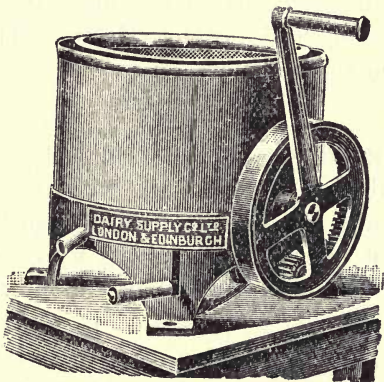

DELAITEUSE OR BUTTER DRYER.

carefully, so as not to get the grain too hard. Careful cleaning of the dryer after use is most necessary, to avoid its rusting and the cloths becoming coated with iron-mould.

(16) **A Temperature Can.**

Is useful for raising or lowering the temperature of the cream when in the churn, should this be necessary. It is filled with either hot or cold water, depending upon whether the temperature of the cream

is to be raised or lowered, and then moved about in the cream until it imparts to it the temperature desired.

(17) **Thermometers, etc.**

A large wall thermometer for recording temperature of the room, and floating thermometer accurately graduated for taking all the temperatures during working. Straining cloths, scales and weights, butter mould, beater, and packer. Grease-proof paper, chip or card boxes if considered necessary, pails, measures, and cream stirrers. Hard brush, mop and squeegee for floors.

(18) **Salt.**

Points of good salt for buttermaking :—

1. It should be free from all traces of grittiness.
2. It should be readily soluble and free from chemical impurities, such as gypsum, etc.
3. It should remain dry when kept under suitable conditions.

A simple test for *Mechanical Purity* is to dissolve a quantity of the salt in a glass of hot water and note if any discoloration or sediment appears on standing. Where butter is dry-salted, pure salt is absolutely essential.

An easy test for *Chemical Purity* may be made as follows. Procure half an ounce of oxalic acid crystals, which dissolve in four ounces of an equal mixture of liquor ammonia and water.

Take the salt to be tested, and dissolve a tablespoonful of it in water and place in a glass test tube, say 8 in. long by $\frac{3}{4}$ in. in diameter. If on pouring

in about a tablespoonful of the oxalic solution a cloudiness appears in the liquid, this indicates the presence of sulphate of lime or gypsum. Care must be taken in the use of oxalic acid, as it is a poison.

(19) **Butter Colouring,**

If used to supplement the natural colour of butter, often deficient, should embrace the following points :

(1.) It should consist of some harmless vegetable material, such as annatto, and be free from taste and smell.

(2.) It should be highly concentrated, easy to apply, and should colour the butter uniformly throughout.

The use of colouring matter composed of aniline dyes is to be condemned, as not only does it impart a non-appetising colour to the butter, but it is injurious to health.

Annatto colours may be recognised by turning a bluish-green colour on the addition of a few drops of sulphuric acid.

If on treatment with sulphuric acid a butter colour turns pink, or is not affected, it should be discarded as unsuitable.

In first-class dairies, the following also are essential :—

(20) **Ice Chest or Refrigerator Chamber,**

In which the butter is stored. This consists of a well insulated zinc lined chamber with compartments for holding the ice, and draw taps for drawing off the water which collects from the melting ice.

If well constructed a refrigerator chamber well packed with ice and salt should maintain articles

stored in it at nearly freezing point. If the doors are not too frequently opened to admit warm air a full charge of ice, etc., should last for about a week.

(21) **Butter Fat Tester**

For determining the percentage of fat in milk, cream, and other dairy products ; the best known of which is the Gerber.

Directions for using the Gerber Tester :—

(a) Invert the test bottles in the stand and add 10 c.c. of sulphuric acid of such a strength that its specific gravity registers 1.820 or 1.825 at 60° F the slightly stronger acid being preferable for winter use. (b) Next add slowly 11 c.c. of milk which has been carefully sampled and shaken so that the fat is evenly distributed throughout it.

It is best to allow the milk to run down the side of the bottle so that it does not come in too violent and quick contact with the acid, as it then becomes charred, and if allowed to stand some time before centrifugalising would produce a discoloration of the fat. Charred matter might also collect in the neck of the bottle and obstruct the reading. (c) Lastly add 1 c.c. of amyl alcohol, which should have a specific gravity of .815 or .816 at 60° F. Insert the rubber stoppers, and shake the bottles well. (d) Place the bottles necks upward in the centrifugal machine as quickly as possible after shaking, so that they do not lose heat, and rotate for about three minutes.

(e) Then take the bottles out of the machine, and if the fat appears as a clear yellow column in the

neck, read off the percentage directly, regulating the column of fat on the scale by either raising or lowering the stopper. If the fat is not clear, or appears frothy, the bottles should be placed in water at a temperature of 160° F. for a minute, and again rotated.

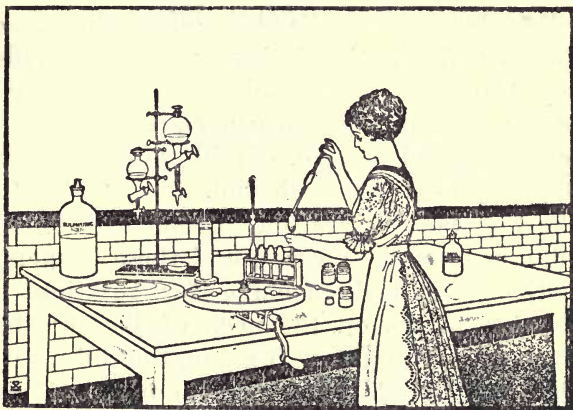

MILK TESTING BY "GERBER" METHOD.

Showing the measuring of milk into the test bottle, centrifugal machine, automatic acid and alcohol measures, etc.

(f) Always read the column of fat from the lowest point to the bottom of the little bubble or meniscus on the top.

Each large division on the scale represents 1 per cent. of fat, and each small division one-tenth, or .1 per cent.; so that if the fat extended over three large divisions and eight small ones this would represent 3.8 per cent.

Half a division, or .05 per cent., may be read in this test.

NOTE.—It is a good plan to keep a supply of ammonia and powdered chalk on hand when this test is in use, in case of accidents.

Ammonia will neutralise the strong burning action of sulphuric acid which may become spilt on clothes, etc.

(22) “Pocket” and “Sal” Methods.

Pocket Method is the Gerber method on a reduced scale. The test bottles and pipettes are half the usual size, and only half the usual quantities of liquid are employed, viz. $5\frac{1}{2}$ c.c. of milk, 5 c.c. of sulphuric acid, and $\frac{1}{2}$ c.c. of amyl alcohol.

The test bottles are put in lots of four into aluminium pockets or cases, and these pockets put into the centrifugal machine for rotation. The graduation marks on the neck of the test bottle are the same distance apart as on the full sized test bottles, hence reading the fat column is made easy. The pocket system reduces the expenses of testing, as only half the quantity of usual chemicals is employed. Furthermore, where the apparatus has to be carried about from place to place in isolated districts, as in the case of making milk records at farms, the lessened weight of materials needed is a great advantage.

Sal method, this method, in which no acid is employed, is recommended for those who are afraid of the danger in using sulphuric acid, which, although slight must not be overlooked. The full size Gerber test bottles are employed in using this method.

(23) Testing Cream.

This may be done in three ways :—

(1) By first diluting the cream with water taking a measured portion of the mixture, and making the test in the *ordinary* Gerber test bottle, treating the diluted cream as if it were milk, or

(2) By measuring cream into Gerber test bottles graduated to read up to 50 per cent. of fat.

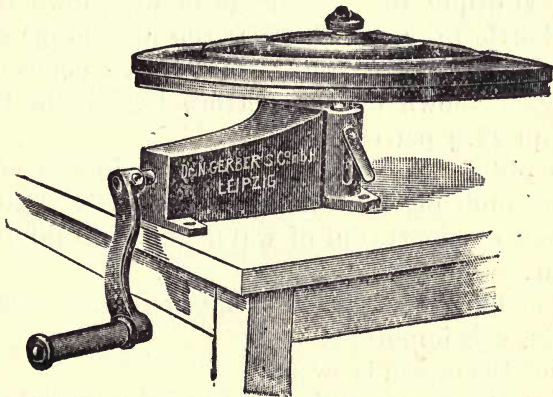

"GERBER" TESTER (CRANK HANDLE PATTERN.)

(3) By weighing the cream and using the *special* Gerber test bottle for estimating the fat in cream and butter.

Using the ordinary Gerber Test Bottle.

The fat in cream may vary from 15 to 70 per cent. Now, the ordinary Gerber test bottle will only show 9 per cent. of fat, hence it is necessary to dilute the cream with two, three, four, five, six or more volumes of water in proportion to its supposed richness.

Assume that cream of the quality ordinarily used for churning purposes is to be tested, then :—

(a) Take 11 c.c. of cream and place it in a dry bottle or flask, and using the same pipette add three pipettesful (33 c.c.) of water.

(b) After carefully mixing the cream and water together, take 11 c.c. of the mixture and test it as if it were milk.

(c) Multiply the percentage of fat shown in the test bottle by 4, which gives the percentage of fat contained in the cream. Thus, if 7.1 per cent. of fat were shown on the bottles, the cream would contain 28.4 per cent.

To obtain the percentage of fat in the cream, always multiply by a number one greater than the number of pipettesful of water added to dilute the cream.

In making this test to get approximately accurate results, it is important :—

That the cream is sweet.

That the cream and water are at a temperature of 70°F. otherwise thorough mixing will be difficult.

That the mixture is measured off and put in the test bottle without delay after mixing.

That the test bottles are read at a temperature of 160° F.

Using Gerber Test Bottles graduated to read up to 50 per cent. Fat.

Mix the cream thoroughly. If very thick or frothy, heat the cream to 110° F., and then cool to 60° F., keeping it well stirred.

- (a) Measure 10 c.c. of sulphuric acid into the test bottle.
- (b) Measure 5 c.c. of cream, and wipe the outside of the pipette before delivering the cream into the test bottle.
- (c) Measure, in another pipette, 5 c.c. of water, and run it through the test bottle through the pipette used for measuring the cream, and so get out all the cream. This is done by inserting the bottom end of the pipette containing the water into the top of the cream pipette, and rotating the two as the water is delivered into the test bottle.
- (d) Lastly, add 1 c.c. of amyl alcohol, and after corking and shaking the test bottle rotate in the centrifugal machine.

To read the result get the bottom of the meniscus, to be found at the top of the fat column, in line with the graduation mark 0.

Weighing the cream and using the Special Gerber Test Bottle, in which a small cup is provided which fits into the rubber stopper; the bottles are open at each end. To make the test:—

- (a) Weigh the rubber stopper and cup empty.
- (b) Fill the cup with cream and weigh again; the difference is the weight of cream taken.
- (c) Place the cup and stopper in the test bottle and add 10 c.c. of sulphuric acid and 10 c.c. of water (preferably distilled water) at a temperature of 70° F.
- (d) Insert the second stopper and shake vigorously; then immerse the bottle in water at 160° F. for a

few minutes, removing the stopper from the top of the bottle.

- (e) Rotate, and then when the fat appears as a clear yellow column, read off the number of divisions it occupies on the scale.

In using these bottles for testing either cream or butter, the result—*i.e.*, percentage of fat—is calculated on 5 grams.

EXAMPLE.—If 4.6 grams of cream were weighed out for the test, and this quantity yielded 27 divisions of fat, then 5, the quantity upon which the result must be calculated because of the construction of the test bottles, would yield 29.3 divisions of fat; therefore the cream contains 29.3 per cent. of fat.

(24) Testing Separated Milk, Skim Milk, and Buttermilk.

For this purpose the special "precision" Gerber test bottle should be used. In this bottle a portion of tube at the extremity is made very narrow, so that the divisions on the scale are wide apart and more easily read.

The points to be observed in testing separated milk and buttermilk are:—

- (1) Use sulphuric acid, which has a specific gravity of 1.816.
- (2) Whirl the bottles longer than in testing new milk, removing them two or three times for heating. The temperature must be kept up to 160° F., otherwise the fat will not separate out.
- (3) Read to the *top* instead of to the bottom of the meniscus.

(25) Gerber Dirt in Milk Tester.

As it is most important that the milk used for buttermaking should be clean, a simple means of testing for the amount of dirt present is required. The "Gerber" Dirt Tester answers well, and is operated as follows:—

The test bottles, which are open at both ends, are made to hold one pint of milk. At the narrow or neck end of the bottle is fitted a small piece of wire gauze which clasps on to the end, forming a strainer. Before the gauze is clasped on to the neck, a small disc of cotton wool is placed on it, thus, when the bottle is fixed in the stand ready for use and the milk poured in at the wide or top end, it flows through the piece of cotton-wool, which retains any dirt or sediment present. The cotton-wool disc may be dried on blotting paper and preserved. It is an excellent plan when buying milk for buttermaking or other purposes to make tests periodically of each supplier's milk, and forward to him the disc of cotton-wool which shows the amount of dirt taken from a pint of milk. There is nothing which will prove so effective and demonstrate so clearly the necessity for cleanliness as to see the dirt on the small cotton-wool pad that has been removed from the milk. The test is best made with milk warmed to 100° F.

(26) Acidimeter.

For testing the degree of acidity (calculated as lactic acid) in milk, cream, starter, etc., as first suggested by Professor F. J. Lloyd. The following are required for the test:—Burette and stand, caustic

soda solution of definite known strength [each cubic centimetre equivalent to .01 grams of lactic acid], phenol phthalein solution, pipette holding 10 c.c., and small porcelain dish with glass stirring rod.

Directions for using Acidimeter.

(a) Take and carefully measure off 10 c.c. of the cream or liquid to be tested. (b) Add three or four drops of the phenol phthalein. This acts as an indicator, turning pink as soon as the acid has been neutralised. (c) Gradually add the caustic

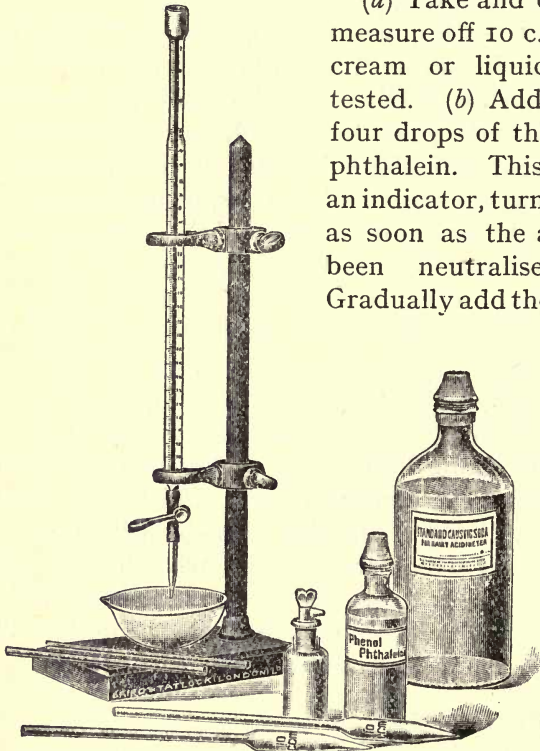

DAIRY ACIDIMETER.

Showing burette in burette stand, porcelain dish underneath for making the test, glass stirring rods, 10 c.c. pipette for measuring milk, drop bottle containing phenol phthalein solution or indicator and stock bottle of n/9 Caustic Soda solution.

soda from the burette, stirring the solution continually. (d) As soon as the permanent pink tinge appears, stop, and note how much soda has been used.

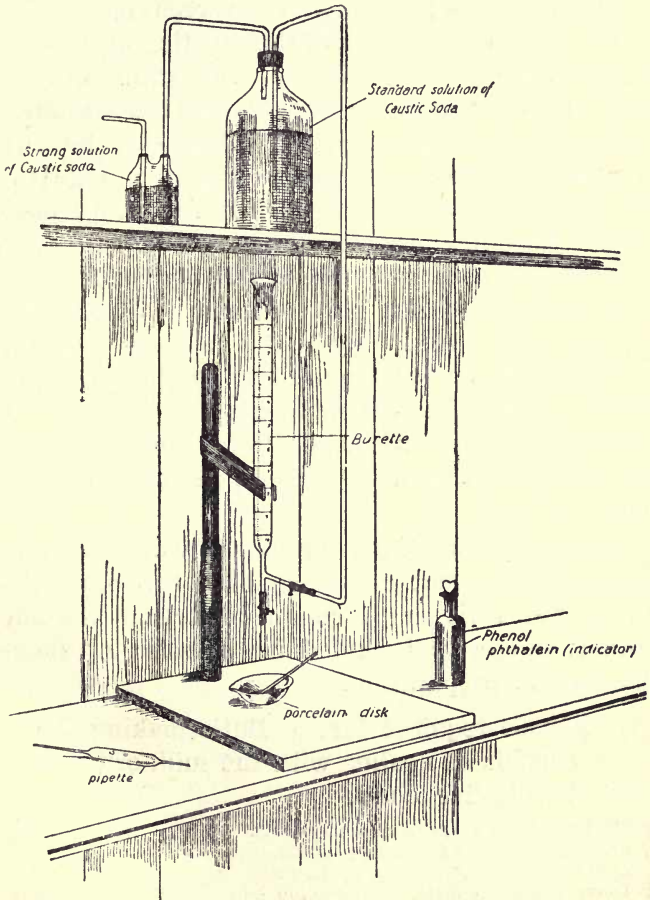

ACIDIMETER

AS USED IN LARGE DAIRY WHERE CONSTANTLY REQUIRED, THE BURETTE IS SELF-FILLED WHEN THE TAP ON THE DOWN TUBE FROM THE STOCK BOTTLE IS OPENED.

EXAMPLE.—Initial reading of burette, 0. When pink tinge is permanent, reading is 5.3—*i.e.*, 5.3 c.c. of caustic soda have been added to neutralise the acid in the cream ; therefore the percentage of lactic acid = .53. The strength of the caustic soda solution is such that each c.c. denotes .01 grams of lactic acid. If this amount were contained in 100 grams of cream, the percentage would obviously be .01 ; if contained in 10 grams of cream, the percentage is .1. Ten grams of cream are very nearly 10 c.c., whence it follows that having taken 10 c.c. of cream, each 1 c.c. of soda used will represent .1 per cent of lactic acid, and each tenth part of a c.c. will represent .01 per cent. Assuming that five large and five small divisions were required to produce the pink colour, then the cream contains .55 per cent acid calculated as lactic acid. Properly ripened cream will contain between .35 and .4 per cent. of lactic acid.

NOTE.—The solution is prepared by dissolving 4.5 grams of 98 per cent. caustic soda in a litre of distilled water, but it is not recommended that the dairy worker, unless well skilled in chemistry, should attempt its preparation.

(27) Utensils required for a Buttermaking Dairy, capable of dealing with the milk of twenty to twenty-five cows.

- 4 Steel Milking Pails, capacity 16 quarts.
- 3 Enamelled Pails, capacity 14 quarts.
- 2 Light Steel Pails, capacity 14 quarts.
- *1 Dairy Herd Recorder, for weighing and recording the weight of milk yielded by each cow.
- 1 Milk Filter or Strainer in which cotton-wool discs are used.
- 4 Railway Churns, capacity 17 gallons.

- 1 Gerber Milk Tester complete, 4 bottle size
- *1 Refrigerator capable of cooling 120 gallons of milk an hour, with pan for milk.
- 1 Cream Separator capable of separating about 60 gallons of milk an hour.
- 1 Churn capable of dealing with 12 gallons of cream at a churning.
- 1 Butterworker, size 44 by 20 inches, with stand complete.
- 3 pairs of Scotch hands.
- 1 Butter Scoop, large size.
- 2 Hair Sieves, diameter 10 inches.
- 2 Butter Boards, 24 by 18 inches.
- 2 Floating Thermometers.
- 1 Wall Thermometer.
- 2 Drums for ripening cream, capacity 96 quarts.
- 2 Wooden Stirrers for cream.
- 1 Cream Squeegee.
- 1 Set of Scales (to weigh up to 10 lb.) and weights.
- 2 Measures, capacity 1 pint.
- 2 Measures, capacity 1 quart.
- Straining Muslin, 20 yards.
- Butter Paper, 14 lbs.
- Dairy Salt, 56 lbs.
- *1 Refrigerator, in which to store and harden butter after making.
- Sundries, including floor brushes and squeegee, large and small can brushes, railway churn brushes, chip butter boxes, etc.

No mention has been made in the foregoing list of apparatus for the supply of hot water. This may be provided either by an ordinary copper or by a small vertical steam boiler of, say, 1 or 1½ horse power. The former method of providing hot water is the more common, as it is the cheaper. Where a boiler is fitted, both steam and hot water are obtainable, and for properly cleansing dairy utensils there is nothing so good as scalding them out with live steam, which quickly destroys all bacteria. The items marked with an asterisk are not absolutely essential in a buttermaking dairy, but their inclusion is strongly to be recommended. If not included, the cost of utensils for a dairy capable of manufacturing into butter the milk of twenty to twenty-five cows would be greatly reduced

CHAPTER III.

THE PRODUCTION OF CREAM.

(28) Systems of Creaming,

THERE are three systems of cream raising :—

- (1) Shallow setting.
- (2) Deep setting.
- (3) Separator.

Shallow Setting System, in which the milk is set to cream in shallow layers. Separation of cream from the milk serum with which it is mixed takes place owing to the action of gravity, the light cream separating from the heavier milk serum. This system includes the production of cream by :—

The use of shallow pans.

The Devonshire method.

The use of leads.

The use of creamers, in which cold water is made to circulate round through jacketted pans.

Deep Setting System, in which the milk is set to cream in very deep layers. The rising of the cream is assisted by surrounding the vessels containing the milk with cold running water or ice.

This system includes the production of cream by :—

The use of Swartz cans.

The use of Cooley cans.

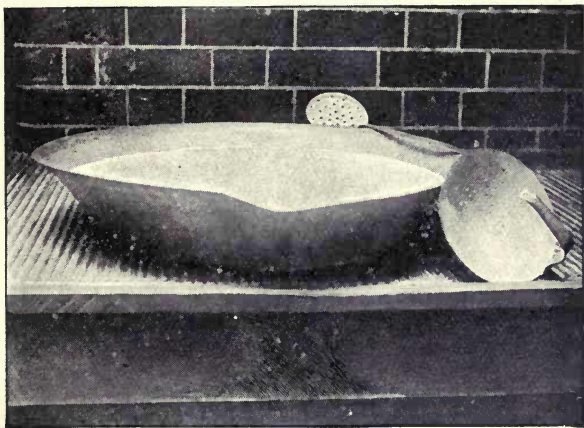

SHALLOW PAN, WITH SKIMMER.

Neither of these methods are much used now, having been displaced by the mechanical cream separator.

Separator System, in which milk is submitted to centrifugal force, and immediately separated into milk and cream.

This system includes the production of cream by means of mechanical separators.

Obtaining cream by means of the separator is the only method that can be adopted where buttermaking for profit is the object in view.

(29) Cream Separators.

The advantages of creaming by means of a separator are :—

(1) The production of cream is brought about immediately, and perfectly sweet cream and separated milk are obtained.

Perfectly sweet cream is very necessary in the cream trade, which cannot well be catered for where other methods of creaming are adopted.

It is essential to commence with sweet cream in buttermaking, as the ripening of partly sour cream cannot be controlled. Sweet cream may be inoculated with starter, and the correct ripening produced.

Sweet separated milk, to which some butter fat substitute, such as linseed or cod-liver oil, is added, is a valuable food for calf-rearing. It is much superior to skim milk obtained from other methods of creaming, which is often stale or sour, especially in hot weather.

(2) The separation of the cream from the milk is so complete that only .1 per cent. of fat is at most lost.

This being the case, much more butter is obtained, and the yield is usually increased 10 to 12 per cent.

Interpreting this in another way, it means that if a cow gives 250 lbs. of butter in the course of a year when a separator is used, the yield would be about

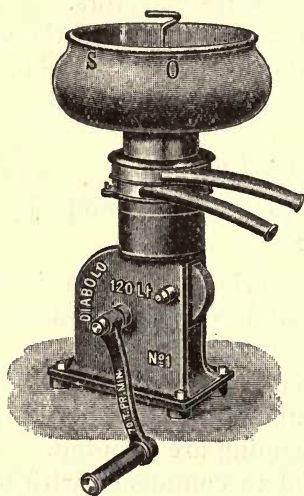

“DIABOLO” HAND-POWER CREAM SEPARATOR.

35 lbs. less were the shallow pan method of creaming adopted.

(3) Less space is occupied in the dairy by a separator than by the utensils used in the other methods of creaming.

(4) Less labour is necessary, the work being quickly and expeditiously performed.

(30) Centrifugal Force.

The centrifugal force by which cream is separated from the heavier milk serum in the bowl of a separator may be regarded as the force of gravity multiplied several thousandfold in strength. Thus the force which takes several hours to bring about the sepa-

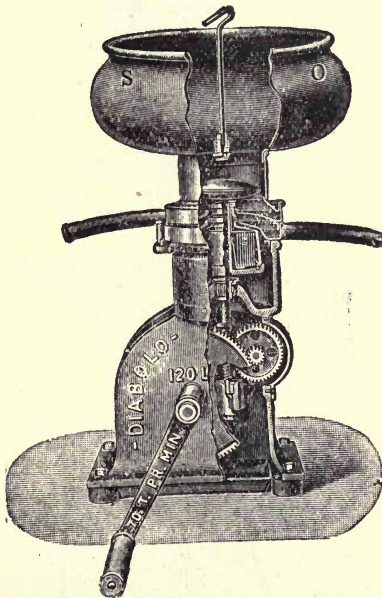

SECTIONAL CUT OF "DIABOLO" HAND-POWER SEPARATOR.

ration of cream from milk in shallow pans is so strengthened that in the separator it is able to do similar work in a minute or two.

Centrifugal force is that force which causes bodies to be thrown off from the centre of revolution ; thus a stone tied to a piece of string and swung round at

a rapid speed is being submitted to centrifugal force and the greater the speed the greater the amount of centrifugal force exerted upon the stone.

In the separator bowl centrifugal force acts and

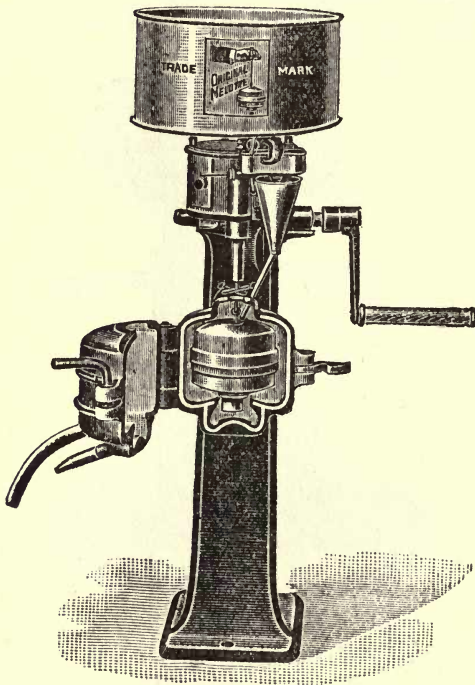

"MELOTTE" HAND-POWER SEPARATOR.

tends to throw both milk serum and cream in an outward direction. The two liquids are of different densities, ; the heavier one is thrown to the outside first, and continues to occupy this position, as the

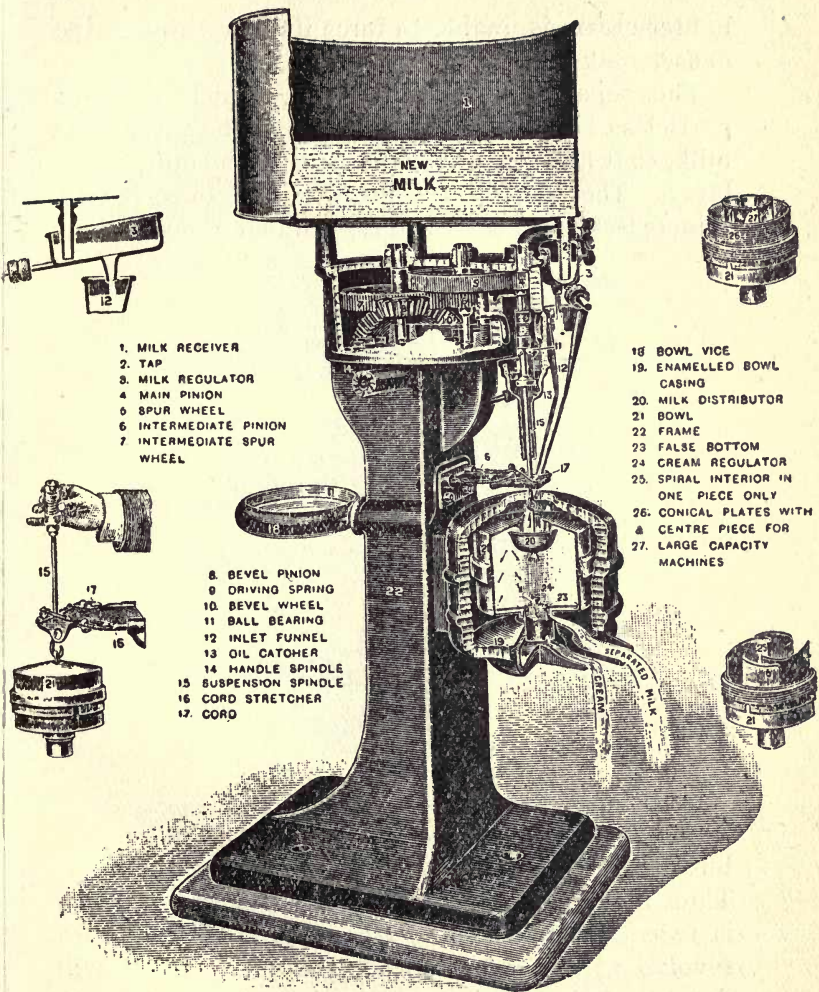

- 1. MILK RECEIVER
- 2. TAP
- 3. MILK REGULATOR
- 4. MAIN PINION
- 5. SPUR WHEEL
- 6. INTERMEDIATE PINION
- 7. INTERMEDIATE SPUR WHEEL

- 8. BEVEL PINION
- 9. DRIVING SPRING
- 10. BEVEL WHEEL
- 11. BALL BEARING
- 12. INLET FUNNEL
- 13. OIL CATCHER
- 14. HANDLE SPINDLE
- 15. SUSPENSION SPINDLE
- 16. CORD STRETCHER
- 17. CORD

- 18. BOWL VICE
- 19. ENAMELLED BOWL CASING
- 20. MILK DISTRIBUTOR
- 21. BOWL
- 22. FRAME
- 23. FALSE BOTTOM
- 24. CREAM REGULATOR
- 25. SPIRAL INTERIOR IN ONE PIECE ONLY
- 26. CONICAL PLATES WITH CENTRE PIECE FOR
- 27. LARGE CAPACITY MACHINES

SECTIONAL CUT OF "MELOTTE" SEPARATOR.

lighter cream is unable to force its way through the denser milk serum.

The separator slime, or filth, which contains particles of dirt, is found to collect on the sides of the milk, so it finds its way even through the milk serum layer. The law respecting centrifugal force is that it increases as the square of the number of revolutions

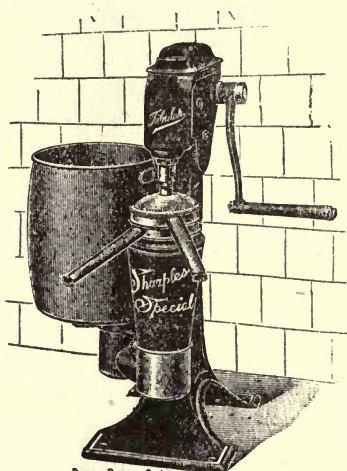

DAIRY OUTFIT CO LTD
KINGS CROSS, LONDON.

“STANDARD” TUBULAR CREAM SEPARATOR.

but decreases directly as the diameter of the bowl. Thus, if there are two separator bowls, one of which is twice the diameter of the other, and they both revolve at the same speed, the larger bowl will develop twice the amount of centrifugal force. But if two bowls of equal diameter are taken, and one made to revolve at twice the speed of the other,

the faster driven bowl will develop four times the amount of centrifugal force.

(31) Efficiency of Separation.

There is in existence at the present time a large number of different makes of cream separators, and

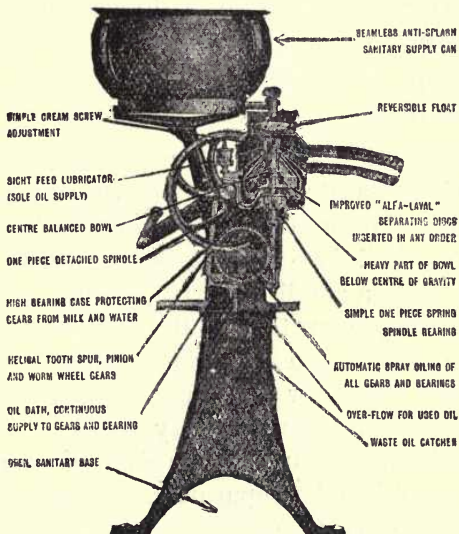

SECTIONAL CUT OF THE "ALFA-LAVAL" CREAM SEPARATOR, WHICH IS FITTED WITH SELF-BALANCING BOWL AND SPINDLE.

the work of many of them is so complete that scarcely any fat is left in the separated milk. A good separator will leave never more than .1 per cent. of fat in the separated milk, whether it be driven by hand or other power. In many power separators, where the milk is separated at a temperature of from 120° to

130° F., the quantity of fat left in the milk can be often reduced to .05 per cent.

(32) Varieties of Separators.

These are of four kinds :—

1. Hand-power separators.
2. Separators driven by a direct-coupled electric motor.
3. Steam turbine separators.
4. Belt-driven separators.

Separators driven by hand power can be produced which will separate from 72 up to 110 gallons per hour. The larger the separator the greater the labour required for carrying out the work.

Where only a small quantity of milk is dealt with a hand-power separator should be used, but for any large quantity an electric, steam turbine or belt-power separator is to be recommended.

Turbine separators are very useful in farm and other dairies when such a quantity of milk is dealt with as would make separation by hand-power too laborious an operation.

The great advantage of the turbine separator is the simplicity with which it is fitted and worked. A steam boiler is all that is required, as a jet of steam, at a comparatively low pressure drives the turbine, hence there is no expense of an engine. Turbine separators may be obtained which will separate from 65 up to 440 gallons per hour. The disadvantage of the turbine is the difficulty in maintaining uniform speed, especially in the large capacity

separators, owing to the steam pressure varying in the boilers.

In separators driven by belt-power, the power may be derived from a steam engine, electric motor

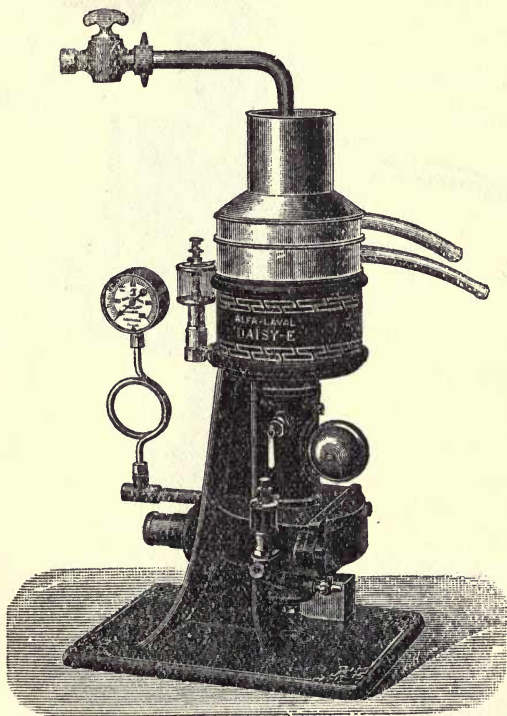

“ALFA-LAVAL” STEAM TURBINE SEPARATOR.

gas, oil or petrol engine. The drive may either be direct on to a pulley attached to the separator, or through an “intermediate” on to the spindle pulley, which is the commoner plan. The direct-driven

machines are now much used, especially in the large size machines.

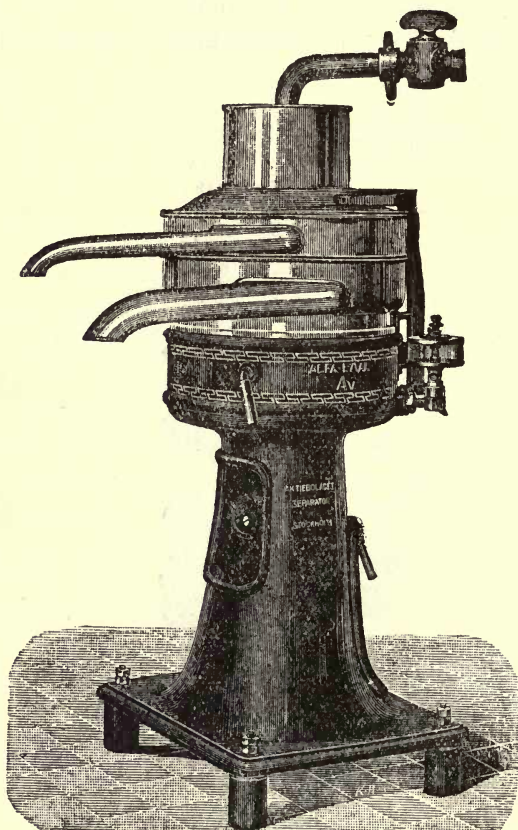

“ALPHA-LAVAL” POWER SEPARATOR.
INTERMEDIATE BELT DRIVE.

Belt power separators may be obtained of almost any capacity up to 800 gallons per hour.

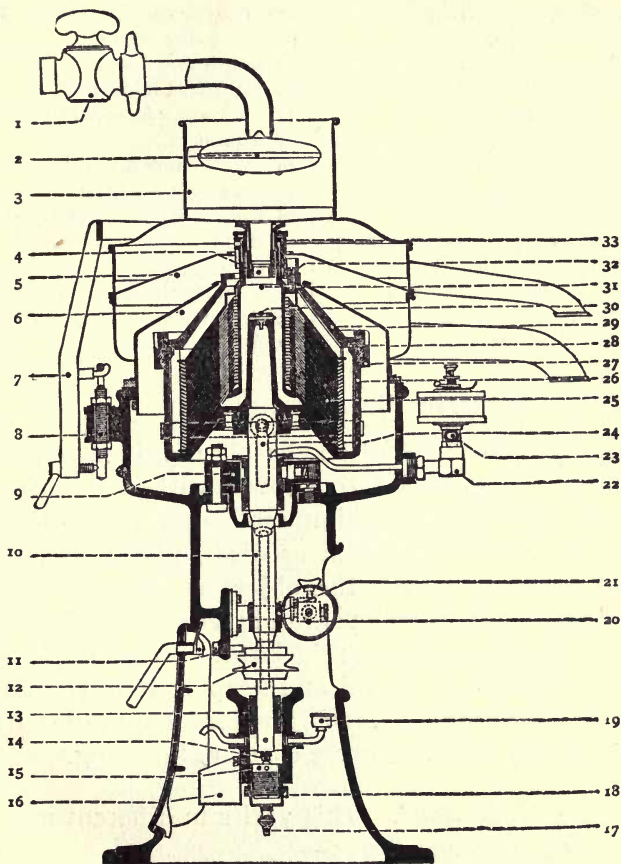

SECTIONAL CUT OF "ALFA-LAVAL" BELT-POWER SEPARATOR.

List of the different parts of the "Alfa-Laval" Separator shown in sectional cut.

- | | |
|----------------------|--------------------------|
| 1 Milk faucet. | 5 Cream cover. |
| 2 Float. | 6 Skim milk cover. |
| 3 Regulating cover. | 7 Cover-arm with hook. |
| 4 Regulating nozzle. | 8 Fixture for cover-arm. |

- | | |
|--|--|
| 9 Spring top-bearing. | 21 Speed indicator sleeve with fixing screw. |
| 10 Bowl spindle. | 22 Lubricator fixture. |
| 11 Stop screw for bowl spindle. | 23 Sight feed lubricator. |
| 12 Rope pulley. | 24 Lock screw for separator bowl. |
| 13 Lower bushing. | 25 Alfa discs. |
| 14 Steel-point with spring and belleville springs. | 26 Bowl cylinder. |
| 15 Bottom screw. | 27 Lock ring for hood. |
| 16 Waste-oil reservoir. | 28 Rubber ring for separator bowl. |
| 17 Escape tap for waste-oil cup. | 29 Hood. |
| 18 Waste-oil cup for bottom screw. | 30 Conveyer. |
| 19 Oil cup for bottom screw. | 31 Tubular shaft. |
| 20 Speed indicator. | 32 Cream screw. |
| | 33 Alfa top disc. |

(33) The Separator Bowl.

Considerable attention has been given to the construction of separator bowls with the idea of producing perfect skimming. Various internal movable structures, such as discs, plates, etc., are used in many bowls, the object of these being to split up the milk into layers and give it a long distance to travel before it leaves the bowl. By giving it this extra distance to travel and keeping it in the bowl longer, it is submitted to a greater amount of centrifugal force, which causes a cleaner skimming.

Speed of the Bowl. This varies in different makes and sizes of separators:—

“Alfa-Laval,” 5,600 revolutions per minute, not to exceed 6,000.

“Crown,” about 6,600.

“Diabolo,” 11,500.

“Lister,” 9,500 to 10,000.

“Melotte,” about 7,000 to 8,000.

“ Perfect,” (hand-power), about 8,000, and (belt-power), 5,600.

“ Standard Tubular,” about 13,000 revolutions per minute.

Regulating the Percentage of Cream Taken off.—
This is done by means of altering the cream screw

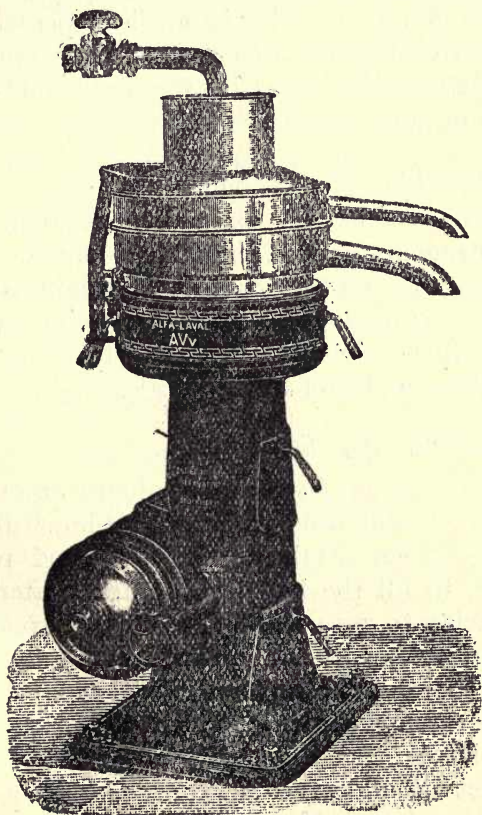

“ ALPHA-LAVAL ” POWER SEPARATOR,—DIRECT BELT DRIVE.

or cream outlet, remembering that the nearer the cream is taken off from the centre of the bowl the thicker and richer it will be. Thus by turning in the cream screw or reducing the outlet a smaller percentage of richer cream is obtained, and *vice versa*.

If it be desired to obtain thicker cream whilst separating is going on, and it is not desired to stop the machine to alter the cream screw, then the result may be attained by increasing the speed and reducing the flow of milk into the bowl.

(34) **Separating Temperatures.**

To obtain cleanest skimming, a temperature between 120° and 130° F. should be adopted. On the farm, milk should be separated straight from the cow before it has lost its animal heat, but never at a temperature below 85° F. Below this temperature clean skimming is not likely to take place.

(35) **Working the Separator.**

The speed should be got up gradually and the milk should not be allowed to enter the bowl until full speed has been attained. It is a good practice, however, to fill the bowl with warm water before commencing to get up speed, as this will reduce the vibration likely to occur in running an empty bowl. When separation is completed, warm water should be passed through the machine whilst still running, which will facilitate cleaning operations. Never stop a separator, but allow it to run down of its own accord, and always thoroughly clean all parts after use.

The Causes of Vibration or Shaking of the Separator : —

- (a) Machine not fixed on a solid foundation or not level.
- (b) Power not applied with perfect regularity and evenness.
- (c) Discs not in their proper order, or one or more left out.
- (d) Top portion of the bowl (the hood) not screwed up tightly.
- (e) Bowl itself out of balance.
- (f) Inflow of milk not regular.
- (g) Bearings worn and allowing the bowl too much play.

The bearings of a separator should occasionally be washed out with a little petroleum, and always be kept well oiled with a suitable brand of separator oil.

Booklets dealing very fully with the working and management of cream separators are supplied by the makers with the different machines.

(36) **The Essentials for Successful Separation.**

- (1.) A uniform and sufficiently high speed of the bowl. Separators should always be worked at the speed recommended by their makers.
- (2.) Clean fresh milk of a suitable temperature. It should never be below 85° F.
- (3.) A uniform supply of milk. It is always best to separate a rather smaller quantity of milk per hour than the separator is capable of dealing with when working at its full capacity.

- (4.) An efficient oiling of all the bearings of the separator. If this is not attended to, the high speed at which separators are driven will soon produce excessive wear on the bearings.

If the separated milk contains too much fat it may be due to want of attention to any of the above points, or because too thick cream is being taken off. In such a case, the cream, being thick and unable to get away quickly is partly driven into the separated milk. Another cause may be the bowl being too low in the frame, when the cream outlet throws a portion of cream into the separated milk cover.

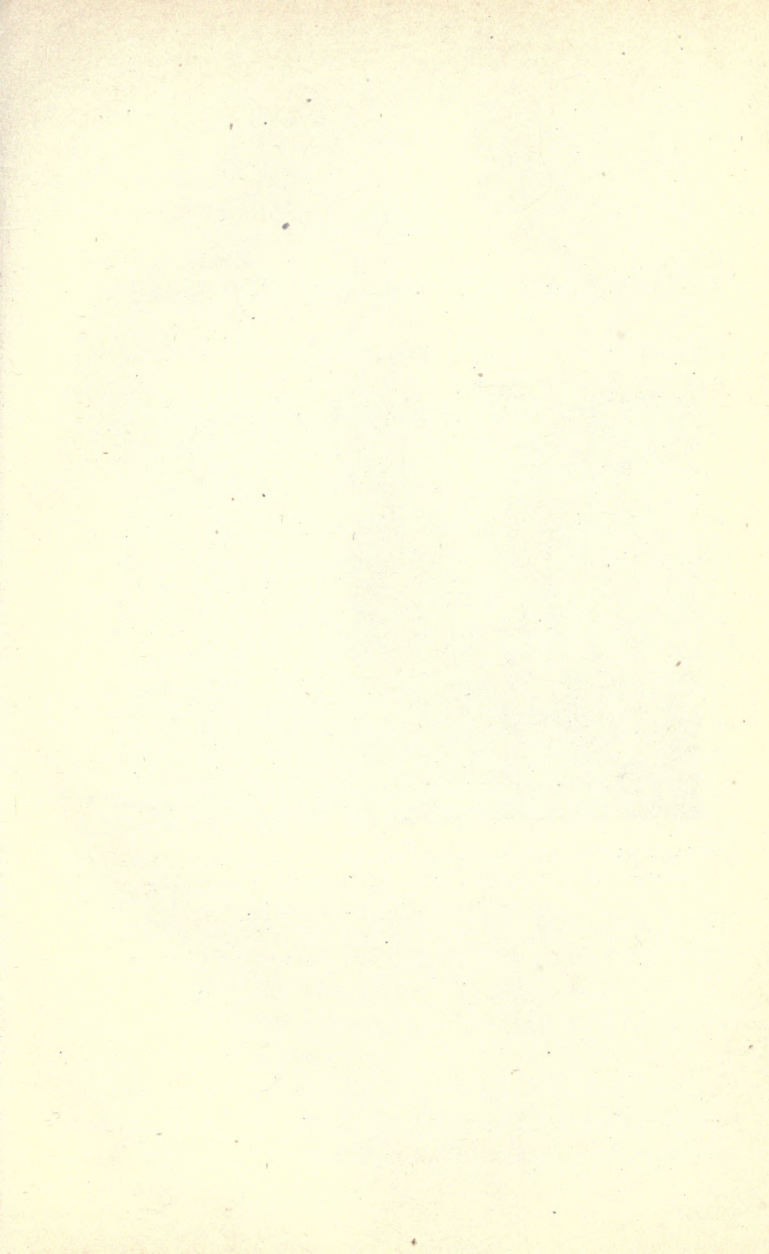



SMALL DAIRY, SHOWING TURBINE DRIVEN PASTEURIZER AND SEPARATOR.—MILK FED INTO PASTEURIZER FROM TANK ON RECEIVING PLATFORM OUTSIDE.

CHAPTER IV.

CREAM PERCENTAGES FOR CHURNING.

THE quality of cream for churning purposes is a very important matter, and must be regulated to suit various requirements.

(37) **Percentage of Cream.**

Expresses the quantity of cream obtained from one hundred parts of milk. By regulating the separator it is possible to take off any number of parts of cream from one hundred parts of milk. In practice the quality of milk is the main factor which regulates the percentage taken off in separating; the richer the milk the greater the percentage obtainable. The percentage taken off will vary from about 10 to 15 per cent., and should be so regulated that the cream contains 26 to 30 per cent. of fat in *summer and autumn*, and 30 to 35 per cent. of fat in *winter*.

For general working, both on the farm and in the creamery, 12 per cent. of cream is a good proportion to take off from the milk. During summer it is advisable to have cream for churning rather poorer in fat than in winter.

Thin cream is to be recommended for *summer and autumn* use, because it is more readily cooled either by natural means or mechanical refrigeration,

it ripens quickly and uniformly, and when churned yields butter grains of the best possible kind. It is always possible to extract the fat more completely from milk by the separator when taking off thin cream.

In winter thicker cream is desirable, because churning is usually done less frequently, a smaller quantity of milk being obtainable. A thicker, richer cream does not ripen so quickly, so that it does not become over-ripe by the time it is required for churning. The difficulties of cooling are absent.

Where the thicker cream is taken off it is desirable to raise the separating temperature, to avoid unnecessary loss of fat in the separated milk.

It is seldom, if ever, advisable for buttermakers to take off less than 10 per cent. of cream or have present over 35 per cent. of fat in it. Auxiliary dairies, however, may separate a richer cream, and so save carriage when sending it to the churning centre, where it may be diluted down with starter or clean fresh separated milk.

(38) Cream Percentage Calculations.

To find the Percentage of Fat in the Cream, given the quality of the milk (percentage of fat) and the percentage of cream taken off.

$$\frac{\left(\begin{array}{l} \% \text{ Fat} \\ \text{in Milk} \end{array} - .1 \begin{array}{l} \text{Loss in} \\ \text{separating} \end{array} \right) \times 100}{\% \text{ of Cream taken off.}} = \% \text{ of Fat in Cream.}$$

EXAMPLE.—Milk contains 3.7 per cent. fat, and 12 per cent. cream is abstracted. What percentage of fat would be present in the cream?

$$\frac{(3.7 - .1) \times 100}{12} = \frac{360}{12} = 30 \% \text{ Fat in Cream.}$$

To find the Percentage of Cream Taken Off, given both the percentage of fat in the milk and in the cream, as found by the Gerber tester.

$$\frac{\left(\begin{array}{c} \% \text{ Fat} \\ \text{in Milk} \end{array} - \begin{array}{c} \text{Loss in} \\ \text{separating} \end{array} \right) \times 100}{\% \text{ of Fat in Cream.}} = \% \text{ of Cream.}$$

If milk containing 3.7 per cent of fat is separated and the cream contains 30 per cent. of fat, what percentage of cream has been taken off?

EXAMPLE.

$$\frac{(3.7 - .1) \times 100}{30} = \frac{360}{30} = 12 \% \text{ Cream taken off.}$$

These calculations are sufficiently accurate for all practical purposes.

CHAPTER V.

CREAM RIPENING.

(39) Cream Ripening or Souring

CONSISTS principally of the development of lactic acid in the cream by bacteria, which convert part of the milk-sugar present into lactic acid. The fermentation which goes on liberates the fat globules from association with the casein in such a way that the process of churning is rendered more complete. Cream ripening is of two kinds— (1) natural, and (2) by use of starters.

(40) Natural Cream Ripening.

The cream, as taken from either separator or pans, is frequently stirred, and allowed to sour or ripen of its own accord. The time taken in ripening will vary with the temperature of the surroundings and the temperature at which the cream is set.

A small quantity of cream will take longer than a large amount, as, owing to greater loss of heat fermentation is not so active. Shallow-pan cream, on account of its having already developed a certain acidity during rising, and being well aërated, ripens more quickly than that fresh from the separator.

Thin cream ripens more quickly than that which is thick and rich, owing to its containing a larger

quantity of sugar and less fat. Sugar helps to promote and fat tends to check ripening.

Any temperature between 60° and 68° F. produces satisfactory ripening. Below 60° F. fermentation other than lactic may take place, and produce bitter flavours in the butter. Above 70° F. the cream and butter develop an oily taste. Roughly speaking, the time taken to ripen cream is from one to two days in summer, and from three to four days in winter. The common reason why farm butter is often so bad in winter is because the cream is kept too long and at too low a temperature. Churning should always be performed at least twice a week.

Mix the different lots of cream, if any, some twelve hours before churning. The ripeness will then be the same throughout. If cream of different ages be mixed together just before churning, a considerable loss of fat in the buttermilk takes place, the butter coming of uneven quality.

Common means of assisting natural ripening include the following :—

(a) Warming the cream to 90° F. and allowing it to cool gradually. This promotes acidification in cold weather.

(b) Adding sour buttermilk obtained from a previous churning of good-flavoured butter at the rate of half to one pint to the gallon of cream. This should be kept at 65° F. until ripe, and then lowered to the temperature at which it is decided to churn. The cooling should be effected several hours before churning, to ensure good texture of butter.

Importance of Stirring Cream during Ripening.—Lactic acid and many bacteria which produce good flavours in cream and butter grow best where a good supply of pure air is obtainable. Butyric and many ferments producing strong, rancid and bitter flavours develop best in the absence of air, hence the necessity of frequent stirring to incorporate air with the cream.

(41) **Starters.**

Are of two kinds :—

- (1.) Naturally prepared, and
- (2.) Pure culture starters.

Natural starters are sour milk, buttermilk, etc. To specially prepare a starter of this kind, take a quart of new milk of known good quality and allow it to sour in a pure atmosphere. The milk best suited for this purpose is that drawn from the clean udder of a healthy cow into a thoroughly scalded vessel. If at a creamery, milk from the supplier who is known to give the greatest care to cleanliness should be taken. In twenty-four hours souring takes place if the milk is kept at a suitable temperature, such as 70° to 75° F. in summer, and 75° to 80° F. in winter. The top is skimmed off and thrown away, and the rest stirred and mixed with a couple of gallons of separated milk which has been pasteurised by heating to a temperature of 185° F. for twenty minutes. This inoculated milk (preferably kept in an enamelled pail) should be frequently stirred for the first few hours, covered over with a muslin cloth, and left to sour. The temperature should be maintained at about 70° F

in summer, and 75° F. in winter. By next day the starter is available, though it is better not to use this, but to put one pint of it into two more gallons of pasteurised separated milk, which, when soured, may be used in the cream to promote ripening.

Pure Culture Starters are prepared either from pure laboratory or commercial cultures. A commercial culture, either as a powder or in liquid form, is well stirred into pasteurised separated milk as above, and kept at 80° F. until the whole has soured. This is added to further quantities of pasteurised milk daily, and so a pure culture starter is kept available. The souring takes from twenty to twenty-four hours, the time being dependent upon the quantity used for renewing into the freshly pasteurised milk, and the temperature at which it is kept; these factors also regulate its consistency. If the souring is too feeble, the quantity used for inoculation should be increased. When large quantities of starter are required, pasteurised milk is similarly inoculated by the use of 8 to 12 per cent. of the old starter. A pure culture starter consists of lactic acid bacteria only. A home-made starter, if properly prepared is practically a pure culture.

(42) **Ripening Cream with Starter.**

The fine flavour of butter depends not only upon the growth of lactic acid bacteria, but upon the development of other ferments in the cream; hence it is that the finest flavoured butter can be produced without the addition of any starter and many first-class buttermakers do not use starter.

The use of too much starter may, in fact, prevent the production of the finest flavoured butter by the lactic acid bacteria crowding out, and preventing the growth of other kinds. Starter should therefore be used with discrimination, and in small dairies will be found most useful where it is difficult without it to ensure producing butter of uniformly good quality.

The amount of starter to add depends upon the quantity and quality of the cream, the temperature and the time in which it is desired to complete the ripening. Roughly, the starter to employ with small quantities of cream is from $\frac{1}{2}$ to 1 pint to each gallon of cream—the former amount say in summer, and the latter in winter.

Successful cream ripening requires :—

(a) A dry and well-ventilated room with a certain amount of daylight, but not too much, as this causes discoloration of the butter.

(b) Clean surroundings, as taints are readily absorbed.

(c) An even and suitable temperature, to promote uniformity in the ripening ; between 60° and 68° F. is most satisfactory.

(d) The use of cultures or buttermilk of known good quality only. Bad taints are easily transmitted by the use of indifferent starters.

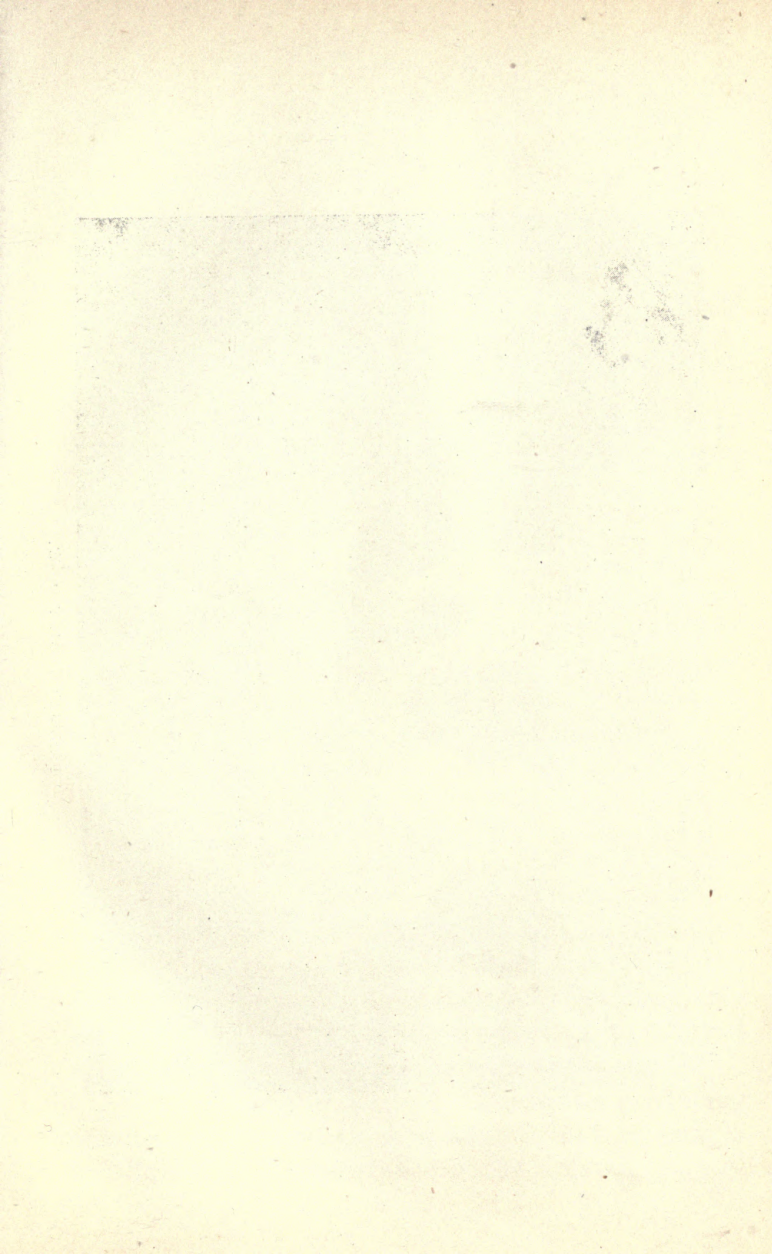

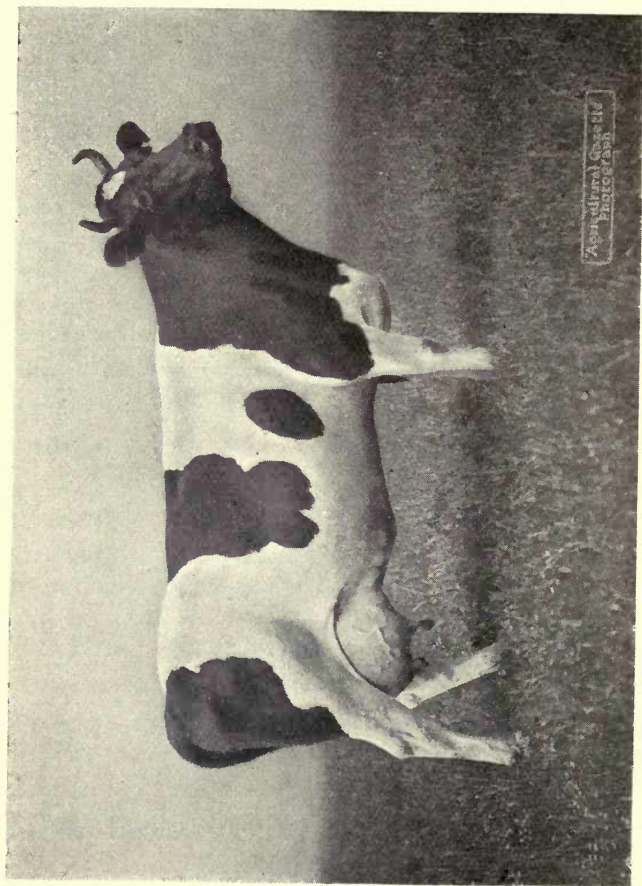

FRIESIAN DAIRY COW.

CHAPTER VI.

THE COLOURING OF BUTTER.

(43) **Artificial Butter Colour.**

WHEN it is found necessary to colour butter artificially, the colour should be added to the cream previous to churning.

Butter colour is usually dissolved in oil, and so readily mixes with the fat of the cream. Of the commercial preparations commonly in use, from half to one drachm (half to one teaspoonful) to every three gallons of cream gives a nice colouring throughout; the amount to be used is left to the discretion of the buttermaker to suit the particular market, or the taste of customers.

(44) **The Natural Colour of Butter.**

Butter is always of a better colour during summer than in winter, and varies with the following factors :

1. *Breed of Cows.*—Channel Island cattle give the best coloured as well as the firmest textured butter, and even one good Jersey or Guernsey cow in a herd of eight or nine animals of another breed will impart to the butter an increased colour.

2. *Individuality of the Cow.*—The butter producing qualities of a cow can to a large extent be judged by the outward appearance of the animal. Individ-

iduals of the same breed that are kept under the same conditions differ much in their capacity for producing butter. The udder of a good cow extends both well forward and behind. The back part should be covered with fine silky hair growing in an upward direction, with the exception of two patches of downward growing hair situated just above the hind teats. The skin of the cow should be pliable, and rather thin but not papery. This "touch" can best be detected in the neighbourhood of the last rib, when the head of the cow is slightly turned towards you. The beautiful golden orange colour, which is especially seen in some Channel Island cattle, is noticeable chiefly about the udder and inner thighs, near the root of the tail, around the eyes, and inside the ears. The whole skin gives the impression of being of an oily nature without any feeling of harshness. The milk veins should be prominent, and the opening where the veins enter the belly large. The flanks should be thin. This is a point often overlooked, yet a lean cow with a thick flank will, when put on to better keep, be more inclined to lay on fat than give a large quantity of rich milk. Length of tail, which should reach below the hock, fineness of shoulder points, shape of head, and colour of horns are by no means solely fancy points, and these with the above all go to make up that somewhat indefinite "quality" which is much sought after by our best judges and practical dairymen.

3. *Period of Lactation and Food.*—As lactation becomes more advanced the colour of butter generally

deteriorates, though this depends much on the time of year and the food supplied. Grass yields the best coloured butter. Carrots, cabbages, swedes and maize silage assist the colour in stall feeding. Most grain and artificial foods produce a pale coloured butter.

4. *Temperatures of Churning and Washing* influence the colour. Generally speaking the lower the temperature the deeper the colour. A high temperature for churning and excessive washing in the churn diminish the colour of the butter.

5. *Strong light*, especially sunlight, bleaches the colour of the cream and butter. .

CHAPTER VII.

THE PREPARATION OF UTENSILS.

THE preparation of utensils will be guided by the weather.

(45) Method of Preparation.

In *winter* the churn, butter-worker, Scotch hands, etc., should be prepared as follows:—

- (1.) Rinse with cold water.
- (2.) Scald with boiling water, being careful to ventilate the churn to allow escape of the steam.
- (3.) Rinse, and leave the butter-worker covered with, cold water. Place a damp butter-muslin over the roller and butter-board.
- (4.) Leave the sieve (usually lined with a muslin tied round), Scotch hands, and scoop on the worker.

In *summer*, unless plenty of ice is available, do not scald the churn just before using it, as it will be impossible to cool it down sufficiently if this is done.

Both in summer and winter leave water in the churn until just before the cream is put in. The water should be at about the temperature at which it is intended to churn, rather colder in summer and warmer in winter. If the churn be left inverted the cream will be prevented from sticking to the lid.

Sometimes the butter-worker and all the wooden utensils, after scalding, should be lightly rubbed over with salt, either with a brush or butter muslin, in order to prevent the butter sticking to the wood.

To Prepare a new Churn for use.—(a) Fill the churn with water and allow it to soak overnight. (b) Next scald with water in which a little washing soda has been dissolved, and then give another scalding to remove all traces of soda. (c) Finally, wash out with cold water and also with buttermilk if obtainable.

CHAPTER VIII.

THE CHURNING TEMPERATURE.

(46) Fixing the Temperature.

THE temperature of the room should be noted before starting work. The best temperature at which to churn is that which will produce the largest proportion of butter from the cream.

In deciding the temperature take into consideration :—

(1.) *Quality of Cream.*—That yielded by Channel Island cows and containing large fat globules churns the most easily, and therefore requires a lower temperature.

(2.) *Ripeness of Cream.*—Both over and under ripe cream need a lower temperature.

(3.) *Feeding.*—Different foods influence both the churnability of milk and the firmness and flavour of the butter, and it is necessary to vary the temperature with the kind of foods in use. Where large quantities of cake are given, especially cotton cake, it is necessary to churn at a temperature four or even five degrees higher than usual.

(4.) *Method by which the Cream was Obtained.*—Cream got by the separator or shallow pans churns more readily than that produced by the deep-setting systems. It is necessary to churn cream obtained

by the deep-setting methods at several degrees higher temperature.

(5.) *Temperature of the Dairy.*—A churning temperature of 55° or 56° F. may be taken as normal if the cream is properly ripened. The temperature may range between 50 to 55° F. in summer, and up to 65° F. when the temperature of the air in the dairy is 50°F. or lower.

TABLE OF TEMPERATURES IN BUTTERMAKING.

It is impossible to give a set of absolutely fixed temperatures for the various operations in butter-making, as so many points have to be taken into consideration as stated above.

The following examples of approximate temperatures giving a mean and also extreme cases may, however, prove a useful guide :—

Temp. of dairy.	Temp. of Churn.	Temp. of Cream.	Temp. of breaking water	Temp. of 1st washing water.	Temp. of 2nd washing water	Temp. of Brine.
60 F. and above	50.	.. 52.	.. 44.	.. 48.	.. 46.	.. 44.
55 F.	55.	.. 55.	.. 48.	.. 50.	.. 49.	.. 48.
45-50 F.	.. 65.	.. 63.	.. 54.	.. 60.	.. 59.	.. 58.

It will be noticed in the above table that the temperature of the churn should be either increased or decreased a little owing to its readily gaining or losing heat according to the air of the dairy.

In all cases the chief difficulty experienced in summer is to keep the temperatures sufficiently low to preserve the butter in a firm condition, as it tends continually to become soft owing to the absorption of heat from the air.

In winter the reverse of this is the case ; for then the butter soon becomes so hard that it is difficult to work, hence the necessity for slightly warming the washing waters and brine.

SIMPLE RULE FOR FIXING CHURNING TEMPERATURE.

A simple method sometimes adopted for fixing the churning temperature is to take 56° F. as a standard.

If the air of the dairy is 56° F., churn at 56° F.

For every 2° F. *increase* in the temperature of the dairy, *lower* the cream 1° F.

For every 2° F. *decrease* in the temperature of the air, *raise* the cream 1° F.

Small quantities of cream may be warmed by standing in a pail of hot water, and keeping the cream stirred, or if the cream requires thinning, slightly warm water may be added.

Cooling may be effected by standing the cream in water, brine, or ice for some time previous to churning. Very cold water may be added to the cream. In both cases where water is added care should be taken that it is pure.

The effect of *too high* a churning temperature is that a soft oily butter is produced with practically no grain, there is an excessive loss of fat in the buttermilk, and the butter cannot be worked or made up.

When the temperature is *too low*, the length of time in churning is greatly prolonged, and the grain is so small and hard that it is extremely difficult to make up.

CHAPTER IX.

THE PRODUCTION OF BUTTER.

(47) Churning

Is simply a mechanical process for bringing together the butter fat globules in order to make them coalesce or unite together.

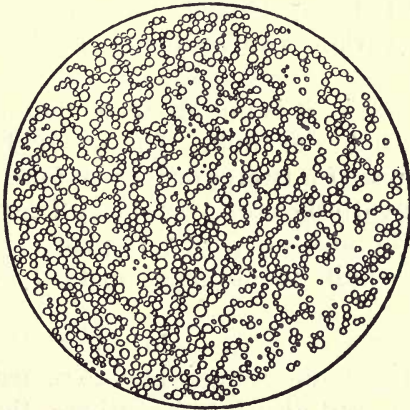

MICROSCOPICAL APPEARANCE OF CREAM, SHOWING THE FAT GLOBULES.

Butter is produced by churning : —

- (1) Ripened or " loppered " whole milk.
- (2) Sweet cream.
- (3) Devonshire clotted cream.
- (4) Ripened (soured) cream.

(48) Churning Ripened or Loppered Milk.

The churning of milk is still largely practised on farms in many districts, but it is gradually giving way to the use of the separator and the churning of cream, on account of the extra expense of working.

In small dairies the whole of the milk is set aside and allowed to sour until it just thickens, when it will contain .5 to .7 per cent. of lactic acid. The time taken in souring will depend upon the temperature. At 70° F. it will be sour in about twenty-four hours. Commonly it is left for two or three days, a fresh lot of milk at each milking being added to the vessel in which it is being ripened. No fresh milk should be added within twelve hours of the time of churning.

In large dairies it is not an uncommon practice to churn only half the milk. The newly-drawn milk is set up in pans for twelve or twenty-four hours, and the top half with the cream is taken off and put away to sour. The advantage of this plan is that some sweet skim milk is obtained instead of all sour buttermilk.

It is a common plan to add salt to the ripening crocks, especially in summer time, to retard too rapid acidification, and also in cases where the churning is not carried out frequently.

As milk, owing to the small quantity of fat it contains, is more difficult to churn than cream, a higher churning temperature must be used, and 65° F. to 68° or 70° F. is to be recommended.

Unless a temperature sufficiently high be used and the milk is properly ripe, a considerable loss

of fat in the buttermilk will take place, and the time of churning will be greatly prolonged.

Churning should be continued until the butter "breaks," when about ten per cent. of water of regulated temperature should be added to assist in separating the butter-grains from the milk serum.

By further churning, the butter should be brought to the size of number four size shot, at which draw off the buttermilk and wash the butter with several lots of cold water.

In no case when churning milk should the butter be churned into lumps, as the result of this will be the enclosing of a lot of buttermilk, and the butter will soon develop a streaky or mottled appearance.

The butter may be either salted with brine or dry salt.

Characteristics of Milk Butter.

Butter produced from churning milk is usually paler in colour than that obtained from cream. It may be made of especially fine flavour by this system and the bye-product—the buttermilk—is a substance of high dietetic value and is usually saleable for human consumption in the districts where produced.

Farmers who sell their milk and sometimes receive churns of it back sour, may with advantage convert it into butter instead of giving it direct to the pigs.

(49) Churning Sweet Cream.

Owing to the growing demand for sweet cream butter and the satisfactory price commonly obtained

for it, the churning of sweet cream may often prove advantageous. Churned under similar conditions sweet cream is converted into butter in less time than is taken in the case of ripened cream.

Although butter is obtained in less time from sweet than from ripened cream, sweet cream yields a smaller proportion of butter, as the fat is not so "churnable" as after it has been subjected to the ripening process. The loss of fat in the buttermilk when churning sweet cream is generally unnecessarily great, and hence the system has fallen into disrepute with many. A great loss of fat always follows from churning the cream at too high a temperature. The best butter is obtained from a cream which has been cooled down and allowed to stand for several hours before churning.

Cream, if sweet, must always be churned at a lower temperature than when ripe. No more than 1 per cent. of fat need be left in the buttermilk if the churning of sweet cream be carried out under suitable conditions. The most suitable temperature for churning sweet cream is from 52° to 54° F., depending upon the quantity—the smaller the quantity the lower the temperature.

During churning the temperature will go up a degree or two more in the case of sweet than in that of ripe cream.

The temperature of the cream at breaking stage must be carefully reduced to 52° F. by means of cold water.

In cases where an undue amount of fat is lost in churning, the buttermilk may be passed through a separator, and so the loss diminished.

Characteristics of Sweet Cream Butter.

Sweet cream butter is usually paler in colour than that made from ripe cream. It has a very mild, creamy flavour, and should be washed very thoroughly to free it from buttermilk, otherwise it will not keep well.

(50) Devonshire Clotted Cream,

The production of scald or clotted cream is chiefly confined to the counties of Devon, Cornwall and Somerset.

In the preparation of this cream, new milk is strained into round pans, either of enamel or blocked tin, and allowed to stand twelve or twenty-four hours according to the time of year, twelve hours being usual in summer.

The pans are deeper than those used in the shallow setting system, holding a layer of milk of six or eight inches deep.

After the cream has risen, the pans are removed to a stove and the contents heated up to 150° to 170° F. if the cream is for buttermaking; or if for sale as clotted cream, to 170° to 190° F.

The heating should occupy from twenty to thirty minutes, in order that the necessary scald flavour may be produced. The pans are then placed in the dairy to cool.

In summer cooling should be done quickly by placing the pans in a current of cold water. The cream is skimmed off after the pans have stood about twelve hours, or when thoroughly cooled.

The pans of milk should be heated by steam in preference to any other way. The loss of fat in the scalded skim milk is usually less than in shallow pan skim milk, and on the average amounts to .5 per cent.

Churning Devonshire Cream.

In churning clotted cream it should be dealt with in the way described for sweet cream.

The old-fashioned method of churning clotted cream is by "tub and hand," or merely stirring the cream in a tub with a wooden hand, which causes it to turn into butter. A greater quantity of butter is obtained by this method than by churning in the ordinary way, owing to the fact that a much greater percentage of water and casein is retained in the butter.

The scalding process to which the milk is submitted in the preparation of the cream enhances the keeping qualities of the butter. It is important, however, to wash the butter with several lots of water, or too much caseinous material will be retained, and the keeping qualities suffer in consequence.

(51) Churning Ripened Cream.

By the ripening process cream is made to yield a maximum amount of its fat as butter. If cream is properly ripened and churned at a suitable temperature, the buttermilk should not contain more than about .2 per cent of fat. There are some instances, however, when certain foods are used which so influence the churnability of the fat in milk that a much larger loss than this will occur. Cream prop-

erly ripened will contain .35 to .4 per cent of lactic acid as shown by the acidimeter.

The Effects of Ripening Cream.

Professor F. J. Lloyd has given us his opinion of cream ripening, which is as follows :—

“ The ripening of cream has a twofold effect. First the production of acid destroys the viscous condition of the casein, granulates it, and so weakens its adhesiveness to the fat globules. From this follows the more complete conversion of the fat globules into butter in churning ripened cream, also the increased yield, as the adhesive action of fresh casein on small globules is so great that they cannot be gathered in the same time as the larger globules. This also is the reason why homogenised milk throws no cream, as the fat globules are so small that the adhesive action of the casein is greater than the gravity action which causes a large globule to rise. This granulating effect of the acidity may be clearly seen proceeding in circles around the lactic acid bacteria if fresh milk is placed under the microscope and studied hour by hour as acidity develops. The second effect of ripening is that of flavour production. So far as I can judge at present, flavouring substances are produced by bacteria and absorbed by the fats. But there is no evidence to show that the fat itself is in any way acted upon by the bacteria. The more sugar, or perhaps it would be more correct to say ‘ serum,’ the bacteria have to act upon, the greater the quantity of flavouring substance produced. Hence the superior flavour of cream raised on the

shallow pan, where the whole of the serum supplies flavouring substances, as compared with ripened separated cream, from which often far too much of the serum has been removed."

(52) Manipulations in Churning.

Strain the cream into the churn through a coarse straining cloth and do not fill the churn more than half full, otherwise the concussion is so minimised that the butter is too long in coming.

The speed of churning and time taken vary with :—

- (a) Thickness and ripeness of the cream.
- (b) Temperature and space occupied by the cream in the churn.
- (c) Number of revolutions of churn per minute.
- (d) Period of lactation of the cow. Newly-calved cows yield milk which is readily churnable.

Commence churning slowly, ventilate frequently, and gradually increase the speed to about fifty revolutions per minute, and slow down towards the finish. Cream, if too thick, adheres to the sides of the churn, and so fails to receive the concussion necessary to produce butter.

Ventilation of the churn is very necessary so as to allow the escape of gases liberated from the cream on commencing to churn. Failure to do this causes the cream to become frothy and difficult to churn, indifferent butter being produced. The gas which is given off consists chiefly of air with which is mixed a small proportion of carbon dioxide.

The time usually occupied in churning is from 20 to 35 minutes. A short churning is chiefly caused by too high a temperature, and a big loss of fat in the buttermilk results, besides inferior texture of butter. Disc and other rapid churns bring the butter into a granular state in from one to five minutes. Amongst rapid churns, Garbutt's improved patent "Two Minute" Churn, as now fitted with wooden beaters, is popular and gives good results. Too long a churning produces butter of poor texture, as the cream receives too much beating.

Rise in Temperature during Churning :

There is always a slight rise in temperature during churning, which is caused by :—

- (a) Friction or beating of the cream, when work is converted into heat.
- (b) Latent heat of solidification. On the liquid fat becoming solid butter, heat is evolved.

The quicker the motion the more the temperature rises. As butter largely acquires texture and consistency during churning, and these cannot afterwards be remedied, it is most important to give very careful attention to the requisite conditions for the best results.

*The Breaking Stage :—*Stop churning immediately the cream breaks, that is when it turns into a fine mealy condition, which represents very fine grains or particles of butter. This stage can be detected by the sound of the falling cream in the churn, and by the glass becoming partly cleared ; if in doubt take the lid off and look. It is very important

as soon as the cream breaks to take the temperature and add breaking water accordingly.

Addition of Breaking Water.—In summer the temperature will need reducing with cold water. In hot weather, if ice is available add about a quart of breaking water at a temperature of from 40° to 45° F., to each gallon of cream churned. If ice is not available use water as cold as can be obtained,

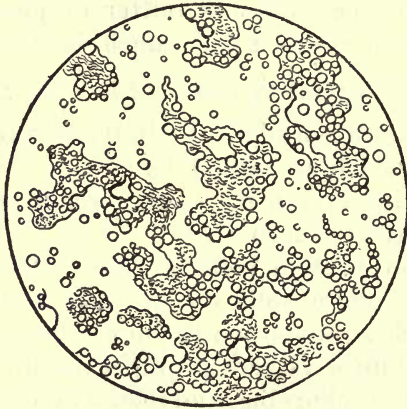

MICROSCOPICAL APPEARANCE OF CREAM TAKEN FROM THE CHURN ABOUT TEN MINUTES BEFORE THE "BREAKING" STAGE. NOTE MASSING OF THE FAT GLOBULES.

and increase the quantity proportionately. By using breaking water the grain is hardened and prevented from gathering together, and it facilitates the removal of buttermilk. In cold weather the temperature of the breaking water should only be a few degrees below that of the cream, say 55° F. to 60° F.

The above are roughly the temperatures at which

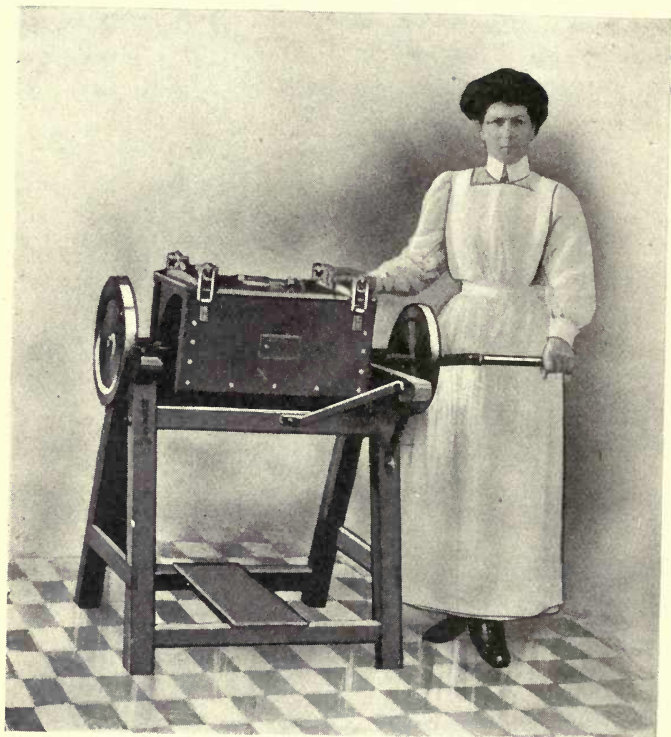

GARBUTT'S "TWO MINUTE" CHURN.

breaking water should be added. A more exact method of settling the temperature of the breaking water to use, or the quantity required if it is at a given temperature, is by calculation. In churning the temperature usually goes up a few degrees. This is particularly noticeable in summer on taking the temperature at the breaking stage.

In winter, although a similar rise takes place, it may not be noticeable owing to loss of heat by radiation, due to the colder surrounding atmosphere. Indeed, the temperature at breaking stage in such cases may be lower than that of the cream at the commencement.

Whether the temperature at the breaking stage is higher or lower than that at the beginning, the object in adding breaking water should be to regulate it to that at which churning was started.

To find temperature of breaking water when a given quantity is added—Assuming for the sake of simplicity that the specific heat of cream may be taken as the same as that of water, then if the quantity of cream be multiplied by its temperature, this gives the number of heat units it contains.

If the cream and added water be multiplied by their temperature the result is the number of heat units contained after the water has been added. If from this number be subtracted the heat units contained in the cream before the water was added, the difference is the number of heat units which come from the water. By dividing these heat units by the water, the answer gives the temperature of the water to be added.

$$\frac{(\text{Cream and water} \times \text{Desired temperature}) - (\text{Cream} \times \text{Temperature at breaking})}{\text{Water}} = \text{Temperature of water to be added.}$$

EXAMPLE :—Temperature of cream at commencement, 56° F. ; quantity, 10 lbs. (1 gallon) temperature at breaking stage, 58° F. ; quantity of water added 2½ lbs. (1 quart) at what temperature should the water be ?

$$\frac{(12\frac{1}{2} \times 56) - (10 \times 58)}{2\frac{1}{2}} = \frac{120}{2\frac{1}{2}} \text{ or } 48^{\circ} \text{ F.}$$

*To find the quantity of breaking water required when the temperature is given :—*If the cream be multiplied by the fall in temperature, this gives the number of heat units lost by the cream. These heat units are taken up by the water added. If the rise in temperature of the added water be divided into this number, the result will give the quantity of water to be added.

$$\frac{\text{Cream} \times \text{fall in temperature}^e}{\text{Rise of the temperature of the added water}} = \text{quantity of water to be added.}$$

EXAMPLE :—Temperature of cream at commencement, 56° F. ; quantity 10 lbs. (1 gallon) ; temperature at breaking stage, 58° F. ; temperature of water to be added, 48° F. How much water must be added ?

$$\frac{10 \times 8}{8} = \frac{20}{8} \text{ or } 2\frac{1}{2} \text{ lbs. (1 quart) of water required.}$$

This, it will be seen, is the converse of the first example.

*Regulating the size of the butter grains :—*Continue churning, ventilating once or twice, until the butter grains are of the desired size.

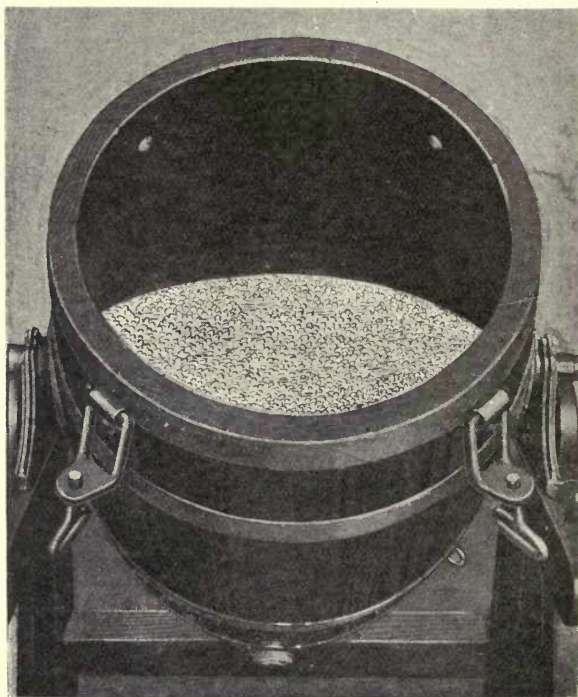

GRANULAR BUTTER IN THE CHURN AT
COMPLETION OF CHURNING.

In the case of making butter in competitions in order to get a perfect grain, it is desirable to add the breaking water in several lots, churning in between. If a large volume of water is thus used, it permits of gradually increasing the size of the grain, and at the same time hardening and making it perfectly round.

In *summer* it is desirable to have them nearly as large as wheat-grains, though as round as possible, since large grains, if gradually hardened, hold up less water than small ones. Less working of the butter is therefore required to deprive it of excess of moisture, so that butter may be made up quickly and put away before it has time to become soft by exposure to the warm atmosphere.

In *winter*, grains of about the size and shape of a cabbage seed are most suitable. More water is retained, and the butter requires more working, yet neither of these points is disadvantageous in winter. The time taken in working need not necessarily be limited, as the butter is not likely to become soft, though it may become hard. The retention of a greater percentage of water tends to keep the butter soft, and this is a much-desired characteristic in butter in cold weather.

(53) **The Finish of Churning.**

Frequently look and churn very slowly between the breaking stage until the butter grains are of the desired size. When the butter has "come" the window shows perfectly clear. If by accident which occasionally happens, the butter gets churned

into small lumps, the buttermilk should at once be drawn off and plenty of cold water added. Turn the churn rapidly a few times, and this procedure will often succeed in breaking down the lumps.



MICROSCOPICAL APPEARANCE OF BUTTER SHOWING FAT GLOBULES
AND DROPS OF WATER.

CHAPTER X.

SUBSEQUENT TREATMENT OF THE BUTTER.

(54) Washing Butter.

DRAW off the buttermilk through the hand sieve, over which a muslin has been tied. This will prevent the loss of any particles of butter in the buttermilk. Strain in enough water to thoroughly float the grain. The temperature of the washing water should be judiciously regulated. In summer, water at a temperature of 45° to 48° F. is best ; ordinary water cannot easily be too cold.

Object of washing butter:—In washing, the aim should be to gradually increase the size of the grain, and at the same time harden it.

In winter it is often advisable to warm the washing water, say from 50° to 60° F., otherwise the butter will be too hard and crumbly to make up. Never use water below 50° F. in winter.

These remarks also apply to the temperature of the brine.

Always rotate the churn a few times on adding each lot of water.

The number of washing waters required may be regulated by the time it is necessary to keep the butter. Washing gets rid of the casein, which, if left, produces bad keeping qualities ; on the other

hand, the more butter is washed the poorer the flavour and the colour will be.

Butter made from perfectly ripened cream is often not washed at all. If for immediate consumption, wash once only, and then brine. If for keeping for a moderate period, wash two or three times or till the water comes off clear.

The last washing water, or brine if used, must not be drawn off until the butter is removed.

(55) **Brining Butter.**

There are two methods of salting butter, one is to brine it and the other to add dry salt.

To brine butter, dissolve either one or two pints or pounds of salt in each gallon of water used for brining. Strain it into the churn ; revolve the churn two or three times, and allow the butter granules to remain in it for a short time. The time will be regulated by the consistency of the butter, and the degree of saltiness required. From five to thirty minutes may be the time, or an average of about ten minutes. For very soft butter leave the longer time. Brining with one pound salt to the gallon, for ten minutes deposits a little over a quarter of an ounce of salt to the pound. It is impossible to get very salt butter by brining at ordinary temperatures. By using a concentrated solution of salt, and leaving the butter in it for half-an-hour, we have been unable to deposit more than 1.7 per cent. salt. Always leave the butter in the brine whilst drawing off the water from the butterworker, and preparing it for use, as this saves time.

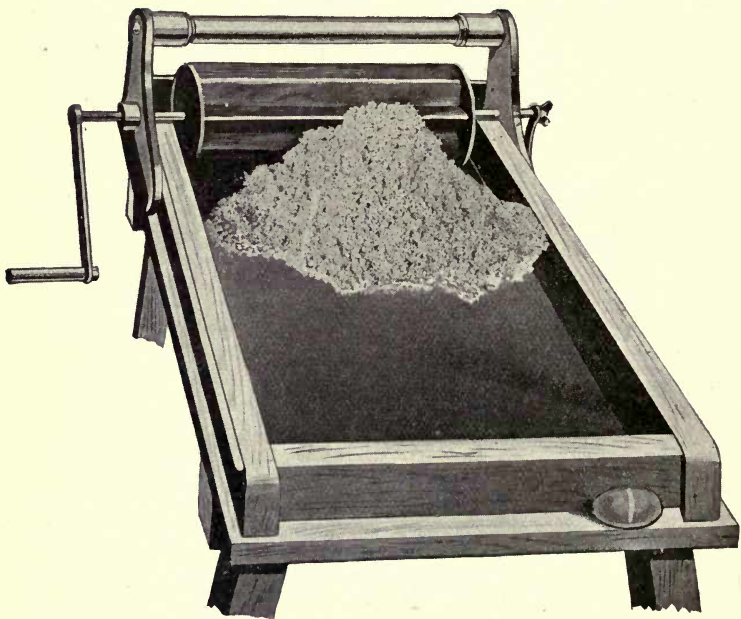

GRANULAR BUTTER ON BUTTERWORKER READY FOR THE
" WORKING ". PROCESS.

Advantages of Brining :

- (a) The salt in dissolving reduces the temperature of the water several degrees ; this is of great value in summer, as it helps to harden the butter.
- (b) It assists in removal of the buttermilk, and so preserves the butter.
- (c) It causes very even distribution of the salt and so streakiness is avoided.

Disadvantages of Brining :

- (a) The cost is very much greater than that of dry-salting, but the brine may sometimes be used again if clean and sound. For several churnings going on simultaneously, the same brine can always be used.
- (b) It is only applicable to small dairies and for special purposes, on account of the cost.

(56) Dry-salting Butter.

Dry-salting is the most common method of salting butter. When the butter is on the worker sprinkle it with fine dry salt from a dredger. A quarter of an ounce of salt to the pound gives a mildly salted butter. For ordinary salting use half an ounce to the pound, and for butter with a pronounced salt taste three-quarters of an ounce. Nearly half of the salt added is pressed from the butter in solution whilst working. After a partial working the butter should be left for some twenty minutes, to allow the

salt to dissolve ; then rework a little, and make up. By so doing, all danger of uneven salting or streakiness is avoided. Butter may sometimes receive a light brining to harden it, and then be dry-salted say with half an ounce to the pound.

(57) **Removing Butter from Churn.**

To remove the butter from the churn, place the sieve in a pail, and hold under the left arm, as near the mouth of the churn as possible. Scoop the floating butter grains out of the wooden shovel, and place them in the sieve ; the excess of water runs into the pail. Care must be taken not to grease the churn by squeezing any of the butter against the sides. When nearly all the butter has been removed in this way and placed on the worker, put the bucket and sieve under the churn. Remove the plug, and let out the brine or water, using a measure to rinse down the sides of the churn. Every particle of butter will thus be washed out into the sieve, and this greatly facilitates the after-cleaning of the churn.

(58) **Working Butter.**

The object of working is to expel as much of the visible water as possible with a minimum injury to the grain. With a rather large and cold grain very little working is required to rid the butter of the necessary moisture. Such a grain should be aimed at when the weather is hot.

Working should be done quickly, but not roughly. Good butter is often taken from the churn and spoiled on the worker by being kept on the table too long

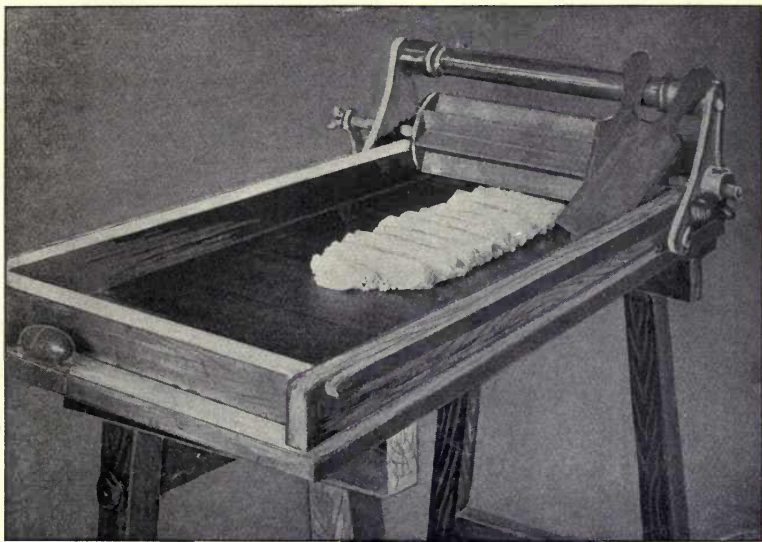

BUTTER ON WORKER UNDERGOING THE PROCESS OF "WORKING."

in a warm room, or over-worked so that it is rendered soft and the grain spoilt.

Pressing, and not rubbing, is required in working butter. Begin working by running the roller over the butter from the upper end of the worker ; bring the roller back to the top of the worker again, and then by rotating it in the opposite direction cause the butter to coil up in a roll. Take the roller back " empty."

Pick up the roll of butter with the Scotch hands, and repeat the operation several times. The number of times butter should be rolled depends upon its consistency and the size of the grain. A very small grain requires more working to get it together. In winter, generally speaking eight or ten rollings may be given. Always use a piece of wrung-out butter-muslin to mop up the water pressed out from the butter on to the worker. Do not wipe with the muslin or it makes the table greasy.

Hardening Butter.

In summer, when no ice is used, the butter is often too soft to work immediately after churning. When this is so it should be wrapped in wet muslin, and set aside on a cold slab in the cellar, or other cold place and worked subsequently when hardened.

Evaporation from the wet cloths in which it is wrapped hardens the butter. Other plans adopted are to put it in muslin, and immerse in brine in a cool place, or it may be lowered down a well. This means a sacrifice of flavour and quality in the produce.

Water in Butter.

Working is the chief factor which regulates the percentage of water left in the butter. It is quite possible to work butter to excess, and leave it too dry with as low as 6 per cent of water. On the other hand, insufficient working leaves an excess of water.

The Government standard for water in butter is now 16 per cent., and there is very little likelihood of well-made butter ever showing as high a percentage as this. Of a large number of samples tested by us from different sources the average water content was about 12½ per cent.

The wood of butter workers often becomes impregnated with grease from the continual working of the butter. When this is the case it causes the butter to stick. As a remedy wash with soda and water, scrubbing with fine fresh lime is also useful. If the roller also sticks it should be taken off and boiled.

The use of salt tends to prevent the butter sticking, but is apt to roughen the wood if used continually. When the workers become roughened (not greasy) which also causes the butter to stick, they are best taken to pieces and the boards planed smooth. An excellent finish may be put on by polishing with fine glass-paper of No. 1 quality or fineness.

(59) Délaiteuse, or Butter Dryer.

Butter-dryers are easy to work, and keep the grain separate when the butter is inclined to be soft, though they will not do for very soft butter.

The water is expelled by means of centrifugal force.

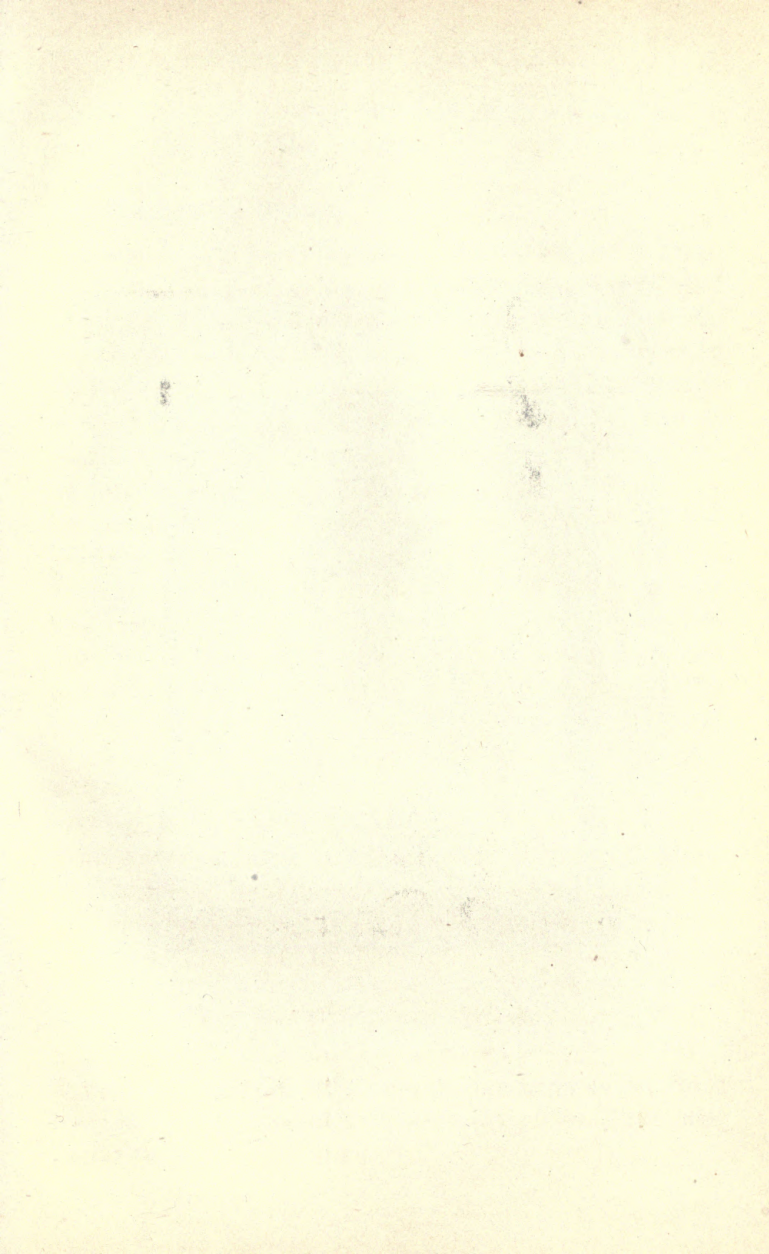

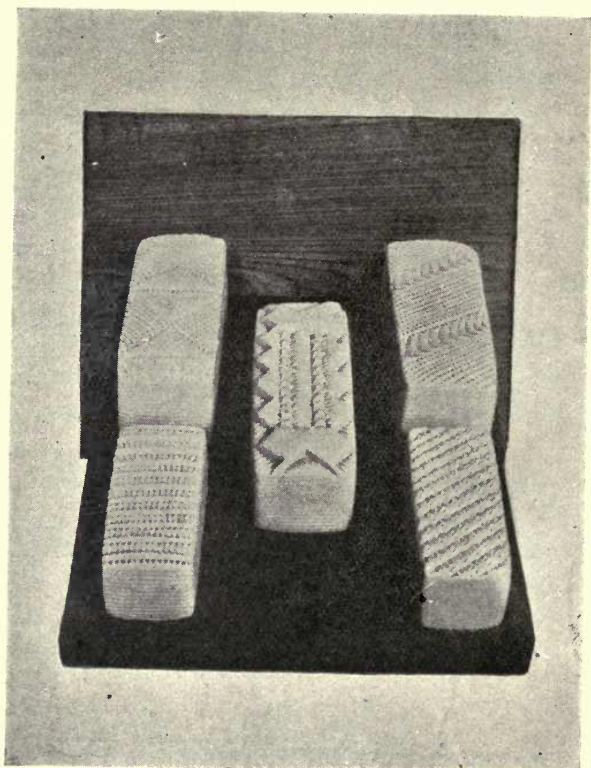

MADE-UP BUTTER—ONE-POUND AND HALF-POUND BRICKS.

The dryer may often be used with advantage in conjunction with the worker.

(60) Making up Butter.

When butter is sufficiently dry and firm it may be made up. Cut it up, and weigh into pounds and half-pounds as required, and replace on the making-up board. The shape into which it should be made depends on the market, rolls, round prints, Oxford prints, and brick-shaped blocks being the usual forms. The last is the commonest and perhaps best way in which butter can be made up.

Scotch hands should be used, and the butter consolidated and pressed into well-shaped oblong blocks not more than six inches long. A pound print of the following dimensions has been found the most suitable size for packing : $4\frac{5}{8}$ by $2\frac{1}{2}$ by $2\frac{3}{8}$ inches. Various fancy designs may be printed on the surface with the edge of one of the hands. The finished article should be wrapped in best vegetable parchment, which keeps it clean and prevents it from getting contaminated.

Mop up the moisture which appears on the board during making up. It is preferable to use dry parchment in which to wrap the butter. Many use it wet, but this we have found to cause mould, and even where the parchment has been soaked in brine mould has appeared after a time.

Making up nicely is a very important part of butter-making, for without good shape and colour and neat and striking appearance, the value will be lessened.

Butter is usually at its best as regards flavour and texture about two days after making.

Flavour is due to very small quantities of decomposition products produced in the butter by bacterial fermentation.

(61) **Washing up Utensils.**

(1.) Wash with warm water to remove grease from all utensils used.

(2.) Scald with boiling water; ventilate churn on first and subsequent revolutions.

(3.) Remove rubber band from lid and oil the metal work of churn.

(4.) Occasionally unscrew and clean the inside of the ventilator. The churn and other utensils should be thoroughly dried each time after using.

CHAPTER XI.

RESUMÉ OF BUTTER-MAKING OPERATIONS.

(62) Short Instructions for Buttermaking.

THE following instructions give a brief summary of the process of butter-making detailed in the previous pages, and will be useful to butter makers when carrying out their work.

This section, printed on a card for hanging up in the dairy, may be obtained separately from the publishers.

(1.) See that a sufficient supply of hot and cold water is available.

(2.) Note the following temperatures:—

(a) Temperature of the dairy.

(b) „ „ „ cream.

(c) „ „ „ cold water.

(3.) Prepare the cream for churning by regulating its consistency and temperature. Cream may be churned at 50° to 56° F. in summer, and 58° to 65° F. in winter.

(4.) Prepare the churn and all utensils as follows:—

(a) Rinse with cold water.

(b) Scald with hot water (except the churn in hot weather.)

(c) Rinse with cold water or brine.

(5.) Regulate the temperature of the churn to that of the cream.

(6.) Leave cold water on the butter-worker, and cover the roller, etc., with damp muslin cloths.

(7.) Strain the cream into the churn through a straining cloth, and do not more than half-fill the churn.

(8.) Begin by churning slowly and ventilate frequently.

(9.) Note that the cream falls at each revolution of the churn.

(10.) Stop churning as soon as the butter begins to collect, as is shown by the clearing of the glass window. Take the temperature at this stage, and add about a quart of cold breaking water to each gallon of cream.

(11.) Continue churning slowly until the butter grains become about the size of a small shot.

(12.) Wash the butter in its granulated state, and carefully regulate the temperature of the washing water inversely to that of the air of the dairy.

(13.) Salt the butter either by putting brine in the churn or by adding dry salt when on the worker. Make the brine by dissolving 1 to 2 lbs. of salt in each gallon of water. or add $\frac{1}{4}$ to $\frac{1}{2}$ oz. of fine dry salt to each pound of butter. Give the salt time to dissolve in the butter before finally making it up.

(14.) Work the butter carefully, taking care not to injure the grain more than necessary in extracting the excess of moisture.

(15.) Allow the last washing water or brine to remain in the churn until all the butter is removed to the worker.

(16.) Make up the butter according to market requirements.

(17.) Clean the churn and all utensils as follows :—

(a) Wash with warm water to remove grease.

(b) Scald with boiling water, ventilating the churn at the first and subsequent revolutions.

(c) Oil the churn screws and all metal work.

CHAPTER XII.

MARKETING AND THE POINTS OF GOOD BUTTER.

(63) Marketing.

NEATNESS of make-up and packing will always enhance the market value of butter. The basket, or box, in which the butter is taken to market should be scrupulously clean, and well lined with muslin cloths. Rhubarb and cabbage leaves are often used to wrap the butter in, and certainly assist in keeping it cool, but we much prefer parchment paper. There is always danger of the green leaves spoiling the appearance and flavour of the butter.

Small chip or card boxes are very useful, preserving the print and shape of the butter, and also preventing it from getting soft. The name and address of the maker should be printed on the boxes. This is a valuable aid to marketing, as when people like any brand they can thus obtain the same again.

If boxes are not used it is always well to have some particular print for marketing purposes, so that it may be recognised by customers.

(64) Points of Good Butter.

Careful examination of the butter should reveal :—

(1.) *Texture*—When cut half through the butter should be solid, and when broken should show a distinct fracture, and a close granular texture.

(2.) *Moisture*.—When pressed by a wooden hand the butter should appear free from large drops of water. The water present should be in a very finely divided state. There should be no milky appearance.

POINTS OF GOOD BUTTER

(3.) *Flavour*.—Should be sweet and nutty, and free from oiliness, acidity, etc. The salt should be evenly distributed throughout.

(4.) *Aroma*.—Should be sweet and characteristic of good butter, or none at all.

(5.) *Colour*.—Should be clear, even all through, and of a tinge pleasing to the eye.

(6.) *General Appearance*.—The butter should be nicely made up, clean, and of an appetising appearance.

(7.) *Keeping Qualities*.—Butter should keep for some time before beginning to change. A good sample of farm butter should keep a week or ten days in summer before showing any signs of changing and in winter two or even three weeks. Butter should always be stored in a cool place, free from contaminating influences. If kept near foods such as meat, game, cheese, onions, etc., or in a bad atmosphere, it readily absorbs the odours prevalent.

(65) **Scale of Points for Judging Butter.**

Most judges adopt their own scale of points. The following we have found to answer satisfactorily :—

Flavour and aroma	50 Points.
Texture, solidity and grain	18 ..
Freedom from moisture, and uniformity of salting	14 ..
Colour	8 ..
Neatness of appearance and general make-up	10 ..
Total		 100 ..

Where several samples of very similar quality have to be judged it is well to sub-divide the above, giving points as follows:—Flavour 40, Aroma 10. Texture: solidity 10, grain 8.

Inferior samples of butter may be readily recognised by their disagreeable odour, and should be discarded as undeserving of further examination.

Where a large number of samples of butter are to be judged, this weeding out of inferior ones simplifies the judging very considerably.

(66) Points for Judging Buttermaking Classes.

The following scale of points is useful for judging the work done by pupils who have undergone a short course of instruction in butter-making at an itinerant dairy school:—

Preparation of utensils	5	Points
Use of thermometer and judgment and skill in churning.. ..	10	„
Condition of grain in churn ..	6	„
Washing	5	„
Condition of grain on worker ..	10	„
Use of worker	7	„
Making up	20	„
Time occupied and smartness in work.. .. .	15	„
Texture and colour of butter..	14	„
Freedom from moisture ..	8	„
	<hr/>	
Total	100	„
	<hr/>	

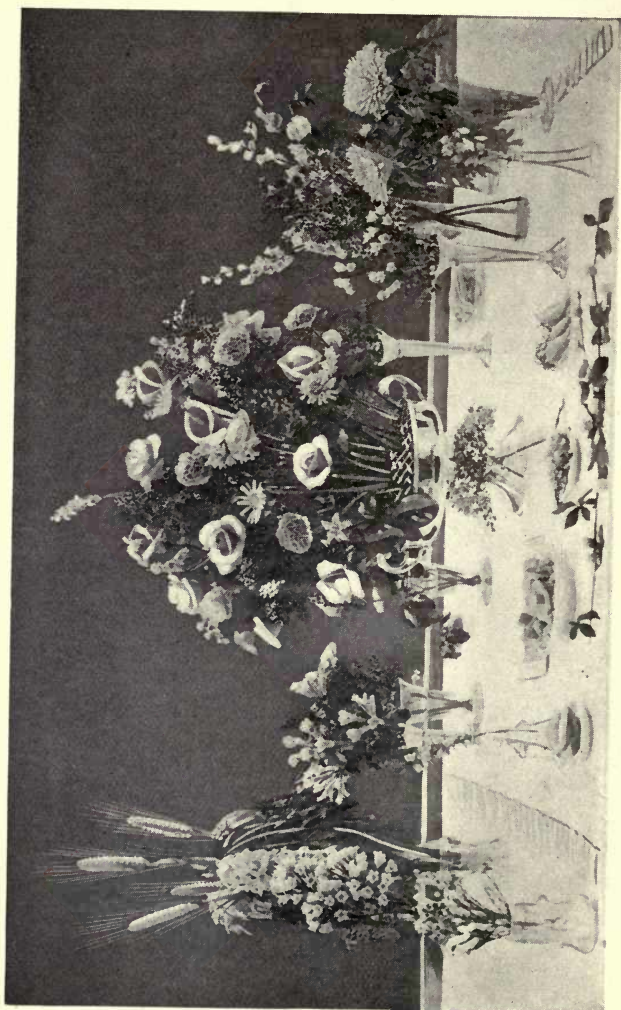

ORNAMENTAL BUTTER.

(67) Points for Judging Buttermaking Competitions and Examinations.

The scale of points adopted by the British Dairy Farmers' Association for their competitions and examinations for certificates in butter-making is as follows :—

Condition of butter in churn	..	10	Points
Condition of butter on the worker	10	„
Making up of butter	20	„
Smartness and cleanliness in work	20	„
Colour of butter..	5	„
Texture of butter	20	„
Freedom from moisture	15	„
		<hr/>	
Total	100	„
		<hr/>	

(68) Ornamental or Fancy Butter.

Ornamental butter, which consists of butter made up chiefly in the forms of flowers and fruits to produce a pleasing effect, although it always attracts crowds of admirers at shows where classes are provided for it, is condemned by many people.

It is condemned chiefly from its want of utility, and from the fact that the human hand is so largely used in its preparation ; such manipulation of butter not being allowable. The preparation of exhibits of fancy butter entails a large amount of very careful work, and calls into play a considerable ingenuity and power of imitation. As aids to the human hands

a few specially-shaped small wooden hands are required. It is essential to have firm butter to work upon, and for this purpose none is better than that obtained from Jersey cows.

A plentiful supply of ice is necessary for making up the butter, and to enable it afterwards to retain the shapes into which it is converted.

CHAPTER XIII.

THE QUALITY OF BUTTER.

(69) Composition of Butter,

THE chief constituent of butter is fat, which varies from 82 to 90 per cent. the greater the percentage of water the less that of the fat. On the average a good sample of butter will be found to contain 85 or 86 per cent. of fat, about 12 to 13 per cent of water, and $\frac{1}{2}$ per cent. of casein or albuminous matter.

Rough test for comparing samples.

A rough, but not at all a bad way of comparing market samples of butter is to arrive at their approximate compositions by melting them and allowing the constituents to separate out. To make the test, take a couple of test-tubes, and put into them about equal quantities of the samples of butter to be compared.

Melt the butter by placing the tubes in boiling water and heating them for about twenty minutes. The constituents of the butter will then separate out, the fat rising to the surface and the water sinking to the bottom of the tube. In between the fat and water will be seen a whitish layer ; this is the casein.

Good butter contains a high percentage of fat and a rather low percentage of water and casein.

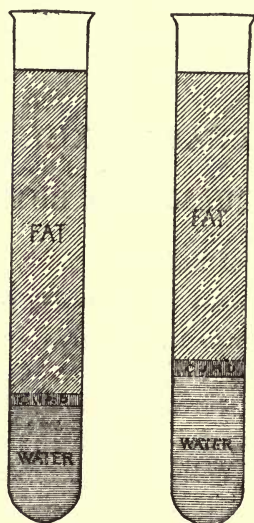

SAMPLES OF BUTTER COMPARED. THE SAMPLE ON THE LEFT IS THE BETTER OF THE TWO, AS IT CONTAINS MORE FAT BUT LESS WATER AND CASEIN.

Butter containing a large quantity of casein generally decomposes quickly, casein being the only substance in butter which can supply nitrogenous food for the bacteria which cause the decomposition.

(70) Estimation of Water in Butter.

The amount of water in butter must be kept within the legal limit of 16 per-cent. Butter which appears to contain an excess of water frequently does not show as much as 16 per cent. whereas butter may contain 17 or 18 per cent. and yet seem dry. It is the distribution of the water which makes butter

appear wet or dry. The finer the distribution of the globules of water in the butter, or the more perfect the emulsion, the drier the butter looks, though on analysis it will be found to contain a high percentage of water.

The most reliable test for water in butter is the simple one of taking a weighed quantity of butter and heating it to drive off the moisture. Although this test may be performed quickly in a rough manner to give approximately the percentage of water present in butter, to get accurate results delicate weighings are necessary.

To perform the test :

(1.) Heat a small porcelain evaporating dish to drive off any moisture it may contain, and allow it to cool in a desiccator (a piece of apparatus in which air is kept dry by a layer of calcium chloride).

(2.) Carefully weigh the dish plus a small piece of glass rod to be used for stirring the butter.

(3.) Add a small portion of butter cut from the interior of the sample (size about 5 grams) and weigh again.

(4.) Place on a heated sand-bath (a tin tray in which a layer of two or three inches of sand is contained).

(5.) Evaporate the butter for twelve minutes stirring occasionally with a glass rod, or until no more moisture comes off.

(6.) Cool in desiccator, and then weigh.

EXAMPLE :

Weight of dish, glass rod and butter ..	30.78	grams.
Weight of dish and rod	24.70	„

Weight of butter ..	6.08	„
---------------------	------	---

Weight of dish, rod and butter <i>before</i>		
evaporation	30.780	grams.

Weight of dish, rod and butter <i>after</i>		
evaporation	30.022	„

Loss of water from 6.08 grams of butter	.758	„
---	------	---

If 6.08 grams lose .758

Then 100 „ „ 12.4

Or, the butter contains 12.46 per cent. of WATER.

It is important in testing butter for water to take a sample from the interior of a lump of butter and to evaporate for a standard time of, say, twelve minutes from the time the butter begins to boil. By placing a cold watch-glass over the dish containing the butter, it may be seen if the water has all been driven off, as then no condensation of water on the cold surface will take place.

The special test-bottles made for the testing of water in butter cannot be relied upon to give accurate results, and if used the determinations can only be regarded as approximately correct to within a per cent. or two.

(71) Loss of Fat in Buttermilk.

In making a test of buttermilk it is very necessary to make an allowance for the quantity of water added

to the cream at the breaking stage, and also any water added to the cream for the purpose of thinning it. Unless this is done it is impossible to state the actual percentage of fat in the buttermilk present.

EXAMPLE :—In an actual churning of 10.5 lbs. of cream containing 27 per cent. fat and fully ripened—*i.e.*, containing .55 per cent. lactic acid, 3.5 lbs. of butter were produced. Two quarts of water were added to the cream.

Deducting the weight of butter produced from the weight of cream taken, we get 7.0 lbs. as the amount of real buttermilk.

Five pounds of water were added to the cream, therefore the substance tested consisted of a mixture of 5 lbs. of water and 7 lbs. of buttermilk—total 12 lbs.

The mixture showed .1 per cent. of fat.

Therefore, if 100 lbs. of mixture contained .1 lb. fat
12 lbs. ,, would contain .012 lbs. ,,

So that 7 lbs. of buttermilk would contain .012 lbs.

If 7 lbs. of buttermilk contained .012 lbs. fat

Then 100 lbs. ,, would contain .17 lbs. ,,

Or, the actual buttermilk contains .17 per cent. of fat.

CHAPTER XIV.

BUTTER RATIO.

(72) Definition of Butter Ratio.

THE proportion of butter derived from the milk during the process of manufacture is known as butter ratio. Every buttermaker should carefully follow the ratio, which gives an indication of any deficiency in the working. The usual ratio will be about 1 : 25, all depending on the quality of the milk—*i.e.*, 1 lb. of butter is obtained from each 25 lbs. of milk. In the farm dairy the ratio may often decrease to 1 to 30 or 35, which shows either very poor quality milk or that considerable loss is occurring at some stage during the manufacture. With the rich milk of Jersey or Guernsey cows the ratio may average 1 : 18. To check ratio, test the quality of the milk, note the quantity separated, and on churning the cream carefully weigh the butter produced. With proper working not more than .2 per cent. fat is lost in both separating and churning.

To calculate how much butter would be yielded from milk of known quality :

$$\frac{(\% \text{ of fat in milk} - .2 \text{ loss}) \times 100}{85} = \begin{array}{l} \text{lb. of butter produced} \\ \text{from 100 lbs. milk.} \end{array}$$

It is here assumed that 100 lbs. of finished butter contains 85 of pure butter fat.

EXAMPLE. — Milk contains 3.6 per cent. fat. How much butter would 100 lbs. of such milk yield, and what would be the butter ratio.

$$\frac{(3.6-.2) \times 100}{85} = \frac{340}{85} = 4 \text{ lbs. of butter from } \begin{matrix} 100 \text{ lbs.} \\ \text{of milk.} \end{matrix}$$

$$100 \text{ lbs. milk} \div 4 \text{ lbs.} = 25.$$

Therefore the butter ratio is 1 : 25.

A gallon of milk weighs 10.3 lbs. To turn pounds into gallons *multiply* by 10 and *divide* the product by 103, or simply *divide* the number of pounds by 10.3.

Another Method of Calculating.

Another method adopted for calculating the amount of butter obtained from milk is to deduct .2 per cent. from the percentage of fat the milk contains and multiply the remainder by the factor 1.16.

This gives the amount of butter produced from 100 lbs. of the milk.

The factor 1.16 assumes that 1 lb. of fat will produce 1.16 ($1\frac{1}{5}$) lb. of butter.

For the formula showing how the butter ratio may be shown in terms of gallons per pound, and other details, refer to the Creamery section of this book.

If the actual churning results compare very unfavourably with those calculated, it must be ascertained by testing what fat is being lost both in the separated milk and the buttermilk. On finding where the fault lies, remedial measures must then be adopted. If in the separator, the running of the machine must be adjusted. If in the buttermilk, the

churning temperature used may be too high, and very commonly the cream churned too sweet. It may even happen that the particular food given to the cows is the cause of not readily churnable cream, excess of fat escaping in the buttermilk. In such a case a change of rations is to be recommended.

CHAPTER XV.

RETURNS OBTAINED FROM BUTTERMAKING.

(73) Annual Returns.

A GOOD cow should produce at least 250 lbs. of butter during the year. Cows which produce less than this are best not retained in the herd where butter only is produced.

Returns from Shorthorn Cows.

A profitable Shorthorn cow may be expected to yield at least 600 gallons of milk during her lactation period; in many herds this quantity is largely exceeded.

Taking the yield of a Shorthorn at 600 gallons for the year, and the average quality of the milk as 3.7 per cent. the returns would be :—

$$600 \text{ gallons} \times 10.3 = 6,180 \text{ lbs.}$$

In separating 12 per cent. of cream is extracted, or 741 lbs. of cream, thus leaving 5,439 lbs. of separated milk.

$$3.7 - .2 \text{ loss} = 3.5 \times 1.16 \\ = 4.06$$

If 100 lbs. of milk yield 4.06 lbs. butter,

Then 1 lb. „ „ $\frac{4.06}{100}$

Therefore 6,180 lbs. „ $\frac{4.06 \times 6,180}{100} = (251 \text{ lbs. nearly}).$

which gives a butter ratio of 1 : 24.6.

SUMMARY OF RETURNS.

251 lbs. of butter.
 5,439 lbs. of separated milk.
 490 lbs. of buttermilk.

Returns from Jersey Cows.

Taking another example, that of a good Jersey cow yielding 500 gallons showing an average test of 5 per cent. of fat :—

$$500 \times 10.3 = 5,150 \text{ lbs.}$$

Taking off 15 per cent. of cream, this gives $772\frac{1}{2}$ lbs. of cream, leaving $4,377\frac{1}{2}$ lbs. of separated milk.

5% fat—2 % loss in separating and churning = 4.8 available
 $4.8 \times 1.16 = 5.56$.

100 lb. milk yield 5.56 lb. of butter,

Therefore, 5,150 lb. milk yield $286\frac{1}{4}$ lb. of butter.

which gives a butter ratio of approximately 1 : 18.

SUMMARY OF RETURNS.

$286\frac{1}{4}$ lbs. of butter.
 $4,377\frac{1}{2}$ lbs. of separated milk, and
 474 lbs. of buttermilk.

It will be noticed that the figures represent gross returns, and no milk has been deducted for use of the calf assumed to be taken away at birth. If the values of butter, separated milk, buttermilk, be taken at current average market prices, the monetary returns can then be obtained. It is useless at the present time to insert prices, owing to the artificial state of markets which are controlled. To the returns must be added the value of the newly-born calf, but on the other hand no account has been taken of the feeding and management of the cow, depreciation and risk, labour involved in converting the milk into butter, and also in marketing it.

CHAPTER XVI.

PRESERVING OR POTTING BUTTER.

(74) Potting Butter

Is often done in summer or when butter is realising a low price. If properly carried out, the butter will keep sound for several months. To ensure success the following points must be attended to :—

(1.) Properly ripened cream, just of the right acidity,—*i.e.*, containing .5 to .6 per cent. lactic acid. If too sweet or too sour the chances of the butter keeping are not so good.

(2.) Liberal washing of the butter when in the granular state to free it from casein.

(3.) Incorporation of a sufficient quantity of salt to make it keep, and thorough working to get rid of as much water as possible.

(4.) It should be properly consolidated in the vessels in which it is packed, and kept out of contact with air.

Add salt at the rate of 1 oz. to the pound, with a pinch of saltpetre, partially work the butter, set it aside for the salt to dissolve, and then rework till well dried.

Glazed crocks, thoroughly scalded and dried, are the best receptacles in which to store the butter. Use a butter-packer and consolidate well. Cover the

butter on the top with a layer of salt about two inches in thickness, and over the crock stretch parchment or bladder.

It is customary in some cases to use strong brine instead of dry salt as a covering layer, and to renew this two or more times during the storage.

Store away in a dry room. When required for use, cut up in pieces and place in a churn of water at a temperature of 60-65° F., and leave for twenty minutes, then work and make up. This rids the butter of a lot of its salt, and it is none the worse for its long storage. Saltpetre and sugar, and also Boron preservative, are often added as well as the salt, and these assist the keeping qualities of the butter.

NOTE :—Should the butter be at all rancid when taken from the crock, due to an improper method of preserving, it should not be soaked in water in the churn used every day in the dairy.

If this is done the wood of the churn will become impregnated with a rancid odour which it will be difficult to remove.

An old churn or other receptacle should be used.

CHAPTER XVII.

DIFFICULTIES OF THE BUTTERMAKER,

(75) **Sleepy Cream**

Is the term applied to cream which fails to yield up its butter, or only does so with difficulty.

It is commonly met with in winter, and it may be due to any of the following causes :—

(1.) Too low a temperature. Cream thickens and becomes viscid, and hangs round the inside of the churn and does not get the necessary concussion. Sometimes too high a temperature causes the cream to froth and swell to such an extent as to prevent its churning.

(2.) Cream not properly ripened, too thick, too thin, or the churn over-filled.

(3.) Failure to ventilate during churning. If the gas is left in, it causes the cream to swell and become frothy.

(4.) Cream obtained from the milk of cows towards the end of lactation. The fat globules are then very small, and difficult to churn.

(5.) Feeding. Winter feeding is often responsible, and also any sudden changes in the diet, as when cows are first turned out in the spring. Poor grass in autumn often causes the cream to be difficult to churn.

REMEDIES.—When cream goes to sleep, as told by its failing to “drop,” stop and test the temperature, and add water to regulate its consistency to that required. Resume churning, ventilate, and note that the cream drops at each revolution. Frequent addition of water of a right temperature will usually make the churning proceed properly.

Where one or two newly-calved cows are kept alongside of those stale in milk, the churning difficulty will be overcome.

The best remedy, and especially where the fault is in the feeding, is to scald the cream to 160° F., cool down, and ripen properly by use of some starter. The cream may be taken from the churn and treated in this way if it is found impossible to churn it otherwise.

(76) **Streaky or Mottled Butter**

And that in which white streaks and specks are noticeable may be caused by:—

- (1.) Impure and unevenly distributed salt.
- (2.) Ripening the cream to excess, thus causing a precipitation of casein, which in a hardened form becomes incorporated in the butter as small white specks.
- (3.) The cream or butter being exposed to sunlight or very strong light. It then becomes bleached of its colouring matter, and if this bleaching occurs in patches it gives an appearance of streakiness.
- (4.) Failure to wash the butter sufficiently and rid it of the casein before brining or dry-salting. The

salt tends to harden the casein left behind, and thus to cause mottling. This is the commonest cause of "streaky" butter, the white streaks consisting of a compound of salt and casein.

REMEDIES :—Ripen the cream properly. Always use a good brand of dairy salt, even if a little more expensive than that commonly obtainable, and adopt the method of dry-salting recommended.

Wash away as much buttermilk from the butter grains as possible by means of plenty of cold water and never churn the butter into lumps.

(77) **Bad-flavoured Butter**

This term includes a number of faults more or less frequently met with. Placed in order, the commonest first, we have :—

- (1.) Butter with a rancid flavour and odour.
- (2.) Butter in which both the smell and taste of foods is noticeable.
- (3.) Butter with a bitter flavour.
- (4.) Butter with a sour flavour.
- (5.) Butter with a tallowy flavour.
- (6.) Butter with a flat, watery, or insipid flavour.
- (7.) Butter tasting as if mixed with flour, which does not dissolve readily on the tongue.
- (8.) Butter with a fishy flavour.
- (9.) Butter with a musty flavour and odour.

Without dealing with each fault individually, it is possible to treat them altogether under the general heading.

Bad flavoured butter generally may be caused by :—

(a) Foods given to the cows which transmit flavours to the butter. The objectionable flavours may either be present in the milk, due to some volatile material of the food actually finding its way into it before it leaves the udder of the cow, or are absorbed by the milk from the air if left remaining for any time in the cow-shed after milking.

(b) Mixing the “colostrum” or “beastings” from newly-calved cows and milk from cows in “œstrum” with that which is to be separated and converted into butter. This should never on any account be done, nor should milk from any cow suffering from an inflamed udder ever be used.

(c) The use of dirty utensils or impure water in washing the butter. A great deal of butter goes bad through the action of the bacteria which get into it from water or from a dirty, microbe-infested churn or other utensil.

(d) The drainage, the dairy becoming impregnated with foul gases, which are absorbed by the cream and butter.

(e) Improper cream-ripening. Keeping the cream at too high a temperature causes too great acidification, which is evidenced in the sour-flavoured butter so common in summer. Keeping the cream at too low a temperature and too long before churning causes the production of the bitter flavour in the cream and butter which is chiefly met with in winter.

(f) Churning temperature too low or too high. If too low, butter with a tallowy flavour may be pro-

duced, whilst if too high the product tastes oily through the presence of too large a proportion of liquid butter fat.

(g) The use of too much ice in summer time results in flat, watery or insipid butter.

The overworking of butter, particularly that which has not been properly freed of buttermilk by washing it when in the granular stage, produces a "floury" taste.

(h) The use of tainted salt or salt of inferior quality. Good salt should always be used, and it should be kept free from taint by storing in an airtight box, as it readily absorbs objectionable odours.

Foods picked up in the pastures which influence the flavour are:—Weeds growing in the hedgerows and the young shoots of hedges eaten chiefly in early spring by the cows, garlic, wild mint, ivy, buttercups, tansy, etc., and fallen leaves taken up with the grass in autumn.

Of the food given to cows, turnips, swedes and cabbages, especially if at all decayed. Too much of inferior cotton and other cakes. Linseed cake, if fed largely, produces an oily flavour. Brewers' grains and also silage, given in excessive quantities, yield tainted butter.

REMEDIES:—See that all pails and utensils are clean; thoroughly wash with soda and steam to sterilise milk churns, etc. Avoid giving excessive quantities of food likely to impart taint, and give *after*, instead of just before milking. Scald the cream to 160° F., cool and ripen, using a suitable quantity of

starter. Refer back to the section dealing with cream-ripening and starters.

Where the shallow-setting system is used, it is a good plan in winter to set the pans, when filled with milk, in water at 150° F.

The rapidly falling temperature causes the cream to rise quickly, and objectionable flavours in the milk, such as those which result from winter feeding, are largely eliminated. Some, indeed, make it a practice in winter to add a small quantity of hot water to each pan of milk on setting, with the twofold object of doing away with food flavour and facilitating the rising of the cream.

We have mentioned the chief difficulties; but there are many others which, with the hints given, an ordinary buttermaker should have no trouble in overcoming.

CHAPTER XVIII.

ITINERANT OR TRAVELLING DAIRY SCHOOLS,

(78) Travelling Dairy Schools,

Conducted by various County Councils have, in instances where the work of instruction has been continued for some time, done a great deal to improve the quality of butter produced on farms. They have also created a widespread interest in the dairy industry in general.

The object of a travelling dairy school should be :—

(1.) To give elementary instruction respecting the treatment of milk and buttermaking to those who have dairy work to carry out at home.

(2.) To replace old methods of buttermaking by newer ones, and to teach the great necessity for cleanliness in all operations, and also that butter must never be touched by the hands.

(3.) To create a desire for further instruction in dairying, and to provide scholarships, so that one or two of the best pupils in the class may be enabled to attend a fairly long course of instruction at some permanent dairy school.

(4.) To provide instruction in the manufacture of cream and simple kinds of soft and small hard cheese where this seems desirable.

Effective Instruction in Buttermaking:—Many County Councils have given up conducting travelling dairy schools after comparatively short trials, owing to the heavy expenses incurred and because no immediate results of the work were apparent. It should be remembered, however, that work of this character must be continued for a considerable time before direct results from it are likely to be seen. The instruction is usually continued for the short period of ten days or a fortnight, and the pupils, in the majority of cases, have not before made butter themselves.

To be really effective, a dairy school should visit a centre not once, but several times at fairly long intervals.

It must not be expected that the best produce can be turned out at a travelling dairy school, as the drawbacks are often considerable, and frequently include :

(a) An unsuitable building, often so cold in winter that the cream has to be churned at an excessively high temperature in order to produce butter at all.

(b) No satisfactory storage-place for the cream, which may frequently become tainted, in which case an objectionable flavour will be imparted to the butter.

(c) A difficulty in securing a sufficient supply of clean cold water. This is chiefly accountable for the inferior quality of butter.

Further than this the teacher has to overcome a considerable amount of prejudice against modern methods which is frequently found in country districts.

There is often a difficulty in getting a sufficient number of pupils enrolled to make it worth while holding a class, a state of affairs which is due to an apathy on the part of the farming community to take up a course of instruction which would be greatly to its benefit.

The fact that butter-making demonstrations are usually conducted under difficulties should serve to show students how it is possible to overcome obstacles which fortunately, do not so often occur under ordinary conditions.

(79) **The Course of Instruction.**

The instruction provided should be of the simplest character possible, and should include such subjects as the composition of milk, the thermometer, milk-testing, refrigerating milk for sale, methods of creaming milk, advantages of the separator, cream-ripening, churning, making up and marketing of butter, potting butter for winter use, cream cheesemaking, etc. The teaching should explain the *reason* for each of the operations in buttermaking, and be given in a manner calculated to encourage pupils to think for themselves.

It is generally the best plan for a teacher to purchase cream from one firm that will agree to take the butter at a given price. This does away with all the complications of purchasing the cream and selling the butter locally.

A small quantity of milk for separating may be purchased near at hand. It is a good plan for the teacher to commence the course with a demonstration

and explanation, either of buttermaking or cream separation. At the second lesson, two pupils may be given one churning of cream to attend to, and the third time each pupil should be required to make butter independently.

A card of instructions will prove handy if hung up near each churn, so that, should the pupil wish to proceed with the work while the teacher's attention is engaged elsewhere, a ready reference to the next thing to be done is available.

In addition to practical work, one hour daily should be devoted to theory.

CHAPTER XIX.

THE UTILISATION OF BYE-PRODUCTS OF THE DAIRY AND SURPLUS WHOLE MILK.

(80) The Bye-products.

These usually consist of separated milk, buttermilk and whey, the latter being available where milk is made into cheese. The composition of these bye-products may readily be seen in the following table :—

	Water	Fat.	Casein, etc.	Milk Sugar.	Ash.
Separated Milk	90.39	.01	3.90	4.65	.75
Buttermilk ..	94.44	.20	3.56	4.10	.70
Whey	93.26	.30	.89	4.90	.65

On farms where milk is sold wholesale, surplus whole milk may frequently have to be dealt with as a bye-product in the spring of the year, for at this, the natural time for cows and heifers to come into profit, over-abundant supplies are common, and it is not always advisable to market cows at that time. Again, a big reduction in the wholesale price of milk, or animals that do not yield milk up to the legal standard of quality, may be contributory causes for utilising the milk on the farm. Fortunately the British producer, veal calves, dairy-fed pork, Sussex fowls, and milk-fed chickens have such a

reputation that as yet foreign competition has had little effect in reducing their value..

(81) Separated Milk as a Food for Human Beings.

Separated milk is largely used, especially for puddings and cooking generally, but its high value as a food is not properly realised owing to its apparently thin, watery character.

Only the fat has been removed, however, from the whole milk, so that separated milk contains practically all the highly nitrogenous or albuminous material in addition to sugar and ash. It is very readily assimilated, and does not satisfy the sense of hunger for long, but never-the-less, comparing it with other foods it is extremely valuable—about half a gallon of separated milk supplying the same amount of nitrogenous material as 1 lb. of lean meat.

Use of Separated Milk in Breadmaking :—Experiments have shown that the use of separated milk mixed with flour instead of water is of great advantage. It increases the yield of bread in addition to giving it a whiter appearance, whilst it also increases the amount of proteid matter in the bread. The digestibility of the bread is practically unaffected by the use of milk, as it is shown to be equally as well digested as bread mixed with water.

The following figures from the Maine Experimental Station show the average composition of bread made with water and made with skim milk :—

Kind of bread.	Water %	Protein matter %	Fat %	Carbo- hydrates. %	Ash. %	Fuel value. Calories
Water bread	39.44	8.93	1.07	49.69	0.87	2,649
Skim milk bread	37.97	9.98	.94	49.82	1.29	2,710

(82) Feeding Calves on Surplus Whole Milk.

It is by no means impracticable to make veal "from the pail," and surplus milk may to advantage be used this way, although, obviously, a calf reared by the cow saves labour and grows faster.

The advantages of hand-milking and rearing are:—

(1.) All the milk is withdrawn from the udder, the bag and teats are kept in good shape; this especially applies to heifers.

(2.) Any excess of milk that the calf cannot take can be used for some other purpose such as rearing a second calf, or for separating, the milk drawn last from the udder being richer than that which is drawn previously.

(3.) Treated in this way for a few weeks another calf could then be put to the cow, unless it is thought preferable to go on with the hand-milking.

Whichever way of feeding is carried out it is necessary to give the "colostrum" or "beastings" to the calf for the first few days of its life, as in addition to high feeding value, colostrum possesses a medicinal effect, and clears out the "meconium," or green, gluey fœces, present in the intestines of the newly born calf.

(83) Feeding Veal Calves.

Exercise is not required in the making of veal, but very close quarters or too much lack of space and air, as seen on some farms, is to be avoided. The calf should have room enough to turn round and lie down,

and is better alone than penned up with others. Two most important factors are cleanliness and regularity in feeding, otherwise too much may be taken as a meal or the milk too quickly swallowed, the result being indigestion and diarrhœa. Although involving more trouble, we recommend feeding three or four times a day. It is by no means impossible to turn out good veal on the dual or usual twice-a-day feeding method, and for convenience sake this is frequently done ; but the growth of the calf is more rapid when fed at least three times daily, provided *always* that the milk is given at its normal temperature of about 95° F., and that the pails are kept properly scalded out. A piece of chalk is sometimes put in the manger, or powdered chalk in the milk, with a view to correct the acidity of the stomach.

Whole milk for Veal Calves.—For first-class veal no food other than whole milk is recommended, although many add a little oatmeal. The best time for feeding calves is when the milk is cheap and veal is dear ; but it is rather impossible to forecast when these two conditions coincide. The wholesale price of milk, even in March has varied from 50 per cent. in price within a few days. Veal is usually sold by the stone of eight pounds. Normally, however, the season for veal is from Easter till Whitsuntide or a little after, and milk at this period is plentiful. It is for the above reasons, and still more the wide difference there is in the individual growth of the animal, and again the weight at actual birth, that figures are so often misleading.

APPROXIMATE QUANTITY OF MILK CONSUMED :

- 7 gallons used at the end of the first week,
- 14 gallons used at the end of the second week,
- 21 gallons used at the end of the third week,

about the same or rather more at the end of the month, and possibly 4 gallons a day after this ; but it cannot be too strongly pointed out that individuals vary immensely. The market size must be studied, many butchers, particularly in the Southern towns, preferring animals of about 9 to 10 stone dead weight of 8 lbs., the calf being under a month old. A cow may give far more milk per week than the calf will take, and many calves grow so as to give much better monetary returns than others.

Most suitable type of calf.—An important point sometimes overlooked is the selection of the animal. We have on occasions made more profit from half-bred Sussex-Jersey than from the better class of Shorthorn, merely because the calf was bought very much cheaper in the first instance. It is safer, however to buy one or breed one that, should it not be sold fat, is likely to turn out a good steer or heifer. A calf that usually fattens well has plenty of width between the eyes, a somewhat dished face, wide loins, supple skin, mossy coat, and general healthy appearance. And if it can be bought direct from the breeder, where both the sire and dam can be seen, so much the better. Chills and scour are two things to be guarded against when buying in the market. One need not value mere size nearly so much as good quality.

(84) Rearing Calves.

For rearing heifer calves the type of a dairy cow should be borne in mind, the position of the teats, folds of the udder, narrow chine, somewhat long head, and thin flanks are points that are discernable. Note also the escutcheon.

From a national economic point of view it is perfectly sound to say "save the calf." There is a shortage of breeding stock and stores all over the country. However, many of the cross-bred bull calves will never pay to rear ; and although breeding such animals is to be deprecated, they can always be converted into veal.

Rearing calves on separated milk and butter fat substitute.—Store cattle, either to come into the breeding herd or to ultimately make beef, can be very successfully reared on separated milk, plus some substitute for the fat that has been removed. In fact, so satisfactory and economical has the use of separated milk, with some fat substitute, been proved that it has become general in many districts. The usual method employed is to give about a gallon of whole milk a day for the first week or ten days of the calf's life, and to then gradually replace new milk by using separated milk, bringing up the total quantity to two or more gallons as the calf gets bigger. Various substitutes can be added to the separated milk to take the place of the cream removed, and the choice will be with either a bought prepared meal, a home-made mixture, or cod liver oil or some other oil. In the case of the cod liver oil it is usual to begin with only

1 fluid oz. and work very slowly up to between 3 and 4 ozs., the time extending up to about 5 months. The oil requires a considerable amount of mixing and breaking down, otherwise it will float to the top, and owing to its rather unpleasant odour may easily put the calves off their feed. A home-prepared meal is to be preferred and this may simply consist of crushed oats or a mixture containing half linseed, and half mixed crushed oats and wheat. Put the calves on to solid food as early as possible by tempting them as soon as they will eat with fine hay and linseed cake. Whatever the substitute used (so long as it is suitable) there can be no question as to the very great saving of expense. The remarks under the head of "Veal," about warmth, cleanliness, and keeping the young stock free from scour, apply even more here, as the conditions are more artificial. With proper care, however, and attention to detail, several substitutes are entirely practical, the finished animal coming out quite as well as those far more expensively reared.

(85) **Pig Keeping.**

The importance of good accommodation is not sufficiently appreciated in pig-keeping. We do not believe in the "store stage." A pig should be kept going, and a damp, cold sty facing north, with the floor below the level of the surrounding land, spells disaster. A building opening towards the south, having a movable wooden slatted floor, together with suitable accommodation for exercise and feeding the pigs is most desirable.

Do not take pigs to the market and bring them

home again. Buy pigs either for breeding or feeding direct from the breeder. Many cases of swine fever involving the slaughter of the whole lot have been known through not acting as above stated. Whether it is desirable to breed or to buy in young stock is entirely a matter for local consideration.

The Breeding Sow.—The ideal animal is one likely to throw and bring up large litters. To know that the animal is bred from one having these attributes is an advantage. The number of teats in a brood sow should not be less than ten or twelve, and the shape is an important point. It must be remembered that the sow is a milking animal, and that flat, plate like blind teats are useless. The sow, then is expected to throw a strong litter, and this condition depends mainly on :—

(a) Her capacity for producing milk.

(b) Length from throat to ham, which should allow plenty of room for the development of the pigs.

(c) Quiet disposition. It is sometimes advisable to take the pigs away before they suck ; the sharp incisor teeth are nipped off, and the pigs returned to their mother. Although this may not be often done the more docile the sow, the easier she is to manage.

(d) Quality and cleanness of bone. A round-boned, "groggy" animal is one liable to cramp and not likely to throw strong, quick-growing litters.

(e) Other characteristics of a good sow are : width between the ears, plenty of the right sort of hair (an indication of lean flesh), lightness of shoulder,

deep sides, and a strong tail, set rather high, showing strength of back. Animals are to be preferred which are as free as possible from wrinkles in the skin about the thigh. The carriage of the ear and colour of the pig is in accordance with the breed.

Porkers or Bacon Pigs.

Local conditions must decide whether it is better to grow small porkers or bacon hogs. On some cheese-making farms, where there is an abundance of whey, the large white breed is the favourite, and pigs are kept till they reach a weight of 160 lbs. to 180 lbs. each. The London trade, which is practically continuous throughout the year, demands a roaster of 7 to 8 stone. Middle-White, Berkshire, or some cross of the Large Black, or Tamworth on one of these makes a useful animal.

Litters of Pigs—A gilt or young sow should be 12 or 13 months old before she pigs down, April or May being very suitable months for farrowing her first litter. The normal period of gestation is 16 weeks, or 114 days, and that is generally the time a young sow will carry her pigs. Older animals frequently go 117 days; and if about to produce small litters, gestation is longer than when a larger number are forthcoming. For older animals there are advantages that may make January and July more suitable months for increasing the stock, thus :—

ADVANTAGES OF JANUARY AND JULY LITTERS :

(a) Pigs bred in January are better for exhibition stock, the ages being often calculated from the 1st of

the year. They would thus gain the full advantage of the classification.

(b) Weaning is best done gradually by not taking all the pigs away at one time. Some of the three-week-old pigs might be sold as suckers during the cold weather.

(c) The other pigs could be weaned at about eight weeks old, and either fed on to be sold as small London porkers, or kept till the following autumn and sold as bacon hogs.

(d) The sow has the great benefit of getting plenty of exercise in a grass paddock or orchard from April to July. This is conducive to her becoming the mother of a strong litter.

(e) July litters. The sow is under shelter during part of the hottest time of the year.

(f) In warm weather pigs grow faster. They might, if exceptionally strong, be run as stubbles, but this practice is not to be recommended. They would come in as either porkers in October, fat Christmas pigs, or kept on to February or March, making baconers from 160 lbs. to 180 lbs.

(g) The sow has again the advantage of going out to grass, or spring tares, &c., may be brought to her she can thus be kept very cheaply all through the late summer and autumn months.

Feeding Pigs.—The dairy farmer has a great opportunity for the disposal of either his separated milk or whey among the calves, pigs or poultry, and the quantity and value can be calculated in various ways.

Assuming, for example, that a gallon of milk makes 1 lb. of cheese, and that a gallon of milk weighs a trifle over 10 lbs., we get from each gallon of milk 1 lb. of cheese and 9 lbs. of whey. If the herd averages 600 gallons a year, 480 gallons might be returned as whey. Calculating separated milk from butter-making by somewhat the same method, we get say, 600 gallons of whole milk—less 10 per cent. of cream = 540 gallons of separated milk. The feeding value of separated milk for pigs and poultry is considerable, seeing that little more than the fat of the total solids has been removed. Whey is not so good for young pigs, but when they are two months old it may be part substituted for skim milk. It must be taken from the vat sweet and should then be scalded to keep it sweet. Whey is chiefly water and sugar and is somewhat of a laxative, but “thirds” mix well with it and make it more suitable for young pigs. Separated milk, is, however, decidedly better than whey either for young pigs or for fattening. Good strong pigs kept on for bacon might get through some three gallons of whey a day, but the more meal fed the less whey they would require. Barley meal, pea meal and whey, or better still, oatmeal, maize meal and separated milk should soon fatten strong pigs. For porkers oatmeal sharps, skim milk and a few boiled potatoes are preferable. Used judiciously, potatoes and other garden stuff mixed with a nitrogenous food makes an excellent and cheap diet. Cinders should always be present in the pig-sty, and the cleaner and drier pigs are kept the better they will thrive. Sows may receive middlings previous

to and for some weeks after they have pigged, a change of food being introduced gradually. With proper accommodation and food at reasonable prices pigs may be a very paying proposition, but it must be remembered pork is one of the most fluctuating food products on the market.

(86) **Poultry Keeping.**

Given the requisite attention, the most profitable of all ways of using separated milk is in feeding poultry. For the general dairy farmer the Sussex cramming system cannot be advised, nor even the penning of birds and trough-feeding them. The best plan usually is merely to breed, rear, and sell at the earliest opportunity, either in the wholesale market or to the shopkeeper. This, with the exception of egg-farming or the more specialised day-old chicken trade, reduces the labour question to a minimum, and requires common sense and attention to detail rather than any great technical skill.

Mating and Breeds of Poultry.—The time to mate the birds is October, November, December, and the time to hatch is the winter and spring months. The earlier the birds are marketed the greater the demand, the highest prices generally being realised from February to July. The breed and crosses recommended are the Sussex (speckled and light), Faverolles, Orpingtons, a cross of Light Sussex with the two latter, the Indian Game crossed with any of the above, or with the Dorking, if the situation is a dry one.

Feeding and Rearing Poultry.—Soft food, consisting of Sussex ground oats and sharps, mixed with separated milk, and separated milk to drink, should form their staple diet. Dry chick food and wheat are sometimes used, and the feeding should be done either three, or better, four times a day. The young birds should be allowed to range over a small field and sleep in coops or “arks” at night. They should be sold at weight ranging from 3 to 4½ lbs. alive, picked straight up out of the field without any preparation. This is not poultry farming in the strict sense of the word, but converting milk into money by the aid of the birds. Some chickens will, of course, be wasters, whilst others not quite up to the mark for sale can be used at home; and to set against this a few pullets and cockerels will usually be disposed of in the autumn for stock purposes. As one becomes more interested in feathered life certain side lines can be attempted. There is always a market for eggs, and just in the glut of the season some can be put down in water glass. Again, in some markets without any advertising there is a sale for “day-old” chickens, and often a dairy farmer may sell the bulk of his incubator hatches in this way, even “any breed,” probably mongrels, making a good price per dozen in boxes. The specialist, would of course, use pure breeds or recognised popular crosses and advertise.

Ducks and Turkeys.—Separated milk may be utilised with great advantage with ducks for laying, either Indian Runner, Khakee, Canbells, or Buff Orpington or Turkey breeding. Rearing Turkeys certainly does involve in the early stages some trouble,

but the old idea of dry land and woods being essential for success is disproved by our own experience. With care Turkeys can be reared on a damp clay soil. Here, again, milk neutralises a multitude of sins and simplifies rearing. The birds are reared in the same field with the chickens, and some of the cheaper biscuit food given them, with the best ground oats in the later stages. The chief trouble is experienced, with stray dogs or vermin, but the possibilities are so good that the rearing is well worth a trial

INDEX.

References are to the numbers of paragraphs.

- Acidimeter, 26.
Alfa Laval Separator, 31, 32, 33.
Annatto, 19.
Arrangement of Buttermaking Dairy, 1.
Artificial Butter Colour, 19, 43.
Asphalt, 3.
- Bacon Pigs, 85.
Breaking Stage, 52.
Breaking Water, 52.
Breeds of Poultry, 86.
Brining Butter, 55.
Butter, Bad flavoured, 77.
Butter Colouring, 19.
Butter composition, 69.
Butter Dryer, 15, 59.
Butter-fat Tester, 21.
Butter Grains, 52.
Butter-hardening, 58.
Butter, making up, 60.
Buttermaking, Conditions in
fluencing, *Introduction*.
Buttermaking Dairy, 1.
Buttermaking Dairy Utensils, 27.
Buttermaking, Returns from, 73.
Buttermaking, short instructions,
62.
Buttermilk composition, 80.
Buttermilk, Fat in, 71.
Buttermilk Testing, 24.
Butter-preserving, 74.
Butter Ratio, 72.
Butter, Streaky, 76.
Butterworker, 14.
Butter-working, 58.
Bye-Products, Utilisation of, 80.
- Calculations, Breaking Water,
52.
Calculation of Butter Ratio, 72.
Calf, points of, 83.
Caustic Soda, 26.
Cement, 3.
Centrifugal Butter Dryer, 15.
Centrifugal Force, 30.
Chemical Purity of Salt, 18.
Churn, 13.
Churning, 47, 52.
Churning Devonshire Clotted
Cream, 50.
Churning Ripened Cream, 51.
Churning Sour Milk, 48.
Churning Sweet Cream, 49.
Churning Temperature, 46.
Clotted Cream, 50.
Colour, Artificial, 19.
Composition of Butter, 69.
Composition of Separated Milk,
80.
Composition of Buttermilk, 80.
Composition of Whey, 80.
Composition of Water Bread, 81.
Composition of Skimmed Milk
Bread, 81.
Conditions influencing Butter-
making, *Introduction*.
Construction of Dairy, 3.
Cream Percentages, 37.
Cream Percentage Calculations,
38.
Cream Ripening, 39.
Cream Separators, 29.
Cream, Sleepy, 75.
Creaming, Systems of, 28.

- Dairy Bye-products, 80.
 Dairy Cow, Points of, 44.
 Dairy Schools, Travelling, 78.
 Dairy Sewage, 10.
 Deep Setting System, 28.
 Delaitouse, 15, 59.
 Design of Dairy, 2.
 Devonshire Clotted Cream, 50.
 Diabolo Separator, 29, 30.
 Dirt in Milk Tester, 25.
 Dry-salting Butter, 56.
 Ducks, 86.

 Efficiency of Separation, 31.

 Fall in Floors, 4.
 Fancy Butter, 68.
 Fat in Buttermilk, 71.
 Feeding Calves, 82, 83.
 Feeding Pigs, 85.
 Feeding and Rearing Poultry, 86.
 Fixing Churning Temperature, 46.
 Flagstones, 3.

 Gerber Tester, 21.
 Good Butter, Points of, 64.

 Hardening Butter, 58.
 Heating Dairy, 9.

 Ice Chest, 20.
 Instruction in Buttermaking, 78, 79.

 Judging Butter, 65.
 Judging Buttermaking Classes, 66.
 Judging Buttermaking Competitions and Examinations, 67.

 Lactation Period, 44.
 Light and Ventilation, 6.
 Litters of Pigs, 85.

 Making up Butter, 60.
 Manipulations in Churning, 52.
 Marketing, 63.
 Materials of Dairy, 3.
 Mechanical Purity of Salt, 18.
- Melotte Separator, 30.
 Milk Testing for Dirt, 25.
 Milk-Butter, characteristics of, 48.

 Natural Cream Ripening, 40.
 Natural Colour of Butter, 44.
 Natural Starter, 41.
 New Churn, Preparation of, 45.

 Objects of Washing Butter, 54.
 Ornamental Butter, 68.

 Percentage of Cream, 37.
 Percentage of Cream Calculations, 38.
 Pig-keeping, 85.
 Pocket Method of Testing, 22.
 Points of Dairy Cow, 44.
 Points of Good Butter, 64.
 Points for Judging Butter, 65.
 Points for Judging Butter-making Classes, 66.
 Points for Judging Competitions and Examinations, 67.
 Points of Calf, 83.
 Porkers, 85.
 Position of Dairy, 2.
 Potting Butter, 74.
 Poultry Keeping, 86.
 Power Separators, 32.
 Preparation of Utensils, 45.
 Pure Culture Starter, 41.
 Pure Water Supply, 11.

 Rearing Calves, 84.
 Refrigerator, 20.
 Returns from Buttermaking, 73.
 Ripened Cream Churning, 51.
 Ripening Cream, 40, 51.
 Roofs, 7.

 Sal Method of Testing, 22.
 Salt, 18.
 Salting Butter, 55, 56.
 Separated Milk Composition and Utilisation, 80, 81, 84.
 Separated Milk Testing, 24.
 Separating Temperatures, 34.

- Separators, 12, 29.
Separator Bowl, 33.
Separator System, 28.
Separator Vibration, 35.
Separator, Working of, 35.
Sewage, 10.
Short Instructions for Butter-making, 62.
Shallow Setting System, 28.
Skimmed Milk Bread, 81.
Skimmed Milk Testing, 24.
Sleepy Cream, 75.
Souring of Cream, 39.
Sour Milk Churning, 48.
Sow, the Breeding, 85.
Speed of Separator Bowl, 33.
Standard Tubular Separator, 30.
Starters, 41.
Starter adding to Cream, 42.
Steam Turbine Separators, 32.
Streaky Butter, 76.
Successful Cream Ripening, 42.
Sulphuric Acid, 26.
Successful Separation Essentials, 36.
Sweet Cream Churning, 49.
Systems of Creaming, 28.
Temperature of Dairy, 6.
Temperature Can, 16.
Temperature of Churning, 46.
Testing Cream, 23.
Test for Water in Butter, 70.
Thermometers, 17.
Tiles, 3.
Turkeys, 86.
Utensils for Buttermaking Dairy, 27.
Utensils, Preparation of, 45.
Utensils, Washing, 61.
Variety of Separators, 32.
Ventilation of Dairy, 6.
Ventilation of Churn, 52.
Verandah, 8.
Walls, 5.
Washing Butter, 54.
Washing up Utensils, 61.
Water Supply, 11.
Water in Butter, 58, 70.
Whey Composition, 80.
Whole Milk for Calves, 82, 83.
Working Butter, 58.

NEW AND REVISED EDITION.

Price 5/6 nett.

PRACTICAL CHEESEMAKING

*A GENERAL GUIDE TO THE
MANUFACTURE OF CHEESE*

BY

C. W. WALKER-TISDALE

AND

WALTER E. WOODNUTT

A simple Text Book embodying the practical points essential to those who wish to manufacture cheese on the best and most economical lines.

SYNOPSIS OF CONTENTS.

The Dairy Building and its Arrangements—The Constitution of Milk and Distribution of Constituents in Cheesemaking—The Ferments of Milk—The Care of Milk for Cheesemaking—Rapid Methods of Milk Analysis—Rapid Tests for Ascertaining the Purity of Milk—The Souring of Milk and Testing for Acidity—The Nature, Preparation and Action of Rennet—Starters, their Nature and Methods of Preparation—Requirements of the Cheesemaking Dairy—The Appliances for Cheesemaking—Process and Methods of Cheesemaking—The Ripening or Curing of Cheese—The Marketing or Disposal of Cheese—Faults or Defects in Cheese—Some Varieties of British Cheese: Cheddar: Cheshire Cheese; Leicester Cheese; Derby Cheese; Caerphilly Cheese: Wensleydale Cheese; Whey Butter; Appendix for Students.

LONDON

HEADLEY BROS. PUBLISHERS, LTD,

72, OXFORD STREET, W. 1.

HALL'S REFRIGERATING MACHINES

for all cooling purposes in
Dairies, Creameries, etc.

Cheese & Butter—Milk & Cream
rapidly cooled and
maintained in good
. . . condition . . .

Use of Ice avoided; low running
costs, simple in working.

J. & E. HALL, Ltd.,

10, St. Swithin's Lane, London, E.C.4, and
Dartford, Kent.

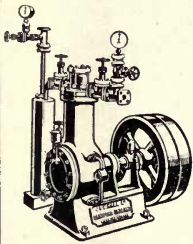

THE WENSLEYDALE PURE MILK SOCIETY, LTD., NORTHALLERTON,

is prepared to take pupils for training in Commercial Dairying. A general all round experience can be gained in Farm Inspections and Tuberculin Testing; Dairy Management, including Purchase and Sales, Separating, Milk Testing and Cheesemaking, Fitting and Fixing Dairy Machinery, Repairs.

A MODERATE PREMIUM REQUIRED.

The Society provides expert advice on the planning and equipment of small and large Dairies. Plans and Specifications of Buildings and Machinery prepared. Advice on selection of sites, water supply, &c., &c.

Particulars on application to the General Manager (Mr. C. W. Walker-Tisdale), Consulting Engineer to the Agricultural Organisation Society.

CHEESE-MAKING

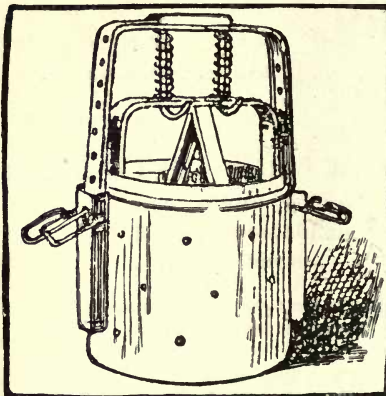

is the most profitable known method of selling Milk. Small Cheeses can be sold immediately or stored until a convenient market day. Remember, 8 gallons of Milk makes a 4-lb Cheese, and the Whey is a very valuable feeding product. The

"Farmer's Friend" Cheese Mould and Press

is specially adapted to make Small Cheeses of splendid quality all the year round. You require no other special utensils if you have our Press, and we send instructions for Cheesemaking to every purchaser, which will teach the most inexperienced to make high-class Cheese in a few hours—Cheese that will keep for months.

The Meat Shortage Demands Increased Cheese Manufacture.

Order a Press at once. Don't risk disappointment later on.

Delivery not guaranteed in less than six weeks from receipt of order.

To make Cheese	1-4 lbs	12s. 6d.
" "	2-6 lbs	15s.
" "	3-10	17s. 6d.

1s. 3d. per Press extra for packing and carriage.

SIMPSON, Press Manufacturers, OTLEY, YORKS. [Please mention this book.]

DAIRY SALT.



HIGGIN'S

"Eureka"

AND

D. V.

BRANDS.

As used in Butter Contests
in all the principal Shows.

also in

Agricultural Colleges and Government Dairies.



ASHTON, HIGGIN & Co., Ltd., LIVERPOOL, or Agents.

THE HINMAN MILKER

Simple, Sanitary, Efficient.

Lowest First Cost. Lowest Upkeep.

Hand mixing is unclean because so much depends upon the state of the milker's hands, in theory these do not touch the milk, in practice contact is frequent. Hand milking necessarily means the use of open pails, open pails mean the collection of impurities from dust and dirt which drop from the cow's hair and often flies. Use a scientific machine with a closed pail into which no dirt or odour can penetrate, and see that you get a fool-proof and simple machine—The Hinman—which ensures milk produced in the best condition for Butter and Cheesemaking.

Write To-Day
for Illustrated Booklet,
'More Money from Milk,'
and full particulars
to
The ASSOCIATED
MANUFACTURERS,
COMPANY,
72-80, Mansell St.,
LONDON,
E.1.

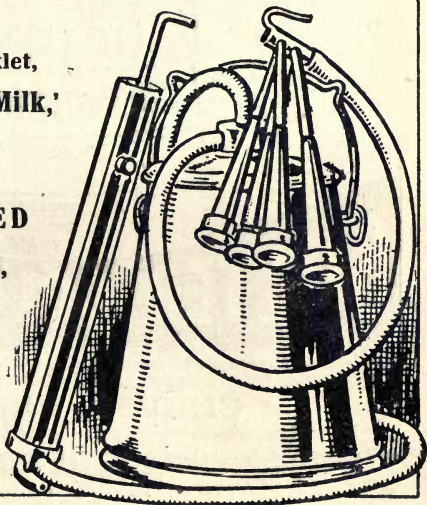

THE WISE FARMER

BUTTER COLOURING

CHEESE RENNET.

The Butter Colouring is a purely vegetable preparation. Gives an even rich appearance to the butter at all seasons. Is in use in all Large Dairies, and butter coloured with it has taken First Prizes at the Principal Shows. Mixes directly with the butter in churning. Sold in bottles,

The Cheese Rennet is a highly concentrated preparation: 1 part curdles 14,000 parts milk, is always the same strength, one tablespoonful being sufficient to curdle 25 gallons of milk. Sold in stone bottles: half-pint, 1 pint, 1 quart, half gallon, 1 gallon, and in casks.

SILVER
BUTTER POWDER

USES ONLY THE SILVER CHURN DAIRY PREPARATIONS

CHURN
LIQUID ANNATTO

Butter Powder greatly lessens Churning, saves time, and produces a firm, sweet butter. Removes the flavour of strong food. Prevents new milk turning sour. Sold in boxes.

Liquid Annatto gives a rich colour to cheese which does not fade. Quite harmless, being purely vegetable. One tablespoonful to 50 gallons milk.

BUTTER COLOURING

TRADE MARK

Large dairies are requested to write for quotations, naming quantities they will buy or contract for. We wish particularly to draw attention to our make of

CHEESE RENNET.

No matter what price is paid, no better article is procurable.

Free Samples and Particulars from **OLDFIELD PATTINSON & CO.,** Manchester, England.

To be had from all Dealers in Dairy Supplies.

CHEESE!

For Cheese-makers the undermentioned Specialities, well-known in the Cheese-making World, may have more interest for our Home Makers than they had in pre-war days.

KEEPS CHEESE RENNET

Keeps Cheese Rennet is prepared by a special and original process from SELECTED VELLS of young calves, insuring uniformity of strength, a HIGH DEGREE OF CONCENTRATION, 1 : 12000, and retains its freshness and milk-curdling power for an almost indefinite time in any climate, provided it is kept in a well-filled vessel, tightly corked, and in a dark, cool place.

KEEPS CHEESE COLOURING (Liquid Annatto)

We guarantee this preparation is made from the finest quality Annatto Pulp of the seed pod of the "Bixa Orellana," and entirely free from Aniline Dyes. Colouring cheese: One to two ounces to each 1,000 lbs. weight of milk, according to tint required.

KEEPS LACTIC ACID FERMENT (Liquid)

A pure culture of Bacillus Acidi Lactici for the speedy ripening of Cream and Milk for Butter and Cheese making. Keeps Lactic Ferment is used in the Creamery, the Dairy and Cheese Factory, to accelerate the preparation of the Starter.

KEEPS (Vacuum) DAIRY SALT

Keeps (Vacuum) Dairy Salt is specially prepared for Dairy purposes, and may be regarded as absolutely pure, since it is composed of not less than 99½ per cent. of chloride of sodium. Ordinary Dairy Salt frequently contains impurities, such as sulphate of magnesium, etc.

Official Leaflets giving some valuable information on the following will be sent on application:—

- (a) Profitable Utilisation of Surplus Milk. Use of Whey.
- (b) Cheese-making (hard and soft).

KEEPS BUTTER PRESERVATIVE ("Diamond Brand")

Dairy Show, London, 1915:—All the 1st, 2nd, and 3rd Prizes in the three Commercial Butter Classes, also the 1st and 2nd Prizes in the Colonial Butter Classes, were won by Butters cured with Keeps "Diamond brand" Preservative, making FOURTEEN Prizes out of a possible EIGHTEEN.

KEEPS, Ltd., 24-26, HOLBORN, E.C.1

Awarded Silver Medal by the British Dairy Farmers' Association.

“VIKING” CHEESE RENNET

**is used by thousands of Cheesemakers
all over the World.**

STRONG, PURE, RELIABLE.

“VIKING” ANNATTO

Gives the Cheese a beautiful colour.

“VIKING” BUTTER COLOUR.

The Best Obtainable.

GUARANTEED BRITISH MANUFACTURE.

Write to us now for Samples and Prices.

THE VIKING RENNET CO., LTD.,

19, Clapton Square, London, E.5.



TRADE MARK.

TO BUTTER AND CHEESE MAKERS.

R. J. FULLWOOD & BLAND'S world-renowned Dairy Preparations are used and recommended at the

PRINCIPAL DAIRY INSTITUTES,
and have the Largest Sale in Great Britain.

R. J. FULLWOOD & BLAND'S CHEESE PREPARATIONS

"SUI
Profes

R. J. FUL

Awarded

Numerous ot

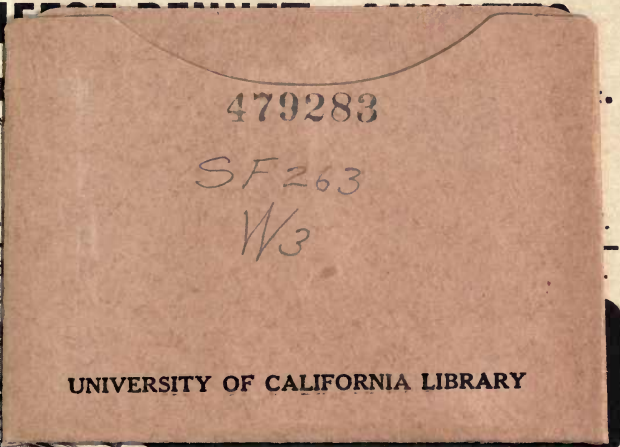

UNIVERSITY OF CALIFORNIA LIBRARY



No. 2 DIABOLO.

Has a larger Sale than any other Separator Sold in Great Britain.

CAPACITIES AND PRICES.

No. 0	Capacity, 15	galls. per hour	£9 0 0
No. 1	„ 27	„	£12 0 0
No. 2	„ 50	„	£21 0 0
No. 3	„ 82	„	£30 0 0

STANDS and CREAM PLATES for No. 0, 21/-; No. 1, 25/-; No. 2, 30/-; No. 3, 45/-.

One Month's Free Trial. Guaranteed 10 Years.

Send for further particulars and List of Testimonials.

R. J. FULLWOOD & BLAND, 31, 33, 35, Beviden St., London, N.

