

A TEXTBOOK
ON
MINING ENGINEERING

INTERNATIONAL CORRESPONDENCE SCHOOLS
SCRANTON, PA.

BLOWPIPING
MINERALOGY
ASSAYING
GEOLOGY
PROSPECTING
PLACER AND HYDRAULIC MINING
WITH PRACTICAL QUESTIONS AND EXAMPLES

1007

SCRANTON
INTERNATIONAL TEXTBOOK COMPANY

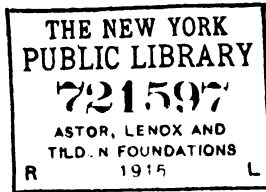

Copyright, 1899, by THE COLLIERY ENGINEER COMPANY.
Copyright, 1900, by THE COLLIERY ENGINEER COMPANY,
under the title of The Elements of Mining Engineering.

Blowpiping: Copyright, 1893, 1894, 1898, 1899, by THE COLLIERY ENGINEER COMPANY.

Mineralogy: Copyright, 1893, 1894, 1898, 1899, by THE COLLIERY ENGINEER COMPANY.

Assaying: Copyright, 1893, 1899, by THE COLLIERY ENGINEER COMPANY.

Geology: Copyright, 1895, 1898, 1899, by THE COLLIERY ENGINEER COMPANY.

Prospecting: Copyright, 1893, 1895, 1898, 1899, by THE COLLIERY ENGINEER COMPANY.

Placer and Hydraulic Mining: Copyright, 1897, 1899, by THE COLLIERY ENGINEER COMPANY.

All rights reserved.

by

BURR PRINTING HOUSE,
FRANKFORT AND JACOB STREETS,
NEW YORK.

NOV 21 1915
BURN
1915

CONTENTS.

BLOWPIPING.	<i>Section.</i>	<i>Page.</i>
Constitution of Matter	34	1
Chemical Elements	34	1
Formation of Chemical Compounds	34	44
Chemical Nomenclature	34	14
Blowpiping	34	19
Wet Tests	34	19
Apparatus for Blowpiping	34	21
Blowpipe Reagents	34	32
Examination of a Substance Before the Blowpipe.	34	36
Reduction of Metallic Oxides with Soda	34	51
Table Showing Colors Imparted to the Flame by Various Minerals	34	56
Table Showing Colors of Borax Beads in Oxidizing Flame	34	58
Table Showing Colors of Borax Beads in Reducing Flame	34	60
Tables Showing Color of Salt of Phos- phorus Beads in Oxidizing Flame	34	62
Table Showing Color of Salt of Phos- phorus Beads in Reducing Flame	34	64
Table of Characteristic Reactions of Common Metallic Oxides	34	66
MINERALOGY.		
Minerals and Their Properties	35	1
Crystallography	35	11
Isometric System	35	12

MINERALOGY—Continued.	<i>Section.</i>	<i>Page.</i>
Tetragonal System	35	15
Orthorhombic System	35	17
Monoclinic System	35	19
Triclinic System	35	22
Hexagonal System	35	23
Distortion	35	26
Iron	35	27
Copper	35	34
Lead	35	42
Zinc	35	47
Silver	35	52
Gold	35	57
Coal	35	60
Metallic Ores of Secondary Importance	35	63
Minerals of Secondary Importance	35	63
Table of Minerals of Secondary Importance	35	64
Table of Minerals Sent with Blowpipe Outfit	35	72
Precious Stones	35	80
Table of Precious Stones	35	82
Gangue Minerals	35	88
 ASSAYING.		
Methods of Analysis	36	1
Fire Assaying	36	5
Preparing the Sample	36	5
Weighing	36	10
Furnaces	36	20
Furnace Tools	36	25
Crucibles, Scorifiers, etc.	36	28
Fluxes	36	32
Table of Crucible Charges for Gold and Silver Ores	36	42
Gold and Silver Assay	36	45
Scorification Assay	36	47
Table of Scorifier Charges	36	48

CONTENTS.

v

ASSAYING—Continued.	<i>Section.</i>	<i>Page.</i>
Crucible Assay	36	60
Calculations	36	66
Ores of Metallic Scales	36	68
Control Assays	36	73
Bullion Assays	36	75
Lead Assay	36	82
Wet Assays	36	85
Apparatus for Wet Assays	36	87
Iron Determination	36	93
Manganese Determination	36	111
Determination of Phosphorus	36	113
Lime Determination	36	118
Insoluble Matter and Silica	36	120
Copper Determination	36	124
Lead Determination	36	131
Zinc Determination	36	132
Sulphur Determination	36	135
Preparation of Reagents	36	137
Weights and Measures	36	142

GEOLOGY.

Introductory	37	1
Dynamical Geology	37	2
Atmospheric Agencies	37	2
Aqueous Agencies	37	7
Igneous Agencies	37	25
Organic Agencies	37	30
Structural Geology	37	32
Stratified Rocks	37	33
Unstratified or Igneous Rocks	37	46
Plutonic or Massive Rocks	37	47
Volcanic or Eruptive Rocks	37	51
Structure Common to All Rocks	37	66
Mineral Veins and Ore Deposits	37	72
Fossils and Characteristics of the Periods	37	91
Economic Geology	37	100
Materials of Commercial Importance	37	100

PROSPECTING.	<i>Section.</i>	<i>Page.</i>
Preliminary Education and Preparation	38	1
Prospector's Outfit	38	5
Location of Placer Claims.	38	9
Prospecting for Lodes or Veins	38	13
Locating Lode Claims	38	17
Tunnel Sites	38	26
Mill Sites	38	28
Locating and Recording	38	29
Prospecting for Gems and Precious Stones	38	31
Underground Prospecting	38	35
Drilling	38	36
Magnetic Prospecting	38	43
Examples of Prospecting Regions	38	45
Prospector's Tools	38	52
PLACER AND HYDRAULIC MINING.		
History of Placer Mining	39	1
Placer Mining.	39	6
Apparatus and Methods Used in Placer and Hydraulic Mining	39	9
Methods of Excavating Material	39	28
Cleaning Up	39	46
Water-Supply	39	53
Reservoirs	39	54
Measuring of Flow of Water	39	63
Ditches and Flumes.	39	76
Pipes	39	83
Examples of Placers	39	91
Working Placers by Dredges.	39	102
QUESTIONS AND EXAMPLES.	<i>Section.</i>	
Blowpiping	34	
Mineralogy	35	
Assaying	36	
Geology	37	
Prospecting	38	
Placer and Hydraulic Mining	39	

INDEX.

NOTE.—All items in this index refer first to the section (see the Preface) and then to the page of the section. Thus, "Acids, 34 16" means that acids will be found on page 16 of section 34.

<i>A.</i>	<i>Sec. Page.</i>		<i>Sec. Page.</i>
Abandonment of lode claim in British Columbia.....	38 26	Amalgamation.....	39 47
Abandonment of placer claim in British Columbia.....	38 12	Amalgamation, Copper plates for.....	39 48
Absorption and evaporation...	39 54	Amethyst, Oriental.....	35 80
Abutments and discharge gates.....	39 57	Amygdaloidal structure of lava	37 58
Accessory apparatus for blow-piping.....	34 31	Analysis, Determination of lime in lime-stone or ores.....	36 118
Acicular structure.....	35 5	" Electric method for copper.....	36 128
Acid, Hydriodic.....	34 35	" Ferrocyanide solution for determination of lead.....	36 131
" tests.....	34 20	" Gravimetric.....	36 1
Acids.....	34 16	" Gravimetric method for determining phosphorus.....	36 114
".....	34 25	" Methods for the determination of zinc.....	36 132
Acre, Area of.....	38 9	" Method of determining sulphur.....	36 135
Actinolite.....	35 75	" of copper ores.....	36 124
Adamantine luster.....	35 3	" " iron ores containing organic matter.....	36 109
Affinity, Chemical.....	34 7	" " manganese ores..	36 111
Agate mortar.....	34 31	" Qualitative.....	36 1
Agenies, Aqueous.....	37 7	" Special method of, for iron ores.....	36 106
" Atmospheric.....	37 2	" Standard ores for use in.....	36 109
" Chemical.....	37 2	" Treatment of copper ores in.....	36 126
" Igneous.....	37 25	" Treatment of iron ores in.....	36 102
" Organic.....	37 30	" Treatment of lead ores in.....	36 132
Age of ore deposits.....	37 79	" Volumetric method for phosphorus...	36 116
Air and blow-off valves.....	39 87		
Alabaster.....	37 118		
Albertite.....	35 62		
Albite.....	35 79		
Alkaline earth metals.....	34 17		
" solutions in vein formation.....	37 86		
Alkalies.....	34 16		
Alma placer.....	39 91		
Alum.....	37 125		
Aluminum.....	35 68		
".....	35 71		
Amalgam, Cleaning of.....	39 49		
" kettles.....	39 48		
" Retorting of.....	39 49		

	<i>Sec.</i>	<i>Page.</i>		<i>Sec.</i>	<i>Page.</i>
Analysis, Volumetric or titration	36	2	Assay, Crucible	36	60
" Wet determination			" " Charge for	36	61
for lead	36	131	" " or fusion	36	45
Analytical balance	36	14	" Fine bullion	36	78
Ancient placer formations	39	3	" Fire	36	2
Andesite	37	52	" Lead	36	82
Anglesite	35	45	" Office, System in	36	62
Anhydrides	34	16	" of ores with metallic		
Annealing cups	36	31	scales	36	68
Annual labor required to hold			" Reporting of results of,		
lode claims in the United			from fine bullion	36	81
States	38	24	" Scorification	36	45
Anthracite	35	61	" "	36	47
Anticline	37	37	" ton system of weights	36	15
Antimony	35	68	" " weights	36	143
"	35	71	Assaying	36	1
"	37	113	" Arrangement of work		
" in closed tube	34	39	during	36	64
" " open tube	34	41	" Fire	36	5
" on charcoal	34	43	" for settlement	36	74
Apatite	35	78	" General method of		
Apex and outcrop of claims	38	21	conducting control	36	75
Apparatus, Accessory, for			Assays, Bullion	36	76
blowpiping	34	31	" Calculation and results		
" and methods used			of	36	66
in placer mining	39	9	" Control	36	73
" Auxiliary, for			" Wet	36	85
placer mining	39	38	Atmosphere, Composition of		
" for blowpiping	34	21	the	37	2
" " wet assaying	36	87	Atmospheric agencies	37	2
Approach, Velocity of	39	69	Atoms and molecules	34	3
Aprons for dams	39	56	Atomic weight	34	3
Aquamarine	35	81	" weights of the ele-		
"	35	84	ments	34	5
Aqueous agencies	37	7	Avoirdupois weight	36	142
Archean or Ezoic	37	43	Axis, Anticlinal	37	37
" period	37	91	" Synclinal	37	37
Area and shape of placer claims			Azurite	36	41
in United States	38	9			
Arenaceous or sand rocks	37	35	B.	<i>Sec.</i>	<i>Page.</i>
Argentite	35	54	Balance, Analytical	36	14
Arid regions, Placers in	39	53	" Button	36	12
Arizona as a prospecting re-			" Pulp	36	11
gion	38	52	Balances	36	11
Arsenic in closed tube	34	88	Banks, Caving of	39	34
" " open tube	34	41	Bar diggings in British Co-		
" on charcoal	34	43	lumbia	38	11
Arsenopyrite	35	72	Barite	36	72
Artesian wells, Cause of	37	21	"	36	89
Asbestos	35	72	Barytes	37	123
"	37	124	Basalt	37	52
Ash from fuels	37	114	Base bullion assays	36	75
Asphaltic coal	35	62	" " Sampling of	36	76
Asphaltum and bitumen	37	116	Bases	34	16
Assay, Battery, for copper	36	128	Batea	39	10
			Battersea crucibles	36	28

	<i>Sec. Page.</i>		<i>Sec. Page.</i>
Battery assay for copper.....	36 128	Bone-ash.....	34 35
Bauxite.....	35 68	Booming.....	38 16
Beads, Borax	34 49	".....	39 27
Beads, Borax, Colors imparted to, by various oxides in O. F.	34 58	Borax.....	34 32
Beads, Borax, Colors imparted to, by various oxides in R. F.	34 60	".....	36 35
Beads, Gold and silver, Parting of	31 55	".....	37 126
" Salt of phosphorus.....	31 51	Borax beads, Colors imparted to, by various oxides in R. F.	34 60
" Salt of phosphorus, Col- ors imparted to, by various oxides in O. F.	34 62	Borax beads, Colors imparted to, by various oxides in O. F.	34 58
" Salt of phosphorus, Col- ors imparted to, by various oxides in R. F.	34 64	Borax, Fusion with.....	34 49
Beakers.....	36 87	" Glass.....	36 35
Bed and joints for flumes.....	39 81	Bornite.....	35 37
" rock, Cleaning up of, when dredging	39 103	Botryoidal structure.....	35 5
Beds, Minerals found in.....	37 75	Bottles, Wash	36 91
" or sheets of lava	37 54	Boulders of disintegration.....	37 5
Beryl.....	35 81	Box, Reagent	34 36
".....	35 84	Boxes, Puddling	39 12
Bicarbonate of soda	34 33	Bracket flumes	39 62
Bichromate solution for iron..	36 94	Brazil-wood paper.....	34 36
" solution for iron, Standardizing of	36 99	Breccia, Volcanic.....	37 57
Binary compounds.....	34 14	British Columbia, Free miners' privileges in.....	38 13
Bismuth flux	34 34	British Columbia, Mill sites in	38 30
" in open tube	34 42	British Columbian practice in regard to lode claims.....	38 24
" on charcoal.....	34 43	British Columbian practice in regard to placer claims.....	38 11
Bisulphate of potash.....	34 35	Brittle silver	35 54
Bitumen and asphaltum.....	37 116	Bromine, Test for.....	34 52
Bituminous coal.....	35 61	Brown clay ironstone.....	35 30
Black copper ore.....	35 40	" coal or lignite.....	35 62
Blacksmithing	38 56	" hematite.....	35 30
Black tellurium.....	35 59	" " or limonite	35 29
" zinc ore.....	35 51	" ocher	35 30
Blast, The blowpipe	34 23	Brush dams	39 36
Blasting gravel banks	39 44	Bucket dredges	39 102
Block riffles.....	39 18	Bucking board	36 6
Blow-off valves	39 67	Building stone.....	37 118
Blowpipe lamps and fuels	34 24	Bullion assays.....	36 75
" outfit, Table of min- erals sent with	35 72	" Silver, Determination of copper in	36 128
" reagents.....	34 32	Bunsen burner	34 24
" Scheme for examin- ing substance be- fore	31 36	" burners	36 93
" The	34 21	Burette and filter stands.....	36 90
Blowpiping.....	34 1	Burettes.....	36 88
".....	34 19	Button balance.....	36 12
Blow-ups.....	39 36	" pincers	36 53
Blue copper carbonate.....	35 41	" tongs.....	36 27
Board, Cupel.....	36 27	Buttons.....	36 19
Bog iron ore.....	35 30	" Parting of	36 55
		" Weighing of	36 53
		C.	<i>Sec. Page</i>
		Cadmium on charcoal	34 44
		Caking coals	35 62
		Calamine	35 50

	<i>Sec. Page.</i>		<i>Sec. Page.</i>
Combining weights of the elements	34 5	Correction or proof assay of fine bullion.....	36 79
Compass, Miner's, or dipping needle	38 43	Corundum.....	35 70
Composition of the atmosphere	37 2	"	35 80
Compounds, Binary.....	34 14	"	37 127
Conchoidal fracture.....	35 6	Covering for pipes.....	39 89
Concretionary or nodular structure	37 41	Cradle or rocker	39 18
Condition of the interior of the earth	37 26	Creek claims in British Columbia	38 11
Conformable strata	37 38	Crest of weir	39 66
Conglomerate, Volcanic.....	37 57	Cretaceous	37 43
Connection of flume with ditch	39 81	" period.....	37 43
Construction of flumes	39 80	"	37 96
Contact deposits	37 77	Cross-section of a ditch.....	39 78
Continents, Origin of the first.....	37 33	Crown grant	38 30
Contractions, Weir with end..	39 65	Crucible assay	36 60
Control assay, General method of conducting	36 75	" " Charge for	36 61
" assays	36 73	" charges for gold and silver ores	36 42
Color of minerals	35 2	" for fusion assay.....	36 45
Colors imparted to the flame by various minerals	31 56	" furnace	36 20
Colorado as a prospecting region	38 45	" tongs	36 25
" or lead-assay crucibles	36 28	Crucibles	36 28
Coloration of the flame	34 46	"	36 90
Columnar structure.....	35 4	Crushers, Laboratory..	36 5
" " of lava	37 55	Cryolite	35 69
Copper.....	35 34	Crystals, Definition of.....	35 8
"	37 105	" Twinned	35 21
" Battery assay for	36 128	Crystalline form	35 8
" Carbonate blue	35 41	Crystallography	35 11
" determination.....	36 124	Cube, The	35 13
" Determination of, in silver bullion.....	36 128	Cupel board	36 27
" determination, Solution for standardizing cyanide in	36 125	" capacity for absorbing litharge.....	36 52
" Electrolytic determination of.....	36 128	" mold and stand..	34 31
" Green carbonate of ..	35 40	" tongs	36 26
" minerals.....	35 35	Cupelling.....	36 50
" Native	35 35	" Temperature of muffle during	36 51
" ore, Black	35 40	Cupels	36 29
" " Red	35 39	" Mold for	36 29
" ores, Treatment of, in analysis	36 126	Cuprite	35 39
" oxide	34 34	Cups, Annealing	36 31
" Peacock.....	35 37	Currents, Effects produced by, in large bodies of water	37 17
" plates for amalgamation	39 48	Curves on flumes	39 81
" pyrites.....	35 36	Cyanide and ferrocyanide of potassium.....	36 78
" veins, Surface changes in.....	37 80	Cyanide of potassium as a flux	34 52
		Cyanide of potassium, Poisoning with, Antidote for.....	36 125
		D.	
		Dam, Masonry core for	<i>Sec. Page.</i> 39 61
		Dams	39 55
		" Aprons for	39 56

	<i>Sec. Page.</i>		<i>Sec. Page</i>
Dams, Brush, for tailings.....	39 36	Dichroscope for determining	
" Clay, Puddle wall for...	39 60	gems.....	38 38
" Debris.....	39 61	Dictator.....	39 31
" Dry-stone.....	39 59	Dikes.....	37 28
" Earth.....	39 60	".....	37 53
" Foundations for.....	39 55	Dike, Vein formed in a.....	37 78
" Masonry.....	39 60	Diorite.....	37 48
" Stone.....	39 59	Dip.....	37 36
" Wasteways for.....	39 58	Dipper dredges.....	39 104
" Wing.....	39 39	Dipping needle.....	38 43
".....	39 62	Direct union or synthesis.....	34 8
" Wooden.....	39 56	Discharge gates for dams.....	39 57
Deep level or ancient placers...	39 9	" of weirs.....	39 69
Deltas.....	37 15	Discovery of lode claim by	
Definition of metamorphism..	37 64	open cut, adit, tunnel, or	
Deflecting nozzle.....	39 32	cross-cut.....	38 18
Dendritic structure.....	35 5	Discovery of vein for lode	
Deposits, Chemical, in lakes...	37 24	claim in British Columbia...	38 24
".....	37 24	Discovery or knowledge of	
" Contact.....	37 77	mineral on placer claim....	38 9
" Gold, Surface		Discovery shaft for lode claim	
changes in.....	37 82	in the United States.....	38 17
" from springs.....	37 23	Disposition of tailings.....	39 36
" Lead, Surface		" " tailings from	
changes in.....	37 81	dredges.....	39 103
" Ore, Age of.....	37 79	Disintegration, Boulders of...	37 5
" Placer.....	37 82	" Process of, in	
" " Forms of.....	39 6	rocks.....	37 3
" " Prospecting		Displacement.....	34 9
for.....	38 6	Distortion in crystals.....	35 26
" Zinc and lead, Occur-		Distribution of gold in placer	
rence of.....	37 90	deposits.....	39 8
Depth, Richness with.....	37 90	" " gold in sluices.	39 51
Derricks.....	39 38	Ditch, Connection of, with	
Determination of copper.....	36 124	flume.....	39 81
" " copper in sil-		" Cross-section of.....	39 78
ver bullion.	36 128	" Size of.....	39 78
" " gold and sil-		Ditches and flumes.....	39 76
ver in ores.	34 53	" Rules for the construc-	
" " lead.....	36 131	tion of.....	39 77
" " lime.....	36 118	" Surveying a line for..	39 77
" " phosphorus..	36 113	" vs. flumes.....	39 79
" " silica.....	36 121	Dodecahedron, The.....	35 13
" " sulphur.....	36 135	Dolerite.....	37 52
" " zinc.....	36 132	Dolomite.....	35 73
Development of life.....	37 42	".....	35 88
Devonian period.....	37 93	Drags.....	37 70
".....	37 43	Dredge, with washing plant	
Diabase.....	37 49	located on the shore.....	39 104
Diamond.....	35 80	Dredges, Bucket.....	39 102
".....	35 82	" Dipper.....	39 104
Diamonds.....	37 127	" Disposition of tail-	
Diamond drill, Fan holes drilled		ings from.....	39 103
with.....	38 37	" General remarks	
" " Prospecting		concerning.....	39 106
with.....	38 36	" Working of placers	
" mortar.....	34 81	by.....	39 103

	<i>Sec.</i>	<i>Page.</i>		<i>Sec.</i>	<i>Page.</i>
Flame, Coloration of the	34	46	Frozen ground, Working of	39	43
" Colors imparted to, by various minerals	34	56	Fuel for blacksmithing	38	56
" Oxidizing	34	27	Fuels, Impurities in	37	114
" Reducing	34	26	" for furnaces	36	20
" Tests for	34	28	" " the blowpipe	34	24
" The character of	34	26	" Mineral	37	114
Flaming	34	50	" Sulphur and phosphorus in	37	115
Flasks	36	88	Funnels	36	88
Float	38	13	Furnace tools	36	25
Flood-plain of a river	37	14	Furnaces	36	20
Flow of water, Measurement of	39	63	" Fuels for	36	20
Fluorine, Test for	34	53	Fusibility, Tests of	34	45
Fluorite	35	78	Fusion with borax	34	49
"	35	89	" " salt of phosphorus	34	51
Fluorspar	35	89			
Flume, Connection of, with ditch	39	81	G.	<i>Sec.</i>	<i>Page.</i>
" waterfalls	39	29	Gabbro	34	49
Flumes	39	79	Galena	35	43
" Beds and joints for	39	81	Galenite or Galena	35	43
" Bracket	39	82	Gangue	37	76
" Construction of	39	80	" material	37	85
" Curves on	39	81	" materials, Character of	36	34
" and ditches	39	76	" minerals	35	88
" vs. ditches	39	79	Garnet	35	81
" Grade of	39	80	"	35	86
" Waste-gates in	39	82	Garnierite	35	66
Flux, Bismuth	34	34	Gas, Natural	37	116
" Cyanide of potassium as a	34	52	Gaseous elements	34	2
" Neutral oxalate of potassa as	34	52	Gash veins	37	78
Fluxes	36	32	Gates, Discharge, for dams	30	57
" Gold and silver crucible	36	40	Gauge, Hook	39	68
" Lead	36	40	Gauging by right-angled V notch	39	63
" Mixed	36	39	Gems and gem stones	37	126
Fluxing and reducing reagents	36	34	" " precious stones, Prospecting for	38	31
Foil, Platinum	34	29	General metamorphism	37	62
Foliated tellurium	35	59	" remarks concerning prospecting	38	34
Fool's gold (see Iron pyrites)	35	33	Geodes	37	41
Forceps	34	20	Geology	37	1
Forge for prospectors	38	57	" Economic	37	1
Forms of placer deposits	39	6	" " "	37	100
Fossils	37	41	" Dynamic	37	1
" and characteristics of the periods	37	91	" Historic and structural	37	1
" Condition and use of	37	42	" Structural	37	32
Foundations for dams	39	55	Geological maps and sections, Use of, in prospecting	38	3
Fracture	35	6	Geological observations, Exposures available for	37	32
Franklinite	35	51	Geological section	37	42
Free milling ores	35	53	" sections, Use of, in prospecting	38	3
Free miners' certificates for British Columbia	38	11	Giant, Evolution of the	39	30
Free miners' privileges in British Columbia	38	13	" Hydraulic	39	32
Frost, Effect of	37	6			
" " " and erosion by water	30	2			

	<i>Sec. Page.</i>	H.	<i>Sec. Page.</i>
Glant, Little	39 82	Halite	35 74
Glacial period.....	37 43	Hammer.....	34 31
Glaciers	37 18	" for beating out lead	
" Work of	39 9	buttons	36 27
Glass, Magnifying	34 32	Hand augers for drilling.....	38 41
" Silica for	37 122	Handling and treating the	
" tubes	34 29	gravel	39 41
Glasses, Watch	34 32	Hardening and tempering	38 57
Glimmering luster.....	35 3	Hardness fracture	35 6
Glistening or sheeny luster ...	35 3	Heating in a closed tube	34 38
Globe monitor.....	39 30	" " open tubes.....	34 40
Gneiss	37 60	" on charcoal	34 42
Gold	35 57	Heavy spar.....	35 89
"	37 101	Hematite	35 28
" adhering to stones in		" Brown	35 29
placer deposits.....	39 15	Hemihedral forms of the hex-	
" and silver assay.....	36 45	agonal system..	35 24
" " crucible fluxes	36 40	" forms of the iso-	
" " " ores, Crucible		metric system..	35 13
charges for..	36 42	" forms of the tet-	
" " " Parting of.....	34 55	ragonal system	
" deposits, Surface changes		of crystalliza-	
in	37 82	tion.....	35 16
" Determination of, in ores	34 53	Hessian or sand crucibles	36 28
" Distribution of, in sluices	39 51	Hexagonal system of crystalli-	
" minerals.....	35 57	zation	35 12
" Mode of occurrence of, in		Hexagonal system of crystalli-	
placers.....	39 6	zation.....	35 28
" Placer, Origin of.....	39 3	Hexoctahedron, The	35 13
" placers, Origin of.....	39 1	Hill digging in British Colum-	
" saving table.....	39 26	bia	38 11
Goose-neck.....	39 30	Historic and structural geol-	
Gouge or selvage.....	37 74	ogy.....	37 1
Grade of flumes.....	39 80	Hook gauge	39 68
" " sluices	39 26	Horn silver.....	35 56
Graduates.....	36 90	Horn spoons	39 12
Granite.....	37 48	Horses.....	37 75
" as a building stone....	37 119	Hot solutions as depositing	
" Origin of	37 65	agents in the formation of	
Granular structure	35 4	veins.....	37 86
Graphic tellurium	35 58	Hydraulic elevators or blow-	
Graphite.....	35 73	ups.....	39 36
"	37 123	" chief.....	39 30
" or plumbago crucibles	36 28	" giant.....	39 32
Gravel, Handling and treating		" mines, Tunnels as	
of	39 41	outlets for	39 43
Gravimetric analysis	36 1	" nozzles, General re-	
Gravimetric method for deter-		marks concerning	39 33
mining phosphorus.....	36 113	Hydraulicking	39 29
Greasy luster.....	35 3	Hydriodic acid.....	34 35
Green carbonate of copper	35 40		
Grizzly or grating for under-		I.	<i>Sec. Page.</i>
currents	39 24	Icebergs	37 19
Ground sluicing	39 28	Ice, Effects of.....	37 18
Guano	37 121	Idaho as a prospecting region..	38 50
Gypsum	35 77	Igneous agencies.....	37 25
"	37 117	" " Effect of.....	37 25

	<i>Sec. Page.</i>		<i>Sec. Page.</i>
Igneous or eruptive rocks,		Isometric system of crystalli-	
Origin of.....	37 58	zation..	35 11
" origin, Subordinate		" " " crystalli-	
phenomena of.....	37 30	zation..	35 13
" rocks, Classification			
of.....	37 47	J.	<i>Sec. Page.</i>
" or unstratified rocks	37 46	Jargon.....	35 81
Igneous or unstratified rocks,		Joints.....	37 66
Modes of occurrence of.....	37 46	" for flumes.....	39 81
Impurities in fuels.....	37 114	" " iron pipes.....	39 85
Inch, Miner's.....	39 75	Jura, Trias.....	37 97
Increase of temperature with		Jurassic period.....	37 43
depth.....	37 25		
Indicator, Phenol-phthalein...	36 117	K.	<i>Sec. Page.</i>
Infiltration, Veins of.....	37 73	Kaolinite.....	35 74
Inquarting.....	36 59	Kettles, Amalgam.....	39 48
Insoluble matter in silica.....	36 120		
Intrusive rocks.....	37 50	L.	<i>Sec. Page.</i>
Iodine, Test for.....	34 53	Labor, Annual, required to	
Iron.....	35 27	hold lode claim in British	
" 	37 103	Columbia.....	38 26
Iron analysis, Adjusting		Labor, Manual, for excavating	
weight of ore to standard		material.....	39 28
solutions.....	36 110	Labor or improvement neces-	
Iron analysis, Examples for		sary to hold placer claim in	
practice in.....	36 104	the United States.....	38 10
Iron analysis, Preparation of		Labor required on placer	
manganous sulphate solution		claim in British Columbia..	38 12
for use in.....	36 106	Laboratory crushers.....	36 5
Iron as a flux.....	36 38	Laccolites.....	37 28
" Bichromate solution for..	36 94	Lakes, Chemical deposits in...	37 24
" Bichromate solution for		Lamellar structure.....	35 4
standardizing of.....	36 99	Laminæ, Inclined...	37 35
" determination of.....	36 93	Lamps and fuels for the blow-	
" determination, Standard		pipe.....	34 24
solutions for.....	36 94	" Oil and spirit.....	34 25
" Effects of carbonaceous		Lava, Amygdaloidal structure	
matter on.....	37 30	of.....	37 58
" minerals.....	35 28	" beds, Sheets or masses	
" ore, Mode of occurrence of	37 103	of.....	37 54
" ores containing organic		" Columnar structure of..	37 55
matter, Analysis of...	36 109	" Determining the age of.	37 55
" ores, Refractory, Treat-		" Positions in which, may	
ment of, in analysis...	36 105	occur.....	37 53
" ores, Special method of		Law of slip in faults.....	37 68
analysis of.....	36 106	Laying pipe lines.....	39 89
" ores, Sulphide, Treat-		Lead.....	35 42
ment of, in analysis...	36 104	" 	37 107
" ores, Treatment of, in an-		" and zinc deposits, Occur-	
alysis.....	36 102	rence of.....	37 90
" Permanganate solution		" as a flux.....	36 39
for.....	36 94	" assay.....	36 82
" pipes.....	39 85	" " Examples for prac-	
" pyrites.....	35 32	" " " tice in figuring..	36 85
" riffles.....	39 20	" " " for sulphide ores..	36 84
" Standardizing the per-		" " " deposits, Surface	
manganate solution for	36 95	changes in.....	37 81

	<i>Sec. Page.</i>		<i>Sec. Page.</i>
Lead determination.....	36 131	Manganese determinations....	36 111
“ fluxes	36 40	Manganous sulphate solution,	
“ glance	35 43	Preparation of, for use in iron	
“ in open tube	34 43	analysis.....	36 108
“ on charcoal	34 43	Manual labor for excavating	
“ ores, Treatment of, in		material	39 28
analysis.....	36 132	Maps, Use of geological and	
“ ore, White	35 44	section, in prospecting.....	38 3
“ test	34 34	Marble.....	37 119
“ “	36 39	Marking of samples.....	36 63
Life, Development of	37 42	Martite	35 29
Lighting placer mines	39 35	Masonry core for dam	39 61
Light ruby silver.....	35 55	“ dams	39 60
Lignite.....	35 62	Massive or plutonic rocks	37 47
Little Giant	39 32	“ rocks, Origin of	37 65
Lime determinations.....	36 118	Material, Arrangement of, in	
Limestone	37 31	veins.....	37 76
“ as a building stone	37 119	“ Methods of excava-	
Lime or calcareous rocks.....	37 36	ting	39 28
Limonite.....	35 29	Materials of commercial im-	
Liquid elements.....	34 2	portance.....	37 100
Litharge	36 36	Matter, Constitution of.....	34 1
Litmus paper	34 35	Matrasses.....	34 30
Local metamorphism.....	37 61	Meaning of the term “rock” ..	37 33
Locating and recording of mill		Measurement of the flow of	
sites in British Columbia....	38 30	water	39 63
Locating and recording of mill		Measures and weights, Tables	
sites in the United States....	38 29	of	36 142
Location notice for lode claim		Mechanical effects of aqueous	
in the United States	38 18	agencies	37 7
Location notice for placer		Melaconite	35 40
claim in United States.....	36 9	Mercuric chloride solution,	
Location of lode claims.....	36 17	Preparation of, for iron an-	
“ “ placer claims.....	36 9	alysis	36 108
Lode claim, British Columbia,		Mercury	35 65
Practice in regard to.....	36 24	“	35 71
Lode claim, United States,		“	37 112
Practice in regard to.....	36 17	“ in bottle	39 28
Lodes or veins, Prospecting of	36 13	“ “ closed tube.....	34 39
Longitudinal riffles	39 18	“ “ open tube	34 41
Long Tom.....	39 14	Mesozoic	37 43
Ludlum elevator.....	39 36	Metallic luster	35 3
Luster of minerals	35 2	“ ores of secondary im-	
		portance	35 63
		“ “ Origin of	37 87
		“ oxides, Reaction of the	
		most characteristic..	34 66
		“ oxides, Reduction of,	
		with soda.....	34 51
		“ scales, Ores with, As-	
		say of.....	36 68
		Metals, Alkaline, Earth	34 17
		“ Effect of carbonaceous	
		matter on	37 30
		Metamorphic rocks	37 59
		“ “ Classes of.....	37 61

M. *Sec. Page.*

Magnesia mixture for phosphorus determinations.....	36 115
Magnet	34 32
Magnetic prospecting.....	38 43
Magnifying-glass.....	34 32
Malachite.....	35 40
Mammillary structure.....	35 5
Manganate	35 30
Manganese	35 63
“	35 64
“	37 109

	<i>Sec. Page.</i>		<i>Sec. Page.</i>
Metamorphism, Definition of..	37 64	Mixed fluxes	36 39
Metamorphism, Effect of horizontal pressure in.....	37 64	Modes of eruption.....	37 53
Metamorphism, Effect of percolating waters in.....	37 64	Modern placers	30 6
Metamorphism, General.....	37 62	Moh's scale of hardness	35 6
" General remarks on.....	37 64	Molecules.....	34 3
" Local	37 61	Molecular weight	34 4
Method of weighing	36 17	Molybdate solution for phosphorus determination.....	36 115
Methods of excavating material	39 28	Molybdenum in open tube. ...	34 42
" " mining placer gravel.....	39 41	" on charcoal.....	34 44
Metric system of weights and measures	36 143	Monazite	37 125
Mica.....	35 75	Monitor, Globe	39 30
".....	37 124	Monitors.....	39 32
Millerite	35 67	Monoclines	37 68
Mill sites in the United States.	38 28	Monoclinic system of crystallization..	35 12
Mill sites, Locating and recording of, in British Columbia..	38 30	" " of crystallization..	35 19
Mineral, Definition of.....	35 1	Montana as a prospecting region.....	38 50
" fuels	37 114	Mortars.....	34 31
" specimens, Examination of	35 10	Mold for cupels	34 21
" veins and ore deposits	37 72	" " 	36 29
Mineralogy.....	35 1	Molds, Assaying.....	36 26
Minerals	35 35	Muffle, Cooling of.....	36 66
" Colors imparted to the flame by various ...	34 56	" furnace	36 20
" constituting metallic ores of secondary importance	35 64	" " 	36 22
" Copper.....	35 35	" Heating of.....	36 65
" found in veins in beds	37 75	" Precautions regarding accidents in	36 66
" Gangue	35 86	" Temperature of, during cupelling.....	36 51
" Gold	35 57	Mundic (see Iron pyrites).....	35 33
" Iron	35 28		
" Lead	35 43	N.	<i>Sec. Page.</i>
" Silver	35 53	Nagyagite.....	35 59
" Zinc.....	35 47	Nascent state.....	34 12
Mines, Drift gravel, A study of Miners' certificates for British Columbia	37 89	Native copper.....	35 35
" compass or dipping needle.....	38 43	" gold	35 57
" inch	39 75	" silver.....	35 54
" privileges in British Columbia.....	38 18	Natrolite.....	35 75
Mining, Methods of, for placer gravel	39 41	Natural gas	37 116
" Origin of hydraulic...	39 29	Neutral oxalate of potassa as a flux	34 52
Miocene period	37 43	Nevada as a prospecting region	38 50
Miscellaneous tools for assaying	36 27	Niccolite.....	35 66
		Nickel	35 66
		" 	35 71
		" and cobalt.....	37 110
		Nitrates, Test for.....	34 53
		Niter (Sodium or potassium nitrate).....	34 34
		" (Sodium or potassium nitrate).....	36 36
		Nodular or concretionary structure.....	37 41

	<i>Sec. Page.</i>		<i>Sec. Page.</i>
Nomenclature, Chemical.....	34 14	Origin of the first continents..	37 33
Non-caking coal.....	35 62	Orthoclase.....	35 76
Notch, Gauging water by	39 63	Orthorhombic system of crys-	
Notice, Location, for lode claim		tallization....	35 12
in the United States.....	36 18	" system of crys-	
Nozzle, Deflecting.....	39 32	tallization....	35 17
Nozzles, Hydraulic, General		Outcrop	37 36
remarks concerning	39 33	Outfit, Prospector's.....	38 5
Numbering of samples	36 63	Oxalate of potassa, Neutral ...	34 52
		Oxidation and reduction	34 18
		Oxides, Action of, with acids..	34 21
O.	<i>Sec. Page.</i>	" Metallic, Character-	
Occurrence of gold	37 101	istic reactions of the	
Ocher	37 123	most common	34 66
" Brown	35 30	" Metallic, Reduction of,	
" Red	35 29	with soda	34 51
" "	35 30	Oxidized iron ores, Treatment	
Octahedron, The	35 18	of, in analysis	33 102
Oil and spirit lamps.....	34 25	Oxidizing flame.....	34 27
Opal	35 87		
"	35 89	P.	<i>Sec. Page.</i>
Opacity as a characteristic		Paleozoic	37 43
of minerals	35 2	Pan for washing gold	39 11
Open tube, Heating in	34 40	Panning.....	36 7
" tubes	34 29	Paper, Brazil-wood	34 36
Ore	37 75	" Filter.....	36 90
" and mineral deposits.....	37 72	" Litmus	34 35
" deposits, Age of.....	37 79	" Turmeric	34 35
" " Surface changes		Parallel veins	37 84
in.....	37 80	Parting of gold and silver....	34 55
" glass (Magnifying-glass)...	34 33	" Strength of reagents	
" Peculiar occurrences of...	37 79	for	36 57
Ores containing organic mat-		" Testing of reagents	
ter, Analysis of.....	36 109	for.....	36 58
" Iron, Treatment of, in an-		" the button.....	36 55
alysis	36 103	Pay chutes or chimneys	37 88
" Manganese, Treatment		Peacock copper	35 37
of.....	36 111	Pearly luster.....	35 3
" Metallic, of secondary im-		Peat bogs	37 30
portance	35 63	Penstock or pressure box.....	33 90
" " Origin of.....	37 67	Percolating waters, Effect of,	
" Standard iron, for use in		in metamorphism.....	37 64
analysis	36 109	Percussive or churn drills for	
" with metallic scales, As-		prospecting	38 43
say of	36 68	Periods, Fossils and character-	
" Zinc, Treatment of, in an-		istics of	37 91
alysis.....	36 134	Permanganate solution for iron	36 94
Organic agencies.....	37 30	Permanganate solution for iron	
Organic matter in iron ores,		analysis.....	36 108
Effect of, on analysis.....	36 109	Permanganate solution for iron,	
Origin of drift or placer gold..	39 3	Standardizing of	36 95
" " gold placers	39 1	Permian	37 43
" " hydraulic mining....	39 29	" period.....	37 97
" " igneous or eruptive		Peroxide of hydrogen, Anti-	
rocks.....	37 58	dote for potassium cyanide	
" " metallic ores	37 87	poison.....	36 123
" " springs and wells....	37 20		

	<i>Sec. Page.</i>		<i>Sec. Page.</i>
Petroleum	37 115	Placer mining, Drifting in....	39 40
Phenol-phthalein indicator for phosphorus determinations..	36 117	" " History of....	39 1
Phenomena, Subordinate, of igneous origin.....	37 30	" Roscoe.....	39 96
Phonolite	37 52	Placers.....	37 101
Phosphates	37 121	" Deep level or ancient..	39 9
Phosphorus determination, Magnesia mixture for.....	36 115	" Examples of.....	39 91
Phosphorus determination, Sodium hydrate solution for.....	36 116	" Gold, Origin of.....	39 1
Phosphorus, Fusion with salt of	34 51	" in arid or dry regions, Characteristics of....	39 53
Phosphorus, Gravimetric method for determining....	36 113	" Mode of occurrence of gold in.....	39 6
Phosphorus in fuels.....	37 115	" Preliminary investigation of	39 51
Phosphorus, Molybdate solution for determination of....	36 115	" Shallow or modern....	39 6
Phosphorus, Salt of.....	34 33	" Working of, by dredges	39 102
Phosphorus, Standard, Acid solution for determination of	36 117	Plane, Symmetry	35 11
Phosphorus, Volumetric determination of.....	36 115	Plate, Streak.....	34 32
Picks for prospecting.....	38 53	Platinum.....	37 113
" Sharpening of	38 54	" crucibles.....	36 90
Pigments.....	37 123	" foil.....	34 29
Pincers, Button.....	36 58	" wire.....	34 29
Pipe lines, Laying of.....	39 89	Pliers	34 31
Pipes.....	39 83	Pliocene	37 43
" Covering for	39 89	Plumbago.....	37 124
" Elbows for	39 87	" or graphite crucibles	36 28
" Filling of.....	39 89	Plutonic or massive rocks....	37 47
" Iron	39 85	" rocks, Mode of occurrence of	37 49
" Joints for iron.....	39 85	" " Subdivisions of	37 49
" Supply or feed.....	39 90	Pockets and horses....	37 75
" Wooden	39 83	Poisoning with potassium cyanide, Antidote for.....	36 123
Placer, Alma.....	39 91	Policeman	36 93
" and hydraulic mining.	39 1	Porcelain capsules	34 32
" claims, British Columbian practice in regard to.....	38 11	" " 	36 31
" claims, United States practice in regard to	38 9	Positions in which lava may occur.....	37 53
" deposits	37 82	Posts and breast caps.....	39 41
" " Distribution of gold in	39 8	Potash and soda salts.....	37 126
" " Forms of	39 6	" Bisulphate of.....	34 35
" " Prospecting for	38 6	Potassa, Neutral oxalate of ...	34 52
" formations, Ancient...	39 3	Potassium and sodium carbonates.....	36 35
" formations, Relation of regions of glaciation to.....	39 4	" " sodium bicarbonates.....	36 35
" gold, Origin of.....	39 3	" cyanide.....	34 52
" mines, Cleaning up at.	39 46	" Cyanide and ferrocyanide of.	36 38
" " Lighting of ...	39 35	Potassium cyanide, Poisoning with, Antidote for.....	36 123
" mining.....	39 6	Potassium cyanide solution for copper determinations...	36 124
" mining, Apparatus and methods used in.....	39 9	Power, Combining.....	34 10
		Precious stones.....	35 80
		" " 	37 126
		Preliminary education necessary for prospectors... ..	38 1

	<i>Sec. Page.</i>		<i>Sec. Page.</i>
Preliminary investigation of placers.....	39 51	Quaternary period.....	37 48
Preparation needed for prospecting.....	38 1	Quicksilver, Amount of, in bottle	39 28
Preparation of reagents.....	36 137	" (see Mercury):.....	37 112
Preparation of standard solutions for iron determination	36 94	R.	<i>Sec. Page.</i>
Preparing the sample.....	36 5	Radiated structure.....	35 4
Pressure box or penstock.....	39 90	Radical.....	34 6
" Effect of horizontal, on rocks.....	37 64	Railroad iron rifles.....	39 21
Process of disintegration in rocks.....	37 3	Rapids, Cause of.....	37 9
Proof, or correction assay of fine bullion.....	36 79	Reagent box.....	34 36
Prospecting.....	38 1	Reagents, Blowpipe.....	34 32
" Drills for.....	38 54	" Examination with.....	34 37
" for gems and precious stones..	38 31	" " with.....	34 36
" " placer deposits	38 6	" Fluxing and reducing.....	36 34
" General remarks concerning.....	38 34	" Preparation of.....	36 137
" Iodes for veins....	38 13	Red copper ore.....	35 39
" Magnetic.....	38 43	" " ocher.....	35 29
" Percussive or churn drills for..	38 43	" " zinc ore.....	35 50
" Picks for.....	38 53	Reducing agents, Reducing power of.....	36 45
" Underground.....	38 35	" and fluxing reagents.....	36 34
" regions, Examples of.....	38 45	" flame.....	34 26
" with a diamond drill.....	38 36	" power of reducing agents.....	36 45
Prospector's forge.....	38 57	" reagents.....	36 39
" outfit.....	38 5	Reduction.....	34 18
" tools.....	38 52	" of metallic oxides with soda.....	34 51
Proustite.....	35 55	Refractory iron ores, Treatment of, in analysis.....	36 105
Psilomelane.....	35 64	Refractory ores.....	35 53
Puddle wall of clay for dam...	39 60	Regions of glaciation and placer formation.....	39 4
Puddling boxes.....	39 12	Relation between carrying power and eroding power of water.....	37 10
Pulp balance.....	36 11	Reniform structure.....	35 5
Pyrrargyrite.....	35 55	Requisites for a good iron ore.	37 103
Pyrite.....	35 32	Reservoirs.....	39 54
Pyrites, Copper.....	35 36	Resinous luster.....	35 3
" Iron.....	35 32	Reticulated structure.....	35 4
" Magnetic iron.....	35 34	Retorting amalgam.....	39 49
" Tin.....	35 63	Retorts for amalgam.....	39 49
Pyrolusite.....	35 64	Reverse faults.....	37 69
Pyromorphite.....	35 46	Rhodochrosite.....	35 65
Pyrrhotite.....	35 34	Rhodonite.....	35 64
		Rhyolite.....	37 52
Q.	<i>Sec. Page.</i>	Richness of veins, Some facts concerning.....	37 88
Qualitative analysis.....	36 1	" with depth.....	37 90
Quartering.....	36 7	Rider, for balances.....	36 13
" 	38 15	Riffles.....	39 17
Quartz.....	35 79		
" 	35 88		

	<i>Sec.</i>	<i>Page.</i>	<i>S.</i>	<i>Sec.</i>	<i>Page.</i>
Riffles, Block.....	39	18	Saddle reefs.....	37	79
" General remarks regarding.....	39	23	Salt.....	37	117
" Iron.....	39	20	" of phosphorus.....	34	33
" Longitudinal.....	39	18	" " phosphorus beads, Colors imparted to, by various oxides in O. F.....	34	62
" Railroad iron.....	39	21	" " phosphorus beads, Colors imparted to, by various oxides in R. F.....	34	64
" Rock.....	39	19	" " phosphorus, Fusion with.....	34	51
" Zigzag.....	39	22	Salts.....	34	17
" for giants.....	39	31	" Soda and potash.....	37	126
Right-angled V notch, Gauging by.....	30	63	Sample, Preparing of.....	36	5
River, Flood-plain of.....	37	14	Sampler, Tin or riffle.....	36	7
Rivers, Cause of winding course of.....	37	13	Samples, Marking of.....	36	63
" Mechanical effects of water flowing in.....	37	7	" Numbering of.....	36	63
River swamp.....	37	14	Sampling.....	36	14
Roasting.....	34	48	" base bullion.....	36	76
" dishes.....	36	29	" of control assays.....	36	73
Rock, Effect of wall, on contents of veins.....	37	84	" the outcrop of a deposit.....	38	14
" Meaning of the term....	37	38	Sand-box.....	39	90
" riffles.....	39	19	Sand or Hessian crucibles.....	36	38
" Slide, or talus.....	37	6	" rocks.....	37	35
Rocks, Arenaceous or sand....	37	35	Sandstone as a building stone.....	37	119
" Connection between metamorphic and sedimentary.....	37	61	Sapphire.....	35	80
" Eruptive, Special forms caused by rapid cooling.....	37	52	".....	35	89
" Igneous, Classification of.....	37	47	Scale of fusibility.....	34	45
" " or eruptive, Origin of..	37	58	" " hardness, Moh's.....	35	6
" Intrusive or trappean..	37	50	Schist.....	37	60
" Lime or calcareous....	37	36	Scorifier charges.....	36	48
" Massive, Origin of.....	37	65	" tongs.....	36	25
" Metamorphic.....	37	59	Scorification assay.....	36	45
" " Classes of.....	37	61	".....	36	47
" Plutonic or massive....	37	47	Scorifiers.....	36	29
" Process of disintegration in.....	37	3	Screens and screening.....	36	9
" Stratified.....	37	33	Sea, Chemical deposits in the.....	37	34
" Structure common to all.....	37	66	Section, Geological.....	37	43
" Trappean.....	37	50	Segregation, Veins of.....	37	73
" Unstratified or igneous.....	37	46	Selenium in closed tube.....	34	39
" Volcanic or eruptive....	37	51	" " open tube.....	34	41
Rods, Stirring.....	36	92	" on charcoal.....	34	43
Roscoe placer.....	39	96	Selvage or gouge.....	37	74
Ruby, Oriental.....	35	80	Serpentine.....	35	76
" Silver.....	35	55	".....	37	60
" Spinel.....	35	80	" as a building stone.....	37	119
" ".....	35	83	Sets, Drift.....	39	41
			Shaft, Discovery, for lode claim in the United States.....	38	17
			Shallow placers.....	39	6
			Sharpening drills.....	38	55
			" picks.....	38	54
			Sheet lead.....	36	39
			Shining luster.....	35	8

	<i>Sec. Page.</i>		<i>Sec. Page.</i>
Side lines of claims, Apex crossing of.....	38 22	Solution, Cyanide, for copper determinations....	36 124
Siderite.....	36 30	“ Manganous sulphate, for use in iron analysis.....	36 108
Sienna.....	37 123	“ Magnesia mixture for phosphorus determination.....	36 115
Silica.....	36 36	“ Mercuric chloride, for use in iron analysis	36 108
“ and insoluble matter, Determination of.....	36 120	“ Molybdate, for phosphorus.....	36 115
“ Determination of.....	36 121	“ Permanganate, for iron analysis.....	36 108
“ for glass.....	37 123	“ Permanganate, for iron, Standardizing of.....	36 95
Silicates, Action of, with acids	34 21	“ Sodium hydrate, for phosphorus determination.....	36 116
Silky luster.....	35 3	“ Standard acid, for phosphorus determination.....	36 117
Silurian.....	37 43	“ Standard ferrocyanide, for the determination of zinc	36 133
“ period.....	37 92	“ Standard, for lead determination.....	36 131
Silver.....	35 53	“ Stannous chloride, for use in iron determinations.....	36 108
“.....	37 103	Solutions, Alkaline, in vein formations.....	37 86
“ and gold assay.....	36 45	“ Hot, in vein formations.....	37 86
“ crucible fluxes.....	36 40	Sorting power of water.....	37 12
“ Brittle.....	35 54	Source of water supply.....	39 53
“ Determination of, in ores.....	34 53	Spatulas.....	36 7
“ glance.....	35 54	Special occurrence of gold....	37 101
“ Horn.....	35 56	Specific gravity.....	35 9
“ Light ruby.....	35 55	Specimens, Mineral, Examination of.....	35 10
“ minerals.....	35 53	Specular iron ore.....	35 29
“ Native.....	35 54	Sphalerite.....	35 48
“ on charcoal.....	34 44	Spinel.....	35 80
“ ores, Crucible charges for.....	36 42	Spirit and oil lamps.....	34 25
“ Ruby.....	35 55	Spoons, Horn.....	39 12
Slate.....	37 120	Spot-plate.....	36 89
Slaty cleavage.....	37 39	Springs, Deposits from....	37 23
Slop jar.....	36 93	“ Eroding action of....	37 20
Sluices.....	39 16	“ Origin of.....	37 20
“ Charging of.....	39 27	Square-work mining.....	39 41
“ Distribution of gold in.....	39 51	Staking a placer claim in British Columbia.....	38 11
“ Grade of.....	39 26	“ of lode claim in British Columbia.....	38 24
Sluicing, Ground.....	39 28		
Smaltite.....	35 67		
Smithsonite.....	35 49		
Soda.....	34 23		
“ and potash salts.....	37 126		
“ Reduction of metallic oxides with.....	34 51		
Sodium and potassium bicarbonates.....	36 35		
“ “ potassium carbonates.....	36 35		
“ chloride.....	36 36		
Sodium hydrate solution for phosphorus determination...	36 116		
Soil, Formation of.....	37 2		
Solid elements.....	34 2		
Solution, Bichromate for iron, Standardizing of ..	36 99		
“ Cobalt.....	34 34		

	<i>Sec. Page.</i>		<i>Sec. Page.</i>
Staking placer claim in the		Structure of a mineral.....	35 4
United States.....	38 10	" Concretionary or	
" of tunnel sites in the		nodular	37 41
United States.....	38 27	Subordinate phenomena of igne-	
Stalactitic or stalagmitic struc-		neous origin.....	37 30
ture.....	35 5	Subscripts.....	34 6
Standard acid solution for		Substance, Scheme for exam-	
phosphorus determination...	36 117	ining of, before the blowpipe	34 36
Standard iron ores for use in		Substitution or exchange.	34 8
analysis.....	36 100	" " "	34 10
" solutions for copper		Subtransparent or semitrans-	
analysis.....	36 124	parent.....	35 2
" solution for lead de-		Sulphates, Test for	81 53
termination... ..	36 131	Sulphide iron ores, Treatment	
" solution for the de-		in analysis	36 104
termination of zinc	36 132	" ores, Lead assay for.	36 84
Standardizing bichromate so-		Sulphides, Action of, with	
lution for iron.....	36 90	acids.....	34 21
Standardizing cyanide solu-		Sulphur.....	37 122
tion for copper determina-		" and phosphorus in	
tion.....	36 126	fuels.....	37 115
Standardizing ferrocyanide solu-		" Determination of	36 135
tion for the determination		" in closed tube.....	34 38
of lead.....	36 131	" " open tube	34 41
Standardizing solution for the		Sulphuric acid, Test for	34 53
determination of zinc.....	36 133	Supply or feed pipes	39 90
Standardizing the permanga-		Supports.....	34 28
nate solution for iron.....	36 95	Surface changes in ore deposits	37 80
Stand for cupels.....	34 31	Surveying a ditch line	39 77
Stands, Burette and filter	36 90	Swamp, River.....	37 14
Stannite	35 63	Syenite	37 48
Stannous chloride solution for		Sylvanite	35 58
use in iron analysis.....	36 108	Symbols, Chemical	34 4
Stellated structure.....	35 4	" of the elements	34 5
Stephanite.....	35 54	Symmetrical body.....	35 11
Stibnite.....	35 68	Symmetry axis	35 11
Stirring rods	36 92	" plane	35 11
Stock work or gash veins.....	37 73	Syncline	37 37
Stone, Building	37 118	Synthesis or direct union.....	34 8
" dams	39 59	System in assay office....	36 62
Stones, Gem	37 126		
" Gold adhering to.....	39 15	T	<i>Sec. Page.</i>
" Precious, and gems,		Table of minerals sent with	
Prospecting for.....	38 31	the blowpipe outfit.....	35 72
Strata, Conformable.....	37 38	Tables, Gold saving	39 26
" Unconformable	37 38	Tailings, Disposition of.....	39 36
Stratified rocks.....	37 33	" Disposition of, from	
Streak plate.....	34 32	dredges..	39 103
Streams, Mechanical effects of		Talc.....	35 77
water flowing in.....	37 7	Talus, or slide rock.....	37 6
Strike.....	37 36	Tellurium, Black.....	35 59
Structural and historic geology	37 1	" Foliated.....	35 59
" geology	37 32	" Graphic.....	35 58
Structure, Cleavage	37 38	" in closed tubes....	34 39
" Columnar	35 4	" " open tube	34 41
" common to all rocks	37 66	" on charcoal	34 43

	<i>Sec. Page.</i>		<i>Sec. Page.</i>
Temperature, Increase of, with depth.....	37 25	Tube, Open, Heating in.....	34 40
" of muffle during cupelling.....	36 51	Tubes, Closed.....	34 30
Tempering and hardening.....	38 57	" Glass.....	34 29
Test lead.....	34 34	" Matrass.....	34 30
Tests of fusibility.....	44 45	" Open.....	34 29
" Wet.....	34 19	" Test.....	31 30
Tenacity.....	35 7	Tunnel, Advantage of having sluices in.....	39 43
Tertiary period.....	37 43	" sites in the United States.....	38 26
Tetragonal system of crystallization.....	35 11	Tunnels as outlets for hydraulic mines.....	39 43
" system of crystallization.....	35 15	" Wooden linings for... ..	39 63
Tetrahedrite.....	35 38	Turmeric paper.....	34 35
Tetrahexahedron, The.....	35 13	Turquoise.....	35 81
Test lead.....	36 39	" 	35 86
" tubes.....	34 30	Twinned crystals.....	35 21
Tests, Acid.....	31 30		
Theories of vein formation... ..	37 85	U	<i>Sec. Page.</i>
Throw of faults.....	37 08	Umber.....	37 123
Timbering for drift mines.....	59 41	Unconformable strata.....	37 88
Tin.....	34 35	Undercurrents.....	39 22
" 	35 63	Underground prospecting.....	34 35
" 	35 65	Union, Direct, or synthesis... ..	34 8 "
" 	37 111	United States, Mill sites in....	38 28
" on charcoal.....	34 44	United States practice in regard to lode claims.....	38 17
" pyrites.....	35 63	United States practice in regard to placer claims.....	38 9
Titrating dishes.....	36 90	United States, Tunnel sites in	33 26
Titration.....	36 2	Unstratified or igneous rocks..	37 46
Tom, Long.....	39 14	Utah as a prospecting region..	38 50
Tools, Furnace.....	36 25		
" Miscellaneous, for assaying.....	36 27	V.	<i>Sec. Page.</i>
" Prospector's.....	38 52	Valence or equivalence.....	34 11
Topaz.....	35 81	Value of a coal deposit.....	37 115
" 	35 88	Valves.....	39 91
" Oriental.....	35 80	" Blow-off.....	39 87
Tongs, Button.....	36 27	Vein formation, Theories of... ..	37 85
" Crucible.....	36 25	" formed in a dike.....	37 78
" Cupel.....	36 26	Veins.....	37 72
" Scorifier.....	36 25	" Action of alkaline solutions in the formation of.....	37 86
Trachyte.....	37 51	" Action of hot solutions in the formation of... ..	37 86
Transparency of minerals.....	35 2	" Arrangement of material in.....	37 76
Trapezohedron, The.....	35 13	" Copper, Surface changes in.....	37 80
Trappean rocks.....	37 50	" Effect of wall-rock on... ..	37 84
Translucent.....	35 2	" Faulted.....	37 84
Triassic period.....	37 43	" Fissure.....	37 74
Triclinic system of crystallization.....	35 12	" Minerals found in.....	37 75
" " " crystallization.....	35 22	" of infiltration.....	37 73
Trisectahedron, The.....	35 13	" or lodes, Prospecting of..	33 13
Trommels.....	39 35		
Troy weight, Table of.....	36 112		
Tube, Closed, Heating in.....	34 38		

	<i>Sec. Page.</i>		<i>Sec. Page.</i>
Veins of segregation.....	37 73	Weights	36 15
" Parallelism of.....	37 84	" and measures, Tables	36 142
" Richness of, with depth.	37 90	" Assay ton.....	36 143
" Some facts concerning the occurrence and richness of	37 83	" Assay ton, System of.	36 15
Velocity of approach	30 69	" Combining or atomic, of the elements.....	34 5
Vitreous luster	35 3	Weir, Crest of.....	39 66
Volcanic conglomerate and breccia.....	37 57	" with end contractions...	39 65
" or eruptive rocks ...	37 51	" without end contractions	39 65
Volcanoes	37 26	Weirs.....	39 65
Volumetric analysis or titra- tion	36 2	" Discharge of.....	39 69
Von Kobell's scale of fusi- bility.....	34 45	Wells, Cause of artesian.....	37 21
Vugs.....	37 90	" Origin of	37 20
		Wet assay	36 1
W.	<i>Sec. Page.</i>	" assaying, Apparatus for..	36 87
Wall-rock, Effect of, on con- tents of veins.....	37 84	" assays	36 85
Wash-bottle	36 91	" tests	34 19
Washing trough.....	39 10	White-lead ore	35 44
Waste-gates in flumes.....	39 82	Willemite.....	35 52
Wasteways for dams.....	39 58	Wind, Effects of.....	37 6
Watch-glasses	34 32	Wind furnace.....	36 20
"	36 88	Wing dams.....	39 39
Water, Chemical effects of ...	37 22	"	39 62
Water, Effects produced by currents in large bodies of..	37 17	Wire, Platinum	34 29
Water gauging by notch... ..	39 68	Wooden dams	39 56
" Measurement of the flow of.....	39 63	" linings for tunnels ...	39 83
" Relation between carry- ing power and ero- ding power of.....	37 10	" pipes	39 83
" Sorting power of.....	37 12	Work of glaciers.....	39 2
" supply.....	39 53	Working frozen ground.....	39 43
" Test for	34 53	" placer by dredges....	39 102
Waterfalls, Cause of.....	37 8		
" Flume.....	39 29	Y.	<i>Sec. Page.</i>
Water-wheels.....	39 38	Yellow ocher.....	35 30
Waves, Effects produced by, in large bodies of water.....	37 17		
Weighing	36 10	Z.	<i>Sec. Page.</i>
" and furnace work, Order of	35 63	Zigzag riffles	39 22
" Method of.....	36 17	Zinc.....	35 47
" the buttons.....	36 53	"	37 108
Weight, Adjusting of, to the standard solutions used in iron analysis.....	36 110	" and lead deposits, Occur- rence of.....	37 90
Weight, Atomic.....	34 3	" blende	35 48
" Molecular	34 4	" determination.....	36 132
		" Extra charge for smelting ores containing.....	36 4
		" minerals.....	35 47
		" on charcoal.....	34 44
		" ore, Black.....	35 51
		" " Red	35 50
		" ores, Treatment of, in an- alysis	36 134
		" white	37 128
		Zincite.....	35 50
		Zircon.....	35 81
		"	35 85

BLOWPIPING.

CONSTITUTION OF MATTER.

1. It is eminently necessary that the student shall, before taking up the subject of Blowpiping, have some knowledge of the fundamental principles of Chemistry, and for that reason we will here briefly state for his benefit those which we deem most essential.

CHEMICAL ELEMENTS.

2. A **chemical element** is a substance which can not be decomposed or divided into simpler substances by any known process. That is, a chemical element is the simplest, or ultimate, form of matter. There are at present (1898) seventy-four recognized elements, or substances that are, as far as we know, elementary. There is no good reason to suppose, however, that these *known* elements comprise all the elementary substances in existence; in fact, the supposition is rather to the contrary. New elements have been discovered from time to time in the past, the year 1894 witnessing the discovery of two—*argon*, a gaseous element closely resembling nitrogen, and *helium*, an element allied to uranium—and there are various scientific reasons for believing that there is still quite a number of undiscovered elements waiting for genius or accident to disclose them to the world.

It is quite possible that some of the substances which we consider elementary, and place in the list of elements, are

in reality compounds of two or more still unknown elements.

3. The elements may be divided, like all other matter, into gaseous, liquid, and solid classes, according to their physical state at ordinary conditions of pressure and temperature.

The gaseous elements are hydrogen, oxygen, nitrogen, argon, chlorine, and fluorine. The first three were formerly called *fixed gases*, as they were supposed to remain in the gaseous state under all conditions, but in the last few years all of them, even hydrogen, the lightest, have been reduced to the form of liquids by the use of enormous pressures and very low temperatures, so that the term has lost its significance and is rapidly falling into disuse.

Only two of the known elements—bromine and mercury (quicksilver)—belong to the liquid class, and the former is very volatile and must be kept air-tight or it will rapidly evaporate at ordinary temperatures. The rest of the known elements are all solids under ordinary conditions.

4. The solid elements may be further classified as *metallic* and *non-metallic*, according to physical peculiarities. Carbon, phosphorus, arsenic, sulphur, boron, tellurium, selenium, iodine, and silicon rank as the non-metallic elements, while the rest of the solid elements are considered metallic. Mercury, also, is classed as a metallic element.

5. The various elements combine among themselves to form chemical compounds, and the elements and their compounds constitute all the matter of the universe. By far the greater portion of the elements occur in nature only in combination, and of those that do occur in the elementary form, in the case of only a few—such as gold and platinum among the solids, and nitrogen among the gases—is this form the usual one; and, so far as is known, no element occurs invariably uncombined, or native. The combination of elements is discussed more at length in Arts. **11** to **24**.

ATOMS AND MOLECULES.

6. A **molecule** of any substance is the smallest portion of that substance that can exist independently and still preserve its identity. That is, if any attempt is made to still further subdivide the substance, the resultant parts will no longer be of the same character as the original substance. Molecules are in turn made up of still smaller masses of one or more chemical *elements*, called *atoms*.

7. An **atom** is the smallest portion of an *element*. With a few exceptions, atoms exist only *in combination with other atoms* of the same or other elements, as a constituent of a molecule. (The molecules of mercury, zinc, and cadmium contain only one atom each.)

To illustrate the relation between molecules and atoms, we may draw a comparison between a molecule of any substance and some familiar compound, say gunpowder. We will consider a grain of gunpowder as representing a molecule. Now, this grain of powder has certain well-defined characteristics, but if we give it sufficient heat it will at once explode, breaking up into gas and a certain amount of solid residue, and neither the gas nor the residue resembles the original gunpowder in the least; but, nevertheless, they were both *constituents* of the grain, and helped to give it its character; and to this extent they bear the same relation to the grains of gunpowder as the constituent atoms of a molecule do to the molecule.

8. **Atomic Weight.**—As an atom is a portion of an element, there must, of course, be as many different kinds of atoms as there are of elements; and as the elements themselves are not all of the same density, the weights of the atoms also are variable. Atoms are infinitesimal, and millions of them are necessary to make a particle that is visible to the eye; so, of course, it is impossible to obtain the *actual weight* of a single atom. The *relative weights* of the atoms of the known elements have been determined, however, within very close limits. The **atomic weight** (also known as the **combining weight**) of an element is the ratio of the

weight of an atom of that element to the weight of an atom of hydrogen. Hydrogen, being the lightest known element, is taken as the standard for determining atomic weights, and the weight of its atom is considered as unity, or 1.

9. Molecular Weight.—The weight of a molecule of any substance, either elementary or compound, is, of course, equal to the sum of the weights of the atoms composing it; therefore the **molecular weight** of the substance is the sum of the *atomic weights* of all the elements composing it, each multiplied by the number of atoms of that element in a molecule of the substance. Elements have both atomic and molecular weight, the latter being usually either two, or some simple multiple of two, times the former, as, with only a few exceptions (see Art. 7), a molecule contains at least two atoms; but compounds can have only molecular weight, as they immediately lose their identity as compounds if they are broken up into their elements.

SYMBOLS.

10. For convenience in writing chemical formulas and equations, the various elements may be represented by their *chemical symbols*. These symbols are merely the initials or an abbreviation of the name of the element, either English or Latin. Table I gives a list of the known elements, and opposite each element is its chemical symbol and atomic or combining weight. The non-metallic elements in the table are printed in **heavy type**.

FORMATION OF CHEMICAL COMPOUNDS.

CHEMICAL FORMULAS AND EQUATIONS.

11. To save the time and trouble of writing out in full the names of compounds, and to facilitate chemical calculations, a system of chemical notation has been devised in which the various elements are represented by their symbols, and their relative proportions by subscripts and coefficients.

TABLE I.

NAMES OF ELEMENTS, THEIR SYMBOLS AND COMBINING WEIGHTS.

	Sym- bol.	Combi- ning Weight.		Sym- bol.	Combi- ning Weight.
Aluminum.....	<i>Al</i>	26.91	Molybdenum.....	<i>Mo</i>	95.26
Antimony (stibium)	<i>Sb</i>	119.50	Neodymium.....	<i>Nd</i>	142.52
Argon	<i>A</i>	? 4.00	Nickel.....	<i>Ni</i>	58.24
Arsenic	<i>As</i>	74.44	Niobium.....	<i>Nb</i>	93.02
Barium.....	<i>Ba</i>	136.39	Nitrogen	<i>N</i>	13.91
Bismuth.....	<i>Bi</i>	206.54	Osmium.....	<i>Os</i>	189.55
Boron	<i>B</i>	10.86	Oxygen	<i>O</i>	15.88
Bromine	<i>Br</i>	79.34	Palladium.....	<i>Pd</i>	105.56
Cadmium.....	<i>Cd</i>	111.54	Phosphorus	<i>P</i>	30.79
Cæsium	<i>Cs</i>	131.89	Platinum.....	<i>Pt</i>	193.41
Calcium.....	<i>Ca</i>	39.76	Potassium (kalium)..	<i>K</i>	38.82
Carbon	<i>C</i>	11.91	Proseodymium.....	<i>Pr</i>	139.41
Cerium.....	<i>Ce</i>	138.30	Rhodium.....	<i>Rh</i>	102.23
Chlorine	<i>Cl</i>	35.18	Rubidium.....	<i>Rb</i>	84.78
Chromium.....	<i>Cr</i>	51.74	Ruthenium.....	<i>Ru</i>	100.91
Cobalt.....	<i>Co</i>	58.55	Samarium.....	<i>Sm</i>	149.13
Copper (cuprum)....	<i>Cu</i>	63.12	Scandium.....	<i>Sc</i>	43.78
Erbium.....	<i>E</i>	165.06	Selenium	<i>Se</i>	78.58
Fluorine	<i>F</i>	18.91	Silicon	<i>Si</i>	28.18
Gadolinium.....	<i>Gd</i>	155.57	Silver (argentum)....	<i>Ag</i>	107.11
Gallium.....	<i>G</i>	69.38	Sodium (natrium)....	<i>Na</i>	22.88
Germanium.....	<i>Ge</i>	71.93	Strontium.....	<i>Sr</i>	86.95
Glucinium.....	<i>G(Gl)</i>	9.01	Sulphur	<i>S</i>	31.83
Gold (aurum).....	<i>Au</i>	195.74	Tantalum.....	<i>Ta</i>	181.45
Helium	<i>He</i>	? 4.00	Tellurium	<i>Te</i>	126.52
Hydrogen	<i>H</i>	1.00	Terbium.....	<i>Tr</i>	158.80
Indium.....	<i>In</i>	113.40	Thallium.....	<i>Tl</i>	202.61
Iodine	<i>I</i>	125.89	Thorium.....	<i>Th</i>	230.87
Iridium.....	<i>Ir</i>	191.66	Thulium.....	<i>Tu</i>	169.40
Iron (ferrum).....	<i>Fe</i>	55.60	Tin (stannum).....	<i>Sn</i>	118.15
Lanthanum.....	<i>La</i>	137.59	Titanium.....	<i>Ti</i>	47.79
Lead (plumbum)....	<i>Pb</i>	205.36	Tungsten (wolfram)..	<i>W</i>	183.43
Lithium.....	<i>Li</i>	6.97	Uranium.....	<i>U</i>	237.77
Magnesium.....	<i>Mg</i>	24.57	Vanadium.....	<i>V</i>	50.99
Manganese.....	<i>Mn</i>	54.57	Ytterbium.....	<i>Yb</i>	171.88
Mercury (hydrargyrum)	<i>Hg</i>	198.49	Yttrium.....	<i>Y</i>	88.35
			Zinc.....	<i>Zn</i>	64.91
			Zirconium.....	<i>Zr</i>	89.72

NOTE.—The elements Neodymium and Proseodymium always occur together, and so they are called Didymium in the tables on blowpipe reactions.

12. Subscripts.—Subscripts are small figures placed after and slightly below the symbols of the different elements of a compound, to indicate the proportion (by volume) of each present, or the number of atoms of each in a molecule of the compound. Thus, H_2SO_4 , the formula for sulphuric acid, indicates that the acid is made up of hydrogen, sulphur, and oxygen, in the proportion of 2 parts (by volume) of hydrogen, 1 of sulphur (when no subscript is given, the subscript 1 is understood), and 4 of oxygen; or, that a molecule of H_2SO_4 is made up of 2 atoms of H , 1 of S , and 4 of O . The formula of water (H_2O) tells the observer at once that water is two-thirds hydrogen and one-third oxygen, by volume. The advantages of such a system of notation are obvious. In reading formulas, the subscripts are read, as they are written, after the symbol of the element they modify; thus, H_2SO_4 is read “ H two, S , O four.”

13. If a parenthesis is placed around the symbols of a group of elements, and a subscript written after the parenthesis, the subscript multiplies everything within the parenthesis. Thus, $Fe_2(SO_4)_3$, (sesquisulphate of iron) might also be written $Fe_2S_3O_{12}$, but the group of elements SO_4 is characteristic of the sulphates, and acts, in replacing and being replaced by other elements, like a single element, and hence is written in parenthesis, with a subscript corresponding to the subscript of a single element whose place it fills. By so doing, compounds can be assigned to their proper class—sulphates, hydrates, etc.—at a glance; while the other method, removing the parenthesis and multiplying the various subscripts, would lead to considerable confusion.

A *radical* is a group of elements (characteristic of a class of compounds) which acts like a single element in replacing or being replaced by elements or in combining with other radicals. As a rule, radicals can not exist by themselves, as the atoms of the elements composing them are not combined in such proportions as to form stable molecules, and hence the radicals must either break down so as to form stable molecules or they must combine with each other or

with elements so as to form stable compounds. The radical of sulphuric acid, SO_4 , has already been mentioned, and it is this that occurs in sulphates. The radical of nitric acid and the nitrates is NO_3 , and that of the hydrates or hydroxides is OH . Thus, $AgNO_3$ is silver nitrate; $Ba(NO_3)_2$ is barium nitrate; KOH is potassium hydrate, and $Ca(OH)_2$ is calcium hydrate. The radical HO seems to combine with itself to form a compound, $H-O-O-H$, or H_2O_2 , which is called hydric peroxide.

14. Coefficient. — Coefficients are numbers placed before symbols of free elements, or formulas of compounds, to indicate the relative amounts of substances under consideration. Coefficients may be illustrated as follows: When we wish to write two molecules of water we write $2H_2O$, or when we wish to write two molecules of hydrochloric acid we write $2HCl$, the coefficient applying to the entire formula.

15. Chemical affinity is the tendency which all elements possess (to a greater or less degree) to combine with each other and so form chemical compounds. This tendency or attraction is not a constant force, but varies between the different elements; for instance, there is practically no affinity between gold and oxygen, but iron rusts or oxidizes in moist air. The affinity between chlorine and hydrogen is so great that if they are merely mixed and exposed to light (not flame) they will explode with great violence and unite to form hydrochloric acid. The affinity of fluorine for hydrogen is even more intense, and light is not necessary to produce combination and explosion when the elements are mixed.

16. A chemical reaction is a change in the arrangement of the atoms of two or more compounds or molecules so as to form different compounds or molecules. Chemical reactions are due to the difference in affinity of the various elements, and usually involve several elements or compounds. These reactions may be represented by chemical equations,

one side of the chemical equation being composed of the factors which enter into the reaction, and the other side of the factors resulting from the reaction, each factor being preceded by its proper coefficient.

Ordinarily, if two elements or compounds that have an affinity for each other are brought together, they unite to form a new compound; but in some cases this union will not take place at ordinary temperatures or under ordinary conditions, and in such cases heat, electricity, or some other agency may be necessary to facilitate the union. As an illustration: If two volumes of hydrogen gas and one volume of oxygen gas are mixed at ordinary temperatures, they would remain in the gaseous condition indefinitely, but should their temperature be elevated, or should the mixture be brought into contact with a flame, they will immediately unite to form water, the formula for which is H_2O .

Chemical reactions may be considered under the three following heads: **Direct union** or **synthesis**, **displacement**, and **substitution** or **exchange**.

17. Direct union or **synthesis** takes place when an element in the free state comes into contact with another element for which it has considerable affinity, and the two combine to form a chemical compound. In the same way two compounds (or an element and a compound) may unite to form a single new compound. As illustrations of direct union or synthesis, we may mention the formation of water by the union of oxygen and hydrogen, as has already been mentioned. The reaction in this case may be represented by the equation

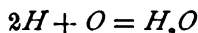

but on account of the fact that this reaction does not take place at ordinary temperatures, some people write the equation

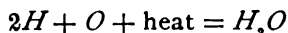

Another illustration of direct union or synthesis has already been mentioned in the formation of hydrochloric acid, the reaction for which may be represented by the equation

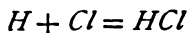

The converse of direct union or synthesis is the breaking up or disintegration of simple compounds into their constituent elements. Analytical chemistry depends upon the breaking up of the compounds to determine their nature. Many compounds, such as carbonates, sulphides, etc., can be decomposed by heat alone, while others are decomposed by electric currents; as, for instance, water may be decomposed into oxygen and hydrogen, and various metallic salts may be decomposed into the metal and free acid by means of electric currents.

18. Displacement takes place when a free element comes in contact with a compound containing some element for which the free element has a greater affinity than the other constituents of the compound. The free element will immediately form a combination with the element for which it has affinity, and the other element or elements of the compound will be set free or forced to form new compounds. This may be illustrated as follows: If metallic zinc and hydrochloric acid be brought into contact in the proportion of two molecules of hydrochloric acid to one of zinc, the reaction illustrated by equation I will take place.

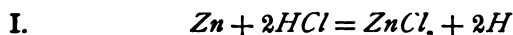

It is by this means that hydrogen gas is usually made in the laboratory. If metallic zinc be brought into contact with a solution of sulphate of copper, the reaction illustrated in equation II will take place.

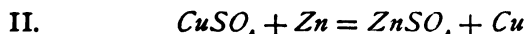

This reaction is employed for the precipitation of metallic copper, and metallic iron may be substituted for the zinc, in which case sulphate of iron and free copper would be the result. The latter method is frequently employed for the precipitation of copper from mine waters containing sulphate of copper in solution, the mine waters being led into tanks containing scrap iron. The scrap iron is changed into sulphate of iron (green vitriol) and the copper deposited

as metallic copper, the sulphate of iron going into the solution and being carried away by the water.

19. Substitution or exchange takes place when two compounds come together, the elements of which are so constituted that some of them have a tendency either to exchange places with a portion of those in the other compound or else to unite and form new compounds. If limestone be brought into contact with hydrochloric acid, the reaction shown in equation III will take place.

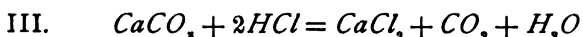

The results of this equation are calcium chloride, carbon dioxide, or carbonic acid gas, as it is sometimes called, and water. This is the reaction commonly used in the laboratory for obtaining carbon dioxide. Another illustration of this class of reactions is shown in equation IV, in which case iron sesquioxide is treated with sulphuric acid, and the resulting compounds will be sesquisulphate of iron and water.

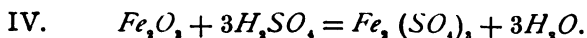

20. All chemical reactions are included in the preceding classification. Occasionally, when a compound is robbed of any of its constituents, the affinity between the remaining elements is not sufficient to keep them together, and they will break up independent of the original reaction.

21. Combining Power.—It has been found that the elements always combine in certain definite proportions, and in all the elements which are gases or can be combined when in the gaseous state, it has been found that these proportions are by volume; and from investigations which have been carried on, it is fair to assume that all elements combine in proportions by volume when in the gaseous state.

For instance, if one volume of *H* (hydrogen) combines with one volume of *Cl* (chlorine), they will form two volumes of hydrochloric acid, *HCl*. This law always holds, and each element has a certain combining or holding power; that is,

its atoms can hold in combination or combine with a certain number of atoms of other elements.

Hydrogen has been taken as the standard by which to measure or compare this combining power. The combining power of the various elements is found to range from an equivalent of one atom of hydrogen up to as high as an equivalent of seven atoms of hydrogen. Those that can hold one atom of hydrogen are called monads; if the element combines with or replaces the equivalent of two atoms of hydrogen or other monad elements, it is called a dyad, and is said to have a valence of two; if it combines with or replaces the equivalent of three atoms of hydrogen, it is called a triad, and has a valence of three; if it combines with four atoms, it is called a tetrad; with five atoms, a pentad; with six atoms, a hexad; and with seven atoms, a heptad.

22. Equivalence or valence may be defined as that property of an element by virtue of which its atom may hold a definite number of other atoms in combination. Hydrogen is always used as a standard for measuring valence.

Hydrogen always has the same valence, while several of the other elements combine in two or more proportions; but if an element has an odd valence, its valence will usually increase or decrease in multiples of two, and hence remain odd; as, for instance, chlorine has valences of one, three, five, and seven, but not two, four, and six, while sulphur has even valences of two, four, and six, but never an odd valence.

To make valence somewhat plainer, it may be stated somewhat as follows: The combining power of the elements may be represented by bonds, and these may be illustrated graphically by short lines. The lines represent the number of bonds and not their direction. *H* has but one bond, while oxygen has two and carbon four, as illustrated below:

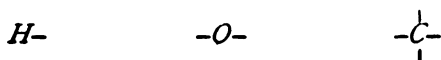

In a chemical compound, all the bonds are supposed to be satisfied.

23. Radicals have free bonds on account of the fact that the elements composing them are not completely satisfied, and it is for this reason that they act as elements; for instance, if one atom of hydrogen and one atom of oxygen be combined, we may assume that they would take the position shown below:



in which there is still a free bond, but now if this same $H-O-$ radical be combined with a similar radical, we may assume that they would take the position:

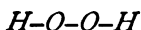

in which a free bond of each radical would be satisfied by that of the other, and the formula would become H_2O , as noted in Art. 13. If to the HO radical we add one atom of hydrogen in place of the other HO radical, we would have obtained the formula $H-O-H$ or H_2O , which would be water.

24. Nascent State.—By experiment in regard to the molecular weight of gases, it has been found that in hydrogen gas the atoms are not free, but the molecule is composed of two atoms, as $H-H$, or H_2 . In the same way the molecules of oxygen gas are composed of two atoms $O=O$, or O_2 . (See Art. 7.) It is evident that the forces necessary to hold these molecules together must reduce their ability to combine with other elements; i. e., before oxygen gas can combine with another element, the molecule which is composed of two atoms of oxygen must be broken up so that the atoms will be set free. The same is true in regard to hydrogen gas, and in this case the reaction may be well illustrated as follows: If ferric chloride (Fe_2Cl_6) be treated with hydrogen gas by passing the gas from a generator through a solution of the ferric chloride, no change whatever in the condition of the chloride will occur, but if the solution of ferric chloride contain free acid—as, for

instance, hydrochloric acid—and then zinc be added to the solution, the reaction that will take place between the zinc and the free hydrochloric acid will be illustrated by equation V.

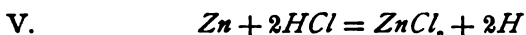

but in this case the hydrogen at the moment it is freed will be in an atomic form; that is, it will not be combined into the molecules composed of two atoms of hydrogen, and hence it is free to form any compound that it may. This free hydrogen will combine with ferric chloride as illustrated in equation VI.



It will be seen that this reaction liberates hydrochloric acid from the ferric chloride and reduces the ferric chloride to ferrous chloride. Now, in certain chemical reactions it is desirable to have a solution of iron in the ferrous state, and this may be accomplished as shown by the reactions above. After the reaction is once started, the hydrochloric acid freed from the ferric chloride would decompose more zinc, and the reaction would be continuous so long as ferric chloride, zinc, and free acid be present.

The fact that the elements are more active at the moment they are freed has led chemists to call this state of an element the nascent state (nascent means being born).

For an experiment to illustrate this, it is well to use a solution of potassium permanganate, which has a dark-red color. If hydrogen from the generator be passed into this solution, no reaction will occur, even though free acid be present, but if zinc and acid be added to the solution, so as to form hydrogen in the solution, the nascent hydrogen will immediately combine with the potassium permanganate to form a colorless solution. The ferric-chloride solution is only slightly yellow, and hence it requires a test to determine the moment at which all the ferric salt has been reduced to a ferrous salt.

CHEMICAL NOMENCLATURE.

25. In the naming of the chemical elements, the only attempt made at system is in restricting the use of the termination *-um* to the metallic elements, and even to this there are two exceptions, selenium and tellurium; these two elements were originally supposed to be metallic, and the names have not been altered since their non-metallic character was recognized.

In the naming of compounds, however, a definite system has been adopted by which the name of the compound is made to indicate its composition.

26. Binary Compounds.—The simplest of chemical compounds are those containing only two elements—*binary compounds*. Such compounds are made up either of a metal and a non-metal or of two elements replaceable by a metal and non-metal respectively, and which may, therefore, for purposes of comparison, be considered as metallic and non-metallic. Thus, hydrogen is replaceable in all acids by metals, and in many of its chemical characteristics resembles the metallic elements. Sulphur and arsenic in some compounds are non-metallic in character and in others they have all the chemical characteristics of metals.

27. In binary compounds, the name of the non-metal gives the name to the class, the termination *-ide* being substituted for the concluding syllable or syllables of the name of the element. Thus, compounds of a metallic element with oxygen are *oxides*; with sulphur, *sulphides*; with chlorine, *chlorides*, etc. The *specific* name of the compound is derived from the metallic element; thus, *copper oxide*, *iron sulphide*, *silver chloride*. Frequently, however, the same elements combine in more than one proportion. Thus, we have two oxides of iron, FeO and Fe_2O_3 , and corresponding sulphates, chlorides, etc. There are several ways of denominating such compounds. Usually we use the Latin name of the metallic constituent and substitute for the final syllable or syllables the suffix *-ic* in the names of the compounds in which the proportion of the *non-metallic*

constituent is largest, and *-ous* in the names of the compounds having smaller proportions of the non-metallic constituent. Thus, FeO is the formula for *ferrous oxide*; Fe_2O_3 for *ferric oxide*; SO_2 is *sulphurous oxide* or anhydride; SO_3 is *sulphuric oxide* or anhydride, etc. In the higher compounds, the same system is also used: $CrSO_4$ is *chromous sulphate*; $Cr_2(SO_4)_3$, *chromic sulphate*, etc.

28. The use of the names of the Greek and Latin numerals as prefixes to the class names of the compounds, instead of the suffixes given above, is quite common. The Greek prefixes *mono-*, *di-*, *tri-*, *tetra-*, *penta-*, *hexa-*, etc. are most frequently used; thus, FeS is *monosulphide* of iron; FeS_2 , *disulphide*, etc. The Latin prefixes *uni-*, *bi-*, *ter-*, *quadro-*, etc. are used interchangeably with the Greek, a *monosulphide* and a *unisulphide* being identical; or a *dioxide* and a *binoxide*. The prefix *proto-* is frequently applied to the class name of the one of two or more compounds of the same element which contains the lowest proportion of the non-metal, and *per-* to the one containing the highest proportion. Thus, $SnCl_2$ is *protochloride* of tin, or *stannous chloride*, and $SnCl_4$ is *perchloride* of tin, or *stannic chloride*.

29. Iron, aluminum, chromium, manganese, nickel, and cobalt form, besides the regular series of oxides and corresponding compounds in which the valence of the metals is even—two, four, and six—another series in which the valence is apparently odd—three—called *sesquioxides*, *sesquisulphates*, etc., the combining proportion of the non-metal to the metal being as 3 to 2; as Fe_2O_3 , $Cr_2(OH)_6$ (chromium sesquihydrate—or *chromic hydrate*—two volumes of OH being equivalent to one of O), etc.

30. A compound in which the metallic constituents are in less than the normal proportion (in other words, in which the valence of the metallic element is less than its minimum normal valence) is distinguished by the prefix *sub-* to its class name. Thus, in *suboxide* of copper (Cu_2O), copper, which is ordinarily a dyad or tetrad, has an apparent valence of 1.

31. Acids.—An acid is a compound of hydrogen with one or more other elements, in which the hydrogen is replaceable, wholly and in part, by a metallic element or a group of elements equivalent to a metal. As a class, acids have a sour (*acid*) taste, and most of them turn certain vegetable colors red—notably in the case of blue litmus, which gives a very delicate test for the presence of an excess of acids.

Certain oxides, when dissolved in water, combine with it chemically and form acids. Oxides having this property are called **anhydrides**, a term meaning “containing no water or hydrogen.” The following equation illustrates the reaction between sulphuric anhydride and water:

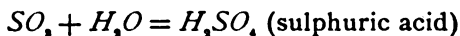

The term *acid* is sometimes used in reference to anhydrides, as “carbonic acid gas” (CO_2), but this usage is being abandoned.

32. Acids containing oxygen are called *oxy-acids*, or *oxacids*, to distinguish them from a group of binary acids containing no oxygen, which are known as *hydracids*—hydrochloric acid (HCl), hydriodic acid (HI), hydrofluoric acid (HF), hydrosulphuric acid or sulphureted hydrogen (H_2S), etc.

When an element forms more than one oxacid, the termination *-ous* is applied to the name of the acid in which the proportion of the oxygen to the characteristic element is smaller (or, to be more exact, to the one in which the characteristic element has the lower valence, the distinction depending rather upon valence than actual proportion), and *-ic* to the more highly oxidized acid.

33. Bases.—A base is a compound—usually an oxide or a hydrate of a metallic element, or of a radical equivalent to a metal—which is chemically opposed to acids in all its reactions and characteristics. Certain bases in which the distinctive chemical characteristics are very marked are called **alkalies**. They neutralize acids, restore the blue color to litmus reddened by acids, and turn yellow turmeric

paper to a reddish-brown color. The most familiar alkalis are caustic soda and caustic potash (sodium and potassium hydrates— $NaOH$ and KOH) and ammonia (ammonium hydrate— NH_4OH). The metallic constituents of these compounds belong to a group known as the *alkali metals*, consisting of sodium, potassium, lithium, rubidium, cæsium, and the metallic radical ammonium (NH_4). The metals of this group and their oxides combine with great readiness with water, forming strongly alkaline hydrates—all except lithium bursting into flame on being wet or thrown into water—and ammonia gas (NH_3) dissolves with remarkable rapidity in twice its weight of water, forming a hydrate. The gas may be completely expelled from the water by heating, and is liberated to a considerable degree at ordinary temperatures. The alkalis impart a peculiar *soapy* taste and feel to water.

The *alkaline earth metals*, barium, strontium, calcium, and magnesium, have many characteristics in common with the alkali metals. The basic compounds of this group are less soluble, however, and their alkaline reactions are less pronounced.

34. Salts.—A salt is a compound produced by the replacement of part or all of the hydrogen of an acid by a metallic element or an equivalent group of elements. Many metals are directly soluble in acid, the reaction giving a salt of the metal and liberating hydrogen gas, thus:

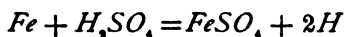

Bases (oxides and hydrates) react with acids, the metal of the base interchanging with the hydrogen of the acid, forming a metallic salt and water, thus:

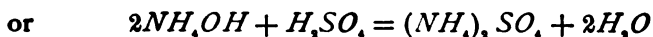
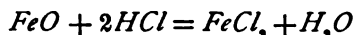

The salts of the alkali metals are all soluble, hence they do not form precipitates, except in very highly saturated solutions.

35. The salts of the hydracids are essentially binary, and take the binary termination *-ide*—chloride, fluoride, sulphide, etc. The salts of the lower or *-ous* oxacids take the termination *-ite*, thus:

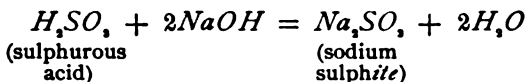

The salts of the higher or *-ic* oxacids take the termination *-ate*, thus:

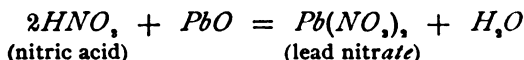

OXIDATION AND REDUCTION.

36. Oxidation, strictly speaking, is a reaction by which a substance takes up oxygen, or is actually *oxidized*, the proportion of oxygen to the metallic constituent being increased. In its *chemical* sense, however, it applies not only to reactions in which there is an actual increase in the proportion of oxygen, but also to all analogous reactions in which there is an increase in the proportion of the non-metallic constituent. Thus, any reaction by which ferrous chloride ($FeCl_2$) is converted into ferric chloride (Fe_2Cl_6), or ferrous sulphate ($FeSO_4$) is converted into ferric sulphate [$Fe_2(SO_4)_3$], is, chemically speaking, just as truly oxidation as the reaction by which ferrous oxide (FeO) is converted into ferric oxide (Fe_2O_3), though in the first case there may have been no *oxygen* in any of the reagents used.

In blowpiping, however, oxidizing reactions are usually attended by *actual* oxidation, or an increase in the proportion of *oxygen*.

37. Reduction is the opposite, or inverse, of oxidation; that is, a reducing reaction is one by which the proportion of non-metallic constituent to the metallic constituent is decreased.

38. Oxidation and reduction always occur simultaneously; that is, an oxidizing reaction is at the same time

reducing, for what one reagent gains it must take from another, either directly or indirectly, and the second reagent is therefore reduced. The reaction is *termed* oxidizing or reducing, according as the *principal product*, to obtain which the mixture of the different reagents was made, is the result of oxidation or reduction.

BLOWPIPING.

39. The purpose of blowpiping is to furnish a rapid method for the determination of the approximate composition of minerals and ores. In general, blowpipe determinations are merely *qualitative*—that is, they indicate the *presence* of the different constituents, but not the *proportions*. In the cases of a few of the metallic elements which can be completely reduced from their minerals before the blowpipe, by methods to be described later, a rough idea of the proportions may be gained; but these results are not at all accurate, on account of the roughness of the method and the losses through volatilization. To determine with any accuracy the percentage composition of a chemical compound, the more elaborate methods of *quantitative* analysis must be used.

40. A mineral is a free native element or an inorganic compound occurring in nature. In this sense, not only are the solid rocks minerals, but water is also a mineral.

WET TESTS.

41. In ordinary chemical analysis the substance to be tested must first be brought into a liquid form by dissolving in acids, and the different constituents then precipitated by means of proper reagents; but by the use of the blowpipe for qualitative analysis, the reactions by which the different constituents are recognized are gotten directly from the substance tested, without previous solution. There are certain simple wet tests, however, which are universally

used in conjunction with the blowpipe tests, and have come to be considered a part of blowpipe practice. These tests are mainly of the solubility of the substances in the common mineral acids—hydrochloric (HCl), nitric (HNO_3), and sulphuric (H_2SO_4)—and the phenomena attending the complete or partial solution.

42. For testing with acids, a mineral should first be powdered; a little of it is then placed in the bottom of a test tube, or matrass, and well covered with the acid. The most important points to be observed are, first, its solubility—whether slow or rapid, complete or incomplete, or whether soluble at all, and whether heating is necessary for the solution; and second, the attendant phenomena—whether a gas is evolved, producing bubbling or effervescence, or a solution is formed without effervescence, or whether a precipitate is formed or an insoluble constituent separated.

43. Hydrochloric acid is the acid most frequently used in testing the solubility of a mineral, though in the case of compounds of lead, silver, and mercury, nitric acid is required, as these metals form insoluble chlorides with HCl . Sulphuric acid is the acid least used as a solvent. Dilute acids are generally used. Minerals which are insoluble or only partially soluble in either HCl or HNO_3 , alone, are usually soluble in aqua regia, which is a mixture of 3 parts of HCl with 1 part of HNO_3 .

REACTIONS OF DIFFERENT MINERALS IN ACIDS.

44. Carbonates.—All carbonates dissolve in acids, liberating CO_2 ("carbonic acid gas") with lively effervescence (see equation III, Art. 19). With many carbonates the solution will take place in cold acid, but with some it is necessary to heat the acid to obtain the reaction, as in the case of magnesite (magnesium carbonate), dolomite, and siderite. Dilute HCl is generally used for the tests. HNO_3 gives the best results with lead, copper, and zinc carbonates.

45. Sulphides.—When metallic sulphides are dissolved in HCl or H_2SO_4 , the gas H_2S (sulphureted hydrogen) is liberated. This is a colorless, highly poisonous gas, very readily recognized by its characteristic odor, which is that of rotten eggs.

Many sulphides, when treated with boiling HNO_3 , decompose, forming a metallic nitrate or oxide, and liberating sulphur, which separates as a white or yellowish precipitate.

46. Silicates.—Many silicates, when finely powdered and treated with boiling concentrated HCl or HNO_3 , are decomposed, the silica separating as a gelatinous precipitate or as a fine powder. Many silicates are unaffected by acids.

47. Oxides.—The majority of the mineral oxides are soluble in acids. HCl alone will dissolve most of them, and there are several more that are soluble in HNO_3 or in aqua regia. There are a number of oxide minerals, however, which refuse to yield to the solvent powers of acids, as the minerals corundum (Al_2O_3), spinel ($MgAl_2O_4$), chromite ($FeCr_2O_4$), rutile (TiO_2), cassiterite (SnO_2), quartz (SiO_2), etc.

48. Besides the insoluble silicates, there are a number of other minerals that are insoluble in acids; mostly, however, of rather unusual occurrence, as titanates, tantalates, columbates, etc. Among the commoner insoluble minerals are barite, celestite, and anglesite—the sulphates of barium, strontium, and lead, respectively—and many phosphates.

APPARATUS.

THE BLOWPIPE.

49. The blowpipe has been employed for a very long time for producing an intensely heated flame, and in later years its use has been extended by such eminent men as Gahn and Berzelius to the determination of minerals and to the preliminary examination of substances before analyzing them quantitatively.

50. There have been numerous modifications of the blowpipe. In its simplest form it is a conical curved tube of brass, terminating in a small orifice about the size of a needle point. This form of blowpipe is not very satisfactory,

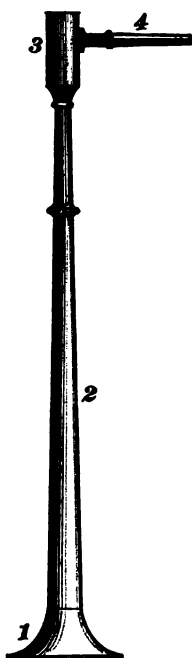

FIG. 1.

however, as the moisture which condenses from the breath is, after blowing some time, thrown into the flame, and becomes very troublesome, and the better forms of blowpipes are all supplied with some sort of enlargement at the turn, to act as a moisture reservoir.

The most improved form of blowpipe is shown in Fig. 1. It consists of four parts: the mouthpiece *1*, made of hard rubber or bone, which is *pressed against the lips*, and is so large as not to tire the operator; the tube *2*, which fits by a ground joint into the moisture reservoir *3*; and the tip-holder *4*, fitting by a ground joint into the reservoir; on the other end of the tip-holder is soldered a small disk or tip of platinum foil, pierced in the center by a very fine hole. Some varieties of blowpipes have detachable conical tips of platinum, fitting onto the tip-holder with ground joints; these are considerably more expensive, however, than the form described, and no better; and the tips are small and apt to get lost, and new tips cost 60 cents apiece. A plain brass blowpipe of the form illustrated in Fig. 1 (the Plattner pattern) costs about \$1.50. The pipe can be taken to pieces for packing. The trumpet mouthpiece is especially desirable as it makes the use of the blowpipe much less tiring to the operator than it would be without it.

51. A much cheaper blowpipe (costing about 25 cents) is shown in Fig. 2. It is made of japanned tin, with the parts brazed together. It is just as satisfactory for pro-

ducing a good flame as the Plattner pattern, but the mouthpiece has to be inserted between the lips, which is more fatiguing, and which necessitates the large moisture reservoir, as the saliva passes into the pipe—something which can not happen when the mouthpiece is pressed only against the lips.



FIG. 2.

52. The Blast.—The success of the blowpipe as a means of qualitatively determining the ingredients of a compound depends upon its careful manipulation. As a necessary condition, the operator must frequently maintain an uninterrupted stream of air for several minutes at a time, and must be able at will to produce an oxidizing or a reducing flame, two diametrically opposite chemical effects. Considerable practice is necessary to cultivate a proficiency in this, and no determinations should be undertaken until the operator has become somewhat expert.

The blowpipe is held in any convenient and comfortable position, usually between the index finger and the thumb, as a pen is held, with the arms resting against the edge of the table. The operator chooses his own position.

53. The blast is produced by the contraction of the cheek muscles, and is not furnished directly from the lungs. The mouth is filled with air, distending the cheeks, not, however, to an uncomfortable degree; then the throat is closed and the operator continues to breathe naturally through his nose, while the air in the mouth is slowly and gently forced out through the blowpipe by the contraction of the distended cheeks. From time to time, the throat is opened for an instant to renew the air supply in the mouth, and then immediately closed again. It is advisable to practice at first without a flame, until the knack of breathing and blowing at the same time is acquired.

The beginner generally commits the errors of blowing too

hard and not shutting off the connection between chest and mouth. In the first case it will be well to remember that very little more force is necessary to produce the blast than naturally results from the contraction of the cheek muscles after being distended; and the second method of blowing will prove injurious to the health. Never, under any circumstances, draw air into the mouth through the pipe. If this were done with the pipe in the flame it might result seriously.

BLOWPIPE LAMPS AND FUELS.

54. Bunsen Burner.—The most convenient fuel for blowpipe operations is illuminating gas, and the burner best suited for the purpose is the Bunsen burner shown in Fig. 3. There are various forms of these burners, the essential feature being the mixture of air with the gas before combustion, but the one shown is the most commonly used.

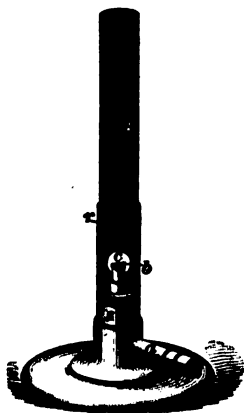

FIG. 3.

The neck *a* is connected to the gas fixture by rubber tubing. The tube *t* screws onto the body of the lamp and the gas flows up into it through a small tube, or tip, *b*, which is flattened at the top so that the gas issues from a mere slit about a quarter of an inch long.

Near the bottom of the tube *t* are two holes *c*, and there are corresponding holes in a short sleeve *s*, around the base of *t*. A small guard-ring *r* keeps the sleeve *s* in position. By turning the sleeve, the quantity of air passing into *t* and mixing with the gas can be regulated. When the openings in the sleeve are between the openings in the tube, the blank spaces in the sleeve cover the openings in the tube and exclude all air, and the gas burns at the top of the tube *t* with the ordinary yellow, luminous flame; but if the sleeve be turned a little, the openings in the tube will be partly uncovered and air will rush in and

mix with the gas, and the flame will become hotter and less luminous, and by opening the air-holes the proper amount a clear, blue, non-luminous flame is obtained, which is very hot. If there is very little dust in the air, this flame can sometimes be gotten so clear as to be invisible against a dark background. If too much air is admitted it is apt to blow the flame out, or off the burner. This colorless gas flame is very convenient for making the flame tests described further on. For blowpiping, however, a yellow flame about $1\frac{1}{2}$ inches high is used, the blowpipe furnishing the necessary oxygen for perfect combustion.

55. In some forms of burners the regulating sleeve is not provided, and in order to get a yellow flame a second tube, whose outside diameter corresponds to the bore of the tube *t*, is slipped inside of *t*, shutting off the air. By flattening this tube at the top into a narrow slit, and cutting it at a slight angle, lengthwise of the slit, instead of horizontally, a flat flame like that of an oil lamp is obtained. Flattened tips are also made to set on the top of the ordinary Bunsen burners to get a flat flame for blowpiping, and specially designed blowpipe burners with flat-tipped tubes are also made.

56. Oil and Spirit Lamps, Etc.—The oil and spirit lamps for blowpiping are of various patterns. They are made of both metal and glass, and with single and double wicks. The oils used in blowpipe lamps should be rich in carbon. Kerosene, refined rapeseed oil, olive oils, and mixtures of alcohol and turpentine, and alcohol and benzine are variously used in lamps, but none of these is as satisfactory as illuminating gas, burned in a Bunsen burner.

Spirit lamps can be used for some blowpipe tests, but alcohol is comparatively poor in carbon and its flame is not very hot, and it is impossible to obtain a strong reducing flame with it. It is very convenient, however, for flame tests.

Candles are sometimes used for blowpiping when no better flame is obtainable, but they are rather unsatisfactory, as the water in the tallow or wax cools the flame and makes it sooty.

THE FLAME.

57. An ordinary luminous flame, like the flame of a candle, lamp, or gas-burner, consists of three parts: an inner zone, just above the wick or burner, of gas or volatilized oil or tallow which has not yet caught fire; immediately outside of this a zone of burning gas, rendered yellow and luminous by innumerable minute particles of incandescent carbon, resulting from the decomposition of some of the hydrocarbons under the influence of heat—this is the luminous portion of the flame; and outside of this again an invisible envelope of CO_2 gas and water vapor (H_2O)—the products of the complete combustion of the hydrocarbons of the fuel.

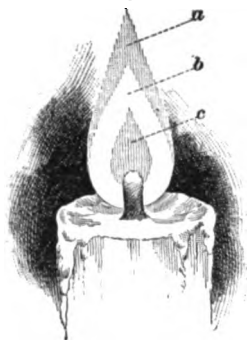

FIG. 4.

The flame of a candle (Fig. 4), for instance, is a typical luminous flame. The inmost cone *c* consists of volatilized wax or tallow not yet ignited, and is blue and transparent; the middle cone *b* is the luminous portion of the flame, and outside of *b* is a third cone, or envelope, *a* of a faint blue color and hardly visible, consisting almost entirely of CO_2 gas and water vapor.

58. Reducing Flame.—If the tip of the blowpipe is held about one-eighth of an inch above the top of the wick or burner of a blowpipe lamp, and just outside of the flame, as shown in Fig. 5, and a strong, steady blast blown, the flame is thrown into a horizontal cone. The amount of air used should be just sufficient to keep a steady, horizontal flame, free from soot, but still yellow. The entire

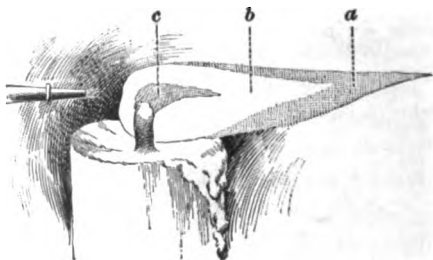
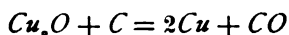
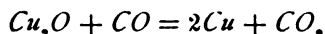

FIG. 5.

flame will be diminished in size, but the temperature will be greatly increased, and if a reducible substance is held just inside of the tip of the yellow cone *b* it will be rapidly deoxidized or reduced. This reducing action of the flame gives it the name of **reducing flame**—for convenience abbreviated to R. F. It is due to the partially burned gas and incandescent carbon of the luminous portion of the flame, which seek to oxidize themselves at the expense of any substance heated in the flame. The reaction of the flame on the mineral cuprite (Cu_2O) may be taken as an example of this. The reaction between the mineral and incandescent carbon is



a reduction of the cuprite to metallic copper, and a partial oxidation of the carbon; and between the mineral and the partially oxidized carbon (CO —carbon monoxide) of the flame is



the CO oxidizing, at the expense of the cuprite, to CO_2 , the highest oxide of carbon. Sulphates are similarly reduced to sulphides, and carbonates first to oxides and then to metals.

NOTE.—If the student wishes to test the reducing flame, it can be done as follows: Place a small piece of metallic tin on charcoal and melt it with the reducing flame. As long as a pure reducing flame is blown the metal will be bright. But if it comes into the oxidizing flame a white coat of the oxide will be formed. The student should practice until he can blow a pure reducing flame.

59. Oxidizing Flame.—If the tip of the blowpipe be introduced *into* the flame, as shown in Fig. 6, and a strong, steady current of air be blown into the flame, it will be elongated into a long, narrow cone; the luminous portion, if sufficient air is supplied, will disappear entirely, the air from the pipe affecting the



FIG. 6.

combustion of the volatilized tallow at *c* in the same way as the air through the ports of a Bursen burner affects that of the gas. The mixture of gas and air burns with a pale-blue, non-luminous flame, to CO , CO_2 , and H_2O (water vapor). The outside cone *a*, in which all the carbon has burned to CO_2 , is unaltered. This flame is called the **oxidizing flame**—abbreviated to O. F. in the text—and a substance held at the tip of the outer cone, where the air can get at it, but away from any possible reducing action of the CO in the cone *b*, will be rapidly oxidized.

60. The oxidizing flame is also used for flame tests, on account of being colorless, and for melting, as it is the hottest flame obtainable with the blowpipe. The hottest point of the flame is just beyond the tip of the inside cone *c*.

NOTE.—To test the oxidizing flame the student can prepare a borax bead and add a little manganese mineral to the same. As long as the bead is kept in the oxidizing flame it will remain violet when hot and reddish-violet when cold. But the reducing flame will clear the bead and render it colorless both when hot and when cold.

SUPPORTS.

61. The materials to be examined before the blowpipe are supported by certain substances which are either infusible or are capable of withstanding a high heat without appreciably changing their form.

62. Charcoal.—For roasting, obtaining coats, reducing metals, and making sulphur tests, charcoal is the support used. A wood that gives a dense coal, with very little ash, is used for making the charcoal. Charcoal can be bought in specially prepared blocks or sticks, of convenient size for blowpiping, for fifty cents a dozen, and in this form is much more satisfactory than lump charcoal. Artificial charcoal, made of charcoal dust, compressed into sticks, is also used. If the artificial charcoal gets damp, it is liable to explode with considerable violence on heating, from the impossibility of the steam escaping fast enough; if such charcoal is slowly dried out for several hours over a stove, it will no longer cause trouble. A small hole is bored with a knife-blade

into the charcoal, for holding the assay, which is moistened if it tends to blow away. Old coats are scraped off with a knife, leaving the coal ready for reuse.

63. Platinum Wire.—For holding the borax beads, platinum wire—No. 27 (or jeweler's hole $12\frac{1}{2}$)—is used, as platinum withstands the high heat and is unaffected by the reagents or flame. Pieces about 2 or 3 inches long are used, held, preferably, in special wire-holders that are made for the purpose (costing about \$1), or else one end is fused into a short piece of glass tubing for a handle, or held in the forceps.

64. Platinum Foil.—For testing for manganese and chromium, a small piece of platinum foil is employed. Care must be taken not to fuse metals like lead, zinc, tin, nickel, copper, or silver on it, nor should compounds of these metals be treated on platinum foil or wire in the R. F., as the metals reduce and form a fusible alloy with the infusible platinum.

65. Forceps.—For testing the fusibility of minerals, the platinum-pointed forceps shown in Fig. 7 are used;

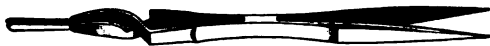

FIG. 7.

they have a pointed steel forceps at the other end that will be found very convenient. Such forceps cost about \$2.25 a pair.

For trimming the flame and for rough work, the iron forceps shown in Fig. 8 are used. They cost only ten or fifteen cents.

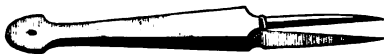

FIG. 8.

66. Glass Tubes.—*Open tubes*, of hard glass, free from lead, from $\frac{1}{16}$ to $\frac{1}{4}$ inch inside diameter, and from 4 to 6 inches long and open at both ends, are used in the examination of substances to be ignited in a current of air. The tube is sometimes bent slightly an inch or two from one end, to keep the body under examination, which is placed in the bend, from falling out.

Closed tubes are used for the ignition of bodies in a limited supply of air. They are made of the smaller sizes of tubing, $\frac{1}{16}$ to $\frac{1}{8}$ inch bore, and closed at one end. They are usually made by heating in the middle a tube of twice the desired length, turning it slowly in the flame so that it will be uniformly heated all the way around, and when it is soft and pasty, pulling it out at both ends, into two closed tubes. The filament of glass on the bottom of each tube can be melted up into the tube by directing the flame on it for a moment, giving a smooth bottom.

A clean tube should be used at each new operation. Tubes may be cleaned by swabbing with soft paper wrapped around a wire.

67. Matrasses.—Glass matrasses are used for testing for acids by fusion with potassium bisulphate, etc., and are also frequently used for the same purposes as are closed tubes. They are of the form shown in Fig. 9



FIG. 9.

—practically only a closed tube with the closed end blown into a bulb. An ordinary, straight, closed tube, about 4 inches long and $\frac{1}{4}$ -inch bore, is a satisfactory substitute for a matrass, or the student can blow a bulb on the end of such a tube and have a matrass or bulb tube which will answer his purpose fully as well as the matrasses he might buy. For holding matrasses, special holders with wooden handles are made, but a strip of paper, folded lengthwise several times and held around the neck of the matrass, with the ends serving as a handle, will answer the purpose.

68. Test Tubes.—Test tubes are used in making wet tests, boiling in acids, effervescence, etc. They are straight glass tubes, closed at one end and with a lip on the open end, and are made of thin, hard glass, that will stand considerable heat without cracking. A test-tube rack, in which the tubes can be stood upright, is also necessary. A holder, for holding tubes while heating, is convenient, but a slip of paper, used as described in Art. 67, will answer.

ACCESSORY APPARATUS.

69. Mortars.—A small agate mortar and pestle are used for reducing materials to a very fine powder. The substance should be powdered by grinding, and never pounded in this mortar, as the mortar is liable to be damaged.

A diamond mortar and pestle, made of the very best tool steel and very hard, are used for crushing minerals and for flattening beads. One form is shown in Fig. 10. The bottom of the mortar is used as an anvil, while the mortar and pestle are used for crushing hard and brittle minerals, as they prevent the loss of pieces by flying out. Such a combined anvil and mortar costs from \$2 to \$4.

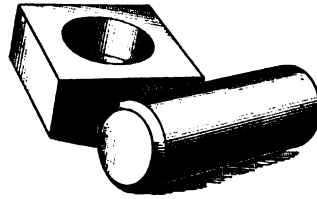

FIG. 10.

70. Hammer.—For knocking chips off of minerals, flattening beads, stamping cupels, etc., a small hammer is necessary. Any small, square-headed hammer, with sharp corners and made of good steel, will do.

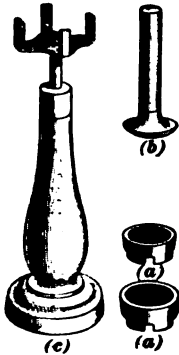

FIG. 11.

71. Pliers.—Cutting pliers are useful in detaching fragments from mineral specimens.

72. File.—A small three-edged file is necessary for cutting glass tubes.

73. Cupel Mold and Stand.—For making the cupellation assay, special iron or steel molds [(a), (a), Fig. 11] are used. After filling these loosely with finely ground bone-ash, moistened with a little water in which a little carbonate of soda has been dissolved, the die (b) is placed on top, and then given two or three smart blows with a hammer, producing a nice, smooth cupel. Cupels should be thoroughly dried before using. The mold with its cupel is set on a stand (c) with

a wooden base while cupelling. After the cupellation is completed, the old, lead-soaked bone-ash is scraped out, the mold is refilled with fresh bone-ash, and a new cupel is struck. The holder, die, and set of two molds cost about \$1.50.

74. Magnifying-Glass.—An indispensable tool for the blowpiper and mineralogist is a good magnifying-glass, and the most serviceable kind for his purpose is the pocket type shown in Fig. 12, which has three lenses of different powers that, combined, make a very strong magnifier. It costs about 60 or 75 cents.



FIG. 12.

75. Magnet.—For detecting the magnetic metals, it is necessary to have a magnet. A small horseshoe or bar magnet is best, but a very convenient one for this purpose, and also for the field mineralogist, is a magnetized blade of a pocket-knife, which is easily made by stroking the blade a few times, from handle to point, with a strong magnet, or holding the point against one of the poles of an electric dynamo.

76. Watch-glasses and porcelain capsules are used for testing the solubility of minerals, and are supported on rings carried by the lamp rod, or else on a wire tripod. The capsules are better than watch-glasses, as they do not crack so readily in heating. The substance should be finely ground, and should be stirred with a glass rod while heating. The acid should be completely driven off, as sometimes it can not be told whether the substance has been affected by the acid until it has been evaporated and redissolved in water.

77. Streak Plate.—A small plate of unglazed porcelain is very convenient for obtaining the *streak* of minerals.

BLOWPIPE REAGENTS.

78. Borax.—The most important blowpipe flux is borax, which makes fusible double borates of soda and most of the metals. As most metals give different colored borax

beads, this serves to distinguish them, though other tests should be made to confirm the metal that the color of the borax bead indicates. The colors from the same metal are usually different in the two flames, and both flames should therefore be tried, and the colors noted while hot, while cooling, and when cold.

Ordinary borax, on heating, at first puffs up and swells greatly from the slow expulsion of the water of crystallization that it contains; this should be driven off, and the borax heated until perfectly quiet, *clear*, and *colorless*, before adding the substance. Borax-glass (borax which has been fused and then ground up) or calcined borax (borax from which the water has been driven off by slowly heating to a temperature slightly above the boiling-point of water) may be used. Care should be taken that the bead is perfectly colorless, as dirt left upon the wire from a previous assay may discolor it and so indicate the presence of metals not contained in the substance to be tested. In case the wire is dirty, boiling in acid will clean it; or, if that is not convenient, making several beads, heating highly, and throwing off the dirty bead and repeating, will wash, or rather flux, the wire clean.

79. Salt of Phosphorus.—Salt of phosphorus is similar to borax in its action, making easily fusible double phosphates of soda and the various metals that usually are differently colored for the different metals. In most cases the colors are the same as with borax, but in some cases they are not. It boils up and is apt to drop off the wire loop on first heating, from the expulsion of a large amount of water of crystallization, but it soon quiets down to a perfectly clear, colorless bead. As with borax, the substance should be added only after it has fused down to a *clear, colorless bead*, especially noting that it has no color from a dirty wire or other impurities. The name is abbreviated in the text to S. P.

80. Soda.—For testing for sulphur, reducing metals, etc. the *bicarbonate* of soda ($NaHCO_3$) is employed. The

name is usually shortened to *soda*. The purest must be used, otherwise it will be apt to give a sulphur reaction; and every new lot should be tested before using to insure its freedom from sulphur (in the form of sulphate of soda). On account of its lightness, it is apt to trouble the beginner by blowing off of the charcoal; but if a very gentle flame is blown on it until it is melted, the strong blast can then be used without any trouble. A gas flame should not be used in testing for sulphur, as it always contains enough sulphur to give a reaction.

81. Cobalt Solution.—For certain tests, a dilute solution of nitrate of cobalt is employed. The substance is moistened with the solution (preferably with a dropping tube), strongly heated on charcoal for about 5 minutes, and then allowed to cool, when different colors result. The colors of certain minerals under this test are very characteristic.

82. Niter.—For a few special tests, niter (sodium or potassium nitrate) is employed on account of its powerful oxidizing effect. While either potash or soda niter can be employed, the former is better.

83. Copper oxide, in the form of a powder, is used in testing for the haloid (chlorine, bromine, and iodine) salts.

84. Bismuth Flux.—For testing for lead and bismuth, a special flux is made up of one part each of iodide and bisulphate of potash and two parts sulphur, which are ground together. Two to four parts (by volume) of this flux are mixed with one of the substance, and heated on charcoal, when bismuth gives a brick-red coat, and lead a yellow coat close to the assay, and greenish beyond. The flux itself gives a white coat, but does not interfere with the above.

85. Test Lead.—For the silver-cupellation assay, finely granulated lead, known as *test* lead, is employed to collect the silver into a button preparatory to cupelling. It usually contains more or less silver, and should be tested by cupellation before using.

86. Bone-ash is employed for making the cupels; it is made of calcined bones, hoofs, and horns, ground to a fine powder.

87. Tin.—For obtaining a strong reducing action, finely ground metallic tin or tin shavings are sometimes used.

88. Bisulphate of potash ($KHSO_4$), in the form of crystals, is used in testing for acids.

89. Acids.—Hydrochloric acid (HCl), sulphuric acid (H_2SO_4), and nitric acid (HNO_3) are necessary in blowpiping. As a rule, the strongest sulphuric acid should be used, while the hydrochloric and nitric acids should be of only medium strength. All these acids should be kept in glass-stoppered bottles, as they corrode and destroy corks.

90. Hydriodic Acid.—For obtaining a very characteristic series of bright-colored coats with the volatile metals, hydriodic acid (HI) is employed on white tablets of plaster of Paris. The substance is placed on the end of a tablet, moistened well with hydriodic acid (preferably with a dropping tube), and then heated with a pure blue flame, as a yellowish flame would smoke the white tablet. The acid itself gives a brownish coat of iodine, but this quickly evaporates and leaves the bright iodide coats. If the acid can not be made (by passing sulphureted hydrogen through water containing iodine crystals until a clear solution is obtained) or purchased, a substitute that will answer, though not so well, is to dissolve iodine in alcohol, or else fuse equal parts of iodine and sulphur together and grind to a powder; the latter is a solid, and much more convenient in traveling than the liquid acid or spirits of iodine.

91. Litmus paper is necessary to test for alkalies and acids, the blue turning *red for acids*, and the red turning *blue for alkalies*. It will be found convenient to use it cut up in the form of strips.

92. Turmeric paper has a fine yellow tint, and is used to detect boron and zirconium, and the alkalies. The

test for boron is very delicate. If a piece of the paper be moistened with a dilute solution of a boron mineral in *HCl* and then dried at boiling temperature by wrapping around a test tube of boiling water, it assumes a reddish-brown color, becoming inky-black if moistened with ammonia. Moistened with a solution of any zirconium mineral in *HCl* it turns orange-red. Alkalies turn it brownish-red.

93. Brazil-wood paper is used to detect fluorine, which gives it a straw-yellow color; also to detect the alkalies, which color it violet.

The list of reagents could be almost indefinitely extended. The most important and most frequently used have been given above. There are others which are used only in special tests and need not be dwelt on here.

Reagent Box.—The dry or solid reagents can be conveniently kept in a block of wood, say 2" × 2" × 8" in size, in which $\frac{1}{2}$ -inch holes have been bored. Common corks can be used for stoppers, and the name of the flux written on top of them or on the box. Such a reagent box can be purchased for about \$1, but it is easily made. Small pill-boxes or vials may be used instead of the block of wood.

EXAMINATION OF A SUBSTANCE BEFORE THE BLOWPIPE.

94. Plattner has recommended the following order of examination:

(a) **Examination without reagents :**

1. *Heating in a small matrass or in a closed tube*, to observe whether the substance is hydrous or anhydrous; whether it gives off volatile products; whether it decrepitates, or is phosphorescent, or changes color, etc.

2. *Heating in an open tube*, to observe whether any constituent is present which oxidizes on ignition in a current of air; and if vapors are given off, attention should be paid to

their odor and to the sublimates they form on the inner surface of the tube, etc.

3. *Heating on charcoal*, to observe the characteristic alterations which substances undergo in both the oxidizing and reducing flames; whether metallic constituents are present which volatilize and form coats on the coal; and to observe the odor after a short exposure to heat, etc.

4. *Heating in platinum forceps*, to test the fusibility, and to observe the colorations of the flame, etc.

(b) Examination with the aid of reagents:

1. *Treatment with a weak solution of nitrate of cobalt* of infusible or nearly infusible substances of a light color, to observe what color is imparted to them.

2. *Fusion with borax*, to observe the colors imparted to the bead, etc.

3. *Fusion with salt of phosphorus*, to observe the colors imparted to the bead, etc.

4. *Treatment with carbonate of soda* on charcoal, to effect the reduction of any metallic oxides present, which can thus be more easily accomplished than by the use of the reducing flame alone.

In all the above operations the smallest possible amount of the substance to be examined, consistent with the success of the reactions, should be used. The substance should, in most cases, be finely powdered. The blowpipe lamp should be set on a piece of stout wrapping-paper, or glazed paper, if convenient, so that the assay may not be lost if, through carelessness, it is allowed to fall. The operations in blow-piping should be conducted in the daytime and in a good light.

95. The closest observation will be found necessary for the detection of the various reactions, and the student is advised to begin with simple substances whose exact composition is known, so that he may fix in his mind their characteristic behavior when treated with and without reagents.

I. HEATING IN A CLOSED TUBE.

96. The substance in a finely powdered state is placed in the bottom of a tube sealed at one end, care being taken that none of it adheres to the inner surface of the tube. It may be introduced by placing it first in a paper trough, holding the tube horizontal, then pushing the trough in the tube clear to the bottom, and finally bringing the tube to a vertical position and carefully withdrawing the trough. The tube is now held in a slightly inclined position over the flame and heated, gently at first, and then, if necessary, more intensely, before the blowpipe. The successive phenomena are closely observed and noted; thus:

1. The substance decrepitates, as fluorite, barite, etc.
2. The substance is phosphorescent, as fluorite, apatite, etc.
3. The substance changes color, and nothing volatilizes except, perhaps, a little water, as zincite and cerussite, which turn yellow, and malachite and siderite, which turn black.
4. The substance fuses, as stibnite, etc.
5. The substance gives off oxygen, as psilomelane; told by placing a bit of charcoal in the tube, heating it first and then heating the assay, whereupon the charcoal will glow brightly.
6. The substance yields water, which condenses in the upper and cooler portions of the tube, as limonite, etc.
7. The residue is magnetic, as in the case of siderite ($FeCO_3$), pyrite (FeS_2), etc.
8. The substance gives sublimes which condense on the cold part of the tube.

(a) **Sulphur.**—A sublimate, dark yellow to reddish-brown while warm, pure sulphur-yellow when cold; this indicates the presence of sulphur either originally free or in combination as a *sulphide*, as in the case of metallic sulphides, like pyrite (FeS_2) and chalcopyrite ($CuFeS_2$).

(b) **Arsenic.**—A sublimate, dark brownish-red to almost

black while warm, orange-red or reddish-yellow to red when cold; this indicates the presence of *sulphide of arsenic*, as in the case of realgar (AsS) and orpiment (As_2S_3), or in combinations of metallic sulphides and arsenides, like arsenopyrite ($FeS_2 + FeAs_3$, or $FeAsS$). A sublimate of a black, brilliant luster, having a garlic odor; this indicates metallic arsenic, as in the case of native arsenic, arsenous and arsenic oxides, and various arsenides. The test may be made very delicate by placing a splinter of charcoal in the tube above the assay, and first heating this red-hot and then heating the assay. The volatilized arsenous oxide will be reduced in passing over the glowing carbon, and will deposit a black mirror of metallic arsenic just above the charcoal. This test will distinguish arsenic when combined with antimony, as the latter gives no mirror under these circumstances.

(c) **Antimony.**—A sublimate when the substance is strongly heated, condensing just above the assay, black when hot, cherry-red to brownish-red when cold; this indicates the presence of *sulphide of antimony*, as in the case of stibnite (Sb_2S_3), or of compound sulphides of antimony and some other metal or metals, like pyrargyrite or ruby silver ore (Ag_3SbS_5 , or $3Ag_2S + Sb_2S_3$).

(d) **Mercury.**—A sublimate, dull black when cold, which becomes red when rubbed with a splinter of wood; this indicates the presence of sulphide of mercury, as in cinnabar (HgS), or where other metallic sulphides are combined with sulphide of mercury, as in mercuriferous tetrahedrite. A sublimate of a lustrous gray color, consisting of metallic globules (use a lens) which can be rubbed together with a splinter; this indicates metallic mercury, as in case of amalgams.

(e) **Selenium.**—A sublimate of a dark red to an almost black color, having the odor of decaying horseradish; this indicates the presence of selenium, as in the case of various selenides.

(f) **Tellurium.**—A sublimate of metallic luster, which condenses in small drops in the upper end of the tube; this indicates tellurium, as in the case of various tellurides.

(The reactions in the closed tube for non-volatile metallic sulphides and those which contain a low proportion of sulphur, for non-volatile arsenides and those containing only one atom of arsenic for two atoms of the metal, and also for tellurides and antimonides, are very uncertain, and sometimes there are none at all.)

II. HEATING IN THE OPEN TUBE.

97. In the open tube the substance is heated in a current of air, and hence is subjected to an oxidizing or roasting action; whereas in the closed tube the substance was heated in a very limited supply of air and volatilized without oxidation. This constitutes the difference between the two chemical reactions.

In heating in the open tube, care must be taken to proceed by gently heating the substance at first, and gradually increasing the heat, otherwise some substances will volatilize at once without oxidation, and will give reactions similar to those in the closed tube. Straight tubes are generally used, as they are easier cleaned, but the beginner may make a slight bend in the tube about an inch from the end, at which point the assay is to be placed. The current of air is started up through the tube by warming it just above the assay first, afterwards bringing the flame immediately under it. A small fragment of the substance, about the size of a grain of wheat, is used, but in case it decrepitates or gives unsatisfactory results, it should be powdered, and an equivalent bulk of the powder used.

When examining a substance, it is advisable to have a moistened piece of litmus paper in the top of the tube, and the effect of the vapors upon it should be noted.

98. The effects of the heating should be observed exactly as in the closed tube, and many of the phenomena will be found identical. Many substances which were not volatile in the closed tube, however, here become oxidized, and escape, some as gases, recognized by their characteristic odor and their action upon litmus paper; others as sublimates

which condense in the cool part of the tube at varying distances from the assay.

The following are the most important open tube tests:

(a) **Sulphur**.—Metallic sulphides and substances containing even trifling amounts of sulphur yield sulphurous anhydride, which is recognized by its sulphurous odor and by reddening moistened blue litmus paper.

(b) **Selenium**.—Selenides and substances containing even small amounts of selenium yield a gaseous oxide of selenium having the characteristic odor of decaying horse-radish. If there be much selenium present, a steel-gray sublimate is formed near the assay, the sublimate becoming red at a greater distance from it.

(c) **Arsenic**.—Metallic arsenic and arsenides containing much arsenic yield a white crystalline sublimate of arsenous acid, which is very volatile, and hence is at quite a distance from the assay. This reaction requires only a moderate heat.

(d) **Antimony**.—Most compounds of antimony yield, *at first*, a dense white smoke, consisting mostly of pure oxide of antimony, which passes through the whole length of the tube, partly condensing on the upper side of the tube and partly escaping. This coat is volatile and may be driven off by again heating to redness. Afterwards a white, non-volatile, infusible sublimate, which consists of a combination of oxide of antimony and antimonic acid, gathers on the lower side of the tube. This sublimate is yellowish while hot.

(e) **Tellurium**.—Most compounds of tellurium yield tellurous acid, which passes through the tube and condenses into a sublimate; this sublimate can be fused into colorless drops, which solidify on cooling, distinguishing it from the corresponding antimony coat.

(f) **Mercury**.—Most compounds of mercury yield a bright metallic sublimate consisting of small globules of metallic mercury, which can be rubbed into a big drop with a splinter of wood. A moderate heat is sufficient for this reaction.

(*g*) **Lead.**—Sulphide of lead yields, in addition to sulphurous acid, a white sublimate of sulphate of lead, which condenses on the bottom of the tube, and when heated strongly, fuses to yellow drops, which are white when cold.

(*h*) **Bismuth.**—Most compounds of bismuth yield a sublimate of oxide of bismuth, which condenses near the assay, and is fusible to drops which are brown when hot and dark-yellow when cold.

(*i*) **Molybdenum.**—Sulphide of molybdenum yields, in addition to sulphurous acid, a thin, white, crystalline sublimate, fusible to drops which are yellowish while hot and nearly colorless when cold. When the R. F. is directed upon them, they become blue, or even copper-red, from reduction. High heating is necessary for this reaction.

III. HEATING ON CHARCOAL.

99. A fragment of the substance is placed in a shallow cavity in the charcoal and the flame directed downwards upon it. Its behavior in both flames is observed. If the mineral decrepitates, it will be found necessary to powder it and make it into a paste with water; this is placed on the charcoal and heated, slightly at first, and then more intensely. If any difficulty is encountered, when infusible and non-volatile substances are treated, in keeping the assay in its place sufficiently long to observe its behavior fully, it will be found advantageous to heat the fragment to redness and then touch it to a grain of borax. The borax attaches itself to the fragment, and both are put on the charcoal and heated. The borax melts and adheres to the charcoal, keeping the assay in place.

100. The characteristic phenomena to be observed are the odor after short exposure to the heat, the fusibility of the substance, the character of the residue, and the sublimate, or coats, formed at a distance from the assay. The color of the coats must be closely observed, both while hot and when cold; it should be noted at what distance from the assay they condense, whether they disappear when

either O. F. or R. F. is directed against them, and how they color the flame.

The following are the most important and characteristic reactions:

(a) **Selenium** melts easily; yields brown fumes in both O. F. and R. F., which deposit near the assay as a steel-gray coat with a feeble metallic luster, and at a somewhat greater distance as a dark-gray, dull coat. The coat is volatile in both flames, and when treated with the R. F., it disappears with a fine azure-blue flame. The odor of decaying horseradish is strongly perceptible throughout the entire operation.

(b) **Tellurium** melts easily; volatilizes in fumes in both flames; and coats the coal at no great distance from the assay. The coat is white, with a red or dark-yellow border, and is volatile in both flames. Under the R. F. the coat disappears with a green flame. In the presence of selenium, the flame is bluish-green.

(c) **Arsenic** volatilizes without fusing, and coats the coal in both flames. The coat is white, appearing grayish when thin, and it forms at a distance from the assay. It can be easily driven off by simply warming with either flame, and if rapidly treated in the R. F., it disappears, coloring the flame a pale blue. During the volatilization of arsenic in the R. F., a strong alliaceous, or garlic, odor is evolved.

(d) **Antimony** melts easily, and forms a coat with both flames. The coat is white, bluish when in thin layers, and is not as distant from the assay as the arsenic coat. It is volatile in both flames, and disappears when treated with the R. F., tingeing the flame pale green.

(e) **Lead** melts easily, coating the coal with oxide in both flames. The coat is dark lemon-yellow while warm, sulphur-yellow when cold, and bluish-white when in thin layers. The coat is volatile in both flames, and disappears in the R. F., coloring the flame azure blue.

(f) **Bismuth** melts easily, coating the coal with oxide in both flames. The coat is dark orange-yellow while hot

and lemon-yellow when cold, being yellowish white in thin layers. It is volatile in both flames, but does not color the reducing flame.

(*g*) **Cadmium** melts very easily, and burns in the O. F. with a dark yellow flame and brown fumes which coat the coal rather near the assay. Next to the assay the coat is thick, crystalline, and of a very dark, almost black, color; farther off it is reddish-brown; and when in thin layers, it is of an orange-yellow color. In appearance, the coat is iridescent, like a peacock's feather. It is volatile in both flames, but gives no coloration to them.

(*h*) **Zinc** melts easily, and burns in the O. F. with a strongly luminous, greenish-white flame, and forms a white coat. The coat is near the assay, and is yellow while hot and white when cold. In the O. F. this coat is luminous, but not volatile. It is volatilized very slowly in the R. F.

(*i*) **Tin** melts easily, and forms in the O. F. an oxide which covers the assay, and can be mechanically blown away. In the R. F. the metal becomes lustrous, and forms a coat which is pale yellow while warm and white when cold, and is so close to the assay that it borders upon it. It can not be driven off by either flame.

(*j*) **Molybdenum** is infusible. In the O. F. it gradually oxidizes and forms a coat near the assay, yellowish and sometimes crystalline while hot and white when cold. When touched for an instant with the R. F., a dark blue color is given to the coat. The flame in this case must not be too hot. In the O. F. the coat is volatile, but leaves a red stain on the coal which is not further affected.

(*k*) **Silver** melts easily. In a powerful O. F., gives a slight reddish-brown coat of oxide. If a little lead is present, the yellow coat of oxide of lead is formed, and then the reddish-brown silver coat is formed just outside of this. With antimony the white coat of oxide of antimony is first formed, which becomes red on continued blowing. With a little of both antimony and lead present, a copious carmine-red coat is formed after the antimony and lead are mostly volatilized.

The sulphides, chlorides, iodides, and bromides of potassium, sodium, rubidium, cæsium, and lithium give less copious white sublimes, similar to those of many of the foregoing metals, while the salts fuse and are absorbed by the coal. In every case these coats disappear before the R. F., coloring it with their several individual and characteristic colors.

IV. TEST OF FUSIBILITY.

101. For arriving at the *comparative* or *relative* fusibility of minerals, the following scale, arranged by Von Kobell, is employed :

1. *Stibnite*; fuses easily in a candle-flame in coarse splinters.

2. *Natrolite*; fuses in the candle-flame only in fine splinters.

3. *Garnet* (the red almandite variety); fuses easily before the blowpipe in coarse splinters.

4. *Actinolite*; fuses with slight difficulty B. B.* in coarse splinters.

5. *Orthoclase*; fuses B. B. only in fine splinters.

6. *Serpentine*; almost infusible; rounded on the edges in very fine splinters (use a lens).

7. *Quartz*; infusible, even on thinnest edges.

102. In using this scale, the hottest, or oxidizing, flame should be employed, and the thinnest possible splinters of the mineral tested. The splinter should be held in the tip of the platinum-pointed forceps, which are best ground to a sharp, thin point, so as to conduct away as little heat as possible. If the substance decrepitates so that a splinter of it can not be used, it should be ground to a powder and mixed with water into a paste. It is then spread out in a thin layer on the coal, and heated, slowly and gently at first, and finally more strongly, until the mass forms a thin,

* B. B. means "Before the Blowpipe."

coherent plate, which can be held in the forceps and tested in a pure O. F.

The various gradations of fusibility are expressed in decimals, thus: B. B. beryl becomes clouded, and fuses at 5.5; which means that in fusibility it is midway between orthoclase and serpentine.

V. COLORATION OF THE FLAME.

103. Many substances give characteristic colorations to the flame. A pure O. F. which is entirely free from yellow streaks should be used. Either a thin splinter of the mineral is used, as in testing for fusibility, or the fragment is powdered, and the loop or flattened end of a platinum wire, moistened by dipping into pure water or HCl , is touched to the powder and then introduced into the flame. Often a mere trace of mineral, such as will adhere to a dry wire, will give much better results than a larger fragment, which is difficult to get hot enough to volatilize.

The greatest care should be observed in these tests that no foreign material adheres to the forceps or platinum wire. They should be chemically clean, and when heated alone in the flame should give no coloration to it. This cleaning is effected by dipping while hot into hydrochloric acid, and then rinsing with distilled water. Drawing the wire through the fingers or wetting with saliva is to be avoided, and likewise too much handling of the specimen to be tested, since in so doing it becomes slightly coated with soda, which gives a very characteristic yellow coloration to the flame. If the specimen is to be powdered, the mortar and pestle should both be thoroughly washed before using.

Some substances when heated *alone* in the flame give only slight colorations, or none at all, in which case they are moistened with sulphuric acid and heated again. By this means the colorations of the flame, as in the case of phosphoric and boric acids, become evident.

Table II gives the various colors and the minerals which impart them.

EXAMINATION WITH COBALT SOLUTION.

104. The cobalt test is applicable only to those substances which are of a light color, *either before or after ignition*, and are infusible, or nearly so.

If the substance will absorb the solution, a splinter or fragment of it is moistened with the solution, and then strongly ignited in the O. F. Friable substances and crystalline substances which are too dense to absorb the solution, are powdered, made into a paste with water, and spread upon the charcoal. They are then gradually heated until a coherent crust is formed, which is moistened with the solution and ignited in the O. F. The colorations imparted to the assay are then closely observed in a good light. The various coats on charcoal may likewise be tested in this way by moistening with a drop of the solution and gently igniting in the O. F.

The colors thus obtained are:

1. From magnesia, flesh-red.
2. From baryta, brownish-red.
3. From alumina and silica, blue.
4. From the oxides of zinc, green (yellowish-green); from tin (bluish-green); titanitic acid (yellowish-green); antimonic acid (dirty, dark green).
5. From strontia and lime, gray.

Various other elements give more or less peculiar colorations with the cobalt solution, but only the colorations for alumina, magnesia, zinc, and tin are to be at all relied upon. This test for alumina and magnesia is infallible when they are in the pure state, and also in many of their combinations. Silicates of zinc, on strong heating, give an ultramarine blue, from the silica, instead of the zinc green. The blue of alumina is not to be confounded with the blue of silica. The blue of the silica almost always appears *fused* on careful examination, while the blue of alumina is dull. The blue of the silica also appears only after intense ignition, and it is therefore well if, after moderate heating, the substance shows no blue, to discontinue the heating before fusion.

ROASTING.

105. When borax and salt of phosphorus, or microcosmic salt, as the latter is sometimes called, are fused with certain metallic oxides, they exert a powerful solvent action upon them, and highly colored glasses are formed which are exceedingly characteristic.

106. It is essential, in the bead tests, when the preliminary examination of the substance has shown the presence of sulphur or arsenic, that these elements be removed, as they interfere with the reactions. This is effected by roasting, which is conducted in the following manner:

The finely pulverized material is placed in a shallow cavity on charcoal and pressed flat with a knife-blade, forming a thin layer. The assay is then treated with a feeble O. F. so that only the tip of the flame touches it. It is thus heated and kept for some time at a low, red heat, during which operation most of the sulphur is volatilized as sulphurous oxide (SO_2), and the metals are oxidized. This sulphurous oxide has a tendency to change into sulphuric oxide at the expense of the already forming metallic oxides, and these are converted into sulphates, and if arsenic be present, into arsenates. When, therefore, the odor of sulphurous oxide has disappeared, the assay is treated to a feeble R. F., which, for the most part, reduces the sulphates and arsenates thus formed, and the arsenic is more or less completely volatilized. When the arsenical odor is no longer apparent, a feeble O. F. is again used, which generally causes a slight odor of sulphurous oxide. The assay which is thus baked together, *but not fused*, is turned with a knife-blade, and the other side treated alternately to the O. F. and R. F. in the same way. The coherent mass, after this treatment, is removed and powdered in a mortar, and since it is not entirely free from sulphates and arsenates, and, if it has not been carefully roasted, may even contain slight quantities of sulphides and arsenides, it is replaced on the charcoal, and subjected to still further roasting.

If the assay *fuses*, it must be removed from the coal,

powdered in a mortar, and then replaced on the coal and roasted.

Substances containing selenium, tellurium, and antimony, *if free from sulphur and arsenic*, usually need not be roasted, since these elements do not interfere with the reactions.

FUSION WITH BORAX.

107. In the O. F.—A clean platinum wire, in one end of which a small loop has been made, is heated to redness and the loop dipped in borax powder, which will adhere to it. The borax is then heated until it fuses to a transparent, colorless bead. This bead, while still hot, is brought in contact with a very small quantity of the substance to be tested, and heated before the blowpipe in the O. F.

The phenomena attending the solution of the substance in the borax must be closely observed, whether it dissolves slowly or rapidly, quietly or with effervescence; and when the solution is effected, the color of the bead must be carefully noted while hot (not red hot, but still soft and pasty), while cooling, and when cold, as well as whether its transparency is disturbed upon cooling. The bead is held before the eyes against the light. A lamp light will not do, as the colors are greatly modified, and the experiments must be conducted in the daytime.

The intensity of the colors depends upon the degree of saturation of the bead. It is well at first to use the smallest possible quantities of the substances to be tested, and afterwards increase them by successive additions until a satisfactory degree of saturation is obtained. If too much of the substance has been used, and the bead is so deeply colored that it is difficult to decide what color it has, it may be flattened, while still hot or pasty, on an anvil with the butt end of the blowpipe; or a portion of the bead may be thrown off the wire by a sudden jerk, and the remaining portion diluted with more borax. If the operator is in doubt

as to the color, the bead should be viewed through a lens, and compared with beads of known color. In fact, this is the only resource for men who are at all "color-blind."

108. In the R. F.—After the phenomena in the O. F. are carefully noted, the bead is brought into the R. F. and observed as before. The flame should be so managed that no soot is deposited upon the bead. Sometimes it is found necessary to add a little more of the substance to the assay. When metallic oxides and acids are present which are not easily reduced from borax, as the oxides of manganese, iron, uranium, chromium, cobalt, and titanio and tungstic acids, the bead may be treated on platinum wire; but when easily reducible oxides are present, as those of zinc, nickel, cadmium, lead, etc., the wire would be injured (see Art. 64), and the bead must be shaken off after treatment in the O. F. on platinum, and treated in the R. F. on charcoal. After blowing one or two minutes, the bead is pinched with the forceps, and drawn out so that its color can be distinctly observed.

The reductions in the borax bead on charcoal are sometimes more easily obtained by placing in contact with the bead a bit of metallic tin, about as large as a pin-head. The tin has a great affinity for oxygen and partly absorbs the oxygen from the metallic oxides in the glass, dissolving itself to a colorless bead, while the oxides in the glass are reduced and produce their characteristic colors.

109. Flaming.—The alkaline earths, barium, strontium, calcium, magnesium, etc., and some other bodies dissolve in borax and form beads which, when almost saturated, are colorless while hot and when cold, but when heated slowly and gently, especially with an intermittent reducing flame, or alternately with the O. F. and R. F., become opaque and enamel-like. This operation is called *flaming*.

Most substances which at a certain degree of saturation become opaque by flaming, do so without flaming when the saturation is carried a little further.

FUSION WITH SALT OF PHOSPHORUS.

110. The same general rules as for fusion with borax are applicable to fusion with the salt of phosphorus. It is a very difficult matter to make a good bead out of salt of phosphorus, owing to the fact that it boils violently while its water of crystallization and ammonia are passing off. It is advisable to melt salt of phosphorus on the platinum wire very gradually, using a small quantity at first and making successive additions until a good bead has been formed.

Silica can be easily recognized in this bead, since silicates are but very slightly soluble in salt of phosphorus. The silica separates from the metals with which it is combined and which are themselves dissolved in the bead, and floats about in the fused glass in the form of a white gelatinous skeleton.

The colors produced in the salt of phosphorus beads are *generally* different from those produced in borax by the same substances, as may be seen by comparing the reactions given in Tables III and IV with the corresponding reactions given in Tables V and VI.

111. The bead tests for iron, manganese, chromium, copper, cobalt, nickel, titanium, tungsten, molybdenum, uranium, vanadium, cerium, and didymium are of themselves distinctive and characteristic of the elements, but the other bead tests are of little importance, except occasionally as confirmatory tests.

REDUCTION OF METALLIC OXIDES WITH SODA.

112. Many oxides can be reduced to the metallic state on coal with the aid of soda, which could not be reduced without it.

The best way to conduct the experiment is to powder the substance in a mortar and mix with moistened soda. The coherent mass is then put into a cavity in the coal and treated to the R. F.

The metals which are reducible from their compounds with soda as above are gold, silver, molybdenum, tungsten,

antimony, tellurium, copper, bismuth, tin, lead, zinc, indium, cadmium, nickel, cobalt, and iron. Arsenic and mercury are also reduced, but are immediately volatilized. They can be obtained in the metallic state by fusing in a matrass.

113. *Neutral oxalate of potassa or cyanide of potassium* may be advantageously substituted for soda when treating oxides which are with great difficulty reduced. The cyanide has the disadvantage of spreading over the coal and scattering the metallic particles. These fluxes are both serviceable when the reduction is conducted in a matrass.

114. Many oxides can not be reduced to the metallic state by soda, but form with it more or less fusible compounds. Silicic, titanitic, tungstic, molybdic acids, etc., form fusible compounds, and so also do baryta and strontia, while most lime salts are decomposed. The compounds formed by baryta and strontia sink into the coal. The lime salts are decomposed, and the soda sinks into the coal, leaving the lime behind.

115. A few elements which have not been mentioned and which are of decided interest, as they form a very important set of compounds, are the halogens—bromine, chlorine, fluorine, and iodine.

(a) **Bromine.**—When bromides are added to a salt of phosphorus bead which has previously been saturated with oxide of copper, and the blowing is continued, the bead is surrounded with a beautiful halo of blue flame, inclining to green on the edges, and this continues as long as the bromine remains. As this reaction may be confounded with those given for chlorine, another test is recommended. The substance should be fused with dry bisulphate of potash in a glass matrass. Bromine and sulphurous acid fumes are liberated, and the matrass becomes filled with yellow fumes. The bromine is recognized by the extremely suffocating odor of the bromine fumes, or by exposing moistened starch or starch paper to these vapors, which turn them yellow.

(*b*) **Chlorine.**—Chlorides may be detected, like bromine, by adding them to a salt of phosphorus bead previously saturated with oxide of copper, and again igniting. The bead is instantly surrounded by an intense purplish-blue flame without any tinge of green.

(*c*) **Fluorine.**—Substances containing fluorine, when heated in a glass tube with bisulphate of potash, give off hydrofluoric acid, which etches the tube immediately above the assay, and imparts to a strip of moistened Brazil-wood paper, placed on the end of the tube, a straw-yellow color.

(*d*) **Iodine.**—Iodides added to a salt of phosphorus bead, previously saturated with oxide of copper, tinge the outer flame an intense emerald-green.

Like bromides, they also are decomposed by fusion with bisulphate of potash, and free iodine is liberated, which may be distinguished by its violet color and disagreeable odor.

116. Nitrates.—When nitrates are fused in a glass tube with bisulphate of potash, dark reddish-yellow fumes of nitrous oxide are liberated. The color is best observed by looking into the tube.

117. Sulphuric Acid.—The presence of sulphates may be detected by fusing the substance with chemically pure soda, then placing the fused assay on a silver coin and moistening with pure water. If sulphuric acid had been present originally in the substance, it was converted in the fusion to sulphide of sodium. This sulphide of sodium will leave a dark-brownish or black stain on the bright surface of the silver.

118. Water.—The presence of hygroscopic moisture may be detected by heating the assay in a matrass or closed tube. Water is immediately given off, and condenses in the cooler portions of the tube.

119. Determination of Gold and Silver in Ores.—Occasionally ores are rich in gold and silver, and their respective minerals can be determined by the blowpipe, but as a rule the ores are of comparatively low grade, and the

amount which could ordinarily be treated before the blowpipe would not be sufficient for the isolation of the precious metals. On this account, one of two methods must be followed. If the ore is free milling it may be amalgamated, while if it is a concentrating ore it may be concentrated in the gold pan.

In either case, the sample (which may weigh several pounds) should be crushed fine in a mortar, so as to set the valuable materials free.

120. In the amalgamation test the sample is placed in the gold pan with sufficient water to saturate and cover the ore. After this a small amount of mercury is added, and the material vanned or panned in such a manner as to carry the pulp around and around over the mercury, or in some cases the pulp is worked comparatively stiff and the mercury worked back and forth through the mass, either with a spatula or by hand. After the ore has been thoroughly exposed to the amalgam, the waste material or gangue is washed away and the amalgam collected.

The excess of mercury is squeezed from the amalgam by passing it through buckskin or canvas. The small piece of the amalgam so obtained can be placed on charcoal, heated before the blowpipe, thus volatilizing the mercury and leaving a small piece of the precious metals, which can be melted down to a bead or button. In case no buckskin or canvas is at hand, the mercury can all be driven off by means of the blowpipe.

121. In the concentration test, the ore is washed as in ordinary panning, and the rich mineral collected as concentrates. It is best to employ two pans, and to wash from one to the other, each time obtaining a small amount of concentrates, which are laid to one side. After the concentration has been carried as far as it is considered necessary, the concentrates may be dried, placed on charcoal, and any arsenic or antimony driven off by roasting them before the blowpipe. The roasted concentrates are mixed with soda and metallic lead. The soda acts as a flux in melting the minerals, and the lead takes up any gold or silver they may

contain. The lead button obtained in this manner must be cupelled in order to separate the lead from the gold or silver. As has already been stated, cupels are made from bone-ash, but in case the prospector has neither bone-ash nor a cupel mold, he may accomplish the desired results by burning a few bones in his camp-fire and then pound them to a fine powder, which can be mixed with water and pressed into a small cupel on a block of dry wood or in a spoon or thimble. When cupelling the lead button, it must be heated with an oxidizing flame, which action results in the formation of lead oxide, part of which is absorbed by the bone-ash and part of which is volatilized. When all the lead has been oxidized, the precious metals will remain as a small bead. Just before the last of the lead is driven out, the bead will appear as though it were spinning rapidly, and be covered with a thin film of oxide. At the moment the last of the oxide disappears, the bead will appear to brighten, and after this will not appear as though spinning.

122. If it is desired to separate the gold and silver in the bead, this may be accomplished by dissolving out the silver with nitric acid (providing there is $2\frac{1}{2}$ times as much silver present as there is gold). Strong nitric acid diluted with an equal amount of water answers this purpose very well. The bead is dropped into the acid, and after the first evolution of gas ceases the acid must be boiled. The acid is then poured off and a fresh supply added, and the bead once more boiled. Any gold will remain behind as black specks, or as a black skeleton of the bead. In case there is more gold than the proportion given, it will be necessary to add some silver to the bead before it can be parted. After the silver has all been dissolved, the gold which remains behind should be washed with clean water (preferably distilled water) and then heated to a red heat, which will restore the ordinary yellow color to the metal. If there is enough gold present, it may be melted down into a bead before the blowpipe. If water or acid give a white precipitate with silver nitrate solution, chlorine is present, and they are not fit for parting.

TABLE II.
Showing Colors Imparted to the Flame by Various Minerals.

Color of Flame.	Substance When Heated Alone.	Moistened with H_2SO_4 and Heated.	Moistened with HCl and Heated.
Yellow.	Sodium and all its compounds give an intensely yellow flame. Even considerable quantities of potassium, when present, do not interfere with the reaction. Much lithium, however, modifies the color to an orange-red.		
Violet.	Potassium and all its compounds except the phosphates, borates, and the infusible silicates. Very small quantities of sodium and lithium will obscure the reaction. In such cases, by viewing the flame through a sufficiently thick blue glass, the potash flame becomes apparent, the glass having the power of intercepting the yellow light of sodium and modifying the red of lithium to violet, while the potassium flame appears purplish-red.		
Red.	<i>Carmine-Red.</i> Lithium and its compounds. The reaction is obscured by much sodium, but not by potassium. Invisible through green glass. <i>Crimson.</i> Strontium and its salts. Reaction is masked when much barium is present. <i>Yellowish-Red.</i> Calcium (lime) and most of its salts. Reaction masked by barium flame. Not to be confounded with strontium flame.		The strontium flame is intensified when the heated assay is moistened with HCl and again ignited. The calcium flame is intensified as above.

<p>Green.</p>	<p><i>Yellowish-Green.</i> Barium and its compounds, silicates excepted. Reaction is not prevented by the presence of lime. <i>Yellowish-Green.</i> Molybdic acid, and also oxide and sulphide of molybdenum. <i>Green.</i> Metallic copper and its salts. Tellurous acid. <i>Bluish-Green.</i> Phosphoric acid. Many phosphates give this reaction.* <i>Yellowish- (or light-) Green.</i> Boracic acid and borates.† <i>Whitish-Green</i> (intense). Metallic zinc.</p>	<p>* Other phosphates must be powdered and then moistened with H_2SO_4. The coloration is often but momentary. † Moistened with H_2SO_4, when powdered, gives an intensely green flame which lasts but a short time and then changes back to its yellowish-green color.</p>	<p>Barium flame intensified when substance is moistened with HCl.</p>
<p>Blue.</p>	<p><i>Light-Blue.</i> Metallic arsenic, arsenates, and arsenous acid, and arsenides of bases which do not themselves color the flame. <i>Greenish-Blue.</i> Metallic antimony, and the sublimate of antimonous acid on charcoal. <i>Azure Blue.</i> Metallic lead, when fused in the R.F.; also selenium; likewise metallic copper and its salts, when moistened with hydrochloric acid (copper chloride).</p>		<p>Copper and its salts moistened with HCl give an intensely azure-blue flame.</p>

0 001 000

0 001 000

Barium, Magnesium,
Cadmium, Lead, Zinc,
Yttrium, Zirconium,
Lanthanum, Actinium,
Nickel.

Silver, Lead, Zinc, Bismuth,
Antimony, Cadmium, and Tellurium.

Nickel.

<p>Little to much</p>	<p>Colorless</p>	<p>Colorless after long blowing. After short blowing, Gray.</p>
<p>Much.</p>	<p>Pale yellow to colorless.</p>	<p>Elements of the Antimony group charred with the colorless after blowing.</p>
<p>Little to medium.</p>		

Chromium.	Little.	Yellow.	Yellowish-green.	Uranium and Cerium enamel-yellow by flaming.
Iron, Uranium, and Cerium.	Medium to saturated.	Deep yellow to orange-red.	Yellow.	
Chromium.	Medium to saturated.	Deep yellow to orange-red.	Yellowish-green.	
Iron with Manganese.	Little.	Red to brown.	Yellowish-red.	Iron recognized by R. F. test.
Cobalt.	Little to medium.	Blue.	Blue.	With manganese, violet hot and cold.
Copper.	Little to medium.	Green.	Blue.	
Mixtures of Copper, Iron, Nickel, and Cobalt.	Medium.	Green.	Various shades of yellow, green, and blue, according to the mixture.	
Nickel.	Little to medium.	Violet (amethystine).	Reddish-brown.	With Cobalt, brownish cold; violet with much Cobalt.
Manganese.	Little.	Violet (amethystine).	Reddish-violet.	With Cobalt, violet hot and cold.
Didymium.	Much.	Pale rose.	Pale rose.	

TABLE IV.
Showing Colors Imparted to a Borax Bead by the Metallic Oxides in the Reducing Flame (R. F.).

Oxides of	Amount of Oxide.	COLOR.		Remarks.
		Hot.	Cold.	
Silicon, Aluminum, and Tin.	Little or much.	Colorless.	Colorless.	Not changed by flaming.
Manganese, Cerium, and Didymium.	Little.	Colorless.	Colorless.	Manganese beads, apt to assume a feeble rose-color on cooling, from incipient oxidation.
Barium, Strontium, Calcium, Magnesium, Glucium, Thorium, Yttrium, Zirconium, Lanthanum, Tantalum, Niobium.	Little or much.	Colorless.	Colorless or opaque white, according to amount of oxide.	Opaque white by flaming.
Silver, Lead, Zinc, Bismuth, Antimony, Cadmium, and Tellurium.	Much.	Pale yellow to colorless.	Colorless after long blowing. After short blast, gray.	Flamed opaque gray. Antimony and Bismuth, on charcoal with tin, black; colorless after long blowing.
Nickel.	Little to medium.			

Titanium and Tungsten.	Medium.	Yellow.	Yellow to yellowish-brown.	Much Titanium, brown, hot and cold; enamel-blue by flaming.
Molybdenum.	Much.	Brown.	Brown.	Separated binoxide of Molybdenum is seen if bead is pressed flat.
Iron.	Little.	Pale green.	Nearly colorless.	Uranium bead, when highly saturated, becomes black by flaming.
Uranium.	Little to much.	Bottle-green.	Pale bottle-green.	Distinctive test for iron.
Vanadium.	Little.	Dirty green.	Fine chrome-green.	
Chromium.	Medium to much.	Green.	Green.	With much, dark, emerald-green.
Copper.	Little to medium.	Colorless to green.	Colorless with little; opaque red with much oxide.*	* Succeeds best on coal, with tin.
Cobalt.	Little to medium.	Blue.	Blue.	
Didymium.	Much.	Pale rose.	Pale rose.	

TABLE V.
 Showing Colors Imparted to a Salt of Phosphorus Bead by the Metallic Oxides in the Oxidizing Flame (O. P.).

Oxides of	Amount of Oxide.	COLOR.		Remarks.
		Hot.	Cold.	
Silicon, Aluminum, and Tin.	Little.	Colorless.	Colorless.	Soluble with difficulty in small quantities. Silica almost insoluble. If much silica or alumina is added the undissolved portion forms a semitransparent skeleton.
Barium, Strontium, Calcium, Magnesium, Gluconium, Thorium, Yttrium, Zirconium, Lanthanum, Tellurium.	Little or much.	Colorless.	Colorless.	Saturated beads, opaque white by flaming.
Antimony, Bismuth, Cadmium, Lead, Niobium, Tantalum, Zinc, Silver.	Much.	Very pale yellow.	Colorless.	Beads containing oxide of silver, opalescent when cold.
Titanium, Tungsten.	Little to medium.	Pale yellow.	Colorless.	
Iron.	Little.	Yellow.	Colorless.	
Cerium.	Medium.			

Uranium.	Medium.	Yellow.	Pale greenish-yellow.	
Molybdenum.	Medium.	Yellowish-green.	Colorless.	
Vanadium.	Little to medium.	Yellow to deep yellow.	Yellow.	
Iron.	Medium to much.	Deep yellow to brownish-red.	Yellow to almost colorless.	
Nickel.	Little to medium.	Reddish to brownish-red.	Yellow to reddish-yellow.	Same in R. F.
Copper.	Little to medium.	Green.	Blue.	Greenish-blue when highly saturated.
Mixtures of Copper, Iron, Nickel, and Cobalt.	Medium.	Green.	Various shades of yellow, green, and blue, according to mixture.	
Chromium.	Little to medium.	Dirty green.	Fine emerald-green.	
Cobalt.	Little to medium.	Blue.	Blue.	With much appears black. Same in R. F.
Manganese.	Medium.	Grayish or brownish violet.	Violet.	Nearly same as borax, but requires more oxide.
Didymium.	Much.	Pale rose.	Pale rose.	

TABLE VI.
Showing Colors Imparted to a Salt of Phosphorus Bead by the Metallic Oxides in the Reducing Flame (R. F.).

Oxides of	Amount of Oxide.	COLOR.		Remarks.
		Hot.	Cold.	
Silicon, Aluminum, and Tin.	Little.	Colorless.	Colorless.	Same as O. F.
Barium, Strontium, Calcium, Magnesium, Glucium, Thorium, Yttrium, Zirconium, Lanthanum.	Little or much.	Colorless.	Colorless.	Saturated beads, opaque white by flaming.
Manganese, Cerium, and Didymium.	Medium.	Colorless.	Colorless.	Manganese beads, apt to become a pale, rose-color on cooling, as with borax.
Silver, Lead, Zinc, Bismuth, Antimony, Cadmium, Tellurium, Tantalum.	Medium to much.	Colorless to very pale yellow or gray.	Colorless after long blowing; after short blast, gray.	Cadmium and Tantalum volatilize as fast as reduced, leaving colorless beads. Other metals volatilize more slowly, or collect into a globule.
Titanium.	Little to medium.	Yellow.	Violet.	

Iron.	Little.	Very pale yellowish-green.	Colorless.	
Uranium.	Medium.	Pale, dirty green.	Fine green.	
Chromium and Vanadium.	Little to medium.		Fine green.	
Molybdenum.	Medium.	Dirty green.		
Iron.	Medium to much.	Yellowish-green or yellow to red.	Almost colorless to pale red-violet.	
Copper.	Little.	Pale yellowish-green.	Pale blue, nearly colorless; sometimes ruby-red.	
Nickel.	Little to medium.	Reddish to brownish-red.	Yellow to reddish-yellow.	Same in O. F.
Copper.	Medium.	Brownish-green.	Opaque red.	
Cobalt.	Little to medium.	Blue.	Blue.	Same in O. F.
Didymium.	Much.	Pale rose.	Pale rose.	

TABLE VII.
Showing the Most Characteristic Reactions for the More Common Metallic Oxides.

Oxides of	Alone on Charcoal and in the Forceps.	With Borax.	With Salt of Phosphorus.	With Soda on Charcoal.	With Cobalt Solution in O. F.	Special Tests.
Aluminum. (Alumina.)	Unaltered.	Dissolves slowly to a clear glass, becoming opaque neither by flaming nor saturation. When much is added in fine powder, the glass is cloudy and scarcely fusible, and shows a crystalline surface on cooling.	Dissolves slowly to a clear glass that is always clear. When much is added the undissolved part becomes semi-transparent.	Swells a little, forms an infusible compound, and the excess of soda goes into the coal.	After a strong blast, assumes a fine blue color, the intensity of which is proportionally apparent only on cooling.	
Silicon. (Silica.)	Unaltered.	Dissolves slowly to a clear, difficultly fusible glass, that cannot be made opaque by flaming.	Dissolves in very small quantities to a clear glass. The undissolved portion becomes semi-transparent.	Dissolves with lively effervescence to a clear glass.	With a little of the solution assumes a feeble bluish color, becoming black or dark gray with more. The thinnest edges can be fused to a reddish-blue glass in a very hot flame.	

Antimony.
(Antimonious
Acid.)

O. F. Is dis-
placed and
spreads partly
over another
spot.

R. F. Is re-
duced and vola-
tilized, tinging
the flame a
greenish-blue.

O. F. Dissolves
largely to a clear
glass, yellowish
while hot, color-
less on cooling.

R. F. The glass
treated only for a
short time with
the O. F. becomes
on charcoal gray-
ish and clouded
from reduced Sb,
but this after-
wards volatilizes,
leaving a clear
glass. With tin
the glass becomes
gray or black, ac-
cording to the de-
gree of satura-
tion.

O. F. Dis-
solves with
ebullition to a
clear glass, on-
ly slightly yel-
lowish while
hot.

R. F. The
saturated
glass becomes
cloudy on coal
at first, after-
wards clear as
the Sb is re-
duced and vola-
tilizes. Treat-
ed with tin the
glass becomes
cloudy from
reduced anti-
mony, but on
longer blow-
ing, clear
again. Tin
produces a
grayish cloud-
iness, even if
very little Sb
is present.

Is reduced
very easily on
coal in either
flame, but the
metal volatil-
izes immedi-
ately, forming
a white coat
of oxide of
antimony.

A coat of Sb
moistened
with cobalt
solution and
ignited in the
O. F.; volatil-
izes in part,
but the re-
mainder is
more highly
oxidized, and
when quite
cool appears
dirty dark
green.

The coat of
oxide is mois-
tened with hy-
driodic acid,
and heated with
a pure blue
flame. The coat
becomes a bril-
liant red; this
color disappears
if exposed to
ammonia fumes.
Tests in open
and closed tubes
(Arts. 95 and
96) are also
very character-
istic.

TABLE VII—Continued.
 Showing the Most Characteristic Reactions for the More Common Metallic Oxides.

Oxides of	Alone on Charcoal and in the Porcers.	With Borax.	With Salt of Phosphorus.	With Soda on Charcoal.	Special Tests.
Arsenic. (Arsenous Acid.)	Volatilizes below a red heat, giving off dense fumes with a characteristic garlick odor.	O. F. Dissolves easily to a clear, yellow glass, which, when a little is present, is colorless on cooling. With more, the glass is yellowish-red while hot, becomes yellow on cooling, and when quite cold is opalescent.	O. F. Dissolves easily to a clear, yellow glass, colorless when cold. With much, the glass can be flamed to an enamel, and with still more it becomes enamel-white of itself, on cooling.	Is reduced on coal with evolution of arsenical fumes, recognized by their garlick odor.	The coat tested with hydriodic acid becomes orange-yellow when heated. Tube tests.
Bismuth.	On coal is reduced in O. F. and R. F. to metal, and is gradually volatilized, forming a coat of yellow oxide; beyond this coat is another thinner white coat. In the R. F. these coats disappear without coloring the flame.	O. F. The glass on coal is at first gray and clouded, then the oxide is reduced to metal with effervescence, and the glass becomes clear. Tin accelerates this reduction.	R. F. On coal, especially with tin, the glass changes, becoming clear and colorless while hot, but blackish-gray and opaque on cooling.	On charcoal is reduced immediately to metallic bismuth.	The coat tested with hydriodic acid becomes reddish brown. With bismuth-flux, on plaster, chocolate-brown coat, changing to brilliant red if exposed to ammonia fumes.

<p>Cadmium.</p>	<p>On coal, in R. F., it shortly disappears and coats the surrounding coal with a reddish-brown to dark-yellow coat. The proper color is seen when cold. The coal beyond the coat shows a variegated tarnish.</p>	<p>O. F. Dissolves very largely to a clear, yellowish glass, almost colorless on cooling. When strongly saturated, the glass becomes milk-white by flaming, and with still more, becomes an enamel-white of itself, on cooling.</p> <p>R. F. The glass containing oxide boils on coal; the cadmium is reduced, and immediately volatilizes, coating the coal with a dark-yellow coat.</p>	<p>O. F. As with borax.</p> <p>R. F. The oxide dissolved in the bead is slowly and imperfectly reduced on coal, forming a very slight dark-yellow coat, showing its proper color only when cold. Tin accelerates the reduction.</p>	<p>O. F. Insoluble.</p> <p>R. F. On coal immediately reduced and volatilizes, coating the coal with reddish-brown to dark-yellow oxide. The more remote portion of the coal assumes a variegated tarnish.</p>	<p>With hydriodic acid the coat becomes white when heated.</p>
<p>Cobalt.</p>	<p>O. F. Unchanged.</p> <p>R. F. Shrinks somewhat, and is reduced, without fusing, to metal, which is magnetic and assumes a metallic luster when rubbed in the mortar.</p>	<p>O. F. Colors very strongly; the glass is pure smalt-blue, both hot and cold. The strongly saturated glass is dark-blue it appears black.</p> <p>R. F. As in O. F.</p>	<p>O. F. As with borax, but the same quantity will not give as intense a blue. The color is best observed on cooling.</p> <p>R. F. As in O. F.</p>	<p>On coal is reduced to a gray magnetic powder, assuming a metallic luster by friction.</p>	<p>In the presence of copper or nickel, the bead must be treated on charcoal with tin before the blue color is distinctly observed.</p>

TABLE VII (Continued)

Showing the Most Characteristic Reactions for the More Common Metallic Oxides.

Oxides of Acids or Charcoal and in the Furnace	With Borax	With Set of Plov Photos	With Soda on Charcoal	Special Tests
Chromium. Unaltered in O. F. and R. F.	O. F. Dissolves slowly, but colors strongly. With little, the hot glass appears yellow (chromic acid), but when cold is yellowish-green. With more, it is dark red when hot, becomes yellow on cooling, and when cold is fine yellowish-green.	O. F. Soluble to a clear glass, red dish white hot, but dirty green while cooling, and when quite cold, a fine green.	Can not be reduced to metallic charcoal, but is metanoptical in form, while the soda sinks into the coal.	When very little of the oxide of chromium is contacted with other metals which also color the beads, we proceed by doing the reduction on platinum foil with a mixture of equal parts of soda and silver. The mass is heated for some time in O. F., then forming chromic acid. The metal is dissolved in water and filtered, and after washed with one or two of acetic acid and a crystal of acetate of lead are added to the solution, whereupon a lemon yellow precipitate <i>lead acetate</i> is formed. This precipitate may be collected on a filter and then tested R. F.
	R. F. The slightly saturated glass has a fine green color, both hot and cold (Cr). With more, it becomes darker, or pure emerald-green. Tin causes no change.	R. F. As in O. F., but the colors are somewhat darker; the same with tin.		

Copper.

O. F. Fuses to a black globule, soon spreads out, and is reduced to metallic copper on the lower side.

R. F. Reduced below the melting point of copper, the reduced particles show a copper luster, but when the blast is stopped, oxidize again on the surface, becoming black or brown. Strongly heated, it fuses to a button of copper.

O. F. Colors rather strongly; a little causes a green glass while hot, and a blue glass when cold. With more, it is dark green to opaque when hot, but greenish-blue on cooling.

R. F. Saturated to a certain degree, the glass soon becomes colorless, but on cooling is red and opaque.

On coal the copper is reduced to metal, and the cold glass is quite colorless. A glass containing oxidetreated on coal with tin becomes brownish-red and opaque on cooling.

O. F. The colors are the same as with borax, but not so strong for the same amount of oxide.

R. F. A rather strongly saturated glass becomes dark green, and on cooling changes, at the moment of solidifying, to an opaque brownish-red. A glass containing but little, if treated on coal with tin, appears colorless while hot, but becomes brownish-red and opaque when cold.

On coal is easily reduced to metal, which can be fused into a button by sufficient heat.

The numerous tests before mentioned for copper will generally serve to detect it. When, however, it is combined with nickel, cobalt, iron, and arsenic, the greater part of the iron and arsenic may be separated by treating the borax bead on charcoal.

The remaining metallic globule is fused with a small quantity of pure lead, and then boracic acid is added, which dissolves the lead and the rest of the cobalt and iron, while most of the arsenic volatilizes.

The remaining globule, an alloy of copper and nickel, is treated in a salt of phosphorus bead in O. F. The bead will be dark green while hot and clear green when cold.

TABLE VII—Continued.
Showing the Most Characteristic Reactions for the More Common Metallic Oxides.

Oxides of	Alone on Charcoal and in the Forceps.	With Borax.	With Salt of Phosphorus.	With Soda on Charcoal.	Special Tests.
Iron.	O. F. Unchanged. R. F. Becomes black and magnetic.	O. F. With little, the glass is yellow when hot, colorless on cooling. With more, it is red while hot, yellow when cold; with still more, dark-red while hot, and dark-yellow on cooling. R. F. The glass becomes bottle-green. On coal, with tin, it becomes, at first, bottle-green, but on longer blowing, vitriol-green.	O. F. With a certain amount, the hot glass is yellowish-red, but becomes first yellow on cooling, then greenish, and finally colorless. With very much, it is dark red when hot, brownish-red, then dirty green while cooling, and finally a less brownish-red. The colors disappear on cooling much sooner than with borax. R. F. The glass seems unchanged with a small amount of oxide; with more, it is red while hot, and on cooling, becomes first yellow, then greenish, and finally reddish. With tin, on coal, becomes green on cooling and finally colorless.	O. F. Insoluble. R. F. Is reduced on coal, yielding a gray, magnetic, metallic powder, when the particles of coal are washed away.	In the presence of lead, tin, bismuth, antimony, or zinc, iron may be detected by treating the borax bead on charcoal until all have been reduced except the iron, which gives the glass a bottle-green color. In the presence of cobalt, nickel, and copper, the two latter will be reduced by tin on charcoal, while the cobalt will color the bead blue. By adding more fresh borax and treating in O. F., the bead will be green while hot, blue on cooling. If the assay is added to a borax bead colored blue by the oxide of copper, and the whole is heated for a few seconds, the protoxide of iron will be further oxidized at the expense of the oxygen of the oxide of copper, and opaque red spots of oxide of copper will appear in the glass when it cools.

On coal is immediately reduced, with effervescence, by either flame and the metal gradually volatilizes, coating the coal with yellow oxide; behind this is another thinner coat of white. The coats disappear under the R. F., tingeing the flame azure blue.

O. F. Dissolves easily to a clear yellow glass, colorless on cooling; with a larger quantity, becomes opaque by flaming; with still more, becomes opaque and enamel-yellow of itself, on cooling.

R. F. The glass spreads out on coal and becomes cloudy; on continuing the blast, the oxide reduces with effervescence.

O. F. As with borax, but requiring more of the oxide to obtain a glass; yellow when hot.

R. F. The glass becomes grayish and cloudy on coal. With more oxide, a yellow coat is formed on the coal. With tin the glass becomes cloudier and darker gray, but never quite opaque.

The oxide is immediately reduced to metal, which afterwards coats the coal with oxide.

The coat treated on coal with hydriodic acid, and heated, becomes chromeyellow, or greenish-yellow in very thin coats.

In solutions of the salts of lead, sulphuric acid gives an almost insoluble precipitate of lead sulphate, which can be separated and further tested B. B.

Lead.

TABLE VII—Continued.
 Showing the Most Characteristic Reactions for the More Common Metallic Oxides.

Oxides of	Alone on Charcoal and in the Forceps.	With Borax.	With Salt of Phosphorus.	With Soda on Charcoal.	Special Tests.
Manganese.	<p>O.F. Infusible. In a hot enough flame yields oxygen, and turns brownish-red.</p> <p>R.F. The same.</p>	<p>O.F. Colors very intensely. The hot glass is violet (amethyst), but on cooling becomes violet-red. An excess renders the glass quite black and opaque, the coloring being visible only by pinching the still soft glass with the forceps.</p> <p>R. F. The glass becomes colorless. With a very dark glass this succeeds better on coal with tin. May be pale rose-color on cooling, from incipient oxidation.</p>	<p>O. F. A considerable addition is requisite to color the glass, which then has a brownish-violet color while hot, and is reddish-violet on cooling, but never opaque. When the glass contains so little as to be colorless, the color can be produced by the addition of a small fragment of niter. A glass containing oxide bubbles and yields gas at a high temperature.</p> <p>R.F. The glass very soon becomes colorless and then remains perfectly quiet.</p>	<p>Not reducible to metal on coal. The soda sinks into the coal, leaving the oxide behind.</p>	<p>The tests given are most characteristic, and generally serve to distinguish manganese even when in very small quantities.</p>

Nickel.

The usual tests for nickel are sufficient, unless it is present with much cobalt, in which case a saturated bead is fused on charcoal with about one grain of fine gold. The oxide of nickel, with a little cobalt, is reduced to metal and unites with the gold. The button is then freed from the bead, and treated again on charcoal in O. F. with salt of phosphorus. The first bead will probably be blue, since cobalt is more easily oxidized, in which case the globe is successively treated in pure beads until the nickel reaction is plainly visible.

O. F. Insoluble.

R. F. On charcoal easily reduced to small, brilliant, metallic particles which are highly magnetic.

O. F. Dissolves to a reddish glass which becomes yellow on cooling; with larger quantity the hot glass is brownish-red and becomes reddish-yellow on cooling.

R. F. The glass from the O. F. is unaltered. On charcoal, with tin, all the Ni^{2+} is reduced after continued blowing and the glass becomes colorless.

O. F. Colors intensely. In small quantities it colors the glass violet while hot, which becomes pale red-brown on cooling; with more, the colors are darker.

R. F. The glass becomes gray and turbid from separation of metallic nickel. By long blowing the metallic particles cohere, and leave the glass colorless. On charcoal, with tin especially, the reduction is more rapid.

O. F. Unchanged.

R. F. On charcoal is reduced to metal. The coherent metallic powder can not be fused; strongly rubbed in a mortar, it assumes a metallic luster, and is highly magnetic.

TABLE VII—Continued.
 Showing the Most Characteristic Reactions for the More Common Metallic Oxides.

Oxides of	Alone on Charcoal and in the Forceps.	With Borax.	With Salt of Phosphorus.	With Soda on Charcoal.	With Cobalt Solution in O. F.	Special Tests.
Mercury.	Is instantly reduced and volatilized.					<p>In case mercury exists in so small a quantity as not to be detected by its sublimes, if a piece of gold leaf be held on an iron wire in the tube just above the assay the volatilized mercury will alloy with the gold, and give it a white color.</p> <p>Heated to redness in a matrass it is reduced and vaporized. The vapors condense in the neck to a metallic coat, which can be united to globules by carefully tapping on the matrass.</p>

TABLE VII—Continued.
Showing the Most Characteristic Reactions for the More Common Metallic Oxides.

Oxides of	Alone on Charcoal and in the Forceps.	With Borax.	With Salt of Phosphorus.	With Soda on Charcoal.	Special Tests.
Molybdenum. (Molybdic Acid.)	O. F. Fuses, spreads out, volatilizes, and forms, at a certain distance, a yellowish, pulverulent coat, consisting of small crystals nearest the assay. The coat becomes white on cooling, and the crystals colorless. Beyond this a thin, non-volatile coat of oxide forms, which, on cooling, is dark copper-red, and has a metallic luster.	O. F. Dissolves easily and largely to a clear glass, yellow while hot, and colorless on cooling. A very large addition produces a glass, dark-yellow to dark-red while hot, and opaline to bluish-green enamel when cold. R. F. The glass produced in the O. F. becomes brown with a certain degree of saturation, and with more, is opaque. In a good flame black flocks of <i>Mo</i> separate and can be seen in the yellowish glass when mashed flat.	O. F. Dissolves easily to a clear glass, which is yellowish-green while hot, if a moderate amount is added, but becomes nearly colorless on cooling. On coal becomes quite dark, and on cooling is fine green. R. F. The glass becomes quite dirty green, but purer green on cooling. The same on coal. With tin somewhat darker green.	On coal fuses with effervescence at first, but afterwards is absorbed by the coal and the greater part is reduced to metallic <i>Mo</i> which can be obtained as a steel-gray powder by washing away the particles of coal.	Substances containing Molybdenum, if finely powdered and heated in a porcelain dish with concentrated H_2SO_4 , give, upon the addition of alcohol, a fine azure-blue color, especially on the sides of the dish.

TABLE VII—Continued.
 Showing the Most Characteristic Reactions for the More Common Metallic Oxides.

Oxides of	Alone on Charcoal, and in the Foretpt.	With Borax.	With Salt of Phosphorus.	With Soda on Charcoal.	With Cobalt Solu- tion in O. F.	Special Tests.
Tin.	<p>O. F. The protoxide of tin takes fire and burns like tin-oxide, called the binoxide, which glows strongly and is yellowish while hot; on cooling becomes dirty yellowish-white.</p> <p>R. F. By long blowing the oxide may be reduced to metallic tin, with formation of a slight sublimate of oxide, which coats the charcoal near the assay.</p>	<p>O. F. Very slowly soluble in small quantities to a colorless bead, which remains clear after cooling, and is not made turbid by flaming.</p> <p>A bead saturated with oxide, allowed to be cool, and then heated gently becomes turbid; loses its round form and manifests indistinct crystallization.</p>	<p>O. F. Very slowly soluble in small quantity to a colorless glass, that remains clear on cooling.</p> <p>R. F. The glass from the O. F. is unaltered either on the wire or on charcoal.</p>	<p>On charcoal is reduced to metallic tin.</p>	<p>Assumes a bluish-green which must be observed after the assay is perfectly cold.</p>	<p>Oxides of tin are best reduced on charcoal with soda or cyanide of potassium. If much iron is present, borax is added.</p> <p>Some compounds of tin, when treated with nitric acid, separate oxide of tin as a white precipitate which can be tested in the usual way.</p>

Showing the Most Characteristic Reactions for the More Common Metallic Oxides.

Oxides of	Alone on Charcoal and in the Forceps.	With Borax.	With Salt of Phosphorus.	With Soda on Charcoal.	Special Tests.
Tellurium. (Tellurous Acid.)	<p>O. F. Fuses and is reduced with effervescence. The reduced metal volatilizes immediately, and a white coating of tellurous acid deposits on coal. The edges of the sublimate are commonly red or dark yellow.</p> <p>R. F. As in O. F. The outer flame is tinged bluish-green.</p>	<p>O. F. Soluble to a clear, colorless glass, which becomes gray from separation of metal when heated on coal.</p> <p>R. F. The clear glass from O. F., heated on coal, becomes first gray and finally colorless, all the tellurium being reduced and volatilized and coating the coal with tellurous acid.</p>	<p>As with borax.</p>	<p>On charcoal is reduced and volatilized with the formation of a coat of tellurous acid.</p>	<p>Substances containing tellurium may be triturated (ground by rubbing) with soda and charcoal dust, and fused in a closed tube; then allowed to cool, and a little hot water dropped into the tube. The water will assume a purple color from the dissolved telluride of sodium. Tellurium compounds, heated with concentrated H_2SO_4, impart to it a purple color, which disappears on cooling or on the addition of water, and a black-gray precipitate is formed.</p>
Silver.	<p>Easily reduced to metallic silver, which fuses to globules.</p>	<p>O. F. Is partly dissolved, and partly reduced to metal. The glass on cooling becomes opaline or milk-white, according to the degree of saturation.</p> <p>R. F. The glass from the O. F. becomes at first gray from separation of metal, then clear and colorless, all the silver separating and fusing to a globule.</p>	<p>O. F. Both the oxide and the metal yield a yellowish glass. A highly saturated bead appears opaline on cooling. Its color is yellow by daylight, and red by candle-light.</p> <p>R. F. As with borax.</p>	<p>Is immediately reduced; fuses to metallic globules, while the soda is absorbed by the charcoal.</p>	<p>When silver is combined with large quantities of lead or bismuth, etc., it had best be fused to a button with the addition of some test lead and borax glass, and the resulting button cupelled in a bone-ash cupel.</p>

T A B L E V I I I *Continued*

Showing the Heat Characteristics Manifested by the Shale Common Marlatta Islets

Alumina on cooling in the presence of	W. F. Point	T. No. of	W. F. Point	Heat charac- teristics of P.	Special Tests
Titanium (Not.)	<p>1) P. None of the above</p> <p>2) P. Fusion of the glass is not complete when cooled slowly on cooling.</p>	<p>1) P. The glass from the white hot, but on cooling, gradually assumes a fine violet color. If the iron, the glass is brown-yellow or brown-red on cooling.</p> <p>On coal, with tin, the glass becomes violet if not too much iron is present.</p>	<p>1) P. The glass from the white hot, but on cooling, gradually assumes a fine violet color. If the iron, the glass is brown-yellow or brown-red on cooling.</p> <p>On coal, with tin, the glass becomes violet if not too much iron is present.</p>	<p>1) P. The glass from the white hot, but on cooling, gradually assumes a fine violet color. If the iron, the glass is brown-yellow or brown-red on cooling.</p> <p>On coal, with tin, the glass becomes violet if not too much iron is present.</p>	<p>A substance containing titanium, if fused with soda and dissolved in HCl and then heated with metallic tin or tin, the titanate acid is reduced and the liquid is temporarily colored violet, and finally the hydrated sesquioxide of titanium is precipitated.</p>
Titanium (Not.)	<p>1) P. None of the above</p> <p>2) P. Fusion of the glass is not complete when cooled slowly on cooling.</p>	<p>1) P. The glass from the white hot, but on cooling, gradually assumes a fine violet color. If the iron, the glass is brown-yellow or brown-red on cooling.</p> <p>On coal, with tin, the glass becomes violet if not too much iron is present.</p>	<p>1) P. The glass from the white hot, but on cooling, gradually assumes a fine violet color. If the iron, the glass is brown-yellow or brown-red on cooling.</p> <p>On coal, with tin, the glass becomes violet if not too much iron is present.</p>	<p>1) P. The glass from the white hot, but on cooling, gradually assumes a fine violet color. If the iron, the glass is brown-yellow or brown-red on cooling.</p> <p>On coal, with tin, the glass becomes violet if not too much iron is present.</p>	<p>A substance containing titanium, if fused with soda and dissolved in HCl and then heated with metallic tin or tin, the titanate acid is reduced and the liquid is temporarily colored violet, and finally the hydrated sesquioxide of titanium is precipitated.</p>
Titanium (Not.)	<p>1) P. None of the above</p> <p>2) P. Fusion of the glass is not complete when cooled slowly on cooling.</p>	<p>1) P. The glass from the white hot, but on cooling, gradually assumes a fine violet color. If the iron, the glass is brown-yellow or brown-red on cooling.</p> <p>On coal, with tin, the glass becomes violet if not too much iron is present.</p>	<p>1) P. The glass from the white hot, but on cooling, gradually assumes a fine violet color. If the iron, the glass is brown-yellow or brown-red on cooling.</p> <p>On coal, with tin, the glass becomes violet if not too much iron is present.</p>	<p>1) P. The glass from the white hot, but on cooling, gradually assumes a fine violet color. If the iron, the glass is brown-yellow or brown-red on cooling.</p> <p>On coal, with tin, the glass becomes violet if not too much iron is present.</p>	<p>A substance containing titanium, if fused with soda and dissolved in HCl and then heated with metallic tin or tin, the titanate acid is reduced and the liquid is temporarily colored violet, and finally the hydrated sesquioxide of titanium is precipitated.</p>

Zinc is difficult to detect when a small quantity of it is combined with large quantities of lead, bismuth, or antimony. In such cases the assay should be fused with a mixture of two parts soda and one part borax. The zinc will be volatilized, and in the moment of coming in contact with the air, is oxidized and coats the coal. If a large amount of lead is present, this also oxidizes and forms a coat, but on moistening with cobalt solution and heating in the O. F., the lead coating is reduced by charcoal, and the zinc coat becomes green on cooling. In the presence of much tin and antimony it is almost impossible to detect small quantities of zinc B. B.

Assumes a fine yellowish-green color, best observed when cold.

O. F. Insoluble.

R. F. On charcoal is reduced. The metal, however, volatilizes immediately, and if the heat be strong, burns with a greenish-white flame, while the charcoal is coated with oxide.

As with borax.

O. F. Easily soluble to a clear glass, which is yellowish while hot, colorless when cold. When considerably saturated may be made opaque by flaming, and when more highly saturated becomes opaque on cooling.

R. F. The saturated glass when first heated becomes turbid and grayish (separation of a part of the oxide); by longer blowing becomes clear again. On charcoal the oxide is gradually reduced, the metal volatilizing and coating the surrounding charcoal with oxide.

O. F. Becomes yellow on heating, but resumes its white color when cold. It is infusible, and glows vividly on strong ignition.

R. F. Gradually reduces, and disappears; the metal volatilizing and reoxidizing is for the greater part deposited as oxide on the charcoal, forming a coat, yellow while hot, white when cold.

Zinc.

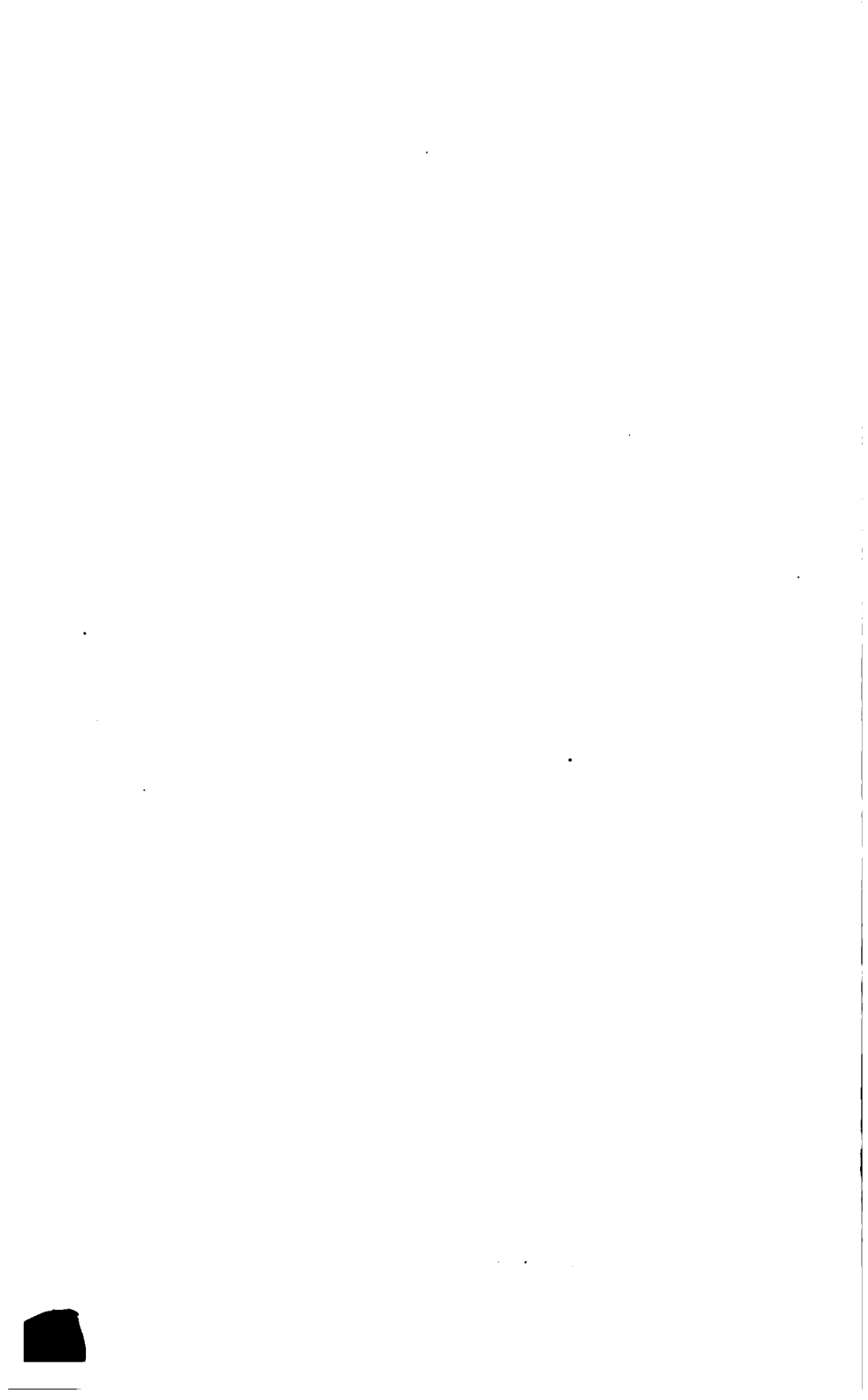

MINERALOGY.

MINERALS AND THEIR PROPERTIES.

1. A **mineral** is a natural, inorganic substance, of definite chemical composition. A mineral may be either an element or a compound, so long as it is one of the forms in which the element or elements constituting it occur in nature. For instance, the most important gold mineral is native, or metallic, gold, while iron very rarely occurs in nature in the metallic form.

2. **Mineralogy** is the study of minerals, their composition and physical and chemical characteristics.

In a careful preliminary examination of a mineral specimen, the student will naturally be struck first by those physical characteristics which are at once obvious to the senses; viz., *transparency, color, luster, feel, structure, cleavage, fracture, hardness, tenacity, and crystalline form*, if distinct; and also, if the specimen be of sufficient size, the weight will give some idea of the *specific gravity*.

The importance of these different physical characteristics varies greatly in different minerals. Thus, the color and luster of some minerals are very characteristic of those minerals and are, consequently, of the utmost importance in their identification, while in other minerals the color and luster are neither characteristic nor important; and the same is true of other properties. Crystalline form and cleavage are usually of less importance to the average prospector or miner than the other physical characteristics, but some knowledge of them will frequently stand him well in hand, and for this reason the student should know at least the principal crystalline forms.

TRANSPARENCY.

3. Transparency is the property, possessed by most substances to a greater or less degree, of *transmitting* light, or allowing light to pass through them. The following terms are used to define the different degrees of transparency:

Transparent, when the substance transmits light perfectly, so that objects viewed through it appear distinct. For example, glass and crystallized quartz are transparent.

Subtransparent or **semitransparent**, when objects can be seen through the substance, but only indistinctly.

Translucent, when the substance allows light to pass through it, but objects can not be distinguished. Ground glass, loaf sugar, and some marbles are translucent.

Subtranslucent, when there is a slight transmission of light through only the thinnest edges of the substance. When a substance transmits absolutely no light, it is said to be **opaque**.

COLOR.

4. The color of a mineral is usually more or less characteristic of the mineral. In the case of some minerals, the finely powdered mineral has a definite color of its own, entirely different from that of the specimen as a whole. The color of the powdered mineral is known as the **streak** of the mineral—from the fact that it is best observed by making a mark, or *streak*, with the specimen, on an unglazed porcelain surface—and is frequently of great importance in identifying minerals.

LUSTER.

5. The luster of minerals depends upon their power of reflecting light, and consequently upon the nature of their surfaces. According to the nature of the reflecting surface, we have seven kinds of luster, each named from some familiar substance of which it is characteristic. They are as follows:

Metallic, the ordinary luster of metals. An imperfect metallic luster is described as *submetallic*.

Vitreous, the luster of broken glass. Imperfect vitreous luster is called subvitreous. This is the characteristic luster of quartz.

Resinous, the luster of ordinary rosin. This is the luster which gives the name "Rosin Jack" to some varieties of zinc-blende.

Greasy, looking as if smeared with oil or grease. This luster is occasionally observed in quartz, and in some varieties of serpentine and steatite.

Pearly, like pearl. This luster is frequently found in such minerals as mica, talc, and gypsum, which are made up of very thin leaves, or layers. Pearly luster combined with submetallic luster forms what is known as *metallic-pearly* luster.

Silky, like silk. This luster is the result of a fibrous structure, like that of asbestos, or of fibrous gypsum.

Adamantine, the luster of the diamond. Minerals having this luster may also be submetallic; in such cases the luster is called *metallic-adamantine*. Cerussite and pyrrargyrite have such a luster.

6. Besides the different kinds of luster, there are different degrees of *intensity* of luster, depending upon the clearness of the reflection. These are:

Splendent, when the surface is a perfect mirror, reflecting light with great brilliancy, and giving well-defined images.

Shining, when an image is produced, but not a clearly defined image.

Glistening or **sheeny**, when there is a general reflection of light from the whole surface, but no image.

Glimmering, when the reflection is very imperfect, and the reflected light comes to the eye not from the entire surface, but from a number of separate points scattered over the surface.

When there is a total absence of luster the mineral is said to be **dull**, or **earthy**. Chalk is a good example of this condition.

FEEL.

7. The **feel** (or feeling) of a substance is of importance in the case of only a few minerals, such as talc and the talcose minerals. The feel of substances will be readily recognized from the terms used to define it, as *greasy*, *smooth*, *harsh*, *gritty*, etc.

STRUCTURE.

8. Among minerals will be found a variety of structure. Most mineral specimens are aggregations of imperfect crystals. Even those whose structure to the naked eye appears destitute of crystallization are probably composed of impalpable crystalline grains.

The structure of a mineral is said to be:

Columnar, when it is made up of slender columns or fibers.

There are several varieties of columnar structure, classified as follows:

Fibrous, when the columns or fibers are parallel, as in asbestos.

Reticulated, when the fibers cross in various directions, and assume a net-like appearance.

Stellated, when the fibers radiate from a center and produce star-like forms.

Radiated, when the fibers radiate from a center without producing stellar forms, as sometimes in stibnite.

Lamellar, when it consists of plates or leaves. These leaves may be curved or straight; in either case the structure is so described; and they may also be very thin and easily separable—a *micaceous* structure.

Granular, when it is composed of crystalline grains. If the grains are not to be distinguished by the naked eye, the structure is said to be *impalpable*.

There are, in addition to these kinds of structure resulting from crystallization, many imitative shapes assumed by different minerals and described as follows:

Reniform—kidney-shaped; *Botryoidal*—like a bunch of grapes; *Mammillary*—breast-shaped, resembling botryoidal, but composed of larger prominences; *Dendritic*—branching, tree-like; *Filiform* or *Capillary*—very long and slender crystals, like a thread or hair; *Acicular*—slender and rigid, like a needle; *Stalactitic* and *Stalagmitic*—like the stalactites and stalagmites found on the roofs and floors, respectively, of caves.

CLEAVAGE.

9. Most minerals have certain directions in which their cohesive force is weakest and in which they yield most readily to a blow. This tendency to break in the direction of certain planes is called **cleavage**.

Cleavage differs, first, according to the ease with which it may be effected, and second, according to the direction as crystallographically determined. We will direct our attention, for the time being, only to the first.

The different degrees of cleavage are classified as follows:

Perfect, or **eminent**, when obtained with great ease, affording smooth, lustrous faces, as in calcite, mica, and galena. *Eminent* is used only in reference to the most perfect and pronounced cleavage.

Distinct, when obtained with tolerable ease, and with fairly good cleavage faces, but neither so easy nor so complete as *perfect* cleavage.

Indistinct, when obtained with some difficulty, and the cleavage faces and angles are not well defined.

Difficult, when obtained only with considerable difficulty, and barely discernible. Cleavage of this sort is very apt to be only in *traces*, that is, with a bit of cleavage face showing here and there.

Interrupted, when the cleavage face discontinues abruptly, only to be continued in another cleavage plane

parallel to the first. This condition may occur in minerals having perfect or distinct cleavage.

The inferior degrees of cleavage are of themselves of no value in identifying minerals; but the absence of cleavage, or very poor cleavage, will sometimes serve to distinguish a mineral from minerals similar to it in appearance, but having more pronounced cleavage.

FRACTURE.

10. The term **fracture** is used in mineralogy to define the kind of surface obtained by *fracturing* a specimen, or breaking it in any direction except along a cleavage plane. The different kinds of fracture have been classified as follows:

Conchoidal, when the mineral breaks in curved, shell-like surfaces.

Even, when the fracture surfaces are approximately regular surfaces, though perhaps somewhat rough.

Uneven, when the fracture surfaces are irregular and rough.

Fracture is characteristic in the case of only a few minerals, and then, like the inferior degrees of cleavage, is valuable only as a distinction from minerals having a similar appearance but a different fracture.

HARDNESS.

11. By **hardness** is meant the resistance which a mineral offers to abrasion. Thus, talc can be scratched by the finger nail, while the diamond is the hardest substance known. As minerals differ in this characteristic, and as each has usually a more or less constant hardness of its own, the following scale, known as Moh's scale of hardness, has been arranged to measure the different degrees of resistance to abrasion offered by minerals:

1. *Talc*—easily scratched by the finger nail.

2. *Gypsum*—scratched with difficulty by the finger nail; does not scratch a copper coin.

3. *Calcite*—scratches pure copper; not scratched by the finger nail.

4. *Fluorite*—not scratched by a copper coin; does not scratch glass.

5. *Apatite*—scratches glass with difficulty; easily scratched by a knife.

6. *Feldspar (orthoclase, etc.)*—scratched with difficulty by a knife; scratches glass easily.

7. *Quartz*—not scratched by a knife; yields with difficulty to a file.

8. *Topaz*—harder than flint; very few substances are as hard as this.

9. *Corundum*—hardest substance known except the diamond.

10. *Diamond*—the hardest substance known.

The hardness of any mineral is determined by ascertaining a point in the scale such that the given mineral will scratch any mineral in the scale below that point, and will be scratched by any mineral above the point. It is well to supplement the test by the minerals of the scale with a test by the finger nail, a copper coin, and a knife. If no set of minerals comprising the scale of hardness are available, a mineral may be tested very well by the finger nail, copper coin, and knife.

TENACITY.

12. The **tenacity** of a substance is the persistency with which its particles cling together. This is different in different substances, but, like hardness, is more or less constant for any one substance. The different degrees of tenacity have been classified as follows:

Brittle, when the substance flies to pieces under a sharp blow, and powders under the edge of a knife in the attempt to cut it, like galena.

Sectile, when pieces may be cut off with a knife without falling to powder, but the substance still goes to pieces under the hammer. This is really a condition intermediate between brittle and malleable.

Malleable, when the substance can be beaten out under the hammer without flying to pieces, like gold.

Ductile, when the substance can be extended or drawn out by tension, as in wire drawing. Ductility is only another phase of the same property as malleability, and is possessed to a remarkable degree by gold, silver, iron, and copper, and some of the rarer metals.

Flexible, when the substance can be bent. Substances which are *malleable* and *ductile* are usually also flexible.

Elastic, when the substance can be bent or otherwise distorted, but returns to its original form as soon as the distorting force is removed. Steel is remarkably elastic. Highly elastic substances are usually more or less brittle.

CRYSTALLINE FORM.

13. All minerals, at some time or other, have been in a liquid state, either through solution or fusion (melting), or in the state of gas, or vapor—conditions in most cases the result of very high temperatures. On cooling, molten matter solidifies and gases condense to liquid or solid form; and as water containing mineral matter in solution cools and evaporates, the mineral contents are precipitated. As the minerals solidify they tend to form **crystals**, or bodies of definite geometrical form, bounded by plane faces. Each kind of mineral crystallizes separately, in a form or forms more or less peculiar to itself, and **crystalline form**, therefore, becomes one of the physical characteristics of every crystallized mineral, and is sometimes of considerable service in its identification. The different varieties of crystalline form are considered farther on under the head of Crystallography.

SPECIFIC GRAVITY.

14. The specific gravity of a substance is the ratio of the weight of a given volume of that substance to the weight of an equal volume of another substance, whose specific gravity is assumed to be unity (1). Water is the accepted standard, and its specific gravity is consequently considered as 1 (or unity).

15. The specific gravity of a mineral may be determined thus:

1. Find the weight of the fragment out of water, just as you would weigh anything else. This weight = w .

2. Then suspend the fragment by a fine, silk thread to the balance beam, submerge it in water and weigh again. This weight = w_1 .

Since the *loss* of weight of a solid submerged in water is equal to the weight of the volume of water displaced, $w - w_1$ = the weight of a volume of water equal to the volume of the mineral, and the specific gravity of the mineral = $\frac{w}{w - w_1}$.

The weights should be accurately taken on a good chemical balance, and the water should be distilled; and as the density of water varies with its temperature, in order to obtain uniform results 60° F. has been adopted as a convenient temperature.

16. Another method, less accurate, and requiring less elaborate apparatus, will usually give a sufficiently close approximation of the specific gravity of minerals to serve the student's purpose. The only apparatus necessary is a pair of scales graduated to about $\frac{1}{10}$ grain or 5 milligrams, and a graduated glass vessel. The graduations on the scales and the vessel should be in the same system, so that the results may be readily figured. Thus, if the scales weigh in grams (metric system), the vessel should be graduated in cubic centimeters and fractions thereof, while if the scales weigh in ounces and grains, the vessel should be graduated

to correspond, so that the weight of water in it can be readily calculated.

To obtain the specific gravity of a substance, a piece of it is weighed in air, in the ordinary manner, and then submerged in water in the graduated vessel. The height of water in the vessel before putting in the fragment is noted. This is subtracted from the height to which the water rises when the fragment is submerged in it, and the difference is the amount of water displaced. The weight of this volume is readily figured—1 cubic inch of water weighs 252.5 + grains, or, in metric measure, 1 cubic centimeter of water weighs 1 gram—and, as before, the weight of the fragment divided by the weight of the water displaced gives the specific gravity of the substance. For this rough work, the change of volume with the temperature need not be considered.

EXAMINATION OF MINERAL SPECIMENS.

17. In the preliminary examination of mineral specimens, the student must note clearly all striking physical characteristics; the hardness should be determined, and the specific gravity, as nearly as possible with the appliances at hand. These results will of course suggest to the student more or less about the specimen, according to his familiarity with minerals. Finally, the specimen should be thoroughly examined before the blowpipe, in accordance with the method already suggested in the Paper on *Blowpiping*, and the information hereinafter given will enable him to determine the specimen with reasonable certainty.

In this Paper are described only such minerals as are of commercial importance, and no attention is paid to those of merely scientific interest. The *important* ores of the ordinary metals of economic value will be given, together with such other miscellaneous minerals as are extensively used in the various industries.

CRYSTALLOGRAPHY.

18. Crystallography is that branch of mineralogy treating of the crystalline forms assumed by the various minerals.

19. For convenience in classification, the crystal forms may be divided into six main classes, or *systems of crystallization*, according to their degrees of symmetry.

A **symmetry plane** is a plane which divides a crystal so that the two portions of the crystal bear the same relation to each other as an object bears to its image in a mirror; that is, every point on the surface of the crystal on one side of the dividing plane has a corresponding point directly opposite, and at the same distance from the plane, on the other side. A **symmetrical body** is a body that can be divided by a symmetry plane. A **symmetry axis** is an imaginary line through the center of a crystal, perpendicular to a symmetry plane and connecting either the centers of opposite crystal faces or the vertices of opposite crystal angles.

In the crystal systems in which the forms are symmetrical, the crystal axes are always also symmetry axes; and in determining the crystal system to which a symmetrical crystal belongs, the more prominent group of symmetry axes is selected, and these are considered as the crystal axes of the system. One axis of the group is selected as the *vertical* crystal axis, and in the examination of the crystal is always considered as being in an upright position; the other axes then become lateral crystal axes.

The six systems of crystallization are the *isometric*, *tetragonal*, *orthorhombic*, *monoclinic*, *triclinic*, and *hexagonal*. The distinguishing characteristics of each system are as follows:

Isometric has three crystal axes, of equal length and intersecting one another at right angles.

Tetragonal has three crystal axes, intersecting one another at right angles; two, which are of equal length, are

considered as lateral axes; the third is the vertical axis, and is not of the same length as the other two.

Orthorhombic has three crystal axes, intersecting one another at right angles, but no two are of the same length.

Monoclinic has three crystal axes; the vertical axis and one lateral axis (the one running from front to back) are oblique to each other, but the transverse lateral axis is at right angles to both of the others.

Triclinic has three crystal axes, all oblique to one another.

Hexagonal has four crystal axes; the three lateral axes are at right angles to the vertical axis, and intersect one another at angles of 60° .

ISOMETRIC SYSTEM.

20. The crystal axes of the isometric system being all of the same length, and all at right angles to one another, it is immaterial which one is selected as the vertical axis, as

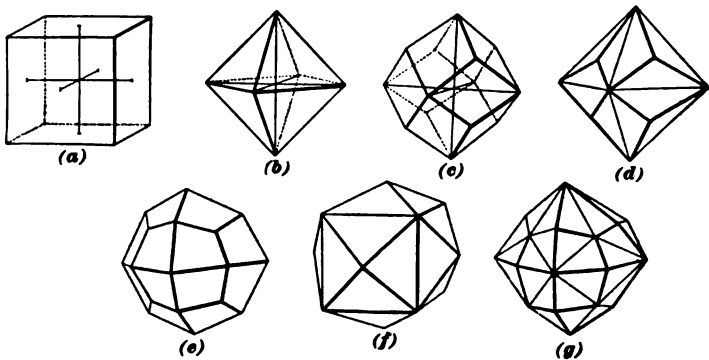

FIG. 1.

the shape of the crystal is the same with reference to all of them. In the elementary forms of this system all the faces are exactly alike. In the compound forms, resulting from a combination of two or more elementary forms, this is, of course, not the case, and in nature an almost infinite

variety in the shape and number of the faces of crystals is produced by this compounding. The elementary isometric forms—shown in Fig. 1—and their distinguishing characteristics are as follows:

Cube (*a*) has six square faces, meeting at right angles.

Octahedron (*b*) has eight faces, each of which is an equilateral (equal-sided) triangle.

Dodecahedron (*c*) has twelve diamond-shaped faces.

Trisoctahedron (*d*) has twenty-four triangular faces. It derives its name from its general resemblance to the octahedron, and the fact that each face of the octahedron is replaced in the trisoctahedron by three faces which form a low triangular pyramid.

Trapezohedron (*e*) has twenty-four faces, each of which is an irregular four-sided figure known as a trapezium. Like the trisoctahedron, it has the general form of the octahedron, but each face of the latter is replaced in the trapezohedron by a group of three of the trapezoidal faces.

Tetrahexahedron (*f*) has twenty-four triangular faces, arranged in groups of four. Each group forms a low, square pyramid, the base of which corresponds to one of the faces of the cube or hexahedron, hence the name.

Hexoctahedron (*g*) has forty-eight faces, arranged in eight groups, of six triangular faces each; has the general form of the octahedron, each group of six faces corresponding to a face of the octahedron; resembles both the trisoctahedron and trapezohedron.

HEMIHEDRAL FORMS.

21. Besides these ordinary, whole, or *holohedral* (all-sided) forms, the elementary *hemihedral* forms should be included in a list of elementary forms. **Hemihedral** forms are crystal forms in which only every other face is developed, and the intermediate ones are omitted. Thus, if in the octahedron [(*b*) Fig. 1], we consider each alternate face to be omitted and the planes of the remaining faces to be

extended till they intersect one another, we have a new form—the **tetrahedron**, or four-faced form, which is shown in Fig. 2 (a). In the figure, the two shaded faces of the small octahedron included in the tetrahedron illustrate how the alternate faces are developed. The tetrahexahedron, treated in the same way, gives the **pentagonal dodecahedron** (twelve-faced form) shown at (b). The hemihedral forms of the trisoctahedron, trapezohedron, and hexoctahedron, which are shown at (c), (d), and (e), respectively, are obtained in the same general way, but instead of developing every other face, as in the other forms, the faces are developed in alternate *sets*, corresponding to the faces of an octahedron. Every face in one octant is developed; then the

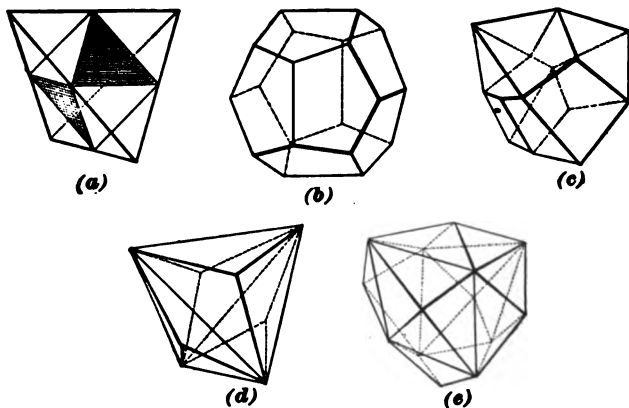

FIG. 2.

next adjacent set is skipped and the faces in the third octant developed, and so on around, developing all the faces in each alternate octant. The faces of a trisoctahedron, developed in this way, intersect one another to form the trapezoidal faces of the **tetragonal tristetrahedron** (c), while the faces of the trapezohedron intersect to form the triangular faces of the **trigonal tristetrahedron** (d), and the faces of the hexoctahedron remain unchanged in the **hex-tetrahedron** (e). The forms given in Fig. 2 are all the elementary hemihedral forms. Like the whole forms, they

combine among themselves in great variety; but hemihedral forms never, under any circumstances, combine with holohedral forms.

TETRAGONAL SYSTEM.

22. In considering a crystal of the tetragonal system, the two equal axes are always assumed as the lateral axes, and the odd axis becomes the vertical axis. The elementary forms of this system are square and octagonal prisms, and double-ended square pyramids (octahedrons) and octagonal pyramids. As in the isometric system, a great variety of forms results from the combination of these elementary forms.

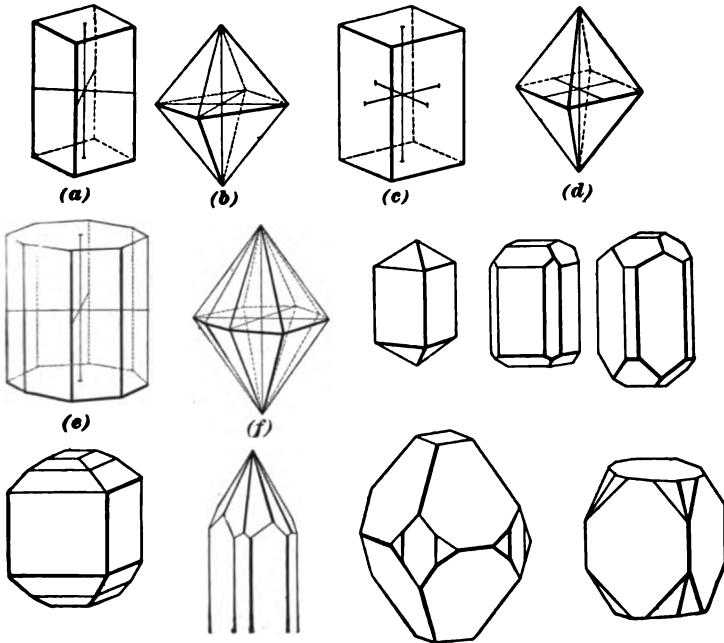

FIG. 8.

Both the prisms and the pyramids of the tetragonal system may be divided into two classes: *direct* and *indirect*. In the direct forms, the crystal faces intersect both lateral

axes, as at (*a*) and (*b*), Fig. 3; in the indirect forms, the faces cut one lateral axis and are parallel to the other, as at (*c*) and (*d*). In all the systems except the isometric, a face parallel to both lateral axes is called a *basal plane*. Such are the faces closing the top and bottom of an ordinary prism. Cleavage parallel to a basal plane is known as *basal cleavage*; parallel to the faces of a prism, as *prismatic cleavage*; parallel to the faces of an octahedron, as *octahedral cleavage*, etc., the cleavage in every case taking its name from the face to which it is parallel.

23. Fig. 3 shows the simpler forms of the tetragonal system. With the exception of the four forms already described (*a*, *b*, *c*, and *d*), and the octagonal prism (*e*) and pyramid (*f*), the forms are all compound.

HEMIHEDRAL FORMS.

24. The hemihedral forms of the tetragonal system, some of which are shown in Fig. 4, are derived in the same way as those of the isometric system. The tetrahedron (*a*)

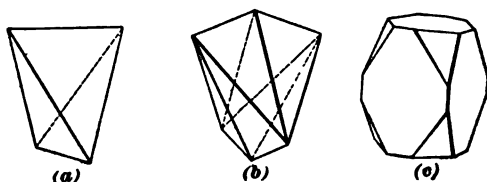

FIG. 4.

is derived from the octahedron; the ditetrahedron (*b*) is derived from the dioctahedron, or octagonal pyramid; and the square prism, which is shown at (*c*), with its corners cut off by the faces of the ditetrahedron, is derived from the octagonal prism.

25. It is frequently somewhat difficult to distinguish certain tetragonal forms from similar isometric forms. This is particularly true of the octahedrons and their half-forms, the tetrahedrons, in which there is no distinction, except that one axis of the tetragonal forms is longer or shorter

than the other two, while all three axes of the isometric forms are of equal length, so that the faces of the isometric crystals are equilateral triangles, while the faces of the tetragonal crystals have only two sides of the triangle equal. Even this distinction is frequently destroyed by a distortion of the isometric crystals, so that the three axes are no longer equal. In such a case we must refer to the crystal angles, or angles formed by the intersection of crystal faces, which remain unchanged, no matter how great the distortion of the crystal. Thus, if the angle at the vertex of an eight-sided crystal is *exactly* a right angle, we know at once that the form is an isometric octahedron, for the vertex angles of the tetragonal and orthorhombic octahedrons are never exactly right angles. In the case of the isometric cube and the tetragonal and orthorhombic prisms, the distinction is much more simple, as, no matter how badly distorted the crystal may be, all the faces of an isometric crystal have exactly the same luster and markings; while the basal plane in the tetragonal and orthorhombic systems has a somewhat different appearance from the prism faces; and in the orthorhombic system the two sets of parallel prism faces differ in appearance from each other, as well as from the basal planes—a characteristic which serves to distinguish orthorhombic prisms from distorted tetragonal prisms. Distorted tetragonal pyramids are similarly distinguished from orthorhombic pyramids, the luster of adjacent faces of the latter being different, while that of opposite faces is identical.

ORTHORHOMBIC SYSTEM.

26. The three axes of the orthorhombic system being all of different lengths, but at right angles to one another, any one of them may become the vertical axis, the selection resting with the operator, and usually depending more or less on the general shape of the crystal. For instance, if the crystal is flat and tabular, the main faces of the tablet are usually considered as basal planes, while if it is long and prismatic, pyramidal, or barrel-shaped, the longest axis is

usually selected as the vertical axis. The longer lateral axis is usually selected as the transverse axis.

The crystal forms of this system correspond to those of the tetragonal system. The direct prisms and pyramids correspond exactly with the similar tetragonal forms, except in the different luster and markings of adjacent faces and the measurement of the solid, crystal angles (angles made by the intersection of three or more faces). Instead of the indirect prism, however, we have two pairs of parallel, vertical faces, which, when both pairs are developed, intersect to form a vertical, rectangular prism with its faces parallel to the lateral axes of the crystal; the pair of faces parallel to the longer or *macro-axis* constitutes a *macropinacoid*, and the pair parallel to the shorter or *brachy-axis* is a *brachypinacoid*. And in the same way, instead of the indirect pyramid, we have two horizontal prisms, each formed by the four faces parallel to one lateral axis and cutting the other lateral axis and the vertical axis; the faces of the prism parallel to the longer lateral axis (the macro-axis) constitute a *macrodome*, and those parallel to the brachy-axis constitute a *brachydome*. If both domes are developed, the resulting form is a rectangular pyramid, or octahedron.

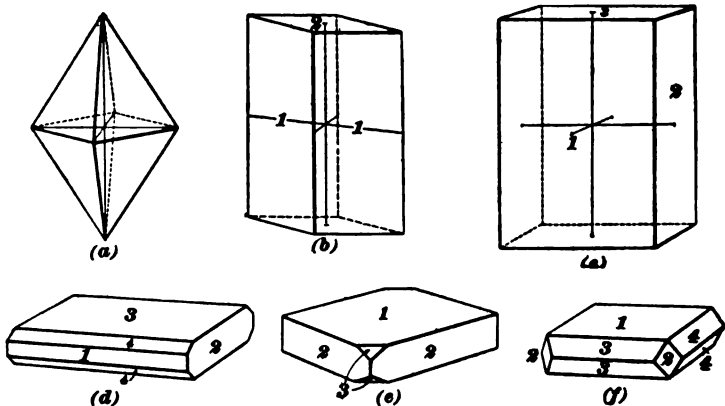

FIG. 5.

27. Fig. 5 shows the principal simple forms of this system. There is only one purely elementary form—the true

octahedron, or pyramid, shown at (a). The other forms of the system are, necessarily, all compounds of two or more forms, as, excepting the pyramid, none of the forms has more than four faces, and the basal planes and pinacoids have only two, and it requires at least six faces to form a complete holohedral crystal. The hemihedral forms of the system are unimportant—in fact, so far as is known, there are no true hemihedral orthorhombic forms in nature—hence they will not be discussed. The forms shown in Fig. 5 are as follows:

(a) *Octahedron* or *pyramid*.

(b) *Prism* (1-1) and *basal plane* (2).

(c) Pinacoidal prism, made up of *macropinacoid* (1) and *brachypinacoid* (2), and *basal plane* (3).

(d) Tabular prism, made up like (c), but with the long edges beveled by a *macrodome* (4).

(e) *Basal plane* (1) and *prism* (2-2) with front and back corners truncated by a *macrodome* (3-3).

(f) *Basal plane* (1), *prism* (2-2), *macrodome* (3-3), and *brachydome* (4-4).

The tabular orthorhombic forms are very characteristic of the mineral barite.

MONOCLINIC SYSTEM.

28. The crystals of the monoclinic system are symmetrical with reference to only one plane. In examining a crystal of this system, the symmetry plane is always considered as being vertical and running from front to back; the symmetry axis, therefore, coincides with the transverse lateral crystal axis. This axis, being at right angles to the symmetry plane, is, consequently, at right angles to both the other axes, since they both lie in that plane, and for this reason it is called the *ortho-* (right) axis. The other lateral axis is oblique to the vertical axis, inclining from back to front, and is called the *clino-* (inclined) axis.

The forms of this system are prisms, pinacoids, pyramids,

domes, and basal planes, as in the orthorhombic system. Instead of macro- and brachydomes and pinacoids, however, we have the *orthodome* and *orthopinacoid* with their faces parallel to the ortho-axis, and the *clinodome* and *clinopinacoid* with their faces parallel to the clino-axis.

The elementary forms whose faces intersect both the clino-axis and the vertical axis are divided into two classes—*positive* and *negative*—according to the position of their faces with reference to the central angles of the crystal. Thus, if a plane be assumed through the vertical axis and the ortho-axis, and another through the two lateral axes, these planes will, of course, intersect each other along the ortho-axis, as it is common to both of them, and at their intersec-



FIG. 6.

tion will form four plane angles, the alternate angles being equal, but one pair—the top-front and lower-back angles—being larger than the other pair, on account of the inclination of the clino-axis; and all crystal forms whose faces are in the two sections of the crystal lying within the planes of the two larger plane angles are known as *positive*, while those whose faces are in the smaller sections are known as *negative*. Fig. 6 shows the four faces forming a positive pyramid. The prism, clinodome, and the pyramid are made up of four faces each; the orthodomes, pinacoids, and basal plane have only two faces to each form.

29. As the least number of faces a solid, holohedral crystal of any form can have is six, none of these elementary forms occur alone in nature; but all monoclinic crystals are made up of combinations of two or more of the elementary forms. In Fig. 7, we have shown a few of the simpler and more common forms. To assist the student in identifying them, we have numbered each kind of face as follows:

- | | |
|------------------------------|------------------------------|
| 1. Orthopinacoidal face. | +5. Positive orthodome face. |
| 2. Clinopinacoidal face. | -5. Negative orthodome face. |
| 3. Prism face. | 6. Clinodome. |
| +4. Positive pyramidal face. | 7. Basal plane. |
| -4. Negative pyramidal face. | |

The last three forms are what are called *twinned* crystals, twinning being merely a combination of two (or more) crystals of the same form, but with their axes in different positions. Twinning sometimes produces what are apparently entirely new forms, but generally the individual forms

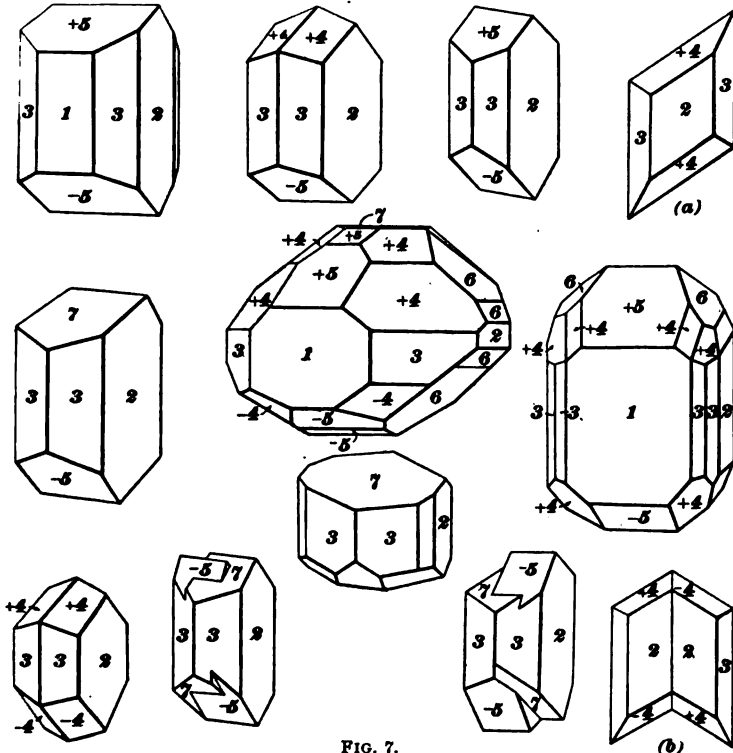

FIG. 7.

can be readily distinguished. Twinned crystals usually have reentrant, or concave, angles, by which they can be readily distinguished from normal crystals, in which concave angles never occur. They may frequently be recognized also by the tiny ridges or striæ on the common face, meeting in a line down the middle of the face, as in the case of gypsum, shown normal at (a) and twinned at (b). This indicates that the face is really made up of two faces in the same plane, but with their striæ in different positions.

TRICLINIC SYSTEM.

30. As the axes of the triclinic system are all of different lengths and all inclined to one another, the system can have no symmetry planes, and there can, under no circumstances, be more than two faces of a kind identical in form, luster, and position with reference to the axes. The simplest crystals thus require at least three different forms to complete the crystal. Thus, the simplest prismatic crystal is made up of two sets of prism faces (two faces to a set)—or the prism may be made up of two sets of pinacoidal faces—and a pair of basal planes; six faces in all, representing three different forms.

The forms of the triclinic system are practically the same as those of the monoclinic prisms, pyramids, domes, pina-

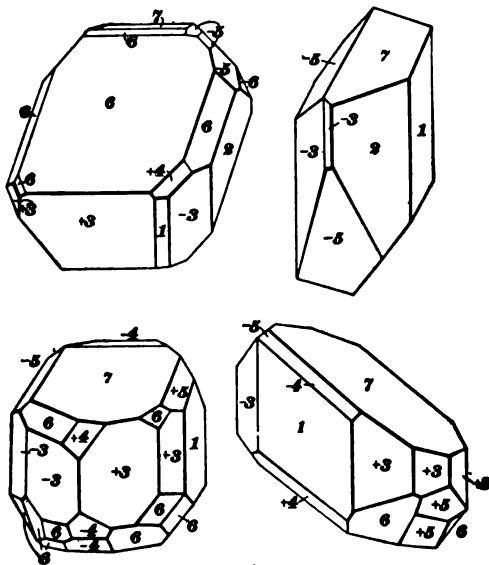

FIG. 8.

coids, and basal planes. Since both lateral axes are inclined to the vertical axis, however, we can not very well specify either as the clino-axis, so we resort again to the terms *macro-* and *brachy-* to distinguish the long and short

lateral axes, respectively, as in the orthorhombic system, and the domes and pinacoids are distinguished in the same way, macrodomes and macropinacoids having their faces parallel to the longer lateral axis, and the faces of brachydomes and brachypinacoids being parallel to the shorter lateral axis.

Fig. 8 shows some of the simpler triclinic crystals with the faces of the different forms marked as follows:

- | | |
|--------------------------|---------------------------|
| 1. Macropinacoid. | — 4. Negative macrodome. |
| 2. Brachypinacoid. | + 5. Positive brachydome. |
| + 3. Positive prism. | — 5. Negative brachydome. |
| — 3. Negative prism. | 6. Pyramid. |
| + 4. Positive macrodome. | 7. Basal plane. |

31. Occasionally the inclination of the lateral axes to each other is so slight that it becomes very difficult to distinguish the triclinic forms from similar monoclinic forms. In such a case the student should remember that the angle between the pinacoidal crystal (and cleavage) faces of the monoclinic crystals is always exactly a right angle, while in the triclinic system there is never any angle less than three or four degrees away from a right angle.

HEXAGONAL SYSTEM.

32. The hexagonal system is very closely allied to the tetragonal system. All the forms of the latter system have exactly corresponding forms in the hexagonal system; there being three equal lateral crystal axes in the hexagonal system, however, all the lateral faces of hexagonal forms occur in multiples of three, while in the tetragonal system they occur in multiples of two, only. The angles between lateral faces also differ correspondingly.

The elementary forms of the system are direct and indirect hexagonal prisms and pyramids (called prisms and pyramids of the *first order* and *second order*, respectively), dihexagonal prisms and pyramids—corresponding to the octagonal

prisms and pyramids of the tetragonal system—and basal planes. These forms are shown in Fig. 9 in the order named.

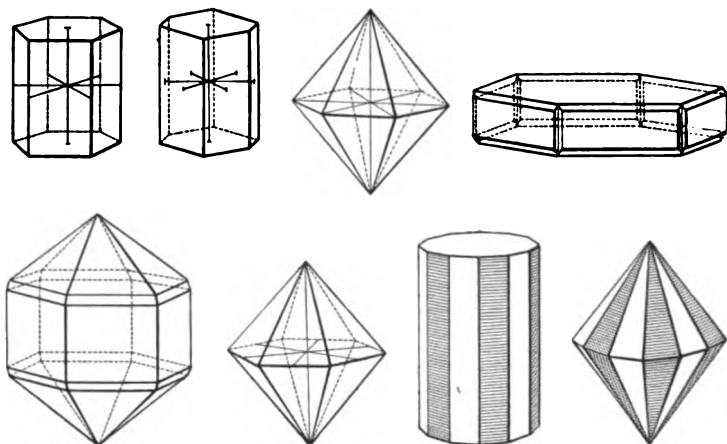

FIG. 9.

HEMIHEDRAL FORMS.

33. The hemihedral forms of the hexagonal system are more abundant in nature, and, consequently, more important than the holohedral forms.

Pyramidal Hemihedral Forms.—There are two distinct classes of hemihedral forms in this system. The elementary forms of the first class, which are called *pyramidal* hemihedral forms, are only two in number, and are derived by developing the faces in the alternate *sections* of the crystal forms between the six vertical symmetry planes. Thus, if in the dihexagonal prism we develop the alternate prism faces, which are shown shaded in Fig. 9, we get a hexagonal *prism of the third order*; and by developing the shaded faces of the dihexagonal pyramid, we get a hexagonal *pyramid of the third order*. The prisms and pyramids of the third order can be distinguished from those of the first and second orders only through their association with other hemihedral forms.

34. Rhombohedral Hemihedral Forms.—The hemihedral forms of the second class, called *rhombohedral* hemihedral forms, are derived in the ordinary manner, each alternate crystal face above and below the horizontal symmetry plane being developed. The class derives its name from the most common and characteristic form—the *rhombohedron*—which is the hemihedral form of the hexagonal pyramid. The rhombohedral hemihedral form of the dihexagonal prism is the *scalenohedron*, a double-ended hexagonal prism, each face of which is a scalene triangle (a triangle with no two sides equal).

Calcite always crystallizes in the rhombohedral-hexagonal system, and so also do dolomite and siderite. Calcite crystals assume a great variety of forms. Fig. 10 represents

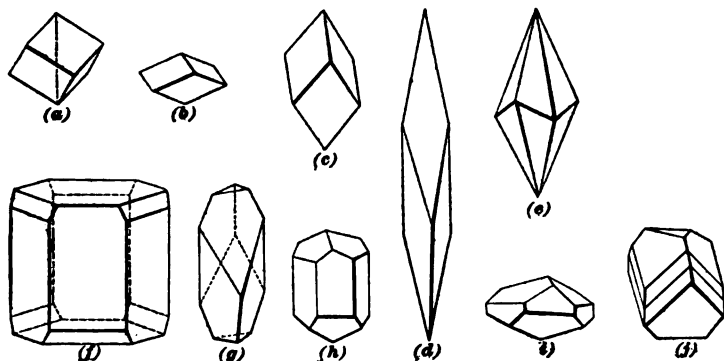

FIG. 10.

some of the many characteristic forms of calcite. The forms from *a* to *d* are rhombohedrons; *e* is a scalenohedron; *f*, prisms with rhombohedron and basal plane; *g*, a rhombohedron with basal plane; *h* and *i*, prism and rhombohedrons; and *j* shows a rhombohedron, scalenohedron, and basal plane.

It is sometimes very difficult to distinguish rhombohedrons from cubes, but the faces of a rhombohedron are never exactly square, or even rectangular, but are always more or less diamond-shaped. The vertical axis in the rhombohedron always connects two opposite solid angles, while in the cube it connects the centers of opposite faces.

Rhombohedral hemihedral forms may be easily distinguished from any other forms from the fact that the intersection of the upper and lower pyramidal faces of this class with one another, or with prism faces, forms a broken, jagged line, with angles alternately above and below an intermediate horizontal plane, whereas the basal edges of pyramidal faces in all other forms are horizontal.

35. Tetartohedral Forms.—Prisms and pyramids of the third order have still further hemihedral forms, formed in the ordinary manner, and called tetartohedral forms, because they have developed only *one-fourth* of the faces of the holohedral forms. The principal forms are a rhombohedron, identical with the rhombohedron of the rhombohedral section, a trapezohedron, almost identical in form with the rhombohedron, the only difference being that each of the six faces is trapezoidal (has four sides, in two pairs of equal sides, but the sides of one pair are not equal to the sides of the other) instead of rhomboidal (diamond-shaped—four equal sides). These forms sometimes occur in quartz crystals.

DISTORTION.

36. Natural crystals are usually more or less distorted—in fact, perfect natural crystals are comparatively rare. The crystal axes are extended lineally, destroying their proper proportion to one another, and making faces, which should be identical in shape, very different; or the axes may be bent or twisted—sometimes very much so, twisting completely around—giving curved crystal faces instead of the normal planes. This curvature of the crystal axes appears to be characteristic of a few certain minerals, as dolomite, siderite, quartz, and chlorite, but linear distortion is common in all minerals.

However badly a crystal may be distorted, it nevertheless always retains certain characteristics of its crystal system, by which it can be identified. Besides the similar luster and markings of corresponding faces, which have already

been discussed, we have the fact that the crystal axes, however badly they may be distorted as to relative length, are never distorted as to their relative position to one another; that is, if all or any two of the axes in the normal crystal intersect at a given angle, this angle is maintained in the distorted crystal, and the corresponding angles between the faces are likewise never distorted.

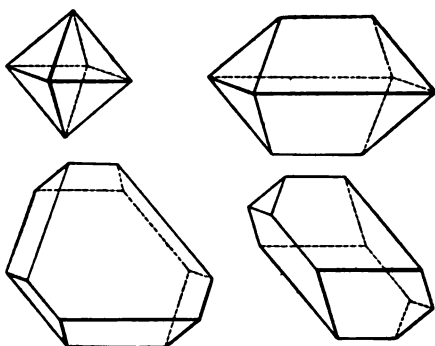

FIG. 11.

Thus, in Fig. 11, there are shown a normal isometric octahedron and three distorted octahedrons, and it will be seen that the faces on the distorted forms are in every case exactly parallel to the corresponding faces in the normal form. Fig. 12 shows a dodecahedron treated in the same way. This same peculiarity runs through all the systems, and forms an infallible guide in identifying them.

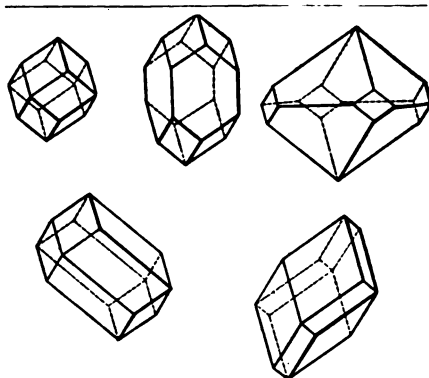

FIG. 12.

IRON (Fe).

37. Iron is the most abundant of the metallic elements, and, from a commercial standpoint, by far the most important. Native metallic iron is occasionally found in meteorites (shooting-stars), but, so far as is known, it does not occur in the native state as a constituent of the earth's crust. The various minerals, however, particularly the oxides, are

very abundant. They are so abundant, in fact, and the market price of iron is so low, that only very rich and pure ores will pay to mine, and then only when in large deposits, convenient for transportation. The iron of commerce is obtained from these ores by smelting.

Iron is a gray, malleable, and ductile metal, highly susceptible to magnetism, in which respect it far surpasses both nickel and cobalt, the only other metals exhibiting this property to a marked degree. Pure iron is more or less soluble in nearly all acids. A peculiarity of metallic iron is that it is insoluble in concentrated sulphuric acid, although readily soluble in the same acid when diluted. On account of this property, iron tanks are used almost exclusively in shipping large quantities of concentrated sulphuric acid. The hardness of pure iron is between 4 and 5.

IRON MINERALS.

38. The iron minerals are all colored, give colored streaks, and are mostly hard, and all are heavy. Before the blowpipe, they all give iron-beads with borax and salt of phosphorus, and when fused with soda on charcoal, in a reducing flame, they nearly all give a metallic mass, which is attracted by a magnet. Most of them dissolve readily in boiling hydrochloric acid, or if that fails, in aqua regia, and if ammonia in excess is added to the solution, it produces a highly flocculent (fleecy) precipitate of iron hydrate, which is light brown at first, but rapidly changes to dark brown. The principal iron minerals are hematite, limonite, magnetite, siderite, pyrite, and pyrrhotite.

39. Hematite.—Hematite is one of the most abundant and most important ores of iron, and occurs in different forms, distinguished by special names. Its hardness, for the different varieties, ranges from 5.5 to 6.5, and its specific gravity from 4.5 to 5.3. Hematite has a metallic luster, often splendid; sometimes earthy. Its color is dark steel-gray or iron-black. It is opaque, except when in thin plates, when it is blood-red by transmitted light. The earthy

varieties are red. All varieties give a cherry-red or reddish-brown streak. The fracture is subconchoidal and uneven. Occasionally, hematite is slightly magnetic.

Composition: Iron sesquioxide (Fe_2O_3) = iron 70%, oxygen 30%, when pure. Titanium and manganese are common impurities.

There are a number of different varieties of hematite, characterized as follows:

Specular Iron.—Luster, metallic and splendid; structure, frequently micaceous.

Red Ocher.—A soft, earthy variety of hematite, of a bright-red color.

Clay Ironstone.—A hard, brownish-black to reddish-brown, heavy stone, of a submetallic to earthy luster. It gives a red streak; consists of Fe_2O_3 , mixed with sand and clay. This name is also applied to similar varieties of limonite and siderite.

Martite.—A variety of hematite in octahedrons, derived, probably, from the oxidation of magnetite.

B. B. (before the blowpipe) is infusible; on charcoal in R. F., becomes magnetic; with borax in O. F., gives a yellow bead while hot, colorless on cooling; if saturated, the bead is red while hot, yellow on cooling; in R. F., gives a bottle-green color, and on charcoal, with tin in R. F., gives a vitriol-green color. With soda on charcoal, is reduced to a gray magnetic powder. Soluble in concentrated hydrochloric acid.

Hematite is distinguished from magnetite by its red streak, and from limonite by its red streak and by its not containing any water. It occurs in the rocks of all ages.

40. Limonite.—Limonite, or *brown hematite*, is, perhaps, the most abundant iron ore. It is usually massive, but occurs in numerous imitative shapes—botryoidal, stalactitic, fibrous, and occasionally earthy. Its hardness ranges from 5 to 5.5; specific gravity from 3.6 to 4. It has a silky luster, often submetallic; sometimes dull and earthy.

Color of fractured surface is some shade of brown, commonly dark, and never bright. Specimens sometimes have a nearly black, varnish-like exterior. The earthy varieties are brownish-yellow to ocher-yellow. The streak is, for all varieties, yellowish-brown.

Composition: A combination of iron sesquioxide and water ($2Fe_2O_3 + 3H_2O$), = iron sesquioxide 85.6%, and water 14.4%. The percentage of metallic iron is nearly 60%. In bog ores and ochers, manganese and phosphorus are common impurities; likewise, clay, sand, etc.

Like hematite, limonite has several different varieties, as follows:

Brown Hematite.—This variety includes all the compact forms—botryoidal, stalactitic, etc.

Brown Ocher and Yellow Ocher.—Loose, finely powdered, earthy varieties, of brown or yellow color.

Bog Iron Ore.—An earthy, brownish-black limonite, occurring in marshy ground.

Brown Clay Ironstone.—Similar in composition to hematite clay ironstone, from which it is distinguished by having a brown, instead of red, streak. It occurs as concretions—more or less rounded, ball-like forms or aggregations in clay and sandstone formations. It is frequently of a *pisolitic* structure, made up of an aggregation of small concretions about the size of a pea, or *oolitic* (looking like the roe of a fish).

B. B. gives the same reactions as hematite. In closed tube, gives water. In salt of phosphorus bead, some varieties give a skeleton of silica which exists in the ore as an impurity.

Limonite is distinguished from hematite by its yellowish-brown streak, its giving water, and its inferior hardness. It occurs in secondary and more recent deposits.

41. Magnetite.—Magnetite, or *magnetic iron ore* (also called *lodestone*), is remarkable for its strong magnetic property, being very strongly attracted by a magnet, and sometimes being itself a magnet. It usually occurs massive, but

crystals are not uncommon. It crystallizes in the isometric system, usually in octahedrons and dodecahedrons, with an imperfect to distinct octahedral cleavage. The luster ranges from metallic to submetallic on crystal faces. The fracture is subconchoidal, of a shining, slightly greasy luster. The mineral is brittle, and its hardness ranges from 5.5 to 6.5, and its specific gravity from 4.9 to 5.2.

Composition: Combination of iron sesquioxide and iron protoxide ($Fe_2O_3 + FeO$, or Fe_3O_4), corresponding to iron 72.48% and oxygen 27.52%. Titanium and manganese are common impurities.

B. B. fuses with considerable difficulty. In the O. F., loses its magnetic qualities. In the beads, and on charcoal with soda, reacts like hematite. Soluble in hydrochloric acid.

It is distinguished from hematite and limonite by its black color and streak and by being attracted by the magnet.

Magnetite is most abundant in the older crystalline rocks, such as granite, gneiss, and mica, hornblende, and chlorite schists, and in crystalline limestones. Also common in disseminated grains in basalt and other rocks of igneous origin.

42. Siderite.—Siderite, or *spathic iron*, usually occurs massive, with a foliated, or lamellar, structure and slightly curved cleavage faces. It has an eminent rhombohedral cleavage. When crystallized it occurs in simple rhombohedrons, with slightly curved faces. It assumes, also, botryoidal and globular forms, having a subfibrous, and occasionally a silky-fibrous, structure.

Perfectly pure siderite is nearly white, but it discolors very rapidly on exposure, from the formation of oxides of iron. It is generally fawn color, changing to brown or nearly black. The streak is white. The coarse crystalline varieties have a pearly luster, while the finer-grained varieties are duller. The hardness ranges from 3.5 to 4.5, and the specific gravity from 3.7 to 3.9. The mineral is brittle and has an uneven fracture.

Composition: Iron carbonate ($FeCO_3$) corresponding to

carbon dioxide (CO_2), 37.9%, and iron protoxide (FeO), 62.1%. Metallic iron = 48.2%. In most cases, a part of the iron protoxide is replaced by manganese oxide, lime, or magnesia. Some varieties of siderite contain from 8% to 10% of manganese, which makes the ore more valuable. As the iron diminishes, the calcareous and magnesian siderites pass into varieties known as brown spar and dolomite.

Clay ironstone, or *ball ironstone*, which resembles nodules of hardened clay, is a siderite clay ironstone, similar to those of hematite and limonite, which is found in the shales of the coal measures.

Clayband ironstone, which is of similar composition, is in connected beds rather than in nodules, and blackband ironstone contains much carbonaceous matter.

B. B. blackens and fuses at 4.5. In closed tube, decrepitates, gives off carbonic oxide and carbonic acid gas, blackens and becomes magnetic. In the beads and with soda on charcoal, reacts for iron, and when heated with soda and niter on platinum foil, generally reacts for manganese. Only slowly acted upon by cold hydrochloric acid, but dissolves with brisk effervescence in hot hydrochloric acid.

Siderite may be distinguished from calcite, the carbonate of lime, and dolomite, the carbonate of lime and magnesium, both of which it much resembles, by its higher gravity, and by becoming magnetic before the blowpipe.

Siderite occurs in many of the rock strata, in gneiss, mica slate, clay slate, and as clay ironstone in the coal measures.

43. The foregoing iron minerals are the ones from which practically all the iron of commerce is obtained. The sulphides of iron are important, less on account of the iron they contain—though sometimes smelted for iron after roasting to expel the sulphur—than on account of their sulphur contents, and because of their frequent association with other metals of great importance, notably gold.

44. Pyrite.—Pyrite, or *iron pyrites*, occurs both crystalline and massive, and also in imitative shapes—globular,

reniform, and stalactitic. It crystallizes in the isometric system, usually in cubes, with the striæ on each face at right angles to those on the adjoining faces—a characteristic of the hemihedral cube. The pentagonal dodecahedron [(b), Fig. 2] is also a very common form, and the octahedron somewhat less common. Combinations of two or all of these forms are frequent.

Pyrite has a pale, brass-yellow color, but the streak is greenish or brownish black. Its luster is metallic, and from splendid to glistening. It is quite hard (from 6 to 6.5) and will strike fire with steel. It is brittle, with a conchoidal and uneven fracture. Specific gravity ranges from 4.8 to 5.2.

Composition: Bisulphide of iron (FeS_2), corresponding to sulphur 53.3% and iron 46.7%. It is used largely in the manufacture of sulphuric acid, and frequently contains gold in paying amounts, for which reasons it is of commercial importance. Small amounts of nickel, cobalt, and copper occur frequently as impurities.

B. B. on charcoal gives off sulphur, burning with a blue flame, and leaving a magnetic residue. In the closed tube, gives a sublimate of sulphur and a magnetic residue. Gives, when pure, reactions for iron in the beads; insoluble in hydrochloric acid, but decomposed by nitric.

Pyrite is distinguished from chalcopyrite by its greater hardness, as it can not be scratched by a knife and strikes fire with steel; and its color is also characteristic. It is distinguished from gold by its brittleness and by giving off sulphur fumes when heated.

Pyrite occurs in rocks of all ages, from the oldest crystalline rocks to the most recent deposits. It occurs usually in small cubes; also in irregular ball-like nodules, and in veins; in clay slate, clay sandstones, and in the coal measures, where it is commonly known to the miner as "sulphur." In other localities it is called "mundic," "brasses," or "fool's gold."

In many gold regions it is worked for gold with profitable results.

45. Pyrrhotite.—Pyrrhotite, or *magnetic iron pyrites*, occurs both crystallized and massive. It crystallizes in the hexagonal system in tabular hexagonal prisms with perfect basal cleavage. It has a granular structure, a metallic luster, and in color is between a bronze-yellow and a copper-red, and tarnishes rapidly. Its streak is dark grayish-black. It is brittle and is slightly susceptible to magnetism, being attracted by the magnet when in a fine powder. It ranges in hardness from 3.5 to 4.5, and in specific gravity from 4.4 to 4.7.

Composition: Variable, but mostly Fe_7S_8 , corresponding to sulphur 39.5%, and iron 60.5%. Sometimes contains from 3% to 6% of nickel, this ore (*nickeliferous pyrites*) being one of the most important nickel ores.

B. B. on charcoal in R. F., fuses to a black magnetic mass; in the O. F., is converted into iron sesquioxide (Fe_2O_3), which, when pure, in the beads and on charcoal with soda, gives only an iron reaction; many varieties give reactions for nickel and cobalt also.

It is unchanged in the closed tube, but gives off sulphur fumes in the open tube. It is decomposed by hydrochloric acid with the evolution of sulphureted hydrogen, which has the odor of rotten eggs.

Pyrrhotite is distinguished from pyrite and chalcopyrite by its magnetic character and its bronze color on surface of fresh fracture.

COPPER (Cu).

46. This metal has been known from remote antiquity, and was anciently employed, alloyed with tin, as bronze, for making edge tools and for other purposes. Copper has a red color and brilliant luster, and is very malleable, ductile, and tenacious, and when warmed or rubbed exhales a characteristic odor. The copper of commerce is not pure, but contains traces of other metals, such as arsenic, tin, silver, etc. Its specific gravity varies in accordance with the treatment it has undergone, from 8.76 to 8.96. Its hardness

ranges from 2.5 to 3. When heated to whiteness, copper gives off metallic vapors, which impart a green color to the flame. At ordinary temperatures, exposed to the action of dry air, copper is not oxidized; but if acted on by a damp atmosphere it becomes covered with a green basic carbonate, known as "verdigris." A concentrated solution of hydrochloric acid attacks finely divided copper with facility, and the more solid masses with greater difficulty. Nitric acid, even when cold and dilute, dissolves it very readily, with a rapid evolution of nitrous oxide, which, coming in contact with the air, produces large quantities of characteristic red fumes of nitric oxide.

COPPER MINERALS.

47. All the copper minerals are colored, all give colored streaks, are rather soft, and most of them are moderately heavy. They are very apt to be associated with one another, which is a great help in distinguishing some of the less characteristic ones. All except the sulphides, which need roasting first, give copper beads with borax and salt of phosphorus, and when treated with soda on charcoal, can be reduced to a button of metallic copper. They all dissolve in aqua regia, and most of them dissolve in boiling nitric acid, and if ammonia is added to the solution, it gives first a whitish-blue precipitate; this dissolves, on adding an excess of ammonia, giving an intense blue color. The carbonates dissolve readily in nitric acid, with effervescence. There are numerous rare copper minerals in addition to the common ones here given. The foregoing list, however, includes all those of commercial importance.

48. Native Copper.—Copper frequently occurs in the native state, as the result, perhaps, of electrochemical action, by which sulphate of copper, arising from the oxidation of its various sulphides, is caused to slowly deposit the metal it contains.

Native copper crystallizes in the isometric system, in various forms, usually more or less distorted. It is malleable

and ductile; is red in color; has a metallic luster and shining streak; has no cleavage; fuses readily before the blowpipe into a metallic globule, which, on cooling, becomes coated with a thin layer of black oxide.

Native copper is met with in irregularly-shaped grains and masses in fissures in rocks containing copper ores, and is most abundant in the vicinity of dikes of igneous rocks. It is frequently found in small amounts at or near the outcrop of copper veins, and in the Lake Superior copper region it forms the entire product of the region, occurring mostly in the shape of fine grains, disseminated through the rock.

49. Chalcopyrite.—Chalcopyrite, or *copper pyrites*, is distinguished by its strong metallic luster and brass-yellow color. It is very much like iron pyrites, but is deeper in color. It usually occurs in amorphous or uncrystallized masses, with an irregular or slightly conchoidal fracture; it is also found in mammillary, stalactitic, and botryoidal forms, and sometimes occurs crystallized, in tetrahedrons and octahedrons of the (hemihedral) tetragonal system, with indistinct cleavage.

Chalcopyrite ranges in hardness from 3.5 to 4, and in specific gravity from 4.1 to 4.3. Its brass-yellow color is subject to tarnish, becoming deep yellow, and often iridescent; streak is greenish-black, and slightly shining.

Composition: Approximately $CuFeS_2$, = sulphur 34.9%, copper 34.62%, and iron 30.5%. Different specimens give different proportions, chalcopyrite really consisting of indefinite mixtures of iron pyrites and copper pyrites.

B. B. on charcoal gives fumes of sulphurous oxide and fuses to a magnetic globule. In the closed tube, decrepitates, and gives a sublimate of sulphur; in the open tube, gives sulphurous oxide fumes. The roasted ore reacts for copper and iron in the bead; with soda on charcoal, gives a magnetic globule of copper and iron. Dissolves in nitric acid, excepting the sulphur, forming a green solution, which ammonia in excess changes to a deep blue color.

Chalcopyrite is distinguished from pyrite by its deeper

color and by its tarnishing, by being easily scratched with a knife, and by the reactions for copper B. B.

The mineral occurs in veins or in lodes in granite, in clay slate, serpentine, gneiss, and other rocks, and is commonly associated with pyrite, blende, galena, and with the other ores of copper.

Chalcopyrite is one of the largest sources of the copper of commerce, and practically all the sulphuric acid of commerce is made from chalcopyrite and iron pyrites.

50. Bornite.—Bornite, or *variegated copper pyrites*—also called *peacock copper*—holds a somewhat important position among copper-producing ores. It has a reddish-brown color and metallic luster; its surface tarnishes rapidly on exposure, and is commonly iridescent with different shades of blue, purple, and red; hence, its common names. Its streak is pale grayish-black, and slightly shining. Its structure is massive, granular, or compact. It is brittle, and its fracture is uneven. When crystallized, it is in isometric octahedrons and dodecahedrons; cleavage in traces. Its hardness is 3; specific gravity 4.4—5.5.

Composition: For crystallized varieties is approximately $FeCu_2S_4$, or sulphur 28.06%, iron 16.39%, copper 55.55%. The above proportions change for other varieties.

B. B. on charcoal fuses in R. F. to a brittle magnetic globule. In the closed tube, gives sublimate of sulphur; in the open tube, gives sulphurous oxide fumes. When roasted, gives reactions in the beads for iron and copper; soluble in nitric acid with separation of sulphur.

Bornite is distinguished from chalcopyrite by its copper-red, or bronze-red, color on surface of fresh fracture.

51. Chalcocite.—Chalcocite, or *copper glance*—also sometimes called *vitreous copper*—occurs both crystallized and massive. It crystallizes in the orthorhombic system, frequently in compound, six-sided prisms. It is found more frequently, however, in compact lamellar masses. The mineral is of a blackish-lead-gray color, often tarnished blue or green by oxidation, which gives it an iridescent appearance.

It has a metallic luster, and its streak is the same color as the mineral on surface of fracture. The ore is friable, slightly sectile, and has a conchoidal fracture. It varies in hardness from 2.5 to 3, and in specific gravity from 5.5 to 5.8.

Composition: Cu_2S (subsulphide of copper) = sulphur 20.2%; copper 79.8%. *Stromeyerite* is chalcocite with half of its copper sulphide replaced by the corresponding silver sulphide.

B. B. on charcoal alone melts to a globule, which boils with spurting; with soda, is reduced to a globule of metallic copper. It yields nothing volatile in the closed tube, but in the open tube gives sulphurous fumes. It is soluble in nitric acid.

Chalcocite is distinguished from the sulphide of silver (argentite), which it greatly resembles, by the copper reactions, and by not being sectile.

52. Tetrahedrite.—Tetrahedrite, or *gray copper*, usually occurs massive, granular (coarse or fine), or compact. When crystallized, it occurs in isometric tetrahedral crystals, from which the mineral derives its name. It ranges in color from steel-gray to iron-black, with the streak the same, or sometimes brown, or cherry-red. It is brittle, and has a conchoidal, uneven fracture. The hardness ranges from 3 to 4.5, and specific gravity from 4.7 to 5.6 (in the mercury-bearing variety).

Composition: It is essentially a mixture of sulphides of copper and antimony, corresponding to the formula $4Cu_2S + Sb_2S_3$ (or $Cu_4Sb_2S_7$), but the sulphide of antimony may be partially replaced by sulphide of arsenic, or of bismuth, or both, and the subsulphide of copper may be partially replaced by corresponding sulphides of silver, mercury, iron, or zinc. The *argentiferous* variety constitutes quite an important silver ore, and is steel-gray to dark gray in color. The *mercuriferous* variety, which often contains 15 to 18% of mercury, is dark gray to iron-black.

B. B. the characteristics differ in different varieties. In the closed tube, all fuse and give a dark-red sublimate of

antimonous sulphide; when containing mercury, a faint dark-gray sublimate appears at a low, red heat; if much arsenic, a sublimate of arsenous sulphide first forms. In the open tube, fuses, gives sulphurous fumes and a white sublimate of antimony. If arsenic is present, a crystalline volatile sublimate condenses with the antimony; if the ore contains mercury it condenses in the tube in metallic globules. B. B. on charcoal, gives a coating of antimonous oxide; sometimes arsenic oxide, zinc oxide, and lead oxide. The arsenic may be detected by the garlic odor exhaled when the coat is treated in the R. F.; the zinc oxide assumes a green color when heated with the cobalt solution. Roasted, the mineral reacts in the beads for copper. With soda on charcoal, yields a button of metallic copper; during this test the presence of even a trace of arsenic becomes apparent by the odor. The presence of mercury is best told by fusing the pulverized ore in the closed tube with about three times its weight of dry soda, the metal subliming and condensing in small metallic globules. The silver is determined by cupellation. Nitric acid decomposes the mineral, with a separation of sulphur and antimonous and arsenous acids.

Tetrahedrite is widely distributed, and is valuable, not so much as a copper ore as an ore of silver.

53. Cuprite.—Cuprite, or *red copper ore*, occurs both crystallized and massive and sometimes earthy. It is remarkable for its color, which is deep red, of various shades. The streak is reddish-brown. It crystallizes in isometric octahedrons and dodecahedrons, and combinations of the two. It has a well-defined cleavage, adamantine to submetallic luster, and an uneven or conchoidal fracture, and is very brittle. Hardness, 3.5—4; specific gravity, 5.85—6.15. When crystals of this mineral are opaque, they have an iron-gray tint on the surface, but their peculiar red color becomes apparent when they are reduced to a fine powder.

Composition: Suboxide of copper (Cu_2O) = oxygen 11.2%, copper 88.8%.

B. B. in the forceps, fuses and colors the flame emerald-

green; moistened with hydrochloric acid, the flame is momentarily colored azure-blue. Unaltered in the closed tube. On charcoal, first blackens, and is then reduced to a globule of metallic copper; in the beads, reacts for copper; soluble in concentrated hydrochloric acid.

It is a very rich and pure ore of copper, but seldom occurs in large quantities, and usually only at or near the outcrop of copper veins.

54. Melaconite.—Melaconite, or *black copper ore*, is another oxide of copper, resembling cuprite in its blowpipe reactions, but differing from it in physical characteristics. It usually occurs as a black powder, or as dull black, friable masses and botryoidal concretions, in veins of other copper ores. These masses are composed usually of melaconite mixed with earthy impurities.

Melaconite frequently contains sulphur and arsenic and often considerable quantities of oxide of iron and manganese. This would indicate that black oxide of copper, which is obtained in many localities in sufficient abundance to render its extraction an important consideration, is the result of the decomposition of other ores, such as copper pyrites. The hardness is about 3; specific gravity, 6.25.

Composition: Copper oxide (CuO) = oxygen 20.1%; copper 79.9%.

B. B. in O. F., infusible. Other reactions, as for cuprite.

55. Malachite.—Malachite, or *green carbonate of copper*, occurs both crystallized and massive, more usually the latter, with a botryoidal, stalactitic, or divergent structure which is very characteristic. Often it is fibrous and banded in color; frequently granular and earthy. It has a perfect cleavage, and crystals have an adamantine luster, inclining to vitreous. The fibrous varieties have a more or less silky luster. The color is usually bright green, the same specimen, however, exhibiting a diversity of shades from bluish- or grass-green to nearly black. The streak is paler green. The fracture is uneven. Hardness, 3.5—4; specific gravity, 3.7—4.

Composition: May be represented by the following formula: $CuCO_3 + CuH_2O_2$, (or $CuCO_3 + CuO + H_2O$)—a mixture of carbonate and hydrate of copper, containing 57.4% metallic copper and 8.2% water.

B. B. fuses at 2, coloring the flame emerald-green; on charcoal, with soda, is reduced to metallic copper; in the beads, reacts for copper; in the closed tube, blackens and yields water; effervesces with acids.

Malachite is easily distinguished by its softness and green color and streak from all other minerals except a series of rare copper minerals that are also green and soft (the phosphates, arsenates, and chlorides); and from these it can usually be distinguished by its radiating structure and by its effervescing with acids.

Malachite is a very common mineral at or near the outcrop of most copper veins, and if hard and solid, it is highly prized as a beautiful ornamental stone for inlaid work, vases, etc., as it takes a fine polish.

56. Azurite.—Azurite, or *blue copper carbonate*, occurs both in mammillary concretions and in well-defined and brilliant crystals. It also occurs massive and likewise earthy. It has a nearly perfect cleavage and a vitreous, almost adamantine, luster. Its color comprises various shades of azure-blue, passing into Berlin blue. Streak is lighter in color. The mineral is brittle and has a conchoidal or uneven fracture. Hardness, 3.5—4.5; specific gravity, 3.5—3.83.

Composition: May be represented by the formula $2CuCO_3 + CuH_2O_2$, corresponding to carbon dioxide 25.6% copper oxide 69.2% (metallic copper 55.4%), and water 5.2%

B. B. the same reactions are observed as for malachite. It is easily distinguished by its softness, blue color and streak, and by effervescing in acids.

Azurite occurs almost always with malachite (or the green carbonate), and is found usually at or near the outcrop of copper veins. The staining power of both of these carbonates in rocks is remarkable, a very small proportion giving

the rock a decidedly blue or green color, and a few per cent. is sufficient to make the rock appear to be almost solid malachite or azurite. For this reason, the appearance of copper-stained rocks is apt to be seriously misleading as to their value.

57. Chrysocolla.—Chrysocolla is never crystallized. It occurs usually as an incrustation, or in thin seams in crevices, and as copper stains on rocks. It also sometimes occurs massive and botryoidal. It is often opal-like or enamel-like in texture, and is sometimes translucent. Most varieties are sectile and have a vitreous or shining luster, or are sometimes earthy. Color is mountain-green or bluish-green, passing into sky-blue and turquoise-blue. Streak, when pure, white. Hardness ranges from 2 to 4; specific gravity from 2 to 2.24.

Composition: Hydrated silicate of copper; composition varies considerably in different varieties, owing to the presence of impurities. The formula for the pure mineral is $CuSiO_3 + 2H_2O$, corresponding to silica 34.2%, copper oxide 45.3% (copper 36.2%), and water 20.5%.

B. B. decrepitates, colors the flame emerald-green, and is infusible. On charcoal, with soda, is reduced; in closed tube, blackens and yields water; decomposed by the acids without a gelatinization of the silica.

LEAD (Pb).

58. Lead is a soft metal of a bluish-gray color, and when recently cut exhibits a surface of strong metallic luster. It rapidly tarnishes when exposed to the air. Lead is both malleable and ductile, but its tenacity is inferior to that of nearly all other ductile metals. It is flexible and inelastic. It is only feebly attacked by hydrochloric acid, even when concentrated and boiling. Weak sulphuric acid does not act on lead when air is excluded, but if heated in a concentrated solution, SO_2 is evolved, and lead sulphate is slowly formed. The proper solvent for lead is nitric acid. Hardness, 1.5; specific gravity, 11.45.

LEAD MINERALS.

59. The lead minerals are all very heavy, quite soft, and, if pure, all except the sulphide (galena) have a non-metallic, highly adamantine luster. Galena has an eminent metallic luster. They easily reduce to a soft, malleable button of metallic lead when treated on charcoal with soda, and, excepting the sulphate, all dissolve readily in boiling nitric acid, and from this solution sulphuric acid precipitates the lead as a white, insoluble sulphate. The carbonate dissolves readily, with effervescence, in nitric acid.

60. Galenite, or Galena.—This mineral, which is also called *lead glance*, occurs principally in cubes, which are frequently of considerable size. It also occurs in coarse and fine grained, massive forms. The very fine-grained *steel galena*, which is quite common in silver regions, cuts under the knife, leaving a smooth, shining, metallic surface. Galena is remarkable for its perfect cubic cleavage and its eminent metallic luster. It is lead-gray in color and streak, very brittle and fragile, and its fracture is uneven. The surface of the mineral is susceptible to tarnish. Hardness, 2.5—2.75; specific gravity, 7.25—7.7.

Composition: Sulphide of lead (PbS), corresponding to sulphur 13.4%, lead 86.6%. All galena is more or less argentiferous, but no external characters serve to indicate the amount of silver present.

B. B. fuses, gives off sulphurous fumes, coats the coal with a yellow coat, and yields a metallic button of lead. In the open tube, gives sulphurous fumes; is soluble in nitric acid.

Galena is distinguished quite easily from other soft, metallic, lead-gray minerals by its perfect cubic cleavage, which is rarely absent, and by its high gravity

Galena occurs in granite, limestone, and in sandstone rocks, and is frequently associated with ores of copper and zinc. The matrix in which this ore has been deposited is, in most cases, either quartz, calcite, fluor spar, or "heavy-spar" (barium sulphate) It is the most common and

important ore of lead, and frequently is also a very valuable silver ore. All galenas carry more or less silver, usually at least 1 or 2 ounces per ton, and when the amount runs up to 10 ounces or over, it generally pays to extract the silver. These silver-bearing, or argentiferous, galenas are more abundant in disturbed or mountainous regions, where they sometimes carry as much as 200 ounces of silver per ton. Every find of galena should be assayed for silver, as this is the only reliable way of determining whether it is silver-bearing.

61. Cerussite.—Cerussite, or *white-lead ore*, is found both crystallized and massive. The massive forms sometimes, though rarely, show a fibrous structure. The crystals take the form of modified orthorhombic prisms, and often compound, two or three crossing each other; frequently they interlace or are in radial masses. The mineral occurs also in concretions and in amorphous, or uncrystallized, friable deposits. The crystal and cleavage faces have an adamantine luster, inclining to vitreous or resinous; sometimes pearly. The crystals are usually thin, broad, and brittle. Cleavage is imperfect. The color is generally white and gray, though it sometimes happens that crystallized specimens are nearly black, from the decomposition of some associated galena; sometimes tinged yellow or brown from iron, or blue or green from associated copper salts. The streak is uncolored. Hardness, 3—3.5; specific gravity, 6.47.

Composition: Lead carbonate ($PbCO_3$), corresponding to carbon dioxide 16.5%, and lead oxide 83.5%, or metallic lead about 77.5%. *Hard carbonates* are impure cerussite, corresponding to the clay ironstones.

B. B. fuses easily, and in R. F. on charcoal, yields a metallic button. In closed tube, decrepitates, loses carbon dioxide, turns yellow at first, and then dark red at a higher temperature, and finally, on cooling, becomes yellow again. Effervesces and dissolves in nitric acid.

Cerussite is readily recognized by its high gravity, by its

effervescing in nitric acid, and by giving a lead button on charcoal.

It is a very valuable ore of lead, quite common in the mining camps of the West. It runs into galena with depth. Like galena, it always contains some silver, and should always be assayed to determine if the silver occurs in profitable amounts—over 5 to 10 ounces per ton.

62. Anglesite.—Anglesite occurs sometimes crystallized, especially on galena, but generally is massive, and is found occasionally as a grayish, ash-like, firmly adhering incrustation on galena. It is brittle, and varies from transparent, in the crystallized variety, to opaque in the massive. Cleavage is usually absent. The fracture is conchoidal.

The color of the pure mineral is white, but generally it is stained brown or yellow by iron, or slightly gray or green by undecomposed galena, copper, and other impurities. The streak is colorless. The luster of the crystallized mineral is adamantine, sometimes inclining to vitreous or resinous; of the massive mineral, dull to earthy. The name of "rock ore" is very appropriately applied to some massive varieties having a very stony appearance. Hardness, 2.75—3; specific gravity, 6.3.

Composition: Lead sulphate ($PbSO_4$), corresponding to sulphur trioxide, 26.4%, and lead oxide 73.6%, or metallic lead, about 68%.

B. B. alone decrepitates and fuses at 1.5 (in candle flame); on charcoal, in the O. F., fuses to a clear glass, which on cooling becomes milk-white; in the R. F., is reduced with effervescence to a metallic button. With soda on charcoal, the lead is reduced, and the soda sinks into the coal. When the surface of the coal is removed and is placed on silver and moistened, it turns the metal black—the test for sulphur in sulphates. Very slightly soluble in nitric acid.

Anglesite is distinguished from cerussite by its compact, dense structure, and by not effervescing with acids, and from other similar minerals by its high gravity, adamantine luster, and by its blowpipe characteristics.

It is an important ore of lead, and occurs chiefly in the upper parts of lead-bearing veins which run into galena with depth. It always contains a little silver, and should be assayed for this metal whenever found.

63. Pyromorphite.—Pyromorphite occurs usually in hexagonal prisms of a bright green, yellow, or brown color, of different shades, sometimes in crystalline crusts, and sometimes globular or reniform, with a radiated structure. The crystals have a lateral cleavage in traces, and are often nearly transparent. The luster is resinous. The streak is white, sometimes yellowish. The crystals are brittle and have an uneven fracture. Hardness, 3.5—4; specific gravity, 6.5.

Composition: A phosphate and chloride of lead [$3(3PbO + P_2O_5) + PbCl_2 = 3Pb_3P_2O_8 + PbCl_2$], corresponding to phosphorus pentoxide 15.75%, lead oxide 74%, and lead chloride 10.25%. Some varieties have arsenic replacing the phosphorus, and in some others lime replaces part of the lead.

B. B. in the forceps, fuses at 1.5, and colors the flame bluish-green, showing the combined presence of lead and phosphorus. This reaction is especially apparent after moistening with sulphuric acid. In the closed tube, gives a white sublimate; alone, on charcoal, fuses, without reduction, to a globule which assumes a crystalline form on cooling, while the coal is coated at a distance from the assay with a white sublimate of lead chloride, and nearer the assay, yellow from lead oxide; on charcoal, with soda in R. F., is reduced to metallic lead. In a salt of phosphorus bead, previously saturated with copper oxide, it colors the O. F. blue, thus showing the presence of chlorine. Soluble in nitric acid.

Pyromorphite is distinguished by its hexagonal prismatic crystals, which are frequently hollow inside, by its green color and resinous luster, by its high gravity, and by its blowpipe characteristics.

It occurs chiefly in veins, associated with other ores of lead.

ZINC (Zn).

64. Zinc has been used from ancient times for the purpose of alloying with copper to form brass. It is a bluish-white metal, and upon a surface of fresh fracture presents a brilliant crystalline structure. At ordinary temperatures it is brittle, but between 100° C. and 150° C. it is ductile and malleable. At 205° C. it again becomes brittle and may with ease be pulverized in a mortar. At 433° C. it fuses, and upon cooling exhibits a highly crystalline texture. Hardness, 2; specific gravity, 6.8—7.2.

Zinc is soluble in hydrochloric and dilute sulphuric acids, with an evolution of hydrogen gas. It is also soluble in boiling solutions of potash or soda, with a similar evolution of hydrogen gas.

The zinc of commerce, known as "spelter," is never chemically pure, but is more or less contaminated with such impurities as lead, cadmium, and iron. It is largely used for galvanizing sheet iron, as a constituent of brass, in electrical appliances, for precipitating gold from potassium cyanide solutions in the cyanide process of gold extraction, for separating gold and silver from lead in the refining of base bullion (lead containing gold and silver), etc.

ZINC MINERALS.

65. A specimen of native zinc is stated to have been discovered at Melbourne, Victoria, in a cavity in basalt; but the occurrence of this metal in the native state requires confirmation. It usually occurs in nature in combination with sulphur, oxygen, and carbonic, silicic, or sulphuric anhydrides.

B. B. the ores of zinc are almost completely infusible. They all, except franklinite, have a non-metallic luster; they are only moderately heavy, are rather hard, and are apt to be associated with one another. On charcoal, after strongly heating with soda, they all give a white coat, which glows brightly, is non-volatile, yellow while hot, but white

on cooling, and which, if moistened with cobalt solution, gives a characteristic yellowish-green, infusible mass. They all dissolve in aqua regia, on boiling, while the carbonate dissolves with effervescence in warm nitric, hydrochloric, or sulphuric acid.

66. Sphalerite.—Sphalerite, or *zinc-blende*, varies greatly in color, from white to yellow, red, brown, and black, and the streak is white to reddish-brown. The luster in some of the black varieties is submetallic to adamantine, but is most frequently resinous. It often occurs crystallized, in isometric dodecahedrons, octahedrons, and their modifications, but is more frequently massive, and has a perfect dodecahedral cleavage. It is brittle and usually opaque, though sometimes transparent when crystallized. The fracture is conchoidal.

The variations in color in this mineral are due to the presence of impurities, the dark variety containing sulphide of iron, while the red variety has frequently as much as 5% of cadmium. Hardness, 3.5—4; specific gravity, 3.9—4.2.

Composition: Zinc sulphide, (ZnS), containing sulphur 33%, zinc 67%. It often has some of the zinc replaced by iron or cadmium.

B. B. difficultly fusible; alone on charcoal, some varieties give first in the R. F., a reddish-brown coat of cadmium oxide; afterwards a coat of zinc oxide, which is yellow while hot and white when cold. With cobalt solution in the O. F., this coat becomes green. With soda on charcoal in R. F., gives a strong green zinc flame. In the open tube, gives sulphurous fumes, and usually changes color. When roasted and treated in the beads, gives an iron reaction.

Distinguished by its resinous luster, softness, yellow streak, cleavage, and infusibility.

It is the most common and important ore of zinc, and most of the zinc of commerce is derived from this ore. It occurs frequently associated with other sulphide minerals (like galena, pyrite, chalcopyrite, etc.) in fissure veins, and carries more or less silver, and occasionally gold, but usually

in insufficient amounts to pay for extraction, as the zinc makes it difficult and expensive to work.

67. Smithsonite.—Smithsonite is sometimes found in crystals, but more frequently as incrustations, and in reniform and stalactitic forms and concretionary masses, and occasionally earthy and friable. When crystallized, it has a perfect cleavage.

Its color, when pure, is yellowish-white, but when contaminated with iron, it is frequently brown or reddish-brown. The streak is white. The luster is vitreous, inclining to pearly. It is brittle and has an uneven fracture. The massive mineral is frequently called "dry-bone" by American miners, from its very characteristic appearance. Hardness, 5; specific gravity, 4—4.5.

Composition: Zinc carbonate ($ZnCO_3$), corresponding to carbon dioxide 35.2%, and zinc oxide 64.8%, or metallic zinc 52%. Part of the zinc is sometimes replaced by iron or manganese, and by traces of calcium, magnesium, or even cadmium.

B. B. is infusible; moistened with cobalt solution and heated in the O. F., gives a green color on cooling. With soda on charcoal, a coating of zinc oxide is formed, yellow while hot, white when cold, which behaves as above when treated with cobalt solution. Those varieties containing cadmium, when treated with soda on charcoal, give a deep yellow or brown coating before the zinc coat appears. In the beads some varieties give reactions for iron, manganese, copper, etc. In the closed tube, it loses carbon dioxide, and if pure, it is yellow while hot, white when cold. It is soluble with effervescence in warm hydrochloric acid.

Distinguished with some difficulty, owing to the absence of any marked individuality. It is usually grayish-white to green or brown, and massive; is soluble with effervescence in warm hydrochloric acid, and gives characteristic blowpipe reactions.

Smithsonite is one of the most important ores of zinc. It occurs almost invariably associated with the silicates,

together with which it is extensively employed for the production of spelter.

68. Calamine.—Calamine was for a long time confounded with the carbonate of zinc, although they differ materially from one another, in both chemical and physical characteristics. It occurs in botryoidal and fibrous forms; also granular, massive, and crystallized. It has perfect prismatic cleavage.

Color is usually white; sometimes it has a bluish or greenish shade; also yellowish to brown. Streak is white. It is transparent to opaque, is brittle, and has a vitreous luster and uneven fracture. Hardness, 4.5—5; specific gravity, 3.2—3.9.

Composition: Hydrous silicate of zinc, $Zn_2SiO_4 + Aq.$ *, corresponding to silica 25%, zinc oxide 67.5%, and water 7.5%; metallic zinc 54.3%.

B. B. is almost infusible ($F = 6$). Moistened with cobalt solution, gives a deep, ultramarine-blue color when strongly heated, from the formation of a silicate of cobalt. The characteristic green color of the zinc-cobalt test is very difficult to obtain directly, but by fusing with soda on charcoal, a coat is obtained which gives the characteristic green with cobalt solution. On charcoal, it gives the same reactions as those already described for smithsonite. It gelatinizes with acids, and is soluble in a strong solution of caustic potash. In the closed tube, decrepitates, whitens, and gives off water.

Calamine is distinguished by gelatinizing with acids, by its infusibility, and its reactions B. B. for zinc, and by its bladed or radiate structure.

It occurs associated with the other ores of zinc.

69. Zincite.—Zincite, or *red zinc ore*, occurs rarely in any well crystallized form, but more frequently in foliated masses or in coarse grains, associated with franklinite and willemite. It is red to orange-yellow in color, and has an

NOTE—**Aq.* is the abbreviation for *aqua* (water), and indicates that the substance contains water.

orange-yellow streak; it ranges from granular to massive in structure, and has a perfect cleavage. It is brittle and opaque, with a subadamantine luster. Hardness, 4—4.5; specific gravity, 5.5.

Composition: Zinc oxide (ZnO), containing zinc 80.26% and oxygen 19.74%. Frequently contains traces of iron and manganese.

B. B. infusible; in the beads, gives a reaction for manganese; on charcoal in R. F., gives a coat of zinc oxide, yellow while hot, white when cold, which gives the characteristic reaction with cobalt solution. Heated in closed tube, blackens, but resumes its original color upon cooling. Soluble in acids.

Zincite is distinguished from allied minerals without difficulty by its physical characteristics.

70. Franklinite.—Franklinite, or *black zinc ore*, occurs usually in coarse, octahedral and dodecahedral grains, resembling magnetite, almost universally associated with zincite, willemite, and calcite. Occasionally it is found massive. It has only an indistinct cleavage. The luster is metallic, color iron-black, and streak reddish-brown. It is brittle, has a conchoidal fracture, and is slightly magnetic. Hardness, 5.5—6.5; specific gravity, 5.1.

Composition: A variable mixture of iron oxide (magnetite), zinc oxide, and oxide of manganese. The average of several samples gave: iron 45.16%, manganese 9.38%, zinc 20.30%, and oxygen 25.16%. It is essentially a magnetite, containing zinc and manganese oxides partly replacing both oxides of iron.

B. B. infusible. With borax in O. F., gives a reddish-amethystine bead, showing the presence of manganese, and in the R. F., the bead becomes bottle-green, which indicates the presence of iron. On charcoal, with a mixture of soda and borax, gives a coat of zinc oxide, which may be further identified by the cobalt solution. When fused with sodium carbonate and sodium nitrate on platinum foil, gives an alkaline manganate of a bright green color. Franklinite is

soluble in hydrochloric acid, with the evolution of a small amount of chlorine gas.

Franklinite is distinguished from magnetite, which it greatly resembles, by its slighter magnetic property, and by its reactions B. B. for zinc.

It is found abundantly at Franklin, New Jersey, associated with the other zinc minerals, zincite and willemite, hence its name.

71. Willemite.—Willemite occurs in minute crystals; massive; disseminated in grains, and infrequently fibrous. Its color is whitish or greenish yellow, to green, red, or brown when impure; streak, uncolored. Its luster is vitreous-resinous. Transparent to opaque. It is brittle and has a subconchoidal fracture. Hardness, 5.5; specific gravity, 3.89—4.27.

Composition: Anhydrous silicate of zinc (Zn_2SiO_4), containing silica 27.1% and zinc oxide 72.9%.

B. B. in forceps, glows and fuses with difficulty to a white enamel. With soda on charcoal, gives the characteristic coat of zinc oxide. It is decomposed by hydrochloric acid with separation of gelatinous silica. With cobalt solution it gives the same reaction as calamine.

Many impure varieties give reactions for manganese and iron.

Found almost universally associated with zincite and franklinite. At Franklin, New Jersey, it occurs in such quantities as to constitute an important ore of zinc.

SILVER (Ag).

72. Silver is a white metal, capable of receiving a brilliant polish. It stands next to gold in point of ductility and malleability. It is harder than gold and softer than copper. Hardness, 2.5—3; specific gravity, 10.5—11.1.

Unless in a fine state of division, silver is not acted upon by hydrochloric acid, and even then it must be heated to boiling before decomposition of the acid is effected. It is

not acted upon by dilute sulphuric acid, but when heated in concentrated sulphuric acid, the acid is decomposed with the formation of silver sulphate and the evolution of sulphurous oxide. Nitric acid attacks silver at even ordinary temperatures, with the formation of silver nitrate, and the evolution of nitric oxide. Oxide of silver may be reduced by heat alone.

SILVER MINERALS.

The silver minerals are all soft, all are heavy, most of them have a metallic luster, and several are sectile. They are all easily fusible, and can be reduced to a button of metallic silver, on fusing with soda on charcoal, or when cupelled with metallic lead. With the exception of the chloride group, they all dissolve in boiling nitric acid, and hydrochloric acid or common salt added to a silver solution throws down a white, curdy precipitate of chloride of silver, which is soluble in an excess of ammonia.

While there is a large number of silver minerals, many of them are very rare, and only those of common occurrence are here described. The ores of lead, copper, zinc, antimony, and arsenic often contain silver in paying quantities, especially in disturbed regions, but in a form that is invisible to the eye, so that it must be cupelled or assayed to determine the presence or quantity of silver.

Dry ores, or milling ores, are those consisting essentially of quartz and rich silver minerals, suitable for amalgamation; those containing sulphides of lead or copper in quantity are *smelting ores*.

Free milling ores are dry ores suitable for direct amalgamation without any previous treatment save crushing.

Refractory ores are those containing antimony, arsenic, sulphur, and zinc-blende, making it necessary to roast the ore before amalgamation. These elements render ore refractory for smelting also, zinc-blende being especially undesirable, and reductions are made on the price of ores when the amount of this ingredient exceeds a certain proportion, usually 12%.

73. Native Silver.—Silver is found in a metallic state accompanying almost all of its ores, particularly the sulphide and chloride. It occurs in distinct crystals, in amorphous masses, in long filamentary strings (*hair or wire silver*), and in compressed plates.

It has a shining, silver-white color and streak, but is frequently tarnished to a grayish-black color. It has a metallic luster when freshly fractured, has no cleavage, and is extremely ductile and malleable. It consists of nearly pure silver, containing usually small amounts of copper and gold.

Native silver is readily distinguished by its high gravity, pure white color, and malleability. It is easily dissolved by nitric acid.

74. Argentite.—Argentite, or *silver glance*, usually occurs massive; also in reticulated and filiform shapes and in modified isometric dodecahedrons. Its color and streak are blackish-lead-gray. The streak is shining. It has a metallic luster, conchoidal fracture, and is malleable. Hardness, 2—2.5; specific gravity, 7.3.

Composition: Silver sulphide (Ag_2S) = sulphur 12.9%, silver 87.1%.

B. B. on charcoal, fuses in the O. F. with intumescence (swelling), emitting sulphurous fumes, and yielding a globule of metallic silver. In the open tube, gives off sulphurous oxide. It is fusible even in the flame of a candle.

Argentite is distinguished from other ores of silver by its malleability.

75. Stephanite.—Stephanite, or *brittle silver*, is of an iron-gray color, inclining to black, with streak of the same color and metallic luster. It has a conchoidal fracture. It usually occurs massive, has no cleavage, and is very brittle. Hardness, 2—2.5; specific gravity, 6.3.

Composition: Sulphide of silver and antimony (Ag_3SbS_4 , or $5Ag_2S + Sb_2S_3$); sulphur 16.2%, antimony 15.3%, silver 68.5%.

B. B. on charcoal, fuses with spurting of small particles, coats the coal with antimonous oxide, which, after long

blowing, is colored red from oxidized silver, and a globule of metallic silver is obtained. In the closed tube, decrepitate, fuses, and afterwards gives a faint sublimate of antimonous sulphide. In the open tube, gives fumes of antimonous oxide and sulphurous oxide. It is soluble in heated dilute nitric acid, with a separation of sulphur and antimonous oxide.

Stephanite is distinguished from other silver-antimony minerals by its color and streak, and from argentite by brittleness and antimony reaction.

76. Pyrargyrite.—Pyrargyrite, or *ruby silver*, usually occurs massive, though occasionally crystallized. The cleavage is imperfect. The mineral is dark-red to almost black in color; has a cochineal-red streak, slightly darker than that of proustite. Its luster is from vitreous to adamantine. It is very brittle. Hardness, 2—2.5; specific gravity, 5.8.

Composition: Ag_3SbS_3 (or $3Ag_2S + Sb_2S_3$) = sulphur 17.7%, antimony 22.5%, silver 59.8%.

B. B. on charcoal, fuses with spurting to a globule, gives off antimonous fumes, and coats the coal white; with soda on charcoal, in the O. F., or by prolonged heating without fluxes in the R. F., gives a globule of silver. In the closed tube, gives a reddish sublimate of antimonous sulphide; in the open tube, gives sulphurous fumes and a white sublimate of antimonous oxide. In some varieties arsenic is present, in which case it can be recognized by its garlic odor when the pulverized mineral is treated in the R. F. with soda on charcoal.

It is decomposed by nitric acid with a separation of sulphur and antimonous oxide.

Pyrargyrite is distinguished by its dark-red color, its streak, and its high gravity.

77. Proustite.—Proustite, or *light ruby silver*, is of practically the same composition as pyrargyrite, but with arsenic replacing much or all of the antimony. It is similar, also, in occurrence and physical properties. It occurs both

crystallized and massive. It has a cochineal-red color and a cochineal-red streak, inclining to aurora-red. Luster is splendid adamantine. It is transparent and very brittle. Hardness, 2.25; specific gravity, 5.5.

Composition: Ag_3AsS_3 , (or $3Ag_2S + As_2S_3$) = sulphur 19.4%, arsenic 15.1%, silver 65.5%.

B. B. on charcoal, fuses and emits odors of sulphur and arsenic; or with soda on charcoal, in the O. F., or by prolonged heating without fluxes in the R. F., gives a globule of silver.

In the closed tube, fuses easily, and gives a faint sublimate of arsenous sulphide; in the open tube, sulphurous fumes and a white crystalline sublimate of arsenous oxide. Some varieties of proustite contain antimony.

Proustite is distinguished from pyrargyrite by its lighter color and streak and by the reaction B. B. for arsenic.

78. Cerargyrite.—Cerargyrite, or *horn silver*, is so called from its horn-like color and luster. It usually occurs massive and looking like horn or wax; often in grains and thin seams; rarely crystallized, and cleavage is absent. It has a grayish color and streak, but becomes tarnished to a brown or violet-brown color on exposure. It has a non-metallic, wax-like luster. It is very sectile, and can be cut into shavings with a knife. A plate of iron rubbed with it becomes silvered. Hardness, 1—1.5; specific gravity, 5.5.

Composition: Silver chloride ($AgCl$) = chlorine 24.7% and silver 75.3%.

B. B. on charcoal, gives a globule of silver. Added to a salt of phosphorus bead previously saturated with copper oxide, and heated in the O. F., imparts an azure-blue color to the flame, indicating chlorine. In the closed tube, fuses without decomposition. A fragment placed on a strip of zinc and moistened with a drop of water swells up, turns black, and is finally reduced to a globule of metallic silver. Insoluble in nitric acid, but soluble in ammonia.

It occurs at or near the surface of most silver-bearing veins, and is distinguished by its sectility and waxy appearance.

GOLD (Au).

79. Gold has a characteristic orange-yellow color, and is the most malleable of all metals. Hardness, 2.5—3; specific gravity, 19.3.

When precipitated from its solutions, gold has a dark-brown color, but assumes its ordinary color and metallic aspect upon being polished or heated.

Gold is not attacked by sulphuric, nitric, or hydrochloric acids separately. Aqua regia completely dissolves it, forming auric chloride. Free chlorine gas attacks gold, and this reaction is the basis of the chlorination process. Dilute solutions of the alkaline cyanides also dissolve it. Pure gold may be indefinitely exposed to the action of air and moisture without becoming tarnished. It is highly esteemed, on this account, for jewelry and coins.

GOLD MINERALS.

80. Gold occurs metallic in nature, alloyed with more or less silver, and frequently with minute quantities of copper and iron. It is also found in combination with the rare metals palladium, rhodium, and platinum, and likewise with mercury, forming a native amalgam. With tellurium it forms several compounds of some commercial interest.

81. Native Gold.—Gold, in the native state, presents a characteristic yellow color, somewhat paler than that of the refined metal, from the presence of some silver. Its natural surfaces are sometimes dull or tarnished, and must be rubbed with some hard substance before they assume the ordinary appearance of gold. When broken by repeated bending, it presents a matted, silky structure, more or less fine in accordance with the purity of the specimen.

It occurs in veins, as grains, scales, wires, leaf-like, and seldom as more or less perfect isometric octahedral and dodecahedral crystals, and very commonly as rounded grains and nuggets in gravel beds and placer deposits. It is very

malleable, and can be hammered out into thin leaves. Cleavage is absent.

Gold can always be distinguished from all minerals of similar appearance by its great weight, softness, eminent malleability, characteristic yellow color, and the fact that it is not attacked by any single acid.

It is soluble in aqua regia (three parts of hydrochloric acid to one part of nitric acid), and fuses quite easily in the blowpipe flame.

Native gold is found most commonly as rounded grains and nuggets in stream beds or placer deposits, at the bottom of the gravel bed. It occurs also in association with quartz and pyrite in veins in slate, schists, and the granitic rocks, especially in highly disturbed regions.

It is also found, though invisible to the eye, in many copper ores, iron ores, and arsenic ores. It contains from a trace to 40% of silver, and sometimes small amounts of other metals.

82. Sylvanite.—Sylvanite, or *graphic tellurium*, is, perhaps, the most abundant combination of gold and tellurium. It occurs most frequently interspersed in quartz vein-stuff in groups of silvery-white crystals, resembling Hebrew characters. This resemblance to written characters gives it the name of *graphic tellurium*. Its color and streak are from silver-white to pure steel-gray, and sometimes nearly brass-yellow. It has a metallic luster, rather a distinct cleavage, and an uneven fracture. Hardness, 1.5—2; specific gravity, 8.2.

Composition is $(AgAu)Te_2$, a telluride of silver and gold; tellurium 55.7%, silver 15.7%, and gold 28.6%. Antimony sometimes replaces part of the tellurium, and lead replaces part of other metals.

B. B. on charcoal, fuses to a dark-gray globule, covering the coal with a white coating, which, treated in the R. F., disappears, giving a bluish color to the flame, indicating tellurium; after prolonged heating, a yellow metallic button is obtained.

In the open tube, gives a white sublimate, shading into gray near the assay; when further heated, this sublimate fuses to clear, transparent drops. Most varieties also give a faint coating on charcoal of the oxides of lead and antimony. Boiled in concentrated sulphuric acid, the tellurium gives a purple color, which disappears on cooling.

Sylvanite is distinguished by its characteristic graphic structure, its high gravity, and its blowpipe characteristics.

83. Nagyagite, or *foliated tellurium*, has a dark, lead-gray color and streak and a foliated structure; generally massive. It is sometimes called *black tellurium*. Its luster is metallic and splendid; it is sectile, and flexible when in thin laminæ. Hardness, 1—1.5; specific gravity, 7.1.

Composition is indefinite, approximately Pb, Au, Sb, Te, S , = lead 57%, gold 7.7%, antimony 7.1%, tellurium 17.6%, and sulphur 10.7%; this corresponds closely with the average analysis of the mineral, though all of the constituents vary considerably in different specimens, and several other elements are sometimes found in varying proportions.

B. B. on charcoal, forms two coatings: one white and volatile, consisting of a mixture of antimonate, tellurate, and sulphate of lead, and the other of yellow oxide of lead, less volatile and quite near the assay. If the mineral is treated for some time in the O. F., a malleable globule of gold remains, which, cupelled with a little granulated lead, assumes a pure gold color.

In the open tube it gives, near the assay, a grayish sublimate of antimonate, tellurate, and a little sulphate of lead; farther up the tube the sublimate consists of antimonous oxide, which volatilizes when treated with the flame, and tellurous oxide, which fuses at a high temperature to clear, colorless drops. In concentrated sulphuric acid it gives the same reaction as sylvanite and other tellurides. It is decomposed by aqua regia.

It is distinguished by its foliated structure and blowpipe characteristics.

COAL.

84. The mineral coal is essentially carbon, associated with more or less of various hydrocarbons (chemical compounds of hydrogen and carbon, in various proportions). It is the result of the decomposition of vegetable matter in the presence of water and out of contact with the air, as, for instance, the submerged accumulations in swamps. The immense coal-beds of the world were formed at periods when such vegetation was much more luxuriant than at present. The beds of *peat* resulting from such decomposition alone were in time covered by other formations, and were gradually consolidated and metamorphosed, by the weight of the accumulating strata and the heat of the earth, or occasionally by the heat due to local faulting or volcanic action, into *coal*, the variety depending upon the stage to which the metamorphosis has progressed. Peat grades into *brown coal* or *lignite*; lignite grades through *semi-bituminous* coal into one of the varieties of *bituminous* coal, and bituminous coal grades through *semi-anthracite* into *anthracite*, which is the highest form of coal. *Graphite* represents a still higher stage in the metamorphosis of vegetable carbon into mineral matter, and the *diamond* is the ultimate product—pure crystallized carbon.

All varieties of coal have a more or less compact, massive structure, not crystalline, and without true cleavage, though sometimes breaking with a degree of regularity, but from a jointed rather than a cleavage structure. It is sometimes laminated, and is often faintly and delicately banded, successive layers differing slightly in luster.

The color varies in different coals from black to grayish-black, brownish-black, and sometimes dark-brown; occasionally it is iridescent. Its luster varies also from dull to brilliant; sometimes either earthy, resinous, or submetallic. Fracture is uneven. It is brittle; rarely somewhat sectile. Without taste except from the impurities present. Infusible to subfusible, but often becoming a soft, pliant, or paste-like mass when heated. On distillation, most kinds

yield more or less of tarry or oily substances, which are mixtures of various hydrocarbons.

85. The different varieties of coal are classified principally according to the proportion of volatile matter they contain and the character of this volatile matter. The volatile matter is made up of more or less water, some sulphur, and the balance, the various hydrocarbon oils and gases. The different varieties of coal also differ from one another, and more or less among themselves, in structure, luster, and other physical characteristics. The hardness varies in the different varieties from 0.5 to 2.5, and the specific gravity from 1 to 1.8. The principal varieties of coal are *anthracite*, *bituminous coal*, *cannel coal*, and *brown coal* or *lignite*.

86. Anthracite.—Anthracite has a bright luster, often submetallic. Color, iron-black, frequently iridescent. Fracture, conchoidal. Volatile matter after drying (volatile hydrocarbons) from 3% to 6% (with a trace of sulphur). Burns with a feeble blue flame. Contains from 80% to 95% of carbon and 4% to 12% of earthy impurities (ash). Anthracite graduates into bituminous coal, becoming less hard and containing more volatile matter; an intermediate variety is called *free-burning anthracite*, or *semi-anthracite*.

87. Bituminous Coal.—The term *bituminous coal* includes several varieties of coal differing widely in constitution and in their action when heated. They have the common characteristic of burning with a smoky, yellow flame, and giving off hydrocarbon oils and tar on distillation. The proportion of these volatile hydrocarbons in the ordinary varieties varies from 20% to 45%, and some varieties contain over 60%. The proportion of ash varies from 1.5% to 7.5%—considerably less than that of anthracite. The explanation of this lies in the fact that anthracite was originally bituminous coal, and as its volume was reduced by the expulsion of volatile matter, the proportion of ash to combustible matter naturally became greater. The sulphur

in bituminous coals ranges from a fraction of 1%, in the best coals, to 2% and 2.5% in poorer varieties.

88. Bituminous coals may be divided into *caking* (or *coking*) and *non-caking* coals.

Caking coals soften when heated, and become pasty, or semi-viscid, and the pieces gum together. If the heating is conducted in retorts or in heaps, with a limited supply of air, so that the volatile matter is distilled off without burning the carbon, the latter will remain, after the distillation is complete, as the familiar iron-gray mass known as *coke*. **Non-caking coal** is apparently in no wise different from caking coal, but will burn freely without any indication of softening or fusing together. Thus far there has been no plausible explanation advanced why one coal should cake and another apparently exactly like it should not, but the fact remains. The only way to recognize a caking coal is to cake it.

89. Cannel Coal.—Cannel coal is frequently considered a variety of bituminous coal and is often coking, but it differs considerably from the ordinary bituminous coals in texture and to some extent in composition, as shown by its products on distillation, and is therefore given a separate place in this classification. It is compact, with little or no luster, and has a slaty appearance, but without any suggestion of a banded structure. It breaks with a conchoidal fracture and smooth surfaces. Its color is dull black or grayish-black. On distillation it affords, after drying, from 40% to 60% of volatile matter, which includes a large proportion of burning and lubricating oils, much larger than the above kinds of bituminous coal.

Albertite, or *asphaltic coal*, is a mineral intermediate between cannel coal and asphalt. It resembles coal in hardness, but is like asphalt in color and luster, is slightly soluble in ether, and about one-third of it is soluble in turpentine, and it softens slightly in boiling water.

90. Brown Coal, or Lignite.—Brown coal, or lignite, is sometimes pitch-black, but oftener rather dull and brownish-black. The structure is usually like that of bituminous

coal, but it is occasionally somewhat lamellar. The term *lignite* should properly be restricted to those varieties of brown coal which retain the structure of the original wood. These coals usually contain 15% or 20% of moisture.

Brown coals are non-coking, but afford a large proportion of volatile matter. Jet is a black variety of brown coal, compact in texture, and takes a good polish.

The varieties of coal known as *semi-bituminous* and *semi-anthracite* coals merge into one or the other of the above, and can not be said to be distinct varieties.

METALLIC ORES OF SECONDARY IMPORTANCE.

91. The ores of the six most important commercial metals, iron, copper, lead, zinc, gold, and silver, and the different varieties of coal, have been described at some length. In Table I we have presented the metallic ores of secondary importance; viz., the ores of manganese, tin, mercury, nickel, cobalt, and antimony.

MINERALS OF SECONDARY IMPORTANCE.

92. Manganese.—All the manganese minerals are colored; most of them give colored streaks; they are only moderately heavy, and most of them are not hard. They all give amethyst-colored beads with borax in the oxidizing flame, and a very characteristic bluish-green mass when fused with nitrate and carbonate of soda on platinum foil. They all dissolve in boiling *HCl* (hydrochloric acid), and the oxides give off free chlorine, while the carbonate effervesces freely with warm *HCl*.

93. Tin.—There are only two tin minerals—the oxide, **cassiterite**, and the sulphide, **tin pyrites** or **stannite**. The latter is so rare as to be of no commercial importance. The oxide is insoluble in acids, is infusible, but gives a white coat on coal when strongly heated with soda in the R. F.

TABLE I. Minerals Constituting Metallic Ores of Secondary Importance.

Metal.	Ores.	Color, Streak, and Luster.	H.	Sp. Gr.	Composition.	Before the Blowpipe.	Distinguishing Characteristics.
Manganese (<i>Mn</i>)	Pyrolusite (oxide)	Color: Iron-black. Streak: Iron-black. Luster: Sub-metallic.	2—2.5	4.8	MnO_2 Mn —63.2% O —36.8%	B. B. alone, infusible; on charcoal, loses oxygen. A manganese reaction in the beads. Causes evolution of chlorine gas when treated with <i>HCl</i> .	Radiated structure; softness; black color and streak, and blowpipe reactions.
	Psilomelane (oxide)	Color: Iron-black. Streak: Brownish-black. Luster: Sub-metallic.	5—6	4.2	Doubtful: Contains varying amounts of MnO_2 , baryta, potash (lithia) and water.	B. B. same as above; also in closed tube, gives water. Reactions for barium and potassium (flame test).	Botryoidal structure. Hardness, color, and streak, and blowpipe reactions.
	Rhodonite (silicate)	Color: Pink to brown. Streak: White. Luster: Vitreous.	5.5—6.5	8.5	$MnSiO_3$ MnO —54.1% SiO_2 —45.9%	B. B. blackens; fuses with slight intumescence (puffing or swelling) at 2.5; in the beads, reactions for manganese. Slightly acted upon by acids. Reaction for silica in salt of phosphorus bead.	Usually massive structure. Color, streak, hardness, and blowpipe reactions.

<p>Manganese (<i>Mn</i>)</p>	<p>Rhodochro- site (carbonate)</p>	<p>Color: Pink to brown. Streak: White. Luster: Vitre- ous.</p>	<p>3.5—4.5</p>	<p>3.5</p>	<p>$MnCO_3$—61.4% MnO—38.6%</p>	<p>B. B. changes color; decrepitates strongly; infusible; manganese reaction in beads; dis- solves with efferves- cence in warm <i>HCl</i>.</p>	<p>Usually mass- ive. Color, perfect cleavage, hard- ness, and blow- pipe reactions.</p>
<p>Tin (<i>Sn</i>)</p>	<p>Cassiterite (oxide)</p>	<p>Color: Nearly white to black. Streak: White. Luster: Ada- mantine.</p>	<p>6—7</p>	<p>6.6</p>	<p>SnO_2 Sn—78.67% O—21.33%</p>	<p>B. B. unaltered; on charcoal with soda, re- duced to metallic tin, and gives a white coat- ing which reacts char- acteristically with co- balt solution. In beads, gives reactions for manganese and iron. Only slightly acted upon by acids.</p>	<p>High gravity, hardness, infusi- bility, and blow- pipe charac- teristics. Structure gran- ular; often reni- form or botryoidal shapes, concentric in structure; also crystalline.</p>
<p>Mercury (<i>Hg</i>)</p>	<p>Cinnabar (sulphide)</p>	<p>Color: Bright to dark red. Streak: Scar- let. Luster: Ada- mantine.</p>	<p>2—2.5</p>	<p>9</p>	<p>HgS Hg—86.2% S—13.8%</p>	<p>B. B. on charcoal, wholly volatile if pure. In closed tube, black sublimate. In open tube, sulphurous fumes and metallic globules of mercury.</p>	<p>Usually mass- ive. Color, streak, high gravity, blow pipe reac- tions.</p>

TABLE I. Minerals Constituting Metallic Ores of Secondary Importance.—Continued.

Metal.	Ores.	Color, Streak, and Luster.	H.	Sp. Gr.	Composition.	Before the Blowpipe.	Distinguishing Characteristics.
Nickel (Ni) and Cobalt (Co)	Nicolite (arsenide)	Color: Copper-red. Streak: Brownish-red. Luster: Metallic.	5—5.5	7.5	NiAs Ni—44% As—56%	B. B. gives arsenical fumes and fuses to a globule, which treated with borax affords reactions for nickel, cobalt, and iron, which exist as impurities. In the closed and open tubes, characteristic reactions for arsenic, the assay becoming yellowish-green. Soluble in aqua regia.	Color and blow-pipe reactions. Brownish-red streak.
	Garnierite (silicate)	Color: Apple-green. Streak: Greenish-white. Luster: Resinous to earthy.	2.5	2.8	Doubtful: A hydrated silicate of nickel and magnesium, of indefinite composition.	B. B. infusible. In closed tube, blackens and gives off water. In the beads, reacts for nickel. Decomposed by HCl without gelatinizing.	Never crystallized; occurs in crusts. Resembles chrysocolite. Falls to pieces in water; may be polished under the nail. Color and blow-pipe reactions.

Millerite (sulphide)	Color: Brass-yellow. Streak: Yellow, bright. Luster: Metallic.	8-8.5	4.0-5.6	NiS Ni-64.4 S-38.6	B. B. on charcoal, fuses to a globule. When roasted, gives reactions for nickel in the beads, and is magnetic. In open tube, sulphurous fumes. Soluble in nitric acid.	Usually in capillary, or hair-like, crystals radiating from a center. Color often bronze-yellow to iridescent; blow-pipe reactions.
Smaltite (arsenide)	Color: Tin-white. Streak: Grayish-black. Luster: Metallic.	5.5-6	6.4-7.2	(CoNi)As ₂ Co-0 to 23.5% Essentially cobalt arsenide, graduating into nickel arsenide (chloanthite).	B. B. on charcoal, gives arsenical odor, fuses to a globule, which treated in the beads gives reactions for nickel, cobalt, and iron. In closed and open tubes, reacts for arsenic. Soluble in nitric acid, giving pink solution.	Color sometimes grayish or iridescent. Streak and blow-pipe reactions.
Cobaltite (sulphide and arsenide)	Color: Silver-white to reddish. Streak: Grayish-black. Luster: Metallic.	5.5	6.3	CoS ₂ + CoAs ₂ Co-85.5% As-45.2% S-19.8%	B. B. on charcoal, gives off sulphur and arsenic and fuses to a globule, which gives reactions in the beads for cobalt. Unaltered in closed tube; in open tube, gives reactions for sulphur and arsenic. Soluble in warm nitric acid, with separation of arsenous oxide and sulphur.	Reddish color or tarnish, and blow-pipe reactions.

Nickel
(Ni)
and
Cobalt
(Co)

TABLE I. Minerals Constituting Metallic Ores of Secondary Importance.—Continued.

Metal.	Ores.	Color, Streak, and Luster.	H.	Sp. Gr.	Composition.	Before the Blowpipe.	Distinguishing Characteristics.
Antimony (<i>Sb</i>)	Stibnite (sulphide)	Color: Lead-gray to blackish-gray. Streak: Same as color. Luster: Metallic, shining.	2	4.6	Sb_2S_3 Sb —71.8% S —28.2%	B. B. on charcoal, fuses at 1, spreads out and gives sulphurous and antimonous fumes, coating the coal white; this coating, treated in the R. F., tinges the flame greenish-blue. In open tube, gives sulphurous and antimonous fumes, the latter condensing in a non-volatile white sublimate. When pure, perfectly soluble in <i>HCl</i> .	Perfect cleavage and often needle-like or bladed crystals of a steel-gray color. Extreme fusibility and blowpipe reactions.
Aluminum (<i>Al</i>)	Bauxite (hydrrous oxide)	Color: White to brown. Streak: Same as color. Luster: Sub-metallic to earthy.	5—5.5	3.6—4	Doubtful: Probably (when pure) $Al_2O_3 + 2Ag$.	B. B. acts like limonite. Bauxite is really a limonite in which most or all of the iron has been replaced by aluminum. Gives characteristic reactions for aluminum, iron, silica, and water.	Blowpipe reactions.

<p>Aluminum (<i>Al</i>)</p>	<p>Cryolite (fluoride)</p>	<p>Color: White to brownish-red. Streak: White. Luster: Vitreous and greasy.</p>	<p>2.5</p>	<p>2.9</p>	<p>$Al_2F_6 \cdot NaF$ or Na_3AlF_6 <i>Al</i>—18.0% <i>Na</i>—32.8% <i>F</i>—54.2%</p>	<p>B. B. in the open tube, heated so that the flame enters the tube, gives off hydrofluoric acid, which etches the glass; the water which condenses in the upper part of the tube reacts for fluorine with Brazilian wood paper. Fuses in the flame of a candle. Reacts for sodium in a colorless flame. On charcoal, fuses to a clear bead, which on cooling becomes opaque; after long blowing the assay spreads out, the sodium fluoride is absorbed by the coal, a suffocating odor of fluorine is given off, and a crust of alumina remains which reacts for alumina with cobalt solution. Soluble in sulphuric acid, with evolution of hydrofluoric acid fumes.</p>	<p>Extreme fusibility and its yielding hydrofluoric acid in the open tube.</p>
--	---------------------------------------	--	------------	------------	--	---	--

TABLE I. Minerals Constituting Metallic Ores of Secondary Importance.—Continued.

Metal.	Ores.	Color, Streak, and Luster.	H.	Sp. Gr.	Composition.	Before the Blowpipe.	Distinguishing Characteristics.
Antimony (<i>Sb</i>)	Stibnite (sulphide)	Color: Lead-gray to blackish-gray. Streak: Same as color. Luster: Metallic, shining.	2	4.6	Sb_2S_3 Sb —71.8% S —28.2%	B. B. on charcoal, fuses at 1, spreads out and gives sulphurous and antimonous fumes, coating the coal white; this coating, treated in the R. F., tinges the flame greenish-blue. In open tube, gives sulphurous and antimonous fumes, the latter condensing in a non-volatile white sublimate. When pure, perfectly soluble in <i>HCl</i> .	Perfect cleavage and often needle-like or bladed crystals of a steel-gray color. Extreme fusibility and blowpipe reactions.
Aluminum (<i>Al</i>)	Bauxite (hydrrous oxide)	Color: White to brown. Streak: Same as color. Luster: Sub-metallic to earthy.	5—5.5	3.6—4	Doubtful: Probably (when pure) $Al_2O_3 + 2Ag$.	B. B. acts like limonite. Bauxite is really a limonite in which most or all of the iron has been replaced by aluminum. Gives characteristic reactions for aluminum, iron, silica, and water.	Blowpipe reactions.

<p>Aluminum (<i>Al</i>)</p>	<p>Cryolite (fluoride)</p>	<p>2.5</p>	<p>Color: White to brownish-red. Streak: White. Luster: Vitreous and greasy.</p>	<p><i>Al</i>₃<i>F</i>₃<i>6 NaF</i> or <i>Na</i>₃<i>AlF</i>₆ <i>Al</i>—13.0% <i>Na</i>—32.8% <i>F</i>—54.2%</p>	<p>B. B. in the open tube, heated so that the flame enters the tube, gives off hydrofluoric acid, which etches the glass; the water which condenses in the upper part of the tube reacts for fluorine with Brazilian wood paper. Fuses in the flame of a candle. Reacts for sodium in a colorless flame. On charcoal, fuses to a clear bead, which on cooling becomes opaque; after long blowing the assay spreads out, the sodium fluoride is absorbed by the coal, a suffocating odor of fluorine is given off, and a crust of alumina remains which reacts for alumina with cobalt solution. Soluble in sulphuric acid, with evolution of hydrofluoric acid fumes.</p>	<p>Extreme fusibility and its yielding hydrofluoric acid in the open tube.</p>
--	--------------------------------	------------	--	--	---	--

TABLE I. Minerals Constituting Metallic Ores of Secondary Importance.—*Concluded.*

Metal.	Ores.	Color, Streak, and Luster.	H.	Sp. Gr.	Composition.	Before the Blowpipe.	Distinguishing Characteristics.
Aluminum (Al)	Corundum (oxide)	Color: Red, blue, green, yellow; colorless when pure. Streak: White or colorless. Luster: Adamantine to vitreous.	9	4	Al_2O_3 Al —58% O —42% (Pure alumina)	<p>B. B. unaltered; dissolves slowly in borax and salt of phosphorus to a clear glass, which is colorless when free from iron. Not acted upon by soda. The finely pulverized mineral when heated with cobalt solution gives a beautiful blue color. Friction excites electricity, and in polished specimens the electrical attraction continues for a considerable length of time.</p>	<p>Hardness—it scratches quartz and topaz; its infusibility and high gravity; the peculiar barrel shape of well-developed crystals. The varieties of corundum are named according to their color: sapphire (blue); oriental ruby (red); oriental topaz (yellow); oriental emerald (green); oriental amethyst (purple); emery (black).</p>

This coat is yellow while hot, but white on cooling, is not volatile, and gives a *bluish-green* color when heated with cobalt solution, which is a very characteristic test (but must not be confused with the *yellowish-green* color that zinc gives when similarly treated).

94. Mercury.—The only mercury mineral of any importance is **cinnabar**.

95. Nickel and Cobalt.—All the nickel minerals are colored and give colored streaks, and most of them are quite hard and very heavy. They are all soluble in aqua regia, giving green-colored solutions, and on treatment with soda on charcoal in the reducing flame, can be reduced to a magnetic mass. They give, after roasting, a brownish-red bead with borax, and a yellow bead with salt of phosphorus in the oxidizing flame, the latter being especially characteristic. The corresponding cobalt minerals are usually associated with the nickel minerals, and when present impart the characteristic cobalt-blue color to the beads.

96. Antimony.—The antimony minerals are soft, are not very heavy, and some have a metallic luster and colored streak, while others have an earthy luster and colorless streak. Most of them are very rare, the only one of commercial importance being the sulphide. They all give a volatile pure white coat on charcoal that turns to a dirty yellowish-green when moistened with cobalt solution and heated. When treated on charcoal with soda, they reduce easily to metallic antimony, but this volatilizes at once, forming a white coat; the volatilized antimony has no odor, which distinguishes it from arsenic, which also gives a pure white coat; but arsenic is more volatile and condenses farther out beyond the assay than antimony, and has a peculiar odor like garlic.

97. Aluminum.—All the aluminum minerals are light, they all give colorless streaks, and most frequently they are white, but are liable to be of any color from the presence of impurities. They differ so from one another as to require special tests for their determination.

TABLE II. Minerals Sent with the Blowpipe Outfit. (Subject to change.)

Name.	Color, Streak, and Luster.	H.	Sp. Gr.	Composition.	Before the Blowpipe.	Distinguishing Characteristics.
Arsenopyrite	Color: Silver-white, inclining to steel-gray. Streak: Dark grayish-black. Luster: Metallic.	5.5—6	6.0—6.4	$FeAs_2S$ (Iron-arsenic sulphide)	On charcoal, gives odor of arsenic. Varieties containing cobalt give blue borax bead in O. F.	Reactions B. B.
Asbestos*	Color: White to green and wood-brown. Silky luster.			Essentially a silicate or magnesium, or of calcium and magnesium.	Infusible. Some varieties give off water in closed tube.	Usually in fibers; infusibility.
Barite*	Color: White, inclining to yellow, gray, blue, red, brown. Streak: White. Luster: Vitreous, resinous, pearly.	2.5—3.5	4.8—4.72	$BaSO_4$ (Barium sulphate)	Decrepitates and fuses at 8, fused mass turning red litmus paper blue. On charcoal, reduces to a sulphide, and with soda, gives sulphur reaction. Insoluble in acids.	High specific gravity; crystals usually tabular; perfect basal cleavage; insolubility; green coloration of blow-pipe flame.

<p>Celestite</p>	<p>Color: White to faint bluish; sometimes reddish. Streak: White. Luster: Vitreous, inclining to pearly.</p>	<p>8—8.5</p>	<p>8.9—8.97</p>	<p>SrSO₄ (Strontium sulphate)</p>	<p>Frequently decrepitate. Fuses at 8, fused mass being alkaline. Colors the flame strontian red. Insoluble in acids.</p>	<p>From carbonate by its failure to effervesce with acids; from barite by its lower specific gravity; by color imparted to flame.</p>
<p>Dolomite</p>	<p>Color: White, reddish or greenish white; also rose-red, green, brown, gray, and black. Luster: Vitreous, inclining to pearly.</p>	<p>8.5—4</p>	<p>2.8—2.9</p>	<p>(CaMg)CO₃ (Calcium-magnesium carbonate)</p>	<p>(See Calcite.) Like calcite. Attacked but little by cold acids. Powder dissolves with effervescence in warm acids.</p>	<p>Failure to effervesce in cold acid when in lumps; rhombohedral form and cleavage; curved crystal and cleavage faces.</p>
<p>Graphite*</p>	<p>Color: Iron-black to dark steel-gray. Streak: Black and shining. Luster: Metallic, greasy.</p>	<p>1—2</p>	<p>2.1—2.2</p>	<p>Pure carbon, with some iron sesquioxide mixed mechanically at times.</p>	<p>Volatilizes at extreme temperatures without flame or smoke. Infusible and unaltered by acids.</p>	<p>Color and streak; from infusibility; from molybdenite by giving no sulphur reaction.</p>

*Of commercial importance.

TABLE II. Minerals Sent with the Blowpipe Outfit. (Subject to change.)—Continued.

Name.	Color, Streak, and Luster.	H.	Sp. Gr.	Composition.	Before the Blowpipe.	Distinguishing Characteristics.
Halite* (Rock salt)	Color: Colorless or white; sometimes yellowish, reddish, bluish, or purplish. Streak: White. Luster: Vitreous.	2.5	2.1—2.25	NaCl (Sodium chloride)	Fuses in closed tube, often with decrepitation. Fused on platinum foil, colors flame deep yellow.	Taste, solubility, and perfect cleavage into cubes.
Kaolinite*	Color: White, grayish-white, yellowish, reddish, brownish, bluish. Luster of plates: pearly; of mass: pearly to dull earthy.	1—2.5	2.4—2.63	$\text{Al}_2\text{Si}_2\text{O}_7 + 2\text{Aq.}$ (Hydrous aluminum silicate)	Yields water. Infusible, and insoluble in acids. With cobalt solution, gives blue color.	Soapy feel, and alumina reaction B. B.

Mica*	Color: White, colorless, yellowish, brown, green, violet, rose-red, and black. Streak: Colorless; grayish-green. Luster: Adamantine, vitreous, pearly, sub-metallic.	2-3.1	2.7-3.1	Silicates of alumina, iron, magnesia, soda, potash, and other substances; often contains fluorine.	Some varieties give water in closed tube. Fusibility varies with the composition from 1 in one variety to difficultly fusible and almost infusible (fusible only on thin edges) in the commercial mica. Most varieties are decomposed by acids.	Cleavage into thin plates; luster.
Natrolite	Color: White, colorless, gray, yellow to red. Streak: Uncolored. Luster: Vitreous to pearly.	5-5.5	2.17-2.25	$Na_2Al_4Si_4O_{16} + 2Aq$. (Hydrated sodium-aluminum silicate)	Loses water in closed tube, becoming white and opaque. Fuses at 2 in flame of candle to colorless glass. Becomes jelly-like with acids.	Reactions. B. B.
Actinolite	Color: Bright green, grayish-green. Streak: Uncolored. Luster: Vitreous to silky.	5-6	8-8.2	$(CaMgFe)_3Si_6O_{22}$. (Silicate of calcium, magnesium, and iron)	Fuses at 4 to a black or green glass.	Color: columnar structure, fibrous, and frequently radiating; luster.

*Of commercial importance.

TABLE II. Minerals Sent with the Blowpipe Outfit. (Subject to change.)—Continued.

Name.	Color, Streak, and Luster.	H.	Sp. Gr.	Composition.	Before the Blowpipe.	Distinguishing Characteristics.
Orthoclase	Color: White, gray, and flesh-red; sometimes greenish to bright green. Streak: Uncolored. Luster: Vitreous to pearly.	6—6.5	2.4—2.6	$K_2Al_2Si_2O_8$ (Potassium aluminum silicate)	Fuses at 5 and is unaltered by acids.	Crystal form (see Fig. 7); basal and pinacoidal cleavages at right angles; luster.
Serpentine*	Color: Various shades of green; also brownish-red, brownish-yellow, sometimes nearly white. Streak: White, slightly shining. Luster: Resinous, greasy, pearly, earthy.	2.5—4	2.5—2.65	$Mg_3Si_2O_8 + 2Ag$ (Hydrous magnesium silicate)	Yields water in closed tube. Difficultly fusible on edges. Decomposed by HCl and H_2SO_4 .	Softness (can be cut with a knife), low specific gravity, and resinous luster.

<p>Talc*</p>	<p>Color: White, various shades of green; sometimes reddish. Streak: White or lighter than color. Luster: Pearly.</p>	<p>1—1.5 2.56—2.8</p>	<p>$H_2Mg_3Si_4O_{10}$ (Hydrous magnesium silicate)</p>	<p>Most varieties yield water in closed tube at high heat. Difficultly fusible on thin edges to a white enamel. Gives pale red color when moistened with cobalt solution and heated. Not decomposed by acids.</p>	<p>Extreme softness; greasy feel; foliated structure; inelastic, though flexible; yielding water only on intense ignition.</p>
<p>Gypsum*</p>	<p>Color: Usually white; gray, reddish, yellow, blue, black. Streak: White. Luster: Pearly to earthy.</p>	<p>1.5—3 2.3</p>	<p>$CaSO_4 + 2Aq.$ (Hydrous calcium sulphate)</p>	<p>Gives off water and becomes opaque in closed tube. Soluble in hydrochloric acid and in 400 to 500 parts of water. When water is driven off gypsum becomes plaster of Paris.</p>	<p>Softness; does not effervesce; does not become jelly-like with acids.</p>
<p>Calcite*</p>	<p>Color: White, colorless, gray, red, green, blue, violet, yellow, brown, and black. Streak: White or grayish. Luster: Vitreous to earthy.</p>	<p>3 2.5—2.8</p>	<p>$CaCO_3$ (Calcium carbonate)</p>	<p>Infusible when pure. Moistened with HCl, colors the flame red (lime). Fragments dissolve with brisk effervescence in cold acids</p>	<p>Crystal form (see Art. 34); perfect rhombohedral cleavage; so soft as to be scratched with a knife; effervescence in cold dilute acid; infusibility.</p>

* Of commercial importance.

TABLE II. Minerals Sent with the Blowpipe Outfit. (Subject to change.)—Concluded.

Name.	Color, Streak, and Luster.	H.	Sp. Gr.	Composition.	Before the Blowpipe.	Distinguishing Characteristics.
Fluorite*	Color: White, yellow, green, rose, crimson-red, violet, sky-blue, brown. Streak: White. Luster: Vitreous, splendid, glimmering.	4	3—3.25	CaF_2 (Calcium fluoride)	Decrepitates and phosphoresces in closed tube. B. B. fuses at 8 and reacts alkaline. Gives fluorine reactions.	Perfect octahedral cleavage. Etching power of hydrofluoric acid.
Apatite*	Color: Sea-green, bluish-green, violet-blue, white, yellow, gray, red, and brown. Streak: White. Luster: Vitreous.	5	2.9—3.2	$3Ca_3P_2O_8 + CaCl_2$ or $3Ca_3P_2O_8 + CaF_2$ (Essentially calcium phosphate with chloride or fluoride of calcium, or both.)	Difficultly fusible on edges. Gives pale, bluish-green flame when moistened with H_2SO_4 and heated. Dissolves in HCl and HNO_3 . Some varieties phosphoresce when heated.	Hexagonal form (usually prismatic). Does not effervesce with acids. Distinguished from beryl by its softness; from pyromorphite by its giving no lead reaction.

<p>Albite</p>	<p>Color: White, bluish, gray, reddish, green. Streak: Uncolored. Luster: Pearly, vitreous.</p>	<p>6—7</p>	<p>2.6</p>	<p>$Na_2Al_2Si_2O_8$ (Sodium-aluminum silicate)</p>	<p>Fuses at 4 to colorless or white glass, coloring the flame intensely yellow. Not acted upon by acids.</p>	<p>Luster, color, reactions B. B.</p>
<p>Quartz</p>	<p>Color: Colorless, yellow, brown, red, green, blue, black. Streak: White, or paler than color. Luster: Vitreous, resinous to dull.</p>	<p>7</p>	<p>2.5—2.8</p>	<p>SiO_2 (Oxide of silicon = silica)</p>	<p>Unaltered; with borax dissolves to clear glass; with soda dissolves with effervescence; with salt of phosphorus unaltered. Insoluble in acids.</p>	<p>Hexagonal crystals and massive; no cleavage; hardness, infusibility, insolubility. Reaction with soda.</p>

• Of commercial importance.

PRECIOUS STONES.

98. There are several minerals which, from their transparent brilliancy, their beauty of color, and their hardness, coupled with the comparative rarity of their occurrence, are highly esteemed as gems. These are the diamond, sapphire (corundum), ruby (spinel), topaz, emerald (beryl), zircon, garnet, turquoise, and opal, and several others holding a doubtful place in the list of precious stones.

The **diamond** is the most highly valued. This mineral, which is pure crystallized carbon, is the hardest of all known substances. The peculiar value of the diamond lies in its singular brilliancy of luster and in its remarkable hardness. It is usually colorless, but has not infrequently a slight tinge of color, of which yellow is the most common and the least esteemed. A diamond of the first water is perfectly transparent and colorless, and free from spots or flaws. The clear green and rose tints are also highly prized. The great diamond-producing regions of the world are South Africa, Brazil, and the southern part of Hindustan.

Corundum ranks next to the diamond in hardness. It is pure crystallized alumina (Al_2O_3), and, when occurring in transparent crystals of pure colors, it yields gems ranking next to the diamond in value. They receive different names, according to their color; the blue variety is called *sapphire*; the red, *oriental ruby*; the green, *oriental emerald*; the violet, *oriental amethyst*; and the yellow, *oriental topaz*. The finest stones are obtained mostly from the East Indies. Gems of this species are also occasionally found in North Carolina, Colorado, New Mexico, and Arizona.

Spinel is a mineral composed of alumina and magnesia, with usually a little iron. It ranks in hardness next to corundum, and when used as a gem is of a fine red color, though green and violet and other tints also occur. This gem, which is called by jewelers *spinel ruby*, is obtained chiefly from Siam and Ceylon. It is also found in the United States in Sussex County, New Jersey, and Orange

County, New York, sometimes in crystals of large size, but rarely fit for jewelry.

Topaz is a silicate of aluminum containing a considerable amount of fluorine. It has a hardness equal to that of spinel, and its color is most commonly yellow, though sometimes green, blue, and white. Those used in jewelry are mostly brought from Siberia, Kamchatka, and Brazil; topaz is also found in Arizona and New Mexico, and on Pike's Peak.

Beryl is a silicate of aluminum and beryllium, which occurs in hexagonal prisms, sometimes of great size. When transparent and of fine colors it affords the valuable green gem, *emerald*, the sea-green or bluish-green *aquamarine*, and the yellow or light green beryl. Its hardness is somewhat less than that of spinel and topaz. Crystals fit for jewelry are sometimes found in the New England States, and in Alexander County, North Carolina, but the emerald and aquamarine are obtained chiefly from the United States of Colombia, Brazil, Hindustan, and Siberia.

Zircon is a silicate of zirconium. The transparent red crystals constitute the gem called hyacinth, and the colorless or smoky crystals, the *jargon*. The hardness of zircon is about the same as that of beryl and exceeds that of quartz. The valuable gems come mostly from Ceylon, Siberia, and Greenland, the United States having as yet afforded but few.

Garnet is a silicate of very variable composition, and is of about the same hardness as quartz. Although of quite common occurrence in mica schist and hornblende schist, and some other crystalline rocks, clear, red crystals, of proper size, are held in some estimation as gems. Stones of the finest quality are found in Colorado, New Mexico, and Arizona.

Turquoise is a hydrous phosphate of alumina. It is opaque, of a delicate blue or bluish-green color, due to copper, which exists as an impurity. Its hardness is inferior to that of quartz. Despite its inferior hardness and opacity, it is estimated as a gem because of its pleasing color and the beautiful combinations it makes when cut with a smooth, rounded surface and set with diamonds or pearls.

TABLE III. Precious Stones.

Name.	Color, Streak, and Luster.	H.	Sp. Gr.	Composition.	Before the Blowpipe.	Distinguishing Characteristics.
Diamond	Color: Colorless; occasionally yellow, red, green, blue, and even black. Streak: Colorless. Luster: Adamantine (brilliant).	10	3.5	Pure carbon.	Burns at very high temperatures, and is wholly consumed, producing carbon dioxide, CO_2 . It is not acted upon by acids or alkalis.	Extreme hardness, brilliant luster, etc.
Sapphire (Corundum)	Color: Generally blue; also red, yellow, green, and purple, as described under corundum. Streak: Colorless. Luster: Adamantine to vitreous.	9	3.9—4	Al_2O_3 (Oxide of aluminum = alumina)	Same reactions as for corundum. Infusible, and insoluble in acids.	Same as for corundum. From spinel by crystallizing in rhombohedral-hexagonal system, usually in barrel-shaped, hexagonal, prismatic crystals, with perfect cleavage, sometimes basal and sometimes rhombohedral.

<p>Ruby (Spinel)</p>	<p>Color: Clear red, also green, blue, yellow, brown, and black. Streak: Colorless. Luster: Vitreous to splendent.</p>	<p>8</p>	<p>8.5—4</p>	<p>(Mg,Fe)Al₂O₄ (Variable; essentially magnesium-aluminum oxide with part of the MgO replaced by FeO, and occasionally part of Al₂O₃ replaced by Fe₂O₃. Other impurities are frequently present.)</p>	<p>B. B. alone, infusible; turns brown, and even black and opaque as the temperature increases, and on cooling becomes green first, and then nearly colorless, and at last resumes its red color. Gives reaction in the beads for iron and chromium, which sometimes contains as an impurity. Decomposed by fusion with potassium bisulphate, and soluble with difficulty in sulphuric acid.</p>	<p>Crystallizes in isometric octahedrons, more or less modified. Imperfect octahedral cleavage. Distinguished from oriental (corundum) ruby by an imperfect octahedral cleavage and its octahedral form; from garnet by its hardness and infusibility.</p>
<p>Topaz</p>	<p>Color: Colorless to yellow. Streak: Colorless. Luster: Vitreous.</p>	<p>8</p>	<p>8.5</p>	<p>Al₂SiO₄ (Aluminum silicate)</p>	<p>B. B. infusible. Some varieties take a wine-yellow or pink tinge when heated. Part of the oxygen is replaced by fluorine; when fused in the open tube with salt of phosphorus, gives reaction for fluorine. With cobalt solution, when heated, gives reaction for alumina. Reacts for silica in salt of phosphorus bead. Insoluble in acids.</p>	<p>Hardness: scratches quartz. Infusibility: cracks at high heat; B. B. yields fluorine. Occurs in orthorhombic prisms with perfect basal cleavage; crystals are usually differently modified on the top and bottom.</p>

TABLE III. Precious Stones.—Continued.

Name.	Color, Streak, and Luster.	H.	Sp. Gr.	Composition.	Before the Blowpipe.	Distinguishing Characteristics.
Emerald (Aquamarine; Beryl)	Color: Green; also pale-blue and yellow. Streak: Colorless. Luster: Vitreous to resinous.	7.5—8	2.65	$Be_3Al_2Si_6O_{18}$ (Beryllium-aluminum silicate)	B. B. alone, unchanged or becomes clouded; at a high temperature the edges are rounded (fusibility = 5.5). Reaction for chromium in borax bead, due to the presence of chromium as an impurity which imparts to the mineral its green color. Slowly soluble in salt of phosphorus, without leaving a silicious residue. Unacted upon by acids.	Distinguished from apatite by its hardness, not being scratched with a knife; from topaz by its imperfect basal cleavage and its fusibility. It never occurs massive; crystallizes in hexagonal crystals. Distinguished from oriental emerald by perfect cleavage, inferior hardness, and fusibility.

<p>Zircon</p>	<p>Color: Colorless to brown; sometimes pink or green. Streak: Colorless. Luster: Adamantine.</p>	<p>7.5</p>	<p>4—4.75</p>	<p>$ZrSiO_4$ (Zirconium silicate)</p>	<p>B. B. infusible. The colorless varieties are unaltered; the red becomes colorless; while the dark-colored varieties are made white. Some varieties glow and increase in density by ignition. Not perceptibly acted upon by salt of phosphorus. In powder, is decomposed with soda on the platinum wire, and if the product is dissolved in dilute HCl, it gives the orange color characteristic of zirconia when tested with turmeric paper. In powder, slightly acted upon by sulphuric acid. Decomposed by fusion with the alkaline carbonates and bisulphates.</p>	<p>Adamantine luster; hardness; and infusibility. It occurs usually in square prismatic crystals of the tetragonal system; also granular.</p>
---------------	---	------------	---------------	--	---	---

TABLE III. Precious Stones.—*Concluded.*

Name.	Color, Streak, and Luster.	H.	Sp. Gr.	Composition.	Before the Blowpipe.	Distinguishing Characteristics.
Turquoise	Color: Sky-blue, bluish-green, apple-green. Streak: White or greenish. Luster: Somewhat waxy.	6	2.6—2.8	$Al_4P_3O_{11} + 5Ag.$ or $2Al_2O_3 + P_2O_5 + 5Ag.$ (Hydrous aluminum phosphate)	<p>B. B. in the forceps, becomes brown and assumes a glassy appearance, but does not fuse. Colors the flame green; moistened with hydrochloric acid, the color is azure-blue, which is due to some copper which exists as an impurity. In the beads, reacts for copper. With salt of phosphorus and tin on charcoal, gives an opaque red bead (copper). In the closed tube, decrepitate, yields water, and turns brown or black; by adding a small fragment of metallic magnesium or sodium to the assay, phosphoretic hydrogen is given off, recognizable by its disagreeable odor. Soluble in hydrochloric acid.</p>	<p>Color and luster; absence of cleavage; blowpipe reactions; infusibility; and solubility in <i>HCl</i>.</p>

<p>Garnet</p>	<p>Color: Red, brown, yellow, white, green, black. Streak: White. Luster: Vitreous to resinous.</p>	<p>6.5—7.5</p>	<p>8.15—4</p>	<p>$Fe_2Al_2Si_2O_{11}$ (precious garnet) (iron-aluminum silicate)</p>	<p>B. B. fuses at 8 to a magnetic globule. After ignition, partly decomposed by hydrochloric acid, with separation of gelatinous silica. Reactions for the elements vary in different varieties. In this variety reactions are obtained for iron, alumina, and silica.</p>	<p>Fusibility and decomposition in HCl, with separation of silica. Most frequently of a dodecahedral form when crystallized.</p>
<p>Opal</p>	<p>Color: White, yellow, red, brown, green, gray; generally pale; frequently an iridescent play of colors. Streak: White. Luster: Vitreous to resinous.</p>	<p>5.5—6.5</p>	<p>1.9—2.8</p>	<p>$SiO_2 + Ag$ (usually) (Oxide of silicon, amorphous silica)</p>	<p>B. B. infusible, but becomes opaque. Some yellow varieties containing iron turn red. In closed tube, yields water.</p>	<p>Never crystallized. Its beautiful opalescent appearance and color. An amorphous variety of quartz, having a somewhat inferior hardness and gravity.</p>

The most valuable specimens come from Khorassan, a province of Persia, and from New Mexico. It is also found in Nevada and Arizona.

Opal is a peculiar, massive, uncrystalline variety of quartz, containing variable amounts of water. It is somewhat softer than crystalline quartz and has a lower specific gravity. The variety used as a gem presents a vivid iridescent play of colors. The opal fit for jewelry has not been found in the United States, but is obtained from Hungary, Honduras, and Mexico.

Table III gives the more important physical and chemical characteristics of each of these gems.

GANGUE MINERALS.

99. The following are a few of the minerals which occur most commonly in the gangue or vein material of metaliferous veins, and are associated with most ores:

100. Quartz.—Quartz is a pure oxide of silica. Its formula and chemical composition are given in Table II. Quartz in veins may occur either crystalline or massive, in which case it is usually banded and has a structure similar to that of agate. It may be transparent, or it may be colored by iron or other coloring matter, so as to render it pink, gray, or almost any color to black.

101. Calcite.—Calcite, or **calcspar**, is composed of calcium carbonate, and its composition and characteristics are also given in Table II. It is mainly detected by the ease with which it effervesces with acids. Calcite as it occurs in vein material is usually crystalline, though it may be present practically as a crystalline limestone.

102. Dolomite.—Dolomite is a carbonate of lime and magnesia, being merely a limestone with part of the lime replaced by magnesia. The only difference that this substance makes in the appearance of the crystals is that they are less transparent and that the crystals and cleavage faces become slightly curved, whereas calcite cleaves

along the plane faces parallel to its crystal faces. Dolomite is slightly harder than calcite, and is distinguished from the former by the fact that it effervesces in hot acids only, while calcite will effervesce with cold acids. Dolomite frequently occurs massive in vein formations.

103. Barite, or Heavy-Spar.—This is composed of barium sulphate and is described in Table II. Barite is of value as a pigment-forming mineral, and, when it can be obtained pure, may find a ready market. Barite usually occurs crystalline in gangue material, but is sometimes found massive, and in certain deposits or veins from which it is obtained as a pigment material it occurs massive.

104. Fluorite, or Fluorspar.—This is calcium fluoride, and usually occurs crystalline in metalliferous veins, but may be massive; it varies in color from colorless to dark brown or black, according to the impurities it contains, and is often colored a beautiful blue or purple. Fluorite is of commercial importance, being employed for the manufacture of hydrofluoric acid, which is used for the etching of glass and for similar purposes; it is also used as a flux in smelting works.



ASSAYING.

METHODS OF ANALYSES.

1. The quantity of any given element or elements in a substance is determined by **quantitative analysis**.

2. **Assaying**, generally speaking, is the quantitative analysis of ores and metallurgical products.

3. There are two general ways of making analyses—the *wet way* and the *dry way*. When the term “assay” is used without any qualification, it is commonly understood to mean the dry, or fire, assay. Wet assays are generally spoken of as *analyses*, to distinguish them from dry, or fire, assays, although the term is, strictly speaking, equally applicable to both.

4. **Wet Assay**.—In the wet assay or analysis, the substance under examination is first taken into solution by liquid chemicals, usually acids. The amount of any given element in the solution is then determined in one of the two following ways:

1. Reagents are added which precipitate the element in the form of an insoluble compound of known composition. This precipitate is then separated from the solution by filtering, and is washed, dried, and weighed. The composition and weight of the precipitate being known, the weight of the element in question may then be readily figured. This method is known as **gravimetric analysis** (analysis by weighing).

2. Reagents are added which combine with the elements in question, forming new compounds, either soluble or insoluble. The strength of the reagent solution is known; that is, we know the weight of the element in question

which will combine with the amount of the reagent in each unit of volume (the unit chosen being usually the cubic centimeter) of the reagent solution. (The strength of the solution is determined by preliminary tests on solutions containing known weights of the element in question.) The reagent is added gradually, and certain physical or chemical changes in the solution under examination become apparent as soon as there is the slightest excess of the reagent present over the amount necessary to combine with the desired element in the solution. For example, in the permanganate method of iron analysis, described in Arts. 175 to 180, a single drop of the permanganate solution, after all the iron is oxidized, will impart a characteristic pink color to the solution under examination; or in analyses in which the reagent used is not of itself a powerful colorant, some chemical may be used as an *indicator*, with which the least excess of the reagent solution will give a strong and characteristic color. The point at which the coloration or change first appears is called the "end point." The reagent solution is known as a "standard solution"; and the weight of the element in question, with which each cubic centimeter (c. c.) of the standard solution will combine, is called the "standard" of the solution. By multiplying the number of cubic centimeters of the standard solution used up to the end point by the standard of the solution, we obtain the amount of the element in question contained in the solution. This method is known as **volumetric analysis**, or **titration**.

5. Fire Assay.—The dry, or fire, assay is adapted to the determination of only a few of the more stable metallic elements, which will, under certain conditions, separate from all materials accompanying them in their ores, when the ore is brought into a liquid state by fusion at a high heat, with proper fluxes.

6. With the exception of gold and silver, all the metals can be more accurately determined in the wet way than by the fire assay. This practically restricts the use of the fire

assay to the determination of gold and silver and a very few other metals, which can be more quickly and conveniently determined in this way, with results sufficiently accurate for practical purposes, and which are, therefore, customarily bought and sold on the results of the fire assay. For instance, in America, lead in ores is almost universally determined by the fire assay, as the wet assay for lead, although more accurate than the fire assay, is quite difficult and complicated, and requires considerable time, while the fire assay is very simple; and by the observation of ordinary precautions, the error in the fire assay may be restricted to a few per cent. of the total lead contents; in the case of a metal as cheap as lead, this error may be disregarded. Moreover, the conditions of the fire assay are practically identical with those of actual smelting, and the results and losses in the fire assay correspond very closely with those in the smelting by which the lead is extracted from its ores on a large scale. For exact chemical analyses, however, the wet assay would have to be employed.

Copper and tin in ores were formerly determined by the fire assay; but the results were very inaccurate, and the practice is now practically abandoned, as the wet analyses have been greatly simplified—particularly in the case of copper—and are vastly more accurate.

The determination of copper by electrolysis is also used to considerable extent in some of the larger smelters, on account of its simplicity, accuracy, freedom from intricate calculation, and the ease with which it can be acquired. The electrolytic method consists of dissolving the copper out of its ores by means of acids, and then, by passing an electric current through the solution, depositing the copper, in the metallic state, upon a platinum cathode, from which it is washed, and, after drying, weighed.

7. This Paper deals with the assays for the precious metals, gold and silver, and the more important of the base metals and gangue materials, commonly associated with them, which have to be assayed at mines or smelters.

8. The value of an ore depends almost as much upon its general composition as upon its metallic contents, as the expense of treating an ore is directly dependent upon its composition. Thus, some ores flux or smelt much more readily than others, according to the proportions of certain minerals in their gangues. For example, either iron oxide or quartz (silica) alone is infusible, but mixed together in equal parts (by weight), they readily fuse to a silicate of iron. Lime acts with silica in much the same manner, and with iron oxide and silica forms a double silicate of lime and iron, which is readily fusible; this is the *slag* of lead and copper smelters. The charge of smelters for treating ores is based on the proportions of these minerals they contain. A fixed charge is made for neutral ores, or ores in which the percentage of silica (SiO_2) is equal to the percentage of iron oxide (FeO) or of iron oxide and lime (CaO). A premium is allowed by the smelter for each unit or per cent. of iron oxide or lime in excess over the silica, and a bonus is charged for each unit of silica in excess over the iron oxide and lime.

9. Gold-silver smelters also make an extra charge for every unit of zinc in ores above a certain amount—usually 12 per cent.; sometimes less—as zinc renders the ore refractory. On the other hand, smelters always pay for the lead and copper in ores if they are present in any considerable amounts, as they are saved by smelting; and not only do they have an intrinsic value of their own, but one or the other is indispensable to the operation of smelting. It is the lead or copper in furnace charges that makes it possible to extract from their ores the almost infinitesimal amounts of gold and silver—amounts often of only a fraction of an ounce to the ton. The lead or copper in the charge is reduced to a metal, and sinking gradually through the melting mass, collects the gold and silver and carries them down with it into the well of the furnace in the form of *bullion*. This bullion corresponds to the lead button obtained in assaying. In fact, *fire assaying is nothing more or less than smelting on a very small scale*. The precious

metals may be separated from the base metals of the bullion in various ways—cupelling, dissolving in acid, etc.—which will not be discussed here.

From the foregoing explanation, the student will readily understand the importance of knowing something more about an ore than merely how much gold and silver it carries.

FIRE ASSAYING.

10. The work and apparatus of fire assaying will be described as nearly as possible in the order of the actual operations.

The outfit of an assay office will naturally vary somewhat, depending not only upon the amount and character of the work to be done, but also upon the individual preferences of the assayer. We give here only the most essential apparatus of the fire-assay office. There are many articles listed by dealers in assay supplies which, though convenient in special cases, are of little or no use in the ordinary run of fire assaying. There are also many little labor-saving devices, however, which the assayer will find very convenient as the work grows heavier. Such articles and their uses we will at least mention.

PREPARING THE SAMPLE.

11. Samples for assaying must be very finely pulverized, in order to obtain uniform results. It is customary to pass the entire final assay sample through an 80 or 100 mesh screen (80 or 100 openings to the linear inch, or 6,400 to 10,000 openings to the square inch, respectively). In the assay of some very refractory ores, a 120-mesh screen is used, as the finer the ore, the more rapid and complete the fusion.

APPARATUS.

12. Crushers.—Lump samples are first broken up quite fine by means of a small laboratory jaw crusher, which may be driven either by hand or by a small electric motor.

In the absence of a jaw crusher, a heavy iron mortar and pestle may be used for crushing. If neither is obtainable, the lumps may be broken up with a hammer, but this method is very slow and unsatisfactory.

13. Bucking Board.—The final pulverization of the sample is usually done on a “bucking board” or rubbing plate. This is a smooth cast-iron plate, usually 18" × 24" in area and 1 inch thick, with raised sides, as shown in Fig. 1. The ore is ground on this plate by means of the cast-iron “muller” or rubber *a*, which has a curved face and is fitted with a handle, as shown in the illustration.

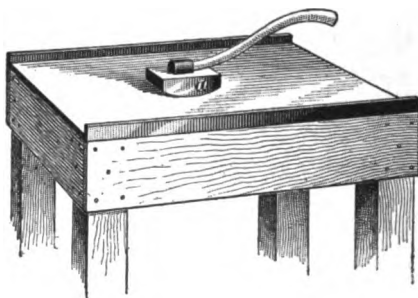

FIG. 1.

The crushed ore is placed in the middle of the plate, and the muller is passed back and forth over it. The operator bears down on the muller with one hand, while with the other he grasps the handle and guides the muller, giving it a slow rocking motion, as

he draws it back and forth, by lowering his hand on the forward stroke and raising it on the back stroke, so that the entire face of the muller comes into use during each stroke. Samples are sometimes pulverized in an iron mortar, but the bucking board is much quicker and more convenient.

For reducing samples which are already comparatively fine, some assayers prefer circular bucking boards or rubbing plates. These are usually about 3½ feet in diameter, and are placed upon a table so situated that the operator can walk around the table as he draws the muller back and forth. They have the advantage that the rubbing takes place in different directions across the plate, so that there is no tendency to wear crevices or scores in the face of the plate.

14. Sampler.—A tin sampler, or “riffle,” is convenient for cutting down or reducing the size of samples. It is merely a number of troughs, side by side, with open spaces between. The width and number of the open spaces and troughs can be made such that the riffle will take out any desired portion of a crushed sample spread evenly over it. The riffles are commonly made to cut the sample into two equal parts, half remaining in the troughs and half falling through.

Samplers, while convenient, are not absolutely necessary, as samples may be cut down by “quartering,” as described in Art. 16—a very simple and convenient method.

15. Spatulas.—The steel spatula is a form of knife used in the laboratory for mixing or sampling pulverized ore or for handling other materials about the laboratory.

Fig. 2 shows a common form of spatula.



FIG. 2.

The blade should

have some spring and at the same time should be stiff enough so that it will not be broken if used for digging material out of a bottle or for similar purposes. The laboratory should usually be provided with several sizes of spatulas, from those having a 3 or 4 inch blade for use at the balances, etc., to those having 10 or 12 inch blades for use in mixing several pounds of material and for sampling large pulps, etc.

Horn spatulas are frequently employed for removing precipitates from beakers and for similar purposes where steel spatulas would be attacked by the acids in the solution.

16. Quartering.—This method of reducing samples takes its name from the peculiar manner in which it is performed. Suppose an assay sample is to be taken from a 100-pound sample of ore, made up of coarse and fine lumps, and representing, perhaps, a carload of ore. The sampling floor is first swept thoroughly, to prevent any rich dust from former samplings becoming mixed with the sample in hand. Then the entire sample is run through a crusher,

which reduces the lumps to a maximum diameter of, say, 1 inch. If the ore is high grade or contains rich lumps in a comparatively barren gangue, the first crushing should be considerably finer, in order to make the even distribution of the values more certain. Two or three 1-inch lumps more of rich ore in one-half of a sample than in the other, when the main mass of the sample is barren gangue material, would cause quite a serious error; but if the ore is crushed to $\frac{1}{2}$ inch as the maximum diameter, a lump more or less of rich ore on either side would cause an error only one-eighth as great as that from a 1-inch lump, as the volume is proportionate to the cube of the diameter, and the chances of the ore being evenly mixed will also be much greater.

The crushed ore is now thoroughly mixed on the floor and heaped up into a conical pile, each shovelful being thrown upon the apex of the cone, so as to run down all around. Now walk round and round the heap, continually raking down a little ore from the pile with the shovel, until the ore is in a flat, circular pile, about 4 inches thick. With a stick mark the pile off into quadrants, as shown in Fig. 3, by two diametrical lines at right angles to each other. Shovel two alternate quarters carefully away. Thus, consid-

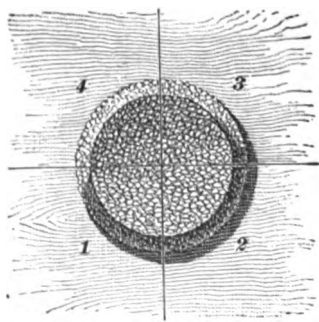

FIG. 3.

ering the quadrants as numbered consecutively from 1 to 4, Nos. 1 and 3 would be discarded, and Nos. 2 and 4 saved, or *vice versa*. This leaves but half the sample to be operated on; and this, if the work has been carefully done, should be of the same value as the discarded portion. This is "quartering." The two quarters which were saved are again crushed—this time to a maximum diameter of perhaps $\frac{1}{2}$ inch—and the entire operation is repeated. This will leave a sample only one-fourth as large as the original sample, but of the same average value. This is further

crushed to $\frac{1}{4}$ inch and again quartered; and so on until only about 3 pounds remain, the largest pieces of which are not more than $\frac{1}{8}$ inch in diameter. This sample is further reduced by quartering, or by using the tin sampler, to about $\frac{1}{4}$ pound; and this is pulverized and screened.

17. For mixing small samples, say 10 pounds and less, heaping up and shoveling will be found rather a tedious and clumsy process. After the sample is down to that size, and for small assay samples, the following method is generally adopted:

The crushed sample is placed on a sheet of oilcloth or rubber cloth, which is placed on the floor or table; the alternate corners of the cloth are then drawn over, one at a time, towards the corners diagonally opposite, rolling and mixing the sample within. When thoroughly mixed, the sample is heaped up into a conical pile by drawing the corners of the cloth upwards. The pile is then flattened as follows: A thin sheet of iron, held as shown in Fig. 4, is pressed down slightly into the apex of the cone; then, using the axis of the cone as the axis of revolution of the plate,



FIG. 4.

twist it gently around. As the plate revolves, it flattens and spreads out the ore, the process being continued until the pile is reduced to the desired thickness. The pile is then marked out into quadrants with a spatula, and quartered as previously described. Quartering has been found by experiment to give accurate average samples, if the work is carefully done.

18. Screens and Screening.—For screening the pulverized ore, a covered tin or wooden box sieve is used.

The former is preferable, as it is much stronger and more durable. The screen cloth is made of brass wire. Very fine sieve cloth is made of hair, but it does not wear very well. Screens should be 80 or 100 mesh (see Art. 11). The sieve is circular, about 8 inches in diameter, and fits into a pan which catches the screened material and prevents loss from dust blowing away. Any ore which fails to pass the screen is returned to the bucking board and further pulverized until it will all go through. The sifted ore is called the "pulp."

19. If any metallic scales are left on the screen after the ore has passed through, they should be tested with a magnet; if they are attracted, they are iron from the crushing apparatus, and may be thrown away; but if not, they are saved and assayed, and their value per ton of ore is calculated and added to that of the pulp, as described in Arts. 122 to 127.

If the scales are principally silver, and quite fine and small in quantity, instead of going to the trouble of a separate assay and the consequent calculations, they may be ground down until they will pass through the sieve, and mixed with the pulp. To do this, place the scales on the bucking board, and cover them with a little of the pulp which has already passed through the sieve; then grind heavily for a few minutes. Most of the scales will now pass through the sieve, particularly if the gangue is hard and silicious; those that will not are again treated in the same manner, and so on until all are through.

WEIGHING.

20. The entire result of a gold-silver assay or any analytical determination is directly dependent upon the accuracy of the weighing, both of the ore charge and, more particularly, of the button or other product resulting from the assay. No matter how well the rest of the work is done, an error in weighing either the charge or the button will render the result, as a quantitative analysis, worthless, and

the assayer's work will be thrown away, as the amounts to be weighed are so small that a very slight error will multiply itself enormously when the results are reduced to the basis of ounces of metal in a ton of ore.

The extreme accuracy required of assay balances may be better realized if the student will consider that the usual charge of ore used in assaying is only a trifle over *half an ounce*, or, in the scorification assay, only a little more than *one-tenth of an ounce* (avoirdupois), the charge in each case representing a ton of 2,000 pounds avoirdupois; and from the weight of the gold and silver obtained from the assay of this charge the assayer is required to estimate, within a few cents, the value of the gold and silver in a ton of the ore. Ores containing less than \$3 in gold per ton are, in some instances, profitably worked, and much smaller proportions of gold than this can be recovered by the fire assay, even from a $\frac{1}{10}$ -assay-ton charge (see Art. 30), and the buttons accurately weighed. Compare the weight of a \$5 gold-piece with a ton of ore; then note the size of a $\frac{1}{10}$ -assay-ton charge, and the extreme delicacy, both of the assay balances and of the fire assay as a method of quantitative analysis, becomes apparent.

BALANCES.

21. Two balances are necessary for gold-silver assaying—one for weighing the charges of ore and the other for weighing the gold and silver buttons resulting from the assays. For general analytical work, a third balance is required having a capacity between the two mentioned. These balances constitute the most important, delicate, and expensive part of the assayer's outfit.

22. Pulp Balance.—The pulp balance for weighing the ore or pulp should have a capacity of at least 200 grams in each pan, and should be readily sensitive to a difference of 5 mg. (milligrams) in the weights in the two pans. A convenient pulp balance is shown in Fig. 5. Such a balance, in a glass case—as shown—costs about \$25. Pulp

balances are frequently used without glass cases, and this reduces the cost somewhat. Two accurately balanced

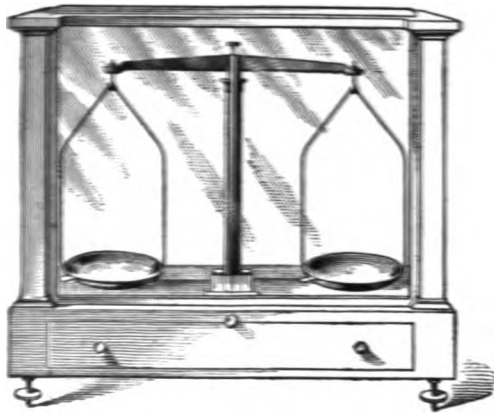

FIG. 5.

watch-glasses make the best possible removable scale-pans, though metal pans are frequently used. The watch-glasses are made with a glass lip or handle for convenience in removing.

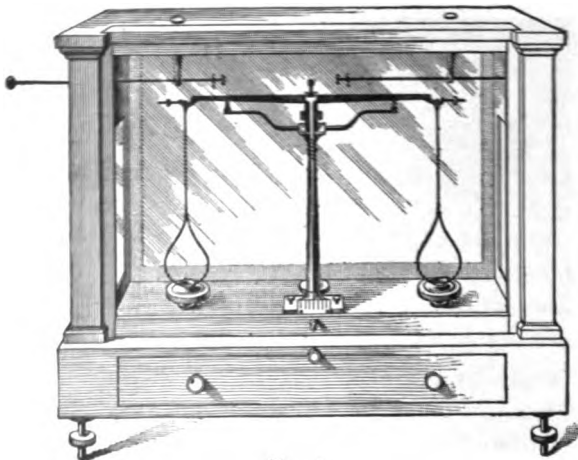

FIG. 6.

23. Button Balance.—The balance for weighing the gold and silver buttons should have a capacity of 1 or 2 grams

in each pan, and should be readily sensible to $\frac{1}{100}$ mg. or less. Balances are made which indicate a variation of $\frac{1}{1000}$ mg. Such extreme accuracy as this is, however, unnecessary in ordinary work, and such balances are very expensive, ranging in price from \$125 to \$250. Balances sensible to $\frac{1}{10}$ mg. can be bought for from \$65 to \$80, and for \$90 or \$95 a balance may be obtained sensible to $\frac{1}{100}$ mg.

24. Fig. 6 shows a button balance with rider attachment, with which device all the more delicate and higher priced balances are equipped. The "rider" is a small loop of platinum or aluminum wire, of the shape shown in Fig. 7, and of definite weight (usually 1 mg. for button balances and 10 mg. and 12 mg. for less delicate analytical balances). This rider is set astride the beam of the balance, which is graduated like the beam of a steelyard. The two pans are brought nearly to a balance by the use of ordinary weights, and the rider is then moved along the beam until the balance between the two sides is perfect. Each division on the beam of the balance is equivalent to a certain fraction (usually $\frac{1}{10}$, $\frac{1}{100}$, or $\frac{1}{1000}$) of a milligram. Thus, if each division is $\frac{1}{10}$ of the length of the beam from the middle bearing to the end, or pan bearing, and a 1-mg. rider is used, each division that the rider is distant from the middle bearing is equivalent to a weight of $\frac{1}{10}$ mg. in the pan on the same side; that is, it will balance that weight in the pan on the other side. If a 10-mg. rider is used, each division represents $\frac{1}{10}$, or $\frac{1}{100}$, mg. The weight thus indicated by the rider should be added to the sum of the weights in the pan on the same side, to obtain the weight of the charge in the opposite pan. If the rider is used on the opposite side from the weights, the amount indicated by the rider must be subtracted from the sum of the weights, in order to get the correct weight of the charge.



FIG. 7.

The rider is moved back and forth along the beam by a hook on the end of a sliding rod extending through the side of the case of the balance. This enables the assayer to do

the final balancing with the case closed, so that the balance can not be disturbed by drafts. The rider is extremely convenient, as it does away with the use of very small weights and renders the accurate adjustment of the balance much more rapid and easy.

25. Analytical Balance.—For weighing material used in gravimetric analysis and for weighing precipitates, platinum or porcelain crucibles, and similar objects, which require the handling of material too heavy for the button balances, an analytical balance is necessary. This is constructed considerably like the balance illustrated in Fig. 5, but is provided with a rider and should have a capacity of from 100 to 200 g. in each pan and be sensitive to a weight of from one-fifth to one-tenth of a mg. Such balances can be obtained for from \$50 to \$75 each.

26. Directions for setting up are furnished with each set of balances, and these should be carefully observed, as balances are very delicate instruments and are easily injured. The button balance in particular should be set in a dry place, away from the furnace, so that it will not be affected by the heat. Any sudden change of temperature is bad; and even the shifting of the sunlight, if it strikes the balance, is sufficient to throw it out of adjustment. No jar or disturbance of any kind should be permitted, as it not only interferes with the weighing, but injures the balance. In ordinary buildings it is difficult to secure a solid support, for if the table on which the balance is set rests directly on the floor, the vibrations from persons walking around the room will be a serious annoyance. In such a case, it is a good plan to set the support for the balances on wooden posts or brick piers, set in the ground underneath the office and projecting upwards through the floor without touching it. The balances should always be tested before using, to see that they are in perfect adjustment.

27. The beam of a balance, while weighing, is supported on steel or agate knife edges, and the pans are also hung from knife edges, thus making the balance almost

frictionless. When not in use or while charging, the beam is raised from the knife edges by turning a knob projecting through the front of the case, and the weight of the pans is supported from beneath by rests or stops, which are worked either by a separate knob or, in most button balances, by the same knob that releases the beam. These rests should always be raised while putting on or taking off weight from either pan, as the knife edges will be dulled if the weight is allowed to fall on them while charging.

28. To protect balances from moisture, a small beaker, partly filled with strong sulphuric acid, may be placed in the case. The acid will absorb the moisture from the air in the case, and thus prevent rusting of the balance. A small quantity of calcium chloride ($CaCl_2$) in a glass vessel, placed inside the balance case, will answer the same purpose as the sulphuric acid, and will not cause so much trouble if accidentally spilled.

WEIGHTS.

29. While any accurate weights may be used for assaying, the metric system has been generally adopted by assayers and chemists, as it greatly simplifies the calculations, all the weights being divided decimally. The assayer should have two sets of weights—one set of metric weights, from 20 or 50 g. to 1 mg., and one set of A.-T. (assay-ton) weights, from 4 A. T. to $\frac{1}{10}$ A. T. An accurate set of metric weights as described above costs from \$9 to \$14. The set usually includes three riders. A set of assay-ton weights as described costs about \$6.

30. The **assay-ton system** is a system of weights devised to simplify the calculation of the results of gold and silver assays. With the exception of fine-bullion assays, which are always reported in parts per 1,000, the returns of gold and silver assays are always reported in troy ounces per ton of 2,000 pounds avoirdupois. Consequently, if the ore charge were weighed in grams or ounces and the button in milligrams or grains, considerable figuring would be

necessary to convert the result into troy ounces per ton. The use of assay-ton weights in weighing the ore charge dispenses with all this figuring; for the assay ton weighs 29,166 mg. (29.166 g.), or just as many milligrams as there are troy ounces in an avoirdupois ton; hence, if an ore charge of 1 A. T. be taken, each milligram that the resulting button weighs represents 1 ounce (troy) of the metals composing the button in a ton of ore. The proportion is obtained as follows:

An avoirdupois pound contains 7,000 grains, and a ton of 2,000 pounds will therefore contain 14,000,000 grains. Now, since there are 480 grains in a troy ounce, by dividing 14,000,000 by 480 we obtain 29,166+, or the number of troy ounces in a ton avoirdupois. Then, if we consider 1 mg. as representing 1 ounce troy, we obtain the following proportion:

$$\begin{array}{l} 2,000 \text{ lb. (avoir.)} : 1 \text{ oz. (troy)} = 1 \text{ A. T.} : 1 \text{ mg.} \\ (29,166 \text{ oz. troy}) \qquad \qquad \qquad (29,166 \text{ mg.}) \end{array}$$

If more or less than 1 A. T. of ore is used, the contents of the ore in ounces per ton may be found by dividing the weight of the button, in milligrams, by the weight of ore taken, in assay tons. For example, if 2 A. T. of ore are taken, the resulting button would be twice as heavy as the button from a 1-A.-T. charge; and its weight would, therefore, have to be divided by 2 to obtain the weight of the button from 1 A. T., in which each milligram represents 1 troy ounce per ton. With a $\frac{1}{10}$ -A.-T. charge of ore, the button is only one-tenth as large as the button from 1 A. T.; consequently, each milligram represents 10 times as much as the same weight in the button from a full A.-T. charge; or, in other words, the weight of the button from $\frac{1}{10}$ A. T. of ore divided by $\frac{1}{10}$ (or multiplied by 10) = the weight of the button from 1 A. T. The following general rule, therefore, may be adopted for the calculation of the results from the assay of any weight of ore:

The weight of the button in milligrams divided by the weight of ore taken in assay tons gives the number of ounces per ton.

31. The weights should always be handled with the pincers supplied for this purpose, as the moisture of the hands corrodes them, and may also appreciably alter the weight of smaller weights. They should always be returned to the box as soon as the weigher is through with them, both to prevent their loss and to save time and prevent errors from the overlooking of small weights which have been left in the pan from a previous weighing.

METHOD OF WEIGHING.

32. Before starting to weigh, it should always be seen that the balances are in perfect adjustment. They must, first of all, be perfectly level. Leveling screws and bubble tubes are provided for this adjustment. The scales are then brought to a perfect balance by means of the adjusting appliance on the beam or by the use of the rider. They are now ready for weighing.

When weighing with delicate balances, or with practically any balance for analytical work, it is as a rule best to weigh on the "swing," as it is expressed, rather than to try and bring the scale to perfect rest. For instance, if the weights have been placed in one pan and the load in the other, the supports are carefully removed and the pans allowed to swing slightly. The long pointer will travel backwards and forwards across the graduated scale between the pans. If after the first two or three swings the pointer were to travel seven divisions to the left, six and one-half divisions to the right, six divisions to the left, five and one-half divisions to the right, etc., thus dropping off a half division (or other equal fraction of a division) each time, but swinging approximately equal, the pans would be equally balanced and the weight would be read without spending the time necessary to bring the beam to rest. The adjustment of the scales should be made in the same way, i. e., they should be made to swing to equal distances on both sides of the center, either when the pans are empty or when they contain equal weights. Usually in a good balance, pans will not come to rest as

rapidly as a half division for each swing, and hence it might require a few minutes to bring them to rest with the pointer in the center. This method of weighing by means of the deflection of the needle to the right and left is both much more rapid and accurate than the system of trying to bring the pans to rest, but at the same time the swing should not exceed a deflection of more than four or five divisions each way.

33. Charge.—The weight of the charge is usually fixed, and so the desired weight is put into one pan. The pulp from which the charge is to be taken is poured upon a sheet of glazed paper or a mixing cloth (a sheet of rubber cloth or oilcloth, about 10' × 15') in front of the scales, thoroughly mixed by rolling, as described in Art. 17, and then with a large spatula spread out into a thin pile. Take out the empty scale-pan and place the pulp charge in it. The charge is taken from all over the surface of the pile of pulp, a dip here and a dip there, to further insure an average sample. When approximately the right amount is in the pan, it is replaced on the scales. Then pulp can be added or removed as required with a small spatula until the correct weight is obtained. The beam is held off the knife edge during charging, being let down only to observe the balance, until very nearly the correct weight is struck. It may then be let down; but the pan rests are still kept up, the pans being released only for observing the balance, and then immediately stopped again. As soon as the correct weight is obtained, the beam is raised from the knife edge again, and the pan removed and its contents brushed into the crucible or other receiving vessel, using a soft camel's-hair brush for this purpose. If duplicate charges are being used, the charges may be weighed separately, all in one pan, or the weights may be removed before emptying the loaded pan, and a charge put into the pan which contained the weights, to balance the weighed charge. The pulp should be rolled and mixed anew for each charge. The pans must always be brushed perfectly clean after each weighing, and should be handled as lightly as possible.

One great objection to weighing balanced charges, that is, placing the weights in one pan and a charge in the other and then removing the weights and balancing the charge already weighed out with another supply of ore, is that there is danger of getting the pans of the balance interchanged, and, as a rule, the pans are not exactly of the same weight, and hence should be kept in their respective places. Most chemists make it a rule to do all their weighing in one pan and to always use the weights in the other. One great advantage of this system is that the small weights are never in danger of becoming mixed in with the ore, or there is no danger of ore or pulp becoming attached to the pan in which the weights are used. When the weights are always used in one pan, a right-handed man will usually find it most convenient to keep the weights in the right-hand pan.

34. Buttons.—The buttons are weighed in practically the same manner as the pulp, except that the unknown weight (button) is put in one pan and then balanced by weights in the other pan. The final balance is usually obtained by the use of the rider. If duplicate buttons are being weighed, the weight of one may be obtained as described, and then the second button substituted for the weights in the weight pan, and the difference in the weights of the buttons, if there is any, balanced by the use of the rider (and the small weights, if necessary, although a difference great enough to require as much as a milligram to measure it is altogether too large to overlook, except in extremely high-grade gold ores or rich silver ores). The front of the scale case should be closed as soon as the difference in weight comes within the limit of the rider, and the final balance obtained without any interfering air-currents. The work can be done about as quickly by leaving the weights in the pan and substituting one button for the other and noting the difference with the rider.

The assayer should have a weight book in which to record all weighings of buttons or other materials obtained in assaying or analytical work, and in reading any given weight

he should first read the weight as recorded by the weights in the pan of the balance and the setting of the rider, and then should read the weight as recorded by the empty spaces in the weight box and the rider. This will give a check on the reading and will also serve to check the loss or oversight of any small weight on the scales.

FURNACES.

35. The furnaces used in assaying vary in size and design with the amount and character of the work done, and also with the kind of fuel used. They are of two general types: **wind** or **crucible furnaces**, in which the vessel containing the charge to be melted is heated by direct contact with the fuel or flame, and **muffle furnaces**, in which the heating is indirect, the vessel being placed in a fireclay muffle or oven, which is heated from the outside. Charcoal, coke, coal, gas, or gasoline may be used as fuel with either type.

36. Wind Furnace.—Wind furnaces are used chiefly for melting bullion, for which purpose a higher heat is necessary than can be obtained in a muffle furnace; the crucibles used for bullion melting are, moreover, too large to enter the ordinary muffle. Occasionally, the wind furnace is used for making fusions of larger quantities of ore than can be safely put into crucibles of a size not too large for the muffle furnace. The American practice, however, is to use the muffle furnace wherever possible, as it is much cleaner and neater, and the work can be more carefully watched and the heat and air more successfully controlled.

Fig. 8 shows the ordinary type of wind furnace for burning solid fuel (anthracite, coke, or charcoal). The furnace is built of red brick, with a firebrick lining at least 4 inches thick in the fire-chamber, the entire thickness of the walls being usually from 8 to 12 inches. The walls are bound

together by angle-irons and tie-rods, or, in some cases, by a complete casing of sheet iron. The latter strengthens the furnace, but radiates more heat than the bricks. The fire-chamber is ordinarily 12 inches square, but may be made of any size desired. The grate-bars are separate and removable, their ends resting on narrow iron ledges built into the furnace walls.

The draft is regulated by the iron door of the ash-pit. The top of the furnace may be either flat or inclined as shown, with a ledge in front on which to set crucibles and molds. It is made of a cast-iron plate, with the opening usually flush with the sides of the firebox. This opening is covered while working with a cast-iron plate or lid. In large furnaces this plate is sometimes lined with fire-brick, and slides back and forth on rollers. The flue connects with the firebox at the back, near the top, and is usually from 16 to 20 square inches in area ($4' \times 4'$, $3' \times 6'$, or $4' \times 5'$) for a $12' \times 12'$ furnace. The stack should be $5' \times 6'$ or $6' \times 6'$ in the clear, and should be at least 20 feet high—the higher the better.

For crucible furnaces intended for melting quite large charges, the covers are frequently provided with iron rings and are hoisted off and removed by means of a small tackle hanging from a trolley which runs on a rail supported over the furnace. The same trolley may be employed for hoisting the pots from the furnace.

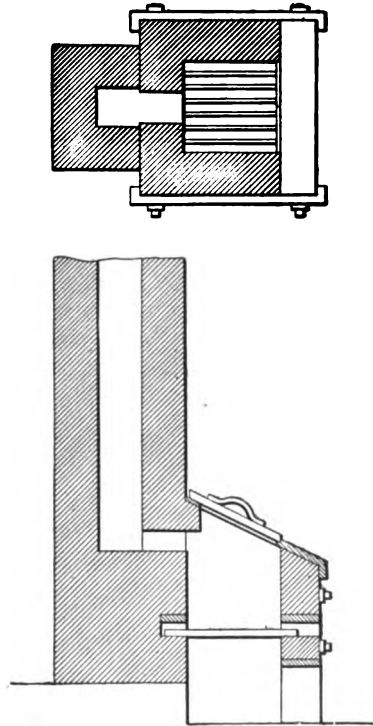

FIG. 8.

Small portable crucible furnaces for assaying are made of fireclay tile, bound together by a sheet-iron casing or by wrought-iron bands.

When gasoline or gas is used to fire assay furnaces, a special style of furnace is sometimes employed in which 4 to 8 crucibles are placed in a small chamber which is covered with a firebrick lid. The fire enters at the back, passes around the crucibles and out through a small flue. The crucibles are removed by lifting off the cover and handling them with tongs. This style of furnace is more economical than a muffle would be for heating crucibles where a limited amount of work is done, using gasoline as a fuel, and a smaller muffle may be employed for the cupellation of the buttons obtained.

37. Muffle Furnace.—Muffle furnaces are built to receive fireclay muffles similar to the one shown in Fig. 9;

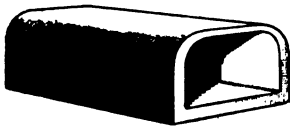
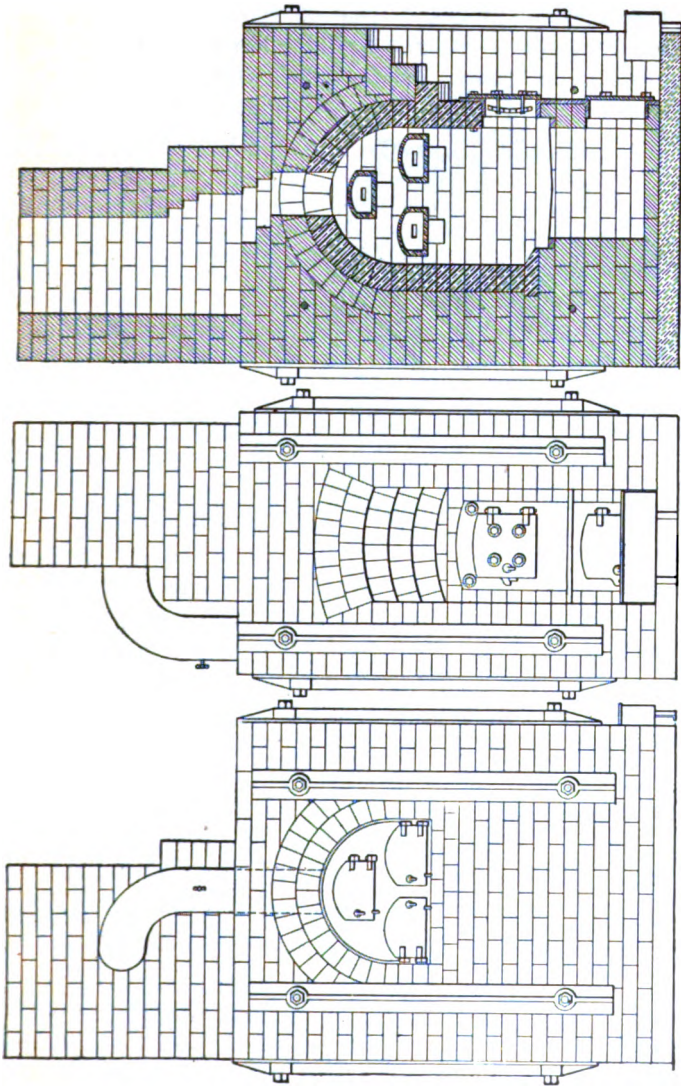

FIG. 9.

these muffles are heated from the outside, like an oven, and the crucibles, scorifiers, or cupels are placed inside. The front of the muffle opens into the air, and a small hole or slit in the rear permits a constant current of fresh air to flow through the muffle while working. The heat of the muffle and the draft through it may be regulated by the door in front. Assay muffles are made in various sizes, from 7 inches long by $3\frac{1}{2}$ inches wide to 18 inches long by 14 inches wide. The $12' \times 6'$ and $14' \times 8'$ sizes are the most commonly used, as they are plenty large enough to receive a double row of 10-g. crucibles—the size most commonly used in assaying. Muffles usually last only a few weeks, but are easily replaced when they break.

38. Fig. 10 shows the construction of a brick muffle furnace built for three muffles and to burn bituminous coal. The construction of muffle furnaces varies somewhat with the nature of the fuel used. Furnaces for burning long-flaming, bituminous coal have the muffle 12 to 18 inches



above the grate-bars, and use a comparatively thin bed of fuel, depending upon the flame to heat the muffle. The fire-door is on the level of the grate. In furnaces for burning coke, charcoal, or anthracite, on the other hand, the muffle is set

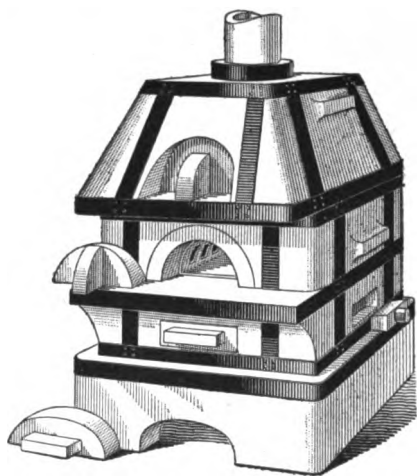

FIG. 11.

within 6 or 8 inches of the grate, and the fuel is packed in around the muffle. These fuels are all very short flaming, and their heat, though intense, is only local, and will scarcely raise a glow in a muffle placed a few inches above the fire bed, hence the necessity of surrounding the muffle by fuel. The fire-door in furnaces of this type is placed some distance above the muffle, and a narrow horizontal slit is made in the furnace on the level of the grate-bars for stirring the fire and cleaning the grate. Stationary muffle furnaces are usually built of red brick, lined with one course of firebrick. The walls are firmly braced with buckstays and tie-rods.

The sheet-iron pipe shown in Fig. 10 is to draw off any fumes that tend to escape from the front of the muffle and conduct them to the chimney.

Portable muffle furnaces are made in all sizes, designed for burning coke, charcoal, or anthracite. They are built of fireclay tile, bound together by wrought-iron strips, as shown in Fig. 11, or completely encased in sheet iron.

39. There are a number of gas and gasoline furnaces made. They are very convenient, particularly when the amount of work is limited and the furnace is used only intermittently. The muffle need be kept hot only while in actual use; the gas may be shut off as soon as the assayer is

through with it, thus economizing greatly in fuel, prolonging the life of the muffle, and adding greatly to the comfort of the office during hot weather. Their neatness is also a great recommendation, as they dispense entirely with coal dust and ashes. Gas is used entirely in the U. S. mints for both melting and muffle furnaces.

FURNACE TOOLS.

40. Firing Tools.—Firing tools—poker, shovel, and scraper—are, of course, necessary in connection with assay furnaces using solid fuel.

41. Crucible Tongs.—When a crucible furnace is used, a pair of crucible tongs is necessary for lifting the

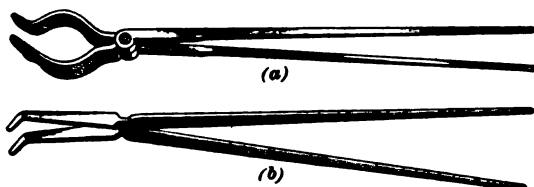

FIG. 12.

crucibles. These are of various designs. Fig. 12 (a) shows the double-bent and (b) the single-bent crucible tongs which are commonly used for handling medium-sized melting crucibles. They are made of wrought iron and are from 30 to 36 inches long.

A pair of small crucible tongs, of the kind used for handling small porcelain crucibles, is convenient for removing nails from assay crucibles and for handling annealing cups.

42. Scorifier Tongs.—Fig. 13 shows the scorifier tongs used for handling the scorifiers and small crucibles



FIG. 13.

used in muffle work. These tongs are made of steel, or of wrought iron with a steel spring, and are from 27 to

36 inches in length. They are large enough to handle 20-g. crucibles, the largest size used in muffle work, and are much handier for that purpose than crucible tongs.

43. Cupel Tongs.—Fig. 14 shows the ordinary form of cupel tongs for handling the bone-ash cupels. Like the



FIG. 14.

scorifier tongs, they are made entirely of steel. A steel guide, fixed in the middle of one leg and passing through a hole in the other, serves to keep them in line. Scorifier tongs are also frequently fitted with similar guides. Cupel tongs are made, as shown, with a bend at the end, so that cupels at the back of the muffle can be removed without disturbing those in front.

44. Molds.—Molds made of cast iron are used to receive the melted contents of scorifiers and crucibles. Their use hastens the cooling of the charge and leaves the crucibles in such a condition—when the fusion has been perfect and the pour clean—that they can be used again if desired. Scorifiers, however, should never be used for more than one fusion, as the scorification usually corrodes the vessel so much as to render it unsafe for use a second time.

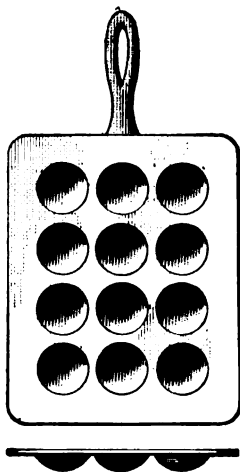

FIG. 15.

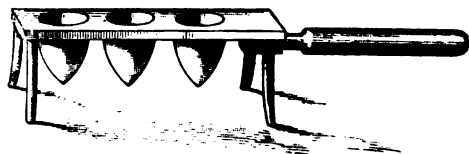

FIG. 16.

Fig. 15 shows a 12-hole mold for ordinary work with scorifiers and 10-g. crucibles. For larger crucibles, a mold with deeper holes must be used. Fig. 16 shows one form of crucible mold.

45. Cupel Board.—An almost indispensable part of the assayer's outfit is the cupel board, or hot board, on which hot cupels are set as they are withdrawn from the furnace. It is merely a bit of 1-inch board, about 10 inches wide, with a handle at one end, as shown in Fig. 17, and with a rectangular piece of $\frac{1}{8}$ -inch sheet iron, about 10" \times 12", screwed to the upper side. It is a good plan to cut a number of small, radiating grooves in the board under the plate, to allow the escape of the gas which forms at first, before the wood has become charred, when the iron plate becomes heated from the red-hot cupels. The gas will usually escape without this precaution, but occasionally it accumulates between the board and the plate and explodes. The explosion is not violent enough to injure the board, but it will upset and mix the cupels, making it necessary to repeat a number of assays.

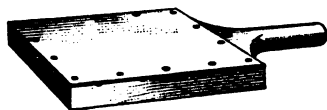

FIG. 17.

46. Hammer.—A hammer is necessary for beating out lead buttons, to free them from slag and get them into convenient shape for cupellation. A 2-pound machinist's hammer with a square face is of a very convenient size and shape for this purpose.

47. Button Tongs.—A pair of spring button tongs, similar to the iron forceps described in Art. 65, *Blowpiping*, is necessary for handling the button while beating it out.

48. Miscellaneous Tools.—Besides the preceding tools, there are many others that are handy around a furnace, such as cupel shovels, cupel rakes, etc.; but these are not necessary, and their work can be conveniently done by the tools at hand. The assayer should, however, be

supplied with a scraper for cleaning up spilled slag and lead from the muffle in case of any accident, such as the boiling over of a crucible or the cracking or spilling of a cupel.

CRUCIBLES, SCORIFIERS, ETC.

49. The crucibles and scorifiers used in assaying must be able to withstand very high heats and sudden changes of temperature without fusing or cracking, and to resist the corrosive action of the charges.

50. Crucibles.—There are various makes and styles of crucibles. In America, **fireclay crucibles**, of the *Colorado or lead-assay* pattern, are used almost exclusively for muffle work. This crucible is illustrated in Fig. 18.



FIG. 18.

The size known as *A*, or *10-gram* (made for running a charge of 10 g. of lead ore), will serve for a $\frac{1}{4}$ -A.-T. gold-silver assay; or for a 1-A.-T. assay, a *20-g.*, or *B*, crucible. The crucibles are low, and broad at the base; this shape is much safer and more convenient for muffle work than that of the regular *Battersea* gold-assay crucibles. The latter are narrower in proportion to their height, and are made with a lip for pouring. They are made, like the lead-assay crucibles, of the best quality of fireclay. Fireclay crucibles are very strong and durable and are smooth and pour cleanly.

51. Sand, or Hessian, crucibles are very little used in this country. They are rather bulky and are not well adapted to muffle work, as their comparatively small base renders them liable to upset. They serve well for melting, but their roughness unfits them for pouring.

52. Graphite, or plumbago, crucibles are largely used for melting bullion. Large *Battersea* clay crucibles are also used for this purpose.

53. Scorifiers.—Scorifiers are made of fireclay. Fig. 19 shows the usual form. They are made in sizes from 1 to 5 inches in diameter. The sizes most commonly used are the $2\frac{1}{4}$ -inch and $2\frac{1}{2}$ -inch, which will receive a $\frac{1}{10}$ -A.-T. charge of ore.



FIG. 19.

54. Roasting Dishes.—Roasting dishes are wide, shallow, saucer-shaped dishes of fireclay, used for roasting sulphide ores, drying and calcining ores, etc. While not indispensable, they are very convenient. They range from 2 to 7 inches in diameter.

55. Cupels.—Fig. 20 shows the most common form of the bone-ash cupels used in separating the gold and silver from the lead buttons. These cupels may be purchased ready made, but most assayers prefer to buy the bone-ash in bulk and make their own cupels. The home-made cupels are much cheaper, and if well made are fully as good as the purchased articles. All the tools required are a brass or iron mold and pestle (shown in Fig. 21) and a wooden mallet.

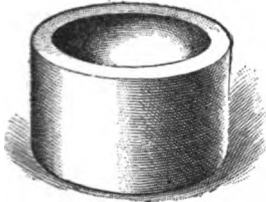

FIG. 20.



FIG. 21.

A pound or so of bone-ash is thoroughly mixed with just enough water to dampen it, so that when squeezed in the hand it will stick together and show distinctly the impression of the fingers. It must not, however, contain enough water to feel wet and dampen the fingers; the proper consistency is difficult to describe, but is soon learned. The cupels will be stronger and less liable to crack in drying if a

strong solution of carbonate of soda or potassium (sal soda or pearlash) be used for moistening the bone-ash instead of water alone. The moistened bone-ash is sifted through an ordinary flour sieve to break up all lumps. To make the cupel, the cupel ring is placed on a smooth block of wood and filled level full with the moistened bone-ash put in loosely; the pestle or plunger is then inserted and struck four or five moderate blows with the mallet, compressing the ash into the form of the cupel. To remove the cupel from the mold, invert the mold; then with a gentle upward pressure turn the plunger to free it from the cupel, and gently but steadily force the cupel out.

The moist cupels are set aside and allowed to dry out slowly. If it is absolutely necessary to use them at once, they may be dried out and made reasonably safe by setting them on top of the furnace for several hours while running; but, if possible, they should be allowed to stand several weeks before using. The British mint keeps the cupels two years before using them.

56. The texture of the cupel is very important. If it is too porous, it will absorb some silver, and the results of the assay will be too low; if too dense, it will crack or "check" in the muffle when it becomes saturated with litharge. The density depends upon the fineness of the bone-ash, the amount of water used in mixing, and the amount of compression. The finer the bone-ash the more dense the cupel, and the damper the ash the greater will be the compression from the same power on the plunger. The cupels should be made of a medium grade of bone-ash, or the mold may be filled about two-thirds full with coarse ash and the remainder with fine. A cupel made in the latter way will absorb a great deal of litharge and very little silver. If about 1 part of common flour to 10 of bone-ash is thoroughly mixed with the bone-ash *before moistening*, the cupels may be compressed rather harder than when bone-ash is used alone; then, when placed in the muffle, the flour will burn out, leaving the cupel quite porous and in good condition for absorbing litharge.

57. The shape of cupels is immaterial. That shown in Fig. 20 is the most common because it is readily removed from the mold and is easily handled in the muffle without risk of tipping. The mold is sometimes made so that the cupel is a trifle wider at the base than at the top; this makes it easier to remove from the mold, but they have to be more carefully handled in the muffle, as the tongs grip the sloping sides of the cupel along their lower edge, and if the point of contact happens to come below the center of gravity of the cupel, the latter will be apt to turn upside down and lose the button. The bowl of the cupel should be large enough to hold the melted lead button without overflowing, and the cupel should weigh when dry approximately at least as much as the lead button to be cupelled in it. The usual diameter is $1\frac{1}{4}$ inches. If a button is too large to absorb in one cupel, it may be cupelled in two portions, or if the bowl of the cupel is large enough to hold the lead, the button may be put in one cupel, and this set upon a second, the latter being set upside down in the muffle. As soon as the upper cupel is saturated with litharge, the excess will be absorbed by the under cupel.

58. Porcelain Capsules.—Small porcelain crucibles, or capsules, are used in parting the gold and silver. The parting may be done, if desired, in test tubes or small parting flasks, and the gold afterwards annealed in small, porous, clay **annealing cups**. The use of porcelain capsules is preferable, however, as they can also be used for annealing; the parted gold is washed in the capsule by filling it with water and decanting (pouring off) the washings, repeating several times; the gold is then annealed in the muffle or over the blast-lamp without removing it from the capsule. The porcelain capsules are, moreover, much stronger and more durable than the annealing cups, and no more expensive.

59. For parting the gold and silver in bullion assays, platinum parting trays are commonly used. The trays are simply small crates of platinum wire, divided into a number of compartments, in each of which is placed a small platinum

cup—merely a small crucible—with a series of slits in the bottom to allow free circulation of the acid and permit it to drain off readily on removing the tray from the bowl. The gold-silver “cornets,” made by rolling the buttons out into thin strips, annealing them by heating to redness in the muffle, and then twisting them into a spiral coil, are put in the tray, one in each cup, and the tray is then hung in a platinum bowl about 3 inches in diameter and 2 inches deep, filled to within about $\frac{1}{2}$ inch of the top with dilute nitric acid of 1.28 Sp. Gr. (50 per cent. concentrated acid), and heated nearly to boiling. They are boiled 10 minutes in this acid; then this is poured off and the dish refilled with fresh acid of the same strength (or sometimes the second acid is used stronger), and they are boiled 10 minutes longer. The crate is then lifted out and the cornets washed in the crate with pure distilled water. They are then dried out over a Bunsen burner or an alcohol lamp, and the crate and its contents are then put into the muffle and allowed to come to a red heat to anneal the cornets. After cooling, the cornets are weighed.

FLUXES.

60. The majority of ores are by themselves infusible, or nearly so, at the temperatures obtainable in an assay furnace; but if the pulverized ore be well mixed with the correct proportions of certain solid chemical reagents, the mixture will readily fuse at a moderate heat to a fluid mass, called *slag*, from which such heavy metals as lead, gold, and silver, which reduce to their metallic state during the fusion, settle out on account of their greater specific gravity. The reagents used for this purpose are called *fluxes*, from their property of making the mixture fluid.

61. *Fluxes* may be, like the ore itself, infusible alone, although fusible when mixed in the proper proportions. For example, iron oxide, calcium oxide (lime), and silica (the most common gangue material of ores) are each, separately, extremely infusible, but when properly mixed they

form a very fusible slag. These three substances are, as a matter of fact, the principal constituents of all slags except that from iron blast-furnaces. In the latter the iron is removed by reduction to a metal at an extremely high temperature and in a very powerful reducing atmosphere, and the slag, or "cinder" as it is more commonly called in the iron trade, is made up mainly of silica and lime. Slags are more or less definite chemical compounds, and in figuring the furnace charge of an ore, its composition, with regard to lime, iron, and silica, is taken into consideration, and the amount of fluxes added is just sufficient to give the correct proportions of these substances to produce a slag of fixed composition.

62. In the case of the use of fluxing materials that are by themselves refractory, any excess of any of them over the correct fixed proportions makes the mixture somewhat less fusible. If, on the other hand, the fluxing material is itself quite fusible, any excess will make the slag more fluid by simple dilution, even if it does not combine chemically with the rest of the slag-making material. In assaying, it is impracticable to determine the composition of each sample before assaying it; hence the fluxes used are mostly those that are of themselves readily fusible, and mixtures are made as nearly as possible universal; that is, the assayer seeks to find a mixture which will flux all ores. A *perfect universal flux* is out of the question, as there is too wide a variation in the chemical characteristics of ores for any one mixture to satisfactorily flux them all. In Arts. **78** to **80**, however, are given a number of fluxes, each of which has been successfully used as a general flux. Occasionally, when using a general flux, an ore will be met that will not flux satisfactorily. In such a case, the cause of refractoriness is determined either by the eye or by chemical analysis, if necessary, and corrected by the addition of the proper fluxing materials. For example, an excess of silica, which is acid in its reactions, may be corrected by the addition of a flux which reacts as a base; the metallic oxides, on the other

hand, are basic in their reactions, and any excess of them must therefore be counteracted by the use of an acid flux.

63. The following are the principal gangue materials, classified according to their chemical character:

GANGUE MATERIALS.

<i>Acid.</i>	<i>Basic.</i>
Silica, uncombined; as, quartz crystals, rock quartz, quartzite, sandstone, etc.	Metallic oxides and carbonates, notably those of iron, calcium (lime), magnesium, and manganese.
Silicates, or silica, combined with a base; as, feldspars, mica, clay, slate, etc.	Fluorite, or fluor-spar (calcium fluoride).
Rocks in which silica, either free or combined, predominates; as, granite, quartz, porphyry, etc.	Barite, or heavy-spar (barium sulphate).
Generally speaking, the acidity of a gangue is due to silica.	Generally speaking, all the metallic elements and their common salts, with the exception of silicates, act as bases.

The gangue as a whole is acid or basic according as the acid or basic constituents are in excess. When both are present in the same proportion, the gangue is said to be *neutral*. All *silicates* are more or less self-fluxing, as the silica is already partially neutralized by combination with the metallic base of the silicate. They may be considered as made up of metallic oxides and silica, with the latter usually more or less in excess; and the metallic oxides may be credited to the bases, as if uncombined, leaving only silica as the acid constituent of gangues.

FLUXING AND REDUCING REAGENTS.

64. A list of the various fluxing and reducing reagents used in assaying, with the use and effect of each, is here given. This will enable the student to better understand the mixed fluxes described in Arts. **78** to **80**, and will also give him some idea of what additions to make to his stock flux in the case of refractory ores.

The principal fluxes are the bicarbonates and carbonates of soda and potash, borax, litharge, silica, salt, niter, and metallic lead and iron. Cyanide and ferrocyanide of potassium are also used to some extent in special cases.

65. Sodium and Potassium Bicarbonates.—Bicarbonate of soda is a readily fusible, basic flux. It also acts as a desulphurizer, and in some cases as an oxidizing agent. Potassium bicarbonate is practically identical with the sodium salts in its physical properties and chemical reactions, and may be substituted for it in fluxes, but the sodium bicarbonate is more commonly used. The bicarbonate should be dried and free from lumps.

66. Sodium and Potassium Carbonates.—These are very similar to the bicarbonates in their action and may be substituted for them. They are very disagreeable to handle, however, as they absorb water from the air and hands with great rapidity, covering the hands and apparatus with a slimy solution of the carbonate, and they cake into solid lumps if left exposed to the air.

67. Borax.—Borax is a very active, fusible, acid flux, and is a constituent of all stock fluxes. Ordinary borax contains a large amount of water, which is given off very readily under the influence of heat, causing the borax to puff and swell, and if used for assaying is apt to overflow the crucible. The water is, therefore, previously removed from the borax used for assaying, either by calcination (slow heating at a temperature slightly higher than the boiling-point of water) or by fusion to a clear glass, in an iron or chalk-lined clay crucible, the melted borax being poured upon a clean surface, and when cold pulverized, forming what is known as *borax glass*. **Borax glass** is largely used as a "cover" for both crucible and scorifier assays, a little being spread over the top of the assay before putting into the furnace. This cover fuses before the main charge, and thus prevents some loss through volatilization of litharge and certain volatile gold and silver ores, and it also aids in starting the fusion.

68. Sodium Chloride.—Sodium chloride (common salt) is also quite commonly used as a cover for crucible charges. Covers are not absolutely necessary, but are universally used.

69. Litharge.—Litharge (yellow oxide of lead) acts as a basic flux and an oxidizing and desulphurizing agent, and by reduction to a metal supplies the necessary lead for the collection of the values in gold-silver crucible assays. Litharge is never entirely free from silver, and each new lot should be assayed, in order that the weight of the silver contained in the litharge of a crucible charge may be deducted from the weight of the resulting button, and the silver not credited to the ore. The crucible method of assay—the same as for oxidized gold and silver ores—is used for determining the silver in the litharge, and the charge taken is usually 1 or 2 A. T.; but the assayer will save time, trouble, and the possibility of arithmetical error if he uses for the assay charge the same amount of litharge as he uses in the flux for his gold-silver assay charges. A good charge for the litharge assay is: litharge, 2 A. T.; sodium bicarbonate, 1 A. T.; argol, 1 g. Cover with borax, and fuse as in regular assay for gold and silver ores. Charcoal or flour may be used instead of argol (see Art. 76). If he mixes his litharge with his stock flux, he need only run duplicate assays of the flux alone, using the same amount for the charge as he mixes with his ore assays. A little silica (sand or powdered glass) added to the litharge-assay charges will save the crucibles, which will otherwise be corroded to furnish the necessary silica for the slag.

70. Silica.—It is sometimes necessary to add silica, in the form of sand or powdered glass (ordinary window or bottle glass; lead glass is to be avoided), to the flux of extremely basic ores, in order to save the crucibles.

71. Niter.—Niter (sodium or potassium nitrate) is a basic flux and a very powerful oxidizing and desulphurizing agent. Its use is, however, objectionable for various reasons. In the first place, its oxidizing power must be

determined, as the amount used must be only just sufficient to accomplish the purpose for which it is added, any excess tending to prevent the reduction of the litharge. This determination involves two sets of assays. The reducing power of the stock flux must first be tested by running duplicate charges and weighing the resulting lead buttons. The amounts of flux and litharge in these charges should be the same as are used in a regular assay charge, the litharge being somewhat in excess of the amount the flux will reduce to metal. Next run two similar charges, with the addition of 1 g. of niter to each. The buttons from this assay will be smaller than those from the previous one, and the difference between the average weight of the lead buttons from the two assays—without and with niter—represents the oxidizing power of niter per gram. If more than 1 g. of niter is used, the difference in weight of the buttons will have to be divided by the number of grams of niter used, to obtain the oxidizing power per gram. After the oxidizing power of the niter has been determined, before it can be used in an assay charge it is further necessary to determine the reducing power of the ore with which it is to be used, in order to know just how much niter to add, and avoid excess. To do this, make up the following charge: ore, $\frac{1}{10}$ A. T.; litharge, 15 g.; sodium bicarbonate (or mixed soda and potassium bicarbonate), 10 g. Run this charge like the previous charges, and weigh the resulting button. The button reduced by $\frac{1}{10}$ A. T. of ore would be five times as heavy; and in an ordinary assay this weight would be added to that of the button reduced by the flux charge. The amount of niter added should be just sufficient to reduce the button to the desired weight.

72. Besides necessitating all the extra work, niter in the flux is troublesome in itself. Its oxygen is given off so rapidly as to cause deflagration and spitting of the charges before they commence to melt, and unless very large crucibles are used, charges containing niter are almost certain to boil over if left unwatched, as the niter causes violent

boiling and effervescence. Taking all these things into consideration, most assayers prefer to use iron wire or nails rather than niter to prevent the reduction of sulphur and arsenic into the buttons from sulphides and arsenides—the principal purpose for which niter is used.

73. Cyanide and Ferrocyanide of Potassium.—

Potassium cyanide is a very powerful desulphurizing and reducing flux. In lead flux, it is apt to reduce some of the more readily oxidizable metals—such as bismuth, tin, and antimony—along with the lead, causing a brittle, heavy button. It is intensely poisonous, and should be handled with the greatest care, never touching it with cracked or sore hands, and grinding it in the open air, with a towel over the top of the mortar. For this reason, it is little used in assaying. The commercial cyanide is used for assaying. The ferrocyanide acts in a similar manner in the flux, though much less powerfully, and is much safer to handle, although care should be exercised in its case also. Like niter, both cyanide and ferrocyanide are apt to cause boiling over, and their place as desulphurizers is usually filled by iron wire or nails.

74. Iron.—Metallic iron is a powerful basic flux. Its principal use, however, is in the crucible assay of sulphides and arsenide ores, to form a matte with the sulphur and arsenic, and thus keep them out of the lead button. It is usually used in the shape of nails or wire coils; the former are more convenient. From two to four nails, according to the amount of sulphur in the charge, are stuck point downwards into the crucible before putting it into the fire. As the charge melts, the sulphur rapidly eats away the iron, forming a matte of iron sulphide. If there is much of this matte, it forms a distinct layer between the button and the slag, both before and after pouring. The matte can be readily distinguished from both slag and button by its crystalline structure and metallic luster. If any of the nails remain undissolved in the crucible, they should be removed, before pouring, by means of the small crucible tongs, tap-

ping them lightly against the edge of the crucible, as they are withdrawn, to shake off any adhering globules of lead.

75. Lead.—Metallic lead acts as a basic flux and also as a collector of the precious metals in gold and silver assays. **Test lead** (pure, granulated lead) is the principal flux used in the scorification assay. **Sheet lead** or lead foil is used in assaying bullion (see Art. 141). Test lead, like litharge, almost invariably contains more or less silver, and should be assayed for that metal and the proper deduction made from the results of all silver assays in which it is used. The assay is run exactly like an ordinary scorification assay, adding silica to the charge.

76. Reducers.—The principal reducing reagents used in fire assaying are charcoal, flour, argol, cream of tartar, sugar, cyanide and ferrocyanide of potassium, or any carbonaceous substance. The first three—charcoal, flour, and argol—are the most commonly used. The carbon in these carbonaceous reagents burns to CO_2 , deriving the necessary oxygen from the reducible metallic oxides in the ore and the litharge in the flux, and reducing them to their respective metals. Sulphur, arsenic, and antimony in ores have a similar reducing effect and assist the reducer in the flux. This fact should be borne in mind in making up the flux for any particular ore. Powdered sulphur is sometimes, though seldom, used as a reducing reagent in flux.

MIXED FLUXES.

77. The following are the formulas for stock crucible fluxes recommended by different authorities. These fluxes have all been thoroughly tested, and while no one of them is suited to *all* ores, any of them will flux the majority of ores met with in custom assay practice. Special fluxes, adapted to particular types of ores, are given in Table I. An assayer whose work is mainly confined to ores of any particular type or district should experiment with various fluxes until he finds the one best suited to those ores and should then stick to that as his stock flux.

78. Lead Fluxes.—The following fluxes are primarily calculated for the fire assay of lead ores. They are all good general fluxes, however, and any one may be used as the basis of a gold-silver crucible flux, merely adding litharge :

No. 1.	Sodium bicarbonate.....	4 parts.*
	Potassium carbonate.....	4 parts.
	Borax glass.....	2 parts.
	Flour.....	1 part.
No. 2.	Sodium bicarbonate.....	13 parts.
	Potassium carbonate.....	10 parts.
	Borax.....	5 parts.
	Flour.....	2½ to 4 parts.

If the ore contains sulphur, the proportion of flour may be reduced, or for heavy sulphides the flour may be omitted entirely. From 1 to 4 tenpenny nails should be added to the charge for a sulphide before the salt or borax cover.

79. Gold and Silver Crucible Fluxes.—Most of the gold-silver crucible fluxes are merely lead fluxes to which litharge has been added. The amount of litharge added should be sufficient to give a lead button weighing about 15 g. from a ½-A.-T. assay. As a general rule, from 20 g. to 1 A. T. of litharge are added to a ½-A.-T. assay charge. Any unreduced litharge goes into slag, and is a splendid flux. If a large amount of litharge is used, the reducing power of the charge must be kept down, so that too large a lead button will not be reduced. A good charge to use is 20 g. of litharge, as there is only a slight excess of litharge over the amount necessary to produce a 15-g. button, and unless the ore contains lead, the button can not run much too heavy. A charge of 17 g. of litharge gives a button weighing slightly over 15 g.—the usual charge of lead flux (without litharge) for a ½-A.-T. assay is about 30 g.; therefore, if the litharge is to be mixed with the flux in bulk, the

* In all the fluxes given in this Paper, the proportions of the constituents are given in parts by weight.

proportion of litharge to lead flux is made about 2 to 3, which is equivalent to 10 pounds of litharge in 25 pounds of mixed flux. If a 10-g. crucible be filled about two-thirds full of this mixed flux—which is about the amount commonly used in $\frac{1}{2}$ -A.-T. crucible assays—and run, the resulting button of lead will weigh approximately 15 g.—the desired weight. The following flux is practically lead flux No. 2, with litharge added in the above proportion:

No. 3. Sodium bicarbonate.....	5 parts.
Potassium carbonate.....	4 parts.
Borax.....	2 parts.
Flour.....	1 part.
Litharge.....	8 parts.

80. Flux No. 3 is a typical general flux for oxidized ores. For sulphides, the flour may be omitted and from 1 to 4 nails added, according to the amount and nature of the sulphides. In this flux and similar fluxes, the amount of litharge is kept as low as is consistent with the formation of a lead button of convenient size for cupellation.

Another class of fluxes less used employs a large excess of litharge, using it largely as a flux as well as an agent for collecting the precious metals in the charge. These fluxes belong to what Brown, in his "Manual of Assaying," calls the "litharge process." Fluxes Nos. 4 and 5 are types of this class.

No. 4. Sodium bicarbonate.....	1 part.
Borax glass.....	1 part.
Litharge.....	5 parts.
Ore.....	1 part.

To this charge sufficient reducer (or niter, if the ore is itself strongly reducing) is added to bring down a button of convenient size for cupellation, and a cover of salt is put on. (For reducing power of the various reducers, see Table II.) The oxidizing or reducing power of the ore should be determined by a preliminary assay, adding a measured quantity of reducer ($\frac{1}{2}$ g. of charcoal or 1 g. flour,

TABLE I.
CRUCIBLE CHARGES FOR GOLD AND SILVER ORES.

Ore.	Character of Gangue.	A. T. Ore.	Grams Lead Flux.	Grams Soda Bicarb.	Grams Litharge.	Grams Potass. Ferrocyanide.	Grams Niter.	Grams Silica.	Grams Argol.	No. Nails.	Grams Borax Glass.	Cover.	Remarks.
Oxidized.	Neutral. No lead.	†	30		25							Borax.	If cover of salt is used instead of borax, add 3 to 5 g. borax glass.
Quartz.	No bases.	†			75				2			Borax.	Special method. If oxide of iron is present, add soda in proportion.
Quartz.	No bases.	†	30	30	20							Salt.	
Oxidized.	Basic. No lead.	†	30-40		20			15				Borax.	If gangue is oxid. or carbonate of iron, add 2 or 3 g. argol.
Oxidized.	Basic with barite ($BaSO_4$).	†	40	20	25			15		2		Borax.	Borax glass may be substituted for part of the silica.
Galena.	Lead, 84%. (Concentrates.)	†	20			10						Salt.	Heat gradually until mass subsides.

Galena.	Silicious.	‡	15	20	20	5			Salt.	Litharge is added, according to the lead contents of the ore.
Lead carbonate.	Neutral.	‡	80	10	15				Borax.	Litharge is added, according to the lead contents of the ore.
Iron pyrites.	None. (Concentrates.)	‡		35	20	5	15	3	Borax.	Collect matte, if any forms, and scorify with lead button.
Copper pyrites.	Iron pyrites. (Concentrates.)	‡		35	30	5	15	3	Borax.	Collect matte, if any forms, and scorify with lead button.
Tellurides.	Silicious.	‡	80	30	40-80				Salt.	If button is hard or brittle, scorify with lead. Scorifier assay preferable.
Tellurides.	Silicious.	‡			80			2	Salt.	Special method.
Arsenical.		‡		15	30		17		Salt.	Scorify button. Scorifier assay preferable.
Slags.		1	20	40	10			10	Salt.	If slag contains matte, add a nail.

for example) if the ore is known to be oxidizing, or even if there is any probability of its being oxidizing. The difference between the weight of the button and the weight of lead that would be reduced by the reducer alone represents the oxidizing power of the ore, if the button is lighter than the reducer button; if it is heavier, the difference represents the reducing power of the ore. For this assay, the charge given in Art. 71 may be used, or $\frac{1}{10}$ A. T. of ore may be run down with $1\frac{1}{2}$ or 2 A. T. of flux No. 4, covering the charge thickly with salt.

The great excess of litharge in this flux renders it highly corrosive in its effect on the crucibles, unless a large quantity of silica is added. Another flux of the same class, more commonly used, approaches more nearly the proportions used in fluxes of the first class and largely overcomes this objection. It is made up as follows:

No. 5. Sodium bicarbonate.....	3 parts.
Litharge.....	5 parts.
Borax.....	2 parts.
Reducer or oxidizer, as in No. 4.	Salt cover.

81. The accompanying table (Table I) of crucible charges for gold and silver ores, covering both general and special cases, is taken, with a few unimportant changes, from Furman's "Manual of Practical Assaying." The figures in column 4 (grams of lead flux) refer more particularly to lead flux No. 1, but will answer just as well for No. 2 or any similar lead flux. It will be observed that the lead flux forms the base of nearly all the charges. A large excess of litharge is necessary with tellurides in order to oxidize the tellurium, which will otherwise be reduced and make the button brittle.

82. Table II gives the approximate reducing power of such reducing reagents as are commonly used in assaying, in terms of the number of parts of lead reduced from litharge by 1 part of the reducer. These figures are, however, only *approximate*, and should not be used in the determination of the oxidizing or reducing power of an ore or a

reagent. For this purpose a test assay of the reducer should always be run, following the method given for determining the reducing power of ores (Art. 71) and using from $\frac{1}{2}$ g. to 2 g. of the reducer in place of the ore charge. For the calculation of general charges, however, they are sufficiently close.

TABLE II.

APPROXIMATE REDUCING POWER OF REDUCING AGENTS (IN TERMS OF PARTS OF METALLIC LEAD REDUCED FROM LITHARGE BY 1 PART OF THE REDUCER).

1 part of <i>charcoal</i>	will reduce 22 to 32 parts of lead.
1 part of <i>hard coal</i>	will reduce 25 parts of lead.
1 part of <i>coke</i>	will reduce 24 parts of lead.
1 part of <i>soft coal</i>	will reduce 22 parts of lead.
1 part of <i>wheat flour</i>	will reduce 15 parts of lead.
1 part of <i>white sugar</i>	will reduce 14 $\frac{1}{2}$ parts of lead.
1 part of <i>starch</i>	will reduce 11 $\frac{1}{2}$ to 13 parts of lead.
1 part of <i>gum arabic</i>	will reduce 11 parts of lead.
1 part of <i>crude argol</i>	will reduce 5 $\frac{1}{2}$ to 8 $\frac{1}{2}$ parts of lead.
1 part of <i>cream of tartar</i>	will reduce 4 $\frac{1}{2}$ to 6 $\frac{1}{2}$ parts of lead.

GOLD AND SILVER ASSAY.

83. There are two general methods in use for the fire assay of gold and silver ores: *scorification* and the *crucible*, or *fusion*, *assay*. With most ores, either method will give accurate results; but certain classes of ore may work better by one method than by the other, either in point of accuracy or of convenience, or both. For example, sulphides, tellurides, and ores carrying much arsenic and antimony can be worked much more conveniently, and frequently somewhat more accurately, by scorification than by the crucible process, for the reason that sulphur, tellurium, arsenic, and antimony, in the crucible assay, unless specially provided for, are apt to be reduced along with the lead and make the button brittle. The difficulties attendant on the oxidation of sulphur, etc., by means of niter have been mentioned in the discussion of fluxes. If they are brought into a matte by the use of iron (nails), the matte

and button have to be scorified together to get rid of the undesirable elements. The matte is brittle, and a little of it is almost certain to fly off and get lost when separating it from the slag, and if the ore is rich this will cause more or less loss. In the scorification assay, on the other hand, the entire operation is one of oxidation, and sulphur, arsenic, etc., are volatilized and pass off in fumes. The scorification assay also gives slightly higher results than the crucible assay on most silver ores.

84. For assaying low-grade gold ores (for assaying purposes, ores carrying over \$5 in gold per ton may be considered as high grade and those less than \$5 as low grade), the crucible process is generally used, as the button from a scorifier charge ($\frac{1}{16}$ A. T.) is so small as to be difficult to handle and weigh, and any error in its weight represents five times as much in the final calculations as the same error in the weight of the button from a $\frac{1}{4}$ -A.-T. crucible charge. This difficulty may be avoided by running a number of scorifier charges and combining the gold buttons, but this involves considerable extra work and expense.

In using nails to decompose sulphide ores, the button can often be rendered soft and the matte gotten rid of by removing the nails about ten minutes before the crucibles are taken from the furnace, and then raising the heat so as to render the slag thoroughly fusible and to as far as possible decompose the matte at the expense of the oxides in the slag. If but a small amount of matte were formed, this method will usually decompose it and carry the gold and silver all into the lead. In some cases, it is necessary to add some excess of litharge to the flux. The litharge will first pass into the slag, and later during the decomposition of the matte the lead will pass into the button and the matte become oxidized and its iron and copper constituents pass into slag. If care is taken in proportioning the charge and too great an amount of reducer is not added, it is usually possible to obtain a lead button of about the desired weight; for the sulphur will first pass into the matte and

subsequently act as a reducer on a portion of the litharge in the charge, thus bringing the button to about the right size.

SCORIFICATION ASSAY.

85. The ordinary ore charge for the scorification assay is $\frac{1}{16}$ A. T. in $2\frac{1}{4}$ or $2\frac{1}{2}$ inch scorifiers. Occasionally $\frac{2}{16}$ A. T. is used. The principal fluxes are test lead and borax glass. Litharge, and occasionally soda and niter, are used in special cases as covers. Silica added to the charge for a basic ore will save the scorifier. Table III is a table of scorifier charges for various ores, recommended by Furman. The charges are figured on a basis of a $\frac{1}{16}$ -A.-T. ore charge.

86. About half of the test lead is put in the scorifier. (The lead need not be weighed, but may be measured with sufficient accuracy by a shot measure or small crucible, the capacity of which is known.) The ore charge is then weighed out and brushed in on top of this, and they are thoroughly mixed with a small spatula. The remainder of the lead is now put on as a cover, and the borax glass on top of this. The borax may be added by measure or by pinches, a little practice enabling the assayer to guess sufficiently close to the correct weight. Duplicate charges are always run, to prevent the possibility of errors from carelessness or accident going undetected. If the two buttons do not check very closely, the assay should be repeated.

87. The scorifiers are now charged into the hot muffle, and the door is closed and kept closed until the charge melts down and active scorification commences, when it is opened to admit a plentiful supply of air. The surface of the charge now displays a clean, mirror-like surface of glowing, molten lead, with a narrow ring of slag around the sides of the scorifier. This slag is formed by the fusion of the gangue of the ore with the borax and the litharge formed by the oxidation of the melted lead in the current of air flowing through the muffle.

TABLE III.
SCORIFIER CHARGES.

Ore.	Grams of Test Lead.	Grams of Borax Glass.	Remarks.
Galena.....	15-18	Up to 0.5	
Galena, with zinc-blende and pyrite.	20-35	0.4-0.8	
Iron pyrites.....	30-45	0.3-0.8	
Arsenical pyrites.....	45-50	0.3-1.5	High temperature. Addition of litharge helps assay.
Gray copper.....	35-48	0.3-0.5	Low temperature.
Zinc-blende.....	30-45	0.3-0.6	High temperature. Addition of oxide of iron helps assay.
Copper ores and mattes.....	35-40	0.3-0.5	Low temperature. If necessary, the button should be rescorified with lead.
Tellurides.....	50	0.3	Add cover of litharge, and rescorify the button.
Silicious.....	25-30		
Basic.....	25-30	0.5-2.0	If the ore contains much lime or magnesia, the addition of sodium carbonate helps the assay.
Basic with barium sulphate.....	25-30	0.5-1.5	Addition of sodium carbonate helps assay.
Lead carbonate.....	10-15	Up to 0.5	

After the door is opened, oxidation goes on more rapidly than before. Sulphur, arsenic, etc., are oxidized by the action of the litharge and of the air-current, and the fumes pass off through the opening in the rear of the muffle. Any metallic gold or silver in the ore is immediately dissolved by the lead as it sinks through the charge. Compounds of gold or silver with other elements—sulphides, tellurides, etc.—are broken up by the action of the litharge, the gold or silver and the lead being reduced to metals and sinking together into the button, while the oxygen of the litharge converts the sulphur, etc., into gaseous oxides, which pass off through the back of the muffle.

88. As the oxidation progresses, the slag ring gradually spreads inwards towards the center, until it finally closes over the top of the lead button, preventing further oxidation. *This marks the end of the scorification.* The door is now closed for a few minutes and the heat raised, to make the slag thoroughly liquid; the scorifier is then removed, tapped lightly on the ledge of the furnace, to settle any suspended shots of lead, and the contents poured into a mold. The mold should be warmed beforehand, or the sudden chilling may cause the slag to break up before the lead has solidified and thus spatter the button; some of the lead, too, is apt to chill in small shots instead of going into the button. The slag should be clean, liquid, and glassy, and the lead should all be collected in one button at the bottom and not scattered in shots through the slag. This button should be soft and malleable.

89. As soon as the assay is cool, the button may be separated from the slag by a few blows with a hammer and then beaten into the form of a cube, to make it easy to handle with the cupel tongs when placing it into the cupel. Brown recommends flattening the sharp corners of the cube by light blows of the hammer, to prevent their injuring the cupel when dropped into it. The buttons are now ready for cupellation, provided they are not too large. The cubes should be about $\frac{1}{4}$ inch on a side—this size button will

weigh about 15 grams. If much larger than this, or brittle, they should be rescorified with borax glass and a little more lead, if necessary, and this should be repeated until they are of the proper size and purity. The loss of precious metals is less by this method than if a large button is cupelled directly, as the only loss in scorification worth mentioning is through volatilization, and is very small, while in cupellation the principal loss is through silver being carried into the cupel by the litharge, in addition to which we have a loss from volatilization nearly or quite as large as that in scorification.

90. Cupelling.—For cupellation, the muffle should be heated to a good red heat. The empty cupels are then set in the muffle, arranged in the proper order for receiving the buttons, and allowed to come to the heat of the muffle. When the cupels have all reached the proper temperature, the buttons are gently placed in their proper cupels, and the door is then closed for a few minutes to melt the buttons down rapidly and “open” the cupels. The buttons melt almost immediately and sink down into the bowls of the cupels. The surface of the melted lead is at first covered with a film of dirt, slag, and oxide; but if the heat is correct and the button is comparatively free from serious impurities, this will soon break up and disappear, and when the muffle door is again opened, the surface of the lead in the cupels will be glowing brightly and giving off fumes of lead oxide. If the buttons refuse to open, place a little coke, charcoal, or a small piece of wood in the front of the muffle and close the door. The gases from the coke or charcoal will usually decompose the film, and as soon as the buttons are open, the door may be opened and the coke or charcoal drawn, and cupellation will usually proceed all right. A small fragment of charcoal placed in the cupel will accomplish the same result, but it is apt to cause a slight loss from “spitting.”

91. The heat of the muffle during the cupellation of the button from high-grade silver ores is of great importance,

as silver is somewhat volatile, and the loss from volatilization is greatly increased by cupelling at a high heat. With gold ores, the heat is less important, as the loss of gold from volatilization is practically nothing. As a general rule, however, *do not carry the temperature of the muffle beyond a good, strong, red heat while cupelling, and for ores rich in silver keep the heat down as low as possible without risk of "freezing" the buttons.* With the proper heat, the cupel is red, and the lead inside is distinct and glows strongly, the fumes rise plentifully, and towards the end of the operation, "feathers" or crystals of litharge gather around the sides of the cupel.

92. If the heat is too high, the cupel appears white hot and glowing and the lead button is scarcely visible, while the fumes are very thin and rise rapidly to the top of the muffle, and the lead may even boil. On the other hand, if the heat is too low, the fumes will be dense and heavy and sink to the bottom of the muffle; the litharge will form on the surface of the lead, too thick to absorb properly and not hot enough to volatilize, and with a tendency to crystallize or freeze over the surface of the lead.

93. In case the buttons do freeze, they may be reopened by employing the schemes given in Art. **90** for opening the cupels at first and raising the heat. The results from a button that has been frozen and then reopened are never thoroughly trustworthy, however, as the reopening usually volatilizes considerable silver. Care should therefore be taken to prevent freezing, and if the buttons show the least sign of it, the door should be closed and the heat raised until they are out of danger.

94. As the cupellation progresses, the litharge formed by the action of the air on the lead is partly absorbed by the cupel, and the remainder is volatilized and passes off in fumes. The button gradually dwindles down until the last of the lead is finally driven off, leaving the pure gold and silver behind in a small bead. Just before the last of the lead is expelled, if the button is watched, rainbow colors will

be observed to play over the surface, arising from a film of melted litharge over the gold and silver bead, and the button appears to spin rapidly around. As the last of the lead leaves, the bead will brighten and glow brilliantly for an instant; then a film closes over it, and the cupellation is completed. This brightening of the button at the end of the cupellation is known as "brightening," "blinking," or "flashing." Just before the button brightens, the temperature should be raised somewhat, to make sure of expelling the last traces of lead. This is usually accomplished by pushing the cupel back into the hotter part of the muffle and leaving it there for two or three minutes after "blinking." If this precaution is not taken, a little lead is apt to remain in the button and be credited as silver.

95. The cupel may now be removed from the furnace and the button cooled and weighed. Buttons of nearly pure silver, especially when quite large, are apt to "spit" or "sprout" if cooled suddenly by drawing directly from the hot muffle into the open air. The liquid silver on the inside of the button bursts through the thin shell of solidified metal around it, sometimes forming very beautiful effervescences, and frequently throwing fine particles of silver some distance from the button. To prevent this, cover the cupel in the furnace with a hot, empty cupel and withdraw gradually from the hot part of the muffle to the front, and after it has cooled down to the temperature of the front of the muffle, take it out, still with the covering cupel on, and allow it to cool for some time before removing the cover. The results from a sprouted button should never be accepted, as there is almost certain to have been some loss in sprouting.

96. A good cupel will efficiently absorb just about its own weight of litharge. As a considerable part of the litharge from the oxidation of the lead buttons passes off in fumes, a cupel may be safely used for a button somewhat heavier than itself. It is much better, however, to have the cupel about a quarter or a half heavier than the button, as

a cupel nearly saturated with litharge absorbs any additional litharge more and more slowly, and absorption may even cease entirely—even with some untouched bone-ash at the bottom of the cupel—just at the time when absorption should, if anything, be most rapid. The bowl of the cupel will usually hold more lead than the cupel will efficiently absorb. If a large button is being cupelled, and it is seen that the cupel will have difficulty in absorbing all the litharge, a second hot cupel may be inverted, and the cupel containing the button set upon this; cupellation will then proceed, though somewhat slowly, the excess of litharge passing into the lower cupel. It is much better, however, to reduce lead buttons to the proper size by scorification and not take any risks.

97. Weighing the Buttons.—As soon as the cupels are cool, the buttons may be removed and weighed. For handling the small gold and silver buttons, a small pair of pincers are necessary, the sharp-nosed style shown in Fig. 22 being preferable. The button is

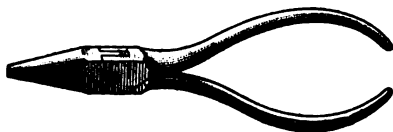

FIG. 22.

grasped firmly with these and pulled loose from the cupel. Any litharge-soaked bone-ash adhering to the bottom of the button is brushed off with a stiff tooth-brush or with a small, cylindrical, double-ended button brush made especially for this purpose, but which is hardly as handy as the tooth-brush.

98. Before starting to weigh, the button balance must be carefully leveled up and adjusted. The scale-pans are first removed (use the weight forceps for this purpose; the pans of the button balance must never be handled with the fingers), turned upside down, and shaken by tapping the back of the forceps, to shake out any dust or traces of gold left from previous weighings, and then replaced in their hangers. Then, having adjusted the balance, place the button to be weighed in one pan; sufficient weights are placed

in the other pan to balance the button within the limit of the smallest weight of the set, and the balancing is finally completed with the rider (or if the button weighs less than the smallest weight of the set, the balancing is done entirely with the rider).

99. Having found the weight of one button, mark it down, and leaving the weights in the pan, remove the button which has been weighed, clean the duplicate button, and place it in the pan which formerly contained the one already weighed. If the buttons are of equal weight, the second one will exactly balance the weights already in the pan; if not, the difference can be made up by shifting the rider or with the use of small weights, but, as a rule, a difference of as much as 1 mg. is altogether too much unless the ore is extremely high grade in silver or gold. For example, suppose an assayer wishes to weigh two duplicate buttons. The balance is in accurate adjustment, the beam on each side is divided into fiftieths, and he is using a 1-mg. rider. The first button is placed in the left-hand pan, and he finds that by placing his 10-mg., 5-mg., and two 2-mg. weights in the other pan, he slightly overbalances the button, while if he replaces one of the 2-mg. weights by his 1-mg. weight, the button side is heavier. Hence the weight of the button must lie between 18 and 19 mg. Leaving the 18 mg. in the pan and using the rider on the right-hand side, he finds that he must move it out 32 divisions to exactly balance the weight of the button; hence he must add $\frac{32}{50}$ mg. or .64 mg. to the sum of the weights in the right-hand pan to obtain the weight of the button; consequently button No. 1 weighs 18.64 mg. The same result would be obtained by leaving the 19 mg. weights in the right-hand pan and moving out the left-hand rider till the beam balanced, which it would do in this case with the rider at 18 divisions, and subtracting from 19 mg. the amount indicated by the rider, thus

$$19 - .36 = 18.64 \text{ mg.}$$

As a rule, it is best to have all the weights come as additions; that is, if the button is in the left-hand pan, it should

not be quite balanced by means of the weights, so that the weight indicated by the rider will always be added, as this may avoid mistakes. Having obtained and recorded the weight of the first button, both by reading the weights in the pan and that indicated by the rider and the weight indicated by the empty spaces in the weight box and the rider, the operator next removes the button and cleans its duplicate and places it in the left-hand pan, and finds upon testing the balances that No. 2 is somewhat heavier than No. 1. In other words, it overbalances the weight, and hence to balance it he moves the right-hand rider out slightly. He finds that by moving it out 7 divisions from the point it formerly occupied, the weight is exactly balanced; hence the weight of the second button is $18 + \frac{3}{100}$, or 18.78 mg. Both buttons are then dumped into their parting capsules, the rider is returned to its place and the weights to the weight box, and the assayer is ready to weigh the next set of buttons. Some operators prefer to balance the buttons against each other, and finding the difference by means of the rider, add or subtract it from the weight of the first button to obtain the weight of the second button; but both this system and the use of the rider on the opposite side of the scale-beam from that on which the weights are placed are more or less confusing where rapid work is required. As it is no uncommon thing for the gold-silver assayer in a large works to be required to run from 30 to 40 samples a day, accurately determining both the gold and silver contents of each, it is evident that he must so systematize his work that everything will be read as directly and systematically as possible. In other words, if the weights are all additions there is never any danger of making mistakes, while if some of the weights are obtained by addition and some by subtraction, there is always a possibility of error.

100. Parting.—The buttons from the cupellation contain both the gold and the silver in the ore. To determine the exact amount of each, the buttons must be treated with dilute nitric acid, which dissolves the silver and leaves the

gold behind as a black spongy mass or powder, which assumes its characteristic yellow color on heating. This operation is called "parting." The gold thus obtained is weighed up, and its weight, subtracted from the weight of the gold-silver buttons, gives the weight of silver in the ore. Duplicate buttons, unless very large and containing a considerable proportion of gold, may be parted together, in order to get a larger amount of gold to weigh and thus reduce the liability of error.

101. The operation of parting, in detail, is as follows: The buttons, if of any size, and particularly when containing much gold, are first flattened in a diamond mortar or by a blow of the hammer on an anvil, in order to expose as much surface as possible to the action of the acid. They are then replaced in a capsule, which is next filled about half full with dilute nitric acid of about 1.2 Sp. Gr. (made by mixing equal parts of strong chemically pure nitric acid and distilled water), and placed on an iron plate or piece of asbestos, or in a platinum triangle, over a Bunsen burner or alcohol flame. If there is enough silver in the button, it will at once commence to dissolve; if not, the acid will not attack it, and it will require to be first "inquarted" (see Art. 105). Assuming that there is a sufficient proportion of silver, the button will rapidly dissolve, the heat not being allowed to reach the boiling-point until all action has ceased and the solution has become colorless. If there is no gold in the buttons, they will not blacken on adding the acid, and will dissolve completely, leaving no residue, and the parting may be stopped at this point and the ore reported as containing no gold.

If, however, the button blackens on adding the acid, and a black, spongy residue, or even a small black speck is left on the bottom of the capsule or floating around in the solution after action has ceased, the solution is brought to a boil for a minute; the capsule is then removed from the heat, and the gold, if it has broken up, should be collected by gently tapping the side of the capsule and giving it a

rotary motion. Very small particles of gold may become enveloped in a film of air, and thus buoyed will float around on the surface of the acid solution, and refuse to be sunk by tapping the crucible. In such a case, "churn" or stir the contents of the capsule vigorously with a glass rod; this will collect the floating particles, and they may then be sunk by tapping. All black particles in the capsule must be assumed to be gold until proved otherwise, and if *any* black specks show, the parting should be continued through to the end, even if there is good reason to suspect that the specks are dirt. A little extra work is many times preferable to false assay returns.

102. Having gotten all the gold together at the bottom of the capsule, pour off the acid very carefully (preferably into another porcelain crucible, so that any gold which might escape through accident may be seen and recovered), using a glass rod to guide the streams and keep it from running back down the outside of the capsule. Then add fresh acid,* and boil for about three minutes. This removes practically the last traces of silver. The gold is collected as before, the acid poured off, and the gold washed three times with hot water. The washing is done by filling the capsules with water, allowing the gold to settle, and then pouring the water off very carefully. Remove the last drops of water with a strip of blotting-paper, being very careful not to take up any of the gold. Then heat for a moment over a Bunsen burner, to drive off the last of the water, and finally place in the muffle or over the blast-lamp and bring to a good red heat. The gold will have assumed its natural yellow color, organic matter will have been burned off, and by the aid of a magnifying-glass any impurities can be readily distinguished. This heating is called "annealing."

The annealed gold sticks together and can be transferred

* The practice in the Western mining States is to have the second acid of the same strength as the first. Many assayers prefer to use two strengths of acid for parting—a solution of about 1.16 Sp. Gr. (10 parts of strong acid to 16 of water) for the first heating, and another of 1.26 Sp. Gr. (16 parts acid to 10 of water) for the second.

to the scale-pans of the button balance for weighing. The assayer must take great care to get all the gold out of the annealer, and the weighing must be done with extreme care.

103. Instead of doing both parting and annealing in the porcelain capsules, many assayers prefer to part the buttons in test tubes, and then, after washing the gold, to transfer it to the capsules or to small porous "annealing cups." This makes it impossible, however, to part more than one set at a time, as the test tube must be held over the flame. The gold is transferred from the test tube to the capsule or annealing cup as follows: The test tube containing the gold is filled to the brim with water; then the capsule is placed, upside down, over the mouth of the test tube, and with a quick motion the whole is inverted, so that the test tube is standing bottom upwards in the capsule. The test tube is drawn up until its mouth is nearly level with the rim of the capsule. The water is held up in the test tube by the pressure of the outside air on the surface of the small amount of water which has flowed out into the capsule, and the gold settles rapidly to the bottom of the capsule. As soon as the last black specks have settled, the test tube is raised very gently until its mouth is level with the brim of the capsule, and then with a quick jerk slid off sideways, the water falling out as soon as the tube is clear of the capsule. The water is then drained off from the gold in the capsule, as previously described, and the gold is annealed and weighed.

104. Distilled water and nitric acid used for parting silver-gold buttons must be tested to see that it is free from chlorine or *HCl*. To test for the presence of chlorine, add a drop of silver nitrate solution to the suspected water or acid, and if a cloudiness, caused by the precipitate of silver chloride, results, chlorine is present. To free nitric acid from chlorine, add silver nitrate solution, a drop at a time, shaking the acid after each addition and allowing the precipitate of silver chloride to settle. When a cloudiness no

longer results from the addition of silver nitrate solution, the nitric acid should be filtered or decanted off, to remove the precipitate of silver chloride, and the pure acid transferred to a reagent bottle ready for use. Chlorine may be removed from distilled water in the same manner, but usually water containing chlorine is thrown away, it not being considered worth the time required to eliminate the chlorine by $AgNO_3$, for a fresh lot can easily be distilled.

105. Inquarting.—If a gold-silver button does not contain at least $2\frac{1}{2}$ times as much silver as gold, the parting acid will not completely dissolve out the silver, or it may not attack the button at all, and it becomes necessary to add sufficient silver to bring the proportion in the button up to this figure. This addition of silver to buttons is called "inquarting" or "quartation," from the fact that it was formerly believed that gold and silver could not be parted by acid if a larger proportion of gold than one-quarter was present.

Chemically pure (c. p.) silver foil is used for inquarting. Small buttons are usually alloyed by merely melting them up on charcoal, together with a small piece of silver foil, by the blowpipe. Larger buttons are wrapped up, together with the necessary amount of silver foil, in sheet lead, and the whole cupelled down in the usual manner. The inquarted buttons are flattened and then parted as usual.

If the amount of silver in the button is not much over three times that of the gold, the button will not break up in parting, but the silver will dissolve out and leave a black skeleton or sponge of gold of the same shape as the original button. On annealing, this sponge will shrink somewhat and turn yellow, but will hold together and retain its shape, making it very convenient for weighing. For this reason, as small an excess of silver as possible is added for inquarting. The experienced assayer can usually tell by the color of a button very nearly what proportion of gold it contains, and he will then weigh out enough silver to bring this proportion down to about 1 to 3.

106. The weight of the gold subtracted from the original weight of the buttons leaves the weight of the silver in the buttons. Thus, returning to the example given in Art. **99**, suppose the buttons used in this case be parted and found to contain together 2.46 mg. of gold; subtracting this from the combined weight of the two buttons (37.42 mg.) the result is 34.96 mg., the weight of silver in the two buttons. The average weight of the silver in the buttons is, therefore, $\frac{34.96}{2}$, or 17.48 mg., and the average weight of the gold is $\frac{2.46}{2}$, or 1.23 mg. Then, if ore charges of $\frac{1}{10}$ A. T. were used, each milligram weight in the button represents 10 ounces per ton, and the ore assays 174.8 ounces of silver and 12.3 ounces of gold per ton.

CRUCIBLE ASSAY.

107. The charge of ore used in the crucible assay varies from $\frac{1}{2}$ A. T. to 4 A. T. In the Western mining States the common practice is to use an ore charge of $\frac{1}{2}$ A. T. in a 10-g. Colorado crucible and fuse in the muffle furnace, dispensing entirely with the wind furnace. The muffle furnace is absolutely necessary, in any event, for scorification and cupellation; hence its use for crucible fusions is clear gain for crucible work. It is much neater and handier than the wind furnace, the heat can be better regulated, and a larger number of crucibles can be run at once than with the ordinary crucible furnace, thus offsetting the advantage of being able to use larger charges.

If the muffle is large enough, low-grade gold ores may be run in 1-A.-T. charges, using 20-g. crucibles; but for general assaying it is more economical to use smaller muffles, as they are cheaper and nearly or quite as durable as the larger sizes; then, if samples are occasionally received so low grade that the ordinary double $\frac{1}{2}$ -A.-T. assay will not give sufficient gold to weigh accurately, run a number of $\frac{1}{2}$ -A.-T. charges, cupel, combine the buttons for gold, and average the results.

108. Charges larger than 1 A. T. can not be safely run in crucibles small enough to enter any of the muffles ordinarily used; and therefore unless the charge is divided, wind furnaces must be used. Very large crucible charges, on account of the amount of ore used, are not usually run in duplicate. The amounts of fluxes in larger crucible charges are in the same proportion to the ore as in the $\frac{1}{2}$ -A.-T. charge, and the reactions in the crucible are the same in both furnaces. No further description of fusions in the wind furnace will therefore be necessary, as the student can readily figure it out for himself from the following description of the crucible assay in the muffle:

109. Charge.—As previously stated under “Fluxes,” the crucible charge is to a considerable extent dependent on the general composition of the ore. If the sample is in lump form, this can usually be determined by a simple inspection, with a few blowpipe tests if necessary. If the sample is pulverized, the minerals composing it may be determined by washing and vanning (shaking gently from side to side and rotating) a little of the pulp with water in a watch-glass, and examining the separated minerals with a magnifying-glass. Then refer to Table I and choose the flux best suited to the ore. If the general character of the ore can not be ascertained by examination, try one of the stock fluxes alone. These will generally flux the ore satisfactorily; and if they do not, they will at least give an index as to where the difficulty lies so that it can be corrected.

110. The flux and litharge can be put in the crucible, and then the ore weighed out and placed on top of it, the ore and flux being mixed thoroughly with a small spatula, the nails inserted point downwards, if the ore is a sulphide, and then the cover of salt or borax glass added. The entire charge should fill the crucible from $\frac{2}{3}$ to $\frac{3}{4}$ full—never more than three-quarters, or the charge is apt to boil over in the muffle. The crucible is now ready for the furnace.

Another way of mixing the charge is to put the flux and litharge on a mixing cloth and the weighed charge of ore on top of it. They can be thoroughly mixed by lifting first one corner and then another, so as to roll the charge over and over (as described in Art. 16). When thoroughly mixed the material is placed in the crucible and the cover and nails added.

111. The muffle should be at a good red heat to get a clean, rapid fusion. The crucibles are placed in the muffle and the door closed. The fusion will usually take from half to three-quarters of an hour. If the furnace is very hot, the crucibles should be watched carefully during the first 15 or 20 minutes, to see that they do not boil over. If the charge commences to froth up over the top of the crucible, the door should be opened and the muffle cooled down, and the heating carried on more slowly until the danger point is passed and the charge commences to subside. The result of an assay that has run over should never be accepted. As soon as the fusion becomes perfectly quiet and no more *cooking* is heard, the fusion is completed. Leave the crucibles in the muffle a few minutes longer, and finish quite hot, to make the slag perfectly fluid. Then remove; take out the remains of the nails, if any were used, with the small crucible tongs, washing them in the slag and tapping them lightly against the side of the crucible as they are withdrawn, to detach any adhering globules of lead; give the crucible a slight whirling motion by moving the hand around in a horizontal circle; tap it gently on the ledge of the furnace, to collect and sink any fine globules of lead that may be held in suspension by the slag; and then pour into its proper hole in the warm mold. From here on, the work—cupellation, parting, etc.—is exactly the same as in the scorification assay.

PRACTICAL SUGGESTIONS.

112. The first essential of a well-conducted assay office is *system*. If an office is not conducted according to a rigid system, endless trouble is certain to result, sooner or later,

from samples or results becoming confused, and the assayer will never be absolutely sure of his work.

113. Marking Samples.—The pulverized samples should be put in envelopes, bottles, or boxes, marked with the assayer's number of the sample or lot, the name of the sender or mine, the metals to be assayed for, and any additional remarks that may be considered necessary. It is a good practice to also put the date of receiving the sample on the envelope or bottle. Envelopes are much more convenient for samples than bottles or boxes, and are cheaper and less bulky. Special sample envelopes are made for assay samples, which close tightly, without sealing, in such a manner that none of the pulp can leak out nor any dirt find its way in, and at the same time they can be opened very readily and without damaging the envelope. Large assay offices usually have their name and the blank form for marking the samples printed on their sample envelopes.

Many assayers, instead of marking samples as above, put only the name and lot number on the envelope, and then under the lot number in a note-book enter a more detailed description of the sample, its character, etc.

114. Numbering.—Assayers usually employ running numbers for their samples; that is, the samples are numbered consecutively, and the numbers are never repeated. This avoids confusing different samples from the same person or mine.

115. Weighing and Furnace Work.—When weighing samples, a record should be kept in a note-book of the order in which the samples are weighed and the amount taken. Number each day's work consecutively, from 1 upwards. The same order should then be preserved all through fusion, cupellation, and parting, to the final weighing of the gold. This will avoid any confusion from the assayer losing track of which buttons came from which ore, etc. If a single one of a batch of assays goes astray, the entire lot might as well be thrown out, as the assayer can never be positively sure just which assays are out of place,

and a result to which the least doubt attaches is worse than useless. In addition to keeping his assays in a fixed order and to help him in so doing, it is well for the beginner to mark his crucibles and scorifiers plainly, in several places, with the numbers of the assays they contain, using redde (red ocher), in the form of either chalk or paint, as it is not affected by the heat of the furnace. The numbers of the buttons can also be scratched on the sides of the cupels as a further precaution. This marking may be abandoned as soon as the assayer has his system thoroughly worked down.

116. The accompanying sketches (Fig. 23) illustrate a convenient system of handling the assays from the weighing of the charge to the weighing of the gold and silver buttons, in order to avoid confusion. The scheme is here worked

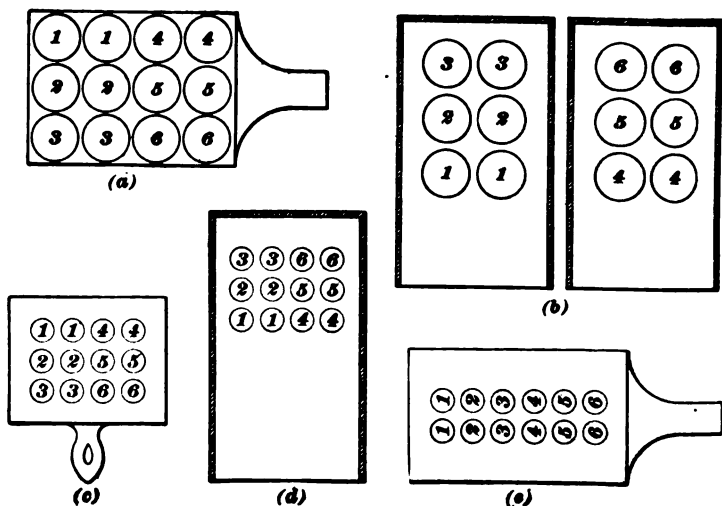

FIG. 23.

out for six duplicate assays and a two-muffle furnace; but the same principles are applicable to any number of assays in any furnace.

The charges as they are weighed out are placed in their respective crucibles or scorifiers on the cupel board, with

No. 1 at the right-hand back corner, and the rest successively, as shown at (*a*). With this arrangement, the assayer never has to reach over already charged crucibles or scorifiers to set assays in their proper places, and thus run the risk of tipping over a crucible or brushing some of the ore off a scorifier charge with his sleeve.

The assays are carried from the weighing room to the furnace on the cupel board. The board is set sidewise on the bench, with Nos. 3 and 6 to the front, as shown at (*a*), and the assays are put into the muffles in the natural order of their positions—those at the front side of the board going to the back of the muffles, and *vice versa*, as shown at (*b*). When the fusion is finished, Nos. 1 and 4, which are in front in the respective muffles, are naturally withdrawn first, and are poured into the back holes of the mold, as at (*c*), bringing the assays once more into the original order. In the cupels in the furnace, the buttons are again in reversed order, as at (*d*), and the cupels are drawn in their proper sequence, as at (*e*), and carried to the weighing room.

117. To Heat the Muffle.—To raise the heat of the muffle rapidly, build a good fire under it, heaping the coal well up and allowing it to burn down to glowing coals; then, as soon as the muffle commences to show a dull red heat, throw a little charcoal or coal *into the muffle* and shut the door. The coal in the muffle will take fire from the heat of the muffle, and its heat added to that of the fire below will quickly bring the muffle to a good fusing heat, when the coals inside may be withdrawn and the crucibles or scorifiers inserted. A shovelful of burning coals from the grate will accomplish the same purpose in even less time. The same scheme may be employed in case the heat should be allowed to fall low while using the furnace, placing the coal or charcoal at the front. In cupelling, this also assists in opening frozen cupels (see Art. 90).

The use of coal in the muffle should be avoided, as the ash is liable to form a sticky slag that is troublesome. The use of wood or charcoal is not so objectionable.

118. To Cool the Muffle.—While cupelling, if the muffle gets too hot at the rear, it can be cooled down locally, without touching the fire, by merely putting in one or more cold crucibles or scorifiers. If any particular cupels get too hot, they can be cooled down without seriously affecting the rest of the cupels in the muffle by putting cold scorifiers on them, each scorifier resting on the edges of two cupels.

119. Accidents.—In spite of the greatest care, an occasional accident is unavoidable in an assay office. Crucibles, scorifiers, or cupels may be spilled, crucibles may boil over, a defective scorifier may be corroded through, or cupels may crack and let the molten button through on to the floor of the muffle. Litharge and oxidizing lead corrode the muffle very rapidly; if the lead is left on the floor of the muffle, it will soon eat its way through, and, once started, the muffle soon goes to pieces. Most slags are not very actively corrosive, but slag is a great nuisance on the floor of the muffle, even in very small quantities, as it causes the vessels to stick, and if they are not released very cautiously a spill is apt to result.

The standard remedy for all such troubles in the muffle is bone-ash. If a vessel boils over or spills, remove it at once and throw in a handful of bone-ash. This will mix with the slag and form a thick paste, which can be readily removed with a scraper. If any lead is left on the floor of the muffle, throw in some more bone-ash on top of it. The bone-ash will absorb the litharge as it forms, and save the muffle to a considerable extent. It is advisable to keep the floor of the muffle always thinly covered with bone-ash; this will afford considerable immediate protection in case of spills, etc., and will also prevent vessels sticking to old slag spots on the bottom.

CALCULATIONS.

120. The calculation of the results of gold and silver assays is a matter of simple arithmetic. It has already been touched upon incidentally under the description of the assay-ton system (Art. 30) and in Arts. 99 and 106, but will

be taken up separately and explained in detail, with examples.

The rule for the calculation of the number of ounces of precious metals per ton of ore (Art. 30) must be kept in mind; the rest of the calculation is mere multiplication. This rule we will here repeat in the shape of a formula:

$$\frac{\text{weight of button in mg.}}{\text{weight of ore taken in A. T.}} = \text{number of ounces per ton.}$$

For example, if the button from an A. T. of ore weighs 213 mg. before parting and the gold from parting weighs 13 mg., the contents of the ore in gold and silver are figured as follows: 213 mg. (gold and silver) - 13 mg. (gold) = 200 mg., the weight of silver in the button.*

Then, since we have 200 mg. of silver from a 1-A.-T. charge of ore, if we set these values in the formula, we have

$$\frac{200}{1} = 200 \text{ ounces silver per ton,}$$

and for the gold (13 mg.),

$$\frac{13}{1} = 13 \text{ ounces gold per ton.}$$

If only $\frac{1}{2}$ A. T. of this ore be taken, the buttons will, of course, weigh only half as much as the buttons from 1 A. T.; but as the ore charge also is only half as large as in the 1-A.-T. assay, the weight of the buttons divided by the weight of ore used gives the same result as in the 1-A.-T. calculations; thus,

$$\frac{100}{\frac{1}{2}} = 100 \times 2 = 200 \text{ ounces silver per ton,}$$

and $\frac{6.5}{\frac{1}{2}} = 6.5 \times 2 = 13 \text{ ounces gold per ton.}$

If only $\frac{1}{10}$ A. T. of the ore were taken, the silver and gold would weigh 20 mg. and 1.3 mg., respectively, and the figures would read

$$\frac{20}{\frac{1}{10}} = 20 \times 10 = 200 \text{ ounces silver per ton,}$$

and $\frac{1.3}{\frac{1}{10}} = 1.3 \times 10 = 13 \text{ ounces gold per ton.}$

* For the purpose of calculating, the gold and silver are considered separately, as if they were in separate buttons, one pure gold and the other pure silver.

121. The value of gold is definitely fixed at \$20.67 per troy ounce, and this value is the same in all civilized countries. Most custom assayers, however, figure gold at \$20 per ounce, as this value is much more convenient for calculations, and is, moreover, the value adopted by smelters in purchasing ores.

The value of silver fluctuates considerably, and the silver values in an ore are figured at the prevailing market price of silver. In all the calculations in this Paper, gold is figured at \$20.67 per ounce and silver at 60 cents per ounce. At these prices, the value of the ore in the preceding examples would be,

Gold: 13 ounces @ \$20.67 per ounce = \$268.71

Silver: 200 ounces @ \$0.60 per ounce = 120.00

Total value of ore in gold and silver, \$388.71 per ton.

ORES WITH METALLIC SCALES.

122. When an ore contains particles of metallic gold and silver too coarse to pass through the screen with the pulp, these scales must be assayed separately, the amount of gold and silver they contain determined and added to the total gold and silver in the pulp, and the sum divided by the number of assay tons in the entire sample—pulp and scales—to obtain the total gold and silver in each assay ton of the sample.

If the sample is known to contain metallic scales, it may be weighed before crushing. After the sample is pulverized, the pulp and scales are weighed separately. Their combined weight should be only a trifle less than that of the original sample, if the work has been carefully done. If the scales do not show in the lump sample, it would naturally be crushed without weighing, and the combined weight of the pulp and scales would then have to be taken as the weight of the original sample; hence, care should be taken, in bucking samples, to lose as little of the sample as possible. If the bucking is carefully done, the loss of ore in an ordinary

sized sample will be so small that the error in the calculations from this cause will not be appreciable.

123. If there is any considerable quantity of scales, they should be scorified down in the usual manner and the lead button cupelled. If there is only a small quantity, they may be wrapped in lead foil and cupelled directly. The gold-silver button is weighed and parted as usual and the gold weighed. The weight of the gold subtracted from the weight of the button will give the weight of silver in the scales from the entire original sample.

124. The pulp is assayed in the usual manner by either scorification or crucible process, using the regular charge— $\frac{1}{16}$, $\frac{1}{8}$, or 1 A. T. The results may then be calculated as follows:

- Let A = weight of the pulp in grams;
 B = weight of the scales in grams;
 C = assay value of pulp in ounces of gold or silver per ton (or mg. per A. T.);
 D = weight of the gold or silver in the scales, in milligrams.

Now, $\frac{A}{29.166}$ = weight of the pulp in assay tons, and
 $\frac{A+B}{29.166}$ = total weight of sample in assay tons. $\frac{AC}{29.166}$ = number of milligrams of gold or silver in the pulp; and if the weight of gold or silver in the scales be added to this, we have

$$\frac{AC}{29.166} + D = \begin{cases} \text{total number of milligrams of} \\ \text{gold or silver in entire sample.} \end{cases}$$

To obtain the weight of gold or silver in 1 A. T., we must divide the total weight of gold or silver in the sample by the weight of the sample in assay tons; thus,

$$\frac{\frac{AC}{29.166} + D}{\frac{A+B}{29.166}} = \frac{AC + 29.166 D}{A+B} = \begin{cases} \text{milligrams of gold or silver} \\ \text{per A. T. (or oz. per ton).} \end{cases}$$

125. EXAMPLE.—Suppose that the pulp from a sample weighs 107.8 g. and the scales weigh 0.235 g. (235 mg.). If the scales contain 135 mg. of gold and 60.5 mg. of silver, and the pulp assays 3.28 ounces of gold and 1.7 ounces of silver per ton, what is the total gold and silver contents of the ore, in ounces, per ton?

SOLUTION.—The complete solution is as follows:

$A = 107.8$; $B = 0.23$; $C = 3.28$ for gold and 1.7 for silver; and $D = 135$ for gold and 60.5 for silver.

$$\text{Then, } \frac{A}{29.166} = \frac{107.8}{29.166} = 3.696 \text{ A. T., wt. of pulp,}$$

$$\text{and } \frac{A+B}{29.166} = \frac{107.8+0.23}{29.166} = \frac{108.03}{29.166} = 3.704 \text{ A. T., total wt. of sample.}$$

The total weight of gold or silver in the pulp =

$$\frac{AC}{29.166} = \frac{A}{29.166} \times C = 3.696 C;$$

hence, for gold,

$$\frac{AC}{29.166} = 3.696 \times 3.28 = 12.123 \text{ mg. gold in pulp,}$$

and for silver,

$$\frac{AC}{29.166} = 3.696 \times 1.7 = 6.283 \text{ mg. silver in pulp.}$$

The total weight of gold or silver in the entire sample = the weight in the pulp + the weight in the scales, or $\frac{AC}{29.166} + D$; hence, *the total gold in the sample* = $12.123 + 135 = 147.123$ mg., and *the total silver in the sample* = $6.283 + 60.5 = 66.783$ mg.

Then, since the entire sample weighs 3.704 A. T.,

$$\frac{147.123}{3.704} = 39.72 \text{ mg., total gold in 1 A. T. of ore (or 39.72 oz. per ton);}$$

and

$$\frac{66.783}{3.704} = 18.03 \text{ mg., total silver in 1 A. T. of ore (or 18.03 oz. per ton).}$$

126. The preceding calculations are given in full merely to more fully illustrate their principle. The same result may be obtained with much less work by simply substituting the values of A , B , C , and D in the final formula $\frac{AC + 29.166D}{A + B} =$ mg. per A. T., or oz. per ton; thus, for gold,

$$\frac{107.8 \times 3.28 + 29.166 \times 135}{107.8 + 0.23} = \frac{353.6 + 3,937.4}{108.03} =$$

$$\frac{4,291}{108.03} = 39.72 \text{ mg. gold per A. T. (or oz. per ton);}$$

and for silver,

$$\frac{107.8 \times 1.7 + 29.166 \times 60.5}{108.03} = \frac{183.3 + 1,764.5}{108.03} =$$

$$\frac{1,947.8}{108.03} = 18.03 \text{ mg. silver per A. T. (or oz. per ton).}$$

127. Horn silver (chloride of silver) in an ore may cause the same trouble as metallic gold or silver, as it is malleable and flattens out into scales instead of breaking up and passing through the screen with the pulp. These scales are treated just like metallic scales, and the results calculated in the same manner.

If there is only a very small quantity of scales and the scales are not very coarse, they may be ground down fine enough to pass the screen by placing them on the bucking board, covering them with a little of the pulp which has already passed the screen, and grinding heavily for a few minutes. Then sift, and if any scales are still left, grind again in the same way, and repeat till they will all pass through the screen. Mix the sample with unusual care when weighing out the charges, to make sure that you have the scales evenly distributed. This involves a little more work in the preparation of the sample, but saves the trouble of the extra assay and the calculations necessary when the scales are assayed separately.

EXAMPLES FOR PRACTICE.

1. *Scorification Assay.* Ore charges, $\frac{1}{10}$ A. T. The gold-silver buttons weigh 1.72 and 1.76 mg., respectively, and the gold from parting weighs 0.98 mg. (a) How many ounces of gold and silver

does the ore contain per ton? (b) What is the value of the ore per ton?

$$\text{Ans. } \left\{ \begin{array}{l} (a) \left\{ \begin{array}{l} \text{Gold, } 4.9 \text{ oz. per ton.} \\ \text{Silver, } 12.5 \text{ oz. per ton.} \end{array} \right. \\ (b) \left\{ \begin{array}{l} \text{Gold, } \$101.28 \text{ per ton.} \\ \text{Silver, } \underline{7.50} \text{ per ton.} \\ \text{Total, } \$108.78 \text{ per ton.} \end{array} \right. \end{array} \right.$$

2. *Crucible Assay.* Ore charges, $\frac{1}{4}$ A. T. Weight of gold-silver buttons, 2.96 and 2.90 mg., respectively. Weight of gold, 1.03 mg. (a) How many ounces of gold and silver does the ore contain per ton? (b) What is the value of the ore per ton?

$$\text{Ans. } \left\{ \begin{array}{l} (a) \left\{ \begin{array}{l} \text{Gold, } 1.03 \text{ oz. per ton.} \\ \text{Silver, } 4.83 \text{ oz. per ton.} \end{array} \right. \\ (b) \left\{ \begin{array}{l} \text{Gold, } \$21.29 \text{ per ton.} \\ \text{Silver, } \underline{2.90} \text{ per ton.} \\ \text{Total, } \$24.19 \text{ per ton.} \end{array} \right. \end{array} \right.$$

3. *Crucible Assay.* Ore charges, 1 A. T. Weight of gold-silver buttons, 0.78 and 0.81 mg., respectively. Weight of gold, 1.34 mg. (Buttons would have to be inquarted.) (a) How many ounces of gold and silver does the ore contain per ton? (b) What is the value of the ore per ton?

$$\text{Ans. } \left\{ \begin{array}{l} (a) \left\{ \begin{array}{l} \text{Gold, } 0.670 \text{ oz. per ton.} \\ \text{Silver, } 0.125 \text{ oz. per ton.} \end{array} \right. \\ (b) \left\{ \begin{array}{l} \text{Gold, } \$13.85 \text{ per ton.} \\ \text{Silver, } \underline{0.07} \text{ per ton.} \\ \text{Total, } \$13.92 \text{ per ton.} \end{array} \right. \end{array} \right.$$

NOTE.—When the quantity of silver contained in an ore is as small as this, it is usually ignored entirely when calculating the value of the ore and reported as a "trace." Such small quantities of silver are never considered in buying and selling ores, and in such a case as the above, only the gold would be paid for. In assaying gold ores known to contain so little silver that it may be safely neglected, it is a common practice to add enough silver to the assay charges—in the shape of silver foil or a small crystal of nitrate of silver—to inquart the gold buttons. This silver will go into the lead buttons along with the gold and silver in the ore, and when they are cupelled the assayer has his buttons all ready to part, and does not have to take the risk of losing them in inquarting with the blowpipe, to say nothing of the work saved. When only the gold is determined, it is not necessary to weigh the buttons before parting, except as a check on the assaying.

4. *Ore Containing Metallic Scales.* Weight of pulp, 138.67 g. Weight of scales, 1.23 g. Scales contain 832.4 mg. silver and 8.58 mg. gold. The pulp is assayed by the crucible process, using $\frac{1}{4}$ -A.-T. charges of ore; the gold-silver buttons obtained weigh 107.54 and 107.28 mg., respectively, and the gold from parting weighs 2.26 mg. (a) How

many ounces of gold and silver does the ore contain per ton? (b)
 What is the value of the ore per ton?

$$\text{Ans. } \left\{ \begin{array}{l} (a) \left\{ \begin{array}{l} \text{Gold, } 4.08 \text{ oz. per ton.} \\ \text{Silver, } 384.20 \text{ oz. per ton.} \end{array} \right. \\ (b) \left\{ \begin{array}{l} \text{Gold, } \$ 83.80 \text{ per ton.} \\ \text{Silver, } 230.52 \text{ per ton.} \\ \text{Total, } \underline{\$313.82} \text{ per ton.} \end{array} \right. \end{array} \right.$$

CONTROL ASSAYS.

128. The price paid by mills, smelters, or sampling works for ores is fixed or controlled by the result of assays run independently, by different assayers, on duplicate samples from each lot of ore. Such assays are aptly named *control assays*, or, briefly, *controls*. The only way in which they differ essentially from ordinary assays is in the extreme care taken in sampling and assaying, in order to insure perfect justice to both the shipper and the works. The following are the details of the method commonly adopted in the Western mining States.

129. Sampling.—When the ore comes into the mill or smelter, the entire lot is crushed, if necessary, and a sample of from 5 to 10 tons, according to the size of the lot, is cut out, usually by an automatic sampler, or by quartering, or by the use of the split shovel. (Small lots of ore are not cut down, but the entire lot is treated in the same way as the sample from a larger lot.) This sample is further cut down in the same manner to 200 or 300 pounds.

This last sample is crushed quite fine by fine-crushing rolls or by a sample grinder, and is then cut down to about 2 or 3 pounds by quartering or by the use of a tin sampler, or riffle. This is the final sample. The whole of this sample is ground down to 100 mesh and screened.

The pulp is very thoroughly mixed by rolling on a rubber mixing cloth, as described in Art. 17, and the sample is then divided into four equal parts by quartering or by the riffle. These are the control samples, and should weigh from 8 to 12 ounces each. They are put into separate sample envelopes, of which each mill has its own printed form.

Each envelope is sealed with the seal of the works, and is marked with the mine number, the name of the mine, and the mill or lot number. The shipper is then given his pick of the samples, generally taking two, another is kept by the mill for assay, and the remaining sample is stamped or marked with the word "Umpire" and retained by the mill, to be assayed by a third party in case the assays of the shipper and the mill fail to agree within reasonable limits. The shipper sometimes also writes or stamps his name on the envelope containing the umpire sample. Some works divide their final sample into five parts, so that both the shipper and the works can have two samples, in addition to the umpire sample.

130. Assaying for Settlement.—The shipper takes one of his samples to the mine assayer, if the mine employs one, or, if not, to any reliable custom assay office, and has it assayed, while the mill assayer assays the sample kept by the mill. They then compare results, and if they check reasonably close—say within 3 or 4 points (a "point" is $\frac{1}{16}$ ounce, or 20 cents per ton, in gold) on an ore carrying \$20 or more per ton in gold—they "split," or average, the results, and the ore is paid for on this basis. For example, if the mine assay shows the ore to contain 2.06 ounces of gold and the mill assay gives 2.02 ounces of gold per ton, the shipper is paid for the average, or 2.04 ounces of gold per ton.

131. If, however, the two assays do not check within these limits, both assayers repeat their work. If, after repeating, they still disagree, and particularly if the mine assay is high, the umpire sample is sent to some disinterested and reliable assayer agreed upon by both parties concerned, and his result is usually taken as final. If he does not check with either of the other assayers, however, the shipper may demand that the lot be resampled or may send his ore elsewhere, as it is always held until the assays are satisfactorily completed and the shipper has been paid for it, before treating.

132. General Method of Assaying.—The assays may be run by either the scorifier or crucible assay, using $\frac{1}{16}$, $\frac{1}{4}$, or 1 A.-T. charges, according to the grade and character of the ore. The assaying is done in the usual manner, but with great care. Many assayers prefer to use 20-g. crucibles for $\frac{1}{4}$ -A.-T. charges, or to take double the number of $\frac{1}{4}$ -A.-T. charges in 10-g. crucibles, in order to have room for a considerable excess of flux. Each assayer has his own way of checking his work. A good scheme is to run three charges and part two buttons together and the third separately as a check. If the work has been well done, the gold from the two buttons should weigh almost exactly twice as much as that from the single button. If it does not, there is something wrong and the assay should be repeated. In parting, it is best to use the first acid quite weak—about 1 in 5—and the last acid strong.

The results of control assays are calculated as in ordinary assays, with gold at \$20 an ounce and silver at the market price.

BULLION ASSAYS.

133. In smelting gold and silver ores by the ordinary lead-bullion process, the gold and silver are carried down by lead, exactly as in the crucible assay. This enriched lead is known as “base bullion,” or lead bullion. As it is taken from the lead well of the furnace it is cast into bars or pigs. These are afterwards refined, the greater portion of the base metals being removed, leaving nearly pure gold and silver. The refined bullion is known as “fine bullion,” or sometimes as gold bullion or silver bullion, when composed almost entirely of gold or silver, respectively. Fine silver bullion containing considerable gold is known as “doré silver” or “doré bullion.” It is, of course, necessary to assay both base and fine bullion in order to determine their respective values.

134. Base-Bullion Assay.—The samples are taken from the bars of bullion by means of a steel punch similar to a harness-maker's punch, but larger and heavier. This

punch is driven about half way through the bars, taking out cores about $\frac{1}{4}$ inch in diameter. Two sets of samples are taken from each bar, one from the top and one from the bottom, towards opposite sides and ends. When sampling a lot of bullion, the bars are usually sampled in bunches of five, as follows:

The five bars are laid side by side on the sampling platform, as shown in Fig. 24, and one sample is taken from

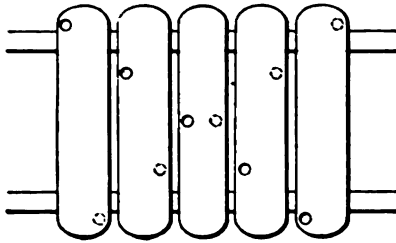

FIG. 24.

each bar, starting at the outside upper or lower corner and working diagonally across, the samples being taken out at the points indicated by the solid circles. Then the bars are turned over, and a second set of samples

taken out in the same order, but starting from the opposite end of the first bar and working along the other diagonal. In the figure, the positions of the punch holes in the lower sides of the bars are indicated by dotted circles.

135. The samples from the entire lot are melted up together in a clay or graphite crucible, care being taken that the heat does not rise to a point where the lead begins to cupel or scorify (volatilize), as any reduction in the proportion of lead in the bullion is equivalent to an increased proportion of precious metals, and the results would therefore be too high. As soon as the sample is perfectly fluid, it is thoroughly stirred with a clean iron rod, and then poured into a mold and cast into a thin, flat bar, 10 to 18 inches long, about 3 inches wide, and $\frac{1}{4}$ or $\frac{3}{8}$ inch thick.

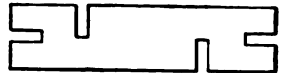

FIG. 25.

The samples for assay are taken from this bar either by punching out pieces from the ends and sides, as shown in Fig. 25, or by punching out pieces at intervals, diagonally across the bar, or cutting strips right across the bar. These samples should each be approximately

of the weight required for the assay, usually $\frac{1}{2}$ A. T. Four samples are usually taken from each bar.

136. One-half A. T. is accurately weighed out from each sample. Each $\frac{1}{2}$ -A.-T. sample is then cupelled separately, the cupellation being conducted exactly as in ordinary ore assays, with as low a heat as is practicable. The cupels should always show "feathers." If the bullion is impure—if it contains considerable quantities of other base metals besides lead, such as copper, arsenic, and antimony, or sulphur—it should be scorified down with a little borax, and if very impure, a little test lead, before cupelling. The cupels should be moved back into the hotter part of the muffle just before "blinking," and should then be withdrawn gradually, to prevent sprouting. A sprouted button should always be rejected.

As soon as the cupels are cool, the buttons are removed, brushed, and weighed. The weights should agree very closely—say within half an ounce on bullion running 200 ounces of silver to the ton.

After weighing, the buttons are flattened out in the diamond mortar or on the anvil, and are then ready for parting.

137. The parting may be performed in small porcelain capsules, as in the ore assay, but with such large buttons it is better to use parting flasks or matrasses, or test tubes. Place two buttons in each flask, add 20 to 30 c. c. of c. p. nitric acid of about 1.16 Sp. Gr. (about 30 per cent. strong acid) and heat slowly till the silver is all dissolved. Then boil until all red fumes have disappeared. A bit of charcoal or a couple of charred pepper beans in the acid will prevent it from bumping and spurting while boiling. About ten minutes is usually sufficient for the first heating. Shake the matrass gently to collect the gold, and then decant (pour) the acid off very carefully and replace it with fresh acid, somewhat stronger (about 50 per cent. strong acid). Boil for about three minutes; then again collect the gold by shaking and pour off the acid. The gold is next washed three times, by decantation, with distilled water, and is

finally transferred to a porcelain capsule or an annealing cup, in the manner described in Art. **103**, dried, annealed, and weighed. The weights of gold from the two sets of buttons should check very closely, and if they do not, two more samples should be assayed. Their results will usually check one or the other of the first two pairs. If they do not, the assay should be again repeated, and so on until good checks are obtained.

138. Base-bullion assays are always reported, like ordinary gold and silver assays, in *ounces per ton*. Fine-bullion assays are reported in parts per 1,000, or as so many "thousandths fine."

139. Fine-Bullion Assay.—Gold in fine bullion is always determined by fire assay. Silver may be determined either by fire assay or by volumetric wet assay. The wet assay is adopted in the mints and in most large metallurgical works, as it is slightly more accurate and less troublesome than the fire assay. It involves considerable knowledge of chemistry and very delicate manipulation, and hence will not be given here. The fire assay, if carefully run and the proof assays are properly made up, will give very closely approximate results and is the method commonly used by custom assay offices and small works.

140. The sample is obtained from the bar by chipping off the diagonally opposite upper and lower corners with a cold-chisel or by boring to the center of the bar from the top and bottom, near the diagonally opposite corners, with a drill-press or ratchet-drill. The latter practice is the better, except in the case of bullion known to be very fine and uniform, and will detect any attempt at fraud, such as filling the center of the bar with lead or copper—a trick that is frequently tried. The very first borings should be rejected, as they are apt to be dirty and give low result. Borings are ready for immediate weighing. Chips have to be flattened out on the anvil or in a small set of rolls made especially for the purpose, until they are thin enough to be cut up by the shears. The samples, borings, or rolled chips are placed in

envelopes properly marked with the number stamped on the bar from which they are taken.

141. The approximate composition of the bullion is first determined by a preliminary assay. Half a gram of bullion is weighed out accurately on the button balance; this is wrapped in from 5 to 10 g. of pure lead foil and cupelled in a small cupel (weighing about 10 or 12 g.). The cupellation is conducted as in the base-bullion assay, with the same precautions, the cupels showing "feathers" just before finishing. The button should then be weighed and parted as usual.

The results indicated by the preliminary assay are used in making up the proof or correction assay, which should be as nearly as possible identical, in every particular, with regular assay charges. The amount of pure silver put into the proof charge is from 5 to 10 mg. greater than the amount indicated by the results of the preliminary assay, as it is roughly estimated that this amount is lost in the cupellation. If the bullion contains very much copper, the amount should be determined as described in Art. **236**, and a corresponding amount added to the proof. Small amounts of copper, however, may be disregarded.

142. If the preliminary assay shows the bullion to contain too much gold to part without inquarting, sufficient pure silver is added to bring the proportions up to $2\frac{1}{2}$ parts of silver to 1 of gold. If the gold is not up to this proportion, some assayers add enough pure gold to make it so. This is not the general practice, however. The only advantage it gives is that the gold stays together in a cornet, and is consequently easier to handle, with less danger of loss during washing.

143. Table IV is used in making up the proof. The method of making up the proof and the use of the table are best illustrated by an example. Suppose a preliminary assay of 500 mg. of bullion gave us 350 mg. of silver and an analysis showed 20 per cent. of copper. The table shows us

that we will have to weigh out 355 to 360 mg. of pure silver and that 12 g. c. p. lead foil will be required for cupellation. Now, as the bullion contains 20 per cent. copper, we must add 100 mg. of c. p. copper foil and 50 mg. of c. p. test lead. [The weight of test lead necessary in the proof is obtained by subtracting from the weight of bullion used the sum of the weights of silver and copper contained in the 500 mg. of bullion, viz., $500 - (350 + 100) = 50$ mg. of test lead.] The whole is wrapped in the 12 g. of c. p. lead foil, when it is ready for cupellation with the regular assay. The proof is

TABLE IV.

Weight in mg. of Silver from Preliminary Assay of 500 mg. Bullion.	Weight of Silver in mg. to be Used in Proof.	Weight in Grams of C. P. Lead Foil to be Used in Proof and in Regular Assay.	Per Cent. of Copper in Bullion as Determined by Analysis.	Weight in mg. of C. P. Copper Foil to be Used in Proof.
475	480	5	2.5	12.5
450	455-460	7	5.0	25.0
425	430-435	8	10.0	50.0
400	405-410	10	15.0	75.0
375	380-385	11	20.0	100.0
350	355-360	12	25.0	125.0
325	330-335	13	30.0	150.0
300	305-310	15	35.0	175.0
250	255-260	17	40.0	200.0
200	205-210	19	45.0	225.0
150	155-160	20	50.0	250.0

made up in this manner merely because the loss of silver in bullion during cupellation depends upon the amounts of copper and lead present. The regular assay is performed as follows: Weigh out two portions of bullion of 500 mg. ($\frac{1}{2}$ g.) each; wrap in the proper amount of lead foil, as shown in the table, together with what pure silver or gold may be necessary to secure the proper proportions for parting, and cupel. The cupel containing the proof assay is

placed between the two regular assays and run along with them. The resulting buttons are weighed, rolled out into ribbons, annealed, rolled into cornets, and parted in parting flasks or in a platinum parting tray (described in Art. 59). The gold-silver buttons should check within 1 milligram, and the gold almost exactly. The loss of silver in the proof assay should not be more than 5 mg., if the cupellation has been run properly; the gold loss, unless the bullion runs quite high in gold, will be hardly noticeable. The amount of the loss of the proof assay is carefully determined and a corresponding amount added to the results of the bullion assay, to make up for the loss during cupellation. The buttons should be bright and clean.

144. The result of the assay is reported in parts fine per thousand—that is, the bullion is reported to contain so many parts pure silver and so many parts gold, and the remainder is base metal, usually lead and copper, the whole summing up to 1,000 parts. For example, if the gold-silver buttons from two 500-mg. ($\frac{1}{2}$ -g.) charges weigh 417 and 418 mg., respectively, and the proof assay shows a loss of 4.5 mg., the first button contains $\frac{417 + 4.5}{500} = \frac{843}{1,000}$, or 843 parts of fine silver and gold, and $\frac{157}{1,000}$, or 157 parts of base metals; and the second button contains $\frac{418 + 4.5}{500} = \frac{845}{1,000}$, or 845 parts fine silver and gold and 155 parts base metals; or, the average total fineness (silver and gold) of the bullion is 844. If the weight of the gold from the two buttons is 24 mg., this weight divided by the weight of the bullion from which the gold was derived, 1,000 mg. (two $\frac{1}{2}$ -g. charges), gives the contents of the bullion in gold. The bullion therefore contains $\frac{24}{1,000}$, or 24 parts fine, of gold. This amount deducted from the total fineness of the bullion (844) gives the fineness in silver, which is thus found to be 820. The silver contents may also be found in the same way as the gold, by dividing the weight of silver in the buttons by the weight of bullion taken; thus,

$421.5 + 422.5 = 844$ mg., corrected weight of gold-silver buttons.

844 mg. $- 24$ mg. $= 820$ mg., weight of silver in $1,000$ mg. (two $\frac{1}{2}$ -g. charges) of bullion.

$\frac{820}{1000} = .820$, or 820 parts silver in bullion.

The results of the preceding assay would be reported:

Silver	820 <i>fine</i> .
Gold.....	24 <i>fine</i> .

This would be stamped on the bar with steel dies as a decimal; that is,

Silver.....	.820
Gold.....	.024

Using two $\frac{1}{2}$ -g. charges for assaying greatly facilitates the calculations, as the weights of the two charges sum up to $1,000$ mg., and by adding the results from the two buttons together, each milligram is $\frac{1}{1000}$ or 1 part, so that no division is necessary, the fineness in silver or gold being the same as the weight of silver or gold in milligrams.

LEAD ASSAY.

145. The fire assay for lead is very similar to the crucible assay for gold and silver; in fact, the fluxes and the reactions in the furnace are practically identical. The litharge is, of course, omitted, as the object of the assay is to determine how much lead there is *in the ore*, and if litharge were used, its lead also would go into the button and make it far too heavy. The lead from the ore is reduced in the same way as the lead from the litharge in the gold-silver assay.

The fluxes are made up, as in the gold-silver assay, in accordance with the character and composition of the ore. Either of the stock fluxes given in Art. 78 will successfully flux most lead ores, however, without any changes or additions.

146. Either 5 or 10 g. charges of ore may be used. The general practice in the Western mining States is to use

5 g. of ore and run duplicates. The method is as follows: Two 5-g. charges of ore are mixed in 10-g. clay crucibles with from 15 to 20 g. of lead flux apiece (for 10 g. of ore use 30 g. flux); the assay is then covered with borax and the fusion is made in the muffle furnace. Put the crucibles into the muffle when it is at a low red heat, and then gradually raise the heat to a full red at the finish. This will avoid danger of boiling over and will give higher results than if the assay is run very hot, as there will be less loss from volatilization. In about 20 to 30 minutes all "cooking" will cease and the charges subside to a quiet, liquid fusion. The heat is then raised or the crucibles are set back into the hotter part of the muffle, and they are left in for a few minutes longer, in order that the slag may become thin and fluid. They are then removed, tapped gently on the edge of the furnace to collect the lead, and poured. As soon as the charges in the mold are cool, they are removed, the slag is broken away from the buttons, and the buttons are hammered out flat, or if large may be hammered into cubes. The hammering will free them of slag. They should be soft and malleable. If they are brittle, they contain sulphur, arsenic, antimony, bismuth, or some similar element; copper or iron makes the buttons hard; *any* impurity makes the buttons heavier than they should be. The slag should be clean and brittle and should contain no shots of lead.

The buttons are brushed and weighed. They should agree within about $\frac{1}{2}$ per cent. (25 mg. on 5-g. charges). The weighing is done on the pulp balance, or, better, on the analytical balance, as no such great delicacy is required as to necessitate the use of the button balance. The assay is reported in per cent.—that is, the ore contains so many per cent. of lead. The figuring is very simple, particularly if 5-g. charges are used. The weight of the buttons is added and the sum divided by the total weight of ore taken, giving the percentage of lead in the ore. For example, if the buttons from two 5-g. charges of ore weigh 3.73 g. and 3.75 g., respectively, the lead contents of the ore are:

$$\frac{3.73 + 3.75}{5 + 5} = \frac{7.48}{10} = .748, \text{ or the ore contains } 74.8\% \text{ of lead.}$$

If the ore runs very high in silver—several hundred ounces per ton—the buttons should be cupelled and the amount of silver determined and deducted from the weight of the lead. Small amounts of silver may be neglected.

147. To assay lead by the fire assay and get good results requires very careful work and considerable practice. There is invariably more or less lead lost through volatilization, and the results of the assay are, consequently, always somewhat lower than the actual contents of the ore, unless the button contains impurities. How to keep the loss as small as possible is the problem confronting the assayer. If the heat is too high, considerable lead is volatilized; if it is too low, on the other hand, the assay must be kept in the furnace longer, and as slow volatilization is constantly going on, the ultimate result is apt to be the same as though the heat were too high. The proper heat and time must be determined by experiment. A number of assays of the same ore with the same charge should be run under different conditions, at various temperatures, and for different lengths of time at the same temperature. The highest result is in all probability the most nearly correct, provided the button is pure and malleable; and the conditions under which it was obtained should be adopted for general work.

148. Sulphides.—The charge given in Art. **146** is for oxidized ores—carbonates, oxides, sulphates, etc. If the lead is in the form of a sulphide (galena) or is associated with other sulphides, iron nails or wire should be added to the charge, as in the crucible assay of sulphide ores for gold and silver, to take up the sulphur. Two tenpenny nails are usually sufficient. Potassium cyanide may be used as a desulphurizer instead of iron, but it is very dangerous to handle and is apt to reduce other metals than lead, so that most assayers prefer to use nails.

149. Lead assays may be run in the wind furnace if desired, although the muffle furnace is much more convenient. If run in the wind furnace, the crucibles are placed in the furnace while the fire is low, in order to get a gradual heat, and fresh fuel is piled around them. The fusion takes from 15 to 25 minutes. As soon as they are quiet they may be removed and poured, and the buttons cooled, beaten out, and weighed as before. The heat in the wind furnace is not so readily controlled as in the muffle furnace, and the results of lead assays run in this way are consequently less uniform and reliable than those run in a muffle furnace.

EXAMPLES FOR PRACTICE.

1. Ore charges, 5 g. each. Weights of buttons, 2.47 and 2.5 g., respectively. What is the per cent. of lead in the ore?

Ans. 49.7%.

2. Ore charges, 10 g. each. Weights of buttons, 6.93 and 6.89 g., respectively. What is the per cent. of lead in the ore?

Ans. 69.1%.

WET ASSAYS.

150. Assayers are frequently called upon to make determinations of other elements than gold, silver, and lead—elements which can not be accurately determined by the fire assay, and for the determination of which some knowledge of chemical analysis in the wet way is necessary. For example, the price paid for ores by smelters depends upon the amount of iron oxide, lime, and silica they contain, as explained in Art. 8. Manganese oxide acts, up to a certain point, like iron oxide, and the same premium is paid for both, and copper in ores is also paid for if present in any considerable quantity; hence, the assayer will find it greatly to his advantage to be able to perform the analyses for these substances. The wet determination of lead is also becoming quite common in smelters and lead works. Zinc is quite an important, though undesirable, constituent of many silver

and gold ores, and its presence and amount are apt to affect the value of the ore considerably; the method commonly used for its determination is therefore given here.

151. Volumetric analyses are usually considerably quicker and less troublesome than gravimetric, and are therefore used wherever possible in smelters where speed is more essential than absolute accuracy. It must not be inferred from this that volumetric determinations are not accurate. Any of the schemes given here are accurate to a small fraction of 1 per cent., and the volumetric assay for some elements is more accurate than the gravimetric. There is rather more room for error in volumetric work, as a slight variation in the end point of the titration or a change in the strength of the standard solution may make a slight difference in the results; but such errors, if the chemist is careful and standardizes his solutions frequently, are so very small that they may be safely neglected. If duplicate determinations are run, any considerable error could not very well escape notice. The average result of the duplicate determination is always taken. Duplicates are seldom run in gravimetric work, on account of the extra work involved and the small probability of error. The final result in gravimetric analysis is obtained by actually *weighing* the precipitate containing the element sought, and consequently, if the analysis has been properly conducted and no error has been made in the weighing and calculations, the result is practically absolute. A good chemist can make volumetric determinations check very closely on gravimetric work, however, and for smelter work extreme accuracy is unnecessary, as the determinations are made principally for the calculation of the furnace charge, the results of which are only approximate at best.

In all analyses, in order that ores may be in the best condition to be acted upon by acids, they must be pulverized as finely as possible. This is accomplished by grinding or rubbing in an agate mortar, treating only a few grams of ore at one time. The pulverization should be carried on

until the ore is in the form of an impalpable powder, that is, until no gritty feeling can be noticed when a small portion is rubbed between the thumb and fingers.

APPARATUS.

152. The list of apparatus given here includes only such articles as are absolutely necessary to properly perform the analyses following. The chemicals necessary will not be described separately, but will be mentioned in their proper places in the descriptions of the methods of analysis, and a table of proportions for the mixing of reagents is given in Art. **252**.

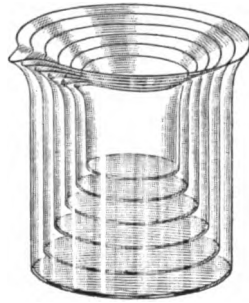

FIG. 26.

153. Beakers.—Glass beakers are necessary for holding solutions. They are made of thin, tough glass which will stand considerable heat, so that solutions can be boiled in them. They come in “nests” of six, as shown in Fig. 26. The smallest, or No. 1, beaker will hold about 100 c. c., while the largest, or No. 6, has a capacity of 1 liter (1,000 c. c.). The form with the lip for pouring, as shown in the figure, is most convenient for general work, but are somewhat more expensive than the form without a lip.

154. Casseroles.—Porcelain casseroles, Fig. 27, are used for dissolving ores in acids. They are particularly useful when the solution must be evaporated down to dryness, as with care they will stand this operation without any danger of cracking, whereas beakers would be very liable to crack as soon as the solutions in them are boiled dry. Casseroles come in various sizes. The 2, 3, or 4 ounce sizes



FIG. 27.

are most convenient for ordinary work, as the ore can be well covered without using an excess of acid.

155. Flasks.—Flasks of the shape of the wash-bottle shown in Fig. 34, made of the same kind of glass as the beakers, are useful for various purposes—dissolving ores, receiving solutions, etc. The 4, 8, and 16 ounce sizes are most convenient.

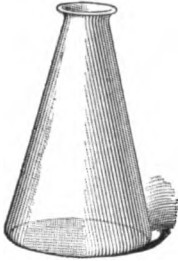

FIG. 28.

Fig. 28 illustrates an Erlenmeyer flask which is very handy for precipitating solutions in and for general analytical work, on account of the large flat bottom which is exposed to the action of the hot plate or sand-bath and owing to the fact that any precipitate forming in the solution in the flask has a tendency to fall away from the sides and on to the bottom of the flask.

Small flasks of this shape are sometimes used in the copper determination.

156. Funnels.—Glass funnels are necessary for making filtrations. The angle between the sides should be 60° , and the stem should be ground off at an angle, as shown in Fig. 29, to draw the stream off to one side, lessening the capillary attraction between the tube and the solution, and consequently hastening the filtration.

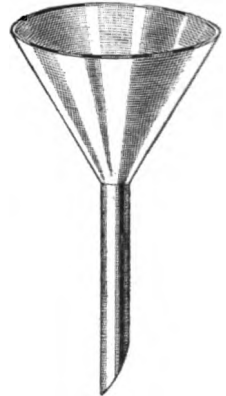

FIG. 29.

157. Watch-Glasses.—Watch-glasses, Fig. 30, are handy for covering beakers, casseroles, and funnels, and for receiving weighed charges of ore or chemicals, precipitates, etc. Like the beakers, they come in assorted sizes.

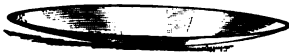

FIG. 30.

158. Burettes.—Burettes are graduated glass tubes fitted with glass stop-cocks, as shown in Fig. 31 at (a), or

with rubber hose connections and pinch-cocks, as shown at (b), from which standard solutions are run into solutions to be titrated or tested volumetrically for certain elements. They come in 25, 50, and 100 c. c. sizes graduated to $\frac{1}{10}$ c. c. The 50-c. c. size is most convenient.

159. Spot-Plate.—The spot-plate is an oblong plate of white porcelain, with a number of small depressions in its surface for receiving the indicator solutions used in some titrations. A few drops of the indicator solution are put into each depression by the use of a dropping tube; then, as the standard solution is run into the solution under examination, the latter is tested from

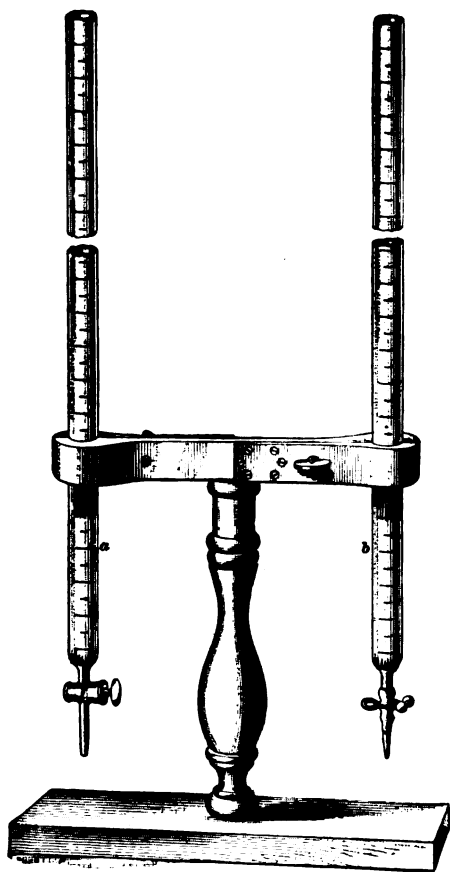

FIG. 81.

time to time for excess of the standard solution, by taking a drop out on the end of a stirring rod and adding it to the indicator solution in one of the depressions. As soon as the standard solution is in the slightest excess over the amount necessary to convert the element sought in the solution under examination, a drop of the latter solution will cause a characteristic reaction when added to the indicator solution.

160. Crucibles.—Porcelain and platinum crucibles are necessary for making fusions and igniting (heating at a high heat) precipitates.

161. Graduates.—Glass graduates are necessary for measuring acids, etc. They may be had in various shapes and sizes. A graduate with straight sides, as shown in Fig. 32, is most convenient. They may be had in sizes varying from 50 to 500 c. c.



FIG. 32.

162. Titrating Dish.—A flat, shallow, white porcelain dish, of about 1 quart capacity—an ordinary ironstone porcelain vegetable dish answers very well—is very convenient for making titrations, as the end point shows sharply against the white porcelain. A sheet of white paper behind a beaker will serve the same purpose.

163. Filter and Burette Stands.—Wooden or iron stands are necessary for holding funnels and burettes while filtering and titrating. A wooden burette stand is shown in Fig. 31. The filter stand is somewhat similar, but has conical holes cut in the cross-bar for the funnels. Sometimes racks are used that will hold several funnels.

164. Filter Paper.—Filter paper is tough, porous paper, used for filtering solutions. It may be obtained in circular sheets of various sizes, in packages of 100. The sheets are folded to fit into the funnel. The folding is done as follows:

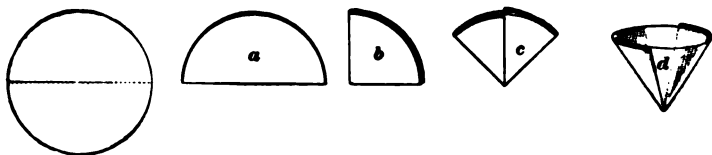

FIG. 33.

Fold over along the diameter, as at *a*, Fig. 33; fold again, corner to corner, as at *b*; then open out into form *a* again,

fold one corner and outside edge in to the center line, and turn the paper over and fold the other corner in the same way on the other side, as at *c*. The filter will then open out into the form *d*, which fits exactly into the funnel. After placing it in the funnel and moistening with water to make it stick to the sides of the funnel, it is ready for filtering.

165. For use in quantitative work where the filter paper has to be burned or ignited with the precipitate, it is necessary that the weight of the ash of the filter should be known. There are two methods of accomplishing this. One is to employ what are known as ashless or acid-washed filters. These are filter papers which have been washed with hydrochloric and hydrofluoric acids, thus removing the solid portion of the ash and leaving practically nothing but carbon in the filter paper, so that it will burn without leaving any ash. The other method is to determine accurately the weight of the ash of the filter paper, and then to subtract this weight from the amount obtained after igniting each precipitate upon its filter paper. Such filter papers can be bought in packages of 100, with the weight of the ash that each sheet will produce stamped on the back of the package. Where very accurate work is desired, the chemist can determine the weight of his own filter papers by burning three or four down to a white ash in an accurately weighed porcelain or platinum crucible. The crucible containing the ash is then weighed, and the increase in weight over the weight of the crucible alone is the weight of the ash. This amount divided by the number of filter papers used gives the weight of the ash from each filter. Ashless or acid-washed filters can be tested in the same way, and three or four of them should give such a small amount of ash that it would not give any perceptible increase in the weight of the crucible.

166. Wash-Bottle.—The chemist has constant use for distilled water. The water for immediate use is kept in a large flask or “wash-bottle,” of 16 to 32 ounces capacity, with two tubes passing through the cork and arranged so that on blowing in one the air-pressure forces the water up

and out through the other, which is drawn out to a fine jet at the tip. Fig. 34 shows the wash-bottle and the arrangement of the tubes. The air-tube need only extend through



FIG. 34.

the cork. The long water-tube should extend nearly to the bottom of the flask, so that it will remain under water even when the water in the flask gets very low. A good plan is to stop the glass tube an inch or two from the bottom, and then put on a short piece of rubber tubing, as shown in the figure, extending to the bottom, or barely clearing it. This avoids the risk of pushing the tube through the bottom of the flask when putting in the cork. A flexible joint of rubber tubing at the jet, as shown, is also convenient for directing the stream. Ordinary flasks may be used for wash-bottles, but specially made flasks, with a heavy ring around the mouth to bear tight corking, are stronger and better. The neck may be wrapped with twine for handling when the water is hot. When boiling water in a wash-bottle, the cork should always be loosened and set up on the edge of the mouth, or the pressure of the steam will force the water out through the jet, little by little, the air-tube being so small that the steam does not escape fast enough to keep the pressure in the flask down to atmospheric pressure.

167. Stirring Rods.—Glass stirring rods, of assorted lengths and sizes—say from 3 to 8 inches long and from $\frac{1}{8}$ to $\frac{3}{16}$ inch in diameter—are essential in the laboratory. A short piece of rubber hose on the end of the rod will prevent it from being pushed through the bottom of the beaker. The rods may be bought of the proper size, or the chemist may buy the glass in 3 or 6 foot lengths and make his own rods. To break the glass rod, make a scratch with a file at the point where it is desired to break it, grasp the rod with both hands, one hand on each side of the file mark, and close the thumbs together, on the side of the rod opposite the mark, and break by pressing up with the thumbs. The broken ends

may be made round and smooth by heating with the blow-pipe or in the blue flame of a Bunsen burner. Stirring rods may also be made from glass tubing by closing the ends of the tubing in the Bunsen flame or with the blowpipe flame. A glass rod with a piece of rubber on the end is sometimes called a "policeman," and may be used for removing precipitates from beakers or other dishes.

168. Bunsen Burners, Tripods, Etc.—Bunsen burners and tripods with wire gauze and asbestos cloth are essential for heating water and solutions. Every laboratory, moreover, should be supplied with an exhaust hood, under which all boiling with acids should be done. The hood is simply a small chamber connected by a flue with the outside air, to draw off disagreeable and poisonous fumes and prevent their spreading through the laboratory. An iron heating table or "hot plate" and a large gas-burner are necessary under the hood if much work is to be done, and are very convenient under any circumstances.

169. Sink and Slop-Jar.—Every laboratory should have a sink and faucet in connection with or convenient to the working desk. A five-gallon earthenware jar should be set under or alongside the desk, to receive washings, spent solutions, etc.

IRON DETERMINATION.

170. The two methods most commonly used in smelters and metallurgical works for the determination of iron are both volumetric—one by titration with a standard solution of *potassium permanganate* ($K_2Mn_2O_8$), and the other by titration with a standard solution of *potassium bichromate* ($K_2Cr_2O_7$). They are about equally used, hence both are given here. The two methods are very similar in their reactions, both depending upon the fact that the reagent used for titrating is an oxidizer, and when added to a solution of a ferrous salt converts it into a ferric salt. Thus, in the permanganate method, ferrous sulphate ($FeSO_4$) is converted or oxidized by the permanganate to ferric

sulphate [$Fe_2(SO_4)_3$], and in the bichromate method ferrous chloride ($FeCl_2$) is converted by the bichromate to ferric chloride (Fe_2Cl_6).

PREPARING THE STANDARD SOLUTIONS.

171. A normal solution of potassium permanganate or of potassium bichromate is a solution each cubic centimeter of which contains just enough of the reagent to oxidize 10 mg. of iron from the ferrous to the ferric state. With ore charges of 1 g. (1,000 mg.), then, each c. c. of a normal solution of permanganate or bichromate will oxidize 1 per cent. of iron. Standard solutions are usually of approximately this strength.

172. Permanganate Solution.—To prepare an approximately normal solution of potassium permanganate, dissolve 5.6 g. of pure crystallized permanganate in 1 liter (1,000 c. c.) of distilled water. Place the solution in a glass-stoppered bottle and shake from time to time until ready for use. The solution should be made up at least 48 hours before standardizing.

173. Bichromate Solution.—The standard bichromate solution is usually made approximately a half-normal solution—that is, 1 c. c. of the solution will oxidize about 5 mg. of iron. The end point in this method is very sharp, and there is less danger of running beyond it with a weak solution than with a strong one, in which each drop contains two or three times as much bichromate as a drop of the weak solution. Some chemists recommend using a strong solution (normal or even somewhat stronger) until nearly to the end point, and then finishing the titration with a decinormal ($\frac{1}{10}$ -normal) solution (1 c. c. of solution = 1 mg. of iron). The half-normal solution is dilute enough, however, and its use obviates the necessity of making up two solutions and of taking two separate readings of the burette for each titration and figuring up the amount of iron oxidized by each solution. The half-normal solution is prepared by dissolving 4.39 (or, roughly, 4.4) g. of pure potas-

sium bichromate in 1 liter of distilled water. Like the permanganate solution, the solution should be allowed to stand for a day or two before standardizing.

STANDARDIZING THE SOLUTIONS.

174. To standardize the solutions, a solution containing a known weight of iron is titrated with the standard solution whose strength is to be determined. The weight of iron in the solution divided by the number of cubic centimeters of the standard solution used, up to the end point, gives the weight of iron which each c. c. of the solution will oxidize. The iron used is in the form of piano wire, which contains 99.7 per cent. of pure iron. The wire should be well rubbed with fine sandpaper or emery-paper before weighing out, to remove dirt and the shellac with which it is sometimes covered to prevent rusting. The pieces for weighing are cut off and coiled around a lead-pencil to get them into convenient shape for weighing, which is very carefully done on the button balance.

Two separate iron solutions are always run for standardizing, and the average result of the two (if they check within reasonable limits) is accepted as the standard of the solution. (If they do not check properly, the work must be repeated.) The charges of wire are intentionally made to differ by from 20 to 50 mg. in weight; this makes accurate work necessary in order to get good checks, whereas, if the two charges were of very nearly the same weight, there might be a perfectly unintentional and unconscious "juggling" of results, to make them agree whether they will or not.

The methods of standardizing both solutions are as follows:

175. Permanganate Solution.—Weigh up accurately two portions of piano wire of about 200 and 250 mg., respectively. Place each in a 250-c. c. flask or beaker and add 10 c. c. of *dilute* sulphuric acid—concentrated H_2SO_4 ,

will not dissolve iron—and 10 drops of hydrochloric acid.* Heat gently until the iron is completely dissolved, adding more H_2SO_4 and another drop of HCl if necessary. The solution will take only a few minutes. As soon as the iron is all dissolved, dilute the contents of the flask up to about 200 c. c. with distilled water.

176. More or less of the iron will be oxidized to ferric sulphate during the solution, and this must be reduced to *ferrous* sulphate before titrating. To reduce the solution, add 2 or 3 g. of pure granulated zinc, and let the solution stand for a short time. The hydrogen liberated by the action of the acid on the zinc reduces the ferric sulphate to ferrous sulphate. The solution, which is at first tinged yellowish by the ferric sulphate, soon becomes perfectly colorless. Very small amounts of ferric salts do not color the solutions perceptibly; hence, to be absolutely certain that all the iron is reduced, the solution should be tested with a weak solution of potassium sulphocyanate ($KCNS$) or of the corresponding sodium or ammonium salt. A few drops of sulphocyanate solution are put into the depressions of the spot-plate, and a drop of the iron solution is taken out on the end of a stirring rod and added to the sulphocyanate on the spot-plate. Ferrous salts do not affect the color of the sulphocyanates, so that if the iron is completely reduced there will be no reaction; if there is the *least trace* of ferric salt present in the solution, however, a drop of the iron solution added to the sulphocyanate on the spot-plate causes a strong and characteristic red coloration. If, then, the test gives a red coloration, the reduction is incomplete, and must be continued until the sulphocyanate no longer gives any reaction on the addition of the iron solution.

*The HCl is added merely in order to have the conditions in the standardization as nearly as possible the same as the conditions in regular determinations, in which it is necessary to use some HCl in dissolving the ore. HCl has a tendency, if there is much of it present in the solution—and particularly if the solution is warm—to decompose the permanganate and cause a high result. By using, however, as little excess of HCl as possible in dissolving the ore, and then diluting the solution up largely, adding a considerable excess of H_2SO_4 and titrating the solution cold, the effect of the HCl can be completely counteracted.

177. As soon as the reduction is complete and the excess of zinc has entirely dissolved, the titration should be proceeded with immediately; if allowed to stand very long exposed to the air, some of the iron will reoxidize. Transfer the contents of the flasks to No. 5 beakers, rinsing out the flasks well with distilled water, and add 20 c. c. of dilute H_2SO_4 , or a correspondingly smaller quantity of concentrated H_2SO_4 , pouring in slowly and stirring constantly to prevent spurting. Concentrated acid has the disadvantage that it heats the solution considerably. (The excess of H_2SO_4 is necessary in the solution, both to promote the desired reactions and to counteract the HCl .) Next dilute the solution up to about 700 c. c. in bulk with distilled water. It is now ready for titration.

178. Fill your burette exactly to the zero-point with the standard solution. The burette should always be rinsed out with distilled water before using, and then a few c. c. of the standard solution should be run through it and thrown away before filling it with the solution. When everything is ready, pour off a little of the iron solution into a small beaker, to hold in reserve, and titrate the main portion, either in the beaker or in a titrating dish. At first several c. c. of the standard solution may be run in at a time, stirring briskly all the while. As the end point approaches, proceed more cautiously, adding a few drops at a time. As the permanganate strikes the iron solution it becomes first brown and then colorless. The action becomes slower and the brown less intense towards the end point, and as soon as the end point is passed, the permanganate no longer breaks up and decolorizes on entering the iron solution, but retains its purple color, tingeing the iron solution a faint pink. The end point may be safely passed in the first titration, as there is more than enough solution in reserve to bring it back. This reserve is now added, rinsing the beaker out thoroughly with distilled water, and the titration is finished very carefully, drop by drop. The end point is reached when a single drop of the standard solution added to the iron solution

causes a faint, permanent, pink tinge (a pink tinge lasting 1 minute may be considered as "permanent" for purposes of comparison). Every chemist has his own particular end point, but whatever tinge is adopted for the end point when standardizing, the same tinge must be used as the end point of all titrations with that solution. The paler the tinge accepted as the end point, the more nearly exact will be the result of the analysis, as the *actual* end point is not the point at which the color shows, but is one drop or a portion of a drop short of that point, when all the iron is oxidized, but there is no free permanganate in the solution.

179. The other solution is titrated in the same way, and the results of the two titrations are calculated and averaged to obtain the standard of the permanganate solution. The following examples will illustrate the method of calculation better than a long verbal explanation: Suppose the two charges of iron wire weighed 0.2054 g. and 0.2396 g., respectively, and the titrations consume 19.9 c. c. and 23.3 c. c. of permanganate solution, respectively. Then we have (see Art. 174)

$0.2054 \times 0.997 = 0.20478$ g. of pure iron in first solution,
and

$0.2396 \times 0.997 = 0.23888$ g. of pure iron in second solution.

In the titration of the first solution, therefore, 19.9 c. c. of permanganate solution oxidize 0.20478 g. of iron, or each cubic centimeter of permanganate solution oxidizes $\frac{0.20478}{19.9} = 0.01029$ g. (or 10.29 mg.).

In the titration of the second solution, 23.3 c. c. of permanganate solution oxidize 0.23888 g. of iron, or each cubic centimeter oxidizes $\frac{0.23888}{23.3} = 0.01025$ g. (or 10.25 mg.).

The average of these two results is the standard of the solution. Thus, $\frac{0.01029 + 0.01025}{2} = 0.01027$ g. = amount of iron each cubic centimeter of the standard solution will oxidize. The bottle containing the solution is then labeled with

the name or formula ($K_2Mn_2O_8$) of the solution and the standard, thus:

Potassium Permanganate.

1 c. c. = 0.01027 g. *Fe.*

180. The solution should be kept in a cool, dark place when-not in use, as it slowly decomposes and loses strength if exposed to the light. (A closet under the table or sink is very convenient for standard solutions and other chemicals which are sensitive to the light.) It should be restandardized every few weeks, as the strength changes slightly with time. If it is restandardized two or three weeks after the first standardization, the results will show how fast it is changing strength, and from this the chemist will know about how often it will be necessary to restandardize the solution.

181. Bichromate Solution.—For titration with potassium bichromate, the iron may be in solution as either ferrous sulphate or ferrous chloride. Two charges of piano wire, of between 100 and 200 mg. each, are weighed up carefully, placed in 250 c. c. flasks or beakers, and dissolved by boiling in either dilute sulphuric acid, as in the permanganate method, or dilute hydrochloric acid (5 c. c. concentrated *HCl* and 20 c. c. distilled water). The solutions are diluted up to about 200 c. c. each, the iron reduced by one of the methods mentioned below, and then the solution transferred to large beakers, diluted up to about 500 c. c. each, and titrated. The method of titration is the same whether hydrochloric or sulphuric acid is used in the solution. If the iron is in the form of sulphate, however, it must be reduced either by means of zinc, as in the permanganate method, or by introducing several grams of granulated lead into the solution and boiling until the reduction is complete; while ferric chloride in solution may be reduced by either of these methods, or much more quickly by means of a moderately strong solution of stannous chloride ($SnCl_2$, = bichloride of tin).

182. The reduction with granulated lead is accomplished as follows: The solution is first heated nearly to boiling over a Bunsen burner, and then about 5 g. of test lead are added. The solution is then boiled for some time. The yellow tinge gradually fades and the solution finally becomes perfectly clear. At this point add 5 g. more of test lead. Then test the solution from time to time with sulphocyanate, as in the reduction by zinc. As soon as the solution is completely reduced and no longer gives a ferric reaction with the sulphocyanate, it is poured off from the lead into a large beaker. The lead is washed several times and the washings are added to the main solution. The solution is then diluted and titrated.

183. The reduction by means of stannous chloride is very quick and simple. The solution is warmed and then a dilute solution of stannous chloride is added, drop by drop, stirring after each drop, until the iron solution becomes colorless. A few drops are usually sufficient. After the solution has become perfectly clear and colorless, add one more drop of stannous chloride, to make complete reduction certain (or test the solution with sulphocyanate to see that iron is all reduced). The slight excess of stannous chloride must then be oxidized by the addition of a large excess of mercuric chloride. About 20 c. c. of a saturated solution of mercuric chloride are added, *all at once*—and immediately after the final drop of stannous chloride—to the iron solution, which should be stirred rapidly to distribute the mercuric chloride quickly throughout the entire solution. The mercuric chloride instantly oxidizes the stannous chloride to stannic chloride, and is itself reduced, forming a dense, curdy, white precipitate of mercurous chloride. This precipitate does not interfere in any way with the subsequent reactions. The mercuric chloride *must*, however, be added suddenly and in great excess; if it is not in considerable excess or is added slowly—which, as the reaction between the stannous chloride and the mercuric chloride is almost instantaneous, has the same effect as adding it in small

quantity—the stannous chloride will reduce part or all of it to gray, metallic mercury, and not only is it then impossible to tell with absolute certainty whether the stannous chloride is completely oxidized, but the mercury renders the result of the titration unreliable. If the precipitate is perfectly white, the chemist is absolutely certain that the oxidation of the stannous chloride is complete, and that his results, if the rest of the work has been done carefully, are correct; but if there is even the faintest tinge of gray, there is room for doubt both as to the completeness of the oxidation and as to the accuracy of the work.

184. As soon as the reduction is complete, the solution is diluted up to about 500 c. c. with distilled water, and about 5 c. c. of strong *HCl* are added. A reserve portion is poured off and the main solution is then titrated. The bichromate solution is run in from the burette, rapidly at first, and stirring meanwhile. The solution, which was colorless at first—or white if it was reduced by stannous chloride—soon acquires a pale-green tint, which becomes darker as more bichromate is added. Should it turn brown, more *HCl* should be added. After the color becomes dark green, the bichromate should be added more carefully, and the iron solution should be tested after each addition by adding a drop of it to an indicator solution of potassium ferricyanide on the spot-plate. (The ferricyanide solution should not be too strong and should be free from *ferrocyanide*.) Ferricyanide gives a blue precipitate with solutions of ferrous salts, even in the most minute quantities, but is not affected by ferric salts; consequently, the indicator solution will turn deep blue with the first additions of the iron solution, but the blue coloration will become paler and paler as the titration proceeds and the bichromate solution oxidizes more and more of the iron, and when the last trace of the ferrous iron is oxidized to the ferric state, it will cease entirely. The point at which the blue coloration ceases, therefore, marks the end of the titration. The end point may be passed in titrating the main solution, as

in the permanganate method; then add the reserve solution, rinsing the beaker out carefully with distilled water and adding the rinsings to the main solution, and titrate very carefully, drop by drop, to the final end point. Titrate the second solution in the same way. The solutions may be titrated either warm or cold; they should both be titrated at about the same temperature, however, and the temperature adopted in the standardization of a solution should be retained in all subsequent determinations with that solution.

185. The results are calculated exactly as in the permanganate standardization: the weight of iron in the solution divided by the number of cubic centimeters of standard solution used equals the strength, or standard, of each c. c. of the standard solution. As before, the average of the two determinations is taken as the standard of the solution.

TREATMENT OF IRON ORES.

186. Most iron ores will yield all their iron contents into solution by simple boiling with acids. For oxidized ore, hydrochloric acid alone is usually sufficient. If, as occasionally happens, an ore will not yield all its iron to the action of hydrochloric acid alone, it will usually do so if treated with a mixture of nitric, hydrochloric, and sulphuric acids, as described in the treatment of sulphide ores. (Art. **194.**)

187. Occasionally, however, an ore is encountered that will not yield all its iron, even to the combined action of all three acids; such refractory ores must be treated as described in Arts. **195** and **196.**

188. Oxidized Ores.—Duplicate charges of ore, of 1 g. each—or $\frac{1}{2}$ g. if the ore runs very high in iron—are treated in small casseroles or beakers with 5 c. c. of concentrated *HCl*. (The use of small vessels in dissolving ores is always desirable, as it avoids a large excess of acid.) The casseroles or beakers should be covered with watch-glasses, concave side up, and should be heated slowly, preferably on a

sand-bath—a shallow pan of sand set over a burner—to avoid spurting and bumping. The solution usually requires about 30 minutes; when it is complete the insoluble residue—consisting usually mostly of silica—is colorless and free from black specks of undecomposed ore. Somewhat refractory ores may sometimes be gotten completely into solution by boiling down to dryness and then adding about 3 c. c. more acid and heating again; or if the iron is to be subsequently reduced by stannous chloride, a few drops of stannous chloride (2 or 3 are sufficient) added to the acid used in dissolving the ore will aid greatly in getting the ore into solution.

189. When the ore is completely decomposed, dilute with distilled water, and stir and rub the insoluble residue with a rubber-tipped glass stirring rod (a policeman), to break up any clots which may have formed. Small specks of solution that have dried on the sides of the vessels and on the watch-glasses may be dissolved by rubbing them with a stirring rod moistened with the dilute acid solution from the casserole or beaker and then washing them off into the main solution with distilled water from the wash-bottle.

190. Heat the solution nearly to boiling and filter into the flask for reducing. The heating is not absolutely necessary, but it takes very little time, as the vessel may be heated with only a screen between it and the flame, and hot solutions filter much more rapidly and cleaner than cold. The vessel and the insoluble residue are washed three or four times with distilled water and the washings run through the filter into the main solution. (In washing the insoluble residue, the solution should be decanted off very carefully on to the filter, leaving as much of the residue in the casserole or beaker as possible until the final washing, as it can be washed much more rapidly and to better advantage in the vessel than in the filter.) The filter paper itself is finally washed by the jet from the wash-bottle and the washings are allowed to run through. Always use a fresh filter paper for each solution.

191. The solution is now diluted with distilled water to about 200 c. c.; 5 c. c. of concentrated H_2SO_4 or HCl —according to the method of reduction and titration to be pursued—are added (20 c. c. of dilute H_2SO_4 may be used instead of the 5 c. c. of concentrated acid); and the solution is then reduced by zinc, lead, or stannous chloride in the same way as the solution was reduced for standardizing.

192. As soon as the iron is completely reduced, dilute each solution to about 700 c. c. if the permanganate method is to be employed for the titration, or to 500 c. c. if the bichromate method is to be used; add a further excess of 5 c. c. of acid for safety, and then proceed with the titration. The titration is conducted exactly as in the standardization, with the same precautions, the same end point, and, as nearly as possible, the same conditions.

193. The amount of iron in the solution is determined by multiplying the number of cubic centimeters of standard solution used by the standard of the solution. If 1-g. charges of ore are used, this gives the percentage of iron directly; if $\frac{1}{2}$ -g. charges are taken, the result must be multiplied by 2 to obtain the percentage of iron in the ore. The average result of the duplicate titrations—which should agree within 0.1 to 0.2 per cent.—is taken.

EXAMPLES FOR PRACTICE.

1. Duplicate 1-g. ore charges are run. The titration of one solution consumes 37.3 c. c. of the standard solution; of the other, 37.4 c. c. The standard of the solution is 0.0097 (1 c. c. = 0.0097 g. iron). How much iron does the ore contain? Ans. 0.3623, or 36.23%.

2. Ore charges $\frac{1}{2}$ g. (500 mg.) each. Standard solution used in titration, 27.6 and 27.5 c. c., respectively. Strength of standard solution, 1 c. c. = 0.0109 g. iron. How much iron does the ore contain? Ans. 0.6006, or 60.06%.

194. Sulphide Ores.—Dissolve duplicate charges of 0.5 g.—or 1 g. if the ore runs low in iron—in small casseroles or flasks, with 2 c. c. of strong HCl , 5 c. c. strong HNO_3 , and 8 c. c. dilute H_2SO_4 , added in the order named.

(The sulphuric acid should be about 60 per cent. concentrated H_2SO_4 and 40 per cent. water. In diluting H_2SO_4 , always pour the *acid into the water*—not the water into the acid—gradually, stirring the water constantly.) If the ore is dissolved in flasks, the subsequent reduction may be made in the same flasks. Heat on a sand-bath or a hot plate until dense, white fumes of sulphurous oxide, which are recognized by their color and suffocating sulphurous odor, are evolved. The purpose of the sulphuric acid is merely to make sure that the last trace of nitric acid is expelled. The nitric acid is necessary to break up the sulphides; but if the least-trace of it remained in the solution, it would ruin the titration. The boiling-point of H_2SO_4 is so much higher than that of HNO_3 and HCl that these last-named acids are completely evaporated from the solution by the time the H_2SO_4 begins to boil and break up, liberating sulphurous fumes; hence, the liberation of copious sulphurous fumes is a pretty certain indication that the nitric acid is all expelled from the solution. Continue the heating for a few minutes longer, to make sure that the last trace of HNO_3 is removed. Then cool the solution and dilute very carefully with distilled water. Do not attempt to add water to the solution while it is hot—the reaction between the water and the hot H_2SO_4 ,—which has been concentrated by evaporation—might cause a serious accident. Filter, wash the residue on the filter, add the washings to the filtrate, and proceed with the reduction and titration as in the case of oxidized ores. The stannous chloride reduction can not be used, on account of the iron being in the form of a sulphate; the reduction with zinc will be found the most satisfactory. This method is applicable to all sulphides—lead, copper, zinc, or iron—in which the percentage of iron is to be determined. Arsenic or antimony in the solution will cause a high result in the permanganate titration and should be precipitated by H_2S and filtered off before titrating.

195. Refractory Ores.—If an ore will not completely decompose in acids, filter off the insoluble residue, ignite

and burn the filter paper to a white ash in a porcelain crucible, and then add 5 g. of potassium bisulphate ($KHSO_4$) and fuse over a Bunsen burner until the fusion becomes quiet. The crucible should be large enough so that the residue and the flux will not fill it more than one-third full, as the bisulphate boils up very quickly and rapidly and is apt to overflow if more than this is used. The heat should be slow at first, to avoid boiling over, and should be increased to a dull red at the finish. The fusion will usually require about 15 minutes. The crucible is then removed from the heat and allowed to cool. When it is sufficiently cool, the fused mass is dissolved out of the crucible with boiling water, the solution and undissolved mass transferred to a beaker, the crucible rinsed into the beaker with distilled water, and the contents of the beaker boiled for a few minutes, to thoroughly disintegrate the fused mass. The solution is then run through a filter into the original filtrate from the insoluble residue, and the whole is reduced by zinc and titrated in the usual manner.

196. The same result may be obtained by fusing the insoluble residue with bicarbonate of soda in a platinum crucible. The insoluble residue is filtered out and ignited as before, but in a platinum crucible, and then 5 g. of sodium bicarbonate are added and fused over a blast-lamp (a gas-burner which is given an artificial blast by means of a blower or foot-bellows) until the fusion is quiet. The crucible is then cooled and the mass dissolved out with very dilute HCl or H_2SO_4 , boiled and filtered, and the filtrate added to that from the original insoluble residue as before. Reduce and titrate as usual.

197. Special Method for Working Iron Ores.—Owing to the fact that both of the methods given for working an iron ore require at least one filtration and that they are comparatively slow, the chemists dealing with the iron ores of the Lake Superior region have worked out a method for determining iron which is much quicker and easier than either of the old methods, while with careful work the results

obtained are fully as accurate. The method contains a number of interesting chemical reactions. The ore is dissolved in concentrated hydrochloric acid (HCl), but if free HCl were present in the solution at the time of titration it would be impossible to use the potassium permanganate solution, hence the work is carried on as follows: Take 0.5 of a gram of ore and add 5 c. c. of stannous chloride ($SnCl_2$) and 5 c. c. of concentrated HCl . Cover the beaker with a watch-glass and boil until the residue is white and flocculent. In this method the iron is reduced by means of stannous chloride, and it will be found that a small amount of stannous chloride in the solution will greatly assist in dissolving the ore; hence a portion of it is added at the time mentioned. Some chemists use more hydrochloric acid than the amount given, but as a rule 5 c. c. is enough, and an excess is to be avoided. While the solution in the beaker is still hot, add more stannous chloride from the burette until the solution is light yellow, then boil and add stannous chloride slowly, shaking and stirring the solution until it is colorless, and add about 5 drops in excess. Wash the watch-glass and sides of the beaker with distilled water and add 15 c. c. of mercuric chloride. The mercuric chloride should be added as quickly as possible and stirred into the solution rapidly, for the reason stated in Art. 183. After the solution of mercuric chloride is added and stirred in, there should be a white, silky-looking precipitate formed, but this will not interfere with the titration. Next add 50 c. c. of the manganous sulphate solution and add 300 c. c. of water. Then titrate with a standard permanganate solution, as in the cases already given. The titration should be done in a large beaker placed on or before a white plate or paper, or, better still, in a white bowl. The titration should be rapid, and as the end reaction approaches a slight darkening of the solution will be noted. The end reaction is a feeble pink, is of short duration, and hence must be ascertained without delay.

198. The preparation of the solutions and their uses may be described as follows:

The **stannous chloride solution** can be made as follows: Take 85 grams of stannous chloride ($SnCl_2$) and add 50 c. c. of concentrated HCl and 50 c. c. of water. Boil until the solution is clear and then dilute up to 1 liter. Keep metallic tin in solution to prevent the formation of oxides.

An excess of the stannous chloride solution in the iron solution is always to be avoided, and in cases where the ore is low in iron it is sometimes necessary to add less than 5 c. c. of this solution while reducing the ore, or else to use 1 gram of ore, add 5 c. c. of stannous chloride and 10 c. c. of concentrated hydrochloric acid. An ore very low in iron may require only a few drops of the $SnCl_2$ solution to perform the reduction.

199. The **mercuric chloride solution** ($HgCl_2$) is made by taking 52 grams of mercuric chloride and dissolving in 1 liter of boiling water. This makes a saturated solution.

200. The **manganous sulphate solution** ($MnSO_4$) is made up as follows: Take 16 grams of $MnSO_4$, dissolve in water, and dilute to 175 c. c. Add 33 c. c. of phosphoric acid (H_3PO_4) (Sp. Gr. 1.7) and 32 c. c. of H_2SO_4 (Sp. Gr. 1.84). The sulphuric acid should be added slowly while the solution is being stirred, to avoid undue heating.

When this solution is added to the hydrochloric acid solution of iron, the manganese sulphate is converted into manganous chloride, thus avoiding the possible decomposition of the permanganate solution by hydrochloric acid, while the phosphoric acid unites with the ferric iron produced, thereby rendering the solution white and making the end reaction plainer to see.

201. The **permanganate solution** given in Art. **172** may be employed, or one may be made up especially to work with $\frac{1}{2}$ -gram weights of ore by dissolving 2.9 grams of pure crystallized permanganate in 1 liter of distilled water. In making up the standard solution, it is well to

have two bottles or carboys in which the solution is kept, and to be using from one while the other is being gotten into shape for use. If a fairly accurate solution is desired, it should be made up and the bottle shaken every day for a week, and then kept in the dark for at least another week before using.

202. Ores Containing Organic Matter.—Certain ores contain organic matter, and if this is left unchanged in the solution to be titrated, the organic matter might be acted upon by the standard permanganate solution. Such ores may be treated as follows: Dissolve the ore in as little concentrated hydrochloric acid as possible, and when the solution is complete add a few crystals of potassium chlorate. Evaporate until the chlorine is expelled, when a very small quantity of acid will still remain. From this point the operations can proceed as before, by adding a small quantity of acid and stannous chloride to reduce the iron. If the organic matter is not destroyed, it renders the slight excess of stannous chloride difficult to adjust, because it imparts to the solution a yellow color resembling ferric chloride.

203. Standard Iron Ores.—As a rule, chemists employed in the determination of iron ores do not standardize their solutions against pure metallic iron, but employ an iron ore of known character. Such standard iron ores, the percentage of iron, phosphorus, silica, and alumina in which is given, can be obtained from chemical-supply houses, and any chemist can easily make up a standard of his own and determine its value by means of the standard received from some supply house. It is a good practice to have a bottle of standard ore at hand near the balances and to weigh out one sample of it each day and run it through with the regular samples to be tested. If the standard sample runs high or low, it shows that the permanganate solution has changed, and hence a slight change will have to be made in the results obtained from all the other samples run in that batch. The

running of the sample along with the batch of ores will not require more than from eight to ten minutes per day where large numbers of samples are being run, and hence it is not much of a tax on the men doing the work, while the fact that the standard is run with each set of samples serves as a check on all the work.

204. -Adjusting the Weight of Ore to the Solution.—In laboratories where a great number of iron determinations are made each day, the chemists rarely attempt to make the permanganate solution read directly into per cent., but adjust the weight of the ore taken so that the solution at hand will read into the per cent. desired. As an example, suppose that the laboratory is using a standard iron ore known to contain 57% iron, and that this standard is titrated with the permanganate solution made up so that it is supposed to read 1% of iron for each cubic centimeter of solution used when $\frac{1}{2}$ gram of iron is taken. Now, if this solution were employed and it were found that only 56.5 cubic centimeters of solution were required, it is evident that the solution is stronger than the half normal solution, and hence the weight of ore which must be taken in order that 1 cubic centimeter of solution would equal 1% of iron can be found by the following equation :

$$.5 : 56.5 = x : 57,$$

$$x = \frac{.5 \times 57}{56.5},$$

$$x = 0.5044.$$

So, in weighing up the samples for analysis, the assayer would first set his balances to weigh 0.5044 (the tenths of a milligram would probably be obtained by means of the rider), and after the weights had been adjusted work would proceed as usual, weighing out samples which would just balance this weight. If the standard which was run out with the ordinary work for any given day did not show the per cent. of iron it should, it would indicate that the strength of the titrating solution had changed, and hence the weight of

ore taken for the next work would have to be adjusted to the present new strength of the solution.

An experienced operator can usually make from 90 to 100 iron determinations per day by the method given above.

MANGANESE DETERMINATION.

205. Manganese may be determined volumetrically by titration with potassium permanganate, using the same solution as is used for iron. The standard of the solution for iron multiplied by 0.2946 gives the standard for manganese. Thus, if 1 c. c. of the permanganate solution will oxidize 0.01 g. of iron, it will oxidize 0.002946 g. of manganese.

206. Treatment of Manganese Ores.—Two slightly different methods in manipulation may be followed in manganese determination. In the first one described, the entire operation is carried on in the vessel in which the first solution is made. Dissolve 1 gram of the ore to be tested in from 30 to 40 c. c. of *HCl* and add a few drops of *HNO*₃ to oxidize any ferrous iron present. The solution should be effected in a beaker at least 5 inches high by 3¼ inches in diameter at the top and having no lip. When practically all the acid has been expelled, allow it to cool somewhat, add 50 c. c. of water, and boil to make sure that all the salts are in solution. Then remove from the hot plate and fill with boiling water to within 1 inch of the top of the beaker. Next, add dry zinc oxide (*ZnO*) in excess, which will precipitate the iron as ferric hydrate, leaving the solution above colorless. The solution will contain the manganese as a chloride. Zinc oxide should be added slowly until all the iron has been precipitated and the acid all neutralized. (Test with litmus paper.) The solution should be stirred thoroughly with a glass rod while the zinc oxide is being added and 1 or 2 grams in excess should be employed. The solution is then ready for titration with potassium permanganate, and it should be vigorously stirred after each addition of permanganate. The oxidation is complete when the

solution, after settling, shows a faint pink color. The heavy precipitate of iron hydrate and zinc oxide has the advantage that it carries the precipitated oxide of manganese to the bottom very quickly, thus enabling the operator to easily determine the end reaction. The titration should be done rapidly while the solution is hot. If the value of the normal permanganate solution is known in terms of iron the resulting number of c. c. should be multiplied by the factor 0.2946, which will give the percentage of manganese. This method has the advantage that the entire operation is carried on in one vessel and that the ordinary permanganate solution for iron is employed.

207. When $\frac{1}{2}$ gram of ore is used in the iron determination, a one-half normal potassium permanganate solution is usually employed, and if this same solution is used for the determination of manganese, it will be necessary to take one-half of the number of c. c. of permanganate solution used and multiply it by the factor given. If the solution is neither exactly a normal nor a half normal solution, it will be necessary to multiply by a factor which will render it normal before employing the manganese factor as given above.

208. Some operators prefer to remove the heavy precipitate of iron hydrate and the zinc oxide so that the titration can be done in a clear solution. This may be accomplished by taking $1\frac{1}{2}$ grams of the ore and treating as above stated, but removing from the hot plate and transferring to a graduate before adding the zinc oxide. After the zinc oxide has been added, the solution should be made up to 300 c. c. Then filter through a dry filter and take 200 c. c. of the filtrate, which will correspond to 1 gram of ore. The rest of the filtrate containing the zinc oxide and the precipitated hydrate of iron is thrown away. The filtrate is then brought to a boil and the titration carried on as before. The fact that the precipitate has a slightly greater specific gravity than the solution will have practically no effect upon the accuracy of the results. As this operation requires

the treating of larger amounts of ore and the use of several vessels for the determination, it is not as rapid as the one first described.

DETERMINATION OF PHOSPHORUS.

209. For the determination of phosphorus there are several methods in use. For individual determinations, the old gravimetric method is probably the most accurate, and hence will be described first.

210. Gravimetric Method.—Dissolve from 2 to 10 grams of the ore to be tested in *HCl*. When only 2 grams are employed, 20 c. c. of *HCl* will be sufficient. It is best to keep the solution on sand-bath or hot plate almost at the boiling-point until it is reduced to a syrup; then add 20 c. c. of concentrated *HNO₃*. Boil down to about 10 c. c. or until no more fumes of *HCl* are given off.

211. In case organic matter is present, it will be necessary to destroy it by carrying the evaporation with *HNO₃* to dryness and then baking the residue until no more acid fumes are given off. When the material becomes cool, dissolve in *HCl*. Evaporate down to a syrup as before, add *HNO₃*, and evaporate until no more *HCl* fumes are given off.

212. Wash down the sides of the beaker and dilute to about 30 c. c. Filter through a rapid filter to get rid of the insoluble residue, and if there is much of this it should be ignited with sodium carbonate, the fused mass dissolved in dilute *H₂SO₄*, and added to the *HNO₃* solution. The solution should contain as little free acid as possible.

Now add 35 c. c. of concentrated *NH₄OH*, which will precipitate any iron and aluminum present and render the solution alkaline. Then add about 37 c. c. of concentrated *HNO₃*. This is to dissolve the precipitate and clarify the solution, thus rendering it slightly acid. If it does not, add a trifle more of the acid. The reaction between the ammonia and the nitric acid will usually heat the solution to about 85° C. Introduce a thermometer, and if the temperature is not 85° C., either cool or heat the solution to this

temperature and take it off the sand-bath. While still hot add 75 c. c. of molybdate solution. This may be added while the material is in a large beaker or in an Erlenmeyer flask. The thermometer which was used in ascertaining the temperature of the solution should be washed off by means of molybdate solution as it is added.

213. If arsenic is known to be present, the temperature of the solution should be reduced to 25° C. before the molybdate solution is added and the material allowed to stand at least four hours with occasional agitation, when the phosphorus will be precipitated and the arsenic will remain in solution.

214. Where arsenic is not present, the molybdate solution is added while the ore solution is hot, as before stated, and the precipitation is assisted by shaking or agitating the solution. If the solution is in a flask or glass-stoppered bottle, it may be shaken mechanically, or if in a beaker or flask, it may be given a rotative motion by whirling or rotating the flask in the hand. If the laboratory is provided with compressed air, the shaking may be accomplished by carrying a current of air into the solution through a glass tube and allowing it to ascend to the surface as bubbles.

After the phosphorus has been thoroughly precipitated, it should be filtered off. Care must be exercised in the filtering and in the subsequent washing so as not to allow the yellow precipitate to crawl over the upper edges of the filter. While the precipitate is on the filter, it should be washed with a 2% nitric acid solution filling at least six times to its edges. This is to remove all iron.

The yellow precipitate can now be dissolved in ammonia, and if any of the precipitate should adhere to the flask or beaker in which the precipitating was accomplished, this may be dissolved in a portion of the ammonia employed for bringing the material on the filter into solution. The solution should now be made acid with dilute sulphuric acid and then alkaline with ammonia in excess. Cool to at least 25° C., and when cold add 50 c. c. of magnesia mixture.

Allow the flask or beaker to stand in a cool place for at least four hours, with frequent agitations, and finally filter on to a filter the weight of the ash of which is known. Wash with water, ignite, and weigh the resulting magnesium phosphosphate and ash. Subtract the known weight of the ash of the filter from the weight obtained and multiply the result by 0.27928, which will give the weight of phosphorus in the amount of the substance taken, and from this the percentage can be easily figured. It is usually best to test the solution before filtering by adding a few drops of magnesia mixture and allowing the solution to stand for a few minutes in order to see if all the phosphorus has been precipitated. If a precipitate results from the addition of more magnesia mixture, it is evident that all the phosphorus has not been thrown down, and the solution must be allowed to stand longer.

215. The Magnesia Mixture.—This may be made by dissolving 1 gram of magnesium sulphate ($MgSO_4$) and 1 gram of ammonium chloride (NH_4Cl) in 4 c. c. of ammonia (NH_4OH) and 8 c. c. of water. One c. c. of this solution will precipitate 0.024 gram of phosphoric acid (P_2O_5). The magnesium sulphate and the ammonia chloride should be in the form of salt.

216. Molybdate Solution.—This may be made up in the following proportions: Dissolve 1 gram of molybdic acid (MoO_3) in 4 c. c. of ammonia and then pour the solution into 15 c. c. of nitric acid (Sp. Gr. 1.2). One c. c. of this solution will precipitate 0.0013 gram of phosphorus.

217. In making either of the above solutions, the proportions will be increased so as to make a sufficient volume of the material required. Either one of the solutions should be allowed to stand for a day or two before it is used and then the clear solution siphoned off. In making up the molybdate solution, it will be necessary to keep the flask immersed in cold water, in order to keep the temperature down while adding the ammonia solution to the nitric acid.

218. Volumetric Determination of Phosphorus.

—From 2 to 10 grams of the ore may be employed for this determination, and the process is as follows when only 2 grams are taken: Add 20 c. c. of HCl and put on a hot plate or sand-bath, and keep almost at a boiling temperature until it is reduced to a syrup; then add 20 c. c. of concentrated HNO_3 , and boil to about 10 c. c., or until all the HCl fumes are driven off. Wash down the sides of the beaker and dilute to about 30 c. c. Filter through a rapid filter to get rid of the silica and wash with as little water as possible. If there is much of the insoluble residue, it may be necessary to fuse the same with sodium carbonate and dissolve and add to the filtrate as in the gravimetric method.

Heat or cool the solution to $85^\circ C.$ and add 75 c. c. of molybdate solution. Shake for ten minutes as in the gravimetric method, and then filter off the yellow precipitate on to a 9 c. m. No. 1 F. filter and wash with a potassium nitrate solution made by dissolving 1 gram of KNO_3 in 100 c. c. of water. Be careful not to allow the phosphomolybdate to crawl over the edges of the filter, and see that the filter is filled with the wash to its edge at least six times, so as to be sure to remove all the iron or acid. Transfer the filter with yellow precipitate to a No. 1 beaker and add 20 c. c. of sodium hydrate ($NaOH$) solution. Unfold the filter with a glass rod, dissolve the precipitate, and beat the filter paper up to a pulp. Dilute with warm water to about 50 c. c. Add 0.5 c. c. of 1% phenol-phthalein solution; then titrate with either HCl or HNO_3 solution, adding drop by drop at the end reaction. The end reaction is indicated by the solution becoming colorless, and the difference between the number of c. c. of $NaOH$ and the number of c. c. of acid used gives the phosphorus direct. In case the insoluble residue has not been fused, this method does not take into account the phosphorus contained in the silicious matter.

219. The Sodium Hydrate Solution ($NaOH$).—

Take 15.4 grams of sodium hydrate and dissolve in 100 c. c.

of water, add a saturated solution of barium hydrate, and stir in until there is no more precipitate. The barium hydrate is added to free the sodium hydrate from sodium carbonate, which is converted to barium carbonate. The solution should then be filtered and made up to 2 liters by the addition of water.

220. The Standard Acid Solution.—This may be either HNO_3 or HCl . In case the nitric acid is employed, take 200 c. c. of HNO_3 (Sp. Gr. 1.42) and dilute up to 2 liters. 200 c. c. of this stock solution can be diluted to 2 liters, and this will form an approximate standard. Run the standard acid solution against the alkali, and so ascertain their relative strength. The stronger can be reduced by the addition of water, and so the two can be brought to an equal value.

After the two solutions have been brought to an equal strength, 0.1 g. of pure ammonium phospho-molybdate may be dissolved in 20 c. c. of alkali solution. This amount of yellow precipitate contains 0.00163 g. of phosphorus, and if the sodium hydrate solution were normal, it should require 16.3 c. c. to neutralize the MoO_4 in the yellow precipitate; hence 3.7 c. c. of acid would be required to neutralize the excess of alkali and change the color of the indicator. In case more or less of the acid is required, the solution can be brought to the right strength by adding water or by adding more of the alkali until the proper strength is obtained. The acid solution can then be brought to the same strength that the alkali has, and the solution will be correct for working with 2 g. of ore; that is, 1 c. c. will be equal to 0.0002 g. of phosphorus or $\frac{1}{1000}$ per cent. phosphorus when 2 g. of ore are taken for analysis.

221. Phenol-Phthalein Indicator.—Five-tenths of a gram of phenol-phthalein are dissolved in 200 c. c. of 95% alcohol; from 3 drops to half a c. c. will be sufficient for each titration.

LIME DETERMINATION.

222. Lime, or calcium oxide (CaO), may be determined either gravimetrically or volumetrically by means of a standard solution of potassium permanganate. The latter method is much the quicker, and if proper care is taken, is fully as accurate as the gravimetric determination. It has the additional advantage that the same standard solution may be used for both iron and lime determination. The standard of the solution for lime is just *half* of the standard for iron. Thus, if 1 c. c. of the permanganate solution equals 0.010 g. of iron, it will equal 0.005 g. of lime.

TREATMENT OF LIMESTONE AND ORES.

223. Limestone and ores containing lime are treated in the same manner. 1 g. of ore is treated in a small casserole or beaker with 20 c. c. of distilled water and 5 c. c. of concentrated HCl . Boil until the soluble portion of the ore is all in solution; then dilute, and filter off the insoluble residue, washing it thoroughly with distilled water and adding the washings to the filtrate. If the ore contains any lead, it should be removed by passing sulphureted hydrogen gas (H_2S) through the solution; the lead will precipitate as lead sulphide, which should be filtered off, and the precipitate well washed. The filtrate should then be heated to boiling and the excess of H_2S oxidized by a few drops of bromine water or a little potassium chlorate. The oxidizer should be added, a little at a time, until the solution is perfectly clear.

Ammonia in slight excess is then added to the filtrate from the sulphide, or, if the ore is free from lead, to the filtrate from the insoluble matter. (The excess may be recognized by the smell or by testing with red litmus paper, which should turn blue if the ammonia is in excess.) The ammonia will precipitate iron and aluminum as hydrates. The solution is then boiled until all the excess of ammonia is expelled. This is necessary, since aluminum hydrate is slightly soluble in an excess of ammonia. To test the

solution to see if all the ammonia is expelled, moisten the tip of a glass rod with *HCl* and hold it over the solution. If there is any ammonia left in the solution, it will form white fumes with the *HCl*.

Filter off the iron and aluminum hydrates. This is a very tedious job, as the precipitate is flocculent and jelly-like; it may be shortened by filtering hot, using funnels with long stems—the longer the stem the greater the suction—and running two or three funnels at once. Wash the precipitate well with hot water and add the washings to the filtrate. If much iron and alumina are present, the precipitate should be redissolved in a little *HCl*, reprecipitated with ammonia, filtered, and the filtrate added to the first filtrate. This is advisable, as a very dense iron-aluminum precipitate is apt to carry down a little calcium hydrate with it.

To the filtrate from the hydrates add 1 c.c. of ammonia and bring the solution to a boil. If any iron or aluminum hydrate forms, it should be filtered off. If white magnesium hydrate forms, it should be redissolved by adding a slight excess of *HCl*, and then again make the solution slightly alkaline with ammonia.

The lime is then precipitated as calcium oxalate by adding a solution of ammonium oxalate or oxalic acid. (If oxalic acid is used, the least possible excess should be added, and the solution should contain a considerable excess of ammonia, so that the solution will be alkaline after adding the oxalic acid.) If the ore contains magnesium, a considerable excess of ammonium oxalate should be added, in order to get all the magnesium into the form of magnesium oxalate, which is soluble. Heat nearly to boiling for a few minutes and then filter off the calcium oxalate. Wash the precipitate with boiling water until the last trace of oxalic acid is removed. This can be tested by means of a very dilute solution of potassium permanganate, pink or pale purple in color, and made acid with H_2SO_4 ; the least trace of oxalic acid in the washings will decolorize the permanganate solution.

If the ore contains much magnesium and very accurate work is desired, the calcium oxalate precipitate should be dissolved in *HCl* and the lime reprecipitated as oxalate and again filtered; otherwise a little magnesium oxalate is apt to be retained in the precipitate and will cause a high result. The error from this source, however, is usually so small that for ordinary work it may be disregarded.

Remove the filter and its contents from the funnel and wash the precipitate off the paper into a beaker with a jet of hot water from a wash-bottle. After all the precipitate that can be removed in this way is gotten off the filter, wash the filter with dilute H_2SO_4 and add the washings to the contents of the beaker. (Sometimes it is difficult to remove the last trace of calcium oxalate from the filter by dilute H_2SO_4 ; in such a case a few drops of *HCl* may be added to the paper.) Dilute the contents of the beaker up to about 100 c.c., add 15 c.c. of sulphuric acid, heat the solution up to $70^\circ C.$ ($158^\circ F.$), and titrate with potassium permanganate. The titration is performed in the same way as the iron titration with permanganate, and the method of calculating the results is the same, except that the standard of the solution for lime is only half of the iron standard, as before mentioned. The permanganate solution is reduced by the oxalic acid liberated by the action of the H_2SO_4 on the calcium oxalate.

224. The result of the titration gives the contents of the ore in lime (*CaO*). Lime contains 71.43 per cent. of calcium and 28.57 per cent. of oxygen, so that the amount of calcium in an ore may be determined, if desired, by multiplying the percentage of lime by 0.7143.

INSOLUBLE MATTER AND SILICA.

225. Insoluble Matter.—The insoluble residue left after treating an ore with acids usually consists principally of silica, together with other substances that are insoluble in the acids used. This residue is spoken of as *insoluble matter*.

To determine the proportion of insoluble matter in an ore, treat 1 g. of the ore with acid, as in the iron and lime determinations, and as soon as all of the soluble portion of the ore is in solution, dilute with water and filter off the insoluble residue on a special filter paper, the weight of the ash from which is known. Wash the residue thoroughly on the filter with hot distilled water, then place the filter and its contents in a weighed porcelain or platinum crucible heat over the Bunsen burner until the moisture has all evaporated, and then ignite in the muffle or in the flame of a blast-lamp, and run down to ash. Cool the crucible and contents and then weigh. The gain in weight of the crucible minus the weight of the filter ash is the weight of the insoluble matter.

226. Silica.—The insoluble portion of an ore does not always consist of silica; in fact, it may contain no silica at all. There are various other substances which are insoluble in ordinary acids—for instance, lead and barium, oxides of tin, chromium, titanium, and aluminum—and these when present in the ore make up the insoluble residue.

Silica, when fused with soda, forms a soluble silicate of soda; the metallic oxides may or may not be converted into soluble compounds. The fused mass is dissolved in hot water, acidified with *HCl*, and evaporated to dryness; this is repeated, using strong *HCl*, to render the *SiO₂* insoluble and to convert the metallic oxides into soluble chlorides. The silica is filtered off, washed with hot water, dried, and weighed.

227. Lead sulphate, if fused with sodium bicarbonate, would be apt to be reduced to metallic lead. Consequently, if any lead sulphate is present in the insoluble residue, it must be removed before performing the fusion. Lead sulphate (and all other lead salts) are readily soluble in a hot solution of ammonium acetate. The solution is best made by adding strong acetic acid to strong ammonia water until the solution is just acid (indicated by the reddening of a

piece of litmus paper placed in the solution) and then adding a few drops of ammonia—just enough to neutralize the excess of acid and make the solution again slightly alkaline (turn the litmus paper blue). Heat this solution nearly to boiling, and then with it wash the residue on the filter several times. The hot ammonium acetate will dissolve out the lead sulphate. Then wash the residue on the filter several times with hot distilled water, transfer to a platinum crucible, and run down to ash as before.

After the filter paper is completely burned, add 2 or 3 g. of bicarbonate of soda (some chemists prefer to use a mixture of equal parts of sodium and potassium bicarbonates or carbonates), and fuse over the blast-lamp or in the muffle until all action has ceased and the fusion becomes perfectly liquid and quiet. The fusion will generally require from 10 to 20 minutes. The heat should be raised as high as possible during the last few minutes.

When the fusion is complete, remove the crucible and dip its bottom into cold water to chill the contents quickly. It is a good plan to place in the crucible before chilling a piece of heavy platinum wire, bent into a hook at the lower end; the fused material will solidify around this hook, and the wire can then be used as a handle with which to remove the fusion from the crucible after it has become loosened. Add boiling water from a wash-bottle to loosen the fusion so that it may be removed. Slightly bending the crucible a few times with the fingers will assist in loosening the fusion, and will not injure the crucible. A little dilute *HCl* may be used to remove the last traces of the fused mass sticking to the inside of the crucible. Wash out the crucible thoroughly, transfer the fused mass and washings to a casserole, add considerable water, and then add *HCl*—drop by drop, to avoid running over, as the carbonate effervesces violently with the acid. Continue the addition of the acid until the carbonate is all dissolved and the acid is in slight excess. Then cover the casserole with a watch-glass and evaporate the solution down to dryness. The evaporation should be completed at a temperature not much above the boiling-

point of water; otherwise the solution is apt to spit when it becomes thick, and thus lose some of the silica. After the mass is dry, raise the heat somewhat, to drive off the last trace of *HCl*. Then add more water and a few drops of *HCl* and again boil. Filter, wash the residue several times with hot water, and then dry and ignite as in the case of the insoluble matter. The residue now consists entirely of silica, the weight of which is determined exactly as in the case of the insoluble matter.

For ordinary work, in which extreme accuracy is not sought, it will not be necessary to evaporate the solution down to dryness and again take up with water. The residue from the solution of the fused mass may be filtered off directly, after boiling the solution, and then washed, ignited, and weighed as silica.

228. Determination of Silica Alone.—When silica alone is wanted, the following rapid method can be followed: Dissolve 1 gram of the ore with *HCl*; evaporate to dryness and redissolve in dilute *HCl*. Filter on to an ashless filter, wash, dry, ignite, and weigh the insoluble silicious residue. The material should be ignited in a platinum crucible, then add a few drops of hydrofluoric acid (*HF*) and a few drops of concentrated H_2SO_4 . Evaporate to dryness and the silica will pass off as silicon fluoride. (The work should be done under a hood.) Ignite the crucible and weigh. The difference between the two weights will be the weight of the silica direct as SiO_2 .

If the insoluble silicious matter contains calcium, magnesium, potassium, or sodium, the loss in weight due to driving off the silica will not be entirely apparent, on account of the fact that some of the sulphuric acid will combine with the above named elements to form sulphates, and hence the amount of sulphuric acid so combined must be determined and added to the amount already found. This may be accomplished as follows: Fuse the residue with sodium carbonate and dissolve in water acidulated with a little *HCl*. Heat to boiling and add a hot solution of barium chloride ($BaCl_2$).

Filter off, ignite and weigh the precipitated barium sulphate ($BaSO_4$). The amount of SO_3 in the barium sulphate can be calculated by multiplying the weight obtained by 0.3433. This should be added to the amount of SiO_2 already obtained. When the ore contains appreciable amounts of barium sulphate, this method is not admissible, on account of the fact that the SO_3 contained in the mineral barium sulphate would appear as SiO_2 .

COPPER DETERMINATION.

229. Copper is determined volumetrically by means of a standard solution of cyanide of potassium. It may also be determined gravimetrically by precipitating the metallic copper electrolytically (by a galvanic current) on platinum, washing and drying it, and weighing it as metallic copper (see Arts. 6 and 237-240). The operation is longer than the volumetric determination, however, and the platinum apparatus is expensive; the electrolytic method is, consequently, employed only in large laboratories and where very accurate results are desired, the volumetric method being used for most determinations of ores.

STANDARD SOLUTION.

230. The cyanide solution should be approximately half normal (1 c. c. = 5 mg. copper). A solution of about this strength may be made by dissolving from 25 to 30 g. of commercial potassium cyanide (c. p. cyanide is unnecessary) in 1 liter of distilled water. The solution should be kept in a tightly stoppered, colored-glass bottle (dark-green glass is best) in a cool, dark place; or if a dark place is not available, the bottle should be covered with black paper, as the cyanide decomposes quite rapidly under the influence of light. Some chemists also pour in a little coal oil above the cyanide solution in the bottle to further protect it from decomposition. The solution should be restandardized frequently. Great care should be exercised in handling it, as it is extremely poisonous.

In case of accidents, it is well to remember that peroxide of hydrogen (H_2O_2) is a powerful antidote for cyanide poisoning. It has been applied successfully in a $2\frac{1}{2}$ to 3 per cent. solution as hypodermic injections, which were applied every four minutes at different parts of the body. At the same time the stomach was washed out with a 2-per-cent. H_2O_2 solution. Peroxide of hydrogen (H_2O_2) forms with hydrocyanic acid (HCN) "oxamide" ($CONH_2$), which is a harmless compound, thus: $2HCN + H_2O_2 = 2CONH_2$.

231. Standardizing.—The cyanide solution is standardized by titrating solutions containing known weights of copper. Weigh up two charges of c. p. copper foil, of between 200 and 300 mg. each (the weights of the two charges should vary considerably, as in the case of the iron wire for standardizing the permanganate solution), place in an Erlenmeyer or flat-bottomed glass flask of about 250 c. c. capacity, and add 5 c. c. of concentrated HNO_3 . The copper will immediately dissolve and the flasks will be filled with dense red fumes of nitric oxide. Place the flasks on the hot plate and heat until the red fumes are completely expelled. Then remove, dilute the contents of each flask to about 100 c. c. with distilled water, and add 10 c. c. of strong ammonia water. Copper hydrate is formed and immediately dissolves in the excess of ammonia, giving a deep-blue solution. The solution is now ready for titration.

Run in the cyanide solution from a burette (the burette should be rinsed with water and finally with a little of the cyanide solution before starting the titration) until the color begins to fade. Then allow the solution to stand for about 10 minutes; then dilute with distilled water to about 200 c. c., and finish the titration very carefully, shaking the flask after each addition of cyanide. It is advisable to hold a little of the copper solution in reserve in case the end point is accidentally passed. The end point most commonly used is the point at which only the faintest tinge of pink shows at the upper edges of the solution when the flask is held against a white background in a good light. Many

chemists stop somewhat short of this, while the entire solution retains a pink tinge; and some go beyond, titrating till *all* the color has disappeared. The latter practice is attended with considerable risk of running high, however; with the former it is rather difficult to always strike the same tint, and even if there is no error made in this way, unless the amount of copper in the ore solutions is approximately the same as that in the copper solutions used for standardizing, there will still be a slight discrepancy, as the exact amount of unconverted copper hydrate necessary to impart the pink tint of the end point is not known. The nearer to colorless the titration is carried, the smaller will be the error due to unconverted copper hydrate.

The results are figured exactly as in the permanganate standardization (the weight of copper in grams divided by the number of c. c. of cyanide solution used = the standard of the solution). The average of the two determinations—if they check satisfactorily—is taken as the standard of the solution.

TREATMENT OF COPPER ORES.

232. Treat duplicate charges of ore, of 1 g. each (or $\frac{1}{2}$ g. if the ore is very rich in copper), in Erlenmeyer flasks or casseroles, with 7 c. c. of concentrated HNO_3 , and 5 c. c. of concentrated H_2SO_4 (commercial acids will answer all purposes). Boil until the nitric acid is all expelled and the sulphuric acid is boiling freely and giving off dense, white, sulphurous fumes. Any sulphur in the ore will be partially, or sometimes wholly, volatilized, part of it recon- densing in the neck of the flask. Any sulphur remaining in the bottom of the flask should by this treatment be fused into globules which are yellow when cold and are free from copper. Remove, cool, and dilute very carefully with water to about 50 c. c. Now add 5 or 6 g. of commercial sheet zinc, cut into strips weighing 2 or 3 g. each. Shake the flask, in order to break up any cake which may have formed in the bottom, and then set aside and allow to stand for about 10 minutes. By that time all the copper will have

been precipitated. Then add 50 c. c. of water and 20 c. c. concentrated H_2SO_4 , to rapidly dissolve the excess of zinc. As soon as the zinc is all dissolved, fill the flask up to the neck with water ("tap" water will answer for this purpose); allow the copper to settle out, and then pour the water off very carefully, leaving the copper behind. Repeat this twice more, to thoroughly wash out the zinc sulphate. Pour off the last water, add 5 c. c. of concentrated HNO_3 , (use c. p. acid for this), and dissolve the copper in the same way as the foil for standardizing was dissolved. From here on the operations are exactly the same as in the standardization—dilute, add ammonia, and titrate. It is usually advisable to filter the copper hydrate solution, either before titrating or when all but about 2 or 3 per cent. of the copper has been neutralized. The object of this filtration is to remove the gangue, lead, ferric hydrate, etc., which may be present, and afford a clear solution with which to complete the titration.

233. If the ore contains silver, a *drop* of HCl should be added to the HNO_3 solution before adding the ammonia; if there is very much silver, 2 drops may be necessary; any unnecessary excess should be avoided. The precipitated chloride of silver is then filtered off, the ammonia added, and the solution titrated as usual.

234. Strips of aluminum may be used instead of zinc for precipitating the copper. The precipitated copper may be dissolved from off the aluminum with nitric acid and the strips washed and used over and over again until they get too thin to handle.

235. If an ore refuses to go into solution with HNO_3 , and H_2SO_4 , a few drops of HCl added will usually suffice to decompose it. Both the HCl and the HNO_3 , must be thoroughly expelled (see Art. 194) before precipitating the copper, otherwise they will hold a little copper in solution and cause a low result.

DETERMINATION OF COPPER IN SILVER BULLION.

236. If fine bullion contains much copper and is to be assayed by the fire assay, it is necessary to know the proportion of copper present in order to make up the proof assay properly.

To determine the amount of copper, dissolve $\frac{1}{2}$ g. of bullion in dilute nitric acid (the bullion should be beaten or rolled out so that it will dissolve rapidly) and add *HCl* in very slight excess. Test for an excess of *HCl* from time to time by adding a drop of the solution to a drop of silver nitrate solution. As soon as a white cloudiness results, the *HCl* is in excess. Then filter off the precipitate of silver chloride, make the filtrate alkaline with an excess of ammonia; and titrate for the copper as usual.

ELECTROLYTIC DETERMINING OF COPPER.

237. This is also sometimes called the *battery assay*. There are several slightly different methods of conducting the electrical determination of copper, but the following is a good general method, especially where zinc and antimony are not present in large quantities: The sample should be passed through an 80-mesh sieve. When determining the contents of copper mattes, $\frac{1}{2}$ gram is sufficient, while in the case of ores the amount taken may vary from 1 to 2 grams, depending upon the richness of the ore, and in the case of slags 3 grams may be taken. After weighing the samples, they are placed in beakers and slightly moistened with cold distilled water. Then add 25 c. c. of strong nitric acid and 10 to 15 drops of strong sulphuric acid. The beakers should be covered with watch-glasses and set on a sand-bath, where they are heated until the nitrous acid fumes have all passed off and the copper is in solution. Wash the watch-glass down into the beaker and evaporate the solution until choking white fumes of sulphuric acid appear. Set the beakers to one side to cool, and then moisten the mass with dilute nitric acid (Sp. Gr. 1.20), using about 6 or 7 c. c. Also add 4 or 5 drops of sulphuric acid and 40 c. c. of water. Heat

on the sand-bath until the mass is in solution, and then filter off the insoluble residue. The residue should be examined to see that there are no copper minerals left undissolved. The filtrate is saved in the beaker ready for precipitating by means of electricity.

The electrical energy necessary to electrolyze the copper solution may be furnished by one of the various forms of batteries or from a dynamo. The gravity cell is probably the most common form of battery employed for this purpose, but a Grove cell will usually give better results, even though it requires more care in its manipulation. It is best to have a surplus of electrical energy, but too strong a current must be guarded against. Ordinarily three Grove cells, freshly made up, will furnish a current sufficient to deposit the copper from six to eight solutions, none of which contains more than .5 of a gram of copper in 1 gram of sample.

238. The copper is deposited on a platinum plate called a cathode, and another platinum surface is provided to act as the other pole for the electricity, and this is called an anode. Fig. 35 illustrates a very convenient form of cathode, which is composed of a plain platinum cylinder about $2\frac{1}{2}$ inches long and 1 inch in diameter. The rod that supports it is $4\frac{1}{2}$ inches



FIG. 35.



FIG. 36.

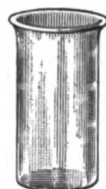

FIG. 37.

long and usually a little less than $\frac{1}{8}$ inch in diameter. Such a cathode would weigh from 16 to 18 grams. It is well to have the cathodes as large as this, on account of the fact that they afford ample surface for the precipitation of the copper without its accumulating into a spongy mass, which would cause loss while weighing. The anode may be made from platinum wire, as shown in Fig. 36. The wire is a little less than $\frac{1}{8}$ inch in diameter and the straight part is about 7 inches in length. The lower end of the wire is twisted into a spiral, which is situated below the cathode in

the solution to be treated. The diameter of the spiral coil is about 1 inch. One advantage of this form of anode is that it affords a uniform evolution of gas throughout the solution, and hence tends to precipitate copper on both the inside and outside of the cathode in an even manner.

239. The solution to be treated is placed on a deep beaker similar to that shown in Fig. 37. The cathode is connected with the positive pole of the battery and the anode with the negative or zinc pole of the battery. The cathode should not be completely immersed in the solution to be treated, and when it is supposed that all the copper has been deposited, the cathode can be immersed deeper in the solution and the current allowed to run for half an hour longer. If any copper deposits on the clean surface, it will show at once that all the metal has not been removed from the solution. After all the copper has been deposited, the anode is loosened and the beaker and anode removed, leaving the cathode with the deposit of copper hanging to the wire connected with the battery. The cathode is next washed with distilled water and then immersed in alcohol. What alcohol adheres to it is burned off so as to ignite and dry the cathode. The copper should appear of a rosy or pinkish color. After the cathode has cooled to the temperature of the room, it is weighed, and the difference in weight between the bare cathode and this second weighing is taken as the amount of copper in the sample treated.

240. Too strong a current will cause too strong an evolution of gas and the copper will deposit dark colored, while if zinc is present it may deposit on the copper. By being careful with the work and determining the conditions best suited to the products being handled, it is possible to do extremely accurate work by means of the battery assay. Copper may be completely deposited and removed from solutions containing iron, aluminum, manganese, zinc, nickel, cobalt, chromium, cadmium, lime, barium, strontium, and magnesium. The solution may subsequently be employed for the determination of other elements which it contains.

The cathode may be cleaned by simply dissolving the deposited copper in nitric acid. After all the copper is dissolved, the cathode should be carefully washed to remove any acid or copper salts before it is again employed for a determination.

LEAD DETERMINATION.

241. Lead may be determined very accurately and comparatively quickly by titration with a standard solution of potassium ferrocyanide.

STANDARD SOLUTION.

242. The ferrocyanide solution should be of such a strength that 1 c. c. will precipitate approximately 10 mg. of lead as ferrocyanide of lead. Such a solution is made by dissolving 14 g. of c. p. potassium ferrocyanide (free from ferricyanide) in 1 liter of distilled water. Keep solution in a tightly stoppered, green-glass bottle, and allow to stand at least one day before standardizing.

243. Standardizing.—The solution is standardized by titrating check solutions containing known quantities of lead. Dissolve two portions of pure lead sulphate, weighing between 200 and 300 mg. each, in hot ammonium acetate, made as described in Art. **227**. Dilute each solution to about 180 c. c. in a 250-c. c. beaker, heat nearly to boiling, and then titrate. The titration is conducted in the same manner as the bichromate titration for iron (see Art. **184**). A moderately strong solution of uranium acetate—made by dissolving the c. p. salt in water and adding a few drops of acetic acid to clarify the solution—is used as an indicator. This solution should be kept tightly stoppered, in a dark place, as it decomposes rapidly when exposed to light and air. As long as there is not an excess of ferrocyanide in the lead solution, the indicator solution on the spot-plate will not be affected by the addition of a drop of the lead solution; as soon as there is the least excess of ferrocyanide,

however, it will turn the indicator solution brown, the shade becoming darker as the excess of ferrocyanide increases. The first tinge of brown in the uranium-acetate solution marks the end of the titration.

TREATMENT OF LEAD ORES.

244. Treat duplicate 1-g. charges of ore (or $\frac{1}{2}$ -g. charges if the ore is rich in lead) in casseroles, with 15 c. c. of concentrated HNO_3 and 10 c. c. of concentrated H_2SO_4 . Boil until the nitric acid is completely expelled and the sulphuric acid is giving off dense, white, sulphurous fumes. Then remove and cool. Dilute very carefully with cold distilled water, stir thoroughly to break up clots, and then boil until all soluble sulphates are in solution. Filter, leaving as much as possible of the residue in the casserole, and then wash this residue twice with hot dilute sulphuric acid (very dilute—1 per cent. concentrated acid) and once with cold water, pouring the washings upon the filter. Wash the precipitate on the filter back into the casserole, using as little water as possible, and then add 30 c. c. of a saturated solution of ammonium carbonate. (A solution of any salt is saturated when it will dissolve no more of the salt.) Heat quickly to boiling, with only a screen between the flame and the casserole, and boil for a minute, in order to decompose any calcium sulphate that may have formed along with the lead sulphate; otherwise the calcium will react on the lead and cause a low result. Filter, and wash the precipitate thoroughly with hot water containing a little ammonium carbonate. Dissolve the washed carbonate of lead with strong c. p. acetic acid; dilute to 180 c. c. and titrate. The results are figured as usual in volumetric work. The average result of the two titrations is taken.

ZINC DETERMINATION.

245. Zinc is commonly determined volumetrically by means of a standard solution of potassium ferrocyanide, which precipitates the zinc as ferrocyanide of zinc.

STANDARD SOLUTION.

246. The ferrocyanide solution should be of such a strength that 1 c. c. will precipitate, approximately, 10 mg. of zinc from solution. Such a solution is made by dissolving 45 g. of c. p. potassium ferrocyanide in 1 liter of distilled water. The solution should be kept in a colored bottle, and should be allowed to stand at least one day before standardizing.

247. Standardizing.—Weigh out two charges of between 200 and 250 mg. each of c. p. zinc oxide which has been previously heated in a porcelain crucible, to drive off moisture and convert any carbonate of zinc into oxide. The oxide will turn yellow on heating, but will resume its white color when cold.

Transfer the two accurately weighed charges to beakers of about 300 c. c. capacity and dissolve the oxide by adding 5 c. c. of concentrated *HCl*. Dilute with about 50 c. c. of distilled water. Add ammonia in slight excess, and then neutralize with *HCl*, using litmus paper as an indicator. (The addition of ammonia and its neutralization with *HCl* are not necessary, but are done simply to have the conditions of the standardization as nearly as possible the same as the conditions of an actual analysis.) To the neutral solution add an excess of 10 c. c. of concentrated *HCl*; then dilute the solution to 250 c. c. with cold distilled water and titrate. The titration is conducted like the titration for lead, using an indicator solution of uranium acetate.

In all subsequent titrations be careful to have the conditions as nearly as possible the same as in the standardization; the bulk of the solutions should always be the same; the zinc solution should be warm (but not too hot to handle) and should contain the same excess of *HCl* in all cases, and the temperature of the standard solution should not vary much, if good results are desired. The precipitate of ferrocyanide of zinc should come down pure white, and the solution should be colorless or nearly so.

TREATMENT OF ZINC ORES.

248. Treat duplicate 1-g. charges of ore in casseroles with 15 c. c. of aqua regia (2 parts HCl and 1 part HNO_3), evaporating nearly to dryness. When the contents of the casserole are nearly dry, add 25 c. c. of a solution of potassium chlorate in nitric acid, made by shaking an excess of crystals of c. p. potassium chlorate with concentrated HNO_3 in a flask. (This solution must be handled with care and kept in an open flask, as it is a violent explosive.) Add the solution very gradually and warm the casserole gently, without covering, until violent action ceases and no more greenish fumes are given off. Then cover with a watch-glass and run down to dryness. As soon as the mass is dry, and the last drop of acid condensed on the watch-glass has evaporated, remove the casserole from the hot plate; overheating or baking the residue will cause more or less error. Cool the casserole, and then add 7 g. of c. p. ammonium chloride, 15 c. c. of strong ammonia, and 25 c. c. of hot distilled water. Boil for one minute, stirring meanwhile with a rubber-tipped glass rod, to break up any clots; rub off any splashes that may have dried on the sides, and cover. Then filter into a 250-c. c. flask and wash the residue several times with a hot solution of ammonium chloride, made by dissolving 10 g. of c. p. ammonium chloride in 1 liter of distilled water and adding a few drops of ammonia to make the solution alkaline. Any iron and aluminum in the solution will be precipitated as hydrates by the ammonia. If the precipitate is heavy, it is apt to carry down some zinc hydrate with it, and should be filtered out, washed well, transferred to a casserole (using as little water as possible), evaporated down to dryness, and then treated with the solution of potassium chlorate in nitric acid in the same manner as the ore was first treated. Run down to dryness, and again treat with ammonium chloride and ammonia, as in the case of the ore; filter off the precipitated iron and aluminum hydrates again, washing with the hot ammonium-chloride solution, and add the filtrate and washings to the first filtrate. If the first precipitate of hydrates is small,

however, the little zinc it carries down may be neglected. Filter the precipitate out, wash as before described, and proceed. If the filtrate is blue, it contains copper, which *must* be removed before titrating. Add *HCl* till the solution is neutral (indicated by the disappearance of the blue color if copper is present, or by blue litmus paper turning red if the solution contains no copper) and then add 10 c. c. excess of concentrated *HCl*. Then, if the solution contains copper, add 20 to 40 g. of test lead and boil the solution until all the copper is precipitated. Then decant the solution from the lead into a beaker, wash the lead and precipitated copper thoroughly, add the washings to the main solution, and then titrate as in the standardization.

249. If, as may sometimes happen, the ore will not decompose completely by treatment with aqua regia, evaporate the solution to dryness, dissolve out the soluble salts with water, and filter off the insoluble residue. Fuse the insoluble residue in a porcelain crucible with carbonate and nitrate of soda, dissolve the fused mass with water and nitric acid, filter off the silica, and add the filtrate to the first filtrate. Evaporate nearly to dryness and proceed as before.

SULPHUR DETERMINATION.

250. The following method will be found useful for the determination of sulphur in practically any compound: Fuse 1 gram of the substance with from one to two sticks of potassium hydrate—*KOH*—(the c. p. caustic potassium by alcohol should be used, as any other generally contains sulphur, and even this should be tested to be sure that no sulphur is present) in a silver crucible (a crucible lined with gold is to be preferred, as the alkali generally attacks the silver crucible to a slight extent) over a spirit-lamp. The best method of making the fusion is to place the *KOH* in the crucible and heat over the spirit-lamp until the fused mass is quiet. Remove the lamp from under the crucible,

brush the substance into it, and heat for from five to thirty minutes, or until the substance is thoroughly decomposed. (A spirit-lamp is used on account of the fact that gas always contains more or less sulphur, and were the gas flame employed, sulphur would be introduced into the material in the crucible.) After the material in the crucible is thoroughly fused, it should be removed from the flame and allowed to cool. As soon as cold, dissolve out the mass in a beaker with warm water, and when it is all transferred to the beaker boil and filter. Wash the filter with boiling water until the washings come through free from sulphides or sulphates. Add to the filtrate from 20 to 40 c. c. of bromine water, heat to about 90° C., and then acidify with *HCl*. If the substance contains silica, it will now be in solution and must be removed by evaporating to dryness, heating the dry material to render the silica insoluble, and then taking up the remainder of the material with water and *HCl*, after which the silica, which has been rendered insoluble, may be filtered off. Boil the filtrate from the silica and add a boiling solution of barium chloride ($BaCl_2$) until all the sulphur is precipitated as barium sulphate ($BaSO_4$). By heating the barium-chloride solution before adding it to the solution, the barium sulphate will be precipitated almost immediately, while if the solution were cold it would take some time. After the addition of barium chloride, the solution is brought to a boil and then removed to a warm place and allowed to settle. When the precipitate has settled to the bottom, filter and wash the precipitate thoroughly with boiling water; then drop a few drops of dilute *HCl* around the edge of the filter paper and wash twice more with hot water. The last washing should be tested with silver nitrate to be sure that all the *HCl* has been removed. The object of the last washing with *HCl* is to insure the removal of all the calcium salts.

The precipitate should now be dried by removing the funnel and filter paper to a ring stand or some suitable support and warming until the precipitate is dry. It may then be removed from the filter paper by placing a platinum

crucible on a sheet of glazed paper or a clean watch-glass and gently rolling the filter paper between the fingers over it in such a manner as to rub off the precipitate. After all the precipitate that it is possible to remove has been transferred to the crucible, the filter paper should be rolled up, placed on the lid of the platinum crucible, and burned by holding the platinum over the flame of a burner or spirit-lamp. The ash of the filter paper is then added to the contents of the crucible and the whole ignited in a muffle or over a blast-lamp. The crucible is then cooled, when its contents should be perfectly white. The precipitate may be weighed either by transferring from the crucible to the watch-glass of a balance or by weighing with the crucible. The weight of the barium sulphate, less the known weight of the ash of the filter paper, multiplied by 0.13734, will be the weight of the sulphur present in the amount of the substance taken.

251. When silica is not present, the evaporation of the filtrate from the solution of the fusion can be omitted, which will greatly shorten the method. When evaporating to dryness, care must be taken on account of the fact that if it is done too rapidly some of the material is liable to be lost by spurting.

PREPARATION OF REAGENTS.

252. The following table of proportions for the preparation of reagents may be found useful. The concentrated acids have not been included in the table on account of the fact that they are used as received from the supply houses.

Dilute hydrochloric acid (HCl).	} One portion of HCl to 3 portions of water by volume.
-------------------------------------	--

Dilute nitric acid (HNO_3).	} One portion of concentrated HNO_3 , to 3 portions of water by volume.
---------------------------------	---

Nitro-hydrochloric acid (aqua regia).	} One volume of concentrated nitric acid added to 3 volumes of hydrochloric acid forms aqua regia, which should be prepared only as required. It may be used either concentrated or dilute.
---------------------------------------	---

- Dilute sulphuric acid
(H_2SO_4).
- One portion of concentrated H_2SO_4 to 4 portions of water by volume.
 Note.—Always pour the concentrated acid into the water, and never water into the concentrated acid. The union of sulphuric acid and water produces heat, and if water were poured into the acid an explosion might result.
 Note.—Some chemists use 1 portion of concentrated acid to 4 portions of water for all the dilute reagents.
- Dilute acetic acid
($HC_2H_3O_2$).
- One portion of 33% acid to 1 portion of water by volume, or 1 portion of glacial to 4 of water.
- Oxalic acid ($H_2C_2O_4$).
- One gram of the crystals to 10 c. c. of water, which makes a practically saturated solution.
- Tartaric acid
($H_2C_4H_4O_6$).
- One gram of crystals to 3 c. c. of water.
- Hydric-sulphide or sulphureted hydrogen
(H_2S).
- This is formed by treating iron sulphide (FeS) with sulphuric acid. If iron sulphide can not be obtained, it may be prepared by fusing iron nails with sulphur, in the proportion of about 1 part by weight of iron to 2 parts by weight of sulphur. H_2S gas may be led into water until the water is saturated and the saturated water used as a reagent. The water should be kept in colored-glass bottles, as it is quickly decomposed when exposed to the light. When it is desired to precipitate any substance from the solution by means of H_2S , it will be better to conduct the gas itself into the solution than to employ water charged with the gas, on account of the fact that in order to add a sufficient amount of gas, it would be necessary to add a very large amount of water, thus unnecessarily increasing the bulk of the solution.

- Chlorine or chlorine water (Cl). { Chlorine may be generated by treating bleaching powder (chloride of lime, $CaOCl_2$) with sulphuric acid, and the gas may be absorbed in water, but chlorine water must be kept in a colored-glass bottle or in the dark, for in the light the chlorine will decompose water and form hydrochloric acid (HCl).
- Note.—Chlorine gas may also be prepared by mixing 50 grams of coarse salt and 40 grams of powdered black oxide of manganese, and adding to it when cold a mixture of 125 grams of concentrated sulphuric acid and 60 grams of water; shake well together and warm, gently collecting the gas as it comes over in water contained in a black-glass bottle.
- Ammonium chloride (NH_4Cl). { One gram of the crystallized salt to 8 c. c. of water.
- Ammonium carbonate ($(NH_4)_2CO_3$). { The ordinary commercial carbonate (known as sesqui-carbonate) produces in solution a mixture of the neutral and acid carbonates. This is objectionable when the neutral carbonate is to be used, and hence the reagent should be made up as follows: Dissolve the crystallized sesqui-carbonate in the proportion of 1 gram of the sesqui-carbonate to 4 c. c. of water and then add 1 c. c. of concentrated ammonium hydrate (NH_4OH).
- Ammonium oxalate ($(NH_4)_2C_2O_4$). { One gram of the crystallized salt to 20 c. c. of water.
- Plumbic or lead acetate $Pb(C_2H_3O_2)_2$. { One gram of salt to 10 c. c. of water.
- Potassium chromate (K_2CrO_4). { One gram of salt to 10 c. c. of water.
- Potassium cyanide (KCN). { One gram of salt to 4 c. c. of water.
Note.—Great care should be taken in handling potassium cyanide, as it is extremely poisonous.

Potassium hydrate (KOH).	{	One gram of salt to 10 c. c. of water.
Potassium iodide (KI).	{	One gram of the salt to 25 c. c. of water.
Potassium ferricya- nide $K_3Fe(CN)_6$.	{	One gram of the salt to 10 c. c. of water.
Potassium sulphocya- nate ($KCNS$).	{	Dissolve 1 gram of the salt to 10 c. c. of water.
Potassium ferrocya- nide $K_4Fe(CN)_6$.	{	One gram of the salt to 10 c. c. of water.
Sodium carbonate (Na_2CO_3).	{	When dry sodium carbonate is employed, 1 gram of the material to 5 c. c. of water makes a practically concentrated solution, while if the crystals are employed it would require 2.7 grams to 5 c. c. of water. This is on account of the fact that the crystals contain water of crystallization.
Sodium hydrate ($NaOH$).	{	One gram of salt to 10 c. c. of water.
Ammonium sulphide ($NH_4)_2S$.	{	Conduct hydrogen sulphide gas (H_2S) into a bottle two-thirds full of concentrated ammonia hydrate (NH_4OH) until it is saturated, which is indicated by the bubbles coming from the liquid undiminished in size. Fill the bottle with concentrated ammonia and mix it thoroughly. This stock solution should be kept in full tightly stoppered bottles, and the bottles should be colored, as light decomposes the ammonia sulphide. Before using, the stock solution should be diluted with twice its volume of water, and this diluted solution should be kept in the ordinary colored-glass reagent bottle.
Yellow ammonium sul- phide ($NH_4)_2S_7$.	{	This is made by adding a small quantity of flower of sulphur to common ammonia sulphide and shaking until the sulphur is dissolved. Enough sulphur should be added to give the solution an amber color.
Barium chloride ($BaCl_2$).	{	One gram of the crystallized salt to 10 c. c. of water.

- Barium carbonate
($BaCO_3$)
- Barium hydrate
 $Ba(OH)_2$.
- Bromine water
($Br + H_2O$).
- Calcium hydrate or
limewater $Ca(OH)_2$.
- Sodium acetate
($NaC_2H_3O_2$).
- Argenic or silver ni-
trate ($AgNO_3$).
- Stannous chloride
($SnCl_2$).
- Barium carbonate may be prepared by precipitating a pure barium chloride solution with ammonium carbonate; then wash on the filter until all the ammonia salts have been removed. The wet precipitate should be stirred into the water so as to form a thin cream or emulsion. It should be thoroughly mixed before using.
- Barium hydrate may be prepared by dissolving salt in the proportion of 1 gram of salt to 10 c. c. of water. This should be digested or heated for several hours and then the pure liquid filtered off and kept in a well-stoppered bottle.
- Bromine water may be formed by making a saturated solution of bromine in distilled water. It should be kept in a tightly stoppered colored-glass bottle and in a cool place. When opening the bromine water in warm weather, care should be taken, for there is liable to be a sudden rush of vapor upon withdrawing the stopper, and this vapor is not only disagreeable, but somewhat poisonous.
- This may be prepared by slacking fresh quicklime and adding a large quantity of water placed in a large glass bottle, and shake well several times; then allow to settle. The clear solution can be decanted off and used as a reagent. It contains 1 part of lime and several hundred parts of water.
- One gram of salt to 10 c. c. of water.
- One gram of salt to 25 c. c. of water.
- One gram of the salt to 3 c. c. of HCl and 8 c. c. of water. Metallic tin should be kept in solution and should be kept from the air to prevent the formation of oxides.

WEIGHTS AND MEASURES.

ENGLISH AND METRIC SYSTEMS.

AVOIRDUPOIS WEIGHT.

16 drams (<i>dr.</i>).....	= 1 ounce.....	<i>oz.</i> =	28.3495 g.
16 ounces.....	= 1 pound.....	<i>lb.</i> =	453.5920 g.
100 pounds.....	= 1 hundredweight... <i>cwt.</i>	=	45.359 Kg.
20 cwt., or 2,000 lb.....	= 1 ton.....	<i>T.</i> =	907.184 Kg.

TROY WEIGHT.

24 grains (<i>gr.</i>).....	= 1 pennyweight.... <i>pwt.</i>	=	1.5552 g.
20 pennyweights.....	= 1 ounce.....	<i>oz.</i> =	31.1035 g.
12 ounces.....	= 1 pound.....	<i>lb.</i> =	373.2419 g.

MEASURES OF LENGTH (*Metric*).

The **meter** is the *unit of length*, and is equal to 39.37 inches, nearly.

10 millimeters (<i>mm.</i>).....	= 1 centimeter..... <i>cm.</i>	=	0.3937 in.
10 centimeters.....	= 1 decimeter..... <i>dm.</i>	=	3.937 in.
10 decimeters.....	= 1 meter....	<i>m.</i> =	3.28 ft.
10 meters.....	= 1 dekameter..... <i>Dm.</i>	=	32.8 ft.
10 dekameters.....	= 1 hektometer..... <i>Hm.</i>	=	328.09 ft.
10 hektometers.....	= 1 kilometer..... <i>Km.</i>	=	0.62137 mi.
10 kilometers.....	= 1 myriameter..... <i>Mm.</i>	=	6.2137 mi.

MEASURES OF WEIGHT (*Metric*).

The **gram** is the *unit of weight*, and is equal to 15.432 grains, or the weight of a cube of pure distilled water at 4° C., the edge of which is *one one-hundredth* ($\frac{1}{100}$) of a meter.

10 milligrams (<i>mg.</i>).....	= 1 centigram..... <i>cg.</i>	=	0.15 gr.
10 centigrams.....	= 1 decigram..... <i>dg.</i>	=	1.54 gr.
10 decigrams.....	= 1 gram.....	<i>g.</i> =	15.432 gr.
10 grams.....	= 1 dekagram..... <i>Dg.</i>	=	154.32 gr.
10 dekagrams.....	= 1 hektogram..... <i>Hg.</i>	=	3.53 oz., avoird.
10 hektograms.....	= { 1 kilogram } <i>Kg.</i> or <i>K.</i>	=	2.20 lb., avoird.
	{ or kilo }		
10 kilograms.....	= 1 myriagram..... <i>Mg.</i>	=	22.05 lb., avoird.

CUBIC MEASURE (*Metric*).

1,000 cubic centimeters (c. c. or *cm.*³) = 1 cubic decimeter, or liter (*l.*).

1 liter of water at 4° C. weighs 2.2 lb., avoirdupois.

1,000 cubic decimeters = 1 cubic meter (*cu. m.*), or kiloliter (*Kl.*).

1 kiloliter of water at 4° C. weighs 22.04 cwt.

ASSAY-TON WEIGHTS.

<i>Multiples</i>	{	4 assay tons = 116.66666 grams.
	{	2 assay tons = 58.33333 grams.
<i>Unit</i>		The assay ton (<i>A. T.</i>) is equal to 29.16666 grams. See Art. 30.
<i>Subdivisions</i>	{	$\frac{1}{2}$ assay ton = 9.7222 grams.
	{	$\frac{1}{3}$ assay ton = 4.8611 grams.
	{	$\frac{1}{6}$ assay ton = 2.9166 grams.
	{	$\frac{1}{7}$ assay ton = 1.4583 grams.



GEOLOGY.

INTRODUCTORY.

1. The surface of the earth, as now seen, is composed of land and water, and both the land and the bed of the ocean are composed of soil and rock. Geology is the study of the rocks, not only as to their value as ores or for building stone, coal, etc., but to learn the history of the earth and to determine the agencies or means which have been instrumental in forming the various rock formations and deposits; or, as stated in other words, geology is a history of the earth as recorded in the rocks and formations as now seen. This history is plainly written in the rocks about us. It has taken men a great many years to learn to read the story, but at present the alphabet at least has been deciphered, and much of the interesting contents of this great book of nature can be understood.

2. The subject seems naturally to divide itself into **Dynamical Geology**, in which the forces acting to produce the various formations and deposits and to effect the changes which have given the earth its present form are studied; **Structural and Historical Geology**, which is a study of the general form of the earth, structure of its rocks, etc., and the history of life upon the earth; and **Economic Geology**, under which may be considered the various deposits of valuable material, the conditions under which they are most liable to occur, and the character of the formations in which they should be searched for.

3. It will be best to take up the study of Dynamical Geology first and learn something of the forces which have been acting, and are still acting, to change the form of the

world we live on. The agencies or means which are and have been acting upon the earth may be divided into *atmospheric agencies*, or the effect of the air in changing the earth; *aqueous agencies*, or the results produced by water; *igneous agencies*, or the part that fire plays or has played in the formation of the earth; *organic agencies*, or the effect of vegetable and animal life.

DYNAMICAL GEOLOGY.

ATMOSPHERIC AGENCIES.

4. Composition of the Atmosphere.—The air or atmosphere which we breathe is composed in the most part of nitrogen and oxygen gases, but it also contains watery vapor, carbonic acid gas, and occasionally other gases or vapors. The inactive gas in the air is practically all nitrogen, but a new element or gas called argon was discovered a few years ago and it was found in the atmosphere with nitrogen. The nitrogen and the argon are inactive gases, and hence produce practically no changes in the formation of the earth. The oxygen, watery vapor, and carbonic acid gas are active in producing chemical changes in the rock. They are also active in producing vegetable and animal growth, and the vegetable and animal material in turn decomposes and forms ammonia and organic gases and acids, which assist the elements in the air in the work of decomposing the rocks and changing the surface of the earth.

5. Chemical Agencies and the Formation of Soil.—The chemical action of the elements in the air grades so gradually into those caused by the water that all the chemical agencies may be considered under atmospheric agencies, and the effects of water may be confined to its ability to erode or wear away the strata and carry it to other locations.

6. All exposed rocks or stones gradually become rounded and more or less worn away, and if we make a careful

examination of the rocks, we will find that practically all of them are more or less cut up by cracks or seams, or that they contain small pores or openings which allow the air or water to circulate through them. In this way the oxygen of the air may change the chemical composition of certain ingredients of the rock, the carbonic acid or the organic acids may dissolve certain portions of the rock, ammonia or other compounds may affect them so that the rock gradually becomes rotten and disintegrates. This disintegration of the rock forms soil, which may be formed from rock in place or it may be formed from rock which has been broken up and brought to its present location by the force of water and has been subsequently disintegrated into soil by atmospheric agencies.

7. Process of Disintegration in Rocks.—The process of rock disintegration may be stated in general as follows: Almost all rocks contain soluble matter, which is dissolved by the moisture in the air, together with the aid of acids and other compounds that it contains, thus leaving the insoluble or less soluble portion as soil. Also, certain compounds are changed by the action of the oxygen in the air, aided by the moisture; as, for instance, the sulphides of the various metals are converted into oxides or carbonates of the same metals, while the sulphur set free is reduced to sulphuric acid, which combines with other elements, thus dissolving certain portions of the rock, forming soluble materials, which finally find their way to the sea; or the sulphuric acid may combine with certain elements to form insoluble sulphates. This action explains the change which has taken place in the outcrop of most mineral veins, and accounts for the absence of the sulphide ores at or near the surface of the rock.

8. Such rocks as granite, gneiss, eruptive rocks, etc., are acted upon by the atmosphere somewhat as follows: Granite and gneiss are composed mainly of quartz, feldspar, and mica. Quartz is practically unaffected by the action of the atmospheric agencies, and mica is only slightly attacked and

changes very slowly. Feldspar is itself composed of a soluble and insoluble portion. The insoluble portion is silicate of alumina, which is combined with other silicates (usually of potash or soda). These other silicates are slowly dissolved, leaving the silicate of alumina in the form of kaolin or clay. As the granite and gneiss are practically bound together by the feldspar, it follows that this reducing action will result in the formation of clay containing grains of quartz and mica, saturated with water which carries potash or soda salts. The eruptive rocks are decomposed in practically the same manner, resulting in clay soils, which are sometimes deeply colored with iron.

9. Limestone can be considered as a mass of grains of calcium carbonate cemented together by means of the same material, and when the cementing material is dissolved out this would result in the lime soil. If the original limestone contained sand or clay, the result would be a marly soil.

10. Sandstone consists practically of grains of sand cemented together by calcium carbonate or by protoxide of iron. The sandstones in which the cement material is calcium carbonate are more or less affected by the weather, and will be in time decomposed into a mass of sand containing lime-water (hard water). The protoxide of iron is very little affected by atmospheric agencies, and it is on this account that most of the red sandstones make such extremely good building material.

11. The slate rocks and shales decompose into a clay soil when their cementing material is dissolved, this cementing material being, as a rule, composed of calcium carbonate.

12. The results thus far described are those which would occur while the material was being transformed into soil in the place the rock had occupied, but most of the soils are composed of material which has been carried by water or other agencies and then broken up by the air, acids, etc., thus resulting in a soil of somewhat more varied composition

than that which would have been derived from the decomposition of any one kind of rock.

13. Boulders of Disintegration.—Where the soil is formed by disintegration of rock in place, any hard masses

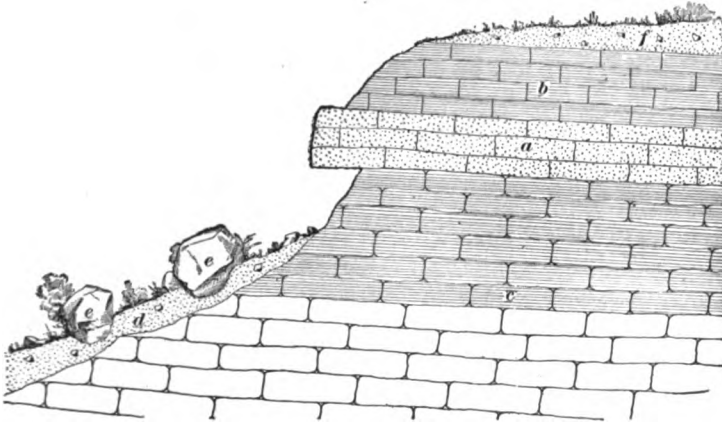

FIG. 1.

of material are slower to disintegrate, and hence may form boulders of disintegration, as shown in Fig. 1, in which case the soft rock *b* at the upper part of the hill has been gradually decomposed and washed away, exposing the harder formation *a*, and this in turn has been undermined by the

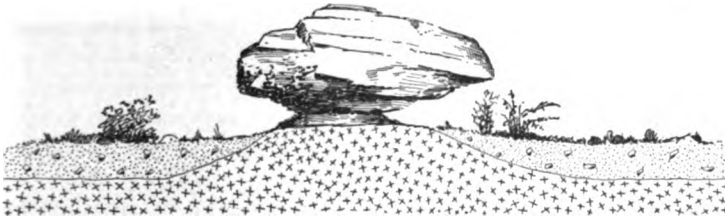

FIG. 2.

decomposition of the formation *c*. Pieces of the rock *a* have broken off and fallen down, forming boulders, as *e*, *e*. In time the corners have become rounded until the rocks assume the usual appearance of boulders. The debris

and disintegrated material from the softer portions of the hill have formed soil, as at *d*, while on the top of the hill the rock *b* has decomposed and formed soil in place, as at *f*. The face

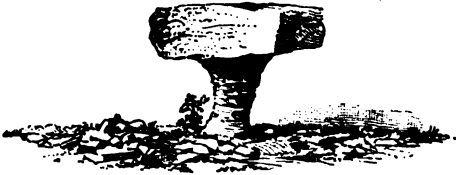

FIG. 3.

of the hill above the rock *a* being too steep for soil to remain where it is formed, this portion is naturally washed off and serves to increase the depth

of the soil in the valley. Sometimes the softer portions of the rock are protected to a certain extent by the harder overlying formations, and this results in the formation of rocking stones or pillars. Fig. 2 illustrates one of these rocking stones formed by disintegration, and Fig. 3 the manner in which pillars are sometimes formed.

14. Effect of Frost.—In cold climates, moisture finds its way into the cracks in the rock, and becoming frozen, splits up the material, often throwing down great masses of rock from cliffs, thus resulting in piles of boulders and broken material at the foot of the cliff, as illustrated at *a*, Fig. 4. This pile of broken material is spoken of as talus, or slide rock. The frost is not only active in breaking off large masses from the cliff, but it continues its action in the breaking up of small stones and in the pulverizing of the grains of rock in the soil.

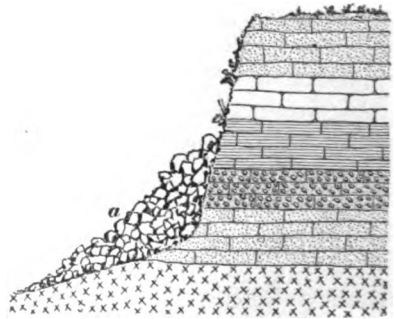

FIG. 4.

15. The Effects of Wind.—Wind often drives sand before it, and in some locations this action has done a great deal to change the face of the country, as, for instance, in Egypt, where whole districts of once fertile country, together

with the villages and temples which once covered them, were buried under the drifting sand from the desert. In a number of places in North America, as, for instance, at Cape Cod, on the shores of the Great Lakes, and on the Pacific Coast, this constant drifting of sand is going on. On the dry plains in some parts of the world, such as those in the Rocky Mountains, the wind drives the sand with such force that it cuts or wears away any rock faces against which it strikes.

16. As will be seen from the foregoing, practically all the effects produced by the atmospheric agencies are destructive or have a tendency to disintegrate the material and tear down the rocks.

AQUEOUS AGENCIES.

17. General Classification.—The effects produced by aqueous agencies may be divided into two general classes: *Mechanical* and *Chemical*.

The mechanical effects are erosion, transportation, and deposit of material, and may be effected (1) by water flowing in rivers or streams; (2) by currents and waves in bodies of water, as large lakes or the ocean; (3) by ice in the form of glaciers or icebergs.

The disintegrating chemical effects of water carrying gases in solution have been considered in connection with atmospheric agencies, on account of the fact that the gases are largely derived from the atmosphere, and hence the chemical effects to be considered in connection with aqueous agencies will be the formation of deposits either in bodies of water or by springs.

MECHANICAL EFFECTS.

18. Water Flowing in Rivers or Streams.—Under this head may be considered the effects produced by the water during its entire cycle. First, the water descends in the form

of rain, snow, fog, or dew, and reaches the sea by one of three methods: (1) As floods or by flowing at once to the sea, and this is the portion which effects the erosion. (2) By soaking into the earth and finally reappearing as springs, and this is the portion which effects the disintegration of the soil. (3) By soaking in and reaching the sea through underground passages. This last-named portion may aid in the disintegration of the rocks and assist in forming the soil, but can have no effect in the erosion, while the second portion may assist in erosion after it reaches the rivers. The proportion between the first and second portions depends largely upon the amount of vegetation upon the country over which the rain falls, and hence countries having comparatively little vegetation are much more sharply eroded than those which are well covered by forests or by vegetable growth. The first portion flows off at once, and is most effective in the work of erosion. Every little rill has a tendency to excavate a channel for itself, and these rills by uniting into streamlets excavate gullies. The streamlets in turn unite with each other and with the water from springs to form streams, or, in a mountainous country, torrents, which excavate ravines, gorges, cañons, or coulees. The streams unite to form rivers, which flow forth upon the plains and to the sea.

19. The rivers deposit some of the material eroded or excavated from the mountains on the plains over which they pass, but a great part of the eroded material is always carried to the sea to be deposited at or near the mouth of the river.

20. The erosive power of water varies as the square of the velocity of the current, hence the steeper the course of the stream and the greater the volume of the water, the more rapid will be the erosion of the country passed through.

21. Cause of Waterfalls. — The most common cause of waterfalls is plainly illustrated in Figs. 5 and 6. In Fig. 5 the stream or river illustrated has fallen over the

hard rock formation, as shown at *a*. This rock formation is, in turn, underlaid by a soft formation, as of shale or soft



FIG. 5.

sandstone, shown by *b*. The water falling over the edge of the hard rock cuts away the soft material *b*, as shown at *c*. This finally undermines the hard rock and causes it to break off and fall down. This action is assisted by the fact that all rock contains joint



FIG. 6.

planes or cracks. In this way a cañon *d* is formed, in the bottom of which the river flows. Fig. 6 is a cross-section at *A B* in Fig. 5 and shows the soft surface rock *e* through which the river flowed above the falls, and the hard rock *a* which was undercut and broken down by the river excavating away the soft material *b*, thus forming the cañon. This is practically the way in which Niagara Falls, the Falls of St. Anthony and of Minnehaha, and most of the large waterfalls of the world have been formed. There are occasional falls which have not been in action through a long period of time, and in which case the rock is very hard, that form exceptions to this general rule. Among the latter class may be mentioned some of the falls in the Yosemite Valley of California, the streams of which occupy beds which they did not themselves excavate, but which have recently been left vacant by the melting away of the glaciers.

22. Cause of Rapids.—If the upper strata over which a stream flows were softer than the underlying material, or if the material were of uniform composition and the fall were considerable, the river would erode a channel

having a quick descent, and thus form a rapids. If during the time this cutting action was going on the land were to rise, the result would be a narrow gorge or cañon, such as is common in many mountainous regions, but especially in the western portion of North America.

23. Relation Between Carrying Power and Eroding Power of Water.—The eroding power of water, as has been stated, varies as the square of the velocity of the stream, and this can be proved as follows: The eroding power, or the power of overcoming the cohesion of the material to be carried away, must vary with the forces which the water can exert upon any given area of material being eroded. If the surface of the obstacle were constant, the force of the running water would vary with the square of the velocity; for instance, if a pier were standing in running water and the velocity of the current were doubled, since the momentum or force is equal to the quantity of matter multiplied by the velocity ($M = Q \times V$), the force of the current against the obstacle (in our case the pier) would be quadrupled, for there would be double the quantity of water striking against the pier in a given time with double the velocity, hence ($M' = 2 Q \times 2 V$) or ($M' = 4 Q V$). In like manner, if the velocity of the current were tripled, there would be 3 times the quantity of water striking with 3 times the velocity,

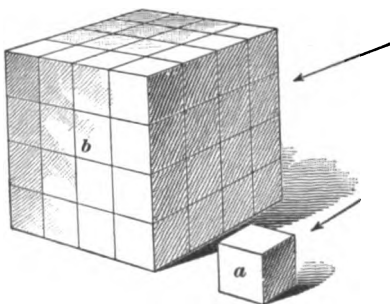

FIG. 7.

and the force would be increased 9 times, while if the velocity were quadrupled, the force would in like manner be increased 16 times. This shows that the force a current can exert against a fixed object varies with the square of the velocity. By means of mathematics it can be proved that the power of a current to carry objects varies with the sixth power of the velocity. As an example to

illustrate this fact, Fig. 7 is given. If there were a cube of rock as at *a*, Fig. 7, which a given velocity of current would just move, the statement is that double the current velocity would move a mass of rock 64 times as great, as at *b*, Fig. 7. It is evident from the figure that the increased current has an area 16 times as large to act upon, and as doubling the velocity of the current would increase the force as the square, it is evident that this new current could move the body 4 times as deep, hence the new current would have force enough to move the body *b*, Fig. 7, just 64 times as large as the body *a*. This statement can be borne out by experiment. It is found by experiment that a current moving 6 inches per second will move fine sand; a current moving 8 inches per second will move coarse sand; moving 12 inches per second will move gravel; moving 24 inches per second will move pebbles; moving 3 feet per second would move angular stones the size of a hen's egg. It will be seen from this that the carrying power increases much more rapidly than the velocity; for instance, the current moving 1 foot per second carries gravel, while the current moving 3 feet per second, only 3 times the velocity, carries stones many times as large as the grains of gravel. It was the discovery of these facts that led to the investigation which shows that the carrying power of the water varies as the sixth power of the velocity. This transporting power, or carrying power, of the water must not be confounded with its erosive power. The resistance to be overcome in one case is weight and in the other is cohesion; the latter varies as the square, and the former as the sixth power, of the velocity.

24. From the above it is evident that if a current of water carrying sediment in suspension be checked, it will be forced to deposit a portion of the sediment, and also that the coarse material will be deposited first.

25. From the experimental work, it was found that a current running at the rate of 3 feet per second, or about 2 miles per hour, would move fragments of stone the size of a hen's egg, or about 3 ounces in weight. It follows from the

preceding law that a current of 10 miles per hour will carry fragments of $1\frac{1}{2}$ tons weight and a current of 20 miles per hour will carry fragments of 100 tons weight. From these considerations, one can easily see why it is that the water rushing through the mountain gorges has such tremendous carrying power, and why it is that the mountains themselves are eroded so rapidly and the great cañons and valleys formed. One would think that streams would be able to carry practically any size stone through some of the mountain gorges, but the fact that the water passes on its course through a series of cascades and falls and that the bed of the stream is extremely rough may very much reduce the actual speed of the flow and hence the carrying power of the water. It is this carrying power of the water that is taken advantage of in hydraulic and placer mining, as will be described later in connection with those subjects.

26. Sorting Power of Water.—Another important fact in connection with the action of the water in effecting geological changes is the sorting power of the water. If a mass of stones, earth, and clay be thrown into still water, the coarse stones will fall to the bottom first, and each succeeding layer will be composed of finer material, the fine clay settling last. Now, if the operation were to be repeated and a second lot thrown into the same water, it would be sorted in the same manner, the coarse material settling first and the fine last. This would result in strata or lamina of material, and if this process were repeated a stratified deposit would be formed. In the case of running water carrying material in suspension, if the current were slightly reduced the coarse material would be dropped first, and if it were still further reduced, finer material would be deposited on top of the coarse material, the coarse material being deposited farther up stream. From this it will be seen that every change in the velocity of a current of water-carrying material in suspension will result in layers of different classes of material at the same point, and hence stratified deposits will be formed. These deposits resulting from the

settling of material from water are called sedimentary deposits, and as all moving water is constantly changing its velocity, it is evident that sedimentary deposits will always be stratified. Conversely, it may be taken as a rule that all stratified masses in which the stratification is the result of sorted material are of sedimentary origin. These facts are of great aid in studying the various rock formations, as they furnish the data by means of which the origin of any particular formation can, to a large extent, be determined.

27. Cause of Winding Course of Rivers.—Practically all rivers have a winding course, and the cause for this is perfectly plain. By referring to Fig. 8, the various causes acting to produce this winding course can be seen. If the river originally flowed from *f* to *e* in a practically straight line, as indicated by the dotted lines, and if the current were of a constant velocity and the bed smooth, the straight course might be maintained for some time, but ultimately some little resistance, such as a log or stone, would turn the stream slightly against one bank, and it would begin to cut or erode this bank, thus forming a curve in the stream, and as the curve became greater the velocity of the current at the outside would become greater and the velocity of the inside less, and hence the course would become more and more irregular by cutting material from the outside and depositing it on the inside of the curve. Finally, a loop, such as that shown at *a c b*, would be formed, and then during some freshet or high-water period the water would cut across as from *a* to *b*, the result

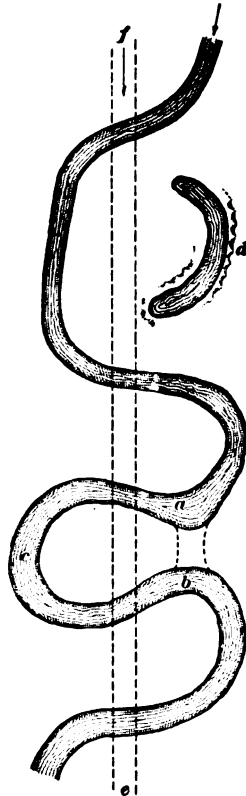

FIG. 8.

being that the portion *c* would be left as a curved lake or lagoon, similar to that shown at *d*. These curved lakes or lagoons are very common in the beds of large rivers flowing through comparatively flat plains.

28. Flood-Plain of a River.—All the lower portion of the river which is overflowed during the high water, and on which more or less material is deposited each year, is called the flood-plain of the river, and this deposit is called the flood-plain deposit. The flood-plain may be divided into two parts, the river swamp and the delta. The *river swamp* is all the portion of the river-bed from the point where it originally emptied into the sea or lake up to the point where the flood-plain deposit ceases. The *delta* is the portion of the flood-plain deposit which has been formed by the material being carried down by the river, having formed land beyond what was once the shore of the sea or lake.

29. River Swamp.—The river swamp often covers a great area of land. In the case of the Mississippi, this extends from about 50 miles above the mouth of the Ohio River to the head of the delta in Louisiana, or for 700 miles,

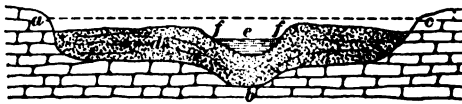

FIG. 9.

and it contains some 16,000 square miles of territory. It is bounded on both sides by high bluffs, which belong to the previous geological period. Fig. 9 illustrates an ideal section of a river swamp or flood-plain. *a b c* is the original surface of the ground, *b* being the original river-bed; *d* is a deposit composed of successive layers of material which have been deposited during the different periods of high water; *e* is the level of the river at low water, and *a c* the level at high water. The flood-plains naturally slope from each side of the river-bank back to the adjacent bluffs, thus forming slight natural levees at the points *f, f*. This is on account of the fact that the water rushing down the main stream carries a greater amount of material in suspension, and upon breaking over the bank at any point and

having its velocity reduced, it naturally makes the heaviest deposit at the points *f, f*. Owing to this action, the river at low water sometimes flows slightly above some of the adjacent country, and in times of high water the bed of the stream may change its course by breaking through these natural levees and silting up or filling up its own bed, thus leaving lagoons, as shown at *d* in Fig. 8.

30. Deltas.—When a river empties into a tideless lake or ocean, the velocity of the current being reduced by meet-

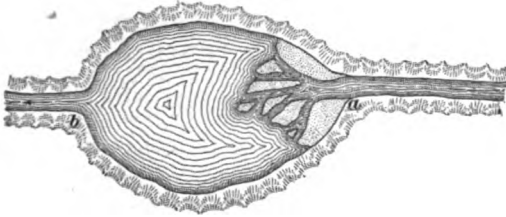

FIG. 10.

ing a great body of water outside, naturally drops its sediment and forms a deposit at the river mouth. These deposits continue until what is called the delta is formed. In Fig. 10 a stream is represented as flowing into a lake at *a*. It has gradually formed a deposit, through which it finds its way to the waters of the lake by a number of mouths. This deposit is known as the delta, and, as a rule, all the



FIG. 11.

matter brought down the river in suspension is left in the lake, the overflow from *b* being clear water. Fig. 11 is a cross-section of such a delta and shows the successive layers or strata as they would appear where comparatively coarse material was brought down by a rushing stream. In the case of large rivers emptying into a comparatively tideless sea, as, for instance, the Mississippi into the Gulf of Mexico,

the greater part of the material carried in suspension is fine, and hence the deposit would not end as abruptly as that shown in Fig. 11. The delta of the Mississippi is very irregular, but its area is estimated at over 12,000 square miles. The name delta comes from the triangular form of such deposits and is derived from the Greek letter delta. Deltas are formed only where rivers empty into tideless bodies of water.

31. Estuary.—Where rivers empty into tidal seas or oceans, there is a wide-mouthed bay, or, as it is called, an estuary, formed by the scouring or eroding action of the tide, which rushes in and out again, carrying much of the debris which the river brings and that which the tide erodes from the land out into the sea.

32. Deposits are formed at estuaries in two locations: (1) Where the force of the water rushing out with the tide

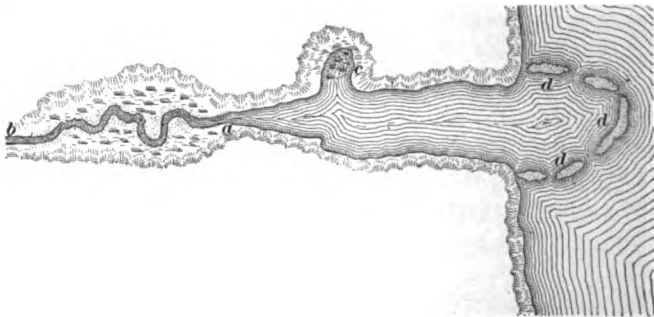

FIG. 12.

is arrested by the water of the ocean, and at this point bars of sand or other material will be deposited, as shown at *d*, Fig. 12. (2) At the head of the estuary where the tide overcomes the current of the river, thus causing still water at high tide, there will be a swamp with its flood-plain as represented in the portion from *a* to *b*, Fig. 12. If there are any other coves or indentations in the sides of the estuary which are not subject to scouring action, they may be filled with debris, as shown at *c*, and ultimately form swamps or marshes. The deposits at the head of the estuary are what

form the salt marshes so common near the sea. The bars at the mouth of the estuary form an obstruction to navigation, and if they are removed by mechanical means they will be formed once more in the same place by the same agencies. To overcome this difficulty, it is necessary to confine the flow, and thus cause the water to scour away the bar, but this will only result in its being formed farther out. Hence man can never prevent the formation of bars at the mouth of an estuary.

33. Effects Produced by Currents and Waves in Large Bodies of Water.—Waves produce no currents, but have great erosive power and may cut away the coast very rapidly and especially where there are currents which will carry away the material as fast as the waves erode it. During a heavy storm, the great waves attain such velocity that they may move rocks of many tons weight and hurl them against the cliffs or against each other, thus rapidly breaking them up into sand or gravel. The ocean currents correspond to a certain extent to the currents in the atmosphere, and are caused by differences in temperature and by the revolution of the earth. These currents take up and carry the material eroded by the waves or brought to the ocean by rivers, and in turn deposit it in banks or beds in the ocean. The ocean currents differ from rivers on account of the fact that their beds and sides are composed of water, and hence they are not disturbed by an irregular course, which tends to mix all the water in the stream and its accompanying sediment, as is the case with rivers. Ocean currents are undoubtedly frequently formed 1,000 feet deep, and while their surfaces may be practically clear, the lower portions of the current will be carrying a considerable amount of sediment. It is undoubtedly true that such currents as the Gulf Stream, sweeping out of the Gulf of Mexico, carry a great deal of sediment, and as they come in contact with large bodies of water, such as the Atlantic, their speed is reduced and much of the material deposited. This is probably the cause that has been active in the

formation of the Bahama Banks, and the banks and shoals at Florida on which the coral reefs have subsequently been formed. It is also probably true that the Banks of Newfoundland have been formed by material brought down by the Arctic currents and mainly transported by means of icebergs.

34. Effects of Ice.—The effects of ice may be divided into two parts: (1) glaciers; (2) icebergs. The effect of frost in heaving or breaking rocks by acting in the cracks has already been mentioned.

35. Glaciers.—Glaciers are formed on mountains whose summits extend into the region of perpetual snow. As this snow falls more rapidly than it melts, if it had no means of escape there is no limit to the height to which it might pile, but by alternate meltings and freezings, the snow becomes a mass of ice crystals, which gradually compact into solid ice and work down the valleys from the mountains as rivers of ice. These rivers of ice are called glaciers. For the formation of a glacier there must be a point extending to above the line of perpetual snow, and there must also be a considerable change in temperature between the seasons so as to form the ice crystals and to compact them into the glacial ice. Glaciers often extend not only a long ways below the snow-line, but even below the line of the mean annual temperature of 32° F. This is on account of the fact that the ice formed at a higher elevation crowds forwards, and it requires a long time to melt the mass.

One may wonder how ice can flow, but if he will take molasses candy at a temperature at which it is practically solid, it can be easily broken up by a sudden blow, but by a slow pressure it would assume any shape into which one desired to press it. In the same way ice under a very slow pressure will assume nearly any shape, while if struck a sudden blow it will crack or break. This, to a large extent, explains the phenomena of glacial flow, though there are many other factors which enter into the case. The surface

of the glacier is not smooth like that of a river, but is always covered with broken and jagged pieces of ice, and often there are deep fissures or crevices formed in the ice. Stone and earth fall from the sides of the valley and are carried on the surface of the ice-river, while the under surface of the ice picks up stones and by their means scours or scores the bed over which it passes, thus eroding a large amount of material, much of which becomes frozen into the ice and is carried under the mass of ice. This material is deposited at the end of the glacier in a more or less crescent-shaped mass. This mass of stone, gravel, and clay is called the "terminal moraine" of the glacier, and is really the delta of the ice-river. Any rows of boulders on top of the glacier are called "lateral moraines," and under some circumstances, when the glacier melts, this becomes deposited as rows of boulders. Often the glacier scours out basins where the rock in its way is softer than the adjoining material, and after the ice has melted away these become small lakes. This is a very common occurrence, especially in mountain regions, and these small glacial lakes frequently become filled with debris washed into them, and thus form meadows or marshes. Glaciers can carry very large masses of rock with them, and their enormous eroding power enables them to cut through almost any obstacle. On this account, they have been very active in effecting geological changes, especially in the Northern Hemisphere, as, for instance, in North America, Europe, and Asia.

36. Icebergs.—When glaciers run into the sea, great masses of ice break off and float away, carrying their burden of stone and gravel. Icebergs are often of enormous size, and may carry many tons of material. Bergs have actually been found grounded in nearly 2,000 feet of water, and at other times they form great ice-floes, which work along through the shallow water, scouring and scratching the bottom and depositing their burden as they gradually melted. Much of the material on the banks of Newfoundland was undoubtedly brought in this manner,

and they have also had a great effect in the forming of certain parts of the continent of North America.

37. Glaciers and streams cut and erode the rock formations and carry the material to the sea. The sea also cuts or erodes the coast in many places by means of waves. The currents in the sea carry the material eroded by the rivers and by the waves and deposit it in beds or stratified deposits. Stratified deposits are also formed to some extent in rivers and lakes.

38. Origin of Springs and Wells.—As has already been stated, water which falls upon the surface of the earth either flows off or soaks into the ground, and that which soaks into the rocks and aids in their decomposition by dissolving the softer portions may reappear as springs or may find its way to the ocean by underground passages. Fig. 13

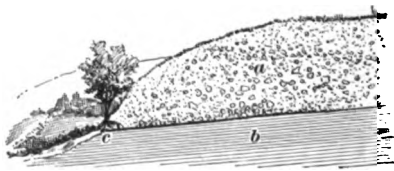

FIG. 13.

illustrates a simple method in which a spring may be formed. The water falling on top of the hill *a* settles through the porous formation until it reaches the impervious bed *b*, which may be composed of clay, shale, or an impervious rock. The water flows along this surface and appears as a spring at *c*, where the impervious strata outcrop.

39. Eroding Action of Springs.—Springs may, under certain circumstances, perform quite a large amount of work in the changing of the surface of any given region; as, for instance, if water falls upon an elevated table-land, as illustrated in Fig. 14, and settles through the soil *c* and the layer of sandstone *a* until it reaches an impervious shale strata *b*, the water will be forced to follow these strata and appear as a spring at *d*. During this course the water will dissolve more or less of the cementing material of the shale, and especially at the point where the water emerges from over the underhanging sandstone. This action finally undermines the sandstone, and great masses break off and fall down, form-

ing huge boulders, as at *e, e*. Such a set of conditions results in a perpendicular face across the side of the mountain or along the sides of a valley. After the boulders are detached and rolled down the hill, they are gradually broken up by frost and other agencies and become a portion of the

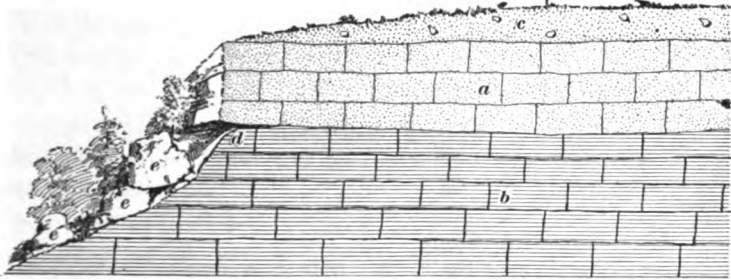

FIG. 14.

soil, or are finally reduced into sand, washed into the rivers, and carried to the ocean.

40. Artesian Wells.—When water falls upon any surface of ground, as at *a*, Fig. 15, and settles into a porous

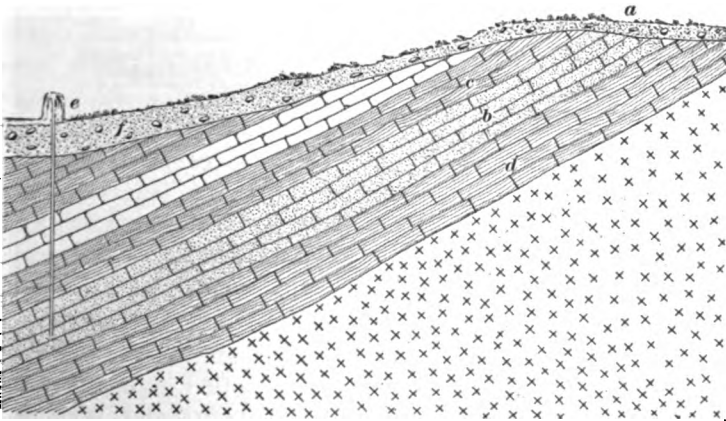

FIG. 15.

stratum, as the sandstone *b*, if this sandstone be overlaid by an impervious layer *c*, the water will collect in the sandstone under pressure, and if a well be drilled at some lower point,

as at *c*, the water will rise from the strata *b* and form an artesian well. In this illustration *d* is an impervious underlying strata; *b* the water-bearing strata, and *c* the impervious stratum which keeps the water down. *f* is the soil and *a* the portion of the outcrop where the water finds its way into the stone to supply the artesian well.

CHEMICAL EFFECTS.

41. Caves.—Under the heading of “Atmospheric Agencies,” it was shown that water carrying carbonic acid gas or other gases would dissolve certain rocks, and this dissolving action may result in forming large caves or underground passages, as illustrated in Fig. 16. If at some sub-

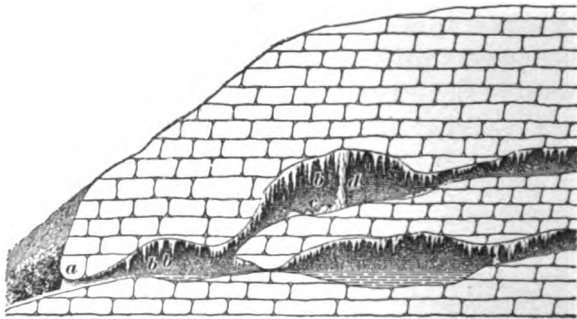

FIG. 16.

sequent time the caves become emptied of the original flow of water, but a certain amount of hard water (water containing lime) is still dripping into them, the water will gradually evaporate and deposit the lime it is carrying. This will result in stalactites, as at *b, b*, which are masses of stone hanging down like icicles on the roof. At the point where the water drips onto the floor an inverted mass will be built up to meet the stalactite; this mass (*c*) is called stalagmite; and if ultimately a stalactite and stalagmite unite, they will form a pillar, as at *d*. Such caverns as this are very common in limestone regions, and the stalactites

and stalagmites frequently form very beautiful effects. In the cave illustrated, a stream flows out through the mouth of the cave at *a*.

42. Deposits from Springs.—If the deposits of limestone or calcareous matter were formed only by the evaporation of the water, their growth would be very slow, but at many springs very large deposits are built up, and hence we must look for some other explanation of the fact. Calcium carbonate is practically insoluble in pure water, but if the water contains carbonic acid gas (CO_2) it becomes soluble, and the amount that can be dissolved in a given amount of water increases with the percentage of the carbonic acid gas in the water, but this in turn increases with the pressure. Some carbonic acid gas comes

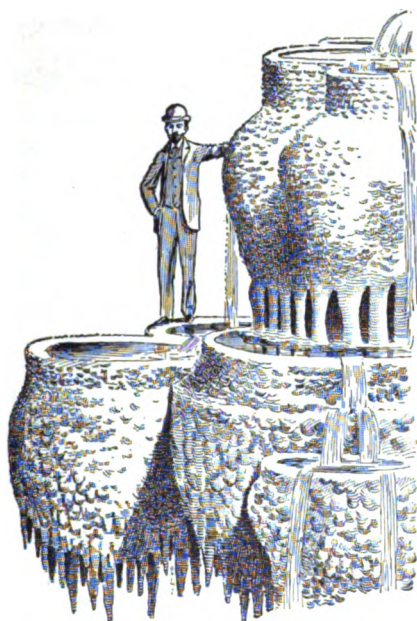

FIG. 17.

from the atmosphere, but much of it may be derived from underground sources, and this is especially true in volcanic regions or in regions where sulphides are decomposed, forming acids which can attack carbonaceous matter and liberate the carbonic acid. This gas is absorbed by the water under pressure, and as a consequence it can dissolve greater amounts of calcium carbonate. When the waters escape at a spring or other opening, the pressure is relieved, and much of the carbonic acid gas escapes, hence the calcium carbonate is deposited. This explains the rapid growth of

stalagmites in some caves and the large deposits of calcareous matter at some springs, and especially at hot springs in regions which have been affected by volcanic action, as, for instance, Yellowstone Park in Wyoming. Fig. 17 is a view of some of the deposits at the hot springs of the Yellowstone National Park. It has already been stated that carbonate of lime is sometimes deposited at springs. Under certain conditions, water charged with carbonic acid gas may dissolve iron, and as the water comes to the surface this will be redeposited as an oxide, the carbonic acid gas escaping. In volcanic regions hot alkaline springs often carry silicious matter in solution, and as the water cools this is deposited in a soft gelatinous condition, but ultimately hardens into a hard silicious rock. Springs which contain hydrogen sulphide gas (H_2S) are usually called sulphur springs, and under certain conditions they may deposit sulphur, or where the gas is also associated with lime salts they may deposit gypsum.

43. Chemical Deposits in Lakes.—Salt lakes may be formed in two ways: Either portions of the sea may be cut off, or rivers may empty into a basin which has no outlet, the waters evaporating, and the small amount of salt contained in them gradually accumulating until the lake becomes salt or brackish. In case the water in the salt lake had the composition of sea-water, materials would be deposited in practically the following order: First gypsum, then salt, and lastly chloride of magnesium. Lakes which are fed by rivers and the waters of which are gradually evaporated sometimes deposit other substances, as carbonate of lime, sulphide of lime, carbonate of soda, and, under certain conditions, iron may be deposited, but this usually requires the presence of organic matter.

44. Chemical Deposits in the Sea.—Comparatively little is known in regard to the chemical deposits formed in the sea. Many of the rivers flowing into the sea carry a much larger percentage of carbonate of lime than is found in sea-water, but much of this undoubtedly is taken up by

the shells and coral, though in some locations the material of deltas is cemented together by carbonate of lime, and in other places, especially in the tropics, where evaporation is rapid, the sand or gravel of sea beaches are becoming cemented into conglomerates by means of the carbonate of lime from the sea-water which is thrown upon them by the waves.

IGNEOUS AGENCIES.

45. Effects.—All the aqueous agencies and the atmospheric agencies have a tendency to tear down or destroy the earth and to bring the surface of the land to the level of the surrounding ocean, or to such a point that the ocean would cover the entire earth. This is prevented by the igneous agencies, which tend to lift the land and to depress the sea bottoms, thus increasing the differences in elevation on the earth, and hence increasing the land area. All the different forms of the igneous agencies are connected with the internal heat of the earth, hence this must be considered first.

46. Increase of Temperature With Depth.—The mean surface temperature of the earth varies from 80° F. at the equator to 0° at the poles, but the rate of decrease in passing from the equator to the poles is not the same in all longitudes. The lines of equal heat, or the isotherms, form quite irregular lines. Below the surface of the earth a point is soon reached where the daily differences in temperature cease to affect the rocks, and a little deeper another point where the annual difference in temperature fails to affect the earth. At the equator this latter point is only a few feet from the surface, while near the poles it may be over 100 feet from the surface. The depth depends largely upon the amount of annual variation in temperatures. The temperature of the earth increases as we descend, and a great many experiments have been attempted to determine the rate of this increase. At first it was supposed to be 1 degree for every 53 feet, but other observations have varied from this,

and it is probable that with the exception of a few volcanic regions, the temperature increases at a very much slower rate, and in some locations it is known to be considerably less than 1 degree for every 125 feet. Owing to the fact that different rocks have different degrees of ability for conducting heat, the lines of equal temperature will be at different depths in different portions of the earth.

47. Condition of the Interior of the Earth.—The condition of the interior of the earth is a point upon which there has been much speculation. At first geologists supposed that the earth had simply a thin shell of solid material and that the interior was a mass of melted rock or lava, which burst through the surface of the earth in places, forming volcanoes, but astronomy has shown that the earth behaves as a solid sphere, and that the density of the earth is very much greater than that of the rocks at the surface. If the temperature increased equally from the surface downwards, a point would soon be reached where all the rocks would be fused if they were under the pressures existing at the surface, but the increased pressure increases the fusing point, and it is probable that the greater part of the earth is in a solid state. Another fact that enters into this case is that the increased pressure upon the rocks would increase their density and hence their ability to conduct heat. Owing to the fact that there have been such great outflows of lava from the earth at different times, many scientists still believe that the interior of the earth contains great chambers or reservoirs of molten or liquid material, and it is from these that the volcanoes are fed.

48. Volcanoes.—All bodies shrink as they become cooler, and the surface of the earth is no exception to this rule. The shrinking which has gone on in this case has caused the surface of the earth to fold or rise in places. These folds or ridges have resulted in continents or mountain ranges, and during this action great fissures or faults have become opened, which in some cases have penetrated to such depths that molten matter flowed forth, causing

volcanic overflows, which in many cases have covered great areas with lava. The volcanic overflows have usually left comparatively small openings, which in time were surrounded by erupted material so as to form volcanic mountains. The openings which are now active are called volcanoes, and they seem to act as vents for the portions of the earth in which they exist. The eruptions which occur from volcanoes and the action which caused different portions of the land to rise or fall are usually accompanied by severe earthquake shocks. The eruptions from existing volcanoes are of two kinds. In one class of volcanoes the material is a thoroughly melted or fluid lava, which gradually rises until it fills and

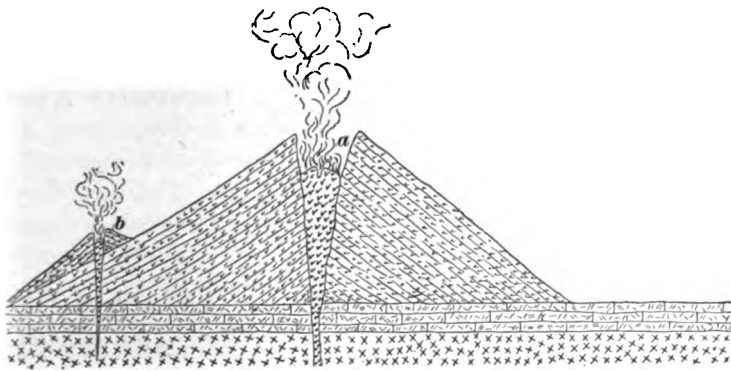

FIG. 18.

the crater overflows, the bottom of the crater being melted as the material rises. The other class of volcanoes does not give out such fluid lava, and the eruption usually commences by the blowing out of the bed or bottom of the crater with a terrific explosion. These explosions are accompanied by great rushes of steam under high pressure, and the steam in the lava blows it into fine dust, which settles over the country as volcanic ashes, or if, as is often the case, accompanied by heavy rains, it forms volcanic mud, and this material may subsequently flow down the side of the mountain. The volcanoes in the Hawaiian Islands are of the first class, and give forth very fluid lava, which, when it first comes from

the mountain, flows with great rapidity. Most of the volcanoes in the Mediterranean and Indian Oceans are of the explosive class. In Fig. 18 is an ideal section of a volcanic cone or mountain. *a* is the original crater through which the material has flowed out and been deposited in successive layers so as to form the mountain. Now, when the mountain has attained some considerable height, the great pressure necessary to raise the lava to the top of the crater often cracks or rends the side of the mountain, thus giving rise to secondary craters or secondary cones on the sides of the original mountain, as at *b*. These secondary cones are called *monticules*.

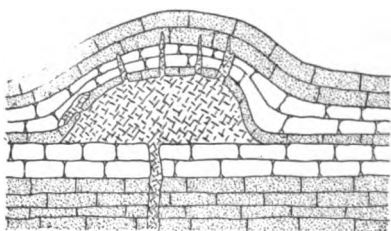

FIG. 19.

49. **Laccolites and Dikes.**— Sometimes an eruption of lava (especially when it is of a semi-fluid character) does not have sufficient force to break through and overflow the original strata, but may simply form a great mass between the layers of rock, thus forcing the strata up into a great mound or mountain, as shown in Fig. 19. Such a formation is called a laccolite. When the action simply causes a crack which is filled with volcanic material, the sheet of material thus formed is called a dike, as shown in Fig. 20. Sometimes where these dikes are composed of harder material than the surrounding rock, they stand out as bold walls, as shown in Fig. 21

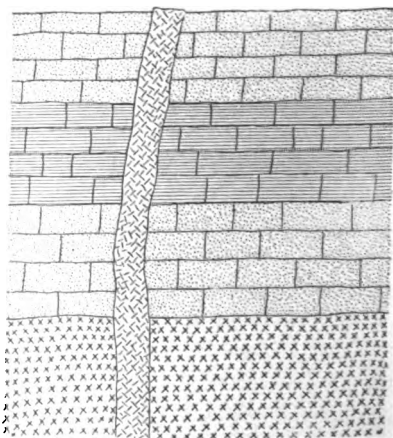

FIG. 20.

50. Changes of Elevation.—The various movements of the earth's surface are not always accompanied by sudden eruptions or earthquake shocks, but may be simply slow changes in elevation. Many parts of the earth's surface are known to be slowly rising or settling. Part of the New Jersey coast is settling at a very slow rate, while Northern Norway and Sweden are rising at the rate of several feet a century. The deltas of the Mississippi and of several other large rivers seem to be slowly settling, though not as fast as the river deposits build them up. The entire lower end of South America is gradually rising,

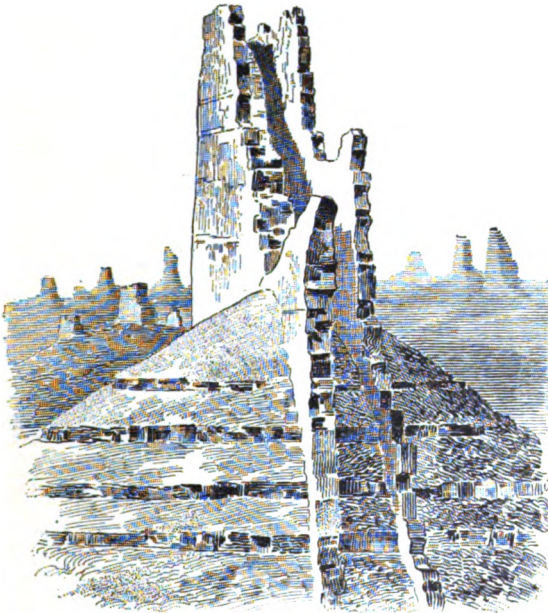

FIG. 21.

but this motion has occurred in a rather irregular and jerky manner, the principal changes being noticed at the time of heavy earthquakes. These changes are usually ascribed to the same general sources that produce volcanoes and similar phenomena.

51. Subordinate Phenomena of Igneous Origin.

—Some of the subordinate phenomena connected with volcanic action are hot springs, which may be charged with carbonates or carbonic acid gas, and which occur quite abundantly in various parts of the earth. Solfataras, which are springs carrying sulphurous acid or sulphureted hydrogen derived from their passage through the still hot volcanic rocks; fumaroles, which are hot springs accompanied with more or less steam and vapor; mud volcanoes, which are hot springs carrying mud with them; geysers, which are intermittent hot springs in which the water is thrown forth in a solid column—all these phenomena are found in regions which still contain active volcanoes or in which the volcanic action has not been long absent. The most noted hot springs and geysers are in Iceland, in the Yellowstone National Park in the United States, and in New Zealand. All these hot springs are more or less active in the production of mineral veins and mineral deposits, as will be seen later

ORGANIC AGENCIES.

52. Peat Bogs and the Formation of Coal.—In certain locations, especially in swamps, vegetable matter accumulates in thick beds called peat bogs or peat swamps. The water prevents the decay of the vegetable material, and it gradually accumulates until it attains a great depth. This material may be gradually compacted, and if it is subsequently covered with other strata, may ultimately become lignite or coal. These peat bogs are very common in some localities and furnish a large proportion of the fuel to the inhabitants of some countries, as, for instance, Ireland, France, Scotland, etc. Some deposits may also be formed where there is an accumulation of drift logs and timber at or near the mouths of large rivers, which ultimately become covered with soil and pressed into a solid mass of carbonaceous matter.

53. Effect of Carbonaceous Matter on Iron and Other Metals.—Bog iron ore is often found at the bottom

of the peat bog in the shape of a hard pan of from 1 to 2 feet in thickness, and the manner in which it is deposited is of considerable interest. Practically all the red coloring matter in the rocks is peroxide of iron (Fe_2O_3), and in this condition the iron is insoluble in water. The decomposition of organic matter is an oxidizing process, and if this occurs in contact with peroxide of iron the organic matter reduces the peroxide (Fe_2O_3) (ferric-oxide) to protoxide (FeO) (ferrous-oxide). The decomposition of vegetable matter always forms organic acids, mainly carbonic acid, which unite to form a carbonate of iron ($FeCO_3$), which is soluble in the presence of an excess of carbonic acid. This action decolorizes the soil or rocks in which it takes place. As soon as the water containing the solution is exposed to a lower pressure, a portion of the carbonic acid gas escapes, and the iron is deposited either as a protoxide, or, in the presence of an excess of carbonaceous matter, as a ferrous carbonate. Clay containing both iron and organic matter is not red, but blue or slate color, but it will make red brick, on account of the fact that during the burning of the brick the carbonaceous matter is driven out and the iron reduced to a protoxide state.

54. Organic material may assist in other chemical reductions and in the depositing of metals, as, for instance, silver, which sometimes replaces carbonaceous fossils, such as leaves, stems, etc.

55. Limestones.—Limestones are derived for the most part from shells or from coral. The shells may be of fresh-water or salt-water origin, but are usually of the latter. The coral is produced by what is called the coral polyp, which builds the coral reefs and coral islands by gradually forming the coral which is broken up by the waves and piled into coral islands. The amount of material in the stratified rocks which has been produced from shells and coral is simply amazing, and in many cases amounts to thousands of feet of strata.

STRUCTURAL GEOLOGY.

56. Crust of the Earth.—Structural Geology treats of the general form of the earth, structure of the rocks, etc. The portion of the earth on which we live and which comes under the observation of man is commonly called the crust of the earth. This does not necessarily signify that it is simply a thin layer of solid rock underlaid by a molten or liquid interior, but the term is undoubtedly a good one, on account of the fact that the surface of the earth is practically all oxidized material, and it is not unlikely that the central part of the earth consists largely of metals in an unoxidized form.

57. Exposures Available for Observation.—The means for observing the various geological formations can be divided into three general classes: Artificial Exposures,

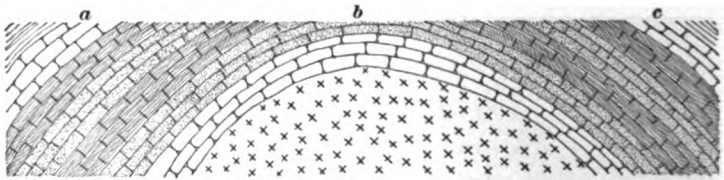

FIG. 22.

Natural Exposures, and Foldings. Under artificial exposures can be classified mines, artesian wells, and all excavations made by man. These very rarely exceed 3,000 feet in depth, and are only available over a comparatively limited portion of the earth. The natural exposures consist of cliffs, ravines, cañons, etc., and in some cases furnish exposures of from 5,000 to 6,000 feet in depth. Foldings give, by all means, the best opportunity for studying the various geological formations. They consist in the bending or contorting of the strata of which the earth is composed, and then the subsequent erosion or removal of the elevated portions in such a manner as to expose a great thickness of strata. Fig. 22 illustrates such an exposure. In passing from the point *a* to *b*, the observer would pass over the out-

crop of several deposits or beds which had been exposed by folding and subsequent erosion, and then, in passing from *b* to *c*, he would pass over the same beds in the opposite order. This means has given the geologist an opportunity of studying the formation and determining something of the nature of the rocks to a great depth.

Some knowledge of the underlying material can also be obtained from the masses of rock occasionally thrown up in connection with volcanic eruptions.

58. Origin of First Continents.—The general outline of the surface of the earth, as to continents, ocean beds, etc., was undoubtedly originally the result of irregular cooling and bending of the various portions, so that after the earth became sufficiently cool for the water to condense on its surface, the oceans were gathered together in certain places, thus leaving the land exposed. This explains the existence of continents. The mountains are undoubtedly the result of subsequent foldings or of subsequent eruptions, or both.

59. Meaning of the Term Rock.—The term "rock," as used in geology, applies to any combination of mineral material deposited in place by natural agents, and it may be hard or soft, for the same bed may be in some portions composed of hard sandstone and in others of sand so soft that it can be easily shoveled from its original bed. This same fact is true of limestone, which may vary in the same bed from marble to soft chalk. Rocks may be divided into two general classes: (1) stratified; (2) unstratified. The stratified rocks are of sedimentary origin and are more or less earthy in their nature. The unstratified rocks are composed of material which has been to a greater or less extent fused, and the masses of which are often crystalline. In general, unstratified rocks are largely of igneous origin.

STRATIFIED ROCKS.

60. General Divisions as to Structure.—In speaking of stratified rocks, three general terms are employed: Large sheets or masses are called strata. These

are in turn divided into beds or layers, and the beds are usually divided into thinner leaves or laminæ. The laminæ are composed of material which has been deposited at the same time, and usually consists of thin sheets. The layers or beds consist of successive laminæ which have been deposited under similar conditions and the general character of which is practically the same throughout. The large sheets or masses called strata may consist of beds varying slightly, but in any one strata they will all have a somewhat similar composition; as, for instance, in the case of a strata of shale which may be composed of beds of slightly different colors or composition, which in turn are composed of thin laminæ, each one of which was deposited under similar conditions, but probably at slightly different times, and the entire mass or strata will represent a set of conditions which do not differ greatly. The next strata might be composed of sandstone, which would in turn be composed of beds, which could be divided into laminæ or thin sheets. Frequently the laminæ in sandstones are of slightly different color, or they may show ripple marks, which would indicate that they had been deposited in shallow water. The consolidation of stratified rocks may be due to the presence of cementing material in the percolating waters, as, for instance, carbonate of lime, silica, or oxide of iron, or it may be due to long-continued pressure accompanied by a greater or less degree of elevation of temperature. Stratified rocks when first deposited are



FIG. 28.

nearly always horizontal; hence, when the strata are found highly inclined or contorted, this state of affairs must be ascribed to subsequent action. Stratified rocks are not always laid down in parallel beds of even thickness and extending over great areas, but are composed of compara-

tively flat cakes which are usually thickest in the center and taper out to the edges. Fig. 23 illustrates the manner in which a series of beds of sandstone or conglomerate may interlap with a series of beds of limestone. Such a set of conditions would occur on a seacoast in which the sandstone or conglomerate was formed by the erosion of an adjoining continent and the limestone by marine deposits from the sea. If during certain times the erosion were more rapid, the sandstone or conglomerate deposits would extend out over the limestone, as shown, while at other times the limestone would extend over the sandstone or conglomerate.

61. Inclined Laminae.—One point that the student of geology wants to observe carefully is that the laminae are not always parallel to the strata. This is illustrated

in Fig. 24, in which the two beds of sandstone have laminae at an angle to their strata. This may have been caused by the waves on the shore of a sea or lake, or by a swift current of water, either in

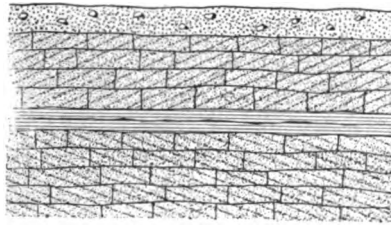

FIG. 24.

a river or large body of water, which deposited the material in the position shown. These inclined laminae are frequently mistaken for inclined strata, and on this account close observation is necessary before deciding as to whether the strata are inclined or horizontal.

62. General Classes of Stratified Rocks as to Material.—Sedimentary rocks are divided into three general classes: **arenaceous** or **sand rocks**, which include sand, gravel, shingle, rubble, etc., of the drift material, and the sandstone, grit-stones, conglomerates, and breccias of the rock formations. (The conglomerates are composed of rounded stones and breccias of sharp angular stones cemented together with some other material.) **Argillaceous** or **clay rocks**, which include the muds and

clays of the drift formation and the shales and slates of the rocks. **Calcareous** or **lime rocks**, which include chalk, limestone, and marble, and rarely have any representations among the drift material, for few of the lime formations are much if any softer than chalk.

63. General Definitions of Terms Used in Geology.—Some of the common terms used in geology are:

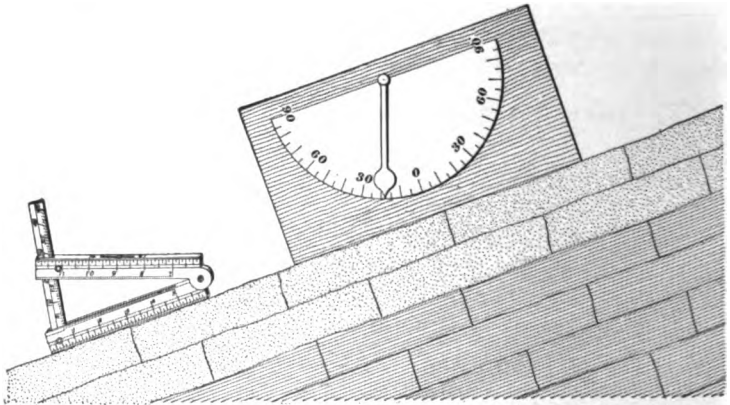

FIG. 25.

The *dip* of the rock is the angle which it makes with the horizontal plane, and it is measured by means of a clinometer, or pitch rule, as illustrated in Fig. 25. The *strike* of the strata is the line of intersection with a horizontal plane, and is always measured at right angles to the dip. For instance, if in Fig. 25 the strata dip to the south, the strike would be east and west. The *outcrop* of a deposit is its exposure on the surface, and may be very irregular on account of the fact that it depends not only on the dip of the formation, but upon the character of the surface over which the formation outcrops. Care must be taken not to confuse the terms strike and outcrop, for the strike is always measured on the horizontal plane, while the outcrop conforms to the surface, and hence may or may not agree with the strike. This point must be taken into con-

sideration when determining the dip of any formation. When strata are bent or contorted into successive waves, as shown in Fig. 26, the saddles, as at *b*, are called *anticlines*, and the troughs, as at *a*, are called *synclines*, while the trend or direction of the ridge is called the *anticlinal axis*, and the direction of the valley the *synclinal axis*. Subsequent erosion

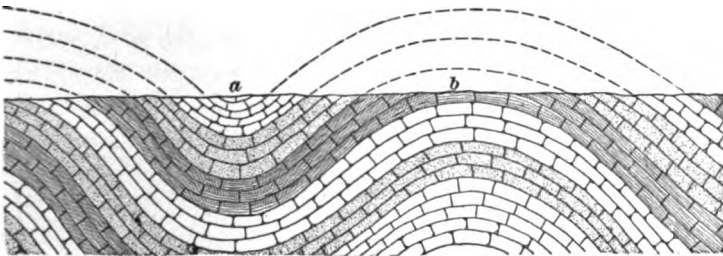

FIG. 26.

may entirely remove the original hills and valleys and produce a comparatively level surface, as illustrated in Fig. 26. The dotted lines show the manner in which the strata were originally bent. When the strata have been eroded in such a manner that the anticlines and synclines are no longer hills and ridges, the anticline may be known by the fact that the

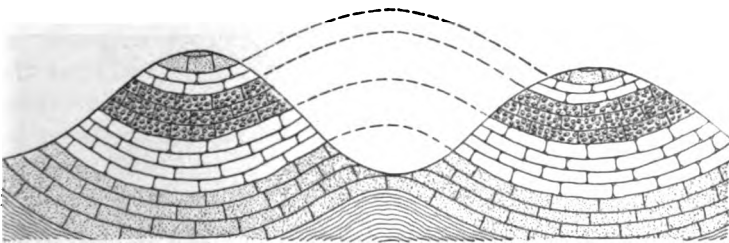

FIG. 27.

same strata are repeated on each side of the axis and that they dipped away from the axis, as shown at *b*; while a syncline may be known from the fact that the same strata are repeated on each side of the axis and dip towards the axis, as shown at *a*. The action which forced or crushed the material together frequently opens fissures along the

anticlines, thus increasing the tendency to erosion along the ridges, and this tendency may cause the ultimate removal of the ridge and the formation of a valley along the anticline, thus resulting in syncline mountains or hills, as shown in Fig. 27. Strata are said to be conformable when they are parallel or continuous, and were formed under the same conditions, and they are said to be unconformable when they are not continuous, being interrupted by an old land surface which has been eroded. Fig. 28 illustrates unconformable

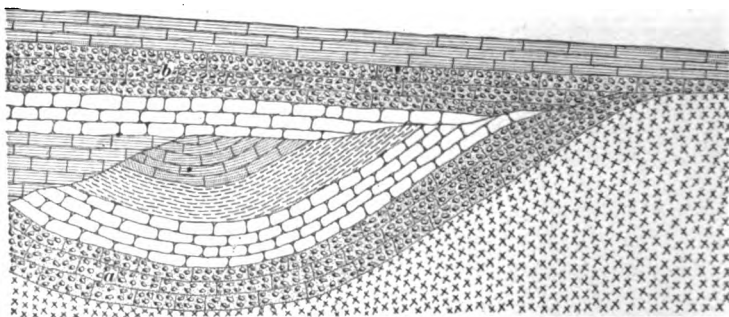

FIG. 28.

strata. The strata shown at *a* were deposited, contorted, and tilted, and subsequently eroded to the form shown in the illustration. After this they were once more submerged and the strata shown at *b* deposited in such a manner as to be unconformable with the original strata, and after the strata had been deposited the entire mass was once more elevated and tilted slightly, so that the strata *b* were no longer horizontal. There are cases in which unconformable strata are practically parallel, as, for instance, when a land surface has been eroded and then submerged without tilting or contortion and the subsequent strata deposited parallel, or practically parallel, to the original strata, but such cases can always be recognized by the fact that the eroded land surface has intervened between the depositing of the formations.

64. Cleavage Structure.—As has already been stated in the case of stratified rocks where the material has been

laid by the sorting power of water, the separate layers can frequently be very easily traced. These strata are often so plainly marked that rocks may be cleaved or split along their bedding planes, and it is in this manner that much of the rock used for flagstones is obtained. This cleavage may be called flagstone cleavage, and is always parallel to the strata. Another form of cleavage is that which occurs in crystals or is caused by crystallization, and as an extreme case of this, the cleavage of mica may be mentioned. The slates which are used for roofing material and for writing-slates are cleaved along very distinct planes, and these planes may intersect the bedding at any angle. This fact puzzled the geologists for a great many years, but by careful examination and by physical experimentation, it has been found that this "slaty cleavage" is always at right angles to the lines of greatest pressure during the alteration of the

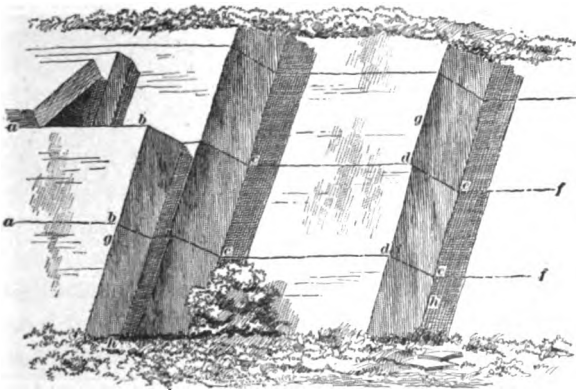

FIG. 29.

rocks. In Fig. 29 the lines *ab, cd, ef* represent the bedding planes in which the material was deposited. The lines *cc, ee*, etc., represent joints which have subsequently been formed at right angles to the bedding planes, and which are present in all stratified rocks. The diagonal lines *g h* and *g h* represent a cleavage which is neither at right angles to the bedding planes nor to the joints, but which cuts through both at an angle independent of the original formation of

the rock. The fact that the slates in many slate quarries and the rock in many other locations had a cleavage of this

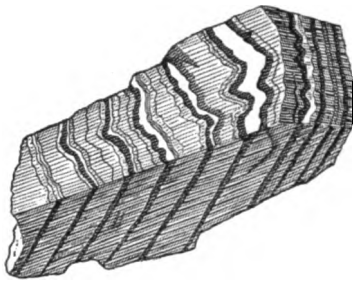

FIG. 30.

character finally developed the fact that this cleavage was at right angles to the direction in which the pressure had been applied when the rocks were contorted or changed. Fig. 30 illustrates a small block of rock showing the manner in which cleavage may intersect the original bedding planes, and also showing the manner in which these bedding planes have become crimped or bent by the pressure which developed slaty cleavage. Fig. 31 illustrates a series of undulating strata and shows the manner in which the cleavage will

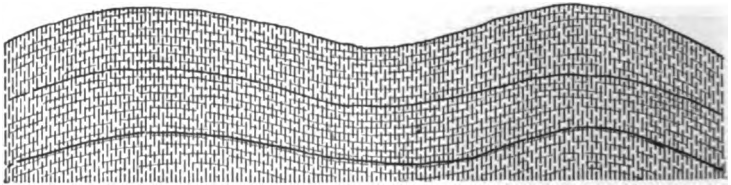

FIG. 31.

be parallel throughout the entire formation, regardless of the direction of the strata at any particular point. It is probable that the great pressure which caused this cleavage was due to the shrinkage of the earth's crust, and that this action forced the continents and the mountain ranges into, approximately, their present position. In many cases the action seems to have been accompanied with very little rise in temperature, so that the material is practically unchanged, while in other cases this action has taken place in rocks which have been altered by heat. The geologist or prospector must be careful not to be deceived by slaty cleavage, which may be easily mistaken for the stratification of the rock.

65. Nodular or Concretionary Structure.—In nearly all rocks, balls or masses of material are found which have been formed after the rocks were laid down. Frequently the stratification passed right through the ball, while in other cases they are independent of the stratification. These balls or nodules are called clay balls, iron balls, lime balls, or sulphur balls, according as they are composed of the different materials named. They are really all nodules or concretions, and may be composed of a great variety of materials. In limestone they are usually composed of silica, while in sandstones the composition will be lime, iron, or sulphur. The sulphur balls are really iron pyrites, and are usually found in coal-measures. Sometimes the balls are hollow and lined with crystals, when they are called *geodes*. Sometimes these concretions assume very peculiar forms and are frequently mistaken for fossils, being called hands, feet, or whatever they may happen to resemble. Fig. 32 illustrates one of these peculiar shaped concretions. As a rule, the concretion is formed about some foreign particle as a base. This may be a fossil fish, leaf, shell, or some similar bit of foreign matter which occurred in the formation.

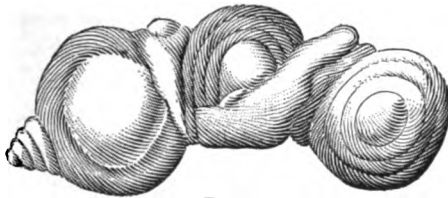

FIG. 32.

66. Fossils.—As has already been mentioned, stratified rocks are composed of material which has been deposited in water, and hence such deposits would naturally contain any shells, bits of coral, leaves, logs, or other material which might happen to be dropped upon the material when the deposit was being formed, or which might be washed from the land into the delta of a river or into a lake. Bodies of animals from the land were also washed into the water and their bones deposited and covered with the sediment, together with the bodies of fish and the various living forms which inhabited the water. Animals walking over the soft

ground or mud left tracks which became covered with sediment and are now found in the rocks. These evidences of the previous existence of living beings are called fossils.

67. Condition of Fossils and Their Use.—Where the fossil consists of all or a part of an organism, it may be presented in any one of a number of forms. In the older rocks the material of the bones or the tissue of the object is rarely ever present, but the fossil consists of a cast or impression of the object, or the object may have been replaced, particle by particle, with solid matter in such a manner as to form a perfect model of the original. This latter class of fossils are said to have been petrified, and one of the best examples of this class is petrified wood. Fossils are useful in determining the relative age of the rocks, and it is by this means that the rocks of different countries can be compared. When life first appeared on the earth, it was of the simplest form, and the organisms on the different continents differed but little, but in each succeeding geological period greater differences appeared between the different continents, until the conditions existing at the present time came into being.

68. Development of Life.—Animal life, and especially higher forms of animals, can not take nutriment or material to live upon directly from the minerals, and hence vegetable life was naturally the first that appeared, and was probably in the form of seaweeds. These simple forms were soon followed by shells, coral, etc. At first animal life could not have existed on the continents for several reasons. (1) The animals could not have obtained food necessary for them, on account of the lack of vegetation and other animal life on which to feed. (2) It is probable that the atmosphere of that period was so heavily charged with carbonic acid gas that no animal breathing through lungs could have existed upon the earth.

69. Geological Section.—As has already been stated, the different series of stratified rocks are separated by periods of elevation and erosion, and hence there is no place











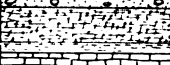











Ages Eras		American Periods		Foreign Equivalents	
Cenozoic	Quaternary		Recent Champlain Glacial	Recent Pleistocene	Age of Man
	Tertiary		Pliocene	Pliocene	Age of Mammals
			Miocene Eocene	Miocene Eocene	
Mesozoic	Cretaceous		(Laramie Series) Upper Cretaceous	Upper Cretaceous	Age of Reptiles
	Jurassic		Lower Cretaceous (Dakota Group) (Comanche Group)	Lower Cretaceous or Neocomian	
	Triassic		Alamosaurus Beds	Oolite. Lias.	
Paleozoic	Carboniferous		Permian	Permian	Age of Amphibians or Age of Acrogens (plants of the coal period)
			Carboniferous or Coal Measures.	Carboniferous or Coal Measures	
			Subcarboniferous	Mountain Limestone	
	Devonian		Catskill, Chamung.	Old Red Sandstone	Age of Fishes
			Hamilton		
			Corniferous		
			Oriskany		
Upper Silurian		Helderberg	Ludlow		
		Onondaga, Salina.			
Lower Silurian		Niagara	Wenlock Llandovery		
		Trenton			
Cambrian PreCambial		Canadian	Bala or Coradoc Llandovery Flags	Age of Invertebrates	
		Aronig			
		Potsdam	Tremadoc Slates Lingula Flags		
		Acadian	Menerian Solva		
Archaean or Eozoic		Georgian	Coerfai	No Distinct Organic Remains	
		Huronian	Archaean.		
		Laurentian			

FIG. 88.

on the earth where the complete series is exposed. On this account, geologists have been forced to compare the records from different portions of the earth, in order to obtain a complete record of the events, and some few pages are still lacking in this history, though practically the entire story has been read from the 'book of nature. By comparing the records of several places, a complete geological section can be made. Such a section is shown in Fig. 33. The names of the great periods of time are given in the column at the left and are called ages; the smaller division, called eras, are given in a second column; the third column illustrates in a general manner the succeeding strata; the fourth column gives the names of the formations as presented in America; the fifth column gives the names of the deposit in various countries which correspond to those in America; the sixth column gives the principal form of life present in any particular age. From this it will be seen that in the Archean age there are no distinct animal remains. In the next eras, composed of the Cambrian and the Lower Silurian, the principal form of life existing consisted of invertebrates, or animals without back-bones, such as shell-fish of all kinds. In the Upper Silurian and the Devonian the fishes appeared as the first vertebrates, or animals having back-bones. In the Carboniferous period the amphibians, or the first animals which could live either in or out of water, appeared, and this age is characterized by great forests of the lower forms of plants, such as ferns, which grew luxuriantly on account of the fact that the atmosphere was overcharged with carbonic acid gas. This rank vegetation has furnished the greater part of the coal which we now burn. During the latter part of this period the first reptiles appeared, but they did not become plentiful until the Mesozoic, when reptiles grew to a great size, and were the principal form of animal life upon the earth. In the Tertiary, we have the mammals, or warm-blooded animals, coming into existence, and in the Quaternary period man appears. From this it will be seen that the earth was gradually prepared as a home for man, by first producing

continents suitable for him to live upon; by getting rid of the poisonous carbonic acid gas of the atmosphere and stor-

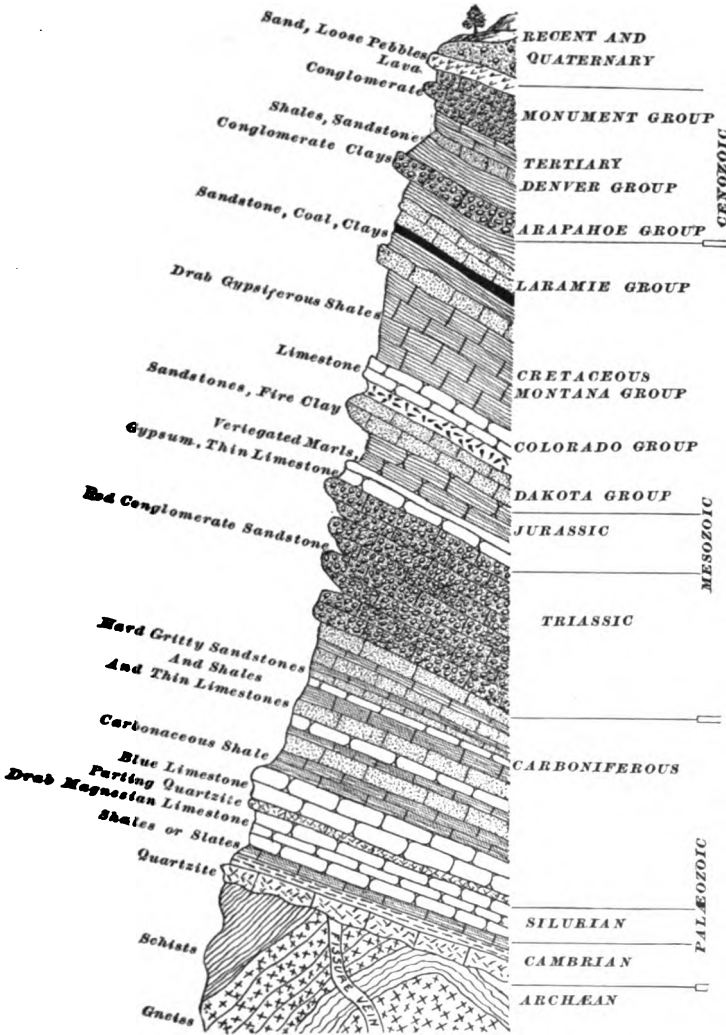

FIG. 34.

ing it up as coal for future use; by developing vegetable and animal forms of life which he needed for his sustenance;

and, last of all, by collecting the minerals and metals into forms in which he could make use of them, as will be shown under the consideration of metalliferous veins and deposits. Fig. 34 is a section of the rocks present in the State of Colorado. From this it will be seen that the Devonian rocks are entirely wanting, and that the series is not complete in several other respects.

The fossils of the different periods will be treated later.

UNSTRATIFIED OR IGNEOUS ROCKS.

70. General Characteristics.—The unstratified rocks are distinguished from stratified rocks by (1) the absence of stratification; i. e., they are not laminated as the result of being sorted by water; (2) there is a total absence of fossils; (3) the general structure of the rock is more or less crystalline or glassy; (4) the general mode of occurrence is usually characteristic, as will be explained later. Most of the unstratified rocks have evidently consolidated from a fused or semi-fused condition, and it is for this reason that they are called igneous rocks. They also frequently occur in dikes or tortuous veins cutting through the regular stratified rocks and producing effects upon the stratified rocks which show that the material was hot at the time the dike or vein was formed. In many cases the igneous rocks closely resemble the modern lavas in their mode of occurrence. Sometimes where there have been several successive flows of volcanic material, the different flows will have a stratified appearance, but the laminæ will be absent; also the character of the material and its connection with the surrounding formations will usually show that it has not been deposited by water.

71. Modes of Occurrence.—Fig. 35 illustrates a number of the common forms in which igneous rocks occur. They may underlie other rocks forming masses, as at *a*, or form a ridge or core of mountain ranges, as at *r*. They frequently appear as vertical sheets, filling fissures or

cracks in the rocks, forming dikes, as at *h*, *g*, *i*, or *m*. They sometimes occur as beds of material forced in between the strata, as at *f*, or as overflows on the surface, as at *k*, or the overflow may form a volcanic cone, as at *o*. Frequently the dikes or fissures which are filled with eruptive material do not break clear through to the surface, as shown at *m*. When such is the case, the existence of the dike would only

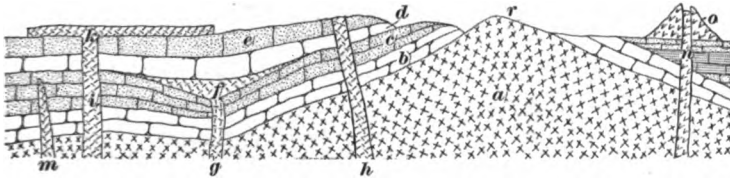

FIG. 85.

be known after the overlying strata were removed by erosion, or it is possible that such dikes might be encountered during the mining operations.

72. Classification of Igneous Rocks.—Igneous rocks are classified by their physical characteristics rather than by their relative age. The common divisions are plutonic, or massive rocks, and volcanic, or true eruptive rocks. The rocks of the first class include the great masses, and those in the latter the rocks which are injected into fissures or outflow over the surface. The plutonic rocks are entirely crystalline and are usually coarse-grained. The volcanic rocks are imperfectly crystalline, or are partly or wholly glassy, and seem to have solidified in the place which they at present occupy, while the plutonic rocks have apparently sometimes been forced into their present position while in a partly solid condition. The two groups pass into each other by such gradual changes that no sharp distinction can be drawn between them.

PLUTONIC OR MASSIVE ROCKS.

73. General Characteristics.—These are characterized by a close-grained, mottled, or speckled appearance, resulting from the fact that they are composed of an

aggregation of crystals of different materials and colors. These rocks are usually made up of a mass of crystals without any ground mass or amorphous or glassy material between them. The minerals which compose practically all the rocks of this class are quartz, feldspar, mica, and hornblende. In the speckled mass the opaque white, or reddish, or grayish crystals with the glistening surface are feldspar; the transparent bluish, glassy spots are quartzite, and the black specks are usually hornblende. The mica can be easily detected as glistening scales of various shades. The principal kinds of rocks of this class may be taken as granite, syenite, diorite, diabase, and its variety, gabbro.

74. Granite.—Granite may be considered as a type of this class of rocks, and it consists of quartz, feldspar, and mica, or of these together with hornblende.

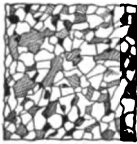

FIG. 36.

Sometimes the mica and hornblende are wanting and the quartz exists in the form of bent plates embedded in feldspar. Sometimes all the crystals are small and evenly granular, but as a rule they are fairly coarse. Fig. 36 shows the general appearance of a piece of

fairly coarse granite.

75. Syenite.—Syenite is a term used in America and England to distinguish rocks of the granite group in which the mica is replaced by hornblende, and where both mica and hornblende are present the rock is called syenite-granite; but on the continent of Europe, and especially among the Germans, the term syenite is applied to a rock composed of feldspar and hornblende only, and when the quartz is present (American and English syenite) they call the rock quartz-syenite. The general aspect of the rock is similar to granite. In the rocks thus far mentioned, the feldspar is the potash feldspar (orthoclase).

76. Diorite.—Diorite is a dark speckled, greenish-gray rock, and is composed of a crystalline aggregation of plagioclase (soda, lime, feldspar, and hornblende), and therefore

differs from the German syenite only in the form of the feldspar.

77. Diabase.—Diabase is a dark, greenish, crystalline rock, usually fine-grained, but sometimes having a coarse-grained structure. In general appearance it is similar to diorite, but differs in the fact that augite replaces the hornblende and it often contains olivine.

78. Gabbro.—Gabbro is a granular diorite or diabase in which the augite takes the form of diallage.

79. Subdivisions of Plutonic Rock.—These different forms of rock merge into each other so insensibly that it is frequently difficult to determine the various classes. Diorite and diabase frequently form dikes of fine-grained material, so that they are sometimes considered intrusive rocks rather than massive rocks, and are often treated as an intermediate class between the two. The plutonic rocks can be divided into two sub-classes, one called acid, and the other basic, rocks. Quartzite is composed of silica, and is acid. The orthoclase feldspar is acid and the plagioclase feldspar basic. In the acid rocks quartzite and orthoclase feldspar predominate, while in the basic rocks hornblende or augite and plagioclase feldspar predominate.

The acid rocks are usually somewhat lighter than the basic rocks, the specific gravity of the former varying from 2.6 to 2.7 and of the latter from 2.7 to 2.9. The acid rocks are also usually lighter in color than the basic rocks. Granite is the best type of the acid class, and diorite and diabase, and especially gabbro, are good examples of the basic class, while syenite takes an intermediate place.

80. Mode of Occurrence of Plutonic Rocks.—The plutonic rocks, and especially the granite and syenite types, occur in large masses forming the axes of great mountain ranges, as, for instance, the Sierra and Colorado Ranges, as shown in Fig. 37, or they may appear in rounded masses in the midst of the stratified rocks, as in several of the New England States, around Lake Superior, and in

various parts of Canada. The rocks of the plutonic group are never found in connection with scoriæ, glass, ashes, or other evidences of rapid cooling in contact with the air. They have never been erupted on the surface, and have

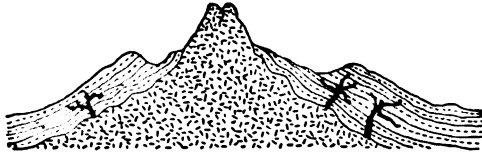

FIG. 37.

evidently been cooled or solidified under pressure in great masses and at great depths. Hence, when they are found on the surface they must have been exposed by extensive erosion.

81. Intermediate Series.—Between the true plutonic rocks and the volcanic rocks there is an intermediate series, the rocks of which are sometimes placed in one group and sometimes in another. They are called the *trappean* or *intrusive rocks*. They occur mostly in the older and middle rocks in the form of dikes filling great fissures, or as beds between the strata. In the acid group of this class of rocks perhaps the most typical is *felsite*. This rock is a very compact, fine-grained aggregation of quartzite and orthoclase feldspar, and therefore it is light-colored. Chemically, it has the same composition as granite, but differs from granite in the fineness of its texture and in the absence of the mica. When felsite rock contains embedded in the fine-grained mass large, well-formed crystals of feldspar or hornblende it is called porphyritic. If quartz crystals are also distinctly visible, then it is called quartz-porphry. The word “porphyry” or “porphyritic” is often applied to any rock in which distinct crystals are visible in the fine-ground mass; thus, there may be porphyritic granite, porphyritic diorite, etc. The porphyritic structure is probably formed by the material being in a fused condition and the large crystals separating out. When partially cooled, and after the crystals had been separated, the material was forced into its

present position. Intrusive rocks of the basic group are usually called greenstones or traps. This term usually includes the intrusive diorites, diabase, etc., which differ from the massive crystalline rocks of the same class only in being finer grained. The difference is probably due wholly to the rate of cooling, and the differences between the massive and intrusive diorites may be due to the same cause. When a mass of lava is cooled rapidly, it will result either in a fine-grained material, or, if the cooling is very rapid, may form a glass-like mass or obsidian. When the cooling is slower, the crystals of the various constituents have an opportunity to separate, and the result is a coarsely crystallized rock, more like the porphyries or the granites.

VOLCANIC OR ERUPTIVE ROCKS.

82. General Characteristics.—In texture these rocks either appear minutely speckled or are usually of a grayish shade, on account of being composed of crystallized or only partially crystallized and fine-grained material. Sometimes their structure is amorphous or glassy, on account of the fact that they have cooled very quickly. They consist for the most part of some form of feldspar with hornblende or augite. Free quartz and mica are sometimes present, but are not necessary and are not common. Other minerals, such as magnetite, are frequently associated with some forms of lava. Volcanic or eruptive rocks are also divided into the sub-classes, acid and basic. The acid rocks consist of an ortho-feldspar which usually takes the form of sanidin or glassy feldspar, while in the basic class the feldspar is plagioclase and is associated with hornblende or augite.

83. Trachyte.—Of the acid group, trachyte is one of the most common forms. It is usually a light-colored rock, and has a peculiar characteristic rough feel, on account of the fact that the ground mass is composed of sanidin in which there are needle-like crystals of the same material which give the rock its peculiar rough feel. Augite is

always present, and other minerals may occur associated with it, especially black mica (biotite).

84. Rhyolite.—Rhyolite is practically the most acid of all the lavas, and is usually light in color and similar to trachyte in composition, and may contain crystals of quartz in addition to those of sanidin. The crystals may be so large as to give the rock the appearance of a porphyry.

85. Phonolite.—Phonolite is a comparatively rare form of lava which has recently been brought into great prominence on account of its association with the rich ore deposits at Cripple Creek. It is usually of a pale greenish-gray color and has a somewhat spotted appearance. As a rule, it is hard to distinguish phonolite from rhyolite or trachyte in the field. It breaks into slate-like pieces, is a very compact mineral, and has a peculiar ring under the hammer, from which it derives its name of phonolite or clinkstone. Occasionally small crystals of feldspar can be seen in the phonolite.

86. Basalt.—Of the basic sub-group, basalt is the most typical. It is a dark, almost black, mineral when freshly broken, but weathers to a rusty brown color on exposure to the air. It consists of a mixture of plagioclase, augite, and olivine in a glassy ground of the same material. Magnetite is frequently present in considerable quantities in the basalt.

87. Dolerite.—Dolerite is a composition very similar to basalt, but lacks the olivine, and is somewhat more crystalline in structure.

88. Andesite.—Andesite is so named because it was first found in the Andes Mountains. It is a dark greenish-gray rock, consisting essentially of plagioclase with hornblende or augite. It is similar to dolerite, but is slightly crystalline, like basalt, and often has a rough feel like trachyte, hence it is sometimes called trachy-dolerite.

89. Special Forms Caused by Rapid Cooling.—All the rocks of both the acid and the basic group, and especially the more typical ones, have their scoriaceous and

glassy or vitreous varieties which compose the light-colored scoriæ and the obsidians on the one hand and the black scoriæ on the other.

90. Modes of Eruption.—There have been two general modes of eruption in geological times. In one case great fissures have been opened up during extensive crust movements, and if they extended to the surface great sheets of lava have flowed from them. At times fissures were simply filled, even though they did not come to the surface. The other general mode of eruption has been where lava came to the surface through chimneys or openings and flowed away as streams. The first form are called fissure eruptions and the second form crater eruptions, or are volcanoes proper. There are no records of fissure eruptions, either at the present time or during very recent periods, and hence, in dealing with the subject of modern volcanoes, only the chimney or crater eruptions need be considered.

91. Positions in Which Lava May Occur.—The lava may occur in any one of several positions, and especially when they have been produced by great fissure eruptions of the past. (1) They may appear as vertical sheets filling great fissures, which by subsequent erosion have been made to outcrop as dikes, or else they may fill small radiating volcanic fissures as volcanic dikes. (2) They may occur as sheets between the strata (intercalary beds), as if forced between the separated strata or else outpoured on the sea bottom and subsequently covered with other deposits. (3) They may occur as great sheets or streams which have been outpoured on the land. (4) They may occur as great domes or masses between the strata.

92. Dikes.—Dikes are fissures filled with igneous material. They may outcrop for great distances (some of them being more than 100 miles long), and may vary in width from a few inches to over 100 feet. They extend down to great, but unknown, depths. If the dike is composed of hard material, it will resist erosion and appear as a rough stone while rising above the surface, as illustrated in

Fig. 21. If the dike is composed of material which is softer than the surrounding material, it will be weathered or eroded out and leave a hollow or trench across the surface of the country. The effect which dikes produce upon the strata through which they cut depends largely upon the character of the strata and the character of the material filling the dike. If the strata are composed of limestone on each side of the dike, and the dike is filled with a material which was injected at a very high temperature, the limestone on each side of the dike will be converted into a crystalline marble. If the dike cuts through a seam of bituminous coal, it will be converted into anthracite, or possibly be reduced to coke, for a few feet on each side of the dike.

93. Beds, Sheets, or Masses Between the Strata or on the Surface.—When the lava occurs as sheets or

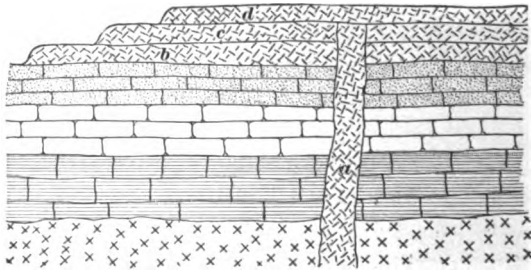

FIG. 38.

beds between the strata, it would be located as shown at *f*, Fig. 35, and subsequent erosion may expose part or all of the deposit. When the material forced between the beds has been of a somewhat more viscous nature, and hence did not have such a tendency to flow or take a flat form, it may crowd the strata up and form a laccolite, as shown in Fig. 19. When lava has been poured out in sheets or streams upon the surface, it will appear as shown at *k*, Fig. 35, or if there have been several successive outpourings, it may appear as successive beds, as shown at *b*, *c*, and *d*, Fig. 38. Some of these great outpourings from large fissures have covered very extensive territories. The great outpouring

in northwestern North America covered northern California, northwestern Nevada, the greater part of Oregon, Washington, Idaho, part of Montana, and extended into British Columbia. In places this overflow is cut through by the Columbia River, and is shown to be from 3,000 to 4,000 feet thick, and it covers, approximately, 150,000 square miles of territory. The Des Chutes River has eroded cañons from 1,000 to 2,500 feet deep in this lava field without reaching the bottom. About a dozen extinct volcanoes can be found over this area, but it is evident that such a large amount of lava did not come from these small volcanoes, but must have been the result of great fissure eruptions.

94. Age.—The age of lava flows can only be determined in a relative degree. For instance, if two dikes occur in such a manner as to cross each other at an angle, the one which cuts through the other must of necessity be the younger. Where beds of igneous material occur between stratified deposits, their age can often be determined by the character of the deposits above and below them. It is evident that the igneous material must be younger than the stratified deposit beneath it, and if it has altered the material over it by heat, it is evident that it was injected between the formations or beds; but if the material on top of the igneous rock is unaltered, it is likely that the flow occurred on the bottom of a lake or sea, and was subsequently covered by other deposits of a sedimentary nature. Where one stream or sheet of lava has flowed over another, it is evident that the upper must be the younger. By comparing the adjacent sedimentary rocks and the relative position of the different flows or seams, some idea as to the age of the igneous deposits may be formed.

95. Columnar Structure.—Many of the eruptive rocks exhibit a remarkable columnar structure. This is most conspicuous in basalt, probably on account of the fact that basalt has evidently been heated much hotter than the other eruptive rocks; that is, it has been superfused, for the melting-point of basalt is lower than that of many other

lavas, and that it was exceedingly hot can be seen from the manner in which it flowed out into thin sheets. Fig. 39 illustrates a rough columnar structure as exhibited in the basalt rock on the shore of Lake Superior. Sometimes the columns are more perfect prisms than those shown in Fig. 39, and they may be regular hexagons. The columns are often of considerable length (varying from a few feet to from 50 to 100 feet), and varying in diameter from a few inches to a foot or so. Where a structure of this nature has been eroded by the sea, by the action of a river, or by atmospheric agencies, it often results in very bold and picturesque cliffs. The Palisades on the Hudson, some of the cliffs at Mt.

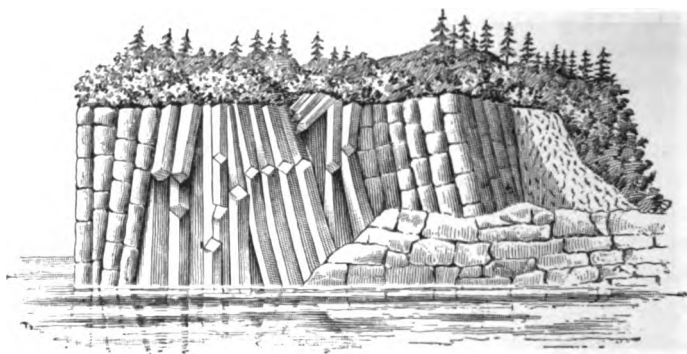

FIG. 39.

Holyoke in Massachusetts, and the cliffs on Lake Superior, and a number of places in the Rocky Mountains furnish illustrations of this structure. In Europe, the Giant's Causeway on the coast of Ireland, and Fingal's Cave on the island of Staffa, on the west coast of Scotland, may be mentioned as especially noted localities for this form of basalt structure.

96. The direction of the columns is usually at right angles to the cooling surfaces, hence in horizontal sheets the columns would be vertical, while in a dike the columns would be formed horizontally, and if the dike was subsequently exposed by the erosion of the adjoining strata, it

would stand out much like a pile of cord-wood. Fig. 40 is an illustration of such a dike.

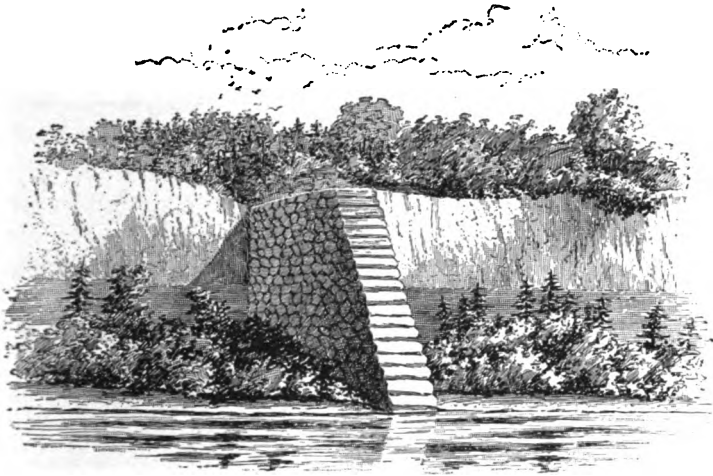

FIG. 40.

97. There is little doubt that this columnar structure is produced by contraction while the rock was cooling, but it is not known why the structure should be more irregular in basalt than in any other known substance.

98. Volcanic Conglomerate and Breccia.—If a stream of fused rock from a crater or fissure runs down the bed of a stream, it will gather up pebbles in its course, and after solidification, will form a conglomerate, which differs from the true conglomerate in the fact that the uniting paste is of igneous instead of sedimentary material. In the same manner a stream of igneous material flowing over a surface with broken rock or rubble would take up the material and form a breccia; or the front and upper surface of the lava may become cooled, and subsequently be crushed and broken by the flow of liquid lava from behind. This broken lava would become mixed with the molten lava and thus form a breccia. The disintegration of volcanic rock and the transportation and depositing of the pieces would give rise to an aqueous conglomerate or breccia composed

of volcanic material, and it is often difficult to distinguish such a deposit from the true volcanic breccia. These breccias and conglomerates graduate into volcanic tufas, which consist of the material thrown out by volcanoes of the explosive type, and which have flowed down the surface of the mountain or valley as a volcanic mud.

99. Amygdaloidal Structure.—Another form of structure very common to igneous rocks or lavas is called amygdaloidal. The rock called amygdaloid greatly resembles volcanic conglomerate, and is apparently composed of almond-shaped pebbles in an igneous paste, but it is formed in a very different manner. The streams of lava or trap always contain more or less gas, and this results in bubbles or openings being left in the material. The gradual flow of the slowly hardening stream elongates these bubbles and gives them their almond shape. In the course of time these bubbles become filled with silica, carbonate of lime, or

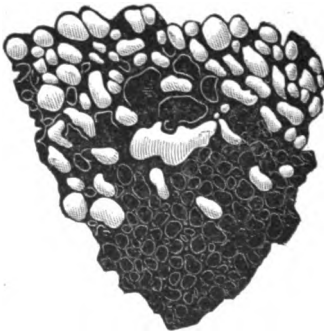

FIG. 41.

some other material, by infiltrating water holding these materials in solution. Sometimes the filling has taken place very slowly, successive additions being composed of different colored materials. It is in this manner that the beautiful agate pebbles are formed. The most common filling is silica, on account of the fact that the waters percolating through igneous

rocks are always alkaline, and hence hold silica in solution. Sometimes very fine opals are found in this amygdaloidal material. Fig. 41 illustrates a mass of amygdaloid rock.

THE ORIGIN OF IGNEOUS ROCKS.

100. There are some reasons for thinking that the igneous rocks are not all eruptive portions of the original fused magma or mass of rock. Among these may be stated

the following: The lavas erupted in the same locality, but at different times, differ very greatly in composition and structure. It seems hard to account for this difference if the material was all drawn from the same source, but the action of water in producing stratified rocks has resulted in extreme differences of material, with pure silica for one extreme and pure lime for the other. If these were re-fused it would produce greater differences than existed in the lavas, but as pure silica or pure lime is practically infusible, when considering the limits of ordinary fusion, the range of possible lavas is reduced to those actually found. Some evidences to prove this theory will be given under the head of metamorphic rocks, where it will be shown that rocks having precisely the same composition as many of the igneous rocks are frequently produced from sedimentary rocks.

101. Metamorphic Rocks.—Metamorphic rocks were evidently originally sedimentary deposits which have been subjected to heat and other agencies which have changed their structure, sometimes entirely destroying the fossils and laminations and inducing a crystalline in place of the stratified structure. Evidence of the sedimentary origin of metamorphic rock is found in the gradual gradation into the true igneous rocks on the one hand and into sedimentary deposits on the other. For this reason they are called metamorphic. Metamorphic rocks are more common among the older formations, and become less and less common as one passes from the earlier to the later periods. They seem to require a great depth of strata and are generally associated with more or less folding, tilting, intersecting of dikes, and other evidences of igneous agencies. Metamorphic rocks are mostly found in mountainous regions and they extend over large areas of country. Nearly all of Canada and Labrador, a large part of the Eastern Appalachians, and much of the Western mountain regions are covered with metamorphic rocks, and they probably underlie all or nearly all the stratified deposits. The Laurentian

series of Canada is probably over 50,000 feet in thickness and is metamorphic throughout.

102. The principal kinds of metamorphic rocks are gneiss, mica-schist, chlorite-schist, talcose-schist, hornblende-schist, clay slate, quartzite, marble, and serpentine.

103. Gneiss.—Gneiss is the most common and characteristic of the metamorphic rocks. It has the general appearance and contains the same minerals as granite, but has a bedded or stratified appearance, and in the case of banded gneiss, the light and dark constituents are arranged in distinct bands, as shown in Fig. 42. Gneiss runs by insensible gradations on the one hand into granite, and on

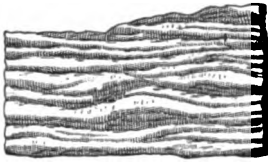

FIG. 42.

the other, through the more stratified forms into sandy clays or clayey sands.

104. Schist.—Schist is composed of practically the same constituents contained in granite or gneiss, but the crystals of mica, hornblende, or the similar constituent, all lie in one direction, so that the material has a laminated appearance and can be split into thin leaves in the direction of the crystals of mica, feldspar, or similar material. According to the preponderance of certain minerals, the rocks are known as mica-schists, hornblende-schists, talc-schists, etc. Both schists and gneisses are frequently very much contorted or folded, as shown in Fig. 43.

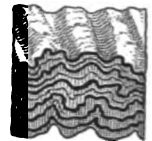

FIG. 43.

105. Serpentine.—Serpentine is a compact, greenish-gray magnesian rock. One peculiarity in regard to serpentine rocks is that many, if not all, of the platinum-bearing regions of the earth are found where serpentine rocks abound, and serpentine has been supposed to be the parent rock of platinum deposits. The other metamorphic rocks, such as marble, etc., need no especial description.

106. Connection Between Metamorphic and Other Rocks.—Hornblende-schists run by insensible gradations into clay slates on the one hand and into diorites and syenites on the other. All the metamorphic rocks can be regarded as changed sands, limestones, and clays. The great variety in metamorphic rocks is due to the differences in the original sedimentary rocks and to the degree of metamorphic action. Pure sand or sandstone forms quartzite; pure limestone forms marble. Clays are usually impure and contain sand, lime, iron, magnesia, etc. Such impure clays, if sand is in excess, form metamorphic gneiss, mica-schists, etc., while if lime or iron is in excess, they form hornblende-schists or clay slates; if magnesia is present in considerable quantities, talcose-schists are formed. The origin of serpentine is not well understood, but it is probably frequently formed by the change of magnesia clays, and in some parts of the Western mountains all stages of the change can be seen, from the clays to the serpentine. In other cases, it seems to have been formed by the change of igneous rocks which contain large amounts of olivine.

107. Classes of Metamorphic Rocks.—In considering the cause of metamorphic rocks, they may be divided into two classes: those produced by local causes and those produced by general causes.

108. Local Metamorphism.—Local metamorphism is that produced by the direct contact with evident sources of heat, as when dikes break through stratified rocks. The fact has already been stated that when dikes come in contact with certain rocks, changes are produced along the face of the dike. Impure sandstones become schists or gneiss; clays are changed into slates, or if they contain much sand they may become jasper; limestones become marbles; bituminous coal becomes coke or anthracite, etc. It is evident that the cause of these changes must have been the intense heat of the material in the dike at the moment it was filled. Such local metamorphic effects usually extend to a comparatively few feet from the walls of the dike.

109. General Metamorphism.—In many cases, the changes can not be traced to any evident source of heat, for rocks thousands of feet in thickness and covering great areas are thoroughly metamorphic. The principal agents of this general metamorphism seem to be heat, water, alkali, and pressure. That heat is a necessary agent is evident from the general similarity between local and general metamorphism, but that the heat was not so intense as in the case of local metamorphism is evident in many cases, for metamorphic rocks are often found interstratified with unchanged rocks, and intense heat would have changed all alike, or nearly alike. Also, minerals are found in metamorphic rocks, which will not stand intense heat; as, for instance, carbon has been found in contact with manganite iron ore, although it is known that this contact can not exist, even at a temperature of red heat, without the reduction of the iron ore. The effect of simple dry heat has been shown, in the case of local metamorphism, to extend to a comparatively few feet, while the general metamorphism penetrates very thick beds.

110. The fact that heat combined with water seems to be the agent has been proved both experimentally and by observation. Water in contact with most rocks at a temperature of 450° F. reduces them to a pasty condition, and at this temperature, quartz, feldspar, mica, augite, and other crystals are formed. It has been found that only a very small amount of water is necessary to produce this result (from 5% to 10% of the bulk of the rock), and as this amount of water is probably present in all sedimentary rock, it is evident that a sufficient amount of water would be present to produce this result.

111. Solutions of alkaline carbonates or silicas are common in all waters, and experiments show that their presence greatly reduces the point at which aqueo-igneous fusion takes place.

112. In order to produce the high temperature necessary, the water must be under considerable pressure, and it

has been found that water at a temperature of from 575° to 750° F. will produce the same effect that dry fusion at a temperature of from $2,000^{\circ}$ to $3,000^{\circ}$ F. would produce, while if a small amount of alkali is present, a temperature of from 300° to 400° F. will produce the same result.

113. All the necessary factors are found associated in the deeply buried sediments. Series of outcropping strata are often found from 20,000 to 40,000 feet in thickness, and the lower strata of such a series would, by the regular increase of the interior heat alone, reach a temperature sufficient, with the included water, to produce aqueo-igneous pastiness, and therefore by cooling they would become crystallized and regular metamorphic rocks. Fig. 44 illustrates

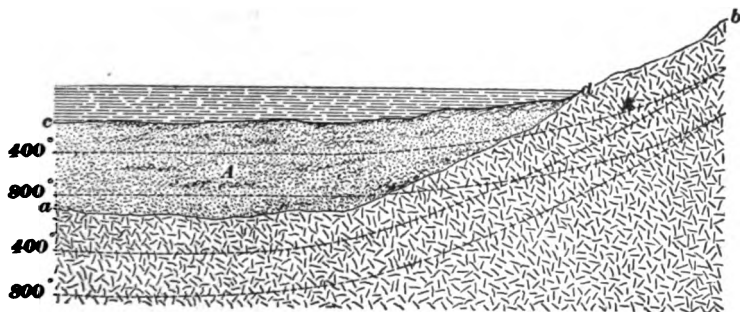

FIG. 44.

a case in which the original rock surface was adb , but a great thickness of sediment A has been deposited on the bed of the sea. The two lines or isotherms of temperature for 400° and 800° F. are drawn in the original rock. Now, as time passed and the sediment became thicker, these lines would evidently rise into the sediment until they assumed the positions as shown by the upper dotted lines. It is evident that where this were the case the temperature in the lower part of the mass of sediment A would be sufficiently high to produce complete metamorphism. It is probable that even as low a temperature as 200° F. in the presence of alkali may produce considerable change in the characteristics of the rock formations.

114. Effect of Horizontal Pressure.—Although simple pressure resulting from the weight of the strata will not cause heat, it is evident that horizontal pressure which crushes the strata will cause heat by the conversion of mechanical energy into heat. Now, in all cases of metamorphism ample evidences exist of horizontal crushings and foldings, together with cleavage of the strata. This crushing of the rock sometimes produces a schist structure, not only in stratified rocks, but even in igneous rocks, and hence this has been called mechanical or dynamical metamorphism, and the rocks of this class are very difficult to distinguish from the truly metamorphic rocks formed from sedimentary deposits.

115. Effect of Percolating Waters.—At other times percolating waters carrying silica at slightly elevated temperatures and under heavy pressure may fill up the space in sandrock, and thus produce a perfect quartzite, which would be another form of metamorphic rock.

116. Definition of Metamorphism.—From what has preceded, we may describe metamorphism as a change in the structure of rock formations, without a change of place. This change may be so extensive as to completely destroy the original characteristics of the rock and any fossils which it contains, or it may simply induce a crystalline structure without destroying the fossils, as is the case in some marbles.

117. General Remarks on Metamorphism.—The explanation of metamorphism gives some of the associated phenomena as follows: The fact that great pressure was necessary and that heat was also necessary explains the usually association of metamorphic action with great thickness of strata. This also explains why the oldest rocks are most commonly metamorphic, since they had newer rocks piled on top of them and have only been exposed by subsequent erosion. The newer rocks are sometimes metamorphic, but it is usually only when the formations are very thick or in volcanic regions. The fact that

some beds in the series of metamorphic rocks are unchanged can be explained by the fact that some rocks are more easily affected by hot waters than others, and the composition of the water in the different strata may be somewhat different; for instance, some rocks would not be liable to contain an alkaline solution. The definition given also explains the reason why metamorphic rocks are usually found associated with mountain chains and with the folding and bending of the strata.

118. Origin of Granite.—The origin of granite was formerly supposed to be entirely igneous, but there is strong reason for believing that much of it was produced by the metamorphism of highly silicious sediments without any accompanying eruptions. In many locations in the mountain regions, every stage of gradation may be observed between the clayey sandstone and gneiss and between gneiss and granite. So perfect is the gradation that it is impossible to draw sharply the distinction, and even geologists who believed that granite was entirely derived from the igneous rocks have been compelled to admit that there is also metamorphic granite which it was practically impossible to distinguish from the primitive granite. It seems almost certain that granites have not been formed entirely by dry igneous fusion, and yet that this rock has been in a liquid or pasty condition is certain from its occurrence in tortuous veins. Therefore, it has evidently been rendered pasty by heat in the presence of water and under great pressure, which always exists in deeply buried strata. The weight of the overlying strata, or else the pressure produced by the folding and crushing of the strata, has forced the pasty material into the cracks or fissures.

119. Origin of Some Other of the Massive Rocks.—Not only have granites been formed in this manner, but such rocks as gneiss, diabase, gabbro, and many, if not all, rocks of the trap group seem to have been formed in the same manner. Some geologists have suggested that this was the manner in which eruptive rocks were

produced, and that the additional heat necessary to force them forth as lavas resulted from the mechanical action in the folding or bending of the earth's crust; and if this view is correct it is possible that every portion of the earth's crust has been worked over many times, being forced out as igneous rocks, eroded from the continents and deposited as sedimentary rocks, only to undergo metamorphism and ultimate re-ejection as volcanic or eruptive rocks.

STRUCTURE COMMON TO ALL ROCKS.

120. Common Peculiarities.—Thus far a brief description of the different classes of all rocks has been given, but there are certain peculiarities or formations which are common to all rocks. These are joints, fissures, and veins.

121. Joints.—All rocks, whether stratified or igneous, are divided by cracks or division planes, which run in three directions and separate the material into irregular prismatic blocks of various shapes or sizes. These divisions are called cracks or joints. Fig. 29 illustrates the bedding planes and joints in a mass of rock, as well as the secondary or slate cleavage which has been induced by pressure. In stratified rocks the planes between the bedding constitute one of the series of cracks. In igneous rocks all division planes are of the nature of joints. In sandstone the blocks are large and irregularly prismatic. In shale they are long and parallel

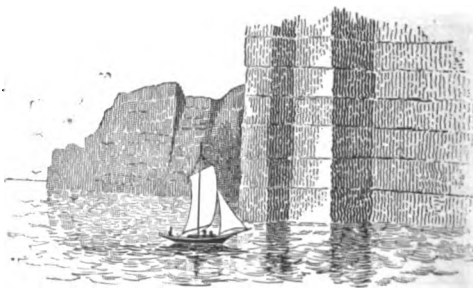

FIG. 45.

divisions. In slates they are small and confused plates, though sometimes slates partake of the same nature as shale. In limestone the divisions are large, regular, and frequently cubical.

In basalt they are regular, and the joints frequently give the material a col-

ummar structure, as shown in Figs. 39 and 40. In granite they are large and frequently divide the material into rough cubes. On account of these divisional planes and the way in which they divide the rock, perpendicular or rocky cliffs often present the appearance of huge masonry walls laid up without cement, as shown in Fig. 45.

122. Cause of Joints.—The cause of joints is probably the shrinkage of the rock while it is consolidating from the condition of sediment or while it is cooling from the previous condition of high temperature in the case of igneous or metamorphic rocks.

123. Fissures.—Fissures or fractures must not be confounded with joints. Joints pass through the individual strata or beds only, while fissures are fractures in the earth's crust that may pass through many strata, or even through several formations. As has been previously stated, joints are probably caused by shrinkage. Fissures are the result of movements of the earth's crust, and they may vary from a few inches to 50 or 100 feet in width, and may extend for a great number of miles. Fissures are on record which extend along the surface from 50 to 100 miles, or even more, and they may continue down to great but unknown depths. They are sometimes filled with material of igneous origin, in which case they are called dikes. In other cases they are filled with material which has been deposited from solution, and then they are called veins.

124. Cause of Fissures.—The cause of great fissures is evidently connected with movements of the earth's crust, either by foldings or by lifting. In either case there would be formed a parallel system of fissures in the direction of the folds. For this reason, fissures are often found running parallel to the mountain ranges. In most cases the walls or two sides of the fissures do not correspond with each other, but one side has been pushed up higher or dropped down lower than the other. Such a displacement is called a fault, a slide, or a dislocation. A fault may occur in connection with a fissure in any kind of rock, but it

is easier to detect faults when they occur in stratified deposits.

125. Monoclines.—When the strata are sufficiently flexible, they may be bent into a single fold in place of being

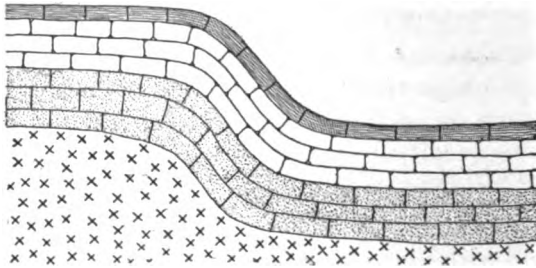

FIG. 46.

broken by the fault. Such a fold is called a monoclinial fold, and is illustrated by Fig. 46. Monoclinial folds have been known to run into faults when the pressure became greater than the flexibility of the strata could accommodate, and one fold may run into several parallel faults.

126. Throw of Faults.—The throw or displacement of faults varies from a few inches to 20,000 feet, and may be even greater than this.

127. Law of Slip in Faults.—The direction of a fault is sometimes perpendicular, but usually it is at an angle, and in the major-

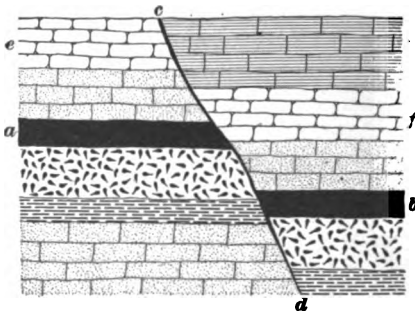

FIG. 47.

ity of cases the upper portion of the material (hanging wall of the fault) has slipped down upon the lower portion (foot-wall of the fault). Such a fault as this is called a normal fault and is illustrated by Fig. 47, in which cd is the fault line, and the material to the right or hanging-wall side of cd

has moved down. Of course, the effect would have been the same if the foot-wall had moved up in reference to the hanging wall, and this is probably the case in many faults. When faults follow the usual rule and are normal faults, the law of finding the continuation of the bed or vein is to follow the greater or obtuse angle when the fault is encountered; for instance, if the bed ab were being worked from the direction a towards the fault, when the fault was encountered the rule would be to follow the greater angle, which would be in the direction of d , and would take the operator to the continuation of the vein or bed. In the same manner, had the work been progressing from b towards a when the fault was encountered, the greater angle would take the operator in the direction of c , which would also find the continuation of the bed towards a . Sometimes faults drag portions of the vein material and distribute it

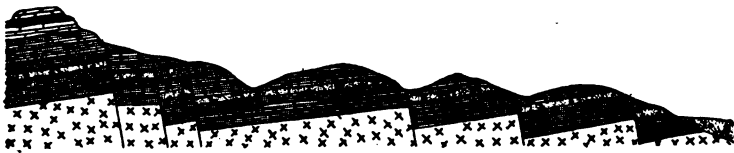

FIG. 48.

along the plane of the fault, and this may give an indication as to the continuance of the deposit sought. If the strata of a region are known, it is possible to find the continuation of a bed by breaking through and examining the material on the opposite side of the fault; as, for instance, in Fig. 47, if work had been carried on from a towards the fault, upon breaking through the fault the limestone bed ef would have been encountered, and as it was known that this bed ordinarily lay above the vein, the operator would sink along the fault to find the continuation of the deposit. Fig. 48 illustrates a series of faults in Nevada, all of which are normal faults.

128. Reverse Faults.—In some cases, and especially in strongly folded strata, such as occur in mountain regions, the hanging wall seems to have been pushed or

made to slide up on the foot-wall. Such a fault is called a reverse fault.

129. Cause of Reverse Faults.—Fig. 49 illustrates the manner in which a reverse fault may be formed. (a) illustrates the bent strata before they had become faulted;

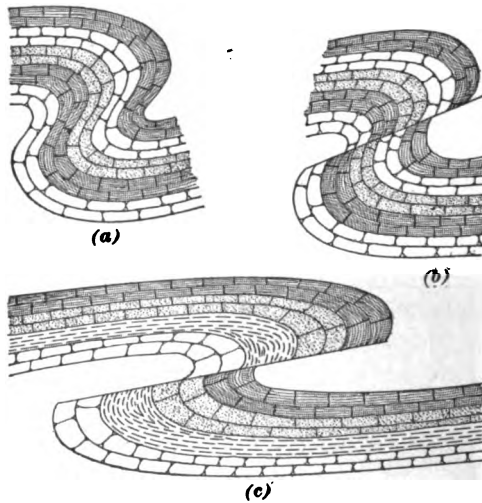

FIG. 49.

(b) represents the strata after the pressure had become sufficient to cause faulting. Sometimes faulting planes are very flat, and in such a case they are called thrust planes, as illustrated at (c) in Fig. 49.

130. Drags.—Sometimes the faults cut through the veins squarely, as illustrated in Figs. 47 and 48, and sometimes they drag the ends of the strata down, as shown in Fig. 49. This bending of the strata near the fault is called a drag, and usually gives indication as to the direction of the fault, though sometimes motion may have taken place along the faulting plane at several different periods, so that the rocks have slid alternately up and down upon each other, and when this has been the case it may be very difficult to determine the direction in which the material has been carried.

131. Cause of Normal Faults.—The explanation of normal faults is not quite as plain at first sight as that of reverse faults, especially when the latter are along thrust planes, but by reference to Fig. 50 the manner in which they may be caused can be seen. At *a* the original form of the strata is shown, together with a series of breaks or fissures previous to faulting. Now, if the underlying material were forced up, it would cause this portion of the strata to take an arched form, as shown at *b*, and this would separate all the faulting planes, as shown in the illustration. Now, if, by the escaping of the pressure stored beneath, either as molten material through the faults or by the relief

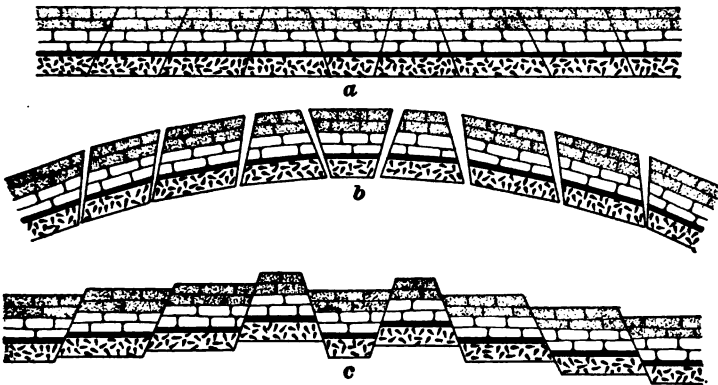

FIG. 50.

of the pressure of the steam and gases, the material were allowed to fall back once more, the blocks would naturally tilt over onto each other, as shown at *c*, and this would result in a series of normal faults. Another possible cause may be as follows: If the material were broken, as shown at *a*, and pressure brought to bear upon the under side of it, the portions having the broad bases would naturally be forced up on account of their having greater areas of base exposed to the pressure, and for the same reason the portion with a narrow base would drop down beneath them, causing, in both cases, normal faults. In many cases subsequent erosion has removed the higher side of the faulted material,

and hence the fault may give no evidence of its existence on the surface. In some cases it is probable that the slip has not been all at once, but has occurred slowly through a comparatively long period of time. Where fissures were caused by lateral pressure, reverse faults would naturally be expected, but where they were formed by lateral contraction or by a stretching of the surface owing to upheaval, normal faults would be expected. Frequently the faces of a fissure rub against each other during the faulting, so that one or both of the surfaces become polished. These polished surfaces are called slick-insides.

MINERAL VEINS AND ORE DEPOSITS.

132. Distinction Between Veins and Dikes.—All regions that have been subjected to faulting and bending (as most mountain regions) are seamed and scarred in every direction with veins or dikes, as if the surface of the country had been broken and mended. These breaks are, as a rule, along the lines of fissures, and when filled with material of igneous origin they are called dikes. When filled with material which had been deposited subsequent to the formation of the fissure, they are called veins. Sometimes the term "vein" is applied to either class, but the distinction above made will save a great amount of confusion.

133. Veins.—True veins are accumulations mostly in fissures of certain minerals which are usually in a purer condition than the surrounding rocks, and often in a sparry or crystalline condition. The accumulation has, in all cases, taken place after the fissure was formed and by a slow process. At times the veins follow no distinct fissure, but the material has been deposited along the lines of crushed or broken rock or at the contact of beds or rock formations.

134. Different Kinds of Veins.—The different kinds of veins may be divided into veins of segregation, veins of infiltration, and fissure-veins.

135. Veins of Segregation.—Veins of segregation do not differ materially from the surrounding or country rock, but are usually composed of the same elements or minerals; as examples, the veins or streaks of coarse-grained granite in granite may be mentioned, which differ only in the color and texture of the contents, or the irregular veins of feldspar in granite and in gneiss. Such veins have no distinct cause, and were not caused by the filling of a crack or fissure, but by the collecting of the material along certain lines, either while the rock was cooling from the fused or plastic state or by the subsequent action of percolating waters, much as concretions or balls of iron ore are formed in some rocks. Such veins may sometimes contain valuable ores, but in small quantity.

136. Veins of Infiltration.—Veins of infiltration may include gash-veins and stockwork. They may be simply deposits in the joint planes which occur in all rocks, or they may be deposits in the bedding planes of rocks. Fig. 51 illustrates the occurrence of gash-veins in joint planes. Sometimes the veins of infiltration occur simply in broken or crushed material.

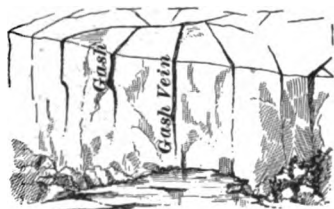

FIG. 51.

They are commonly filled with silica or calcium minerals, and sometimes contain very rich ore, though they are never of great extent. The term "stockwork" is applied to such veins when they are so intimately associated with the country rock and cross each other in such a network that the entire formation has to be mined to obtain the material in the veins. Usually veins of this class have distinct walls, and frequently the material deposited in them has a ribbon or banded structure very similar to the bands in the agate, and this structure was probably caused by the material being deposited at different periods and very slowly, in the same manner that agates or opals

are deposited in the amygdaloid volcanic rocks. Sometimes when the country rock is limestone, the agencies depositing the material seem to have dissolved away some of the limestone rock and formed chambers or enlargements of the gash-veins, and the gash-veins may be connected with deposits between the bedding planes or in a zone of broken limestone near the bottom of the formation. The lead veins of the upper Mississippi Valley are of this class.

137. Fissure-Veins.—Fissure-veins, like dikes, are formed by the filling of great fissures, and hence extend along the country for considerable distances, and also extend into the earth to great and unknown depths. They may be very wide and, like dikes and fissures, frequently occur in parallel systems.



FIG. 52.

138. Selvage or Gouge.—The dividing line between the vein material and the country rock is usually distinctly

marked, on account of the fact that the vein has resulted from the filling of a previously existing fissure. At times this line is marked by a deposit of clay or other material along the face of the vein between the ore and the rock. This dividing deposit is commonly called selvage or gouge.

139. Minerals Found in Veins and Beds.—Iron occurs principally in beds or large deposits, and in many cases seems to have been dependent upon organic matter for the formation of the deposit. Lead and zinc occur mostly in flat beds or deposits in or on limestone. Manganese also occurs in a manner similar to iron ore. Most of the other metals occur in veins, and the majority of large deposits occur in fissure-veins. If the outcrop of a vein is soft, subsequent erosion may form gullies or valleys where the veins outcrop. Fig. 52 is an illustration of a mountain-side on which two series of veins cross each other, and erosion has formed a series of valleys approximately following the outcrops of the veins.

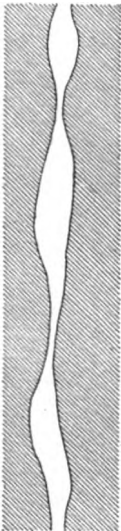

FIG. 53.

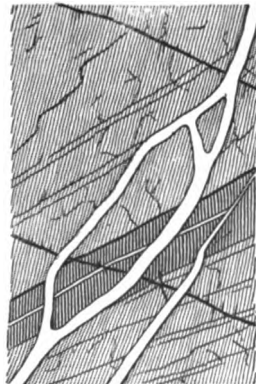

FIG. 54.

140. Pockets and Horses.—When rock is faulted, it does not always break into perfectly straight or smooth

planes, but frequently the surface of the break is irregular in the direction of the dip of the fault and decidedly crooked in the direction of the strike of the fault. If the fault stops in such a position as to leave the projections on the opposite walls together, it results in a set of conditions similar to that illustrated in Fig. 53. Such a case may give rise to pinches or narrow places and to the wide places or pockets in many veins. Sometimes masses of rock become broken from the walls and are subsequently surrounded by vein matter. Such masses are called horses, and one is illustrated in Fig. 54.

141. Gangue.—The contents of all mineral veins may be divided into two parts: the vein stuff or gangue, which is usually composed of barren material, and the ore or mineral of value. The principal gangue minerals are quartz, carbonate of lime (calcspar), carbonate of baryta, carbonate of iron, sulphate of baryta (heavy-spar), fluoride of calcium (fluorspar). Sometimes various manganese minerals, or other lime compounds than those mentioned, such, for instance, as dolomite, occur in the gangue material or veins.

142. Ore.—In the case of practically all ores the mineral of value occurs either in small bunches or particles scattered through the gangue in certain small streaks and leaders, or it may occur in pockets of considerable magnitude where the vein is intersected by other veins or dikes, or where the conditions have favored the concentration of the ore material. Nearly any of the metallic minerals described in the Paper on *Mineralogy* may occur in veins as ore.

143. Arrangement of Materials in Veins.—Occasionally the minerals in the vein are associated so as to form an ordinary rock, and hence the vein has considerable resemblance to a dike, but in most cases the material filling the vein has been deposited in successive layers or bands. Fig. 55 illustrates this banded, or, as it is sometimes expressed, ribboned structure. The central vein *a* is composed of galena; the bands *b, b* of fluorite; *c, c* of baryta;

d, d of quartz, which has crystallized as shown in the illustration; *f, f* are the gouge or selvage; *g* the hanging wall and *h* the foot-wall of the deposit. This banded structure is not always as plain as shown in the illustration, for the mineral or some of the gangue constituents may be pinched out in a portion of the vein, only to reappear again as pockets in a wider part of the deposit.

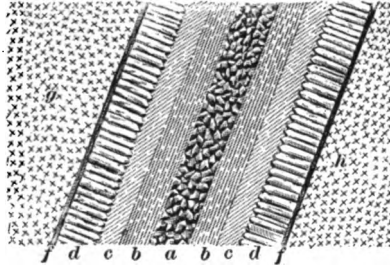

FIG. 55.

At times the narrow portions of the deposit contain the richest mineral, and these narrow portions are sometimes called ore leaders or stringers.

144. Contact Deposits.—Deposits of ore frequently occur at the contact between igneous rocks and the adjoining country rock, or between joints or cracks of country rock, especially where two kinds of rock join.

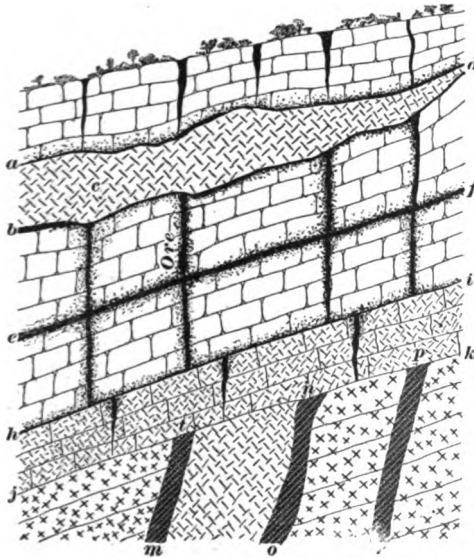

FIG. 56.

Fig. 56 illustrates a number of these cases. In the lower part of the figure the original country rock was gneiss. This was cut by a large porphyry dike, and subsequently contact veins formed at *t m* and *n o* on each side of the dike. The

fissure pr was filled as a regular or true fissure-vein. Subsequently the surface was eroded and the deposit of quartzite $hikj$ laid down, probably as a sandstone. Then on top of this the limestone was deposited; subsequently the region was again disturbed and the intrusive porphyry dike c forced into the limestone. After this, contact deposits formed along both sides of the intrusive sheet of porphyry, as at ad and bd . Farther down in the limestone the bedding plane ef became an ore bed, and the vertical joints all through the

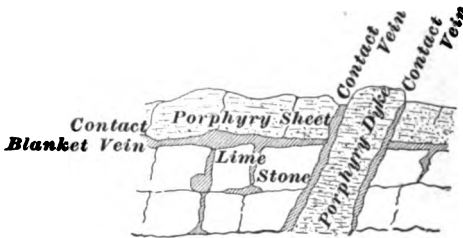

FIG. 57.

limestone became ore chutes. The contact hi between the quartzite and the limestone also became a contact deposit, the ore extending slightly into the joints of the quartzite, but no contact ore-body being formed along the line jk between the quartzite and the gneiss. It is evident that the porphyry played an important part in the formation of these ore-bodies in the limestone. Fig. 57 illustrates another case in which a dike and an overflow of porphyry have been instrumental in forming contact veins between the porphyry and the limestone.

145. Vein Formed

in a Dike.—Frequently a vein consists of a decomposed dike of some eruptive rock which is highly impregnated with mineral, the impregnation taking place most strongly at the contact

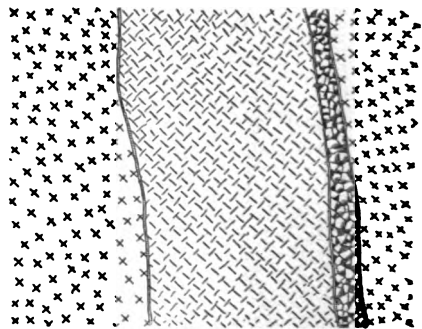

FIG. 58.

between the dike and the country rock. Fig. 58 illustrates such a case.

146. Peculiar Occurrences of Ore.—In the Silver Cliffs region at the Bassic mine, the ore deposit seems to be composed of the throat of an extinct volcanic crater filled with lava pebbles, the spaces between the pebbles being filled with very rich ore. At the Bull Domingo mine the same formation occurs, only the pebbles are all granite and are coated with a layer of galena rich in silver, the pebbles themselves being entirely barren. Sometimes percolating waters have mineralized some certain bed or stratum in the formation, and thus formed the blanket

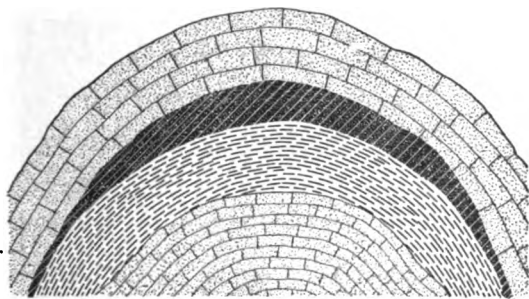

FIG. 59.

deposits or the saddle reefs. Subsequent metamorphic action may change these strata into quartzite or other solid mineral, without destroying or changing the value of the formation as an ore. The great low-grade gold mines of the Black Hills and the Treadwell mine in Alaska are examples of this class. Also, the blanket gold deposits of Africa and the Saddle Reefs of Australia. Fig. 59 illustrates a saddle-reef formation occurring in an anticline, the ore deposit being situated between the sandstones and slate rocks.

147. Age of Ore Deposits.—The age of veins or ore deposits can not in many cases be accurately determined. In the case of veins, it is evident that the ore deposit must be younger than the rocks through which the vein or fissure cuts. Then, too, the relative age of two or more deposits can frequently be determined by observing which of the

formations is cut or faulted by the other. In other words, the relative age of fissures can only be determined by knowing their relative position, as in the case of determining the age of volcanic rocks and dikes.

148. Surface Changes.—Mineral veins seldom if ever outcrop on the surface in the condition in which they have been described, but their surface exposures undergo certain changes caused by the influence of atmospheric agencies, which render their appearance along the outcrop quite different from that of the same vein at a greater depth. A practical knowledge of these changes is of great importance to any one searching for minerals of value, but the changes are extremely various, differing not only according to the metallic contents of the vein, but also according to the gangue material and to the country rock; therefore, a knowledge of the conditions in any given case can only be obtained by observation in that locality. It may be well to take up the general changes which occur in a few of the most prominent minerals as examples of this class of atmospheric effects.

149. Copper Veins.—The original form in which copper minerals seem to exist is as a sulphide of some form, and frequently as a double sulphide with iron ($CuFeS_2$). Now, along the back or outcrop of copper deposits the vein usually contains little or no copper, but consists of gangue material (more or less changed according to its position), among which are scattered masses of brownish hydrated peroxide of iron, usually in a light spongy condition. This peculiar form of peroxide of iron is characteristic of the outcrop of copper veins, and is called by the Cornish miners "gossan," and by the German and French miners "iron hat."

Below the gossan or oxidized portion of the vein there occurs a rich deposit of copper minerals, composed of native copper, red and black oxide of copper, green and blue carbonates of copper, etc. Below this rich deposit the vein will be found in its unaltered condition. Sometimes the rich deposit is located on one wall more than on the other; at

other times it extends entirely across the vein at or near the drainage level of surface waters. Fig. 60 illustrates

these conditions. *a* is the outcrop or blossom of the vein; *b* is the gossan; *d* represents the rich deposit of secondary mineral; *c* the unaltered portion of the vein; *e* the hanging wall and *f* the foot-wall. The portion of the vein *b* undoubtedly originally contained the mineral in practically

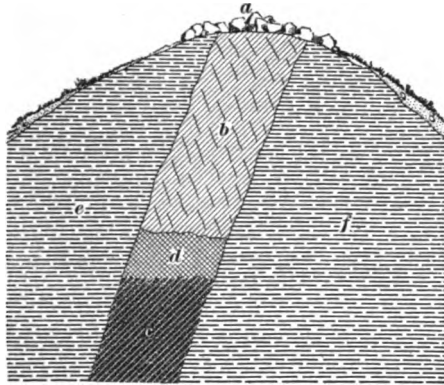

FIG. 60.

the same condition in which it is found in the portion *c*, but the action of the surface water has leached out the copper and redeposited it at *d*. The deposit *d* may represent not only the copper from the portion of the vein *b*, but from a greater portion, for it is undoubtedly true that the process of erosion has gone on simultaneously with the process of leaching, and hence a considerable portion of the leached ore may have become removed by erosion. Sometimes where gold or silver ores occur associated with the copper ores, the gold may remain in the gossan, together with a portion of the silver, so that the outcrop of the vein appears to be a gold or silver ore rather than a copper ore. This was especially true of most of the mines at Butte, Montana. The rich deposit of secondary mineral may occur quite near the surface or may be several hundred feet from the surface, depending largely upon the topography of the country and upon the depth to which the effects of surface agencies extend.

150. Lead Deposits.—The natural or original form in which lead occurs seems to be as a sulphide of lead or galena, but along the outcrop of the veins it is commonly

found as a carbonate. The explanation seems to be that the galena (PbS) is decomposed by atmospheric agencies and becomes a sulphate ($PbSO_4$), and then the sulphate, by reaction with carbonate of lime derived from the wall-rocks or from calcspar in the gangue material, becomes carbonate of lead. In proof of this, it is stated that the galena thrown out from lead mines in England along with the rubbish of limestone has all in the course of time been changed into carbonate. Moreover, it is common to find in lead deposits masses of sulphide changed on the outside to carbonate.

151. Gold Deposits.—Gold is found largely associated with iron pyrites or other metallic sulphides. In many cases, gold seems to be in a metallic state even when contained within the crystals of the sulphides. Now, at the outcrop of the vein the sulphides become oxidized and reduced to sulphates, which are leached out by the circulating waters, leaving (in the case of iron) some peroxide of iron and free gold. On this account, the gold in the outcrop of most veins is in a free condition, while at greater depths a large portion of the value may be contained in the sulphides. The quartz of the vein which originally contained the sulphide is left in a granular or porous condition by the leaching out of the sulphide, and it is frequently colored red by the oxide of iron which remains. As in the case of the ores previously described, the effect of these surface agencies may extend to a depth of several hundred feet, but below that point the gold is usually found associated with the sulphides.

152. Placer Deposits.—During the process of erosion and disintegration of the rocks, it has been seen that the material eroded undergoes a sorting action while being transported and deposited in the water. During this sorting action the heavier particles settle first. Now, certain heavy minerals or metals are unaffected by the atmosphere, and hence would naturally collect into deposits near the places from which they were eroded. Among this class of material may be mentioned native gold, platinum, tinstone,

or oxide of tin, monazite sands, and some precious stones. These deposits containing material of value, but especially those containing metallic gold, are termed placer deposits. It is probable that many of the placer deposits contain practically all the gold from very large areas of strata which have been eroded, and the greater part of the contents of which have been washed to the sea, leaving the gold or heavy minerals deposited comparatively near the rocks from which it was obtained.

153. Some Facts Concerning the Occurrence and Richness of Metalliferous Veins.—Metalliferous veins occur mostly in regions where the crust movements have produced tiltings, foldings, and the resulting fissures. This action is usually accompanied by more or less metamorphism of the rocks, and these conditions seem to be necessary for the formation of most mineral veins, hence most minerals are found in mountainous regions or in regions which have undergone the greatest metamorphic action. Lead and zinc seem to be an exception to this rule, and these exceptional occurrences will be considered separately. Metalliferous veins occur mostly in older rocks, but the principal reason for this seems to be that these rocks have undergone the greatest amount of change or metamorphism, hence the age of the formation is not as much of a criterion as to its value as is the location of the formation and the amount of change it has undergone.

154. Pay Chutes or Chimneys.—The contents of any vein, whether it be a gold or silver vein, or whether the precious metal be associated with other materials, is liable to vary greatly from point to point, and the rich ore will usually be found in chutes or chimneys. Sometimes this ore can be detected by a slight change in color or character of the gangue material, which is probably due to the slightly different solution from which the ore was deposited; but these indications may, and often do, vary in different parts of the same mine, and hence the exact value of any gold or silver ore and the limits of the pay ore can be determined

only by assaying. It has already been stated that regions which have undergone metamorphic action are those in which gold or silver and other metals are most liable to be found.

155. Parallel Veins.—Usually parallel veins contain similar ores, though veins at right angles frequently contain similar ores, on account of the fact that there is the usual secondary series of fissures at right angles to the principal fissures caused during any crust movement. Veins at other angles than those which are practically parallel or at right angles usually contain different ores.

156. Effect of Wall-Rock on Vein Contents.—In fissure-veins the country rock seems to have less effect upon the contents of the vein than in the smaller deposits and gash-veins, and yet it is not uncommon to find a fissure-vein carrying one form of mineral while passing through one rock formation, and other forms of mineral while passing through other rock formations. Metallic veins are usually richer at points where they are intersected by granite or dikes of igneous origin, and this is especially true where the strata adjoining the dike have undergone considerable metamorphism from the heat of the material in the dike. When two veins intersect, the point of intersection frequently contains richer ore than either vein does in its ordinary course. Sometimes veins are barren, as far as mineral value is concerned, except where they intersect dikes or igneous rock. The Silver Islet mine in Lake Superior is a good illustration of this. The vein occurs in a fissure cutting through the unaltered flags of that region, and at the point where it intersected and faulted a dike which had previously been formed, the vein became filled with valuable silver mineral.

157. Faulted Veins.—When veins are faulted or slipped, the continuation is searched for by the same rules employed in searching for beds which have been faulted; that is, that the foot-wall of the fault has usually moved up in regard to the hanging wall, or, in other words, to find the

continuation of the vein, follow the greater angle. As has already been stated, the surface indications of veins vary in different regions, and the prospector must of necessity become familiar with the region in which he expects to operate.

158. The Theories of Vein Formation.—Some parties have held that veins, like dikes, were filled with igneous injections; others, that the vein contents are the result of deposits from vapors containing minerals which were ascending through the fissures; and still others have held that electric currents traveling certain fissures or veins have been influential in forming the deposits. All these theories seem to lack positive proof, and while each may apply in certain instances, practically all scientists are at present agreed that, in general, the vein filling has been the result of the circulation of percolating waters. The manner in which smaller amygdaloids may be formed in cavities has already been noted, as has the method in which the waters may obtain minerals from the country rocks, and it is probable that small gash-veins, etc., are practically all filled by this method of lateral infiltration from surface waters; but in the case of deep fissure-veins it is probable that most of the deposits are the result of heated alkaline solutions which have ascended through the veins and which contained the minerals or other material in solution. The waters may have derived a large portion of their contents from the adjoining country rock, or it may all have been derived from great deposits.

159. Gangue Material.—The ribbon structure and the net-like system of crystals as exhibited in many veins indicate that the material was deposited in successive bands or portions from solutions. Fig. 55 illustrates this banded or ribboned structure. Silica or quartz is the most common of the gangue minerals, and it is evident that the beautiful crystals frequently found in veins could not have been formed in any other manner than from solutions. The material in the veins often contains small cavities in the

crystals or in the body of the gangue minerals, and these cavities contain fluid which has been enclosed at the time the vein was formed. The cavities in quartz are easily observed on account of the transparent nature of the mineral. These cavities could not have been formed if the veins had been formed under any other conditions than from aqueous solutions. Also, many of the minerals found in veins will not stand fusion, and hence have evidently been deposited without fusion.

160. Hot Solutions.—It is evident that the solutions were heated from the following considerations: Deep fissures would naturally become filled with water, and the lower portion of the fissures would naturally reach to depths where the waters would be hotter than the surface waters, and hence an ascending current would be set up in the fissure, the water to supply the current gradually settling down through the adjoining country rock. But one of the best proofs as to the temperature of the water can be derived from the fluid cavities found in the gangue minerals. The fluid does not always fill these cavities, showing that there is a vacuum in the cavity and that the fluid was deposited at the higher temperature. By heating the material until the cavity is filled, the temperature at which the deposit was made can be approximately ascertained. By this means it has been determined that the temperatures varied from ordinary temperatures to from 300° to 350° F. Veins are almost inevitably associated with regions where metamorphic action has occurred, and hence it would be expected that the waters contained in the veins or fissures would be hot.

161. Alkaline Solutions.—That the solutions which effected the filling of the veins were alkaline is evident from the following facts: Alkaline carbonates and *sulphates* are the only solvents for silica or quartz, which is the most common of the gangue minerals, and if these waters contain an excess of carbonic acid gas, as is usually the case, they would also naturally dissolve the carbonates of lime, baryta,

iron, etc. In California and Nevada such hot alkaline carbonate and sulphide springs abound, and are now depositing silica as quartz, together with carbonates of lime and iron, and some of them are even filling fissures.

162. Origin of Metallic Ores.—It is probable that the metallic ores were deposited in the same manner that the gangue materials were deposited, and probably at about the same time. Metallic sulphides are the most common form of ore, and many of the other forms in which the ore occurs can be traced to them. Metallic sulphides are slightly soluble in alkaline sulphides, and these latter are often found associated with alkaline carbonates, as, for instance, in many of the hot springs in California and elsewhere. Such waters would deposit both the gangue materials and the ore upon cooling, or the mineral might be precipitated by the meeting of different solutions or by the presence of organic matter. It is also not unlikely that the enclosed walls of country rock had more or less to do with the depositing of some minerals.

163. The view that metallic sulphides and their ores were deposited from hot springs receives considerable support from the fact that the hot springs of California and Nevada, and especially the Steamboat Springs near Virginia City, Nevada (so called on account of the periodic eruptions of hot steam and water), are forming such deposits at the present time. The waters of the Steamboat Springs are strongly alkaline and deposit silica in abundance. This deposit fills fissures, some of which are practically filled, and now form veins. The filling material exhibits a perfect ribboned structure in some cases. Moreover, the sulphides of several metals, i. e., iron, lead, mercury, copper, and zinc, have been found in the quartz gangue material. In this case, then, a true metallic vein is being formed at present. Practically the same process is going on at the Sulphur Bank, Lake County, California, where hot alkaline sulphide waters coming up from beneath are depositing silica and cinnabar in small irregular fissures and cavities,

thus forming quartz veins containing cinnabar. The deposit is so recent that much of the silica is in a soft hydrated condition and can be cut like cheese.

164. Percolating waters traveling in any direction may carry or deposit material of value, but the ascending waters are most likely to produce extensive deposits. Hence, the large fissure-veins are the most liable to be paying mineral deposits. It is evident that the fissures would furnish free watercourses, and that the waters would naturally tend to ascend, and in so doing to become cooler. Sometimes, in place of the formation of a single fissure, the rock is simply crushed, so as to form a series of small parallel seams, which ultimately become filled with mineral. The cinnabar bodies of California are particularly good illustrations of this class of deposit. At other times the fissure breaks or crushes quite an area of rock, and the vein material cements this broken country rock together, thus forming a kind of breccia. At other times, certain soluble rocks, such as limestone, have passages dissolved in them by the circulating waters, and these passages or spaces are subsequently filled with ore by the same agencies. Even a porous rock, like sandstone, may become a place for ore deposits, as, for instance, the silver and copper bearing sandstones of New Mexico and Utah. The exact chemical reactions which took place in the forming of mineral deposits are not fully understood, but there seems to be no doubt that the greater part of our supply of mineral has been deposited in this way from hot alkaline solutions.

165. It is known that the sea-water contains most metals in solution and that they are deposited in small amounts over the sea bottom and become scattered through all sedimentary rocks. Volcanic rocks also contain small amounts of different metals disseminated through them. Circulating waters may subsequently dissolve these particles of mineral and then redeposit them in veins or beds. In this way it is possible for waters to contain metals, even though they have not ascended from great depths, and the

solutions may come from almost any kind of rock formation. After the material is in solution, the water may descend to a great depth, and subsequently deposit its burden of mineral while ascending through some fissure.

166. A Study of the Drift Gravel Mines.—Some evidences as to the method of formation of mineral veins

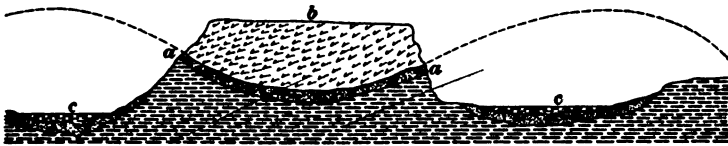

FIG. 61.

can be obtained from a study of the drift gravel mines of California. These are placer deposits in ancient river-beds, which have been covered with subsequent lava flows. Fig. 61 illustrates such a condition. The original river-bed was in the hollow *a a*, and its gravel or placer deposit was subsequently covered by an overflow of lava *b*; *c* and *c* are the present river-beds. The lava in these overflows was frequently underlaid by a deposit of volcanic scoriæ or mud, and the lava itself was not of the thoroughly fused type. The gravel in the ancient river deposit usually contains more or less driftwood and other organic matter. Waters percolating through the lava deposit have become alkaline and have taken silica and various sulphides in solution, which they have subsequently deposited in the old river channel. Some of the logs or other organic material have been petrified, the silica taking the place of the wood. Iron pyrites has been deposited in some parts of the gravel formation, and these pyritic crystals frequently carry gold very similar to that found in the ordinary gold vein. But probably the strangest part of the deposit consists in the growth of gold nuggets. The placer gravel undoubtedly originally contained small gold nuggets, and in many cases they seem to have been enlarged by the subsequent deposits of gold

upon the outside, until they have grown to masses which in some cases weigh several pounds.

167. Lead and Zinc Deposits.—Lead and zinc deposits frequently occur in comparatively flat or unaltered limestone formations. In such cases the mineral sometimes seems to have been derived from adjoining rock formations, while in others they may have come from circulating waters which have ascended through the fissures and then traveled laterally out through the limestone, where they deposited their burden of ore.

168. Vugs.—Ore veins or ore deposits frequently contain vugs or openings which have not been filled with ore or gangue material.

169. Richness With Depth.— There have been many claims in regard to the effect of depth on ore deposits, some claiming that fissure-veins become richer with depth, while others hold to the opposite theory. There seems to be no particular ground or reason for either belief, and as far as is now known no definite law can be stated concerning this point. Some veins have been explored to a depth of about one mile, and have not been found to change to a considerable extent in value, while others may have a number of alternate changes, first becoming richer and then poorer. As has already been stated, the walls enclosing a deposit may possibly have some effect upon the value of the vein, as, for instance, it is not uncommon to find a vein containing good ore while passing through limestone, but upon following it into the underlying granite it may be pinched out and become barren or almost barren, or it may carry some other mineral than the one which formed the principal value of the ore in the limestone. From this it will be seen that the statement so often met with in the prospectuses of different mining companies that fissure-veins always become richer as they gain in depth has no foundation whatever.

FOSSILS AND CHARACTERISTICS OF THE PERIODS.

170. Before taking up a detailed study of the materials of economic importance which are recovered by mining or quarrying, it may be well to consider the principal fossils and remains of life found in the different geological periods, as these remains are all of great assistance in determining the age of any given rock formation, and this age is frequently of considerable local importance.

171. Archean.—The Archean rocks contain no distinct fossils, but the presence of masses of graphite indicates that there must have been some form of organic life from which the carbon was obtained, and the existence of extensive beds of limestone is evidence that some form of organism may have existed to form these deposits.

172. Cambrian.—The Cambrian period contains a number of marked or characteristic fossils. Fig. 62 illustrates a few of the most important and characteristic of these.

1, 2, and 3 represent three forms of trilobites which were one of the first forms of crustacea. The crustacea include our modern crabs, lobsters, etc. 6 and 7 represent two forms of shells which are comparatively common in some of the Cambrian rocks. 4 represents the tracks made by the crustacea while traveling over the soft sea

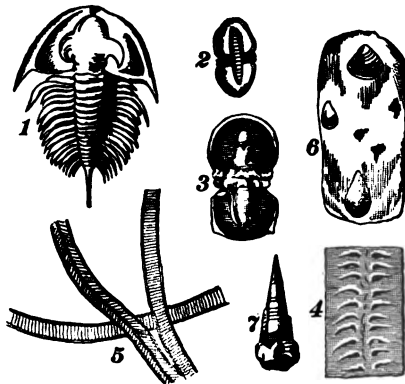

FIG. 62.—CAMBRIAN FOSSILS.

1, 2, and 3, Trilobites; 4, Track of Crustacea; 5, Track of Worms; 6, *Lingula Antiqua*; 7, Pteropod: *Hyalolithes primordialis*.

bottom or beach. 5 represents the tracks of worms. The burrows of worms are also frequently found and consist of small round holes which the worms had drilled or bored in the earth and in which they lived. These holes have become

filled with other matter, and can frequently be seen upon breaking open rocks of this period.

173. Silurian.—The Lower Silurian, and probably a portion of the Upper Silurian, belongs to the period before

any vertebrate life came upon the earth, but in the Upper Silurian a few fishes appeared, though the Devonian is really the age of fishes.

The Silurian period is characterized mainly by the large number of shells and coral which were developed during this time. Figs. 63 and 64

illustrate some of the most common Silurian fossils. In Fig. 63, the figures 1 to 6 show some of the characteristic shells of the period.

7*a* represents a trilobite open, and 7*b* represents the same species when curled up or closed. 8 and 9 are two of the simple coral forms, though the majority of the coral of this formation were not of the branchy type,

such as exists so commonly at the present day, but were more of the form shown at

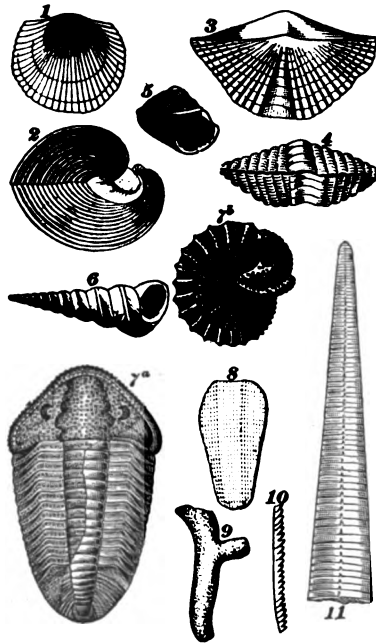

FIG. 63.—SILURIAN FOSSILS.

1, *Orthis-Davidsonii*; 2, *Pentamerus Knightii*; 3 and 4, *Spirifer Cumberlandiæ*; 5, *Pleurotomania agava*; 6, *Murchisonia gracilis*; 7*a* and 7*b*, *Calymenes Blumenbachii*; 8, *Coral Fenestella*; 9, *Coral Choetites*; 10, *Graptolite*; 11, *Orthoceras Duseri*.

(*d*), Fig. 64, which represents a cup or horned coral, or at (*c*), Fig. 64, which represents a coral which was composed of long cells joined together in a series of chains, as shown in the illustration. It was during this period that the form from which the modern nautilus and cuttlefish have descended first appeared. The nautilus has a shell composed of chambers as shown at (*a*), Fig. 64, which repre-

sents the modern nautilus. The chambers are connected by a tube running from the animal back through all the chambers, though the chambers themselves are empty. When the animal outgrows the forward chamber in which it lives, it advances the shell and leaves another sealed chamber behind it. The first shell of this type was chambered in the same manner, but was not coiled as is the nautilus. 11, Fig. 63, illustrates this shell, which was called the orthoceras.

(b), Fig. 64, represents a species of curved chambered shell which also came into existence before the end of the Silurian period. Another important form of life which appeared during this time was the crinoid.

This is illustrated at (c), Fig. 64. The crinoids were practically all attached to the sea bottom by long stems; the head of the crinoid was shaped considerably like a lily or flower, having five or more fingers or plates, which it could open or close while searching for food. In fact, the crinoid was a good deal like a starfish on the end of a stem. One very characteristic little fossil which is found in the Silurian rocks, but not found above them, is shown at 10, Fig. 63. This is called the graptolite.

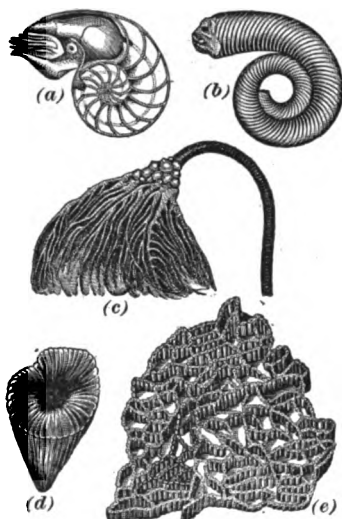

FIG. 64.—SILURIAN FOSSILS.

(a), Pearly Nautilus; (b), *Lituites cornu-arietis*; (c), Crinoid; (d), *Zaphrentis bilateralis*; (e), *Halysites catenulata*.

174. Devonian.—Fig. 65 illustrates a few of the most important of the Devonian fossils. 1, 2, and 3 are three of the common form of shells. 4 is one of the common forms of chamber shells belonging to the nautilus family which existed during that time. 5, 6, and 7 are three of the common coral forms. The corals of the Devonian period were

also more massive than those of the present time, and the cup coral, as shown at (*d*), Fig. 64, continued throughout this period, though in a slightly different form. 8, 9, and 10

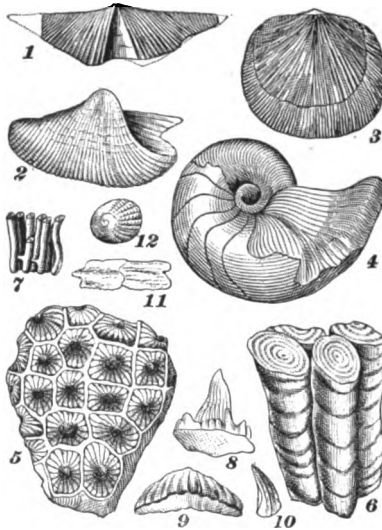

FIG. 65.—DEVONIAN FOSSILS.

1, *Spirifer perextensus*; 2, *Comocardium*; 3, *Orthis Liva*; 4, *Goniatites*; 5, *Acervularia Davidsonii*; 6, *Crepidophyllum Archici*; 7, Coral; 8, 9, and 10, Fish teeth; 11 and 12, Fish scales.

represent the teeth of fish and 11 and 12 scales or plates from fish. The Devonian fish were of the intermediate type largely, and were in many cases different from most of the modern fish. The earliest forms did not have scales such as most of the modern fish possess, but the bodies were covered with irregular horned plates; in some species only the forward part of the bodies was covered, and it is probable that these fish lived in holes in the mud of the sea bottom, only dashing out and exposing their soft bodies when actually pursuing prey.

The modern garpike has scales or plates on its body very similar to those of most Devonian fish, and many of the Devonian fish had teeth similar to those of the sharks of our day.

Both the Devonian and the Silurian rocks frequently contained pockets of graphite, pitch, or asphaltum, which seem to have been derived from organic remains of some kind. These organic remains may have been either seaweed or animal remains. It is also probable that the natural gas and oil derived from these formations come from the slow distillation of these organic remains after the rocks had become buried under their strata and the internal heat of the earth has had an opportunity to act upon the remains contained in the rock.

175. Carboniferous.—Fig. 66 illustrates a few of the most common fossils found in the Carboniferous formations.

Numbers *1a*, *1b*, *1c*, *2*, *3*, *6*, *7*, *8*, *9*, and *13* are shells which occur commonly among these rocks. Figs. *4* and *10* represent two of the common chambering shells of the nautilus type, as existing during the Carboniferous period. *5, 5* illustrate crinoids, though this type is sometimes called *blastids*, on account of the fact that the fingers are not well developed, but are replaced by five petal-like projections. Near the crinoids in the center of the picture can be seen two small disks which are sections broken from crinoid stems.

Both these sections and short pieces of crinoid stems are of very common occurrence in all rocks in Paleozoic times. *11* and *12* are characteristic coral forms of this period.

Some trilobites are found in the Sub-Carboniferous, but they disappeared during this period. The orthoceras or straight-chambered shells disappeared with the end of the Paleozoic time, and are practically, if not quite, extinct during the Devonian Age, though the curved or spiral chambered forms continued in great abundance.

During the Carboniferous period, fishes had become more abundant and had attained a higher stage in the scale of development than during the Devonian times. Before the end of the Carboniferous the first amphibians appeared.

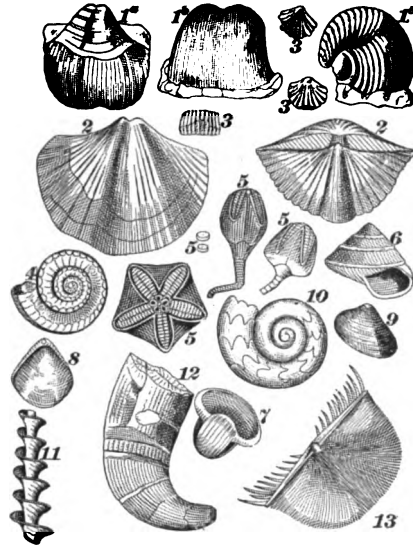

FIG. 66.—CARBONIFEROUS FOSSILS.

1a, *1b*, and *1c*, *Productus*; *2*, *2*, *Spirifer*; *3*, *3*, *3*, *Rhynchonella*; *4*, *Euomphalus*; *5*, *5*, *Crinoids (Pentremites)*; *6*, *Pleurotomaria*; *7*, *Bellerophon*; *8*, *Athyris Subtilita*; *9*, *Astartella*; *10*, *Goniatites*; *11*, *Coral (Archimedes Wortheni)*; *12*, *Coral (Clisiophyllum Gabbi)*; *13*, *Chonetes Dalmaniana*.

These are animals most of which carry throughout life both lungs and gills, and hence can breathe either air or water. But the characteristic of the Carboniferous period was, as its name indicates, the great abundance of vegetable life, which resulted in the formation of coal deposits. The vegetable life of the Carboniferous period was of the lower forms, such as our club mosses, ferns, etc., of the present

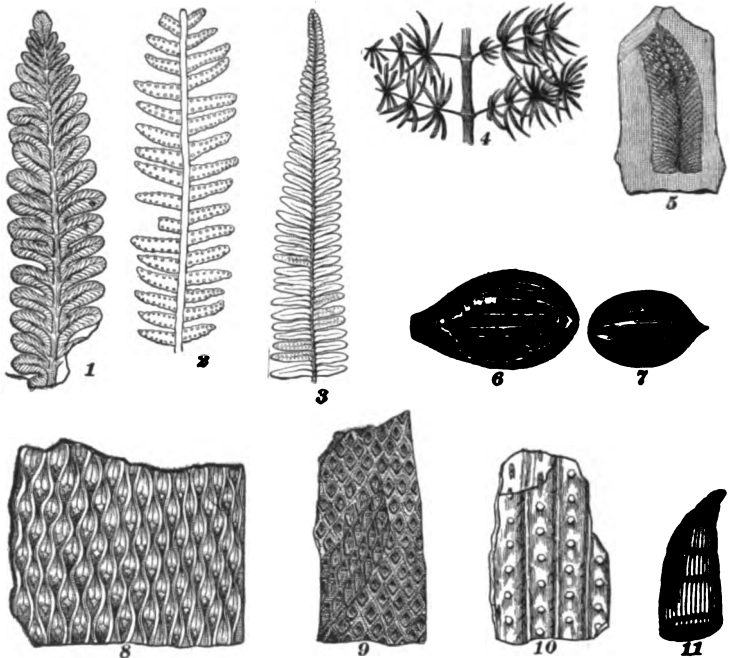

FIG. 67.—CARBONIFEROUS FOSSILS.

1, *Callipteris Sullivanti*; 2, *Pecopteris Strongii* (showing fructification); 3, *Pecopteris Strongii*; 4, *Asterophyllites foliosus*; 5, *Neuropteris*; 6 and 7, *Rhabdocarpon*; 8, *Lepidodendron modulatum*; 9, *Lepidodendron diplotegioides*; 10, *Sigillaria obovata*; 11, *Calamites* (lower end of stem).

day. There were no fruit-trees and no flowers, but the dense growth of vegetation in the swamps and on the low ground resulted in great peat-bogs, which finally became the coal seams of the present day.

A few of the characteristic fossils of the vegetable remains of the Carboniferous period are illustrated in Fig. 67. 1, 2, and 3 are ferns of the coal period, while 4 is a very common

form of vegetable life, and 5 a small leaf. 6 and 7 are fruit from the carboniferous trees. 8, 9, and 10 are impressions of the bark of the larger plant forms, while 11 represents the lower end of the stem of a calamite. These are very common in the fireclay underlying the coal-measures, while ferns, bark, and fruit are more common in slates which overlie the coal or any thin seams of slate in the coal-measures.

At the end of the Carboniferous period the thick deposits of sediment which had been so long accumulating in the Appalachian regions were folded and forced up to form the Appalachian Mountains. At the same time, or very soon afterwards, the Utah Basin region was upheaved to form land, while the Nevada Basin region sunk to become sea. In fact, the Pacific shore line was transferred eastward, but there still remained a narrow sea between the Appalachian Mountains and what are now the Rocky Mountains.

176. Permian.—The Permian is usually classed with the Carboniferous period, but is in reality the transition period between the Paleozoic and the Mesozoic time. In North America the transition between the two periods was marked by great changes in the continent. The Appalachian Mountains were forced up from the sea bed, and many extensive changes took place in the western portion of the country; hence in most places the Permian is entirely wanting in this country, though in parts of Illinois, Kansas, and some other localities it is present.

177. Jura-Trias.—In the greater part of North America it is impossible, or practically impossible, to determine the dividing line between the Triassic and Jurassic periods, hence they are usually considered under the one name of Jura-Trias, and the deposits of this period consist of a narrow strip along the Atlantic Coast, to which belong the sandstone deposits of the Connecticut River, similar deposits in New Jersey, and the coal deposits of North Carolina and Virginia. Also during this period there were extensive deposits both east and west of the principal range of the Rocky Mountains. During this period fish

developed into a form more like that known at the present time. True reptiles appeared, and also reptiles which very closely resembled birds, and finally birds which did not fly and probably had teeth. The vegetation approached more nearly that of the present time. In some parts of the world this period is marked by extensive salt deposits, and in others by extensive gypsum deposits. This is especially true of much of the formation of the eastern slope of the Rocky Mountains. Insects also became common during this period and some forms of land animals were developed.

At the close of the Jura-Trias, the eastern portion of the continent was elevated so as to bring the northern part of the Atlantic beds above the sea. Portions of the deposits in the Central States east of the Rocky Mountains were elevated, while other portions became covered with fresh-water or brackish lakes. The Sierra Mountains and the Cascade range were formed at the close of this period, thus moving the Pacific shore line westward again.

178. Cretaceous.—The Cretaceous period is mainly characterized by a general transition of the animal types, from those of the Jura-Trias to those of the Tertiary. The deposits of this period in America are confined to the Southern and Southeastern States of the United States, the central portion of the continent east of the Rocky Mountains, and the strip along the Pacific Coast. During this period the entire peninsula of Florida was under water. The chalk formations of Europe and England belong to the Cretaceous, and were formed from the remains of certain small shells which lived in the deep seas. The Cretaceous formations in the United States contain some quite extensive coal-fields, which are mainly situated in the Rocky Mountains, though the coal of this period, unless altered by metamorphic action, is liable to be rather soft. The plants approach more nearly to those of the present time. Great reptiles still lived in the sea and on the land, but the fish of the shark and whale family appeared. During this period the form of shell-fish of the nautilus or chambered order developed a great variety

of curved and crooked shells, some of them having the form of a trumpet or spiral spring, but many of them had very beautiful shells. The birds seem to have all had teeth set in distinct sockets similar to those of the reptiles, and great reptiles ruled both the land and the sea. At the close of the Cretaceous, the Wahsatch and Uintah Mountains were elevated, and the portion of the country which had formerly been a sea dividing North America into two continents was elevated into land.

179. Cenozoic.—At the close of the Mesozoic the greater part of North America was above water, but the Coast range on the Pacific side had not yet been formed, and the interior of the country contained great fresh-water lakes; also the Gulf or Southern States were still under the sea. During this period the land was ruled by great mammals and the sea by great fishes of the whale or shark order. These were so plentiful that in some places in the Southern States whole beds of sharks' teeth are found, and bones of the gigantic whale are frequently found in Alabama and Georgia. In the deposits of the great fresh-water lakes of the West many mammals, both large and small, are found, and the animals seem to have undergone a rapid evolution during this period. At the end of the Miocene the Pacific Coast underwent an extensive revolution, the coast chain being forced into existence and at the same time great fissures opened, which resulted in extensive lava flows over much of western and northwestern North America. At the end of the Cretaceous period practically all the area of North America was above water, as was also the greater part of Europe. During the Tertiary period there were a large number of coal deposits formed, but in most cases the coal is of a soft nature (lignite). The rocks of the Cretaceous and Tertiary periods of the extreme western portion of the continent have undergone metamorphic action, and hence are firm, solid rocks, while in most other locations they are not completely solidified. The soft rocks of the Mesozoic period have given rise to the peculiar formations

known as the Bad Lands of the West, which consist of irregular table-lands having steep valleys eroded through them. Frequently these irregular masses of material, which have been left in the process of erosion, look like distant cities or villages, or like great castles. During the Tertiary period the mammals developed to an enormous size, but in subsequent periods most of the mammals have disappeared. Some time during the Quaternary period man appeared, but he did not become ruler of the universe at once, but has developed as all other forms have. This period seems to have been characterized in the Northern Hemisphere by an elevation of the northern part of the continent, so that it became much colder than in the previous periods and was covered with a great ice sea which extended far south, forming the glacial period. Subsequently the continent was lowered as a whole to a point somewhat lower than that which its northern part now occupies, and after this gradually lifted to its present position. During the Mesozoic time and the Tertiary time the temperature of all the northern countries seems to have been very much warmer than at present, while during the glacial period the temperature was very much lower than at present.

ECONOMIC GEOLOGY.

180. Materials of Commercial Importance.—The general form of mineral deposits and the mode or manner of occurrence of most minerals have been considered under the head of Structural Geology, but there are some materials of commercial importance which should have separate consideration.

Among these are the following: (1) The metals, gold, silver, iron, copper, lead, zinc, manganese, nickel, cobalt, tin, mercury, antimony, and platinum. (2) Mineral fuels, petroleum and natural gas, bitumen and asphaltum, salt, building stone and slate, clay, gypsum, phosphates, sulphur, silica and other materials for the manufacture of glass,

pigments or the materials for the manufacture of paint, graphite, asbestos, mica, monazite, alum, borax, the soda and potash salts, and precious stones and gems.

GOLD.

181. Occurrence.—Gold, as stated in the Paper on *Mineralogy*, occurs in nature both as native or free metallic gold and as various minerals principally associated with tellurium. Gold deposits may be divided into three general classes: placer deposits, deposits which are mined for gold or gold and silver only, and from which the metal or metals are obtained by some milling or lixiviation process, and ores in which the gold is associated with copper or lead, from which it is obtained by means of a smelting or refining process. The surface changes that occur in gold deposits have been treated in Art. 151.

182. Placers.—Placers have been described in Art. 152 as resulting from the decomposition and erosion of various deposits and the subsequent accumulation of the gold (owing to its great specific gravity) by the sorting power of water. The methods of prospecting for placer deposits, of testing various gold ores by panning, and of working placer and hydraulic mines, do not come under the head of geology, but should be treated in works pertaining to these subjects.

183. The ores of gold in which the metal is associated with copper or lead, and which require smelting, are usually considered as copper or lead ores carrying gold, and hence would naturally come under the head of those ores and be treated according to the methods usually pursued for the recovery of such metals.

184. Special Occurrences.—Gold occurs not only in veins, but in beds or blanket deposits, as has been noted in connection with the subject of Structural Geology. Sometimes these beds or blanket deposits are undoubtedly placer deposits which have accumulated either in river-beds or on or near old sea or lake shores; or the gold in the rock may

have been deposited from circulating waters which have flowed through sandstone or other open formations and deposited gold, together with various minerals, there, subsequent to the time that sandstone was deposited. Owing to the fact that some of the gold reefs have in places films of gold on the outside of grains of sand or mineral matter, it has been thought probable that their gold was not deposited at the time the bed was formed, but was the result of subsequent deposits from circulating waters. The principal values in gold deposits generally occur in pay chutes or pockets as described in Art. 154.

185. Gold occurs in almost all countries, but is always more common in the regions that have undergone the most change.

SILVER.

186. Occurrence.—The silver minerals and the manner in which the silver occurs have been spoken of in the Paper on *Mineralogy*, where it is stated that native or metallic silver may be found under certain conditions, but most silver occurs as silver mineral. The distinction between dry, or milling, ores and smelting ores, and the distinction between free milling and refractory ores, was also explained in the Paper on *Mineralogy*. Silver minerals in the ore can frequently be detected by the eye or be determined by means of the blowpipe, but in the majority of cases an assay is necessary to determine the value of any given ore.

187. As in the case of the gold, the principal values in silver veins usually run in chutes or chimneys, and silver is not always found in veins or associated with other metals, but may occur in sandstone, as was the case in both Utah and New Mexico, where the organic remains of the fossils in the sandstone seem to have played an important part in the deposit of the silver. In the Lake Superior copper mines, nuggets of pure silver are frequently found associated with metallic or native copper. The copper and the silver are, as a rule, not alloyed, but occur in separate nuggets,

which may be joined with each other so as to form one mass of metal, the nugget being copper on one end and silver on the other. A large portion of the world's supply of silver comes from the argentiferous lead and copper ores, and in fact the silver often forms the principal value of such ores. Frequently the outcrop of a copper vein carrying silver contains silver, but no copper, the latter having been leached out and deposited farther down in the vein, as described in Art. 149.

188. Silver, like gold, is found in nearly all countries and in nearly all geological formations, but usually occurs in the regions which have undergone the greatest amount of metamorphism. The silver ore itself may occur in dikes or veins in nearly any kind of rocks or as pockets in limestone deposits.

IRON.

189. Requisites for a Good Ore.—The principal iron minerals have been given in the Paper on *Mineralogy*. The requisites for a good iron ore for making cast iron or for making Bessemer steel are that it should be very low in phosphorus. No iron or steel should contain over .1% phosphorus, and hence no iron ore for this process should contain over .05% phosphorus. The ore may be considerably higher in silicon, as this does not injure its quality, and the silicon may assist in the Bessemer process. For making basic iron, the ore should be high in phosphorus and contain practically no silica, as in this process the phosphorus is burned out in the steel converter, while in the Bessemer process the silicon is burned out. It is impossible for a prospector to determine the percentages of iron or of impurities in the iron ore, hence the assay or analysis should always be made by a good chemist.

190. Mode of Occurrence.—Iron ores very rarely, if ever, occur in true veins, but are found in lenses or beds, and organic matter seems to have played an important part in their formation. Ores of iron are especially abundant in

the coal-measures, but these deposits are practically all composed of ferrous carbonate, which occurs mixed with clay, and hence it is called clay ironstone. Often the ore is nodular or mammillated, and is called kidney iron ore. When it occurs intimately mixed with carbonaceous matter, it is called black band ore. Deposits of this latter class are found in Pennsylvania and Ohio, and some of the deposits have furnished a considerable portion of the supply of ore in England and Scotland.

191. Most of the iron deposits in formations other than the coal-beds occur in the form of ferric oxide. They may be hydrated, in which case they form brown hematites or limonites, or they may be anhydrous, in which case they are red hematites. The deposits also often contain magnetic oxides. The outcrops of pyritic veins are often oxidized, forming deposits of hematite and limonite. In the West such deposits frequently carry gold and silver, and as iron is required as a flux in the lead smelters, this class of ores is especially welcome, for the gold and silver will be recovered during the smelting process. Deposits of pyrite are of value when located in a mining region as a fuel for pyritic smelting, or the pyrite may be employed to form a matte with dry gold and silver ores. When the deposits occur in regions where large amounts of sulphuric acid are employed, they are valuable for the manufacture of this acid, and sometimes the resulting iron oxide has been employed in making certain grades of iron. As a rule, however, iron ores containing large amounts of sulphur are valueless as ores of iron, but sometimes ores containing some sulphur, especially when low in phosphorus, are roasted to expel the sulphur, and then employed in the manufacture of iron.

192. Ores of iron occur in most geological horizons, but different formations seem to contain the best deposits in different regions. The great iron ore deposits of the Lake Superior region are practically all in the Archean rocks, while many of the deposits worked in other parts of North

America are of more recent origin. As a rule, the largest deposits seem to be in the older rocks.

193. Most, if not all, of the deposits of magnetic iron ore appear to have been formed from the other oxides by metamorphism, and this also seems to be the origin of a large number of the deposits of hard hematite. Frequently the rocks containing these hard ores are not conformable with the strata containing the soft ores, and the latter frequently occur in valleys between the hills of the older rocks, and appear as though the deposits had been formed in the valleys which they now occupy.

194. The sharp competition in the iron industry and the extremely strict demands as to the purity of the ores have shut many deposits out of the market, so that now most of the supply of iron ore in North America comes from the Lake Superior region and from Alabama, though quite a large amount is produced in Pennsylvania or other portions of the East, and in Colorado. Good ore has also been furnished from various other points of the Rocky Mountains, from Missouri, from several of the Eastern and Southern States not previously mentioned, from Cuba, and South America. Iron ore is mined in several localities in England and in a large number of places on the continent of Europe, ranging from northern Sweden to southern Spain. Ore of good quality has been discovered in Africa and many parts of Asia.

COPPER.

195. The ores of copper are given in the Paper on *Mineralogy*. The world's supply of the metal comes from two sources: (1) The mines producing native copper only; (2) the mines producing some of the ores of copper, with possibly a small amount of native copper near the surface.

The mines producing native copper only are limited to those of the Lake Superior region in the United States. Where the copper occurs as fine threads or grains in trap or conglomerate rock, occasionally large masses are found, and

the native copper is accompanied by small amounts of native silver, the silver as a rule not being alloyed with the copper and occurring as silver nuggets, which are nearly pure silver, and a strange feature of the deposits is that frequently a nugget may be composed partly of silver and partly of copper, as though the two had been welded together. A considerable portion of the world's supply of the metal comes from these Lake Superior ores. They have the advantage over all other ores that the metal, being in a pure state, simply has to be crushed and washed free from rock; also, on account of the fact that such impurities as sulphur, arsenic, etc., are unknown in these deposits.

196. In veins or deposits where the copper occurs in a mineral, it is not uncommon to find a considerable quantity of native copper near the surface, but this seems to have always resulted from the decomposition of sulphide ores through the action of surface agencies. Fig. 60, Art. **149**, illustrates the manner in which the upper part of a vein carrying metallic sulphides or other metallic compounds may become leached out and a secondary deposit formed. *b* represents the leached portion of the vein, *d* the secondary deposit, and *c* the unaltered portion of the vein. In the case of copper minerals, this enriched deposit usually consists of native copper, together with the rich oxides, carbonates, and sulphides of copper, and occasionally native silver. Sometimes the copper has been leached from the upper part of the vein, leaving only silver and gold, or one of the metals alone, in the weathered portion of the deposit. At times the outcrop of the copper veins shows no signs of copper, all the metal having been leached out. At other times a small amount of the metal has been reduced to the form of a carbonate, and has so stained the rock that it gives the appearance of a very much greater deposit of the metal than really exists.

197. In western North America there are copper deposits which follow in a general line the mountain systems all the way from British Columbia to the Isthmus. The

richest of these deposits occur at Butte City, Montana, and at various points in New Mexico, Arizona, and Old Mexico. Colorado also furnishes considerable copper, most of which is a by-product from the concentrates of gold and silver mines, or as matte from the lead smelters, the copper minerals having been associated with the other constituents of the ore and the copper being recovered as a by-product during its treatment. Practically all the copper ores of this section carry gold and silver, which in many instances form the principal value. A small amount of the copper mineral has been obtained from the lead and zinc mines of the Mississippi Valley. At Sudbury, Ontario, there are rich deposits containing copper, nickel, and cobalt. In the Eastern and Southern States of the United States, deposits of copper are often worked, but in most cases they are secondary ores resulting from the decomposition of veins by atmospheric agencies and the concentration of the ore in certain portions of the vein, as illustrated by Fig. 60, Art. 149. For this reason, though many of the deposits may be rich, they are of small extent and are soon exhausted. The copper deposits of South America follow the Andes Mountains, much as those of North America follow the Rocky and the Sierra Mountains. Copper is also produced at various points on the continent of Europe, especially in Spain, and in other portions of the world, as Japan, Australia, etc.

LEAD.

198. The ores and minerals of lead are given in the Paper on *Mineralogy*. Lead ores are divided into two general classes, depending upon their contents of silver. The silver-bearing ores are called argentiferous. Those which do not carry silver are called non-argentiferous. Lead ores occur in veins and also in bedded deposits mainly in or on limestone rocks, and, in fact, deposits of both lead and zinc are rarely found separated from limestone. The outcrop of lead veins or deposits rarely consists of galena, but is composed of a carbonate or sulphate ores which have

resulted in the decomposition of the galena. Such ores usually carry practically the same per cent. of silver or gold that are found in the original galena. With depth, these deposits run into galena. The general surface changes which are most common in lead deposits have been described in Art. 150. In some localities lead and zinc ores are mixed together in such a manner that they require separation by means of a concentrating plant. This is especially true of certain portions of southwestern Missouri.

199. Deposits of lead which are more or less argentiferous occur in eastern North America, following, in a general way, the line of mountains parallel to the seaboard, but as a rule these deposits have proved too small to be of commercial importance. Similar deposits occur in the Lake Superior region, but so far no really large lead mines have been developed in this portion of the country. The Mississippi Valley contains large deposits of non-argentiferous galena, located in western Illinois, Wisconsin, Iowa, Missouri, and Kansas. It is from these sources that a considerable portion of the supply of lead used in the United States has been derived. In the western portion of the continent, all through the mountain region, veins or beds of argentiferous lead ores occur, and they produce large amounts of lead as a by-product during the process of gaining the silver. Argentiferous lead ores also occur all through the Andes Mountains in South America and in a number of countries, such as Japan, Australia, etc. In North America the most important deposits of argentiferous lead ore are found in Colorado, Utah, Idaho, British Columbia, Arizona, Nevada, and Old Mexico.

ZINC.

200. The ores and minerals from which zinc is produced are given in the Paper on *Mineralogy*, and may occur as gash-veins in nearly horizontal country rock or disseminated through limestone formations in practically bedded deposits on top of, or in, limestone formations or in true

fissure-veins. At times the zinc mineral is so finely disseminated in the limestone that it is difficult to distinguish the ore from the country rock.

If the ore is high in silver, zinc forms a very unwelcome constituent, as it will interfere seriously with the smelting of the ore and the recovery of the lead, gold, and silver, though of late such ores are treated by forming an oxide of the zinc and a portion of the lead which is collected and employed as a pigment in the manufacture of paint, the gold and silver being collected in a small amount of lead bullion.

201. In most cases zinc-blende seems to have been the original zinc mineral, and surface deposits which are composed of carbonates, oxides, silicates, etc., seem to have been derived from the sulphide ores. In localities where the surface has been subject to decomposition or weathering, the sulphide ores of either lead or zinc are rarely found exposed.

202. Zinc deposits of importance occur in North America in the following regions: In New Jersey, Pennsylvania, Virginia, and other Eastern States, in Iowa, Wisconsin, Kansas, Illinois, and Missouri, in the Mississippi Valley, and in various portions of the Rocky Mountains. As a rule, zinc ores of the Rocky Mountains are associated with argentiferous galena, and may themselves carry gold and silver. Zinc ores are also mined in a number of European countries and in North Africa. Large deposits are known to occur in a number of countries which have not yet become producers.

MANGANESE.

203. Manganese minerals are rarely found pure in nature. The ores consist mostly of carbonates or oxides, and are often associated with iron or zinc. Manganese ores are employed in the manufacture of spiegeleisen, which is a highly crystalline compound of iron containing from 10% to 15% of manganese and a large amount of carbon.

204. Some of the manganese used in the manufacture of iron or steel is derived from the manganiferous iron ores, i. e., from iron ores containing from 6% to 8% of manganese. Some zinc ores, as, for instance, some of those occurring in New Jersey, contain both iron and manganese, and after the zinc has been volatilized the resulting mixture of iron and manganese is employed in the manufacture of spiegel-eisen.

205. Deposits of manganese ore are worked in Colorado, Arkansas, California, Georgia, New Brunswick, and a number of other locations in North America. It is also produced in Belgium, Greece, and other countries on the continent of Europe, and mines are operated in South America. Deposits are known to exist in Asia and various other portions of the world, which have not as yet been brought to a producing state. In general, manganese ores are found in practically the same horizons as those of iron, and they usually occur in beds or lenses similar to the ores of iron.

206. Some of the manganese ores are silver-bearing (as those mined in Colorado), and are worked for the silver they contain. Manganese ores are also sometimes employed in place of iron ores as fluxes at lead smelters.

207. The dioxide or black oxide of manganese (pyrolusite) is employed in bleaching, and its value for this purpose depends upon its ability to give up oxygen, so that when it is treated with hydrochloric acid it sets chlorine free, and the chlorine is employed for bleaching. Manganese dioxide is also used in the manufacture of glass to do away with the green or brown color due to the presence of small amounts of iron in the glass. The name pyrolusite comes from this ability to remove or wash away the color in the glass, and the action depends upon the fact that the dioxide can give up free oxygen.

208. Nickel and Cobalt.—Nickel and cobalt are usually associated in nature. Cobalt is never found in a

native or metallic state. The ores are sulphides, arsenides, arseno-sulphides, an oxide, a carbonate, a phosphate, and an arsenate. Nickel is found also associated with cobalt in the sulphides and arsenides. The ores of nickel are sulphides, arsenides, arseno-sulphides, an antimonial sulphide, a sulphate, carbonate, silicate, arsenate, and the metal is a constituent of several cobalt ores and also of pyrrhotite (magnetic pyrites). Metallic nickel has been found alloyed with iron in certain meteorites. Nickel ores are usually associated with those of copper or other metallic sulphides. The deposits are usually found in veins or in contact deposits at the sides of dikes.

209. At present the world's supply of these metals is practically all derived from two localities: First, the Sudbury district, in the Province of Ontario, Canada, where the metals occur associated with copper in sulphide and arsenide ores, which also carry platinum, and second, in New Caledonia, where the nickel occurs as a silicate associated with some cobalt and practically free from copper. At one time the "Gap" mine in Pennsylvania was the largest single producer of nickel in the world, but at present these workings are closed. Some nickel and cobalt are derived as a by-product from the lead and zinc mines of Missouri and from mattes at the various reduction works throughout the world. Deposits of nickel silicate occur in Oregon and in California, but thus far practically nothing has been done towards their development. Small amounts of nickel have been obtained from gash-veins or other small deposits throughout the Eastern United States, but none of these deposits has been of sufficient magnitude to warrant mining on a large scale. Nickel ores are also mined in various parts of the continent of Europe.

TIN.

210. As stated in the Paper on *Mineralogy*, the principal ore of tin is cassiterite, or oxide of tin. This is usually found in irregular or gash veins, in granite, in quartzose-

gneiss, or in mica-schist. It is often associated with wolfram, pyrite, and other minerals. The species of granite usually associated with tin is called greisen. So far, no regular veins or true fissures carrying tin ore and extending to great depths have been discovered. Owing to the fact that the mineral has such a high specific gravity (from $6\frac{8}{10}$ to 7), when deposits of this mineral are eroded, the tin-stone is collected in placers much as gold is, and a large portion of the world's supply of this metal is derived from these placers; the tin thus recovered is commonly called stream tin, on account of its having been washed from the sands or gravel of the streams.

211. Practically all of the world's supply of tin comes from the mines in Cornwall, Australia, the Island of Banca, in the East Indies, and from Malacca. Deposits of tin ore are known to occur in the eastern portion of North America, but not in sufficient quantities to justify working. There are also deposits in various portions of the western mountain regions, especially in the Black Hills of South Dakota, at San Diego, California, and in various portions of Idaho and Montana and in Old Mexico. Deposits are also reported as occurring in South America, but thus far none of these has been worked on a commercial scale.

MERCURY.

212. Mercury occurs native alloyed with silver, forming a natural amalgam, in combination with sulphur, selenium, chlorine, or iodine, and with sulphur and antimony in some tetrahedrite; the ore which is of the greatest commercial importance, however, is the sulphide. While mercury occurs in widely different geological horizons, yet the conditions under which it occurs are usually similar. The Spanish deposits are in Silurian strata, the Austrian in lower Triassic, while the deposits in California are in the Cretaceous formations. The sulphide (cinnabar) is the principal ore, though it is usually associated with many of the other mercury minerals. The ore usually occurs in slates

or sandstones and in broken or shattered rocks which have been broken or shattered by faulting; that is, in place of the rocks being fissured, they have been simply crushed along certain lines. Mercury occurs in Oregon, California, Nevada, Old Mexico, and British Columbia. At present the only producing mines in North America are situated in Old Mexico, California, and British Columbia. Deposits of ore are known to exist in several other States, including some in the eastern part of the continent, but the deposits are too small to be worked. In Europe, Austria and Spain furnish the main portion of the supply. Some is also derived from Russia and Italy. China is said to contain rich deposits of the ore, but thus far they have never been worked.

ANTIMONY.

213. Antimony usually occurs in pockets in veins producing silver, lead, zinc, or iron, and sometimes the ore is disseminated through the minerals carrying the above named metals. Antimony is also a constituent of a number of different ores, but the ore from which practically all the commercial supply of the metal is derived is the sulphide (stibnite). This compound can always be distinguished by the readiness with which it fuses. It can be melted even in the flame of a candle. It can also be distinguished by its characteristic reaction before the blowpipe. The States producing antimony at present are California, Utah, Montana, Idaho, and Nevada. Some ore is also produced in New Brunswick and in Old Mexico, but most of the antimony of commerce comes from European ores. Some is also derived from Japan and from Australia.

PLATINUM.

214. Practically all of the world's supply of platinum is at present derived from placer deposits, in which it occurs in the metallic state and usually alloyed with a small amount of some of the other minerals, as silver, copper, or some of the

heavy metals of the platinum group. Platinum is known to be a constituent of several different ores, and especially of the nickel and cobalt ores. In the Sudbury district in Ontario, some of the metal has been obtained as a by-product during the electrolytic refining of the nickel and cobalt ores from these deposits.

When the platinum occurs in placers with gold, the two metals can always be separated by inspection, for the small amount of other metals alloyed with either of them does not materially change their respective colors.

MINERAL FUELS.

215. Coal Formations.—The minerals which come under this head are considered under the subject of coal in the Paper on *Mineralogy*. No coal of commercial importance is found below the Carboniferous period, owing to the fact that up to this time there was not sufficient vegetation to produce carbonaceous matter in any large quantities. All the formations succeeding the Carbonaceous period contained beds of coal when the conditions for its formation were present. The beds in the later periods are liable to be composed of lignite or brown coal, but in some cases metamorphic action has changed these into bituminous, or often to anthracite, coal.

216. Impurities.—The value of coal to a large extent depends upon its freedom from impurities. These impurities may be considered under three heads: (1) Those which take heat from the coal or reduce its heating efficiency, without leaving any residual components, such as ash, or without having any special effect upon the furnace or other chamber in which the fuel is burned. To this class belong moisture or water and nitrogen gas. (2) Ash, or the residue which remains after the coal has been burned. (3) Deleterious elements which pass into the gases and attack the furnace or chamber in which the fuel is employed.

217. Ash.—Under the second head of ash must be considered all the materials composing the residue left after

the coal is burned. When the ash is practically silicious and has a gray color, it is, as a rule, harmless. If colored red or brown, it indicates the presence of iron, and the presence of iron, lime, or alkalis usually produces an ash which fuses into a slag or cinder, thus stopping up the grates and possibly attacking the grate-bars or walls of the chamber in which the coal is burned.

218. Sulphur and Phosphorus.—Under the third head come sulphur and phosphorus. The sulphur is generally present as iron pyrites, and the sulphur passing into the gases attacks the furnace or boiler, thus doing considerable damage; and in case the coal is used for domestic purposes, it may give rise to foul-smelling and deleterious gases, which find their way into the dwelling. Sulphur is also sometimes present united with calcium to form gypsum. Both the iron and the calcium pass into the ash and become unwelcome constituents of the same. Phosphorus is usually present in small quantities, and it enters the gases in much the same manner as sulphur does, but if the coal were used in the manufacture of iron, both the phosphorus and sulphur may enter the iron and so reduce the quality of the resulting product.

219. Value of a Coal Deposit.—The commercial value of a coal deposit depends upon the purity of the material, the thickness of the seam, and its location, both in regard to the adjoining rock and property, which affect the facility with which it can be worked or mined, and its location with regard to the railroad market, etc.

PETROLEUM.

220. Petroleum is a general name given to a class of hydrocarbon oils of varying composition and degrees of fluidity. Sometimes the oil occurs in such a thin and pure condition that it can be burned for lights without subsequent refining, while in other cases it is of such a character that it can be used for lubricating without previous refining.

Most of the illuminating and lubricating oils, together with such products as vaseline, paraffin, etc., are derived from petroleum during the process of refining. Petroleum usually has a disagreeable odor. It is found in much the same geological horizon as coal, though it may occur in paying quantities in rocks below the Carboniferous. The petroleum usually occurs in sandstones or conglomerate or limestone, filling the pores of the rock very much as though it were contained in a sponge. The porous rock is usually underlaid and overlaid by clay or shale formations, which are impervious to the petroleum. In the Province of Ontario, in Canada, petroleum is found in the Carboniferous, which is the Lower Devonian; in Pennsylvania it occurs in the Upper Devonian; in West Virginia and Ohio in the Carboniferous or Upper Devonian; in California in the Tertiary. Hence it will be seen that petroleum may be looked for in most geological horizons, providing the conditions for its formation and storage are present.

NATURAL GAS.

221. Petroleum is usually associated with more or less hydrocarbon gas, which is commonly called natural gas. In some regions there apparently was not a sufficient amount of carbonaceous matter to form the petroleum, and it has all been reduced to natural gas and some heavy carbon compound as bitumen or a form of coal.

BITUMEN AND ASPHALTUM.

222. Bitumen and asphaltum are names applied to carbonaceous compounds of a pitch-like nature which occur in various parts of the world. Asphaltum is especially abundant around the Dead Sea, in Asia, and in the island of Trinidad, off the coast of South America. In the latter place it occurs as a lake, the shores of which are composed of solid pitch, but the material in the center of the lake is boiling. Deposits of material of the same or similar com-

position are found in a number of places in both North and South America, and usually find a ready market, providing they are situated so that the material can be transported from the deposits with ease. Deposits of grahamite (gilsonite) occur in Utah and have been quite extensively worked. The material is used for making varnish, insulating electric wire, etc. Deposits of sandstone or limestone containing bitumen are also found in many localities, and are worked for use as paving material. California furnishes the most of the asphaltic limestone.

SALT.

223. Salt occurs in nature, both in solution, as in the sea, salt lakes, springs, or wells, and in deposits of halite or rock salt. Both are of commercial or economic importance. Salt occurs in all rocks, from the Silurian down to those of the present time. There are extensive deposits of halite in Europe, North Africa (where it occurs as great hills and extended plains), in Asia, South America, and in various portions of North America, as western New York State, West Virginia, Louisiana, Michigan, Kansas, and most of the Rocky Mountain States. It also occurs in Canada and Old Mexico. At present salt is being produced from the rock-salt deposits of Louisiana, Kansas, Michigan, New York, Utah, Nevada, and California. It is also produced in various portions of Europe and Africa and in other parts of the world. Much of the salt of commerce is obtained by the evaporation of sea-water, of saline solutions obtained from springs, wells, or lakes.

GYPSUM.

224. Geological Occurrence.—Gypsum deposits are usually associated with those of salt, but have a wider range than the salt deposits. Gypsum is found in the rocks of all geological formations, in some cases even occurring in connection with volcanic formations.

225. Productive Regions.—Gypsum is produced in Michigan, Kansas, New York, Ohio, Texas, Iowa, Virginia, South Dakota, and small amounts have been derived from California, Colorado, Oklahoma, Montana, Utah, and Wyoming. It is also produced in Nova Scotia and Mexico. The material is of widespread occurrence and is mined in nearly all civilized countries.

226. Alabaster.—Alabaster is pure massive gypsum, and when of good quality is employed in the manufacture of statuary. The greater portion of the alabaster used for statuary and vases is obtained from Italy, though some of the gypsum deposits of North America contain sufficiently pure varieties for this purpose. At times, pure massive gypsum is treated chemically and thus made to represent variegated marbles. In this form it is employed for internal decorative purposes in buildings, etc.

BUILDING STONE.

227. Essential Qualifications.—The essential qualifications necessary in any stone to render it a good building stone are a firm texture, a cementing material that will not be softened or disintegrated by exposure to the atmosphere, and that will not undergo chemical changes such as break or split the stone. The stone must also be free from particles of material which would undergo chemical changes, either breaking or staining the material. Among such materials may be mentioned especially iron pyrites. A fine texture is also desirable, and stones are often considered better fitted for this purpose when they will receive a high polish.

228. Varieties of Building Stone.—Among the most common building stones obtained from the stratified or unaltered rocks may be mentioned sandstone and limestone. Occasionally a sandstone is employed which contains considerable argillaceous material.

229. Among the varieties of building stone obtained from the massive metamorphic or altered rocks may be

mentioned sandstones which have been converted into quartzite, or have only been partially reduced to quartzite, gneisses, granites, etc., which have been derived from sandstones or argillaceous slates, and marble which has been derived from limestone.

230. Marble.—In the case of marble, sometimes the metamorphic action has not been sufficient to destroy the fossils contained in the limestone, and they may add to the beauty of the marble. Marble varies in color from white to black, and includes all shades of red and blue, the color being caused by impurities, mostly iron, contained in the original limestone. Statuary marbles are white, hard, semi-transparent, fine-grained, and are derived from the fine limestones of the older geological formations which have undergone thorough metamorphic action. The best marble for this purpose comes from Italy.

231. Granite.—*Granite* varies in texture and shades of color according to the size and character of the grains composing the same, and according to the color of the various ingredients and the proportion of each in the stone. In color it varies from light gray to red, and for building or monumental purposes should have a fine texture and be capable of receiving a high polish.

232. Serpentine.—Frequently serpentine or similar rocks are found capable of receiving a high polish and are used as building material, especially for internal ornamentation.

233. Sandstone.—As a rule, the brown or red sandstones in which the cementing material is largely composed of iron are more durable than those in which the cementing material is composed of argillaceous or lime material.

234. Limestone.—This should be firm and, as a rule, close-grained to be a good building stone.

235. Flagstones.—Frequently deposits of argillaceous sandstones occur which will split into large flat slabs suitable

for flagstones. The splitting occurs along the laminations or bedding planes.

236. *Slate.*—The slate which is employed for roofing and similar purposes is composed of a hard argillaceous slate which has undergone thorough metamorphism, and, as was stated in Art. 64, the slaty cleavage is frequently independent of the bedding planes of the deposit, as illustrated by Figs. 29, 30, and 31. In the United States most of the slate quarried comes from Pennsylvania, New York, Vermont, Maine, and Virginia, though good deposits occur in many other States where the rocks have undergone metamorphism, and some slate is produced in a number of Western States. Fine slate is also produced in England and on the continent of Europe.

CLAY.

237. Under the head of clay may be considered all the forms, ranging from pure kaolin, which has been derived from the decomposition of feldspar and is used in the manufacture of porcelain or for glazing paper, to the more imperfect varieties employed in the manufacture of brick, tiles, drain-pipes, heavy crockery, stoneware, etc. The presence of iron in the clay makes the resulting product red or brown.

Ordinary firebricks are made from clay and silicious material or from clay containing sand or silica.

Most of the supply of clay for commercial uses is obtained from surface openings or clay banks, but in order to obtain more uniform products, a number of works are operating underground clay mines.

238. The products manufactured from clay vary in the percentage of clay they contain, all the way from porcelain, which is made from practically pure kaolin, to the silicious firebrick called dinas brick, and which are made from silicious material or crushed quartz, together with a little

milk of lime or a very small percentage of clay in the water employed for moistening the material before it is molded into the bricks. Such bricks may contain as high as 99% silicious material.

PHOSPHATES.

239. Phosphates occur in nature in two forms, in one of which they are available for plant life, and in the other of which they require treatment with acids before phosphoric acid is liberated. Some marls, as the greenstone or glauconitic of the Cretaceous and Tertiary, of New Jersey, contain phosphoric acid in such a form that it is available for plant food.

Phosphorus also occurs in the mineral apatité, which is a phosphate and chloride of lime. This occurs in many parts of the world, and has been mined in Canada, Massachusetts, New York, and some other locations. It requires treatment with sulphuric acid to render the phosphoric acid free or soluble.

Most of the phosphates employed in the manufacture of fertilizers are obtained from beds of calcium or lime phosphates, and require treatment with sulphuric acid. The material is produced in Florida, North and South Carolina, and Tennessee, in the United States, while in Europe it is produced in a number of countries, but the majority of the foreign product comes from Algeria.

240. On the continent of Europe, the regular phosphate rocks have been, to a large extent, displaced in the manufacture of fertilizers by the use of basic slag, resulting from the basic process for the manufacture of iron and steel, and in which many iron ores high in phosphorus are employed.

241. Guano.—Guano is a natural fertilizer in which the phosphoric acid is available for plant life. It consists of the excrement of sea-fowls and is found in dry islands in the Tropics, especially off the coast of Africa and Australia.

SULPHUR.

242. Sulphur is found in a free condition in volcanic regions, where it has been deposited by sublimation. It also occurs at some sulphur springs, where it has been deposited by the decomposition of the sulphur gases, but the greater part of the world's supply comes from deposits found in gypsum, bituminous marl, or limestone. Some sulphur is also manufactured from iron pyrites. Sulphur is ordinarily obtained from the ores by distilling, or by setting fire to the material so that the sulphur melts and flows out of the lower part of the furnace or kiln. In the Island of Sicily, in the Mediterranean Sea, sulphur occurs in the gypsum in the Tertiary deposits, and it is from this source that the greater part of the world's supply comes. The sulphur exported from Japan is found in volcanic regions and was deposited by sublimation. Deposits also occur in California, Nevada, Wyoming, Utah, and New Mexico, in most of which the sulphur is free. In Louisiana extensive deposits have been discovered under the swamps in or near the delta of the Mississippi, but they are so situated that it is practically impossible to recover the sulphur by ordinary mining methods. These deposits are either Cretaceous or Tertiary. As has been previously mentioned, iron pyrites are frequently mined for the manufacture of sulphuric acid, and sometimes a portion of the sulphur is obtained in a free state.

SILICA FOR GLASS.

243. Glass is, generally speaking, a double silicate of potash with lime or lead, or a double silicate of soda with lime or lead. If the glass is to be pure or clear, the silicate must be free from iron and other impurities. Sands fit for this purpose are obtained on the seashore and in certain sandstones of almost all ages, from the Silurian up to the present. Glass has been manufactured on a large scale from sandstones which occur in Illinois, Wisconsin, Missouri, Pennsylvania, Ohio, Minnesota, New Jersey, and other localities in North America. Sometimes glass is manufactured from

flint which has been crushed and is used in place of the sand or silica. This makes what is called "flint glass." For the manufacture of a common or coarse glass for making bottles, a granite containing only quartz and feldspar, with practically no mica, may be used in place of the silicate.

PIGMENTS.

244. Pigments are materials used in the manufacture of paint. Among them may be mentioned the following:

245. Ocher.—Ocher, which consists of an oxide of iron containing water and gives various shades of yellow, brown, and red. This is found in almost all geological formations, and occasionally as surface deposits of recent origin.

246. Umber.—Umber is a variety of ocher, containing oxide of manganese, which gives it a brown color, and upon being calcined it takes on a reddish brown color which is known as burnt umber.

247. Sienna.—Sienna consists of oxides of iron and manganese, together with clay.

248. Barytes.—Barytes is a common constituent of the gangue material of many mineral veins and is used in the manufacture of white paint, together with zinc white or white lead. The supply comes mostly from Virginia and Missouri, though it has also been produced in Pennsylvania, Michigan, Tennessee, and Maine.

249. Zinc White.—Zinc white is an oxide of zinc which is made from various zinc ores and is usually called zinc pigment. Sometimes zinc ores carrying lead are treated in such a way as to form a pigment composed of zinc oxide and some lead oxide.

GRAPHITE.

250. Characteristics and Uses.—Graphite, or, as it is commonly called, plumbago, is mentioned in the Paper on *Mineralogy* as being carbon in a higher state of metamorphosis than is the case with anthracite coal.

251. Occurrence.—Graphite occurs in the oldest formations or in those which have undergone the greatest metamorphic action. The principal mines producing graphite at present in America are situated in New York State, although it is found in greater or less quantities all the way from Canada to the Gulf of Mexico, mostly in the Archean rocks along the mountain ranges. It also occurs in Michigan and in various portions of the West. Graphite is also produced in several locations in Europe.

252. Plumbago is pure graphite, and it is usually found associated with various impurities. It is employed in the manufacture of lead-pencils, and it is from this that it has derived its name of plumbago. It is infusible and is not changed by high temperatures, and hence it is employed in the manufacture of crucibles for the melting of brasses and other alloys. Pure graphite has a greasy feel to the touch and is employed as a lubricant.

ASBESTOS.

253. Asbestos is a variety of the minerals hornblende, pyroxene, and serpentine, and is usually found associated with the latter. It occurs in crevices in the crystalline rocks, but often to a limited extent. When found in long, fine, tough fibers, it becomes valuable for commercial purposes, for it is infusible and is unaltered by ordinary fire. It is employed as a covering or protecting material for steam-pipes and other surfaces exposed to a moderate degree of heat. The most extensive asbestos mines are situated in Canada, though it is found in a number of the Middle and Southern Atlantic States, in California, and several other of the Western States. Asbestos is also produced in several other countries, a peculiar blue variety being found in South Africa.

MICA.

254. Mica occurs crystallized in veins of coarse granite in the oldest (Archean) rocks. The variety known as muscovite, or white mica, is of commercial importance, and

as the plates become larger, the irregularities fewer, and the transparency greater, its value increases. Owing to the fact that mica is infusible and is tough, it is employed as windows or for closing openings where it will be exposed to a considerable degree of heat, and yet where it is desirable that the interior can be observed, as the peep-holes in blast-furnaces and cupolas or for the doors in stoves. Mica is also employed for insulating material in electrical construction, and the ground or pulverized mica is employed in connection with some lubricants.

MONAZITE.

255. Monazite is a phosphate of cerium and lanthanum containing small quantities of didymium and thorium (ThO_2). The latter is the valuable constituent of the mineral, for it is used in the manufacture of Welsbach, or incandescent gaslights. Monazite is found in various granitic rocks, and owing to the fact that it is a very heavy mineral, it collects in placer deposits similar to gold or tin-stone. Considerable of the material has been obtained from such deposits in North and South Carolina, and it is known to exist in some of the Western States, but at present practically all of the world's supply comes from South America.

ALUM.

256. Alum is obtained principally from alum shales, the most desirable of which are pyritous and clay rock containing disseminated coaly matter. Such deposits occur in the coal and lignite regions of Europe, and it is from them that the principal supply is obtained. Alunite, or alum-stone, is another source, and is found in volcanic regions, though it is not common. There are valuable alum shales in a number of locations in Western North America, but thus far nothing has been done towards their development.

BORAX.

257. Native borax is found in several places, but it is also obtained from native boracic acid and from the mineral ulexite. The usual occurrence is in the mud at the margin or at the bottom of saline lakes, also as incrustations in marshes which are dry at times. In the former condition it is found near Clear Lake, in California, and in the latter, to a considerable extent, in Nevada, from which most of the product for the United States is obtained. Several marsh localities in California are yielding good supplies.

SODA AND POTASH SALTS.

258. Soda and potash salts occur in nature in a number of forms; the most common soda salt, that is, halite or common salt, has already been described. The other salts of soda, as the carbonates, sulphates, etc., are found in the beds of dry lakes or in marshes which are dry a portion of the year. Such deposits exist in a number of places in western North America. Nitrate of soda occurs in vast deposits in Chili, in South America. Small amounts of it have also been found in caves in all parts of the world. Potash salts are found in a number of locations, but at present practically all of the world's supply comes from Stassfurt, in Germany, where it occurs in connection with deposits of halite or common salt.

GEMS AND GEM STONES.

259. The most important precious stones have been mentioned and described in the Paper on *Mineralogy*, and the location in which most of them occur has been given, but there are a few points worthy of notice. Most precious stones belong to the older rock formations, as granite, gneiss, porphyritic rocks, etc., and are generally found in the debris resulting from the disintegration of such material. Certain

diamond-bearing soils are of comparatively recent age, but they are made up of the constituents of older rocks.

260. Corundum not only furnishes the valuable gems, but also the material employed as an abrasive. Corundum of good quality for this purpose has been found in several of the Eastern States of the United States, previous to which most of the world's supply came from Asia.

261. Diamonds.—Diamonds have been referred to in the Paper on *Mineralogy* as being pure crystallized carbon and as representing the highest or purest form in which carbon occurred in nature. In India, diamonds are found in a conglomerate made of rounded stones cemented together; in America a few have been found in flexible sandstones, mostly in the southern portion of the United States; in Australia they occur in gold-bearing conglomerate; in Brazil the greater portion of the supply is obtained from a conglomerate of white quartz pebbles and light-colored sand, sometimes containing yellow and blue quartz and iron sands. In South America the diamondiferous alluvial deposits consist chiefly of nodules of granite, basalt, and sandstones, in which are found garnets, jasper, agates, etc., associated with diamonds. In the East Indies, diamonds are often found in the river gravel, associated with topaz, garnets, zircon, spinal ruby, native gold, tinstone, etc. At the Kimberly mines, in South Africa, the diamondiferous ground forms a pipe or chimney surrounded by formations totally different from the payable rock. The country rock is made up of red, sandy soil on the surface, underneath which is a layer of calcareous tufa, then yellow and black shales, and below this hard, igneous rock. The diamond-bearing ground consists of "yellow ground" (really decomposed "blue ground"), which is comparatively friable, and, deeper down, the "blue ground," which is a hydrous magnesian conglomerate, which is usually so hard that it requires blasting with dynamite. The blue ground is of a dark bluish or greenish gray color and has a greasy feel. It is mixed

with portions of boulders of various rocks, such as serpentine, quartzite, granite, etc. All the blue ground has evidently been subjected to heat. The gems are in the material which binds the rocks together and not in the rocks themselves. Diamonds have been found in America, Russia, Australia, New Zealand, Borneo, etc.

PROSPECTING.

PRELIMINARY EDUCATION AND PREPARATION.

1. To save a vast amount of time and futile labor, the would-be prospector should acquire all the knowledge he can, both theoretical and practical, pertaining to his chosen calling. He should learn in what rocks and under what conditions he may reasonably hope to discover certain minerals, so that he may not be found looking for coal in granite, nor for gold and silver veins in the unaltered rocks of the flat prairie. Hence, a knowledge of the elements of geology, of the different kinds of rocks and minerals, their appearance, associations, and value, and also some knowledge of panning, assaying, and blowpiping, are essential.

2. One of the best preliminary educations is actual work in the mines and mills, where the student may get an idea of the ores, how they occur in nature, and their relative value. A good plan is to go from district to district, studying the ores peculiar to each district, their peculiar mode of occurrence, and, in fact, the entire geology of each district. He will find, for instance, that the ores and mineral conditions occurring in different formations, as limestone, granite, and volcanic rocks, vary as widely as the rocks themselves, and also that the character and mode of occurrence of ores in the same class of rocks are subject to local variations in the different districts he may visit. This varied experience will prove invaluable to him, and there is no other way of acquiring it. Many valuable and well-defined ore-bodies were overlooked in the early days of mining, and are even now, because the prospector's experience had been confined

to a few peculiar varieties of rock occurring in the particular region where he was raised, and he goes through mountains diligently searching for a duplicate of the one to which his study has been confined, frequently passing over much richer deposits, which, to his limited ideas, present no mineral signs at all.

3. He will also find it of great advantage to be able to recognize the various rocks, not only by close examination of hand specimens, but by their general appearance in the field and the characteristic forms they assume in large masses. Thus, hills built of limestone, sandstone, or other sedimentary rock have an entirely different appearance from those composed of rugged granite, and areas of purely igneous rock display characteristics differing from both. Hills made up of sedimentary rock usually have smooth, rounded outlines, or show long, distinct, regular ridges and strata. Granite is apt to be in rugged, massive spires with bold, ragged outlines. Lava flows are apt to appear as broad, level table-lands, with the peculiar columnar structure more or less pronounced. Their horizontal bedding gives them a striking, though rather monotonous, appearance. Great masses of porphyry or diorite appear as isolated laccolitic domes, with their outlines cut into spires and minarets.

4. In selecting a district for prospecting, the prospector may wisely ascend to the top of some prominent peak and scan the district over, and soon acquire a general idea of the geology from his knowledge of the peculiar forms of rocks and the colors they are liable to assume, the result of different degrees of hardness, peculiarities of structure, and ability to resist weathering and erosion.

5. The student should learn the use of pick, drill, and blasting-powder. By working around a concentrating table he will learn to distinguish between mineral and gangue, and by sorting ore in a mine he will acquire an intuitive faculty of recognizing rich ore from poor ore or barren gangue almost at sight. A little knowledge of carpentry



n
n
g
t
h
r
s

i-
y
t
d
e
e
h
e
e
e
e
s
r
's
;
it
A
e
s
n
e
y
n
e

PUBLICITY
ASTOR, L
TILDEN FOUND

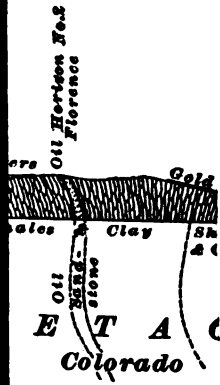

Hogbacks

THE NEW YORK
PUBLIC LIBRARY

ASTOR, LENOX
TILDEN FOUNDATIONS

will enable him to make a hand-winch, and a few lessons in blacksmithing will teach him how to temper and sharpen tools. These are important qualifications, for his calling frequently takes him to places miles from the nearest carpenter or blacksmith shop. He will soon learn to crush quartz and pan it to see if it carries any gold, and from other prospectors he will pick up all sorts of labor-saving dodges and makeshifts, such as are used by them in the field.

USE OF GEOLOGICAL MAPS AND SECTIONS.

6. As soon as a mining district comes into any prominence, the Government causes a complete geological survey of it to be made, and from the notes of this survey a report is compiled on the district. All important geological and mineralogical features are shown in vertical sections. The student will find these reports a great assistance in his study of the various regions. If in the vicinity of one of the noted sections, he can not take a better lesson than, with map in hand, to follow the section through all its details, noting carefully the appearance of the various strata, the occurrence of veins and faults, etc. This will familiarize him with rocks and practical geology. Fig. 1 is an example of a geological section, showing a generalized section of the Rocky Mountains in Colorado, with the economic products in the different horizons and strata. Fig. 2 in a similar manner presents a generalized vertical section of the earth's crust in Colorado. Such an example is rarely, if ever, found complete in any part of the world, but portions of it may be found in various cliff sections and cañons. A remarkable example is that of the Grand Cañon of the Colorado River, where a thickness of the earth's crust is exposed for over a mile in depth, yet even this great cañon shows but a few of the great formations composing the whole upper crust of the earth; hence, many sections, in many places, must be studied and put into a generalized section like Figs. 1 and 2 if we would get a complete idea of the whole.

7. A general section, giving the different geological formations and periods as they would occur in a perfect section

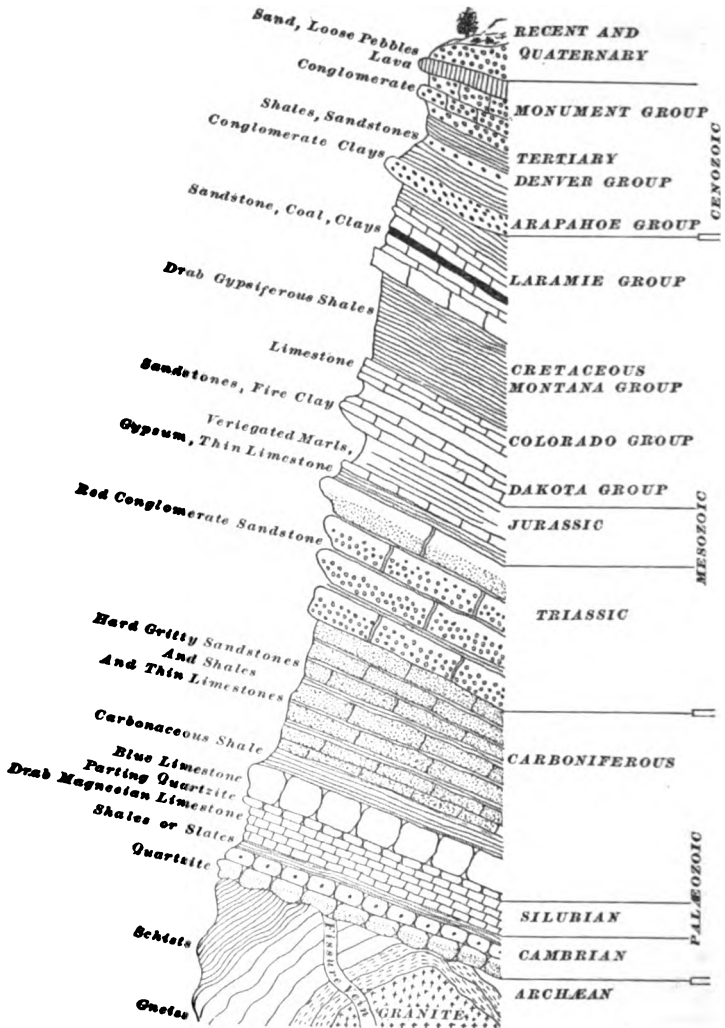

FIG. 2.

made up from different parts of the earth, has been given in the Paper on *Geology*.

8. The use of fossils for determining the different geological ages or periods has been treated in the Paper on *Geology*, and illustrations of some of the fossils which are most characteristic of the different periods given.

9. A good example of the use of fossils occurs in connection with certain limestone beds occurring at Aspen and Leadville, Colorado. Certain of the beds carry very rich lead-silver ores, and they are distinguished from similar limestone in the same State by the fact that they carry certain characteristic fossils of the lower Carboniferous age. The prospector will find fossils useful in giving a general idea of the geological horizon in which he is operating, but to determine the age of any particular bed in a given locality, he will have to become familiar with the fossils of that region.

PROSPECTOR'S OUTFIT.

10. The prospector's outfit is very simple; the simpler the better. It usually consists of a donkey or pony packed with a couple of heavy blankets, as the nights in the mountains are nearly always cool, a small, portable "A" tent, cooking utensils, etc., such as are found in every mining town, a supply of flour, sugar, bacon, salt, baking-powder, and coffee sufficient to last usually about a month, an ax, and prospecting tools. These latter consist of pick, shovel, pan, or horn spoon for separating the gold, hammers, three or four drills of assorted lengths, a "spoon" or scraper for cleaning out drill holes, a few pounds of blasting-powder or dynamite with fuse and caps, an iron melting ladle, a pocket magnifying (ore) glass, and sometimes a blowpiping outfit or even a small muffle furnace, for assaying, packed on an extra animal. A rubber blanket will be found handy, as the prospector is apt to be exposed to violent and frequent rainstorms. A rifle or shotgun is also considered indispensable where game is plentiful. Carry no unnecessary articles.

11. In the new part of the Lake Superior region, in much of Canada, and in Alaska, there are so many swamps

that it is impossible to use packhorses, and in such a case the prospector has to take one or two men as porters, or, as they are called, packers. Each one of these men will carry from 100 to 125 pounds.

PROSPECTING FOR PLACER DEPOSITS.

12. Prospecting may be treated under two heads: hunting for loose gold, platinum, or tinstone in placers or alluvial deposits, and hunting for metal-bearing ores in place as lodes or veins.

13. Placers are deposits resulting from decomposition and wearing away of metal or mineral bearing rocks by natural agencies, and the accumulation of the fragments in beds lower down in the mountains, where they have been carried by water, glaciers, etc. The principal materials obtained by placer mining are metallic gold, metallic platinum, tinstone or oxide of tin, monazite, and precious stones; these all being of sufficient specific gravity to become concentrated by the action of water, and at the same time being sufficiently stable to resist the action of the atmosphere. Water soaking into the surface and cracks of rock expands on freezing and causes the rock to crack and flake off, and the scales and dust resulting are carried down by streams and freshets into the rivers below. The action of the water separates the mineral portion from the lighter material, and its greater specific gravity causes it to sink to the bottom, while the dirt is carried along with the stream until it reaches some point where the current slackens, when it is deposited. Naturally, the larger particles of mineral sink first, accompanied by the coarser portions of the gravel, so that it would be unreasonable to expect coarse gold or mineral deposits at any great distance from the mother-lode, though fine gold and mineral may be carried great distances, particularly in streams having the steep grades and high velocities of mountain creeks, which will carry even quite coarse gold some distance. In a somewhat similar way, glaciers wear away the rocks over which they pass, and,

melting, deposit the debris in moraines and windrows along their paths. These deposits are worked over by the streams which take the place of the glaciers, and from them many of our richest placer beds are formed. The prospector, following up an ancient river-bed from which the water has long since subsided, can, from his observations of modern streams, recognize places where there must once have been an eddy, where the stream took a sudden drop over a bench, or where it hollowed out a pot-hole under a waterfall; these places he should carefully prospect. When possible, he sinks at once to bed-rock, as there the mineral is naturally thickest, and on reaching it he examines it closely, searching with his knife or pick for scales or grains of mineral hidden in the crevices of the bed-rock. He also has an eye for rusty streaks in the gravel bank or for dark lines of "black sand" or magnetite, as the iron minerals forming these streaks are, from their great specific gravity, commonly associated with gold and other valuable minerals in placer deposits, and hence each one of the streaks represents a possible zone of "pay dirt."

14. Thus far, the world's supply of platinum has been derived from placer mines. The prospector, looking for gold placer deposits, should examine any heavy particles of white metal, to see if they are not platinum, since platinum is as valuable as gold. The metal can be distinguished from native silver by its not being attacked by any single acid.

15. Panning.—The prospector tests the bank from time to time as he descends, by "panning." The pan he uses for this purpose is about 10 or 12 inches in diameter on the bottom, 16 to 20 inches at the top, and $2\frac{1}{2}$ to 3 inches deep, pressed out of a single sheet of Russia iron (see Fig. 3). The rim is sometimes strengthened by turning it over a wire. The manipulation of the pan, while quite simple, requires considerable practice before one can become expert. The manner of testing is as follows: The prospector fills the pan about half



FIG. 3.

full of water, throws into it a shovelful of dirt, first picking out the larger pebbles, and works the whole mass thoroughly with his fingers till all the clay is reduced to a fine sand and mud. The muddy water is then carefully poured off and the pan refilled with water. Now he takes the pan in both hands, one on either side, and, inclining it slightly away from him, gives it a peculiar circular motion. At each revolution a portion of the water slops over the depressed edge of the pan, carrying with it some of the sand and lighter minerals, the gold, owing to its greater specific gravity, remaining at the bottom. He continues this until there is only about a teaspoonful of sand or matter left, in which he can see the specks of gold shining. He then pours nearly all the water off, and moving the pan to and fro, the gold gradually collects, and a slight tilt and jerk of the pan to one side will carry the sand off towards the other, leaving the gold in an orange-yellow streak. This orange-yellow color



FIG. 4.

of gold usually suffices to distinguish it from iron pyrites, which is brass-yellow, or copper pyrites (chalcopyrite), which is bronze-yellow. However, if the operator is still in doubt, the malleability of gold and its insolubility in any single acid, in connection with its color, are infallible tests. The operation of panning is

somewhat facilitated if one edge of the pan is kept submerged beneath the surface of a pool or quiet stream of water during the entire operation up to the separation of the "color" from the heavy sand in the pan (see Fig. 4).

16. By noting roughly the weight of dirt in a pan charge and the value of gold extracted therefrom, an

approximate estimate can be made of the amount of gold in a ton or a cubic yard of the placer dirt, and from this a rough estimate of the yield of the entire placer may be made if desired.

LOCATING PLACER CLAIMS.

17. The location of a mining claim, either placer or lode, consists in defining its position and boundaries, and in doing such other acts as indicate and publish the intention to occupy and hold it under the laws of the government within whose domain it lies.

UNITED STATES PRACTICE.

18. Area and Shape of Placers.—The amount of ground which may be located as a placer is limited to 20 acres to each individual or person, a corporation being considered as an individual, regardless of the number of its incorporators. An association of persons (not incorporated) may locate a claim in common, not exceeding 20 acres to each individual, or 160 acres for the entire association. It requires at least eight *bona fide* locators to lawfully claim 160 acres.

19. The shape of the placer claim is immaterial, it usually following the course of the stream or deposit. Unlike lode claims, the exterior lines of placer claims can not be extended over other placer claims. The dimensions may vary as much as desired so long as they do not include more than the legal area. One acre equals 43,560 square feet, the area of a square 208.71 feet on a side.

20. Discovery or Knowledge of Mineral Value.—It is necessary for a valid location that the land be known to have mineral value, either by discovery or previous knowledge, and in the case of an association a separate discovery is required on each 20 acres.

21. Location Notice.—Having discovered a placer deposit, the prospector is allowed 30 days from the date of

discovery to complete the location and record. He posts a preliminary notice similar to the one here shown:

PRETTY JOE PLACER CLAIM.

The undersigned claims 20 acres for placer-mining purposes, with 30 days from date to complete location and record.

Sept. 29, 1897.

JAMES E. MURRAY.

This notice is posted conspicuously at the center of the claim or at some point where prospecting pits give evidence of actual work.

22. Having completed his location, the prospector replaces the preliminary notice with the regular location notice, of which the following is the common form:

PRETTY JOE PLACER CLAIM.

The undersigned claims 20 acres for placer-mining purposes, as staked on this ground. Date of discovery, Sept. 29, 1897.

JAMES E. MURRAY.

23. The dimensions of the claim, instead of its total area, are sometimes specified. In Idaho, posting and staking must be done within three days after discovery.

24. Staking.—The locator is required to mark each angle of his claim by a substantial post, sunk into the ground at that point. In Idaho the size of the said "substantial post" is fixed by law at 4 feet high and 4 inches square, and these dimensions are tacitly accepted throughout the country. Where posts are not obtainable, the monuments usually consist of mounds of stone 3 feet high and 3 feet in diameter at the base. These monuments must be tied, or referred by distance and direction, to permanent monuments or natural landmarks, so that they can be readily located in case of controversy.

25. The labor or improvement necessary to hold a placer claim is the same as that for a lode claim—\$100 worth annually. This must be actual work in developing and improving the property. Where several claims are being worked as a group, all the work may be performed on any

one of the group. The record of location must be placed with the recorder of the county or district in which the claim lies.

BRITISH COLUMBIAN PRACTICE.

26. The laws of the Canadian Government in reference to placer mining are much narrower and more stringent than those of the United States. Miners or mining companies are obliged to take out "free miner's" certificates, at an annual expense of \$5 for individuals, \$50 for corporations capitalized for \$100,000 or less, and \$100 for corporations with over \$100,000 nominal capital, before they are entitled to the privilege of prospecting and mining in Canadian territory. This regulation also applies to lode mining. Violations render miners liable to a fine of \$25 and costs.

27. Size of Claims.—One hundred feet is the uniform length of all individual claims, except those granted to the discoverers of districts. Such discovery claims may be 400 feet in length for a single discoverer, 600 feet for a party of two discoverers, 800 feet for a party of three, and 1,000 feet for a party of four. For larger discovery parties only the ordinary length of claim will be granted for each additional person above four. A "creek discovery" includes all ground to the top of the hill on each side of the creek, so long as the total width does not exceed 1,000 feet.

Creek claims extend laterally from base to base of hill or bench on each side, unless this distance be less than 100 feet when they are 100 feet square.

Bar diggings are in width the distance from high-water mark to the edge of the stream at its lowest water-level.

Hill diggings have a 100-foot base-line parallel to the main direction of the stream, and the side lines extend to the summit of the hill, at right angles to the base-line. All other diggings are 100 feet square.

28. Staking.—The method of staking and posting notice is similar to that in vogue in the United States. The

claim must be as nearly rectangular as possible, following the general course of the river, and the corners marked by "legal" posts, 4 feet high and 4 inches square. One of these posts must be marked "Initial Post," and on it must be posted the location notice, similar to the American form previously given. If any side line exceeds 100 feet in length, additional posts must be placed along such line, not more than 100 feet apart.

29. Recording.—The Canadian mining law, somewhat like that of the United States, requires that the location be recorded at the Mining Recorder's office of the mining division in which the claim is situated. The claim must be recorded within three days after the location is completed, if the claimant is within ten miles of the recorder's office, or one additional day for each additional ten miles or fraction thereof.

30. Unlike the American practice, however, the Canadian law does not give the miner permanent ownership of the claim. Placer claims are recorded for a term of one or more years, and may be re-recorded for another term of years, and during the existence of a record or a re-record the term may be extended one or more years, the fee for recording, re-recording, or extension being \$2.50 per year.

31. Abandonment.—If, after recording a location, and before the expiration of the record, a miner desires to abandon his claim, he is obliged to give notice of such intention to the Mining Recorder, together with a fee of \$2.50. His interest in the claim ceases from the date of recording such notice.

32. Work on Placer Claims.—Every placer claim must be worked continuously during working hours, in the open season, by the holder or his representatives. If left idle for a period of *seventy-two hours*, in the working season, without valid excuse, the claim is considered abandoned and forfeited. A miner is, however, entitled to one year's leave of absence from his claim upon proving an expenditure

equivalent to \$1,000 on each full interest in any claim or set of claims, without reasonable returns, or in case of a set of claims, on application signed by all the holders. Such leave of absence will not exempt the holder from the provisions respecting free miners' certificates, records, etc.

33. Free Miners' Privileges.—Any person holding a free miner's certificate may locate not more than one placer claim on any creek or hill, and not more than two claims in the same locality. He may, by purchase, however, hold any number of claims. He may kill game for his own use, while prospecting or mining, at any season of the year, and may cut timber for mining purposes on any public lands.

Prospecting or mining without a free miner's certificate is illegal, and renders the person so doing liable to a fine not exceeding \$25 and costs. A certificate may be extended for one or more years on the payment of \$5 for each year, and if lost will be replaced for \$1.

PROSPECTING LODES OR VEINS.

34. In searching for metal-bearing deposits in place, the prospector meets with conditions quite different from those of the placer deposits. Placer mines differ very little from one another in general characteristics, one placer being practically an example of the whole class; but in the case of veins or lodes, very seldom are two claims found on which the conditions are identical, even in the same district. The prospector is obliged to trust much more to his intuition, and at the same time more knowledge of geology and mineralogy is required, if he would work to the best advantage.

FLOAT.

35. Having selected a district for prospecting which, for geological or other reasons, he considers "likely," the prospector's first effort is to find "float." Float is vein matter which has become detached from the "mother-lode"

by natural agencies. The fragments roll down-hill, or are carried by water and snowslides, sometimes great distances from the original ledge. Some of this float may be barren quartz or other vein rock, while some may be more or less mineralized. Commonly, float is a rusty, spongy mass of rock, stained red or green from the oxidation of the iron or copper sulphides it originally contained. The spongy character of the mass is generally due to the cavities left by the metallic sulphides when they oxidized and dissolved out. These sulphides are also sometimes found in the float in their original state.

36. Having discovered float, the prospector endeavors to trace it up to the ledge from which it was broken. Naturally, it will have come from a point above that where he discovered it, and rolled down-hill; so up-hill he goes, following the course of the stream or slide, which is marked by pieces of float, gradually increasing in size and number as he ascends, till he comes upon the mother-ledge in full view, or a zone where the float ceases abruptly. In the latter case he starts a trench across the probable course of the vein—as indicated by the direction of the float zone—and prolongs this trench up and down the hill until he strikes the vein or becomes discouraged and concludes that “the game isn’t worth the candle.” If he finds float in the bed of a cañon or watercourse, he follows it up the stream till it turns off up-hill, and then proceeds as just described.

SAMPLING THE OUTCROP.

37. Suppose the prospector is fortunate enough to find the vein and trace its outcroppings; he next makes an approximate estimate of the value of his find. Breaking off at intervals along the outcrop fragments of likely-looking rock, he crushes them up to about the size of peas, or even coarser if he has a large sample or the ore is thought to be low grade. He then mixes the sample well on a piece of canvas and “quarters” it down to half the size. This half he further crushes and again “quarters,” repeating the

operation till he has left only a few ounces of finely powdered ore, which, however, represents quite accurately the average value of the samples he has taken from the vein.

38. Quartering.—The operation of reducing samples takes the name “quartering” from the peculiar way in which it is performed, the sample being spread out into a flat circular pile, divided into quadrants by two diametrical lines at right angles to each other; two alternate quarters are saved, the other two are thrown away. The method is as follows: The crushed sample is placed in the center of a canvas sheet and thoroughly mixed, either with a shovel, or, if the sample is small, by drawing the corners of the cloth, one after another, up and over, rolling and mixing the ore within.

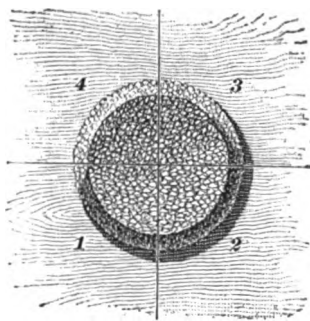

FIG. 5.

When thoroughly mixed, the sample is heaped up in a conical pile. If the sample is large, the operator walks slowly around it,

scraping the ore from the apex of the cone towards the outside with his shovel as he goes. This he continues till the sample is reduced to a flat pile. Through the center of this pile he draws two lines at right angles to each other, which divide the sample into quadrants. He then shovels away two alternate quadrants, preserving the other two for further treatment. Thus, if, as in Fig. 5, we consider the quadrants as numbered consecutively from

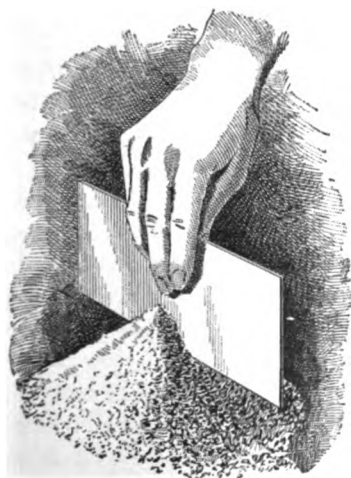

FIG. 6.

1 to 4, Nos. 1 and 3 would be saved and 2 and 4 discarded, or *vice versa*. The two quarters which were saved are again mixed and treated in the same way, and so on down to any size desired. As the pile and material get smaller, to flatten the pile, instead of scraping the ore down with a shovel, a thin sheet of iron may be conveniently used. It is grasped as shown in Fig. 6 and pressed down slightly into the apex of the cone; then, using the axis of the cone as the axis of revolution of the plate, twist it gently around. As the plate revolves, it flattens and spreads out the ore, the process being continued till the pile is reduced to the desired thickness. This method of reducing samples has been found by experiment to give accurate results if carefully done. The resulting sample he may test in his pan for free gold or preserve to be assayed at his leisure.

39. Care should be taken to thoroughly clean the sampling cloth after using, or the fine and valuable portion of the ore, which has settled to the bottom and adhered to the cloth, may make the next batch sampled appear valuable even though it be a totally barren rock.

BOOMING.

40. When the prospector finds the rock of the hillside he wishes to examine covered with a layer of drift, it is often possible to remove the earth and expose the rock by the process called booming. This is really ground sluicing to remove the earth. The water is either confined in a reservoir near the top, and suddenly released to plow its way down to the valley, carrying much of the earth with it, or a ditch is dug from some creek and carried along the hillside until it gains a sufficient height above the valley, when it is allowed to flow down over the hill. Frequently the earth in the course of the water is loosened with a pick, and the stream made to carry it away. Under favorable circumstances, a man can move more earth in a day by booming than he could in several weeks with a pick and shovel.

LOCATING LODE CLAIMS.**UNITED STATES PRACTICE.**

41. Size of Claim.—If, as the result of his investigations, the prospector considers the deposit a promising one, he proceeds to “locate” it according to the laws of the district in which the property lies. The mining laws of the United States limit the dimensions of a lode claim to 1,500 feet along the course of the vein by 600 feet wide, horizontal distance—300 feet on each side of the center of the vein at the discovery shaft. In Colorado, the State Legislature has fixed the legal width of a claim at 300 feet, except in the case of Gilpin, Clear Creek, Boulder, and Summit Counties, where the limit is 150 feet. In all the other States and Territories the dimensions specified by the Act of Congress of 1872—1,500 feet by 600 feet—hold, and can under no circumstances be exceeded for individual claims. The only provision in the United States mining laws in regard to the shape of the claim is that *the end lines must be parallel*. The side lines may run in any direction so long as they are nowhere more than the legal distance apart, and the location will still hold. They are usually surveyed parallel to the center line, however, and at the maximum legal distance from it, when such a course will not bring them into conflict with other properties, as it is not human nature to give up any land which might be had without additional expense.

42. Discovery Shaft.—To render a location valid in Colorado, Idaho, Wyoming, New Mexico, Arizona, and Montana, a shaft or equivalent opening must be made which shall expose the ore-body at a depth of at least 10 feet below the lowest point of the surface at the opening. In those States in which the depth of the discovery shaft is not fixed by law, an exposure of the vein is all that is necessary, and if the vein outcrops on the surface, no digging at all is required. The “discovery shaft” is not necessarily the opening by which the lode was discovered, but merely a condition of a valid location, subsequent to discovery, and may

be sunk at any point along the vein. The statutes of Idaho require the discovery shaft to be 16 square feet in area, as well as 10 feet deep. The discovery shaft must be included in the location, and any change of boundaries that excludes the discovery shaft renders the location invalid.

43. Discovery by Open Cut, Adit, Tunnel, or Cross-Cut.—In case of discovery by an open cut, adit, tunnel, or cross-cut, to be sure of complying with the law the prospector should have at least 10 feet vertical depth above the bottom of the breast of the opening.

44. Location Notice.—The discoverer of a claim has sixty days from the date of discovery to complete his discovery shaft, and three months in which to record. This extra time is given him so that after his discovery shaft is completed he may have time to trace the course of the vein before setting his stakes, as, having once set his stakes and recorded, he can claim only that portion of the vein lying within their limits. Even if the staking is delayed beyond the specified time, the location is not invalidated if no other claims conflict with his. As soon as the vein is discovered, it is customary, though not necessary, to post a preliminary notice at the point of discovery, of the following form:

TRUE BLUE LODGE.

The undersigned claims sixty days to sink discovery shaft, and three months to record on this vein.

Sept. 27, 1897.

MICHAEL A. KELLY, *Discoverer.*

Having completed his discovery shaft and decided on the course of his claim, he substitutes for the preliminary notice, at the point of discovery, one of the following form—the regular location notice:

The TRUE BLUE LODGE, discovered by Michael A. Kelly, Sept. 27, 1897. Claim 750 feet northerly and 750 feet southerly from discovery.

MICHAEL A. KELLY.

The signature is customary, but not necessary. This notice should be conspicuously posted, either on a post, tree, or pile of rocks.

45. Staking.—Having decided as to the course of his claim, the prospector proceeds to mark its boundaries by means of stakes, or, if these are not obtainable, by monuments of stone or earth. A stump or boulder properly marked fully answers the purpose of a stake. The stakes should be at least 4 inches in diameter and 3 feet long, and set 18 inches in the ground. One such stake is set at each

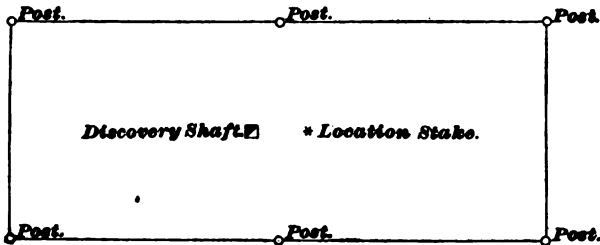

FIG. 7.

corner of the claim, blazed on the side towards the claim, and marked with the name of the lode and the number of the corner. When the center line of the claim is a straight line, a similar stake is set in the middle of each side line, blazed on the inside and marked. If the center line is a broken line, stakes are set at all angles of the side lines and

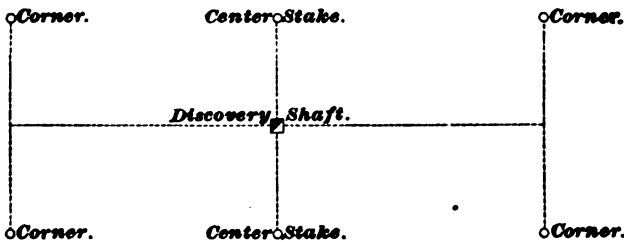

FIG. 8.

numbered continuously around the claim, starting with one of the corner stakes as No. 1. Only the stakes at the angles are numbered, center stakes, when present, being merely marked as such. In the Dakotas and Arizona a stake is required in the middle of each end line. Fig. 7 is a diagram of a lode correctly located under the present law in Colorado and most of the other mining States and Territories.

Fig. 8 shows the lines which it is necessary to run for the prospect survey.

When a stake can not be driven on account of bed-rock, it should be fixed in a pile of stones. If, on account of precipitous ground, it is impossible to set the stake where it belongs, a *witness stake* should be set at the nearest available point along one of the lines of the survey, suitably marked to designate the position of the corner.

46. Rights of Locator.—Having properly located the claim and recorded the location with the Recorder of the

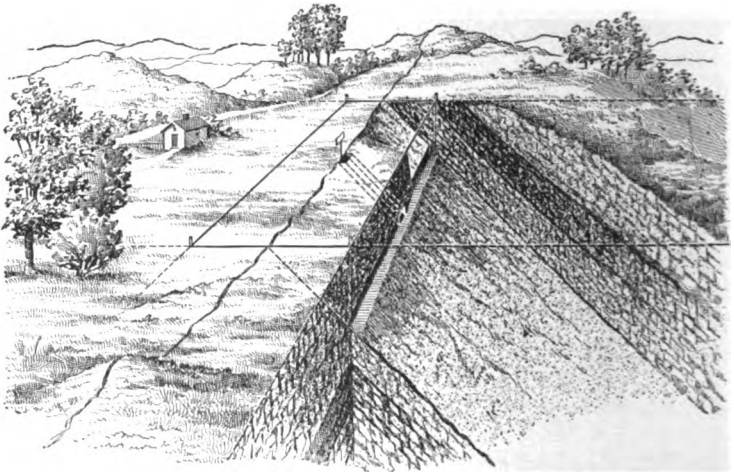

FIG. 9.

county or district, the prospector is entitled to all veins apexing within his boundaries that are not already claimed, and may work such veins on their dip, to their full depth, for the distance between the parallel vertical planes of the end lines. Under no condition, however, can he follow the vein outside of the vertical planes of the end lines. If the vein, in its dip, turns and crosses the end plane, he loses all further right to follow it on its dip beyond where it crosses. Thus, the miner may follow the lode down indefinitely if, as in Fig. 9, it remains within the end planes, but if it turns

and passes out through either end plane, as in Fig. 10, he has no claim to any portion of the lode beyond the end plane.

47. The terms *apex* and *outcrop* must not be confounded. Flat, stratified deposits, such as coal-beds, the zinc-ore beds

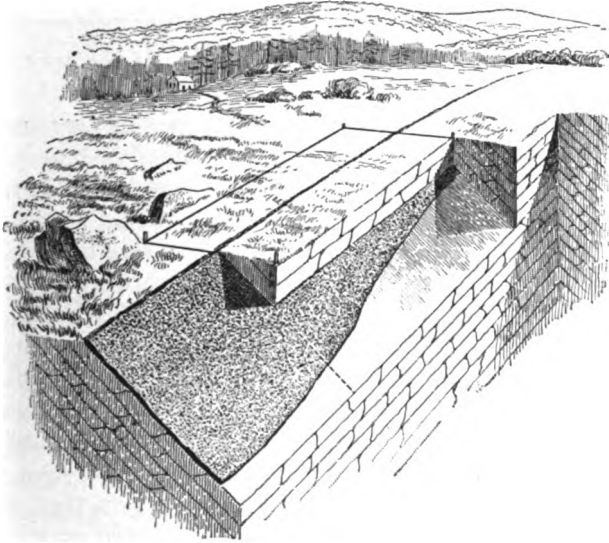

FIG. 10.

of Missouri, or even blanket veins, can not fairly be considered to have an apex, or highest point, though they may have a well-defined outcrop. In the cases of coal and zinc beds and stone quarries, no extralateral rights are ever granted, the locator being entitled only to that portion of the bed vertically underneath his surface location. The case of flat veins and blanket deposits, though coming under another statute, would appear analogous, and is generally so considered by the courts. A location on the outcrop of a vein with a dip of 8° was held to give the locator no extralateral rights, and subsequent locations made on the dip of the same vein were held to be valid, with the same restrictions.

48. *If the apex crosses one side line, as in Fig. 11, the courts have decided that the point *a* of departure of the*

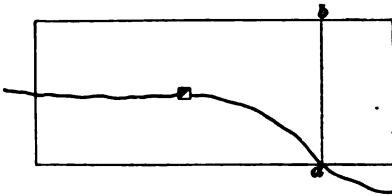

FIG. 11.

vein becomes in effect one point of an end line *a b* parallel to the other end lines, beyond which the locator has no rights on the vein.

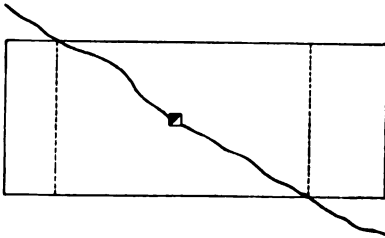

FIG. 12.

49. *If the apex crosses both side lines, the same rule usually holds, each end line being moved up to the nearest point of intersection of the vein with the side line, as indicated by the dotted lines in Fig. 12; or the court may fix new end lines*

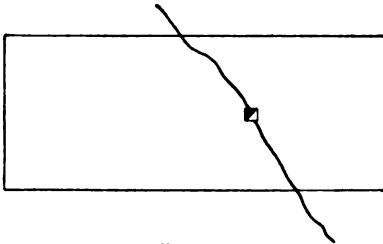

FIG. 13.

through these points, at right angles to the strike of the vein. If, however, the apex intersects the side lines at a high angle, as in Fig. 13—in the words of the ruling, “substantially at right angles”—

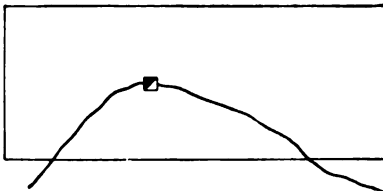

FIG. 14.

so that the distance between the end lines, if moved in, would be less than the legal width of the claim, the side lines become in effect end lines, and the rights of the locator

are limited by the vertical planes of both side and end lines.

50. *If the apex departs from one side line twice, as in Fig. 14, the locator is entitled to only that portion of the vein within the vertical planes of his side lines.*

Such cases as the preceding are, however, more or less in the hands of the courts, and mining cases are always in doubt till the final decision of the highest court is made. The construction a court may put upon certain phrases and conditions of the statutes is frequently totally unexpected and without precedent, so that the prospector should exercise the utmost care in locating his claim, to have it incontestable. Otherwise, if it shows well on development, he is almost certain to have a few lawsuits over it.

51. The form of the mining claim does not have to be a rectangle, but may be laid out as shown in Fig. 15, in which case the line $AefB$ is supposed to approximately follow the vein, and the entire length of which must not be over 1,500 feet. The end lines through the point A and B can not be over the full width of the claim as allowed by law, and these end lines must be parallel to each other; that is, the line ab , passing through the point A , must be parallel to the line cd , passing through the point B . The side lines are parallel to the center line, and in no place should the perpendicular distance between them be over the allowed width of the claim. These angular claims are used to overcome the difficulties illustrated in Figs. 11, 12, 13, and 14. The stakes are numbered as in the case of rectangular claims, and may start as from the point a , and be numbered in order, as shown in the illustration.

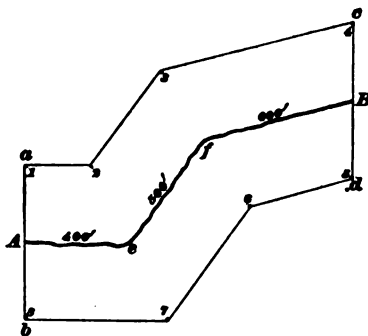

FIG. 15.

52. For location notice, it is not necessary that the survey of the claim be tied to a special government monument, patent corner, or section corner, but it is sufficient for it to be tied to natural landmarks or to monuments which can be easily identified. When the claim is finally

surveyed for patent, the survey must be tied to a government monument or section corner.

53. Annual Labor.—To hold a claim, the locator or owner is obliged to perform at least \$100 worth of labor each calendar year, until claim is patented, in actual development of the property, or to make improvements of that value, such as buildings, machinery, etc. Where a number of claims are worked as a group, all the work (usually called *assessment work*) may be done on any one claim of the group.

54. In the eastern and southern portions of the United States, the discoverer is not allowed to stake out a claim, as in the West, but must purchase the land on which the mineral occurs from the Government; or, if it is owned by private parties, he may either purchase it or obtain the privilege of mining by paying a royalty or a definite lease. In these regions, the mining must be confined to the vertical planes passing through the boundaries of the property; in other words, the miner is not allowed to follow his vein under another person's property.

BRITISH COLUMBIAN PRACTICE.

55. Size and Shape of Claim.—A mineral (lode) claim, according to the mining laws of British Columbia, may be, but can not exceed, 1,500 feet square. *All angles must be right angles*; that is, the claim must be rectangular. Two sides of the claim must be as nearly as possible parallel to the general course of the vein.

56. Discovery of Vein.—To make a location valid, ore must be discovered in place, as in the American laws, but there are no regulations as to openings. A "discovery post" must be placed as near as possible to the point of discovery. This must be the ordinary "legal post" described under placer mining in British Columbia.

57. Staking.—Besides the discovery post, the Canadian prospector is obliged to set only two other posts. (See

Fig. 16.) These are set along the line of the vein, not more than 1,500 feet apart. They must be "legal posts," and numbered respectively No. 1 and No. 2. Upon No. 1 post there must also be written the words "Initial Post," the approximate *compass bearing* or direction of No. 2 post, and

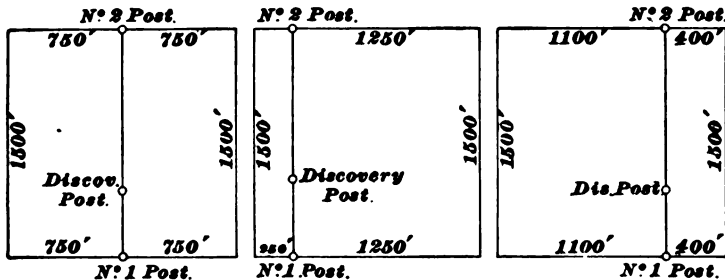

FIG. 16.

a statement of the number of feet the locator claims on each side of the line between the two posts, known as the "location line." Thus:

Initial Post. Post No. 2—1,500 feet northeasterly. 900 feet of this claim lie on the right and 600 feet on the left of the line from No. 1 to No. 2 post.

He is obliged to so mark the location line that it can be plainly seen. If the country is timbered, he blazes the trees and removes the underbrush along the line; if it is open, he sets legal posts, or monuments of earth or stone not less than 2 feet high and 2 feet in diameter at the base, so that the line can be easily traced.

Once set and recorded, No. 1 post can not be moved or tampered with in any way. If the distance between No. 1 and No. 2 is found to be more than 1,500 feet, the Provincial Land Surveyor can move No. 2 in to the proper point; if, however, the distance is less than 1,500 feet, it can not be changed after the claim is recorded.

58. Recording.—The miner is given fifteen days from the date of location in which to record his claim, if within ten miles of the Recorder's office, and one additional day

for each ten miles or fraction thereof beyond this distance. A claim not recorded within the time prescribed will be considered abandoned.

59. Abandonment.—The law regarding abandonment is the same as for placer claims (see Art. 31), except that it is not necessary to work claims continuously in order to hold them. A free miner can not relocate a claim which he has abandoned or forfeited without a written permit from the Gold Commissioner.

60. Annual Labor.—Work must be done on the claim or in proximity to it, with intent to develop it, to the amount of \$100 a year, from the date of recording, and an affidavit filed with the Gold Commissioner setting out a detailed statement of the work done, before the expiration of each year from the date of record. Unlike the American law, surveying done on the claim within one year from the date of record, to an amount not to exceed \$100, is counted as development work. Two or more miners may work their claims as a group, after having filed a notice of such intention, and all the work for the group may be done on one claim.

TUNNEL SITES.

61. In the United States, any person or persons desiring to do so may claim a *tunnel site* for the purpose of running a tunnel for the discovery and development of lodes, with the right to hold and work, for a distance of 1,500 feet along their length, all veins not previously known to exist, which may be cut by the tunnel within a distance of 3,000 feet from its "face" or mouth. All lodes cut must be staked and recorded exactly as if discovered from the surface, with the exception that the tunnel discovery renders the discovery shaft unnecessary. The location notice should be set on the surface at a point directly above the tunnel, on the center line of the claim. To set the surface stakes, the approximate dip and strike of the vein are noted where it is

cut by the tunnel; these are projected up to the surface and the stakes set accordingly.

62. Dump Room.—Each tunnel-site location carries with it the option of locating an additional space 250 feet square at the mouth of the tunnel for dump room, upon the specification of such claim in the location notice and record.

LOCATION OF TUNNEL SITE.

63. The courts are at present considerably at variance in their interpretations of the tunnel-site statutes, and no absolute rules can be given for locating and recording claims. It has been practically settled that the legal "line of the tunnel" means a parallelogram 1,500 feet wide, parallel to and including the actual line of the tunnel. The

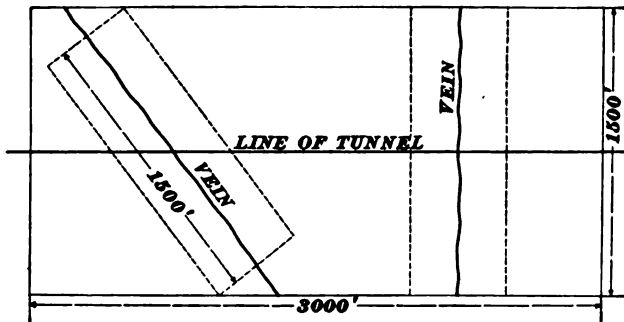

FIG. 17.

latter need not necessarily be midway between the boundary-lines. If, however, a vein be oblique to the tunnel, the 1,500 feet will have to be taken along the vein, as in Fig. 17; hence the width of 1,500 feet for a tunnel site has no particular legal value.

64. Staking.—The location notice is placed at the mouth of the tunnel. A substantial stake is placed vertically over the ultimate end of the tunnel, 3,000 feet from the mouth; this is the end stake. Three or four stakes should be set at intervals along the line of the tunnel

between the mouth and the end stake. The four corners of the tunnel site are marked by the ordinary "substantial" stakes. Dump ground is marked by stakes at the four corners.

65. Location Notice and Certificate.—The location notice and certificate, in all their essential features, are practically the same as the notice and certificate for ordinary lode claims. The notice must contain a description of the claim, the bearing of the line of the tunnel, and the claim of all lodes discovered in the tunnel and not previously known to exist, with the distance claimed on either side of the line of tunnel. The end stake should be tied to prominent landmarks or fixed monuments, and such ties should be indicated in the notice. If dump room is claimed, the claim should be added at the bottom of the notice, thus:

Dump 250 feet square, as staked.

The location certificate also contains all these features, but greatly elaborated, with bearings and distances to corner stakes, distances to intermediate stakes along the line of tunnel, etc.

66. Annual Labor and Abandonment.—The work done or money expended on a tunnel is counted as annual labor on all lodes opened and developed by it, for each of which \$100 worth of work must be done yearly. Neglect to work a tunnel for a period of six months constitutes an abandonment of the rights of the owner to all veins along the line of the tunnel, though not of the tunnel itself.

MILL SITES.

67. A *mill site* is a grant of non-mineral land for purposes incidental to mining. The United States statutes further divide mill sites into two classes, according to the purpose for which they are to be used. The first class, **mill site with lode**, is of most interest to the prospector. Such a mill site is a grant of land, which may be adjacent to the claim of the locator, but not on the lode nor on known

or supposed mineral land, not exceeding five acres in area; in some districts the area is still further restricted. It may be used for any purposes incidental to the working of the claim, as for storage room, boarding-houses, ore bins, etc., or for mills for treating the ore from the mine. The creation of this class arose from the necessity, in largely operated mines, for more surface room for the purposes mentioned than is usually to be had, suitable for such purposes, within the limits of the claim proper. The application for a mill site of this class must be made by the owner of the lode claim for which it is to be used.

68. The second class, **mill site for mill or reduction works**, covers all claims in which the application is made for the mill site alone, independent of any particular lode claim. Such a mill site must be used for the purpose for which it is claimed, i. e., a site for a mill or reduction works—incidental uses are not sufficient.

The British Columbian laws do not make any such distinction. Their only provision is that the land be unoccupied public land, and, as far as known, non-mineral. British Columbian statutes entitle the owner of a mill site to surface rights only, reserving all minerals which may be subsequently discovered on the land, together with the right to enter the property and mine such minerals, for the Government and its licensees. They also require that the mill site shall be as nearly square as possible.

LOCATION AND RECORDING.

AMERICAN PRACTICE.

69. Staking.—Mill sites are located, like lode claims, by placing a substantial post at each angle (the British Columbian laws stipulate that such posts be “legal posts”) marked with the name of the mill site and the number of the corner. The corners should be tied to natural landmarks or permanent monuments, and, in fact, their location should conform in every way to the requirements of a

mineral-claim location, except in the matter of mineral values. A location notice must be posted on some prominent point on the claim, which should read substantially as follows:

LOCATION NOTICE.

I claim the *Little Eva* mill site (500 feet south by 400 feet north) as staked on this ground. Date of location, Oct. 5, 1897.

J. K. HAWLEY.

70. Recording.—The record of a mill-site location is practically the same as that of a mineral claim. The property should be so described in the certificate that there can be no difficulty in relocating it in case of litigation.

BRITISH COLUMBIAN PRACTICE.

71. Aside from the differences already mentioned, the British Columbian statutes in reference to mill sites are very similar in intent to those of the United States.

Area and Staking.—As in the United States, the area of a mill site is limited to five acres. The corners are marked by "legal posts," with a notice on each post stating:

1. The name of the locator. 2. The number of his free miner's certificate. 3. The intention, within sixty days from date of notice, to apply for the land as a mill site. 4. The date of notice.

72. Application for Lease.—Having properly located and staked his mill site, the locator, within the sixty days specified, applies to the Provincial Land Surveyor for a lease on the property, and, on depositing duplicate plans and making affidavit as to the location of the claim, is granted a lease for one year. If in that time the lessee has placed or constructed machinery or done other work on the property, for mining or milling purposes, to the value of \$500, he can obtain a *Crown grant* (the equivalent of the United States *patent*) to the mill site, at the expense of \$5 per acre.

The interpretation of the term "mining purposes" is not so broad as in the American practice. It includes only the erection of machinery and buildings for transporting, reducing, crushing, or sampling ores, or for the transmission of power for working mines.

PROSPECTING FOR GEMS AND PRECIOUS STONES.

73. Most gems are obtained in the debris of the older rock formations, that is, from the gravels or sands of rivers. The prospector looking for gold or other placer material can examine the gravel for precious stones, the gold pan being used to separate any stones from the clay or fine sand which may be associated with them; but if a person intends to prospect especially for gems, it is better to be provided with a more extensive prospecting outfit. The following has been recommended as an outfit for a person searching for gems: A shovel and pick with which to loosen and move gravel; two sieves, one having two or three meshes to the linear inch and the other having twenty or more meshes to the linear inch (the coarser sieve should be arranged so that it can be fastened onto the top of the finer one); a tub of sufficient size to enable the prospector to submerge the sieves in water during the washing process; an oilcloth for sorting the gravel upon; several stones as a scale of hardness; a small pocket magnifying-glass, and a dichroscope. In some cases, more or less of this paraphernalia is dispensed with. The process of prospecting is as follows: Having discovered a promising location, the prospector fills his tub with water, fastens the coarse sieve on top of the fine one, and places a shovelful of the material to be examined in it; then immersing the sieves in the water, he works all the clay and fine material through the upper sieve with his hands. This leaves only the larger stones above. The upper sieve may now be removed, the stones examined and thrown away. Then the material in the lower sieve is washed until all the clay and fine sand has been separated from the gravel. After this, a little quick jiggling motion will carry the heavier and coarser stones to the bottom of the sieve. The sieve is then removed from the water and suddenly turned over upon the oilcloth, so as to bring the material that was at the bottom onto the top of the pile. The prospector now examines each piece with his glass or

scale of hardness, and if he is in doubt about any of the gems, he may be able to settle their identity with the dichroscope. Few of the precious stones are of sufficient specific gravity to cause them to concentrate into decided deposits, as in the case of gold, tinstone, and some other heavy compounds, but, nevertheless, they are usually somewhat concentrated. Garnets are frequently found in pockets on the bed-rock or in patches, where they have been carried by eddies or other disturbances in the flow of the streams. These patches of garnets are considered a good indication of the possible presence of more valuable gems.

THE DICHRISCOPE.

74. To settle the identity of a stone, the dichroscope (in shape a cylinder 2 inches long and 1 inch in diameter, and so easily carried about) is most useful, taking for granted that some practice with the various kinds of translucent or transparent stones of various shades and colors has been acquired. A preliminary examination of a few sapphires and rubies, spinel rubies, garnets, topazes, tourmalines (green, brown, red), zircons of various colors, andalusite, water sapphire, colored quartz (including amethyst), etc., will impart a confidence very much more than any tabulated results of dichroism, which depends much on the intensity or depth of color in the stone.

75. Fig. 18 illustrates the dichroscope in position for use with a stone in the tweezer, while Fig. 19 illustrates the manner in which the two colors appear. When a semitransparent stone is examined, the color of the square *a* will sometimes be of different shade from that of the square *b*, and these differ-

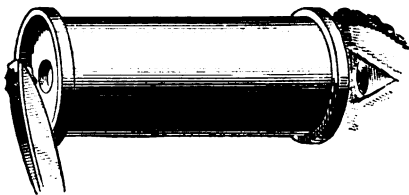

FIG. 18.

ent effects are caused by the dichroism of the stone being examined.

76. Placing (by means of tweezers) a translucent or transparent stone close to one end of the instrument where the two square images are seen when the instrument, held skywards, is looked into, and turning it about in various directions, and at the same time turning the instrument around, the observer will notice whether the



FIG. 19.

color of the two squares is one and the same. If the stone is amorphous, such as glass, flint, obsidian, etc., or crystallizes according to the cubic system, such as diamond, spinel ruby, garnet, etc., the two squares will be of the same color. In other cases the color of one square will be of a different color to that of the other when the colored stone is examined in certain directions, though it may be the same in certain others. Thus, a true ruby, which affords two shades of pink, can be distinguished from a spinel ruby or garnet without dichroism, or from a pink tourmaline (rubellite), which gives two colors, but somewhat differently to those of a ruby; so, too, a sapphire, which gives a blue shade in one square and a light shade of color without any shade of blue in the other (though sometimes in a deeply-colored stone what might be considered as a greenish blue is noticed), can be distinguished from an amethyst, which affords two shades of purple, or from a blue spinel (which does not show any twin coloration), or from an iolite (or water sapphire), in which the coloration is of its own kind.

77. A tourmaline (very frequently associated with other gems, especially in Ceylon), either the green or brown, can be recognized directly (indeed, often without using the dichroscope) by the color of the one square being quite dark compared to that of the other.

78. An emerald affords two distinct shades of green (one bluish) easily remembered (quite distinguishable from the dichroism of a green tourmaline); so a green garnet, which does not show twin coloration, can not be mistaken for it.

79. With the dichroscope and two or three minerals, such as the sapphire, topaz, and rock crystal, to test for hardness, and a little practice—the more the better—and a slight knowledge of the crystallization of minerals, which, though frequently found water-worn, not uncommonly retain traces of the original crystal edges and faces, the prospector can examine his specimens with a very much easier mind than he would do without them.

80. The following gems display dichroism when examined with a dichroscope: All the corundum minerals, topaz, emerald, amethyst, iolite (water sapphire), tourmaline, and zircon. The following gems do not display dichroism: Diamonds, spinel, and garnet. Cat's-eye, turquoise, and opals, not being transparent, can not be tested with the dichroscope.

GENERAL REMARKS CONCERNING PROSPECTING.

81. When the prospector discovers mineral in place in a vein, he must not be too sure of its character or value until it has been prospected to the point below the influence of the surface agencies, or, as is commonly stated, to below the water-line, for it is quite a common occurrence to find a deposit containing free milling gold ore in its upper portions, rich oxides of copper or other minerals near the water-level, and farther down such a small amount of base sulphides as to render the material valueless as an ore.

82. The term ore is used in this work as signifying any material that can be extracted with profit. It will be seen that this definition would rule out material in one region as being worthless, while in another location it might be classed as an ore.

83. Sometimes the prospector discovers what appears to be the outcrop of a bed of hematite or limonite, which proves to be the weathered outcrop of a pyrite vein, and hence valueless as an ore of iron.

UNDERGROUND PROSPECTING.

84. At times, especially in precious-metal mines, the vein becomes lost, and prospecting has to be carried on underground as well as on the surface.

In reality, the openings of the mine become simply an extension of the surface exposures, and the prospecting is carried on very much as it would be from the surface.

85. When exploration is being carried on in advance of the regular mining, this work is usually called exploration and development work, and is considered in connection with the mining.

86. When searching for a lost vein from the underground workings of a mine, the exposed surfaces are examined and a careful study made of the geological conditions, both underground and on the surface.

In cases where the vein has simply pinched out or become barren, it may be found again by following such indications as stains or rusty streaks in the rock, small leaders of the mineral itself, or veins of material other than the country rock.

After having examined all the indications, as exposed in the mine and on the surface, if the ore is thought to be in a certain direction the work must be continued in the desired direction, either by drilling or by actual mining operations.

87. When the vein or ore-body has been cut by a fault which has thrown the rock either up or down, it may be discovered once more by breaking through into the formation beyond the fault and carefully examining the rock to ascertain whether it is the formation above or below the body sought. If the fault has thrown the vein or deposit to the right or left, or up or down at an angle (that is, so as to carry it up or down as well as to one side), it will be necessary to make a careful study of the geology of the region, and to determine the probable direction of the throw by the rules for the throw of faults as given in the Paper on *Geology*, together with any local characteristics in that respect. If,

after examining all the indications both above and below ground, it is thought probable that the mineral lies in a certain direction, work may be continued in the desired direction either by regular mining operations or by drilling.

DRILLING.

PROSPECTING WITH A DIAMOND DRILL.

88. Deposits which do not outcrop to the surface, or the outcrop of which gives no definite idea as to the position of the deposit, may be prospected for by drilling. The diamond drill is the best machine for operating in rock. The machines and their working are described in *Percussive and Rotary Boring*, but the following points are of interest in laying out the prospecting of any particular piece of ground.

89. There are many cases in which the deposits are not of a regular nature, and are so located that the diamond

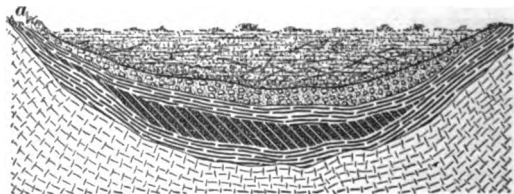

FIG. 20.

drill is practically the only means by which they can be prospected. Fig. 20 illustrates an ore-body occurring beneath a bog or lake. This is very common in the case of the ores of iron or manganese. There is a slight outcrop at *a*, but, owing to the nature of the ground over the deposit, it would be impossible to prospect by means of test pits or shafts without their being excessively expensive. In such a case, a diamond drill may be placed upon the surface when it is frozen, the stand-pipe being driven through the soft material

to bed-rock, and the drilling accomplished as though there were no soft material over the deposit. Drilling has been done in this way from the ice of lakes in the winter, and very valuable discoveries have thus been made. After the ore has been found, it may be possible to drain the bog or lake, and thus recover the deposit.

90. It may be stated, as a general rule, that where the strike and dip of the deposits sought for are fairly well known, the diamond-drill holes should have a direction practically at right angles to the deposits sought, as illustrated in Fig. 21, $c d$ being the diamond-drill hole and a the deposit.

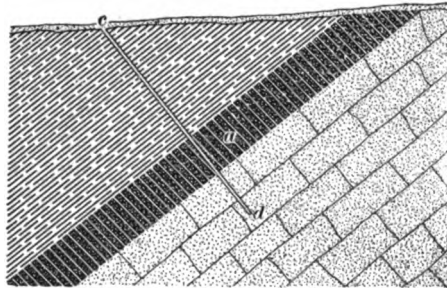

FIG. 21.

91. Sometimes, where it is possible to sink to bed-rock around the edges of the deposit, test pits are put down, and a series of holes drilled from the bottom of the test pits, the drill being placed on the bed-rock. Such holes are commonly called **fan holes**. Fig. 22 illustrates a case in which a property has been prospected by three sets of fan holes drilled from three shafts or test pits, A , B , and C . The long lines a, a, a', a', a'', a'' , etc., represent holes drilled at a comparatively flat inclination, while the shorter ones b, b, b', b', b'', b'' , etc., represent holes drilled at a steeper angle. It is best to do the work from more than one shaft or test pit, if possible, in order that the lines of the diamond-drill holes may cross each other, as shown in the illustration. The drill pits, or test pits, in which the diamond drill is to be placed, as shown at A , B , and C , are situated at such points that they will not have to penetrate the bog or extremely wet ground immediately adjoining a lake, and for this reason they are usually situated at the foot of the hills, as shown in the illustration. It may be

cheaper to sink pits some distance in the rock at the foot of the hill than it would be to keep the water pumped out, had

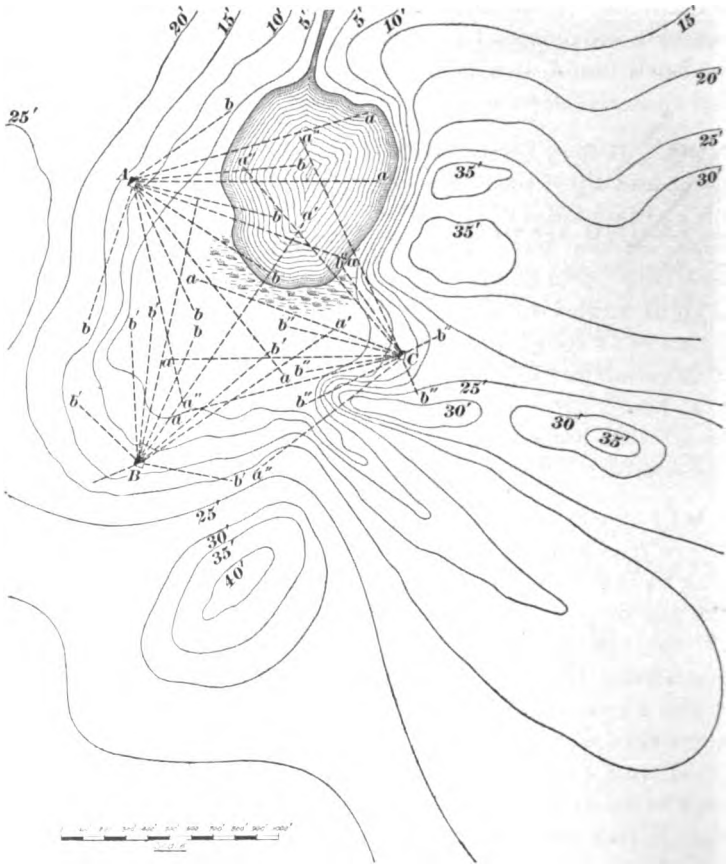

FIG. 22.

the pit been placed in the softer material of the swamp or bog.

92. It may be stated, as a general rule, that when the dip or general direction of the formation is not known, the ground should be blocked off into approximate rectangles and the holes drilled in such a manner as to cross each other, thus, if possible, discovering any small or irregular deposits

of valuable material. It is not always safe to depend upon a rectangular form for the system of blocking out the ground for diamond drilling. Fig. 23 illustrates a case in which a lense or body of ore occupies a trough, and had two diamond-drill holes been drilled as shown at *a* and *b*, they would

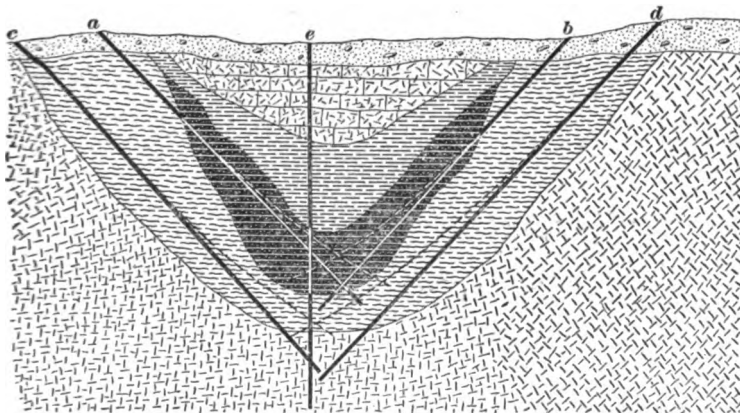

FIG. 23.

give very erroneous indications as to the size of the deposit, while if they had been drilled as at *c* and *d*, they would have missed the deposit entirely. If the holes are drilled close

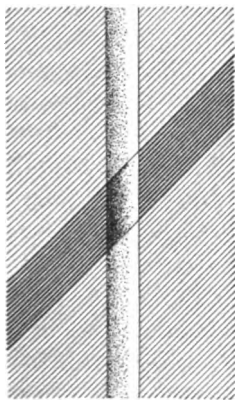

FIG. 24.



FIG. 25.

enough together and in rectangular form, they will give a fairly close idea as to the form of the deposit, but vertical holes should also be drilled as at *e*, for the probabilities are that the inclined holes would drift up as indicated by the dotted lines, and hence give a false idea as to the location of the deposit, which the vertical holes would correct.

93. A single hole drilled through an inclined formation, as shown in Fig. 24, may

give a very false idea as to the dip of the strata, for while the dip, with regard to the center line of the hole, will be clearly indicated in the core, as shown by Fig. 25, the core may, and probably will, become turned in the core-barrel while being drawn from the hole, and hence will give no idea as to the true dip of the formation.

94. In order to determine the dip of any given deposit, it is necessary to drill a number of holes and compare the records; as, for instance, in Fig. 26, if holes were drilled at

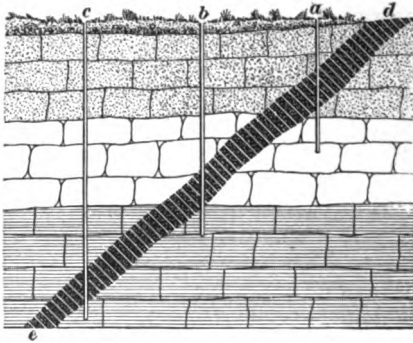

FIG. 26.

at *a*, *b*, and *c*, and their results compared, it would be easy to tell that the vein *d e* had a uniform dip in the direction indicated.

95. Sometimes it is necessary to drill holes very close together on account of the fact that formations may be very erratic, as illustrated in Fig. 27. In this case,

the hole *a b* has passed perpendicularly through a small body of ore, thus giving indication of a large deposit, while the hole *c d* has passed through a thin portion of a large ore-body, thus giving indication of a small deposit. When prospecting for material which is liable to occur in irregular pockets or lenses, it is necessary to put down a number of holes, and to place them in a somewhat regular order; for instance, if other holes had been drilled from the positions occupied by the machine while drilling *a b* and *c d*, as indicated by the lines from *a* and *c*, it is evident that a fairly good idea as to the dimensions of the deposits in this plane would have been determined; and if another series of holes had been drilled from the position *c*, as indicated, a very much more definite idea of the form of the deposit would

have been obtained. By means of a careful and systematic exploration of the ground with a diamond drill, it may be

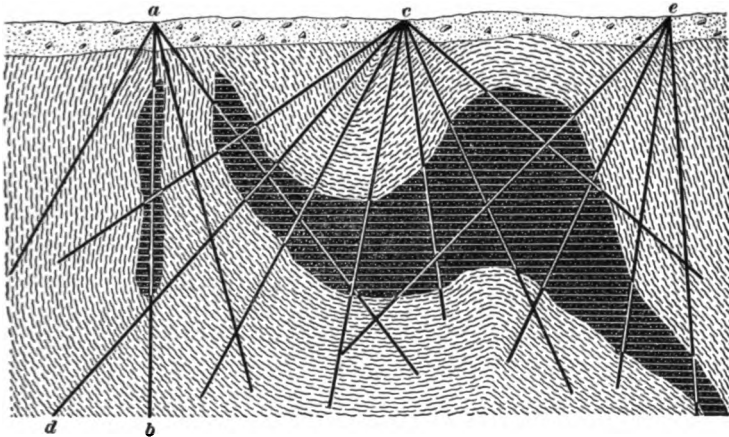

FIG. 27.

possible to obtain all the data necessary for laying out a mine or for attacking a new portion of the deposit.

96. One advantage of prospecting with a diamond drill is that the work can be done at a very much less cost per foot, and so several diamond-drill holes can be put down for the amount of money it would require to sink one shaft or drive one tunnel, and the results obtained by means of the diamond drill may render it possible to so locate a shaft or tunnel through which the ore is finally removed that it will be very much more effective, and permanently reduce the cost of mining; hence the diamond drill is one of the best methods of prospecting certain forms of deposits.

HAND AUGERS FOR DRILLING.

97. While the diamond drill is preeminently fitted for drilling in rock formations, it is sometimes necessary to prospect in comparatively soft material near the surface,

as, for instance, when searching for iron ore in clay beds or for deposits of manganese ore, bog-iron ores, phosphate rock, clay, etc. For this work a simple auger may be used, as shown by Fig. 28. This is usually composed of a bar of steel, or of iron with a steel tip, which is twisted to a



FIG. 28.

spiral form and the point of which is split and sharpened. A good length for the auger is about 13 inches, with a diameter of 2 inches. The auger should have about 4 turns in a distance of 13 inches. For the operation of the tool, it has a piece of 1-inch pipe welded to it, and as the boring progresses, other pieces are screwed on by means of ordinary pipe-couplings. For the turning of the auger there is a handle arranged with a central eye so that it can be slid up and down the pipe and fastened at any desired point by means of a set-screw. In case hard rock is encountered when prospecting with this outfit, it is possible to continue the work by means of a churn-drill, formed by a piece of $1\frac{3}{8}$ -inch octagon steel having a 2-inch cutting edge, and with a piece of pipe welded to its upper end. For the first section of rod above the steel chopping bit, a piece of $1\frac{1}{4}$ -inch round iron may be substituted for a section of the pipe. This has the advantage of giving the necessary weight to the churn-drill for driving it through the formation.

Prospecting has been carried on to a depth of over 60 feet with such an apparatus as this, the churn-drill being used when hard rock was encountered, and the auger-bit while working in soft strata. One great advantage of this outfit is that it costs but little, and can be made or repaired at any blacksmith shop. When using the chopping bit, the material drilled may be worked stiff enough to remove the debris by means of the auger-bit, or a sand-pump made from a piece of pipe with a leather valve at its lower end may be employed. During the work sufficient water is introduced into the hole to keep the tools cool and to render the cutting somewhat easier.

PERCUSSIVE, OR CHURN, DRILLS FOR PROSPECTING.

98. Sometimes large drills of the percussive type, such as are ordinarily used for boring wells, are employed in prospecting, but the results obtained are not nearly so good as those obtained with a diamond drill, owing to the fact that the entire product is broken up into fine grains, and the valuable portions may be broken so small that it is impossible to tell the exact character of the material passed through. Machines of this class are illustrated in *Percussive and Rotary Boring*.

MAGNETIC PROSPECTING.

99. When prospecting for bodies of magnetic iron ore, both the ordinary compass and the dipping-needle, or miner's compass, can be employed. The miner's compass is illustrated in Fig. 29, and consists of a magnetic needle so mounted that it can move in a vertical plane. Fig. 30 illustrates the manner in which the ordinary compass would behave in passing about a body of magnetic ore situated at *a*. If a prospector were to start at *b*, the compass, instead of pointing due north, would be deflected slightly towards the ore-body *a*, and as he advanced towards the position *c* the deflection would become greater and greater until it reached the maximum opposite, or nearly opposite, the body of ore *a*, and after passing this point the attraction

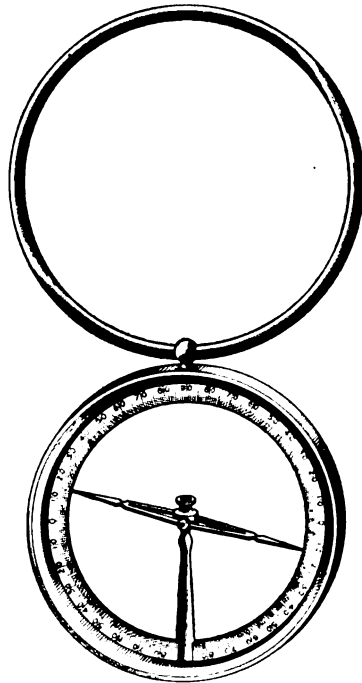

FIG. 29.

would become less and less. Similarly, in passing from *d* to *e*, the magnetic needle would deflect towards the body *a*. By this means some idea as to the position and extent of the

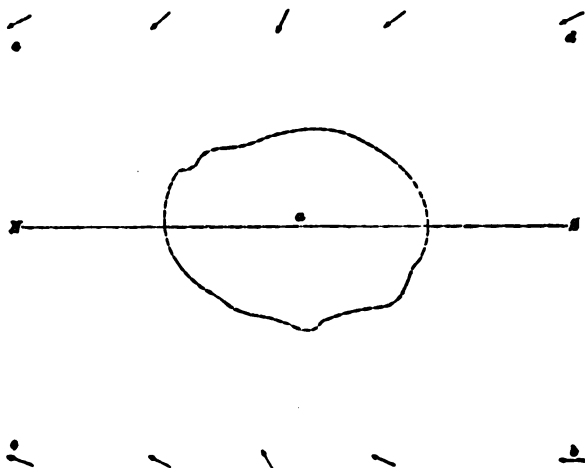

FIG. 30.

center of attraction may be determined. After having gone over the ground with an ordinary compass, the prospector may use the dipping-needle, or miner's compass, and obtain the results shown in Fig. 31, which is a vertical section on the line *NS*, Fig. 30. If the dipping-needle

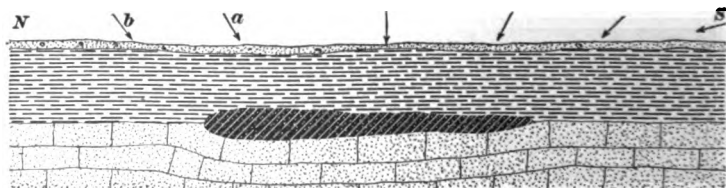

FIG. 31.

were taken from the point *S* towards the point *N*, the dip would vary until, if the body of ore be large and near the surface, the needle would point directly down, or might often assume a reversed position as shown at *a* and *b*, where the needle is taken beyond the ore-body towards the north. After the center of magnetic attraction has been determined,

prospecting can be continued either by sinking or by the use of the diamond drill. Sometimes beds or bodies of material containing magnetic sand may cause magnetic disturbances which would produce the same effect as a body of magnetic ore, and on this account magnetic prospecting may possibly give false ideas as to the position of ore-bodies and as to their extent.

EXAMPLES OF PROSPECTING REGIONS.

PROSPECTING REGIONS OF COLORADO.

100. If we study the geological map of Colorado (Fig. 32) as a type of the Rocky Mountains generally, we see that the two main crystalline bodies of rock, the granitic and eruptive rocks, have somewhat definite positions. The granite areas are very large, and are arranged along certain definite lines from north to south across the State, preserving a rough parallelism to one another and corresponding to the three principal ranges, and are separated from one another by intervals of surface matter or by overlapping sedimentary rocks. The first of these granitic areas on the east, bordering on the great plains, is the Colorado, or Front, Range, extending from beyond the Wyoming boundary south to the Arkansas River, and continued southward under the name of the Wet Mountains. Some miles to the west, and irregularly separated from the Front Range by the depressions of the North, Middle, and South Parks, and the Wet Mountain Valley, is the Park, or Mosquito, Range, a narrow range whose granite base is overlaid at intervals by old, metamorphosed, sedimentary rocks belonging principally to the Cambrian, Silurian, and Carboniferous series. This range is continued southward, under the names of the Sangre de Cristo and Culebra Ranges, to the southern boundary of the State. A little west of the Mosquito Range is the great, massive, but comparatively short, granite area

of the Sawatch Range, separated from the Mosquito by the depression of the Arkansas River Valley.



FIG. 32.

101. These are the main great outcrops of the granitic system in Colorado. Not that this fundamental granite is confined to these areas, however, for it underlies elsewhere, at varying depths, the rest of Colorado and the whole Rocky Mountain system, but in these areas it is brought most prominently to light by uplift and erosion, while elsewhere

it is buried out of sight by superficial and sedimentary rocks, sometimes of enormous thickness, or by broad sheets and deluges of lava. In other parts of the mountains we find the granite here and there exposed by great local denudation, where a cañon has bitten deeply into the earth's crust, as in the San Juan region; here great areas have been covered up to a depth of 3,000 to 4,000 feet by deluges of lava; profound cañons cutting through these sheets of lava will sometimes reveal the granite in the bottom of the stream-bed.

102. If we turn to the map to look for the areas of eruptive volcanic rocks, we observe that they are much more irregularly and indefinitely distributed than the granites. They are not quite so abundant towards the north as towards the south of Colorado. They appear most plentifully in a rough line from north to south, through the central-western regions of the mountains. They seem to follow principally an irregular line west of the Parks, the Mosquito and Sawatch Ranges culminating towards the southern-central portion of the mountains, in the prodigious eruptive mass of the San Juan region. These dark patches on the map represent, however, more the great sheets and broad eruptive overflows than the multitude of narrow dikes and local intrusive sheets of volcanic matter to be found scattered here and there over the entire mountain region. These latter, though unimportant and too small for representation on a map, may be of great local consequence in connection with ore deposits in local mining centers, as, for instance, at Central, Idaho Springs, Boulder, Leadville, and Aspen.

103. Let us next consider where the older Paleozoic series of sedimentary rocks, commonly metamorphosed by heat, are most prominently shown. These "old-life," or "Paleozoic," rocks lie generally close upon the primitive granite, and comprise three divisions. The Cambrian, composed of hard, vitreous, white quartzites, lies right upon the granite. Upon this comes the Silurian, mostly of drab-

colored, thin-bedded limestones, and on this the Carboniferous, composed of dark-gray, or "blue," heavy-bedded, massive limestones below, and a great thickness of shales and conglomerates or grit-stones above. The Lower Carboniferous "blue limestone," when overlaid or penetrated by intrusive sheets of porphyry, gives us the most important lead-silver deposits in the State, as, for example, at Leadville and Aspen. The united thickness of this Paleozoic series in Colorado is rarely more than 2,000 feet to 3,000 feet.

104. As these rocks were all laid down by the ancient seas as successive shores and sea beds when our great granite ranges were merely a series of islands in oceans almost universal, we would naturally look for their outcrops along the borders of those island ranges, or capping, as in the Mosquito Range, even their highest and once submerged summits, while the rest of their broad sheets pass under the more recent sedimentary strata of the parks and prairies and lie deeply buried beneath them. In the latter position they are unaltered and uncrystallized by heat; in this condition we find them along the eastern border of the Front Range at Perry's Park, Manitou, and Cañon City. A glance at the geological map shows this class of rocks outcropping along the Mosquito and Sangre de Cristo Ranges at intervals, also down the Wet Mountain Valley to the Culebra Range at the southern extremity of the State. On the western slope of the Mosquito, at various points in the Arkansas Valley below Leadville and above Leadville to Tennessee Pass, then down the valley of the Eagle River to Redcliff and beyond, it appears and occupies large areas about the Grand and White Rivers and in the White River plateau.

105. Again, it skirts the old Sawatch Island on both sides, going north and west from Leadville, round by way of Frying-Pan and Lime Creeks, to Aspen, outcropping in several places in the region occupied by the volcanic peaks of the Elk Mountains. To the southwest it outcrops here

and there from under the lava overflows of the San Juan and La Plata Mountains, and locally here and there in other parts of the State where the Paleozoic seas laid it down around the primitive granite islets, or where exposed by the removal and erosion of overlying and more recent formations.

106. Such is the general sketch of the geological and geographical distribution of these eminently metalliferous rocks in Colorado. Of course, it is only occasionally that these rocks are productive of precious ores, and then only under certain peculiar, and often local, conditions. But it is well to point out to the prospector that these are the likely rocks in which to look for precious metals, to prevent him from wasting his time on other areas and among other classes of rocks, often widely represented in Colorado, which experience has so far shown to be unproductive.

OTHER PROSPECTING REGIONS.

107. We have taken Colorado as our type of the Rocky Mountains, because very similar geological structures are found all over the Rocky Mountain region, in Montana, Utah, Nevada, in the Black Hills of South Dakota, and also down in New Mexico and Arizona. Not but what there is an infinite diversity, not only in every region, but in every principal mining district, to describe which individually would take many volumes. In the California region we find, too, many of the same formations and the ores under very similar conditions, so that if any one knew well how to prospect Colorado, knew all its geological structure and the prevailing habitat of the ores, he would not find himself very much at sea in any other of the Rocky Mountain regions; for instance, in the Black Hills of South Dakota. That little mountain range is a miniature of the great Rocky Mountain system of Colorado. The Black Hills consist of a granite nucleus, once doubtless a granite island, overlaid by ancient slates and schists of a period intervening between the Archean and Cambrian, called by geologists the

Pre-Cambrian period. This is also found in some parts of Colorado, particularly near Ouray, where the Pre-Cambrian schists and quartzites are upwards of 14,000 feet thick. Through these schists come up long dikes and veins of granite and porphyry, in which, or at the contact of which with the schists, are found ores of tin, silver, and gold. Resting upon these schists are the Paleozoic formations, traversed, as in Colorado, by eruptive, intrusive rocks. So a man conversant with Colorado geology and accustomed to prospect there would very soon learn the indications of the new camp.

108. In Utah he would again find much the same structure as in Colorado. The main mountain mass, the Wahsatch Range, is of granite, with Paleozoic limestones, etc., dipping off from it and much faulted. He would look for fissure-veins in the granite as in Colorado, and silver-lead deposits in the limestones, especially when traversed by porphyries. As for gold, he would look for that in decomposed dikes of porphyry, or in quartz veins in the granite, or else in placer deposits in the stream-beds.

109. In Montana he would have mainly a granitic type of rocks to prospect, traversed by porphyry sheets, and, in connection with the latter, would look out for the ore signs.

110. In Idaho Territory he would meet largely with great masses of eruptive and volcanic rock, and some of the richest gold mines there are in decomposed dikes of porphyry.

111. In Nevada he would find a series of isolated mountains and mountain chains scattered about, and in some places, as at Eureka, he would find Paleozoic limestones tilted up on granite and traversed by eruptive rocks. He would find many of the silver-lead deposits there in cavernous deposits in the limestone as at Leadville, Colorado. In the Washoe district, where the great Comstock lode is, he would be in a region composed of many different kinds of eruptive rock, and at the junction of some of these with

each other he would observe the great Comstock quartz fissure-vein running through the country and splitting up into little branches at either end.

After this great fissure was discovered, extensions of it were prospected, but without much success. It is sometimes a good thing to follow up the extension of a noted lode, but it has been observed that frequently Nature seems to have exhausted all her resources in the main part of the fissure where the ore has been found most abundant, so extensions are not always to be relied upon as good properties. Again, the Comstock is an example of the fact that a particular kind of rock, producing good ore in one district, may not be at all productive in another and distant district. The Comstock miners hunted up the same porphyry all over Nevada and other regions as is found in the Comstock, yet without success. The mere existence of a certain variety of rock can never be safely considered as a guarantee of ore; other conditions are necessary, such as fissuring, accompanied by evidences of ancient hot springs, volcanic eruptions, and many other phenomena of less importance generally, but often of great local importance.

112. In California we have the Sierra Nevada and Coast Ranges abounding in ores. The gold is generally found in quartz veins traversing the slates, but often in little scattered pockets, and sometimes in dikes of eruptive rock. There is one mineral that is almost peculiar to California in America, and that is cinnabar, the sulphide of mercury. The ore is found in crevices or in Cretaceous sandstones, which it impregnates, sometimes in fissure-veins in slates, and not infrequently associated with a green serpentine rock, which may have once had an eruptive origin. In the New Almaden mines it was found mostly near evidences of faulting, associated with signs of movement and friction in the rock, such as fragments of rock more or less rounded by attrition, or polished and slicken-sided. The ores are brownish-red or brownish-black to vermilion in color, according to their purity, and give a scarlet streak. There

are a great many red ores which might be taken for cinnabar, but on heating a specimen of the latter in a tube with carbonate of soda it gives off quicksilver, which condenses in the upper part of the tube, this reaction readily distinguishing it from minerals of similar appearance.

113. The ore deposits and geological formations of New Mexico are very similar to those of Colorado: granites, eruptive rocks, Paleozoic limestones, etc., with gold, silver, and lead ores, and some copper.

114. In Arizona there are many fine prospecting fields, largely in granitic and eruptive rocks, producing much gold, silver, and copper. Towards certain portions of Arizona are areas of Paleozoic limestones, etc., traversed by porphyries, producing ore-bodies of lead-silver in much the same way as in Leadville. Some of these ore-bodies occur in the great cliffs of the Grand Cañon of the Colorado, and are rather inaccessible to railroads. Rich gold placers are also said to abound in the beds of old streams, but are at present worthless because of the absence of water with which to work them. This state of affairs is quite common both in Arizona and New Mexico, the sands in some cases being very rich, but the placer valueless because of the scarcity of water.

PROSPECTORS' TOOLS.

115. The most essential of the prospector's tools are picks, drills, hammers, and shovel, and these are kept down to the minimum number and weight, in order that the prospector shall be as free and unencumbered as possible in climbing around the mountains.

For his trip as a whole, the prospector may carry a more or less complete outfit of tools, packed upon a burro or pony, but when he arrives in a likely-looking region, he makes a temporary camp, pickets his pack animal, and taking only a light prospecting or geological pick, weighing probably three or four pounds, he starts out on a general reconnoiter. The pick he takes is a little single-hand affair, about

10 inches long, with one end a square-faced poll or hammer and the other a pick-point; the handle is about 15 inches long. The edges of the poll are sometimes beveled, but a square, sharp-cornered face is better, as the sharp edges and corners are better adapted for breaking rock than the rounded or beveled ends. The pick should be all of good steel, with a good-sized eye to admit a strong and springy hickory handle. [See (I), Fig. 33.]

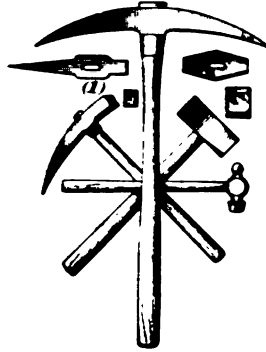

FIG. 33.

Armed with this little weapon, the prospector climbs the hillsides, hunting for float or for the rusty outcrops of ledges. Loose pieces of float he cracks open with the hammer end; softer rock in place he explores with the pick. Old prospectors consider this little pick indispensable for preliminary search. If the prospector finds anything likely "in place," he marks the spot and goes on; when he returns to camp at noon or evening, as the case may be, he unpacks his heavy digging pick and shovel, and in the afternoon or next morning goes back to his "find" with these tools and proceeds to "open up"; then, if the ledge appears to be worth further exploration, on his next visit to camp he brings up drills, hammers, and blasting outfit, and goes systematically to work.

PICKS AND DRILLS.

PICKS.

116. Picks and drills that are used on rock rapidly become dulled, and the prospector, at a long distance from blacksmith shops, is forced to become his own blacksmith and sharpen and temper his own tools. The kind of sharpening and the nature or degree of tempering depend upon the kind of rock to be worked, whether hard or soft, loose-

grained or fine-grained, silicious or clayey. Drills, for example, would have to be differently sharpened and tempered for hard, vitreous quartzite than for soft sandstone or limestone or hardened clay. The same remark applies also to picks. Picks may be either double-pointed or poll picks, with one point and a hammer head which can be used for breaking rocks. The essential points of a good pick are strong cutting tips, a stout eye, and a tight handle. The little prospecting pick is made of the best steel throughout, but in the heavier picks only the wearing parts, the tips, are made of steel, and these should be made replaceable; an all-steel pick soon becomes shortened and useless working among rocks, while an iron pick-eye may be made to last indefinitely by welding on steel tips from time to time.

117. Sharpening.—For mining purposes, both tips of a pick are usually made pointed or pyramidal. The tips are forged into points on an anvil, the character of the point varying with the nature of the ground in which it is to be used. Thus, for hard, dense rock the point is made on a blunt taper; for loose, fissured rock a slim taper is used; if the ground is soft, tough, or clayey, one tip is usually sharpened to a chisel-point for cutting the ground.

DRILLS.

118. By far the most important of the metal-miner's tools are his drills. Drills are made from round or octagonal steel bars, the latter form being preferable, as it is more easily turned. The bars are cut into the desired lengths, and then one end of each piece is forged to a cutting edge, slightly wider than the diameter of the bar to save weight and prevent the drill from sticking in the hole, and the other, the striking face, is left flat. Drills vary in length from 1 to 4 or 5 feet, or even more for special purposes, and in diameter from $\frac{3}{8}$ inch to 2 inches, the larger size being used exclusively for double-hand or three-hand work, one man turning and another, or two others, striking. The ordinary sizes for single-hand work are $\frac{3}{4}$ -inch to $\frac{1}{2}$ -inch steel,

and for double-hand $\frac{7}{8}$ -inch to 1-inch steel, the smaller sizes being too springy and the larger sizes too heavy.

The flare of the cutting edge, as well as the angle, varies with the kind of rock to be worked. For soft rock, like limestone or sandstone, a drill with a tapering edge is used, the bit flaring to sometimes twice the diameter of the stock, while as the rock gets harder the edge angle is made flatter, and the flare is diminished, till for very hard granite or porphyry it is as low as $\frac{1}{8}$ inch on each side, cutting a hole about

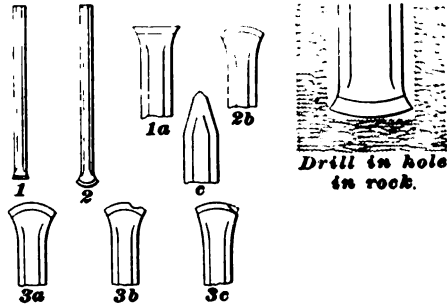

FIG. 34.

$\frac{3}{16}$ inch greater in diameter than the stock of the drill. The drills used in soft rock are usually straight-edged, as in 1 and 1a, Fig. 34, as the straight edge cuts more freely than the curved edge, shown in the other cuts in the figure, but it is weaker, and the corners are more apt to chip off; hence, for harder rock the edge is slightly curved. This curving also keeps the center of the bit in advance of the corners, and thus tends to equalize the work, which in the straight-edged bit increases towards the circumference in proportion to the distance from the center. As it is, the corners of the bit receive the brunt of the wear, and straight bits naturally tend to wear to a curve or an angle with its apex at the center.

In a set of drills, to insure the longer drills working freely in the hole, the width of the bit is very slightly reduced in each successive length. For all-around work, such as a prospector's tools have to stand, the bits should flare to about $\frac{1}{4}$ inch or $\frac{3}{8}$ inch greater width than the diameter of the stock.

119. Sharpening.—To sharpen a blunted drill the bit-end is first placed in the forge and heated to a working

heat; it is then taken out and hammered to a width a little greater than the diameter of the hole to be bored; the cutting edge is next hammered up with a light hammer to the requisite angle, and the corners beaten in to give the exact diameter of the bore hole desired. The edge is touched up with a file. Heavy hammering and high heats should be avoided, and the steel should be kept well covered with coal while heating to protect it from the air. Overheated or "burned" steel is liable to fly, and drills so injured are useless until the burned portion has been cut away; a cherry-red is the heat for steel—no higher. Care is required in forming the cutting edge to get it even and of the full form. If the corners get hammered, as in *3a*, Fig. 33, they are said to be "nipped," and the drill will not free itself readily in cutting. A bit is "backward" when there is a depression in the edge, as in *3b*, and "odd-cornered" when one of the corners is higher than the other, as in *3c*. Either of these defects causes the main force of the blow to be thrown upon only a portion of the edge, which is apt to become overstrained and break.

BLACKSMITHING.

120. Blacksmithing is an art by itself, and one can become expert at it only by long practice. The prospector can, however, learn enough in a short time to enable him to sharpen and temper his own picks and drills.

121. Fuel.—The best fuel for blacksmithing is a slightly caking coal, which gives an open fire, considerable flame, and a high heat. Coke gives a greater heat, but is harder to keep fire in. Whatever fuel is used, it should be as free as possible from sulphur, phosphorus, and shale, or slate. The two former corrode the steel, and the latter forms a pasty cinder that sticks to the drill, clogs the fire, and is a nuisance generally. Iron in the ash (red ash) also renders the coal liable to clinker. Away from civilization, charcoal is frequently used as a fuel, or even chips of wood, which should be blown with a small bellows.

122. Prospector's Forge.—A prospector who is obliged to be his own blacksmith wants to keep his outfit down as light as possible, and hence resorts to many make-shifts to lighten his luggage. A simple blacksmith's forge that is quite commonly used by prospectors is made up of one, two, or three blasting-powder cans with the heads cut out of all but the bottom one, and one head must be cut out of this; these are placed one on top of the other to make the furnace. A $1\frac{1}{2}$ -inch hole is punched in the side of the lowest can, close to the bottom, for draft, and to put the points of the tools in to heat them. Some prospectors carry a small bellows to furnish a blast. A chunk of steel or railroad iron about 6 or 8 inches long can be made to serve as an anvil.

123. Hardening and Tempering.—Steel is iron containing carbon, the presence of which gives to steel its well-known property of hardening and "tempering" on being suddenly chilled. The hardness of steel depends upon the proportion of carbon present, the temperature from which it was chilled, and also on the presence of other elements, as nickel and chromium. As the percentage of carbon increases, the melting-point of the steel decreases, and this greater fusibility reduces its welding quality. A steel that has been suddenly cooled from a very high temperature and has become as hard as possible is called "hardened." Hardening is accomplished by heating the iron to a cherry-red color and then plunging it suddenly into some liquid which extracts the heat from the tool. The quicker it is cooled and the greater the difference of temperature, the harder the steel, but, on the other hand, the more sudden the cooling the more brittle the steel. Either oil or water is used for the chilling fluid; both volatilize at a temperature much below that of the immersed tool, surrounding it with a vapor, so that the hardening really takes place, not in a liquid, but in a gas. Oil-hardening gives a tougher steel than water-hardening, as on the first plunge the metal becomes coated with soot, which tends to retain the heat in the steel, so that the cooling is slower.

124. Hardened steel is too brittle for tools, and the hardness has to be reduced, or "tempered," to a degree varying according to the purpose for which the tool is designed, the toughness increasing as the hardness decreases. Hardening is the extreme of tempering, as the word is commonly used, and tempering is merely "drawing the temper" of the hardened steel down to any desired point by reheating the chilled steel up to a certain temperature, the heat partially removing the effect of the chilling. The relative temperatures of the steel are indicated by the colors of the film of oxide which forms on a clean steel surface. When a piece of hardened steel is slowly reheated, its surface will be observed to gradually assume different colors, beginning with a light straw-yellow and passing through successive shades of yellow, brown, purple, and blue, up to a cherry-red; at cherry-red, the color before hardening, the effect of the chilling will disappear entirely. Each one of these shades corresponds to a definite temperature of the steel, and by noting them the expert smith can tell just how far the tempering, or reduction of hardness, has proceeded, and having previously determined just what temper the tool should have for any certain purpose, can obtain that temper by stopping the reheating when the proper color is reached.

125. Razors, springs, knife-blades, and any other articles which require tempering throughout, are first hardened and then tempered, as above, in a separate operation, but for tools like drills and picks, which require only the point or edge hardened, the two operations are combined. The point and a few inches of the stock of the tool are heated up to a cherry-red—the operation may be performed immediately after sharpening, if desired, with the same heat—and then plunge the tip, for about an inch or two, into the water or oil; this chills and hardens the point. The tool should not be held in this one place, but should be waved gently back and forth, and worked in and out of the water for some distance above the temper line, so that the change

from hard steel to soft steel will not be too abrupt, as otherwise the internal strains set up by the hardening renders the tool apt to break very easily along the line of change. While there is still considerable heat left in the stock of the tool, the point is withdrawn from the liquid and the scales rubbed off on wood or brick, so that the colors can be carefully watched; the heat is noted to draw gradually towards the edge from the hotter portion above. As soon as the desired tempering color is reached, the tool is again immersed and completely cooled. The idea that steel is cooler at a blue than at a yellow color, in the final drawing, is erroneous, for more of the heat of the stock is conducted to the point than is radiated out into the air in the same time, and the first heat to the edge produces only a yellow color; with more it becomes brown, purple, and so on. In tempering drills, the tool is usually plunged when a copper color is reached; for picks, the reheating is continued to a light blue.



PLACER AND HYDRAULIC MINING.

HISTORY OF PLACER MINING.

THE ORIGIN OF GOLD PLACERS.

1. The fragmentary deposits carrying gold, known as placers, have been formed by disintegration or breaking up of rocks and the subsequent sorting of the resulting material by water. This disintegration or breaking up may have resulted from any one of several causes. The rocks may have been ploughed or broken down by glaciers, water falling on the surface may have soaked into the cracks and subsequently frozen and expanded, thus rending or breaking the rocks, or water percolating through the rock masses may have dissolved the softer portions, and so caused the disintegration of the entire mass. If there had been no disintegration of the rock masses, the mountains would be simply vast smooth rolling billows of strata, broken occasionally by great cliffs, the result of faulting. As mineral veins are mainly due to the action of circulating waters, which pass through the faults or crevices and appear at the surface as hot springs, geysers, fumaroles, etc., the monotony of the landscape would have been broken by an occasional mass of calcareous or silicious matter along the line of some fault or fissure, similar to the masses now seen at the hot springs in the Yellowstone National Park and elsewhere. These masses would indicate the points at which veins were being formed below, or points where they had already been formed.

If upon this surface the various agencies of erosion had been set at work, our present rough and jagged mountain system would be the result.

2. Work of Glaciers.—The glaciers are great ice sheets which fill every fold and undulation of the surface, and press forwards, planing off the tops of the mountains and cutting great valleys and gorges down their sides. The material or debris cut from the mountains is piled in the valleys, or on the flanks of the mountains and hills as moraines, to be subsequently winnowed and distributed by the action of streams and rivers, the finer material being carried on and distributed on the plains to form soil, or washed to the ocean, while the heavier and coarser material has settled near the point where the glacier left it, and this



FIG. 1.

naturally contains the greater part of the gold. Owing to the fact that changes of temperature between the different seasons of the year affect the active work of glaciers, these agencies are most effective in the high or moderately high latitudes only, and in the tropics we must look for some other series of forces as the principal agents in the production of placer deposits. Fig. 1 shows the manner in which the glaciers flow from the mountains down through valleys.

3. Effect of Frost and Erosion by Water.—In the higher mountains of the tropics, frost has played an important part by freezing water in the pores of the rocks, thus splitting the material, as it has done all through the higher latitudes. The material thus quarried or broken loose has been

subsequently washed away by the force of the streams resulting from the rainfalls or from the melting of snow. In the tropics the rainfall is frequently very heavy, and this heavy rainfall furnishes enormous quantities of water, which rush down the mountainsides, cutting and tearing everything before them, and carrying great masses of debris on to the plains below. In many places the humid air, assisted by the rank tropical vegetation, has disintegrated the rocks to great depths, and during the heavy rain-storms great gulches are washed through this soil, and the material thus eroded is winnowed and deposited in the valleys.

4. Origin of Drift or Placer Gold.—The materials eroded from the rocks by the action of glaciers or atmospheric agencies, such as frost, percolating waters, etc., contain not only the gold from the veins of quartz or other material which existed in the rocks eroded, but also any gold which may have been disseminated through the formation in minute particles. It is well known that the crystalline rocks, such as granites, porphyries, lavas, and other igneous rocks, contain small amounts of gold disseminated through them, and by the concentration of this over an extended area it would be easy to account for the formation of placers. If all the gold that has been spread far and wide in minute grains through the rocks could be collected, it would far exceed all that has been, or ever will be, obtained by man in his puny efforts at placer mining and sand washing, for not only do the massive rocks contain gold, but it is found in small quantities in many of the stratified rocks and in minute quantities in the waters of the sea.

5. Ancient Placer Formations.—Though modern placer deposits are generally conceded to have been laid down by the action of comparatively recent glaciers, streams, and other bodies of water, in more or less loose, incoherent banks, yet there are other far older formations firmly consolidated into rock, which may be considered as ancient placers having had the same alluvial origin as modern placers, and withal gold-bearing, such, for instance, as the

uptilted gold-bearing conglomerates of the Transvaal (Fig. 2) and the gold-bearing Cambrian quartzites of the Black Hills of Dakota. These are but ancient placers, river-beds, or sea-beaches containing gold, consolidated by time into hard

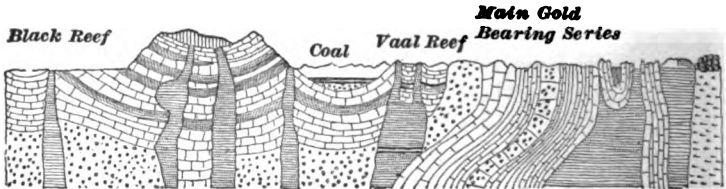

FIG. 2.

gold-bearing rock, and tilted up by the upheaval of the mountains.

6. Regions of Glaciation and Placer Formation.—

Since glaciers have been active in the production of such great masses of loose material, especially in the northern mountain regions, such as Alaska and Western North America, Siberia, and many other parts of the world, one would naturally expect to find exceptionally fine placer deposits resulting from the subsequent washing of these great masses of debris by the waters of rivers and streams, and such is the case. Another factor which has played an important part in turning the attention of man to placer deposits in high latitudes is the fact that they are not concealed under dense jungles or tropical vegetation, as is the case in the tropics, and as a rule the variation between winter and summer affords a better opportunity for placer operations, during a few months of the year, than can be found at any time in many locations in the tropics. For these reasons the regions which have been affected by the glaciers have not only produced most of the known placers of the present time, but have afforded a better opportunity for working the same than is the case in the tropics.

7. One reason why the placers in the tropics have not been worked more is because the low river-bottoms in

which they occur are often infested with germs of fevers and other diseases, which render it practically impossible for white men to work placers in such climates. The prin-

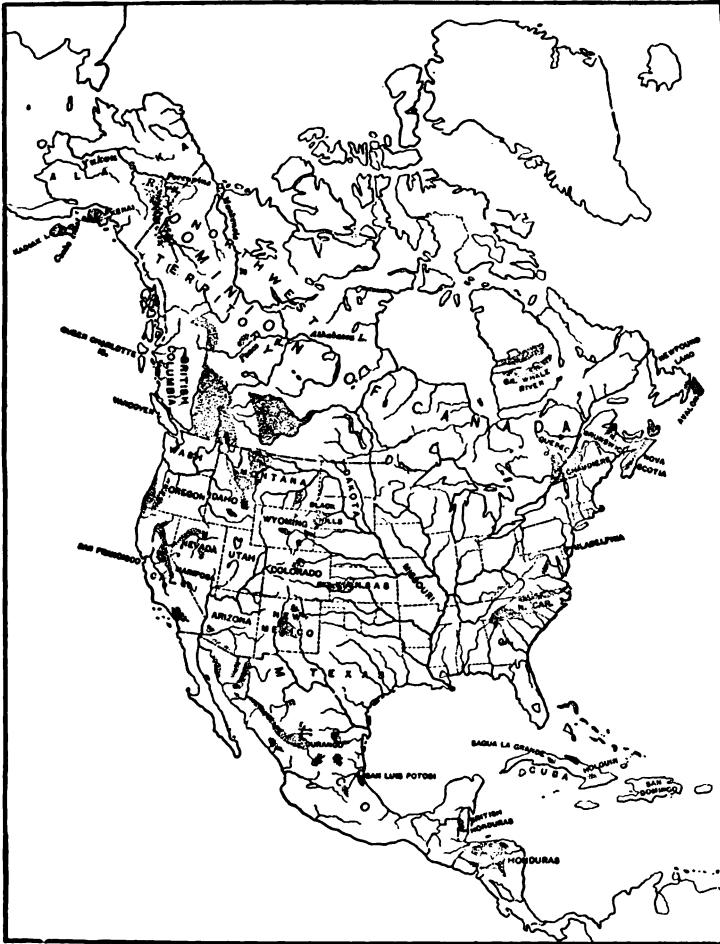

FIG. 3.

incipal placer areas of North America are shown by the shaded portions on the map, Fig. 3.

8. The simple fact that a region is covered with disintegrated material or glacial drift can not be taken as evidence

that placer deposits of value will be found there. As, for instance, the entire northern portion of North America is covered with glacial drift deposits, which in the Central States often aggregate 300 to 700 feet in thickness, and the material of which has been winnowed and rewashed by the modern rivers, and practically all this region is barren of placer deposits, on account of the fact that the rocks from which most of the glacial material was derived did not carry gold in any appreciable quantities. In most cases it is necessary that the action of the glacier has been succeeded by that of running water, in order that the placer deposits may be of value, because the glacier simply acts as a plane for quarrying or breaking the material, while the water sorts it and concentrates the gold.

PLACER MINING.

FORM OF DEPOSITS.

9. Shallow or Modern Placers.—As has already been stated, placers are deposits of material which has been eroded from rock formations, and the heavier portions of which have become concentrated by the action of water in such a manner as to form deposits rich in gold. The placer deposits which are most accessible are those occurring in beds of modern or recent rivers. These have been worked from the dawn of history, and the greater part of the gold that has been obtained in all ages has come from these modern placer deposits. The material of the deposit may consist of sand, gravel, loam, or clay.

Shallow deposits may occur in the beds of rivers, or as bars along the banks or shores of rivers, or on the seashore where the waves have gradually concentrated the gold in the sea sand into a richer deposit than the average sand. Any of these deposits may become deep placers by being subsequently buried under lava or debris.

10. Mode of Occurrence of the Gold.—These deposits contain metallic gold in fragments ranging from

the finest dust to nuggets which weigh more than 100 pounds. The gold is also associated with more or less metallic platinum, and occasionally with metallic silver, lead, and copper, and the heavier iron minerals, tinstone, and precious stones.

11. The velocity of the current and the amount of material carried by a river will determine whether it will erode its channel or deposit material. If the river is carrying less sediment in suspension than it is capable of carrying, erosion will take place, while if it is overloaded, some of the material in suspension will be deposited. Just at the point where a river begins to deposit some of the heavy material it is carrying, a concentrating action will take place and particles of different density will be separated. As the bed-rock of most rivers is rough and forms a series of natural pockets or riffles, one would expect to find the best deposits of precious metal at this point, and such is usually the case. All changes in direction of the course of a river, depressions or holes in its bed, changes in its width, or the character of the bottom, usually form places for the deposition of gold.

This is illustrated by (a), (b), and (c), Fig. 4. A pocket at one side of the bed of the stream, which would form a

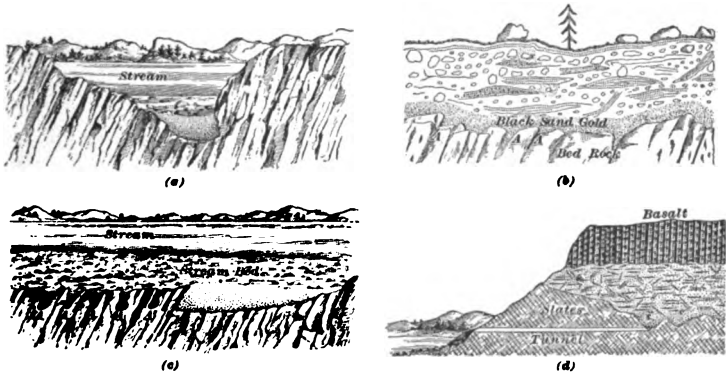

FIG. 4.

likely receptacle for gold, is shown in (a). In (b) and (c) are a series of pockets formed by the upturned edge of the strata, as illustrated at A, A; these would probably contain rich deposits of placer material. After the current has

commenced to deposit material, it sometimes deposits so rapidly that there will be a stratum which contains but a small amount of gold as compared with that concentrated on the bed-rock. Then if this be succeeded by a period of somewhat more rapid current, a richer strata will be formed with the gravel previously laid down as a bed-rock, or if the current slows down a bed of clay may be deposited which will later form a floor on which a deposition will take place. These floors or beds on which later depositions occur are called false bed-rocks, and frequently a mass of gravel will have a series of rich streaks running through it parallel to bed-rock. Rivers which change their courses back and forth through broad sandy beds act in the same way, and often form rich pockets in the material of the bed.

12. Even though the pockets on the bed-rock are usually rich, the holes at the feet of waterfalls are sometimes barren and contain only a small amount of gold on the lower rim of the pot-hole. This fact is to be accounted for by the manner in which the water plunging over the waterfall would wash everything, coarse or fine, heavy or light, out of the hole, and then by some sudden change the pot-hole may be suddenly washed full of gravel or other debris, without an opportunity for concentration to take place.

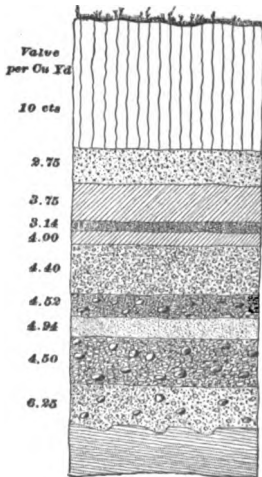

FIG. 5.

13. Distribution of Gold in the Deposit. — Even where the gold is fairly uniformly distributed throughout the material of the placer deposit, it is usually richer at or near bed-rock, and the different layers of gravel, sand, or other material will usually have a somewhat different average value. Fig. 5 is an example which will illustrate this point. The figures opposite the different strata

represent the value per cubic yard of the materials composing the several strata, as obtained by a careful series of tests in the particular case under consideration. It is not to be supposed that all cases will be exactly like this. Sometimes the richest deposit may occur fairly high up in the formation on a false bed-rock, and at times the surface of the deposit may be entirely barren.

14. Deep Level or Ancient Placers.—Placers may become deep by successive deposits of material, and finally the river which formed them may be diverted from its course, or entirely lost by changes in the elevation of the continent, or by lava flows in the upper portion of its course. Such placer deposits may subsequently be cut by modern rivers, and they will then form bench or hill placers or diggings. In some cases the deposit is from 400 to 500 feet in thickness, the upper portions of it being as a rule composed of lower grade material than that of the portion near bed-rock.

In other cases the old river-bed has become filled with lava, which has covered the placer gravel to a greater or less depth. Subsequent erosion may form new channels which frequently cross or cut into the old deposits.

The deep placers, whether covered with lava or not, frequently become cemented into a kind of conglomerate, either on account of the presence of oxide of iron, silicious matter, or calcareous matter, which has been carried into the deposit by percolating waters.

The deep or buried placers were first discovered at points where they were intersected by the courses of modern rivers, and were explored by drifts or tunnels along their courses.

APPARATUS AND METHODS USED IN PLACER AND HYDRAULIC MINING.

15. Ancient Methods.—Gold was originally washed in a crude manner in all parts of the world, and all the primitive washing apparatus imitated as nearly as possible the methods Nature employed in the production of placer

deposits; that is, they provided some kind of dish or apparatus in which the gold-bearing material could be subjected to the action of water, so as to wash away the lighter portion and leave the gold behind. These efforts resulted in a number of washing devices, some of which are used at the present time.

16. Washing Trough.—In China, among the Malays, and in the Philippine Islands a kind of shallow trough, like a reversed house roof, came into use for gold washing. This is rocked backwards and forwards in such a manner as to cause the water to flow up one side and then up the other, carrying the lighter sand with it. This action gradually works the gold down into the bottom of the trough. The device is easy to handle, but is very slow, it being necessary to repeat the operation several times before fairly clean gold-dust can be obtained.

17. Batea.—In South America, a round wooden vessel called the batea came into use. This is a wooden bowl, usually about 20 inches in diameter and $2\frac{1}{2}$ inches deep. The sides of the bowl, which is turned from a single piece of wood, slope at a uniform angle from the outside to the center. The batea is sometimes used floating in water, the barren material being worked over the edge and the gold concentrated at the center. As a rule, the batea is much better for the saving of fine gold or for concentrating pyrites than the pan which is to be described later. This is on account of the fact that the surface of the wood is better adapted for the catching and holding of fine material, and also it is easier to concentrate some classes of fine material in the point of the batea than in the edge of the pan. The batea is sometimes made of enameled iron and has a small hole in the center of it, fitted with a plug or cork. This form is extremely useful for ore concentration tests, as after a heading has been obtained near the center, the richest portion of it can be washed through the hole, the cork replaced, and the concentration continued until another small portion is

ready to wash through the center of the pan. The washing can be accomplished by pouring a small stream of water from a dipper in such a manner as to carry the desired portion of the material through the center of the pan.

18. Pan.—The pan is used mostly for washing gold by hand in North America and Australia. It consists of a pan 10 or 12 inches in diameter at the bottom, 16 to 20 inches in diameter at the top, and from 2½ to 3 inches deep, pressed out of a single sheet of Russia iron, as shown in Fig. 6. The rim is sometimes strengthened by turning it over a wire. The pan is mostly used in prospecting, in cleaning gold-bearing sand, collecting amalgam in the sluices, and throughout placer mining generally, as a test or check on all the work.

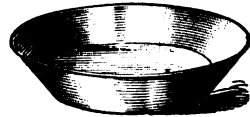

FIG. 6.

Its manipulation requires considerable skill. A quantity of dirt to be washed is placed in the pan, occupying about two-thirds of its capacity. If water is plenty, the pan with its contents is immersed in the water and the mass stirred so that every particle may become soaked. All lumps of clay should be broken up, and the coarse and worthless

stones thrown out. The pan is then taken in both hands, one on each side, and without allowing it to entirely emerge from the water, is suspended in the hands, not quite level, but tipping slightly from the operator. In this position it is given a slightly rotary or shaking motion, which allows the water to discharge all



FIG. 7.

light, earthy particles over the edge of the pan. Fig. 7 shows two men in the act of panning. After the light or

earthy material has been worked off, there will remain a certain amount of gold-dust, heavy sand, small stones, etc. The small stones can be picked out, washed off and thrown away, and by carefully turning the wrist so as to give the pan a slight rotary motion, the muddy water is allowed to escape over the edge, a little at a time, without carrying the heavy sands with it. By repeating this operation, the material can be washed until nothing remains in the pan but gold-dust and heavy black sand, with possibly a little earthy matter. By carefully working with plenty of clear water, the earthy matter can be completely removed, but the heavy iron sand can not be gotten rid of by simply washing, owing to the fact that its specific gravity is so near that of the gold. If the iron sand be magnetic, the grains can be removed by means of a magnet. If there are fine particles of pyrites in the pan, they can generally be distinguished from the gold by their lighter color, the gold being commonly a rich orange.

19. Horn Spoons.—Horn spoons, cut out of black ox horn or made from black rubber, are sometimes used by prospectors, especially for finishing the work begun in the pan. The surface holds the gold well and the colors show very plainly upon it.

20. The Puddling Box.—The puddling box is a wooden box, which may be either square or round. If round, it is usually formed by sawing a barrel in two, though puddling boxes are sometimes made six or eight feet in diameter, and are sometimes made square or rectangular. The box is provided with a series of plugs in the side, and its object is to remove clay from the gold-bearing material before it is panned or worked in a cradle. The box is filled with water and gold-bearing clay and then stirred, either by means of a rake or, if round, by a rotating drag. When the clay has become thoroughly mixed with the water, one of the plugs in the side is removed and the muddy water allowed to run off. After this the plug is replaced, more water is put in, and the process repeated, with possibly

the addition of some more material, until the box is filled, with gravel and black sand carrying gold-dust, up to the lowest plug. The contents are then shoveled out and worked in pans or cradles by hand. The water from the puddling box is frequently trapped, allowed to settle, and used over and over. Round boxes have the advantage that the water can be given a rotative motion, which has a tendency to keep the fine clay material in suspension, and thus make a better separation than can be accomplished in the square boxes.

21. Cradle or Rocker.—The rocker probably originated in Georgia, and was introduced into California during the early days of gold mining. It is a box about 40 inches long by 16 inches wide and 1 foot high, with one or two riffles across the bottom, the box being set on rockers, as shown in Fig. 8, which gives an end view and a longitudinal section of the rocker.

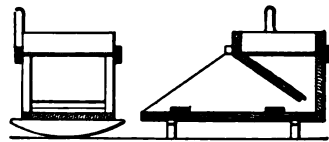

FIG. 8.

On the upper end there is a removable hopper, 18 to 20 inches square and about 4 inches deep, with an iron bottom perforated with holes about $\frac{1}{2}$ inch in diameter. Beneath the hopper, below the perforated plate, there is a light frame placed on an inclination from front to back, and on this frame a canvas or carpet apron is stretched. To use the rocker, material is thrown



FIG. 9.

into the hopper, water is poured on with the dipper held in one hand, while with the other hand the cradle is kept rocking. The water washes the finer stuff through the bottom of the hopper, and the gold or amalgam is either caught on

the apron or collects in the bottom of the rocker behind the riffles, while the rocks or stones are picked out from the hopper by hand, washed off, and thrown away. The lighter and worthless material washes over the riffles and discharges at the lower end of the rocker, while the gold or amalgam collects behind the riffles. Sometimes the entire bottom of the apparatus under the riffles is covered with carpet. Rockers were used in placer mining before the introduction of sluicing. Now they are mainly employed in cleaning up placer claims and quartz mills and for collecting finely divided particles of quicksilver or amalgam. Fig. 9 shows a man operating a rocker.

22. The Long Tom.—The “Long Tom” is a rough trough about 12 feet long and from 15 inches to 20 inches wide at the upper end, 30 inches wide at the lower end, and about 8 inches deep. It is set on timbers or stones, with an inclination of about 1 inch per foot. The lower end of the box is cut off at an angle of 45° , and closed by

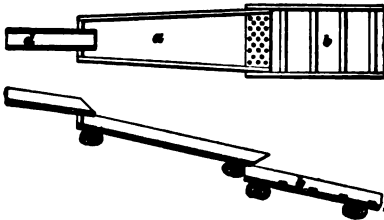

FIG. 10.

means of a sheet-iron plate or riddle perforated with $\frac{1}{2}$ -inch holes, as shown in Fig. 10, in which *a* represents the Long Tom proper, *d* the sluice which feeds it, and *b* the riffle box. The material from the sluice flows down over the Long Tom *a*, where it is worked by means of a rake or fork so as to break up the lumps of clay. The finer material passes through the holes in the riddle or screen at the bottom of the Tom, while the gravel or large stones collect against it and are removed periodically by means of a shovel or fork. The finer material which passes through the riddle into the riffle box is washed through the box, and the heavy particles, such as gold-dust or black sand, collect behind the riffles. The old-fashioned Long Tom was about 14 feet long. It was followed by the “Victoria” and the “Jenny

Lind," or "Broad Tom." The latter is only 6 feet to 7 feet in length, 12 inches wide at the upper end and 3 feet at the lower end. From two to four men work at one washer of this class, one man being required to rake and work the material in the portion *a* and discharge the coarse gravel and stones which collect against the riddle, while the others are employed in digging material and shoveling it into the trough *a*. The riffle box *b* is placed at such an inclination that the water passing over it will just allow the bottom to become and remain covered with a thin coating of fine mud. Sometimes a little mercury is placed behind the riffles to assist in retaining the gold, and at times the riffle box is sup-

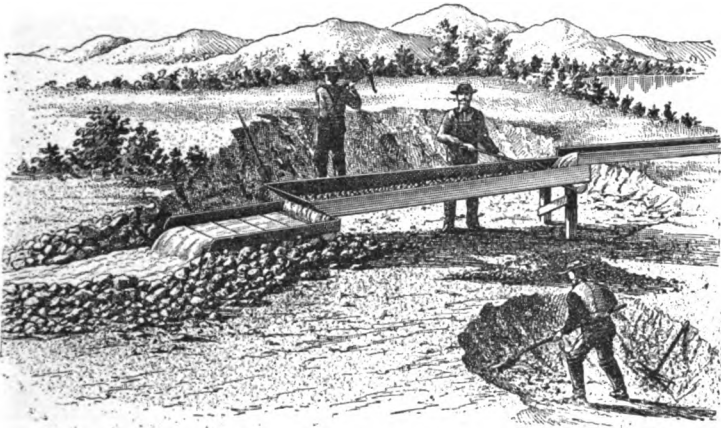

FIG. 11.

plemented by a series of sluice boxes, which may be provided with blankets in the bottom for catching the very fine gold. Toms are cleaned up periodically, the gold and amalgam from the riffle box being washed or cleaned with cradles or by means of a pan. Fig. 11 shows three men working at a "Broad Tom."

23. Gold Adhering to Stones.—Frequently the large stones or boulders have more or less gold adhering to them, and possibly attached to them by means of clay or the cementing material which held the gravel together. To free the boulders of this gold, it is necessary that they

be rubbed together with each other and with fine stones, in the presence of water. This may be accomplished by allowing them to flow together through a long sluice by passing them through a trommel, where they are tumbled over and over against each other in the presence of water, or by working them backwards and forwards by manual labor, as is done in the "Long Tom."

24. Sluices.—When washing gravel by means of a Tom, the material is broken up and disintegrated in the Tom proper by means of a fork or rake, and only comparatively fine sand or gravel is fed on to the riffle box. On this account quite a good separation can be made with a short series of riffles, but it was found that even here it was usually best to add one or two riffle boxes, and these practically form a short sluice. Owing to the fact that the capacity of the Tom is rather small and that the labor involved in breaking up the material and shoveling out the big stones is considerable, this form of apparatus is totally unsuited for working large masses of comparatively low-grade material. For working this class of deposits, sluices proper were introduced. In the sluice all of the material as dug is passed through a series of boxes, and the coarse stones are depended upon to grind up and disintegrate the masses of clay, etc.

25. The term "sluicing" is applied to the washing of material down any channel, whether it be boxes, a ditch dug in the ground on bed-rock, or a natural ravine; but when the material is washed over natural surface, it is called "ground sluicing," and when washed through boxes it is called "box sluicing," or simply "sluicing." The sluice boxes are made of boards, and vary in width from 1 foot to over 5 feet, and in depth from 8 inches to 2 feet, or more. The boxes are usually made in sections from 12 to 14 feet long. For working shallow deposits where the material is shoveled into the sluice, the boxes are ordinarily from 16 to 18 inches wide and from 8 to 12 inches deep. The boxes are frequently constructed with the bottom narrower at

one end than the other, so that they will telescope one into the other. This construction has the advantage that the sluice box can be quickly taken up and replaced in a different position. The line of troughs or sluices rests on trestles or stones, and usually shows a uniform grade throughout the whole series, the grade varying from 8 to 18 inches in 12 feet, depending upon the character of the material being washed. It is important that the sluice should be conveniently near the level of the ground at the point where the pay dirt is introduced, and this has an influence on the grade, as has also the character of the pay dirt and the length of the sluice. The steeper the grade, the quicker the dirt is washed away by the force of the water. The tougher the dirt, the steeper must be the grade, as tough clay does not break up so quickly in a slow current as in a rapid one. In short sluices the grade should be comparatively light, as there is more danger of the fine gold being lost in the short sluices than in the long ones. The steeper the grade the more material can be put through a sluice. As ordinary pay dirt is generally completely disintegrated in the first 200 feet of a moderately low-grade sluice, the extra length beyond this is useful only for catching the gold. Sometimes, therefore, the grade of the last part of the sluice is reduced. When the grade of the sluice is very low, say 1 foot in 40 or 50, the gold is easily caught, and much of it would rest even upon the smooth floor of the sluice, but additional means, such as riffles, are usually employed. In case the grade of a sluice changes, particular attention will have to be paid to the point of change, as the larger stones are liable to lodge at such points and block the course, so as to cause the sluice to overflow. Frequently all stones as large as the two fists are thrown out of the sluice by means of a fork having several prongs (sluice fork).

26. Riffles.—If the wooden sluice were not lined with any material, the gravel would very soon wear through the sides and the bottom; hence false bottoms and sides are

necessary. The sides are usually simply planked linings, but the false bottom is generally in the form of riffles which assist in the catching and holding of the gold.



FIG. 12.

in the direction of the length of the sluice. They are usually fitted up in sections of such a length that it requires two sections to each sluice box. This would make the riffles about 6 feet long. The slats are held apart by small wedges or blocks placed one or two feet apart, and are frequently provided with strips nailed across the ends. They are held down in the sluice boxes by wedges, and sometimes by having the side linings placed on top of them and then spiked to the sides of the sluice. Fig. 12 shows the arrangement of a set of riffle bars. The bars composing the riffles may be made of 2' x 4', 2' x 6', 4' x 4', or 4' x 6' scantling.

28. Block Riffles.—Where there is a great quantity of pebbles and boulders running through the sluice, the longitudinal riffles are sometimes worn away very rapidly, and hence their place is frequently taken by block riffles. In the block riffle the timber is sawed across the grain instead of with it, so that the blocks stand with the grain as it was in the original

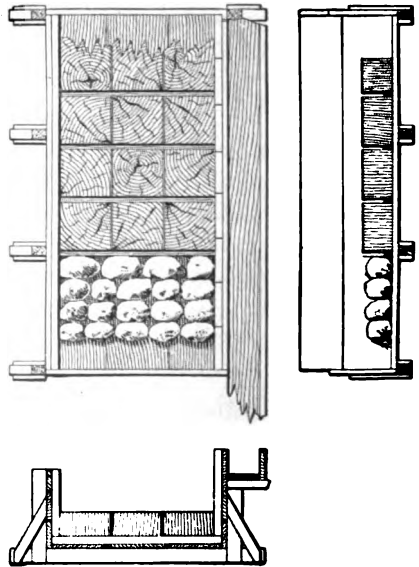

FIG. 18.

tree, and the material rubs across the surface of the grain. In the upper part of Fig. 13 is shown a series of block riffles formed from sawed material. The riffles are held in place by having strips of wood nailed to them by means of headless nails, as shown in the illustration. These strips form narrow spaces between the blocks, which spaces are effective in the collecting of gold. Sometimes round blocks are used in place of square blocks, as shown in Fig. 14. Where round blocks are used, they are held in place by being nailed to transverse strips, as in the case of the square blocks, and one series of blocks is started from one side of the sluice and the next from the opposite side, so that if the sets of blocks do not go clear across, the spaces left will not form a channel.

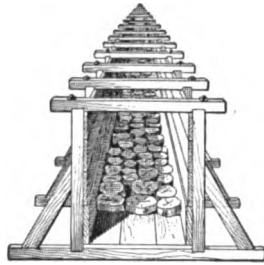

FIG. 14.

The blocks used for lining the bottom of sluices, whether square or round, are usually from 8 to 12 inches high, and are used until worn down to 3 or 4 inches thick, when they are disregarded. The sides of the sluices are usually lined with plank.

29. Rock Riffles.—Sometimes sluices are paved with rock in place of wood. These rock riffles may be of two kinds, dressed, or squared rock riffles, which are blocks of rock that have been quarried and dressed approximately square, like paving-stones, and are arranged in the sluice in sections of 5 or 6 feet in length. Between each section of rock riffles a piece of timber should be securely fastened across the bottom of the sluice, so that in case some of the stones should become loosened, the flow of the material through the sluice could not rip up the entire series of riffles from one end to the other, and thus carry the gold already caught into the tailings. The other class of rock

riffles are formed by simply selecting water-worn boulders or cobblestones and arranging them as shown in the lower part of Fig. 13. They are also arranged in sections of about half the length of an ordinary sluice box, with pieces of timber securely fastened between them.

30. Iron Riffles.—Sometimes a portion of the riffles at the head of the sluice is replaced by iron riffles, or the

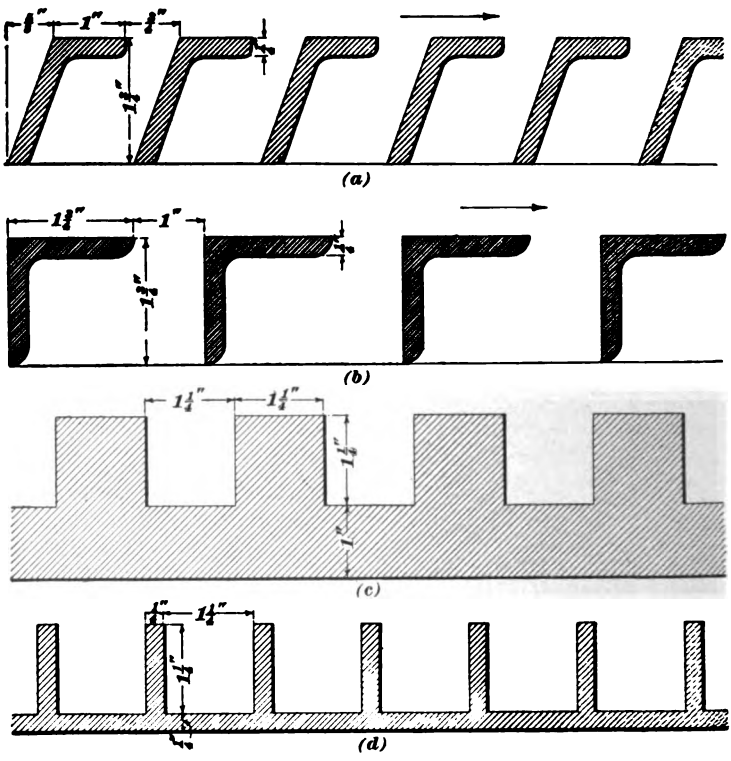

FIG. 15.

sluice may be entirely fitted with iron riffles. Fig. 15 illustrates several forms of iron riffles: (a) represents a set of cast-iron riffles, which are placed in the sluice so that the material flows in the direction indicated by the arrow. This particular form has been found very effective in saving

values; in one case 8 feet of such riffles, made in sections of about 15 inches each, were placed at the head of a line of sluice boxes 100 feet long; 98 per cent. of all the gold caught was found in these iron riffles, and the remainder was distributed throughout the wooden block riffles which occupied the remainder of the sluice. Iron riffles are usually cast in short sections of 15 or 16 inches along the length of the sluice, and having a width, or, as is the case with a transverse riffle, a length, equal to the width of the sluice, the succeeding riffles being held in place by plates cast across the end of the block mentioned. (*b*) represents a series of angle-iron riffles as frequently used. This consists of ordinary angle-irons which are secured at the ends either by riveting them to a longitudinal strip or by any other simple device, such as placing blocks on the sides of the sluice so as to hold them in place. These riffles have proved very effective in catching gold, and have been used in a great many instances, especially in Australia, New Zealand, and South America. (*c*) represents a form of cast-iron riffle in which the width of the riffle is equal to the width of the pocket; the pocket has vertical sides. The advantage that these riffles possess is that they are strong and resist wear well when used in sluices where great amounts of heavy material are run, but for some reason they have not been as close savers as some of the others. (*d*) shows a riffle in which the width of the riffle is only one-fifth that of the pocket; these riffles have been used in cases where all the coarse material has been removed from the gravel by means of a trommel, and they have proven to be exceedingly close savers, for they retain nearly all the gold in the gravel.

31. Railroad-Iron Riffles.—Where heavy cement gravel is being washed, longitudinal riffles are sometimes made by placing railroad iron in the bottom of the sluice. This greatly reduces the wear and tear on the sluice and forms a good surface for the steep portion of the sluice, where the greatest part of the grinding takes place while the

cement gravel is being reduced by means of the boulders in the material.

32. Zigzag Riffles.—Where considerable quantities of fine gold are present in the gravel, zigzag riffles are sometimes employed. These extend only partially across the sluice and from alternate sides, so that the current is made to pass backwards and forwards from side to side of the sluice. This character of riffles is supposed to assist in amalgamating the fine gold, the amalgam being caught by means of ordinary riffles farther down.

33. General Remarks in Regard to Riffles.—In selecting the kind of riffles to be used in any particular case, it will be necessary to consider the form of the riffles, the character of the material which is to be run over them, the amount of material to be passed through the sluice, the amount of water, and the grade of the sluice. Some riffles which are especially adapted for dealing with large amounts of coarse material are not as effective as others would be for the fine material, while some riffles which are especially adapted for fine material are not well suited for coarse material; for instance, the form shown at *d*, Fig. 15, is intended primarily for fine material, while the forms shown at *a*, *b*, and *c*, Fig. 15, are intended for handling coarse or fine material as it may come. Block and stone riffles are about equally efficient on coarse or fine material, but the stone riffles wear longer when very large rocks are run through the sluices. Where much of the gold is saved by amalgamation, block riffles made of soft wood seem to be most effective, as they broom up and thus retain the small particles of amalgam and the gold. Where block riffles are employed, the crevices or cracks of the old blocks frequently contain a considerable amount of gold, and hence it pays to save the old blocks, burn them and pan the gold out of the ashes.

34. Undercurrents.—In order to catch the fine gold running through sluices, it is necessary that the velocity

of current and depth of the flow be reduced. To accomplish this, it is necessary to separate the fine from the coarse material and to increase the width of the flume for a distance. Undercurrents are established for this purpose. They are really wide sections of a flume. Into the bottom of the regular flume is introduced a grating composed of iron bars, set from half an inch to an inch apart across the flume, as shown in Fig. 16. The fine material drops through between the bars, while the coarse stones and a portion of the water continue in the main flume. The floor or pavement of the sluice above the grating should be at least 1 inch higher than

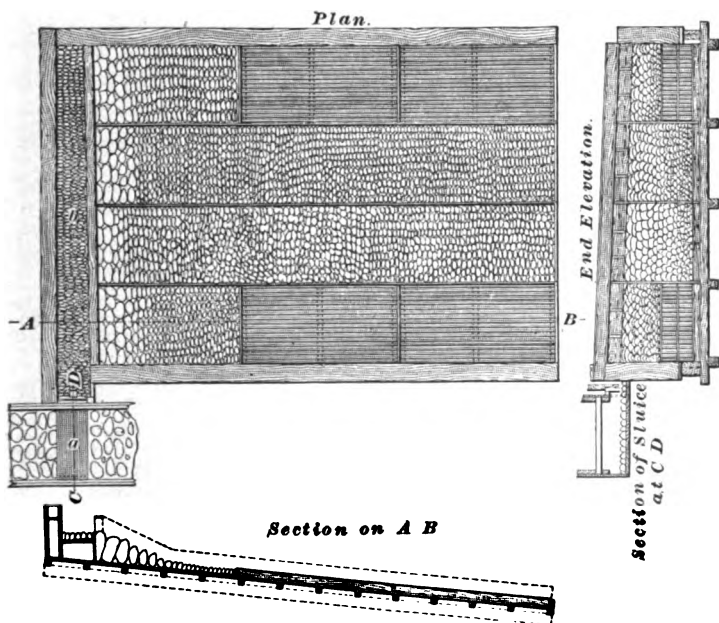

FIG. 16.

the grating, for if this is not the case the grating is liable to become clogged. In order to maintain this condition, it is necessary to renew the portion of the pavement immediately before the grating quite frequently. In the undercurrent illustrated in Fig. 16, after the material passes through the grating at *a*, it flows through a box or sluice

placed at right angles to the regular sluice, and provided with block or cobblestone riffles. This transverse sluice *b* has a slight grade as it recedes from the main sluice, and it also becomes slightly narrower. It is provided with wings or distributing boards (not shown in the drawing), which distribute the flow over the various sections of the undercurrent proper. In the undercurrent shown in the illustration, the two outside sections are paved for a short distance with cobblestones, and for the balance of their length with longitudinal riffles, while the two central sections are paved entirely with cobblestones. Such an undercurrent as this would be intended to handle anything that would pass through the spaces of a grizzly or grating. The grade of the undercurrent may be greater or less than that of the sluice. It usually depends very much on the character of the riffles employed. Where several undercurrents are employed, the upper one may be constructed as shown, or may have cobblestones, block or iron riffles throughout, and have a grade somewhat steeper than that of the sluice, the depth of the flow being reduced to 1 or 2 inches. The material which passes over the undercurrent is, if possible, returned to the main sluice, and frequently the coarse stones which will not go through the grating *a* are passed over a drop in the main sluice, which has a tendency to pulverize any balls of clay or to break up any portions of cement, gravel, etc., which may have been carried to this point. The next undercurrent would probably be provided with a somewhat flatter grade than the first, and possibly with a different form of riffle. Sometimes the last undercurrent is made much wider than the first, given a very flat grade (sometimes as little as 3 inches in 12 feet) and lined with carpet, blankets, plush, or burlap. The width of the undercurrent is usually from five to ten times that of the sluice, and its length may vary from 20 to 50 feet. Sometimes it is possible to arrange an undercurrent at such a place that the coarse stones which pass over the grating or grizzly are discharged over a precipice, while all the material which passes through is taken to the undercurrent.

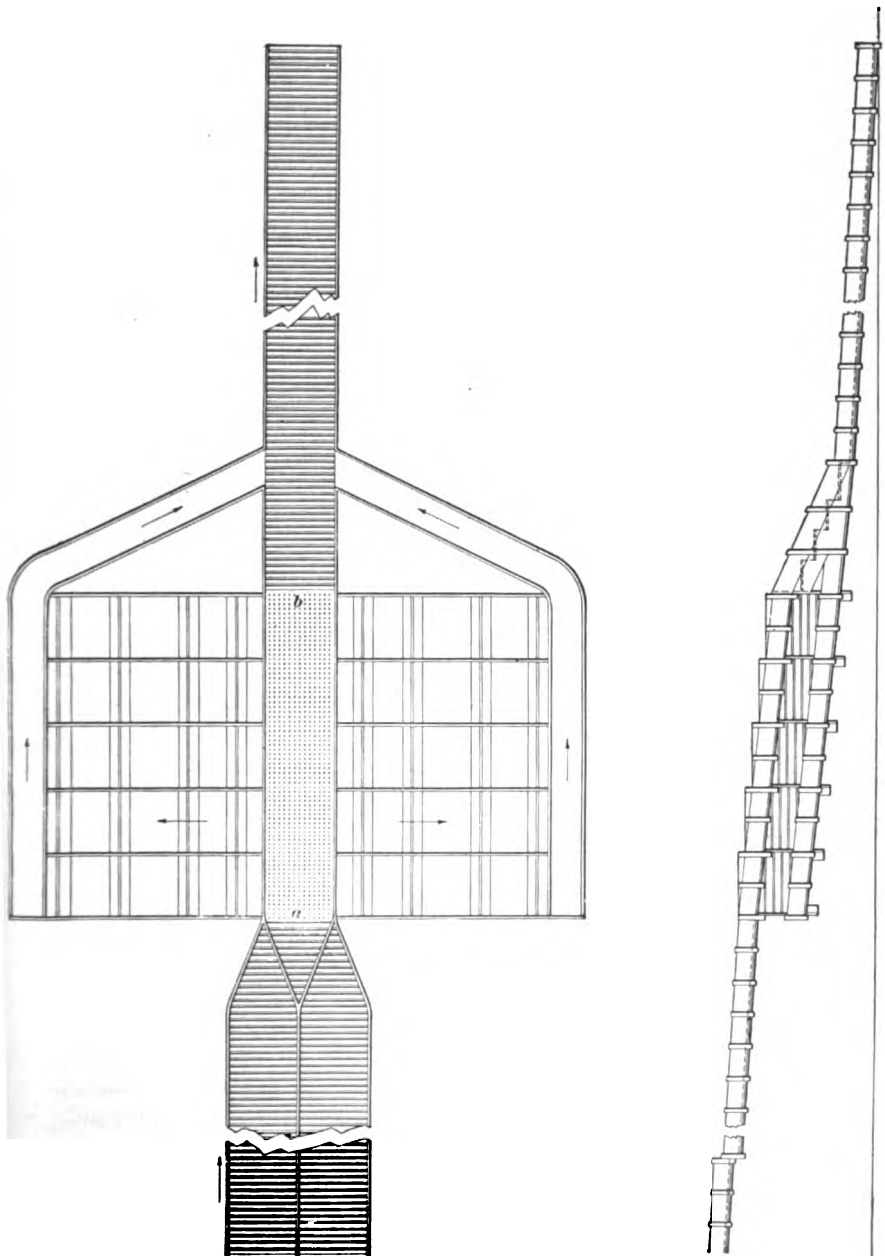

FIG. 17.

35. Gold-Saving Tables.—Sometimes undercurrents are constructed in sections, and are often called gold-saving tables. Fig. 17 shows such an arrangement. The sluice above the table is made double, so that either portion of it can be cleaned up separately, or the gates above *a* can be removed and both portions employed at the same time. The portion of the main sluice from *a* to *b* has no pavement, but is provided with an iron floor perforated with small holes. The fine material passes through these holes and on to the tables at the right and left, flowing in the direction of the arrows. These tables may be covered with canvas, carpet, burlap, or may be provided with fine riffles. Usually they are covered with some fibrous material. After the fine material has passed over the tables, it is taken up by the branch sluices and returned to the main sluice lower down. Below the point *b* the main sluice has a series of drops, as shown in the side elevation. These drops are paved with iron riffles, and serve to disintegrate any material which has not been broken up above the point *b*. Any section of the tables may be stopped at any time by turning the material from it on to the adjoining sections by means of deflecting boards under the main sluice, and the section thus exposed for cleaning. Gold-saving tables similar to those shown in the illustration are very largely used in South America, Australia, and New Zealand. The riffles are usually made similar to those shown at *b*, Fig. 15, and the main sluice is provided with a lining of cocoa matting before the riffles are put in place. This cocoa matting serves to hold any fine gold which might otherwise escape, and also prevents currents from flowing under the riffles.

36. Grade of Sluices.—As a rule, in working comparatively tough or cemented gravel, especially when it contains much clay, it is best to set the sluices on considerable grade and provide numerous drops to break up and disintegrate the gravel, depending upon the undercurrents to catch possible gold rather than upon the sluices proper.

37. Booming.—Booming is ground sluicing on a larger scale, by means of an intermittent supply of water. The water is frequently collected behind a dam with an automatic gate, working somewhat like that shown in Fig. 18. When the dam is full of water, the overflow fills the small tank which operates the gate. The weight of the water in the tank opens the gate, so that the entire mass of water in the reservoir escapes with a rush and carries the material before it into the sluices or down through the gulch.

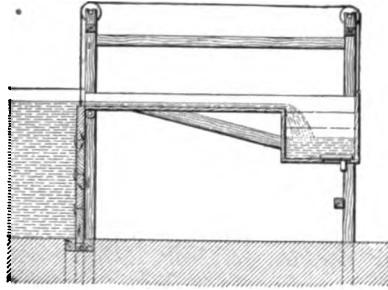

FIG. 18.

The rush of the water lets the heavier particles of gold and magnetic iron or black sand settle on the bed-rock or in the sluice, and these are subsequently collected and washed in pans or cradles. When the small tank containing the water drops, a trap-valve in its bottom is opened, allowing the water in the tank to escape, and when this takes place the gate closes of its own weight, thus returning the tank to its former position.

CHARGING THE SLUICES.

38. When commencing operations at a large placer mine, the sluices are made ready and are examined to see that they are water-tight. Then water is turned into the pipes and material run through the sluices for a day or two, so as to pack them with sand and gravel. The water is then shut off and a charge of quicksilver put into the upper portion of the sluices. In the case of very long sluices, quicksilver may be put into the first two or three hundred feet of the boxes and a small quantity distributed through all, except the last 400 feet of the line. In the case of a 6-foot sluice, the first charge may require as much as three flasks. The undercurrents are charged at the same time, and a small

amount of quicksilver put into the tailings sluice. Quicksilver is added daily during the run, in gradually lessening quantities, the object being to keep the surface of the mercury uncovered and clean on the riffles in the upper portion of the sluice. Hence the quantity charged is regulated by the amount exposed to view. A 24-foot undercurrent may be given from 80 to 90 pounds of quicksilver. In charging the riffles, the quicksilver should not be sprinkled or splashed, as by this action the mercury is reduced to such small particles that they are readily carried off by the swift stream, and if broken sufficiently fine will be carried away. The surface of the water from mining sluices often yields minute particles of quicksilver, and sometimes also float gold. In large placer-mining operations as much as 2 or 3 tons of quicksilver are sometimes required, a portion being in the sluice, a portion being held in reserve for use as needed, and the remainder being in the form of amalgam.

In the United States a flask of quicksilver is supposed to contain $76\frac{1}{2}$ pounds; the quicksilver is shipped in iron flasks.

METHODS OF EXCAVATING MATERIAL.

39. Manual Labor.—Originally the placer gravel was loosened with pickaxes and shoveled into pans, rockers, Toms, or sluices. The sluices ran so much more gravel than the men could shovel that the operators found it necessary to adopt some more expeditious means of handling material.

40. Ground Sluicing.—Ground sluicing is much more rapid than manual labor, and has been used in a great majority of cases to feed the material into the sluices. The operation consists in the carrying of a stream of water along the surface of the ground and into the end of the sluice. This stream loosens and carries with it much of the gravel and earth. Its action is often assisted by men who stand in the stream or on the sides of it and loosen the material with

pickaxes, bars, or shovels. By this means one man can sometimes run more gravel into the sluice in a day than he would be able to shovel in a month. Ground sluicing naturally partakes of the nature of flume sluicing, and the current tends to sort the material, leaving the boulders, coarse gold, and black sand on the bed-rock. The streams of water which flow over the bank and effect the ground sluice are sometimes called *flume waterfalls*.

HYDRAULICKING.

41. Origin of Hydraulic Mining.—The origin of hydraulic mining is usually credited to Edward Mattison, of Connecticut, who was working in the placer mines of California. He conceived the idea of directing a stream of water under pressure against the gravel bank from a nozzle, and so doing away with the pick and bar necessary in ground sluicing and flume-waterfall work. He conveyed the water through a rawhide hose with a wooden nozzle, and discharged it against the bank in the manner shown in Fig. 19. Others soon took up the method, and the size of the hose and nozzles rapidly increased; but these pipes gave a great deal of trouble by bucking, knocking the men down and causing considerable damage, the evolution finally resulting in the invention of the Giant, or Monitor, which is shown in operation in Fig. 20.



FIG. 19.

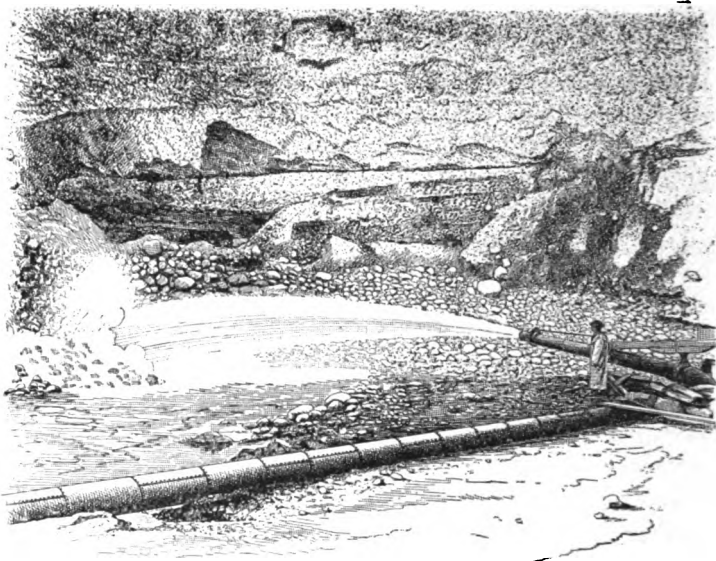

FIG. 20.

EVOLUTION OF THE GIANT.

42. Goose-Neck.—The original form of nozzle for use on the end of the metal pipe was the Goose-neck, as shown at (*a*), Fig. 21. This consisted of two elbows turned in opposite directions, the upper one being provided with a nozzle. The trouble was that the pressure of the water caused the joints to leak, and when the pipe was turned so as to make an angle with the direction of the supply-pipe, it would buck or fly back, endangering the lives and limbs of the operators.

43. Globe Monitor.—The Goose-neck was succeeded by the "Craig Globe Monitor," as shown at (*b*), Fig. 21. This consisted merely of a ball-and-socket joint, to which the nozzle was attached. The pressure of the water in the joint made it very difficult to operate.

44. Hydraulic Chief.—Mr. F. H. Fisher invented the Hydraulic Chief, which was the next in advance. This machine is shown at (*c*), Fig. 21. The main improvements consisted in the use of two elbows placed in reversed positions

when in a straight line, connected by a ring in which there were anti-friction rollers. The ring was bolted to a flange in the lower elbow, but allowed the upper elbow a free horizontal movement, while the vertical motion was obtained by means of a ball-and-socket joint in the outlet of the upper elbow. The interior was unobstructed by a bolt or other fastenings, and the man at the pipe could operate it by means of a lever without danger to himself. Riffles similar to those shown at (g), Fig. 21, were inserted in the discharge-pipe to

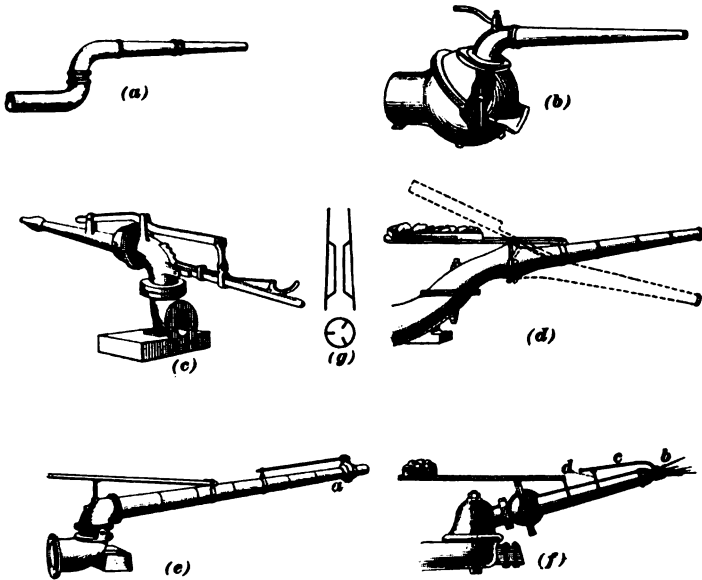

FIG. 21.

prevent the rotary movements of the water caused by the elbows and to force it to issue in a solid stream. These machines soon became leaky at the joints, but the riffles have remained as one of the features of the Giants ever since. If the water issues from the nozzle with a rotary motion, it will spray and not form a solid stream.

45. Dictator.—The Hoskins Dictator was the next step in advance. This was a single-jointed machine with elastic packing instead of two metal cases. The joint

worked up and down on pivots, and in rotating it, small wheels ran around against the flange.

46. Little Giant.—The Little Giant, a subsequent invention of Mr. Hoskins, on account of its simplicity and durability, superseded all previous machines. This is illustrated at (*d*), Fig. 21. It is a two-jointed machine, portable and easily handled, having a knuckle-joint in the nozzle to give it a vertical range, and a swivel-joint in the pipe for the horizontal movement. The nozzle was provided with riffles.

47. Hydraulic Giants.—The Little Giant was succeeded by the Hydraulic Giant, one form of which is shown at (*e*), Fig. 21. In this form the pivot or knuckle-joint is placed between the two elbows, the swivel being at the top of the lower elbow. The joint has no bolts passing through it, as was the case in the Little Giant, thus giving a free passage to the water. The pipe is provided with a balance weight similar to that shown in connection with the Little Giant.

48. Monitors.—The Monitor is a form of hydraulic machine invented by Mr. H. C. Perkins and shown at (*f*), Fig. 21.

49. Deflecting Nozzle.—In the earlier forms of Giants it was necessary to drag the pipe backwards and forwards, or lift or depress it, by manual labor, and this was extremely difficult and coupled with more or less danger to the operator. Mr. Hoskins invented the deflecting nozzle, which is a simple device by means of which one man can easily handle the largest Giant. The attachment is shown in connection with the machines illustrated at (*e*) and (*f*), Fig. 21, and may be described as follows: There is a small extension to the regular nozzle, which in some cases is slightly larger, and in others practically the same diameter as the nozzle. The extension is connected to the main pipe by means of a ball-and-socket joint, as shown at *a*, Fig. 21 (*e*), and at *b*, Fig. 21 (*f*). The deflecting nozzle is operated by means of a handle *c*, which ordinarily rests on a support *d*. When the

handle *c* is on the support *d*, the two nozzles are in line. If the deflecting nozzle be moved in any direction by means of the handle *c*, one side of it will be brought into contact with the stream as it issues from the regular nozzle, and the force of the stream reacting against the deflecting nozzle will force the entire pipe in the direction of the interference. In order to cause the pipe to travel in any given direction, it is only necessary to thrust the handle *c* in that direction. If the pipeman is cool and collected, this deflecting nozzle gives him absolute control over the pipe at all times, and removes much of the danger formerly connected with this part of hydraulic mining.

50. General Remarks in Connection with Hydraulic Nozzles.—Monitors or Giants of any description

have to be securely fastened down by bolting them to timbers, and weighting the timbers and the first joint of pipe with rock; for if the Giant can get in motion and once starts to trembling, it is almost sure to buck, and frequently tears loose from the pipe, so that the Giant and the man at the pipe are both washed away by the flood of water from the supply-pipe. In using the pipe for hydraulicking or washing down banks, considerable skill or experience is required. If the bank contains a stratum of clay, together with a considerable quantity of large boulders, it is possible to cut the clay down in such a manner that it will practically lubricate the way for the boulders, so that they will slide over the bed-rock and into the sluices as though the way had been greased. On the other hand, the mixing of the boulders and clay will facilitate the breaking up of clay balls. This is especially true where the sluices are provided with drops. Considerable skill is required for the operation of the Giant, and a good pipeman, as the men who operate the Giant are called, is much more valuable than several less experienced men would be about a placer mine, on account of the fact that he knows just how to take advantage of the different classes of material to be washed and to get the most work out of the water.

CAVING BANKS.

51. In opening up a placer mine, the work is commenced near the sluice. As the bank recedes, bed-rock cuts or ground sluices have to be advanced to the face, to facilitate the washing of the gravel into the sluice proper. The banks are ordinarily caved by turning two or more streams against any one point in the bank in such a manner as to undermine it, as illustrated in Fig. 22. The water is delivered

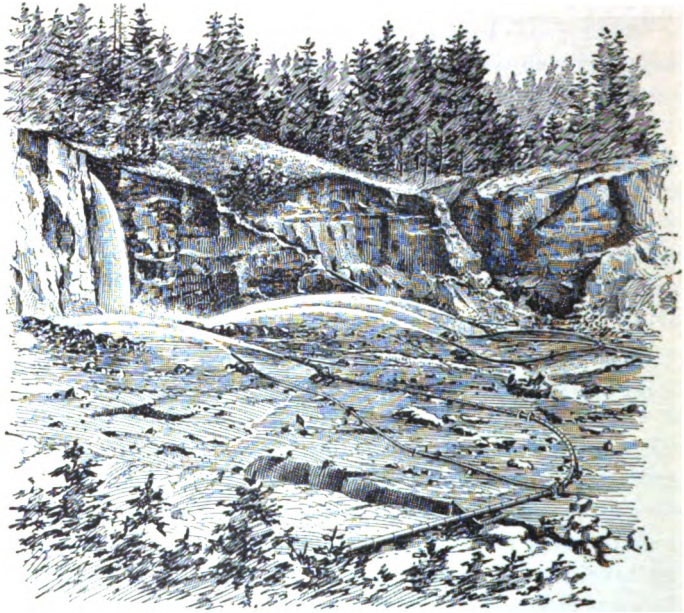

FIG. 22.

with a force of from 150 to 200 pounds to the square inch; it rapidly undermines the bank, washes away the material, and carries the debris into the sluice. If the bank caves readily, one pipe may be used for cutting, while the stream from the other will be employed for washing the gravel through the bed-rock cuts into the sluice. The face of the bank should be kept square, advantage being taken of any corners which may be left, and under no circumstances should a horseshoe shape be formed. When the cut is rapidly pushed ahead and the work not squared, the men at the pipes become

encircled by the high walls and their lives are in danger. Where the banks exceed 150 feet in height, the deposit is usually worked in two benches. When the men at the pipes see that the bank is about to cave, the water should be immediately turned away, for if the cave falls on water, a rush of debris is liable to follow, which may bury the pipes and force the men to run for their lives. In mines which are only operated by day, caves are usually made just before quitting time at night. Where possible, the washing should be continuous and no water allowed to run to waste; hence it is desirable to have several faces or openings, so that the stream may be diverted from one to the other while the bed-rock, cuts, or sluices are being lengthened. The cuts or bed-rock sluices are trenches made in the bed-rock near the face, to collect the water and material and convey them to the sluices. Sometimes these cuts are as much as 60 or 70 feet deep. As a precaution against theft, where claims are worked intermittently the sluices are run full of gravel before closing down.

TROMMELS.

52. In many placer mines trommels are employed for disintegrating or breaking up the gravel and for separating the fine material from the coarse stones. The rolling action of the trommel, together with the water which is discharged on to it, thoroughly washes or cleans all the boulders, and removes all clay or gold from them before they are discharged. Trommels are especially useful where the amount of water is not sufficient to carry the boulders through the sluice, or where it is impossible to obtain a sufficient fall for a length of sluice that would disintegrate the material and then sufficiently concentrate it. Trommels are used very largely in the Siberian placer mines.

LIGHTING.

53. Where mines are worked night and day, some form of artificial light must be employed for the night-work. In some cases, locomotive reflectors or bonfires are employed, but most of the large mines now use arc lights.

DISPOSITION OF TAILINGS.

54. General Remarks.—In large placer mines disposition of the tailings has always been a serious question. In many cases they are simply washed into some rapidly flowing river, but sooner or later they are liable to work down the stream and to block the course of the river, causing serious floods and the burying of much valuable land in the agricultural districts. On this account, a permanent injunction has been granted against certain classes of placer-mining work in California. To overcome this difficulty, several devices have been resorted to.

55. Brush Dams.—Dams of brush or logs are frequently constructed in gorges or cañons, and the tailings allowed to accumulate behind them. As the level of the tailings reaches that of the top of the dam, the height of the dam is increased. By carefully constructing the dams and by keeping them up to full height, the tailings may be indefinitely held in the cañon or gorge by this means; but in many cases the level of the tailings would soon reach that of the ground from which they were being excavated, and hence work would be brought to a standstill. To overcome this, some form of elevator became necessary. In some cases tailings have been elevated mechanically by means of bucket elevators, but this is expensive and is rarely resorted to.

HYDRAULIC ELEVATORS OR BLOWUPS.

56. The Ludlum Elevator.—One of the first hydraulic elevators that was constructed to raise tailings is illustrated in Fig. 23. The principle is that of the ejector. A stream of water under considerable pressure is discharged through a nozzle similar to a Giant nozzle, as shown in the illustration, and gravel mixed with water is fed to the opening around the nozzle, the force of the stream carrying the entire mass up the discharge-pipe to a considerable height. Similar elevators or ejectors are also constructed for removing water from workings in the beds of

ivers, or other places which have a tendency to become flooded.

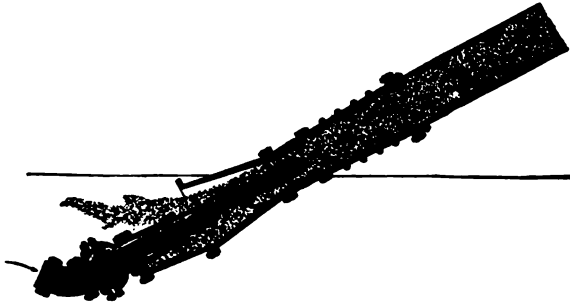

FIG. 23.

57. Evans Elevator.—Fig. 24 illustrates the Evans elevator, which works on the same principle as the ejector.

The water under pressure enters through *a* and is discharged through a nozzle *a*. The suction for the gravel is through a large opening in front, and the rapid flow of the water draws the material in and ejects it up through the contracted portion *e* and on through the discharge-pipe. One great advantage claimed for this elevator is the introduction of the two auxiliary suctions *b* and *c*. These are placed at the sides of the main suction and may be employed for draining the pit of water, for drawing in fine material, or even for draining places in bed-rock at some distance from the elevator. One great advantage in the use of these auxiliary suctions is that

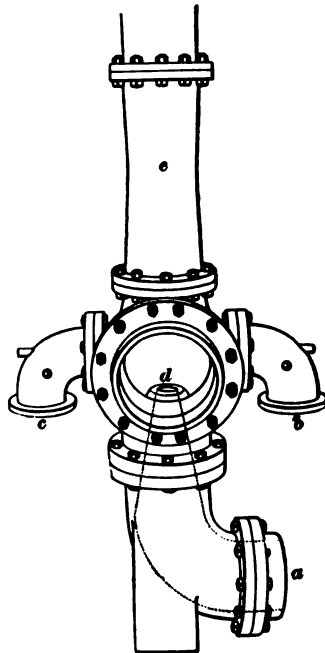

FIG. 24.

the space back of the nozzle is thus provided with a flow of

water, and the boulders and other material drawn in through the main suction prevented from rushing around into this space with a great force, which they would otherwise have a tendency to do. These elevators are built with a capacity to handle stones 18 inches in diameter and lift material 15 feet high for every 100 head of water.

AUXILIARY APPARATUS.

58. Derricks.—Strong derricks are used in hydraulic mining to remove heavy boulders. The mast is frequently 100 feet high and the boom over 90 feet long. The mast is held in position by guy wires and is provided with the proper tackle both for raising and lowering the boom and for raising any weight attached to the boom. Such derricks are usually operated by means of water-wheels of the “hurdy-gurdy” pattern, the wheels frequently being as much as ten feet in diameter and sometimes being connected to the drums which operate the ropes by means of gearing.

59. Water-Wheels.—The “hurdy-gurdy” or some form of impact wheel which can be moved by a stream or

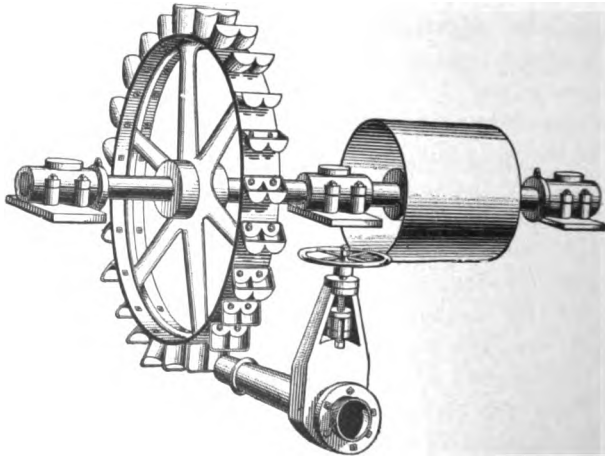

FIG. 25.

jet of water issuing from a nozzle under pressure, and

striking open buckets on the circumference of the wheel, is frequently used for operating the derrick, or furnishing other power around the placer mine. One form of Pelton wheel is shown in Fig. 25. Undershot water-wheels are also frequently employed for operating the Chinese pumps or bucket elevators in connection with wing-dams in bar mining.

WING-DAMS.

60. The material below the level of a stream may be worked by means of wing-dams similar to that shown in Fig. 26. The stream is dammed and the water carried along one side either in a ditch or flume. The portion of the bed thus separated from the current is pumped out, and the gravel removed and sluiced. The water may be removed from the portion isolated by means



FIG. 26.

of hydraulic elevators, power pumps, or by means of water-wheels or Chinese pumps. In Fig. 26 a modified form of Chinese pump is in operation. On the right of the figure will be seen an undershot water-wheel which operates a Chinese pump at the left of the figure. This pump, consisting of a large wheel around which passes a chain-bucket system, lifts the water and dumps it into one of the sluices shown at the left of the figure, thus draining the workings. The other sluice shown at the left of the figure is the gravel sluice, which is supplied with water from the stream above the dam, and is used for sluicing the gravel taken from the opening. In the examples of placer mining at the latter part of this Paper there is a description of the Roscoe placer, which was exposed by a wing-dam.

DRIFTING.

61. In the case of deep placers overlaid with lava caps, it is sometimes necessary to resort to drifting in order to obtain the material on the bed-rock. In some cases, only the bed-rock gravel will pay for excavating, while in others it is possible to work the material for some distance above bed-rock, and occasionally it would be found profitable to work the gravel on two different levels, there being a false

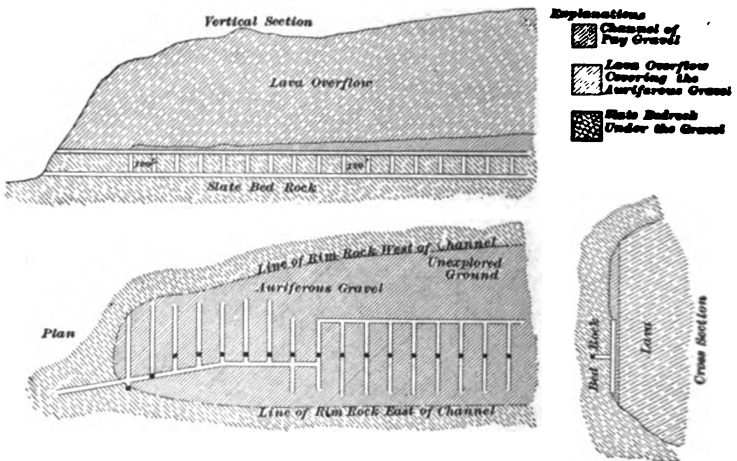

FIG. 27.

bed-rock some distance above the true bed-rock. In working these drift mines, the entrance may be effected either through a shaft or tunnel. In some cases an old river-bed is cut by a modern river-bed in such a manner that the drift or tunnel can follow the old bed, but in most cases it will be found necessary to drive a tunnel from some adjacent valley or to operate the mine through a shaft. Operating through a shaft has the disadvantage that the water must be removed, and this would often render the mining operations unproductive. Fig. 27 gives a plan and two sections of the "Sunny South" drift mine in California. This mine is operated through a tunnel driven from an adjacent valley in such a way that it passes under the lowest part of the ancient river-bed, and access is obtained to the gravel by

means of raises. Drifting is only profitable when the precious metal has been concentrated in well-defined strata or portions of the channel. The location of the tunnel through the "rim rock" is a matter of great importance. However, if it is not located below the lowest part of the deposit, it will be necessary to pump the water and raise the gravel to the tunnel, and hence the main object sought in drifting will be missed.

62. Handling and Treating the Gravel.—The gravel is removed in mine-cars to the mouth of the tunnel, where it is dumped on the floors and washed in sluices, if not too firmly cemented. If the material is firmly cemented, it must be crushed in stamps previous to washing. These stamps differ from those used in gold and silver mills in that they have a double discharge and use a very much coarser screen than is common in mill-work, the screen usually being at least $\frac{3}{16}$ -inch mesh. An attempt is made to amalgamate the greater part of the gold in the battery, but copper plates outside of the battery are also employed, and these are usually followed by sluices. As a rule, no attempt is made to save the gold-bearing sulphides contained in the gravel. In some mines, steam locomotives are used for transporting the men and materials through the tunnel, which in some cases is over a mile in length.

63. Timbering and Method of Mining.—The tunnel is timbered like an ordinary drift by means of sets similar to those shown in Fig. 28. The gravel is mined much like coal is worked, the deposit being divided into panels or divisions, which are subsequently worked either on the pillar-and-stall system or by means of square work. When worked by the pillar-and-stall system, the pillars are sometimes robbed clean, the entire deposit on bed-rock being recovered. This is accomplished by building packs or pillars of the larger boulders in the worked-out rooms, and also by supporting the roof temporarily by means of posts and breast caps similar to those shown in Fig. 29. If the gravel is comparatively soft, it may be necessary to timber the entire roof,

and in that case the posts may support stringers, which in turn carry the lagging, or a series of drift sets may be used

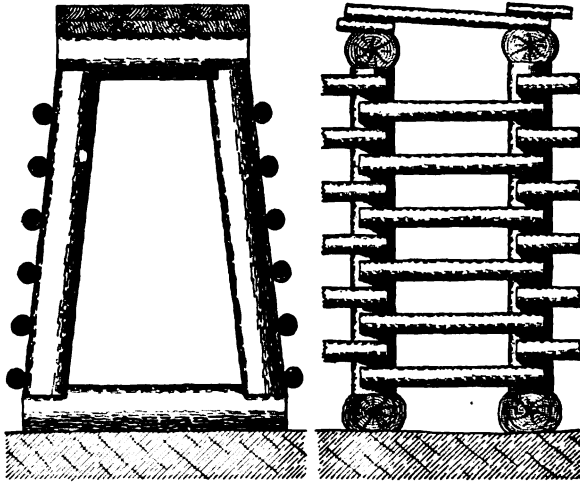

FIG. 28.

side by side. When the square-work system is employed, the drifts or breasts are carried in both directions at right angles, leaving the pillars as illustrated in Fig. 30. It will be seen that by this means three-fourths of the deposit can

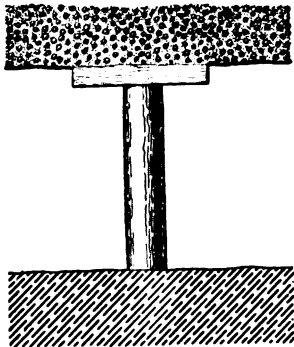

FIG. 29.

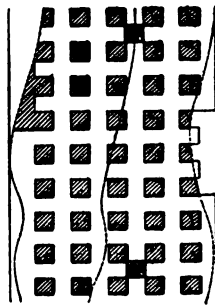

FIG. 30.

be recovered, providing the drifts and pillars are of the same width.

64. Tunnels as Outlets for Hydraulic Mines.

—Some placer deposits occur in ancient river-beds where they are not overlaid with lava caps, but are so situated that they have no natural dumping-ground. An outlet for these deposits is frequently provided by driving a drift or tunnel to some neighboring ravine or cañon. A shaft is sunk to connect with the inner end of the tunnel, and the gravel washed down through the shaft and out through the tunnel. Sometimes sluice boxes are placed in the tunnel, while in other cases the material is allowed to run on the rock bottom of the tunnel, the floor of the tunnel forming a natural ground sluice. When this latter process is followed, the material is liable to wash the floor of the tunnel into very irregular hollows, and may in time cause very serious caves. There is one advantage in having a sluice inside of a tunnel, and that is the tunnel can be provided with doors, which can be kept locked in such a manner as to prevent the stealing of the gold which has accumulated in the sluices. After the work has progressed for some time and the gravel has been removed to bed-rock, at the point where the shaft descends to the tunnel, it may be possible to place a portion or all of the sluices on the bed-rock above the point where the material enters the tunnel. The introduction of hydraulic elevators has furnished a means for working a large number of deposits which were formerly operated by means of tunnels, as just described.

65. Working Frozen Ground. — In Siberia and Alaska the ground is frozen to a considerable depth, and the summer season is so short that, as a rule, it would not thaw sufficient gravel to give the miner a fair season's work, and in some cases would never thaw to bed-rock. On this account the material is mined during the winter, while frozen, and is thawed and washed during the summer. The frozen gravel is much harder to work than ordinary rock, owing to the fact that it is so tough that it resists drilling, blasting, or picking, so the miner thaws the ground before attempting to break it down. He accomplishes this by

building a fire against a portion of the ground to be removed. In sinking his shaft, if the surface is frozen, he builds a fire of wood where he desires to sink, and the heat from this thaws the ground for a little distance. The fire is often rendered more effective by a cover of charcoal, so as to confine the heat. When the fire dies down, the miner scrapes aside the embers, and shovels away the loosened ground beneath until he comes once more to a frozen portion, where another fire is built, and the whole operation repeated. This is continued down to bed-rock. The sides of the shaft are given what support is necessary by means of timber cribbing or rough square sets with lagging. From the bottom of the shaft the drift is started, every foot having to be thawed. A strong wood fire is built against the face of the drift and covered with charcoal, as before, and allowed to burn out. After the material is thawed, it is removed and another fire built. All workings must be tightly, though not necessarily heavily, timbered, owing to the fact that the constant use of the fires underground soon softens the roof, and portions of it are liable to cave and cause serious results. Some simple ventilating device is usually necessary to remove the gases generated by the fire. This may be accomplished by means of a brattice until the mine has been extended a sufficient distance to drive an air-shaft. The work is usually carried on by means of the square-work system, as shown in Fig. 30. The effect of the fires in the drifts is to raise the temperature to an oppressive point, so that in some large Siberian mines the miners work naked, though the temperature outside may be several degrees below zero. An amount of wood equivalent to the thickness of 1 foot across the face will thaw about the same depth of gravel, and 14 inches is practically the maximum depth which can be thawed with one fire.

66. Blasting.—When working cement-gravel mines by the hydraulic process, it is frequently necessary to loosen the gravel by means of blasting. For this purpose, a tunnel is driven into the bank some distance, and drifts turned to the

right and left, parallel to the face. Boxes or barrels of powder are packed into these drifts and connected with the surface by means of wires, so that they can be exploded when desired. The tunnel is then carefully tamped with fine gravel or clay, so as to prevent the escape of the gas through this opening, and thus increase the efficiency of the blast.

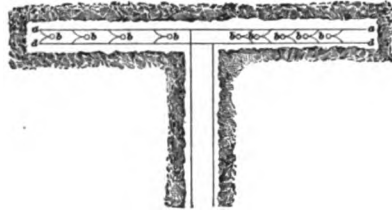

FIG. 31.

The tamping should be thoroughly rammed in with wooden mauls. Occasionally blasts are fired by means of fuses, and when this is done, two or three lines of fuse should be laid, so as to avoid misfires. The general arrangement of the tunnel drifts and charges is shown in Fig. 31, in which *a a* and *d d* are the wires connected with the two poles of the battery, and *b b* are the charges to be fired. Comparatively soft cement gravels are best blasted by means of black powder, which is simply used to lift and somewhat disintegrate the bank. Where the cement gravel is extremely hard, it is sometimes blasted by means of low-grade dynamite or giant powder. In banks of ordinary cement gravel, 50 to 150 feet high, Bowie recommends that the main drift should be run in a distance of two-thirds the height of the bank to be blasted. The cross-drifts from the end of the main drifts should be run parallel to the face of the bank, their length being determined by the extent of the ground to be removed. The powder required is from 10 to 20 pounds of black powder per 1,000 cubic feet of ground to be loosened. Even when black powder is employed for the blast, the exploders *b, b* are usually inserted in cartridges of giant powder and placed on top of the paper covering the black powder. By this means a much more powerful detonation is obtained, and the action of the black powder is made more effective.

CLEANING UP.

67. The length of the run depends upon the wear of the pavement or riffles and upon the value of the material being put through the sluices. Some claims are cleaned up every twenty days, others every two or three months, and a few only once a season. All pavements should be cleaned as soon as they begin to wear in grooves. Where large quantities of gravel are washed, it is advisable to clean the first 1,000 or 2,000 feet of sluice about every two weeks, the tailing sluices being only cleaned once a year. Undercurrents should be cleaned up whenever quicksilver is found spread over the lower riffles, with a tendency to discharge over the end into the tailings. The gold-saving tables are cleaned up every few days without stopping the work in the main sluice, by simply diverting the water from one table while it is being cleaned up, and repeating the operation until all of the tables have been cleaned. When it is decided to make a general clean-up, the bed-rock and ground sluices are washed clean. No material is turned into the sluices, clear water alone being run until the sluices are free from dirt. A small quantity of water in which a man can conveniently work is then turned through the sluice, the blocks are taken out with crowbars, washed, cleaned from amalgam, and laid alongside the sluice. This is done in sections of 100 feet or so. One row of blocks is left in the sluice between each section. These rows serve as riffles to prevent the gold and quicksilver from passing down the sluice. After the first section of blocks is taken up, the men follow the gravel and dirt as it is slowly washed down the sluice and pick out the quicksilver and amalgam with iron spoons and place it in sheet-iron buckets. As each riffle is reached, the amalgam and quicksilver are collected, the blocks removed, and the residue washed down to the next riffle, etc., down the entire line of the sluice. When this operation is finished, the water is turned off entirely and workmen go over the sluice with small silver spoons, digging the amalgam out of the nail holes and cracks. After this, the side lagging is overhauled

and the blocks are replaced. Very long sluices are usually lined in the lower portion with heavy rock riffles, which can be used for a longer period without cleaning up than is the case with the smaller riffles used farther up. In some cases it is customary, where mines are run night and day, to clean up as long a section as possible during the day, to replace the lining, and resume washing at night, proceeding thus until the entire sluice is cleaned up.

AMALGAMATION.

68. Although heavy gold may be arrested by the various contrivances described, such as riffles, undercurrents, etc., much fine gold might escape in the absence of mercury or quicksilver. When this is present, it instantly seizes and amalgamates any gold coming in contact with it. When using zigzag riffles, a vessel containing quicksilver, and pierced by a small hole which allows the metal to escape drop by drop, is sometimes placed at the head of the sluice. The quicksilver trickling down from riffle to riffle overtakes, absorbs, and retains the fine gold, the amalgam thus formed being caught in the regular riffles farther down. Where the sluices are provided with longitudinal riffles, after starting the washing, more mercury is poured into the head of the sluice and finds its way down with the current, though the larger proportion of it will remain in the upper boxes. Small quantities of quicksilver are sometimes introduced at intervals farther down the sluice, the quantity being increased in direct proportion to the amount of fine gold present. Where block riffles are employed, an attempt is sometimes made to impregnate the pores of the wood with mercury. This is accomplished by grinding the end of a piece of gas-pipe to a thin edge, and driving it into the wood. The gas-pipe is then filled with mercury, and the pressure of the column will force a certain amount of the fluid into the pores of the wood. As the wood gradually wears away, this mercury becomes exposed and amalgamates any gold that may come in contact with it. When cleaning

up the sluice, the amalgam remaining on the surface of the wood is simply scraped off.

69. Copper Plates.—Where gold is very fine, amalgamated copper plates are sometimes employed. These are usually at least 3 feet wide by 6 feet long, and sometimes the stream is split and carried over two or three such plates, so as to reduce the speed of the current on the plates as much as possible. The plates are placed nearly level and at considerable distance from the head of the sluice, as it is intended to catch only the fine gold; and for this reason also a screen is placed above the plates in such a manner as to remove all the coarse material and allow only the fine material to pass over the plates. The screens employed for this purpose are frequently perforated with holes $\frac{1}{2}$ inch by $\frac{1}{8}$ inch, similar to the slotted screens used in the stamp batteries of gold and silver mills. The copper plate is amalgamated by first cleaning its upper surface with dilute nitric acid, and then applying some mercury which has been treated with dilute nitric acid to form a little nitrate of mercury. The current must be slow and shallow, so that every particle of gold may come in contact with the surface of the plate. A freshly amalgamated plate may become coated with a green slime of subsalts of copper. This must be carefully scraped off and the plate carefully rubbed with fresh mercury. To remove the amalgam in ordinary cleaning up, the plates are sometimes cleaned by means of a whisk-broom, the bristles of which have been cut very short, or are scraped with a knife or scraper. If it is desired to remove practically all the amalgam, this may be done by gently heating the plate and then scraping off the amalgam; but plates always catch gold better when there is a little amalgam remaining on them, and the warming of the plate makes it more difficult to re-coat. For these reasons, it is not always advisable to resort to these means during a clean-up. The copper plates should not be less than $\frac{1}{8}$ inch thick.

70. Amalgam Kettles.—Amalgam kettles are ordinary sheet-iron buckets or porcelain kettles. They are used

as receptacles in which to collect mercury and amalgam while cleaning up sluices and undercurrents, and also for floating amalgam to free it from foreign substances before it is strained and retorted.

71. Cleaning the Amalgam.—The quicksilver and amalgam obtained in cleaning up the sluices and undercurrents are well stirred in buckets, if necessary, with the addition of mercury. The coarse sand, nails, and other foreign substances which float to the surface are skimmed off. This residue of sand, which always retains some amalgam, is concentrated by working in pans or rockers, and the concentrates are ground in iron mortars with some clean quicksilver to free the amalgam. Any base material floating on the surface after this second cleaning is melted separately to a base bullion, and the clean quicksilver and amalgam are added to the clean portion from the first. The quicksilver is then separated from the amalgam by straining through canvas, chamois-skin, or buckskin, and the dry amalgam is treated in iron retorts.

72. Retorting.—When the amount of amalgam to be treated is small, hand retorts answer all requirements. These are simply cast-iron pots having a cover that can be fastened on, and through which a bent pipe passes. The iron pot is partially filled with amalgam, placed in an ordinary forge fire, and the end of the bent pipe immersed in water. In this way the mercury is driven over and into the water. Care must be taken that at the end of the retorting the heat of the fire is not allowed to fall in such a manner as to form a vacuum in the retort; for in such a case the water would rush back into the iron pot, form steam, and probably result in a disastrous explosion.

Where large amounts of amalgam are handled, stationary cast-iron retorts are used. If the furnace were to be left unattended for a short time, and it were placed immediately above the fire, it is apt to become overheated. In this case, the weight of the metal inside of the retort would cause it to "belly," thus ruining it completely. To prevent this, the

retort should be supported at several points and arranged with the fire on one side, so that the heat may be evenly distributed over it.

Fig. 32 illustrates such a retort. Before putting the amalgam into any retort, the inside should be coated with

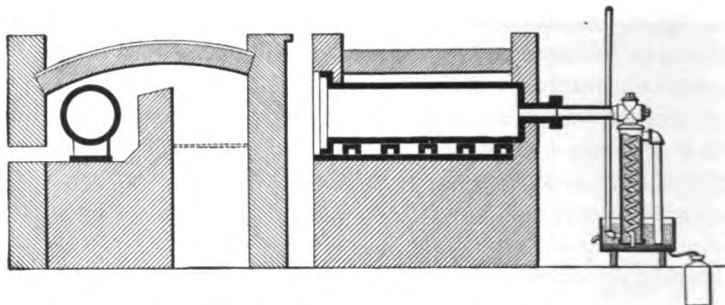

FIG. 32.

a thin sheet of clay, which prevents the amalgam from adhering to the iron of the retort. The amalgam should be carefully introduced and spread out evenly. The pipe connecting the back of the retort with the condenser must be cleaned of all obstructions, and the amalgam should be so spread that by no possible mischance can this pipe become choked, for if this happens an explosion will probably result. Such an explosion would fill the retorting room with the poisonous fumes of mercury and greatly endanger the lives of the workmen. When the amalgam is first placed in the retort, care should be taken that none of it is too close to the pipe connecting with the condenser, for when retorting begins, the amalgam swells or puffs up, and this action might close the condensing pipe. To avoid the danger of excessive puffing or bubbling of the amalgam, and also the overheating of the retort, the heat should be very slow at first. The cover is put on with a luting of clay or a mixture of clay and wood-ashes, and securely clamped. After this the fire is lighted and the heat gradually raised, a dark-red heat being all that is necessary to volatilize the quicksilver. Towards the end of the operation, the heat may be raised to a cherry red until distillation ceases. The retort is then

allowed to cool, and when cool is opened. During the operation the condenser coil at the back of the retort should be kept cool by means of a continuous supply of fresh water, which enters from the lower end of the box containing the condenser, the warm water discharging from the upper end of the box. For the purpose of cleaning, it is better to have the condenser in the form of a straight tube than in the form of a coil, for it is impossible to run a rod through the coil for the purpose of cleaning; it is also impossible to satisfactorily inspect the coil and see if it is clean. The retorted bullion is cut or broken into pieces and melted in well-annealed black-lead crucibles, and the gold cast into bars.

DISTRIBUTION OF GOLD IN SLUICES.

73. In sluicing, the greater part of the gold (usually at least 80%) is caught in the first 200 feet of the sluice. For example, in a claim yielding \$63,000 on a 100 days' run, \$54,000 was obtained from the first 150 feet and \$3,000 from the undercurrents. The first undercurrent, 790 feet from the head of the sluice, yielded 50 per cent. of the total amount taken from the undercurrents; the second undercurrent, containing 33 per cent. of the gross undercurrent yield, was 78 feet distant and 40 feet below the first. The last undercurrent was 98 feet from the second, with a drop of 50 feet between them, and its yield was about \$500. The balance of the gold was obtained from the bed-rock above the sluices. Another case has already been spoken of in connection with the iron riffles, in which 8 feet of iron riffles were employed at the head of the sluice, and 98 per cent. of the gold caught was found in these 8 feet of riffles, the other 2 per cent. being distributed over the 92 feet of block riffles.

PRELIMINARY INVESTIGATION OF PLACERS.

74. The value of the gravel deposit is the first consideration. Its determination involves the ascertaining of the course of the channel, the depth of the deposit, and the

position of bed-rock, which in some cases may be under hundreds of feet of material. The total size of the deposit must be determined, and an estimate made of the yield which the ground can make and of the cost required to work it. The geology and topography of the deposit and its surrounding must be considered, as they will assist in determining the course of the channel and the depth to bed-rock; the conditions for dump should also be considered. The value of the gravel may be approximately determined by making shallow pits and washing the material obtained from them and from other available places, as where the bank has been exposed by the cutting of streams. Deep placers and large enterprises frequently require prospecting by shafts sunk to bed-rock and by drifts. The water-supply conditions and the length of the working season should likewise be carefully considered. Different-colored gravels, as red, rusty, and blue, are sometimes considered good signs, but they are not reliable. Black sand is frequently accompanied by gold, but it may be barren.

The careful prospecting of a large placer deposit frequently involves the expenditure of a large sum of money, as, for instance, in the case of the Malakoff property in California, where it was found necessary to sink four shafts and to drive over 1,200 feet of drifts, making in all, counting shafts and drifts, over 2,000 feet of exploration workings. The average assay of the samples from the various drifts was \$2.01 per cubic yard, and the actual yield obtained by treating 21,000 tons of the material extracted was at the rate of \$2.75 per cubic yard. The cost of the preliminary work in this case was \$66,956.20. From this it will be seen that large and deep placers are certainly not poor men's mines.

When investigating placer deposits in arid or dry regions, the following facts should be borne in mind: The greater part of the gold in such a region was not deposited by constantly running streams, but by intermittent flows, most of which were of the character of cloudbursts or floods. On this account, the gold will not be found concentrated, as in

the beds of streams which have a comparatively even flow, but will usually occur on false bed-rock above the true bed-rock, the pay gravel being in irregular patches, which, as a rule, do not extend over large sections of country. Frequently the soil just under the grass roots is the richest portion of the entire deposit. This fact may be accounted for as follows: In regions which have wet seasons, the soil becomes soft to a considerable depth, and any particles of gold tend ultimately to find their way to bed-rock, while in the arid regions the rain-storms usually soften but a few inches of the surface, and hence any gold contained in the soil accumulates a few inches from the top of the deposit, the first few inches being thus freed of the gold, which will settle through to a lower point. The barren surface soil is blown away as dust during the dry season, or washed away during the rainy season; as this process continues, the gold gradually works its way downwards, always remaining within a few inches of the surface. Such occurrences of gold high in the deposit should not lead the prospector to believe that the material will become richer and richer until true bed-rock is reached, for these formations are frequently barren in their lower portions.

WATER-SUPPLY.

75. Source of Water.—The water-supply for placer operations is obtained from running streams, melting snows, and rains. The snow accumulates on the mountains during the winter, and the heavy rains of the spring cause rapid thawing of the snow-banks, and enormous volumes of water rush down the gullies and ravines. In case the country is timbered, the streams may furnish a sufficient supply throughout the year; but near the timber line or in a sparsely timbered country, the water usually rushes off in the spring, and the streams are dry later in the year. In order to provide a supply of water for hydraulic mining in such a region, it becomes necessary to collect the water in a reservoir, from which it is drawn for use during the dry season.

RESERVOIRS.

76. Reservoir Site.—In selecting the site for a reservoir, the following points should be observed:

1. A proper elevation above the point at which the water is required.

2. The supply of water furnished by all creeks and springs and the catchment area, or area drained into the reservoir, should be carefully determined. In this connection, one point must be observed, and that is that usually all streams and springs within the area are fed by the rainfall within such area, and hence the total amount of water can never exceed the amount which falls on the surface, and owing to evaporation and other losses will always be much less.

3. The average amount of rainfall and snowfall should be carefully determined.

4. The formation and character of the ground with reference to the amount of absorption and evaporation should be determined.

The elevation of the reservoir depends upon the location of the mines and the extent of the country which it is proposed to supply by means of the ditch. The reservoir should be located below the snow line if possible, and at the lowest point of the catchment area or watershed, in order to obtain the maximum supply of water. The average minimum supply of water from all streams should be carefully determined. The rainfall is often greater in the mountain districts than in the lower countries, and is greatest on the slopes facing the direction from which the moist winds blow. Snow measurements are taken on the level, and a given amount of snow is reduced to an equivalent amount of water, the total year's fall being calculated as rain.

77. Absorption and Evaporation.—The most desirable formation of ground for a reservoir site is one of compact rock, like granite, gneiss, or slate. Porous rocks, like sandstone and limestone, are not so desirable, on account

of the fact that they may absorb water. Steep bare slopes are best, as but little water escapes from them. The greater the slope, the more rapidly will the water flow into the reservoir. The presence of vegetation causes absorption, but at the same time the rainfalls are often greater in regions covered with vegetation, and the streams have a more uniform flow. At the Bowman reservoir in California, 75 per cent. of the total rain and snowfall (reduced to rain) is said to be stored in the reservoir. A reservoir must be made large enough to hold a supply capable of meeting the maximum demand. The area of the reservoir should be determined, and a table made showing its contents for every foot of depth, so that the amount of water available can always be known. Besides the main storage reservoir, all hydraulic mines have distributing reservoirs, which receive the water from the main ditch and deliver it to the claims through the pressure pipes. These auxiliary reservoirs act as safety devices which protect the ditch and flumes from being overflowed, as they are usually capable of holding sufficient water for about a day's run, and if operations should suddenly cease, they could be depended upon to take care of the water until the flow in the main ditch could be stopped.

DAMS.

78. Dams are used for retaining water in reservoirs, for diverting streams, and for storing debris coming from placer mines in cañons and ravines.

79. Foundations.—The foundation for a dam must be solid to prevent settling, and must be water-tight to prevent leakage under the base of the dam and wear in front by water running over the top. Whenever possible, the foundation should be solid rock. Gravel is better than earth, but when gravel is employed, it will be necessary to drive sheet piling under the upper toe of the dam to prevent water from seeping through the formation under the dam. Vegetable soil is unreliable, and all porous matter,

such as sand, gravel, etc., should be stripped off until hard pan or solid rock is reached. In case springs occur in the area covered by the foundation of the dam, it will be necessary to trace them up and confine their flow to the inner or upper side of the dam, so that they will have no tendency to ultimately become passageways for water from the upper face of the dam, which might ultimately wash holes through the foundation and destroy the structure.

WOODEN DAMS.

80. Wooden dams are constructed of round hewn or sawed logs one or two feet in diameter, laid in a series of cribs 8 or 10 feet square. The logs composing the cribs are pinned together by means of treenails, and the individual cribs are attached by the same means, or by bolting. The cribs are usually filled with loose rock to keep them in place, and in many cases are secured to the bed-rock by means of bolts. A layer of plank on the upper face of the dam makes it water-tight.

81. Aprons.—Where water discharges over the top or crest of a dam, it will be necessary to provide some surface to receive the impact of the falling water, for if this is not done the dam may be undermined and thus destroyed. If the dam is on firm bed-rock, the upper surface can simply be extended slightly and the water allowed to fall on the bed-rock, which will not be badly cut; but where there is danger of the foundation being washed away, it will be necessary to provide some form of apron or water cushion. An apron may be formed by providing small cribs, which are set on the lower side of the dam and are covered with a plank floor, on to which the water falls and from which it is discharged into the stream below. Sometimes the plank of the floor is made to pitch back towards the dam in such a manner as to form a tank, into which the water falls, the impact of the fall being taken by the water cushion in the tank. A similar result may be accomplished by building a low dam just

below the main dam, so as to form a small pond between the two, which acts as a water cushion and protects bed-rock or foundation.

82. Abutments and Discharge Gates.— Abutments are the structures at the ends of a dam, and may be constructed from timber, masonry, dry rock-work, or wooden cribs. If possible, abutments should have a curved outline and should be so placed that there is no possibility of the water overflowing them or getting behind them during floods. If the discharge from the dam takes place from the main face, the gates may be arranged in connection with one of the abutments or by means of a tunnel or culvert through the dam. In either case, some structure should be constructed above the outlet so as to prevent drift-wood, brush, or other material from stopping the discharge gates. In Fig. 33 the water is discharged through three pipes which pass through the upper face of the dam and are protected

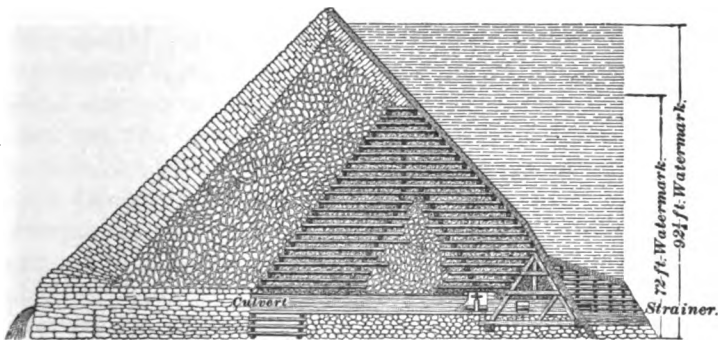

BEDROCK.

FIG. 33.

by a timber, screen, or strainer. Each pipe has a valve in the tunnel or culvert, as shown in the illustration, and these pipes discharge into the wooden flume which conveys the water to the face of the dam, and from here it flows down through a flume to the mine. When the discharge gates are placed at one side of the dam, they are usually arranged outside of the regular abutment, between it and

another special abutment, the discharge being through a series of gates into a flume or ditch.

83. Wasteways.—Wasteways are openings provided in dams for discharging the water during floods or freshets. In the case of timber dams, they are usually surrounded by solid cribs filled with rocks, and the waste-gates each have 40 or 50 square feet of area. There are two general forms for constructing waste-gates. One consists of a comparatively narrow opening in the dam, extending to a considerable depth. Water is allowed to discharge through this during flood-time, but when it is desired to stop the flow, planks are placed over the upper end of the opening in such a manner as to close it. The opening, which is usually not over 3 or 4 feet wide, is provided with guides on the upper face of the dam, between which the planks are slid down, the individual pieces of plank being at least a foot longer than the opening is in width. Another device which is frequently employed consists in providing a spillway to one side of the regular spillway, with a crest 2 or 3 feet lower than the regular crest of the dam. The crest of this spillway is composed of heavy timber. Four or five feet above the crest timber is placed a parallel timber, and the space between these two is closed by what are called flash-boards. These are made from pieces of 2 or 3 inch plank, about 8 or 10 inches wide. The planks are placed against both timbers so as to close the space. The individual planks are made sufficiently long, so that they extend from 1 to 2 feet above the upper timber, and through the upper end of each plank is bored a hole, through which a piece of rope is passed and a knot tied at the end of the rope. These ropes are secured to staples in the upper timber. When it becomes necessary to open the wasteway, men go along with peevies, cant-hooks, or pinch-bars, and pry up the plank in such a way as to draw the lower end out of contact with the lower timber, when the force of the water will immediately carry the plank down the stream as far as the rope will allow it to go. After the first plank has been loosened, the

succeeding ones can be pulled up with comparative ease, and two men can open a 25 or 30 foot section of wasteway in a very few minutes. The ropes keep the plank from being lost, and the space can be closed once more by passing a plank down at one side of the opening and then moving it sideways in the current. Some skill is required both in opening and closing the wasteways.

STONE DAMS.

84. Dry-Stone Dams.—In regions where cement or lime is expensive and large quantities of suitable rubble-stone can be obtained, dams are frequently constructed without the use of mortar. They are rendered water-tight by a plank facing on the upper side of the dam. Fig. 33 illustrates the Bowman dam, constructed as the main dam for the Bowman reservoir in California. There is another dam at this reservoir which is used as the waste dam, and it is supposed that the water will never have to pass over the top of the large dam, but, owing to the fact that there are several other reservoirs farther up the stream and that these may break at some future time, thus flooding the reservoir, the dam had to be constructed so that it would be able to take care of a heavy and sudden rush of water over its top. Originally the dam consisted of unhewn cedar and tamarack logs notched and firmly bolted together, and solidly filled with loose stones of small size. A skin of pine plank was constructed on the water face to form a water-tight lining. This dam was 72 feet high. Subsequently the dam was increased to a height of 100 feet by building a dry-stone structure below the main dam. This is composed mainly of angular stones taken from the mountainside and carefully laid up in irregular range-work so that they break joints. This range-work was faced with quarried stones on both the upper and lower faces. Part of the lower face was made practically vertical, being given a batter of only 15 per cent. for $17\frac{1}{2}$ feet in height. This vertical wall was composed of heavy stones carefully laid and

securely bolted together and to the structure behind them. The face of the dam above was given less inclination, as shown, and was also built of quarried stones laid up dry. The dam was made water-tight by means of a plank facing on the upper side, as shown. Many of the dams in California have been made of dry-stone work, being rendered water-tight by means of a plank facing on the upper surface. If water ever flows over the top of such a dam, a great deal of it is liable to pass through the interstices in the slanting stonework, thus subjecting the lower portion of the structure to considerable hydrostatic pressure. To overcome this, the vertical portion is provided with openings through which this portion of the water would find a ready exit, and, as has been stated, the stones in the vertical portion are securely bolted together and to the rest of the dam.

85. Masonry Dams.—Masonry dams are not much used for placer and hydraulic mining, on account of the fact that the length of time during which the dam will be required is rarely sufficient to warrant an expense sufficient to construct a masonry dam. Masonry dams are usually thinner than those constructed of dry-stone work, and their shape is carefully determined according to known laws, on account of the fact that the cement renders stonework one solid mass, while in the case of dry-stone dams, each individual stone in the face of the dam has to resist being washed away by its weight. In either masonry or dry-stone dams, the stone should not be laid in horizontal courses extending from front to rear.

EARTH DAMS.

86. Earth dams are used for reservoirs of moderate depth. They should be at least 10 feet wide on the top, and a height of more than 60 feet is unusual.

87. Puddle Wall.—Where the material of which the dam is to be constructed is not of itself water-tight, as, for instance, gravel, sand, etc., it is sometimes necessary to construct what is called a puddle wall. This consists of a

narrow dam made of clay mixed with a certain proportion of sand. If the foundation of the dam is open gravel or sand, the puddle wall should be carried to bed-rock or to an impervious stratum. The puddle wall should not be less than 6 or 8 feet thick at the top of the dam, and should be given a slight batter on each side, so that it will be somewhat wider at the base. It is constructed during the building of the dam, and should be protected from direct contact with the water on the upper face by a considerable thickness of earth, for water will slightly dissolve and wash it away. The upper face of an earthen dam is usually protected by means of a plank lining or a pavement of stones.

88. Masonry Core.—Sometimes earth dams are provided with a masonry core, in place of a puddle wall, to render them water-tight. This consists of a masonry wall carried to an impervious strata and up through the center of the dam. This masonry core should not be less than 2 or 3 feet thick at the top, and should be given a batter of at least 10 per cent. on each side.

DEBRIS DAMS.

89. These are dams or obstructions across the beds of streams to hold back the tailings from mines and to prevent damage in the valleys below. They may be made of stone, timber, or brush. The difference between a debris dam and a water dam is that no attempt is made to render the debris dam water-tight, the only object being that it shall retard the flow of the stream and give it a greater breadth of discharge, so that the stream will naturally have to drop or deposit the sediment which it is carrying. This sediment soon silts or fills up against the upper face of the dam, so that the area above the dam soon becomes a flat expanse or plain, over which the water finds its way to the dam. When these dams are constructed of stone, the individual stones in the lower face and crest of the dam should be so large that the current will be unable to displace them, while the upper

face and core of the dam may be composed of finer material. In case a breach or break should occur in a debris dam, it will not necessarily endanger the region farther down the stream, as is the case where a break occurs in a water dam. The reason for this is that the debris dam is not made water-tight, and hence there is never much pressure against it. In case a breach should occur, the only result would be that more or less of the gravel held behind the dam would be washed through the breach and down the stream.

WING-DAMS.

90. For turning streams from their courses, wing-dams are sometimes employed. Wing-dams may extend partly across the stream and then down one bank, forming a course for the stream, or it may simply extend partly across the stream, so as to turn the water into a sluice or flume. In the case of comparatively small streams, wing-dams are usually of a temporary nature, and are constructed of brush or

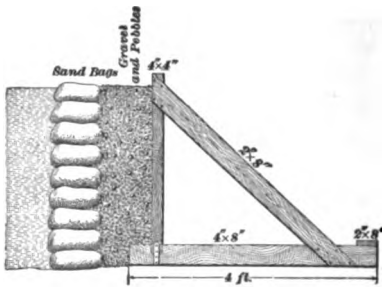

FIG. 34.

constructed of brush or light cribs filled with stones, which are subsequently backed up with earth, stones, or some timber-work. Fig. 34 illustrates one method by means of which wing-dams may be constructed. In this case, bags filled with sand were piled across the course of the stream and backed up with gravel and pebbles. The sand-bags and earth turned the course of the stream, and enabled the operators to construct triangular wooden bents or frames behind the bank, as shown in the illustration. These frames were subsequently weighted down with stones and their lower face covered with a riprap of drift boulders, etc., so that in case the water ever came over the dam, it would not wash it away and destroy the work.

MEASUREMENT OF FLOW OF WATER.

91. Various forms of meters are used for this purpose. Some of them are so devised that they measure the actual quantity of water flowing through the weir; others simply give the velocity of the current, and from this and the size of the channel through which the water flows, the quantity is determined.

92. Gauging by Right-Angled V Notch.—A right-angled V notch, cut from thin sheet iron, is frequently used for gauging comparatively small flows. The notch is fitted in one end of a box, as shown in Fig. 35. The edge of the plate forming the notch must be sharp, and the bevel must be on the lower side of the plate, the inside face being at right angles to the surface of the still water. To prevent

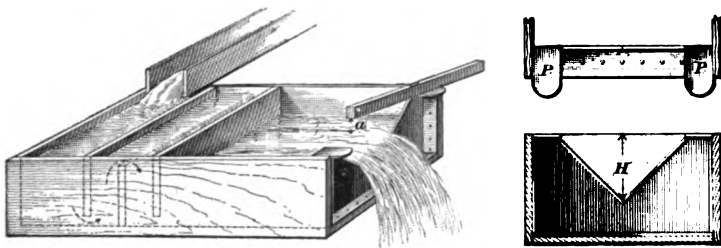

FIG. 35.

surface currents in the box, baffle boards are placed some distance back, as shown in the illustration. The distance a of the surface of the water below the top of the weir and below the top of the box is taken at a point some distance back from the notch (at least 18 to 24 inches), where the water surface is level. This distance subtracted from the total depth H of the notch gives the head h of water passing over the notch. This head may be obtained as follows: A straight-edge or level is placed on the weir plate P , so as to extend back over the surface of the water in the box. The distance a between its lower edge and the surface of the water is measured. This distance subtracted from H

TABLE I.

DISCHARGE OF WATER THROUGH A RIGHT-ANGLED V NOTCH.

# Head, Inches.	Quant. per Min., Cu. Ft.	# Head, Inches.	Quant. per Min., Cu. Ft.	# Head, Inches.	Quant. per Min., Cu. Ft.	# Head, Inches.	Quant. per Min., Cu. Ft.	# Head, Inches.	Quant. per Min., Cu. Ft.
1.05	0.3457	3.25	5.827	5.45	21.22	7.65	49.53	9.85	93.13
1.10	0.3884	3.30	6.054	5.50	21.71	7.70	50.34	9.90	94.37
1.15	0.4340	3.35	6.285	5.55	22.20	7.75	51.16	9.95	95.56
1.20	0.4827	3.40	6.523	5.60	22.70	7.80	51.99	10.00	96.77
1.25	0.5345	3.45	6.765	5.65	23.22	7.85	52.83	10.05	97.98
1.30	0.5896	3.50	7.012	5.70	23.74	7.90	53.67	10.10	99.20
1.35	0.6480	3.55	7.266	5.75	24.26	7.95	54.53	10.15	100.43
1.40	0.7096	3.60	7.524	5.80	24.79	8.00	55.39	10.20	101.67
1.45	0.7747	3.65	7.788	5.85	25.33	8.05	56.26	10.25	102.92
1.50	0.8432	3.70	8.058	5.90	25.87	8.10	57.14	10.30	104.18
1.55	0.9153	3.75	8.332	5.95	26.42	8.15	58.03	10.35	105.45
1.60	0.9909	3.80	8.613	6.00	26.98	8.20	58.92	10.40	106.73
1.65	1.0700	3.85	8.899	6.05	27.55	8.25	59.82	10.45	108.02
1.70	1.1530	3.90	9.191	6.10	28.12	8.30	60.73	10.50	109.31
1.75	1.2400	3.95	9.489	6.15	28.70	8.35	61.65	10.55	110.62
1.80	1.3300	4.00	9.792	6.20	29.28	8.40	62.58	10.60	111.94
1.85	1.4240	4.05	10.100	6.25	29.88	8.45	63.51	10.65	113.26
1.90	1.5220	4.10	10.410	6.30	30.48	8.50	64.45	10.70	114.60
1.95	1.6250	4.15	10.730	6.35	31.09	8.55	65.41	10.75	115.94
2.00	1.7310	4.20	11.060	6.40	31.71	8.60	66.37	10.80	117.29
2.05	1.8410	4.25	11.390	6.45	32.33	8.65	67.34	10.85	118.65
2.10	1.9550	4.30	11.730	6.50	32.96	8.70	68.32	10.90	120.02
2.15	2.0740	4.35	12.070	6.55	33.60	8.75	69.30	10.95	121.41
2.20	2.1960	4.40	12.420	6.60	34.24	8.80	70.30	11.00	122.81
2.25	2.3230	4.45	12.780	6.65	34.89	8.85	71.30	11.05	124.21
2.30	2.4550	4.50	13.140	6.70	35.56	8.90	72.31	11.10	125.61
2.35	2.5900	4.55	13.510	6.75	36.23	8.95	73.33	11.15	127.03
2.40	2.7300	4.60	13.890	6.80	36.89	9.00	74.36	11.20	128.45
2.45	2.8750	4.65	14.270	6.85	37.58	9.05	75.40	11.25	129.90
2.50	3.0240	4.70	14.650	6.90	38.27	9.10	76.44	11.30	131.35
2.55	3.1770	4.75	15.040	6.95	38.96	9.15	77.49	11.35	132.81
2.60	3.3350	4.80	15.440	7.00	39.67	9.20	78.55	11.40	134.27
2.65	3.4980	4.85	15.850	7.05	40.38	9.25	79.63	11.45	135.75
2.70	3.6660	4.90	16.260	7.10	41.10	9.30	80.71	11.50	137.23
2.75	3.8380	4.95	16.680	7.15	41.83	9.35	81.80	11.55	138.73
2.80	4.0140	5.00	17.110	7.20	42.56	9.40	82.90	11.60	140.23
2.85	4.1960	5.05	17.540	7.25	43.30	9.45	84.01	11.65	141.75
2.90	4.3820	5.10	17.970	7.30	44.06	9.50	85.12	11.70	143.28
2.95	4.5740	5.15	18.420	7.35	44.82	9.55	86.24	11.75	144.82
3.00	4.7700	5.20	18.870	7.40	45.58	9.60	87.37	11.80	146.36
3.05	4.9710	5.25	19.320	7.45	46.36	9.65	88.52	11.85	147.91
3.10	5.1780	5.30	19.790	7.50	47.14	9.70	89.67	11.90	149.48
3.15	5.3880	5.35	20.260	7.55	47.92	9.75	90.83	11.95	151.05
3.20	5.6050	5.40	20.730	7.60	48.72	9.80	92.00	12.00	152.64

1 cubic foot contains 7.48 U. S. gallons; 1 U. S. gallon weighs 8.34 pounds.

leaves h , which is the depth or head of water in the notch. This head may also be obtained by measurements from the bottom of the box, in which case the height of the bottom of the notch above the bottom of the box will be subtracted from the depth of water in the box. This depth may be obtained by measuring with a rule or scale which extends to the bottom, or by means of a hook gauge, as explained later.

The discharge in cubic feet per second is equal to 0.0051 times the square root of the fifth power of the head expressed in inches. Table I gives the discharge in cubic feet per minute through the right-angled V notch for heads h varying from 1.05 inches up to 12 inches.

WEIRS.

93. A weir is an obstruction placed across a stream for the purpose of diverting the water so as to make it flow through the desired channel. This channel may be a notch or opening in the obstruction itself, and it has been found that when properly constructed and carefully managed, such a weir forms one of the most convenient and accurate devices for measuring the discharge of streams. Many careful experiments have been made to determine the quantity of water that will flow over different forms of weirs under various conditions. As the result of these experiments, two forms have come into general use, and the amount of flow over either can be determined by simple formulas and coefficients that depend upon observed conditions.

94. A Weir With End Contractions.—Such a weir is shown in Fig. 36 (a). The notch is narrower than the channel through which the water flows, thus causing a contraction at the bottom and two sides of the issuing stream.

95. A Weir Without End Contractions.—This is also called a weir with end contraction suppressed, and is shown in Fig. 36 (b). In this case, the notch is the full width

of the channel leading to it, and consequently the stream issuing is contracted at the bottom only.

96. Crest of the Weir.—The edge *a*, Fig. 36 (*c*) and Fig. 36 (*d*), is called the crest of the weir. The inner edge of the crest should be made sharp, so that the water in passing over it touches only a sharp edge. For very accurate work, both vertical and horizontal, edges should be made

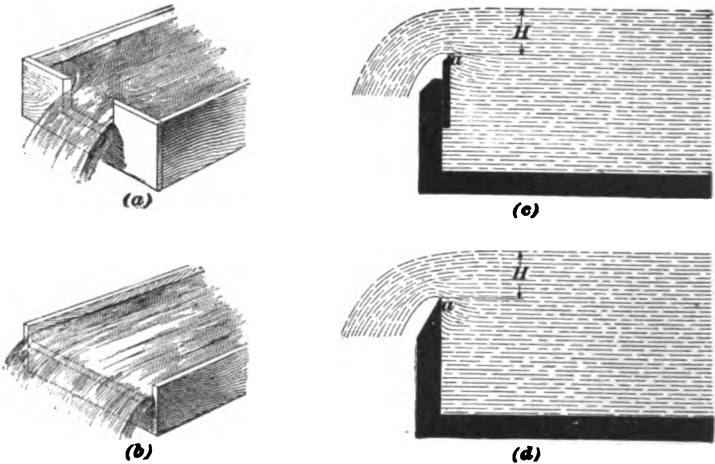

FIG. 36.

from thin plates of metal having a sharp inner edge, as shown at (*a*), Fig. 36 (*c*), but for ordinary work the edges of the board in which the notch is cut may chamfer off, as shown in (*b*). Frequently this edge is not made absolutely sharp, but is left flat for about $\frac{1}{8}$ inch, so as to increase the strength of the edge and to decrease the liability of its being damaged. The bottom edge of the notch must be straight and set perfectly level; the sides must be at right angles to the bottom. The inside or upper edges of the notch must always be in a plane at right angles to the surface of still water. The head *H* producing the flow is the vertical distance from the crest of the weir to the surface of the water, as shown in Fig. 36 (*c*) and Fig. 36 (*d*). This head must be measured at a point sufficiently back from the crest so that

the surface of the water is not affected by the curvature of the stream flowing over the weir.

97. The distance from the crest of the weir to the bottom of the feeding canal, flume, or reservoir should be at least three times the head, and with a weir having end contractions, the distances from the vertical ends or edges to the sides of the canal should each be at least three times the head also.

98. The water must approach the weir with little or no velocity. To accomplish this, it is sometimes necessary to provide means for reducing the velocity of approach, such as baffle boards similar to those used in connection with the V notch.

99. Fig. 37 shows a simple form of weir located in a small stream for the purpose of measuring the discharge.



FIG. 37.

A plank dam is put across the stream at a convenient point, care being taken to prevent any leakage around or under the dam. The length of the notch is great enough to

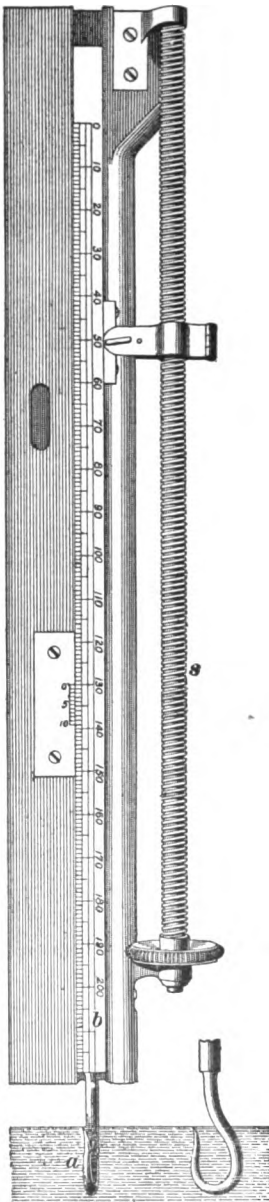

FIG. 38.

provide for a flow having a head of from 0.5 to 1.5 feet, but at the same time the length of the crest for accurate work should never be less than three or four times the head. If it is desired to measure smaller amounts of water, the V notch can be used. A stake *E* is driven firmly into the ground at a point about 6 feet up-stream from the weir and near the bank, as shown. The stake is driven down until its top is exactly level with the top of the weir. The head is the vertical distance from the top of this stake to the surface of the water, and it may be measured by means of a 2-foot rule or a square, as shown in the illustration. For very accurate work, the hook gauge is used.

HOOK GAUGE.

100. For accurate measurements, such as are made when testing the efficiency of water-wheels, the head is measured with an instrument called the hook gauge, shown in Fig. 38. A hook *a* is attached to the lower end of a sliding scale *b*; the scale is graduated to hundredths of a foot, and is provided with a vernier, by means of which readings can be made to thousandths of a foot. The scale and the hook can be raised or lowered by means of a screw *s*. The instrument is fastened securely

to some substantial structure at a point a few feet up-stream from the weir, and where the surface of the water is quiet and protected from the influence of winds or eddies. The hook is so set that the gauge will read to zero when the point of the hook is at the same level as the crest of the weir. When the point of the hook is raised to the surface of the water, it lifts the surface slightly before breaking through. To use the gauge, start with the hook slightly below the surface of the water and raise it slowly until a slight pimple, caused by the lifting of the surface, appears over the point of the hook. The reading of the scale for this position of the hook gives the head of water.

DISCHARGE OF WEIRS.

101. When the dimensions of the notch and the head on the crest of a weir are known, the discharge can be computed by means of the following formulas and tables of coefficients:

- Let l = length of the weir in feet;
- H = measured head in feet;
- v = velocity with which the water approaches the weir in feet per second;
- h = head equivalent to the velocity with which the water approaches the weir, or a head which would produce a velocity equal to v ;
- c = coefficient of discharge;
- Q = actual discharge in cubic feet.

The actual discharge for weirs with end contractions is given by the formulas:

$$Q = 5.347 c l (H + \frac{1}{3} h)^{\frac{3}{2}}, \quad (1.)$$

which is used where the water approaches the weir with a velocity equivalent to the height h , and

$$Q = 5.347 c l H^{\frac{3}{2}}, \quad (2.)$$

where the water has no velocity of approach.

The actual discharge for weirs without end contractions is given by the following formulas:

$$Q = 5.347 c l (H + 1.4 h)^{\frac{3}{2}}, \quad (3.)$$

which applies in cases where the water has a velocity of approach, and

$$Q = 5.347 c l H^{\frac{3}{2}}, \quad (4.)$$

which applies where the water has no velocity of approach.

102. Velocity of Approach.—By this term is meant the velocity with which the water flows through the canal leading to the weir. This may be obtained by finding, approximately, the amount of water discharged in a given time and the area of the cross-section of the canal leading to the weir. Then the velocity of approach will be equal to the given amount of water divided by the area; or, if

A = the area of the cross-section of the canal in sq. ft.,

v = the velocity of approach in ft. per sec.,

Q = the quantity of water in cu. ft.

we have
$$v = \frac{Q}{A}.$$

Q may be obtained approximately by assuming that v is equal to zero and applying the formula for the class of weir in question, as given above. Having obtained this quantity Q and from it the value of v , the equivalent head h may be found by the formula

$$h = 0.01555 v^2. \quad (5.)$$

Since v is small with a properly constructed weir, it is usually neglected unless great accuracy is required.

103. Table II gives the values of the coefficients of discharge c for weirs with end contractions and different values of H and l . In this table the head given is the effective head $H + \frac{1}{3} h$. When the velocity of approach is small, h is neglected and the head becomes simply H , but this change will not affect the coefficients in the table.

TABLE II.

VALUES OF THE COEFFICIENT OF DISCHARGE FOR WEIRS WITH END CONTRACTIONS.

Effective Head in Feet.	Length of Weir in Feet.						
	0.66	1	2	3	5	10	19
0.10	0.632	0.639	0.646	0.652	0.653	0.655	0.656
0.15	0.619	0.625	0.634	0.638	0.640	0.641	0.642
0.20	0.611	0.618	0.626	0.630	0.631	0.633	0.634
0.25	0.605	0.612	0.621	0.624	0.626	0.628	0.629
0.30	0.601	0.608	0.616	0.619	0.621	0.624	0.625
0.40	0.595	0.601	0.609	0.613	0.615	0.618	0.620
0.50	0.590	0.596	0.605	0.608	0.611	0.615	0.617
0.60	0.587	0.593	0.601	0.605	0.608	0.613	0.615
0.70		0.590	0.598	0.603	0.606	0.612	0.614
0.80			0.595	0.600	0.604	0.611	0.613
0.90			0.592	0.598	0.603	0.609	0.612
1.00			0.590	0.595	0.601	0.608	0.611
1.20			0.585	0.591	0.597	0.605	0.610
1.40			0.580	0.587	0.594	0.602	0.609
1.60				0.582	0.591	0.600	0.607

104. Table III gives the values of c for weirs without end contractions. Weirs with end contractions are more often used and are to be recommended in most cases. Values of c corresponding to values of H and l between those given in the tables can be found by interpolating or taking an average between the desired figures, assuming that the variation is uniform between the values given. In Table III the head given is the effective head $H + \frac{1}{3}h$, which, when h is neglected, becomes simply H . This does not affect the value of the coefficient in the table.

TABLE III.

VALUES OF THE COEFFICIENT OF DISCHARGE FOR
WEIRS WITHOUT END CONTRACTIONS.

Effective Head in Feet.	Length of Weir in Feet.						
	19	10	7	5	4	3	2
0.10	0.657	0.658	0.658	0.659			
0.15	0.643	0.644	0.645	0.645	0.647	0.649	0.652
0.20	0.635	0.637	0.637	0.638	0.641	0.642	0.645
0.25	0.630	0.632	0.633	0.634	0.636	0.638	0.641
0.30	0.626	0.628	0.629	0.631	0.633	0.636	0.639
0.40	0.621	0.623	0.625	0.628	0.630	0.633	0.636
0.50	0.619	0.621	0.624	0.627	0.630	0.633	0.637
0.60	0.618	0.620	0.623	0.627	0.630	0.634	0.638
0.70	0.618	0.620	0.624	0.628	0.631	0.635	0.640
0.80	0.618	0.621	0.625	0.629	0.633	0.637	0.643
0.90	0.619	0.622	0.627	0.631	0.635	0.639	0.645
1.00	0.619	0.624	0.628	0.633	0.637	0.641	0.648
1.20	0.620	0.626	0.632	0.636	0.641	0.646	
1.40	0.622	0.629	0.634	0.640	0.644		
1.60	0.623	0.631	0.637	0.642	0.647		

105. The tables and formulas thus far given require the measurements to be taken in hundredths of a foot. Frequently operators are not provided with apparatus for accomplishing this, and hence Table IV is given, which gives the cubic feet of water per minute for every inch in length of the weir corresponding to the depths given in the table, the table giving the depths by eighths of an inch from 1 inch to 25 inches. This table is not accurate for weirs whose depths are great compared with their lengths, and should not be used unless the length of the crest of the weir is at least three or four times the depth of the water on the weir.

TABLE IV.

WEIR TABLE GIVING CUBIC FEET DISCHARGED PER MINUTE FOR EACH INCH IN LENGTH OF WEIR FOR DEPTHS FROM 1-8 INCH TO 25 INCHES.

Inches.	1	2	3	4	5	6	7	8
		0.01	0.05	0.09	0.14	0.20	0.26	0.33
1	0.40	0.47	0.55	0.65	0.74	0.83	0.93	1.03
2	1.14	1.24	1.36	1.47	1.59	1.71	1.83	1.96
3	2.09	2.23	2.36	2.50	2.63	2.78	2.92	3.07
4	3.22	3.37	3.52	3.68	3.83	3.99	4.16	4.32
5	4.50	4.67	4.84	5.01	5.18	5.36	5.54	5.72
6	5.90	6.09	6.28	6.47	6.65	6.85	7.05	7.25
7	7.44	7.64	7.84	8.05	8.25	8.45	8.66	8.86
8	9.10	9.31	9.52	9.74	9.96	10.18	10.40	10.62
9	10.86	11.08	11.31	11.54	11.77	12.00	12.23	12.47
10	12.71	13.95	13.19	13.43	13.67	13.93	14.16	14.42
11	14.67	14.92	15.18	15.43	15.67	15.96	16.20	16.46
12	16.73	16.99	17.26	17.52	17.78	18.05	18.32	18.58
13	18.87	19.14	19.42	19.69	19.97	20.24	20.52	20.80
14	21.09	21.37	21.65	21.94	22.22	22.51	22.79	23.08
15	23.38	23.67	23.97	24.26	24.56	24.86	25.16	25.46
16	25.76	26.06	26.36	26.66	26.97	27.27	27.58	27.89
17	28.20	28.51	28.82	29.14	29.45	29.76	30.08	30.39
18	30.70	31.02	31.34	31.66	31.98	32.31	32.63	32.96
19	33.29	33.61	33.94	34.27	34.60	34.94	35.27	35.60
20	35.94	36.27	36.60	36.94	37.28	37.62	37.96	38.31
21	38.65	39.00	39.34	39.69	40.04	40.39	40.73	41.09
22	41.43	41.78	42.13	42.49	42.84	43.20	43.56	43.92
23	44.28	44.64	45.00	45.38	45.71	46.08	46.43	46.81
24	47.18	47.55	47.91	48.28	48.65	49.02	49.39	49.76

106. As an illustration of the use of Table IV, suppose that we had a weir 5 feet in length and that the water

upon it stood at a depth of $10\frac{5}{8}$ inches. Then the amount of water passing for each inch of length of the weir would be found by noting the figure 10 in the left-hand column of the table and passing along this horizontal line until the value under $\frac{5}{8}$ was obtained, which would be found to be 13.93 cubic feet per minute, and as the weir was 60 inches long, the total amount passing per minute will be $13.93 \times 60 = 835.8$ cubic feet per minute.

107. The following examples are given to illustrate the use of the formulas and tables:

EXAMPLE 1.—What is the discharge of the stream in Fig. 37 if the length of the weir is 5 feet, the head $10\frac{1}{4}$ inches, the coefficient of discharge .603, and the velocity of approach 0?

SOLUTION.—Applying formula 2, we have

$$Q = .603 \times 5.347 \times 5 \times .875^{\frac{3}{2}} = 13.1984 \text{ cu. ft. per second. Ans.}$$

EXAMPLE 2.—What is the discharge from a weir with end contractions under the following conditions: The length of the weir is 4 feet $1\frac{1}{4}$ inches and the measured head $10\frac{1}{8}$ inches. Assume that there is no velocity of approach.

SOLUTION.—The length l of the weir = 4 feet $1\frac{1}{4}$ inches = 4.125 feet, and the head $H = 10\frac{1}{8}$ inches = .84 foot. From Table II we find the coefficient $c = .600$ for a weir 3 feet long and a head of .8 foot and $c = .604$ for a weir 5 feet long with the same head. This is an increase in the coefficient of $(.604 - .600) \div 2 = .002$ for each increase of 1 foot in length. The coefficient for a weir 4.125 feet long is, therefore, $.600 + (1.125 \times .002) = .60225$. The rate of increase for a head of .9 foot is $(.603 - .598) \div 2 = .0025$, and the coefficient for a weir 4.125 feet long is $.598 + (1.125 \times .0025) = .60081$. The decrease in the coefficient for an increase in head of .1 foot is $.60225 - .60081 = .00144$, and for an increase in head of .04 foot the decrease is $.00144 \times \frac{.04}{.1} = .000576$. This subtracted from the coefficient for .8 foot gives $.60225 - .000576 = .601674$ as the coefficient of discharge for a weir 4.125 feet long and a head of .84 foot. Using but four decimal places, the discharge by formula 2 is

$$Q = 5.347 \times .6017 \times 4.125 \times .84^{\frac{3}{2}} = 10.22 \text{ cu. ft. per second. Ans.}$$

EXAMPLE 3.—If the canal leading to the above weir is 10 feet wide and 3 feet deep below the crest of the weir, what is the head equivalent to the velocity of approach?

SOLUTION.—The depth of water in the canal is the depth below the crest plus the head = 3.84 feet. The area of the cross-section of the water in the canal is $A = 3.84 \times 10 = 38.4$ square feet, and the velocity is $v = \frac{10.22}{38.4} = .266$ foot per second. The head h equivalent to the velocity v is, according to formula 5,

$$h = .01555 \times .266^2 = .0011 \text{ foot. Ans.}$$

NOTE.—This value of h is so small that its influence on the discharge is much less than the probable errors in measuring the head H , and so need not be considered in finding the discharge.

MINER'S INCH.

108. The miner's inch varies in different districts and is by no means a definite quantity of water, as the methods of deriving it vary in different places. Merriman states that the miner's inch may be roughly defined as the quantity of water which will flow from a vertical standard orifice 1 inch square when the head on the center of the orifice is $6\frac{1}{2}$ inches, and determines this amount of water to be equal to 1.53 cubic feet per minute, and states that the mean value of the miner's inch may, therefore, be taken at 1.5 cubic feet per minute. Bowie states that in different counties in California the value of the miner's inch varies from 1.20 to 1.76 cubic feet per minute. The reason for these variations is mainly due to the fact that when water is bought in large quantities, it is discharged through large areas; thus, at Smartsville a vertical orifice or opening 4 inches deep and 250 inches long, with a head of 7 inches above the top edge, is said to furnish 1,000 miner's inches. At Columbia Hill an opening 12 inches deep and $12\frac{3}{4}$ inches wide, with a head of 6 inches above the upper edge, is said to furnish 200 miner's inches. In Montana the common method of measurement was formerly through a vertical rectangle 1 inch high, with the head on the center of the orifice 4 inches. The number of miner's inches was said to be the same as the number of linear inches in the rectangle; thus, under the given head an orifice 1 inch deep and 60 inches long would be 60 miner's inches.

109. The State Legislature of Montana has now passed a law defining the miner's inch as a certain amount of water flowing per second regardless of the pressure or size of the opening through which it passes. The statement is as follows:

“Where water rights expressed in miner's inches have been granted, 100 miner's inches shall be considered equivalent to a flow of $2\frac{1}{2}$ cubic feet (18.7 gallons) per second; 200 miner's inches shall be considered equivalent to a flow of 5 cubic feet (37.4 gallons) per second, and this proportion shall be observed in determining the equivalent flow represented by any number of miner's inches.”

110. If this amount be reduced to cubic feet per minute, it will be found to be equal to a flow of 1.5 cubic feet per minute as the equivalent of the miner's inch, which is the value given by Merriman. In some states, or some portions of states, the miner's inch is defined as the amount of water which will flow through a certain sized opening, the thickness of the plank and the character of the faces comprising the opening being mentioned in some cases; but no two of these definitions seem to agree. In some counties in California what are known as 24-hour, 12-hour, 11-hour, or 10-hour inches are in use, and represent the amounts of water which would flow through a given opening in these lengths of time. For convenience in converting cubic feet into gallons, it may be stated that a cubic foot is equal to 7.48 U. S. gallons.

DITCHES AND FLUMES.

111. Thousands of miles of ditches have been made in placer-mining districts for carrying water from reservoirs to locations where it was to be employed. On account of the rocky character of the country in such districts, steep grades are necessary, and high trestles with flumes and wrought-iron or wooden pipe are frequently built for carrying the water across cañons or ravines.

112. For the construction of ditches, Bowie recommends the observance of the following rules:

1. The source of supply should be at a sufficient elevation to cover the greatest range of mining ground at the smallest expense, great hydrostatic pressure being always desirable.

2. An abundant and permanent supply of water during the summer months should be secured.

3. The snow-line, when possible, should be avoided, and the ditch, especially in snow regions, should be located so as to have a southern exposure.

4. All watercourses occurring on the line of the ditch should be secured. Their supply partially counteracts the loss by evaporation, leakage, and absorption, and frequently furnishes an additional quantity of water during several months of the year.

5. At proper intervals waste-gates should be arranged so as to discharge the water when necessary, without risk of damage to the ditch. In regions of heavy snow, these wasteways should be provided at intervals not greater than one-half a mile.

6. Ditches, when practicable and the cost not excessive, should be preferred to flumes.

DITCHES.

113. Surveying a Ditch Line.—A preliminary examination of a ditch line can be made by means of carefully compared aneroid barometers. By this means, the elevations, not only of the termini, but of any intermediate points, can be approximately determined. Subsequently surveying parties may be started from these various points for the approximate location of the line.

114. After the survey line has been carried through and the various necessary points are established, the line is constructed and the leveling done. In leveling, all turning-points should be made on grade, if possible. The stations

should be properly numbered and staked and pegs driven to grade. Bench-marks should be placed every one-fourth or one-half mile for convenient reference. The bench-marks should be to one side of the regular ditch line, so that they will not be disturbed during subsequent work.

All details of tunnels, cuts, and depressions requiring fluming or piping should be worked out in full. In this work the hand level can often be employed with advantage for filling any minor details. Complete notes should be made of the character of the ground along the center line, and also of any possible changes.

115. The size of the ditch is regulated by its requirements. Its form will be modified often by circumstances, according to the judgment of the engineer. The smallest section for any given discharge is when the hydraulic depth is one-half of the actual depth. The hydraulic depth is the quotient obtained by dividing the area of the cross-section of the stream at any point by the wet perimeter at that point, the wet perimeter being that portion of the outline of the cross-section which comes in contact with the bottom of the ditch below the surface of the water. Trapezoidal and rectangular forms are adopted for ditches and flumes, respectively. The resistance due to formation in the latter form is the smallest when the width is twice the height. Half of a regular hexagon is a common form for ditches. In a mountainous country with a rocky soil, narrow and deep ditches with steep grades are adopted in preference to wider ditches with gentler slopes, as they are cheaper to excavate and to keep in repair, ditches with grades of from 16 to 20 feet per mile being quite common in mountainous regions. Before commencing work, the ditch line must be cleared of trees and brush. Where flumes are to be constructed, the brush for at least 10 feet on each side is burned off. On a hillside the line should be graded so that the ditch may have walls of solid untouched ground, and not mud banks. The banks should be at least 3 feet wide on top. In mountain regions where the material excavated is of a comparatively firm nature, the

upper side of the ditch in hillside work is frequently given an angle of 60° and the lower bank an angle of 50° . This varies with the nature of the ground. Contracts for the digging of ditches are either let out so much per unit of length or at so much per cubic yard. The material excavated from the ditch is piled on the lower side and ultimately consolidates into firm ground, thus raising the height of the sides of the ditch and increasing its capacity. If ditches are not so steep as to scour or erode their bottoms, they will ultimately become lined with a scum or silt of fine clay which closes up the pores and openings in the soil, thus stopping leakage and increasing the carrying capacity of the ditch. Bowie states that the annual cost of running and maintaining ditches in California averages \$400 per mile. A number of the large California ditches cost nearly half a million dollars each, and many of them are more than 50 miles in length.

116. Fig. 39 illustrates a cross-section of the North Bloomfield ditch in California. The dimensions of this ditch, as will be seen, were 5 feet in width at the bottom, 8.6 feet at the top, and $3\frac{1}{2}$ feet in depth, with the upper side at an angle of 65° and the lower side at 60° .

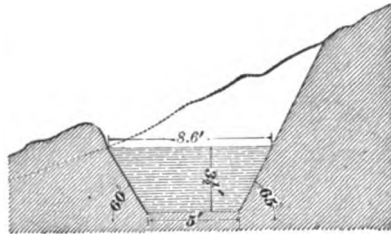

FIG. 39.

FLUMES.

117. In general the use of flumes is to be avoided wherever possible, for long experience has demonstrated that they are not economical, being too liable to destruction by fire, wind, and snow-storms, or by decay; hence they are a source of continual expense.

118. Flumes vs. Ditches. — There are instances where the formation of the country requires the use of flumes rather than ditches. For example, in cases where the water must be carried along the face of vertical cliffs;

there are also certain conditions of ground, independent of topography, where a ditch can not be employed so economically as a flume; for instance, when the ground is composed either of very hard or of porous and broken material. Likewise, where the water is scarce and evaporation and absorption are great, flumes must necessarily be preferred. In such cases as these, either flumes or pipes may be advantageously used.

119. Grade.—Flumes are usually set on a steeper grade than is possible for ditches, the grade frequently being as much as from 25 to 30 feet to the mile. This results in an increase in the velocity of the flow, and hence a proportional decrease in the cross-section of the flume.

120. Construction of Flumes.—Flumes are usually constructed of seasoned pine plank from $1\frac{1}{2}$ to 2 inches thick, from 12 to 24 inches wide, and from 12 to 16 feet long. The edge joints are battened on the inside with pine strips from 3 to 4 inches wide and $\frac{1}{2}$ inch thick. The structure is reinforced every 4 feet by a frame consisting of a sill, a cap, and two posts. A flume 4 feet wide by 3 feet deep requires $4' \times 5'$ posts and caps, $4' \times 6'$ sills, and $8' \times 10'$ stringers. Posts are set into the sills with the gain $1\frac{1}{2}$ inches deep and are not mortised.

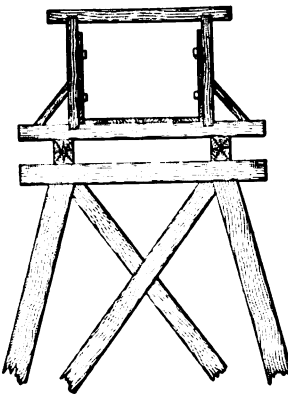

FIG. 40.

The sills are allowed to extend from 12 to 20 inches beyond the posts, and diagonal braces are usually introduced, as illustrated in Fig. 40, which shows a cross-section of a flume and trestle. The posts are usually made of sufficient length so that there is a space of 3 or 4 inches between the top of the side planking and the cap. In carrying a flume along a hillside, the bed should be graded out and the flume placed in close to the bank, so as to avoid danger from snowslides, etc. The ground is first

graded and the stringers laid in place. The sills are subsequently laid on this and the flume constructed. The stringers prevent the sills from coming in contact with the earth, and thus protect them from rotting. Another advantage of having a flume close to the bank is that in cold weather the snow usually stops up the space at the sides of the flume, thus preventing the circulation of air under it, and its subsequent chilling effect.

121. Curves.—Curves should be laid with care to insure the maximum flow of water and to prevent splashing, as where splashing takes place excessive freezing is liable to occur in cold weather. The box must be cut into two, three, or four parts, necessitating more sills, posts, and caps. For good curving, the side planks are sawed partly through in places so as to make them bend easily. Where the water passes around the curve, it has a tendency to rise on the outer side of the curve, and hence the flume must be blocked up on this side. This is usually accomplished by judging the amount of inclination first and changing it after the water is running by wedging the flume up until all splashing ceases.

122. Bed and Joints.—In constructing a flume, the bed is carefully prepared, the stringers are laid, and the sills placed upon them proper distances apart; the bottom planks are then nailed to the sills, the end joints being carefully fitted. The side planks are nailed to the bottom plank and the posts set in gains in the sills, an occasional cap being placed on the posts to hold the flume in shape. Sixteen-penny and twentypenny nails are used for fastening the material together. The joints are battened with thin material nailed on with sixpenny nails. Each box when complete is set on grade and wedged into place.

123. Connection with Ditch.—Where a flume connects with a ditch, the posts for a distance of several boxes back are lengthened to permit the introduction of an additional plank on each side. The end boxes of the flume are flared to permit a free entrance and discharge of the water. At the junction of the flume with the ditch, or where a flume

passes through the bank of earth, an outer siding may be nailed on the outside of the post to protect the flume. The lumber should be prepared in exact sizes at the mill, so that rapid work can be done in the construction. The lumber is usually delivered at the head of the flume and enough water turned in to float the material down as the work progresses. Where trestles are employed, the supports are usually placed from 8 to 12 feet apart. The life of a flume will usually not exceed 20 years at most, and is generally little more than 10 years.

124. Waste-Gates.—Waste-gates should be placed every half mile to empty the flume for repairs or in case of accidents. Waste-gates are also useful in running snow out of the flume. In snow belts, flumes are frequently covered with sheds in exposed places to protect them from snowslides. If anchor ice freezes on the bottom of a flume, the water should be immediately turned out. If snow fills the flume when no water is running through it, it may be gotten rid of by turning on the water and flushing it out before it has time to pack.



FIG. 41.

125. Bracket Flumes.—When it becomes necessary to carry a flume along the face of a cliff at such an elevation that a trestle is practically out of the question, brackets

may be employed. Fig. 41 illustrates a bracket flume which was employed in Butte County, California. The cliff is a perpendicular wall of basalt, and for a distance of 500 feet the flume is carried on brackets 118 feet above the bed of the ravine, and at one point 232 feet below the top of the cliff. The brackets are made of 30-pound **T** rails bent in the shape of an **L**; the longer arm (10 feet long), on which the bed of the flume rests, is placed horizontally, having the end next the cliff supported in a hole drilled in the rock. The short arm stands vertically, and has in its upper end an eye into which is hooked one end of a $\frac{3}{4}$ -inch round iron rod connecting with a ring-bolt soldered into a hole in the cliff above. The brackets were set 8 feet apart, and were tested to stand a weight of $14\frac{1}{2}$ tons. The flume is 4 feet wide and 3 feet deep, with a capacity of 3,000 miner's inches.

PIPES.

126. Wooden Pipes.—For moderate heads, wooden-stave pipes are commonly used. They are practicable for any desired head, but are only economical to the point where the pressure necessitates such close banding that the cost exceeds that of iron or steel pipe of the same strength. If kept full of water, the stave pipe will last indefinitely, and the bands may be protected from rust by a coating of asphaltum or mineral paint. The amount of iron in the bands for each foot of pipe is the same as that required for a foot of sheet-iron pipe of the same diameter calculated to withstand the same head or pressure with a considerable margin of safety. Fig. 42 illustrates a wooden-stave pipe in which the bands are composed of round steel rods. One advantage of a wooden-stave pipe is that it can be made to conform to the irregularities of the ground more easily than is the case with an iron pipe.

127. Wooden Lining for Tunnels.—On some extensive ditch lines it has become necessary to carry water through tunnels, and owing to the fact that the irregular rock lining of the tunnel interfered considerably with the

flow of the water, it has been found best to line the tunnels with timber. This has been done by building a wooden

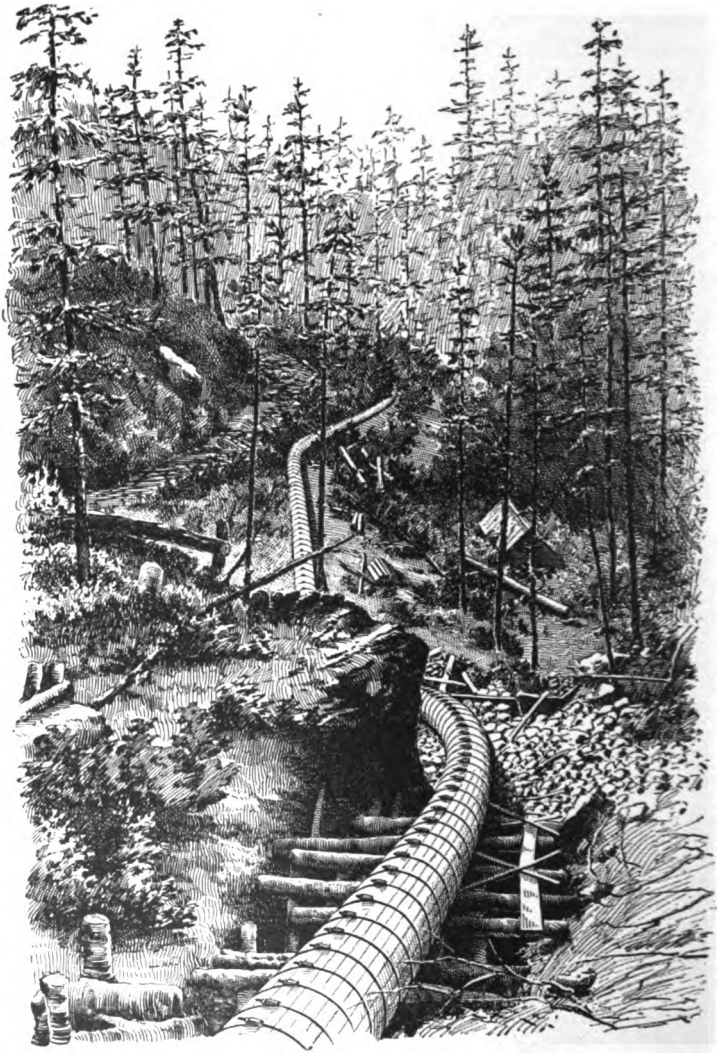

FIG. 42.

pipe inside the tunnel, the pipe being backed with cement and no bands being employed. In fact, it becomes simply

a wooden lining for the tunnel. Where such linings are employed, the tunnels are sometimes driven below the water-level of the ditch, so that they really become inverted siphons, and in case the water should be turned off in the ditch, the tunnel would always be filled, and hence there would be no tendency for the lining to dry out and crack. Such a lining always remaining under the water will last indefinitely.

128. Iron Pipes.—Wrought-iron or steel pipes are exclusively used for high heads. For low heads, either wood or iron may be employed, the choice between them being a matter of location and cost. Pipes are used as water conduits for replacing ditches or flumes, as the supply or feed pipes passing water from the pressure box to the claim, and as distributing pipes taking water from the distributors or gates at the end of the supply-pipe line and delivering it to the discharge-pipes, Giants, or nozzles. Pipes used for carrying water across depressions and placed so as to follow the natural surface of the ground are called *inverted siphons*. The thickness of the metal for pipes is determined by the pressure of the water and the diameter of the pipe. The pipe, when put together, soon becomes water-tight from the foreign matter in the water. This result may be hastened by throwing in a few bags of sawdust. The pipes thus rendered water-tight will remain so when subjected to a pressure as great as 200 pounds per square inch. In the Texas pipe line, Nevada County, California, there is an inverted siphon 4,438.7 feet long, constructed of riveted sheet-iron pipe 17 inches in diameter. Its inlet is 304 feet above the outlet and at the full head will discharge 1,260 miner's inches. The maximum head is 770 feet, which is equivalent to a pressure of 334 pounds per square inch on the pipe at its lowest point.

129. Joints.—Ordinarily, pipes vary from 11 to 40 inches in diameter, and are constructed of sheet iron or steel, varying in thickness from No. 8 to No. 14 or 16 (Birmingham Wire Gauge). The sheets are riveted together into

sections of from 30 to 36 inches in length, and these in turn into lengths of from 20 to 30 feet, or into convenient

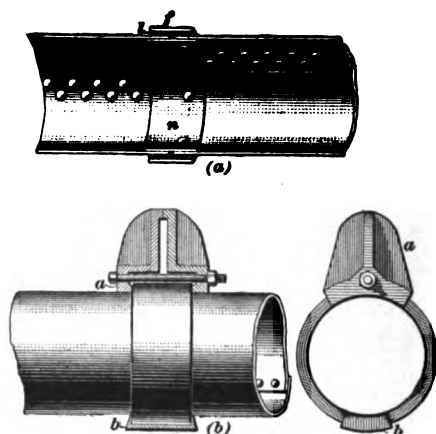

FIG. 43.

lengths for transportation. These longer pieces may be put together by a number of different devices. Sometimes they are simply put together stovepipe fashion, neither rivets, wire, nor any other contrivance being necessary to hold the joint in place. Where there is great pressure, iron collars or lead joints are frequently used. Fig. 43 (a) shows

this style of joint as it is frequently used; *f* is a wrought-iron collar about 5 inches in width and $\frac{1}{4}$ inch thicker than the pipe iron. The inside diameter of this collar is $\frac{3}{8}$ of an inch greater than the outside diameter of the pipe; *l* is a joint composed of lead which is run in between the collar *f* and the pipe and then calked tight from both sides; *n* is a nipple about 6 inches in length which is riveted in one of the sections by means of $\frac{3}{8}$ -inch rivets. Sometimes, owing to expansion and contraction of the pipe, the lead in the joint has a tendency to work out, and to replace this lead or force it back into the joint, the clamp shown in (b), Fig. 43, has been devised. At *a* is shown the clamp and its method of application for forcing back the lead which is worked out. The clamp is shown both in side view and in cross-section. At the lower part of (b), Fig. 43, will be seen another clamp *b*, which is driven over the joint to keep the lead in place after it has been forced in by means of the clamp *a*.

130. Sometimes wrought-iron pipes are provided with hooks, which are riveted near the ends of the pipe and are

fastened together by winding wire about the hooks on the adjacent lengths of pipe, thus counteracting the tendency which the pipes have to work apart, owing to expansion and contraction.

131. Elbows.—Sharp bends should always be avoided in pipe-lines when possible, and all turns should be made

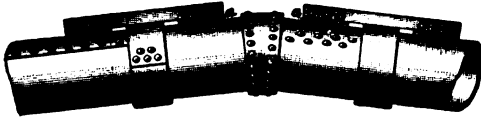

FIG. 44.

by gradually bending the pipe, if this can be accomplished. When short curves are necessary, elbows similar to that shown in Fig. 44 may be employed. In this case, *a, a* are the angle-irons riveted on to the elbow and connected by straps to similar angle-irons riveted on to the adjacent sections of pipe, as shown in the illustration. These angle-irons and straps are necessary to prevent the pipe from pulling apart at this point, owing to expansion and contraction.

132. Air and Blow-Off Valves.—Blow-off valves are provided to allow the escape of air while the pipes are being filled, and also to prevent the formation of a vacuum, and the consequent collapse of the pipe, which might occur in case of a break. The simplest form is a loaded flap-valve of leather on the inside of the pipe, arranged to cover a hole from 1 to 4 inches in diameter. A very simple automatic valve is shown in Fig. 45, which consists of a small chamber above the pipe, in which hangs an inverted

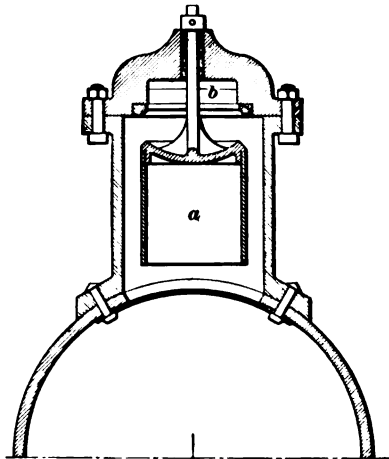

FIG. 45.

bell or cylinder *a*, closed at the top. When simply air is escaping, this cylinder will remain in the position shown in

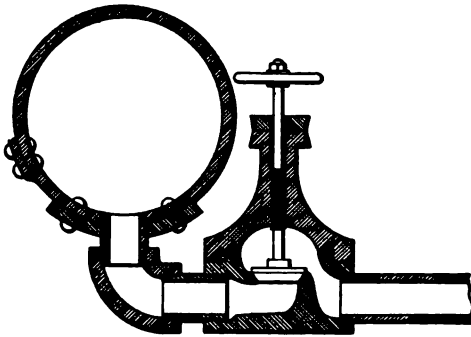

FIG. 46.

the illustration, owing to its own weight, but as soon as water rises into the chamber, air will be trapped under the bell, causing it to float up and seat against the top of the chamber, thus closing the opening *b*, and hence preventing

the escape of the water. Should the flow of water cease, the bell will immediately fall and air will enter through the opening *b*, thus protecting the pipe from collapse.

Fig. 46 shows a form of blow-off, or drain valve, employed at

low points along the pipe for emptying the same. Fig. 47

shows a combination automatic blow-off and vacuum valve, which is employed at high points in the pipe-line.

The valve on the right is kept closed when the pipe is full and the valve immediately over the pipe open.

The pressure in the horizontal tube will keep the central valve closed.

In case any small amount of air does collect in the pipe, it can be easily discharged by opening

the small valve at the right. Now, if a break should occur anywhere in the pipe-line and a vacuum result at the upper point, the central valve would fall of its own weight, thus admitting air and preventing the collapse of the pipe. On

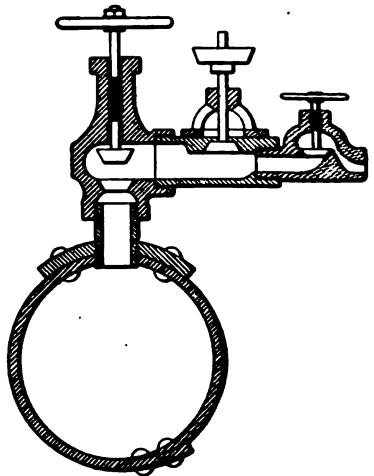

FIG. 47.

refilling the pipe, this valve, being open, allows the air to escape, and when properly constructed will close upon being reached by the water. This latter effect may be accomplished either by making the lower part of the valve so that it will trap some air and float up, or by shaping the upper disk properly, the escaping water will strike it and lift it high enough so that the current can catch and close it.

133. Laying Pipe-Lines.—To preserve iron pipe, it should be laid in a trench and covered with earth to a depth of at least one foot. Wooden pipe should be painted on the outside with the same mixture that is used for covering the bands. Iron pipes should be covered inside and out with asphalt or coal-tar. Such pipes, well coated, have been found in good condition after 15 years of continuous service. The following are mixtures that have been found to give good results for this purpose:

	Crude Asphalt.....	28%
	Coal-tar (free from oily matter).....	72%
Or,	Refined Asphalt.....	16.5%
	Coal-tar (free from oily matter).....	83.5%

To prepare either of these, the asphalt is broken into small pieces and heated with the coal-tar to a temperature of about 400° F. and well stirred. The pipe to be coated is dried and immersed in this mixture, where it should be allowed to remain until it acquires the temperature of the bath. When coated, it is removed and placed on trestles to drip and dry in the sun and air. For convenience in immersing, wrought-iron troughs of such a size that they will conveniently contain one section of pipe are provided.

134. Filling Pipes.—Pipes should be filled in such a manner as to prevent as far as possible the admission of air, which will be drawn in with the water in surprising quantities unless care is taken. The best plan is to put a gate in the pipe below the intake, and thus regulate the flow and maintain a steady pressure. Where the pipes which convey water to the mines are supplied from flumes, some

kind of box is necessary. This is commonly called a penstock or pressure box, and is illustrated in Fig. 48. A grating of bars should be so placed in the flume as to remove all dirt or brush before the water passes into the penstock, and the surplus water should be allowed to flow



FIG. 48.

over a weir and escape, as shown in the illustration. The water in the pressure box should be sufficiently deep and quiet to prevent air from being carried into the pipe. To accomplish this, the box is frequently made of two parts, the water flowing from the flume into one and from it into the other through a grating or partition provided with small holes. As the water coming through ditches almost invariably carries more or less sand with it, and as this would be liable to cut and scour the inside of the metal pipe, it is quite important that it should be settled out or separated before the water enters the pipe. This is usually accomplished by means of a sand-box, which may be constructed in connection with the pressure box, or at a point in the flume somewhat above the pressure box. The sand-box is simply an enlargement in the flume, so arranged that the velocity of the current is reduced and the sand allowed to settle on the bottom of the box, where it accumulates and from where it is occasionally flushed out by means of a gate near the bottom of the box. Sometimes pressure boxes are made large and provided with a chamber below the intake pipe, it being intended that the sand will accumulate in this chamber and that it can be removed from there periodically.

135. Supply or Feed Pipes.—Water is conveyed in iron pipes from the pressure box to the claim and distributed to the discharge-pipes by means of iron gates. The supply pipe is usually funnel-shaped where it connects with the pressure box, and from there it is usually of a uniform

diameter. Where pipes from 22 inches to 30 inches in diameter are employed, metal lighter than No. 14 B. G. is not advisable. The main supply pipe should descend into the diggings or mine by the most convenient and direct line possible. Sharp angles and rises or depressions should be avoided. Air-valves should be provided for the escape of the air when filling the pipe, and to prevent collapse in case of a break the pipes should be well braced and weighted at all turns or angles. In filling the supply pipe, water should be turned on gradually,

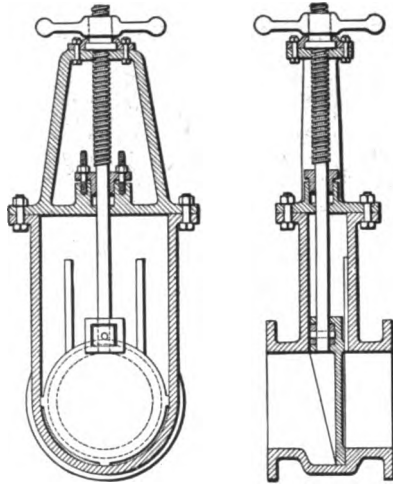

FIG. 49.

for if this is not the case, the moment the pipe becomes filled the sudden check in the flow of the water will result in a violent water-hammer, which may strain the pipe badly, or even burst it. Leakage in any of the joints may be stopped by running some sawdust into the supply pipe. Wherever it is necessary to join the supply pipe and one of the distributing pipes, the present practice is to fork the main pipe by means of a Y joint and to provide each branch with a gate-valve similar to that shown in Fig. 49.

EXAMPLES OF PLACERS.

ALMA PLACER.

136. As an example of ordinary placer mining, we may take that of the Green Mountain Company at Alma, South Park, Colorado. In South Park, at an altitude of 10,000 feet above the sea, is an extensive area of placer ground located on the banks of the South Platte River and extending from

the base of Mt. Lincoln to Fairplay, a distance of over 20 miles. This area consists of rolling banks of pebbles,

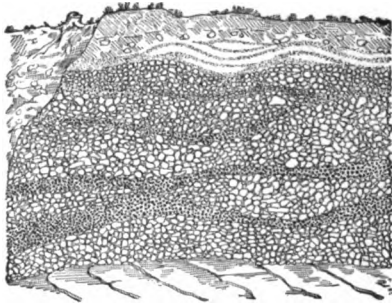

FIG. 50.

boulders, gravel, and sand on both sides of the stream, the surface being covered with grass and a few spare trees, and sloping gently towards the mountainside for an average width of about half a mile. Portions of these placer banks have been worked at Alma and at Fairplay, but the banks

are far from being exhausted. The principal hydraulic workings are at Alma, where the banks are thickest, owing to the convergence of the tributary streams at that point. A good supply of water can be obtained during the summer months, and hence the beds are worked continuously night and day during the season. The gravel and drift material was undoubtedly first brought down by the glaciers, but has subsequently been washed and worked over again by the streams which flowed from the cañons. Where a section of the bank is exposed, as at Alma, it exhibits a structure from the grass roots down to bed-rock, similar to that shown in Fig. 50, which may be described as follows: At the top there is first a foot or two of black earth in which there is little gold. Below this, a foot or two of clay with pebbles in it, and then a few feet of sandy layers irregularly bedded in streaks as if formed by eddies and currents, and likewise comparatively poor in gold. The remainder of the deposit to bed-rock, 30 to 50 feet, is composed of subangular and rounded pebbles and boulders of all sizes, from a fraction of an inch to a yard or more in diameter, the whole being cemented together with sand, clay, and in places with iron oxide, so that it forms a tolerably tough conglomerate which can be attacked only by means of a pick or with a Giant having a good head of water. The banks continue

down both sides of the creek for several miles, but are thickest at Alma opposite the outlet of the tributary cañons—Buckskin and Mosquito. Here is the site of one of the oldest workings in Colorado. The banks have been cut back for a long distance from the river, presenting a vertical cliff, in some places 70 feet high and about a mile in length. This cliff is cut by narrow channels, ravines, or gashes, which have been made by the Giants or flume waterfalls. Some of these cuts are narrow gashes not penetrating far into the bank, while others lead through narrow ravines into wide open amphitheatres surrounded by high banks, the center being occupied by piles of large boulders which have been thrown out of the sluices and stacked up in the course of the work. Winding through this mass of debris may be seen the remains of the old abandoned gravel sluices.

The Alma placer is operated in this district, and it may be described as follows: The sluices pass to the river-bottom through a narrow ravine, as shown in Fig. 51, and the ends of the sluices are divided into short curved tributaries so as to distribute the tailings over the river-bottom.

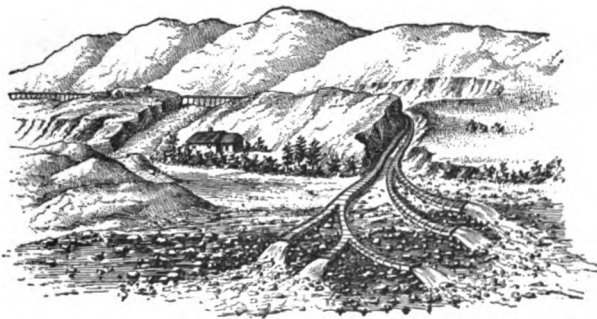

FIG. 51.

In this mine there are two sluices coming from the amphitheater out through the ravine, the ravine being over a thousand feet long and the amphitheater 200 feet wide and about 70 feet deep. Fig. 52 illustrates the amphitheater at the head of the sluices, and here the method of

carrying on the work may be seen. Water is allowed to flow over the bank as flume waterfalls, which can be seen at the far end of the illustration. The disintegration of the material left standing between the gulches cut by these waterfalls is effected by means of hydraulic Giants, and all the material is washed into the gravel sluices. The sluices are lined with block pavement similar to those which have already been described. The operations may be



FIG. 52.

described as follows: After the washing has continued for some time, a greater or less number of large boulders accumulate at the feet of the waterfalls and above the sluices. When this occurs, the flume waterfalls are turned off and the Giants turned on to some other portion of the bank. Then men climb into the pathway of the refuse stream and pick out the larger boulders, some of which have to be blasted before they can be handled. These boulders, if small, are loaded on a stone-boat, which is hoisted out of the way by means of a large derrick seen in the center of the illustration. Large boulders are slung on to the derricks by means of chains and hoisted without the use of the stone-boat. The derrick is operated by a 10-foot Pelton water-wheel similar to that shown in Fig. 25. After the large boulders have been removed, the Giants are once more turned on, and the gravel and pebbles which had been held back by the boulders are washed into the flumes so as to expose the sandstone

bed-rock. The bed-rock cleaners then dig up and shovel into the sluice the rotten surface of the sandstone to a depth of a foot or so, or to such a depth as experience has proved that the gold will occur. They examine all cracks in the rock and scrape out any gold there with knives or brush it out. After this the bed-rock cuts are advanced and the work of the flume waterfalls and Giants begins again as before. While the water is flowing down over the bank, men are at work with long-handled shovels ground-sluicing or helping along or removing out of the way of the stream any boulders, and keeping the water in as definite a channel as possible, so that its work may be effective. The ravine leading to this placer, which is 1,000 feet long, and the amphitheater, 200 feet wide by 70 feet deep, were both excavated within six months.

137. Preliminary Operations Necessary.—Before this particular enterprise was undertaken, the ground was prospected and the presence of gold in paying quantities assured by sinking shafts to the bed-rock and testing the gravel from them, and also by testing the material from the exposed faces by panning. The question of water-supply was considered and a reservoir constructed with an area of 5 acres and an average depth of 10 feet. The dam is made of gravel and brush and is provided with timber cribs and gates for the wasteway. The ditch from the dam to the mine is about 2 miles long and carries 2,000 miner's inches. It is 12 feet wide, 3 feet deep, and has a grade of 10 feet to the mile. At one place a flume 240 feet long was built and carried on trestles, the flume being 6 feet wide and 3 feet deep. At the end of the flume on trestles there is a flume resting on a rock and running at right angles to the main flume, and from this four ditches are carried to the general workings. A penstock is placed at the end of one of these branch ditches, and from this point two pipe-lines are carried to the Giants. The pipes are 22 inches in diameter at the penstock, but taper gradually to 10 inches in diameter at the Giants, the lines being

each approximately 500 feet long. There are two Giants of the size known as No. 2. The Giants use 200 miner's inches each, and the ditch has a capacity of about 2,000 miner's inches, the remainder of the water being employed for operating the derrick, or as a flume waterfall. The two sluices are each 3 feet wide by 4 feet high, or deep, but they are paved with wooden-block riffles 8 inches thick, which reduces the depth by that amount. The force of the water in the sluices is so great that boulders weighing 100 pounds are frequently carried entirely through the sluices. The grade of the sluices is 4 inches to 12 feet, or $33\frac{1}{2}$ inches to 100 feet. The sluice line is laid on bed-rock, which has been cut down in places to receive it. At curves the gravel sluices are raised on the outer side. The sluices are each 4,000 feet in length, but most of the gold collects in the first 400 feet of each sluice.

138. Cleaning Up.—In this placer about 2 ounces of quicksilver are supposed to be used for each ounce of gold to be caught. The clean-ups, which occur at regular intervals, are conducted as follows: The riffles are first taken out in sections and everything washed clear. The packing of small stones, which was located between the blocks, is then removed with 12-tined forks and the floor cleaned. The quicksilver is removed and washed clean from the black sand, after which it is strained, the amalgam retorted, and the bullion melted down, preparatory to being sent away, as described in Arts. **67** to **72**.

ROSCOE PLACER.

139. As an example of a placer which has been exposed by means of a wing-dam, the Roscoe placer may be described. This is situated in the cañon of Clear Creek, Colorado. Clear Creek Cañon is one of the steepest and grandest in the front range. It is cut through granite rock for a distance of some 40 miles to an average depth of 1,000 feet. About 13 miles from its outlet on the plain the creek forks, one

branch leading up to the gold-mining region of Central and the other to the gold-mining region of Idaho Springs. The main creek receives the drainage of two gold-bearing districts. At Central, in addition to the gold derived from the veins and rocks direct, the creek brings down a great deal of flour gold and fine amalgam in the tailings from the old stamp-mills, which, by their crude methods, lost in the past upwards of 40 per cent. of the gold in the ore, together with a good deal of amalgam. This refuse matter from the mills had been accumulating for 30 years, and was in addition to all that the placer formerly contained. Miners and prospectors in the past obtained a good deal of gold from the shallow or surface washings, but the deep, underlying bed-rock was out of their reach. At one point the cañon is crossed by several hard quartz and feldspar veins. These formed a natural dam, which was finally broken through by the creek as its cañon was being eroded; but the miners confined it to narrow limits at this point. At some comparatively recent time some huge masses of rock have fallen into the creek at this point in such a manner as to practically dam it and form a waterfall about 30 feet high. Above this natural dam there is a large expanse of ground, consisting of placer material and old tailings. The Roscoe placer was opened to work this deposit. The fall of water over the natural dam gave a good dumping-ground for the tailings, and the flat area above made it convenient to construct a large flume along one bank of the creek, into which the stream was turned by means of a wing-dam, thus exposing the bed of the creek with its placer ground and accumulation of tailings.

140. Preliminary Work.—Before commencing operations, the ground was prospected by sinking shafts to bed-rock, and the presence of gold assured. In general, the work was carried out as follows: First, a flume was constructed on the south bank of the stream capable of carrying all the water of the creek. This flume was 10 feet wide, 6½ feet deep, and 2,400 feet long. The flooring of the

flume was 4 inches thick and the sides 2 inches. The grade on curves was $1\frac{1}{4}$ inches to 16 feet and in the straight portions $\frac{3}{4}$ inch to 16 feet. The flume was not straight, but followed the course of the stream, the outside edge of the flume being elevated on curves so as to prevent the water from splashing. The water was turned into the flume by means of a wing-dam, which was first constructed with the aid of sand-bags, as shown in Fig. 34, and subsequently backed up by means of a bank of earth and a substantial wooden framework composed of triangular bents. The whole was then backed up with stone and gravel, and the down-stream face riprapped with boulders taken from the drift material. By this means the entire creek bed above the natural dam was exposed for work. To provide a water-supply for the operation of the Giants and hydraulic elevators, a dam was constructed about 3 miles up stream and an intake flume 800 feet long built to a combination penstock and sand-box.

This penstock was provided with a grating which removed the brush, leaves, etc., and was made large and deep enough to serve as a sand-box, the surplus water escaping over a weir and flowing back to the river. The penstock was 8 feet square and 16 feet deep. Part way down, one side of the penstock was connected to a 48-inch wooden-stave pipe made of pine boards banded with round steel hoops, like that shown in Fig. 42. After leaving the penstock, the pipe was buried for a distance of about 300 feet under a stone embankment and then passed under the railroad track by means of an arch. The wooden pipe diminished gradually from a diameter of 48 inches at the penstock to 22 inches where it joined the metal pipe. The wooden pipe extended to within about $\frac{3}{8}$ of a mile from the mine, where it was joined to a metal pipe, which gradually diminished from 22 inches to 16 inches in diameter. For the last $\frac{1}{4}$ mile there were 2 metal pipes, one 16 inches and the other 12 inches in diameter, which ran parallel. One of these pipes supplied the water for the Giant nozzle and the other for the hydraulic elevator. The pressure on the pipes at the nozzle was 87 pounds per square inch, and the Giant would throw a column

of water 4 inches in diameter for a distance of 165 feet. If the pipes were closed at the end, the pressure would be

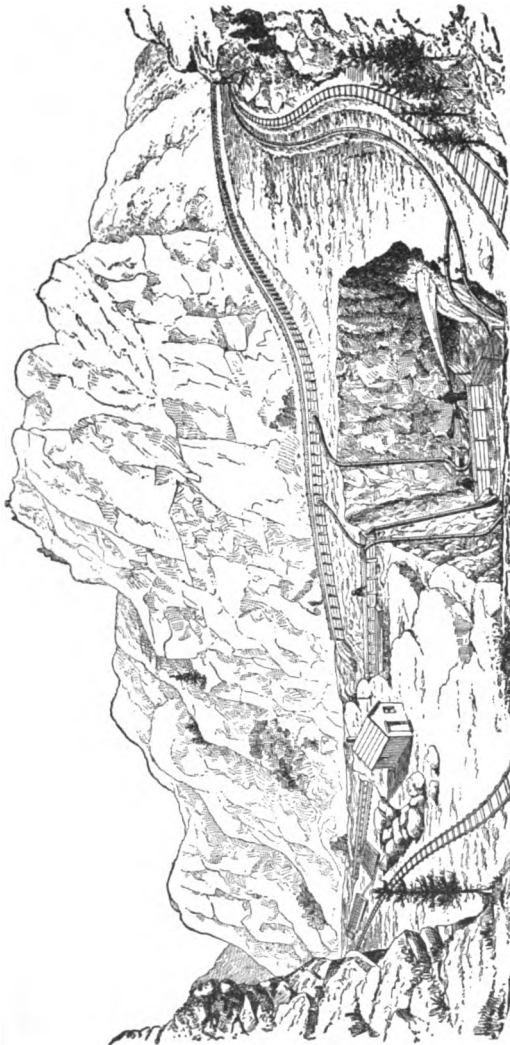

FIG. 53.

189 pounds per sq. in. In addition to the construction of the flume and wing-dam for diverting the stream and the

pipe-lines for supplying water, it was necessary to construct sluices to supply water for washing the gravel, and for the undercurrents which treated the fine material. The main

gravel sluice was 208 feet long, 4 feet wide, and 3 feet deep, and was paved with square wooden-block riffles. At the end of this sluice there was a grizzly which removed all material over $\frac{3}{4}$ inch in diameter and passed it to the waterfall, the fine portion going to the first undercurrent, which was 12 feet wide, 24 feet long, and set on a grade of 6 inches in 24 feet. This box was lined with riffles made by nailing narrow wooden slats across the bottom and securing pieces of flat strap iron to the top, so that the edges of the strap iron projected over the slats on both sides. This formed riffles very much like the angle-iron riffles illustrated in Fig. 15. The material which passed over the first undercurrent was taken up by a second sluice and carried to a second undercurrent, which was 24 feet wide, 45 feet long, and covered with burlap or sacking material. The burlap carpets were occasionally drawn off on to wooden rollers and carried to wooden tanks, where they were carefully washed. The material caught by this undercurrent

consisted largely of flour gold and pyrites, which had accumulated from the tailings of the mills above. Before the



FIG. 54.

material passed on to the second undercurrent, it passed over a perforated plate, which removed everything over one-half inch in diameter.

141. Method of Operation.—After the flumes and pipe-lines were constructed, operations were started as follows: A pit was sunk at the upper end of the sluice line with the aid of the hydraulic Giants and hydraulic elevator. The elevator used was of the Ludlum type, as illustrated in Fig. 23. Fig. 53 gives a general view of the placer, showing the railroad track on the north bank, the main flume for deflecting the course of the stream on the south bank, and the pit in which operations were carried on in the foreground. To the left of the pit can be seen the gravel sluices, and below them the two undercurrents. Fig. 54 is a general view showing the entire valley from the point at which water for the pipe-line was taken from the stream down to below the last undercurrent. Fig. 55 shows the pit

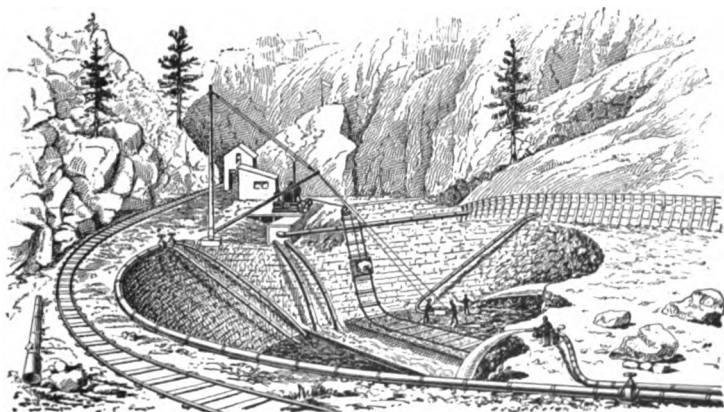

FIG. 55.

or excavation at the lower end of the workings. In this illustration it will be noticed that water for some of the work was taken directly from the large flume which deflected the stream, while the water for operating one of the Giants and the hydraulic elevators was conveyed down by the pipe-

line. Of the two pipes at the back of the illustration, which ascend from the pit into the gravel sluices, one is a gravel elevator and the other a water elevator. The cleaning-up, preparing, retorting of the amalgam, and melting of the bullion were carried on in the manner already described.

WORKING PLACERS BY DREDGES.

142. General Consideration.—Where streams can not be diverted from their course by flumes and wing-dams so as to expose the bed, or in cases where bench placers do not have sufficient water for hydraulicking, it becomes necessary to introduce some other method for excavating and handling the material. Such deposits are commonly worked by means of dredges. Dredges may be divided into two classes, those which excavate the material by means of a line of buckets on an endless chain, and those of the dipper type, which are provided with a single bucket, like a steam shovel.

BUCKET DREDGES.

143. General Description of Plant.—This class of dredges is usually employed in operating placers in the beds of streams or where a sufficient quantity of water can be obtained to use a flatboat, on which the machinery is placed. The plant consists of a series of buckets on chains, which excavate the material and lift it on to the dredge. There are also sets of centrifugal pumps for furnishing water to the sluices and handling tailings, and for similar purposes, and usually an elevator for raising the tailings and depositing them behind the dredge. After the material is excavated, it always takes up considerably more space than in the bank, and hence the tailings pile is always higher than the bank from which it is extracted. As the material comes from the buckets, it is usually passed through a trommel to remove the larger stones, which pass

at once to the tailings discharge or through a chute, which drops them in the rear of the dredge. The material which passed through the trommel is conveyed over sets of riffles—tables covered with burlap, matting, or other fibrous material—and sometimes over amalgamated copper plates. Frequently several trommels or screens are introduced into the line of apparatus so as to remove portions of the material at different points; as, for instance, the first trommel may allow anything that will pass through a 1-inch opening to go over the first riffles; the second may remove all above $\frac{1}{2}$ inch in diameter and be situated above the last riffles or the tables; and where copper plates are employed a screen is frequently introduced which removes everything above $\frac{1}{16}$ inch in diameter, so that the plates will not be subject to an excessive scouring action.

144. Disposition of Tailings.—Tailings are elevated and discharged in the rear of the dredge. This may be accomplished by means of a bucket elevator and discharge sluice, or they may be collected in a well or sump and forced to the rear by means of the centrifugal pump.

145. Cleaning of the Bed-Rock.—The gold which is situated on bed-rock may be obtained by a number of devices. Sometimes the suction of a powerful centrifugal pump is passed over the surface of the bed-rock for the purpose of drawing up any particles of gold, black sand, or other material which may be deposited upon the bed-rock; but it is probable that this device would not be able to handle any nuggets, and it is certain that it would not obtain the gold from deep crevices in the bed-rock.

Where the bed-rock is soft, 2 or 3 feet of it may be taken up by means of the buckets of the dredge and run through the sluices in the ordinary manner.

If the material on bed-rock is very rich and the bed-rock hard and uneven, diving-bells may be employed and men sent down to the bottom to clean the bed-rock by hand.

In working placers which are not situated in the bed of a river, and especially when working placers located on

high benches, the dredge is sometimes operated when floating in water which has been pumped into the pit. In this case, it may be possible to pump the pit dry and clean up the bed-rock by hand, the dredge being supported upon special piles or legs while this operation is in progress. The water necessary for use in the sluices while working the material cleaned from bed-rock is obtained either by pumping the water which flows into the opening through the centrifugal pump, or the water pumped from the pit may be retained in a reservoir or dam adjoining the pit, and the centrifugal pump draw its supply from this source.

146. Washing Plant Located on Shore.—It has also been proposed to employ dredges located in the stream, and to convey the material to washing plants on the shore, which would be provided with ordinary sluices, under-currents, etc.; but this device has the disadvantage that it requires the disposition of the tailings at some distance from the point where active operations are being carried on, and that the tailings are liable to bank up and necessitate the removal of the permanent works.

DIPPER DREDGES.

147. General Description of Plant.—Dipper dredges are practically steam shovels, which are fitted up for operating in gravel banks, and are provided with some form of gravel elevator for removing the tailings and stacking them to one side of or behind the machine. They also have a set of trommels, pumps, sluice boxes, tables, amalgamating plates, etc. The water for use in the trommels and on the tables is frequently supplied by a small pumping plant which draws its supply from a reservoir near the plant, and the water which drains out of the tailings is allowed to flow into the same reservoir, so that it is used over and over.

148. General Application.—These dipper dredges are employed where there is not water enough to use a boat, and hence the other form of machine is not practi-

cable. In some cases there is not even water enough to sluice the material over the riffles, and hence some form of dry-placer washing machine has to be introduced. These dry-placer washers work on the principle of the fanning mill or pneumatic jig, the material being screened to a comparatively uniform size and the lighter sand blown away, leaving the gold collected behind the riffles, where it is sometimes held as amalgam by means of quicksilver.

GENERAL REMARKS CONCERNING DREDGES.

149. As a rule, moving or handling material by mechanical means is always more expensive than hydraulicking, but it becomes necessary when a sufficient head and volume of water can not be obtained. As a rule, it is always best to employ one of the dredges which operates in water, as their capacity is usually greater and the wear and tear on the machine less. Dredges of this class have been employed for raising and working the tailings from old concentration mills.

Placer dredging is a comparatively new method of operation, but it has certainly been very successful in many cases, and it is undoubtedly not only the best but the only economical method to work certain classes of deposits.



A SERIES
OF
QUESTIONS AND EXAMPLES
RELATING TO THE SUBJECTS
TREATED OF IN THIS VOLUME.

It will be noticed that the various Question Papers that follow have been given the same section numbers as the Instruction Papers to which they refer. No attempt should be made to answer any of the questions or to solve any of the examples until the Instruction Paper having the same section number as the Question Paper in which the questions or examples occur has been carefully studied.

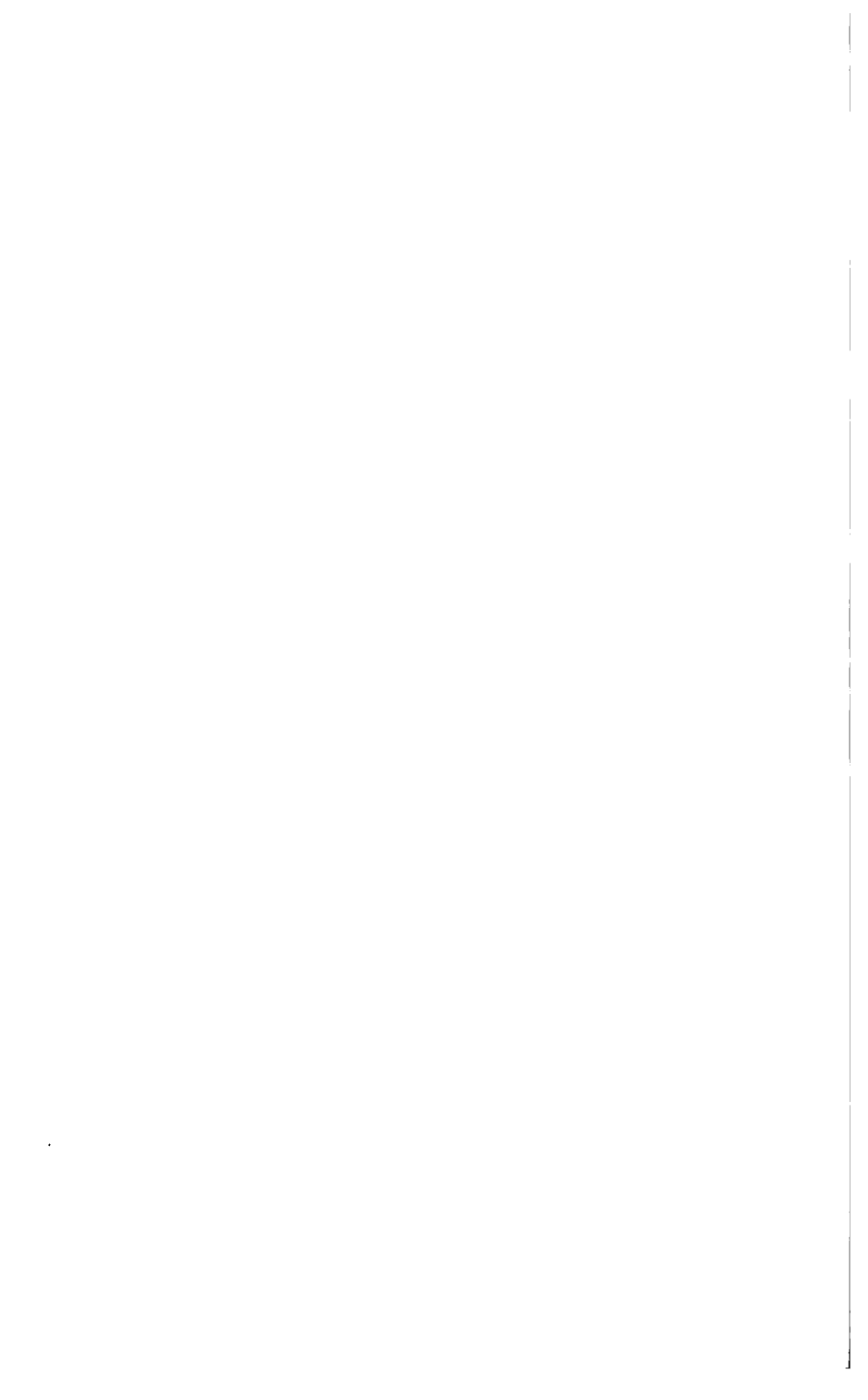

BLOWPIPING.

- (1) What is a *chemical element*?
- (2) Name the gaseous elements; the liquid elements; the non-metallic elements.
- (3) Define molecule; atom.
- (4) Define atomic weight; molecular weight.
- (5) Give the chemical symbols for lead, copper, iron, sulphur, arsenic, and antimony. What is the advantage of the use of chemical symbols?
- (6) Express, as a proper chemical formula, a compound containing two parts (by volume) of aluminum, and six each of oxygen and hydrogen, combined as the hydrate radical (*OH*). Give the formula for chromic sulphate (chromium sesquisulphate).
- (7) What is *chemical affinity*?
- (8) Name and illustrate by equations the three classes of chemical reactions.
- (9) What is the *valence* of an element?
- (10) What are subscripts, and how are they used?
- (11) What is a *radical*?
- (12) What are coefficients, and how are they used?
- (13) How does a coefficient or subscript, immediately outside of brackets enclosing a chemical expression, affect the expression within the brackets?
- (14) Define acid; anhydride.
- (15) Define base; salt.

(16) Describe the characteristic reactions produced by subjecting carbonates, sulphides, and silicates to the action of the common mineral acids.

(17) Mention some mineral substances not affected by these acids.

(18) State clearly how the blowpipe should be used, and tell what precautions the beginner should observe.

(19) In what particulars is the Bunsen burner superior to the spirit lamp or candle for blowpiping?

(20) Define oxidation.

(21) Define reduction.

(22) What wet tests are employed in connection with the blowpipe?

(23) Give Plattner's scheme for the examination of substances B. B.

(24) Name the elements whose compounds give characteristic reactions in the closed tube and in the open tube; also state what is the chemical difference in the reactions in the two tubes.

(25) Give the reactions for arsenic and antimony in both open and closed tubes.

(26) How is selenium recognized both in the open and the closed tube tests?

(27) Give reactions for tellurium in both tubes.

(28) Describe the method of heating on charcoal, and state what precautions must be observed in the case of materials which decrepitate or tend to blow or fly away.

(29) To what principle is the oxidizing action of the O. F. due, and to what principle is the reducing action of the R. F. due?

(30) Give the reactions on charcoal for bismuth, cadmium, and zinc.

(31) Describe in detail the operation of roasting. Why

is it necessary to roast substances containing sulphur and arsenic before treating them in the beads?

(32) Give Von Kobell's scale of fusibility. How would you test the fusibility of a mineral that decrepitates or flies to pieces when heated?

(33) What characteristic reactions do each of the following elements give when tried with a colorless flame: sodium; barium; copper; and calcium?

(34) To what class of substances is the test with cobalt solution applicable? In the case of what elements is it to be relied upon?

(35) Describe clearly and briefly the method of testing substances in the borax and salt of phosphorus beads. What is flaming?

(36) Give the reactions with borax bead in both flames for iron; manganese; zinc; nickel; copper; cobalt; and chromium.

(37) Give the reactions with salt of phosphorus bead in both flames for the elements named in the preceding question.

(38) What metals are reducible from their compounds on charcoal with soda? What other fluxes are of advantage in the case of difficultly reducible substances?

(39) Give the characteristic tests for fluorine, chlorine, and bromine.

(40) Give the characteristic reactions for (a) zinc; (b) mercury.

(41) How is the presence of water detected in minerals?

(42) How is the presence of sulphur detected when it is in the form of a sulphate?

Test each of the minerals named in questions 43–50, and, as your answer to each question, describe the reactions obtained, stating what element each indicates; and also state your inference as to the composition of the minerals,

referring, if you desire to do so, to Instruction Paper, subject *Mineralogy* (or to any other convenient source), for the composition, as a check on your work :

- (43) Chalcopyrite.
- (44) Franklinite.
- (45) Calamine.
- (46) Stibnite.
- (47) Siderite.
- (48) Halite.
- (49) Calcite.
- (50) Barite.

MINERALOGY.

- (1) What is a mineral ?
- (2) In examining a mineral, what physical characteristics should be observed ?
- (3) What is the difference between cleavage and fracture ?
- (4) What is meant by *conchoidal fracture* ?
- (5) What is meant by the *streak* of a mineral ? How is it best obtained ?
- (6) What is meant by *brittle ; flexible ; malleable ; ductile ; elastic* ?
- (7) Define splendent luster ; vitreous luster.
- (8) Give Mohs' scale of hardness, and describe how it is used in determining the hardness of a mineral.
- (9) Give a general scheme for the examination of mineral specimens.
- (10) What is the *specific gravity* of a substance ? How may it be determined ?
- (11) What is meant by *columnar structure ; granular structure* ?
- (12) Name the crystal systems, and give the principal characteristics of each.
- (13) Define *symmetry plane ; symmetry axis*.
- (14) What are *hemihedral* forms ?
- (15) What is *basal cleavage* ?
- (16) What is *twinning* ?
- (17) Are perfect crystals common in nature ?
- (18) How may distorted crystals be identified ?

- (19) How does gold occur in nature ?
- (20) What tests distinguish gold from substances having a similar appearance ?
- (21) Name the principal iron minerals.
- (22) What are the general characteristics of the iron minerals ?
- (23) Give the color and streak of each of the principal iron minerals.
- (24) What are the distinguishing characteristics of pyrite ?
- (25) How is siderite distinguished from minerals of similar appearance ?
- (26) What are the general characteristics of the lead minerals ?
- (27) What valuable impurity do the lead minerals often contain ?
- (28) What are the principal zinc ores ?
- (29) What tests distinguish franklinite from similar minerals, notably magnetite ?
- (30) Give the general characteristics of the silver minerals.
- (31) Describe the mineral *cerargyrite*.
- (32) What are the general characteristics of the copper minerals ?
- (33) How is malachite distinguished from chrysocolla ?
- (34) Describe the mineral *cuprite*.
- (35) How may chalcopyrite be distinguished from pyrite ?
- (36) Describe the mineral *garnierite*, and give its blow-pipe and other characteristics.
- (37) What is *stibnite*, and how is it distinguished ?
- (38) Describe the mineral *sphalcrite*, and give its chemical composition.
- (39) What are the principal varieties of coal ?

(40) What difference in composition is particularly noticeable in the different varieties of coal ?

(41) How may calcite be distinguished from fluorite ?

(42) Give the general characteristics of the manganese minerals.

(43) Describe the mineral *cinnabar*, and give its blow-pipe reactions.

(44) How may dolomite be distinguished from calcite ?

(45) Describe the mineral *opal*.

(46) What makes a mineral a precious stone ?

(47) What varieties of corundum are precious stones ? Give the color of each.

(48) How is the corundum (oriental) ruby distinguished from the spinel ruby ?

(49) How is a garnet distinguished from a (oriental) ruby ?

(50) What is *gypsum* ? Give its composition and characteristics.

(51) Of what value are pyrite and chalcopyrite ?

(52) For what purposes is zinc used ?

(53) Name four of the principal gangue minerals and give a description of each.

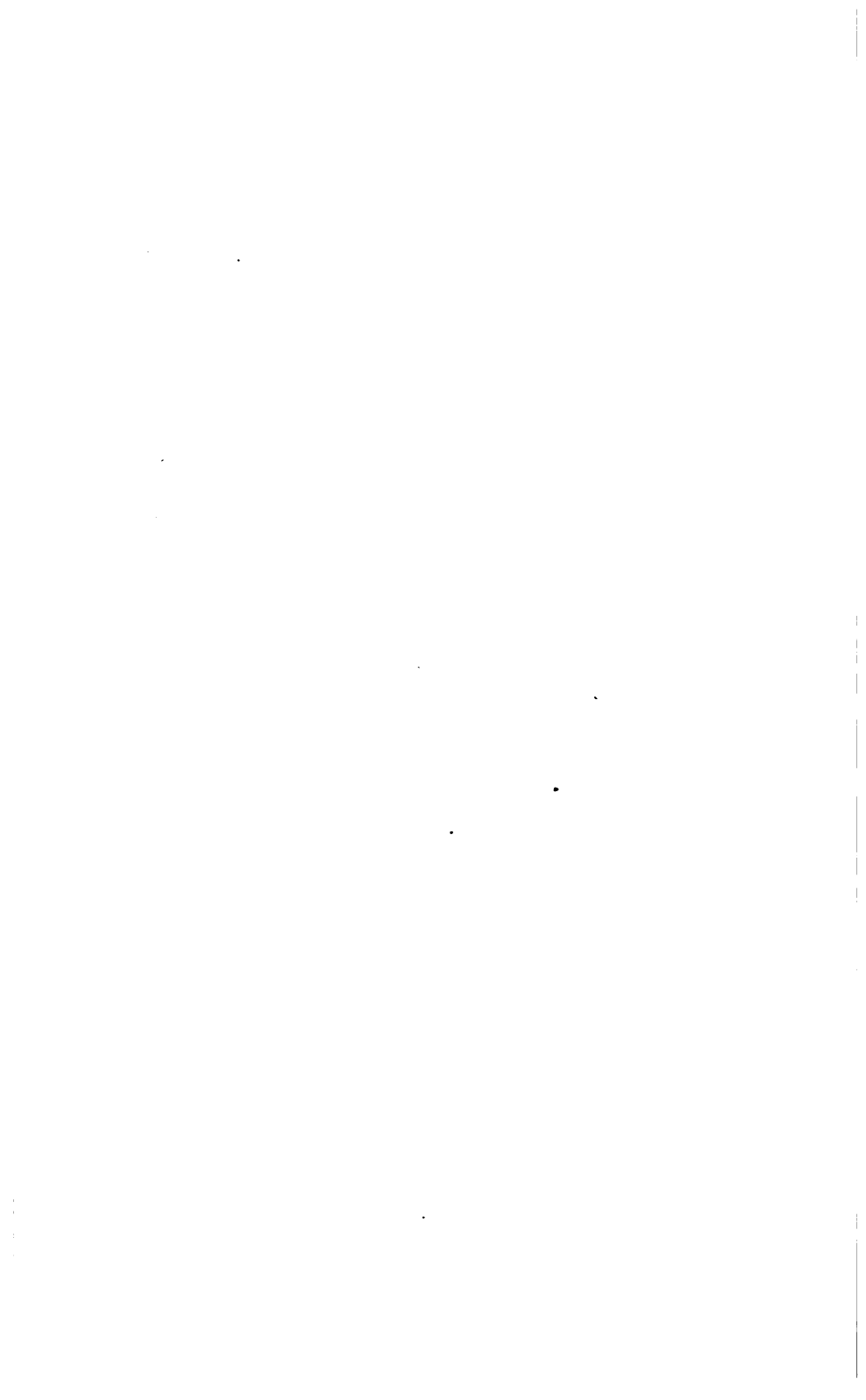

ASSAYING.

(1) (a) What is quantitative analysis? (b) What is usually understood by the term "assay"?

(2) What is assaying?

(3) To what may fire assaying be compared in its operations?

(4) Describe the crucible method of assaying as conducted in a muffle furnace.

(5) (a) Describe the sampling and assaying of base bullion. (b) How are the results of a base-bullion assay reported?

(6) (a) What precautions must be taken when setting up balances? (b) How may balances be prevented from rusting?

(7) (a) What are the advantages of the muffle furnace? (b) For what are wind furnaces chiefly used?

(8) From duplicate $\frac{1}{2}$ -A.-T. charges of an ore, two gold-silver buttons are obtained weighing 15.76 mg. and 15.74 mg., respectively; and after parting, the gold from the two buttons is found to weigh 1.98 mg. In weighing, a 1-mg. rider is used, and each division of the balance beam corresponds to $\frac{1}{10}$ mg. (a) Describe the *complete* operation of weighing the buttons, before and after "parting," naming the weights used, giving number of divisions on balance beam indicated by rider, etc. (b) Report the assay of the ore in ounces of gold and silver per ton of ore.

(9) (a) How is fine bullion sampled? (b) For what purpose is the "preliminary assay" of fine bullion made? (c) How are the results of a fine-bullion assay reported?

(10) (a) By what three methods may *ferric* chloride be reduced to *ferrous* chloride in the solution obtained in the bichromate method for the determination of iron in ores?

(b) Describe the reduction of ferric chloride to ferrous chloride by means of test lead.

(11) What method of analysis is generally used for the determination of copper in its ores?

(12) What is meant (a) by volumetric analysis? (b) by gravimetric analysis? (In answering, state briefly the principles involved in making volumetric and gravimetric analyses.)

(13) (a) What is a "rider" and how is it used? (b) What are the advantages of a rider?

(14) (a) What are fluxes and their uses? (b) Name the principal fluxes and reducing agents.

(15) Tell how you would assay a sample of concentrates—consisting principally of iron pyrites—(a) by the crucible method of assaying; (b) by the scorification method of assaying. (Give fluxes to be used and amounts of each.)

(16) If from a preliminary assay of 500 mg. of fine bullion we obtain 300 mg. of silver, and analysis shows the bullion to contain 15 per cent. copper, how would the "proof" assay be made up?

(17) *Volumetric determination of iron in ore.* Duplicate 1-g. ore charges. Titrations of the solutions of iron consumed 48.3 and 48.2 c. c., respectively, of the standard solution. Standard of solution is 0.00995 (1 c. c. = 0.00995 g. of iron). What per cent. of iron does the ore contain?

(18) (a) What metals are commonly determined by the fire assay? (b) What metals can be most accurately determined by the fire assay? (c) Why should we use the fire assay for any other metals?

(19) (a) What weights should the assayer have, and how should they be handled? (b) Why are metric weights used in analytical chemical work?

(20) (a) For what is litharge used in the crucible assay? (b) Why should each new lot of litharge be assayed before the litharge is used in assaying ores? (c) How would you make a litharge assay?

(21) (a) Describe the operation of "parting" the gold-silver buttons from ore assays. (b) What is "inquarting"?

(22) The standard of a potassium-permanganate solution for *iron* is 0.01. In a volumetric analysis of a *manganese* ore in which 1 gram of ore was used, 20.5 c. c. of the standard solution were consumed. What per cent. of manganese does the ore contain?

(23) Describe the volumetric method of determining copper in its ores by means of a standard solution of cyanide of potassium.

(24) (a) When determining the value of an ore, what, in addition to its gold and silver contents, should be taken into consideration? (b) Mention the principal ingredients of ores, besides gold and silver, for which the smelters pay a bonus, and also mention the ingredients for which the smelters make an extra charge.

(25) (a) What furnace tools are required for assaying? (b) For what are iron molds used?

(26) If from 2 A. T. of litharge we obtain a *silver* button weighing 1.5 mg., and in a subsequent crucible assay of an ore in which 1 A. T. of ore and 1 A. T. of litharge are used, we obtain a button of silver weighing 5.75 mg., how many ounces of silver does a ton of the *ore* contain?

(27) How does the determination of copper in fine bullion differ from the determination of copper in ores?

(28) If, after making all corrections for loss of silver in a fine-bullion assay, we find that 500 mg. of bullion contains 398.5 mg. of silver and 16 mg. of gold, how would the results of the assay be reported?

(29) The standard of a potassium-permanganate solution for *iron* is 0.01. In a volumetric analysis of an ore for

lime (CaO), 30.4 c. c. of the standard solution were consumed. (a) What per cent. of *lime* does the ore contain? (b) What per cent. of calcium (Ca) does the ore contain?

(30) In the phosphorous determination, if arsenic is known to be present, what precaution in regard to the temperature of the ore solution must be taken at the time the molybdate solution is added?

(31) (a) What is an "assay ton"? (b) Show how the assay ton is derived, giving proportion expressing the relation between an assay ton and a ton of 2,000 pounds avoirdupois.

(32) If from 45 g. of test lead we obtain a button of *silver* weighing .3 mg., and in a subsequent scorification assay of an ore in which .1 A. T. of ore and 45 g. of test lead are used, we obtain a button of silver weighing 32.5 mg., how many ounces of silver does the *ore* contain per ton?

(33) (a) Describe the fire assay for lead with oxidized ores. (b) How does this assay differ from the assay of sulphide lead ores?

(34) (a) What is "insoluble matter"? (b) How is it determined in an ore?

(35) (a) What apparatus is required for crushing and otherwise preparing samples for assay previous to weighing charges? (b) What is a tin sampler?

(36) (a) Name the different kinds of crucibles used in fire assaying, melting bullion, etc. (b) What qualities should good crucibles and scorifiers possess?

(37) *Scorification assay.* Ore charges $\frac{1}{16}$ A. T. The gold-silver buttons weigh 3.45 mg. and 3.47 mg., respectively, and the gold from both buttons weighs 2.12 mg. (a) How many ounces of gold and silver does the ore contain per ton? (b) With gold at \$20.67 per ounce and silver at \$.60 per ounce, what is the value of the ore per ton?

(38) *Lead fire assay.* Duplicate 5-g. ore charges are used. Weights of lead buttons are 3.25 g. and 3.27 g.,

respectively. (a) What per cent. of lead does the ore contain? (b) Had we taken 10-g. charges of ore instead of 5-g. charges, and the buttons weighed 3.25 g. and 3.27 g., respectively, what per cent. of lead would the ore have contained?

(39) What forms the basis of the separation of silica from other insoluble matter?

(40) If an ore contains 15 per cent. of copper, how many c. c. of a solution of cyanide of potassium having a standard of 0.005 will be consumed in titrating a solution when 1 g. of the ore is used?

(41) Describe in detail the operation of pulverizing a sample by means of the bucking board and muller.

(42) Give rule for the calculation of the number of ounces of gold and silver per ton of ore (without metallic scales), and state same in the shape of a formula.

(43) (a) What is "lead flux"? (b) Give the parts (by weight) of the constituent chemicals of a good lead flux.

(44) *Crucible assay.* Ore charges $\frac{1}{2}$ A. T. Weight of gold-silver buttons 4.76 mg. and 4.75 mg., respectively. Gold from both buttons weighs 0.75 mg. (a) How many ounces of gold and silver does the ore contain per ton? (b) What is the value of the ore per ton, with gold and silver worth \$20.67 and \$.59 per ounce, respectively?

(45) (a) What two volumetric methods are commonly used for the determination of iron in its ores? (b) In what are these two methods similar? (c) Mention the principal chemical change that takes place in the iron solution during titration in each method. (In answering (c) give the condition in which the iron exists at start as well as at end of titration.)

(46) How would you prepare and standardize an approximately half-normal solution of cyanide of potassium for the volumetric determination of copper in its ores? (Give each step in standardizing.)

(47) Describe in detail the operation of crushing and "quartering" a large sample—of about 90 pounds weight—of a uniform-grade gold ore, for assaying.

(48) Describe in detail the operation of weighing out duplicate ore charges for assay.

(49) (a) What are the two general methods in use for the fire assay of gold and silver ores? (b) To what kinds of ores is the scorification method of assaying best suited?

(50) Describe briefly the scorification method of assaying.

(51) (a) What are "control" assays? (b) Describe the operation of sampling for control assays, and tell how control assays are made for settlement.

(52) What will the gold from a $\frac{1}{2}$ -A.-T. charge of a \$10 gold ore weigh, gold being worth \$20.67 an ounce?

(53) (a) For what should distilled water and nitric acid used in "parting," etc., be tested? (b) How are these tests made?

(54) (a) For what are screens used? (b) What do we mean by 80 and 100 mesh screens? (c) What is the "pulp"?

(55) (a) What qualities should a good cupel possess? (b) Describe the operation of making cupels.

(56) What is the principal source of loss of the precious metals (a) in cupellation? (b) in scorification?

(57) (a) State formula used for calculating the results of the assays of gold and silver ores containing metallic scales. (b) *Ore containing metallic scales.* Weight of pulp 248.5 g. Weight of metallic scales 1.98 g. Metallic scales contain 5.62 mg. of gold and 853.51 mg. of silver. The pulp is assayed by the crucible method of assaying, using duplicate $\frac{1}{2}$ -A.-T. charges of ore; the gold-silver buttons obtained weigh 98.53 mg. and 98.51 mg., respectively, and the gold from the two buttons weighs 1.75 mg. How many ounces of gold and silver does the ore contain per ton? (c) What

is the value of the ore per ton with gold and silver at \$20.67 and \$.60 per ounce, respectively?

(58) How would you prepare and standardize an approximately normal solution of potassium permanganate? (Give standardizing operations in detail.)

(59) (a) Should the results from a sprouted button be accepted? (Give reasons.) (b) How may large silver buttons obtained by cupellation be prevented from "sprouting"?

(60) What are the requirements (a) of the pulp balance? (b) of the button balance?

(61) In a determination for sulphur, 1 gram of the substance was taken and 0.423 gram of barium sulphate and filter-paper ash were obtained. The ash of the filter paper was known to weigh .004. What per cent. of sulphur did the substance contain?

(62) (a) What precautions must be observed during cupellation? (b) Should the lead buttons—containing precious metals—refuse to open when cupelling, what must be done? (c) What is "blinking," and what does it indicate?

(63) What is (a) base bullion? (b) fine bullion? (c) "doré" bullion?

(64) In standardizing a solution of bichromate of potassium, two charges of piano wire (99.7 per cent. pure iron) were used, weighing 0.105 g. and 0.112 g., respectively, and the titrations consumed 20.9 c. c. and 22.4 c. c. of permanganate solution, respectively. What is the standard of the solution? (Give all calculations involved in obtaining the standard.)

(65) An assayer is given an ore, with the request that he determine its gold, silver, iron, lime, copper, zinc, and silica contents. For the determination of the gold and silver, he used the crucible method of assaying, using $\frac{1}{2}$ -A.-T. charges of ore, and obtained gold-silver buttons weighing 8.63 mg. and 8.62 mg., respectively, and the gold from both buttons weighed 2.35 mg. In all volumetric determinations he

used 1-g. charges of ore. A solution of potassium permanganate having an *iron* standard of 0.01 was used to determine the iron and the lime, and in the *iron titration*, 25 c. c. of the standard solution were consumed, and in the *lime titration*, 18.4 c. c. of the standard solution were consumed. In the copper determination, 26.3 c. c. of a solution of potassium cyanide having a standard of 0.0049 were consumed; in the zinc determination, 4.5 c. c. of a solution of potassium ferrocyanide having a standard of 0.0099 were consumed; and from a 1-g. charge of the ore the silica weighed 0.125 g. How many ounces of gold and silver did the ore contain per ton, and what were the percentages of iron, lime, copper, zinc, and silica in the ore?

GEOLOGY.

- (1) What is geology ?
- (2) Into what three divisions does the subject of geology seem to naturally divide itself ?
- (3) What are the constituents of the atmosphere, and which of them are effective in changing the form of the earth, and why ?
- (4) What are boulders of disintegration, and how are they formed ?
- (5) How do such rocks as granite, gneiss, etc., become disintegrated ?
- (6) What effect has frost upon rocks ?
- (7) What is talus, or slide rock ?
- (8) How are waterfalls formed ?
- (9) What is the relation between the carrying power and the eroding power of water ? Describe fully.
- (10) What is meant by the sorting power of water, and what effect has it upon deposits made from running water ? Answer fully.
- (11) Explain why a river has a winding course.
- (12) What is the flood-plain of a river, and of what two parts is it composed when a river empties into a tideless sea or lake ?
- (13) What is an estuary, and what deposits may form in an estuary ?
- (14) What is a glacier, and what effect have glaciers in changing the surface of the earth ?
- (15) What is the origin of springs ? Explain and illustrate with a sketch.

- (16) What is the cause of artesian wells ?
- (17) Explain the manner in which deposits are formed at springs, and state why it is that if the material can be in solution before the water comes to the surface, it becomes deposited after the water reaches the surface.
- (18) What is the general effect of all the aqueous and atmospheric agencies in their action upon the earth, and what is the general effect of igneous agencies ?
- (19) If one were to descend into the earth, what changes in temperature would be noted as the depth below the surface increased ?
- (20) What is a volcano ?
- (21) What are dikes, and how are they formed ?
- (22) Is the surface of the land stationary, or are certain changes going on ?
- (23) From what is the coal formed ?
- (24) What effect does carbonaceous matter have in the depositing of iron and other metals ?
- (25) What is the origin of limestone ?
- (26) What is meant by the crust of the earth ?
- (27) What is meant by the term "rock" as it is commonly employed in geology ?
- (28) Define the following terms: "Dip," "anticline," "conformity," and "strike."
- (29) What are fossils ?
- (30) Why is it that vegetable life has to precede animal life on the earth ?
- (31) Name the different eras or ages as they would occur in a complete geological section, and give the characteristic form of life for each period.
- (32) What is the distinction between stratified and unstratified rocks ?
- (33) Give the characteristics of the plutonic or massive rocks, and name one of the forms belonging to this class.
- (34) What is porphyry ?

(35) Give the general characteristics of the volcanic or eruptive rocks, and name one of the rocks belonging to this class.

(36) What is the distinction between acid and basic rocks ?

(37) What is a dike ?

(38) How can the relative age of igneous rocks be determined ?

(39) What is volcanic conglomerate or breccia ?

(40) What is meant by amygdaloidal structure in lava ?

(41) How may general metamorphism of the rocks be effected ?

(42) Define metamorphism.

(43) What is the probable origin of granite ?

(44) What is the distinction between joints and fissures in rock formations ?

(45) What is a fault ?

(46) Give the common law of slip in faults.

(47) What is a reverse fault ?

(48) What is the distinction between a mineral vein and a dike ?

(49) What is a horse in a vein ?

(50) What are the common gangue minerals ?

(51) How can the age of a rock deposit be judged ?

(52) What changes occur near the surface of veins ?

(53) What are placer deposits ?

(54) Has the wall rock any effect upon the contents of the vein ?

(55) What evidence is there that the material in veins was deposited from hot solutions ?

(56) Does depth have any effect upon the richness of mineral deposits ?

(57) What fossils occur in the Archean rocks ?

(58) In what age did fishes first appear in any considerable abundance ?

- (59) Why is the Carboniferous period frequently spoken of as the Coal period ?
- (60) What are pay chutes or chimneys ?
- (61) How does gold occur in nature ?
- (62) How does silver occur in nature ?
- (63) What are the requirements for a good iron ore ?
- (64) How does iron ore occur ?
- (65) What two general classes of copper ores are there ?
- (66) What are the uses for manganese ores ?
- (67) What can you say in regard to the occurrence of nickel and cobalt ?
- (68) What are the impurities which occur in coal, and what effect have they upon the value of the coal ?
- (69) What are the essential qualifications for a good building stone ?
- (70) Define pigments, and name two materials which are commonly classed under this head.
- (71) What is another name for graphite ?
- (72) For what is corundum used ?

PROSPECTING.

- (1) Define the term "ore."
- (2) How does the outcrop of a vein differ from the deeper parts and the surrounding country rock?
- (3) What is "float," and how does the prospector follow it up?
- (4) How is the outcrop of a vein sampled? Describe "quartering."
- (5) What is "booming"?
- (6) What are the dimensions of individual lode claims (a) in the United States? (b) in Canada?
- (7) What is the "discovery shaft," and how deep should it be for a valid location in the United States? How does the Canadian practice differ in this respect?
- (8) Show by diagram how a lode claim is staked (a) in the United States; (b) in Canada.
- (9) Give distinction between apex and outcrop of a vein.
- (10) How are the locator's rights limited (a) if the apex of the vein crosses one side line of a claim? (b) if the apex crosses both side lines? (c) if the apex departs from one side line twice? Give diagrams.
- (11) What assessment work is necessary to hold a lode claim?
- (12) Does a lode claim have to be rectangular? Make a sketch of a lode claim and describe it.
- (13) What are placer deposits, and how are they formed?
- (14) How are placer deposits prospected? Describe panning.

- (15) What are the dimensions of placer claims for individuals (*a*) in the United States? (*b*) in Canada?
- (16) How are placer claims located and recorded (*a*) in the United States? (*b*) in Canada?
- (17) Is the discoverer allowed to stake out a claim in eastern or southern United States?
- (18) From what formations are gems obtained?
- (19) Describe an outfit suitable for a prospector searching for gems.
- (20) How can you search for a lost vein underground (*a*) when pinched out? (*b*) when cut by a fault?
- (21) Why does one diamond-drill hole give no indication as to the dip of the formation passed through? Illustrate with a sketch.
- (22) Sketch an irregular ore-body and show a good arrangement of diamond-drill holes for prospecting the same.
- (23) What is magnetic prospecting, and how should it be carried on?
- (24) What are the two classes of mill sites? Describe each.
- (25) What are the dimensions of a tunnel site?
- (26) How is a tunnel site staked, and where is the location notice placed?
- (27) What are the rights of the locator of a tunnel site?
- (28) How is steel hardened? What is tempering?
- (29) What conditions determine the temper of tools?
- (30) What are the geological formations and prevailing ores of Arizona and California?
- (31) What are the main geological features (*a*) of Nevada? (*b*) of Utah?
- (32) What are the general geological features of the Black Hills of South Dakota, and what are the ores found there?

PLACER AND HYDRAULIC MINING.

- (1) Describe the method of formation of placer deposits.
- (2) What is the character of the country in which the most favorable conditions for the formation of placer deposits occur ?
- (3) How are placer deposits worked ?
- (4) What is hydraulicking ? Describe the operation.
- (5) How may slight leaks in pipes be stopped ?
- (6) How are iron pipes made and put together ?
- (7) What is an inverted siphon, and when is it employed ?
- (8) How is gold usually distributed in placer deposits ?
- (9) What are deep or ancient placers ?
- (10) Why can flumes be given a steeper grade than ditches ?
- (11) Describe booming.
- (12) How are deposits in frozen ground worked ?
- (13) Describe drifting and state under what conditions it is resorted to.
- (14) In hydraulic mining, how is the earth broken down and removed ?
- (15) How is a placer deposit prospected ?
- (16) In selecting a reservoir site, what points should be observed ? What should be the character of the ground ?
- (17) For what purposes are dams employed ?
- (18) Why are masonry dams not employed extensively in placer mining ?
- (19) Under what circumstances are earthen dams used ?
- (20) What are wasteways ?

- (21) How is flowing water measured ?
- (22) What is the miner's inch ?
- (23) What points should be observed in constructing a ditch line ?
- (24) What is the smallest cross-section of a ditch for a given discharge ? What is the "hydraulic depth" ?
- (25) In digging a ditch on a hillside, what precaution should be observed ?
- (26) What precaution should be observed in carrying a flume along a hillside ?
- (27) How are flumes constructed ? Mention special points to be observed in laying curves.
- (28) How may flumes be carried along the face of a cliff ?
- (29) Under what conditions are wooden and iron pipes, respectively, used ?
- (30) What precautions are to be observed in filling pipes ?
- (31) How are iron pipes treated to prevent rusting ?
- (32) For what purpose are air-valves employed ?
- (33) Describe the "Hydraulic Giant" and the action of the deflecting nozzle.
- (34) What is a batea ?
- (35) Describe the "Cradle or Rocker."
- (36) Describe the "Tom."
- (37) What are the conditions affecting the length and grade of sluices ?
- (38) When dredges are employed for working placer deposits, by what different methods may the bed-rock be cleaned ?
- (39) Name and describe the different kinds of riffles used in box sluicing.
- (40) What are undercurrents, and for what are they used ?
- (41) Describe an undercurrent, including the grizzly in the main sluice.

(42) Describe the method of blasting cement gravel banks.

(43) For what purposes are tunnels used in placer mining?

(44) Describe the method of charging sluices.

(45) Describe the operation of cleaning up a sluice and the preparation of amalgam for retorting.

(46) Describe the retorting of amalgam, giving the precautions which must be observed during the process.

(47) State how banks are caved, giving the precautions which must be observed during the process.

(48) For what class of deposits are dredges employed?

(49) Describe the Ludlum hydraulic gravel elevator.

(50) What form of joint is used at the junction of the supply pipe and one of the distributing pipes?

