

TS 1583

.P3

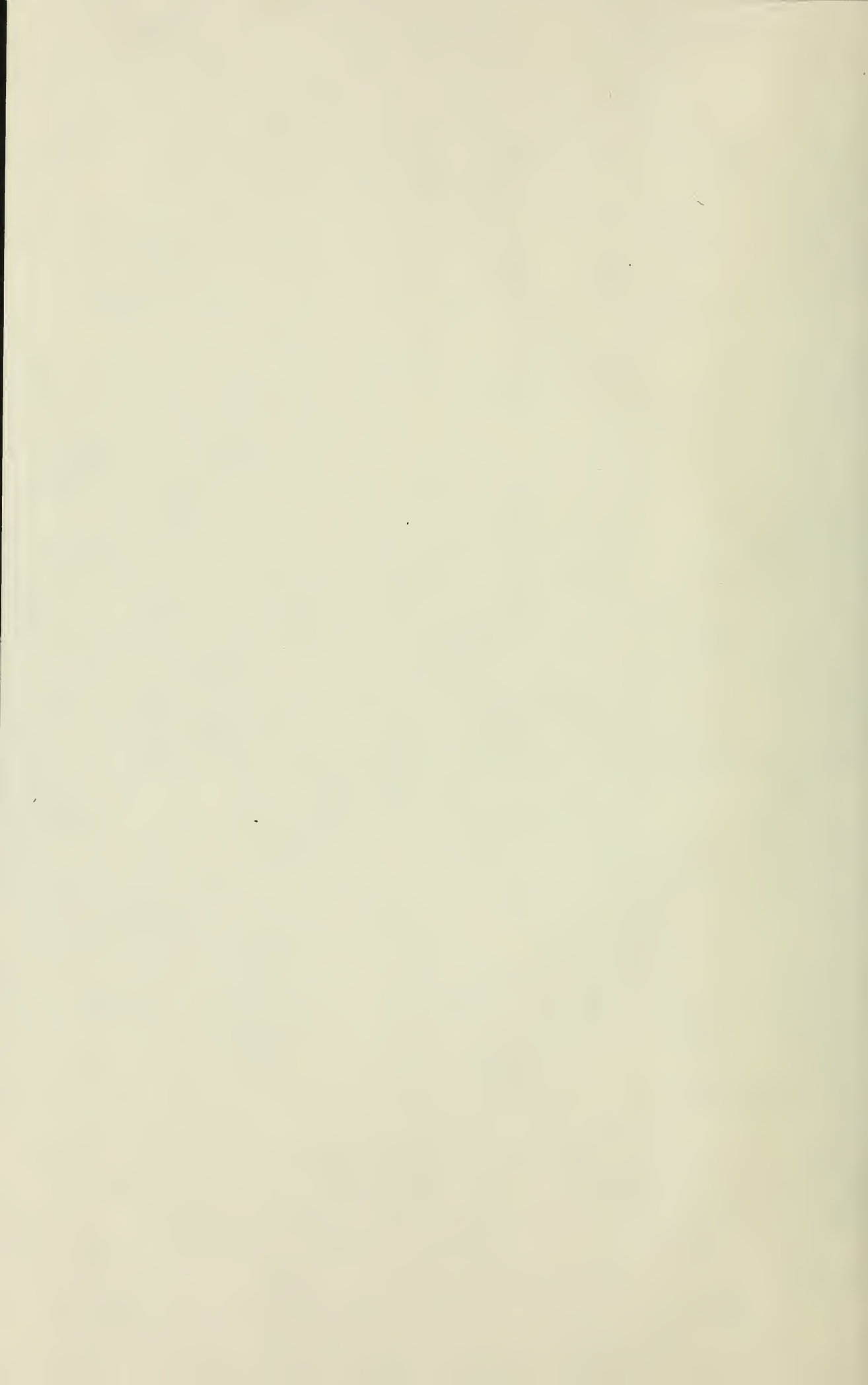

Cotton Mill Machinery Calculations.

A Complete, Comprehensive and Practical Treat-
ment of all Necessary Calculations on

Cotton Carding and Spinning Machines.

—BY—

ortholomew
B. M. PARKER, B. S.

Asst. Professor, Carding and Spinning, Textile Dept.
N. C. College of A. & M Arts.

PRICE \$1.50

Published by B. M. PARKER,
WEST RALEIGH, N. C.

WASHBURN PRESS
(RAY PRINTING CO.)
CHARLOTTE, N. C.

TS1583
.P3

13-9116

#150

PREFACE.

This book is intended to fill what, to the Author, has been a long-felt want, that is, a book that would give the practical calculations that are needed in running a cotton mill, from pickers to looms, in a simple, straight-forward manner, so as to be easily understood and mastered by any one who understands simple arithmetic.

It is, in great part, a reprint of a series of articles that were written for and printed by "Cotton" during the years 1911 and 1912, being entirely revised and somewhat enlarged, with the addition of numerous tables scattered throughout its length, and covering practically all the calculations, simple and otherwise, that any one would ever need in handling a modern mill.

Wherever possible, long tedious descriptions of individual mechanisms, peculiar to some one make or type of machine, have been omitted, as this was not the object in writing the book, but no pains have been spared to make the calculations complete yet simple and easily understood.

As will be noticed, the tables occurring at the end of the different chapters of the book, are mostly taken from the catalogues of some of the cotton mill machine builders and the Author wishes here to express his appreciation of their kindness in allowing the use of such tables.

Criticisms of this work, made in a spirit of friendliness, will be gladly received, as it is almost impossible to prevent the occurrence of a few mistakes.

With the above remarks, the work is submitted for the approval of the public and with the hope that it will be the means of bringing a more thorough understanding of the calculations used in the mill to some who have found them a little puzzling.

THE AUTHOR.

West Raleigh, N. C.

October, 1912.

Copyrighted February 1st, 1913
By B. M. Parker, B. S.,
West Raleigh, N. C.

TABLE OF CONTENTS.

	Page.
CHAPTER I—Discussion of Motion — Draft — Calculating Draft from Gearing—Actual and Figured Drafts Compared—Intermediate and Break Drafts.....	7
CHAPTER II—Calculations for Pickers — Draft—Speed—Length of Lap—Production Constant.....	15
CHAPTER III—Card Calculations—Draft—Doffer Speed—Use of Draft, Doffer Speed and Production Constants	32
CHAPTER IV—Combing Process—Calculations for Draft, Speed and Production on Sliver and Ribbon Lappers—Combers, Draft, Production and Waste Calculations—Production Constants	50
CHAPTER V—Railway Heads and Drawing Frames—Draft, Speed and Production Calculations—Metallic and Leather Rolls—Production Constants	69
CHAPTER VI—Hanks and Numbers	84
CHAPTER VII—Fly Frames—Draft—Roll Settings—Twist—Differential or Compound—Winding—Cones—Tension, Lay, Take-up or Bottom Cone and Taper Gearing—Production—Production Constant	92
CHAPTER VIII—Spinning—Draft, Twist, Speed—Production—Roll Setting—Average Numbers	126
CHAPTER IX—Twisting—Counts of Ply Yarns—Amount of Twist—Twist Calculations and Constant—Production Calculations and Constant	142
CHAPTER X—Organization—Draft Proportioning—Program of Drafts, Weights and Numbers—Machinery Equipment—Number of Looms.....	155

CHAPTER I.

DISCUSSION OF MOTION—DRAFT—CALCULATING DRAFT FROM GEARING—ACTUAL AND FIGURED DRAFTS COMPARED—INTERMEDIATE AND BREAK DRAFTS.

MOTION.

When two gears are meshed together, such as A and B, and motion is given to one, A, the speed of the other, B, will depend upon the speed of A, the number of teeth in A, and the number of teeth in B. If A and B have the same number of teeth, the speed of B will equal the speed of A. If A has twice the number of teeth of B, the speed of B will be twice the speed of A; and if B has twice the number of teeth of A, the speed of B will be one-half the speed of A. Suppose A to have 40 teeth and B 20 teeth, then the relative speed of B as compared with the speed of A, will be $40 \div 20$ or 2; and if A is making 10 revolutions per minute, the speed of B will be twice the speed of A or 20 revolutions per minute. If A had 90 teeth and B 30 teeth, then speed of B would have been three times the speed of A. If A was making 25 revolutions per minute, the speed of B would have been $3 \times 25 = 75$ revolutions per minute. In other words, the speed of B will always be to the speed of A, as the number of teeth in A is to the number of teeth in B.

Looking at this in another way, we can say that the speed of A, multiplied by the number of teeth in A, will always give a product that will be the same as the product of multiplying the speed of B by the number of teeth in B. Putting this in the form of a rule, we have:

The speed of A multiplied by the number of teeth in A, and this product divided by the number of teeth in B will give the speed of B.

This is always true and must be kept in mind in dealing with speed calculations. Taking the last problem above, the speed of B is found as follows:

$$\frac{25 \times 90}{30} = 75 \text{ revolutions per minute, speed of B.}$$

If gears A and B are separated by one or more intermediate gears, as shown in Fig. 1 the same statements hold good, as the intermediate gears C and D simply serve to transmit the motion of A to B, and will in no wise affect the speed of B regardless of

the number of teeth in either one of the intermediates. Such gears are used simply to fill in the space between A and B or to change the direction of motion of B, and are called "idler" or "carrier" gears. When a gear receives motion at its axis or center, by virtue of being attached to a revolving shaft, and conveys this motion, through its outer edge or rim, to another gear, it is a driving gear or driver; and any alteration in its speed or the number of teeth will directly affect the speed of all the gears controlled by it in the same proportion. In Fig. 1 A is a driving gear, and doubling its speed or number of teeth will double the speed of B.

When a gear receives motion at its outer edge or rim and conveys it thence to its axis, before affecting any other gear, it is a driven gear. In Fig. 1 B is a driven gear, and any change in the number of teeth of B will affect its speed in inverse ratio; as doubling the number of teeth of B will divide its speed by two, and consequently the speed of any gears controlled by the shaft on which B is located will be affected the same way.

When a gear receives motion on its outer rim and conveys it along its rim to another gear, it is an idler gear or "carrier." Any change in the number of teeth of such gear has no effect on the speed of any of the succeeding gears in the train. A gear may act

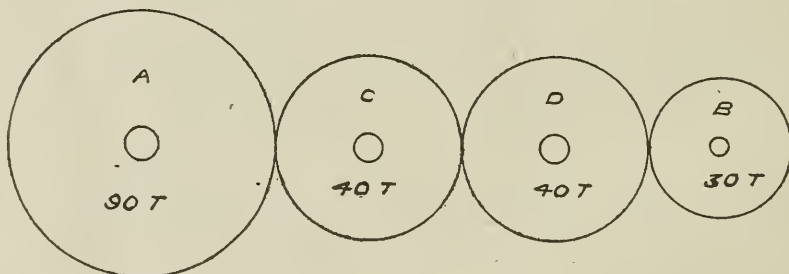

FIG. 1. DIAGRAM ILLUSTRATING A SIMPLE TRAIN OF GEARS IN MESH.

as a carrier in relation to one train of gearing and also as a driver or driven gear in relation to another train of gearing.

In the form of gearing shown in diagram Fig. 2 we have a different arrangement. A and B are connected by means of two gears C and D and a shaft E, the two gears C and D being fixed on the shaft E, which means that they will have the same speed regardless of the number of teeth they may have. The gears C and D are not carrier gears, as D receives motion at its rim from A and passes the motion to the shaft at its center, while C receives motion at its center from the shaft and transmits it to B at its rim.

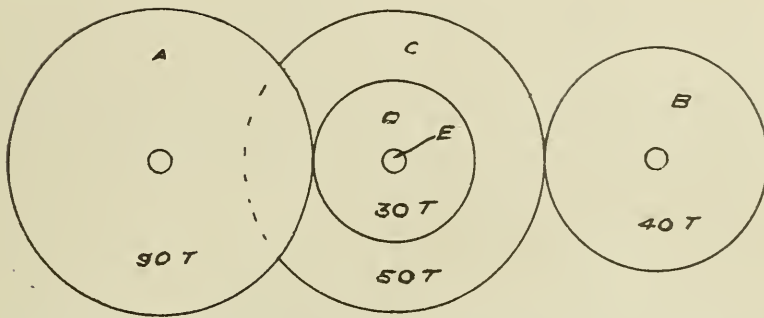

FIG. 2. DIAGRAM ILLUSTRATING A COMPOUND TRAIN OF GEARING IN MESH.

Suppose A to have 40 revolutions per minute; then the speed of D will be:

$$\frac{40 \times 90}{30} = 120 \text{ revolutions per minute.}$$

As the speed of D is 120, the speed of C will also be 120, and we can take this speed and follow the same rule and find the speed of B as follows:

$$\frac{120 \times 50}{40} = 150 \text{ revolutions per minute.}$$

Finding the speed of B in one operation is a matter of simply combining the two formulas as follows:

$$\frac{40 \times 90}{40} \times \frac{50}{40} = 150 \text{ revolutions per minute.}$$

In the above it will be seen that gears A and C are drivers, and D and B are driven gears.

PULLEY CALCULATIONS.

In dealing with pulleys the same statements and rules as for gears hold good, using the pulley diameters instead of the number of teeth.

Rule for pulleys:

Multiply together the speed of the driving pulley and its diameter, and divide by the diameter of the driven pulley. The quotient will be the speed of the driven pulley.

There are several ways of stating the above rule, but the one given is very simple. The main point to remember is that the product of the diameter and speed of the driving pulley in all cases

will be the same as the product of the speed and diameter of the driven pulley.

Example: Suppose the driving shaft in a mill to be running 300 revolutions per minute and has a 10 inch pulley on it driving a machine that has a 20 inch pulley on it. The revolutions per minute of the 20 inch pulley would be:

$$\frac{300 \times 10}{20} = 150 \text{ revolutions per minute.}$$

Suppose you knew the required speed of the shaft of the machine, the size of its pulley, and the speed of the driving shaft, and wanted to find the size of the pulley to put on the driving shaft. The products of the speeds and diameters must be equal, so that the product of the speed and diameter of the known pulley, divided by the speed of the required pulley, will give the diameter of the required pulley.

$$\frac{150 \times 20}{300} = 10 \text{ inches.}$$

So far we have dealt only with speeds of rotation expressed in revolutions per minute. In many calculations we use the surface or circumferential speeds of pulleys and different parts of machines. The circumference of any pulley or roll is equal to its diameter multiplied by 3.1416. The surface or circumferential speed of any pulley or roll is equal to its circumference multiplied by its revolutions per minute. In the preceding example, the pulley on the shaft would have a surface speed of:

$300 \times 10 \times 3.1416 = 9.425$ inches or 785.4 per minute. The pulley on the shaft of the machine must take up as much belt as is delivered by the pulley on the driving shaft, that is, its surface speed must be equal to the surface speed of the driving pulley, or 785.4 feet.

The preceding explanation should enable any one to understand all the calculations relating to speeds as they may come up later on.

DRAFT.

Every machine that operates on the cotton, from the time it is opened in the picker room until it is spun on bobbins in the spinning room in the shape of yarn, has a certain amount of draft. It will be well to find out exactly what draft is before we attempt to figure drafts on the machine. The object of draft in cotton mill machinery is to secure a gradual reduction of the mass of cotton as it is fed into the pickers to the size of the spun thread as it leaves the rolls of the spinning frame. Every machine has its part to

perform in reducing the bulk or weight. Draft, then, is a reduction in bulk or weight and a consequent increase in the length of the material under operation and is therefore the relative surface speed of the feed roll and delivery roll of the machine.

To illustrate: Suppose a machine receives cotton at the rate of 10 yards a minute and delivers it at the rate of 60 yards a minute, or six times the length it receives, the draft of the machine will be six, that is, for every yard received it would deliver six yards. It must be remembered, however, that as the length of the material increases, its weight per yard decreases; hence one yard at the front of the machine will weigh only one-sixth of the amount of the same length at the back of the machine. If the material entering the above machine weighed 60 grains per yard the total weight fed in per minute would be 600 grains. The machine must turn out the same weight in the same time as is fed into it, so there will have to be 600 grains fed out per minute, but this weight must be spread over the 60 yards instead of 10 yards and each yard will weigh only 10 grains or one-sixth of what it did when fed into the machine.

From the above it will be seen that the draft can be expressed in two ways:

(1) *Draft is the ratio between the weight per yard fed into and delivered by the machine, and can be found by dividing the total weight per yard entering the machine by the weight per yard delivered by the machine.*

(2) *Draft is the ratio of the surface speeds of the receiving and delivery rolls, and can be obtained by dividing the length delivered by the machine by the length fed into it in a given time.*

The drafts of the different machines depend upon the arrangement of the machinery and the layout of the mill. They may be varied in the machines within certain limits. Usually the smaller the mass of cotton being handled, the greater the draft.

CALCULATING DRAFT FROM THE GEARING.

There are different rules for finding draft. The method illustrated below will prove easy of application, suits the most complicated gearing found, needs no considering of driving and driven gears and, from actual experience, is found to be most easily understood and worked.

Draw a straight horizontal line, put the diameter of the front roll above the line, the number of teeth in the gear on the front roll under the line, the next gear meshing into it above the line, the next under. Continue this until the diameter of the back roll is reached which naturally comes under the line. Leave out all car-

rier gears in thus preparing for the calculation. Multiply together the figures above the line and divide this product by the product of all the figures under the line. The answer will be the draft of the machine.

The points to be noted are: Always start the calculation with the front roll diameter over the line and finish with the back roll diameter under the line. If all idler gears are left out of the calculation there will be the same number of figures above as below the line.

Fig. 3 represents three drawing rolls connected by gearing and illustrates the arrangement found on fly frames. Applying the rule just given we get the following:

$$\frac{1\frac{1}{8} \times 100 \times 56}{37 \times 34 \times 1} = 5 \text{ draft between front and back rolls.}$$

In all cases it will simplify matters to express the diameters of the two rolls in the same terms. In the above the $1\frac{1}{8}$ -inch front roll can be expressed as 9, and the back roll as 8.

In every train of draft gearing a "change" gear is located at some convenient point. By changing the size of the gear, the ratio between the surface speeds of the delivery and feed rolls is changed, thus changing the draft. This gear is spoken of as the draft change gear or draft gear. It is not necessary to work through the entire train of gearing every time a change in draft is desired

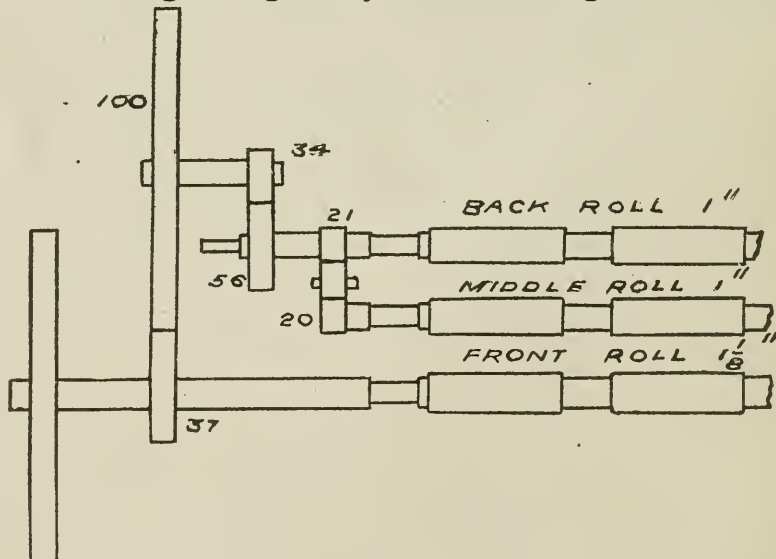

FIG. 3. DIAGRAM OF A TRAIN OF GEARS FOR DRAFTING ROLLS.

and the usual custom is to work out a draft factor or "constant" for the machine which, divided by the draft gear, will give the draft, or divided by the draft will give the draft gear. In Fig. 3

the 34 tooth gear is the draft gear. By leaving this gear out of the calculation for draft just given, but retaining all the other figures in the same relative positions, we get the draft constant, as follows:

$$\frac{9 \times 100 \times 56}{37 \times X \times 8} = 170.27 \text{ draft constant.}$$

To find the draft:

$$170.27 \div 34 = 5 \text{ draft.}$$

To find the draft gear:

$$170.27 \div 5 = 34 \text{ draft gear.}$$

From the above we get the following rules in regard to draft that apply to practically every machine in use in the mill:

$$\text{Constant} \div \text{draft} = \text{gear.}$$

$$\text{Constant} \div \text{gear} = \text{draft.}$$

$$\text{Draft} \times \text{gear} = \text{constant.}$$

INTERMEDIATE DRAFTS.

In the foregoing only the draft between the front and back rolls or the total draft has been considered. The total draft on every machine is split into two or more intermediate drafts. Referring to Fig. 3 there will be noticed two different drafts, namely, the draft occurring between the front and middle rolls and the draft occurring between the middle and back rolls. The draft between any two such intermediate points can be found by applying the foregoing rule, always considering the two points under discussion as the receiving and delivering rolls, regardless of their relative positions to the other rolls in the machine.

Figuring the draft between the front and middle rolls in Fig. 3, we get:

$$\frac{9 \times 100 \times 56 \times 20}{37 \times 34 \times 21 \times 8} = 4.77 \text{ draft.}$$

The draft between the middle and back rolls is found by same method.

$$\frac{1 \times 21}{20 \times 1} = 1.05 \text{ draft.}$$

In this case we must consider the middle roll as the delivery roll of the two. The product of all the intermediate drafts of any machine is equal to the total draft. Taking the two intermediate drafts above we find their product is 5, which is the same as the total draft previously figured.

BREAK DRAFT.

In changing the total draft of a machine by making a change in the size of the draft gear, we alter only one of the intermediate drafts, the other drafts in the machine remaining the same. In the above case any change in the draft gear will affect the total draft between the front and back rolls, but will not affect the draft between the middle and back rolls. To change the draft between these would require a change in the size of either the 20 or 21 tooth gears. This intermediate draft is spoken as the break draft to distinguish it from the other intermediate drafts.

TENSION DRAFT.

There is only a very slight draft occurring between certain points on machines in a mill which serves the purpose of keeping the material tight so there will be no undue sagging of the ends. These drafts are not enough to materially affect the total draft of the machine or the weight of the finished product. They are sometimes spoken of as tension drafts or more commonly referred to simply as tension.

CHAPTER II.

CALCULATIONS FOR PICKERS—DRAFT—SPEED—LENGTH OF LAP—
PRODUCTION—PRODUCTION CONSTANTS.

DRAFT OF PICKERS.

The draft of the breaker picker is small and seldom changed, any desired change in the weight of the breaker laps being usually secured by changing the amount of feed on the automatic feeder. The draft ranges between 1.5 and 2. The draft of the intermedi-

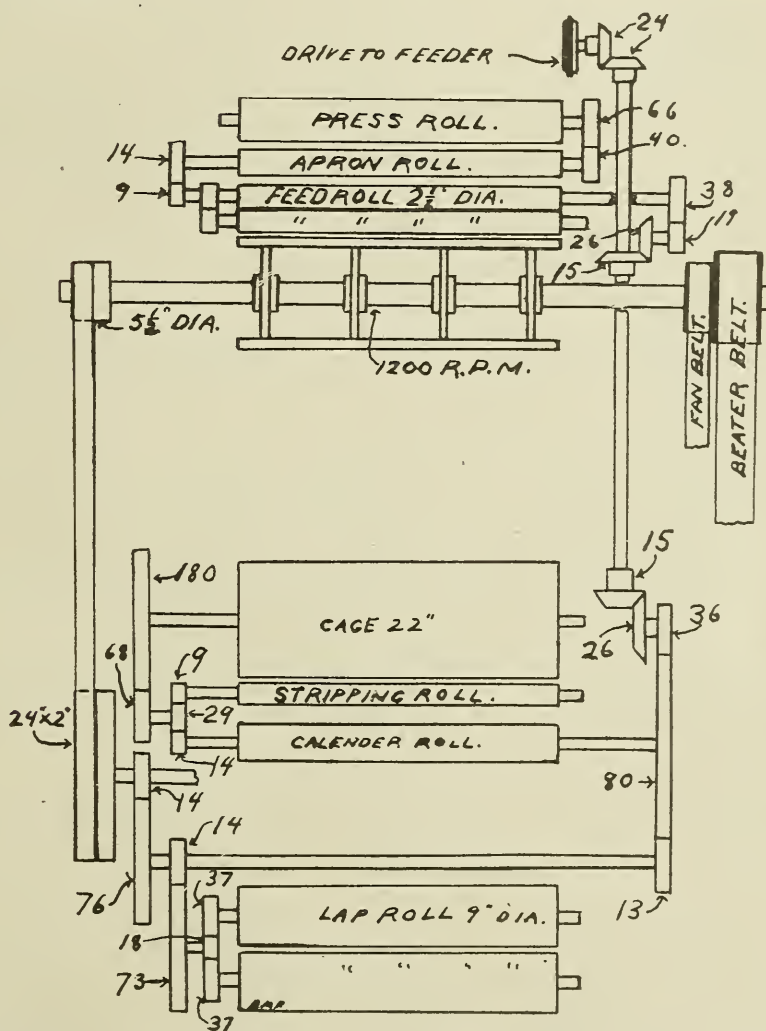

FIG. 4. DIAGRAM OF GEARING ON THE KITSON BREAKER PICKER.

ate and finisher pickers is about 4, with 4 laps fed in at the back and the evener belt driving at the middle of the cones.

Fig. 4 shows the gearing of the Kitson breaker picker. There

is no draft change gear on this machine.

To calculate the draft of the breaker picker from the gearing shown in Fig. 4, start with the 9 inch lap roll, placing it above the line, and alternate the gears below and above the line until the feed roll is reached, the latter coming under the line, as in figures used in the previous chapter:

$$\frac{9 \times 18 \times 14 \times 36 \times 15 \times 26 \times 38}{37 \times 73 \times 13 \times 26 \times 15 \times 19 \times 2.5} = 1.85 \text{ draft}$$

Fig. 5 shows the gearing plan of a Kitson intermediate picker or lapper with a two-bladed beater to revolve at 1500 R. P. M. The gearing for the finisher picker is the same as for the intermediate. To calculate the draft of the intermediate picker from the gearing shown in Fig 5, using a 23 tooth draft gear, start with the 9 inch lap roll, placing it above the line and proceeding as in the calculation on the breaker picker:

$$\frac{9 \times 18 \times 14 \times 14 \times 30 \times 54 \times 3.25 \times 85 \times 28 \times 12}{37 \times 73 \times 76 \times 23 \times 40 \times 10 \times 1 \times 20 \times 16 \times 2} = 3.95 \text{ draft.}$$

To work out a draft constant, use the same figures as above, but leaving out the 23 tooth draft gear and substituting X in its place, as follows:

$$\frac{9 \times 18 \times 14 \times 14 \times 30 \times 54 \times 3.25 \times 85 \times 28 \times 12}{37 \times 73 \times 76 \times X \times 40 \times 10 \times 1 \times 20 \times 16 \times 2} = 90.86.$$

As the draft gear comes under the line, the draft constant 90.86, must be divided by the draft gear to obtain the draft.

$$90.86 \div 23 = 3.95 \text{ draft.}$$

Now to find the correct gear to give any desired draft, divide the draft constant by the draft desired.

$$90.86 \div 3.95 = 23.1 \text{ or } 23 \text{ tooth draft gear.}$$

In all calculations in which the answer is the number of teeth in a gear, use a whole number as the final answer. A good rule to follow is to work out the answer to the first decimal and, if this fraction is less than .5, discard it, as in the above case, but increase the whole number by one in case the fraction is .5 or over. If the answer of the above calculation had been 23.5, we would have given it as 24 teeth. For all practical purposes 91 can be used, as the draft constant instead of 90.86, as the small amount of increase necessary to bring it to a whole number will not affect the results to any appreciable extent.

It will be noticed from Fig. 5, that any change in the size of the draft gear will affect the speed of the feed rolls only and will

not alter the speed of the cages, lap or calender rolls. A larger draft gear will drive the feed rolls faster and cause them to feed in more cotton, and thus lessen the draft. The largest portion of the draft on the pickers occurs between the feed rolls and the screens or cages, and any change in the total draft occurs between these two points. The drafts between the other intermediate points, such as cages to stripping rolls, stripping rolls to calen-

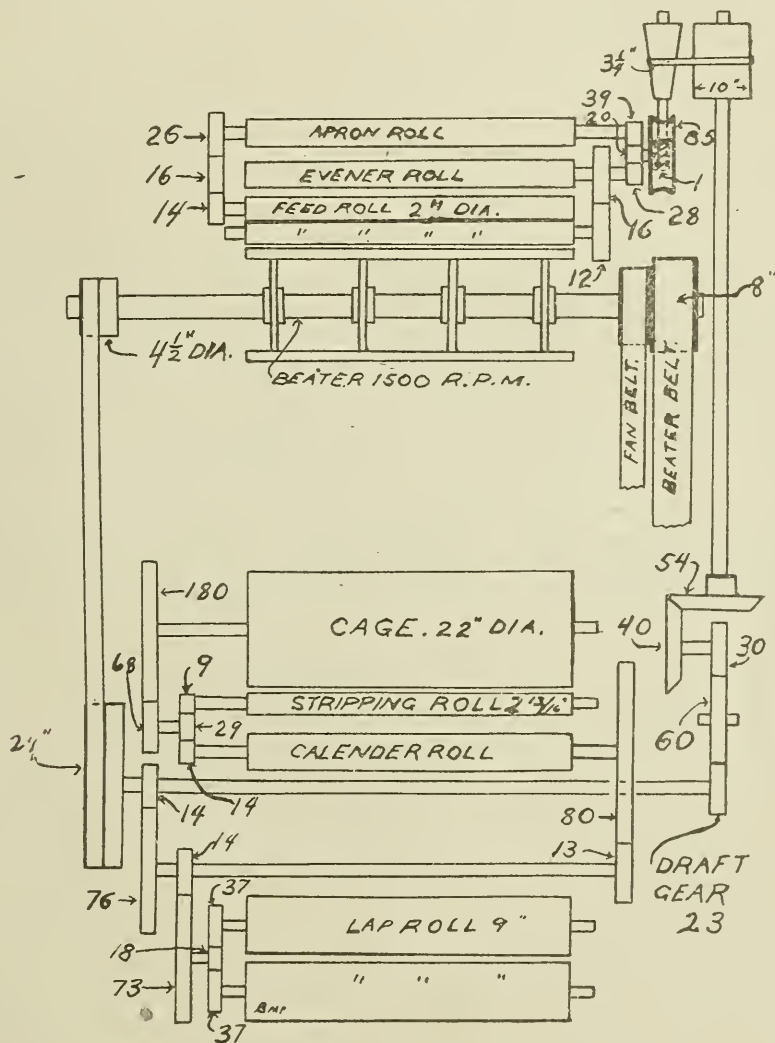

FIG. 5. DIAGRAM OF GEARING ON THE KITSON FINISHER PICKER.

der rolls and calender rolls to lap rolls, are very small. These drafts are spoken of as tension and only serve the purpose of keeping the material tight as it is passed through the machine. Considering the cages as the delivery rolls and working back to

the feed rolls, using the same method as before, we get the following:

$$\frac{22 \times 68 \times 14 \times 13 \times 14 \times 30 \times 54 \times 3.25 \times 85 \times 28 \times 12}{180 \times 29 \times 80 \times 76 \times 23 \times 40 \times 10 \times 1 \times 20 \times 16 \times 2} = 3.07 \text{ draft between the cages and the feed rolls.}$$

Not considering the tension draft between the different points, we can get the draft between the cages and the lap rolls by the following calculation:

$$\frac{9 \times 18 \times 14 \times 80 \times 29 \times 180}{37 \times 73 \times 13 \times 14 \times 68 \times 22} = 1.29 \text{ draft.}$$

The product of these two intermediate drafts will be the total draft, thus:

$$3.07 \times 1.29 = 3.96 \text{ total draft.}$$

By similar figuring, it is possible to work out all the intermediate drafts or find the draft between any two points on the machine. In the above figuring, the cone or evener belt is considered to be working in the middle of the cones, as this is considered best by most carders. The diameter of the driven cone at this point is 3.25 inches. The numeral 1 in the calculation is the single worm on the end of the driving cone. Some carders prefer to run the cone belt about one-third the distance from the large end of the driven cone. In this case the diameter of the cone can be taken as 4. This would give a draft constant of 112, and a 23 tooth draft gear would give a draft of 4.87 instead of 3.95.

It is seldom necessary to change the draft gear on the pickers, because the cone drive to the feed rolls permits of such wide variations in draft by simply moving the evener belt. The range of drafts used also is small and any radical change desired in the weight of finished laps is usually made in the feed of the machine.

In figuring the draft from the weight of cotton being fed into and delivered by the machine, the rule is:

Divide the weight going in at the back by the weight coming out at the front.

Example: There are four laps on the apron of the picker, each weighing 14 ounces per yard. The lap delivered weighs 14.5 ounces per yard. What is the draft?

$$\frac{4 \times 14}{14.5} = 3.76 \text{ draft.}$$

Draft thus figured from the actual weight on the front and back of a machine, is spoken of as actual draft and, on every machine that produces waste, the actual draft is larger than the figured draft obtained from the gearing. In other words the actual

draft is the ratio between the weight fed into the machine and the weight delivered from the machine. It takes into account any loss of cotton in the form of waste that may occur between the feed and delivery rolls. Figured draft is the ratio between the surface speeds of the delivery roll and feed roll, and remains the same regardless of the amount of cotton lost in the form of waste.

On the pickers we can count on losing about 3 per cent. or more as waste of the total amount of cotton fed into the machine, depending upon the grade of cotton being handled and the cleanliness desired in the finished product. Now if the picker takes out 3 per cent. waste, the amount delivered from the machine will represent 97 per cent. of the amount fed into the machine. Then the amount going in at the back must be decreased by the amount of waste made before we can figure the actual weight at the front.

To illustrate this point: If we figure the draft of the picker from the gearing to be 3.95, and there are 4 laps on the apron each weighing 16 ounces per yard, then the following* should give the theoretical weight of lap at the front.

$$\frac{4 \times 16}{3.95} = 16.2 \text{ ounces per yard.}$$

Now to allow for the loss in weight, on account of the 3 per cent. waste taken out, we must multiply the weight at the back by .97, and then find what the weight on the front will be:

$$\frac{16 \times 4 \times .97}{3.95} = 15.71 \text{ ounces per yard.}$$

The actual draft of the machine figured from the weight on the front and the back would be this:

$$\frac{16 \times 4}{15.71} = 4.07 \text{ draft.}$$

It will be seen from the above that using a 23 tooth gear which we have figured to give us a draft of 3.95 with 16 ounce laps on back and a loss of 3 per cent. waste, we would actually have a draft of 4.07 and the lap would weigh 15.71 ounces per yard instead of 16.2 ounces per yard. In actual practice this would not make any difference, as the correct weight of laps would be obtained by a slight change in position of the evener belt.

In the same way in finding the weight of laps on the apron of the picker from the weight at the front and the figured draft, we must allow for the loss of waste in order to be absolutely accurate.

Example: The weight of the lap at the front is 15.71 ounces per yard, the waste is 3 per cent., and the figured draft is 3.95. What is the weight of the lap at the back of the picker?

$$\frac{15.71 \times 3.95}{4 \times 97} = 16 \text{ ounces, weight of lap on apron.}$$

The principles underlying these two problems can be expressed in the following formulas, understanding that the draft used is the figured draft and not the actual draft:

To find the weight of the lap at the front:

$$\frac{\text{Wt. at back} \times \text{doublings} \times 1 \text{ less per cent. of waste}}{\text{draft}}$$

To find the weight at the back:

$$\frac{\text{Wt. at front} \times \text{draft}}{\text{doublings} \times 1 \text{ less per cent. of waste}}$$

The expression, 1 less per cent. of waste, is easily explained if we remember that the percentage of waste can be expressed decimally as well as the way given, as 3 per cent. can be expressed as .03 and will have the same value. Now the .97 used in working the two problems equals 1 minus .03 equals .97. If the machine makes 4 per cent. waste, we would use .96 in the formula.

SPEED.

The two-bladed beater usually revolves at 1,500 R. P. M. while the three-bladed beater is run at about 1,200 R. P. M. If the Kirschner carding beater is used, it should revolve at about 1,500 R. P. M. The fan runs from 900 to 1,050 R. P. M., depending upon the amount of waste desired. The speed of the lap rolls varies from 4.5 to 9 R. P. M. In getting the speed of any revolving part of the picker, it is well to bear in mind that the product of the driving pulley multiplied by its diameter, in every case, will be equal to the product of the driven pulley multiplied by its diameter.

To find the speed of the beater shown in Fig. 5 when the main shaft speed is 325 R. P. M.: The pulley on the main shaft driving the picker being 28 inches in diameter, the pulley on the picker counter shaft being 18 inches in diameter, the large pulley on the counter which drives the beater being 24 inches, and the pulley on the beater shaft 8 inches in diameter.

Starting with the speed of the main shaft, we get the following:

$$\frac{325 \times 28 \times 24}{18 \times 8} = 1,516 \text{ R. P. M. of beater.}$$

This can be considered as 1,500, as the slippage in the belts is liable to bring it down to that figure.

The speed of the fan can be obtained as follows: The fan pulley is 8 inches in diameter and the pulley on the beater shaft driving the fan is five inches in diameter.

$$\frac{1,500 \times 5}{8} = 937.5 \text{ R. P. M. of fan.}$$

In figuring the speed of the lap rolls, we must start with the $4\frac{1}{2}$ inch pulley on the end of the beater shaft. This is called the speed pulley, and the size of this pulley controls the production of the picker. Changing the size of this pulley changes the speed of every part of the machine, except the beater and fan. A larger pulley drives the machine faster, thus increasing the production.

The following calculation will give the speed of the lap rolls:

$$\frac{1500 \times 4.5 \times 14 \times 14 \times 18}{24 \times 76 \times 73 \times 37} = 4.83 \text{ R. P. M.}$$

In the above, the diameter of the pulley and the teeth in the gears are used together in the same calculation, as, in either case, they are used to express the relation between the different parts being considered, and it makes no difference whether this relation is expressed in diameters or teeth.

LENGTH OF LAP.

The total weight of the finished lap is governed by the number of yards it contains. It is measured by the revolutions of the lap rolls, the picker automatically stopping after the required number of yards are wound. The regulating device is called the knock-off, a plan of the gearing of same being shown in Fig. 6. The knock-off or lap gear makes 1 revolution for each lap wound. Thus any change made in the size of the knock-off gear will give a corresponding change in the number of yards in the lap; a larger gear will give more yards in the lap, a smaller gear less.

The lap rolls are 9 inches in diameter or 28.27 inches in circumference and will have to make 1.27 revolutions to wind up one yard of lap. Now if we start with the one revolution of the knock-off gear, while the lap is forming, and figure around to the 9 inch lap roll (see Fig. 6), we would get the number of revolutions of the lap roll while the lap is forming. Then, as the lap roll has to make 1.27 revolutions to wind one yard, if we divide this by 1.27 we would get the number of yards in the lap, as follows:

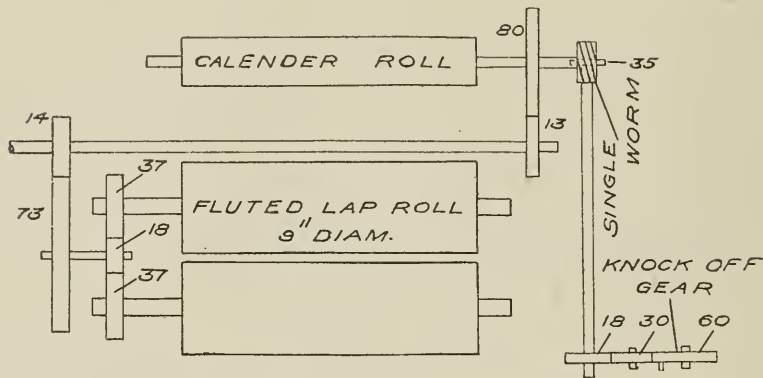

FIG. 6. DIAGRAM OF KNOCK-OFF GEARING.

$$\frac{1 \times 60 \times 35 \times 80 \times 14 \times 18}{18 \times 1 \times 13 \times 73 \times 37 \times 1.27} = 52.74 \text{ yards in lap.}$$

We can get the knock-off constant by the same method as above, by simply leaving out the knock-off gear, thus:

$$\frac{1 \times X \times 35 \times 80 \times 14 \times 18}{18 \times 1 \times 13 \times 73 \times 37 \times 1.27} = .879 \text{ constant.}$$

The change gear appears above the line in this case, and the constant must be multiplied by the gear to get the number of yards per lap, thus:

$$.879 \times 60 = 52.74 \text{ yards in lap.}$$

To find the number of teeth in the knock-off gear to give any desired number of yards in the lap:

Divide the number of yards in the lap by the knock-off constant.

$$52.74 \div .879 = 60 \text{ teeth in knock-off gear.}$$

PRODUCTION.

An intermediate or finisher picker will produce from 1,500 to 2,500 pounds of laps per day of 10 hours, while the breaker picker will produce from 2,500 to 4,000 pounds of laps a day. Where good clean laps are desired for the cards the lower productions are recommended. The production of a picker depends upon the speed of the lap rolls, the weight per yard of the lap and the time lost in taking off the full laps, cleaning up, etc.

Suppose the picker is delivering a 14 ounce lap, and the lap rolls are making 6 R. P. M. Allowing 20 per cent loss of time, what would be the production in a 10 hour day?

The lap roll is 9 inches in diameter and its circumference is $9 \times 3.1416 = 28.27$ inches. It makes 6 R. P. M., so every minute it will deliver $6 \times 28.27 = 169.62$ inches of lap or 10,177.2 inches an hour. In a 10 hour day it will deliver $10,177.2 \times 10 = 101,772$ inches; or 2,827 yards of lap. Each yard weighs 14 ounces, so in a day there will be $2,827 \times 14 = 35,578$ ounces of lap delivered. From this we must take the 20 per cent. loss of time, therefore $35,578 \times .80 = 31,662.4$ ounces actually produced. Then $31,662.4 \div 16 = 1,987.9$ pounds produced per day. This calculation has been given in detail, so that all steps necessary will be clearly seen and understood.

All production calculations are based on the same principles and differ only in the terms used. The above allowance of 20 per cent. loss of time is ample for all necessary stoppages and may be considered too high by some, but it is far better to make an error on the side of too little production in our calculations than too much.

The above production problem can be expressed in one formula showing at a glance every step taken to get the answer, thus:

$$\frac{9 \times 3.1416 \times 6 \times 60 \times 10 \times .80 \times 14}{36 \times 16} = 1978.9 \text{ pounds.}$$

In the above problem we can consider everything as fixed except the speed of the lap rolls and the weight of the lap. The speed of the lap rolls varies with the size of the speed pulley to give different productions. The weight of the lap may vary from 10 to 16 ounces per yard, so, if we leave these two variable quantities out of the production calculation, and use the remaining figures in the formula, we get a production factor or constant:

$$\frac{9 \times 3.1416 \times X \times 60 \times 10 \times .80 \times X}{36 \times 16} = 23.56 \text{ production constant.}$$

Rule for using production constant:

• *Multiply the constant by the weight per yard of lap in ounces and by the R. P. M. of the lap rolls.*

The above constant is based on a 10 hour day with an allowance of 20 per cent. loss of time. Using constants of this character on the different machines in the mill will greatly simplify the work necessary in figuring the production. A small speed indicator is a great convenience in finding the actual speeds of the different machines in the mill under working conditions. With it the speed of any machine or revolving part of the machine can be found.

There are other methods in use for figuring production on pickers with the same idea in view of simplifying the work. The two following rules are taken from the Kitson catalogue and will give correct answers.

Rule to find the production of a picker for a day of 10 hours, allowing 10 per cent. loss of time:

Multiply the weight of lap in ounces per yard by the R. P. M. of beater and by the diameter of the feed pulley and divide this product by 52.

Example: The weight of lap is 13 ounces per yard; beater speed is 1,500 R. P. M.; and the feed pulley is 6 inches in diameter. What is the production?

$$\frac{13 \times 1,500 \times 6}{52} = 2,250 \text{ pounds, a day.}$$

Rule to find the diameter of the feed pulley needed to give any number of pounds a day:

Multiply the number of pounds wanted by 52, and divide by the product of the weight of lap in ounces per yard, multiplied by the R. P. M. of beater.

Example: How large a feed pulley will be needed to produce 2,250 pounds a day, if the lap weighs 13 ounces a yard and the beater speed is 1,500 R. P. M.?

$$\frac{2,250 \times 52}{1,500 \times 13} = 6 \text{ inches, diameter of feed pulley.}$$

In using the above short rules for production, remember that the constant 52 is figured for a 10 hour day with an allowance of 10 per cent. for loss of time.

ATHERTON FINISHER PICKER.

Fig. 7 shows the draft gearing of the Atherton finisher picker. These machines were formerly built by the A. T. Atherton Machine Co., Pawtucket, R. I. The company has since sold out to the Kitson Machine Shop, Lowell, Mass.

The calculation for draft is given below, considering the evener belt to be working at the middle of the cones, where the diameter of the two are the same and they have no affect on the draft, both running at the same speed:

$$\frac{9 \times 13 \times 15 \times 20 \times 20 \times 22 \times 90 \times 24}{54 \times 72 \times 52 \times 40 \times 50 \times 1 \times 7 \times 3} = 3.93 \text{ draft.}$$

Omitting the draft gear of 22 teeth, but using the remainder of the formula, will give the draft constant:

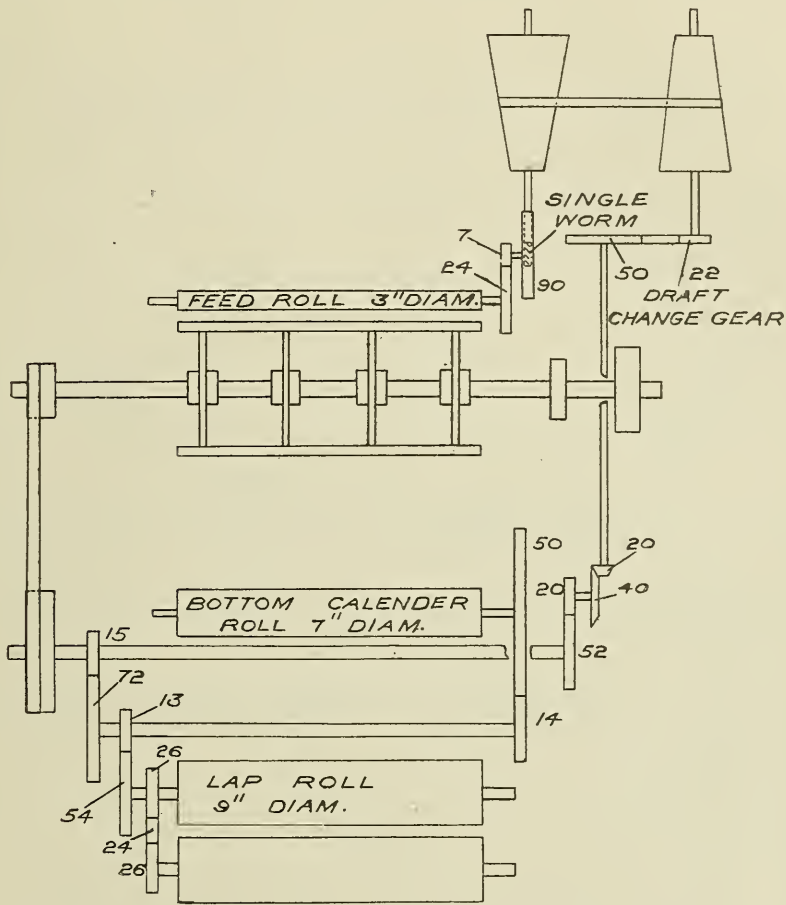

FIG. 7. DIAGRAM OF DRAFT GEARING OF ATHERTON FINISHER PICKER.

$$\frac{9 \times 13 \times 15 \times 20 \times 20 \times X \times 90 \times 24}{54 \times 72 \times 52 \times 40 \times 50 \times 1 \times 7 \times 3} = .78 \text{ draft constant.}$$

In this case a different arrangement is found from the usual rule in that the draft gear occurs above the line. This necessitates a different handling of the draft constant.

Rule to find draft:

Multiply the draft constant by the gear.

Rule to find draft gear:

Divide the draft by the constant.

The knock-off gearing used on the Atherton picker is shown in Fig. 8. The following gives the length of lap, starting with one revolution of the knock-off gear:

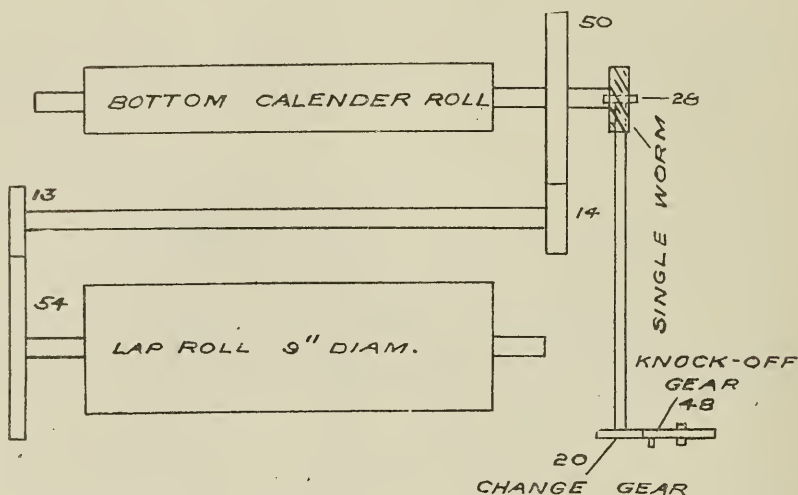

FIG. 8. DIAGRAM OF KNOCK-OFF GEARING ON ATHERTON PICKER.

$$\frac{1 \times 48 \times 28 \times 50 \times 13}{20 \times 1 \times 14 \times 54 \times 1.27} = 45.5 \text{ yards in lap.}$$

Leaving out the change gear of 20 teeth, will give the knock-off or lap constant.

$$\frac{1 \times 48 \times 28 \times 50 \times 13}{X \times 1 \times 14 \times 54 \times 1.27} = 90.98 \text{ constant.}$$

This constant of 90.98 can be used in figuring the number of yards in the lap without making the long calculation, but in this case as the change gear of 20 teeth comes under the line, the constant must be treated differently from the one worked out on the Kitson picker.

Rule for using lap factor on Atherton pickers:

Constant \div *teeth in change gear* = *number of yards in lap.*

Constant \div *number of yards in lap* = *number of teeth in change gear.*

HOWARD AND BULLOUGH PICKER.

A gearing plan of a Howard and Bullough intermediate and finisher picker is shown in Fig. 9. The normal working position of the evener belt recommended by the builders is about 5 inches from the large end of the top cone. At this point the ratio of the diameters of the two cones is 1.6 to 1, so we can use this ratio in place of the actual diameters. The following figures give the draft, treating the double threaded worm as a gear of two teeth:

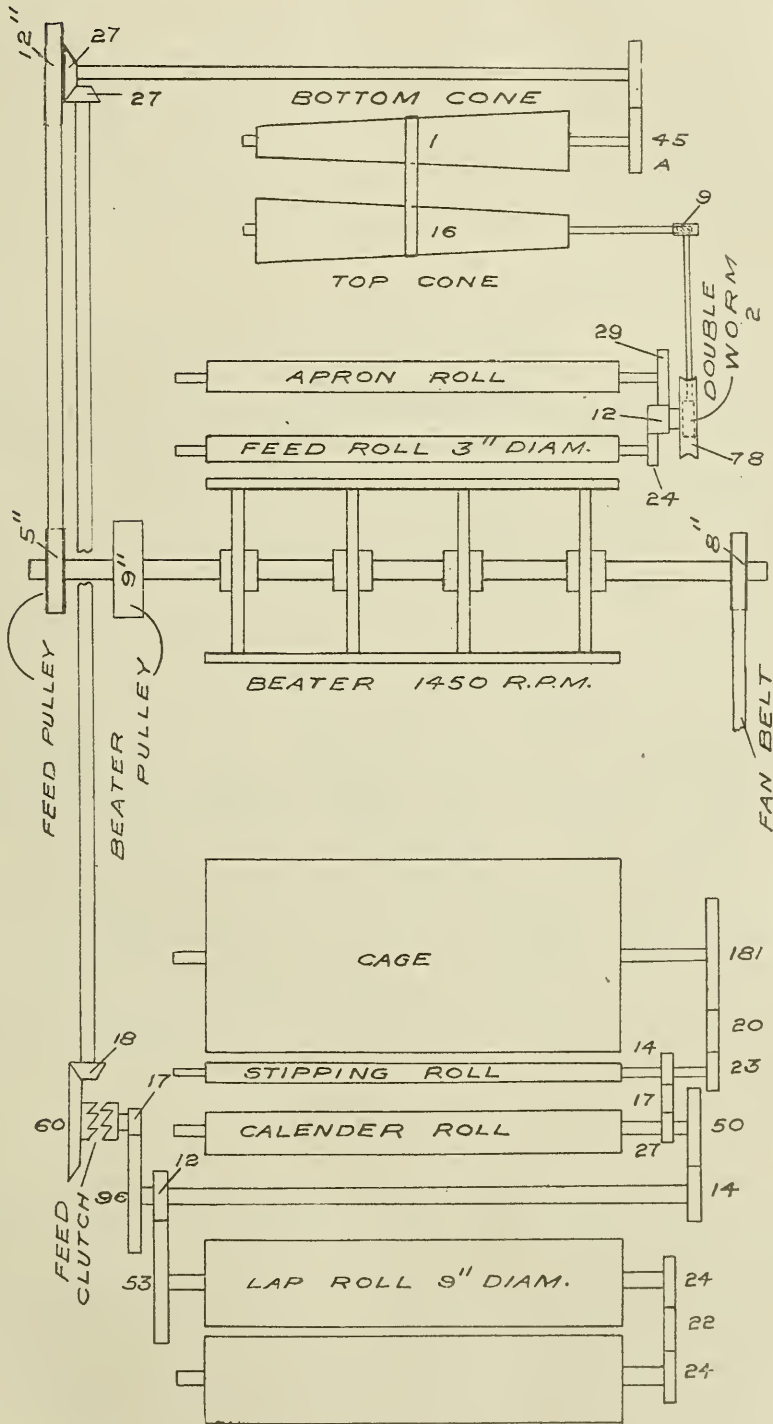

FIG. 9. GEARING PLAN OF HOWARD & BULLOUGH FINISHER PICKER.

$$\frac{9 \times 12 \times 17 \times 18 \times 27 \times 45 \times 1.6 \times 9 \times 78 \times 24}{53 \times 96 \times 60 \times 27 \times 45 \times 1 \times 9 \times 2 \times 12 \times 3} = 4.5 \text{ draft.}$$

The gear on the end of the cross shaft, lettered A, and the one on the bottom cone, lettered B, are both change gears, and, in changing the draft, both of these gears have to be changed. The sum of the number of teeth in both gears must always be 90.

The draft constant is found as follows, leaving out the gears A and B:

$$\frac{9 \times 12 \times 17 \times 18 \times 27 \times X \times 1.6 \times 9 \times 78 \times 24}{53 \times 96 \times 60 \times 27 \times X \times 1 \times 9 \times 2 \times 12 \times 2} = 4.5 \text{ draft constant.}$$

Rules for finding the draft on Howard & Bullough pickers:

Multiply the draft constant by the gear A, and divide the result by the gear B.

The draft constant divided by the draft required will equal the change gear B divided by the change gear A.

Example: What gears will be needed to give a draft of 3.6?

$$4.5 \div 3.6 = 1.25.$$

Then $B \div A = 1.25$ or B must be one-fourth larger than A, that is the ratio between the two must be 5 to 4; then B will have 50 teeth and A will have 40 teeth. If the evener belt is worked in the middle of the cones, which is the more common rule, the cone diameters will be equal; both will run at the same speed and have no effect upon the draft. In this case the draft will be considerably reduced, being only 2.81 with the change gears of 45 teeth at A and B, instead of a draft of 4.5. The draft constant in this position of belt would be 2.81. With the cone belt at the middle of the cones, a draft of 4 would call for a 53 tooth gear at A on the bottom cone, and a 37 tooth gear at B on the cross shaft.

$$\frac{2.81 \times 53}{37} = 4.02 \text{ draft.}$$

It is evident from this that, except when unusual conditions make it absolutely necessary to change these gears, they will very likely never be altered.

The lap gearing of the Howard & Bullough picker is so arranged that the number of teeth in the knock-off gear corresponds to the number of yards in the lap. This arrangement is very convenient, calling for no figuring to calculate the length of lap or of the size of gear to use.

The following short rule is taken from the catalogue of the Howard & Bullough machines and gives the pounds produced in

a 10 hour day, allowing a loss of 10 per cent. for stops, and a beater speed of 1,450 R. P. M.:

Multiply 38.5 by the diameter of the feed pulley and this by the ounces per yard in the lap.

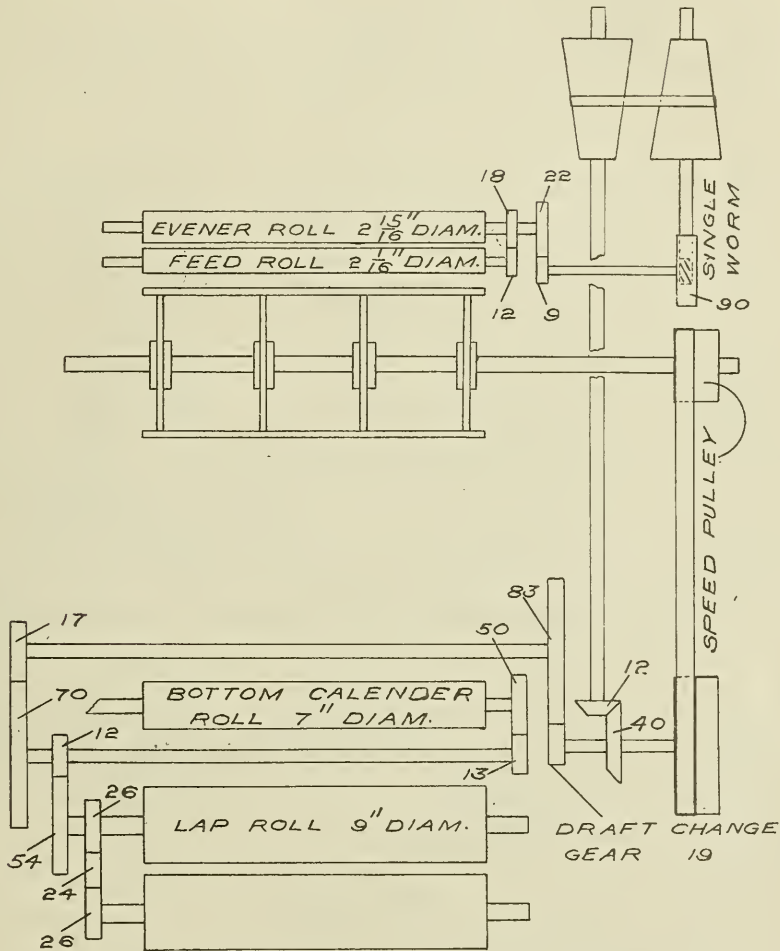

FIG. 10. DIAGRAM OF GEARING OF POTTER & JOHNSTON FINISHER PICKER.

POTTER AND JOHNSTON PICKERS.

The gearing diagram of the Potter & Johnston intermediate and finisher picker is shown in Fig. 10. This is a new machine on the market. The draft calculation is given below, considering the evener belt to be in the middle of the cones or on equal diameters:

$$\frac{9 \times 12 \times 17 \times 19 \times 12 \times 90 \times 22 \times 12}{54 \times 70 \times 83 \times 40 \times 1 \times 9 \times 18 \times 2 \frac{1}{16}} = 3.95 \text{ draft.}$$

$$54 \times 70 \times 83 \times 40 \times 1 \times 9 \times 18 \times 2 \frac{1}{16}$$

Using the above formula but leaving out the draft gear of 19

teeth, which comes above the line, we get the draft constant:

$$\frac{9 \times 12 \times 17 \times X \times 12 \times 90 \times 22 \times 12}{54 \times 70 \times 83 \times 40 \times 1 \times 9 \times 18 \times 2 \frac{1}{16}} = .208 \text{ draft constant.}$$

Rule for using draft constant:

Constant multiplied by the gear will give the draft.

Draft divided by the constant will give the gear.

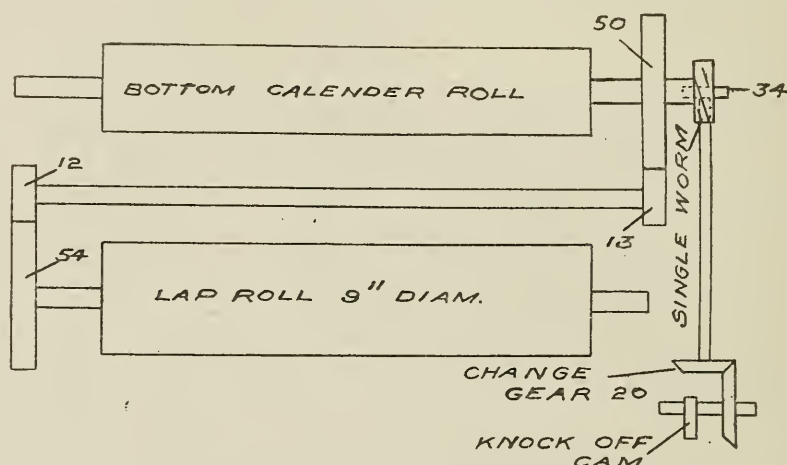

FIG. 11. KNOCK-OFF GEARING ON POTTER & JOHNSTON PICKER.

The lap gearing for the Potter & Johnston picker is shown in Fig. 11. The method of finding the constant and length of lap is the same as that given above.

Example: Find length of lap:

$$\frac{1 \times 40 \times 34 \times 50 \times 12}{20 \times 1 \times 13 \times 54 \times 1.27} = 45.76 \text{ yards in lap.}$$

To find knock-off constant:

$$\frac{1 \times 40 \times 34 \times 50 \times 12}{X \times 1 \times 34 \times 54 \times 1.27} = 915.2 \text{ constant.}$$

Rules for using knock-off factor on this machine:

Constant \div gear = yards in lap.

Constant \div yards in lap = teeth in gear.

In operating any of the foregoing machines, the production can be easily calculated by using the production constant of 23.56 given above and based on the speed of the 9 inch lap roll and the weight of lap.

Constant \times R. P. M. of lap roll \times ounces per yard in lap = pounds per day of 10 hours, allowing 20 per cent. for loss of time.

PRODUCTION TABLE

Weight of Lap in Ounces per Yard

Diameter of Feed Pulley in Inches	Weight of Lap in Ounces per Yard																		
	8	9	10	10½	11	11½	12	12½	13	13½	14	14½	15	15½	16	16½	17	17½	18
4	920	1040	1150	1210	1270	1330	1380	1440	1500	1560	1610	1670	1730	1790	1850	1900	1960	2020	2080
4½	1040	1170	1300	1360	1430	1490	1560	1620	1690	1750	1820	1880	1950	2010	2080	2140	2210	2270	2340
5	1150	1300	1440	1510	1590	1660	1730	1800	1870	1950	2020	2090	2160	2240	2310	2380	2450	2520	2600
5½	1270	1430	1590	1670	1740	1820	1900	1980	2060	2140	2220	2300	2380	2460	2540	2620	2700	2780	2850
6	1380	1560	1730	1820	1900	1990	2080	2160	2250	2340	2420	2510	2600	2680	2770	2850	2940	3030	3110
6½	1500	1690	1870	1970	2060	2160	2250	2340	2440	2530	2620	2720	2810	2910	3000	3090	3190	3280	3370
7	1610	1820	2020	2120	2220	2320	2420	2520	2620	2720	2830	2930	3030	3130	3230	3330	3430	3530	3630
7½	1730	1950	2160	2270	2380	2490	2600	2700	2810	2920	3030	3140	3240	3350	3460	3570	3680	3790	3890
8	1850	2080	2310	2420	2540	2650	2770	2880	3000	3110	3230	3340	3460	3580	3690	3810	3920	4040	4150
8½	1960	2210	2450	2570	2700	2820	2940	3060	3190	3310	3430	3550	3680	3800	3920	4040	4170	4290	4410
9	2080	2340	2600	2730	2850	2980	3110	3240	3370	3500	3630	3760	3900	4020	4150	4280	4410	4540	4670

USED BY PERMISSION OF KITSON MACHINE SHOP

10 per cent allowed for stoppages.
 Revolutions per minute of beater, 1500.
 10 hours in a day

NOTE.—The diameter of the feed pulley multiplied by 1.07 will give the speed of the 9 inch lap roll.

CHAPTER III.

CARD CALCULATIONS—DRAFT—DOFFER SPEED—USE OF DRAFT,
DOFFER SPEED AND PRODUCTION CONSTANTS.

In looking at the gearing diagrams of the cards shown, it will be noticed that they are all very similar. In all cases a change from a small to a larger draft gear will drive the feed roll faster, feeding in more stock and thus decreasing the draft of the machine and increasing the weight of the sliver delivered. An opposite change would give opposite results. In dealing with the draft constant of the cards the following rules apply:

Draft constant divided by the draft equals the gear to use.

Draft constant divided by the gear equals the draft of the card.

In the doffer speed gearing we find a similarity. About the only noticeable difference is in the gearing between the barrow pulley and the doffer. On all cards a change from a small to a large doffer change gear will drive the doffer faster, thus increasing the production of the card, by causing it to deliver a greater length of sliver, but not affecting the weight of the sliver per yard. This change gear is also called the production gear or the speed gear, and in all cases directly controls the production of the card.

It will be understood from the above, that any desired change in the weight of the card sliver will be secured by a change in the size of the draft change gear and any change in the total production of the card will be secured by a change in the doffer change gear. The following rules for the use of the doffer speed constant hold good on all cards:

Speed constant multiplied by the teeth in the change gear gives the speed of the doffer.

The doffer speed divided by the constant gives the size gear to use.

The standard speed for card cylinders is 165 revolutions per minute, and in most cases they are run at this speed. The cylinders are built fifty inches in diameter and forty inches or forty five inches across the face. The driving pulleys are made twenty inches in diameter. The draft of the card varies from 80 to 125, with 100 considered as an average draft. The speed of the doffer varies between 9 and 18 revolutions per minute depending upon the quality desired, the production needed and the size of the doffer, which may be 24, 26, 27 or 28 inches in diameter. The use of the 24 inch doffer is considered out of date now.

The weight of the sliver run depends upon the internal conditions in the mill and the style or quality of finished product and

may be anywhere between 35 and 70 grains per yard. Fig. 12 shows a diagram of the gearing of the Saco-Pettee card with 27 inch doffer made by the Saco-Pettee Co., Biddeford, Maine and Newton Upper Falls, Mass. Using our same method for figuring

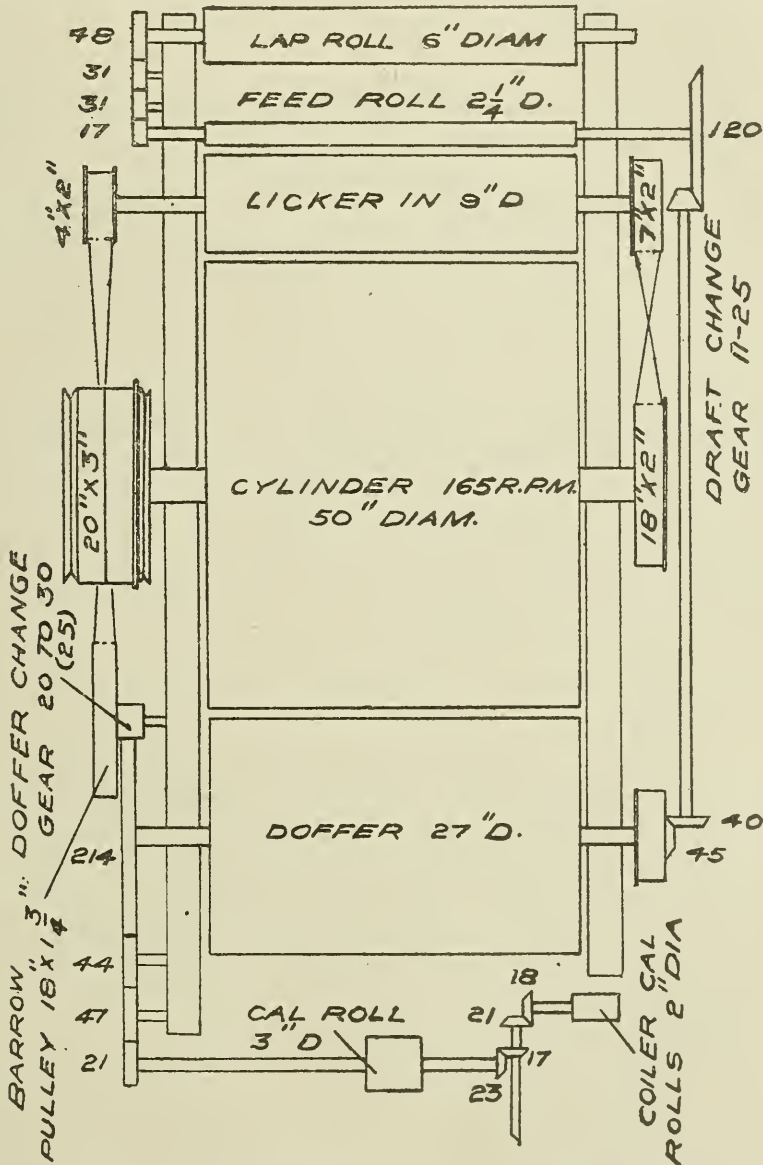

FIG. 12. PLAN OF GEARING ON THE SACO-PETTEE CARD.

draft and working between the 2 inch coiler calender roll and the 2 1/4 inch feed roll, leaving out the draft gear, we get the draft constant as follows :

$$\frac{2 \times 21 \times 23 \times 214 \times 40 \times 120}{18 \times 17 \times 21 \times 45 \times X \times 2.25} = 1525.09 \text{ draft constant.}$$

$$\frac{\text{Constant}}{\text{Gear}} = \text{Draft.}$$

$$\frac{\text{Constant}}{\text{Draft}} = \text{Gear.}$$

In getting the speed of the doffer, start with the cylinder speed, which is 165 revolutions per minute, and treat as in any ordinary speed problem, remembering that the product of the speed of the driver multiplied by its diameter must equal the product of the speed of the driven multiplied by its diameter.

The following figures give the speed of the doffer:

$$\frac{165 \times 18 \times 4 \times 25}{7 \times 18 \times 214} = 11 \text{ revolutions per minute.}$$

To find the doffer speed constant, use same method as above, leaving out the doffer change gear which was a 25 tooth gear.

$$\frac{165 \times 18 \times 4 \times X}{7 \times 18 \times 214} = .44 \text{ doffer speed constant.}$$

$$\text{Constant} \times \text{Gear} = \text{Speed.}$$

$$\frac{\text{Speed}}{\text{Constant}} = \text{Gear.}$$

There is always a slight draft between the coiler calender roll and the card calender roll, and also between the card calender roll and the doffer. This draft or tension is simply for the purpose of keeping the cotton tight and preventing undue sagging of the web or sliver at either place. Care should be taken to see that this tension is not too much, as there will be the chance of stretching the roving at places, which would make it uneven. This tension should be just enough to keep the cotton up.

The draft and doffer change gears are the only change gears on the card. There is usually some point between the coiler rolls and the doffer where a change in gearing can be made to give the desired tension to the sliver.

In Fig. 13 is shown a diagram of the gearing of the Mason card with a 24 inch doffer, made by the Mason Machine Works, Taunton, Mass. Their 27 inch doffer card gearing is very similar to that shown.

The coiler calender roll is $1 \frac{11}{16}$ inches in diameter, and the feed roll is $2 \frac{7}{16}$ inches in diameter. Reducing these two figures to the same terms, we get $\frac{27}{16}$ for calender roll and $\frac{39}{16}$ for

feed roll, and we can use the figures 27 and 39 for the diameters of the two rolls. With this in mind, the draft constant may be obtained as follows:

$$\frac{27 \times 24 \times 29 \times 190 \times 34 \times 130}{18 \times 15 \times 29 \times 34 \times X \times 39} = 1,520 \text{ draft constant.}$$

To find the doffer speed constant:

$$\frac{165 \times 18 \times 4 \times X}{7 \times 15 \times 190} = .595 \text{ or } .6 \text{ speed constant.}$$

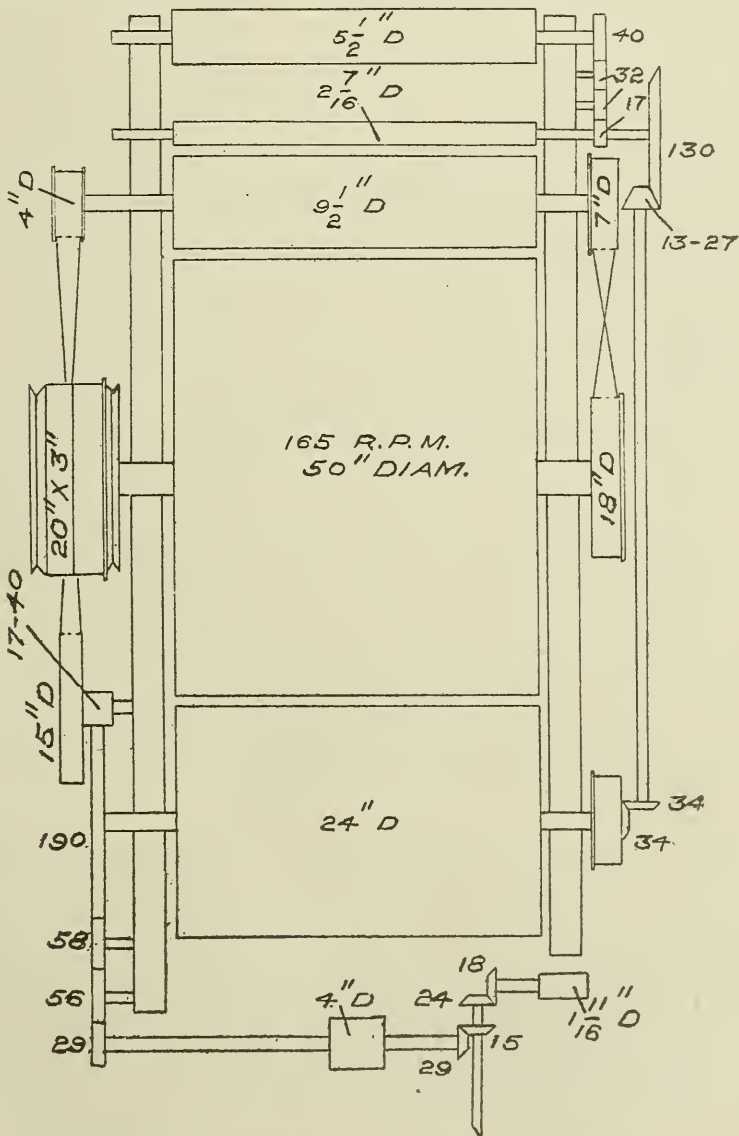

FIG. 13. PLAN OF GEARING ON THE MASON CARD.

Fig. 14 shows a diagram of the gearing of the Whitin card with a 27 inch doffer, made by the Whitin Machine Works, Whit-

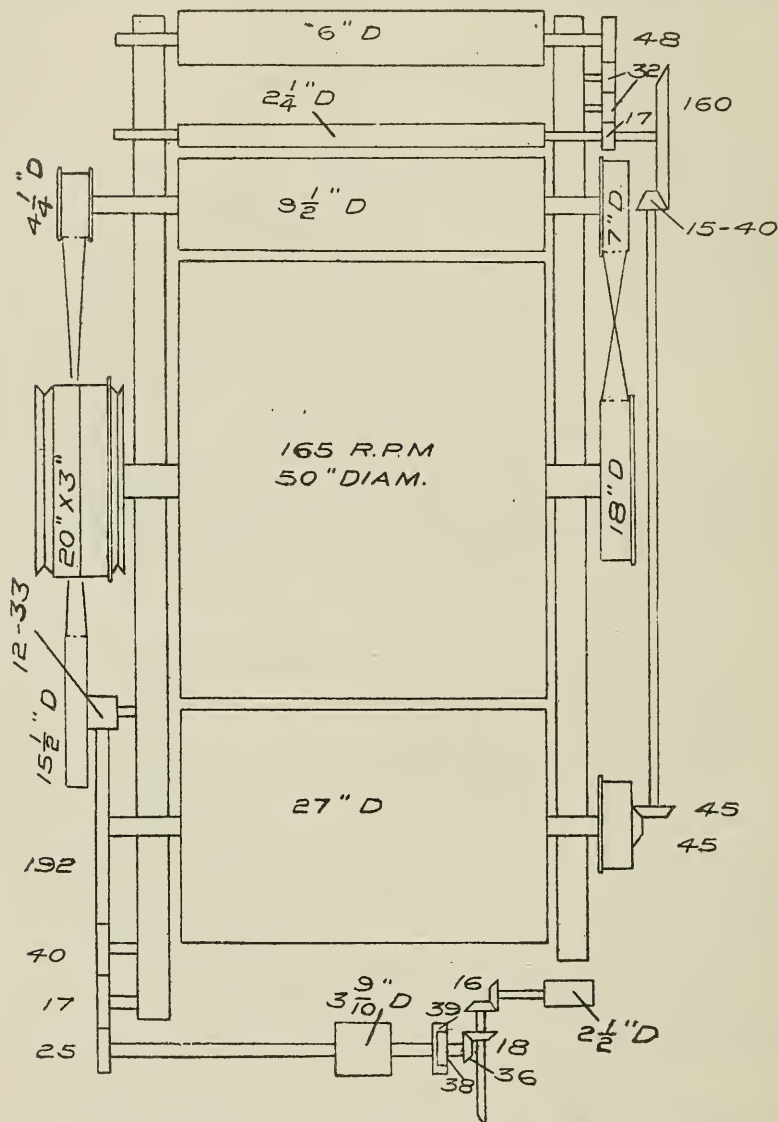

FIG. 14. PLAN OF GEARING ON THE WHITIN CARD.

insville, Mass. It will be noticed that between the upright shaft and the card calender roll there are two gears of 39 and 38 teeth respectively. This arrangement readily permits the variation of the speed of the coiler calender rolls when necessary to keep the sliver tight between the two points.

The draft constant is found as follows :

$$\frac{2 \times 36 \times 39 \times 192 \times 160}{18 \times 38 \times 25 \times X \times 2.25} = 2,242 \text{ draft constant.}$$

In the above calculation the two 16 tooth bevel gears on the ends of the upright shaft and coiler calender roll, and the two

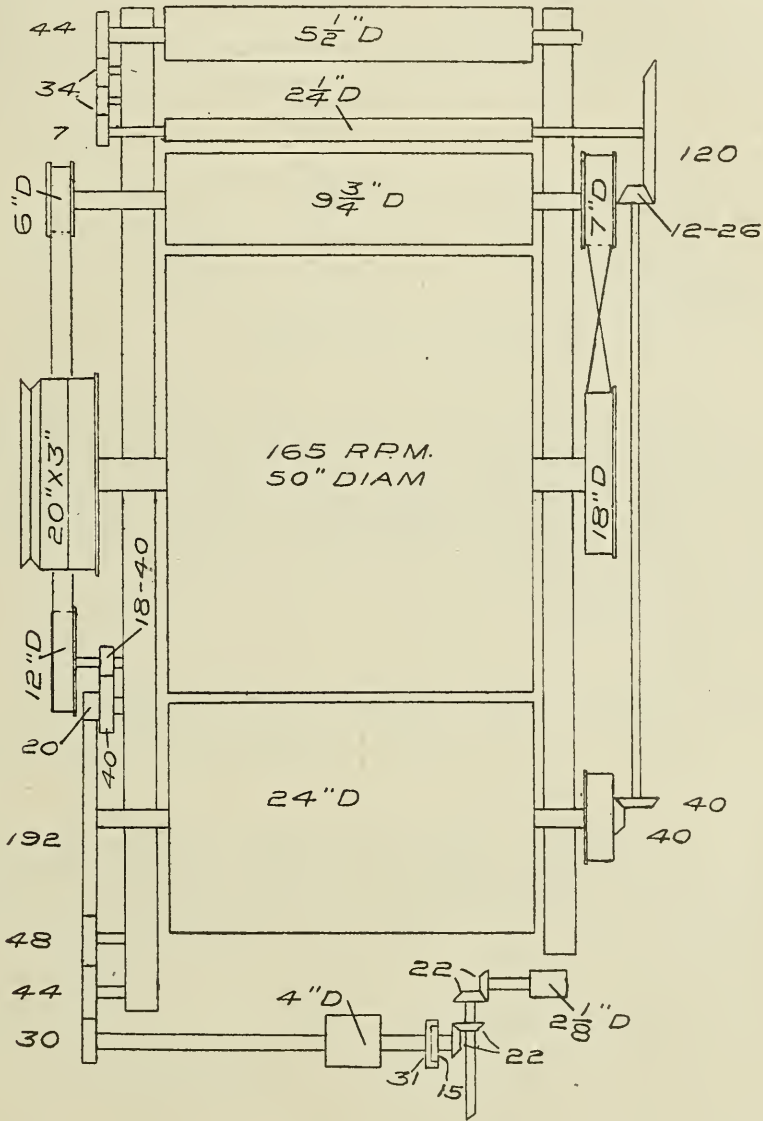

FIG. 15. PLAN OF GEARING ON THE LOWELL CARD.

45 tooth bevel gears on ends of doffer shaft and side shaft, have been left out, as they would have no effect on the constant if used. Where two gears meshing together and having the same number of teeth appear in any calculation, both can be disregarded. The doffer speed constant is obtained as follows:

$$\frac{165 \times 18 \times 4.25 \times X}{7 \times 15.5 \times 192} = .606 \text{ speed constant.}$$

In Fig. 15 is shown a diagram of the gearing of the Lowell card with 24 inch doffer, made by the Lowell Machine Shops, Lowell, Mass. This diagram is taken from the older model of card, their latest model card having a 28 inch doffer, the gearing of both being very similar. The draft constant is obtained as follows:

$$\frac{2.125 \times 31 \times 192 \times 120}{15 \times 30 \times X \times 2.25} = 1,499 \text{ draft constant.}$$

The following figures give the doffer speed constant:

$$\frac{165 \times 18 \times 6 \times X \times 20}{7 \times 12 \times 40 \times 192} = .552 \text{ doffer speed constant.}$$

Fig. 16 shows a diagram of the gearing of the Howard and Bullough card with 26 inch doffer, made by Howard and Bullough, American Machine Company, Ltd., Pawtucket, R. I. This card is built with a 26 inch doffer only and the gearing is similar to the others. The draft constant is found as follows:

$$\frac{2 \times 25 \times 180 \times 120}{16 \times 19 \times X \times 2.25} = 1,579.$$

The doffer speed constant is found as follows:

$$\frac{165 \times 19 \times 6 \times 26 \times X}{7 \times 9 \times 104 \times 180} = .414.$$

In Fig. 17 is shown a diagram of the gearing of the Potter and Johnston card with a $25\frac{3}{4}$ inch doffer made by Potter and Johnston Machine Co., Pawtucket, R. I. The following figures give the draft constant:

$$\frac{2 \times 32 \times 204 \times 13 \times 120 \times 50}{15 \times 32 \times 13 \times X \times 40 \times 2.25} = 1,813.33.$$

The doffer speed constant is found as follows:

$$\frac{165 \times 25 \times 15 \times X}{13.875 \times 105 \times 204} = .208 \text{ or } .21.$$

The method used on these cards for driving the licker-in, doffer and flats all with one belt, is shown in Fig. 18. The belt leaves the under side of cylinder pulley, goes over the licker-in pulley, then to the doffer driving pulley and around the doffer grinding pulley, then up and around the flat driving pulley and back to the cylinder pulley. When the card is working, the pulley on the end of doffer runs loose and serves only as a binder pulley to carry the

belt down and out of the way. When grinding the card, this pulley is fast and serves to drive the doffer from the cylinder.

In getting the foregoing draft constants, we have figured, in every case, between the feed roll and the coiler calender roll. In

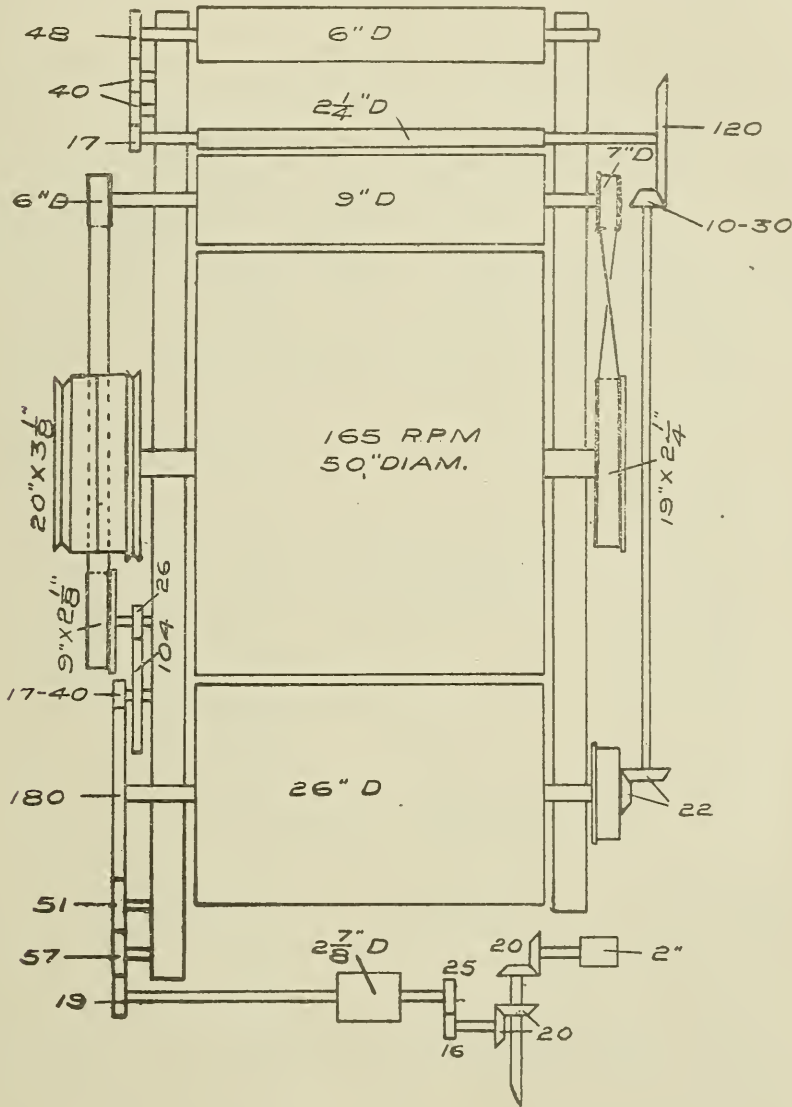

FIG. 16. PLAN OF GEARING ON THE HOWARD AND BULLOUGH CARD.

this way the total draft of the machine is obtained, with the exception of the slight tension always present between the feed roll and the wooden lap roll, but this is too small to affect the results to any great extent.

As mentioned before, there is always a slight tension between the coiler and card calender rolls, and between the card calender

rolls and the doffer. Take the Lowell card, shown in Fig. 15, for example, and calculate the tension between the coiler and card calender rolls as follows:

$$\frac{2.125 \times 31}{15 \times 4} = 1.098.$$

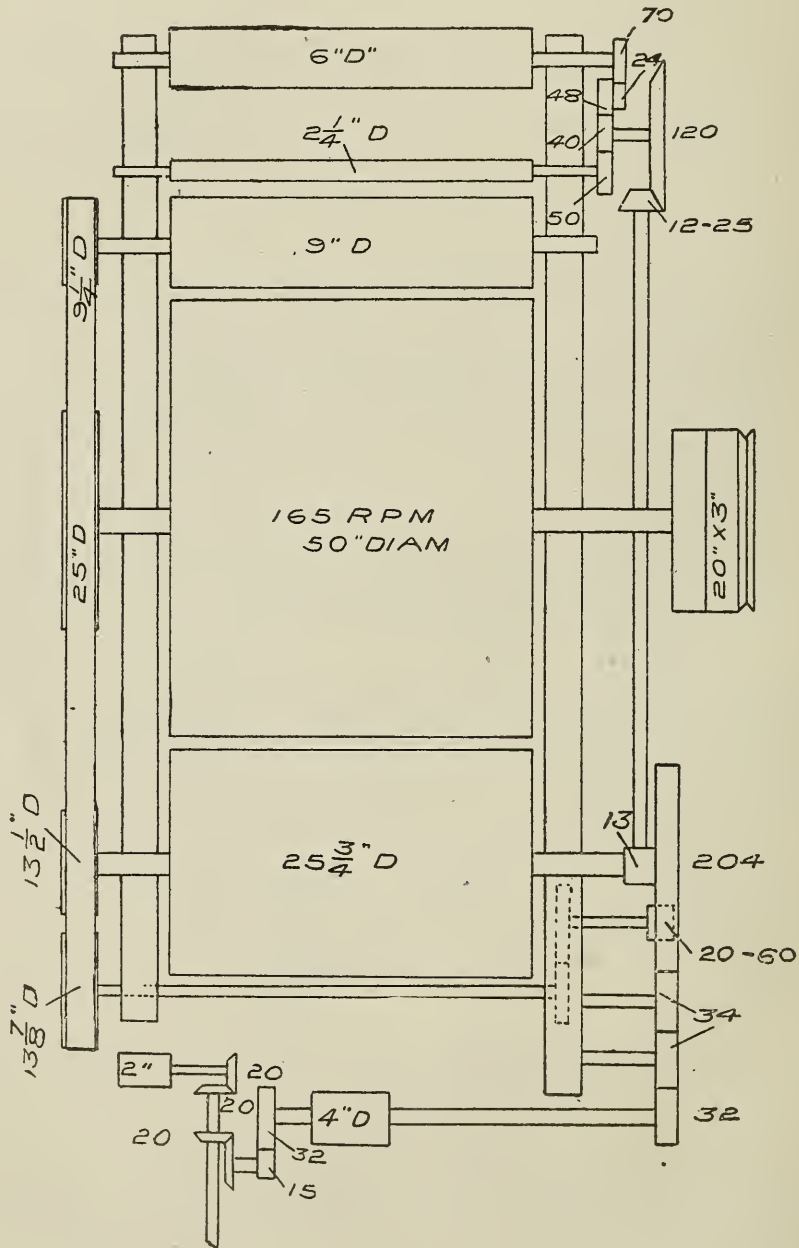

FIG. 17. PLAN OF GEARING ON THE POTTER AND JOHNSTON CARD.

Find the tension between the 4 inch card calender roll and the 24 inch card doffer as follows:

$$\frac{4 \times 192}{30 \times 24.75} = 1.034.$$

In this calculation the diameter of the doffer is taken at 24.75 inches or from point of teeth to point of teeth on opposite side of doffer, as this is the surface from which the cotton is combed. The doffer measurements are always given on the bare surface and the clothing is $\frac{3}{8}$ inch thick, which makes the additional $\frac{3}{4}$ inch added to the doffer diameter.

If these two tensions are multiplied together we will get 1.135 as the total draft or tension between the coiler rolls and the doffer, and if we figure this tension from the gearing we find that the two coincide as seen below:

$$\frac{2.125 \times 31 \times 192}{15 \times 30 \times 24.75} = 1.135.$$

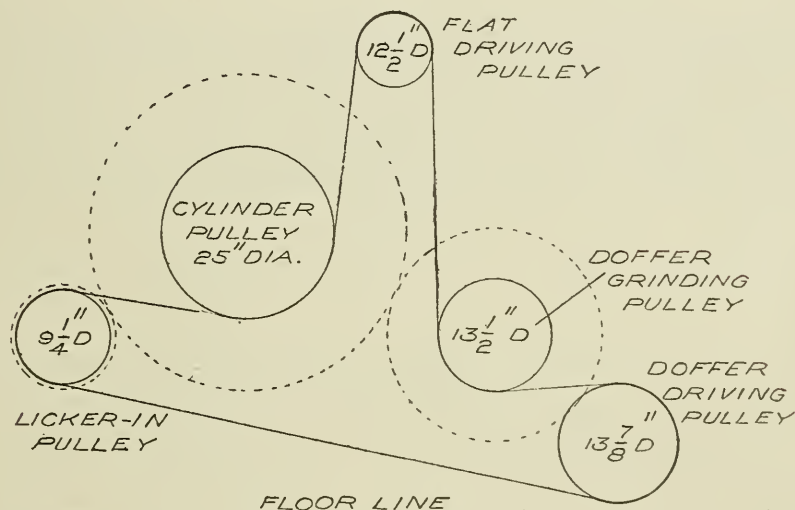

FIG. 18. SIDE VIEW OF POTTER AND JOHNSTON CARD SHOWING METHOD OF DRIVING DOFFER, FLATS AND LICKER-IN.

It must be taken into consideration, that, in using the draft constant to get the draft of a card, we get the figured draft, that is, the actual ratio between the length of material received and delivered. This draft is always less than the actual draft, as obtained from the weights on the front and back of the card. As the actual draft is the exact ratio between the weights at these two points, it must of necessity take into consideration any loss of material in the form of waste taken out by the card as the cot-

ton passes through. The amount or per cent. of waste made by the card must be deducted from the total weight on the back before we can get the exact weight of the sliver on the front.

Example: If the lap on the back of the card weighs 14 ounces per yard, the card makes 5 per cent. waste, the figured draft is 100, what is the weight of the sliver? As the sliver is expressed in grains per yard, we must reduce the weight of the lap to grains, there being 437.5 grains in an ounce. Now to allow for the waste made we can multiply by .95, which is the same as getting 5 per cent. of the total and subtracting it from the total weight. The following figures will give the weight of the sliver:

$$\frac{14 \times 437.5 \times .95}{100} = 58.19 \text{ grains per yard.}$$

Now if we take the above weight of sliver and divide it into the weight of the lap we will get the actual draft of the card:

$$\frac{14 \times 437.5}{58.19} = 105.25 \text{ as the actual draft.}$$

In finding the weight of the lap from the weight of the sliver on front and the figured draft of the card, the per cent. of waste must be taken into consideration just the same as before.

Example: Sliver weighs 58.19 grains per yard, the figured draft is 100, and the waste made is 5 per cent., what is the weight of lap on back?

$$\frac{58.19 \times 100}{437.5 \times .95} = 14 \text{ oz. lap.}$$

If we figure the weight of lap from the actual draft of 105.25 and the weight of sliver obtained above, we get:

$$\frac{58.19 \times 105.25}{437.5} = 13.998 \text{ oz. lap.}$$

This is close enough to call a 14 oz. lap. The foregoing examples and figures ought to make clear the effect the waste has on the weight of the sliver and the difference between figured draft, obtained from the gearing, and the actual draft, obtained from the weight on front and back of the machine. Always bear in mind that the weight on the back of the card is 100 per cent. or the whole; that in figuring the weight on the front, the waste must be taken out of the total weight going into the machine, unless we use the actual draft. Also the weight on the front and the figured draft multiplied together will give a certain percentage of the total weight on the back, this percentage depend-

ing upon the amount of waste taken out during the operation of the machine.

In the above cases, the weight on the back is taken as 100 per cent., then the waste is 5 per cent. and the amount that passes through the machine is 95 per cent. Consequently the weight of the sliver multiplied by the figured draft will represent only 95 per cent. of the amount being fed into the machine, the other 5 per cent. being waste. The two following formulas are deduced from the foregoing remarks and examples:

To find the weight of sliver:

$$\frac{\text{Weight of lap} \times 437.5 \times .95}{\text{Figured Draft}} = \text{grains per yard in sliver.}$$

To find the weight of lap:

$$\frac{\text{Weight of Sliver} \times \text{Figured Draft}}{437.5 \times .95} = \text{Weight of lap in ozs. [per yard.]}$$

It will be understood that when the actual draft is known instead of the figured draft, it is simply a case of dividing the weight on the back by the actual draft to get the weight on the front, and the weight on the front multiplied by the actual draft will give the weight on the back. In the above example the waste of the card has been taken as 5 per cent., as this is considered a good fair average, but where the waste is more or less, the allowance must be made. For instance if the card is making 6 per cent. of waste, use .94 in the rules given in place of the .95.

PRODUCTION.

The production of the card depends upon the quality and quantity of sliver desired and is governed by the weight of the sliver, the size and speed of the doffer, and the time lost due to stripping, grinding, etc. The amount of time lost, taking all things into consideration, will not be far from 10 per cent. for the whole room. This is making allowance for one card out of every 24 to be stopped for grinding.

The actual number of pounds delivered by the card during a day may vary from 60 to 70 on fine work and sometimes below these figures, to 200 or over on coarse work. In the former case, quality is the main consideration, and in the latter case the considerations of quality have been pushed aside by the demands of quantity. It is useless to think that the two can go together, for whichever one is the most desired, the other falls off.

The speed of the doffer affects the speed of every part of the

card except the cylinder, licker-in and flats. A change in the size of the doffer gear has no effect on the draft of the machine or on the weight of the sliver, as an increase in the doffer speed increases the speed of the feed rolls and calender rolls in the same proportion, and its only effect is to put more cotton through the card in the same time. Consequently, the faster the doffer speed the more the card produces.

In working out the production of the card the following rule is used:

Diameter of doffer \times 3.1416 \times *speed of doffer* \times *minutes per day* \times *weight of sliver* \times *allowance for loss of time* \div *inches in one yard* \times *grains in one pound*.

Example: Find the production of a card from following data: Doffer 27 inches in diameter, doffer speed 14 revolutions per minute, weight of sliver 50 grains, working 10 hours a day and allowing 10 per cent. for loss of time. Substituting the above figures in the formula we get:

$$\frac{27.75 \times 3.1416 \times 14 \times 600 \times 50 \times .90}{36 \times 7,000} = 130.77 \text{ pounds.}$$

To be absolutely accurate in figuring production on the card, we should take the speed of the coiler calender rolls, as the sliver is weighed after passing them and is lighter than when being combed off of the doffer, due to the influence of the tension between these points. The production is more than the figures just obtained, and the difference will vary with the varying amount of tension between these points. The only reason for the use of the doffer speed as a basis for production calculations, is that it is more easily determined, if not already known.

If we take the Whitin card gearing, shown in Fig. 14, which has a 27 inch doffer, and calculate the speed of the coiler calender rolls, we get:

$$\frac{14 \times 192 \times 39 \times 36}{25 \times 38 \times 18} = 220.7 \text{ R. P. M. of coiler rolls.}$$

Now take this speed as a basis of calculation, figure the production of the card and make the same 10 per cent. allowance for loss of time, we get:

$$\frac{2 \times 3.1416 \times 220.7 \times 600 \times 50 \times .90}{36 \times 7,000} = 148.57 \text{ pounds.}$$

Figuring by this method shows a difference of 17.8 pounds in the total production, or an increase of the former figures of about 13 per cent. That is, the production as figured from doffer

speed is about 13 per cent. less than the card actually produces, and, unless some allowance is made for this, all production figures will be too small.

If we calculate the tension between the doffer and coiler calender rolls on the card shown in Fig. 14, we get:

$$\frac{2 \times 36 \times 39 \times 192}{18 \times 38 \times 25 \times 27.75} = 1.128 \text{ or practically } 1.13.$$

That is, for every yard combed off the doffer, 1.13 yards will be delivered into the can, and for every revolution of the doffer, there is 13 per cent. more sliver put into the can than its circumference would indicate. Therefore, any production calculation based on doffer speed will necessarily give results that will be too little, unless this fact is taken into consideration.

The tensions between the doffer and coiler calender rolls for the different cards illustrated will be seen in the following table and will indicate the per cent. of increase in calculating production in each case:

- Fig. 12. Saco-Pettee, 1.15.
- Fig. 13. Mason, 1.15.
- Fig. 14. Whitin, 1.13.
- Fig. 15. Lowell, 1.135.
- Fig. 16. Howard & Bullough, 1.10.
- Fig. 17. Potter & Johnston, 1.05.

From this table it will be seen that, as a general rule, 13 per cent. must be added to the production when calculated upon a basis of doffer speed. It must also be understood that the above tensions and other drafts and speeds refer to the gearing shown in the different drawings, and, unless the machine has exactly the same layout of gears, the results will be different.

For use in figuring productions it is convenient to have a constant on account of the amount of time saved. In getting a production constant the same method is followed as previously dealt with on the pickers. On the card the variable quantities in the production calculation are the speed of the doffer and the weight of the sliver. Take the figures used in finding the production and eliminate these two quantities, and we get the following, which gives the production constant:

$$\frac{27.75 \times 3.1416 \times 600 \times .90}{36 \times 7,000} = .1868.$$

On account of the above explained tension or draft between the doffer and the coiler calender rolls, this figure must be increased 13 per cent. to give the correct production, then:

$.1868 \times 1.13 = .2111$ Production Constant.

As will be noticed this constant is figured for a 10 hour day, allowing 10 per cent. loss of time for oiling, stripping, etc.

Rule for finding the production, using the production constant:

Production constant \times *revolutions per minute of the doffer* \times *weight of sliver* = *pounds per day per card.*

Example: What is the production of a card with a 27 inch doffer, making 14 revolutions per minute and delivering a 50 grain sliver?

$.2111 \times 14 \times 50 = 147.77$ pounds.

The production figured before with same data resulted in 148.57 pounds, so it will be seen that the constant will give results close enough for all practical purposes. As there are in use cards with doffers of different diameters, there is given below a table of constants for production for use on cards that have the different size doffers:

24 inch doffer, .1877 production constant.

26 inch doffer, .1980 production constant.

27 inch doffer, .2111 production constant.

28 inch doffer, .2187 production constant.

In all the above an allowance of 10 per cent. loss of time has been made, and 10 hours is considered as a day; allowance also has been made in the figures for the tension between the doffer and the coiler calender rolls. In making changes in the drafts and speeds of a card the calculations can be conveniently and quickly made by proportion, as illustrated by the following rules.

Rule to change the weight of the sliver:

Multiply the weight of the sliver wanted by the gear on the card and divide the product by the weight of the sliver on the card. Answer will be the size gear to use.

Example: A card is running a 50 grain sliver with a 16 tooth draft gear. What size gear will have to be used to change the sliver to 56 grains?

$$\frac{56 \times 16}{50} = 17.9 \text{ or } 18 \text{ tooth draft gear.}$$

Also in dealing with the draft and weight instead of gear and weight:

Multiply the draft by the weight on the card and divide by the weight wanted. Answer will be the draft needed.

In changing the draft of the card, use the following rule:

Multiply the draft of the card by the draft gear and divide

by the draft wanted. Answer will be the draft gear needed.

Rule to change doffer speed:

Multiply the desired speed of doffer by the change gear on the card and divide by the present doffer speed. Answer will be the size gear needed.

Rule to change the production of the card:

Multiply the speed of the doffer by the production wanted and divide by the present production of the card. Answer will be the required speed of the doffer.

The production of the card can be changed from the size of the doffer gear direct, by putting in the above rule the size of the change gear in place of the doffer speed.

Example: A card is producing 160 pounds per day with a 26 tooth doffer change gear. What size gear will be needed to give a production of 135 pounds per day?

$$\frac{26 \times 135}{160} = 21.9 \text{ or } 22 \text{ tooth doffer change gear.}$$

CARD DRAFT TABLE

Showing the Figured Draft for Different Weights of Sliver and Lap
Allowance of 5 per cent Waste has been made

Ounces Per Yard in Lap	GRAINS PER YARD IN SLIVER																		
	40	42	44	46	48	50	52	54	56	58	60	62	64	66	68	70	72	74	
10	104	99	95	91	87	83	80	77	74										
10.5	109	104	99	95	91	87	84	81	78	75									
11	114	109	104	99	95	91	88	85	82	79	76	74							
11.5	119	114	109	104	100	96	92	89	86	83	80	77	75						
12	125	119	114	109	104	100	96	92	89	86	83	80	78	76					
12.5		124	119	114	109	104	100	96	93	90	87	84	81	79	76				
13			123	118	113	108	104	100	96	93	90	87	85	82	79	77			
13.5				122	117	112	108	104	100	97	94	90	87	85	83	80	78		
14					121	116	112	108	104	100	97	94	91	87	85	83	81	79	
14.5						121	116	112	108	104	100	97	94	91	89	86	84	81	
15							125	120	115	111	107	104	101	97	94	92	89	86	84
15.5								124	120	115	111	107	104	101	98	95	92	89	87
16									123	119	115	111	107	104	101	98	95	92	90
16.5										122	118	114	111	107	104	101	98	95	93
17											122	118	114	110	107	104	101	98	95

The Table below shows the production of a card with a 27" doffer for a 10 hour day allowing 10% loss of time.

R.P.M. of 27-inch Doffer	WEIGHT IN GRAINS OF ONE YARD OF SLIVER FROM COILER															
	40	42	44	46	48	50	52	54	56	58	60	62	64	66	68	70
8	70	73	77	80	84	87	91	94	98	101	105	108	112	115	119	122
8½	74	78	82	85	89	93	97	100	104	108	111	115	119	123	126	130
9	79	83	87	90	94	98	102	106	110	114	118	122	126	130	134	138
9½	83	87	91	95	100	104	108	112	116	120	125	129	133	137	141	145
10	87	92	96	101	105	109	114	118	122	127	131	135	140	144	149	153
10½	92	96	101	106	110	115	119	124	128	133	138	142	147	151	156	161
11	96	101	106	111	115	120	125	130	135	139	144	149	154	159	163	168
11½	101	106	111	116	121	126	131	136	141	146	151	156	161	166	171	176
12	105	110	115	121	126	131	136	142	147	152	157	163	168	173	178	184
12½	109	115	120	126	131	137	142	147	153	158	164	169	175	180	186	191
13	114	119	125	131	136	142	148	153	159	165	170	176	182	187	193	199
13½	118	124	130	136	142	147	153	159	165	171	177	183	189	195	201	206
14	122	128	135	141	147	153	159	165	171	177	184	190	196	202	208	214
14½	127	133	139	146	152	158	165	171	177	184	190	196	203	209	215	222
15	131	138	144	151	157	164	170	177	184	190	197	203	210	216	223	229
15½	135	142	149	156	163	169	176	183	190	196	203	210	217	224	230	237
16	140	147	154	161	168	175	182	189	196	203	210	217	224	231	238	245
16½	144	151	159	166	173	180	187	195	202	209	216	224	231	238	245	252
17	149	156	163	171	178	186	193	201	208	215	223	230	238	245	253	260
17½	153	161	168	176	184	191	199	206	214	222	229	237	245	252	260	268
18	157	165	173	181	189	197	205	212	220	228	236	244	252	260	267	275
19	166	174	183	191	199	208	216	224	232	241	249	257	266	274	282	291

CHAPTER IV.

COMBING PROCESS—CALCULATIONS FOR DRAFT, SPEED AND PRODUCTION ON SLIVER AND RIBBON LAPPERS—COMBERS, DRAFT, PRODUCTION AND WASTE CALCULATIONS—PRODUCTION CONSTANTS.

THE COMBING PROCESS.

In the manufacture of the finer grades of cotton yarns intended for the hosiery and underwear trade, for the better grades of cotton dress goods, for mercerizing, for crochet and embroidery cottons and for the manufacture of lace and sewing thread, the cotton is passed through another process of cleaning after the carding, known as combing. This is intended for use

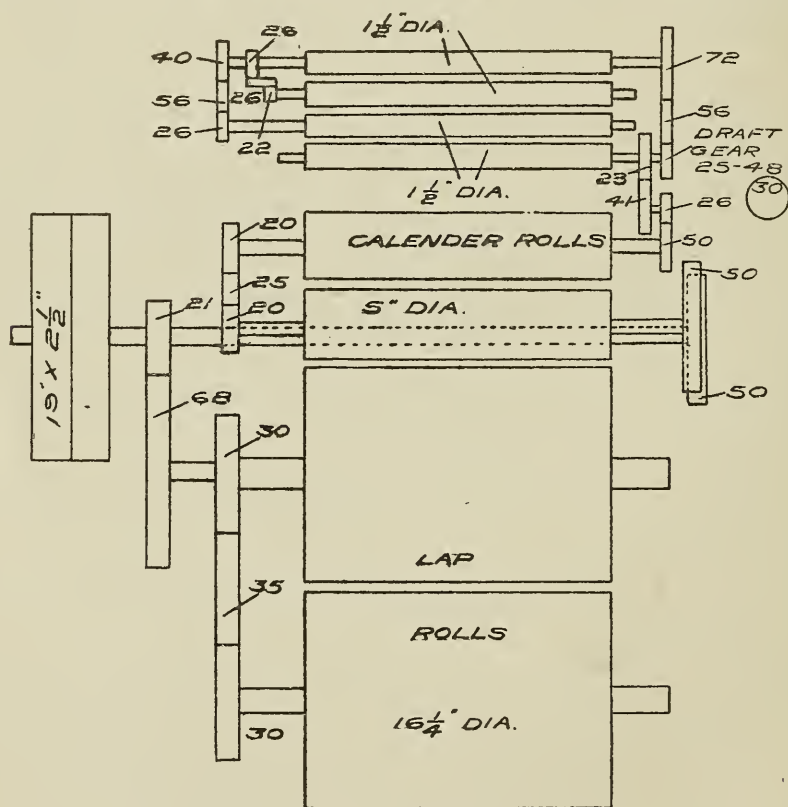

FIG. 19. GEARING PLAN OF WHITIN SLIVER LAPPER.

only in those mills that are making a class of product that is desired to be exceptionally smooth and clean and, on the coarser grades of work, it is entirely too expensive and not necessary to use. Only where the cost of production is secondary to the qual-

ity of the finished product is it possible to use the combing process to advantage.

There are usually three machines used in combing, the sliver lapper, the ribbon lapper and the comber. The first two are simply preparatory machines and are used for the purpose of getting the fibers in a parallel condition and putting the material in a suitable shape for use on the comber, while the last does the real work of cleaning.

THE SLIVER LAPPER.

The object of the sliver lapper is to take from 12 to 20 card

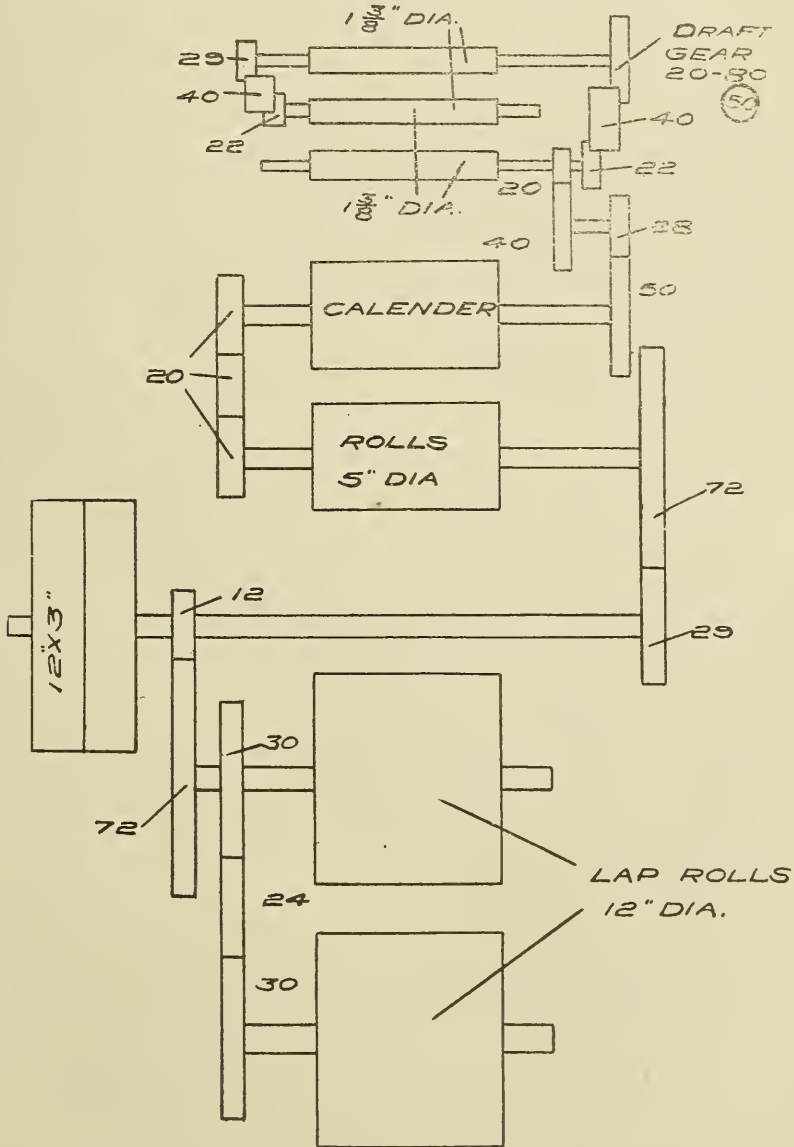

FIG. 20. PLAN OF GEARING ON MASON SLIVER LAPPER.

slivers, give them a draft of from 1.5 to 3.5 and combine them into a smooth, even sheet or lap and wind this lap upon a wooden spool for use on the ribbon lapper. The drawing bringing the fiber into parallelism.

Stop-motions are provided which operate to stop the frame when one end breaks or runs out at the back, and also when the lap reaches a certain size, thus preventing singles at the back and making all laps approximately the same length.

The drawing is accomplished by means of three or four pairs of drawing rolls arranged for common or metallic rolls and, in operation and care, similar to those in use on drawing frames. In fact both the sliver and ribbon lappers can be considered as modified drawing frames. Fig. 19 shows a diagram of the gearing of the sliver lapper built by the Whitin Machine Works, geared for use with leather rolls. This machine has four pairs of drawing rolls, which distributes the total draft more widely than would be the case with three rolls.

With a 30 tooth draft gear and figuring the draft between the $16\frac{1}{4}$ inch lap roll and the $1\frac{1}{2}$ inch back drawing roll, we get the draft, as follows:

$$\frac{16.25 \times 21 \times 50 \times 20 \times 26 \times 23 \times 72}{68 \times 50 \times 20 \times 50 \times 41 \times 30 \times 1.5} = 2.342 \text{ total draft.}$$

Using the above formula, but leaving out the 30 tooth draft gear, we get the draft constant, as follows:

$$\frac{16.25 \times 21 \times 50 \times 20 \times 26 \times 23 \times 72}{68 \times 50 \times 20 \times 50 \times 41 \times X \times 1.5} = 70.267 \text{ draft constant.}$$

$$\text{Constant} \div \text{gear} = \text{draft. Then: } 70.267 \div 30 = 2.342 \text{ draft.}$$

The above total draft is distributed or divided into five intermediate drafts, as follows:

- (1) Draft between back and third drawing rolls;
- (2) Draft between third and second drawing rolls;
- (3) Draft between second and front drawing rolls;
- (4) Draft between front drawing roll and the calender rolls;
- (5) Draft between the calender rolls and the lap rolls.

The first three of the above intermediate drafts are the ones that perform the real reduction in the bulk or weight of the material, while the last two serve simply to keep the material tight, and in no case should be enough to stretch the lap. The break draft, or the one that is altered when a change is made in the total draft, is between the front and second drawing rolls, the other drafts re-

maintaining the same regardless of any change made in the total draft.

Fig. 20 shows a diagram of the gearing of the sliver lapper built by the Mason Machine Works. This machine is built on the same principles as and is similar to the one shown in Fig. 19, but has three drawing rolls. Using a 50 tooth draft change gear on the back roll, the following gives the draft:

$$\frac{12 \times 12 \times 72 \times 20 \times 28 \times 20 \times 50}{72 \times 29 \times 20 \times 50 \times 40 \times 22 \times 1.375} = 2.28 \text{ draft.}$$

By leaving out the 50 tooth draft gear in the above formula, we get the draft constant as follows:

$$\frac{12 \times 12 \times 72 \times 20 \times 28 \times 20 \times X}{72 \times 29 \times 20 \times 50 \times 40 \times 22 \times 1.375} = .0496 \text{ draft constant.}$$

In any arrangement of this kind, where the draft gear is a driven gear, it will come above the line in the formula for draft, and must be treated in a different manner from the one just worked out. In this case the rules for using the draft constant will be:

$$\text{Constant} \times \text{gear} = \text{draft.}$$

$$\text{Draft} \div \text{constant} = \text{gear.}$$

Example: Given a draft constant of .0496, what draft will a 50 tooth draft gear give?

$$.0496 \times 50 = 2.28 \text{ draft.}$$

PRODUCTION.

On either of the above machines the production varies greatly, depending upon the speed at which they are run and the weight of the lap produced. The laps vary in weight from 250 to 450 grains per yard, and the 5 inch calender rolls vary in speed from 60 to 120 revolutions per minute, which would give a front drawing roll speed of 200 to 450 revolutions per minute. This would make the production vary from 500 to 1,500 pounds per day of 10 hours, allowing for 25 per cent. loss of time due to stoppages, etc. Basing the production on the speed of the calender rolls, the method of figuring would be as follows:

Example: What would be the production of a sliver lapper, if the calender rolls were making 100 revolutions per minute, the lap weighing 350 grains per yard, and allowing for 25 per cent. loss of time, in a 10 hour day?

$$\frac{5 \times 3.1416 \times 100 \times 600 \times 350 \times .75}{36 \times 7,000} = 981.75 \text{ pounds.}$$

In determining the speed of the driving pulleys on the machines we must take into consideration the ratio in speed between the calender rolls and the driving shaft. On the Whitin frame, geared as shown in Fig. 19, one revolution of the driving pulley gives one revolution to the calender rolls; so the speed of the two will be the same. On the Mason frame, as shown in Fig. 20, it takes 2.48 revolutions of driving pulley to give the calender rolls one revolution, so that the speed of the driving pulley will equal the speed of the calender rolls multiplied by 2.48. With this in view the following calculations for getting the size of the pulleys needed to run the machines will be understood.

Example: If the main line shafting has a speed of 325 revolutions per minute, what size pulley is needed to drive the calender rolls of a Whitin sliver lapper at 100 revolutions per minute, the driving pulley on the machine being 19 inches in diameter?

$$\frac{100 \times 19}{325} = 5.85 \text{ inches, or about a 6 inch pulley is needed.}$$

Example: Find the size of pulley to drive the calender rolls on a Mason machine at 100 revolutions per minute? In this case we must multiply the speed of the calender rolls by 2.48 to get the speed of the driving pulleys.

$$\frac{2.48 \times 100 \times 12}{325} = 9.15 \text{ inches, or about a 9.25 inch pulley.}$$

THE RIBBON LAPPER.

The object of the ribbon lapper is to further prepare the laps for the comber so that they will be of a more uniform structure than is possible with the sliver lapper, thus placing the fibers in a better condition for the combing by the needles of the comber. It is usually made to double six laps, though sometimes only four laps are used. The average draft is six, though we must consider the weight of finished laps desired. Each lap is drawn by separate drawing rollers and placed one above the other on the sliver plate, where they are condensed and calendered by the calender rolls and wound up in the form of a lap at the end of the machine. The laps are made 8 to 12 inches wide, depending upon the width of lap the comber can handle. Stop motions are provided to stop the machine when a lap runs out, thus preventing singles, and also when the laps are full, thus insuring the laps to be of uniform length. Leather or metallic rolls may be used for drawing, though the common preference seems to be for leather rolls on both the sliver and ribbon lappers.

Fig. 21 shows a diagram of the gearing of the Whitin ribbon

lapper. The arrangement of the draft rolls and gearing is very similar to that in use on the drawing frame. The draft gear, as shown, is located on the stud with the 100 tooth gear, called the crown gear, which is driven from the front roll. The diagram shows only one set of drawing rolls, the others being simply a continuation of those shown.

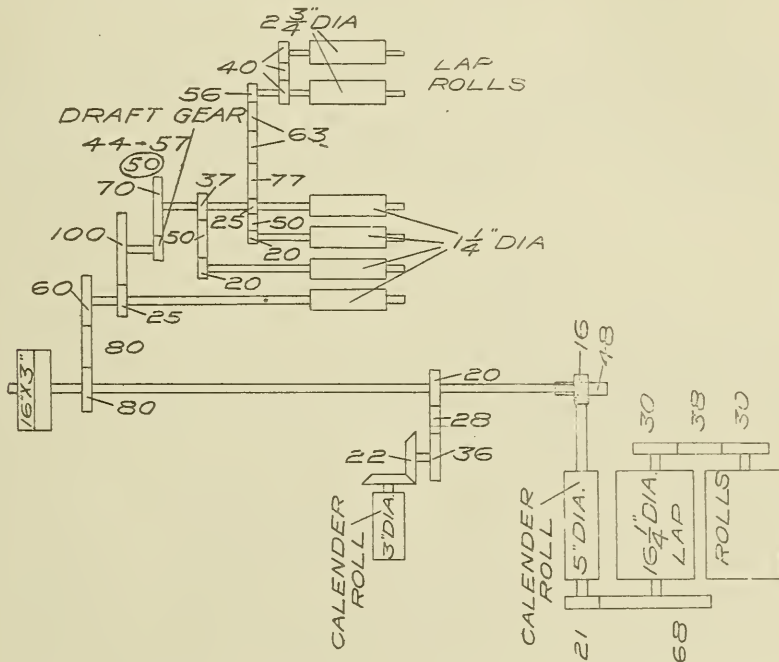

FIG. 21. GEARING PLAN OF WHITIN RIBBON LAPPER.

Starting with the $16\frac{1}{4}$ inch lap roll and figuring back to the $2\frac{3}{4}$ inch wooden lap rolls, we get the following as the draft constant:

$$\frac{16.25 \times 21 \times 16 \times 60 \times 100 \times 70 \times 56}{68 \times 48 \times 80 \times 25 \times 25 \times 2.75} = 286 \text{ draft constant.}$$

Constant ÷ gear = draft. Then: $286 \div 50 = 5.72$ draft with a 50 tooth draft gear on the machine.

The drafts occurring between the different drawing rolls are the ones that do the real reduction of the bulk of the material, the others being, in each case, just enough to keep the material tight.

Fig. 22 shows a diagram of the gearing of the Mason ribbon lapper. This machine is built on the same principle as the one shown in Fig. 21. The draft factor, figuring between the 12 inch lap rolls and the $2\frac{3}{4}$ inch wooden lap rolls on the back, is obtained as follows:

$$\frac{12 \times 21 \times 14 \times 19 \times 68 \times 100 \times 70 \times 56}{50 \times 20 \times 40 \times 72 \times 25 \times X \times 30 \times 2.75} = 300.78 \quad \text{or practically } 301 \text{ draft} \\ \text{[constant.]}$$

Constant \div *gear* = *draft*. *Constant* \div *draft* = *gear*.

Then a 50 tooth draft gear would give a draft of 6.02, as follows: $301 \div 50 = 6.02$ draft.

PRODUCTION.

On these two machines the production varies greatly, depending upon the speed at which the machine is run and the weight of the lap. The same remarks made in reference to the sliver lap machines can apply here, as regards speeds, etc., and,

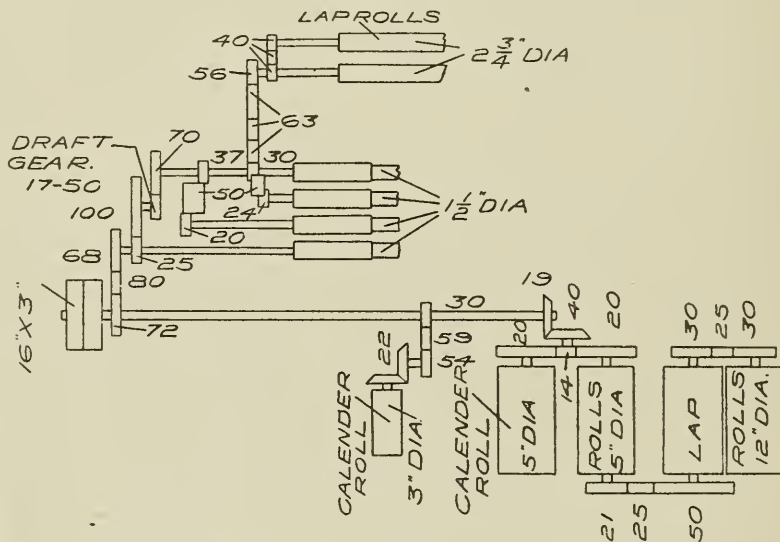

FIG. 22. GEARING PLAN OF MASON RIBBON LAPPER.

as the same size calender rolls are used on all, the same figures for getting production will apply.

Both the Whitin and Mason ribbon lappers are constructed to give three revolutions to the driving pulley to one revolution of the 5 inch calender rolls; so the speed of the driving pulley on either must be three times the speed of the calender rolls. Both machines have 16 inch driving pulley; so the following calculations for the size pulley needed to drive the machines will apply to both.

Example: What size pulley will be required to drive the ribbon lapper, if the calender roll speed is to be 100 revolutions per minute and line shafting speed is 325 revolutions per minute?

$$\frac{3 \times 100 \times 16}{325} = 14.76 \text{ inches, size of pulley.}$$

The production formula and calender roll diameter being the same on all the machines, and allowing a loss of time of 25 per cent., a production constant can be worked out that will be applicable to any one of the four machines shown. The production calculation for the sliver lapper, previously given in this chapter, is identical with a production calculation for the ribbon lapper. A look at this calculation will show that there are only two quantities in which we may expect to find any variation, that is, the speed of the calender rolls, given as 100 revolutions per minute, and the weight of the lap, given as 350 grains per yard. So then, if we eliminate these two variable figures from the calculation, we get the production constant as follows:

$$\frac{5 \times 3.1416 \times 600 \times .75}{36 \times 7,000} = .028 \text{ production constant.}$$

This constant of .028 multiplied by the speed of the calender rolls and the weight of the lap, will give the production of either of the machines, based on a 10 hour day and allowing for 25 per cent. loss of time. Then $.028 \times 100 \times 350 = 980$ pounds. This corresponds closely with the production figured by the former figures.

As both the sliver and ribbon lappers are, in principle and action, only types of drawing frames, and subject the cotton to the same treatment, the speed of the front drawing rolls should be about the same as that on the drawing frame. To get the best results, as regards good, even drawing, the front roll speed should be under 375 revolutions per minute. From Fig. 19 the following speed ratio is found:

$$\frac{1 \times 50 \times 41}{26 \times 23} = 3.428$$

which shows that the front drawing roll makes 3.428 revolutions to every one revolution of the calender roll. Now, if the calender roll speed is 100 revolutions per minute, the front drawing roll will have a speed of 342.8 revolutions per minute, or 3.428 times the speed of the calender roll. This ratio can be determined for any machine and enables us to find the front roll speed for any given calender roll speed.

THE COMBER.

The cotton, having been placed in laps of the proper size and weight and the fibers thoroughly paralleled by the two former machines, is now placed on the lap rolls of the comber, slowly unwound and fed into the machine, which combs out all the trash, neps, motes and short fiber. The comber has six or eight heads, combing six or eight laps, each lap being combed separately, and

the webs from these heads are condensed and formed into separate slivers. These slivers are passed along a sliver plate at the front of the machine and delivered to the draw-box, which has three or four pairs of drawing rolls, fitted with leather or metallic rolls, the use of leather rolls being more common.

Here these individual slivers are drawn, condensed and formed into a single sliver which is passed up to the coiler head and delivered to the can. After passing through the comber the slivers are usually given one or two drawings before being ready for the slubbers.

Fig. 23 shows a diagram of the gearing of the late model Whitin high speed comber. This machine is built for higher speeds than the older models and will do good work at 125 to 135 nips per minute, thus greatly increasing the production over what was formerly obtained.

The feed rolls are driven by a pin on the main, or cylinder shaft, which works into a 5 pointed star-wheel. This gives the star-wheel $1/5$ of a revolution for every one of the cylinder shaft. On the same stud with the star-wheel is the draft gear of 14 to 20 teeth, which drives the feed roll gear of 44 teeth. The feed roll drives the $2\frac{3}{4}$ inch wooden lap rolls. The draft gear is changed to alter the total draft of the machine. The driving shaft carries a 30 tooth gear which, by means of the 69 tooth intermediate gear, drives the 80 tooth gear on the cam shaft. The cam shaft drives the table calender roll shaft by a 21 to a 142 tooth gear. This 21 tooth gear is changeable to regulate the tension on the web in the pans.

The draw-box has a set of four drawing rolls, the draft at this point being 5. The gear on the back roll of the draw-box is changeable to permit the regulation of the tension on the slivers on the sliver plate. The small gear of 27 teeth on the driven end of the front roll is a change gear, which gives a change in the draft of the draw-box. Any change of this gear gives a change in the length of sliver fed out of the draw-box, and necessitates a change in the size of the 50 tooth coiler connecting gear which drives the coiler upright shaft, to enable the coiler calender rolls to take up the sliver delivered by the draw-box. This gear may vary from 25 to 75 teeth.

It is understood that it is usual to change only the draft gear, for, after the tensions between the other points have been regulated and adjusted, no further changes are usually made in them. The draft constant of this comber, figuring between the 2 inch coiler calender rolls and the $2\frac{3}{4}$ inch wooden lap rolls, is found as follows:

$$\frac{2 \times 16 \times 22 \times 60 \times 5 \times 44 \times 23 \times 55 \times 47}{16 \times 22 \times 50 \times 1 \times X \times 23 \times 20 \times 35 \times 2.75} = 709.$$

With a 17 tooth draft gear the total draft would be $709 \div 17 = 41.3$. This, of course, is figured draft and is less than the actual draft by a variable amount, depending upon the amount of waste taken out by the machine.

The above total draft is distributed over several points, the main portions being between the feed rolls and the table calender rolls, where the combing takes place, and in the draw box, where the combed slivers are drawn and condensed into a single sliver. These are the points where the real reduction in bulk of material occurs, the others having just enough draft or tension to keep the material tight.

Fig. 24 shows a diagram of the comber built by the Mason Machine Works. In general arrangement it is similar to the one shown in Fig. 23. In figuring the draft between the $1 \frac{11}{16}$ inch coiler calender rolls and the $2 \frac{3}{4}$ inch lap rolls, we can simplify matters by reducing both diameters to sixteenths, in which case they would be $27/16$ as diameter of the first and $44/16$ as diameter of the latter. Now we can use the two numbers, 27 and 44, to represent the diameters of the two rolls. Then the following gives the draft:

$$\frac{27 \times 24 \times 21 \times 53 \times 5 \times 38 \times 23 \times 55 \times 47}{18 \times 16 \times 90 \times 1 \times 17 \times 23 \times 20 \times 35 \times 44} = 26.1$$

By using the above figures with the exception of the 17 tooth draft gear, which comes under the line, we get a draft constant of 443.7.

Constant \div gear = draft, as follows: $443.7 \div 17 = 26.1$ draft.

In order to ascertain the proportion of the total draft that occurs at the combing operation, we will figure the draft between the $2 \frac{3}{4}$ inch table calender rolls and the feed roll as follows:

$$\frac{2.75 \times 19 \times 80 \times 5 \times 38}{142 \times 80 \times 1 \times 17 \times .75} = 5.48 \text{ draft.}$$

The draft between the $2 \frac{3}{4}$ inch draw-box calender rolls and the $1 \frac{1}{8}$ inch draw-box back roll is:

$$\frac{2.75 \times 20 \times 45 \times 50 \times 46}{43 \times 37 \times 45 \times 16 \times 1.125} = 4.41 \text{ draft.}$$

Following the same method, the tensions can be figured between the other points on the machine, and the product of all the intermediate drafts will equal the total draft.

COTTON MILL MACHINERY CALCULATIONS.

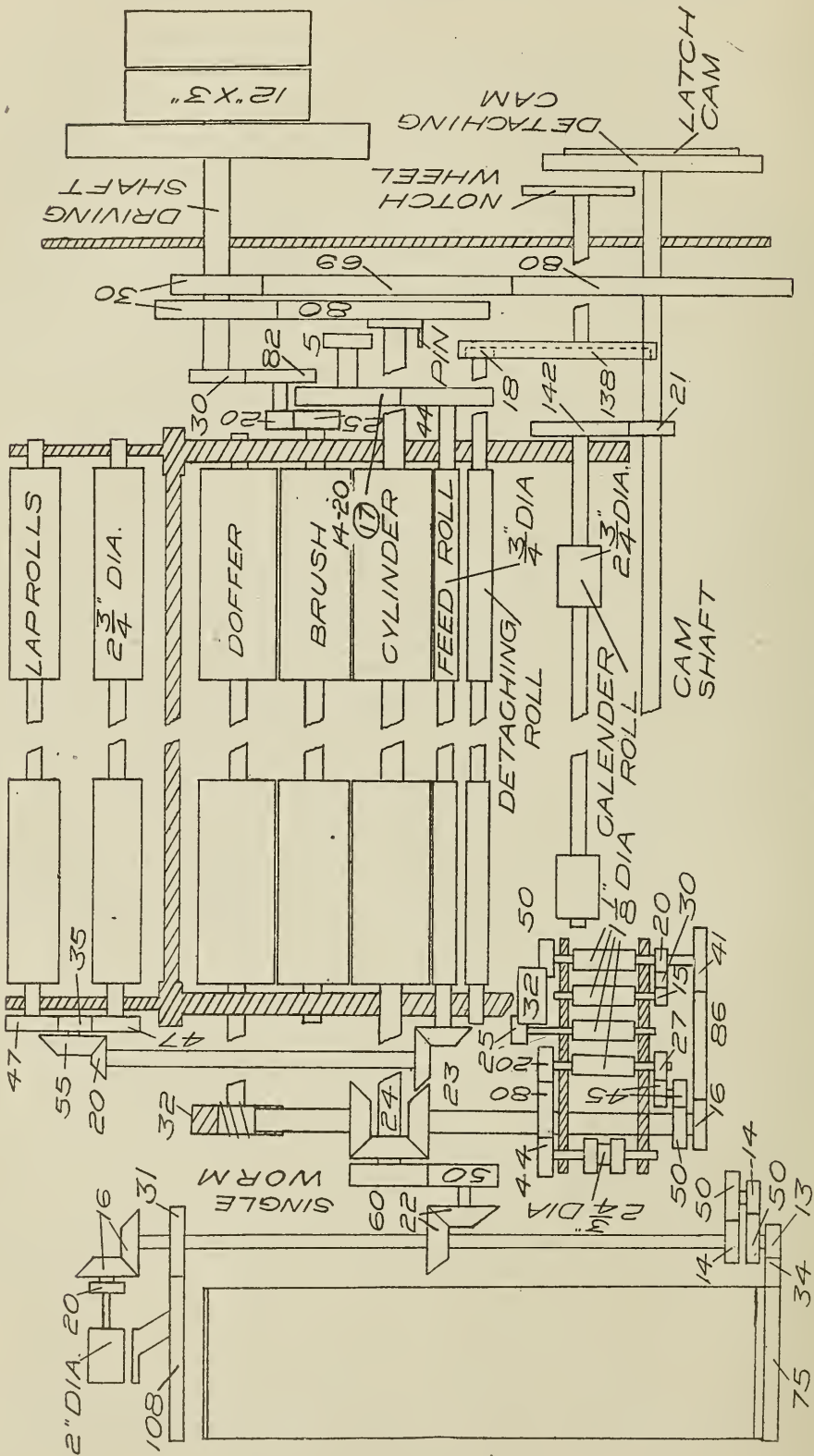

FIG. 23. GEARING DIAGRAM OF WHITIN COMBER.

In figuring the weight of sliver delivered by the comber from the draft of the machine and the weight of the laps, the percentage of waste made must be taken into consideration, as the draft just obtained is figured draft and does not take into consideration the amount of cotton taken out in the form of waste. On the sliver and ribbon lappers there is no loss of material as waste, and hence the actual and figured draft will be practically the same.

On the comber the waste varies from 10 to 25 per cent. and will have a corresponding varying effect upon the weight of the finished sliver. For example, take a comber with six laps up, a figured draft of 30 and making 20 per cent. waste. If the laps weigh 300 grains per yard, what will the sliver weigh?

The total weight entering the machine will be $6 \times 300 = 1,800$ grains. Now, if there is no waste made, $1,800 \div 30 = 60$ grains per yard as the weight of the finished sliver. But, of the total 1,800 grains entering the machine, 20 per cent is lost or taken out as waste, leaving only 1,440 grains to be delivered in the form of sliver. Then: $1,440 \div 30 = 48$ grains per yard as the weight of the finished sliver. With the above figures for weight of lap and sliver we can figure the actual draft as follows:

$$\frac{6 \times 300}{48} = 37.5 \text{ actual draft.}$$

Then it will be seen that a figured draft of 30 with a 20 per cent. loss in waste will give an actual draft of 37.5. There are several ways of determining the per cent. of waste made, but the following is about as short and easy as any:

Find the figured draft from draft gear and draft factor. Find actual draft from weight of sliver and weight of lap. Divide the figured draft by the actual draft and subtract the answer from one.

Example: With comber which is geared to give a figured draft of 30 and which has an actual draft of 37.5, what is the per cent. of waste being made?

$$30 \div 37.5 = .80. \quad 1 - .80 = .20 \text{ or 20 per cent of waste.}$$

Example: What would have to be the weight of laps to use on a comber that is delivering a 48 grain sliver, using a figured draft of 30, making 20 per cent. waste and doubling six laps on the back?

$$\frac{48 \times 30}{6 \times .80} = 300 \text{ grains per yard.}$$

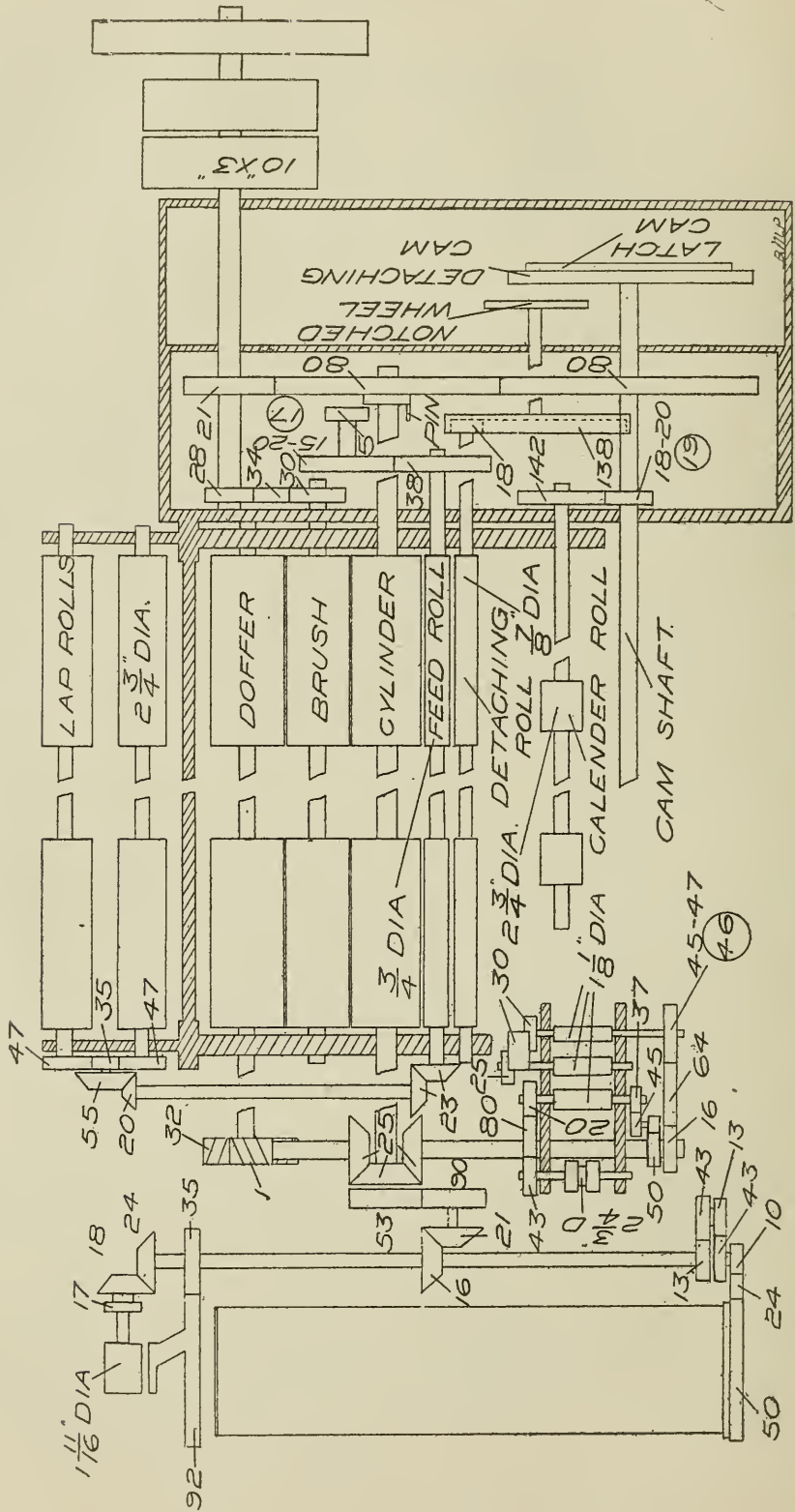

FIG. 24. GEARING DIAGRAM OF MASON COMBER.

PRODUCTION.

The production of the comber depends upon the speed of the machine, or nips per minute, and the weight of the finished sliver. Where the best quality of finished product is desired, it is not good policy to use too high a speed or too heavy a sliver, as the machine cannot do good work under these conditions. The Whitin high-speed comber is capable of making 100 to 140 revolutions per minute, delivering a sliver varying from 40 to 75 grains per yard, which gives a total production of 68 to 181 pounds per day.

In figuring the production from the nips per minute, we must figure out the ratio in speed between the cylinder shaft and the coiler calender rolls, as the latter is the real delivery point of the machine and the production depends upon the weight of finished sliver and the speed of the calender rolls. On the single nip machine, shown in diagram, the cylinder speed and nips per minute are the same, while on a duplex or double nip comber the cylinder speed is one-half the number of nips. The ratio between the cylinder speed and the coiler calender rolls, using gears in Fig. 23, is:

$$\frac{1 \times 60 \times 22 \times 16}{50 \times 22 \times 16} = 1.2$$

Then the cylinder speed or nips per minute multiplied by this ratio of 1.2 will give the speed of the coiler calender rolls. As before stated, the speed of the coiler rolls is regulated by a change gear, and any change made in the size of this gear will change the speed of the coiler calender rolls and necessitate a new calculation for a ratio between these points.

Example: What would be the production in a 10 hour day on a Whitin comber, geared as shown in Fig. 23, running at a speed of 120 nips per minute, delivering a 50 grain sliver, and allowing for a loss of time of 5 per cent.?

$$\frac{120 \times 1.2 \times 2 \times 3.1416 \times 600 \times 50 \times .95}{36 \times 7,000} = 102.32 \text{ lbs.}$$

In the above example the nips per minute are multiplied by the ratio of 1.2, and this gives the coiler calender roll speed, the other figures being what we ordinarily expect in such a calculation. In the above, we can consider that the speed of the machine and the weight of the sliver are variable quantities, and, as the speed of the coiler calender rolls are sometimes changed to suit different conditions of draft and weight of sliver, we may also consider the ratio as being a variable quantity. Now considering

these three points as varying quantities, the following gives a production constant:

$$\frac{2 \times 3.1416 \times 600 \times 50 \times .95}{36 \times 7,000} = .1421.$$

This constant will apply only on the later type of Whitin combers, with a loss of time of 5 per cent, based on 10 hours a day. The production can be figured from the above constant by the following rule:

Production constant \times *nips per minute* \times *ratio* \times *grains per yard in sliver* = *pounds per day.*

Example: What would be the production of a Whitin comber at 120 nips per minute, delivering a 50 grain sliver, allowing for 5 per cent loss of time? Ratio between cylinder speed and coiler roll speed is 1.2.

$$.1421 \times 120 \times 1.2 \times 50 = 102.31 \text{ pounds.}$$

This figure corresponds closely with the production figured above. When there is little or no chance of the ratio between the coiler rolls and the cylinder shaft being changed, a constant can be worked out considering only the nips per minute and the weight of the sliver as being variable quantities. With gears as used this constant would be .17052, and this constant multiplied by the weight of sliver and the nips per minute would give the production in pounds, as follows:

$$.17052 \times 120 \times 50 = 102.312 \text{ pounds produced.}$$

The production on the Mason comber can be found by the same method as used above. The ratio between the speed of the cylinder and the coiler calender rolls is found by the following:

$$\frac{1 \times 53 \times 21 \times 24}{90 \times 16 \times 18} = 1.03.$$

The difference in the two ratios on the two machines can be explained by the difference in the amount of draft in the draw-box. The greater the draft at this point, the larger the ratio has to be.

Example: Find the production on a Mason comber at 100 nips per minute, 60 grain sliver, 10 hours a day and 5 per cent loss of time. The 1 11/16 inch coiler rolls are 5.3 inches in circumference.

$$\frac{100 \times 1.03 \times 5.3 \times 600 \times 60 \times .95}{36 \times 7,000} = 74 \text{ lbs. produced.}$$

As there is practically no change in tension between the coiler rolls and the draw-box, the above ratio of 1.03 will remain the same and a production constant can be worked out, considering only the speed of the machine and the weight of the sliver as being variables, as follows:

$$\frac{1.03 \times 5.3 \times 600 \times .95}{36 \times 7,000} = .123.$$

Multiplying this production constant by the nips per minute and the weight of sliver will give the production.

The speed of the driving pulleys on the combers is simply a matter of taking the nips per minute and multiplying by the ratio between the cylinder shaft and the driving shaft. On the Whitin frame 2.66 revolutions of driving shaft are necessary to get one revolution of cylinder shaft and with the machine running at 120 nips per minute, the driving pulleys would make $2.66 \times 120 = 319$ revolutions per minute. The calculation for the size of pulley needed to drive the machine is similar to that used before.

SLIVER LAP MACHINE, 1906 MODEL

Production per day of ten hours, allowing 25 per cent off for oiling, cleaning, etc.

Revolutions per min. of 5 in. Calendar roll	GRAINS PER YARD OF LAP PRODUCED													
	350	360	370	380	390	400	410	420	430	440	450	460	470	480
	Lbs.	Lbs.	Lbs.	Lbs.	Lbs.	Lbs.	Lbs.	Lbs.	Lbs.	Lbs.	Lbs.	Lbs.	Lbs.	Lbs.
85	834	7 858	5 882	3 906	1 929	9 953	7 978	3 1001	3 1025	9 1049	7 1073	5 1097	3 1121	1 1144
90	883	8 909	0 934	2 959	4 984	6 1009	8 1035	9 1062	2 1086	3 1111	5 1136	7 1161	9 1187	1 1212
95	932	9 959	5 986	1 1012	7 1039	3 1065	9 1093	4 1119	1 1146	9 1173	2 1199	8 1226	4 1253	0 1279
100	982	0 1010	0 1038	0 1066	0 1094	0 1122	0 1151	0 1178	0 1207	0 1235	0 1263	0 1291	0 1319	0 1347
105	1031	1 1060	5 1089	9 1119	3 1148	7 1178	1 1208	5 1236	9 1267	3 1296	7 1326	1 1355	5 1384	9 1414
110	1080	2 1111	0 1141	8 1172	6 1203	4 1234	2 1266	1 1295	8 1327	7 1358	5 1389	3 1420	1 1450	9 1481
120	1178	4 1212	0 1245	6 1279	2 1312	8 1346	4 1381	2 1413	6 1448	4 1482	0 1515	6 1549	2 1582	8 1616
130	1276	6 1313	0 1349	4 1385	8 1422	2 1458	6 1496	3 1531	4 1569	1 1605	9 1641	9 1678	3 1714	7 1751
140	1374	8 1414	0 1453	2 1492	4 1531	6 1570	8 1611	4 1649	2 1689	8 1729	0 1768	2 1807	4 1846	6 1885
150	1473	0 1515	0 1557	0 1599	0 1641	0 1683	0 1726	5 1767	0 1810	5 1852	5 1894	5 1936	5 1978	5 2020

USED BY PERMISSION OF WHITIN MACHINE WORKS

Three revolutions of driving pulley to one revolution of 5 inch calendar roll.

RIBBON LAP MACHINE, 1907 MODEL

Production per day of ten hours, allowing 25 per cent off for oiling, cleaning, etc.

Revolutions per min. of 5 in. Calendar roll		GRAINS PER YARD OF LAP PRODUCED																										
		400	410	420	430	440	450	460	470	480	490	500	510	520	530													
		Lbs.	Lbs.	Lbs.	Lbs.	Lbs.	Lbs.	Lbs.	Lbs.	Lbs.	Lbs.	Lbs.	Lbs.	Lbs.	Lbs.													
85	953	7	978	3	1001	3	1025	3	1049	7	1073	5	1097	3	1121	1	1144	9	1168	8	1192	6	1216	4	1240	2	1264	0
90	1009	8	1035	9	1060	2	1086	3	1111	5	1136	7	1161	9	1187	1	1212	3	1237	5	1262	7	1287	9	1313	1	1338	3
95	1065	9	1093	4	1119	1	1146	6	1173	2	1199	8	1226	4	1253	0	1279	6	1306	3	1332	9	1359	5	1386	1	1412	7
100	1122	0	1151	0	1178	0	1207	0	1235	0	1263	0	1291	0	1319	0	1347	0	1375	0	1403	0	1431	0	1459	0	1487	0
105	1178	2	1208	5	1236	9	1267	3	1296	7	1326	1	1355	5	1384	9	1414	3	1443	8	1473	2	1502	6	1532	0	1561	4
110	1234	2	1266	1	1295	8	1327	7	1358	5	1389	3	1420	1	1450	9	1481	7	1512	5	1543	3	1574	1	1604	9	1635	7
120	1346	4	1381	2	1413	6	1448	4	1482	0	1515	6	1549	2	1582	8	1616	4	1650	0	1683	6	1717	2	1750	8	1784	4
130	1458	6	1496	3	1531	4	1569	1	1605	5	1641	9	1678	3	1714	7	1751	1	1787	5	1823	9	1860	3	1896	7	1933	1
140	1570	8	1611	4	1649	2	1689	8	1729	0	1768	2	1807	4	1846	6	1885	8	1925	0	1964	2	2003	4	2042	6	2081	8
150	1683	0	1726	5	1767	0	1810	5	1852	5	1894	5	1936	5	1978	5	2020	5	2062	5	2104	5	2146	5	2188	5	2230	5

USED BY PERMISSION OF WHITIN MACHINE WORKS

Three revolutions of driving pulley to one revolution of 5 inch calendar roll.

PRODUCTION TABLE OF WHITIN HIGH SPEED COMBER

Showing the number of pounds of Combed Sliver produced in one day of ten hours allowing 5 per cent off for cleaning, oiling, etc.

Coiler connection gear 50 tooth

GRAINS PER YARD OF COMBED SLIVER

Nips per Min.	40		42		44		46		48		50		52		54		56		58		60		62		64		66		68		70		72		74		76	
	Lbs.	Lbs.	Lbs.	Lbs.	Lbs.	Lbs.	Lbs.	Lbs.	Lbs.	Lbs.	Lbs.	Lbs.	Lbs.	Lbs.	Lbs.	Lbs.	Lbs.	Lbs.	Lbs.	Lbs.	Lbs.	Lbs.	Lbs.	Lbs.	Lbs.	Lbs.	Lbs.	Lbs.	Lbs.	Lbs.	Lbs.	Lbs.	Lbs.	Lbs.	Lbs.	Lbs.	Lbs.	
100	68	22	71	63	75	04	78	45	81	86	85	27	88	68	92	09	95	50	98	91	102	32	105	73	109	15	112	56	115	97	119	38	122	79	126	20	129	61
105	71	63	75	20	78	79	82	37	85	95	89	54	93	12	96	70	100	28	103	86	107	44	111	02	114	60	118	19	121	77	125	35	128	93	132	51	136	09
110	75	04	78	79	82	54	86	30	90	05	93	80	97	55	101	30	105	05	108	80	112	56	116	31	120	06	123	81	127	57	131	32	135	07	138	82	142	57
115	78	45	82	37	86	29	90	22	94	14	98	06	101	98	105	90	109	83	113	75	117	67	121	59	125	52	129	44	133	36	137	28	141	21	145	13	149	05
120	81	86	85	95	90	05	94	14	98	23	102	33	106	41	110	51	114	60	118	70	122	79	126	88	130	98	135	07	139	16	143	25	147	35	151	44	155	53
125	85	27	89	54	93	80	98	06	102	33	106	59	110	85	115	12	119	38	123	64	127	91	132	17	136	44	140	70	144	96	149	23	153	49	157	75	162	02
130	88	68	93	12	97	55	101	99	106	42	110	85	115	29	119	72	124	16	128	59	133	02	137	46	141	89	146	83	150	76	155	19	159	63	164	06	168	50
135	92	09	96	70	101	30	105	91	110	51	115	12	119	72	124	32	128	93	133	53	138	14	142	74	147	35	151	95	156	56	161	16	165	77	170	37	174	97
140	95	50	100	28	105	05	109	83	114	61	119	38	124	16	128	93	133	71	138	48	143	26	148	03	152	81	157	58	162	36	167	13	171	91	176	68	181	46

USED BY PERMISSION OF WHITIN MACHINE WORKS

2.66 revolutions of driving pulley to one nip.

CHAPTER V.

RAILWAY HEADS AND DRAWING FRAMES—DRAFT, SPEED, AND PRODUCTION CALCULATIONS—METALLIC AND LEATHER ROLLS—PRODUCTION CONSTANTS.

RAILWAY HEADS.

The essential difference between the railway head and the drawing frame is the fact that the railway attempts to overcome the irregularities in the card sliver by a change in the speed of the rolls, while the drawing frame has no such mechanism; and its evening effect is obtained solely from the fact that there are six ends doubled at the back, drawn out and delivered as one end at the front, of about the same weight as the single ends received at the back. In the old style of railway head, connected direct to a line of cards by means of a travelling apron, or trough, it was essential that the front roll be the one to vary in speed as the material increased in weight but, after the introduction of the modern revolving flat card, the railways took their slivers from cans and the back rolls on some were the ones that were made to vary in speed according to the bulk of material passing through the evener trumpet on the front.

In Fig. 25 is shown a diagram of the gearing of the railway head built by the Lowell Machine Shop. It will be noticed that the front roll is driven from the top cone, which is driven from the bottom cone, and hence the top cone speed varies with the position of the cone belt, this latter depending upon the pull exerted by the sliver as it passes through the evener trumpet, thus giving a corresponding variation in the speed of the front roll. The back roll is driven at a constant speed from the driving shaft, and the second and third rolls are driven from the back roll. The draft gear is located on the end of the top cone shaft. The break draft occurs between the front and second drawing rolls, and this draft changes with any movement of the cone belt or with any change in the size of the draft gear, the drafts between the other rolls remaining the same. This is in accordance with the old custom of using the railway in connection with the old style stationary flat cards.

Considering we are using common rolls, or steel fluted bottom rolls with leather covered top rolls, the following gives the draft constant between the front and back rolls, both diameters being expressed as eighths:

$$\frac{12 \times X \times 72 \times 30 \times 60}{36 \times 32 \times 37 \times 27 \times 9} = .15 \text{ draft constant.}$$

Rule for using draft constant:

$\text{Constant} \times \text{gear} = \text{draft.}$

$\text{Draft} \div \text{constant} = \text{gear.}$

Then a draft gear of 40 teeth would give a total draft of 6, as follows:

$$15 \times 40 = 6.$$

It is assumed and understood that the evener cone belt is working midway of the cones, where the diameters of the two are

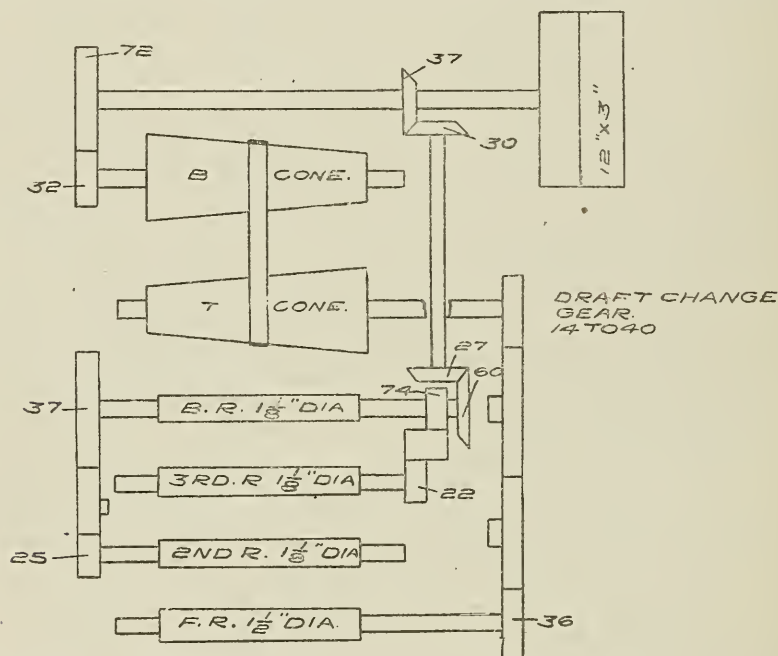

FIG. 25. GEARING PLAN OF LOWELL RAILWAY HEAD.

the same and they do not affect the draft. In running railways this point should be looked after, as it gives plenty of leeway for belt movement in either direction when variations in weight of card sliver occur.

In Fig. 26 is shown a diagram of the gearing of the railway head built by the Whiting Machine Works. In general plan it is similar to the one just illustrated. Using leather rolls the following gives the draft constant, figuring between the $2\frac{1}{2}$ inch calendar and the $1\frac{1}{8}$ inch back drawing rolls, both diameters being expressed as eighths:

$$\frac{20 \times X \times 44 \times 55}{43 \times 30 \times 24 \times 9} = .1738 \text{ draft constant.}$$

Then a draft gear of 30 teeth will give a draft of: $30 \times .1738 = 5.214$.

In Fig. 27 is shown a diagram of the gearing of the railway head built by the Saco-Pettee Co. Some differences will be noticed in the construction as compared with the two just considered. The front roll is driven by a belt from the driving shaft under the frame, and has a constant speed. The front roll drives the second roll. The back roll is driven from the front roll by means of two short cones and a friction belt, and has a variable

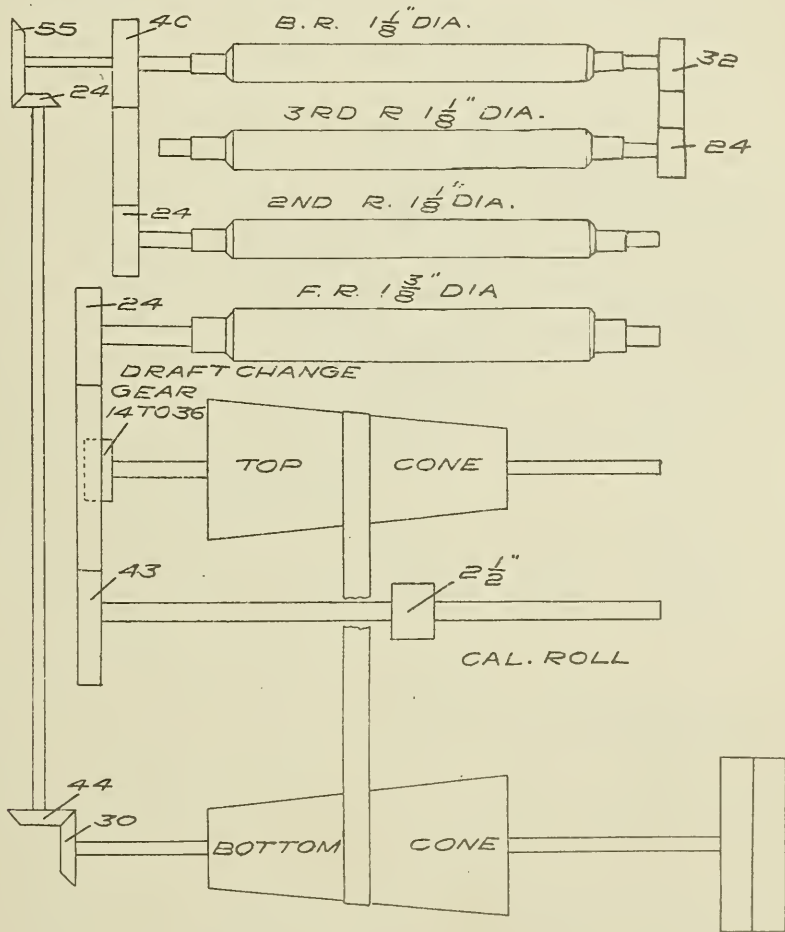

FIG. 26. GEARING PLAN OF WHITIN RAILWAY HEAD.

speed depending upon the position of the cone belt. The back roll drives the third roll. Any change in speed of back roll, due to change in size of draft gear or movement of cone belt, will change the draft between the second and third rolls, the other drafts remaining the same.

Figuring between the 2 inch calender and the $1\frac{1}{8}$ inch back drawing roll, we get the following draft constant:

$$\frac{16 \times 32 \times 24 \times 100 \times 60}{24 \times 45 \times 26 \times X \times 9} = 292 \text{ draft constant.}$$

Rule for using draft constant on Saco-Pettee railway head:

Constant \div *draft* = *gear*.

Constant \div *gear* = *draft*.

Therefore a 50 tooth draft gear will give a draft of 5.84.

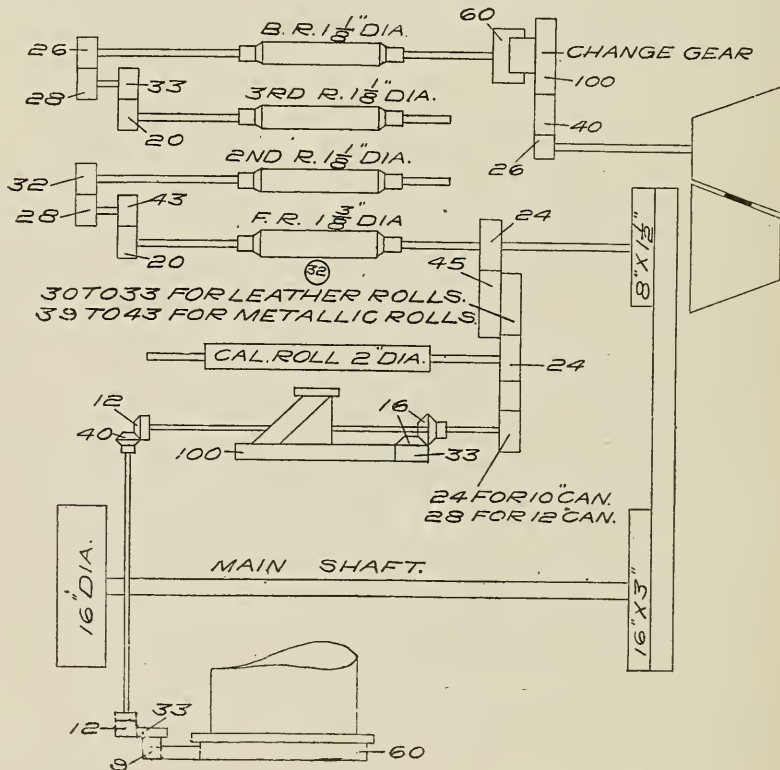

FIG. 27. GEARING PLAN OF SACO-PETTEE RAILWAY HEAD.

DRAWING FRAMES.

Fig. 28 shows a diagram of the gearing of the drawing frame built by the Lowell Machine Shop. This gearing is different from those to follow in that the draft gear is located in the position ordinarily occupied by the crown gear, a larger draft gear having the effect of causing a slower speed of the back roll, hence increasing, instead of decreasing, the draft; and also the third roll drives the back roll instead of the back roll driving the third roll, as is the common practice. The gears on the end of back and calender rolls are numbered two sizes, the letter *c* referring to the

size gear to use with common rolls and the letter *m* for metallic rolls.

Using the gearing for common rolls and figuring between

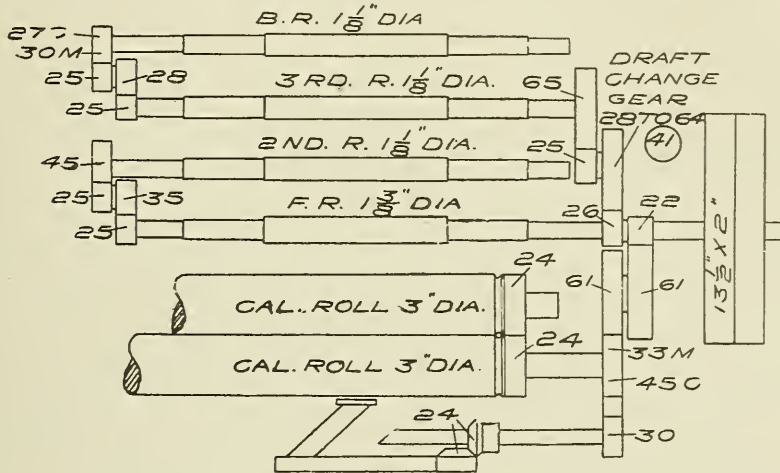

FIG. 28. GEARING PLAN OF LOWELL DRAWING FRAME.

calender and back drawing rolls, using a 41 tooth draft gear, we get a total draft of 6.46, as follows:

$$\frac{24 \times 61 \times 22 \times 41 \times 65 \times 28 \times 27}{45 \times 61 \times 26 \times 25 \times 25 \times 25 \times 9} = 6.46 \text{ total draft.}$$

By leaving out the draft gear of 41 teeth in the above calculation, we get the draft constant, as follows:

$$\frac{24 \times 61 \times 22 \times X \times 65 \times 28 \times 27}{45 \times 61 \times 26 \times 25 \times 25 \times 25 \times 9} = .1576 \text{ draft constant.}$$

Rule for using draft constant on Lowell drawing frame:

Constant \times *gear* = *draft*.

Draft \div *constant* = *gear*.

By using the same method of figuring we can get the following intermediate drafts:

Draft occurring between first and second drawing rolls:

$$\frac{11 \times 35 \times 45}{25 \times 25 \times 9} = 3.08 \text{ draft.}$$

Draft occurring between second and third drawing rolls:

$$\frac{9 \times 25 \times 25 \times 41 \times 65}{45 \times 35 \times 26 \times 25 \times 9} = 1.626 \text{ draft.}$$

Draft occurring between third and back drawing rolls:

$$\frac{9 \times 27 \times 28}{25 \times 25 \times 9} = 1.209 \text{ draft.}$$

Draft occurring between calender and front drawing rolls:

$$\frac{24 \times 61 \times 22}{45 \times 61 \times 11} = 1.066 \text{ draft.}$$

The product of these four intermediate drafts should be equal to the total draft, as figured previously, or:

$$3.08 \times 1.626 \times 1.209 \times 1.066 = 6.46 \text{ total draft.}$$

In using metallic rolls on either drawing frames or railways, the common custom is to use a $1\frac{3}{8}$ inch front roll and a $1\frac{1}{8}$ inch roll for the other three lines, bottom and top rolls the same size. The rolls are made of different pitch, that is, different number of flutes for each inch in diameter; a 32 pitch roll being more commonly used on the front line, while a 32 or 24 pitch roll is used on the second line, a 24 pitch roll is used on the third line and a 16 pitch roll is used on the back line. On account of the crimping action of the flutes the rolls deliver more than a smooth roll of the same diameter. The pitch line collars, located just beyond the flutes, keep the flutes from bottoming, thus preventing the cutting of the material as it passes through the rolls. The flutes of the coarser fluted rolls are deeper and cause a greater crimping of the material and give a greater increase to the delivery of the roll. The collars on the 24 and 32 pitch rolls are of such size as to give about the same increase in delivery, tests having been made which indicate this increase at about 33 per cent. The 16 pitch roll, being coarser fluted and the flutes deeper, gives about 47 per cent. increase in delivery over a common roll of the same diameter. From the above, we can get the effective diameter of any metallic roll by increasing its diameter by 33 per cent. or 47 per cent. depending upon its pitch, and this method can be used in working out draft on metallic rolls.

The following table gives the diameters, the pitch, the effective diameters and the effective diameters reduced to sixths, so as to facilitate the finding of draft, etc:

- 1 inch roll, 32 pitch, effective diameter 1.33, figured as $\frac{8}{6}$.
- $1\frac{1}{8}$ inch roll, 32 pitch, effective diameter 1.50, figured as $\frac{9}{6}$.
- $1\frac{1}{4}$ inch roll, 32 pitch, effective diameter 1.66, figured as $\frac{10}{6}$.
- $1\frac{3}{8}$ inch roll, 32 pitch, effective diameter 1.83, figured as $\frac{11}{6}$.
- $1\frac{1}{2}$ inch roll, 32 pitch, effective diameter 2.00, figured as $\frac{12}{6}$.

It should be remembered that any 24 pitch roll can be figured as a 32 pitch roll.

$1\frac{1}{8}$ inch roll, 16 pitch, effective diameter 1.66, figured as 10/6.

$1\frac{1}{4}$ inch roll, 16 pitch, effective diameter 1.83, figured as 11/6.

$1\frac{3}{8}$ inch roll, 16 pitch, effective diameter 2.00, figured as 12/6.

$1\frac{1}{2}$ inch roll, 16 pitch, effective diameter 2.07, figured as 13/6.

A 2 inch calender roll is figured as 12/6.

A $2\frac{1}{2}$ inch calender roll is figured as 15/6.

A 3 inch calender roll is figured as 18/6.

With the above table as reference, it is easy to figure the draft of metallic rolls. The pitch of a metallic roll is easily detected by the appearance of the flutes but, if not certain, count the number of flutes and divide by the diameter of the roll.

In Fig. 29 is shown a diagram of the gearing of the drawing frame built by the Whitin Machine Works, geared for metallic rolls. The total draft between the 3 inch calender roll and the $1\frac{1}{8}$ inch, 16 pitch back drawing roll, using a 30 tooth draft gear, is as follows:

$$\frac{18 \times 55 \times 19 \times 72 \times 70}{30 \times 56 \times 30 \times 30 \times 10} = 6.27 \text{ total draft.}$$

The diameters of the calender and back rolls are expressed as 18 and 10 as shown in the table above.

By leaving out the draft gear of 30 teeth in the above calculation, we get the draft constant.

$$\frac{18 \times 55 \times 19 \times 72 \times 70}{30 \times 56 \times 30 \times X \times 10} = 188 \text{ draft constant.}$$

Rule:

Constant \div *gear* = *draft*.

Constant \div *draft* = *gear*.

Assuming the front and second rolls to be 32 pitch, the third roll 24 pitch and the back roll 16 pitch, we can figure the draft between the different rolls, as follows:

Draft between calender and front rolls:

$$\frac{18 \times 55 \times 19}{30 \times 56 \times 11} = 1.017 \text{ draft.}$$

Draft between front and second rolls:

$$\frac{11 \times 40 \times 30}{20 \times 27 \times 9} = 2.716 \text{ draft.}$$

Draft between second and third rolls:

$$\frac{9 \times 27 \times 20 \times 72 \times 70 \times 27 \times 24}{30 \times 40 \times 30 \times 30 \times 26 \times 36 \times 9} = 1.74 \text{ draft.}$$

Draft between third and back rolls:

$$\frac{9 \times 36 \times 26}{24 \times 27 \times 10} = 1.30 \text{ draft.}$$

The product of these four intermediate drafts is 6.25, which is very close to that figured direct from the gearing.

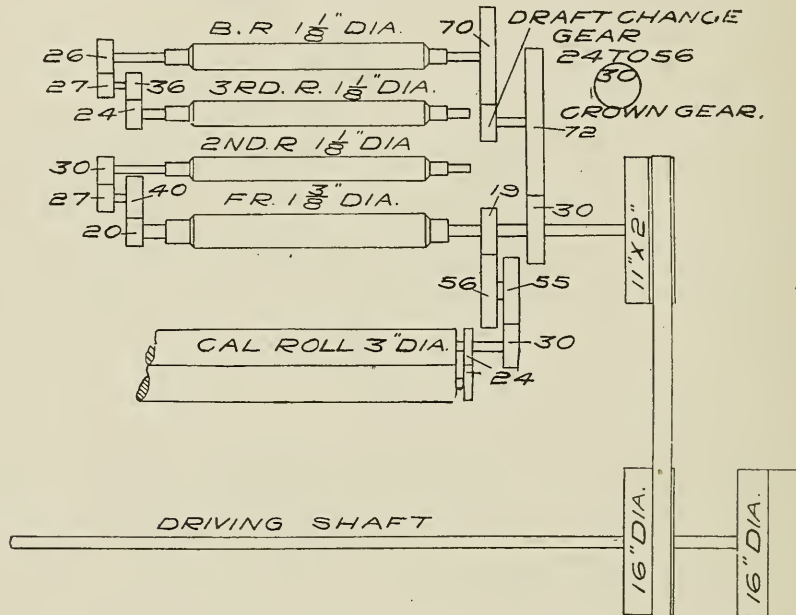

FIG. 29. GEARING PLAN OF WHITIN DRAWING FRAME.

The actual drafts on the railways or the drawing frames, as figured from the weight of the slivers on back and front, vary somewhat from the figured drafts as obtained from the gearing. This difference is due to the varying amount of crimping of the material by the flutes of the rolls, and the amount of such variation depends upon the bulk of the material being handled. For instance, with the same drafts and speed, a heavy sliver being doubled and fed into the back of the machine, will show less variation in the actual and figured drafts than if a light sliver was being handled. This is explained by the fact that the heavy mass of fibers entering the back rolls do not yield to the crimping action of the flutes to the extent that a lighter mass of fibers would, and hence the increase in the working diameter of the back roll is not so great. When the mass has reached the front rolls, its bulk has been decreased enough to allow of the full crimping effect of these rolls. However, draft calculated by the above method will come near enough to the actual draft for most practical purposes.

Fig. 30 shows a diagram of the gearing of the drawing frame

built by the Saco-Pettee Co. The following gives the draft constant, with common rolls, figuring between the 2 inch calender and the $1\frac{1}{8}$ inch back rolls:

$$\frac{16 \times 32 \times 24 \times 100 \times 60}{24 \times 45 \times 24 \times X \times 9} = 316 \text{ draft constant.}$$

Figuring the draft constant for metallic rolls, we get the following:

$$\frac{12 \times 42 \times 24 \times 100 \times 60}{24 \times 45 \times 24 \times X \times 10} = 280 \text{ draft constant.}$$

Using a 45 tooth draft gear with metallic rolls will give only a draft of 6.22, while with common rolls the same gear will give

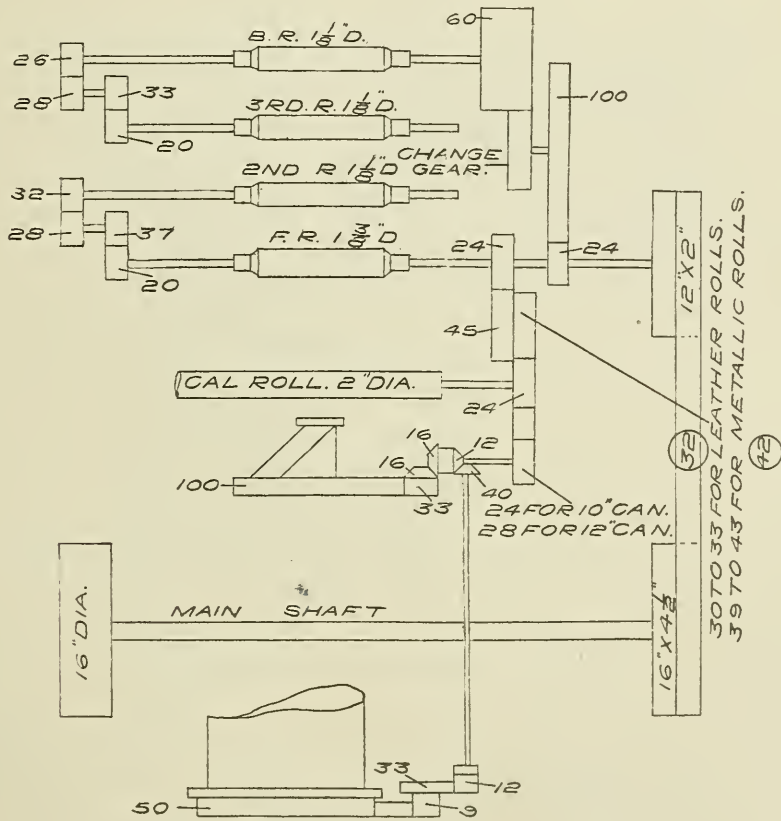

FIG. 30. GEARING PLAN OF SACO-PETTEE DRAWING FRAME.

a draft of 7.02. This readily shows the increase in the crimping of the coarse fluted back rolls over the finer fluted front rolls, for if both the front and back rolls crimped the material to the same extent, the drafts with metallic and leather rolls would be the same.

A diagram of the gearing of the drawing frame built by Howard & Bullough, American Machine Co. is shown in Fig. 31. Figuring for metallic rolls between the 3 inch calender and the $1\frac{1}{8}$ inch back roll, we get the following draft constant:

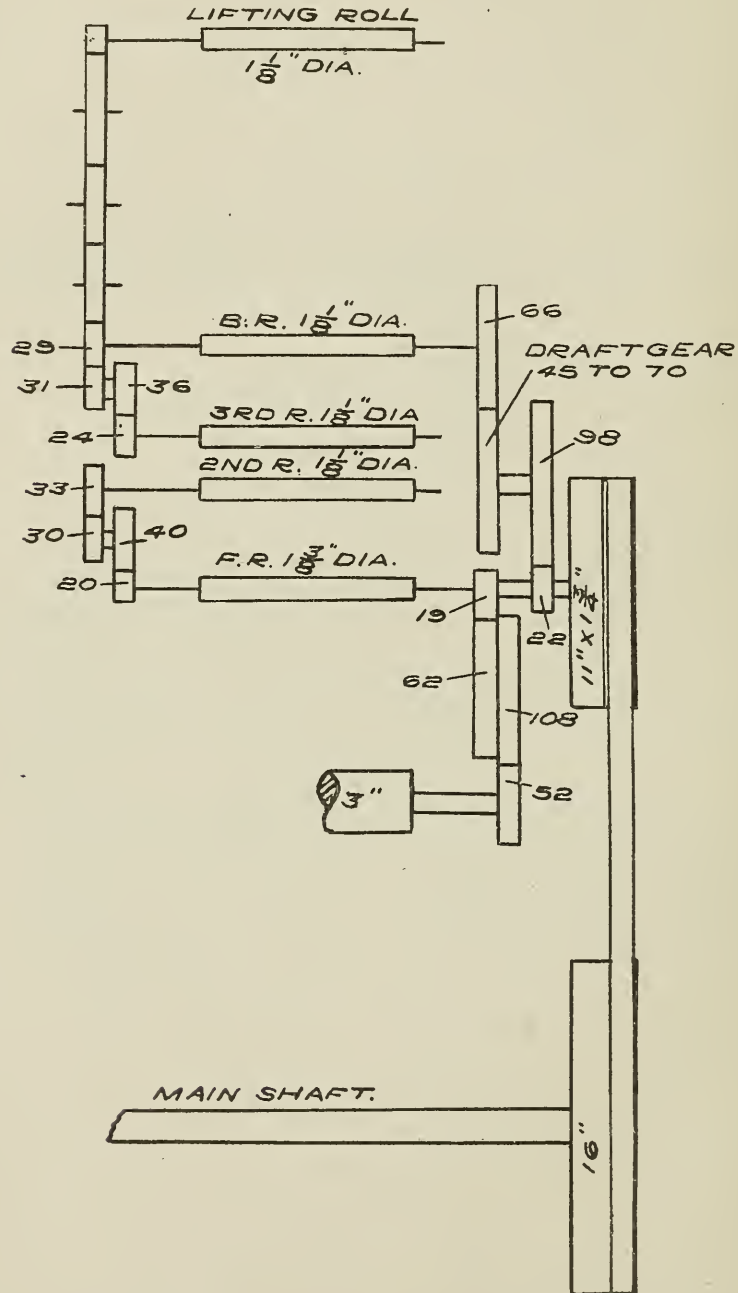

FIG. 31. GEARING PLAN OF HOWARD & BULLOUGH DRAWING FRAME.

$$\frac{18 \times 108 \times 19 \times 98 \times 66}{52 \times 62 \times 22 \times X \times 10} = 336.8 \text{ draft constant.}$$

A diagram of the gearing of the drawing frame built by the Mason Machine Works is shown in Fig. 32. This gearing is arranged for metallic rolls. The draft constant is 311, as shown below:

$$\frac{15 \times 31 \times 90 \times 48}{44 \times 22 \times X \times 10} = 311 \text{ draft constant.}$$

Rule for using the above two constants:

Constant \div *draft* = *gear*.

Constant \div *gear* = *draft*.

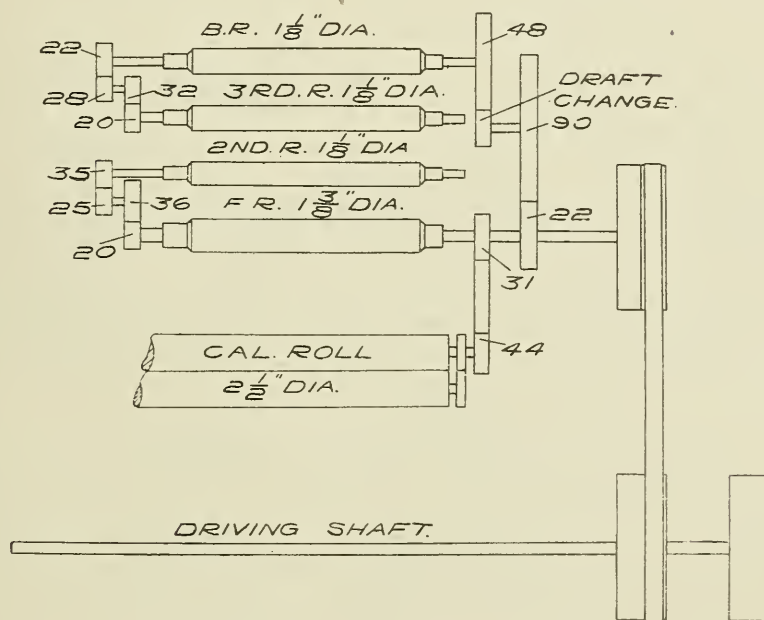

FIG. 32. GEARING PLAN OF MASON DRAWING FRAME.

From the foregoing it will be seen that, with the exception of the Lowell drawing frame, all the frames are geared very similarly. In each case a larger draft gear will drive the back roll faster, feed in more material, decrease the draft and increase the weight of the sliver on the front. The Saco-Pettee railway is similarly arranged, while the Lowell and Whitin railways are differently constructed. A larger draft gear on these last two has the effect of increasing the speed of the front roll, increasing the draft and reducing the weight of the sliver.

The following rule will give the actual draft of the frames:

$$\frac{\text{Weight of single sliver on back} \times \text{doublings.}}{\text{Weight of sliver on front.}} = \text{draft.}$$

The draft increases as the size of the draft gear decreases and the following holds good on all except the Whitin railway and the Lowell railway and drawing:

$$\frac{\text{Gear on the frame} \times \text{draft of the frame}}{\text{Draft desired}} = \text{draft gear needed}$$

Example: If a drawing frame with a 50 tooth draft gear has a draft of 6, what size gear will be needed to give a draft of 5.75?

$$\frac{50 \times 6}{5.75} = 52 \text{ tooth draft gear.}$$

On the Lowell railway and drawing and the Whitin railway the rule would be as follows:

$$\frac{\text{Gear on frame} \times \text{draft desired}}{\text{Draft of the frame}} = \text{draft gear needed.}$$

In dealing with the weight of the sliver and the draft gear, the following rule applies, with the same exceptions as noted above, and enables a change of draft gear direct to give any desired variation in weight of sliver:

$$\frac{\text{Gear on frame} \times \text{weight of sliver desired}}{\text{Weight of sliver on frame}} = \text{draft gear needed.}$$

Example: If a drawing frame is producing a 50 grain sliver with a 60 tooth draft gear, what size draft gear will be needed if the sliver is desired to be 42 grains in weight?

$$\frac{60 \times 42}{50} = 50.4 \text{ or } 50 \text{ tooth draft gear needed.}$$

On the Lowell railway and drawing and the Whitin railway the above rule would be changed to read as follows:

$$\frac{\text{Gear on frame} \times \text{weight of sliver on frame}}{\text{Weight of sliver desired.}} = \text{draft gear needed.}$$

PRODUCTION.

The basis of the production calculations on the above frames is the speed of the front roll and the weight of the sliver. In dealing with the older types of railways and those geared as shown in

Figs. 25 and 26, the speed of the front roll is a variable quantity, depending upon the size of the draft gear and the position occupied by the cone belt. Consequently there is always present a chance for error. On the drawing frames and those railways that have a constant front roll speed, the production can be figured accurately. There is always present a small element of error in the calculations due to the fact that there is a greater length of sliver delivered to the can than is delivered by the front roll, due to the tension between these points, necessary to keep the ends tight. However, this is small and may be neglected.

Example: What is the production in a ten hour day of a drawing frame, if the front roll is $1\frac{3}{8}$ inches in diameter, making 400 revolutions per minute and delivering a 50 grain sliver? Allow for 20 per cent. loss of time and assume the use of common rolls. The circumference of a $1\frac{3}{8}$ inch common roll is 4.32 inches, then:

$$\frac{4.32 \times 400 \times 600 \times 50 \times .80}{36 \times 7,000} = 164.6 \text{ pounds produced.}$$

By eliminating the two variable quantities, the speed of the front roll and the weight of the sliver, we get the production constant, as follows:

$$\frac{4.32 \times 600 \times .80}{36 \times 7,000} = .00823.$$

Rule for using the production constant:

Production constant \times *revolutions per minute of front roll*
 \times *weight of sliver* = *pounds per day production.*

Example: Find the production of a drawing frame with a front roll speed of 400 revolutions per minute and delivering a 50 grain sliver?

$$.00823 \times 400 \times 50 = 164.6 \text{ pounds.}$$

The above constant applies to all railways or drawing frames with $1\frac{3}{8}$ inch front common roll, based on a ten hour day, with 20 per cent loss of time for stoppages.

In dealing with frames equipped with metallic rolls, we must allow for the extra delivery of the front roll due to the crimping action of the flutes. This crimping, as has been noted in a 32 pitch roll, amounts to about 33 per cent., so, in the above calculation, we can increase the circumference of the front roll by 33 per cent., and in place of the 4.32 inches used, put 5.75 inches as the circumference of the metallic roll. This will give a calculated production of 219 pounds instead of 164.6. Another method of get-

ting the same thing would be to increase the production figured for common rolls by 33 per cent.

The above production constant of .00823 can be increased by 33 per cent., which will give a production constant that can be used for metallic rolls, as follows: $.00823 \times 1.33 = .01095$ production constant for metallic rolls. The same rule for use of this constant applies as before, then: $.1095 \times 400 \times 50 = 219$ pounds produced.

In the above, one delivery is assumed as the basis. The production of a drawing frame varies directly with the speed of the front rolls and the weight of the sliver.

Example: A drawing frame is producing 160 pounds per day with a front roll speed of 400. What speed would be required to give a production of 140 pounds per day?

$$\frac{400 \times 140}{160} = 350 \text{ revolutions per minute of front roll.}$$

Example: A drawing frame is delivering a 50 grain sliver and producing 160 pounds per day. What would be the production if the weight of the sliver was increased to 56 grains?

$$\frac{160 \times 56}{50} = 179.2 \text{ pounds.}$$

ROLL SETTING.

No fixed rule can be given for getting the distance to set the rolls of a drawing frame or railway head. As a general statement, the lighter the bulk of material handled and the higher the speed of the rolls, the closer they can be set. The following distances are usually given as good usage, based on stock 1 inch long:

Between front and second rolls, 1 $\frac{1}{4}$ ".

Between second and third rolls, 1 $\frac{1}{2}$ ".

Between third and back rolls, 1 $\frac{3}{4}$ ".

The above figures apply to leather rolls and, in using metallic rolls, they will have to be increased by about $\frac{1}{8}$ " in each case. They will not hold good in all cases, as experience will show. The only real test of the correctness of the settings is in the appearance of the sliver as it leaves the front rolls. Irregular and uneven drawing will show up at this point and will be easily detected.

PRODUCTION OF DRAWING FRAME

Table showing number of pounds Drawing Sliver produced in one day of 10 hours, allowing 20 per cent. for cleaning, oiling, etc.

NUMBER OF GRAINS IN ONE YARD OF SLIVER

Rev. of Front Roll Per min.	35		40		45		50		55		60		65		70		75	
	Com. Roll	Met. Roll	Com. Roll	Met. Roll	Com. Roll	Met. Roll	Com. Roll	Met. Roll	Com. Roll	Met. Roll	Com. Roll	Met. Roll	Com. Roll	Met. Roll	Com. Roll	Met. Roll	Com. Roll	Met. Roll
250	74 6	97 7	85 3	111 7	125 7	139 6	153 6	167 5	181 5	195 5	209 4	223 3	237 3	251 3	265 3	279 3	293 3	307 3
260	77 6	101 6	88 7	116 2	130 7	145 2	159 7	174 2	188 8	203 3	217 8	232 3	246 8	261 3	275 8	290 3	304 8	319 3
270	80 6	105 5	92 1	120 6	135 7	150 8	165 9	180 9	196 1	211 2	226 7	241 2	256 7	271 2	286 7	301 2	316 7	331 2
280	83 6	109 5	95 5	125 1	140 7	156 4	172 0	187 6	203 3	219 0	234 6	250 3	265 8	281 3	296 8	312 3	327 8	343 3
290	86 6	113 4	98 9	129 6	145 8	162 0	178 1	194 4	210 5	226 7	242 0	258 3	274 8	290 3	306 8	322 3	338 8	354 3
300	89 6	117 3	102 4	134 0	150 8	167 5	184 3	201 1	217 8	234 6	251 3	268 1	284 8	301 6	318 3	335 1	352 6	369 1
310	92 5	121 2	105 8	138 5	155 8	173 1	190 4	207 8	225 1	242 4	259 7	276 0	293 3	310 6	327 9	345 2	362 5	379 8
320	95 5	125 1	109 2	143 0	160 8	178 7	196 6	214 5	232 3	250 2	268 1	286 0	304 9	322 8	340 7	358 6	376 5	394 4
330	98 5	129 0	112 6	147 4	165 9	184 3	202 7	220 9	238 0	256 9	275 0	293 8	312 7	331 6	350 5	369 4	388 3	407 2
340	101 5	132 9	116 0	151 9	170 9	189 9	208 9	227 9	246 9	265 8	284 8	303 7	322 6	341 5	360 4	379 3	398 2	417 1
350	104 5	136 8	119 4	156 4	175 9	195 5	215 0	234 6	254 1	273 7	293 2	312 7	332 2	351 7	371 2	390 7	410 2	429 7
360	107 5	140 7	122 8	160 8	180 9	199 6	219 2	238 0	258 6	277 5	297 1	316 0	335 9	354 8	373 7	392 6	411 5	430 4
370	110 5	144 6	126 2	165 3	186 9	206 6	225 2	244 0	264 7	283 6	303 2	322 1	341 0	360 9	379 8	398 7	417 6	436 5
380	113 4	148 6	129 6	169 8	191 0	212 2	231 8	250 4	270 1	289 0	308 6	327 2	346 9	365 7	384 4	403 1	421 8	440 5
390	116 4	152 5	133 0	174 2	196 0	217 8	236 4	255 0	274 8	293 4	312 0	330 6	349 2	367 8	386 4	405 0	423 6	442 2
400	119 4	156 4	136 5	178 7	199 6	220 9	239 6	258 2	277 8	296 4	315 0	333 6	352 2	370 8	389 4	408 0	426 6	445 2
410	122 4	160 3	139 9	183 2	203 1	224 2	243 8	262 4	281 0	300 6	319 2	337 8	356 4	375 0	393 6	412 2	430 8	449 4
420	125 4	164 2	143 3	187 7	206 1	229 0	248 6	267 2	285 8	304 4	323 0	341 6	360 2	378 8	397 4	416 0	434 6	453 2
430	128 4	168 1	146 7	192 1	210 1	234 6	253 2	271 8	290 4	309 0	327 6	346 2	364 8	383 4	402 0	420 6	439 2	457 8
440	131 4	172 0	150 1	196 6	216 1	240 1	258 0	276 2	294 9	312 9	330 9	348 8	366 6	384 4	402 2	420 0	437 8	455 6
450	134 3	175 9	153 5	201 1	222 2	245 7	264 5	282 3	301 1	319 5	337 9	356 3	374 7	393 1	411 5	429 9	448 3	466 7

USED BY PERMISSION OF WHITIN MACHINE WORKS

CHAPTER VI.

HANKS AND NUMBERS.

The machines following the drawing frames are called fly frames or roving frames. This is simply a continuation of the drawing process, but with the idea of gradually reducing the bulk of the material to a suitable size and putting it in a convenient form to be used on the spinning frames. Three processes of fly frames are usually used, though, in coarse work, the general rule is two processes, or sometimes only one, while in making fine yarns four processes are used. The machines are called the slubber, the intermediate, the fine frame and the jack frame, each having the same end in view and being built to handle material of gradually decreasing bulk. In the mills the fine frames are spoken of as speeders and the names coarse speeder and fine speeder are often used to designate the intermediate and fine frames.

Up to this point we have dealt with the weight of the product of the different machines, expressed as ounces or grains per yard; but, when we reach the fly frames, the product is referred to as roving and we no longer use its weight to designate its size, but use a different system, the size of the roving being designated by the hank and spoken of as a certain size hank roving, as four hank roving. So, before taking up the calculations on the fly frames, it is best to give a review of this system, together with some rules and examples that will be needed when working with hanks.

The principles underlying the numbering of roving or yarn are the same, and are based on two fundamental facts:

First. That 840 yards always constitute a hank.

Second. That 840 yards, or one hank, of one hank roving or number one yarn, always weighs 7,000 grains or one pound.

Then the hank or size of any roving, or the number or counts of any yarn, corresponds to the number of hanks of that yarn or roving that it takes to weigh one pound, or 7,000 grains.

If we measure off 840 yards of roving and find that it weighs one pound, it would be called one hank roving, or 1 H. R., and one yard of it weighs 8.33 grains, as: $7,000 \div 840 = 8.33$.

If we measure off 840 yards of roving and find that it weighs one-half pound or 3,500 grains, it would be called 2 H. R., because it takes two hanks of it to weigh one pound and one yard of it weighs 4.166 grains, as: $3,500 \div 840 = 4.166$.

When we speak of 10 H. R. we mean that it takes 10 hanks

of it, or $10 \times 840 = 8,400$ yards, to weigh one pound. Then it will be seen that the hank of the roving or the counts of the yarn refer to the number of hanks that it will take to weigh one pound.

By dividing 7,000 grains by the weight in grains of one hank, or 840 yards, of any roving or yarn, we get the hank or counts of that roving or yarn. As it is not necessary or convenient to measure off 840 yards when sizing our roving or yarn, it is customary to reel only 12 yards of roving and divide its weight in grains into 100 and to reel 120 yards of yarn and divide its weight in grains into 1,000, as 12 and 120 bear the same ratio to 100 and 1,000 as 840 does to 7,000.

Example: If 12 yards of roving weigh 25 grains, what is its size or hank?

$$100 \div 25 = 4 \text{ H. R.}$$

Example: If 120 yards of yarn weigh 40 grains, what is its size or counts?

$$1,000 \div 40 = 25\text{'s yarn.}$$

In dealing with odd lengths of yarn or roving, the following rule will be found useful, and is the basis of several others:

The number of yards of roving or yarn \times 8.33 \div weight in grains of the length taken = the size.

Example: If 20 yards of roving weigh 33 grains, what is its size?

$$\frac{20 \times 8.33}{33} = 5 \text{ H. R.}$$

One thing must be borne in mind when dealing with hanks and counts: The larger the H. R., the less it weighs per yard and the greater the number of yards or hanks it takes to weigh one pound; the smaller the H. R., the greater the weight per yard and the less the number of yards or hanks it takes to weigh one pound. For instance, a 2 H. R. weighs 4.166 grains per yard and there are 1,680 yards or 2 hanks to one pound, while a 6 H. R. weighs 1.388 grains per yard and there are 5040 yards or 6 hanks to one pound.

The weight per yard of any roving can be found by dividing 8.33 by the hank of the roving, and the weight of 12 yards can be found by dividing 100 by the hank of the roving.

The following rules and examples will be found useful in figuring drafts and numbers on the fly frames. In figuring on the slubber, the material on the back is expressed by the weight per yard and this must be reduced to hanks, by dividing this

weight into 8.33, to correspond with the roving on the front, or the weight of the roving on the front can be figured in grains per yard and this weight reduced to its equivalent hank roving.

Example: If the sliver on the back of the slubber weighs 60 grains per yard and the draft of the machine is 4, what is the H. R. delivered on the front?

$$60 \div 4 = 15 \text{ grains. } 8.33 \div 15 = .55 \text{ H. R.}$$

In this case the weight on the back of the slubber is divided by the draft, which gives 15 grains per yard as the weight of the roving. Then 8.33 divided by this weight will reduce it to its equivalent hank.

From the hank roving on the front of the slubber and the draft, it is easy to figure the weight of the sliver on the back by the following rule:

Divide the H. R. on front of slubber by the draft and divide 8.33 by this number.

Example: A slubber has a draft of 4 and is running a .55 H. R. What is the weight of the drawing sliver on the back?

$$.55 \div 4 = .1375. \quad 8.33 \div .1375 = 60 \text{ grains.}$$

In working with the weight of the material on the previous machines, the weight on the back divided by the draft gave the weight on the front, but, in dealing with hanks, the weight decreasing as the number increases, the reverse is true and the hank on the back, multiplied by the draft, will give the hank on the front. On the intermediate and fine frames, where there are two ends doubled in the creel to be drawn and combined into one end on the front, the size of the single roving in the creel must be divided by two. For illustration, two ends of 2 H. R. doubled in the creel are the equivalent in size and weight of one end of 1 H. R. and should be so treated; also 5 H. R. doubled in the creel is the equivalent of a single 2.5 H. R.

From the above we get the following rules. Rule to find the H. R. a frame is delivering when the draft and H. R. in the creel are known:

$$H. R. \text{ in creel} \times \text{draft} \div 2 = H. R. \text{ on front.}$$

Example: The H. R. in creel is 1.5 doubled, draft of machine is 5, what is the H. R. on the front?

$$\frac{1.5 \times 5}{2} = 3.75 \text{ H. R. on front.}$$

Rule to find the draft when the H. R. on front and in the creel are known:

H. R. on front $\times 2 \div$ *H. R. in creel* = *draft*.

Example: The H. R. being delivered on front is 15, with 5 H. R. doubled in the creel. What is the draft?

$$\frac{15 \times 2}{5} = 6 \text{ draft.}$$

Rule to find the H. R. in the creel, the draft of the machine and the H. R. on front being known:

H. R. on front $\times 2 \div$ *draft* = *H. R. in the creel*.

Example: If the H. R. on the front is 10 and the draft is 5, what is the size of the single roving in the creel?

$$\frac{10 \times 2}{5} = 4 \text{ H. R. in the creel.}$$

The following problem, worked out first by the hanks and secondly, by the weight of the material, will illustrate clearly both methods and serve to show that either one is correct.

Example: What size roving is being made if the sliver on the back of the slubber weighs 42 grains per yard? The slubber has a draft of 4, the intermediate a draft of 5, and the fine frame a draft of 6, with roving doubled in the creels of the intermediate and fine frames.

$$(1). \quad 8.33 \div 42 = .198.$$

$$\frac{198 \times 4 \times 5 \times 6}{2 \times 2} = 5.95 \text{ H. R.}$$

$$(2). \quad \frac{42 \times 2 \times 2}{4 \times 5 \times 6} = 1.4.$$

$$8.33 \div 1.4 = 5.95 \text{ H. R.}$$

In working the above example, the first method was to reduce the 42 grain sliver, on the back of the slubber, to .198 hank sliver by dividing 8.33 by 42 and then multiplying this .198 by the drafts on the three fly frames and dividing by the doublings on the intermediate and fine frames. In the second method illustrated, the weight of the sliver on the back of the slubber was divided by the drafts of the three frames and multiplied by the doublings on the intermediate and fine frames. This gives the weight, in grains per yard, of the fine roving, and 8.33 divided by this weight gives the size of the roving.

COTTON MILL MACHINERY CALCULATIONS.

TABLE FOR NUMBERING ROVING.

12yds. weigh grains.	Hank roving.	12yds. weigh grains.	Hank roving.	12yds. weigh grains.	Hank roving.	12yds. weigh grains.	Hank roving.	12yds. weigh grains.	Hank roving.
1.	100.00	9.	11.11	16.	6.25	23.	4.35	30.	3.33
.2	83.33	.1	10.99	.1	6.21	.1	4.33	.1	3.32
.4	71.43	.2	10.87	.2	6.17	.2	4.31	.2	3.31
.6	62.50	.3	10.75	.3	6.13	.3	4.29	.3	3.30
.8	55.56	.4	10.64	.4	6.10	.4	4.27	.4	3.29
2.	50.00	.5	10.53	.5	6.06	.5	4.26	.5	3.28
.2	45.45	.6	10.42	.6	6.02	.6	4.24	.6	3.27
.4	41.67	.7	10.31	.7	5.99	.7	4.22	.7	3.26
.6	38.46	.8	10.20	.8	5.95	.8	4.20	.8	3.25
.8	35.71	.9	10.10	.9	5.92	.9	4.18	.9	3.24
3.	33.33	10.	10.00	17.	5.88	24.	4.17	31.	3.23
.1	32.26	.1	9.90	.1	5.85	.1	4.15	.1	3.22
.2	31.25	.2	9.80	.2	5.81	.2	4.13	.2	3.21
.3	30.30	.3	9.71	.3	5.78	.3	4.12	.3	3.19
.4	29.41	.4	9.62	.4	5.75	.4	4.10	.4	3.18
.5	28.57	.5	9.52	.5	5.71	.5	4.08	.5	3.17
.6	27.78	.6	9.43	.6	5.68	.6	4.07	.6	3.16
.7	27.03	.7	9.35	.7	5.65	.7	4.05	.7	3.15
.8	26.32	.8	9.26	.8	5.62	.8	4.03	.8	3.14
.9	25.64	.9	9.17	.9	5.59	.9	4.02	.9	3.13
4.	25.00	11.	9.09	18.	5.56	25.	4.00	32.	3.12
.1	24.39	.1	9.01	.1	5.52	.1	3.98	.1	3.12
.2	23.81	.2	8.93	.2	5.49	.2	3.97	.2	3.11
.3	23.26	.3	8.85	.3	5.46	.3	3.95	.3	3.10
.4	22.73	.4	8.77	.4	5.43	.4	3.94	.4	3.09
.5	22.22	.5	8.70	.5	5.41	.5	3.92	.5	3.08
.6	21.74	.6	8.62	.6	5.38	.6	3.91	.6	3.07
.7	21.28	.7	8.55	.7	5.35	.7	3.89	.7	3.06
.8	20.83	.8	8.47	.8	5.32	.8	3.88	.8	3.05
.9	20.41	.9	8.40	.9	5.29	.9	3.86	.9	3.04
5.	20.00	12.	8.33	19.	5.26	26.	3.85	33.	3.03
.1	19.61	.1	8.26	.1	5.24	.1	3.83	.1	3.02
.2	19.23	.2	8.20	.2	5.21	.2	3.82	.2	3.01
.3	18.87	.3	8.13	.3	5.18	.3	3.80	.3	3.00
.4	18.52	.4	8.06	.4	5.15	.4	3.79	.4	2.99
.5	18.18	.5	8.00	.5	5.13	.5	3.77	.5	2.99
.6	17.86	.6	7.94	.6	5.10	.6	3.76	.6	2.98
.7	17.54	.7	7.87	.7	5.08	.7	3.75	.7	2.97
.8	17.24	.8	7.81	.8	5.05	.8	3.73	.8	2.96
.9	16.95	.9	7.75	.9	5.03	.9	3.72	.9	2.95
6.	16.67	13.	7.69	20.	5.00	27.	3.70	34.	2.94
.1	16.39	.1	7.63	.1	4.98	.1	3.69	.1	2.93
.2	16.13	.2	7.58	.2	4.95	.2	3.68	.2	2.92
.3	15.87	.3	7.52	.3	4.93	.3	3.66	.3	2.92
.4	15.62	.4	7.46	.4	4.90	.4	3.65	.4	2.91
.5	15.38	.5	7.41	.5	4.88	.5	3.64	.5	2.90
.6	15.15	.6	7.35	.6	4.85	.6	3.62	.6	2.89
.7	14.93	.7	7.30	.7	4.83	.7	3.61	.7	2.88
.8	14.71	.8	7.25	.8	4.81	.8	3.60	.8	2.87
.9	14.49	.9	7.19	.9	4.78	.9	3.58	.9	2.87
7.	14.29	14.	7.14	21.	4.76	28.	3.57	35.	2.86
.1	14.08	.1	7.09	.1	4.74	.1	3.56	.1	2.85
.2	13.89	.2	7.04	.2	4.72	.2	3.55	.2	2.84
.3	13.70	.3	6.99	.3	4.69	.3	3.53	.3	2.83
.4	13.51	.4	6.94	.4	4.67	.4	3.52	.4	2.82
.5	13.33	.5	6.90	.5	4.65	.5	3.51	.5	2.82
.6	13.16	.6	6.85	.6	4.63	.6	3.50	.6	2.81
.7	12.99	.7	6.80	.7	4.61	.7	3.49	.7	2.80
.8	12.82	.8	6.76	.8	4.59	.8	3.47	.8	2.79
.9	12.66	.9	6.71	.9	4.57	.9	3.46	.9	2.79
8.	12.50	15.	6.67	22.	4.55	29.	3.45	36.	2.78
.1	12.35	.1	6.62	.1	4.52	.1	3.44	.1	2.77
.2	12.20	.2	6.58	.2	4.50	.2	3.42	.2	2.76
.3	12.05	.3	6.54	.3	4.48	.3	3.41	.3	2.75
.4	11.90	.4	6.49	.4	4.46	.4	3.40	.4	2.75
.5	11.76	.5	6.45	.5	4.44	.5	3.39	.5	2.74
.6	11.63	.6	6.41	.6	4.42	.6	3.38	.6	2.73
.7	11.49	.7	6.37	.7	4.41	.7	3.37	.7	2.72
.8	11.36	.8	6.33	.8	4.39	.8	3.36	.8	2.72
.9	11.24	.9	6.29	.9	4.37	.9	3.34	.9	2.71

HANKS AND NUMBERS.

TABLE FOR NUMBERING ROVING.

12 yds. weigh grains.	Hank roving.	12 yds. weigh grains.	Hank roving.	12 yds. weigh grains.	Hank roving.	12 yds. weigh grains.	Hank roving.	12 yds. weigh grains.	Hank roving.
37.	2.70	48.	2.08	65.	1.54	100	1.00	190	.53
.1	2.70	.2	2.07	.5	1.53	101	.99	192	.52
.2	2.69	.4	2.07	66.	1.52	102	.98	194	.52
.3	2.68	.6	2.06	.5	1.50	103	.97	196	.51
.4	2.67	.8	2.05	67.	1.49	104	.96	198	.51
.5	2.67	49	2.04	.5	1.48	105	.95	200	.50
.6	2.66	.2	2.03	68.	1.47	106	.94	202	.50
.7	2.65	.4	2.02	.5	1.46	107	.93	204	.49
.8	2.65	.6	2.02	69.	1.45	108	.93	206	.49
.9	2.64	.8	2.01	.5	1.44	109	.92	208	.48
38.	2.63	50.	2.00	70.	1.43	110	.91	210	.48
.1	2.62	.2	1.99	.5	1.42	111	.90	212	.47
.2	2.62	.4	1.98	71.	1.41	112	.89	214	.47
.3	2.61	.6	1.98	.5	1.40	113	.88	216	.46
.4	2.60	.8	1.97	72.	1.39	114	.88	218	.46
.5	2.60	51.	1.96	.5	1.38	115	.87	220	.45
.6	2.59	.2	1.95	73.	1.37	116	.86	222	.45
.7	2.58	.4	1.95	.5	1.36	117	.85	224	.45
.8	2.58	.6	1.94	74.	1.35	118	.85	226	.44
.9	2.57	.8	1.93	.5	1.34	119	.84	228	.44
39.	2.56	52.	1.92	75.	1.33	120	.83	230	.43
.1	2.56	.2	1.92	.5	1.32	121	.83	235	.43
.2	2.55	.4	1.91	76.	1.32	122	.82	240	.42
.3	2.54	.6	1.90	.5	1.31	123	.81	245	.41
.4	2.54	.8	1.89	77.	1.30	124	.81	250	.40
.5	2.53	53	1.89	.5	1.29	125	.80	255	.39
.6	2.53	.2	1.88	78.	1.28	126	.79	260	.38
.7	2.52	.4	1.87	.5	1.27	127	.79	265	.38
.8	2.51	.6	1.87	79.	1.27	128	.78	270	.37
.9	2.51	.8	1.86	.5	1.26	129	.78	275	.36
40.	2.50	54.	1.85	80.	1.25	130	.77	280	.36
.2	2.49	.2	1.85	.5	1.24	131	.76	285	.35
.4	2.48	.4	1.84	81.	1.23	132	.76	290	.34
.6	2.46	.6	1.83	.5	1.23	133	.75	295	.34
.8	2.45	.8	1.82	82.	1.22	134	.75	300	.33
41.	2.44	55.	1.82	.5	1.21	135	.74	305	.33
.2	2.43	.2	1.81	83.	1.20	136	.74	310	.32
.4	2.42	.4	1.81	.5	1.20	137	.73	315	.32
.6	2.40	.6	1.80	84.	1.19	138	.72	320	.31
.8	2.39	.8	1.79	.5	1.18	139	.72	330	.30
42.	2.38	56.	1.79	85.	1.18	140	.71	340	.29
.2	2.37	.2	1.78	.5	1.17	141	.71	350	.29
.4	2.36	.4	1.77	86.	1.16	142	.70	360	.28
.6	2.35	.6	1.77	.5	1.16	143	.70	370	.27
.8	2.34	.8	1.76	87.	1.15	144	.69	380	.26
43.	2.33	57.	1.75	.5	1.14	145	.69	390	.26
.2	2.31	.2	1.75	88.	1.14	146	.68	400	.25
.4	2.30	.4	1.74	.5	1.13	147	.68	410	.24
.6	2.29	.6	1.74	89.	1.12	148	.68	420	.24
.8	2.28	.8	1.73	.5	1.12	149	.67	430	.23
44.	2.27	58.	1.72	90.	1.11	150	.67	440	.23
.2	2.26	.2	1.72	.5	1.10	152	.66	450	.22
.4	2.25	.4	1.71	91.	1.10	154	.65	460	.22
.6	2.24	.6	1.71	.5	1.09	156	.64	470	.21
.8	2.23	.8	1.70	92.	1.09	158	.63	480	.21
45.	2.22	59.	1.69	.5	1.08	160	.62	490	.20
.2	2.21	.2	1.69	93.	1.08	162	.62	500	.20
.4	2.20	.4	1.68	.5	1.07	164	.61	525	.19
.6	2.19	.6	1.68	94.	1.06	166	.60	550	.18
.8	2.18	.8	1.67	.5	1.06	168	.60	575	.17
46.	2.17	60.	1.67	95.	1.05	170	.59	600	.17
.2	2.16	.5	1.65	.5	1.05	172	.58	625	.16
.4	2.16	61.	1.64	96.	1.04	174	.57	650	.15
.6	2.15	.5	1.63	.5	1.04	176	.57	675	.15
.8	2.14	62.	1.61	97.	1.03	178	.56	700	.14
47.	2.13	.5	1.60	.5	1.03	180	.56	725	.14
.2	2.12	63.	1.59	98.	1.02	182	.55	775	.13
.4	2.11	.5	1.57	.5	1.02	184	.54	825	.12
.6	2.10	64.	1.56	99.	1.01	186	.54	900	.11
.8	2.09	.5	1.55	.5	1.01	188	.53	1000	.10

TWIST OF ROVING.

Hank roving.	Square root.	Twist, 1.2 × sq. root.	Hank roving.	Square root.	Twist, 1.2 × sq. root.	Hank roving.	Square root.	Twist, 1.2 × sq. root.	Hank roving.	Square root.	Twist, 1.2 × sq. root.
.10	.316	.38	.80	.894	1.07	2.20	1.483	1.78	4.32	2.078	2.49
.11	.332	.40	.82	.906	1.09	2.22	1.490	1.79	4.36	2.088	2.51
.12	.346	.41	.84	.917	1.10	2.25	1.500	1.80	4.40	2.098	2.52
.13	.361	.43	.86	.927	1.11	2.28	1.510	1.81	4.44	2.107	2.53
.14	.374	.45	.88	.938	1.13	2.31	1.520	1.82	4.48	2.117	2.54
.15	.387	.46	.90	.949	1.14	2.34	1.530	1.84	4.52	2.126	2.55
.16	.400	.48	.92	.959	1.15	2.37	1.539	1.85	4.56	2.135	2.56
.17	.412	.49	.94	.970	1.16	2.40	1.549	1.86	4.60	2.145	2.57
.18	.424	.51	.96	.980	1.18	2.43	1.559	1.87	4.64	2.154	2.58
.19	.436	.52	.98	.990	1.19	2.46	1.568	1.88	4.68	2.163	2.60
.20	.447	.54	1.00	1.000	1.20	2.49	1.578	1.89	4.72	2.173	2.61
.21	.458	.55	1.02	1.010	1.21	2.52	1.587	1.90	4.76	2.182	2.62
.22	.469	.56	1.04	1.020	1.22	2.55	1.597	1.92	4.80	2.191	2.63
.23	.480	.58	1.06	1.030	1.24	2.58	1.606	1.93	4.84	2.200	2.64
.24	.490	.59	1.08	1.039	1.25	2.61	1.616	1.94	4.88	2.209	2.65
.25	.500	.60	1.10	1.049	1.26	2.64	1.625	1.95	4.92	2.218	2.66
.26	.510	.61	1.12	1.058	1.27	2.67	1.634	1.96	4.96	2.227	2.67
.27	.520	.62	1.14	1.068	1.28	2.70	1.643	1.97	5.00	2.236	2.68
.28	.529	.63	1.16	1.077	1.29	2.73	1.652	1.98	5.04	2.245	2.69
.29	.539	.65	1.18	1.086	1.30	2.76	1.661	1.99	5.08	2.254	2.70
.30	.548	.66	1.20	1.095	1.31	2.79	1.670	2.00	5.12	2.263	2.72
.31	.557	.67	1.22	1.105	1.33	2.82	1.679	2.01	5.16	2.272	2.73
.32	.566	.68	1.24	1.114	1.34	2.85	1.688	2.03	5.20	2.280	2.74
.33	.574	.69	1.26	1.122	1.35	2.88	1.697	2.04	5.24	2.289	2.75
.34	.583	.70	1.28	1.131	1.36	2.91	1.706	2.05	5.28	2.298	2.76
.35	.592	.71	1.30	1.140	1.37	2.94	1.715	2.06	5.32	2.307	2.77
.36	.600	.72	1.32	1.149	1.38	2.97	1.723	2.07	5.36	2.315	2.78
.37	.608	.73	1.34	1.158	1.39	3.00	1.732	2.08	5.40	2.324	2.79
.38	.616	.74	1.36	1.166	1.40	3.03	1.741	2.09	5.44	2.332	2.80
.39	.624	.75	1.38	1.175	1.41	3.06	1.749	2.10	5.48	2.341	2.81
.40	.632	.76	1.40	1.183	1.42	3.09	1.758	2.11	5.52	2.349	2.82
.41	.640	.77	1.42	1.192	1.43	3.12	1.766	2.12	5.56	2.358	2.83
.42	.648	.78	1.44	1.200	1.44	3.15	1.775	2.13	5.60	2.366	2.84
.43	.656	.79	1.46	1.208	1.45	3.18	1.783	2.14	5.64	2.375	2.85
.44	.663	.80	1.48	1.217	1.46	3.21	1.792	2.15	5.68	2.383	2.86
.45	.671	.80	1.50	1.225	1.47	3.24	1.800	2.16	5.72	2.392	2.87
.46	.678	.81	1.52	1.233	1.48	3.27	1.808	2.17	5.76	2.400	2.88
.47	.686	.82	1.54	1.241	1.49	3.30	1.817	2.18	5.80	2.408	2.89
.48	.693	.83	1.56	1.249	1.50	3.33	1.825	2.19	5.84	2.416	2.90
.49	.700	.84	1.58	1.257	1.51	3.36	1.833	2.20	5.88	2.425	2.91
.50	.707	.85	1.60	1.265	1.52	3.39	1.841	2.21	5.92	2.433	2.92
.51	.714	.86	1.62	1.273	1.53	3.42	1.849	2.22	5.96	2.441	2.93
.52	.721	.87	1.64	1.281	1.54	3.45	1.857	2.23	6.00	2.449	2.94
.53	.728	.87	1.66	1.288	1.55	3.48	1.865	2.24	6.04	2.458	2.95
.54	.735	.88	1.68	1.296	1.56	3.51	1.873	2.25	6.08	2.466	2.96
.55	.742	.89	1.70	1.304	1.56	3.54	1.881	2.26	6.12	2.474	2.97
.56	.748	.90	1.72	1.311	1.57	3.57	1.889	2.27	6.16	2.482	2.98
.57	.755	.91	1.74	1.319	1.58	3.60	1.897	2.28	6.20	2.490	2.99
.58	.762	.91	1.76	1.327	1.59	3.63	1.905	2.29	6.24	2.498	3.00
.59	.768	.92	1.78	1.334	1.60	3.66	1.913	2.30	6.28	2.506	3.01
.60	.775	.93	1.80	1.342	1.61	3.69	1.921	2.31	6.32	2.514	3.02
.61	.781	.94	1.82	1.349	1.62	3.72	1.929	2.31	6.36	2.522	3.03
.62	.787	.94	1.84	1.356	1.63	3.75	1.936	2.32	6.40	2.530	3.04
.63	.794	.95	1.86	1.364	1.64	3.78	1.944	2.33	6.44	2.538	3.05
.64	.800	.96	1.88	1.371	1.65	3.81	1.952	2.34	6.48	2.546	3.05
.65	.806	.97	1.90	1.378	1.65	3.84	1.960	2.35	6.52	2.553	3.06
.66	.812	.97	1.92	1.386	1.66	3.87	1.967	2.36	6.56	2.561	3.07
.67	.819	.98	1.94	1.393	1.67	3.90	1.975	2.37	6.60	2.569	3.08
.68	.825	.99	1.96	1.400	1.68	3.93	1.982	2.38	6.64	2.577	3.09
.69	.831	1.00	1.98	1.407	1.69	3.96	1.990	2.39	6.68	2.585	3.10
.70	.837	1.00	2.00	1.414	1.70	3.99	1.997	2.40	6.72	2.592	3.11
.71	.843	1.01	2.02	1.421	1.71	4.02	2.005	2.41	6.76	2.600	3.12
.72	.849	1.02	2.04	1.428	1.71	4.05	2.012	2.41	6.80	2.608	3.13
.73	.854	1.02	2.06	1.435	1.72	4.08	2.020	2.42	6.84	2.615	3.14
.74	.860	1.03	2.08	1.442	1.73	4.11	2.027	2.43	6.88	2.623	3.15
.75	.866	1.04	2.10	1.449	1.74	4.14	2.035	2.44	6.92	2.631	3.16
.76	.872	1.05	2.12	1.456	1.75	4.17	2.042	2.45	6.96	2.638	3.17
.77	.877	1.05	2.14	1.463	1.76	4.20	2.049	2.46	7.00	2.646	3.17
.78	.883	1.06	2.16	1.470	1.76	4.23	2.057	2.47	7.04	2.653	3.18
.79	.889	1.07	2.18	1.476	1.77	4.26	2.064	2.48	7.08	2.661	3.19

TWIST OF ROVING.

Hank roving.	Square root.	Twist, 1.2 × sq. root.	Hank roving.	Square root.	Twist, 1.2 × sq. root.	Hank roving.	Square root.	Twist, 1.2 × sq. root.	Hank roving.	Square root.	Twist, 1.2 × sq. root.
7.10	2.665	3.20	10.62	3.259	3.91	14.84	3.852	4.62	19.76	4.445	5.33
7.15	2.674	3.21	10.68	3.268	3.92	14.91	3.861	4.63	19.84	4.454	5.35
7.20	2.683	3.22	10.74	3.277	3.93	14.98	3.870	4.64	19.92	4.463	5.36
7.25	2.693	3.23	10.80	3.286	3.94	15.05	3.879	4.66	20.00	4.472	5.37
7.30	2.702	3.24	10.86	3.295	3.95	15.12	3.888	4.67	20.08	4.481	5.38
7.35	2.711	3.25	10.92	3.305	3.97	15.19	3.897	4.68	20.16	4.490	5.39
7.40	2.720	3.26	10.98	3.314	3.98	15.26	3.906	4.69	20.24	4.499	5.40
7.45	2.729	3.28	11.04	3.323	3.99	15.33	3.915	4.70	20.32	4.508	5.41
7.50	2.739	3.29	11.10	3.332	4.00	15.40	3.924	4.71	20.40	4.517	5.42
7.55	2.748	3.30	11.16	3.341	4.01	15.47	3.933	4.72	20.48	4.525	5.43
7.60	2.757	3.31	11.22	3.350	4.02	15.54	3.942	4.73	20.56	4.534	5.44
7.65	2.766	3.32	11.28	3.359	4.03	15.61	3.951	4.74	20.64	4.543	5.45
7.70	2.775	3.33	11.34	3.367	4.04	15.68	3.960	4.75	20.72	4.552	5.46
7.75	2.784	3.34	11.40	3.376	4.05	15.75	3.969	4.76	20.80	4.561	5.47
7.80	2.793	3.35	11.46	3.385	4.06	15.82	3.977	4.77	20.88	4.569	5.48
7.85	2.802	3.36	11.52	3.394	4.07	15.89	3.986	4.78	20.96	4.578	5.49
7.90	2.811	3.37	11.58	3.403	4.08	15.96	3.995	4.79	21.04	4.587	5.50
7.95	2.820	3.38	11.64	3.412	4.09	16.03	4.004	4.80	21.12	4.596	5.51
8.00	2.828	3.39	11.70	3.421	4.10	16.10	4.012	4.81	21.20	4.604	5.52
8.05	2.837	3.40	11.76	3.429	4.12	16.17	4.021	4.83	21.28	4.613	5.54
8.10	2.846	3.42	11.82	3.438	4.13	16.24	4.030	4.84	21.36	4.622	5.55
8.15	2.855	3.43	11.88	3.447	4.14	16.31	4.039	4.85	21.44	4.630	5.56
8.20	2.864	3.44	11.94	3.455	4.15	16.38	4.047	4.86	21.52	4.639	5.57
8.25	2.872	3.45	12.00	3.464	4.16	16.45	4.056	4.87	21.60	4.648	5.58
8.30	2.881	3.46	12.06	3.473	4.17	16.52	4.064	4.88	21.68	4.656	5.59
8.35	2.890	3.47	12.12	3.481	4.18	16.59	4.073	4.89	21.76	4.665	5.60
8.40	2.898	3.48	12.18	3.490	4.19	16.66	4.082	4.90	21.84	4.673	5.61
8.45	2.907	3.49	12.24	3.499	4.20	16.73	4.090	4.91	21.92	4.682	5.62
8.50	2.915	3.50	12.30	3.507	4.21	16.80	4.099	4.92	22.00	4.690	5.63
8.55	2.924	3.51	12.36	3.516	4.22	16.87	4.107	4.93	22.08	4.699	5.64
8.60	2.933	3.52	12.42	3.524	4.23	16.94	4.116	4.94	22.16	4.707	5.65
8.65	2.941	3.53	12.48	3.533	4.24	17.01	4.124	4.95	22.24	4.716	5.66
8.70	2.950	3.54	12.54	3.541	4.25	17.08	4.133	4.96	22.32	4.724	5.67
8.75	2.958	3.55	12.60	3.550	4.26	17.15	4.141	4.97	22.40	4.733	5.68
8.80	2.966	3.56	12.66	3.558	4.27	17.22	4.150	4.98	22.48	4.741	5.69
8.85	2.975	3.57	12.72	3.567	4.28	17.29	4.158	4.99	22.56	4.750	5.70
8.90	2.983	3.58	12.78	3.575	4.29	17.36	4.167	5.00	22.64	4.758	5.71
8.95	2.992	3.59	12.84	3.583	4.30	17.43	4.175	5.01	22.72	4.767	5.72
9.00	3.000	3.60	12.90	3.592	4.31	17.50	4.183	5.02	22.80	4.775	5.73
9.05	3.008	3.61	12.96	3.600	4.32	17.57	4.192	5.03	22.88	4.783	5.74
9.10	3.017	3.62	13.02	3.608	4.33	17.64	4.200	5.04	22.96	4.792	5.75
9.15	3.025	3.63	13.08	3.617	4.34	17.71	4.208	5.05	23.04	4.800	5.76
9.20	3.033	3.64	13.14	3.625	4.35	17.78	4.216	5.06	23.12	4.808	5.77
9.25	3.041	3.65	13.20	3.633	4.36	17.85	4.225	5.07	23.20	4.817	5.78
9.30	3.050	3.66	13.26	3.641	4.37	17.92	4.233	5.08	23.28	4.825	5.79
9.35	3.058	3.67	13.32	3.650	4.38	17.99	4.241	5.09	23.36	4.833	5.80
9.40	3.066	3.68	13.38	3.658	4.39	18.06	4.250	5.10	23.44	4.841	5.81
9.45	3.074	3.69	13.44	3.666	4.40	18.13	4.258	5.11	23.52	4.850	5.82
9.50	3.082	3.70	13.50	3.674	4.41	18.20	4.266	5.12	23.60	4.858	5.83
9.55	3.090	3.71	13.56	3.682	4.42	18.27	4.274	5.13	23.68	4.866	5.84
9.60	3.098	3.72	13.62	3.691	4.43	18.34	4.283	5.14	23.76	4.874	5.85
9.65	3.106	3.73	13.68	3.699	4.44	18.41	4.291	5.15	23.84	4.883	5.86
9.70	3.114	3.74	13.74	3.707	4.45	18.48	4.299	5.16	23.92	4.891	5.87
9.75	3.122	3.75	13.80	3.715	4.46	18.55	4.307	5.17	24.00	4.899	5.88
9.80	3.130	3.76	13.86	3.723	4.47	18.62	4.315	5.18	24.08	4.907	5.89
9.85	3.138	3.77	13.92	3.731	4.48	18.69	4.323	5.19	24.16	4.915	5.90
9.90	3.146	3.78	13.98	3.739	4.49	18.76	4.331	5.20	24.24	4.923	5.91
9.95	3.154	3.79	14.04	3.747	4.50	18.83	4.339	5.21	24.32	4.932	5.92
10.00	3.162	3.79	14.10	3.755	4.51	18.90	4.347	5.22	24.40	4.940	5.93
10.05	3.170	3.80	14.16	3.763	4.52	18.97	4.355	5.23	24.48	4.948	5.94
10.10	3.178	3.81	14.22	3.771	4.53	19.04	4.363	5.24	24.56	4.956	5.95
10.15	3.186	3.82	14.28	3.779	4.53	19.11	4.371	5.25	24.64	4.964	5.96
10.20	3.194	3.83	14.34	3.787	4.54	19.18	4.379	5.26	24.72	4.972	5.97
10.25	3.202	3.84	14.40	3.795	4.55	19.25	4.387	5.26	24.80	4.980	5.98
10.30	3.209	3.85	14.46	3.803	4.56	19.32	4.395	5.27	24.88	4.988	5.99
10.35	3.217	3.86	14.52	3.811	4.57	19.39	4.403	5.28	24.96	4.996	6.00
10.40	3.225	3.87	14.58	3.818	4.58	19.46	4.411	5.29	25.04	5.004	6.00
10.45	3.233	3.88	14.64	3.826	4.59	19.53	4.419	5.30	25.12	5.012	6.01
10.50	3.240	3.89	14.70	3.834	4.60	19.60	4.427	5.31	25.20	5.020	6.02
10.55	3.248	3.90	14.76	3.842	4.61	19.67	4.435	5.32	25.28	5.028	6.03

CHAPTER VII.

FLY FRAMES—DRAFT—ROLL SETTINGS—TWIST—DIFFERENTIAL OR COMPOUND—WINDING—CONES—TENSION AND LAY GEARING—TAKE-UP OR BOTTOM CONE GEARING—TAPER GEARING—OR COMPOUND—WINDING—CONES—TENSION AND LAY GEAR-

FLY FRAMES.

The object of the fly frames is to reduce the bulky drawing sliver to a suitable size and put it into a convenient form to be used on the spinning frame, the size of the final roving and the number of frames used depending upon the size and quality of yarn desired. Double roving is used in the creels for the sake of evenness and added strength to the finished yarn.

The action of the fly frames can be divided into three operations, all three occurring at the same time, *viz*: drawing, twisting and winding. The drawing and twisting are comparatively simple operations, easily understood and necessitating only simple mechanisms to obtain the required results, while the correct winding of the roving on the bobbin is more difficult to understand, requires more careful watching and adjusting, and calls for far more complicated mechanisms.

The drawing is accomplished by three lines of fluted steel rolls, suitably geared, with double bossed leather top rolls, each boss carrying one or two rovings. The use of shell rolls on the front line and solid rolls on the middle and back is common, while some use shell rolls on the front and middle lines of rolls, or on all three. The best arrangement would be to use the self-oiling, ball-bearing type of shell rolls on all three lines of rolls. This gives a good, even smooth drawing of the fibres, lessens the chances of the rolls binding, and produces better and smoother work with less care and attention. Metallic rolls have been used on fly frames with success, but only in a few cases.

The twisting is accomplished by the revolutions of the flyer. The roving leaves the front roll, reaches and passes through the nose of the flyer, goes down the hollow arm of the flyer and through the eye of the presser foot onto the bobbin. The roving, by this means, is practically held by the flyer, the rapid revolving of which produces the twist. The twist is introduced in the roving between the front roll and the flyer nose, the amount of twist depending upon the speed of the flyer and the delivery of the front roll. A faster front roll speed gives a greater delivery of roving and causes a corresponding decrease in the amount of twist put in the roving.

The winding of the roving on the bobbin is caused by the difference in the surface speed of the bobbin and the presser foot of the flyer. The spindle, which carries the flyer and, consequently, the flyer itself, is driven at a constant speed, and the speed of the bobbin is varied as the bobbin builds, so that, at all stages of its growth, the surface speed of the bobbin will be equal to the surface speed of the presser foot plus the surface speed of the front roll, or its delivery. This necessitates the bobbin to be driven in such a manner that its speed can be slightly reduced after the winding of each layer of roving; being at its fastest speed at the start of a set, when its diameter is smallest, and at its slowest speed at the finish of a set, when its diameter is largest. This is spoken of as "bobbin lead," the surface speed of the bobbin always being in excess of the surface speed of the presser foot, the bobbin thus pulling the roving through the flyer and wrapping it onto itself.

In the case of the "flyer lead" the conditions are reversed. The bobbin is carried on the spindle and driven at a constantly increasing speed, while the flyer is driven separately at a fixed speed, the surface speed of the bobbin being always slower than the surface speed of the presser foot by the amount of roving delivered by the front roll. The presser foot, in this case, wraps the roving onto the bobbin, which may be said to be lagging behind. The gradually increasing speed of the bobbin is necessary from the fact that, as the bobbin increases in size, it takes less wraps around it to take up the delivery of the front roll. Consequently, as the roving is wrapped onto the bobbin by the presser foot, the bobbin has to lag behind the flyer a less number of revolutions. This method of driving the bobbins and flyers brought about undesirable conditions which it is not necessary to discuss here, but led to the adoption of the bobbin lead type of gearing, and all the modern fly frames are built with this feature.

On the modern fly frames the gradual reduction of the speed of the bobbins is accomplished by driving the bobbins by means of a differential motion or "compound," the relative speed of the parts of the "compound" being controlled by the speed of the bottom cone, the speed of the bottom cone being, in turn, controlled by the position of the cone-belt.

The up and down traverse motion of the bobbin rail, the length of which is automatically decreased after each layer of roving is wound, is controlled by the builder, which also serves, indirectly, to shift the cone-belt on the cones and to reverse the direction of the rail at the same time. The direct cause of the above motions is the movement of the tumbling shaft, which is held stationary while the builder dog or "flop-over" is in contact

with the face of the builder. This "flop-over" is held against the face of the builder by the action of a spring and lever acting against a "dog" or cam on the bottom of the tumbling shaft. When the traverse has reached the point at which the face of the builder slides by the "flop-over," this spring and lever move the tumbling shaft enough to allow the gap gear, on its upper end, to come in contact with the bevel gear on the end of the top cone shaft. This gives the tumbling shaft a half revolution, which moves the cone-belt, through the tension train of gearing, reverses the motion of the rail by moving the reverse gear, and shortens the traverse by closing the builder jaws. This closing of the builder jaws is done by the movement of the cone-belt rack; thus the amount of the shortening of the traverse depends upon the movement of the rack, and, as this movement is varied as the size of the roving varies, the finer the roving, the less movement of belt rack and the less closing of the builder jaws.

Fig. 33 shows a plan of the general gearing of a 7 inch by 3 inch fly frame built by the Woonsocket Machine and Press Co., Woonsocket, R. I. Figs. 34 and 35 show the draft and twist gearing on the same frame. From these the change gears mentioned below can be easily found, and also their relation to the other parts of the frame can be understood.

There are, on all fly frames, four things to regulate and change when making a change in the size of the roving that is being run:

First: The draft. This is governed by the draft gear which drives the back roll and is on the stud with the crown gear. A smaller gear will drive the back roll slower, feed in less material, increase the draft, decrease the weight delivered by the front roll and give a larger hank roving.

Second: The twist. This is regulated by the twist gear which is on the end of the main or "compound" shaft. This gear drives the top cone shaft and, from here, the front roll, thus controlling the speed and also the delivery of the front roll. In fact the twist gear controls, directly or indirectly, the speed of every part of the frame except the spindles, which are driven from the main shaft direct. A smaller twist gear drives the front roll slower, decreases the delivery of the front roll, increases the twist in the roving, and would be put on when changing to a finer roving.

Third: The lay of the roving on the bobbin. This is regulated by the lay or rail gear which controls the speed of the rail, thus producing the correct spacing of the coils of roving on the bobbins. This gear is located on the end of the reversing shaft, or at some convenient point in the lay train of gearing. Not like the first two considered, there is a lack of uniformity in the plac-

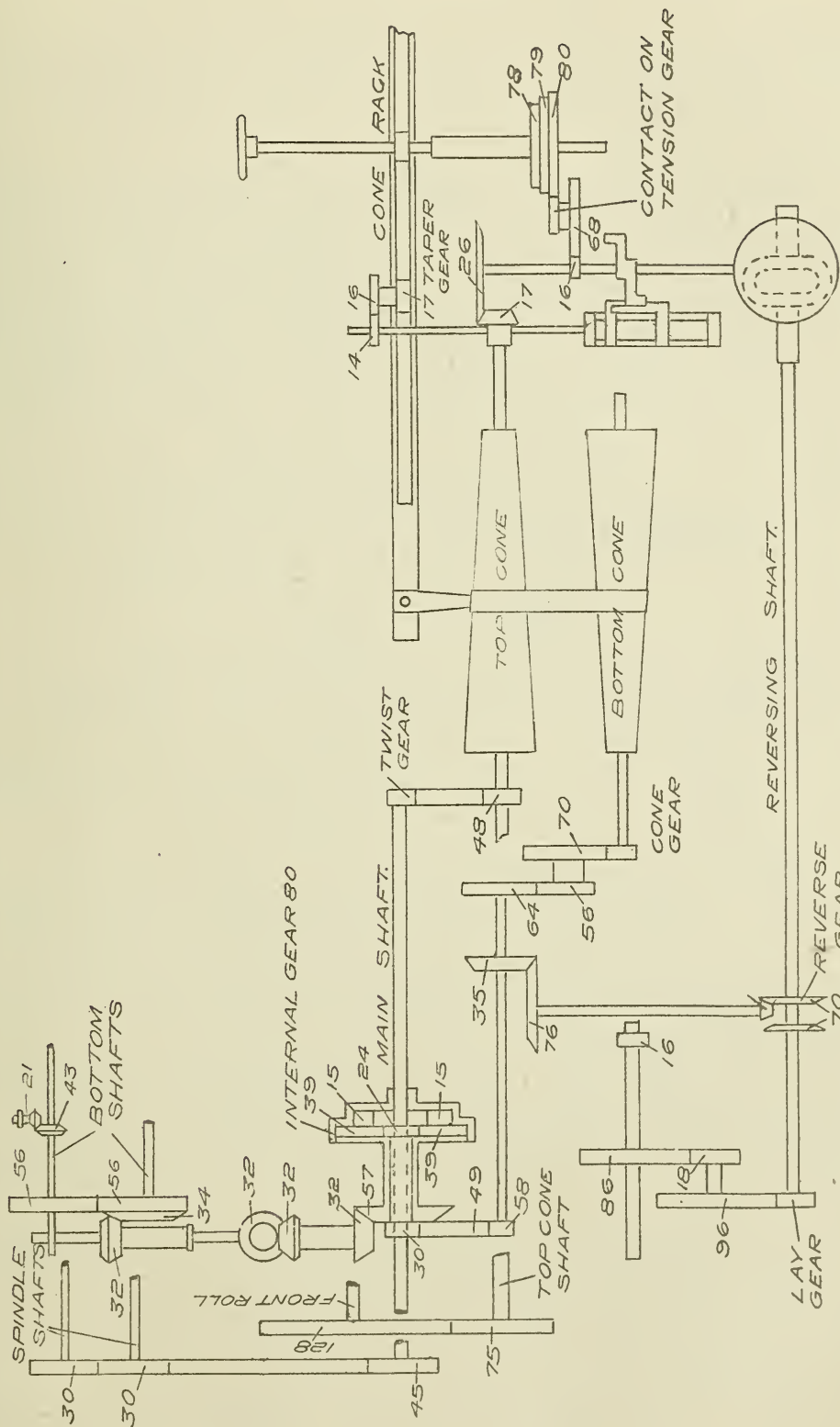

FIG. 33. GENERAL GEARING PLAN OF FLY FRAME OF THE WOON SOCKET MACHINE & PRESS CO.

ing of this gear by the different builders. A smaller gear drives the rail slower, decreases the space allowed for each individual coil of roving, and would be called for when changing to a finer roving.

Fourth: Tension. This is regulated by the tension or contact gear which controls the distance the cone-belt is shifted at the end of each traverse of the rail. This shifting of the cone-belt changes the speed of the bottom cone and the "compound" and, consequently, the bobbins. This gear is located somewhere in the tension train of gearing between the upright or tumbling shaft and the cone-belt rack. A smaller gear causes less movement to the cone-belt and, consequently, a smaller decrease in

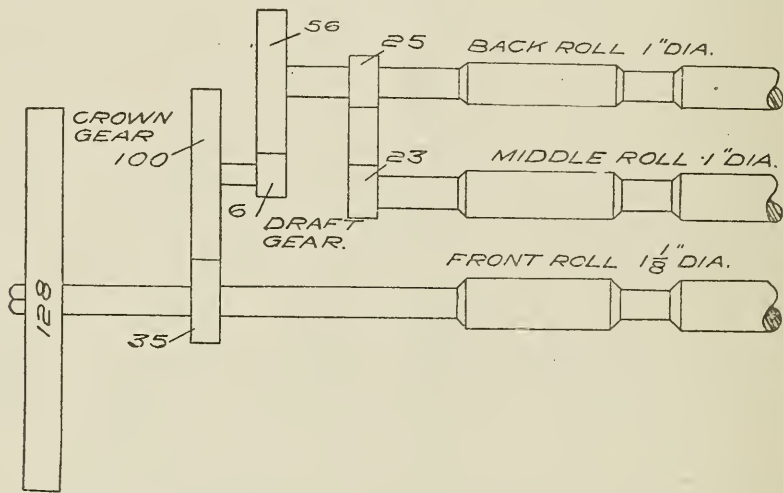

FIG. 34. DRAFT GEARING ON WOONSOCKET FLY FRAMES.

bobbin speed, also an increase in the tension on the roving, and would be called for when the roving is running "slack" or when changing to a finer roving.

The four gears above should be changed when any decided difference is made in the size of the roving run. A larger gear in each case above would have the opposite effect noted.

There are two other gears that may be considered as change gears:

First: The taper gear. This is a small gear that regulates the amount of closing of the builder jaws after the winding of each layer of roving on the bobbin, thus shortening the traverse of the rail and causing the taper on the ends of the bobbin. This should not be changed after the correct taper on the bobbins is once obtained.

Second: The take-up or cone gear. On the Saco-Pettee and Lowell frames this gear is spoken of as the take-up gear and is

located on the end of the small shaft, driven by the bottom cone, which drives the sun-wheel; while on the Howard and Bullough, Woonsocket and Providence frames it is spoken of as the cone gear and is located on the end of the bottom cone. Under either name it serves the same purpose, *viz*: the regulating of the speed of the "differential" or "compound" and, hence, the bobbins, thus, together with the starting position of the cone-belt, giving the correct tension on the roving at the start of a set, or while the first layer of roving is being wound on the bobbins. A smaller gear would drive the "compound," also the bobbins, slower, decreasing the tension on the roving.

After the proper gear is obtained and the correct starting point of the cone-belt is determined, both being dependent each upon the other, there is no need of changing either, except in case of a change in the diameter of the bobbins used. This would call for a change in the tension at the start and would necessitate a readjustment at one or both of the points mentioned.

DRAFT ON FLY FRAMES.

The middle and back rolls are made 1 inch in diameter, while the front roll may be $1 \frac{1}{16}$, $1 \frac{1}{8}$, $1 \frac{3}{16}$, or $1 \frac{1}{4}$ inches in diameter. The more common sizes are $1 \frac{1}{4}$ inch front roll on slubbers and the large size intermediates, and $1 \frac{1}{8}$ inch front roll on the small size intermediates, fine and jack frames.

As the weight of the roving decreases, the draft of the rolls increases and, also, the speed of the machine. Good average drafts for the different fly frames are as follows: Slubbers, 4; intermediate, 5; fine frame, 6; and jack frame, 7.

The use of the larger drafts on the smaller frames is permissible from the fact that the rolls have a smaller amount of material to deal with. Consequently there is less work on the rolls and less chance for slippage and poor drawing.

The custom is to use very little draft between the middle and back rolls, throwing most of the draft between the front and middle rolls. The rolls of all fly frames are geared at the head end of the machine, the arrangement being similar to the one illustrated in Fig. 34, though on extra long frames double gearing is resorted to; that is, the rolls are geared at both ends. This arrangement overcomes the strain put on the rolls while running, and will have a tendency to cause both ends of the rolls to start at the same time, producing a smooth, even movement to the rolls. It necessitates the changing of draft gears at both ends of the frame, however.

The draft between the middle and back rolls is found as follows:

$$\frac{1 \times 25}{23 \times 1} = 1.087 \text{ draft.}$$

The draft constant is found from the following figures:

$$\frac{9 \times 100 \times 56}{35 \times X \times 8} = 180 \text{ draft constant.}$$

$$\text{Constant} \div \text{Gear} = \text{Draft.}$$

$$\text{Constant} \div \text{Draft} = \text{Gear.}$$

The draft gearing varies with the different makes of frames and with frames of the same make and different sizes, but all are arranged similarly to the one illustrated.

The following rules for changing the draft gear without the use of the constant will be found useful. The draft and hank roving vary inversely, and the weight varies directly with the size of the gear. The larger the draft gear, the smaller the draft, the smaller the hank roving and the heavier the weight of the material delivered.

In changing the gear from the draft use the following rule:

Gear on the frame \times *draft on the frame* \div *draft desired* = *draft gear needed*.

Example: If a frame is using a 30 tooth draft gear and has a draft of 6, what size draft will be needed to give a draft of 5?

$$\frac{30 \times 6}{5} = 36 \text{ draft gear needed.}$$

By substituting hank roving in the above rule in the place of draft, we can change the draft gear for variations in the size of the hank roving.

Example: A frame is running a 6.25 H. R. with a 30 tooth draft gear. What size gear would be needed to give a 5.5 H. R.?

$$\frac{30 \times 6.25}{5.5} = 34 \text{ draft gear needed.}$$

In changing the draft gear by the weight of the material being delivered, the following rule holds good:

Draft gear on the frame \times *weight desired* \div *weight on the frame* \times *draft gear needed*.

Example: A frame running with a 30 tooth draft gear is delivering a roving that weighs 17 grains to 12 yards, what size

draft gear will be needed to give a weight of 20 grains to 12 yards?

$$\frac{30 \times 20}{17} = 35.3 \text{ or } 35 \text{ tooth draft gear needed.}$$

In setting the rolls on a fly frame, no fixed inflexible rule can be given, as the distance between the rolls depends upon the staple, the feel of the fibres, the bulk of material being handled, the draft and the speed of the rolls. Usually the higher the speed the larger the draft and the finer the roving, and the closer the rolls can be set. A rule found very good on slubbers and intermediates is:

Distance between front and middle rolls, $\frac{1}{8}$ -inch greater than the length of the staple being run.

Distance between middle and back rolls, $\frac{1}{4}$ -inch to $\frac{3}{8}$ -inch greater than the length of the staple being run.

This distance to be measured from center to center of rolls. On the fine frames and in making very fine roving, closer settings than the above can be used and give better work. However, the true test of the correctness of the setting of the rolls is the appearance of the roving as it leaves the front roll.

In this connection it is good to remember that the best results cannot be obtained unless the steel rolls are kept well lubricated at all times. One of the most satisfactory lubricants for this purpose is "Non-Fluid Oil", as it lasts for quite a while, is easily applied and will give excellent results. The same can be said in regard to its use in the bearings of drawing, spinning and twister rolls. These oils are manufactured by the New York and New Jersey Lubricant Company of New York.

TWIST ON FLY FRAMES.

Each revolution of the spindle or flyer puts in one turn of twist, and the amount of twist in the roving depends upon the ratio of the spindle speed and the delivery of the front roll. If the flyer made 10 revolutions while the front roll was delivering 5 inches of roving, each inch of roving would contain 2 turns or twists and the twist in the roving would be spoken of as two turns. The twist in roving is always spoken of as so many turns per inch.

Now, if we work out the speed of the spindles and the delivery of the front roll in inches, dividing the spindle speed by the delivery of the front roll, we find the twist, or turns per inch, in the roving. Referring to Fig. 35 and assuming a speed of 400 R. P. M. of main shaft, we get the following as the speed of the spindles:

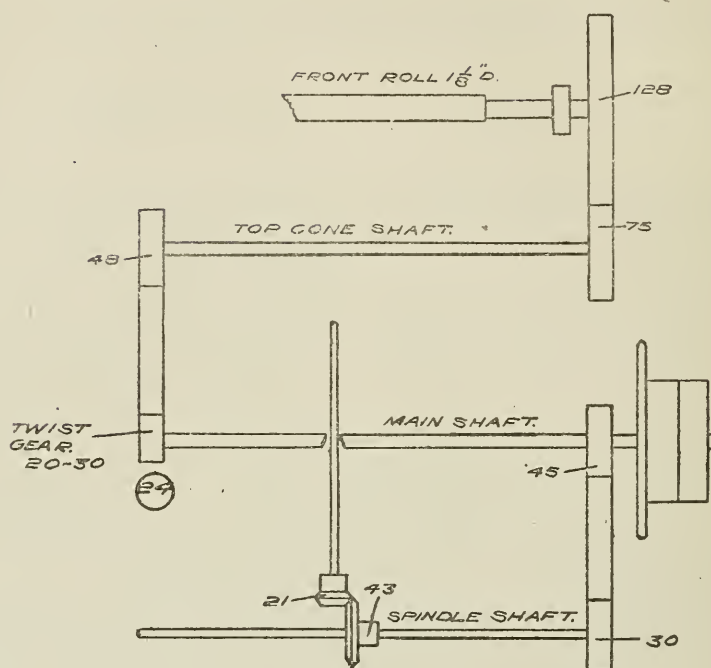

FIG. 35. TWIST GEARING ON WOONSOCKET FLY FRAMES.

$$\frac{400 \times 45 \times 53}{30 \times 21} = 1128.5 \text{ R. P. M.}$$

Assuming same speed to main shaft and using a 24 tooth gear, the following will give the front roll speed:

$$\frac{400 \times 24 \times 75}{48 \times 128} = 117.18 \text{ R. P. M.}$$

The front roll is $1\frac{1}{8}$ inches in diameter or 3.534 inches in circumference. Hence it will deliver 414.11 inches of roving per minute. ($117.18 \times 3.534 = 414.11$). By dividing the R. P. M. of the spindles by this front roll delivery, we get the twist as follows:

$$1228.5 \div 414.11 = 2.966 \text{ twist per inch.}$$

From this it will be clearly seen that the twist in the roving depends upon the ratio between the spindle speed and the delivery of the front roll, and any change in this ratio will make a corresponding change in the twist.

The usual method of figuring the twist constant, or the twist, is from the gearing direct.

Start with the circumference of the front roll under the line, put the gear on the end of the front roll over the line, the next gear under, the next over, and continue alternating the gears till

we get to the bevel on the bottom of the spindle, which will come under the line. Divide the product of the numbers above the line by the product of the numbers under the line. The answer is the twist.

The reason for this will be seen from the fact that, if we start with one revolution of the front roll and work out the spindle speed, we will get the revolutions of the spindle for each revolution of the front roll, or the number of turns of twist that is put in the amount of roving delivered by the one revolution of the front roll. As we want the twist per inch and not the twist per revolution of front roll, we must divide this by the delivery of the roll for one revolution, which is, of course, its circumference. In this case, the circumference of the roll is 3.534 inches, and if we start with this figure under the line, we get the same result as would be gotten by the method mentioned above.

Referring to Fig. 35, using a 24 tooth twist gear and starting with the circumference of the front roll under the line, we get the twist, as follows:

$$\frac{128 \times 48 \times 45 \times 43}{3.534 \times 75 \times 24 \times 30 \times 21} = 2.966 \text{ twist.}$$

By using the same figures, leaving out the 24 tooth twist gear, we get the twist constant:

$$\frac{128 \times 48 \times 45 \times 43}{3.534 \times 75 \times X \times 30 \times 21} = 71.19 \text{ twist constant.}$$

Twist constant \div *twist per inch* = *twist gear*.

$$71.19 \div 24 = 2.996 \text{ twist per inch.}$$

$$71.19 \div 2.996 = 24 \text{ twist gear.}$$

In changing the twist gear without the use of the twist constant, the following rule holds good, remembering that the twist and the hank roving vary inversely as the size of the twist gear; for a larger twist gear gives less twist and is used for a smaller hank roving.

Twist gear on frame \times *twist on frame* \div *twist desired* = *gear needed*.

Example: A frame has on a 30 tooth twist gear and is putting in 2.5 turns of twist. What size twist gear is needed to give 3 turns of twist?

$$\frac{30 \times 2.5}{3} = 25 \text{ twist gear needed.}$$

3

In changing the size of the twist gear from the hank roving,

the above rule applies by substituting the square root of the hank roving in place of the twist.

Example: A frame is running a 6 H. R. with a 24 tooth twist gear. What size gear would be needed if the roving was changed to 6.5 H. R.?

$$\frac{24 \times \sqrt{6}}{\sqrt{6:5}} = \frac{24 \times 2.45}{2.55} = 23 \text{ twist gear.}$$

As the basis of the twist in the roving is the square root of its hank, and, as the twist always varies in accordance with this basis, any change in the size of the twist gear must be made on the same basis, otherwise we are in error. This is why, in working the above example, the square root of the hank roving was used instead of the hank roving itself.

There can be no inflexible rule given to determine the correct amount of twist required for different rovings. There are several conditions that will cause a variation in the amount of twist that would be desirable to run: the length of the staple, the harshness or softness of the fibers and the number of previous drawing operations that the cotton has been subjected to.

The usual rule for twist in roving is: $\sqrt{\text{H. R.}} \times 1.2 = \text{twist per inch.}$

This is the rule universally used for Uplands cotton, and meets the requirements in the majority of cases, though, at times, less twist can be used to advantage; and, again, some cases will require the use of more twist. In running longer stapled cotton, the amount of twist can and has to be decreased, and the amount of this decrease grows more as the length of the staple increases. For medium staple, between 1 inch and 1 $\frac{1}{4}$ inches, the following rule will give good results:

Twist in slubber roving = $\sqrt{\text{H. R.}}$

Twist in intermediate roving = $\sqrt{\text{H. R.}} \times 1.1.$

Twist on fine and jack frames = $\sqrt{\text{H. R.}} \times 1.2.$

For cottons of longer staple than the above it is possible to use even less twist. The sole object of introducing twist in the roving is simply to give strength enough to hold it together while being put on the bobbin and being pulled off in the creel of the frame following. Any more than this amount is not only unnecessary, but it causes a corresponding decrease in the production of the frame, throws more work on the rolls of the following frame, and may cause bad drawing.

DIFFERENTIAL MOTION OR COMPOUND.

The purpose of the differential motion or compound is to give a suitable means for the correct driving of the bobbins. The bob-

bins must revolve as fast as the spindles and enough in excess of this speed to wind on the amount of roving delivered by the front roll. As the bobbins increase in size, the number of revolutions necessary to wind on the roving decreases, and consequently the bobbins must decrease in speed. This decrease in bobbin speed is obtained by automatically changing the position of the cone-belt on the cones by means of the tension gearing, giving a varying speed to the bottom cone. The compound receives this variable speed from the bottom cone, combines it with the constant speed of the main shaft, and delivers it as one motion to the sleeve gear. The speed of the bobbins, due to the motion of the main shaft, considering the bottom cone as being stationary, is equal to the speed of the spindles, and consequently no winding would take place. When the bottom cone is in motion, the speed of the bobbins is

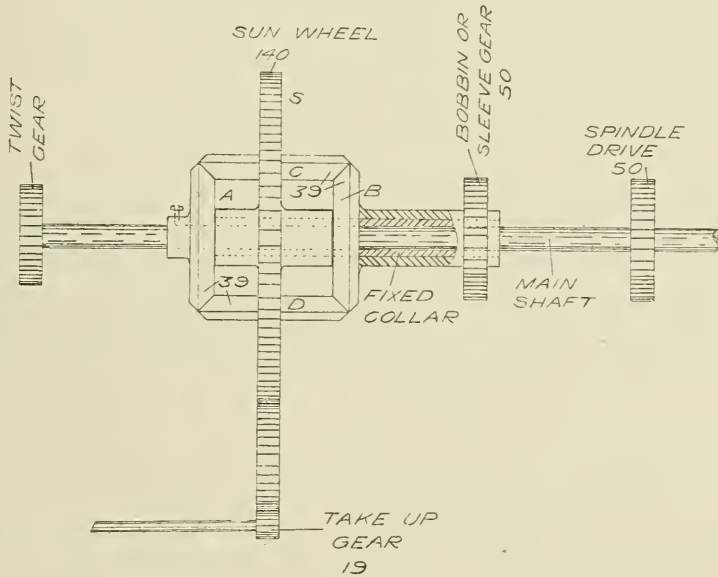

FIG. 36. THE BEVEL GEAR DIFFERENTIAL MOTION OR COMPOUND.

greater than the speed of the spindles, and the roving is being wound on the bobbins. This additional speed of the bobbins, spoken of as the excess speed of the bobbins, is due to the bottom cone speed and is necessary to produce the winding. The changing of the position of the cone belt changes the bottom cone speed and the speed of the compound, thus changing the speed of the bobbins.

The majority of American machine builders have adopted one type of compound, the old style bevel gear compound, a cut of which is shown in Fig. 36. Keyed on the main shaft, which carries the twist gear and the gear driving the spindles, is a bevel A which drives, by means of two idler gears C and D, another bevel gear B, this latter gear forming part of the loose or "sleeve" gear,

also called the bobbin gear. This sleeve consists of the bevel gear B and the spur gear of 50 teeth, which drives direct to the bobbins, the two being joined together by a collar or sleeve, the sleeve gear having no connection whatever with the main shaft, being carried on a fixed collar and revolving independently of the main shaft. The two idlers, C and D, serve simply to transmit motion from A to B, their axes being spokes of the sun-wheel S, and when S is revolved around the shaft, C and D will revolve about the shaft with S. The sun-wheel revolves independently of the main shaft or the fixed collar, being driven from the bottom cone at a variable speed.

It will be seen that the final speed of the sleeve gear B is a combination of the fixed speed of the gear A and the variable speed of the gear S, the speed S being the one that gives the excess speed to the bobbins and, also, the one that is varied to give the decreasing speed that is demanded by the increasing size of the bobbins while the winding is taking place.

Without going into the theory underlying the construction of the compound, we can explain its action by following each motion in detail. If we revolve A one revolution, the carriers C and D will transmit this direct to B and B will have one revolution, the gears A, C, D and B having the same number of teeth. The direction of the revolution of B will be opposite to that of A. By using the signs + and — to denote the direction of revolution, we will get the following statement of the facts, it being understood that S is being held stationary.

$$A1 + = B1 -$$

If we consider A as stationary and revolve S one revolution we will get two revolutions to the bevel B. The direction of the revolutions of B will be the same as that of S. While S revolves, the idlers C and D are being carried around the shaft by S and, as they are in gear with B, B will, of necessity, be carried around the shaft in the same direction as S and will have one revolution for one of S. We can refer to this revolution as due to the revolving of C and D around the shaft.

While S is making one revolution and carrying the gears C and D around the shaft with it, C and D, being in contact with the fixed gear A, will have to roll around the face of A. Having the same number of teeth, this will cause C and D to revolve on their own axis and will give them one such revolution for every revolution of S. This will cause B to have one revolution and it will be in the same direction as the gear S. We can refer to this revolution as due to the revolving of C and D on their own centers, due to their contact with the gear A, while being carried

around the shaft by S. Then the following statement will be in accordance with the above facts:

$$S1 + = B2 +$$

As it is the desire to revolve the sleeve gear B faster than the fixed bevel A and, as the revolving of S in the same direction as A would have the effect of reducing the speed of B, it will be seen that the sun-wheel must revolve in the opposite direction to the main shaft or bevel A. As A revolves in (+) direction we must revolve S in the opposite or (—) direction and the conditions will be as follows:

$$S1 - = B2 -$$

Now take the two equations for A and S and combine them and we will get the graphic statement of the facts:

$$A1 + = B1 -$$

$$S1 - = B2 -$$

$$(A1 +) + (S1 -) = B3 -$$

With the sun-wheel and main shaft revolving in opposite directions the speed of B is greater than A and is reduced as the speed of S is reduced. If the sun-wheel and main shaft revolve in the same direction the speed of B would be less than the speed of A and would be increased as the speed of the sun-wheel is decreased. This last condition is found in the old style flyer lead frames.

The above can be summed up in the following words:

The speed of the sleeve gear is equal to the speed of the main shaft plus twice the speed of the sun-wheel.

The speed of the sun-wheel is greatest at the start of a set and is decreased as the bobbin builds, due to the decrease in bottom cone speed which occurs as the cone belt is moved on the cones.

In Fig. 37 is shown a cut of the Daly differential motion used on the Woonsocket 7 by 3 inch fly frame. This motion employs spur gears and all parts revolve in the same direction, the whole being enclosed so as not to be constantly accumulating dust and fly.

On the main shaft is an internal gear A of 80 teeth, driving a small gear of 15 teeth which is compounded with a gear of 39 teeth, both being carried on a stud which is fixed into the plate gear D. This plate gear also carries a bevel of 57 teeth which drives direct to the bobbins. The 39 tooth gear is in gear with the 24 tooth gear C which is on a sleeve, the other end carrying a gear of 30 teeth, this latter being driven from the bottom cone.

The gears 24 and 30 are compounded together by the sleeve connecting the two, the whole being called the sleeve gear and revolves on, and in the same direction with, the main shaft. The

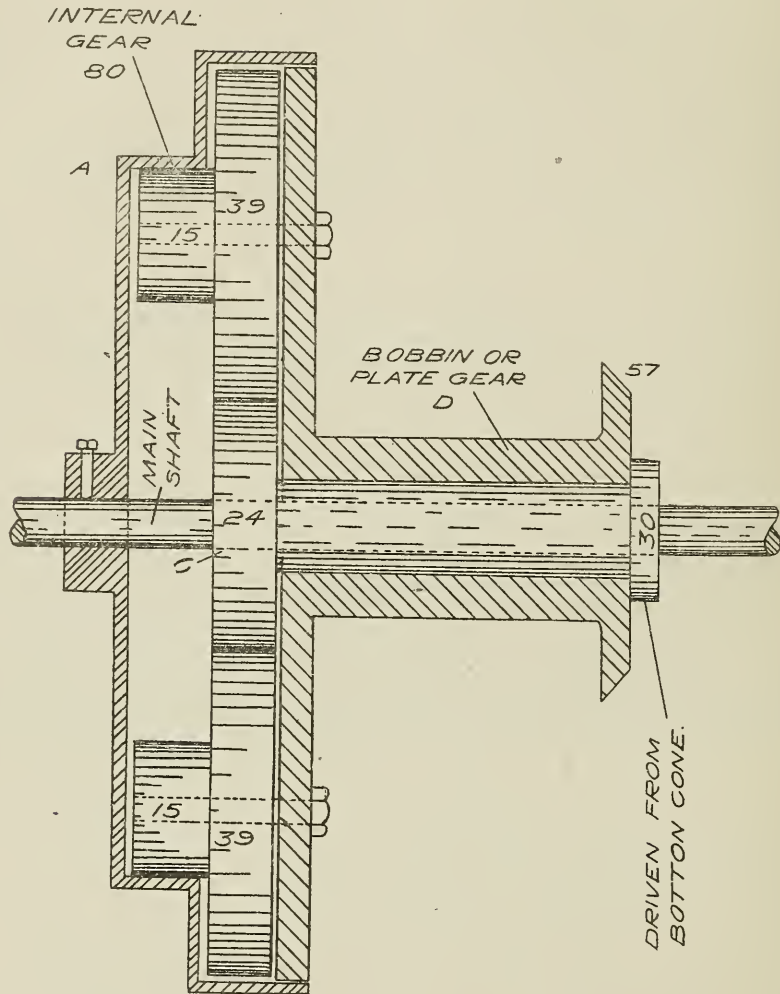

FIG. 37. DALY DIFFERENTIAL.

bobbin or plate gear D revolves on the collar of the sleeve gear and in the same direction as the main shaft.

As in the former case, there are two motions which are combined into one;

First: The fixed constant speed of the main shaft gear A.

Second: The variable speed of the sleeve gear C, which comes from the bottom cone and gives to and regulates the excess speed of the bobbins.

If we consider the effect of these two motions separately on the gear D, we will be able to understand the operation of the com-

round. While A is moving and C is held still, A carries the compound gear 15 and 39 around with it, because it cannot revolve on its own axis, due to the fact that the 24 and 39 tooth gears are in contact and the 24 tooth gear is stationary. While the compound gear of 15 and 39 teeth is being carried around the shaft by the movement of the gear A, the 39 tooth gear is meshing with the 24 tooth gear, which will cause the 15 and 39 tooth gear to revolve on its own axis. This action will cause a lagging behind of the gear D or a slipping ahead of the gear A. Now, if A is given one complete revolution, it will be seen that the gear D will not revolve a full revolution, due to the compound gear 15 and 39 revolving on its own axis caused by the 39 tooth gear rolling around the face of the stationary gear of 24 teeth and, to revolve A far enough to cause a complete revolution to D, the 39 tooth gear will revolve entirely around the 24 tooth gear and make $24/39$ of a revolution on its own axis, hence the 15 tooth gear compounded with the 39 tooth gear will make the same fraction of a revolution. This will cause the gear A to advance ahead of the gear D by the following fraction:

$$\frac{24}{39} \times \frac{15}{80} = .115.$$

Then, when A makes 1.115 revolutions, D will make 1 revolution and while A is making 1 revolution D will make .896 of a revolution. Now, if we express the speed of D, due to the speed of A, in terms of A, we get the following:

$$D = A \times .896.$$

Now take the second condition and suppose A is still and revolve C. When C is revolved the gear of 24 teeth gives motion to the 39 and the 15 tooth compound gear and causes it to revolve on its own axis. This will cause the 15 tooth gear to be moved around the internal gear A of 80 teeth and give the gear D a part of a revolution for every revolution of C, expressed by the value of the train of gearing:

$$\frac{24 \times 15}{39 \times 80} = .115.$$

Then the speed of D, due to the speed of C and expressed in terms of C, will be as follows:

$$D = C \times .115.$$

Now combining the two speeds of D, due to the speeds of A and C, in terms of both A and C, we have:

$$\text{The speed of D} = (A \times .896) + (C \times .115).$$

The value of the train of gearing between the main shaft and the spindles and between the gear D and the bobbins, is such as to give the same speed to the spindles and bobbins when C is stationary, then it will be seen that when C revolves, the bobbins have a speed faster than the spindles and are winding on the roving and that, when the speed of C is reduced the speed of the bobbins is reduced.

WINDING.

The winding of the roving on the bobbin is accomplished by the excess speed of the bobbin which is gotten from the bottom cone by means of the compound. The speed of the bottom cone is regulated by the position of the cone belt which is automatically changed by the tension gearing at the end of each layer wound. Consider the bobbin to be 1 inch in diameter when empty and 4 inches when full, then the bobbin will increase in uniform amounts from 1 inch to 4 inches, a total increase in diameter of 3 inches which, supposing the cones to be 30 inches long, is an increase in diameter of $\frac{1}{10}$ inch for every inch of belt traverse, or $\frac{1}{2}$ inch increase for a belt traverse of 5 inches, or $\frac{1}{6}$ the total length of the cones.

The above, although true, is misleading, as the statement is often made, based on the above facts, that the speed of the bottom cone, and hence of the bobbins, decreases in regular amounts for each layer wound from start to finish of a set. It is true that the increase in bobbin diameter is in regular amounts for each layer wound, or each movement of the cone belt, but the proportional increase in bobbin diameter is not regular, being larger at the beginning than at the end of a set, hence, the variation in speed of bottom cone and bobbin is not regular, but decreases as the bobbin builds by a lesser amount for each layer wound. This will be seen when we consider that, at the start of a set, we are winding the roving on a bobbin that is only 1 inch in diameter, while, at the end of a set the diameter of the bobbin is 4 inches, hence, the relative increase in bobbin diameter, by the addition of one layer of roving, must be greater when the bobbin is small than when it is large.

When the bobbin has become 2 inches in diameter, it has wound on a thickness of roving of 1 inch, which is one-third the total increase in the bobbin diameter, so the belt must have traveled one-third the length of the cones. Now, the bobbin at this point is one-half its full diameter, so its excess speed and, also, the speed of the bottom cone, must have decreased by one-half, as it now takes only one-half the number of revolutions of the bobbin to wind on the delivery of the front roll. The diameter of the bot-

tom cone at this point will be the same as that of the top cone.

The following facts are true and demonstrable:

First: Straight faced cones will not give the proper results when applied to fly frames.

Second: The speed of the bottom cone and bobbin does not decrease in regular amounts for every layer wound on the bobbin, but must decrease in inverse ratio to the proportional increase of bobbin diameter.

Third: At all opposite points of a correct pair of cones the sum of the top and bottom cone diameters will be equal, the cones will give a variable decrease in the speed of the bobbin, this de-

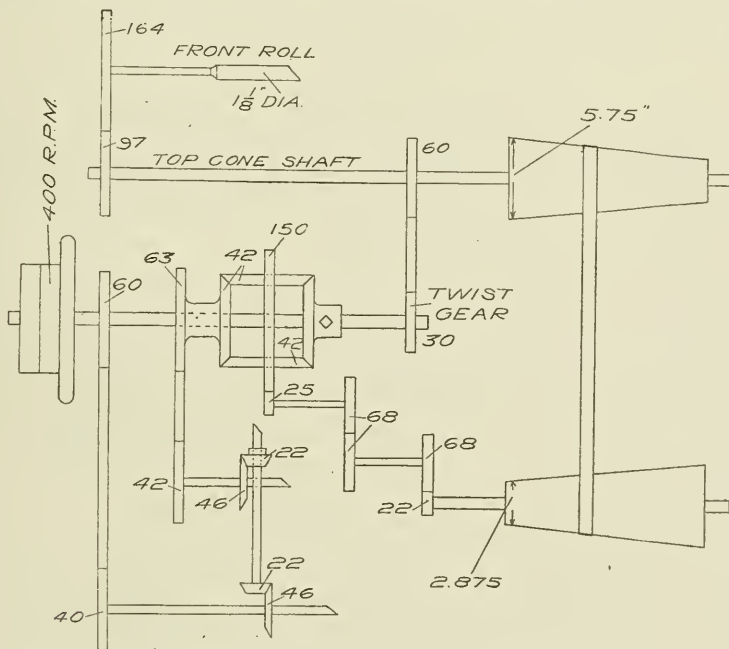

FIG. 38. SPINDLE AND BOBBIN GEARING. LOWELL 7 BY 3½ INCH FLY FRAME.

crease being larger at the start of a set than at the end and the outline of the cones will be concave and convex curves, equal diameters coming at one-third the length of the cones, measured from the large end of the top cone. The top cone is concave and the bottom cone convex, the greatest curve in their outlines coming at the large end of the top and the small end of the bottom cone.

As the total speed of the bobbin is governed by the delivery of the front roll, the size of the bobbin and the speed of the spindle, the required speeds of bobbin and bottom cone can be figured and the correct diameters determined at any point in the build of a bobbin.

Fig. 38 is a diagram of the spindle and bobbin gearing of a fine fly frame built by the Lowell Machine Shop. This frame is $5\frac{1}{4}$ inches space and 7 inches traverse and builds a bobbin 7 by $3\frac{1}{2}$ inches, the diameter of the empty bobbin being $1\frac{3}{8}$ inches. Main shaft speed at 400 R. P. M. and using a 30 tooth twist gear, gives a top cone speed of 200 R. P. M. The front roll speed is:

$$\frac{400 \times 30 \times 97}{60 \times 164} = 118.29 \text{ R. P. M.}$$

The front roll is $1\frac{1}{8}$ inches in diameter, and will deliver 418.04 inches of roving per minute. The spindle speed is:

$$\frac{400 \times 60 \times 46}{40 \times 22} = 1254.54 \text{ R. P. M.}$$

As we start with an empty bobbin diameter of $\frac{1}{4}$ inch, it will wind on 3.1416 inches of roving for every revolution that it makes, hence, the speed of the empty bobbin to wind on the delivery of the front roll is as follows:

$$418.04 \div 3.1416 = 133.065 \text{ R. P. M.}$$

This allows for no increase in bobbin speed to provide for the proper tension on the roving and should be increased about 1.67 per cent, which gives 135.27 R. P. M. of bobbin to wind on the delivery of the front roll. This is the excess speed of the bobbin and must be added to the speed of the spindle to give the total speed of the bobbin, as follows:

$$1,254 + 135.27 = 1389.81 \text{ R. P. M. of bobbin.}$$

Take this figured speed of the bobbin as a starting point, the following figures will give the speed of the sleeve gear:

$$\frac{1389.81 \times 22 \times 42}{46 \times 63} = 443.12 \text{ R. P. M.}$$

The speed of the sun-wheel equals one-half the difference between the speeds of the main shaft and sleeve gear, so:

$$\frac{(443.12 - 400)}{2} = 21.56 \text{ R. P. M. of sun-wheel.}$$

The speed of the bottom cone at the start is found from the sleeve gear speed, as follows:

$$\frac{21.56 \times 150 \times 68}{25 \times 22} = 399.8 \text{ R. P. M. or practically 400 R. P. M.}$$

By taking the bobbin at any diameter during its build and fol-

lowing the above method of figuring, we can determine the bobbin and bottom cone speeds.

Although the frame builds a bobbin only $3\frac{1}{2}$ inches in diameter when full, starting with an empty bobbin diameter of $1\frac{3}{8}$ inches, it is necessary to make the calculations for a bobbin smaller at the start and larger at the finish than is actually used, as it is impossible to run the cone belt on the extreme end diameters, as would be required if we made the calculation with the same sizes to empty and full bobbin that is actually run on the frame and, also, to have ample room at the ends of the cones. This enables the starting and finishing points of the cone belt to be changed to suit varying conditions.

The following table gives the required speeds of the bobbin and bottom cone and the diameter of the bobbin at the start of a set and after each belt movement of 5 inches :

Speed of bottom cone.	Speed of Bobbin.	Diam. of Bobbin.
Start, 400	1389.81	1 inch.
1st point, 266.66	1344.77	$1\frac{1}{2}$ inches.
2nd point, 200	1322.14	2 inches.
3rd point, 160	1308.68	$2\frac{1}{2}$ inches.
4th point, 133.33	1299.56	3 inches.
5th point, 114.33	1293.22	$3\frac{1}{2}$ inches.
6th point, 100	1288.34	4 inches.

These figures were obtained from calculations based on the actual delivery of the front roll, spindle speed and the diameter of the bobbin, allowing for tension during the winding of the roving. This last is a variable quantity and there are other factors to be taken into consideration, still the above speeds are accurate enough for all practical purposes and are very close to those that would be found, under the same conditions, in the running of the frame.

If we now figure a pair of cones, based on the speeds in the above table, we will get the results shown in Fig. 39. This shows a pair of cones, with the cone diameters, bottom cone and bobbin speeds for every belt movement of 5 inches.

The speed of the bottom cone varies in inverse ratio to the proportional increase in bobbin diameter, then, the following rule for figuring bottom cone speed is correct.

The speed of the bottom cone at start \times diameter of empty bobbin \div the diameter of the bobbin at any point = the speed of the bottom cone at that point.

From this we find that the bottom cone at the first point, or

at the end of a traverse of 5 inches, will have a speed of 266.66 R. P. M. as follows:

$$\frac{400 \times 1}{1.5} = 266.66$$

The same method of calculation was used to get the bottom cone speeds at the remaining points and, in every case, it will be

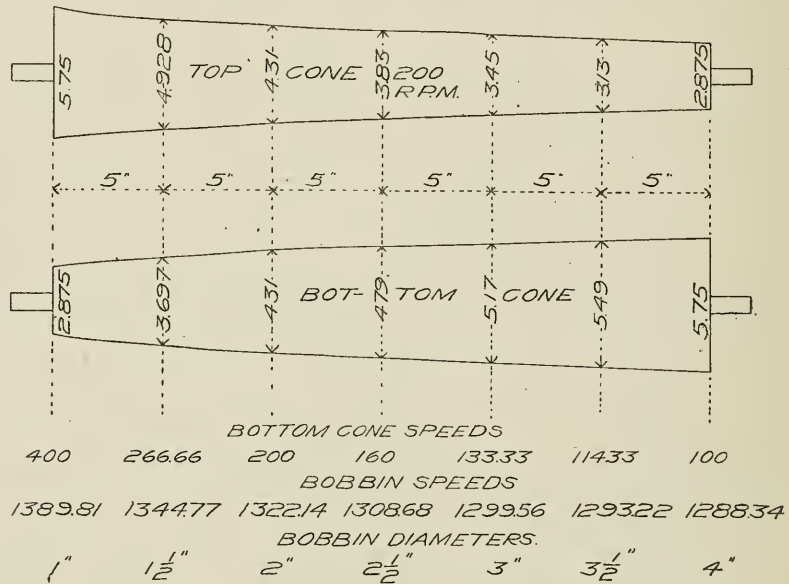

FIG. 39. A PAIR OF CONES FIGURED ON THE BASIS OF THE TABLE OF SPEEDS GIVEN.

noted that these speeds will coincide with those shown in the table.

With the speeds of bottom and top cones known, the diameters of the two cones were found by the following rules:

Sum of cone diameters \times *bottom cone speed at any point*
sum of cone speeds at that point = *the top cone diameter.*

The sum of the cone diameters — *top cone diameter* = *the bottom cone diameter.*

Then, taking the figures for the first point, the sum of the cone diameters being 8.625, we will get the following as the cone diameters at this point:

$$\frac{8.625 \times 266.66}{200 + 266.66} = 4.928$$

$$8.625 - 4.928 = 3.697$$

Then the top cone diameter will be 4.928 inches and the bottom cone diameter will be 3.697 inches. The diameter of the two cones at the other points were figured by the same method.

It will be noticed that at the second point, or when the belt has moved 10 inches or 1-3 of the length of the cones, the bobbin has increased 1 inch in diameter or 1-3 its total increase and is $\frac{1}{2}$ its full diameter, the speed of the bottom cone is $\frac{1}{2}$ its speed at the start, and the diameters of the two cones are equal. This fact proves that straight faced cones cannot be used as their equal diameters come at the middle of the cones. It will be also noticed that the diminution in the speed of the bobbin is greatest during the first movement of the belt, this decrease growing smaller as the end of the set is reached by a varying amount. This is the actual condition, for the proportional increase in bobbin diameter is greatest at the start of a set, when the bobbin is small, although the actual increase in bobbin diameter is practically the same for each layer wound.

It will be noticed that the results obtained from this pair of developed cones are similar to those as figured from the front roll delivery, hence, the cone outlines must be correct. For comparison, select the figures for the second point and start with the main shaft speed and figure the total speed of the bobbin and compare with the required speed as given in the table or with the speed as shown in Fig. 39. The speed of sun-wheel is:

$$\frac{400 \times 30 \times 4.31 \times 22 \times 68 \times 25}{60 \times 4.31 \times 68 \times 68 \times 150} = 10.78 \text{ R. P. M.}$$

The speed of the sleeve gear is $400 + (2 \times 10.78) = 421.56$ R. P. M. Then the speed of the bobbin is obtained as follows:

$$\frac{421.56 \times 63 \times 46}{42 \times 22} = 1322.16 \text{ R. P. M.}$$

This speed is practically the same as obtained by our former figures, and using the above method, and figuring the bobbin speed at any point, will give results that will be practically the same as those found before. This shows that the cone diameters given in Fig. 39 must be correct and their method of development meets the requirements in the case.

TENSION GEARING.

We have already found that the shape of the cones was such that, for each layer wound on the bobbin, the cone belt is moved an equal distance along the face of the cone, giving the correct decrease in bobbin speed and a uniform tension from start to finish of a set. The amount of this traverse would naturally be the length of the cone used, from start to finish of the set, divided by the number of layers put on the full bobbin. No rule can be given to

determine the proper tension gear for different sizes of roving that will work under all conditions, as the tension depends largely upon the amount of twist in the roving and the lay of the roving on the bobbin. A change of atmospheric conditions will affect the tension, for roving that will run all right on a damp day may be too tight on a clear, dry day, necessitating a change of one or two teeth in the size of the tension gear.

The amount of twist in the roving also influences the tension to a certain extent, for, if the roving is hard twisted, its diameter is smaller and consequently, the bobbin increases slower in diameter, necessitating a slower decrease in speed.

The size of the rail or lay gear, governing the speed at which the rail is traversed, thus determining the closeness of the coils in each layer, also has a tendency to affect the tension. If the lay gear is too large, the rail speed will be too fast and the coils would be more open, allowing the next layer of roving to draw down between the coils, therefore, the diameter of the bobbin would not increase as rapidly with each layer wound. This would require a slower decrease in bobbin speed and call for the use of a smaller tension gear than we would naturally expect.

From the above facts, the conditions governing the tension on the roving are seen to be of such a variable nature that the final judge of the correctness of the tension on the roving must be its appearance as the frame runs, and the tension gear must be changed to suit the conditions regardless of how far from its calculated size we may have to vary.

Fig. 40 shows the plan of gearing on a 12 × 6 inch Saco-Pettee slubber. The upright, or tumbling shaft, carries a double threaded worm, driving into a 32 tooth worm gear. On the stud with this worm gear is a 60 tooth gear driving into a 50 tooth gear. On the stud with this gear is the tension gear, gearing direct into the cone rack. After the winding of each layer on the bobbin the tumbling shaft is revolved $\frac{1}{2}$ a revolution by the gear on the end of the top cone shaft. This causes the worm gear to move one tooth, thus moving the belt a certain distance on the cones, this distance depending upon the size of the tension gear.

If we assume the main shaft speed as 250 R. P. M., with a 56 tooth twist gear on and the frame to be running .64 H. R., then the top cone speed will be:

$$\frac{250 \times 56}{46} = 304.35 \text{ R. P. M.}$$

The belt starts on the top cone 2.75 inches from the end. The diameter of the top cone at this point is 6.75 inches and the corresponding diameter of the bottom cone is 3.75 inches, giving a ratio

between the two of 1.8. Then the bottom cone speed at the start is :

$$304.35 \times 1.8 = 547.83 \text{ R. P. M.}$$

When the bobbin is full its diameter is 6 inches and the belt has moved its full traverse on the cones. The diameter of the empty bobbin is $1\frac{7}{8}$ or 1.875 inches, hence, the bottom cone speed at this point will be :

$$\frac{547.83 \times 1.875}{6} = 171.19 \text{ R. P. M.}$$

Knowing the top and bottom cone speed, we can find the top cone diameter by the following :

$$\frac{10.5 \times 171.19}{304.35 + 171.19} = 3.77 \text{ inches for the top cone diameter when the bobbin [is 6 inches in diameter or full.}$$

As the point on the top cone where the diameter is 3.77 inches is 28.5 inches from the point where the belt starts, then the belt and belt rack must move 28.5 inches while building a full bobbin. There are 32 teeth in 10 inches of rack or 3.2 teeth in every inch. Therefore, the rack must move: $28.5 \times 3.2 = 91.2$ teeth in order to move the belt 28.5 inches.

There are eight coils per inch on the bobbin ($\sqrt{.64} \times 100 = 8$) and, as the layers per inch are four times the coils per inch, there will be 32 layers per inch on the bobbin. The diameter of the empty bobbin is $1\frac{7}{8}$ inches, and the diameter of the full bobbin 6 inches, therefore, there is $4\frac{1}{8}$ inches of roving put on the bobbin, or $2\frac{1}{16}$ inches on each side, to build it out to 6 inches in diameter. Then: $2\frac{1}{16} \times 32 = 66$ layers of roving wound on the bobbin, which calls for 66 reversions of the rail and 66 movements of the cone belt rack.

The tumbling shaft makes $\frac{1}{2}$ a revolution for every reversion of the rail, or for every movement of the belt rack, then 33 revolutions of tumbling shaft will be required for the 66 reversions of the rail. Therefore, to wind on the 66 layers of roving, or to move the belt rack the 28.5 inches necessary, it will require 2.47 revolutions of the stud carrying the tension gear, as follows :

$$\frac{33 \times 2 \times 60}{32 \times 50} = 2.47.$$

As there is a total of 91.2 teeth used in the rack in traversing the belt the necessary 28.5 inches, there will be required 37 teeth in the tension gear, as follows: $91.2 \div 2.47 = 36.9$ or 37 teeth. Then: $\sqrt{.64} \times 37 = 29.6$ tension constant.

Rule for using tension constant:

$$\text{Constant} \div \sqrt{HR} = \text{tension gear.}$$

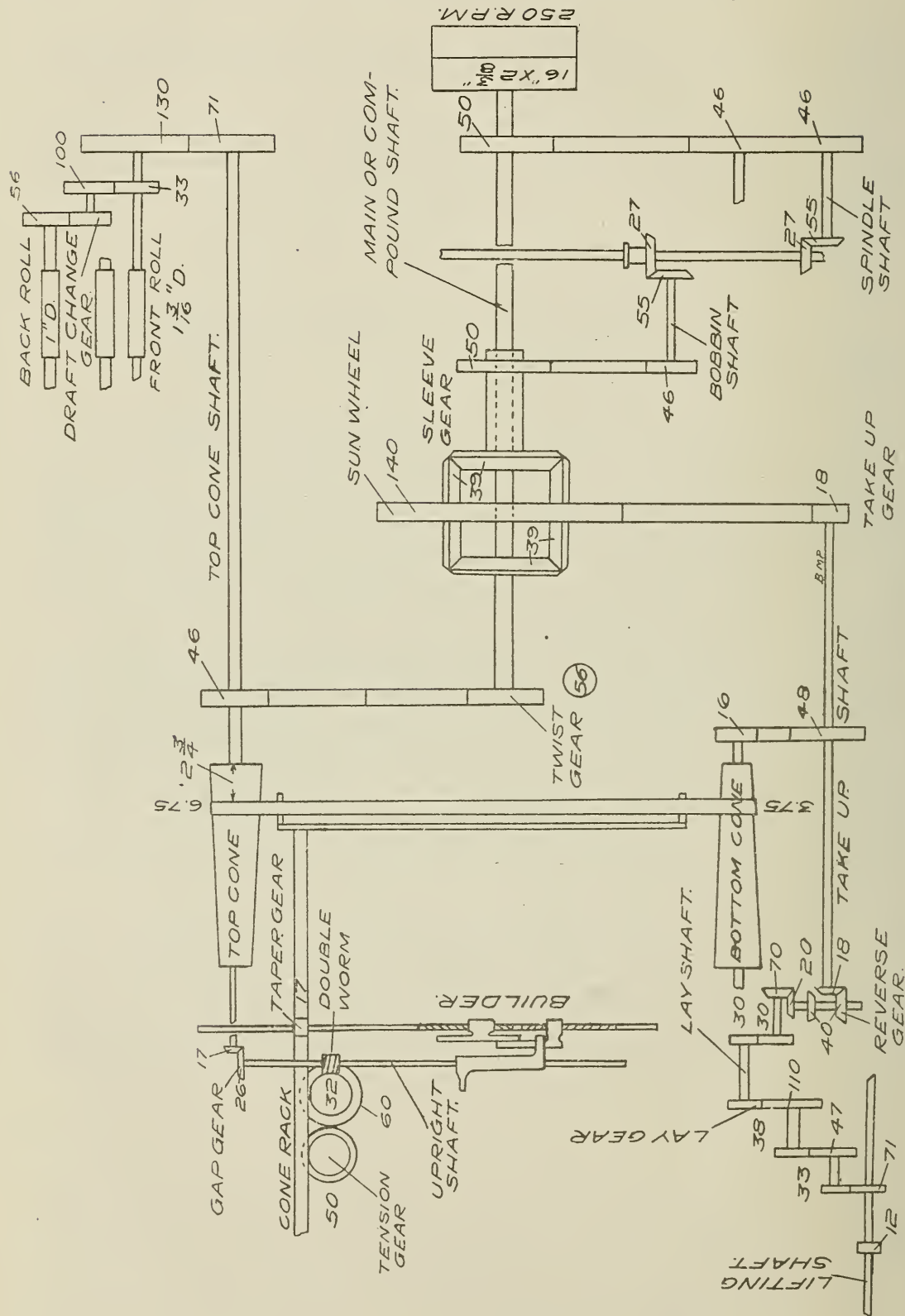

FIG. 40. SACO-PETTEE 12 x 6 SLUBBER.

LAY GEARING.

Referring again to Fig. 40, the bottom cone drives the take-up shaft, which, through a train of bevel and spur gears, drives the lay shaft carrying the lay gear. This gear is also called the traverse or rail gear. The lay gear, by a train of spur gears, drives the lifting shaft. On the lifting shaft is a 12 tooth pinion in gear with the lifting arm or segment that raises and lowers the rail.

As we found before, the bottom cone has a speed at the start of 547.83 R. P. M., then the speed of the take-up shaft will be:

$$\frac{547.83 \times 16}{48} = 182.61 \text{ R. P. M.}$$

By following the train of gears between the take-up shaft and the lay shaft, we get the speed of the lay shaft to be:

$$\frac{182.61 \times 18 \times 20 \times 30}{40 \times 70 \times 30} = 23.48 \text{ R. P. M.}$$

The above is the calculated speed of the lay shaft that would be present under the above conditions. The correct lay of the roving on the bobbin is based on the square root of the roving and, under ordinary conditions, will not be far from the results obtained from the following rule:

$$\text{Coils per inch} = \text{square root of the H. R.} \times 100.$$

As we have assumed, in the calculation for the tension gear, that the frame is running on .64 H. R., the coils per inch will be: $\sqrt{.64} \times 100 = 8$, that is, 8 strands of .64 H. R. will lie in one inch of bobbin length.

The bobbin, when empty, is 1.875 inches in diameter, or 5.89 inches in circumference, then every coil on the bobbin will have 5.89 inches of roving in it and, as there are 8 coils per inch, the bobbin will wind up: $5.89 \times 8 = 47.12$ inches of roving for every inch of rail traverse.

The speed of the front roll is found as follows:

$$\frac{250 \times 56 \times 71}{46 \times 130} = 166.25 \text{ R. P. M.}$$

The front roll is $1 \frac{3}{16}$ inches in diameter or 3.73 inches in circumference, then: $166.25 \times 3.73 = 620.113$ inches of roving will be delivered by the front roll per minute. By dividing the delivery of the front roll per minute by the amount of roving wound on the bobbin per inch of traverse, we will get the speed at which the rail will have to move: $620.113 \div 47.12 = 13.18$ inches per minute.

The lifting gear has 12 teeth and moves the lifting arm 13.26 inches during a 12 inch traverse of rail. The teeth on the lifting arm are placed 10 in 6.5 inches or each tooth occupies a space of .65 inch, then: $.65 \times 12 = 7.8$ inches which the lifting arm moves for every revolution of the lifting gear. As the lifting arm has to move a total of 13.26 inches for a full traverse of the rail, so: $13.26 \div 7.8 = 1.7$ revolutions of lifting gear to a full 12 inch traverse of the bobbin rail.

Now, if the bobbin rail travels at the rate of 13.18 inches per minute and it takes 1.7 revolutions of the lifting gear to traverse the rail 12 inches, then the speed of the lifting gear or shaft will be 1.86 R. P. M., as follows:

$$\frac{13.18}{12} \times 1.7 = 1.86 \text{ R. P. M.}$$

By following the train of gearing, we get the speed of the 110 tooth crown gear to be:

$$\frac{1.86 \times 71 \times 47}{33 \times 38} = 4.949 \text{ R. P. M.}$$

and the total number of teeth used on the crown gear will be: $4.949 \times 110 = 544.39$ teeth per minute.

As the lay gear drives this crown gear and we have found the speed of the lay shaft to be 23.48 R. P. M., we get the number of teeth in the lay gear as follows:

$$544.39 \div 23.48 = 23 \text{ tooth lay gear.}$$

$$\text{Then: } \sqrt{.64} \times 23 = 18.4 \text{ lay constant.}$$

Rule for using the lay constant:

$$\text{Constant} \div \sqrt{HR} = \text{lay gear.}$$

The following rule is useful in changing the hank roving on the frames and applies to both the lay and tension gears:

$$\sqrt{H. R. \text{ on frame}} \times \text{gear on frame} \div \sqrt{H. R. \text{ desired}} = \text{gear needed.}$$

It is understood that, in using the rule, there is no change to be made in the size of the roving on the back of the frame.

TAKE-UP GEARING.

Referring to Fig. 40, the bottom cone drives the take-up shaft by a 16 into a 48 tooth gear at a speed, as we have before found, of 182.61 R. P. M. The take-up shaft carries the take-up gear which drives the sun-wheel and provides for the excess

speed of the bobbin necessary to wind on the delivery of the front roll. As the excess speed of the bobbin is the only speed we need to consider, it being the only one affected by the take-up gear, the total speed of the bobbin need not be figured.

We have found that the front roll delivers 620.113 inches of roving per minute and the circumference of the $1\frac{7}{8}$ inch bobbin to be 5.89 inches, hence, the bobbin will have to make 105.3 R. P. M. to wind on the roving delivered by the front roll. This is the excess or winding speed of the bobbin, derived from the bottom cone and being entirely independent of the bobbin speed obtained from the main shaft.

Starting with this speed and following the train of gears back to the sleeve gear, we get the following:

$$\frac{105.3 \times 27 \times 46}{55 \times 50} = 47.6 \text{ R. P. M.}$$

This 47.6 R. P. M. represents the speed of the sleeve gear obtained from the sun-wheel. This is not considering the speed of the sleeve gear derived from the speed of the main shaft. Then the speed of the sun-wheel is $47.6 \div 2 = 23.8$ R. P. M. There are 140 teeth in the sun wheel, so the speed of the sun-wheel, multiplied by its number of teeth and divided by the speed of the take-up shaft, will give the size of the take-up gear to use.

$$\frac{23.8 \times 140}{182.61} = 18.2 \text{ or } 18 \text{ teeth in the take-up gear.}$$

After the proper take-up gear has been put on and the correct starting position of the cone-belt determined to give the proper tension on the roving during the winding of the first layer on the bobbin, there is no need to change the size of the gear.

By a similar method of calculation, the cone gear can be found on those frames that use this gear as a change point instead of a take-up gear. There is one disadvantage in changing the gear on the bottom cone, to change the speed of the bobbin at the start, which is not present when the take-up gear is changed and, that is, when it ever becomes necessary to change the cone gear, we change the value of the train of gearing that drives the rail and the lay of the roving on the bobbin is altered to a certain extent. When the take-up gear is altered, the only change made is in the speed of the bobbin and, as this is present throughout the complete building of the bobbin and all the other motions are left as before, the tension gearing or traversing of the cone belt is in no wise affected. No change gear should ever be placed in such a position that a change in its size will affect the value

of any other train of gearing that is controlled by another change gear.

TAPER GEARING.

The builder is carried in a suitable frame mounted on the bobbin rail and moves with the rail. The two sliding builder jaws are mounted on a right and left handed screw, so that, turning the screw will cause the builder jaws to move closer together or farther apart, thus decreasing or increasing the length of the traverse. On the end of this screw is connected a square rod, which slides through a square hole in the center of the taper gear, this latter, gearing direct into the belt rack. Now, as the belt rack is moved at the end of each layer wound, the taper gear is turned, thus turning the screw and closing the builder jaws together, thus causing the next layer wound to be shorter than the previous one. This is repeated after each layer and causes a gradual reduction in the length of the layers put on, giving the taper on the ends of the bobbin.

The traverse is shortened $\frac{1}{2}$ coil at each reversion of the rail and, as there are 66 reversions to the rail to wind the full bobbin, the traverse will be shortened a total of 33 coils. The roving lays 8 coils per inch, hence, the total shortening of the traverse is $4\frac{1}{8}$ inches. One revolution of the taper gear closes the builder jaws $\frac{3}{4}$ inch, then: $4.125 \div .75 = 5.5$ revolutions needed to the taper gear. The total traverse of the cone belt rack, in building a full bobbin, is 28.5 inches or 91.2 teeth, consequently, the size of the taper gear will be: $91.2 \div 5.5 = 16.6$ or 17 teeth.

PRODUCTION.

The production of a fly frame depends upon the spindle speed, or amount of twist put into the roving, the number of sets or doffs per day, the number of ends broken, the number of spindles to a frame and the general efficiency of the operative. As all of the above conditions are variable, it is almost impossible to give a definite statement in regard to the amount of time lost during the operation of a frame. On fine and jack fly frames, all conditions being good, making 6 to 10 H. R., an allowance of 10 per cent. loss of time should be sufficient, on intermediates, from 10 to 14 per cent. and on slubbers from 12 to 25 per cent., depending upon the size of the roving being run and the length of the frame used. For instance, a slubber on .4 H. R. will run about 11 doffs a day, while the same slubber, at the same spindle speed, would only run about 4.75 doffs per day on .8 H. R., con-

sequently, the loss of time due to doffing, when running the .4 H. H. R., would be more than 2 1/3 times as great as when running the .8 H. R., and the percentage of the total production obtained in the former case would be correspondingly less. This is true on all the frames. Some mills use doffer girls, whose duty it is to help the tenders doff and creel their frames, one girl being placed to a certain number of frames. Where this system is used, the percentage of production is larger.

All frames are equipped with a clock which registers the number of hanks run. The mechanism of the clock is run from a worm on the end of the front roll and is adjusted to the size of the roll so that it will register one hank when the roll has made enough revolutions to cause it to deliver 840 yards of roving. The clocks should be read at the same time every day, thus showing a record of each day's run for each frame and operative, giving a comparison between the efficiency of the operatives.

The actual production of the frame in pounds per day can be found by the following rule:

Multiply the hanks registered on the clock by the number of spindles on the frame and divide by the H. R. being run.

Example: A fine frame is running 6 H. R., the spindle speed is 1,200 R. P. M., the twist per inch is 2.92 turns, the front roll is 1 1/8 inches in diameter and is making 116 R. P. M. The hank clock registers 7.7 hanks for one day's run and the frame has 160 spindles, what is the production in pounds?

$$\frac{7.7 \times 160}{6} = 205.33 \text{ lbs. per day.}$$

The above gives a correct idea of the production of the frame and, where several frames of the same size are running on the same H. R., an average of the clock readings of all the frames can be used to figure the total production that is being turned off, but it gives us no idea of the per cent. of production that is being produced. To do this, we must calculate the theoretical production of the frame and compare the two sets of figures.

To get the theoretical production, there are two methods that we can use:

First: Base our calculations on the front roll speed. This varies with every change in twist gear and should be ascertained before making the calculation or the results will not be correct.

Second: Base our calculations on the speed of the spindles and the twist in the roving. However, the speed of the spindles is often not what it is supposed to be, on account of loss of motion due to belt slippage, etc.

Taking the second method and calculating the production

without allowance for loss of time, we get the theoretical production. Spindle speed divided by the twist per inch gives the inches delivered per minute: $1,200 \div 2.92 = 410.96$ inches of roving per minute. Multiplied by the minutes in a day gives the inches delivered in a day: $410.96 \times 600 = 246,396$ inches per day. Divide this by 36 to get the yards per day: $246,396 \div 36 = 6,844.33$ yards. Then divide the yards delivered by the number of yards in one pound of 6 H. R. and it will give the pounds produced.

$$\frac{6,844.33}{6 \times 840} = 1.358 \text{ lbs. produced.}$$

This amount is for one spindle and must be multiplied by the number of spindles in the frame to give the total theoretical production of the frame. Then: $1,358 \times 160 = 217.28$ pounds per day.

The actual production, as figured from the clock reading, was 205.33 pounds. Then: $205.33 \div 217.28 = .94 +$ or a production of a little over 94 per cent., showing a loss of time of nearly 6 per cent.

In running the card room, the theoretical production for the whole room can be figured and a comparison made with the actual results obtained from the clock readings, showing, at a glance, the per cent. of possible production being turned off and giving an accurate idea of the efficiency of the machines and operatives.

If we figure the theoretical production from the front roll speed, we get the following, the front roll being 3.53 inches in circumference:

$$\frac{3.53 \times 116 \times 600 \times 160}{36 \times 6 \times 840} = 216.65 \text{ pounds.}$$

This compares closely with the 217.28 pounds obtained from the former figuring above, the difference being explained in the handling of the decimals.

It is not possible to work out a production constant for fly frames that would be applicable to any and all conditions, as all the quantities in the production calculation are variable to a large extent. However, assuming the conditions mentioned in the example to be present, the production constant, based on one spindle and no allowances for loss of time, would be:

$$\frac{1,200 \times 600}{36 \times 840} = 23.8.$$

If we divide this constant by the product obtained by multiplying the twist per inch by the size of the hank roving, we will get the pounds produced by one spindle.

A production constant of this kind, based on the conditions as actually present on the machines, would be useful in determining the theoretical production on any number of frames, for any size roving and give, at a glance, the amount of roving to be expected from any given number of spindles.

In getting the average number of roving or yarn that is being produced on a set of frames, we have to base the figures on the total length turned out and the total pounds produced. The rule is:

Divide the total hanks produced by the total pounds produced.

Example: A card room has 20 fine fly frames of 160 spindles each; 6 frames on 3 H. R., the clock readings average 9.5 hanks per day; 4 frames on 3.50 H. R., the clock readings average 9 hanks per day; 7 frames on 4.5 H. R., the clock readings average 8.25 hanks per day; 3 frames on 5.5 H. R., the clock readings average 7.6 hanks per day. What is the average H. R. being run?

$6 \times 160 \times 9.5 = 9,120$ hanks.	$9,120 \div 3 = 3,040$ lbs.
$4 \times 160 \times 9 = 5,760$ hanks.	$5,760 \div 3.5 = 1,646$ lbs.
$7 \times 160 \times 8.25 = 9,240$ hanks.	$9,240 \div 4.5 = 2,059$ lbs.
$3 \times 160 \times 7.6 = 3,648$ hanks.	$3,648 \div 5.5 = 663$ lbs.

Total hanks = 27,768

Total pounds = 7,402

Then: $27,768 \div 7,402 = 3.75$ average H. R. being run.

The following table of production constants, based on the speed of the spindles, are worked out for a range of speeds, based on a 10 hour day and no allowance made for loss of time. Any production figured with their use will be theoretical production and it can be used as a comparison with what is actually obtained from the machines.

Rule:

$$\frac{\text{Production Constant}}{\text{Twist} \times \text{counts}} = \text{lbs. per spindle.}$$

Production constant for intermediate speeds, not shown in the table, can be gotten by proportion or by multiplying .0198 by the speed of the spindles.

Example: What would be the production constant on a speeder that has a spindle speed of 1,187 R. P. M.?

$$1187 \times .0198 = 23.50 \text{ production constant.}$$

SPINDLE SPEED	PRODUCTION CONSTANT
650	12.87
700	13.86
750	14.85
800	15.84
850	16.83
900	17.82
950	18.81
1,000	19.80
1,050	20.79
1,100	21.78
1,150	22.77
1,200	23.76
1,250	24.75
1,300	25.74

The production of a fly frame is often based on the speed of the front roll. As the front roll on all frames are not the same size, the following constants were worked out to suit the different sizes of rolls that may be used. They are based on a 10 hour day and no allowance made for loss of time.

Rule:

$$\frac{\text{Production Constant} \times \text{R. P. M. of front roll}}{\text{Counts}} = \text{lbs. per spindle.}$$

- .078 for 1¼" roll.
- .074 for 1 3/16" roll.
- .070 for 1 1/8" roll.
- .066 for 1 1/16" roll.

PRODUCTION OF FLY FRAMES

Number of Roving	Grains per Yard	Twist per Inch	Pounds per Day per Spindle								
			Slubber			Intermediate		Roving		Jack	
			10 in. Space	9 in. Space	9 in. Space	6½ in. Space	6 in. Space	5¼ in. Space	4½ in. Space	4¼ in. Space	
.20	41.67	.54	58.71								
.30	27.78	.66	41.60	39.09							
.40	20.83	.76	31.19	30.69	29.36						
.50	16.67	.85	24.03	24.29	23.99						
.60	13.89	.93	19.32	20.05	19.95						
.70	11.90	1.00	15.75	16.60	16.92						
.80	10.42	1.07	13.25	14.13	14.46						
.90	9.26	1.14	11.24	12.04	12.36	13.92					
1.00	8.33	1.20	9.83	10.64	10.97	12.33	12.88				
1.10	7.57	1.26	10.48	9.75	11.15	11.75				
1.20	6.94	1.31	8.70	10.16	10.65				
1.30	6.41	1.37	9.03	9.50				
1.40	5.95	1.42	8.21	8.75				
1.50	5.55	1.47	7.52	8.15				
1.60	5.20	1.52	6.89	7.64				
1.70	4.90	1.56	5.91	7.19				
2.00	4.16	1.70	5.63	5.87			
2.25	3.70	1.80	4.94	5.21			
2.50	3.33	1.89	4.21	4.45			
2.75	3.03	1.98	3.72	3.86			
3.00	2.77	2.08	3.32	3.54	3.57		
3.50	2.38	2.24	2.93	3.06		
4.00	2.08	2.40	2.39	2.45		
4.50	1.85	2.54	2.07	2.13		
5.00	1.67	2.68	1.75	1.83		
5.50	1.51	2.81	1.54	1.67		
6.00	1.38	2.94	1.37	1.43		
7.00	1.19	3.17	1.15		
8.00	1.04	3.39965		
9.00	.92	3.60787		
10.00	.83	3.79675	.822	
11.00	.76	3.98614	.747	
12.00	.69	4.16622	
14.00	.59	4.49497	
16.00	.52	4.80410	
18.00	.46	5.09355	
20.00	.42	5.37297	
22.00	.38	5.63262	
24.00	.35	5.88233	
26.00	.32	6.12206	
Rev. of Pulley per Minute,			344	391	392	490	441	423	456	556	
Rev. of Flyer per Minute.			660	750	800	1000	1150	1300	1400	1700	
Size of Full Bobbin,			12 in.	11 in.	10 in.	9 in.	8 in.	7 in.	6 in.	5 in.	
Cotton on Full Bobbin,			x	x	x	x	x	x	x	x	
			6½ in.	5¾ in.	5½ in.	4⅝ in.	4¼ in.	3¾ in.	3¼ in.	2½ in.	
			46 oz.	33 oz.	27 oz.	21 oz.	16 oz.	10½ oz.	7½ oz.	4 oz.	

CHAPTER VIII.

SPINNING—DRAFT—TWIST—SPEED—PRODUCTION—ROLL SETTING—AVERAGE NUMBER.

SPINNING FRAMES.

The object of the spinning process is to convert one or two strands of roving, by reducing its size and adding a certain amount of twist, into a smooth, strong yarn and putting it on a bobbin or quill of suitable size for use on the machines following. The reduction in size is accomplished by the action of three lines of steel fluted drawing rolls with leather covered top rolls and the twisting and winding is accomplished by the revolutions of the spindle and traveler.

The amount of draft used varies greatly, depending upon the requirements of the case and the ideas of different individuals. The average draft used can be stated as being eight when using single roving and ten when using double roving. These figures are neither too high nor too low and will, under most conditions, produce good, even drawing and give a smooth, strong yarn.

The amount of twist put into the yarn depends upon its size and the purposes for which it is intended. Warp yarn, on account of the strength desired, requires more twist than filling. The twist is based on the square root of the number or counts of the yarn in all cases. The different multiples or multipliers used depend upon the requirements of the different yarns. The following are the usual multipliers used:

Warp yarn, 4.75.

Filling yarn, 3.25.

Doubling yarn, 2.75.

Hosiery yarn, 2.50.

The rule for determining the amount of twist is:

Square root of the counts \times *twist multiplier* = *twist per inch.*

Following this rule, the twist required for 36's warp yarn would be: $\sqrt{36} \times 4.75 = 28.50$ turns per inch.

For 36's filling, the twist is: $\sqrt{36} \times 3.25 = 19.50$ turns per inch.

The winding of the yarn on the bobbin is accomplished by the drag of the traveler as it is being carried around the ring by the yarn, the speed of the traveler depending upon the delivery of the front roll, the speed of the spindle and the size of the bobbin, its speed decreasing as the bobbin increases in size.

The production of the frame depends upon the spindle speed, the twist in the yarn and the amount of time consumed by doffing, oiling, etc., and should be 90 per cent, and over, under most conditions. The coarser the yarn, the more doffing required and the greater the amount of time lost.

The draft gearing of the majority of spinning frames is so alike in arrangement that one diagram will be sufficient for our purposes. The gearing is placed at either the head end or foot end of the frame, the head end gearing being the best arrangement as it relieves the tin drum of the strain of transmitting the power necessary to drive the rolls and the traverse motion. Fig. 41 gives a diagram of the draft gearing of a spinning frame built by the Fales and Jenks Machine Co., Pawtucket, R. I. The front

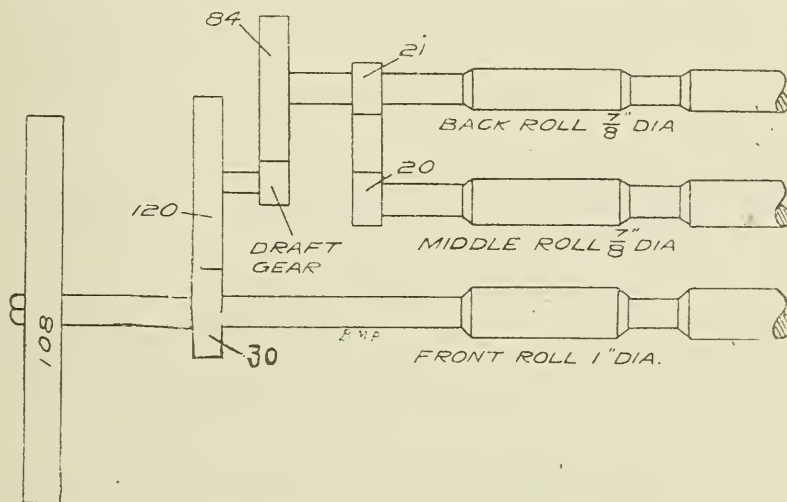

FIG. 41. DRAFT GEARING OF FALES & JENKS SPINNING FRAME.

roll is 1 inch in diameter and the middle and back rolls are $\frac{7}{8}$ inch in diameter. The large gear of 108 teeth on the end of the front roll is part of the twist gearing, being driven from the cylinder shaft. The front roll gear of 30 teeth drives the crown gear of 120 teeth. On the stud with the crown gear is the draft change gear which drives the 84 tooth gear on the back roll. This gives a draft constant of:

$$\frac{8 \times 120 \times 84}{30 \times X \times 7} = 384.$$

Constant \div *draft* = *gear*.

Constant \div *gear* = *draft*.

Then, with a 38 tooth draft gear on, we would have the following draft: $384 \div 38 = 10.1$ draft.

The draft between the middle and back rolls, or back draft, is small, being usually about 1.05, as in the above diagram.

The total draft divided by the back draft gives the front draft: $10.1 \div 1.05 = 9.619$ front draft.

For small changes in the size of the yarn the proper draft gear can be found by calculations similar to the ones given on the fly frames.

Example: A spinning frame is making 36's yarn with a 33 tooth draft gear on, what size draft gear will be needed to give 32's yarn?

Rule: *Gear on frame* \times *counts on frame* \div *counts wanted* = *gear needed*.

Then: $33 \times 36 \div 32 = 42.7$ or 43 tooth draft gear needed.

In changing the draft gear from the weight of the yarn, the following rule holds good:

Gear on the frame \times *weight wanted* \div *weight on the frame* = *gear needed*.

Example: A frame with a 40 tooth draft gear is delivering yarn that weighs 54 grains per 120 yards, what size gear will be needed to change the weight to 50 grains?

$40 \times 50 \div 54 = 37$ tooth gear needed.

In changing the draft gear from the draft of the machine, the following rule is correct:

Gear on frame \times *draft on frame* \div *draft desired* = *draft gear needed*.

Example: If a draft gear of 38 teeth gives a draft of 10, what size gear will be needed to give a draft of 10.75?

$38 \times 10 \div 10.75 = 35.3$ or 35 tooth gear.

In figuring the actual draft from the weight of material back and front, the following rule holds true:

Weight on back \times *doublings* = *weight on front* = *actual draft*.

In figuring from the counts or size, use the following rule:

Counts on front \times *doublings* \div *hanks on back* = *actual draft*.

In dealing with draft on the spinning frames a peculiar fact presents itself, that is, the actual draft, as figured from the weight of roving and yarn, is less than the figured draft, as obtained from the gearing. This is explained by the fact that while the yarn is being twisted, it contracts in length and this contraction increases its weight, hence, the roving has to be drafted an additional amount to overcome this heavying up while twisting. Thus,

if a frame is spinning 30's yarn from 6 H. R. doubled, the actual draft is: $30 \times 2 \div 6 = 10$. Now, if we calculate the draft from the gearing, we will find it to be about 10.3, or an increase of about 3 per cent., which is the amount of yarn contraction due to twisting. So then, any calculation for draft, made from the weight or size of the yarn, must have the result increased about 3 per cent. in order to get the correct figured draft, or size of draft gear necessary to put on the frame. If the draft is figured

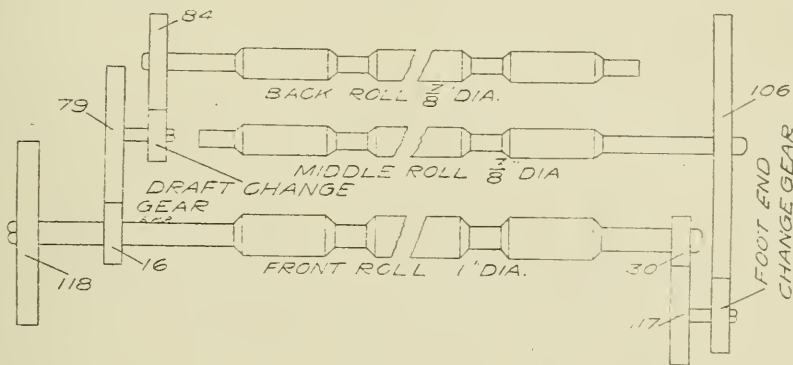

FIG. 42. GEARING OF DRAWING ROLLS ON SACO-PETTEE SPINNING FRAMES.

from the weight of the material, the easiest way of allowing for this contraction is to deduct it from the weight of the finished yarn on the front, getting, what we may term, the weight of the yarn before twisting, as follows:

30's yarn weighs .2778 grs. per yard. Then: $.2778 \div 1.03 = .2697$ grs. before twisting. 6 H. R. weighs 1,388 grs. per yard.

$$\text{Then: } \frac{2 \times 1,388}{.2697} = 10.29 \text{ draft.}$$

Fig. 42 shows a diagram of the draft gearing of the Saco-Petree spinning frame, the only case in which the draft gearing is not arranged as shown in Fig. 41. The front roll drives the back roll by a train of gearing similar to the one shown in Fig. 41, but, instead of the back roll driving the middle roll, the middle roll is driven from the front roll by a train of gearing similar to the one driving the back roll, being located at the opposite end of the frame. This calls for the use of two change gears and necessitates two calculations to get the correct gears to use.

The draft constant for the total draft is figured as follows:

$$\frac{8 \times 79 \times 84}{16 \times X \times 7} = 474 \text{ constant for total draft.}$$

Constant \div *draft* = *gear*.

Constant \div *gear* = *draft*.

By following the gearing at the other end, we find the constant for the draft between the front and middle rolls, or front draft, to be:

$$\frac{8 \times 117 \times 106}{30 \times X \times 7} = 472.46 \text{ constant for front draft.}$$

Rule: *Constant* \div *change gear on foot end* = *draft between front and middle rolls*.

If we take the total draft and divide it by 1.05, the amount of draft desired between the middle and back rolls, we get the front draft. Divide the constant for front draft by the draft wanted and we get the proper change gear to use at this point.

Example: With above gearing, what draft gears would be necessary to give a draft of 10.3? Head end draft gear figured as follows: $474 \div 10.3 = 46$ tooth draft gear.

Foot end change gear figured as follows: $10.3 \div 1.05 = 9.8$ front draft. $472.46 \div 9.8 = 48$ tooth foot end change gear.

In the above arrangement, any change made in the total draft, affects the back draft and the break draft is the one occurring between the middle and back rolls.

There is no absolute necessity of making the calculation for the foot end change gear, as its size can be determined from the size of the draft gear, if we remember that it is one tooth larger than the draft gear when that gear has 45 teeth or less and two teeth larger when the draft gear has more than 45 teeth.

TWIST GEARING.

The twist is considered as the ratio between the delivery of the front roll and the spindle speed. Fig. 43 shows the arrangement of the twist gearing of the spinning frame. On the tin cylinder or drum is a 30 tooth gear, called the drum or cylinder gear, which drives the 90 tooth jack or stud gear. On the stud with the jack gear is the twist gear which drives to the front roll gear of 118 teeth, using one intermediate in one drive and two in the other, thus giving both drawing rolls motion in opposite directions. The cylinder is 7 inches in diameter and the whorl of the spindle is $\frac{7}{8}$ inch in diameter. As the ratio between the diameters of the cylinder and whorl is not the ratio between their speeds, we cannot use the two diameters, but have to use a ratio which is supposed to represent the number of revolutions the spindle makes for every one of the cylinder under working con-

ditions. This ratio is given as 7.25 for the two diameters used above and is figured so as to make necessary allowance for band slippage, etc.

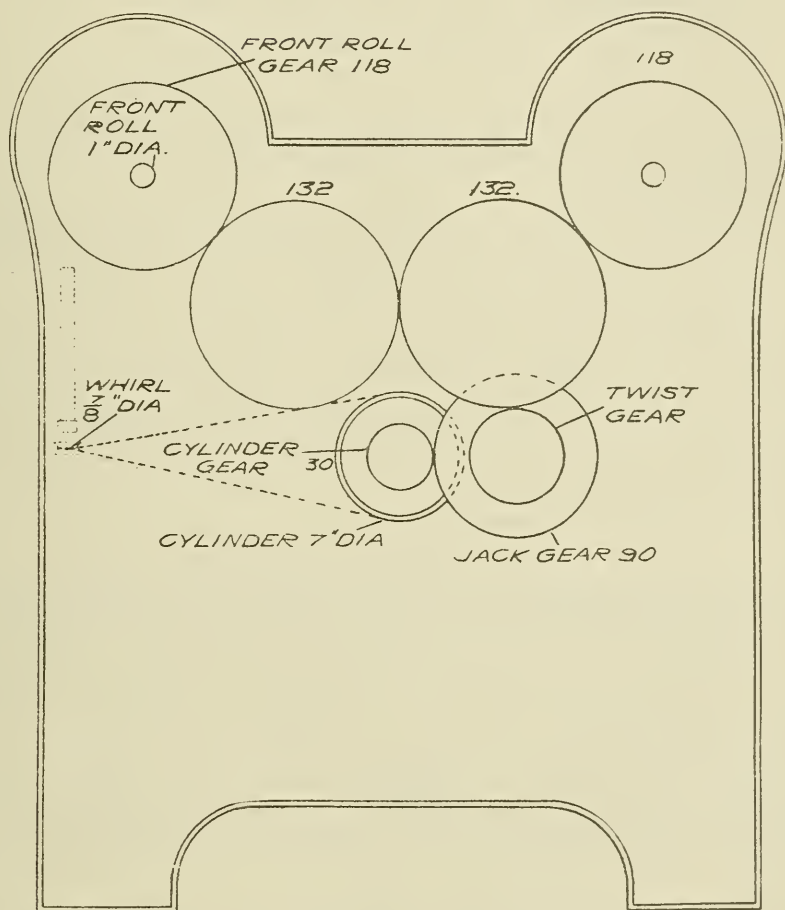

FIG. 43. GEARING END OF A SPINNING FRAME SHOWING ARRANGEMENT OF TWIST GEARING.

The front roll is 1 inch in diameter or 3.1416 inches in circumference and the twist constant is found as follows, the calculation being similar to that used on the fly frames:

$$\frac{118 \times 90 \times 7.25}{3.1416 \times X \times 30} = 817.36 \text{ twist constant.}$$

Putting this in the form of a rule we get the following:

$$\frac{\text{Front roll gear} \times \text{jack gear} \times \text{ratio}}{3.1416 \times X \times \text{drum gear.}} = \text{twist constant.}$$

Constant \div *gear* = *twist*.

Constant \div *twist* = *gear*.

Example: With a frame geared as above, what size twist gear would be required to run 25's warp yarn?

$\sqrt{25} = 5$; $5 \times 4.75 = 23.75$ turns of twist:

Then: $817.36 \div 23.75 = 34.4$ or 34 tooth gear required.

By using different combinations of jack and cylinder gears and different size front roll gears almost any range of twist desired can be obtained.

In figuring the twist gear when changing the size of the yarn, the following rules will be found useful and convenient:

Gear on the frame \times *twist in the yarn* \div *twist wanted* = *twist gear needed*.

Example: A frame is putting in 32 turns of twist with a 40 tooth twist gear on, what size gear will be needed to reduce the twist to 24 turns?

$$\frac{32 \times 40}{24} = 53 \text{ tooth gear needed.}$$

By using the square root of the yarn, the proper twist gear can be determined, without knowing the amounts of twist, by the following rule:

$\sqrt{\text{Counts on frames}} \times \text{gear on frame} \div \sqrt{\text{counts wanted}} = \text{twist gear needed}$.

Example: A frame is running 28's warp with a 40 tooth twist gear on, what size gear will be needed to run 32's warp?

$$\sqrt{28} = 5.29. \quad \sqrt{32} = 5.66.$$

$$\frac{5.29 \times 40}{5.66} = 37.3 \text{ or } 37 \text{ tooth gear needed.}$$

Although the universal custom is to consider the speed of the spindle as the basis for determining the amount of twist put in the yarn, the statement that every revolution of the spindle puts in one turn of twist is not correct and the ratio between the spindle speed and the front roll delivery is not the exact twist. The amount of twist actually put into the yarn depends upon the speed of the traveler, as the revolving of the traveler around the ring produces the turning or twisting of the yarn on its own axis. The traveler speed depends upon the spindle speed, the size of the bobbin and the front roll delivery, being greatest when the bobbin is full. In other words, the traveler lags behind the spindle enough revolutions to cause the bobbin to wind up the yarn delivered by the front roll. Suppose the front roll to make 120 R.

P. M., the spindle speed to be 9,500 R. P. M., and the diameter of the bobbin to be $\frac{7}{8}$ inch. Now, while the bobbin and spindle go at the same speed, the traveler lags behind. The front roll delivers: $120 \times 3.1416 = 376.99$ inches of yarn per minute. Allowing for the 3 per cent. contraction in twisting, then the length of yarn actually delivered to and wound on the bobbin is: $376.99 \times .97 = 365.68$ inches.

The bobbin is $\frac{7}{8}$ inch in diameter or 2.75 inches in circumference, then, for every revolution that the traveler lags behind, the bobbin will wind on 2.75 inches of yarn and, to wind on the total delivery of the front roll, the traveler will have to lag behind: $365.68 \div 2.75 = 133$ revolutions.

Then, $9,500 - 133 = 9,367$ R. P. M. as the speed of the traveler. Divide the traveler speed by the front roll delivery and we get the actual amount of twist that is being put into the yarn, as follows:

$$9367 \div 365.68 = 25.61 \text{ turns per inch.}$$

If the twist is based on the spindle speed, it works out as follows:

$$9500 \div 365.68 = 25.97 \text{ turns per inch.}$$

This shows very little variation from the correct conditions and is not of enough importance to be considered. Ordinarily the twist calculation is based on the front roll surface speed and the spindle speed, no allowances for yarn contraction or the lag of the traveler being taken into consideration and the result is accurate enough for every purpose. In the above case, the spindle speed divided by the surface speed or delivery of the front roll, will give 25.19 turns of twist per inch, not enough variation to be noticed.

Although, on most frames, there is a traverse gear, which regulates the speed of the ring rail and is changed when making wide variations in the size of the yarn, there is no calculation necessary to determine its size, it being simply a matter of judgment based upon the way the yarn lays on the empty bobbin.

PRODUCTION.

As on the fly frame, the production of a spinning frame can be figured from the spindle or front roll speed. Either will give good results.

Example: What is the production of a frame of 256 spindles on 28's yarn, warp twist, if the spindle speed is 9,500 R. P. M., allowing a loss of time of 10 per cent.: $\sqrt{28} \times 4.75 = 25.13$ turns of twist.

$$\frac{9500 \times 600 \times 256 \times .90}{25.13 \times 36 \times 28 \times 840} = 61.72 \text{ lbs. per day.}$$

The above calculation can be made for one spindle, by leaving out the 256, and this result multiplied by the number of spindles will give the total production.

The finer the yarn run, the fewer times the frame is doffed and the less the loss of time, so, in coarse yarns we can look for less production, as compared with the theoretical production, than when running the finer numbers of yarn.

A production constant can be worked out, from the data given in the above example, based on one spindle and no allowance for loss of time, as follows:

$$\frac{9500 \times 600}{36 \times 840} = 188.5 \text{ production constant.}$$

The above constant is worked out for full time and a spindle speed of 9,500 R. P. M., for a 10 hour day and is applicable under no other conditions. However one can be worked out for any spindle speed and length of day and, unless the loss of time, due to doffing, etc., is allowed for, will give the theoretical production, or the amount that would be produced in that time if the frame was run continually with no stops.

Rule for using constant:

Constant \div *Twist per inch* \times *counts of yarn* = *lbs. per spindle.*

By multiplying the spindle speed by .0198 the production constant for any spindle speed can be gotten for full time.

Example: What would be the production constant for full time if the spindle speed was 8,600 R. P. M.?

$$8,600 \times .0198 = 170.28 \text{ production constant.}$$

If it is desired to figure the production from the front roll, it can be done by using the following formula, the 1 inch front roll being 3.1416 inches in circumference?

$$\frac{3.1416 \times R. P. M. \text{ of front roll} \times \text{minutes run.}}{36 \times \text{Counts} \times 840} = \text{lbs. per spindle.}$$

The production constant of .0623, is based on a 10 hour day and no allowance for loss of time.

Rule:

$$\frac{\text{Production constant} \times R. P. M. \text{ of front roll}}{\text{Counts of yarn}} = \text{lbs. per spindle.}$$

ROLL SETTING.

As a general rule the rolls of a spinning frame can be set closer than those on a fly frame, but no fixed rule can be given and the final decision must rest upon the appearance of the stock as it leaves the rolls. A great deal depends upon the condition of the stock, the feel of the fibers, the draft and speed of the rolls.

Distance between front and middle rolls should be 1/16 to 1/8 inch greater than the length of the staple used.

Between middle and back rolls, 1/8 to 1/4 inch.

AVERAGE NUMBER.

In a spinning room or mill, where several sizes of yarn are being run, it is often desired to know what is the average counts turned out. Although it is figured by several methods, there is only one that will give the correct results and it is based on the pounds produced. Any calculation based on any other basis is wrong. The following rule and example will illustrate and explain the method:

Rule: Divide the total hanks spun by the total pounds spun. Answer will be the average number of yarn spun.

Example: A mill produces 2,500 lbs. of 30's, 3,000 lbs. of 36's, 5,000 lbs. of 40's, 8,000 lbs. of 50's and 2,000 lbs. of 60's in one week, what is the average number run?

2,500 × 30 =	75,000 hanks of 30's
3,000 × 36 =	108,000 hanks of 36's
5,000 × 40 =	200,000 hanks of 40's
8,000 × 50 =	400,000 hanks of 50's
2,000 × 60 =	120,000 hanks of 60's
20,500	903,000

By applying the above rule:

$$903,000 \div 20,500 = 44.05 \text{ average number.}$$

TABLE FOR NUMBERING YARN BY GRAINS

Number of Yarn	Grains per Hank	Number of Yarn	Grains per Hank	Number of Yarn	Grains per Hank	Number of Yarn	Grains per Hank	Number of Yarn	Grains per Hank	Number of Yarn	Grains per Hank
9	777.77	20 $\frac{1}{4}$	344.44	31 $\frac{1}{4}$	224.08	42 $\frac{1}{4}$	165.68	53 $\frac{1}{4}$	131.45	77	90.90
9 $\frac{1}{4}$	756.75	20 $\frac{1}{2}$	341.46	31 $\frac{1}{2}$	222.22	42 $\frac{1}{2}$	164.70	53 $\frac{1}{2}$	130.84	78	89.70
9 $\frac{1}{2}$	736.84	20 $\frac{3}{4}$	337.34	31 $\frac{3}{4}$	220.47	42 $\frac{3}{4}$	163.74	53 $\frac{3}{4}$	130.23	79	88.60
9 $\frac{3}{4}$	720.51	21	333.33	32	218.75	43	162.79	54	129.62	80	87.50
10	700.00	21 $\frac{1}{4}$	329.41	32 $\frac{1}{4}$	217.05	43 $\frac{1}{4}$	161.84	54 $\frac{1}{4}$	129.03	81	86.40
10 $\frac{1}{4}$	682.92	21 $\frac{1}{2}$	325.58	32 $\frac{1}{2}$	215.38	43 $\frac{1}{2}$	160.91	54 $\frac{1}{2}$	128.44	82	85.40
10 $\frac{1}{2}$	666.66	21 $\frac{3}{4}$	321.83	32 $\frac{3}{4}$	213.74	43 $\frac{3}{4}$	160.00	54 $\frac{3}{4}$	127.85	83	84.30
10 $\frac{3}{4}$	651.16	22	318.18	33	212.12	44	159.09	55	127.27	84	83.30
11	636.36	22 $\frac{1}{4}$	314.60	33 $\frac{1}{4}$	210.52	44 $\frac{1}{4}$	158.19	55 $\frac{1}{4}$	126.69	85	82.40
11 $\frac{1}{4}$	622.22	22 $\frac{1}{2}$	311.11	33 $\frac{1}{2}$	208.95	44 $\frac{1}{2}$	157.41	55 $\frac{1}{2}$	126.12	86	81.40
11 $\frac{1}{2}$	608.69	22 $\frac{3}{4}$	307.69	33 $\frac{3}{4}$	207.40	44 $\frac{3}{4}$	156.42	55 $\frac{3}{4}$	125.56	87	80.40
11 $\frac{3}{4}$	595.74	23	304.34	34	205.88	45	155.55	56	125.00	88	79.50
12	583.33	23 $\frac{1}{4}$	301.07	34 $\frac{1}{4}$	204.30	45 $\frac{1}{4}$	154.69	56 $\frac{1}{4}$	124.49	89	78.60
12 $\frac{1}{4}$	571.42	23 $\frac{1}{2}$	297.87	34 $\frac{1}{2}$	202.89	45 $\frac{1}{2}$	153.84	56 $\frac{1}{2}$	123.89	90	77.80
12 $\frac{1}{2}$	560.00	23 $\frac{3}{4}$	294.73	34 $\frac{3}{4}$	201.43	45 $\frac{3}{4}$	152.95	56 $\frac{3}{4}$	123.34	91	76.90
12 $\frac{3}{4}$	549.01	24	291.66	35	200.00	46	152.17	57	122.80	92	76.10
13	546.15	24 $\frac{1}{4}$	288.65	35 $\frac{1}{4}$	198.58	46 $\frac{1}{4}$	151.30	57 $\frac{1}{4}$	122.27	93	75.30
13 $\frac{1}{4}$	526.11	24 $\frac{1}{2}$	285.71	35 $\frac{1}{2}$	197.32	46 $\frac{1}{2}$	150.53	57 $\frac{1}{2}$	121.73	94	74.50
13 $\frac{1}{2}$	518.51	24 $\frac{3}{4}$	282.82	35 $\frac{3}{4}$	195.80	46 $\frac{3}{4}$	149.73	57 $\frac{3}{4}$	121.21	95	73.70
13 $\frac{3}{4}$	509.09	25	280.00	36	194.44	47	148.93	58	120.68	96	72.90
14	500.00	25 $\frac{1}{4}$	277.22	36 $\frac{1}{4}$	193.10	47 $\frac{1}{4}$	148.14	58 $\frac{1}{4}$	120.17	97	72.30
14 $\frac{1}{4}$	491.22	25 $\frac{1}{2}$	274.50	36 $\frac{1}{2}$	191.78	47 $\frac{1}{2}$	147.34	58 $\frac{1}{2}$	119.65	98	71.40
14 $\frac{1}{2}$	482.75	25 $\frac{3}{4}$	271.84	36 $\frac{3}{4}$	190.47	47 $\frac{3}{4}$	146.59	58 $\frac{3}{4}$	119.14	99	70.70
14 $\frac{3}{4}$	474.57	26	269.23	37	189.18	48	145.83	59	118.47	100	70.00
15	466.66	26 $\frac{1}{4}$	266.66	37 $\frac{1}{4}$	187.91	48 $\frac{1}{4}$	145.07	59 $\frac{1}{4}$	118.14	105	66.70
15 $\frac{1}{4}$	459.01	26 $\frac{1}{2}$	264.15	37 $\frac{1}{2}$	186.66	48 $\frac{1}{2}$	144.32	59 $\frac{1}{2}$	117.64	110	63.60
15 $\frac{1}{2}$	451.61	26 $\frac{3}{4}$	261.68	37 $\frac{3}{4}$	185.42	48 $\frac{3}{4}$	143.58	59 $\frac{3}{4}$	117.15	115	60.90
15 $\frac{3}{4}$	444.44	27	259.25	38	184.21	49	142.85	60	116.66	120	58.30
16	437.50	27 $\frac{1}{4}$	256.88	38 $\frac{1}{4}$	183.00	49 $\frac{1}{4}$	142.13	61	114.80	125	56.00
16 $\frac{1}{4}$	430.76	27 $\frac{1}{2}$	254.54	38 $\frac{1}{2}$	181.81	49 $\frac{1}{2}$	141.41	62	112.90	130	53.80
16 $\frac{1}{2}$	424.24	27 $\frac{3}{4}$	252.52	38 $\frac{3}{4}$	180.63	49 $\frac{3}{4}$	140.70	63	111.10	135	51.80
16 $\frac{3}{4}$	417.91	28	250.00	39	179.48	50	140.00	64	109.30	140	50.00
17	411.76	28 $\frac{1}{4}$	247.78	39 $\frac{1}{4}$	178.34	50 $\frac{1}{4}$	139.30	65	107.70	145	48.30
17 $\frac{1}{4}$	405.79	28 $\frac{1}{2}$	245.61	39 $\frac{1}{2}$	177.21	50 $\frac{1}{2}$	138.61	66	106.10	150	46.70
17 $\frac{1}{2}$	400.00	28 $\frac{3}{4}$	243.46	39 $\frac{3}{4}$	176.10	50 $\frac{3}{4}$	137.93	67	104.40	155	45.20
17 $\frac{3}{4}$	394.36	29	241.37	40	175.00	51	137.29	68	102.90	160	43.80
18	388.88	29 $\frac{1}{4}$	239.31	40 $\frac{1}{4}$	173.91	51 $\frac{1}{4}$	136.58	69	101.40	165	42.40
18 $\frac{1}{4}$	383.56	29 $\frac{1}{2}$	237.28	40 $\frac{1}{2}$	172.83	51 $\frac{1}{2}$	135.92	70	100.00	170	41.20
18 $\frac{1}{2}$	378.37	29 $\frac{3}{4}$	235.29	40 $\frac{3}{4}$	171.77	51 $\frac{3}{4}$	135.26	71	98.60	175	40.00
18 $\frac{3}{4}$	373.33	30	233.33	41	170.73	52	134.61	72	97.20	180	38.90
19	368.42	30 $\frac{1}{4}$	231.40	41 $\frac{1}{4}$	169.69	52 $\frac{1}{4}$	133.97	73	95.90	185	37.80
19 $\frac{1}{4}$	363.63	30 $\frac{1}{2}$	229.50	41 $\frac{1}{2}$	168.67	52 $\frac{1}{2}$	133.33	74	94.60	190	36.80
19 $\frac{1}{2}$	358.97	30 $\frac{3}{4}$	227.64	41 $\frac{3}{4}$	167.66	52 $\frac{3}{4}$	132.70	75	93.30	195	35.90
19 $\frac{3}{4}$	354.43	31	225.80	42	166.66	53	132.07	76	92.10	200	35.00
20	350.00										

TWIST TABLE

Number of Yarn	Square Root	Extra Warp Twist	Warp Twist	Whitman's Warp Twist	Extra Mule Twist	Mule Warp Twist	Filling Twist	Doubling Twist	Hosiery Twist
1	1.0000	5.00	4.75	4.50	4.00	3.75	3.25	2.75	2.50
2	1.4142	7.07	6.72	6.36	5.66	5.30	4.60	3.89	3.54
3	1.7321	8.66	8.23	7.79	6.93	6.50	5.63	4.76	4.33
4	2.0000	10.00	9.50	9.00	8.00	7.50	6.50	5.50	5.00
5	2.2361	11.18	10.62	10.06	8.94	8.39	7.27	6.15	5.59
6	2.4495	12.25	11.64	11.02	9.80	9.19	7.96	6.74	6.12
7	2.6458	13.23	12.57	11.91	10.58	9.92	8.60	7.28	6.61
8	2.8284	14.14	13.43	12.73	11.31	10.61	9.19	7.78	7.07
9	3.0000	15.00	14.25	13.50	12.00	11.25	9.75	8.25	7.50
10	3.1623	15.81	15.02	14.30	12.65	11.86	10.28	8.70	7.91
11	3.3166	16.58	15.75	14.92	13.27	12.44	10.78	9.12	8.29
12	3.4641	17.32	16.45	15.59	13.86	12.99	11.26	9.53	8.66
13	3.6056	18.03	17.13	16.23	14.42	13.52	11.72	9.92	9.01
14	3.7417	18.71	17.77	16.84	14.97	14.03	12.16	10.29	9.35
15	3.8730	19.36	18.40	17.43	15.49	14.52	12.59	10.65	9.68
16	4.0000	20.00	19.00	18.00	16.00	15.00	13.00	11.00	10.00
17	4.1231	20.62	19.58	18.55	16.49	15.46	13.40	11.34	10.31
18	4.2426	21.21	20.15	19.09	16.97	15.91	13.79	11.67	10.61
19	4.3589	21.79	20.70	19.61	17.44	16.35	14.17	11.99	10.90
20	4.4721	22.36	21.24	20.12	17.89	16.77	14.53	12.30	11.18
21	4.5826	22.91	21.77	20.62	18.33	17.18	14.89	12.60	
22	4.6904	23.45	22.28	21.11	18.76	17.59	15.24	12.90	
23	4.7958	23.98	22.78	21.58	19.18	17.98	15.59	13.19	
24	4.8990	24.49	23.27	22.05	19.60	18.37	15.92	13.47	
25	5.0000	25.00	23.75	22.50	20.00	18.75	16.25	13.75	
26	5.0990	25.50	24.22	22.95	20.40	19.12	16.57	14.02	
27	5.1962	25.98	24.68	23.38	20.78	19.49	16.89	14.29	
28	5.2915	26.46	25.13	23.81	21.17	19.84	17.20	14.55	
29	5.3852	26.93	25.58	24.23	21.54	20.19	17.50	14.81	
30	5.4772	27.39	26.02	24.65	21.91	20.54	17.80	15.06	
31	5.5678	27.84	26.45	25.04	22.27	20.88	18.10	15.31	
32	5.6569	28.28	26.87	25.46	22.63	21.21	18.38	15.56	
33	5.7446	28.72	27.29	25.85	22.98	21.54	18.67	15.80	
34	5.8310	29.15	27.70	26.24	23.32	21.87	18.95	16.03	
35	5.9161	29.58	28.10	26.62	23.66	22.19	19.23	16.27	
36	6.0000	30.00	28.50	27.00	24.00	22.50	19.50	16.50	
37	6.0828	30.41	28.89	27.37	24.33	22.81	19.77	16.73	
38	6.1644	30.82	29.28	27.74	24.66	23.12	20.03	16.95	
39	6.2450	31.22	29.66	28.10	24.98	23.42	20.30	17.17	
40	6.3246	31.62	30.04	28.46	25.30	23.72	20.55	17.39	
41	6.4031	32.02	30.41	28.81	25.61	24.01	20.81	17.61	
42	6.4807	32.40	30.78	29.16	25.92	24.30	21.06	17.82	
43	6.5574	32.79	31.15	29.51	26.23	24.59	21.31	18.03	
44	6.6332	33.17	31.51	29.85	26.53	24.87	21.56	18.24	
45	6.7082	33.54	31.86	30.19	26.83	25.16	21.80	18.45	

TWIST TABLE—Continued

Number of Yarn	Square Root	Warp Twist	Whitman's Warp Twist	Extra Mule Twist	Mule Warp Twist	Filling Twist	Doubling Twist
46	6.7823	32.21	30.52	27.13	25.43	22.04	18.65
47	6.8557	32.56	30.85	27.42	25.71	22.23	18.85
48	6.9282	32.91	31.18	27.71	25.98	22.52	19.05
49	7.0000	33.25	31.50	28.00	26.25	22.75	19.25
50	7.0711	33.59	31.82	28.28	26.52	22.98	19.45
51	7.1414	33.92	32.14	28.57	26.78	23.21	19.64
52	7.2111	34.25	32.45	28.84	27.04	23.44	19.83
53	7.2801	34.58	32.76	29.12	27.30	23.66	20.02
54	7.3485	34.90	33.07	29.39	27.56	23.88	20.21
55	7.4162	35.23	33.37	29.66	27.81	24.10	20.39
56	7.4833	35.55	33.67	29.93	28.06	24.32	20.58
57	7.5498	35.86	33.97	30.20	28.31	24.54	20.76
58	7.6158	36.17	34.27	30.46	28.56	24.75	20.94
59	7.6811	36.49	34.56	30.72	28.80	24.96	21.12
60	7.7460	36.79	34.86	30.98	29.05	25.17	21.30
61	7.8102	37.10	35.15	31.24	29.29	25.38	21.48
62	7.8740	37.40	35.43	31.50	29.53	25.59	21.65
63	7.9373	37.70	35.72	31.75	29.76	25.80	21.83
64	8.0000	38.00	36.00	32.00	30.00	26.00	22.00
65	8.0623	38.30	36.28	32.25	30.23	26.20	22.17
66	8.1240	38.59	36.56	32.50	30.47	26.40	22.34
67	8.1854	38.88	36.83	32.74	30.69	26.60	22.51
68	8.2462	39.17	37.11	32.98	30.92	26.80	22.68
69	8.3066	39.46	37.38	33.23	31.15	27.00	22.84
70	8.3666	39.74	37.65	33.47	31.37	27.19	23.01
71	8.4261	40.02	37.92	33.70	31.60	27.38	23.17
72	8.4853	40.30	38.18	33.94	31.82	27.58	23.23
73	8.5440	40.58	38.45	34.18	32.04	27.77	23.50
74	8.6023	40.86	38.71	34.41	32.26	27.96	23.66
75	8.6603	41.14	38.97	34.64	32.48	28.15	23.82
76	8.7178	41.41	39.23	34.87	32.69	28.33	23.97
77	8.7750	41.68	39.49	35.10	32.91	28.52	24.13
78	8.8318	41.95	39.74	35.33	33.12	28.70	24.29
79	8.8882	42.22	40.00	35.55	33.33	28.87	24.44
80	8.9443	42.48	40.25	35.78	33.54	29.07	24.60
82	9.0554	43.01	40.75	36.22	33.96	29.43	24.90
84	9.1652	43.53	41.24	36.66	34.37	29.79	25.20
86	9.2736	44.05	41.73	37.09	34.78	30.14	25.50
88	9.3808	44.56	42.21	37.52	35.18	30.49	25.80
90	9.4868	45.06	42.69	37.95	35.58	30.83	26.09
92	9.5917	45.56	43.16	38.37	35.97	31.17	26.38
94	9.6954	46.05	43.63	38.78	36.36	31.51	26.66
96	9.7980	46.54	44.09	39.19	36.74	31.84	26.94
98	9.8995	47.02	44.55	39.60	37.12	32.17	27.22
100	10.0000	47.50	45.00	40.00	37.50	32.50	27.50

SPINNING.

PRODUCTION TABLE OF RING FILLING YARN.
FRONT ROLL 1 INCH IN DIAMETER.

No. of Yarn.	Size of Spindle.	Gauge of frame.	Diameter of ring.	Length of traverse.	Twist per inch.	Revolutions of front roll per minute.	Revolutions of spindle per minute.	Hanks per spindle per day of 10 hours.	Pounds per spindle per week of 58 hours.	Pounds per spindle per week of 60 hours.	Pounds per spindle per week of 66 hours.				
4	Draper No. 2, for all Numbers.	2 3/4 for all Numbers.	1 1/2 to 1 5/8.	7 inches.	6.50	240	5000	10.00	14.40	14.88	16.37				
5					7.27	230	5400	10.00	11.50	11.95	13.15				
6					7.96	220	5600	9.85	9.53	9.86	10.84				
7					8.60	214	5800	9.85	8.13	8.40	9.24				
8					9.19	208	6000	9.75	7.07	7.31	8.04				
9					9.75	202	6200	9.65	6.24	6.46	7.10				
10									10.28	196	6400	9.60	5.56	5.76	6.33
11									10.78	190	6500	9.50	5.00	5.18	5.70
12									11.26	184	6600	9.40	4.54	4.70	5.17
13									11.72	180	6700	9.35	4.15	4.29	4.72
14					12.16	176	6800	9.25	3.82	3.95	4.35				
15					12.59	172	6900	9.15	3.53	3.65	4.02				
16					13.	168	7000	9.05	3.28	3.39	3.73				
17					13.40	166	7100	9.00	3.07	3.17	3.48				
18					13.79	162	7200	8.80	2.84	2.93	3.22				
19			6 1/2		14.17	158	7200	8.70	2.64	2.74	3.02				
20					14.53	156	7300	8.60	2.49	2.58	2.83				
21					14.89	154	7300	8.50	2.34	2.42	2.67				
22					15.24	152	7400	8.40	2.21	2.29	2.52				
23					15.59	150	7400	8.30	2.09	2.16	2.38				
24					15.92	148	7600	8.20	1.98	2.05	2.25				
25					16.25	146	7600	8.10	1.87	1.94	2.13				
26					17.84	144	8000	7.95	1.77	1.83	2.01				
27					18.19	142	8200	7.85	1.68	1.74	1.91				
28					18.52	140	8200	7.75	1.60	1.66	1.83				
29					18.84	138	8300	7.60	1.52	1.57	1.73				
30					19.17	136	8300	7.55	1.45	1.51	1.66				
31					20.88	134	8500	7.45	1.39	1.44	1.58				
32			1 3/8		21.21	132	8800	7.35	1.33	1.38	1.52				
33					21.54	130	8900	7.25	1.27	1.31	1.44				
34					21.87	128	8900	7.20	1.22	1.27	1.39				
35					22.19	126	8900	7.10	1.17	1.21	1.33				
36					22.50	124	8900	7.00	1.12	1.16	1.28				
37					22.81	122	8800	6.90	1.08	1.11	1.23				
38					23.12	120	8800	6.80	1.03	1.07	1.18				
39					23.42	118	8800	6.70	.99	1.03	1.13				
40					23.72	116	8800	6.65	.96	1.00	1.10				
41					24.01	114	8700	6.55	.92	.96	1.06				
42					24.30	112	8700	6.40	.88	.91	1.00				
43			5 1/2		24.59	110	8600	6.30	.84	.87	.96				
44					24.87	108	8600	6.20	.81	.84	.93				
45					25.16	106	8500	6.10	.78	.81	.89				
46					25.43	104	8500	6.	.75	.78	.86				
47					25.71	104	8500	6.	.74	.76	.84				
48					25.98	102	8400	5.90	.71	.73	.81				
49					26.25	102	8300	5.90	.69	.72	.79				
50			1 1/4		26.52	100	8200	5.80	.67	.69	.76				
55					27.00	96	8200	5.50	.58	.60	.66				
60					27.00	92	8000	5.30	.51	.53	.58				
65					27.00	88	7700	5.10	.45	.47	.52				
70					27.19	84	7400	4.90	.40	.42	.47				
75					28.15	82	7400	4.80	.37	.38	.42				
80			5		29.07	80	7400	4.60	.33	.34	.37				
85					29.96	78	7400	4.60	.31	.32	.35				
90					31.00	76	7400	4.40	.28	.29	.32				
95					31.68	74	7400	4.40	.26	.27	.30				
100					32.50	72	7400	4.30	.24	.25	.28				

SPINNING.

PRODUCTION TABLE OF RING WARP YARN.
FRONT ROLL 1 INCH IN DIAMETER.

No. of Yarn.	Size of Spindle.	Gauge of frame.	Diameter of ring.	Length of traverse.	Twist per inch.	Revolutions of front roll per minute.	Revolutions of spindle per minute.	Hanks per spindle per day of 10 hours.	Pounds per spindle per week of 58 hours.	Pounds per spindle per week of 60 hours.	Pounds per spindle per week of 66 hours.				
1	Draper No. 4.	3 inches.	2 1/4	7 or more	9.50	204	6200	10.50	15.22	15.75	17.32				
5					10.62	200	6800	10.40	12.06	13.72					
6					11.64	196	7300	10.30	9.95	11.33					
7					12.57	192	7700	10.20	8.45	9.61					
8					13.44	188	8100	10.10	7.32	8.33					
9					14.25	184	8400	10.00	6.44	7.33					
10					Draper No. 2.	2 1/4 inches.	1 3/4	6 1/2	15.02	180	8600	9.80	5.68	5.88	6.46
11									15.75	176	8800	9.60	5.06	5.23	
12									16.45	172	9000	9.40	4.54	4.70	
13	17.13	168	9000	9.20					4.10	4.24					
14	17.77	164	9000	9.00					3.72	3.85					
15	18.40	160	9300	8.80					3.40	3.52					
16	19.	156	9400	8.60					3.11	3.22					
17	19.58	152	9400	8.40					2.86	2.96					
18	20.15	148	9400	8.20					2.64	2.73					
19	20.71	144	9400	8.00					2.44	2.52					
20	Draper No. 2.	2 1/4 inches.	1 3/4	6 1/2	21.24	140	9400	7.80	2.26	2.34	2.57				
21					21.77	138	9400	7.70	2.12	2.20					
22					22.28	136	9500	7.60	2.00	2.07					
23					22.78	134	9500	7.50	1.89	1.95					
24					23.27	132	9600	7.40	1.78	1.85					
25					23.75	130	9600	7.30	1.69	1.75					
26					24.22	128	9700	7.20	1.60	1.66					
27					24.68	126	9700	7.10	1.52	1.57					
28					25.13	124	9700	7.00	1.45	1.50					
29					25.58	122	9800	6.90	1.38	1.42					
30	Draper No. 2.	2 1/4 inches.	1 3/4	6 1/2	26.02	120	9800	6.80	1.31	1.36	1.49				
31					26.45	120	9900	6.80	1.27	1.31					
32					26.87	118	10000	6.70	1.21	1.25					
33					27.29	118	10100	6.70	1.17	1.21					
34					27.70	116	10200	6.60	1.12	1.16					
35					28.10	116	10300	6.60	1.09	1.13					
36					28.17	114	10200	6.50	1.04	1.08					
37					28.24	114	10100	6.50	1.01	1.05					
38					28.31	112	10000	6.40	.97	1.01					
39					28.38	112	10000	6.40	.95	.98					
40	Draper No. 2.	2 1/4 inches.	1 1/2	6	28.46	110	10000	6.30	.91	.94	1.03				
41					28.81	110	10000	6.30	.89	.92					
42					29.16	108	10000	6.20	.85	.88					
43					29.50	108	10000	6.20	.83	.86					
44					29.65	106	10000	6.10	.80	.83					
45					30.19	106	10000	6.10	.78	.81					
46					30.51	104	10000	6.	.75	.78					
47					31.85	104	10000	6.	.74	.76					
48					31.18	102	10000	5.90	.71	.73					
49					31.50	102	10000	5.90	.69	.72					
50	Draper No. 2.	2 1/4 inches.	1 1/2	6	31.81	100	10000	5.80	.67	.69	.76				
55					33.37	96	10000	5.60	.59	.61					
60					34.86	92	10000	5.40	.52	.54					
65					36.28	88	10000	5.20	.46	.48					
70					37.65	84	10000	5.	.41	.42					
75					38.97	80	9800	4.80	.37	.38					
80					39.08	78	9600	4.70	.34	.35					
85					39.18	76	9400	4.60	.31	.32					
90					40.32	74	9400	4.50	.29	.30					
95					41.22	72	9400	4.35	.26	.27					
100					42.50	70	9400	4.20	.24	.25	.27				

TRAVELLER TABLE
For Whitin Ring Spinning Frames with Separators.

Warp Yarn					Filling Yarn				
Number of Yarn	Revolutions of Spindles	Diameter of Ring	Number of Traveller	Weight of 10 Travellers in grains	Number of Yarn	Revolutions of Spindles	Diameter of Ring	Number of Traveller	Weight of 10 Travellers in grains
4	4950	2"	14	39	4	4000	1½"	16	44
6	5900		12	33	6	4800		13	36
8	6700		9	23	8	5450		10	26
10	7250		8	20	10	5950		8	20
11	7500		7	18	11	6150		7	18
12	7750		6	16	12	6350		6	16
13	7950		6	16	13	6500		5	14
14	8100		5	14	14	6700		4	13
15	8300		4	13	15	6850		3	12
16	8450		3	12	16	6950		2	11
17	8600		2	11	17	7100		1	10
18	8750		1	10	18	7200		1-0	9
19	8850		1-0	9	19	7300		3-0	8
20	8900		2-0	8½	20	7400		5-0	7
21	9050		3-0	8	21	7500		5-0	
22	9100		4-0	7½	22	7600		6-0	6½
23	9150		5-0	7	23	7700		6-0	
24	9200		6-0	6½	24	7800		7-0	6
28	9500	1¾"	7-0	6	28	7900	1¾"	8-0	5½
32	9500		8-0	5½	32	7900		9-0	5
34	9600		9-0	5	34	7900		10-0	4½
36	9700		10-0	4½	36	7900		11-0	4
38	9800		11-0	4	38	7900		12-0	3¾
40	9700	1⅝"	12-0	3¾	40	7900	1¼"	13-0	3½
45	9700	1½"	13-0	3½	45	7900		14-0	3¼
50	9700		14-0	3¼	50	7900		15-0	3
55	9600		14-0		55	7900		15-0	
60	9600		15-0	3	60	7900		16-0	2¾
65	9600		15-0		65	7800		16-0	
70	9500		16-0	2¾	70	7800		17-0	2½
75	9500		16-0		75	7800		17-0	
80	9300		17-0	2½	80	7700		18-0	2¼
85	9100		17-0		85	7600		18-0	
90	9100	1⅜"	18-0	2¼	90	7400		19-0	2
95	9000		19-0	2	95	7400		20-0	1¾
100	8700		20-0	1¾	100	7200		21-0	1½
110	8500		21-0	1½	110	6900		22-0	1¼

USED BY PERMISSION OF WHITIN MACHINE WORKS

Sizes of Travelers will vary from the above table according to variations in speed, quality of cotton, etc., but the table may serve as a basis to select from. The higher the speed the lighter the traveler and vice versa, varying in proportion of one or two grades of travelers to each 1,000 revolutions of spindle. Without separators a few grades heavier traveler would be required.

CHAPTER IX.

TWISTING—COUNTS OF PLY YARNS—AMOUNT OF TWIST—TWIST CALCULATIONS AND CONSTANT—PRODUCTION CALCULATIONS AND CONSTANT.

Twisting is the process of combining two or more single threads into one by the simple act of twisting them together. The machine doing this is called a twister, being similar in general construction to the spinning frame. It does no drawing, the rolls being arranged to grip the yarn and feed it forward at a constant speed to the spindles, which put the twist in the yarn. The machines are built smaller and are run at a higher speed as the counts of the yarn twisted increase. They are also built to do wet or dry twisting, wet twisting, that is, passing the yarn through water just before it reaches the rolls, being used to give the yarn a smoother finish and less tendency to kink from the twist present. The use of either warp or filling wind is possible.

The yarn, after being twisted, is spoken of as "ply" yarn, the word "ply" signifying that there is more than one individual strand in the yarn. As the ply yarn may contain two, three or more strands in its make-up, it is usual to designate the number of such strands present, as two-ply or three-ply yarn. The most common is the two-ply or doubled yarn.

The counts of ply yarns are given as the counts of the single yarn of which it is composed, with a figure in front indicating the number of threads twisted together. If two single yarns of 40's counts are twisted together the resulting ply yarn would be called two forty's and expressed thus: 2/40's; the figure 2 indicating the number of strands in the completed yarn and 40 the size of the individual yarns. In calculations for the weight of goods, twist and production, we must consider the yarn as being 20's, as 2 strands of 40's yarn is the equivalent in weight of a single 20's. In the same way 3/30's means a 3-ply yarn composed of 3 strands of 30's yarn and is the equivalent of a single 10's yarn.

There is no set or fixed rule for determining the amount of twist to put in twisted yarn, the exact amount depending upon the purpose for which the product is to be used and, as this varies to a very great extent, the twist will vary also. In making two-ply yarns for market, it is usual to twist the single yarns slacker than warp twist and use four as a multiplier for twist in the ply yarn. In filling orders it is usual for the buyer to state the amount of twist desired and the mill puts that amount in the yarn. Yarns for weaving are spun and twisted slacker than warp; if for mer-

cerizing the amount of twist is less than filling. The hardest twisted yarns are those intended for lace work and sewing thread, while the softest twisted yarns are those intended for crochet and embroidery yarns.

The general rule is to spin the yarn with regular or "warp" twist and twist with reverse twist, that is the spindles of the twister will revolve in an opposite direction to those on the spin-

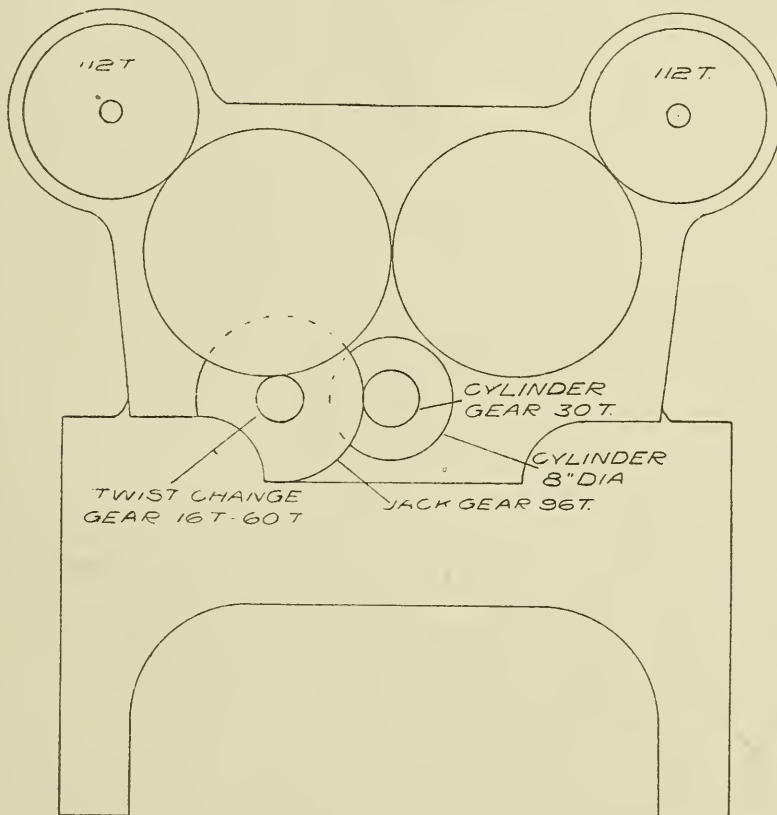

FIG. 44. DIAGRAM OF GEARING ON THE FALES & JENKS TWISTER.

ning frame. This is always done in making two-ply yarns, but is not necessarily held to in making yarns for special purposes, where the yarn is doubled and twisted and the ply yarns again twisted making a 4-ply yarn or higher.

In calculating the amount of twist for ply yarns, the figures are always based on its equivalent to single yarn. For illustration, the twist put in 2/50's, using 4 as a twist multiplier, would be as follows:

2/50's is the equivalent of a single 25's, then: $\sqrt{25 \times 4} = 20$ turns per inch twist in the yarn.

In the same way 3/50's would have: $\sqrt{16.67} \times 4 = 16.33$ turns of twist per inch.

Fig. 44 shows a cut of the geared end of a twister built by Fales & Jenks Machine Co., Pawtucket, R. I. This type of gearing is similar to most twisters and consists of two front roll gears of 112 teeth, driven by two large intermediates that are in gear with each other. One of the intermediates is driven by the twist change gear which is carried on the stud with the jack gear of 96 teeth. The cylinder or drum gear of 30 teeth, located on the end of the cylinder, drives the jack gear. The roll is $1\frac{1}{2}$ inches in diameter, the cylinder 8 inches in diameter and the whorl on the spindle is 1 inch in diameter. The ratio of the cylinder to the whorl is 1 to 7.04.

The twist constant is found by the same method as used on the spinning frame. The circumference of the $1\frac{1}{2}$ inch roll is 4.71 inches.

$$\frac{112 \times 96 \times 7.04}{4.71 \times X \times 30} = \text{twist constant.}$$

$$\text{Constant} \div \text{Gear} = \text{Twist per inch.}$$

$$\text{Constant} \div \text{Twist per inch} = \text{Gear.}$$

There is a large range of twist possible with this frame, and its construction allows the cylinder gear to be varied considerably without changing the size of the jack gear, the cylinder and twist gears being interchangeable, thus giving two or more sets of twists for the same set of change gears. In another model of this machine, using compound twist gearing, the gears being interchangeable, it is possible to get almost any desired range of twist with but few gears carried in stock.

Fig. 45 shows a cut of the geared end of the Hopedale twister, built by the Draper Co., Hopedale, Mass. This gearing is similar to the one just shown. In this case, however, the gear on the end of the drum is the change gear. The drum or twist change gear and the stud gear are interchangeable, the pin carrying the jack and stud gears, working in a slot in the jack gear arm, is movable thus allowing a change in the distance between gear centers which permits the using of any size drum gear without any change in the size of the jack gear. With this arrangement and a few extra gears it is possible to get almost any desired twist.

With the roll $1\frac{1}{2}$ inch, drum 8 inches and whorl 1 inch in diameter, the following gives the twist constant:

$$\frac{90 \times 120 \times 7.04}{4.71 \times 32 \times X} = 504 \text{ twist constant.}$$

Constant \div Gear = Twist.

Constant \div Twist = Gear.

Then a twist gear of 30 teeth will give 16.8 turns per inch twist, as follows: $504 \div 30 = 16.8$.

If the stud gear is changed we get an entirely new value to the train of gearing and consequently a different set of twists for the same twist gears. Suppose we put on a 36 tooth gear in place of the 32 tooth stud gear. This will have the effect of increasing the front roll speed thus decreasing the twist. We can then get our new constant as follows:

Multiply the present constant by the stud gear on the frame and divide by the stud gear that is to be used. $32 \times 504 \div 36 = 448$ twist constant with 36 tooth stud gear.

A twist gear of 30 teeth will give only 14.9 turns of twist instead of 16.8 as before, as: $448 \div 30 = 14.9$ turns of twist.

This variation from the former standard will be present in the same proportion with all the twist gears used, so it will be seen how easy it is to obtain a new set of twists with the use of the same gears.

PRODUCTION.

The production of a twister depends upon the spindle speed, the twist in the yarn, the size of the yarn and the time lost. It can be figured from the size of the yarn and the roll delivery, or from the spindle speed, size of yarn and the twist. The time lost while doffing, creeling and oiling varies with the size of the yarn, the amount of twist run, the number of the ply and the size of the bobbins made, being greatest when running the lower numbers of yarn.

Example: A twister on 2/30's yarn has a front roll speed of 80 R. P. M. Time lost 10 per cent. Diameter of front roll $1\frac{1}{2}$ inch. What is the production per spindle for a 10 hour day? Circumference of the $1\frac{1}{2}$ inch roll is 4.71 inches.

$$\frac{4.71 \times 80 \times 10 \times 60 \times .9}{36 \times 15 \times 840} = .448 \text{ pounds.}$$

In the above calculation 15 is used instead of 30 as the yarn after twisting is the equivalent of a single 15's yarn.

If we consider 10 per cent to be a good fair average for loss of time while doffing, oiling, etc., we can see that there are only two variable quantities in the above production calculation, the speed of the roll and the size of the yarn. Now if we leave these

two quantities out and work out the value of the remaining figures we get the production constant, as follows:

$$\frac{4.71 \times 10 \times 60 \times .9}{36 \times 840} = .0841 \text{ production constant.}$$

If the production constant is multiplied by the roll speed and

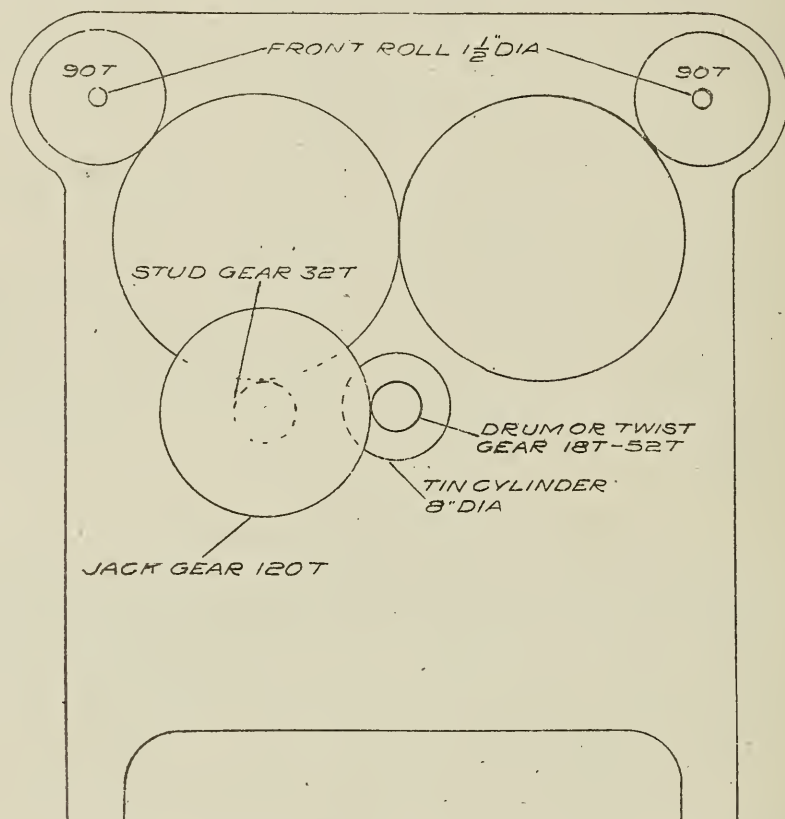

FIG. 45. TWIST GEARING ON THE DRAPER TWISTER.

divided by the equivalent counts of the twisted yarn, the result will be the production per spindle, as follows:

$$.0841 \times 80 \div 15 = .448 \text{ pounds per spindle.}$$

It will be noticed that this gives the same result as obtained in the first calculation. This constant only holds good on frames with a $1\frac{1}{2}$ inch roll and is based on a 10 hour day with a 10 per cent allowance for loss of time.

When two yarns are twisted together there is a tendency for the yarns to contract and become shorter. This increases the weight of the yarn, causing it to be heavier than is expected. The amount of this contraction varies with the amount of twist put in both the single and the ply yarns. If two hard twisted single

yarns were doubled and twisted slack, the tendency to contract and become heavier might be overcome by the opposite action going on in the single yarns. Under most conditions there is a contraction of the twisted yarns and to overcome this heavying up of the yarn while being twisted it is usual, where accuracy is desired in the size of the finished yarn, to spin the single yarns a number or so lighter. In this case what is called 2/40's is not twisted from 40's yarn but from 41's or 42's single yarn. The amount of variation in the numbers depending upon the amount of contraction in twisting and this in turn depending upon the amount of twist in the yarns.

SIZE OF TRAVELLERS.

There can be given no rule for determining the size travellers to use in twisting, as they vary according to varying conditions of twist, speed, size of ring and bobbin, length of traverse, etc. The only method of getting the exact size to use is by experimenting with the different numbers, finally selecting the size that seems to give the best results. However, below is given a table that will serve simply as a guide and not intended to be exact. It is for dry twisting two-ply yarns with 4 as a twist multiplier and a ring 2" for the coarser numbers and $1\frac{3}{4}$ " in diameter for the finer numbers.

TABLE OF TRAVELLERS.

SIZE OF YARN.	SIZE TRAVELLER.
10	14's
12	14's
14	13's
16	12's
18	11's
20	10's
22	10's
24	9's
26	8's
28	8's
30	7's
32	7's
34	6's
36	6's
38	5's
40	5's
44	4's
46	3's
50	2's
60	1-0
70	3-0
80	6-0
90	9-0
100	11-0
110	14-0
120	16-0

PRODUCTION TABLE FOR TWISTING

TWO PLY PRODUCTION TABLE

POUNDS PER SPINDLE PER WEEK OF 58 HOURS

Number of Yarn	Gauge	Ring	MULTIPLIER 2			MULTIPLIER 3			MULTIPLIER 4		
			R.P.M. of 1½ in. Roll	R.P.M. of Spindle	Pounds per Spindle	R.P.M. of 1½ in. Roll	R.P.M. of Spindle	Pounds per Spindle	R.P.M. of 1½ in. Roll	R.P.M. of Spindle	Pounds per Spindle
4	4"	3"	187	2500	38.01	175	3500	37.03	142	3800	31.00
5	"	"	182	2700	30.99	164	3700	29.00	133	4000	24.09
6	"	"	178	2900	26.05	155	3800	23.38	125	4100	19.32
7	"	"	175	3100	22.36	147	3900	19.28	119	4200	15.95
8	"	"	172	3300	19.53	141	4000	16.39	114	4300	13.49
9	3½"	2½"	169	3400	17.26	137	4100	14.30	110	4400	11.66
10	"	"	166	3500	15.40	133	4200	12.61	107	4500	10.29
11	"	"	163	3600	13.87	130	4300	11.28	104	4600	9.16
12	"	"	160	3700	12.56	127	4400	10.16	102	4700	8.28
13	"	"	158	3800	11.52	125	4500	9.27	100	4800	7.53
14	"	"	156	3900	10.61	123	4600	8.51	98	4900	6.87
15	"	"	155	4000	9.87	121	4700	7.84	97	5000	6.37
16	3¼"	2¼"	154	4100	9.22	120	4800	7.31	96	5100	5.93
17	"	"	153	4200	8.64	119	4900	6.84	95	5200	5.53
18	"	"	152	4300	8.13	118	5000	6.42	94	5300	5.18
19	"	"	151	4400	7.66	117	5100	6.04	93	5400	4.86
20	"	"	150	4500	7.24	116	5200	5.69	92	5500	4.58
22	"	"	147	4600	6.46	113	5300	5.05	90	5600	4.08
24	"	"	144	4700	5.82	110	5400	4.52	88	5700	3.66
26	3"	2"	141	4800	5.27	107	5500	4.07	86	5800	3.31
28	"	"	139	4900	4.83	105	5600	3.71	84	5900	3.01
30	"	"	137	5000	4.46	103	5600	3.41	82	6000	2.74
32	"	"	135	5100	4.13	101	5700	3.14	80	6000	2.51
34	"	"	134	5200	3.86	99	5800	2.90	78	6100	2.31
36	"	"	133	5300	3.62	97	5800	2.68	76	6100	2.13
38	"	"	132	5400	3.41	96	5900	2.52	75	6200	1.99
40	2¾"	1¾"	131	5500	3.22	95	6000	2.37	74	6200	1.87
42	"	"	130	5600	3.05	94	6100	2.24	73	6300	1.76
44	"	"	129	5700	2.89	93	6200	2.11	72	6400	1.66
46	"	"	128	5800	2.75	92	6200	2.00	71	6400	1.56
50	"	"	126	5900	2.49	90	6300	1.80	69	6500	1.40
55	"	"	123	6100	2.21	87	6400	1.59	66	6500	1.22
60	"	"	120	6200	1.98	84	6500	1.41	64	6600	1.08
65	2¾"	1½"	117	6300	1.78	82	6600	1.27	62	6700	.97
70	"	"	115	6400	1.63	80	6700	1.16	60	6700	.87
75	"	"	113	6500	1.50	78	6700	1.05	58	6700	.79
80	"	"	111	6600	1.38	76	6800	.96	57	6800	.73
85	"	"				74	6800	.88	56	6900	.67
90	"	"				72	6800	.81	55	7000	.62
95	"	"				70	6800	.75	54	7000	.58
100	2½"	1½"				69	6900	.70	53	7100	.54
110	"	"				66	6900	.61	51	7100	.47
120	"	"				63	6900	.53	49	7100	.42
130	"	"							47	7100	.37
140	"	"							45	7100	.33
150	"	"							44	7200	.30
160	"	"							43	7200	.28

PRODUCTION TABLE FOR TWISTING

TWO PLY PRODUCTION TABLE

(Continued)

POUNDS PER SPINDLE PER WEEK OF 58 HOURS

Number of Yarn	Gauge	Ring	MULTIPLIER 5			MULTIPLIER 6			MULTIPLIER 7		
			R.P.M. of 1½ in. Roll	R.P.M. of Spindle	Pounds per Spindle	R.P.M. of 1½ in. Roll	R.P.M. of Spindle	Pounds per Spindle	R.P.M. of 1½ in. Roll	R.P.M. of Spindle	Pounds per Spindle
4	4"	3"	120	4000	26.84	102	4100	23.23	90	4200	20.87
5	"	"	111	4100	20.59	94	4200	17.64	82	4300	15.62
6	"	"	104	4200	16.37	88	4300	14.05	77	4400	12.46
7	"	"	98	4300	13.38	83	4400	11.46	73	4500	10.20
8	"	"	93	4400	11.21	80	4500	9.73	70	4600	8.61
9	3½"	2½"	90	4500	9.71	77	4600	8.38	67	4700	7.36
10	"	"	87	4600	8.49	74	4700	7.27	65	4800	6.44
11	"	"	85	4700	7.58	72	4800	6.46	63	4900	5.70
12	"	"	83	4800	6.80	70	4900	5.78	62	5000	5.15
13	"	"	81	4900	6.15	69	5000	5.27	61	5100	4.69
14	"	"	80	5000	5.66	68	5100	4.84	60	5200	4.29
15	"	"	79	5100	5.23	67	5200	4.46	59	5300	3.95
16	3¼"	2¼"	78	5200	4.85	66	5300	4.13	58	5400	3.64
17	"	"	77	5300	4.52	65	5400	3.83	57	5500	3.38
18	"	"	76	5400	4.22	64	5400	3.57	56	5500	3.13
19	"	"	75	5400	3.95	63	5500	3.33	55	5600	2.92
20	"	"	74	5500	3.70	62	5500	3.12	55	5700	2.77
22	"	"	72	5600	3.28	61	5700	2.79	54	5900	2.48
24	"	"	70	5700	2.93	60	5900	2.52	53	6100	2.23
26	3"	2"	68	5800	2.63	59	6000	2.29	52	6200	2.02
28	"	"	67	5900	2.41	58	6100	2.09	51	6300	1.85
30	"	"	66	6000	2.22	57	6200	1.92	50	6400	1.69
32	"	"	65	6100	2.05	56	6300	1.77	49	6500	1.55
34	"	"	64	6200	1.90	55	6400	1.64	48	6500	1.43
36	"	"	63	6300	1.77	54	6500	1.52	47	6600	1.33
38	"	"	62	6400	1.65	53	6500	1.42	46	6600	1.23
40	2¾"	1¾"	61	6400	1.55	52	6600	1.32	45	6600	1.15
42	"	"	60	6500	1.45	51	6600	1.24	44	6700	1.07
44	"	"	59	6500	1.36	50	6600	1.16	43	6700	1.00
46	"	"	58	6600	1.28	49	6600	1.09	42	6700	.93
50	"	"	56	6600	1.14	47	6600	.96	41	6800	.84
55	"	"	54	6700	.98	46	6800	.85	40	6900	.74
60	"	"	52	6700	.88	45	7000	.77	39	7000	.67
65	2¾"	1½"	50	6700	.79	44	7100	.69	38	7100	.60
70	"	"	49	6800	.72	43	7200	.63	37	7200	.54
75	"	"	48	6900	.65	42	7300	.57	36	7300	.49
80	"	"	47	7000	.60	41	7300	.53	35	7400	.45
85	"	"	46	7100	.55	40	7400	.48	35	7500	.42
90	"	"	45	7100	.51	39	7400	.45	34	7500	.39
95	"	"	44	7100	.47	38	7400	.41	33	7500	.36
100	2½"	1½"	43	7200	.44	37	7400	.38	32	7500	.33
110	"	"	41	7200	.38	35	7400	.33	30	7500	.28
120	"	"	39	7200	.33	34	7400	.29	29	7500	.25
130	"	"	38	7200	.30						
140	"	"	37	7300	.27						
150	"	"	36	7300	.25						
160	"	"	35	7400	.22						

TWIST TABLE FOR TWISTING

TWO PLY TWIST TABLE

No. of Yarn to be Twisted	No. of Twisted Yarn	Sq. Root of No. of Twisted Yarn	TWIST PER INCH						
			Square Root Multiplied by						
			1½	2	2½	3	3½	4	4½
1	.5	.707	1.06	1.41	1.77	2.12	2.47	2.83	3.18
2	1.0	1.000	1.50	2.00	2.50	3.00	3.50	4.00	4.50
3	1.5	1.225	1.84	2.45	3.06	3.68	4.29	4.90	5.51
4	2.0	1.414	2.12	2.83	3.54	4.24	4.95	5.66	6.36
5	2.5	1.581	2.37	3.16	3.95	4.74	5.53	6.32	7.11
6	3.0	1.732	2.60	3.46	4.33	5.20	6.06	6.93	7.79
7	3.5	1.871	2.81	3.74	4.68	5.61	6.55	7.48	8.42
8	4.0	2.000	3.00	4.00	5.00	6.00	7.00	8.00	9.00
9	4.5	2.121	3.18	4.24	5.30	6.36	7.42	8.48	9.54
10	5.0	2.236	3.35	4.47	5.59	6.71	7.83	8.94	10.06
11	5.5	2.345	3.52	4.69	5.86	7.04	8.21	9.38	10.55
12	6.0	2.450	3.68	4.90	6.13	7.35	8.58	9.80	11.03
13	6.5	2.550	3.83	5.10	6.38	7.65	8.93	10.20	11.48
14	7.0	2.646	3.97	5.29	6.62	7.94	9.26	10.58	11.91
15	7.5	2.739	4.11	5.48	6.85	8.22	9.59	10.95	12.33
16	8.0	2.828	4.24	5.66	7.07	8.48	9.90	11.31	12.73
17	8.5	2.916	4.37	5.83	7.29	8.75	10.21	11.66	13.12
18	9.0	3.000	4.50	6.00	7.50	9.00	10.50	12.00	13.50
19	9.5	3.082	4.62	6.16	7.71	9.25	10.79	12.33	13.87
20	10.0	3.162	4.74	6.32	7.91	9.49	11.07	12.65	14.23
21	10.5	3.240	4.86	6.48	8.10	9.72	11.34	12.96	14.58
22	11.0	3.317	4.98	6.63	8.29	9.95	11.61	13.27	14.93
23	11.5	3.391	5.09	6.78	8.48	10.17	11.87	13.56	15.26
24	12.0	3.464	5.20	6.93	8.66	10.39	12.12	13.86	15.59
25	12.5	3.536	5.30	7.07	8.84	10.61	12.38	14.14	15.91
26	13.0	3.606	5.41	7.21	9.02	10.82	12.62	14.42	16.23
27	13.5	3.674	5.51	7.35	9.19	11.02	12.86	14.70	16.53
28	14.0	3.742	5.61	7.48	9.36	11.23	13.10	14.97	16.84
29	14.5	3.808	5.71	7.62	9.52	11.42	13.33	15.23	17.14
30	15.0	3.873	5.81	7.75	9.68	11.62	13.56	15.49	17.43
31	15.5	3.937	5.91	7.87	9.84	11.81	13.78	15.75	17.72
32	16.0	4.000	6.00	8.00	10.00	12.00	14.00	16.00	18.00
33	16.5	4.062	6.09	8.12	10.16	12.19	14.22	16.25	18.28
34	17.0	4.123	6.18	8.25	10.31	12.37	14.43	16.49	18.55
35	17.5	4.183	6.27	8.37	10.46	12.55	14.64	16.73	18.82
36	18.0	4.243	6.36	8.49	10.61	12.73	14.85	16.97	19.09
37	18.5	4.301	6.45	8.60	10.75	12.90	15.05	17.20	19.35
38	19.0	4.359	6.54	8.72	10.90	13.08	15.26	17.44	19.62
39	19.5	4.416	6.62	8.83	11.04	13.25	15.46	17.66	19.87
40	20.0	4.472	6.71	8.94	11.18	13.42	15.65	17.89	20.12
41	20.5	4.528	6.79	9.06	11.32	13.58	15.85	18.11	20.37
42	21.0	4.583	6.87	9.17	11.46	13.75	16.04	18.33	20.62
43	21.5	4.637	6.96	9.27	11.59	13.91	16.23	18.55	20.87
44	22.0	4.690	7.04	9.38	11.73	14.07	16.42	18.76	21.11
45	22.5	4.743	7.11	9.49	11.86	14.23	16.60	18.97	21.34
46	23.0	4.796	7.19	9.59	11.99	14.39	16.79	19.18	21.58
47	23.5	4.848	7.27	9.70	12.12	14.54	16.97	19.39	21.82
48	24.0	4.899	7.35	9.80	12.25	14.70	17.15	19.60	22.05
49	24.5	4.950	7.43	9.90	12.38	14.85	17.33	19.80	22.28
50	25.0	5.000	7.50	10.00	12.50	15.00	17.50	20.00	22.50
51	25.5	5.050	7.58	10.10	12.63	15.15	17.68	20.20	22.73
52	26.0	5.099	7.65	10.20	12.75	15.30	17.85	20.40	22.95
53	26.5	5.148	7.72	10.30	12.87	15.44	18.02	20.59	23.17
54	27.0	5.196	7.79	10.39	12.99	15.59	18.19	20.78	23.38
55	27.5	5.244	7.87	10.49	13.11	15.73	18.35	20.98	23.60
56	28.0	5.292	7.94	10.58	13.23	15.88	18.52	21.17	23.81
57	28.5	5.339	8.01	10.68	13.35	16.02	18.69	21.36	24.03
58	29.0	5.385	8.08	10.77	13.46	16.16	18.85	21.54	24.23
59	29.5	5.431	8.15	10.86	13.58	16.29	19.01	21.73	24.44
60	30.0	5.477	8.22	10.95	13.69	16.43	19.17	21.91	24.65

TWIST TABLE FOR TWISTING

TWO PLY TWIST TABLE — (Continued)

No. of Yarn to be Twisted	No. of Twisted Yarn	Sq. Root of No. of Twisted Yarn	TWIST PER INCH						
			Square Root Multiplied by						
			5	5½	6	6½	7	7½	8
1	.5	.707	3.54	3.89	4.24	4.60	4.95	5.30	5.66
2	1.0	1.000	5.00	5.50	6.00	6.50	7.00	7.50	8.00
3	1.5	1.225	6.13	6.74	7.35	7.96	8.58	9.19	9.80
4	2.0	1.414	7.07	7.78	8.49	9.19	9.90	10.61	11.31
5	2.5	1.581	7.91	8.70	9.49	10.28	11.07	11.86	12.65
6	3.0	1.732	8.66	9.53	10.39	11.26	12.12	12.99	13.86
7	3.5	1.871	9.36	10.29	11.22	12.16	13.10	14.03	14.97
8	4.0	2.000	10.00	11.00	12.00	13.00	14.00	15.00	16.00
9	4.5	2.121	10.61	11.67	12.73	13.79	14.85	15.91	16.97
10	5.0	2.236	11.18	12.30	13.42	14.53	15.65	16.77	17.89
11	5.5	2.345	11.73	12.90	14.07	15.24	16.42	17.59	18.76
12	6.0	2.450	12.25	13.48	14.70	15.93	17.15	18.38	19.60
13	6.5	2.550	12.75	14.03	15.30	16.58	17.85	19.13	20.40
14	7.0	2.646	13.23	14.55	15.87	17.20	18.52	19.85	21.17
15	7.5	2.739	13.69	15.06	16.43	17.80	19.17	20.54	21.91
16	8.0	2.828	14.14	15.55	16.97	18.38	19.80	21.21	22.62
17	8.5	2.916	14.58	16.04	17.49	18.95	20.41	21.87	23.33
18	9.0	3.000	15.00	16.50	18.00	19.50	21.00	22.50	24.00
19	9.5	3.082	15.41	16.95	18.49	20.03	21.57	23.12	24.66
20	10.0	3.162	15.81	17.39	18.97	20.55	22.13	23.72	25.30
21	10.5	3.240	16.20	17.82	19.44	21.06	22.68	24.30	25.92
22	11.0	3.317	16.58	18.24	19.90	21.56	23.22	24.88	26.54
23	11.5	3.391	16.96	18.65	20.35	22.04	23.74	25.43	27.13
24	12.0	3.464	17.32	19.05	20.78	22.52	24.25	25.98	27.71
25	12.5	3.536	17.68	19.45	21.21	22.98	24.75	26.52	28.29
26	13.0	3.606	18.03	19.83	21.63	23.44	25.24	27.05	28.85
27	13.5	3.674	18.37	20.21	22.05	23.88	25.72	27.56	29.39
28	14.0	3.742	18.71	20.58	22.45	24.32	26.19	28.07	29.94
29	14.5	3.808	19.04	20.94	22.85	24.75	26.66	28.56	30.46
30	15.0	3.873	19.37	21.30	23.24	25.17	27.11	29.05	30.98
31	15.5	3.937	19.69	21.65	23.62	25.59	27.56	29.53	31.50
32	16.0	4.000	20.00	22.00	24.00	26.00	28.00	30.00	32.00
33	16.5	4.062	20.31	22.34	24.37	26.40	28.43	30.47	32.50
34	17.0	4.123	20.62	22.68	24.74	26.80	28.86	30.92	32.98
35	17.5	4.183	20.92	23.01	25.10	27.19	29.28	31.37	33.46
36	18.0	4.243	21.21	23.34	25.46	27.58	29.70	31.82	33.94
37	18.5	4.301	21.51	23.66	25.81	27.96	30.11	32.26	34.41
38	19.0	4.359	21.80	23.97	26.15	28.33	30.51	32.69	34.87
39	19.5	4.416	22.08	24.29	26.50	28.70	30.91	33.12	35.33
40	20.0	4.472	22.36	24.60	26.83	29.07	31.30	33.54	35.78
41	20.5	4.528	22.64	24.90	27.17	29.43	31.70	33.96	36.22
42	21.0	4.583	22.91	25.21	27.50	29.79	32.08	34.37	36.66
43	21.5	4.637	23.19	25.50	27.82	30.14	32.46	34.78	37.10
44	22.0	4.690	23.45	25.80	28.14	30.49	32.83	35.18	37.52
45	22.5	4.743	23.72	26.09	28.46	30.83	33.20	35.57	37.94
46	23.0	4.796	23.98	26.38	28.77	31.17	33.57	35.97	38.37
47	23.5	4.848	24.24	26.66	29.09	31.51	33.94	36.36	38.78
48	24.0	4.899	24.49	26.94	29.39	31.84	34.29	36.74	39.19
49	24.5	4.950	24.75	27.23	29.70	32.18	34.65	37.13	39.60
50	25.0	5.000	25.00	27.50	30.00	32.50	35.00	37.50	40.00
51	25.5	5.050	25.25	27.78	30.30	32.83	35.35	37.88	40.40
52	26.0	5.099	25.50	28.04	30.59	33.14	35.69	38.24	40.79
53	26.5	5.148	25.74	28.31	30.89	33.46	36.04	38.61	41.18
54	27.0	5.196	25.98	28.58	31.18	33.77	36.37	38.97	41.57
55	27.5	5.244	26.22	28.84	31.46	34.09	36.71	39.33	41.95
56	28.0	5.292	26.46	29.11	31.75	34.40	37.04	39.69	42.34
57	28.5	5.339	26.69	29.36	32.03	34.70	37.37	40.04	42.71
58	29.0	5.385	26.93	29.62	32.31	35.00	37.70	40.39	43.08
59	29.5	5.431	27.16	29.87	32.59	35.30	38.02	40.73	43.45
60	30.0	5.477	27.39	30.12	32.86	35.60	38.34	41.08	43.82

TWIST TABLE FOR TWISTING

TWO PLY TWIST TABLE—(Continued)

No. of Yarn to be Twisted	No. of Twisted Yarn	Sq. Root of No. of Twisted Yarn	TWIST PER INCH						
			Square Root Multiplied by						
			4	4½	5	5½	6	6½	7
61	30.5	5.523	22.09	24.85	27.61	30.38	33.14	35.90	38.66
62	31.0	5.568	22.27	25.06	27.84	30.62	33.41	36.19	38.98
63	31.5	5.613	22.45	25.26	28.06	30.87	33.67	36.48	39.29
64	32.0	5.657	22.63	25.46	28.28	31.11	33.94	36.77	39.60
65	32.5	5.701	22.80	25.65	28.50	31.36	34.21	37.06	39.91
66	33.0	5.745	22.98	25.85	28.72	31.60	34.47	37.34	40.22
67	33.5	5.788	23.15	26.05	28.94	31.83	34.73	37.62	40.52
68	34.0	5.831	23.32	26.24	29.15	32.07	34.99	37.90	40.82
69	34.5	5.874	23.50	26.43	29.37	32.31	35.24	38.18	41.12
70	35.0	5.916	23.66	26.62	29.58	32.54	35.50	38.45	41.41
71	35.5	5.958	23.83	26.81	29.79	32.77	35.75	38.73	41.71
72	36.0	6.000	24.00	27.00	30.00	33.00	36.00	39.00	42.00
73	36.5	6.042	24.17	27.19	30.21	33.23	36.25	39.27	42.29
74	37.0	6.083	24.33	27.37	30.41	33.46	36.50	39.54	42.58
75	37.5	6.124	24.50	27.56	30.62	33.68	36.74	39.81	42.87
76	38.0	6.164	24.66	27.74	30.82	33.90	36.99	40.07	43.15
77	38.5	6.205	24.82	27.92	31.02	34.13	37.23	40.33	43.44
78	39.0	6.245	24.98	28.10	31.22	34.35	37.47	40.59	43.72
79	39.5	6.285	25.14	28.28	31.42	34.57	37.71	40.85	44.00
80	40.0	6.325	25.30	28.46	31.62	34.79	37.95	41.11	44.28
81	40.5	6.364	25.46	28.64	31.82	35.00	38.18	41.37	44.55
82	41.0	6.403	25.61	28.81	32.02	35.22	38.42	41.62	44.82
83	41.5	6.442	25.77	28.99	32.21	35.43	38.65	41.87	45.09
84	42.0	6.481	25.92	29.16	32.41	35.65	38.88	42.13	45.37
85	42.5	6.519	26.08	29.34	32.60	35.85	39.11	42.37	45.63
86	43.0	6.557	26.23	29.51	32.79	36.06	39.34	42.62	45.90
87	43.5	6.596	26.38	29.68	32.98	36.28	39.57	42.87	46.17
88	44.0	6.633	26.53	29.85	33.17	36.48	39.80	43.11	46.43
89	44.5	6.671	26.68	30.02	33.35	36.69	40.02	43.36	46.70
90	45.0	6.708	26.83	30.19	33.54	36.89	40.25	43.60	46.96
91	45.5	6.745	26.98	30.35	33.73	37.10	40.47	43.84	47.22
92	46.0	6.782	27.13	30.52	33.91	37.30	40.69	44.08	47.47
93	46.5	6.819	27.28	30.69	34.10	37.50	40.91	44.32	47.73
94	47.0	6.856	27.42	30.85	34.28	37.71	41.13	44.56	47.99
95	47.5	6.892	27.57	31.01	34.46	37.91	41.35	44.80	48.24
96	48.0	6.928	27.71	31.18	34.64	38.10	41.57	45.03	48.50
97	48.5	6.964	27.86	31.34	34.82	38.30	41.79	45.27	48.75
98	49.0	7.000	28.00	31.50	35.00	38.50	42.00	45.50	49.00
99	49.5	7.036	28.14	31.66	35.18	38.70	42.21	45.73	49.25
100	50.0	7.071	28.28	31.82	35.36	38.89	42.43	45.96	49.50
101	50.5	7.106	28.42	31.98	35.53	39.08	42.64	46.19	49.74
102	51.0	7.141	28.56	32.13	35.70	39.28	42.85	46.42	49.99
103	51.5	7.176	28.70	32.29	35.88	39.47	43.06	46.64	50.23
104	52.0	7.211	28.84	32.45	36.06	39.66	43.27	46.87	50.48
105	52.5	7.246	28.98	32.61	36.23	39.85	43.47	47.10	50.72
106	53.0	7.280	29.12	32.76	36.40	40.04	43.68	47.32	50.96
107	53.5	7.314	29.26	32.91	36.57	40.23	43.89	47.54	51.20
108	54.0	7.349	29.40	33.07	36.74	40.42	44.09	47.77	51.44
109	54.5	7.382	29.53	33.22	36.91	40.60	44.29	47.98	51.67
110	55.0	7.416	29.66	33.37	37.08	40.79	44.50	48.20	51.91
111	55.5	7.450	29.80	33.53	37.25	40.98	44.70	48.43	52.15
112	56.0	7.483	29.93	33.67	37.42	41.16	44.90	48.64	52.38
113	56.5	7.517	30.07	33.83	37.58	41.34	45.10	48.86	52.62
114	57.0	7.550	30.20	33.98	37.75	41.53	45.30	49.08	52.85
115	57.5	7.583	30.33	34.12	37.91	41.71	45.50	49.29	53.08
116	58.0	7.616	30.46	34.27	38.08	41.89	45.69	49.50	53.31
117	58.5	7.649	30.60	34.42	38.24	42.07	45.89	49.72	53.54
118	59.0	7.681	30.72	34.56	38.41	42.25	46.09	49.93	53.77
119	59.5	7.714	30.86	34.71	38.57	42.43	46.28	50.14	54.00
120	60.0	7.746	30.98	34.86	38.73	42.60	46.48	50.35	54.22

TWIST TABLE FOR TWISTING

TWO PLY TWIST TABLE—(Continued)

No. of Yarn to be Twisted	No. of Twisted Yarn	Sq. Root of No. of Twisted Yarn	TWIST PER INCH						
			Square Root Multiplied by						
			4	4½	5	5½	6	6½	7
121	60.5	7.778	31.11	35.00	38.89	42.78	46.67	50.56	54.45
122	61.0	7.810	31.24	35.15	39.05	42.96	46.86	50.77	54.67
123	61.5	7.842	31.37	35.29	39.21	43.13	47.05	50.97	54.89
124	62.0	7.874	31.50	35.43	39.37	43.31	47.24	51.18	55.12
125	62.5	7.906	31.62	35.58	39.53	43.48	47.43	51.39	55.34
126	63.0	7.937	31.75	35.72	39.69	43.65	47.62	51.59	55.56
127	63.5	7.969	31.88	35.86	39.84	43.83	47.81	51.80	55.78
128	64.0	8.000	32.00	36.00	40.00	44.00	48.00	52.00	56.00
129	64.5	8.031	32.12	36.14	40.16	44.17	48.19	52.20	56.22
130	65.0	8.062	32.25	36.28	40.31	44.34	48.37	52.40	56.43
131	65.5	8.093	32.37	36.42	40.47	44.51	48.56	52.60	56.65
132	66.0	8.124	32.50	36.56	40.62	44.68	48.74	52.81	56.87
133	66.5	8.155	32.62	36.70	40.77	44.85	48.93	53.01	57.09
134	67.0	8.185	32.74	36.83	40.93	45.02	49.11	53.20	57.30
135	67.5	8.216	32.86	36.97	41.08	45.19	49.30	53.40	57.51
136	68.0	8.246	32.98	37.11	41.23	45.35	49.48	53.60	57.72
137	68.5	8.277	33.11	37.25	41.38	45.52	49.66	53.80	57.94
138	69.0	8.307	33.23	37.38	41.53	45.69	49.84	54.00	58.15
139	69.5	8.337	33.35	37.52	41.68	45.85	50.02	54.19	58.36
140	70.0	8.367	33.47	37.65	41.83	46.02	50.20	54.39	58.57
141	70.5	8.396	33.58	37.78	41.98	46.18	50.38	54.57	58.77
142	71.0	8.426	33.70	37.92	42.13	46.34	50.56	54.77	58.98
143	71.5	8.456	33.82	38.05	42.28	46.51	50.73	54.96	59.19
144	72.0	8.485	33.94	38.18	42.43	46.67	50.91	55.15	59.40
145	72.5	8.515	34.06	38.32	42.58	46.83	51.09	55.35	59.61
146	73.0	8.544	34.18	38.45	42.72	46.99	51.26	55.54	59.81
147	73.5	8.573	34.29	38.58	42.87	47.15	51.44	55.72	60.01
148	74.0	8.602	34.41	38.71	43.01	47.31	51.61	55.91	60.21
149	74.5	8.631	34.52	38.84	43.16	47.47	51.79	56.10	60.42
150	75.0	8.660	34.64	38.97	43.30	47.63	51.96	56.29	60.62
151	75.5	8.689	34.76	39.10	43.45	47.79	52.13	56.48	60.82
152	76.0	8.718	34.87	39.23	43.59	47.95	52.31	56.67	61.03
153	76.5	8.746	34.98	39.36	43.73	48.10	52.48	56.85	61.22
154	77.0	8.775	35.10	39.49	43.88	48.26	52.65	57.04	61.43
155	77.5	8.803	35.21	39.61	44.02	48.42	52.82	57.22	61.62
156	78.0	8.832	35.33	39.74	44.16	48.58	52.99	57.41	61.82
157	78.5	8.860	35.44	39.87	44.30	48.73	53.16	57.59	62.02
158	79.0	8.888	35.55	40.00	44.44	48.88	53.33	57.77	62.22
159	79.5	8.916	35.66	40.12	44.58	49.04	53.50	57.95	62.41
160	80.0	8.944	35.78	40.25	44.72	49.19	53.66	58.14	62.61
161	80.5	8.972	35.89	40.37	44.86	49.35	53.83	58.32	62.80
162	81.0	9.000	36.00	40.50	45.00	49.50	54.00	58.50	63.00
163	81.5	9.028	36.11	40.63	45.14	49.65	54.17	58.68	63.20
164	82.0	9.055	36.22	40.75	45.28	49.80	54.33	58.86	63.39
165	82.5	9.083	36.33	40.87	45.42	49.96	54.50	59.04	63.58
166	83.0	9.110	36.44	41.00	45.55	50.11	54.66	59.22	63.77
167	83.5	9.138	36.55	41.12	45.69	50.26	54.83	59.40	63.97
168	84.0	9.165	36.66	41.24	45.83	50.41	54.99	59.57	64.16
169	84.5	9.192	36.77	41.36	45.96	50.56	55.15	59.75	64.34
170	85.0	9.220	36.88	41.49	46.10	50.71	55.32	59.93	64.54
171	85.5	9.247	36.99	41.61	46.24	50.86	55.48	60.11	64.73
172	86.0	9.274	37.10	41.73	46.37	51.01	55.64	60.28	64.92
173	86.5	9.301	37.20	41.85	46.51	51.16	55.81	60.46	65.11
174	87.0	9.327	37.31	41.97	46.64	51.30	55.96	60.63	65.29
175	87.5	9.354	37.42	42.09	46.77	51.45	56.12	60.80	65.48
176	88.0	9.381	37.52	42.21	46.91	51.60	56.29	60.98	65.67
177	88.5	9.407	37.63	42.33	47.04	51.74	56.44	61.15	65.85
178	89.0	9.434	37.74	42.45	47.17	51.89	56.60	61.32	66.04
179	89.5	9.460	37.84	42.57	47.30	52.03	56.76	61.49	66.22
180	90.0	9.487	37.95	42.69	47.44	52.18	56.92	61.67	66.41

CHAPTER X.

ORGANIZATION — DRAFT PRODUCTION — PROGRAM OF DRAFTS,
WEIGHTS AND NUMBERS—MACHINERY EQUIPMENT—NUMBER
OF LOOMS.

DRAFT PROPORTIONING.

To one who has had considerable experience in the mill in working drafts, speeds, etc., on various sizes of yarn, the question of what size sliver to run on drawing to produce a given size of yarn, with good drafts on the intervening frames, is easily settled. To the beginner this is often puzzling and hard to figure out. To either, determining the exact amount of draft to give each machine, so as to have no unusual drafts at any point, is not always settled so easily, therefore, the following rules and example will be useful to some.

The total draft, between any two points in the processes of yarn manufacture, is the product of all the intermediate drafts occurring between these points.

Taking the following as good average drafts for the frames given: Slubber, 4; Intermediate, 5; Fine Frame, 6; Spinning, 10.5; we see that the total draft on the above four machines is 1,260. Now, if any contemplated lay-out calls for a total draft between these points inclusive, that is greater than 1,260, the resulting intermediate drafts will necessarily be larger than the above figures and the reverse is also true.

If it is proposed to spin any given counts of yarn from any given weight of sliver, it is easy to determine the total draft necessary, by the following method:

First. Reduce the grain sliver to hank sliver, by the following rule:

Divide 8.33 by the weight of one yard of sliver, in grains.

Second. Find the total draft, by the following rule:

Multiply the counts of the yarn to be spun by all the doublings on the frames and divide the product by the hank sliver.

From the above, it will be easy to determine, for any given contemplated lay-out, whether the intermediate drafts will be higher or lower than the average.

Example: Suppose it is desired to spin 30's yarn from a 50 grain sliver on the back of the slubber, using three fly frames and double roving on the spinning frame.

$$8.33 \div 50 = .166 \text{ hank sliver.}$$

$$\frac{30 \times 2 \times 2 \times 2}{.166} = 1,445 \text{ total draft.}$$

It will immediately be seen from this that the drafts on the four frames will be above the normal figures given.

The effective draft is the amount of draft that would be required to reduce the sliver to the desired size of yarn, if there were no doublings, or it is the number of yards of yarn spun on the spinning frame for each one yard of sliver fed into the back of the slubber. If it is desired to find the effective draft, this can be done by dividing the total draft by the product of the doublings.

Take the conditions above and the effective draft is as follows:

$$\frac{1445}{2 \times 2 \times 2} = 180 \text{ effective draft.}$$

Now, the hank sliver multiplied by the effective draft will give the counts of the yarn spun:

$$180 \times .166 = 29.88 \text{ or } 30\text{'s yarn.}$$

The effective draft can be easiest found by dividing the counts of the yarn spun by the hank sliver, as follows:

$$30 \div .166 = 180 \text{ effective draft.}$$

You can figure the weight of the sliver to run to give any desired counts of yarn, using the above named average drafts for the four frames, by transposing the rule for getting the total draft. The rule will now read as follows:

Multiply the desired counts by all the doublings and divide the product by 1,260, which is the total draft corresponding to the average drafts named. The result will be the hank sliver. Dividing 8.33 by the hank sliver will give the weight of the sliver.

The above results can be duplicated by figuring from the weights of the material instead of using hanks.

Having selected 4, 5, 6 and 10.5 as the average, normal drafts for the four frames, we can distribute, or divide, the total draft of 1,445 among the four frames, considering the above figures as the ratios for the frames given, by the following rule:

Multiply the fourth root of the total draft to be divided by any ratio and divide the product by the fourth root of the product of the ratios. The result will be the draft for the frame, according to which ratio is used.

This rule can be expressed in a formula which will show more clearly the steps taken:

$$\sqrt[4]{\text{Total draft} \times \text{ratio}} = \text{draft for frame.}$$

$$\sqrt[4]{\text{Product of ratios}}$$

Note.—The fourth root of any number is obtained by getting the square root of the number and then extracting the square root of this root.

The product of the ratios is:

$$4 \times 5 \times 6 \times 10.5 = 1260.$$

$$\text{The fourth root of } 1,260 = 5.95.$$

The total draft, as found above, is 1,445.

$$\text{The fourth root of } 1,445 = 6.16.$$

Using the ratio of 10.5 for the spinning frame, we get the spinning draft as follows:

$$\frac{6.16 \times 10.5}{5.95} = 10.87 \text{ spinning draft.}$$

For the fine frame:

$$\frac{6.16 \times 6}{5.95} = 6.21 \text{ fine frame draft.}$$

For the intermediate:

$$\frac{6.16 \times 5}{5.95} = 5.18 \text{ intermediate draft.}$$

For the slubber:

$$\frac{6.16 \times 4}{5.95} = 4.14 \text{ slubber draft.}$$

Multiplying these four drafts together gives a total draft of 1,447, which is only two points variation from the 1,445 started with.

It will be seen from this that, where the total draft is in excess of 1,260, this excess will be proportionately distributed between the four intermediate drafts and will show no excessively high drafts. Herein lies the advantage in using this rule to map out the drafts where there is no severe restrictions in the matter. If the total draft were lower all the intermediate drafts would be lower. Another point gained by using the above method is that in no case will the result show an excessive draft on one or more frames and low drafts on the others. In other words,

when the total draft is high, all the drafts will be high and when the total draft is low, all the drafts will be low.

The numbers 4, 5, 6 and 10.5, are not arbitrarily fixed, where more or less draft is considered advisable on any of the frames, the ratio for that frame can be altered and not destroy the efficiency of the rule.

In running low numbers of yarn, the intermediate frame not being used, the rule will apply if the ratio 5 is thrown out and the cube root substituted for the fourth root. If using single roving in the spinning, with two or three fly frames, change the ratio of 10.5 to 7.5 or 8 and modify the formula to suit the number of fly frames used.

ORGANIZATION SHEET.

In estimating an organization sheet or working program of drafts, weights, speeds, productions and number of machines for a cotton mill, several important points have to be dealt with.

In planning for a new mill the question of capacity and number of machines is not very difficult, but, in planning for an old mill, the most desirable combinations of drafts, doublings and speeds have sometimes to be abandoned and a less satisfactory arrangement resorted to in order to increase the production of some one class of machines to enable them to keep up with the process ahead and, thus, increase the total production.

There is considerable range to drafts, weights and speeds on all classes of mill machinery and there are probably no two mills on the same class of goods that have identically the same program all through the different processes.

Aside from the capacity and proportions of the machines available, the most important considerations are the numbers and qualities of the yarns made and the uses to which they are to be put. The finest numbers of yarn and the better qualities of hosiery yarns demand a long combed stock and a large number of doublings. Coarse yarns for weaving do not require such stock and the number of doublings is decreased. All yarns for knitting, where the best quality is desired, should be spun from combed stock using the mule, with double roving and slack twist, as this tends to greater evenness, smoothness and regularity and gives the softest feel to the yarn.

There is a very great diversity of opinion in regard to the use of single roving. Many mills on print cloth, using 28's warp and 32's filling, spin both from single roving; some spin both from double roving, and others use double roving on warp, on account of the added strength, and single roving on filling. If evenness is desired in coarse yarns, double roving is often used

and also in some cases to save making roving of a different size. As filling does not require so much strength as warp, it is often spun from single roving and the warp, of about same size or coarser, is spun from double roving.

In spinning 20's and under the intermediate roving frame is often thrown out and longer drafts used, while for finer yarns, say 60's and over, a fourth roving frame is used.

It is always desirable to have as few sizes of roving as possible in making yarns of different numbers, and it often happens in mills making a range of numbers, that longer and shorter drafts than are customary are used. The amount of draft at the various machines also depends upon the stock being used. Long staple cotton will admit of more draft than short staple cotton, and as a rule the draft increases as the bulk decreases. In figuring a program where there are no severe limitations, average drafts in each case would be assumed, varying these slightly to bring the roving to standard sizes, remembering that, within reasonable limits, the heavier the sliver and the rovings and the longer the drafts, the smaller the amount of machinery necessary to produce the required amount of roving.

It is not possible to follow a program of weights and numbers exactly, but where any degree of care and accuracy is taken in working it out, the actual results obtained will not vary greatly from the figured program.

The method employed to proportion the different machines for a mill to each other is a simple matter. The production of a spinning spindle is usually taken as the basis of calculation and all the other machinery is laid out with direct reference to it. The productions of the different machines, under varying working conditions of speed and weight of material delivered, can be gotten from the catalogs issued by the machine builders and will be found useful and save the time and trouble necessary to work them out, yet, at the same time, we ought to be able to do this work for ourselves and understand the methods employed in getting the results.

PROGRAM OF WEIGHTS, DRAFTS AND NUMBERS.

Assume a mill of 10,000 spindles, making 22's yarn for the market and work out a program of weights, numbers, drafts and machinery, or organization sheet.

We will have to first work out the program for drafts, weights and numbers for the different processes. The drafts, assuming that a 50 grain sliver will be used at the back of the slubber, worked out by the rule given above, are found to be as follows: Spinning, 10.05; fine, 5.74; intermediate, 4.79; slubber, 3.83.

You will notice that all these drafts are low, which shows that a heavier sliver could easily be substituted for the one taken and then not have excessive drafts.

120 yards of 22's yarn weigh 45.45 grains. As the yarn contracts and becomes heavier while being twisted, we must allow for this contraction and estimate the weight before it is twisted or just as it leaves the drawing rolls. This contraction is about 3%, then:

$$45.45 \div 1.03 = 44.12 \text{ grs. wt. before twisting.}$$

Draft of spinning frame 10.05. Double 2.

$$\frac{44.12 \times 10.05}{2} = 221.7 \text{ grs. wt. 120 yds. fine roving.}$$

$$221.7 \div 10 = 22.17 \text{ grs. wt. 12 yds. fine roving} = 4.5 \text{ H. R.}$$

Draft of fine frame 5.74. Double 2.

$$\frac{22.17 \times 5.74}{2} = 63.63 \text{ grs. wt. of 12 yards of intermediate roving} = [1.57 \text{ or } 1.6 \text{ H. R.}]$$

Draft of intermediate 4.79. Double 2.

$$\frac{63.63 \times 4.79}{2} = 152.39 \text{ grs. wt. of 12 yds. of slubber roving} = .66 \text{ H. R.}$$

Draft of slubber 3.83. No doublings.

$$\frac{152.39 \times 3.83}{12} = 48.6 \text{ or } 49 \text{ grs. wt. of 1 yd. sliver on back of slubber.}$$

Draft of drawing frame 6. Double 6.

This does not change the weight of the sliver, hence the card sliver will weigh 49 grs. per yard.

Draft of card 100. Allow for 5% waste.

$$\frac{49 \times 100}{.95 \times 437.5} = 11.2 \text{ oz. lap from the finisher pickers.}$$

This lap is too light and could easily be made heavier by using more draft on the fly frames and spinning frame, thus calling for a heavier card sliver.

MACHINERY EQUIPMENT.

Having worked out a suitable program of weights and drafts, the next step is to estimate the production required at each stage of the operation. In getting these figures we must allow a certain percentage at the different machines for waste and stoppages. It would be impossible to produce the same num-

ber of pounds of yarn as there were pounds of card sliver, as every frame the material passes through makes some waste, due to breakages, etc., hence it is imperative to start with more pounds of cotton than the required number of pounds of yarn. After this allowance in the production is made there should be a certain allowance at each process for loss of time while doffing, oiling, etc. These amounts vary with different machines and also with the same machine on different classes of work. It is not possible to make a fixed allowance for each operation, but a fair average can be estimated from actual results. After this average allowance has been provided for any discrepancy in production can be easily overcome by raising or lowering the speeds where needed.

It is not the best policy to use extra large machines in spinning and roving or very small ones. In the former case the loss of time while doffing, etc., is increased, and in the latter the cost of production is increased. It is not well to use excessive speeds anywhere as, by so doing, the quality of the product is impaired and the percentage of breakages increased, thus increasing the time lost and the percentage of waste made.

In getting the figures which follow it has been endeavored to strike a good average all the way through, without excessive speeds or production, which will give a good, smooth, strong yarn at the spinning with the minimum of stoppages and waste.

SPINNING SPINDLES.

Speed of spindles 9,500 R. P. M. Time run 10 hours per day. Allow for 10% loss of time. Product on constant, under above conditions, is 169.65.

$$\sqrt{22 \times 4.75} = 22.28 \text{ turns of twist.}$$

$$\frac{169.65}{22.28 \times 22} = .34 \text{ lbs. per spindle per day.}$$

Total spindles in the mill 10,000, then:

$$10,000 \times .34 = 3,400 \text{ lbs. of yarn per day produced by the mill.}$$

Using 208 spindles per frame, we get:

$$10,000 \div 208 = 48 \text{ frames.}$$

This figures 16 spindles short but is not enough to be considered.

FINE FRAME.

The waste between the fine frame and yarn will probably not run much over 2% and the time allowed for stoppages, for

oiling, doffing, piecing-up, etc., should not exceed 15%, so, in order to get a production of roving sufficient to keep the spindles running, we must make these two allowances and figure, in one case, for a 2% heavier production and, in the other case, for a 15% loss of time on the frames.

Spindle production 3,400 lbs.

$3,400 \times 1.02 = 3,468$ lbs. roving required from fine frames to keep spindles running. Speed of flyer 1,200 R. P. M. Size of bobbin $7 \times 3\frac{1}{2}$ inches. Hank roving 4.5. Twist per inch in the roving is $\sqrt{4.5 \times 1.2} = 2.54$ turns. Loss of time 15%. Diameter of front roll $1\frac{1}{8}$ ". Production constant, based on above is 20.24.

$$\begin{array}{r} \text{Then: } 20.24 \\ \hline 2.54 \times 4.5 \end{array} = 1.77 \text{ lbs. per spindle.}$$

And $3,468 \div 1.77 = 1,959$ spindles.

Allowing 160 spindles to a frame, we get:

$$1,959 \div 160 = 12 \text{ frames.}$$

This figures 39 spindles short and this shortage can be made up by getting 4 frames of 168 spindles each instead of all having 160 spindles.

INTERMEDIATE FRAMES.

Spindle production 3,400. Allow 4% for waste of material between the intermediate roving and yarn, then: $3,400 \times 1.04 = 3,536$ lbs. of roving required from the intermediate spindles.

Speed of flyer 950 R. P. M. Size of bobbin $9 \times 4\frac{1}{2}$ inches. Hank roving 1.6. Twist in the roving is $\sqrt{1.6 \times 1.2} = 1.52$ turns. Loss of time 18%. Front roll $1\frac{1}{4}$ " in diameter. Production constant, based on above conditions, is 15.45.

$$\begin{array}{r} \text{Then: } 15.45 \\ \hline 1.52 \times 1.6 \end{array} = 6.35 \text{ lbs. per spindle.}$$

And: $3,536 \div 6.35 = 557$ spindles.

Allowing 96 spindles to a frame, we get:

$$557 \div 96 = 6 \text{ frames.}$$

SLUBBERS.

Spindle production 3,400 lbs. Allow 8% for waste of material between slubber roving and yarn, then: $3,400 \times 1.08 = 3,672$ lbs. of roving required from the slubbers.

Speed of flyer 650 R. P. M. Size of bobbin 12×6 inches. Hank roving .66. Twist per inch is $\sqrt{.66 \times 1.2} = .97$ turns.

Front roll $1\frac{1}{4}$ " in diameter. Time lost 20%. Production constant, based on above conditions, is 10.31.

$$\text{Then: } \frac{10.31}{.97 \times .66} = 16.11 \text{ lbs. per spindle.}$$

$$\text{And: } 3,672 \div 16.11 = 228 \text{ spindles.}$$

Allowing 56 spindles to a frame, we get:

$$228 \div 56 = 4 \text{ frames.}$$

DRAWING.

Spindle production 3,400 lbs. Allow 10% for loss of material between drawing sliver and yarn, then: $3,400 \times 1.10 = 3,740$ lbs. sliver required from the draw frames.

Speed of front roll 350 R. P. M. $1\frac{3}{8}$ " metallic front roll, 32 pitch. Weight of sliver 49 grains. Loss of time 20%. Production constant, under above conditions, is .01095.

$$\text{Then: } .01095 \times 350 \times 49 = 188 \text{ lbs. per delivery.}$$

$$\text{And: } 3,672 \div 188 = 19.5 \text{ or } 20 \text{ deliveries.}$$

Using 4 deliveries per head gives one drawing frame of 5 heads with 4 deliveries each for each process of drawing. Use two processes.

CARDS.

Spindle production 3,400 lbs. Allow 12 per cent. for loss of material between card sliver and yarn, then:

$$3,400 \times 1.12 = 3,808 \text{ lbs. sliver required from the cards.}$$

Diameter of doffer clothed 27.75". Speed of doffer 14 R. P. M. Wt. of sliver 49 grs. Time lost 10%. Production constant, based on above conditions, is .2111.

$$\text{Then: } .2111 \times 14 \times 49 = 145 \text{ lbs. per card.}$$

$$\text{And: } 3,808 \div 145 = 26.2 \text{ or } 26 \text{ cards.}$$

PICKERS.

Spindle production 3,400 lbs. Allow 20% for loss of material between finished laps and yarn, then:

$$3,400 \times 1.20 = 4,080 \text{ lbs. of lap required from the finishers.}$$

Speed of lap rolls 7.75 R. P. M. Diameter of lap rolls 9". Weight of laps 11.2 ozs. per yd. Time lost 20%. Production constant, based on above conditions, is 23.56.

$$\text{Then: } 23.56 \times 7.75 \times 11.2 = 2,038 \text{ lbs. per picker.}$$

$$\text{And: } 4,080 \div 2,038 = 2 \text{ finisher pickers.}$$

This will call for 2 intermediate pickers and one breaker and one opener picker, the last two to be connected by dust trunk or other suitable connection.

In the above figures, the allowance made for loss of material at the different processes, includes the waste of all sorts, a good deal of which, of course, is perfectly clean and can be used over.

In attempting to run the foregoing program with the equipment worked out, there will, in all probability, be some discrepancies that will cause a little trouble, but none that cannot be overcome by readjusting some of the speeds, etc. There should be a certain amount of elasticity in every program, as the loss of time varies with the efficiency of the operatives and the quality of work done, as well as the speed used; the production likewise varies from the same causes. Reducing the speed of fly frames will often increase the production from the fact that there will be a less amount of lost time due to breakage of the roving, etc.

In many cases higher and lower speeds than those given are used with good results, greater and less productions obtained, more and less time lost by stoppages, etc., but the allowances made and the results obtained as given here are such as can be equalled and in many cases exceeded, by any well-organized and well-managed mill.

LOOM EQUIPMENT.

In our previous figuring we have not taken into consideration any calculations for determining the production or number of looms, the figures given being intended for a mill making yarns for the market. When figuring a program for a weaving mill, the number of looms to install and the size to spin our warp and filling must be settled. It is first necessary to decide upon the style of goods to be made, that is, the weight per yard, the width and the number of threads of warp and filling to use.

Suppose it is desired to build a mill to produce plain cloth, 40 inches wide, 68 threads of warp and filling each per inch and to weight 4 yards per pound. This would be expressed as, 68 × 68, 40 inches, 4 yard goods. The looms are to run 160 picks per minute and allow for 15 per cent. loss of time. The mill is to contain 20,000 spindles.

We must first determine the sizes of warp and filling yarns to spin to make a cloth of the above construction. To do this we must figure the average number of yarn in the cloth and from this we can decide upon the size warp yarn to use and figure the corresponding size of filling yarn. On the above class of goods we

can figure the warp and filling to take-up about ^{8.3%} 8 per cent. in weaving and the increase in weight of warp, due to sizing, as 6 per cent.

Then: $68 \times 40 = 2,720$ ends in the warp, and, $2,720 + 24 = 2,744$ ends in the warp including 24 extra ends for selvages.

As the warp contracts 8 per cent. in weaving, it will take 108 yards of warp to weave 100 yards of cloth, then: $2,744 \times 108 = 296,352$ yards of yarn in 100 yards of cloth. We can figure the increase in the weight of warp yarn, due to the added size, as an increase in the number of yards and get correct results, then: $296,352 \times 1.06 = 314,133.12$ yards of warp yarn allowing for take-up in weaving and sizing. And: $314,133.12 \div 840 = 373.76$ hanks of warp yarn in 100 yards of cloth.

The width in the loom will be found as follows:

$$40 \div .92 = 43.47 \text{ inches.}$$

$$\text{Then: } \frac{43.47 \times 68 \times 100}{840} = 351.9 \text{ hanks of filling in 100 yards of cloth.}$$

And: $373.76 + 351.9 = 725.66$ total hanks of yarn in 100 yards of cloth. The cloth weighs 4 yards per pound and 100 yards will weigh 25 pounds, hence:

$$725.66 \div 25 = 29.02 \text{ or } \underline{29}'\text{s counts of warp and filling yarn to spin.}$$

As it is customary to spin the warp 3 to 8 numbers coarser than the filling, we will assume that the warp is to be spun 27's counts and work out the required size of filling. We found that there would be 373.76 hanks of warp yarn in 100 yards of cloth, therefore: $373.76 \div 27 = 13.84$ pounds as the weight of the warp yarn, and: $25 - 13.84 = 11.16$ pounds as the weight of the filling yarn. As there are 351.9 hanks of filling yarn in 100 yards of cloth, then: $351.9 \div 11.16 = 31.53$ or practically 31.5's counts of filling yarn required.

We have figured the warp, in 100 yards of cloth, to weigh 13.84 pounds and the filling 11.16 pounds which gives 55.3 per cent. warp and 44.7 per cent, filling. Then, for every 100 pounds of yarn spun there would be 55.3 pounds of warp and 44.7 pounds of filling and the total spindles in the mill will have to be divided between warp and filling so as to spin the yarns according to the above proportion.

SPINDLES.

Assume the warp spindles to have a speed of 9,500 R. P. M. and allow for 10 per cent. loss of time. Production constant, for above conditions, is 165. The twist is 24.68 turns per inch.

Rule for using production constant:

Constant divided by the counts of the yarn multiplied by the twist per inch equals the pounds per spindle per day of 10 hours

Then: $165 \div 27 \times 24.68 = .247$ pounds per spindle per day.

Therefore: $55.3 \div .247 = 224$ warp spindles.

Assume the filling spindles to have a speed of 8,300 R. P. M. and allow for 10 per cent. loss of time. Production constant, for above conditions, is 147. Then: $147 \div 31.5 \times 18.24 = .255$ pounds per spindle per day. Therefore: $44.7 \div .255 = 175$ filling spindles. This gives a total of 399 spindles to produce the above amount of warp and filling yarns in the proportion needed for the cloth, 56 per cent. being warp spindles and 44 per cent. being filling spindles and the total 20,000 spindles contained in the mill must be divided according to the above percentages. This gives 11,200 warp spindles and 8,800 filling spindles. The above divided into frames of 208 spindles each will give 54 warp frames and 42 filling frames.

The production of a warp spindle was found to be .247 pounds per day, then: $11,200 \times .247 = 2,766$ pounds of warp yarn produced per day. The production of a filling spindle was found to be .255 pounds per day, then: $8,880 \times .255 = 2,244$ pounds of filling yarn produced per day. Then the total amount of yarn produced will be: $2,766 + 2,244 = 5,010$ pounds per day. Allowing for an average loss of 2 per cent. in weaving the above yarn into cloth, there would be only 4,909 pounds of cloth produced per day.

LOOMS.

The following rule will give the production per loom per day in pounds:

Multiply the picks per minute by the minutes per day, with the allowance for loss of time, and divide this by the product of the picks per inch multiplied by 36 and by the yards in one pound of cloth.

The loom speed was given as 160 picks per minute and the loss of time as 15 per cent., then the following will give the production per day:

$$\frac{160 \times 600 \times .85}{68 \times 36 \times 4} = 8.33 \text{ pounds per loom.}$$

The figures above gave a production of 4,909 pounds of cloth per day, then: $4,909 \div 8.33 = 558$ looms.

Assuming any given number of looms and figuring the number of spindles required for them is a more direct method, but

gives no very definite idea of the number of spindles required until the work is completed. Where it is desired to have a given number of spindles, the above method will give correct results.

In installing the above spinning frames, it is advisable to order several frames fitted with combination builders so as to be able to spin either warp or filling on them. In this way the process is more elastic and permits the spinning of more or less warp or filling as the requirements of the case might call for.

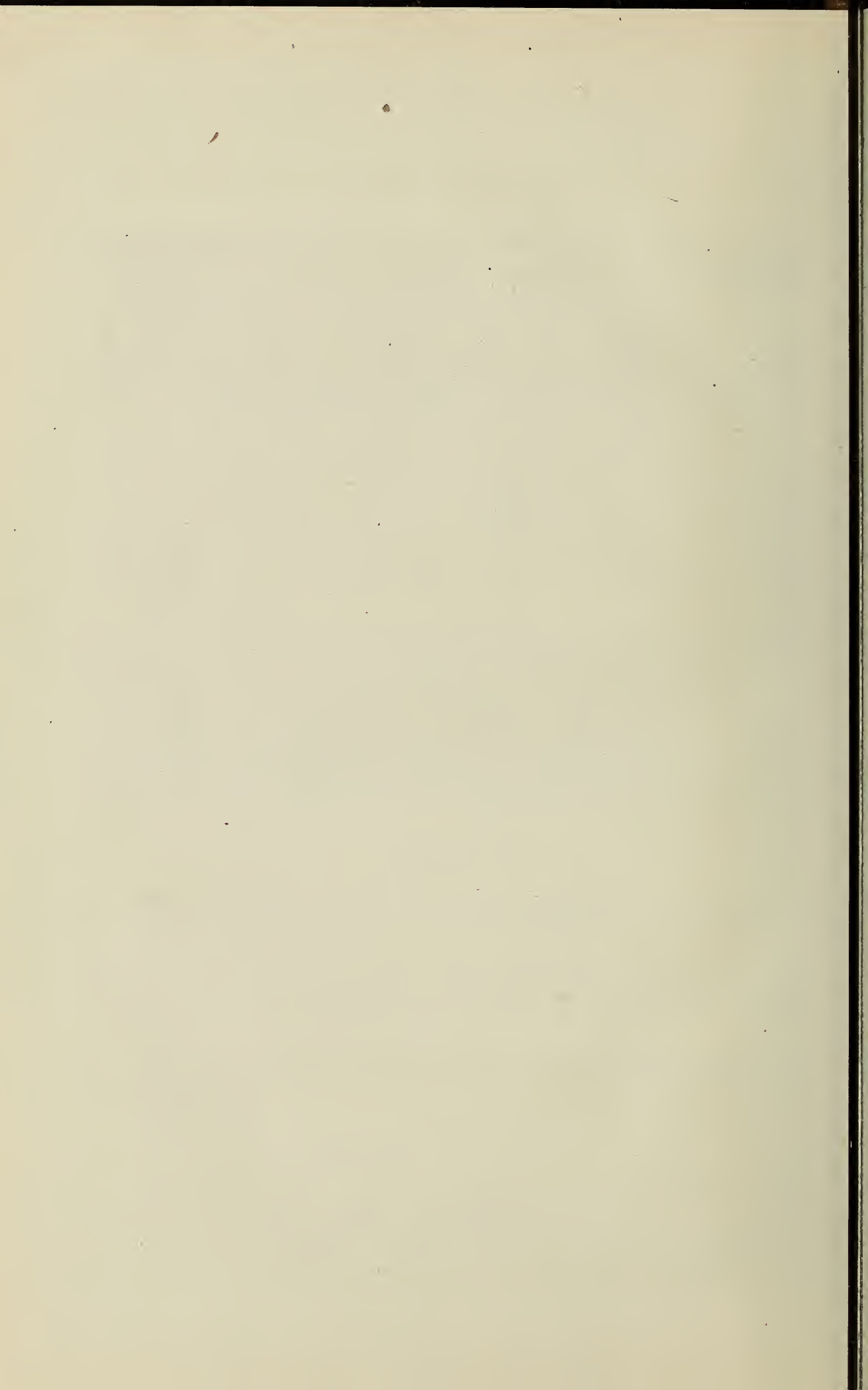

COTTON MACHINERY



FEEDERS
SELF-FEEDING OPENERS
BREAKER, INTERMEDIATE AND FINISHER LAPPERS
REVOLVING FLAT CARDS
DRAWING FRAMES (ELECTRIC OR MECHANICAL STOP MOTION)
SLUBBING, INTERMEDIATE, ROVING AND JACK FRAMES
IMPROVED SPINNING FRAMES
TWISTERS FOR WET OR DRY WORK

H. & B. AMERICAN MACHINE COMPANY

PAWTUCKET, R. I.

BOSTON OFFICE

65 Franklin St.
C. E. RILEY, Pres.

ATLANTA OFFICE

814 Empire Bldg.
E. CHAPPELL, So. Rep.

COTTON MILL MACHINERY SPECIALISTS

POTTER & JOHNSTON MACHINE CO.
PAWTUCKET, R. I.
Picking Machinery and Revolving Flat Cards

WOONSOCKET MACHINE & PRESS CO.
WOONSOCKET, R. I.
Drawing Frames and Roving Machinery

FALES & JENKS MACHINE CO.
PAWTUCKET, R. I.
Spinning and Twisting Frames

EASTON & BURNHAM MACHINE CO.
PAWTUCKET, R. I.
Spooling and Winding Machinery

T. C. ENTWISTLE CO.
LOWELL, MASS.
Warping, Beaming and Balling Machinery

SOUTHERN AGENT

J. H. Mayes, - - Charlotte, N. C.
1112 Independence Building

THE
Whitin Machine Works

WHITINSVILLE, MASS.

BUILDERS OF

**COTTON MILL
MACHINERY**

**Cards, Combers, Drawing Frames,
Roving Frames,
Spinning Frames, Spoolers,
Twisters, Reels,
Long Chain Quillers, Looms and
Dobbies**

SOUTHERN AGENT

STUART W. CRAMER

CHARLOTTE, N. C.

For the best results on your spinning frames, they
should be equipped with our

**Rabbeth Centrifugal Clutch
Spindles**

Mirror Spinning Rings

(Trade Mark Reg. U. S. Patent Office)

Rhoades-Chandler Separators

**Shaw & Flynn Lifting Rod
Clearers**

AND

Speakman Lever Screws

DRAPER COMPANY

HOPEDALE, MASS.

J. D. CLOUDMAN, Southern Agent,

40 So. Forsyth St., Atlanta, Ga.



NORTHROP LOOMS

TRADE MARK REGISTERED

EARN More Wages for the Weaver
Larger Dividends for the Mill

DRAPER COMPANY

HOPEDALE, MASS.

SACO-LOWELL SHOPS

NEWTON UPPER FALLS—LOWELL—BIDDEFORD

COMPLETE COTTON MILL EQUIPMENTS

CARDS

DRAWING

SLUBBERS

INTERMEDIATES

FINE FRAMES

JACK FRAMES

SPINNING FRAMES

TWISTERS

SPOOLERS

WARPERS

SLASHERS

WARTER BEAMS

SIZE KETTLES

SIZE PUMPS

SIZE SYSTEMS

BALLERS

DUCK BEAMERS

PLAIN FANCY AND DUCK LOOMS

CAMLESS WINDERS

SOUTHERN OFFICE:

CHARLOTTE, N. C.

ROGERS W. DAVIS, SOUTHERN AGENT

SACO-LOWELL SHOPS

NEWTON UPPER FALLS—LOWELL-- BIDDEFORD

MANUFACTURERS OF COMPLETE

PICKING AND WASTE RECLAIMING EQUIPMENTS

Bale Breakers Conveying Systems
Condensers Distributors
Breaker Lappers Intermediates
Finisher Lappers Thread Extractors
Roving Waste Openers
Hard Waste Openers
Card and Picker Waste Cleaners
4-Coiler Waste Cards Lap Winders

SOUTHERN OFFICE:

CHARLOTTE, N. C.

ROGERS W. DAVIS, SOUTHERN AGENT

COTTON MILL MACHINERY

CARDS

SPINNING

MASON MACHINE WORKS TAUNTON, MASS.

MULES

LOOMS

Southern Office, Charlotte, N. C. EDWIN HOWARD, Agent

Wm. Firth, Pres. Edwin Barnes, Vice-Pres. John H. Nelson, Treas.

WILLIAM FIRTH COMPANY

558-559 John Hancock Bldg., 200 Devonshire St., Boston, Mass.

Sole Importers of

ASA LEES & COMPANY, LIMITED TEXTILE MACHINERY

of every description for cotton, woolen and worsted

SOLE AGENTS FOR

Joseph Stubbs, Limited, Gassing, Winding and Reeling Machinery for Cotton, Worsted and Silk.

George Orme & Co., Patent Hank Indicators, Etc.

William Tatham, Limited, Waste Machinery

R. Centner Fils, Heddles.

Goodbrand & Co., Yarn Testing Machinery, Warp Reels, Etc.

Joshua Kershaw & Son, English Roller Skins, Etc.

Buckley & Crossley, Spindles, Flyers and Pressers, Etc.

George Smith, Doffer Combs, Etc.

Bradford Steel Pin Co., Comber Pins.

ALSO AGENTS FOR

Joseph Sykes Bros., Hardened and tempered steel Card Clothing for Cotton.

Dronsfeld Bros., Limited, Emery Wheel Grinders, Emery Fillet and Flat Grinding Machines.

United Velvet Cutters Association, Limited, Corduroy Cutting Machines, Etc.

George Thomas & Co., Tachometers, &c.

Pick Glasses, Leather Aprons, Patent Wire Chain Aprons.

CALL ON US
WHEN YOU COME TO TOWN

MODERN POWER PLANTS STEAM HYDRAULIC ELECTRIC

A. H. WASHBURN CO.
CONTRACTING ENGINEERS

CHARLOTTE, N. C.

REALTY BLDG.

SOUTHERN AGENTS

CURTIS & MARBLE MACHINE CO.
BOOMER & BOSCHERT PRESS COMPANY
H. W. BUTTERWORTH & SONS COMPANY
TOLHURST MACHINE WORKS
C. G. SARGENT'S SONS CORPORATION
DELAHUNTY DYEING MACHINE COMPANY

FORT WAYNE ELECTRIC WORKS
HOOVEN, OWENS RENTSCHLER COMPANY
LOMBARD IRON WORKS AND SUPPLY CO.
WHITLOCK COIL PIPE COMPANY
AMERICAN BLOWER COMPANY
LAIDLAW, DUNN, GORDON COMPANY
GOLDEN FOUNDRY AND MACHINE CO

YOU WILL BE
CORDIALLY RECEIVED

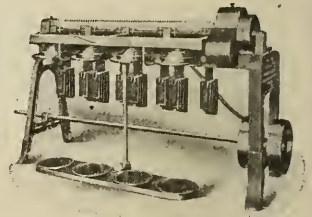
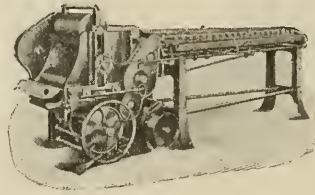
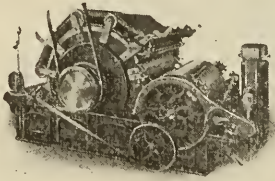

PICKING MACHINERY
 REVOLVING FLAT CARDS
 LAP WINDERS
 DRAWING FRAMES
 EVENER DRAWING
 FRAMES

SACO-LOWELL SHOPS

SLUBBERS
 INTERMEDIATES FINE
 and
 JACK ROVING FRAMES
 SPINNING FRAMES
 SPOOLERS and REELS

BUILDERS OF
 IMPROVED
 COTTON
 MILL
 MACHINERY

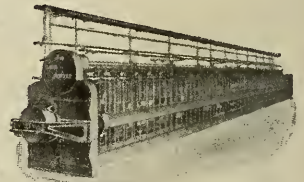
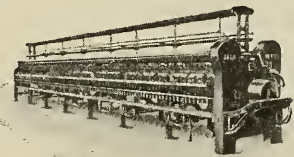

WE WANT YOU TO
 LEARN ABOUT THE
 MANY IMPROVE-
 MENTS WE HAVE
 MADE

WORKS AT
 NEWTON UPPER FALLS, MASS.
 BIDDEFORD, MAINE
 LOWELL, MASS.

WE WANT EVERY-
 BODY TO KNOW
 HOW WELL WE
 BUILD OUR
 MACHINERY

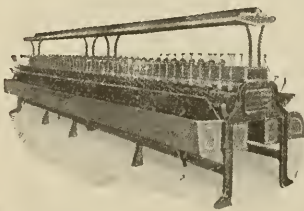

ROGERS W. DAVIS
 SOUTHERN AGENT
 Suite 1000 Realty Building
 CHARLOTTE, N. C.
 WRITE FOR CATALOGUE

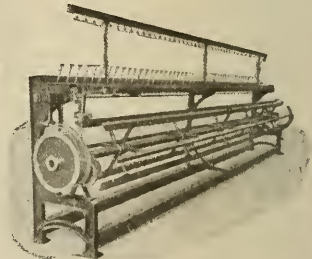

Manufacturers should look up the advantages of

The Metallic Drawing Roll

Over the leather system before placing orders for new machinery, or, if contemplating an increase in production, have them applied to their old machinery.

25 TO 33 PER CENT

More Production Guaranteed

Saves: Roll Covering, Varnishing, Floor Space, Power,
Waste and Wear.

One-Third Less Weight Required

Runs Successfully on: Railway Heads, Drawing Frames,
Sliver Laps, Ribbon Laps, Comber Draw Boxes,
Detaching Rolls, Slubbers and Intermediate Roving
Frames.

Write for points claimed and particulars to

THE METALLIC DRAWING ROLL CO.

Indian Orchard, Massachusetts

The Highest Standard of Loom Harness Quality

Those who use our loom harnesses little realize how many harnesses fail to pass the rigid inspection which they are obliged to undergo. We criticize our own work more severely than it is criticized by anyone else and throw out harnesses which probably would not be criticized by the user. It is this policy which has given our harnesses a reputation for always being uniform in quality.

Let us tell you more about these Harnesses.

GARLAND MFG. CO., Saco, Maine



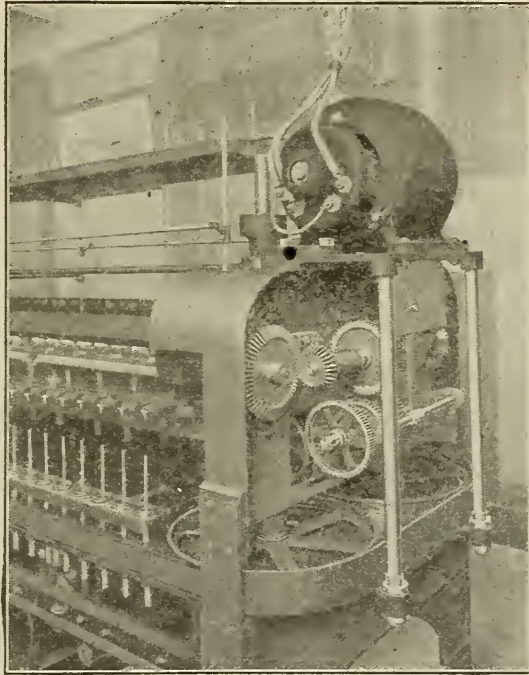

This Spinning Frame

was originally built with ordinary plain bearings on the two large vertical shafts. $7\frac{1}{2}$ horsepower was required to run it, and the plain bearings heated so that the machine had to be stopped after a half-hour's run.

HESS-BRIGHT BALL BEARINGS

Built for Endurance

were substituted for the plain bearings. The power required was thereby reduced to $2\frac{1}{2}$ horsepower, and the machine runs all day without heating.

The Hess-Brights require oiling only about once in six months, and no other attention of any sort. They are permanently snug, as well as cool and free-running.

Hess-Brights are solving difficult bearing problems for many builders and users of textile machinery.

Hess Bright Ball Bearing Line Shaft Hangers are the most frictionless and most durable of their kind. The highest in price, they are the most economical in the end.

Our Engineering Department will answer your request for further information.

THE HESS-BRIGHT MFG. COMPANY
55 East Erie Ave., Philadelphia, Pa.

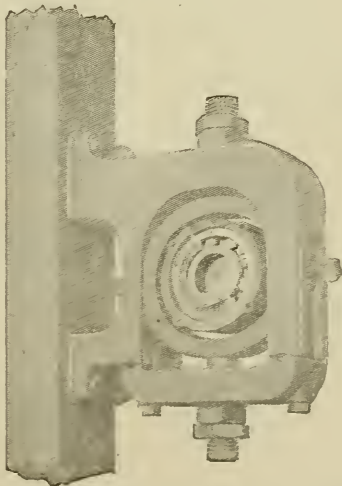

THE STANDARD SINCE 1835

HOYT'S FLINT STONE LEATHER BELTING

THE best drawn and most exacting belt specifications will not insure your getting the best belt for your service.

Your machinery might require an extra heavy single belt,—or on the other hand a light double thick one would more favorably influence toward the highest machine efficiency.

Hoyt's Flintstone Leather Belting is cut and built with a view to its meeting the most exacting requirements of shop and machine tool operation.

Two different Hoyt's Flintstone Belts, designed to meet the same conditions will gauge up to within almost micrometer measurement of each other.

We have employes who have been with us for over forty years (and younger ones following in their footsteps) who have never worked elsewhere. These men will gauge a hide to make a certain weight belt and when the belt is built an accurate scale will show their selection to have been as nearly correct as predetermination can make.

That is but one feature of the expert service that helps to make Flintstone Leather Belting the best that's made.

Let our corps of belting engineers suggest the solution of your problems.

ESTATE

Edward R. Ladew

GLEN COVE, N. Y.

Charlotte, N. C.
Philadelphia
Portland, Ore.

New York
Newark, N. J.
Providence, R. I.

Boston
Chicago
Atlanta

Pittsburg
Tacoma
Milwaukee

EMMONS LOOM HARNES CO.

MAY STREET, LAWRENCE, MASS.

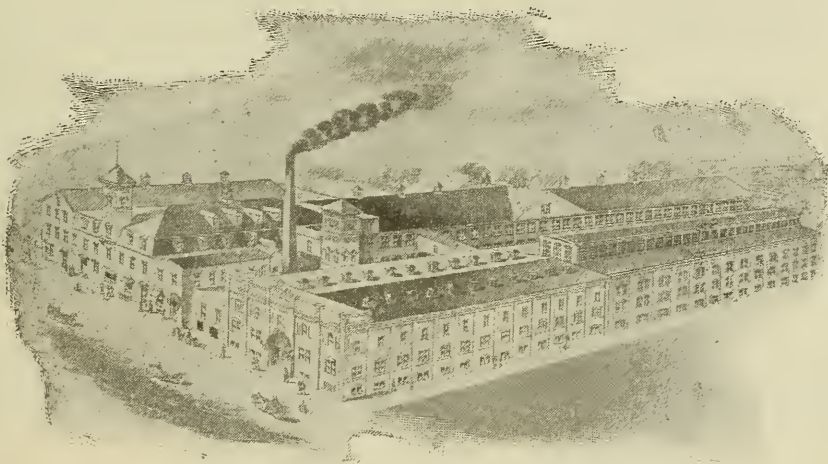

COTTON HARNES, MAIL HARNES AND REEDS

For Cotton, Duck, Worsted and Silk Goods

SELVEDGE HARNES

Any depth up to 24 inches, for weaving Tape Selvedges

Beamer and Dresser Hecks

Mending Eyes and Mending Twine

Slasher and Striking Combs

Warper and Leice Reeds

Baked { English Harnes Mail Jacquard Heddles
 { Mail Harnes Cotton Selvedges
 { French Braided Heddles Mail Selvedges

For Broad Silks and Ribbons

“Emmons’ False Reed” or Thread Clearer

Patented Feb. 13, 1906

A CLEARER MADE OF THREAD, BAKED FINISH

Will wear as long as the harnes

ALFRED SUTER TEXTILE ENGINEER

200 FIFTH AVENUE, NEW YORK

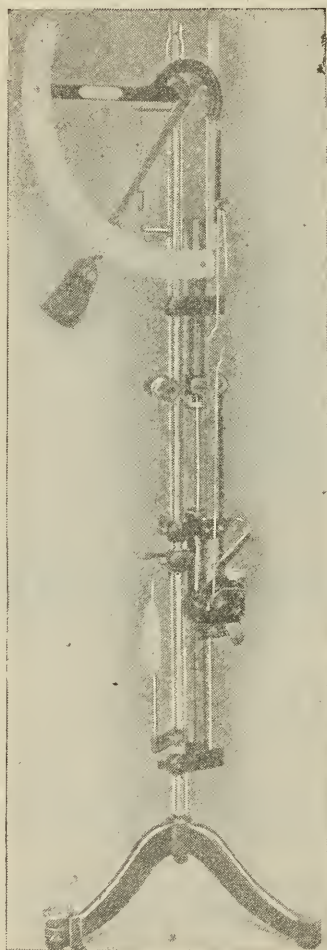

AUTOMATIC STRENGTH AND
ELASTICITY TESTER
FOR YARNS

Importer of Baer's Yarn and
Cloth Testing Apparatus

such as

Direct Yarn Numbering Scales

Yarn and Roving Reels

Twist Testers

Strength Testers

Conditioning Ovens

Evenness Testers

Microscopes

Pick Counters

Hank Counters for Spinning

Frames, etc.

also

Warp Sizing Machines

Yarn Conditioning Apparatus

Yarn and Cloth Mercerizing

Machines of Latest Types

CATALOGUES AND INFORMATION
GLADLY FORWARDED



NEW TWIST TESTER WITH TAKE-UP REGISTER AND MAGNIFYING GLASS
FOR SPINNING TWIST

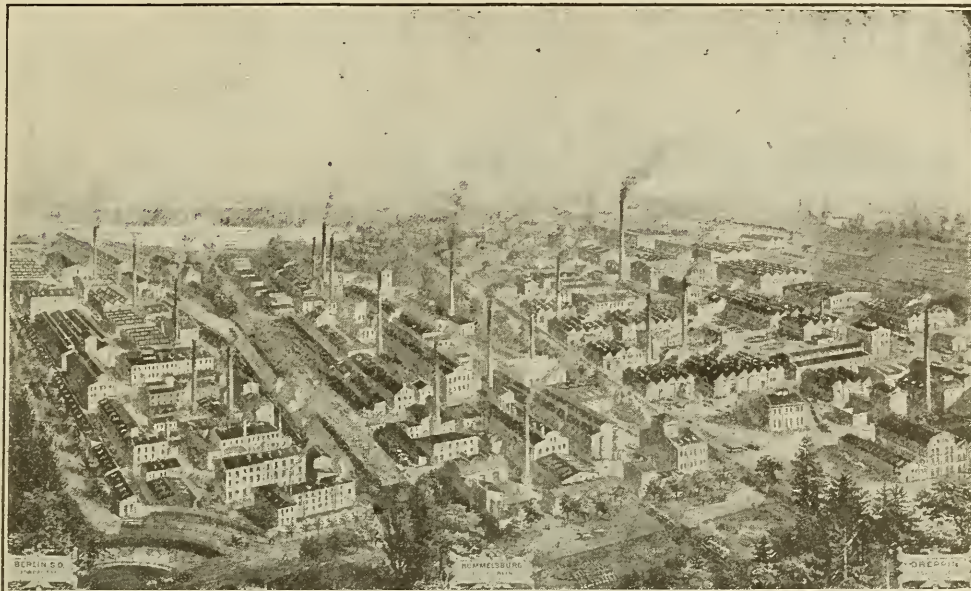

BERLIN ANILINE WORKS

Main Office: 213-215 Water Street, New York

Branches: Boston; Chicago; Philadelphia; Montreal

SOUTHERN BRANCH

TRUST BUILDING, CHARLOTTE, N. C.

Dyes for All Textile Purposes

Direct Colors, Sulphur Colors, Developed
Colors, Aniline Salt, Aniline Oil, etc.

Constantly bringing out New and Improved Products

Capable Salesmen and Expert Demonstrators
connected with all offices

The Most Popular Dye Concern in the World

Economical Cotton Dyeing and Bleaching

In the Psarski Dyeing Machine

Saves Labor
Saves Dyes
Saves Drugs
Saves Steam
Saves Water

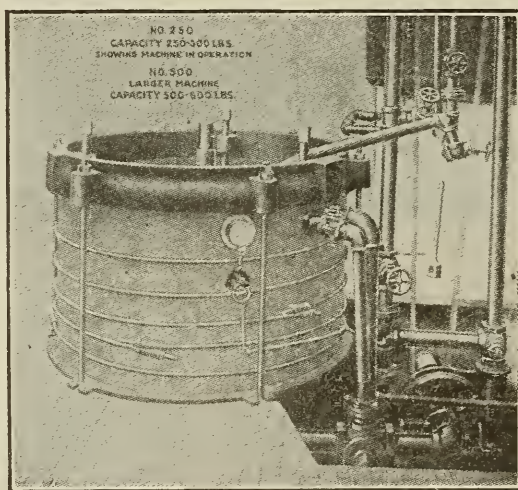

Saves
Fibre



Sulphur—Developed—Vat Dyes
Done Equally Well

RAW STOCK DYEING—The cotton goes to cards in as good condition as directly from bales. Is not rolled into balls and strings.

BLEACHING—Bleached and washed PERFECTLY CLEAN—FREE FROM CHLORIN OR ACID. 3½ hours to batch. Is not pounded and twisted into practically waste.

SKEIN DYEING—No Boiling Out—No Tangles—Yarns are left Smooth and in perfect condition for winding, knitting, etc.

HOSIERY—Recommended size of machine does 300 pounds to batch, SULPHUR OR DEVELOPED BLACKS. It is not Roughed—No Singeing required—No Sorting—No Damaged.

15 to 20 per cent Saving in Drugs

The Psarski Dyeing Machine Co.
3167 Fulton Road CLEVELAND, OHIO

F. J. MUIR
Greensboro, N. C.
Agent Southern States

WM. INMAN
964 No. Cambridge St., Milwaukee
Agent Western States

R. D. BOOTH
933 No. Broad St., Philadelphia
Agent Eastern States

Problems in Dyeing



WE are prepared to dye any shade upon any fabric submitted, or we will match any required shade and submit exact dyeing directions. Information of a technical nature cheerfully given. No charge is made for such service, and in accepting it there is no obligation to purchase from us anything that you can buy or that you think you can buy to better advantage elsewhere.

Cassella Color Company

182-184 Front Street : New York

BOSTON, 39 Oliver Street PHILADELPHIA 126-128 S. Front St.
PROVIDENCE, 64 Exchange Place ATLANTA, 47 N. Pryor St.
MONTREAL, 59 William Street

DE HAVEN'S High Carbon Steel Spinning Travelers, Bronze Composition and Bronze Twister Travelers. Specially treated Travelers for silk spinning.

DE HAVEN'S High Carbon Steel Spinning Traveler is the only Traveler on the market made from steel wire in which the hardening elements are introduced before the Travelers are formed. They are the most uniform in temper, and the most durable Travelers manufactured.

MADE ONLY BY

De Haven Manufacturing Co.

50 Columbia Heights

BROOKLYN, N. Y.

BRANCHES

Chicago, San Francisco, Glasgow and London

WILLIAM FIRTH, Pres,

FRANK B. COMINS, Vice-Pres. and Treas.

AMERICAN MOISTENING COMPANY

120 Franklin Street, Boston, Mass.

Comins Sectional Humidifier

Makes This System Absolutely Perfect

Our system has been most advantageously adopted by the representative mills of this country. Our system will increase your production and overcome troublesome electricity, making your carding, spinning and weaving run much better. It will reduce your waste account and generally prove a profitable investment. With our system a

PERFECT-CARDING, SPINNING OR WEAVING ATMOSPHERE
IN ANY CLIMATE OR WEATHER IS ASSURED

Over 70,000 of our Humidifiers in Operation

Purifies the Air and makes it Healthier for the Workpeople
Write for Booklet on Humidification

Southern Representative: JOHN HILL

Atlanta, Ga.

IT PAYS TO USE THE BEST
SHUTTLE POSSIBLE TO OBTAIN

THE GAIN IN EFFICIENCY
OF YOUR LOOMS AND THE
LESSEned YEARLY COST FOR
SHUTTLES WARRANT USING

SHAMBOW SHUTTLES

SHAMBOW SHUTTLE COMPANY
WOONSOCKET, R. I.
PATENT HAND THREADING SHUTTLES

What 4c a Month Will Do for You

You buy your magazines for their value to you and irrespective of their price. You are not adverse to getting big value at small cost. Here it is.

COTTON will bring you the best ideas of a long line of able and practical men. These men are paid contributors. You could not buy their individual service and advice short of many hundreds of dollars.

For \$1 you can get COTTON two years. It will contain over 800 pages of reading matter pertaining to textile work. Almost an encyclopedia of textile information.

Sample copy free on request.

COTTON PUBLISHING CO.
Atlanta, Ga.

"The Blue Book," Textile Directory

The only
Textile
Directory
issued with



thumb
indexes
for quick
reference.

Contains the Latest Reports from all

Cotton Mills	Cotton Goods Converters
Woolen and Worsted Mills	Yarn Dealers
Carpet Mills	Raw Silk Importers, Dealers, Etc.
Silk Mills	Cotton Dealers
Knitting Mills	Mattress Manufacturers
Jute, Linen and Flax Mills	Wool and Hair Dealers
Canadian Mills	Waste Dealers and Manufacturers
Dyers, Finishers and Bleachers	Wholesale Rag Dealers
Dry Goods Commission Merchants	Fibre Brokers

Separate List of New Mills
Textile Maps of the New England States, Middle Atlantic States, Middle Western States and Southern States, showing all Towns at which Mills are located
List of 572 Railroads on which Textile Mill Towns are located
Thumb Index dividing Office Edition into 14 Sections, Pocket Edition into 12 Sections
Alphabetical Index to Mills and Owners
Classified Directory of Cotton and Woolen Mills, showing under each heading all Mills making each line of goods, with Nos. of Yarns made by Spinners
Textile Supply Directory, giving Manufacturers of Chemicals, Dye Stuffs, Yarns Textile Machinery and Supplies of all kinds, thus enabling the trade to communicate with first hands.

A SPECIMEN MILL REPORT SOUTH CAROLINA.

LANCASTER, Lancaster Co. (N.) Pop. 3,500. RR. 250,443.
Lancaster Cotton Mills. Inc. 1905. Cap. \$1,000,000. Leroy Springs, Pres.; W. C. Thomson, Sec., Treas. and Buyer; A. H. Robbins, Supt. Sheetings and 1 to 30 Single and Ply Yarns for market. 120 Cards. 1,578 Broad Looms 74,184 Ring Spindles. 11 Boilers. Electric Power. Employ 1,050. Deering, Milliken & Co., N. Y. and Boston Selling Agts. for Cloth; Yarns sold direct.

Office Edition, 1,100 Pages, Price \$4, Delivered. Pocket Edition, 1,000 Pages, Price \$3, Delivered

Circular giving full contents sent on request

DAVISON PUBLISHING COMPANY, 407 Broadway, New York



FIRE : LIGHTNING : WINDSTORM

The HOME INSURANCE COMPANY
NEW YORK

ELBRIDGE G. SNOW, President
Organized 1853 Main Offices 56 Cedar St.

Cash Capital, \$3,000,000

Assets, January 1, 1912	\$32,146,565
Liabilities (Including Capital)	16,521,125
Reserve as a Conflagration Surplus	1,800,000
Net Surplus over all Liabilities and Reserves	13,815,440
Surplus as Regards Policy Holders	18,615,440
Losses Paid Since Organization, over	132,000,000

Any one interested in maintaining a manufacturing or distributing plant may have, for the asking, helpful suggestions and proper advices relating to the Standards of CONSTRUCTION and PROTECTION and safeguarding of the FIRE HAZARD by applying to the agents of the HOME INSURANCE COMPANY, anywhere, or to the Department of Improved Risks, 56 Cedar Street, New York City.

TEXTILE DEPARTMENT

NORTH CAROLINA

A. and M. COLLEGE.

**FULL EQUIPMENT FOR PRACTICAL AND THEORETICAL
INSTRUCTION IN COTTON MANUFACTURING.**

COURSE OF INSTRUCTION :

1. Two Year Course in Cotton Manufacturing.
2. Four Year Course in Cotton Manufacturing.
3. Textile Chemistry and Dyeing.

The courses include Picking; Carding; Combing; Ring and Mule Spinning; Warp Preparation; Designing; Plain, Dobby and Jacquard Weaving; Textile Chemistry and Dyeing; Mill Accounting.

For catalogue and other information, address,

THOMAS NELSON,
WEST RALEIGH, N. C.



LIBRARY OF CONGRESS

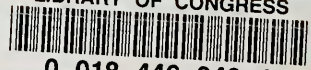

0 018 446 340 4

