



ADVANCED TYPE OF COTTON ROVING FRAME
Providence Machine Co.

Cotton Spinning

A Complete Working Guide to

MODERN PRACTICE IN THE MANUFACTURE OF COTTON YARN, INCLUDING
THE NATURAL CHARACTERISTICS OF THE DIFFERENT VARIETIES
OF COTTON, GRADING AND MECHANICAL TREATMENT OF
FIBER, AND CONSTRUCTION, OPERATION,
AND CARE OF SPINNING MACHINERY

By CHARLES C. HEDRICK
Mechanical Engineer
Lowell Machine Shop, Lowell, Mass.

ILLUSTRATED

3
3 3 3
0 3
3 3 3
3 3

CHICAGO
AMERICAN SCHOOL OF CORRESPONDENCE
1909

TS 1519
-124

LIBRARY of CONGRESS
Two Copies Received
MAR 22 1809
Copyright Entry
Jan. 8, 1909
CLASS a XXG. No.
227394
COPY B.

**COPYRIGHT 1908 BY
AMERICAN SCHOOL OF CORRESPONDENCE**

Entered at Stationers' Hall, London
All Rights Reserved



9-9357

Foreword



THE Textile Industry has shared to such an extent the modern tendency toward specialization, and has been marked by the development of such a multiplicity of types of machinery and special mechanical and chemical processes, that the various branches of this great industry to-day constitute in reality distinct though closely related arts. The present volume is intended to supply a working guide to the latest approved practice in the fundamental branch of Cotton Spinning, covering every detail from the growth and natural characteristics of the different varieties of cotton and the grading of cotton fiber, to the mechanical treatment of the raw material and the machinery and processes involved in the creation of the finished product.

Special stress is laid on the *practical* as distinguished from the merely theoretical or descriptive form of treatment, the work being based on a careful study of conditions and needs as developed in the best American mills.

This volume will be found especially adapted for purposes of self-instruction and home study, fitted not only to meet the needs of the beginner in textile art, but also to serve as a reference work and instruction manual full of information and suggestions of great practical value to the most advanced and experienced textile worker.

¶ The method adopted in the preparation of this volume is that which the American School of Correspondence has developed and employed so successfully for many years. It is not an experiment, but has stood the severest of all tests — that of practical use—which has demonstrated it to be the best method yet devised for the education of the busy workingman.

¶ For purposes of ready reference, and timely information when needed, it is believed that this volume will be found to meet every requirement.

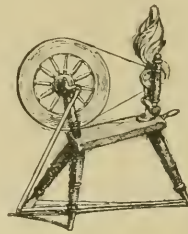

Table of Contents

COTTON PLANT AND FIBER Page *11

Historical Sketch—World's Cotton Crop—Varieties of Cotton—Cultivation—Picking—Ginning—Baling—Structure of Fiber—Commercial Varieties (Sea Island, Egyptian, Gulf, Upland, Texas, Peruvian)—Grading

PRELIMINARY MECHANICAL PROCESSES Page 32

Opening Bales—Mixing—Systems of Picking—Automatic Feeder and Opener—Cleaning Trunks—Breaker Picker with Condenser and Gauge-Box—Intermediate and Finisher Pickers—Beaters—Breaker Picker with Screen—Combination Breaker and Finisher—Blowing Systems—Eveners—Automatic Safety-Stop and Knock-Off Devices—Calculation Rules for Picker and Finisher—Carding and Card-Room Arrangement—Theory of Carding—Feed-Plates—Leader, Cylinder, and Flats—Cylinder Doffer and Flats—Settings—Gauges for Setting Doffer, Leader, Feed-Plate, Screens, Back and Front Plates, etc.—Gearing of Cards—Coiler—Stop Motions—Flexible Bend and Adjustments—Flat Chain—Adjustable Cylinder Bearing—Clothing for Leader, Cylinders, Doffer, and Flats—Defects in Clothing—Foundation for Clothing—Applying Clothing—Wire Points per Square Foot in Clothing—Kinds of Wire for Card Clothing—Grinders (Long-Roll, Traverse, Flat)—Speed of Grinder Rolls—Grinding Former—Burnishing—Stripping-Card Calculation Rules—Combing—Silver Lap Machine—Ribbon Lapper—The Comb—Calculation Rules for Combing Machines—Feed Motion of Comb—Timing Dial—Nipper and Cushion Plate—Detaching Roll Motion—Top Comb—Detaching Roll Cams—Top Comb Motion—Timing the Setting of Comber Parts—Comber Gearing—Drawing—Railway Head—Evener Motion—Gearing of Railway Head—Drawing Frame—Arrangement and Operation of Drawing Frames—Stop Motions (Electrical, Mechanical Back, Full Can, Calender Roll)—Clearers—Sizes of Fluted Rolls—Setting of Rolls—Top Rolls—Draft Gearing of Drawing Frame—Drawing Frame Calculations—Table of Change Gears—Fly Frames—Weight and Standard Twist for Roving—Flyer Lead and Bobbin Lead—Fly Frame Gearing—Cones—Reversing Motion—Builder—Full Bobbin Stop Motion—Back Stop Motion—Calculation Rules for Draft and Twist Gearing in Fly Frames—Sizes of Bobbins

RING SPINNING Page 269

Ring Frames—Spinning Room Arrangement—Creel—Roll Stands—Thread Board—Thread Guide or "Pig Tail"—Roller Beam—Ladder or Spindle Rail—Spindle—Ring Rail—Drum and Supports—Creel Rod—Cross-Shafts—Lifting Rods—Separators—Adjustable Feet—Drum-Box—Weighting of Rolls—Rings and Plate-Holders—Ring Travelers—Builders (Warp, Filing, Combination)—Warp and Filing Bobbins—Ring Frame Gearing and Calculations—Speed of Rolls and Spindles—Programs of Drafts and Weights

MULE SPINNING Page 307

The Mule—Mule Carriage—Headstock or Mule Head—Mule Gearing—Backing-Off Motion—Backing-Off Chain—Tightening Motion—Fallers—Winding—Clutches—Quadrant—Builder or Copping Rail—Roller Motion—Snarling Motion

INDEX Page 333

*For page numbers, see foot of pages.

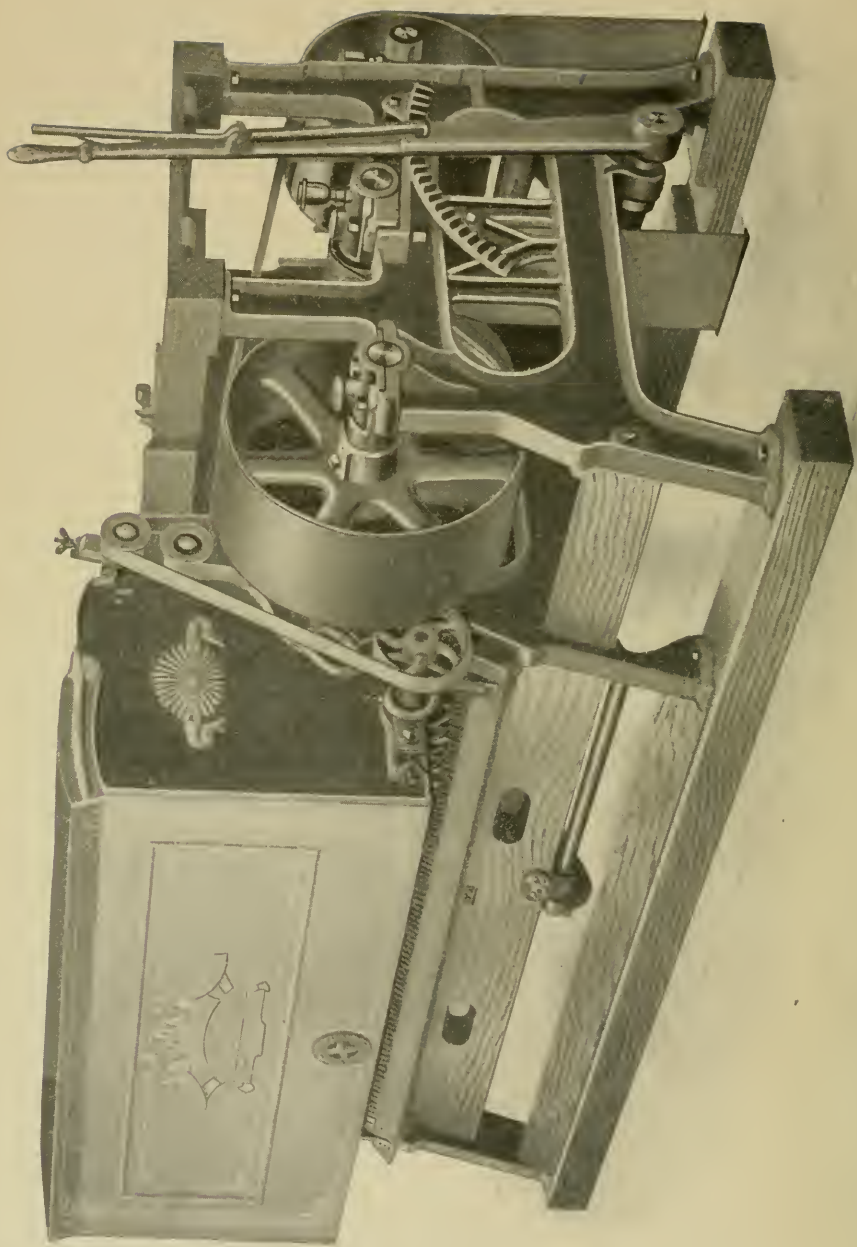

MUNGER MAIN BELT HULLER COTTON GIN
Continental Gin Co.

COTTON FIBER.

Before studying the manufacture of cotton, it will be interesting to know something of the history, botany and general characteristics of the plant, and of the early records of the application of its fiber to the manufacture of cloth.

It is probable that to the Hindoos should be credited the first practical use of the cotton fiber. Early records show that it was known as early as 800 B.C. both as a plant and as a textile.

Heroditus, 445 B.C., makes mention several times of the cotton plant, and of the fiber for the manufacture of cloth.

The cultivation of the plant or the manufacture of cloth from the fiber did not attract much attention at this time in any country but India; in fact, from about 1500 B.C. to 1500 A.D. India was the center of the manufacturing as well as the cotton-raising industry.

Although flax was the article most used by Egyptian weavers, it is probable that cotton was known to them at a very early date, as Pliny writes: "In upper Egypt, toward Arabia, there grows a shrub which some call *Gossypium* and others *Xylon*, from which the stuffs are made which we call *Xylina*," and his description of the plant which follows refers to cotton.

There is abundant evidence that cotton was grown in the New World prior to the advent of the earlier discoverers.

Columbus in 1492 found cotton growing in the West Indies. He and other explorers found it equally abundant on the mainland, and also found the natives showing considerable skill in the manipulation of its fiber in the manufacture of cloth, fish lines and nets.





Cortez found cotton in Mexico in 1519, and used it in stuffing the clothing of his soldiers as a protection against the natives. Pizzaro found cotton in Peru in 1522, and cotton cloth has been found in the ancient tombs of that country. De Vica in 1536

found the cotton plant growing in that region which is now Texas and Louisiana.

Summing the matter up, we are led to believe that on a belt of the earth's surface coinciding very nearly with the cotton belt of to-day, the plant was found either in a wild or cultivated state in the earliest ages of which we have records.

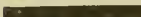
At the present day the cotton-raising territory includes practically the whole of India, parts of China and Japan, Central Asia, the valley of the Nile in Egypt, and Syria in the Old World. In the New World, the Southern States and their islands, Mexico, Brazil, Peru, and several islands in the Pacific.

The following diagram shows approximately the proportions of the world's crop raised in the various countries mentioned. The figures given represent bales of five hundred pounds each.

	World's Crop	1892-93	11,950,000
	United States	1892-93	6,700,000
	India	1892-93	2,200,000
	China	1892-93	1,200,000
	Egypt	1892-93	1,000,000
	South America	1892-93	225,000

COTTON IN THE UNITED STATES.



According to the most reliable records, the first cotton cultivated in the American colonies was in Virginia, in 1609.

A more extensive effort at cotton cultivation was undertaken in the same colony in 1621, at which time "cotton wool" was quoted at eight shillings per pound. English colonists in the Carolinas undertook the cultivation of cotton about 1660.

The first export of any considerable amount of cotton occurred in 1770, at which time twenty bales were shipped to Liverpool.

One hundred years later the exports amounted to about three million bales, and at the present time the export of American cotton is between six and seven million bales annually.

The following diagram allows a comparison between the world's crop and the crop of the United States for the years 1893 and 1900. It will be seen that in 1900 Texas alone produced thirty-four per cent of the crop of the United States, and about twenty-five per cent of the world's crop.

	World's Crop	1893 and 1900
	United States	1893 and 1900
	Texas	1900

The following table gives approximately the amounts of cotton raised in the different states of the United States for the years 1870, 1895 and 1900. The figures given represent bales of five hundred pounds each.

	1870	1895	1900
Alabama	429,500	1,000,000	1,023,000
Arkansas	248,000	850,000	813,000
Georgia	474,000	1,300,000	1,203,000
Louisiana	351,000	600,000	705,000
Mississippi	565,090	1,200,000	1,046,000
North Carolina	145,000	465,000	477,000
South Carolina	224,500	800,000	748,000
Texas	350,000	3,276,000	3,438,000
All others	225,000	410,000	670,000
Total	3,012,006	9,901,000	10,123,000

BOTANICAL VARIETIES.

Cotton is the most widely cultivated and manufactured of all the textiles, and is the product of a plant belonging to the Malvaceæ or Mallow family, to which family also belong the Mallow Hollyhock and Okia. It is known scientifically by its generic name, *Gossypium*.

Among the early botanists much confusion existed in regard to the proper classification of the species growing in different parts of the world, their classifications ranging from three to eighty-eight species. It is generally agreed that Dr. Boyle's classification covers those cottons known to commerce, and can be accepted as satisfactory for all practical purposes. His classification gives *G. Arboreum*, *G. Barbadense*, *G. Herbaceum*, and *G. Hirsutum*.

Gossypium Arboreum, or *Tree Cotton*. This cotton is a perennial, varying in height from six to twenty feet, and sometimes attains a diameter of five inches; the flowers are brownish red, seed green, and adhering strongly to the fibers. The fibers are of a yellowish tinge, soft, silky, and an inch or less in length. This cotton cannot be considered as a cultivated variety, and comparatively little is used.

Gossypium Barbadense. This species is so called from the

fact that it is a native of Barbadoes. It has a yellowish blossom, a black seed which is free from the hairy covering of other varieties, and is distinctly shrubby in growth. Height from six to ten feet. Commercially, this is a very valuable and important cotton, being fine and long stapled. The long, silky cotton known as Sea Island, and the more valuable of Egyptian cottons, belong to this species. By cultivation this species has been extended to the West Indies, the coast of the Southern States and their islands, Central America, Jamaica, Porto Rico, Egypt, Island of Bourbon and Australia.

The yield of lint from Sea Island cotton is in smaller proportion than from any other kind of cotton grown in this country, but on account of the length and quality of its fiber it is adapted to the finest classes of goods, and on that account can be considered a very valuable variety.

Gossypium Herbaceum. This is undoubtedly the hardiest variety of cotton, and on that account has the widest geographical range. Most of the cotton produced in the Old World is of this species, which is generally considered to be of Asiatic origin. It is an annual, and herbaceous in nature; average height, five feet. It has yellow seeds covered with a gray down, fibers adhering strongly to the seeds. Staple of medium length. This cotton is grown in Arabia, India, China, Turkey and Egypt, as well as in this country.

Gossypium Hirsutum. This variety is so named on account of the hairy character of the plant. Maximum height about six feet, but varying greatly in different locations and soils. Seeds are covered with a greenish down. Staple white, and regular in length. The greater proportion of Gulf and Upland cotton cultivated in the United States belongs to this species, though some varieties have more of the characteristics of the *Herbaceum* type.

Another species of cotton, *G. Peruvianum*, is often given, but many botanists include this with *G. Barbadosense*. This cotton is a native of Peru, and is of some importance. Its chief characteristic seems to be a harsh, woolly condition of the fiber, though of good length.

CULTIVATION OF AMERICAN COTTON.

The methods of cultivation and the time of planting and picking vary in the different localities of the cotton-raising portion of the United States, and is due to differences in soil and temperature. Planting is done as early as possible; in fact as soon as danger from frosts has passed. There can be considered two distinct periods in the life of the cotton plant. The first is from the time of planting to midsummer, when every effort is made to secure a strong, vigorous growth. At this time plenty of moisture, sunshine and cultivation are necessary, and tropical conditions are desired to secure and store the strength which will later go to the seed. The second period is from midsummer to the time of picking. Cultivation is now stopped, the ground is allowed to become hard and compact, and dry, cooler weather is desirable. These conditions tend to retard the further growth of the plant, and allow the stored strength to go to the seed.

Cotton is planted in rows three or four feet apart, and appears above the ground in about ten days. As soon as the plants are large enough to give evidence of strength the rows are "chopped out," leaving hills from eight to fifteen inches apart, and from these hills the weaker plants are pulled. From this time until about the end of June the crop is constantly cultivated by means of shovel plows, scrapers and "scooties," to retain the moisture in the soil and to keep the field clear from weeds and crab grass.

In seventy-five or eighty days after planting the blossom appears, and the plant continues to blossom for some time. These blossoms are at first a creamy white; the second day they turn pink or red, and the third day a purplish blue, at which time they drop off. After the dropping of the blossom the seed-pod, or "boll," commences to form, and attains its full growth in from six to eight weeks.

When fully developed the boll bursts, commencing at the apex, and the separations extending down the sides disclose from

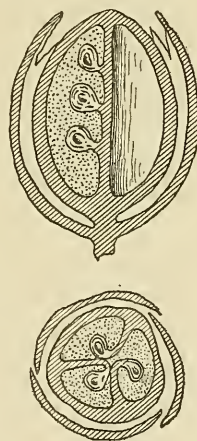

Fig. 1.

three to five cells, divided by walls of membrane. (See Fig. 1.) These cells contain from six to eleven seeds each, or from twenty-eight to thirty-six in each boll. Each seed is covered with the cotton fibers, which are attached at one end in the same manner as the hair on one's head. (See Fig. 2.)

When a sufficient number of bolls are open, picking commences and lasts until frost kills the plant, or until all the ripe fibers are picked, which may be some time after frost in the more northerly sections. It is desirable to pick the cotton as fast as it ripens and before it can be damaged by rain, wind and dust. Cotton fields are, as a rule, picked over three times, generally in September, October and November, although in the Gulf States picking commences in August and sometimes lasts through December.

Picking is done entirely by hand, and the cotton placed in bags hung around the neck or waist of the picker, leaving both hands free to work. These bags are emptied into baskets as fast as filled, and a record of the weight taken, as all picking is paid for by weight. Several

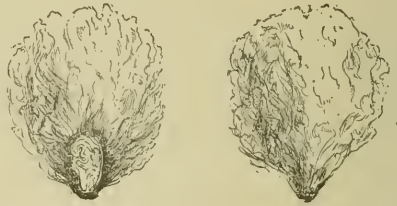

Fig. 2.

forms of cotton-picking machines have been tried, but without much success, as they gather too large a proportion of leaf and boll.

The price paid for picking is from forty to fifty cents per hundred pounds of seed cotton, which would be equal to from one dollar and twenty cents to one dollar and a half per hundred pounds of lint. Pickers have been known to gather as much as four hundred pounds of seed cotton per day, but this is the highest record, and was accomplished under the most favorable conditions. An average day's picking is one hundred pounds.

The foregoing prices for picking apply to Upland cotton under ordinary conditions. The picking of Sea Island cotton commands better prices. From a cent to a cent and a half per pound is generally paid. The yield of Sea Island is less per acre, and more territory must be covered by the pickers for each pound secured. Owing to the greater value of Sea Island cotton more

care is taken in picking, and, as a result, the cotton is more free from leaf and dirt than Upland cotton. The seed cotton is hauled from the field to the storehouse, or directly to the cotton gin, where the seed and lint are separated.

GINNING.

Ginning is the operation of removing the cotton fibers from the seed. Of cotton picked, two-thirds by weight consists of seed and only one-third is material that can be used in the manufacture of cloth. Some cottons are much easier to gin than others, as the seeds are smooth, free from down, and adhere less strongly to the fibers. Sea Island and Egyptian cottons belong to this class.

There are two styles of gins in use: the roller gin and the saw gin; there are also several forms of each, differing in mechanical construction but similar in principle and operation.

The origin of the roller gin dates from the time of the early cultivation of cotton in India. The original roller gin, known as the foot-roller, consisted simply of a flat stone and a round wooden roll. The cotton was spread over the stone and a rolling motion imparted to the roll by the foot of the worker, the effect being to detach the fibers from the seed and force the seed away from the fibers. This primitive form of gin was employed only for hard seeded cotton, and the product of one person was only about five pounds per day.

The next step in advance gave an improvement over the foot-roller, and was known as the "Churka." This "machine" is of very ancient origin, it was formerly used in most of the cotton-growing countries, and can be found in some districts of India to-day. It consisted of two rollers: an upper one of iron about half an inch in diameter, and a lower one of wood about two inches in diameter. These rolls were revolved toward each other, and were fixed in rigid bearings, very close together. The cotton was fed by hand to these rolls, which grasped the fibers and passed them between the rolls. The fibers were freed from the seed by this action, as the seed was too large to pass through the limited space between the rolls. The action of this gin was very easy on the cotton fiber, but the product was small, about eight or ten pounds a day being the capacity of the machine.

The modern roller gin, of which there are several forms used in this country for Sea Island cotton, may be briefly described as follows: The seed cotton is fed on a table, or by an endless apron, to a leather roller, generally of walrus hide. Along the face of this roller, where the seed is delivered, is a steel blade, the edge of which is set close to the surface of the roll, and prevents the passage of seed. The leather-covered roll revolves toward the steel blade, or "doctor," and being rough on its surface draws the fibers under the blade and away from the seed.

There is a rapidly oscillating comb which knocks the seed away from the "doctor" after its fibers have been engaged and drawn under by the rapidly revolving roll. The cleaned seeds fall through slots in the feeding table, and the fibers are cleaned from the roll and delivered by a revolving brush.

The cotton fiber receives little if any damage from the action of the roller gin, and in this particular the roller gin is considered far superior to the saw gin. The chief disadvantage of the roller gin is its limited production, being under average conditions about two bales per day.

A late form of roller gin, known as the Prior gin, differs from others in the construction of the cylinder. In this gin the revolving cylinder is covered with a lagging composed of horse-hair and rubber, giving a rough surface, which readily grasps the cotton fiber. The production of this gin is somewhat in advance of that of the ordinary roller gin, but is much less than that of the average saw gin.

Roller gins are built with both single and double rollers.

The saw gin (Fig. 3), which is generally used in this country for everything but Sea Island cotton, was invented by Eli Whitney in 1794. The modern saw gin consists of a box or chamber, M, into which the seed cotton is automatically fed by an endless spiked apron. One side of this receptacle consists of a grate of metal bars or ribs, C. Through the slots of this grate project notched steel discs or saws, B, from forty to eighty in number, arranged on an arbor with collars between. The teeth of these saws, which revolve at a speed of three hundred to five hundred revolutions per minute, engage the fiber and pull it from the seed and through the grate, allowing the cleaned seeds to fall through a slot, K, at

the bottom of the box. The cotton fiber clinging to the teeth of the saws is removed by a rapidly revolving brush, H, which, aided by the current of air which it generates, throws the ginned cotton on the floor of the ginhouse, or against condensing cages, which deliver it.

Saw gins are also built with a double set of saws, but their construction is substantially the same. A saw gin of sixty saws, at a speed of four hundred revolutions per minute, will gin about ten bales per day, although a smaller production would give a better quality of product.

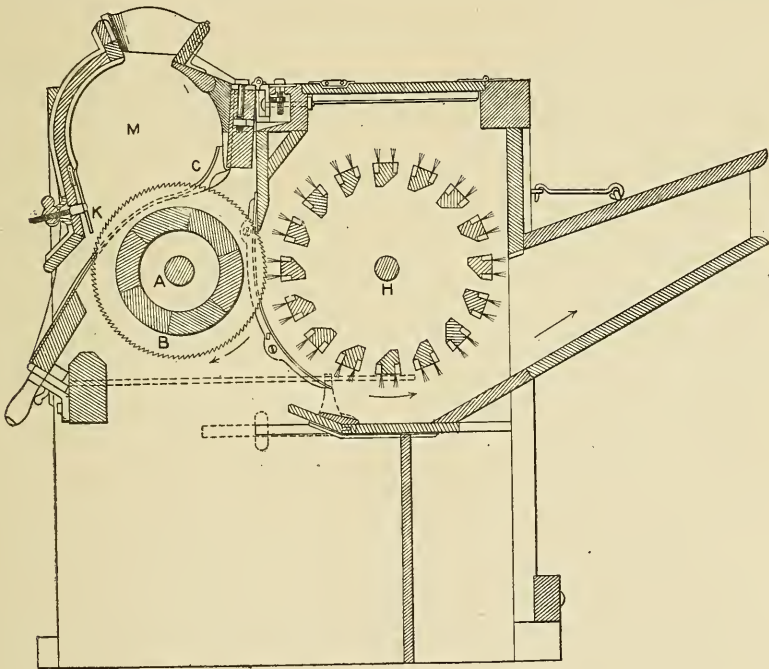

Fig. 3.

There are several conditions which will cause a decided damage to the cotton in the operation of ginning. An experienced judge of cotton can readily detect the result of improper ginning by an examination of cotton in the bale.

Cut staple is the result of too high saw speed, or of having the teeth of the saws too sharp on the edge. This damage is a serious one, as it greatly weakens the fibers that are not actually cut by the operation.

Neppy cotton is another serious condition which may arise from overcrowding the gin, or from the fact that the saws are set too close to the bars of the grate. Neps are little tangled fibers, or tangled bunches of fibers, which are hard to remove from the cotton in the after processes, and the presence of neps in any considerable quantity condemns cotton which otherwise might grade well.

Stringy or "tailed" cotton is the result of ginning when the cotton is too wet. Although not as serious a defect as the two preceding, it has an influence on the grading of the stock and on the action of the cotton in manufacturing operations.

The damage to the fiber in ginning is not present to any extent when roller gins are used, and for that reason roller-ginned cotton will bring a better price, other conditions equal, than saw-ginned cotton. There has for some time been an effort to secure the adoption of some form of roller gin in the South, some manufacturers claiming that roller-ginned cotton is worth to them one-half to one cent per pound more than saw-ginned cotton. Up to the present time no great advance has been made in this direction, but many predict that the roller gin will eventually displace the present form of saw gin.

BALING.

After being ginned the cotton is ready for baling. There are several forms of baling press, the most common of which is the screw press connected with the ginhouse. This press gives a bale which on reaching the market or shipping point is again compressed.

The square bale, or American bale (Fig. 4), though varying greatly in size, is supposed to be fifty-four inches long, twenty-seven inches wide, and to weigh five hundred pounds. The thickness depends upon the amount of compression, and averages about sixteen inches. This bale is covered with coarse burlap bagging and bound with iron hoops or "ties." The American bale has the reputation of being the poorest bale made. The ties, six or eight in number, are hardly sufficient to confine the bale, the covers are generally of poor quality, and the weight of bagging and ties a large per cent of the gross weight. The loss of room in shipping

and the loss of cotton and damage is considerable; in short, the bale is clumsy, dirty, expensive and far from satisfactory.

Egyptian cotton is received in this country in much better shape. The cotton is completely covered by the bagging and bound by eleven or twelve ties. The Egyptian bale (Fig. 5) is compressed to a density of about forty-five pounds to the cubic foot, and weighs on an average seven hundred pounds.

Peruvian cotton is received in smaller bales, of about two hundred pounds weight, and generally in good condition.

There are two other systems of baling, of comparatively recent date, which are attracting considerable attention among manufac-



Fig. 4.

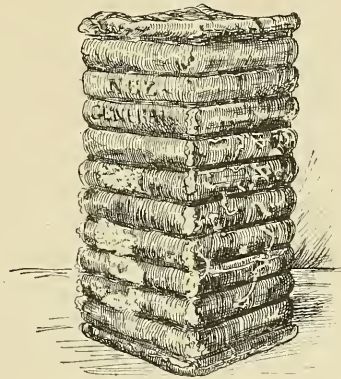

Fig. 5.

turers and cotton planters. One of these is called the Bessonette or "round-lap" system. By this system the lint as it comes from the gin is blown into a reservoir or bat former, where it is converted into an even, continuous sheet. This sheet is wound around an arbor or core under pressure, the pressure being light at first and increasing with the size of the roll. The pressure is applied by revolving iron rolls until the bale becomes of full size and density. By this method of rolling under pressure, bales are produced which are twenty-two inches in diameter, thirty-four and forty-eight inches in length, and averaging 275 and 425 pounds each. The density of this bale is about thirty-five pounds to the cubic foot as against about twenty-two pounds in the American bale. With the Bessonette bale no hoops are needed,

as the bale is covered with a strip of cotton cloth before the baling pressure is released, and the ends of the bale are capped with cloth, also. Of the cotton crop of 1900, about five hundred thousand bales were of this type.

Another form of cylindrical bale is the "Lowry bale." This bale is formed by feeding the cotton loose from the gin into a receptacle, the bottom of which is a revolving plate containing several slots radiating from a center to the circumference. Under this revolving plate is a cylindrical chamber, into which the cotton is first packed by hand. The bottom of this chamber is held by hydraulic pressure. The cotton in the receptacle passes through the slots in the revolving plate, and by the circular motion of the plate is drawn through and placed very compactly in the chamber below. As the bale builds, the pressure of the cotton overcomes the hydraulic pressure, and the bottom of the cylinder is forced downward until the bale has attained the required length. This bale is secured by several wire ties placed longitudinally around the bale and afterward enclosed in cotton cloth. This bale is of uniform size, eighteen inches in diameter and thirty-six inches in length, and is compressed to a density of about forty-five pounds per cubic foot, weighing, with cover, about 250 pounds. There were 122 presses of this type operated throughout the country for the crop of 1900, producing about 375,000 bales.

There are several advantages possessed by both of these cylindrical bales over the old-style American bale. They are easier and cheaper to handle, less waste from sampling, cleaner, smaller percentage of bagging and ties, less risk from fire and greater salvage in case of fire. The insurance and freight are also lower. The Bessonette bale is sometimes called the Underwriters bale.

The tare, or bagging, and ties on the American bale amount to twenty-four to thirty pounds per bale, or about five or six per cent. On either form of cylindrical bale the cover weighs two and one-half or three pounds per bale, giving less than two per cent of tare.

The position of the cotton in the Bessonette bale can be compared to a roll of wide tape. In the Lowry bale its form is more that of a flat coiled spring.

COTTON FIBER.

Although a knowledge of the diseases to which a cotton plant is liable, the insects which affect its growth, and the cost of production in various localities is interesting and valuable, a consideration of the structure of the fiber and the commercial varieties and gradings is far more important.

In every lot of cotton three classes of fibers can be recognized: the ripe, half-ripe and unripe. A perfect cotton fiber consists of four parts: First, an outer membrane; second, the real cellulose, which constitutes about eighty-five per cent of the fiber; third, a central spiral deposit of harder nature; and fourth, a central secretion corresponding to the pith of a quill.

Covering the fiber is a varnish amounting to less than one per cent of the weight of the fiber, and known as "cotton wax." This is the substance which makes the fiber slow to absorb moisture, and which in absorbent cotton has been removed by chemical action.

The cotton fiber, which appears to be a smooth, round filament to the naked eye, has under the microscope a very different appearance. The ripe cotton fiber, when seen under the microscope, has the appearance of a collapsed, twisted tube with corded and slightly corrugated edges, and somewhat resembles an elongated corkscrew. These convolutions or twists of the fiber are peculiar to cotton, and are not present to any extent in any other fiber, either vegetable or animal. To these convolutions is due to a great extent the value of the cotton fiber. The twisting which the fibers receive in the process of spinning interlocks these convolutions of the fiber and gives great strength to the yarn. It also overcomes any tendency of the fibers to slip over each other when tension is applied. Fig. 6 shows the appearance of various fibers under the microscope. A and B represent the appearance of fibers of wool, showing the scales which in spinning are interlocked, which gives considerable strength to woolen yarn. C represents the appearance of a ripe cotton fiber, and shows the twists or convolutions and the corded edges. D represents a fiber of silk and E of camel's-hair. These twists of the cotton fiber are not as numerous in half-ripe fiber, and are almost lacking in the unripe or immature fiber. Owing to this fact the unripe fiber is

of little value to manufacturers. It is also lacking in strength, and is slow to take dye, as its structure is less porous. Unripe fiber can be detected by the eye on account of its glossy, transparent appearance.

Fig. 7 shows the appearance of several cotton fibers at different stages of maturity. A and B are the unripe fibers, C the half-ripe, and D and E are the fully ripe or mature fibers.

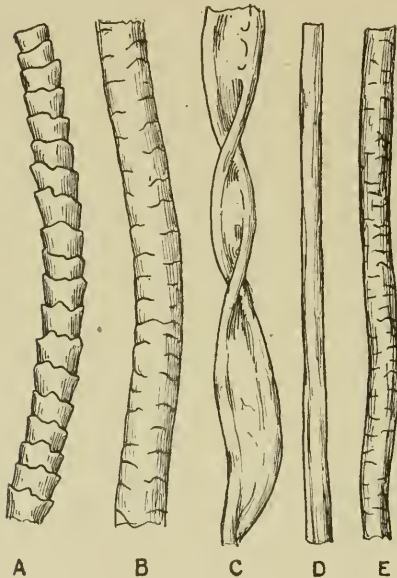

Fig. 6.

Fig. 8 represents cross-sections of the same. A represents the unripe fibers, B the half ripe and C the fully ripe.

The microscope can therefore be depended upon to identify the cotton fiber. Other tests, however, can be made. The burning of the fiber will distinguish between cotton and wool or silk. The cotton fiber burns with a flash, leaving a white ash, while wool or silk emit a disagreeable odor, leaving a small lump of carbonized matter on the end of the fiber.

A strong solution of caustic soda will entirely destroy wool or silk; the effect of wetting a cotton fiber with caustic soda is to distend the fiber and almost eradicate the convolutions, leaving it stronger than before. It also gives it the appearance of a round glass rod which has been bent in every direction.

The value of cotton depends principally on the length, strength and fineness of the staple. The diameter of cotton fibers vary from $\frac{1}{2000}$ inch to $\frac{1}{1000}$ inch, and length from $\frac{1}{2}$ inch to $2\frac{1}{4}$ inches. De Bowman estimates that there are 140,000,000 fibers to the pound. The number of convolutions or twists in the cotton fiber is greater and more regular in some varieties than in others. In Sea Island cotton the convolutions are very regular, and have

been estimated as between three and four hundred per inch of fiber length. Poorer varieties of cotton have less frequent convolutions, as low in some cases as one hundred per inch of length.

As the authorities on the lengths of cotton fiber do not entirely agree in all cases, it will be safe in treating this subject to give the average length, diameter and general characteristics of a few of the more important commercial varieties in the order of their length of staple. The numbers and kinds of yarn for which the different lengths and varieties of cotton are used will be

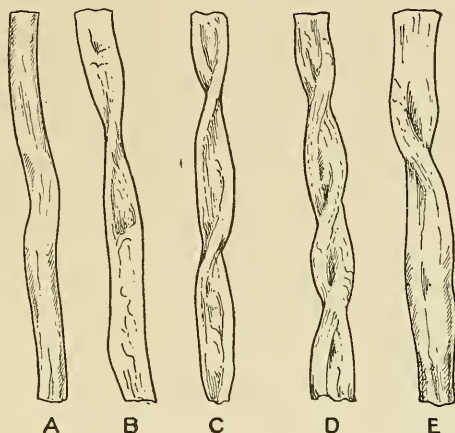

Fig. 7.

found to vary widely in different locations and under different conditions. These numbers are for warp yarns, and, in many cases, the cotton can be spun into somewhat finer numbers for filling yarn, as the required strength for filling is not as great.

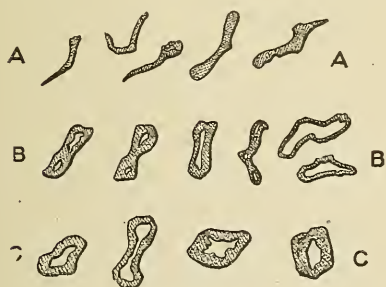

Fig. 8.

Sea Island is by far the finest cotton grown, and therefore careful attention is given to the picking, ginning and baling. The best of *Sea Island* cotton is grown on Edisto, Port Royal and St. Helena Islands off the coast of South Carolina, and the Cumberland Islands off the coast of Georgia. Some *Sea Island* cotton is grown on the low

portion of the coasts of these States. It has a long, glossy, silky fiber, with regular convolutions, and contains much unripe fiber; it is usually combed. The black seed free from hairy covering makes the ginning comparatively easy. It is ginned on roller gins only. It is used largely for the manufacture of sewing thread

and for the finest of lawns and muslins. It is regularly spun from 150 to 300, and commercially as fine as 600; has been spun experimentally as high as 2,000.

The territory adapted to the raising of this crop is very limited, which accounts for the comparatively small amount grown. The Sea Island crop of 1900 amounted to 88,294 bales, a decrease of 8,985 bales from the crop of the preceding year. The principal markets for Sea Island cotton are Charleston, S. C., and Savannah, Ga. The average price obtained for 1900 was for South Carolina, \$.256; Georgia, \$.20, and Florida, \$.19 per pound.

Egyptian Cotton. The brown Egyptian cotton is used to a considerable extent in this country. It is a long, silky, clean cotton, from a dark to light golden color. It contains a large per cent of short fibers and is generally combed. The color of this cotton is due to the presence of a natural substance known as "Endochrome." Length of fiber from $1\frac{1}{3}$ to $1\frac{1}{2}$ inches, a large proportion running about $1\frac{5}{16}$ inches. This cotton ranks next to Sea Island, and larger amounts are being imported each year. It is largely used for the better grades of underwear and hosiery, and to some extent for thread for lace work. The yarn made from this cotton is one of the best for mercerizing, as the fiber is naturally smooth. It is grown in the valley of the Nile in Egypt. The principal market is Alexandria. The imports of this cotton into the United States were about sixty thousand bales in 1895.

Gulf cotton, or New Orleans as it is known in England, is the best of strictly American cotton, for Sea Island cotton, although grown in this country, is not generally ranked as an American cotton, but occupies a class by itself. Gulf cotton properly includes many varieties, known as Peeler-Benders, Red River, Allan seed, etc. These last varieties of Gulf cotton somewhat resemble the poorer Sea Island grades. Peeler is one of the best of the Gulf cottons that are raised in sufficient amounts to be of commercial value. It is long, silky, and of bluish white color, generally combed, and a fine working cotton, somewhat similar in that respect to Egyptian. Gulf cotton, as a rule, ranges from $1\frac{1}{8}$ to $1\frac{3}{8}$ inches in length of staple, though some of the better varieties are longer. Gulf cotton is used for warps from 30 to 50, and for filling from 50 to 70.

Upland Cotton. This is the most common and useful cotton grown and constitutes the greater part of the world's crop. The fibers are very uniform in length; color generally good, and is a strong, reliable cotton. This cotton is grown in Georgia, North and South Carolina, Alabama and Virginia. There are many varieties of Upland cotton, taking their names from States or localities where they are grown. Upland cotton is used for warp yarns up to 38 and for filling to 48. Upland staple ranges from $\frac{7}{8}$ inch to $1\frac{1}{8}$ inches in length, a large portion reaching $1\frac{1}{8}$ inches. The average price for middling Upland $1\frac{1}{8}$ inches for the year 1900 was \$.0896+ per pound.

Texas cotton is somewhat similar to Upland, but slightly shorter and more harsh, though of very good quality. The character of the crop varies largely from year to year. During a dry year it is likely to be unusually harsh, short and brittle, and is often "tinged" or off color. The production of Texas cotton is increasing, and more care is constantly being given to its cultivation and preparation. Texas cotton is especially suited for warp yarns from 24 to 36. Length of staple from $\frac{7}{8}$ inch to $1\frac{1}{8}$ inches. This is the best of American cottons for use in mixing with wool. Principal market, Galveston.

Peruvian cotton is comparatively little used in this country. It is very harsh and wiry. Red Peruvian is a deep reddish brown in color, the white Peruvian being of a cream tint. The small amount that is consumed is used largely for woolen adulteration, as the fiber more nearly resembles wool in feeling than that of any cotton grown.

GRADING.

The grading of cotton is entirely a matter of judgment and experience, and no definite rules can be given. The cotton grader is one who from long experience and numberless comparisons has educated his eye and hand to distinguish between the grades and recognize the differences in quality which would add to or detract from the market value of the cotton. Cotton is universally sold (except in some districts of the South) by samples and not by inspection of the bales. It is also graded in the same way.

In grading cotton the principal points to be taken into consideration are : First, the strength and evenness in length of the staple ; second, its freedom from "neps," "leaf-motes," sand and other foreign substances, and third, the color or evenness of color.

The strength of the staple is important in determining the grade, as that is one of the principal points of value of the stock.

The *evenness* in length is also very important, for a cotton that is of good average length and that is clean may contain a large proportion of very short fibers, in which case the strength of the yarn is considerably diminished.

The freedom of the cotton from foreign impurities is one of the principal factors in determining the grade, for not only must the impurities be considered as waste, but their removal, if present in considerable amounts, adds greatly to the cost of the manufactured product. The presence of foreign matter is largely due to carelessness in picking and ginning. A certain amount of leaf, boll, husk, seed and sand is present in any cotton, and if this amount is considerable the grade of the cotton is lowered accordingly. The presence of "neps," "motes" and immature fibers also detracts from the value of the cotton and influences the grading.

"Neps" are tangled fibers or minute panglens of several fibers. Their appearance is that of a small white "fleck," hardly larger than a grain of sand, which, if examined under a microscope, will be found to consist of a ball of fibers so rolled and knotted together as to make their separation an impossibility. "Neps" are caused by improper ginning when found in cotton samples, though they are often produced in the manufacturing process in the picker and card.

"Motes" are minute pieces of seed, or immature seeds, and are hard to remove in the process of manufacture, especially if they are "bearded motes," or small pieces of seed to which adheres the downy seed covering.

Another condition to be taken into consideration in the grading is the color of the cotton. A pure white cotton is desirable, and it is important that the color or tint shall be uniform throughout a lot of cotton. This is especially true if the cotton is to be used for filling yarn, as in this case it will show largely on the

face of the goods, for it is used without any dressing or sizing, which might effect or modify its color. Should a sample of cotton show portions that were stained, or off color, the grading would suffer accordingly, and in some cases the cotton would be classed as "tinged."

Cotton is usually graded according to a standard agreed upon in the leading cotton markets. The American system consists of seven *full* grades, the best of which is "fair." They are :

Fair
Middling Fair
Good Middling
Middling
Low Middling
Good Ordinary
Ordinary

These grades are subdivided into quarter, half and three-quarter grades, which express the minutest difference in condition and cleanliness. In the market the quarter and three-quarter grades are seldom recognized. The quarter, half and three-quarter grades are expressed by the prefixes, "barely," "strict" and "fully."

The following table presents the gradings of American cotton in as comprehensive a manner as possible :

QUARTER GRADE.	HALF GRADE.	THREE-QUARTER GRADE.
Barely Fair	Strict Middling Fair	Fully Middling Fair
Barely Middling Fair	Strict Good Middling	Fully Good Middling
Barely Good Middling	Strict Middling	Fully Middling
Barely Middling	Strict Low Middling	Fully Low Middling
Barely Low Middling	Strict Good Ordinary	Fully Good Ordinary
Barely Good Ordinary	Strict Ordinary	Fully Ordinary
	FULL GRADE.	
	Middling Fair	
	Good Middling	
	Middling	
	Low Middling	
	Good Ordinary	
	Ordinary	

Egyptian cotton is commonly divided into four grades. They are :

Good
Fully Good Fair
Good Fair
Fair

Brazilian and Peruvian cotton usually have these grades :

Good Fair
Fair
Middling Fair

It will be seen from the foregoing that grade really means the appearance of the cotton, particularly as to cleanliness.

In buying cotton for mill use there are several important points to be considered. First, the length of the staple. Second, the strength of the staple. Third, the uniformity in length.

These facts are determined by a process known as "pulling cotton." This process consists of grasping a small amount of cotton with both hands and pulling it apart. One-half is then thrown away, and the ends of the fibers projecting from the half which is retained are grasped between the thumb and forefinger of the right hand with the thumb held uppermost and drawn from the mass in the left hand, which is discarded. We now have a tuft of cotton held at one end between the thumb and forefinger of the right hand. With the left hand this tuft of fibers is straightened out, the short fibers removed and the ends grasped with the left hand. The right hand, or the forefinger and thumb of the right hand, now straighten out the projecting fibers and remove the shorter fibers, leaving a little tuft of cotton, the fibers of which are particularly uniform in length and parallel. This tuft of straightened fibers can be measured to determine the length of staple. They can be broken by firmly grasping the ends with the forefinger and thumb of both hands, and the power required to break gives the expert an idea of the strength of the staple. The amount of short fiber removed in the pulling process determines approximately the proportion of short fiber in the sample.

Something of harshness, strength and spinning qualities of cotton is sometimes determined by noting the sound produced by pulling apart a bunch of cotton held close to the ear.

After the length, strength and evenness have been determined, the next points are: The amount of sand and foreign matter contained; the proportion of unripe fibers; the color and evenness of color, and the amount of moisture.

In examining a cotton sample to determine the amount of impurity contained, it is fair to assume that a proportion of the sand and dirt has been shaken out in the handling which a cotton

sample receives, and on that account the sample will be slightly cleaner than the original stock. The amount of dirt in the cotton must, however, be determined by the appearance of the sample and the amount of sand and dirt on the paper in which the sample is wrapped.

Unripe fibers can be detected by the eye on account of their semitransparent, glossy appearance. "Nèps" and "motes" are also evident on close examination and inspection of the sample.

The color of a cotton sample can best be determined by comparison, and for such comparisons a north light is desirable. A sample of cotton may seem of good color when examined alone, and show a very decided tint when compared with other cotton or with an object which is a clean white. The presence of blue paper near a cotton sample has a tendency to neutralize the yellow tint and make cotton appear a pure white.

"Tinged" cotton is cotton which is stained in spots from the action of the juices from the crushed seed or plant, or from the presence of coloring matter from the soil. Tinged cotton should be avoided, especially for the manufacture of white goods.

The amount of moisture contained in the cotton cannot be determined from the sample unless the sample be freshly drawn, which is seldom the case. The odor of mildew, which is easily detected, is an indication of excess of moisture in the bale from which the sample is drawn.

In examining a bale of cotton at the mill, and in comparing it with the sample by which the cotton was sold, which is commonly done, the amount of moisture contained, if excessive, is easily determined by the feeling of the cotton, or by holding a handful against the face. A more correct method of determining the amount of moisture is by the "furnace test."

In this case a handful of cotton from the bale is very carefully weighed on delicate scales and the weight noted. The cotton is then subjected to the heat of a gas oven for several hours, at a temperature from 170° to 180°, and weighed again. This gives the entire amount of moisture in the cotton. The cotton is now allowed to remain for some time in the air, under normal conditions, until it has absorbed a reasonable amount of moisture from the air, after which it is again weighed. The difference between

the first and last weighing gives the excess of moisture in the cotton, which is often from two to four per cent. A certain amount of moisture is desirable in working the stock, but manufacturers do not care to pay for large amounts of water. (From five to eight per cent of moisture is normal.)

One very important condition to be kept in mind, in selecting cotton for mill use, is to see that the samples are "even running" as to length of staple. In other words, to see that one or more bales of longer or shorter staple have not been mixed in with the cotton. Long-staple cotton is more valuable than short staple, all other conditions being equal, but the presence of long staple with the short causes an endless amount of trouble and annoyance in the mill, as will be explained later, and on that account great care is exercised to be sure that the cotton in the several bales of one lot is of about the same length of staple.

The purchase of cotton by the mills of New England is generally made from November to February inclusive, at which time it is not unusual for a year's supply to be secured.

Cotton is generally sold to Northern manufacturers on cash terms and delivered at New York, Fall River or Boston. The cotton is invoiced at gross weight, no allowance being made for bagging and ties. Cotton shipped to England, or "The Continent," is invoiced at net weight, as it is the custom to purchase it in that manner in those countries.

In invoicing cotton, or in purchasing cotton, the variety, grade and length of staple are mentioned as well as the number of bales and the weight of each. An order for cotton might read as follows: One hundred bales, Georgia Midland, Strict Middling, inch and one-eighth, or

500 Bales — Texas — Low Middling — One inch.

OPENING AND MIXING.

The opening of the American bale simply consists in cutting the ties, removing the bagging and ties, and breaking up and shaking out the condensed mass of cotton. When the bale is opened, the contents will be found in sheets, or layers, of condensed cotton, due to the pressure exerted in baling. This cotton is hard and compact, and before use must be allowed to expand. One

advantage claimed for the round lap bale is that several bales can be unrolled and fed to the opener, or breaker picker, at the same time. In this case, however, the mixing is not as extensive as it is when the cotton is taken from a pile consisting of many bales.

There is a machine in general use in England, but comparatively little known in this country, called the Bale Breaker. This machine takes the condensed sheets of cotton as they come from the bale and tears them apart, delivering them in smaller pieces, and allowing the cotton to open or expand in the process. The bale breaker, a common type of which is shown in Fig. 9, consists of an endless apron, or lattice, on which the sheets of cotton

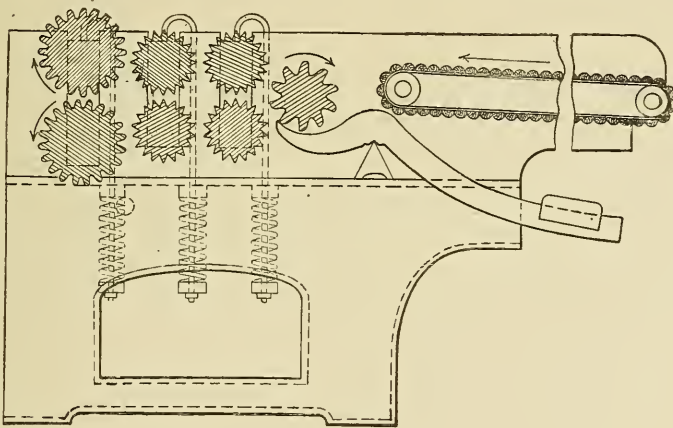

Fig. 9.

from the bale are placed. Directly in front of this traveling lattice is a revolving feed roll which grasps the cotton from the lattice and passes it over the pedals to the first pair of fluted and toothed rolls. There are usually three pairs of these rolls running at increased speeds. As the cotton passes from the back to the front of the machine the mass is pulled apart.

These rolls are driven by spur gearing and are positive in their action; the top roll in each case being weighted by stiff coil springs. The surface speed of the middle pair of rolls is about three times that of the back roll, and of the front roll about seven times that of the middle roll, which gives the surface speed of the front roll about twenty-one times that of the back roll, or a draft

of twenty-one. The draft of the bale breaker, or the relation of the surface speeds of the front and back roll, varies according to conditions, but is commonly twenty to one to thirty to one, or a draft of from twenty to thirty.

Another form of bale breaker is shown in Fig. 10. In this case a swiftly revolving beater with projecting arms is employed to still further open the cotton and remove a portion of the heavier impurities.

The first process in the cotton mill after the bales have been opened is the mixing. This is, or should be, a part of the process of every mill, but in some cases its importance is underestimated. By mixing we do not necessarily mean only the mixing of differ-

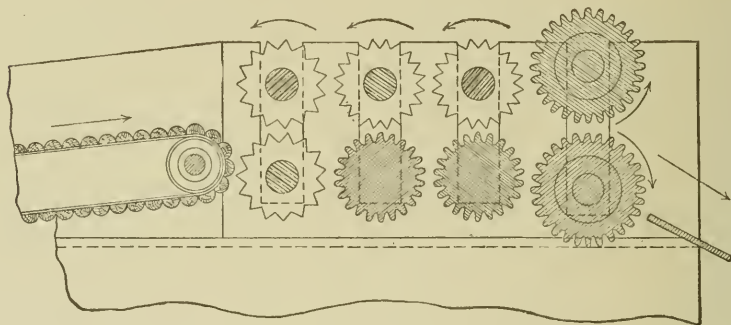

Fig. 10.

ent grades or varieties of cotton, but the mixing of different bales of the same grade and variety. This is absolutely necessary to produce the best results, for even when the different bales are of the same variety, the same grade, and grown in the same locality, and supposed to be of the same length of staple, there are likely to be found slight differences in length, color and condition.

There is also a great difference in the amount of moisture in different bales. Some are too dry to work well and some too moist, and by mixing, the dry absorbs some of the moisture from the damp bales, and a better average condition is secured. The mixing also allows the "opening up" or expanding of the condensed cotton, leaving it in better shape for the action of the beaters in the picking process. The common method of mixing in this country is to provide extensive floor space back of the

feeders. The larger the better within reasonable limits. When the bales are opened, a sheet or armful of cotton is taken from one or more bales and scattered evenly over the floor. This is repeated with cotton from other bales until a pile or stack is formed containing enough cotton for several days' run. This pile of cotton is composed of many thin layers, each layer representing a bale, more or less. When this cotton is fed to the machines it is taken in as nearly vertical sections as possible, so that each armful will contain parts of several bales. In this way a very thorough mixing is secured, giving a uniform condition of cotton from start to finish. Large mixings are to be preferred to small ones; the size being limited in many instances only by the floor space available.

Many modifications of this process are to be found in different cotton mills. In some cases the bales are opened in the storehouse, and the cotton from several bales fed into the hopper of a distributor. From here the cotton is drawn by an air current through sheet metal pipes and delivered on the floor of the picker-room back of the feeders.

In some cases the mixing is done in large bins which have movable floors, so that, as the cotton is used, the stack can be moved forward to be at all times within convenient distance of the feeders, and mixing can be carried on at the back of the bin. In this case the cotton from several bales is thrown into the bin through a hole in the floor above. With this arrangement the mixing is a continuous operation and can be performed at the back of the bin while the cotton from the front is being used.

In English spinning mills there are in many instances elaborate preparations for very large mixings; in some cases sufficient amounts to last during a month's run. This is necessary on account of using so many different grades and varieties of cotton, in which case the mixing of several kinds at a different price, each to produce a certain result at a certain cost, becomes a fine art.

Variation in color or tint in the yarn produced is less liable to occur where large mixings are used.

When different cottons should be mixed in exact proportions, or when a combination of colored and white cotton is used to produce a certain tint, the mixing can be done more correctly at the

intermediate or finisher picker. This will be explained more fully later. If mixed in the stack, the proportion of each would not run evenly from start to finish, therefore producing yarn which would vary slightly in color from time to time.

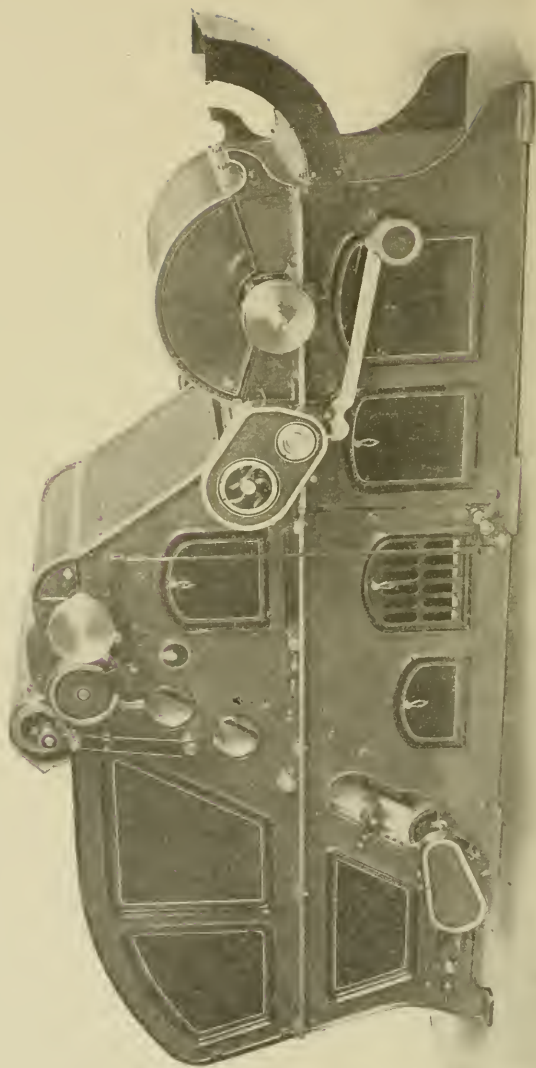

COMBINED SELF FEEDER AND OPENER WITH 30-INCH SPECIAL CYLINDER
Howard & Bullough Am. Machine Co. (Ltd.)

COTTON SPINNING.

PART I.

OPENING AND PICKING.

When upland cotton has been ginned, it is made ready for transportation into loosely packed bales, in which form it is often used in nearby cotton mills, but for shipment to any distance, by railroad or steamship, the bales are collected at some central point and compressed by heavy presses and made less bulky, saving much space.

The dimensions of the standard bale are 54 inches length by 27 inches width, the thickness depending upon the pressure to which it has been subjected, and is intended to weigh 500 pounds. But, as a fact, the bales vary from 52 to 72 inches in length, from 24 to 30 inches in width, 18 to 24 inches in thickness, and weigh from 400 to 600 pounds.

They are covered with bagging and bound with hoop-iron bands, or ties, fastened together by iron buckles. The bagging is of such coarsely woven stuff that it is very easily torn and offers but scant protection against dust, rain and fire, and, as the bales are often allowed to stay in a cotton yard some time before shipment, the cotton on the surface becomes very much damaged. It is certain that this method of baling and handling cannot add to the value of the cotton, and custom alone seems responsible for it.

Another form in which cotton is packed is the "round bale." These, as the name implies, are cylindrical, and are of two lengths, 35 and 48 inches; and 22 and 25 inches, respectively, in diameter. They are made by feeding the cotton to a revolving core, or arbor, which is held in position between two iron rolls by a heavy rubber belt. One of the rolls is stationary and the other, which is kept firmly held against the bale by hydraulic pressure, recedes as the bale increases in size. The friction of the belt and rolls causes the bat to be wound into a hard, firm roll,

which weighs about 35 pounds to the cubic foot. When the bale has reached the full diameter, and before it is removed from the press, it is wound with one turn of cotton cloth, which is sewed on.

Cotton that is grown in different localities varies in quality, and as bales from widely separated districts are likely to be used in the same mill, careful selection is necessary. Wide experience and good judgment are required to get the best results.

To obtain as nearly as possible uniformity in quality, length of staple, and, for some varieties of work, color, and the cotton is mixed; that is, the bales to be used are placed on edge, the ties and bagging removed. They are then turned on their sides, and a sheet of cotton taken from each in turn, by hand, and thrown into the cotton bin, ready for the opener. By this means an average is obtained.

Cotton which is to be spun into fine yarn must be long staple, uniform in color, and clean, while that to be used for goods which are to be bleached may require long staple, while color and cleanliness are not so essential, but no rule for mixing the different varieties and grades can be followed. Some mills use lower grades of stock than others for the same class of work with apparently equally good results.

In many of the smaller mills it is the custom to mix enough cotton to last three or four days, or even longer, if space in the opening and mixing room will permit, and, by allowing it to air for several days, an equalization of the moisture in the whole mass takes place. In large mills, on the contrary, it is usually the practice, because of the amount consumed, to take the cotton from the bales and throw it directly into the feeder of the opener. It is not necessary to air the cotton, as it is bought in large quantities and stored in cotton houses, where it often remains for a long period and is therefore partially dried.

Opening and picking, which is the first mechanical process the cotton undergoes, is, briefly stated, the removal of as much foreign substance as possible with the least injury to the fibers. The foreign substances found are particles of sand, which have been blown about and have become lodged in the bolls; dirt, which, during a heavy rain has splattered upon the bolls, which grow low upon the stalks; particles of dried leaves and stalks,

gathered in picking, and pieces of seed and husks, broken in ginning.

The various styles of machines used in picking differ but slightly in principle and design, each having some features peculiar to each particular make. They are arranged, generally, in sets of two, three or four, the number of sets depending upon the production required and the number of machines in each set; upon the quality and condition of the stock being worked, very dirty cotton requiring, of course, more picking and cleaning.

There are four systems into which the operation of picking may be divided:

1. *That in which part of the machinery is on one floor and part on another.*
2. *That in which all of the machinery is on one floor and no cleaning trunk is used.*
3. *That in which all of the machinery is on one floor and a cleaning trunk is used.*
4. *That in which the bales are opened in an adjoining building or room and the cotton is "blown" into the picker room.*

The arrangement of the several machines necessary in each system depends upon the location of the carding machinery; the aim being to have the laps delivered from the finisher picker upon the same floor, and as near the cards as possible, in order to save time and expense in carrying them about and to avoid any unnecessary handling of the cotton. This, of course, cannot be done always, especially in some of the old mills, but in planning a new one this should be borne in mind.

SYSTEM ONE.

Fig. 1 is a plan of the opening room of a modern cotton mill equipped with two sets of picking machinery, arranged on the three-process system, a style in use in many mills at the present time. Fig. 2 is a plan of the second floor of the same mill, and Fig. 3 is a sectional elevation.

The machines on the first floor are an automatic feeder, A, connected to an opener, B; and on the second floor are a single beater breaker picker, D, with a condenser and gauge-box, a single beater intermediate picker, E, and a single beater finisher picker,

F. A cleaning trunk, C, connects the opener on the first floor with the breaker on the second.

Beneath the opening-room is the dust-room, into which the

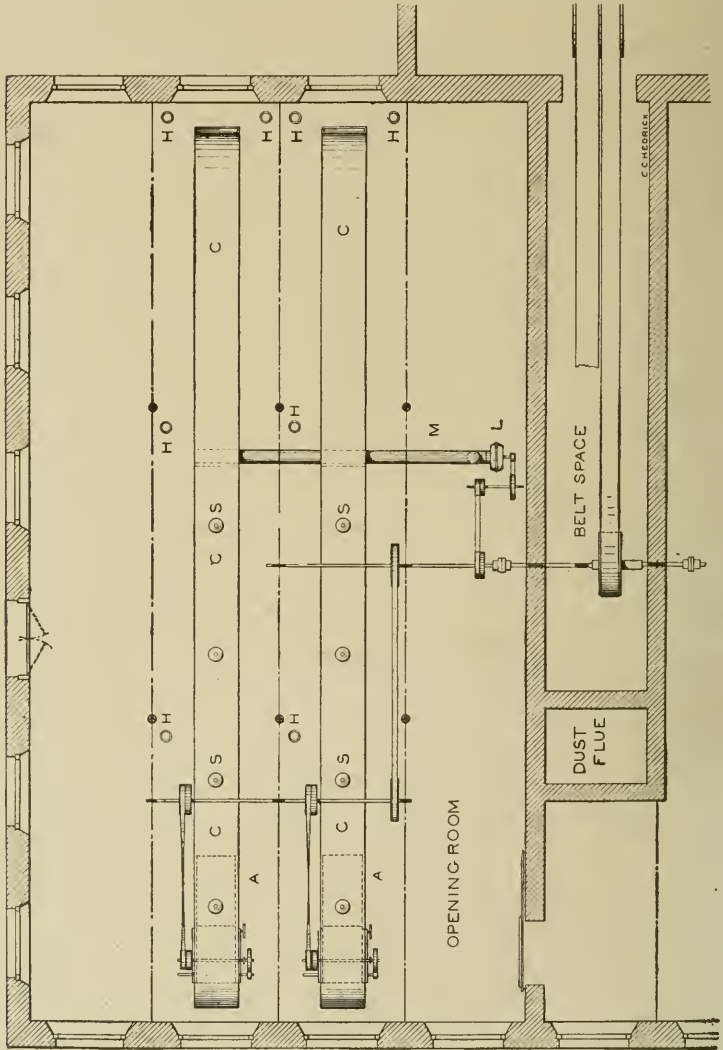

Fig. 1. Plan of Opening Room.

dust, dirt and fine particles of cotton are discharged from the picker by fans, through the galvanized iron pipes, H. These pipes are provided with an automatic closing damper, K, which is



HOPPER BALE OPENER, CAPACITY 175,000 LBS. PER WEEK
Howard & Bullough Am. Machine Co. (Ltd.)

kept open while the picker is running by the pressure of air in the pipe, but when the machine is stopped the pressure ceases, and the damper closes of its own weight, assisted by the pressure in the dust room, produced by the other fans. This automatic closing of the damper prevents the dust and dirt from blowing back into any machine not running.

The dust-room is provided with a flue, or chimney, which leads through the roof and which should have an area of about 3 square feet for each fan. It usually occupies all of the space beneath the opening-room the floor should be cemented, and the overhead woodwork covered with tin or any fireproof material. The heavy dust and leaf settle to the floor, while the light dirt passes out with the air.

In the systems shown in Figs. 1, 2 and 3, the cotton is thrown into the hopper of the automatic feeder, A, and is then delivered to the feed apron of the opener, B, by which it is carried forward between the feed rolls to the beater. Most openers have a three-bladed beater about 20 inches in diameter. Beneath the beater is a grid, over which the dirt is driven as the cotton is drawn through its surface and up through the cleaning trunk, C, to the breaker picker, D. The starting and stopping of the feed of both opener and feeder are controlled by the breaker picker.

The cleaning trunk is provided with a grid surface, over which the cotton passes to the breaker picker. The dirt, which is heavier than the cotton, settles between the grids into pockets directly beneath, which can be cleaned out when necessary.

The cotton enters the breaker picker through a condenser and gauge-box, which delivers it to the feed apron. It then passes forward through the feed rolls to the beater, which is usually three-bladed, where it receives a most thorough cleaning. Passing forward over inclined grid bars, through which some of the loose dirt falls, it is deposited upon two slowly revolving cages or screens. From these cages it is drawn forward between several calender rolls, formed into a sheet and wound upon a lap roll. This is the first formation of a lap in the process.

The laps from the breaker are now taken to the intermediate picker, E, to undergo another cleaning and picking. Four laps

are placed upon the apron of this machine, this being the first doubling of the laps. The cotton next passes through the intermediate and is formed into a lap in the same manner as in the breaker picker. From the intermediate it passes to the third

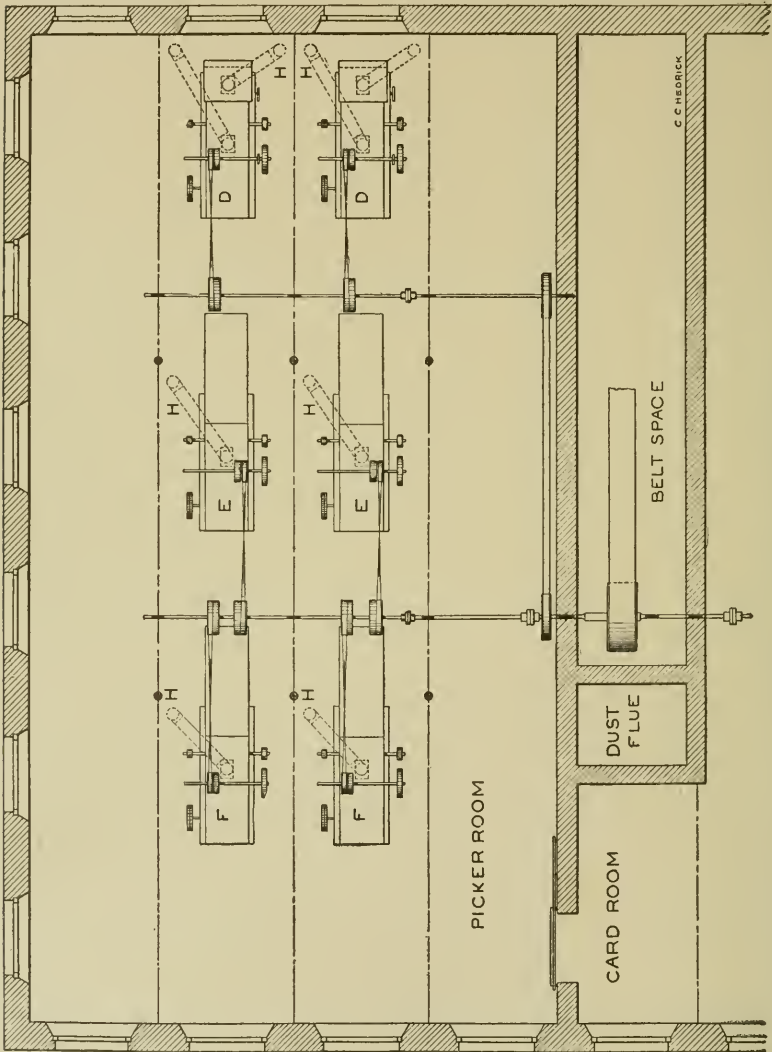

Fig. 2. Plan of Picker Room.

machine, the finisher picker, F, which is substantially the same as the two previously mentioned machines, the laps being doubled four into one on the apron. Here the cotton is formed into a

finished lap, ready for the card. As before stated, both the intermediate and finisher pickers are generally provided with eveners, several styles of which will be shown.

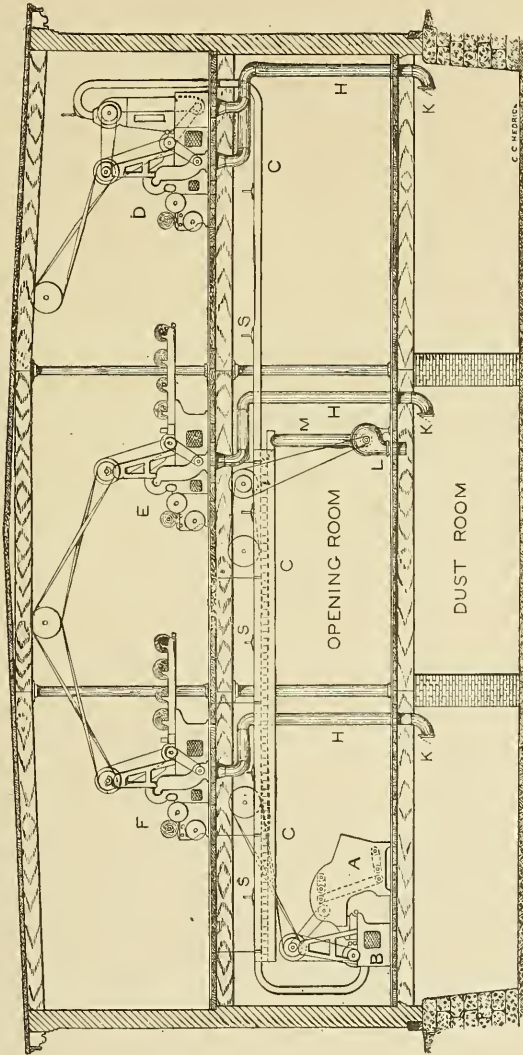

Fig. 3. Sectional Elevation.

The Old Style Feeder contrasts strongly with the present automatic or hopper feeder, and a description of it may be interesting to some. In the old way the feed apron was divided off

every yard or two, usually by painting some of the apron slats a darker color than the rest, and the attendant would place an armful of cotton on a pair of scales set to some particular weight and then spread the amount between the divisions on the apron. The attendants were often careless, sometimes the weight of their arms was included, while at other times they simply went through the motions of weighing, not even looking to see if the scales balanced or not. Frequently, when pressed for time, they would take an armful from a bale and throw it on the apron, regardless of the amount. It will readily be seen that this method could not be satisfactory.

The Automatic Feeder and Opener. Fig. 4 shows an automatic feeder connected to an opener. The hopper A is kept about two-thirds full, in order that the cotton shall be fed as evenly as possible. The bottom of the hopper is formed by a horizontal apron, B, called the bottom apron, or lattice, by which the cotton is carried forward against the elevating apron C¹, which runs in an almost vertical position, and which is supported at intervals by carrier rolls, and consists of a heavy canvas belt backed with leather strips, to which are fastened wooden slats. Projecting from these slats are pins, by which the cotton is caught and carried upwards. At the top of the elevating apron is situated the spike roll D, which is about six inches in diameter and has steel pins or spikes projecting about three-fourths of an inch from its surface. The object of this roll is that it should strike off any surplus bunches of cotton which cling to the elevating apron, and to regulate the amount of cotton carried forward to the opener. Around the spike roll runs an endless leather apron, E, called the spike-roll apron, which has slots or openings in it corresponding in position to the pins of the roll, and through which the pins project as the apron passes around the roll. Any cotton that is disposed to collect on the pins is readily stripped off by this means.

The amount of cotton which is delivered to the opener is regulated by the position of the spike roll, which is adjustable horizontally; thus, the greater the space between it and the elevating apron, the more cotton is allowed to pass. In order that the spike roll shall stand parallel to the elevating apron, and that the roll shall be moved parallel with it when changing its position,

indexes are placed on the outside of either side of the hopper, by which the exact position may be noted. Between the lower end of the elevating apron and the end of the bottom apron is a space of about $1\frac{1}{2}$ inches, which allows dirt and foreign substances to fall through into the hopper screen. This screen can be dropped and the dirt removed.

The cotton which is left upon the pins of the elevating apron, after it has passed the spike roll, is next acted upon by the doffer, F. This is driven from a countershaft by the belt, K, and is about 15 inches in diameter, and has, extending across its whole

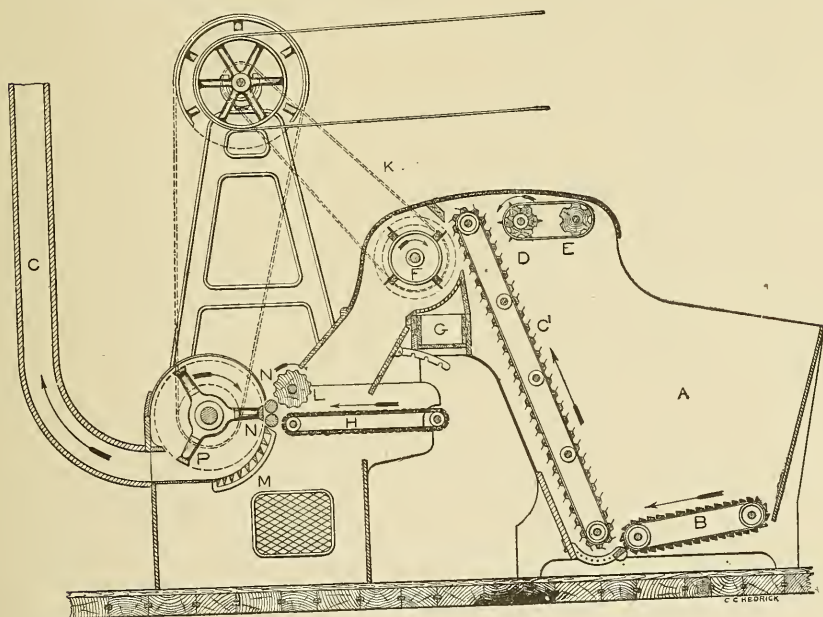

Fig. 4. Section of Automatic Feeder and Opener.

face, four wooden blades faced with leather, which are slightly in contact with the pins of the elevating apron, and, as the doffer runs about 160 revolutions per minute, a continuous series of blows is given, by which the cotton is stripped or beaten from the pins and thrown against a screen or grid directly beneath the doffer, called the doffer screen, through which any loose dirt will fall. Beneath the doffer screen is a dust drawer, G, which receives dust and dirt that is beaten out by the doffer. From the doffer

screen the cotton passes down an incline on to the feed apron of the opener, H, being assisted by the current of air produced by the doffer.

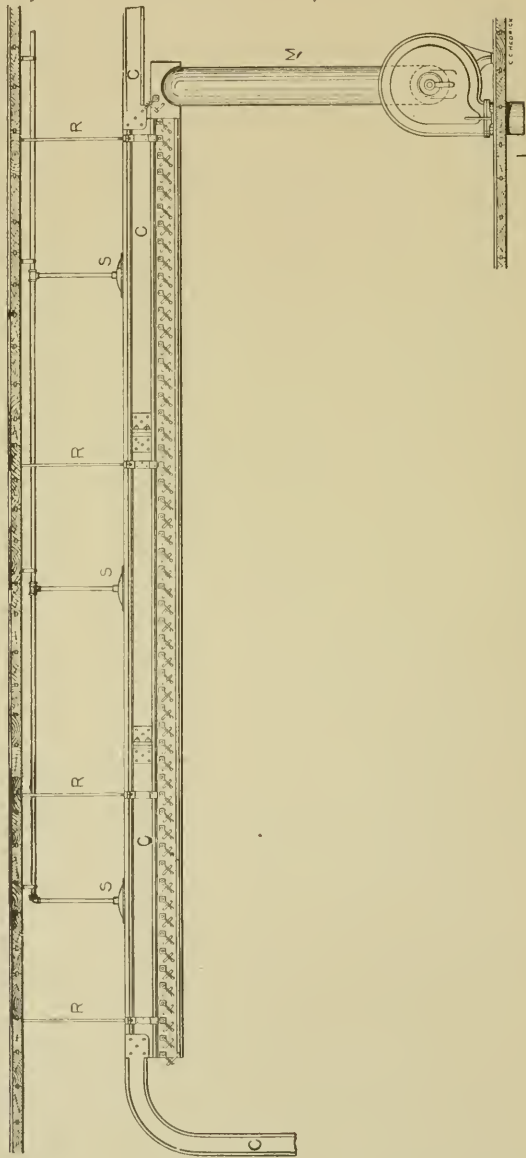

Fig. 5. Horizontal Cleaning Trunk.

The cotton is next carried forward by the feed apron, pass-

ing under the press roll, L, to the feed rolls, N. The press roll condenses the cotton, that it may be drawn readily between the feed rolls, which, being small in diameter, could not receive it in a loose form. After passing the feed rolls the cotton is acted upon by the blades of the rigid beater, P. This consists of three steel blades running across the width of the machine, which are securely riveted to four or five sets of arms or spiders, which are fastened to the beater shaft. These blades are beveled slightly

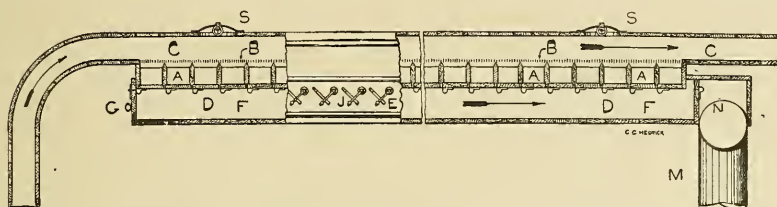

Fig. 6. Section of Horizontal Cleaning Trunk.

on each edge, but not enough to cut the cotton, and as they become dulled by constant use the beater can be reversed in its bearings and the other edges brought into use, both ends of the beater shaft being made alike for this purpose.

The beater generally runs 1,200 revolutions per minute, therefore each inch of cotton delivered by the feed rolls receives a great many blows, by which it is opened, cleaned and removed from the rolls in small tufts, which are thrown with considerable

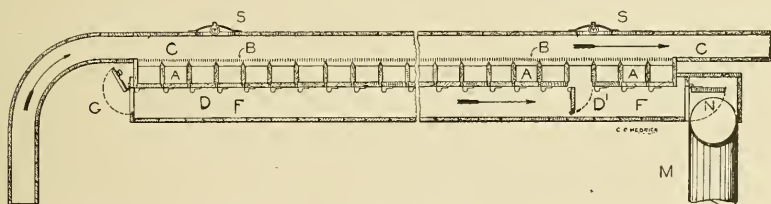

Fig. 7. Same as above, with pockets Dropped for Cleaning.

force against the beater grid, M. Thus the dirt, seed and heavy impurities, which are struck down with the cotton, fall between the bars into the space below, while the cotton, which is very light, is prevented from passing through with the dirt by the current of air which draws it through the trunk to the breaker and which is produced by the fan in the gauge-box section of the breaker.

Horizontal Cleaning Trunk. Figs. 5, 6 and 7 show details of the trunk connecting the opener and breaker picker. Fig. 5 shows the whole length of the grid, or cleaning surface, 40 feet being usually sufficient for all but very dirty stock. The trunk is hung from the under side of the floor above by rods, R, placed about 10 feet apart, lengthwise, and upon each side. As many of the fires which occur in the picker room are caused by the beater in the opener striking some hard substance, means must be provided to prevent injury to the trunk, which, being of wood, takes fire very easily; hence automatic sprinklers, S, are placed at intervals along the top of the trunk opening into the passage through which the cotton is drawn, a very slight fire causing the sprinklers to operate. At one end of the trunk is a galvanized iron pipe, M, connected to a fan, L. This is for cleaning the trunk, which must be done regularly. Usually the fan is connected to the end of the trunk nearest the opener, as the greater portion of dirt falls out of the cotton before it reaches the farthest end of the grid surface: but for convenience it is sometimes connected to the other end, and in order to show the arrangement without obstructing the view of the opener, it is placed in this position in Figs. 1, 3 and 5.

Enlarged sections of the trunk are shown in Figs. 6 and 7. The trunk is divided vertically into three sections. The top one, C, through which the cotton passes to the breaker, is separated from the middle one by a grid surface, B. The middle section consists of a series of pockets, or compartments, A, into which the dirt and leaf settle as the cotton passes slowly over the grid. The bottom of these pockets, D, is hinged at one side, the hinge being connected to a handle, E, on the outside of the trunk, which is held in a closed position by a spring, J. The lower section of the trunk F is a passage, connected to the exhaust fan L by the pipe M. The bottom of the pockets opens into this passage, which is closed at both ends by the doors G and N.

When it becomes necessary to clean the trunk, which is done from two to four times a day, the feed on the opener is usually stopped. The fan L, which is driven separately from the opener, from a countershaft, is started, and the doors G and N opened as shown in Fig. 7, this producing a strong current of air through

the lower section or passage leading to the fan. The springs on the outside of the trunk, which hold the bottom of the pockets in position, are pressed and release the handles and allow the bottom of the pockets to fall into a vertical position, as shown at D¹ in Fig. 7. The refuse falls into the passage and is carried along by the air current and discharged into the dust room. Every other pocket is usually taken at one cleaning.

Breaker Picker with Condenser and Gauge-box. When the breaker picker is located at some distance from the opener and is connected by a trunk, as in Figs. 1, 2 and 3. There must be considerable cotton in transit between them when they are in operation. As the feed of the opener is stopped, usually, for a brief period while doffing the breaker, it is evident that the cotton in the trunk would be drawn forward and deposited upon the apron of the breaker. This would cause a thick place to be formed in the first part of the next lap wound, followed immediately by a thin place, while the cotton is being drawn along the trunk. This is, of course, for a short time only, but in order to insure the laps being free from any irregularities in weight from such cause, the receiving end of the breaker is provided with a condenser and gauge-box, which is shown in the section of the breaker picker in Fig. 8.

In the top of the condenser is a revolving screen, or cage, A, on the inside of which is a stationary shield, or cradle, B, which covers a little more than one-half of its surface, the air current passes through the perforations of the cage not closed by the cradle. The cotton, which enters from the trunk C through the top of the condenser box, is deposited upon the open side of the cage. Each end of this cage opens directly into a dust passage, D (shown by dotted lines), on the outside of the gauge-box. The air passes out through the ends of the cage and down this dust passage to the fan E, from which it is forced out through the pipe H to the dust room.

As the screen revolves slowly, the cotton which is deposited upon its surface is brought around between the screen and the roll F. At this point the cradle covers the screen, preventing the passage of air; the cotton is thus very readily stripped from its surface, being assisted by the roll G, whose surface runs in

the opposite direction to the surface of the cage. The cotton passes between the rolls, F and G, and falls upon the feed apron, J.

It will be seen that the roll, G, is held rigidly in its bearings, but the roll, F, is supported at either end by a lever, G¹, which is centered at F¹. The short end of this lever carries the roll, while the long end, being heavier, keeps it pressed against the cage, subject to the varying thickness of the cotton passing through.

The gauge-box is divided into front and back compartments, M and K, by a swinging partition, L, which regulates the amount of cotton allowed to pass forward on the feed apron. The front compartment, which receives the cotton as it falls from the condenser roll, is usually about half full, but with the stopping of the breaker and feed of the opener, the cotton is drawn out of the trunk and fills this compartment. Any surplus will fall over into the back compartment, and can be removed by opening a door at K¹. With the starting of the breaker, the cotton that is contained in the front compartment serves as a source of supply until the cotton comes through the trunk. By narrowing the front compartment by the swinging partition, L, the feed may be made lighter, as a smaller portion of the surface of the feed apron will be covered. The position of the partition is regulated by a pin which fits into a series of holes drilled in the under side of the board, L¹, which forms the bottom of the compartment, K.

From the feed apron the cotton is drawn between the feed rolls, N¹ and N², and brought into contact with the blades of the rigid beater, P. This beater, which is constructed in the same manner as the one previously described in the opener, runs about 1,500 revolutions per minute. The object of this beater is to continue opening and cleaning, the dirt being driven down between the bars of the beater grid, G², by the force of the blows it receives from the blades of the beater.

It will now be seen that a double operation is going on, the cotton being drawn along by the air draft, while the heavy impurities are being driven through the grid against the air draft which enters from below and passes up between the bars.

The speed of the fan, F, which is about 1,000 revolutions per minute, plays an important part in separating the dirt from the cotton. If the draught is not strong enough the cotton will be

driven down through the grid with the dirt, making too much waste, while if it is too strong, the dirt will be drawn along with the cotton into the lap.

The beater grid consists of stationary bars, which extend from side to side and around the beater for a quarter of its circumference. The first bar under the bottom feed roll is set about $\frac{3}{8}$ inch from the circle described by the beater blade, while

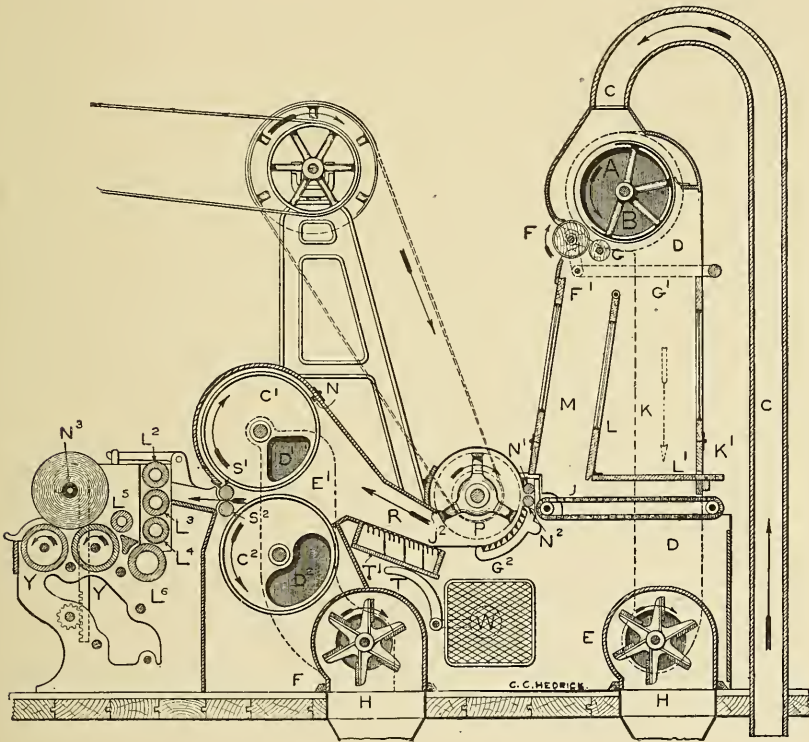

Fig. 8. Section of Breaker Picker, with Condenser and Gauge Box Section.

the last bar is set about $1\frac{1}{4}$ inches away. The grid bars are supported by brackets, which are adjustable, and are bolted to the frame. The space between the bars is graduated, those nearest the feed roll having the widest space between them, as the greater part of the dirt is removed before the cotton passes to the last of them.

The cotton is now under the influence of the fan draft, by which it is drawn forward over the inclined grate bars, R, and is collected upon the revolving cages, C¹ and C². The strip, N, which is faced with leather, prevents it from collecting above this point on the top cage. As the cotton passes over the inclined grate bars, the dust and dirt which are shaken out of it settle down between them into the box, T¹. A dead-air space is formed by every fourth bar extending to the bottom of the box, thus preventing the dirt from being drawn back into the cotton. The bottom of the box is kept up in position by the lever, T, and the weight, W, as shown by dotted lines on the outside of the picker. When it is necessary to clean out the box the weight is raised, allowing the bottom, which is hinged at one side, to swing down.

The stripping plate, J², by reason of being set close to the beater, prevents the cotton from following around with the air current caused by the beater. The air draft passes out at both ends of the cages, through the openings, D¹ and D², and down the dust passage, E¹, (represented by dotted lines), to the fan, F. From this point the air is forced out through the pipe, H, into the dust-room. The cages thus form a screen which assists in cleaning the cotton, the fine particles of dust and lint passing through the perforations with the air draft. The openings, D¹ and D², can be closed by dampers when it is desired to throw the draft all on one side of the cages, as the lap sometimes becomes thin on one edge. The perforations, or meshes, in the top cage are generally made larger than those in the bottom cage, thus allowing a greater passage of air through the top cage, and consequently a thicker sheet of cotton is formed. If the cotton is deposited equally on each cage, although formed into one sheet by passing between, there is a tendency to separate, or split, when unrolled behind the finisher picker or card, but as the sheet from the top cage forms the inside face of the lap, this trouble is in a measure overcome.

Another method for preventing the splitting of the laps, and which is in use by some builders of machinery, is to have the top cage considerably larger in diameter than the bottom one. By this means the exposed surface of the top cage is made larger and a thicker sheet of cotton is formed. When one cage is used

in the formation of a sheet the laps are not as likely to split, since there is only one surface upon which the cotton is deposited.

From the cages the cotton is stripped off by the stripping rolls S^1 and S^2 , and drawn between the calender rolls L^2 , L^3 , L^4 and L^6 , which are heavily weighted, and being slightly different in diameter, the faces of the lap are smoothed or ironed, which also tends to prevent them from splitting. After leaving the calender rolls the cotton passes forward under the press roll L^5 , and is wound on lap roll N^3 . This lap roll is held down by friction and rests upon two fluted rolls, Y , called lap calender rolls, which revolve and cause the lap roll to wind on the sheet of cotton as it comes from the calender rolls. The lap is thus wound very compactly and firmly.

Leaving the breaker picker, the cotton passes through the intermediate and finisher pickers. The principle of these two machines, so far as the opening and cleaning is concerned, is the same as in the breaker picker, with the addition of an evener and a long feed apron. The design is also practically the same, differing only in mechanical construction.

When the double-carding system was used almost wholly, not so much attention was given to the weight of the picker laps, but with the increasing tendency towards spinning finer yarns, and the general introduction of the revolving flat card, it became necessary to produce picker laps of a more uniform size and weight. This led to the adoption of single beater pickers instead of using two or three beater machines as formerly.

The first operation of doubling is placing four laps upon the apron of the intermediate picker, so that the thin or light places will be distributed over its surface. If the laps from the breaker are unrolled and held to the light, there will be seen thick and thin places, and as they are not always in the same portion of the lap, by placing one lap over another we get a more even sheet, but one four times as thick.

Intermediate and Finisher Pickers. A section of an intermediate picker is shown in Fig. 9. The laps M , B , A and G , from the breaker, rest upon the feed apron D , by which they are unrolled. It is advisable that they be of different diameters, so that a continuous sheet four laps thick may pass through the feed rolls.

If the laps are all of the same diameter, or nearly so, there is a possibility of two or more running out at once, and, during the time required to replace them, a break is likely to occur in the continuity of the four thicknesses; but with the laps of different

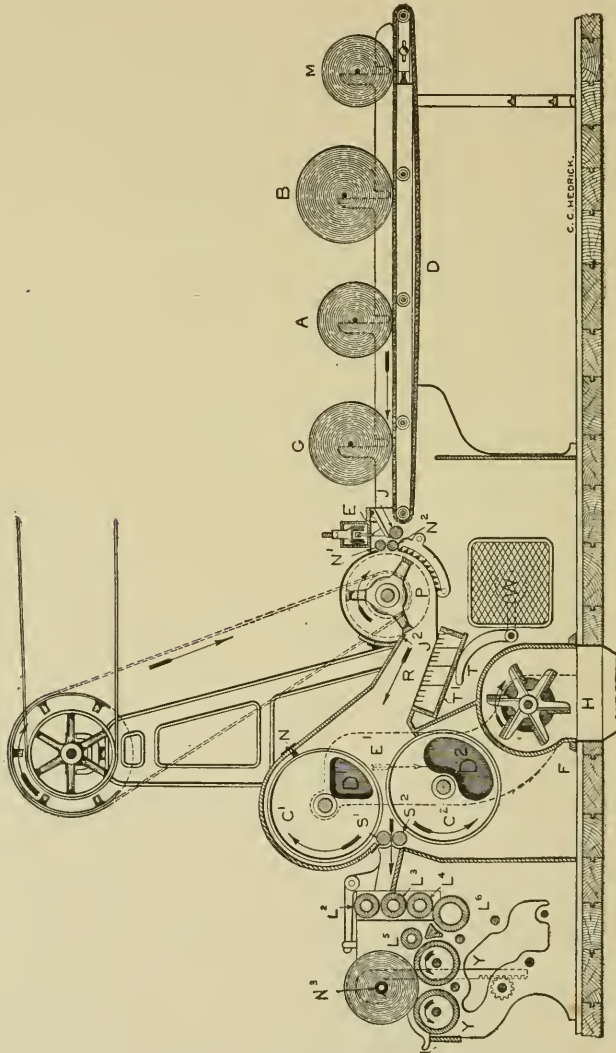

Fig. 9. Section of Intermediate or Finisher Picker.

diameters, the replacement of one, which can be done very quickly, makes a break in the doubled laps well-nigh impossible. The laps are carried forward on the feed apron, and are drawn between

the evener roll, J, and the sectional plates, E, then between the feed rolls, N¹ and N². From this point the cotton is treated in exactly the same manner as in the breaker. The letters of reference are the same on the sections of both machines.

The cotton when taken from the intermediate picker goes through the third process, that of the finisher picker. It is treated the same as in the previous machine, the only difference in the two machines being the carding beater, used generally in the finisher.

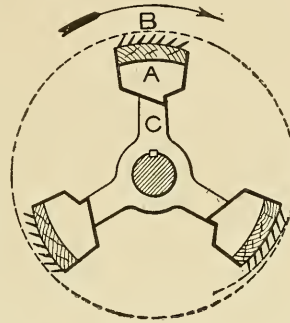

Fig. 10. Carding Beater.

Beaters. Of the different styles of pin beaters which have been in use from time to time, the carding beater gives the best results. A section of this beater is shown in Fig. 10. It will be seen that it consists of three wooden lags, A, securely fastened to the arms, C, of the beater shaft. From these lags project steel pins, B, arranged spirally, each row being farther from the center than the row preceding it. The carding and beating action is combined in this beater, the pins penetrating the tufts of cotton, thoroughly separating and dividing them.

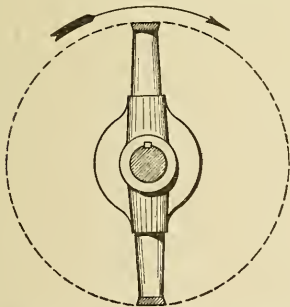

Fig. 11. Two-bladed Beater.

In this way the cotton is deposited on the cages in a finer and more even sheet, and the work of the card is lessened slightly. Notwithstanding the claim made by many to the contrary, the carding beater is capable of removing more dirt and leaf than the rigid beater. Figs. 11 and 12 show sections of two-bladed and three-bladed rigid beaters. In comparing them, it will be seen that the two-bladed one must be run at a higher speed to get the same number of blows per minute, and while

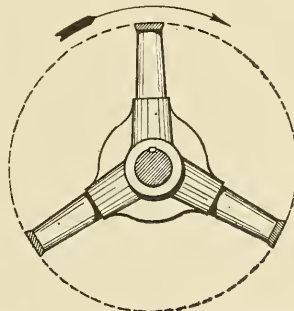

Fig. 12. Three-bladed Beater.

some object to this necessary high speed, it is certainly cheaper to construct this style. The three bladed beater is generally used on openers, and the two bladed on breakers, intermediates and finishers.

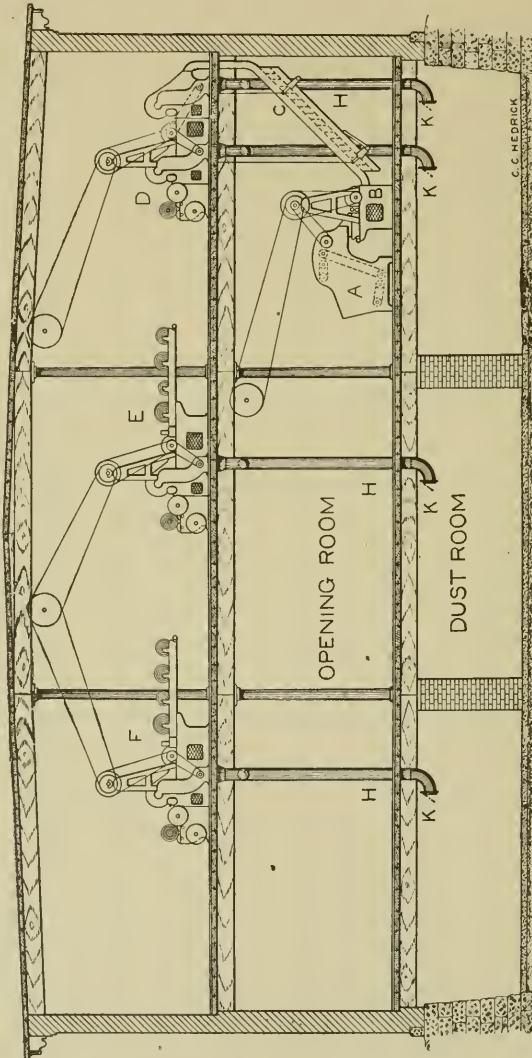
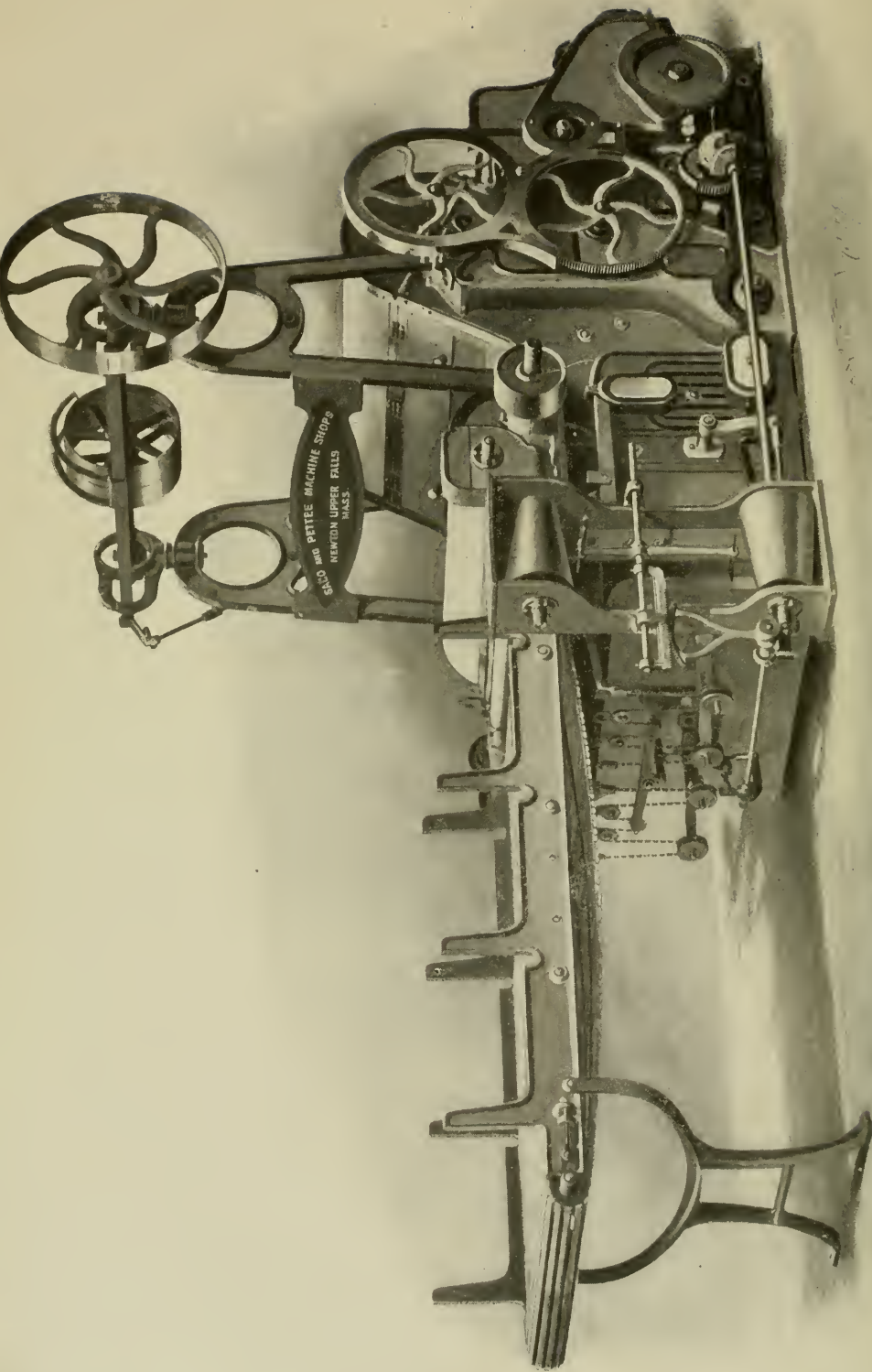

Fig. 13. Section of Elevation of Mill showing Inclined Cleaning Trunk.

Some of the rigid beaters are made with the edges of the blades of hardened steel, but these do not wear any better than



the ordinary ones, and become dulled about as soon, and cannot be sharpened without grinding, which is considerable trouble, while the others can be sharpened by simply planing off the dulled edges.

Picking Machinery on Different Floors. This is shown in the sectional elevation of a cotton mill in Fig. 13, which is very similar to the one shown previously in Fig. 3, also

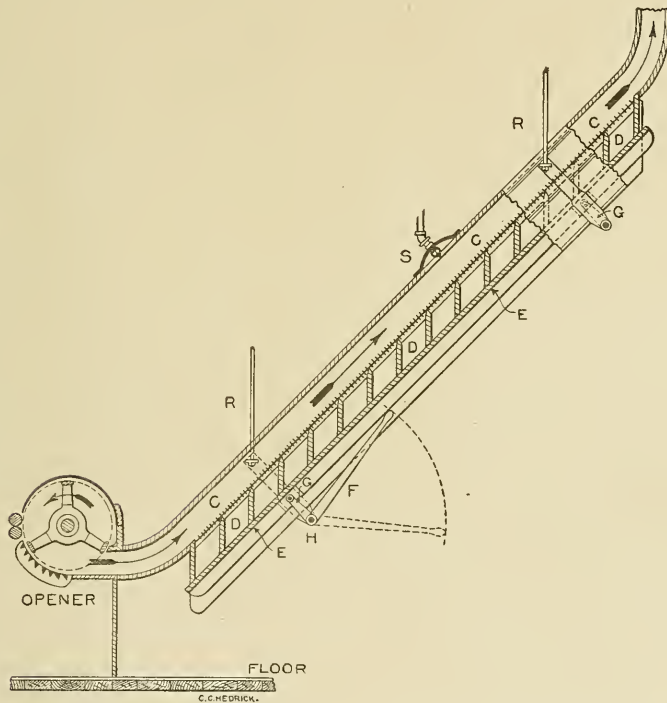

Fig. 14. Section of Inclined Cleaning Trunk, with Pockets closed.

a three-beater system. The horizontal cleaning trunk is dispensed with and an inclined trunk used in its place. One end of this trunk is connected to an opener on the first floor, the other to a one-beater breaker picker, with a screen section on the second floor. The distance between the opener and the breaker is short and does not require a condenser and gauge-box to receive the cotton, otherwise the machinery used is exactly the same as in Fig. 3. The inclined cleaning trunk is used quite extensively in

preference to the horizontal one, as the length of grid, or cleaning, surface is considered by many to be sufficient for the removal of nearly all of the loose dirt, and the cleaning of this style of trunk can be very quickly accomplished.

Inclined Cleaning Trunk. Fig. 14 shows a section of an inclined trunk, with the pockets closed, as when the machine is running. It is suspended from the floor above by rods R, and consists of two parts: the top passage C, through which the

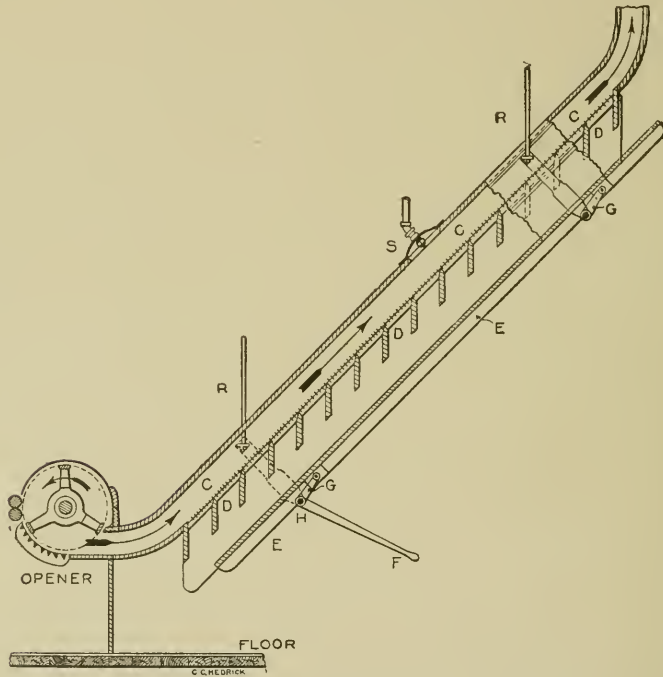

Fig. 15. Section of Inclined Cleaning Trunk, with Pockets open.

cotton passes from the opener to the breaker; and the pockets D, which receive the dirt which falls out of the cotton. The top passage is provided, in case of fire, with an automatic sprinkler, S. The pockets are separated from the passage by the grid surface, which consists of flat iron slats placed edgewise and running across the trunk at right angles to the direction of the cotton in transit. As the cotton is drawn along by the air draft, each slat presents a narrow surface, against which it strikes, caus-

ing the dirt to be shaken out and to fall between them into the pockets.

The bottom, E, of these pockets is made in one piece, extending the whole length of the trunk, and is held up against the under side of them by levers G, which are fastened at each end of the bottom to a strip which runs along the under side. These levers are controlled by a handle, F, the bottom forming a connection to the upper lever. Fig. 15 shows a trunk with the pockets

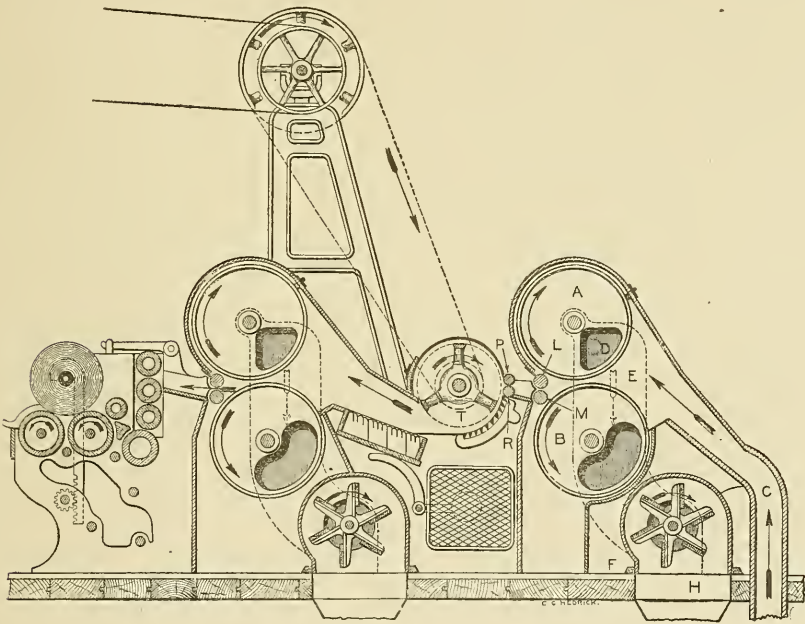

Fig. 16. Section of Breaker Picker, with Screen Section.

opened for cleaning. The handle is swung down into the position shown, which draws the bottom away from the under side of the pockets. The refuse slides down into a box, or basket, placed beneath the lower end of the trunk. Sometimes the trunk is provided with a connection, by which the dust is allowed to fall directly into the dust room.

Breaker Picker with Screen Section. Fig. 16 shows a section of a breaker picker. The cotton enters from the trunk C, and is deposited upon two revolving screens, A and B, which form the

screen section and are simply for cleaning the cotton and forming it into a sheet, to be fed to the beater. As the distance traversed by the cotton between the opener and the breaker

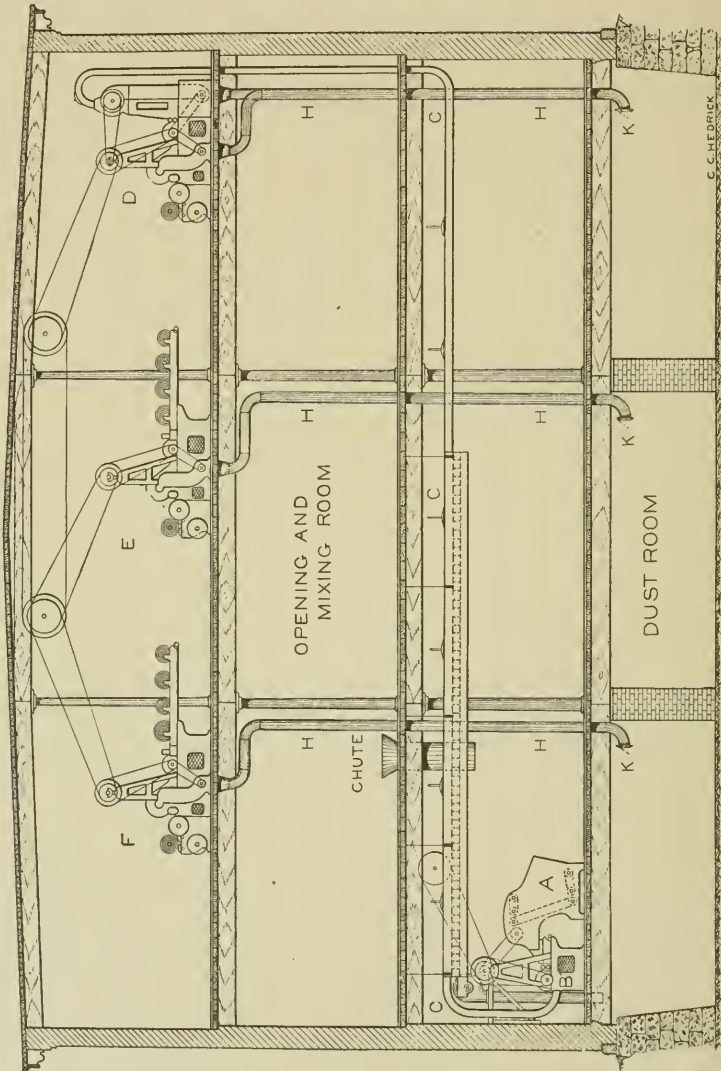

Fig. 17. Sectional Elevation of Three-story Mill, with Horizontal Cleaning Trunk.

is short, what little cotton there might be in the trunk would not materially affect the weight of the laps by the stopping of the feed of the opener while doffing the breaker, and this may

be entirely overcome by doffing without stopping the feed. Each screen is provided with an opening, D, at each end, which leads into a dust passage to the fan F, by which the dust and dirt are forced through the pipe H into the dust room. As the screens revolve, the cotton is carried around to the stripping rolls L and M, and removed by them. Passing forward between the feed rolls P and R, it comes into contact with the blades of the rigid beater T. From this point the cotton undergoes the same treatment as in the machines previously described.

Three-storied Mill Arrangement. Fig. 17 shows a sectional elevation with a three-beater system. The openers and feeders are placed on the first floor and connected by a horizontal cleaning trunk. The breaker is fitted with a condenser and gauge-box, which provides for the long distance traversed by the cotton.

The second floor is used for opening and mixing the cotton, after which it is dropped through a chute to the feeders on the floor below. It will be seen that the fan for cleaning the trunk is upon brackets which are fastened to the wall on the end of the trunk nearest the opener, instead of the opposite end, as in the first arrangement shown (Fig. 3). Sometimes only a part of the second floor is used for opening and mixing, while often the first floor is used for this purpose, and the second floor devoted to some other process.

Another way of arranging this system is to divide the first floor into sections, leaving only a small space around the feeders for the cotton, the rest of the floor being used as a repair shop.

When the pipes leading to the dust room pass through the rooms below, it is customary usually to bring them down near the side walls or some of the columns, in order that they shall be out of the way as much as possible.

SYSTEM TWO.

Fig. 18 shows an arrangement with all of the machinery on one floor, as when space is limited, and the cotton is opened and made into a finished lap on the same floor as the card room. With this arrangement no cleaning trunk is used. The machinery consists of a two-beater breaker with an automatic feeder, the first section of the breaker corresponding to the opener, which is shown

in the arrangement with the trunk system. The rest of the machinery is a single-beater intermediate picker, also with an evener and a carding beater. Any of these single-beater machines can be

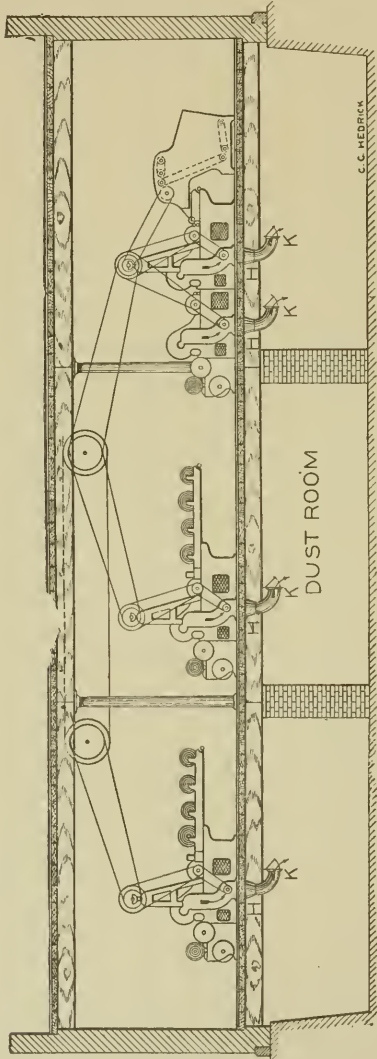

Fig. 18. Section of Mill with three processes, and no Cleaning Trunk.

made with two or three beaters when the nature of the cotton requires a very thorough cleaning and the floor space is limited.

For spinning fine numbers of yarn which require long staple cotton, the fibers must be treated as carefully as possible, and as the opening and cleaning process is an unavoidable evil, it is necessary to reduce the beaters in a system to the least number possible. Fig. 19 shows a system which consists of an automatic feeder, usually provided with an evener, connected to a single beater breaker picker, and a single-beater finisher with an evener and rigid beater.

In all the arrangements previously described, the carding beater has been recommended for the finisher picker, as giving the best results, but for the treatment of very long staple cotton, the rigid

beater is used in preference, as the action of the carding beater is considered too harsh.

Combination Machine. When in small mills the production per day is not large enough for even one complete set of machines,

a combination breaker and finisher picker with a feeder attached is used. This machine is shown in sectional elevation in Fig. 20 and is simply a finisher picker with a feeder connected to the end of a long feed-apron.

If the cotton is to undergo three processes, the number of pounds required for the day's run is put through the picker and allowed to fall in a loose pile in front of the calender head, and then is carried to the rear end and thrown onto the feeder again for the second process, when it is formed into laps. For the third process the laps are doubled, three or four, on the apron and made into the finished lap ready for the card-room. While this is the

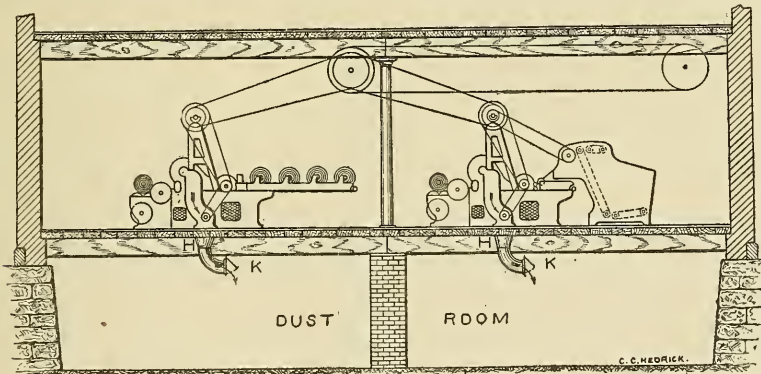

Fig. 19. Section of Mill with two processes, and no Cleaning Trunk.

usual method of handling the cotton, it can be made into laps after each process, if desired. When two processes only are required, the cotton should always be formed into laps the first time it is run through the machine.

The combination breaker and finisher is fitted with an evener specially adapted for running loose stock, and of which reference will be made later. It should have also a rigid beater, as the pin beater will not do when the cotton is put through three processes. Sometimes this style of machine is made with two beaters, when it is desired to give the cotton a very thorough cleaning and to put it through twice only. The front section may then be provided with a pin beater and the rear with a rigid beater.

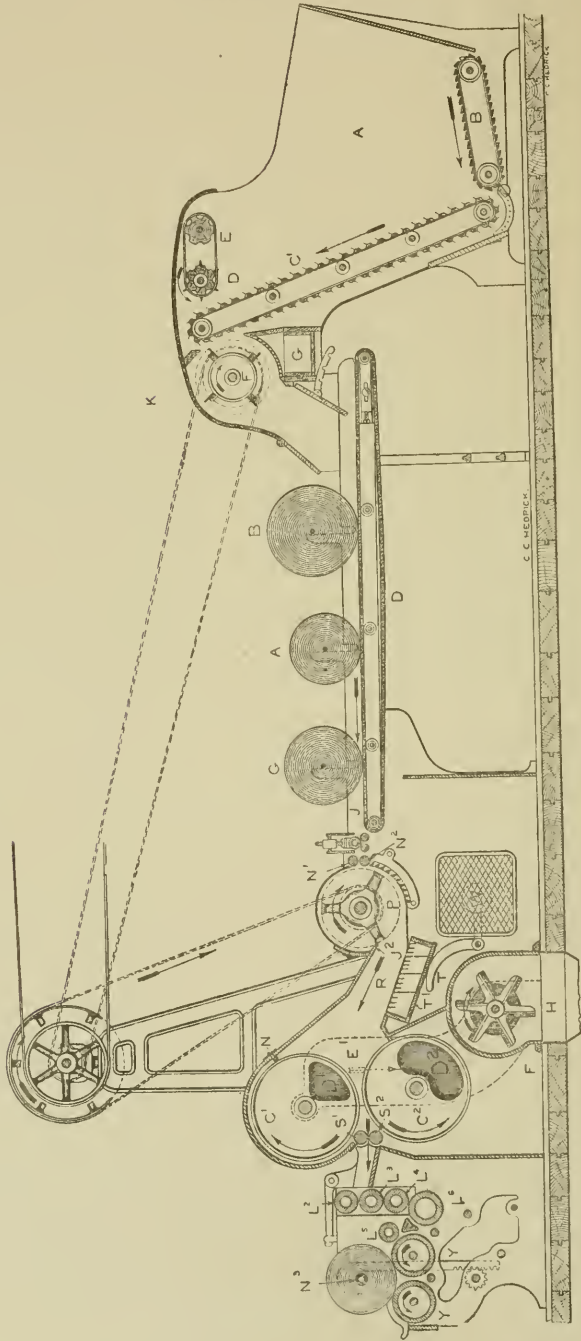

Fig. 20. Section of Combination Breaker and Finisher with Automatic Feeder.

SYSTEM THREE.

When the picking machinery is all upon the same floor, and a trunk is used for connecting the opener and breaker, the machinery may be arranged as in Fig. 21. The inclined cleaning trunk which is used for this is connected to the condenser of the breaker by a galvanized iron conveying pipe about 12 inches in diameter, which extends horizontally above the finisher and intermediate to the back of the breaker. In this way the loose cotton is fed to the opener and returned in the form of a lap in about the same part of the opening room.

Another method of arranging the machines all on one floor, with a horizontal trunk, is shown in Fig. 22. The feeder and opener are close to the breaker by having the trunk in two sections of 20 feet each, one just above the other. This saves considerable space across the room. The trunk is cleaned in the manner described in Figs. 6 and 7, one end of each section being connected to the cleaning fan.

Both of these arrangements are frequently used in a one-story building, but in the drawings shown the second floor is used for a slasher room.

SYSTEM FOUR.

It often happens that the bales of cotton cannot be unloaded near the opening room, and when this is the case an additional handling is necessary, which is quite an expense, particularly in a large mill. A method adopted by some of the leading manufacturers is to connect the opening room with the cotton house (where the bales are unloaded) by a galvanized iron pipe 12 to 24 inches in diameter and of any reasonable length.

In the cotton house is an automatic feeder which is connected to one end of the pipe. The cotton is thrown into this feeder, which delivers it to the pipe, through which it is drawn by a strong current of air produced by an exhaust fan. This fan has a style of wheel known as a wool wheel, which is ordinarily used for blowing wool. The other end of the pipe is provided with a condenser, consisting of a revolving screen about 18 inches in diameter, upon which the cotton is deposited. The screen is connected to

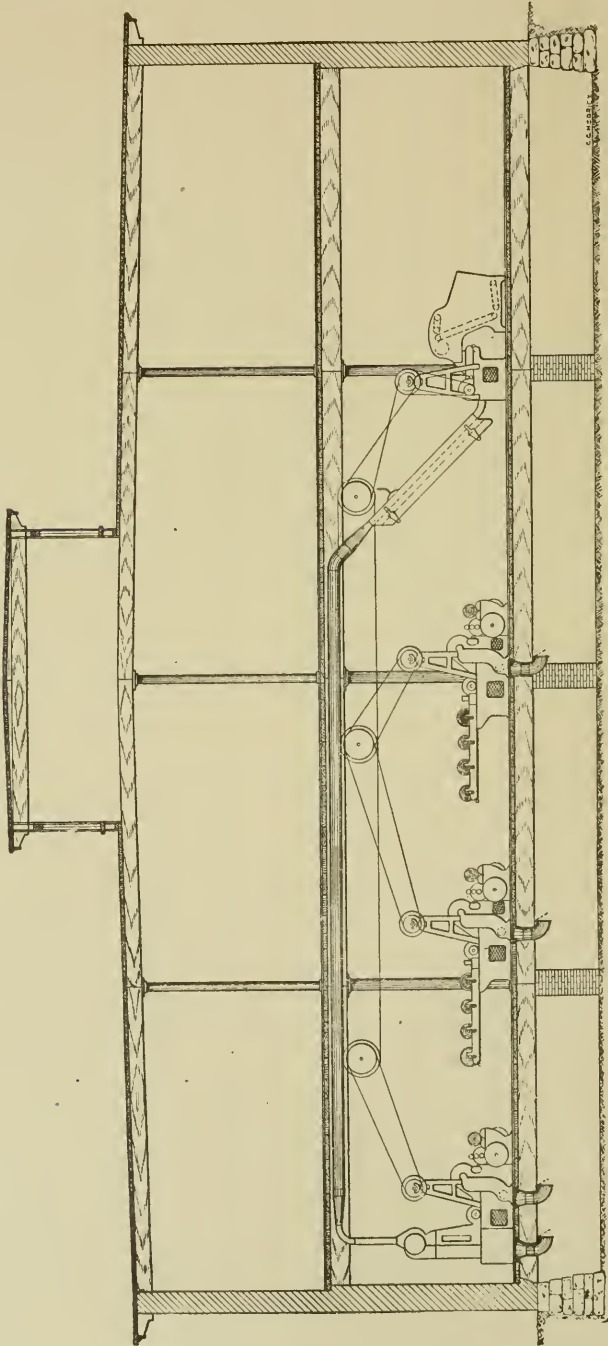

Fig. 21. Section of Mill, showing all machinery on same floor with Inclined Cleaning Trunk.

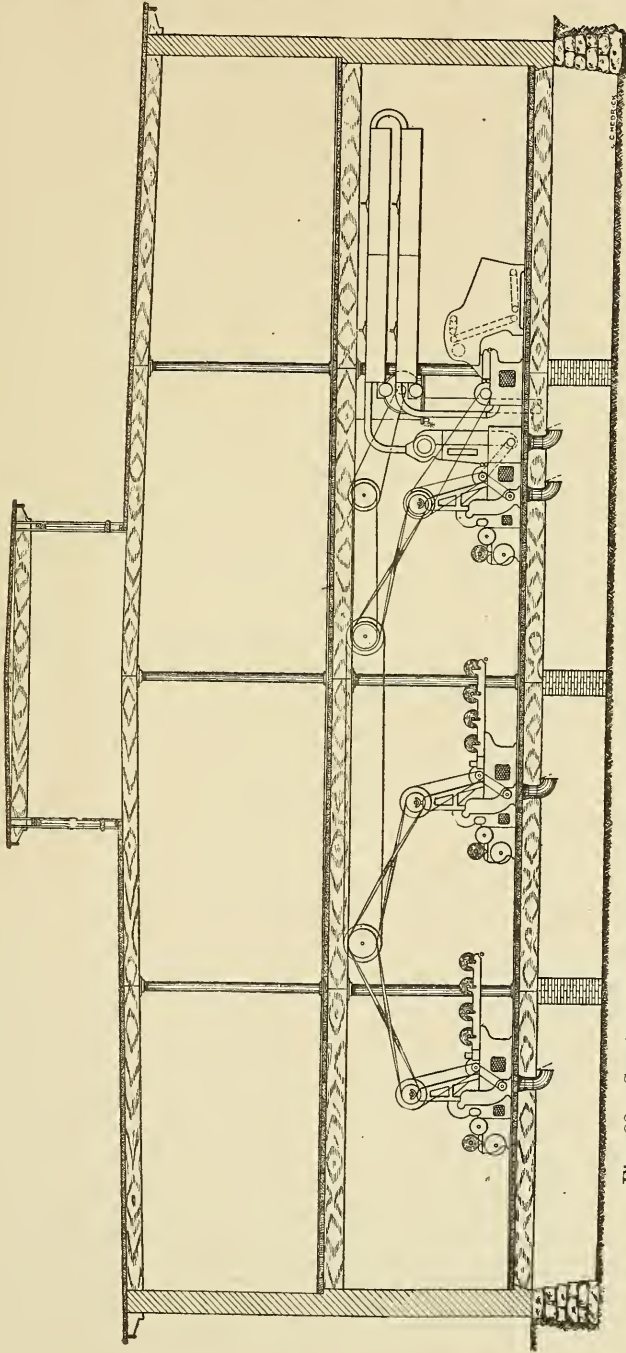

Fig. 22. Section of Mill, showing all machinery on same floor with Horizontal Cleaning Trunk.

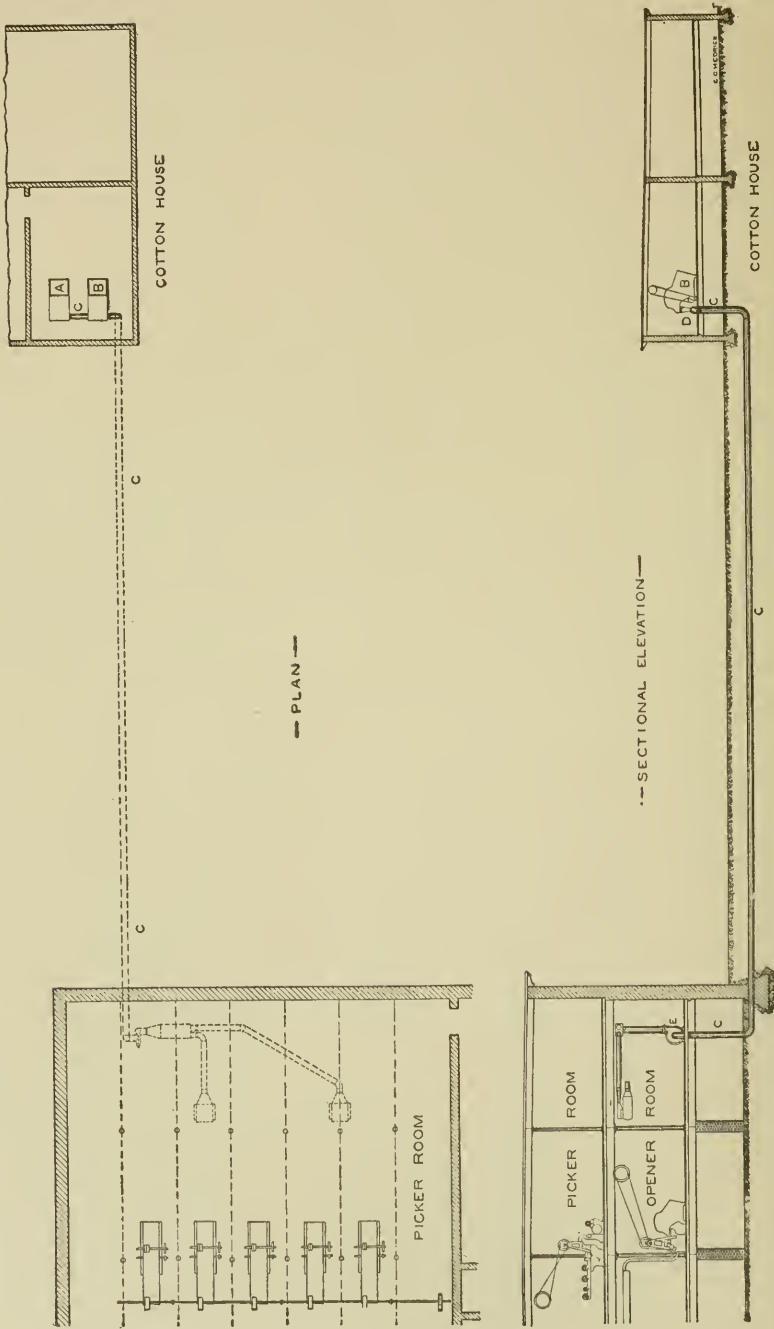

Fig. 23. Plan and Sectional Elevation of Mill and Storehouse, showing Blowing System.

a fan, and being open at both ends, the light lint and dust pass through, while the cotton is removed as the screen revolves and falls in a pile upon the floor.

A system of this kind is shown in Figs. 23 to 27, inclusive. Fig. 23 is a plan and sectional elevation of a mill and storehouse, with a galvanized iron pipe 14 inches in diameter connecting them for conveying the cotton, and Fig. 24 is a plan and elevation, on a larger scale, of the automatic feeders for this system.

One end of the cotton house is partitioned off from the remainder of the building by a brick division wall, which forms a room where the bales are opened. In this room are two automatic feeders,

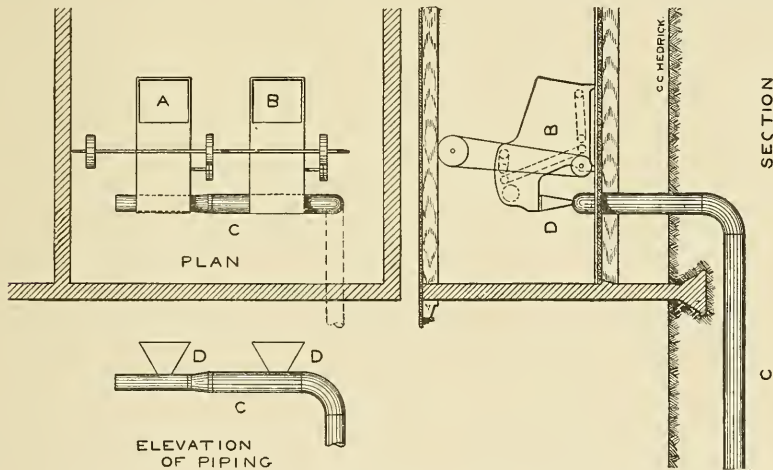

Fig. 24. Plan and Sectional Elevation of Feeders in Storehouse.

A and B, with especially large hoppers, which are driven by an electric motor and which deliver the cotton to the conveying pipe, C, through mouthpieces, D. The fan, E, for drawing the cotton through the pipe, is placed in the opener room at the top of the upright pipe.

Fig. 25 is a plan and elevation showing the piping in detail. Two condensers are used for supplying the five feeders. This affords an opportunity for distributing the cotton in two piles, so that it may be readily supplied to the feeders.

After the cotton passes through the fan, it enters an enlarged part of the pipe, rectangular in section and in which is a gate, K,

shown by dotted lines, which may be operated from the outside of the pipe. From this point, the pipe divides, line, F, leading to condenser, G, and line, H, to condenser, J. If it is desired to send all of the cotton through condenser, J, the gate is moved to the position shown, which closes the opening in pipe, F, all of the cotton passing through pipe H. But if both condensers are to be run,

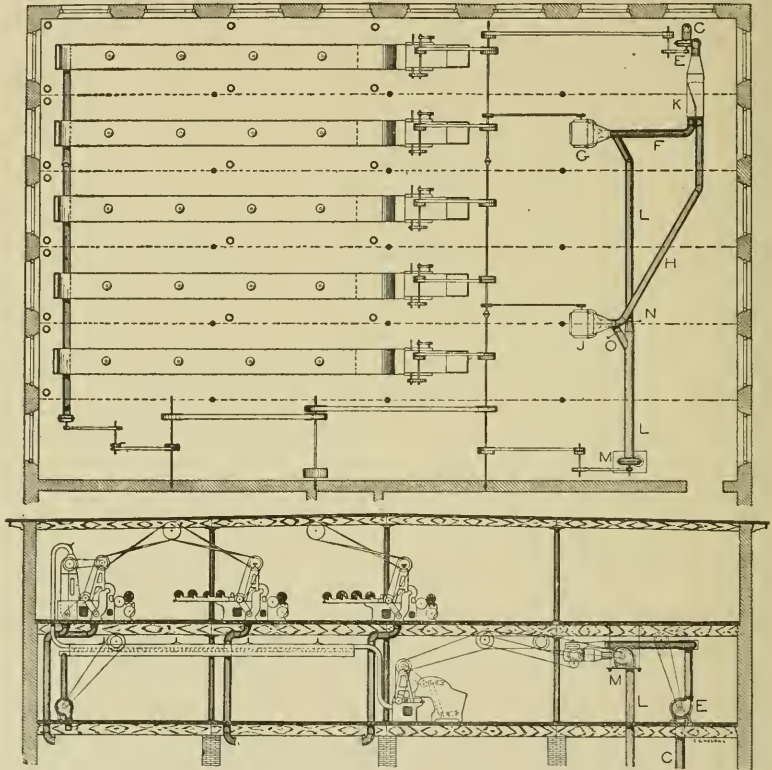

Fig. 25. Plans and Sectional Elevation, showing details of piping for Blowing System.

the gate is moved straightway of the pipe, leaving both branch pipes open to the condensers.

The dust and dirt from the condensers are discharged into the dust room through the pipe, L, by the fan, M. When only one condenser is running, it is necessary to close the pipe leading to the other so that the air will all be drawn from the one that is running. This necessitates the wind gates, N and O. If the con-

denser, J, is running, the gate, N, should be closed, while if G is running, O is closed. When both are in operation, the gates should both be left open, so that the air will draw equally from each, but as the draft from the condenser nearest the fan is generally the strongest, it is often necessary to slightly close one of the gates, so that the draft from each condenser shall be equal.

When a small quantity of cotton is to be run through a blowing system, instead of having an automatic feeder as in Fig. 24, the feed end of the pipe is

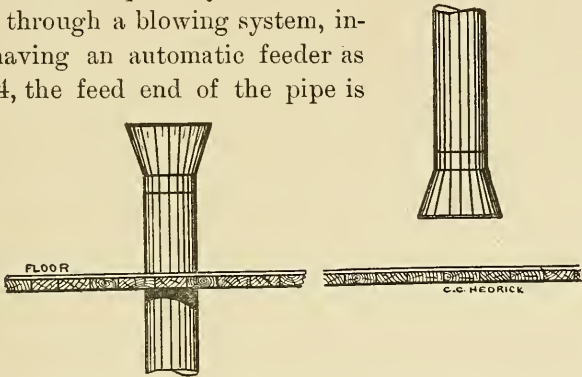

Fig. 26. Straight Pipe Mouth Pieces.

made as shown in Figs. 26 and 27. In Fig. 26 it is enlarged slightly, so that the cotton may be thrown in readily. The pipe may be inverted and the cotton drawn up instead of down which is

much better, as it affords an opportunity for pieces of hoop iron, nails etc., to drop out, while with the pipe leading down, as in the drawing, the heavy substances simply fall to the bottom of the vertical part of the pipe and have to be removed. Hand holes are made in this part of the pipe and in all parts where it is necessary.

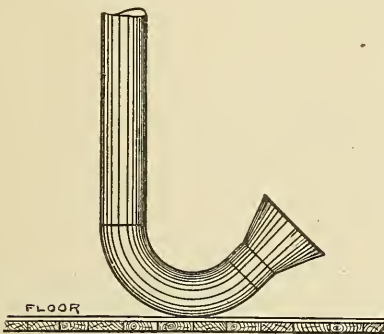

Fig. 27. Elbow Mouth Pieces.

Fig. 27 shows another form for the feed end of the pipe, which embodies the points of both pipes previously referred to in Fig. 26. The shape of the pipe permits the cotton to be dropped in and the vertical part allows

the heavy dirt to fall to the bottom, where it can be removed.

It is considered advisable in all cases to use an automatic feeder with a blowing system in the cotton house, as the lumps of cotton are broken better by being tumbled about in the hopper, and the danger of fire is less from the fan striking a hard substance, particularly when putting a large quantity through the pipe. The production from one feeder may be called, safely, 8,000 pounds for a day of ten hours, without crowding the machine.

Eveners. One of the characteristics of good yarn is evenness. This is dependent upon the successful manipulation of the cotton in all of the processes which it undergoes. Reference has been made previously to the doubling of the laps upon the aprons of the intermediate and finisher pickers. This is of great importance in the process of evening, but the first stage in the formation of the lap, which is upon the breaker picker, may be considered as the starting-point for this operation. While it is true that a carefully made lap may be entirely spoiled by the careless handling of the machines before it is spun into yarn, as is often the case, the sooner we commence the operation of evening the mass of cotton, the better final result will be obtained.

It is a well-known fact that when the hopper of the automatic feeder is quite full, the lap is apt to be heavy, and if the cotton is allowed to run low in the hopper, the lap will be found to be correspondingly light. When an attendant is required to take care of quite a number of feeders, the laps from the breaker picker vary considerably in weight, owing to his inability to keep them filled to near enough a uniform height. In order that the automatic feeder shall deliver the same amount of cotton to the opener at all times, many feeders are provided with eveners of some description.

Evener for Automatic Feeder. Fig. 28 shows a section of an automatic feeder which, besides having an evening device, possesses some points quite distinct from all other feeders. It consists of a bottom apron, A, an elevating apron, B, supported by carrier rolls, and a doffer, C. Beneath the doffer is a screen, D, and a dust drawer, or box, E, while beneath the elevating apron is also a screen, all of which parts are common to most feeders. Instead, however, of having a spike-roll to remove the surplus bunches of cotton from the elevating apron, this feeder is provided with

a comb, F, which is carried by several arms, G. These arms are fastened to the comb shaft, H, which is hung from the shaft, P, by swing stands, M. The oscillations of the comb are obtained from a pulley, J, in one arm of which is fastened a stud, T. This stud is connected by a pitman, K, to a similar stud, V, in the arm, L, which is fastened to the comb shaft.

Fig. 29 shows an enlarged section of a part of the feeder and Fig. 30 an elevation of the same.

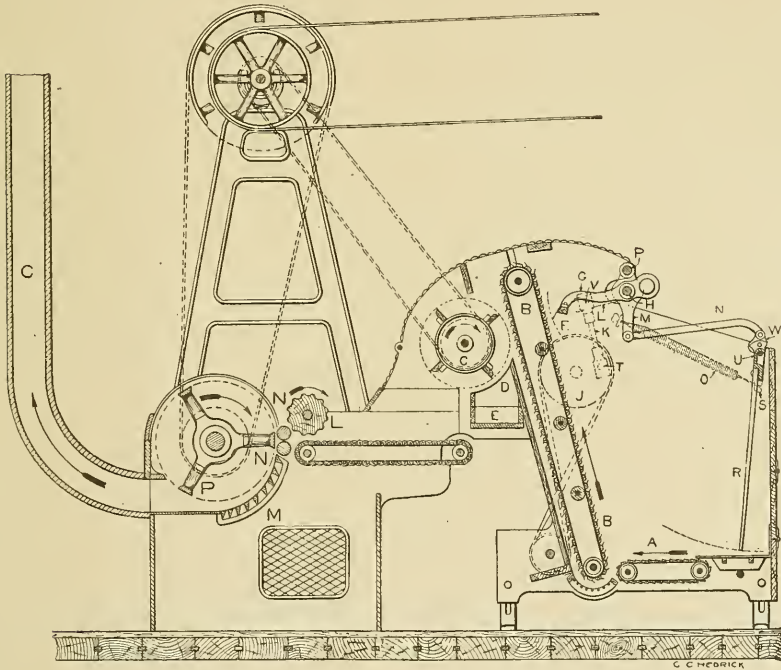

Fig. 28. Automatic Feeder with Evener Attached.

The device for regulating the feed is constructed in the following manner: In the back part of the hopper is a rack, R, constructed similarly to a rake, with very long tines, which is suspended from each side of the hopper by studs, U, which form a center about which it swings. Projecting from the top of the rack are stands, W, connected to the comb-shaft swing stands by arms, N. By this arrangement, any swinging motion of the rack will be com-

municated to the comb by the parts described. On the outside of the hopper are springs, O, connected to the arms, S, which are

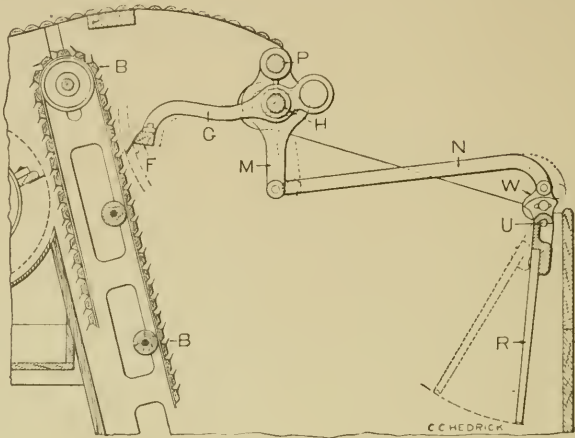

Fig. 29. Section Showing Evener Parts.

fastened to the outside ends of the studs, U, from which the rack swings. The pull of the springs is such as to draw the rack

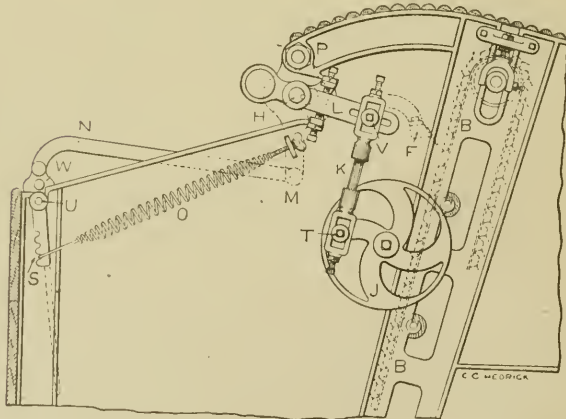

Fig. 30. Elevation Showing Evener Parts.

towards the elevating apron. When the hopper is full, or nearly so, the cotton keeps the rack in an almost vertical position, but as it

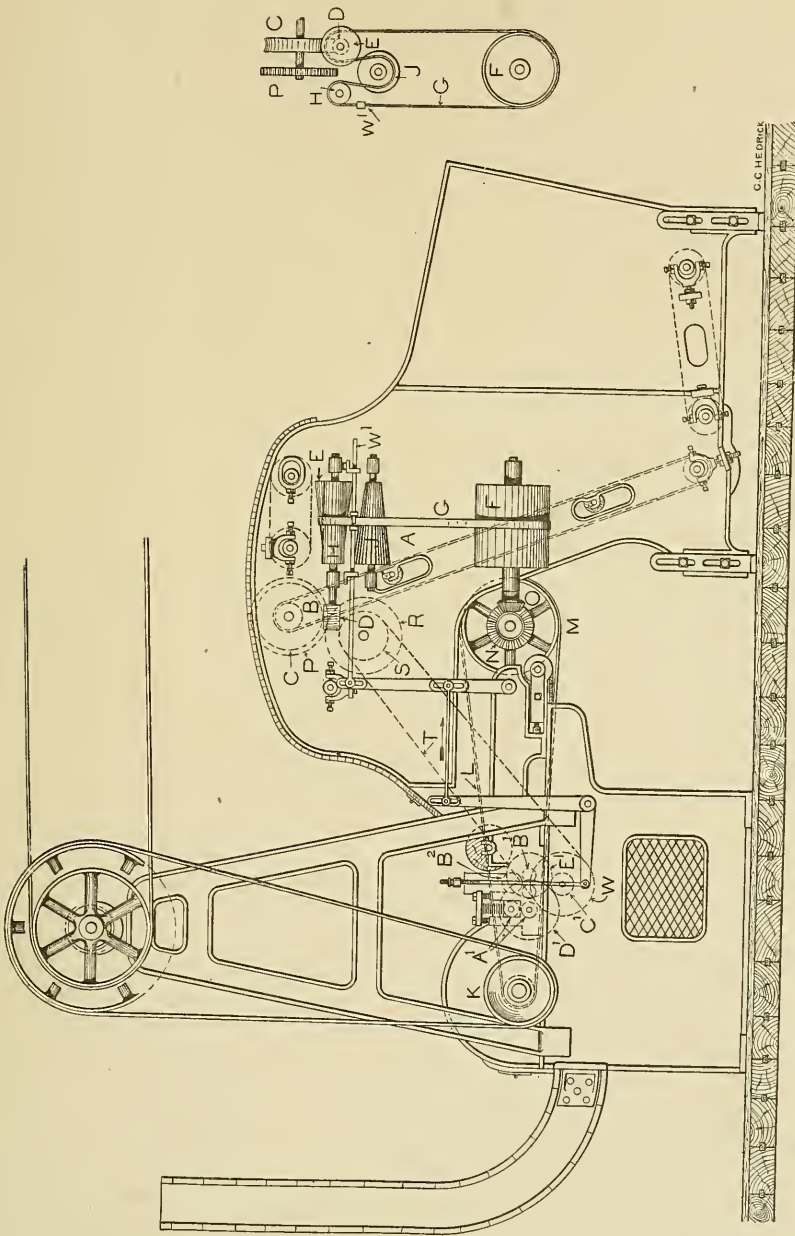

Fig. 31. Section of Automatic Feeder with Cone Evener Attached.

gets low in the hopper, the springs draw the rack forward towards the elevating apron while the comb is drawn slightly away from it. By thus increasing the distance between the comb and the apron (which is shown by the dotted lines in Fig. 29), more cotton is allowed to pass forward to the opener, tending to keep the delivery of the feed the same at all times.

Another style of automatic feeder, provided with an evener, is shown in connection with an opener in Fig. 31. With this feeder the supply of cotton delivered to the opener is regulated by

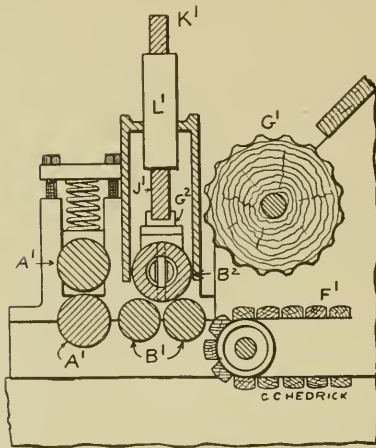

Fig. 32. Section Showing Evener Rolls and Feed Rolls.

the speed of the elevating apron, which in turn is governed by the thickness of the sheet of cotton passing between the evener rolls. As the quantity of cotton in the hopper grows less, the amount fed to the opener is lighter; thus the speed of the elevating apron and the feed rolls on the opener are correspondingly increased, so that the amount of cotton delivered shall be always the same. The elevating apron, A, is driven by frictional contact with the top apron roll, B, on the end of which is a worm gear, C, which is driven from the worm, D, upon the end of the cone, E. This cone is driven from the drum, F, by the belt, G, which passes around the carrier roll, H, and the binder cone, J.

An end elevation of the cone is shown at the right in Fig. 31. On the end of the beater shaft, and shown by dotted lines, is a pulley, K, which drives the drum, F, by means of the belt, L, pulley, M, and gears, N and O, the last being upon the end of the drum shaft. On the top apron roll is a gear, P, which drives a similar gear, R, and upon the hub of the latter is a sprocket wheel, S, which drives, by means of the sprocket chain, T, the wheel, W. The feed rolls, A¹, are driven from the hub of this sprocket by the gears, C¹

and D^1 , and the evener rolls, B^1 and B^2 , are driven by the gears, C^1 and E^1 . It will be seen that by this arrangement any change in the speed of the levating apron directly affects the speed of the evener and feed rolls.

Fig. 32 is a section showing the arrangement of the evener rolls and feed rolls. Fig. 33 is a view of the evener case showing the rolls, levers and parts connected.

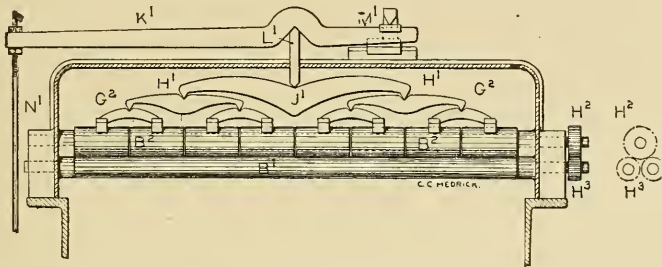

Fig. 33. Elevation Showing Evener Rolls and Levers.

The cotton passes along on the feed apron, F^1 , under the press roll, G^1 , and is drawn between the bottom evener rolls, B^1 , and the top evener roll, B^2 , and then between the feed rolls, A^1 . The bottom evener rolls, which are about 2 inches in diameter, are made solid, while the top roll, which is driven from one of the bottom ones by gears, H^2 and H^3 , is about 3 inches in diameter and is made up of a series of short rolls, eight in number, each about 5 inches long and which are hollow and connected as shown in Fig. 34.

In the face of the rolls, and near each end, is a hole through which is driven a steel pin. These pins, A^2 , are connected by dogs,

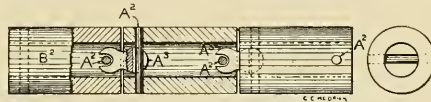

Fig. 34. Section of Flexible Evener Roll.

or universal joints, A^3 . In this way, rotary motion is communicated from one to another, while a vertical movement of one or more can take place, subject to the varying thickness of the cotton passing between them and the bottom rolls. The whole arrangement forms a very neat flexible roll.

On the top of each of the short rolls (Fig. 33) rests one end of a small saddle, G^2 . These saddles are connected by other saddles,

H¹, while a main saddle, J¹, forms a connection between all of them. On the top of the evener case is the evener lever, K¹, which is connected to the main saddle by the stem, L¹. The fulcrum of the lever is at M¹ and the long end is connected to a rod, N¹.

Fig. 35 is a side elevation showing the connections between the evener lever and the cone-belt guide. It will be seen that the lower end of the rod, N¹, is connected to a bell crank-lever, O¹, which turns on a stud, P¹. A horizontal rod, R¹, connects the vertical arm of this lever with the lever, S¹. At the lower end of the

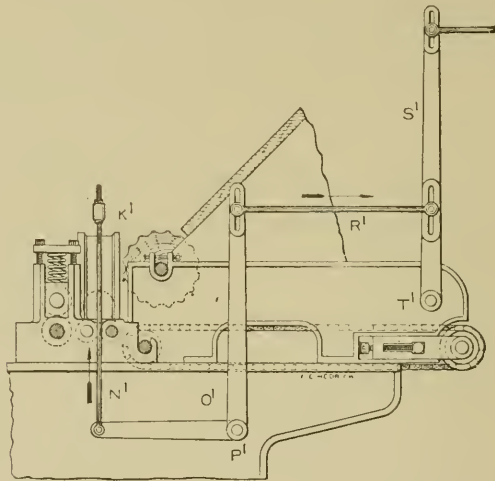

Fig. 35. Elevation Showing Connections from Evener to Cone Belt.

latter is a stud, T¹, which forms a fulcrum about which the lever turns and at the upper end is connected the cone-belt guide, W¹. When the evener roll is raised, by reason of an unusual thickness of cotton going through, the evener lever also raises and the connections, just described, move in the direction shown by arrows. This moves the cone belt towards the large end of the driven cone, E (Fig. 31), and a slower movement of the elevating apron takes place, delivering less cotton to the opener. A light feed will cause a reverse movement in the direction of the cone belt towards the small end of the driven cone, thus increasing the speed of the elevating apron. This style of evener, for regulating the feed of

cotton when in loose form, "raw stock" as it is called, is one of the most perfect in use.

Eveners for Pickers. The operations of the evener on the intermediate and finisher pickers depend wholly upon the thick-

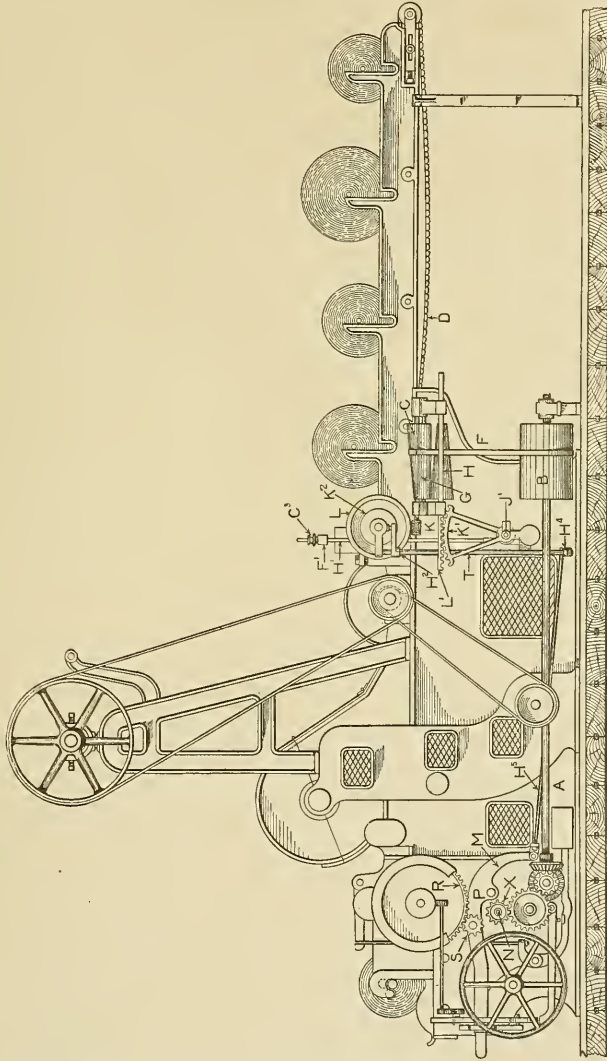

Fig. 36. Elevation of Picker with Evener Attached.

ness of the sheet of cotton which passes between two surfaces and not upon the weight, as is also the case when the evener is applied to the automatic feeder and, unless the cotton has been thoroughly

opened, the same weight in a lap may be slightly different in thickness, consequently the evener is not always absolutely perfect in its work.

A side elevation of a finisher picker provided with an evener is shown in Fig. 36. The evener is driven from the draft gear, X, on the calender head, or delivery end of the machine, by the side shaft, A. On the back end of this shaft is a drum, B, which drives the evener cone, C, by means of the belt, F, which passes over the carrier roll, G, and under the binder cone, H, which can be lowered to take up the slack as the belt stretches. On the end of the evener cone is a worm, K, which drives the worm gear, L, which is connected directly to the evener and feed rolls.

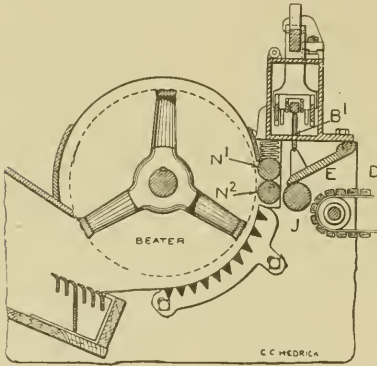

Fig. 37. Section Showing Evener Rolls and Feed Rolls.

Fig. 37 shows a section through the evener and Fig. 38 shows a side elevation and section of the same.

The laps are carried forward on the feed apron, D, and are drawn between the evener roll, J, and the sectional plates, E, then between the feed rolls, N¹ and N². The sectional plates, of which there are sixteen, extend across the whole width of the face of the evener roll. Rest-

ing in a socket on the top of each of these plates are short rods, B¹, which support saddles, C¹. These saddles are connected to the stem, D¹, by other and larger saddles all of which act as levers, the stem forming a connection between the top saddle, E¹, and the top lever, F¹. The top lever, which has its fulcrum at G¹, is connected at its long end by a rod, H¹, the lower end of which terminates in a rack, A¹, which is in gear with a pinion, C⁴, this last being on the quadrant shaft, J¹. On the outer end of the quadrant shaft is a segment gear, K¹, called the quadrant, the teeth of which are in contact with the teeth of the cone-belt guide, L¹.

When the position of the sectional plates is changed, by reason

of a difference in thickness of the sheet of cotton passing under them, the quadrant shaft is turned slightly, and by the connections just described, the cone belt is moved to a different position on the face of the cone, changing the speed of the evener and feed rolls. This will continue until the thick or thin place, as the case may be, has passed by the sectional plates, when they will resume their normal position. At the top end of the rod, H^1 , is a thumbscrew, C^3 , by which the position of the cone belt may be changed slightly when adjusting the evener.

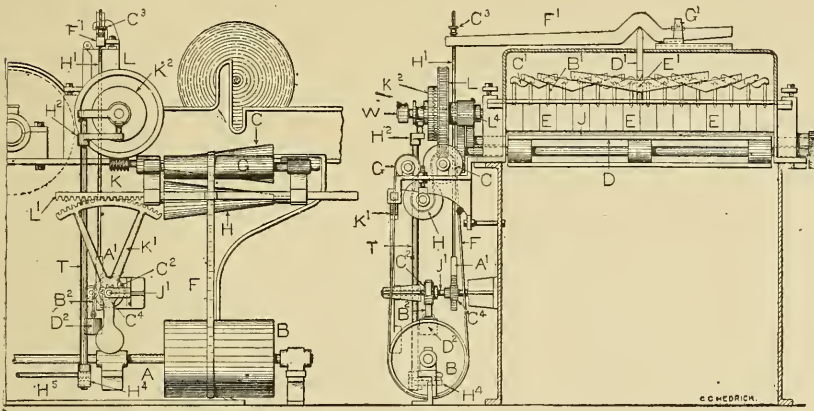

Fig. 38. Section and Side Elevation of Evener for Picker.

In order that the sectional plates shall not rise too easily, a drum, or weight pulley, C^2 , is fastened to the quadrant shaft. Around this pulley, and fastened to it, passes a strap, B^2 , the lower end of which is connected to a weight hook upon which hangs a weight, D^2 . By this means, the sectional plates are pressed firmly down upon the lap.

The gearing of the picker is so arranged that the feed and delivery of the cotton can be started and stopped while the picker is running. It will be seen that in Fig. 36 the gear, R , which is upon the delivery calender roll, is driven from the pinion, S , which is carried by the drop lever, M , and that the feed rolls and evener rolls are driven from the draft gear, X , which is on the end of the shaft, N . Both the pinion and draft gears are driven from the calender pulleys on the opposite side of the calender head and

revolve all the time that the picker is running. The drop lever turns on a stud at P. To the lower end of the lever is fastened a rod, H^5 , which is connected to the lower end of the upright shaft, T, by the arm, H^4 . When the feed rolls are started, the drop lever is raised and the pinion, S, is brought into contact with the gear, R, and at the same time, the evener and feed rolls are started by means of a clutch being thrown into contact with the worm gear.

An enlarged section, an elevation and a partial plan of this clutch and worm gear are shown in Fig. 39. On the stud, W, is a sleeve, L^4 , with a gear on one end which drives the evener and feed rolls and a dog, or driver, L^2 , keyed to the other end. The clutch, K^2 , has two lugs, or bosses, N, which project between the arms of the dog. The worm gear, L, which runs loose on the sleeve, has teeth upon one side which engage with the teeth in the clutch. When the clutch is thrown out, the worm gear runs without imparting motion to the evener and feed rolls but when the calender head is started, the slipper rod, H^5 , which is drawn forward by the raising of the drop lever causes the clutch to engage with the teeth of the worm gear, the sleeve being driven by the lugs projecting between the arms of the dog.

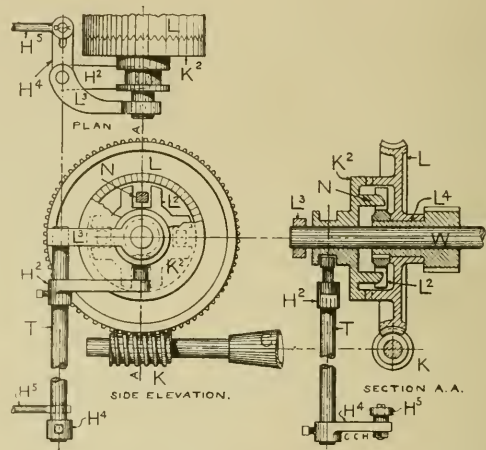

Fig. 39. Clutch and Worm Gear.

When the clutch is thrown out, the worm gear runs without imparting motion to the evener and feed rolls but when the calender head is started, the slipper rod, H^5 , which is drawn forward by the raising of the drop lever causes the clutch to engage with the teeth of the worm gear, the sleeve being driven by the lugs projecting between the arms of the dog.

Another style of evener, which is applied to intermediate or finisher pickers, is shown in three views, a section, an end elevation and a partial plan in Fig. 40. On the end of the evener roll, B, is a worm gear, D, which is driven by a worm, F, on the upper end of the driven cone, H. This cone is driven by a belt, J, from the driving cone, L, which in turn is driven from the side shaft, R.

by the gears, N and P. The cotton passes on the feed apron, A, and between the evener roll, and the pedals, C, then between the feed rolls, E and G. These pedals, eight in number, are made with one end a flat surface over which the cotton passes, and are balanced on a knife blade, K. To the long end of the pedals is connected a series of links and saddles, which are connected to a main saddle, M, the whole arrangement being similar to the evener shown last. Directly beneath the main saddle is a shaft, O, on one end of which

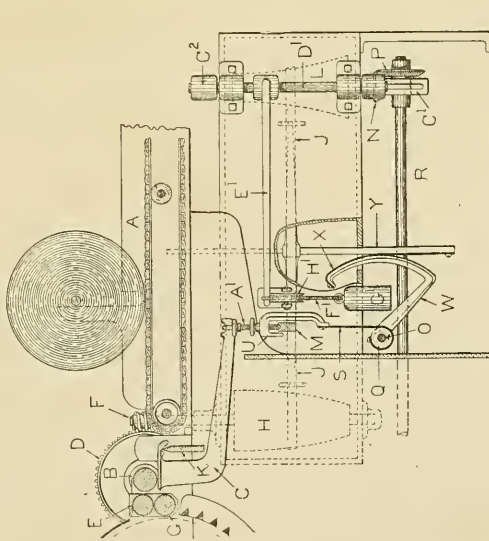
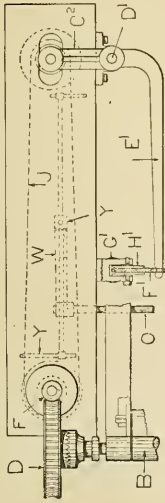
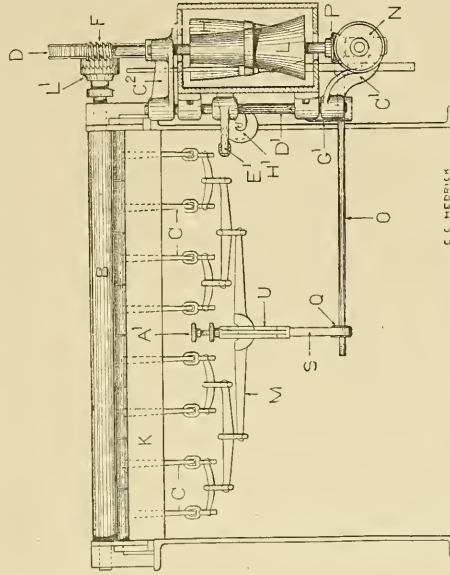

Fig. 40. Section and Elevation and Partial Plan of Evener.

is a roll, or drum, Q, which is connected to the main saddle by a thin steel band, S, and a yoke, U. One end of the band passes

partially around the drum and the other is fastened to the lower end of the yoke. On the other end of the shaft is a quadrant, W, which is connected to the cone-belt guide, Y, by a thin, steel band, X, similar to the one connecting the main saddle.

When the position of the pedals is changed by a difference in the thickness of the cotton passing between them and the evener roll, the shaft, O, is rotated and the cone belt moved to a different position on the face of the cones. An adjusting screw, A¹, connects the yoke and main saddle, by which the cone belt may be moved slightly when adjusting the evener for the correct weight of lap.

The driven cone, H, is held rigidly in its bearings but the driving cone, L, is held by arms, C¹ and C², which swing from the shaft, D¹. Fastened to the shaft is a lever, E¹, on the end of which is connected a chain, F¹, and weight, G¹, the chain running over a pulley, H¹. By this arrangement the cones are kept apart and the cone belt tight.

Evener Cones. The question often arises as to why the outlines of the evener cones are curved instead of being a straight taper. The reason for this is very simple but, in order that it shall be understood, a few words on the subject may not be amiss.

It is usually customary to double four laps on the apron of the picker so that four thicknesses shall pass under the evener roll, but, if one of the laps should run out, it is evident that the evener roll ought to run proportionately faster in order that the same weight of cotton shall be fed to the beater in a given time.

A diagram of a pair of cones and an evener roll is shown in Fig. 41. The roll, A, is 9 inches in circumference or $2\frac{7}{8}$ inches in diameter. On the end of it is a worm gear, B, of sixty teeth, which is driven by a single threaded worm, C, on the upper end of the driven cone, D. The driving cone, E, runs at a constant speed of 480 revolutions per minute and is driven from the side shaft, H, by gears, F and G. Let us suppose that four laps, each weighing 12 ounces per yard, are passing under the evener roll, the speed of which is 8 revolutions per minute; now, as the roll is 9 inches in circumference, there would be fed into the machine 72 inches, or 2 yards, of cotton weighing 48 ounces per yard, 96 ounces in all. With the evener roll at 8

revolutions, the cone will make 480 revolutions ($8 \times 60 \div 1 = 480$) the cone belt being midway of the ends of the cone. Now suppose one lap runs out, leaving only three thicknesses, or 36 ounces, passing into the machine, it is evident that the evener roll should increase enough in speed to feed in an equal amount, weighing 36 ounces per yard in the same time as when that weighing

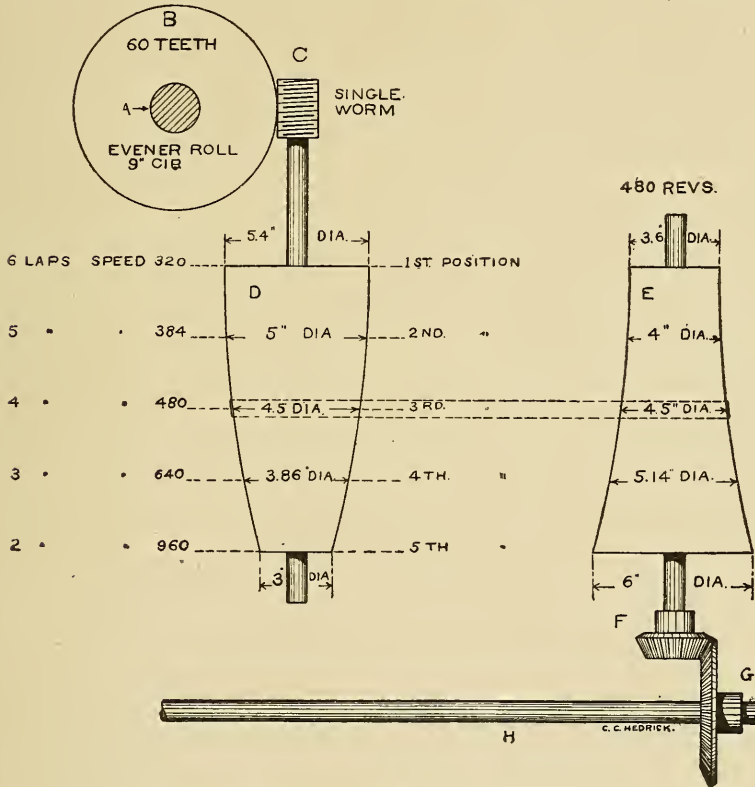

Fig. 41. Evener Cones with Correct Outline.

48 ounces per yard is going in. To accomplish this, the speed of the roll must be increased to 10.66 revolutions per minute, which will feed in 2.66 yards, which, weighing 36 ounces per yard, brings the total to 96 ounces. To give the evener roll 10.66 revolutions per minute, the driven cone would have to run 640 revolutions per minute and as the driving cone runs 480 revolutions, it is easily seen that the belt should move to a point on the face of the cones

where the diameter will be such as to give 640 revolutions to the driven cone.

The cones in the diagram are made with a difference in diameter between the large and small ends to provide for a range in speed adapted to pass in from two to six laps, and, as the cones are 16 inches long, the difference of one lap in the thickness of the sheet will move the cone belt up or down the face of the cones 4 inches. Therefore, with three thicknesses of lap going through, the cone belt will move down the cones to the fourth position and the speed of the driven cone will be 640 revolutions per minute. The diameters of the cones at this point should be 5.14 inches for the driving cone and 3.86 inches for the driven cone.

The following table shows the speeds of the evener roll and driven cones and the corresponding diameters of the cones necessary for the different speeds. From the table, it will be seen that the diameters of both cones, taken at the same points and added together, give the same total.

Weight in ounces delivered by evener roll.	Length in yards delivered by evener roll.	Revolutions of driven cone per minute.	Revolutions of evener roll per minute.	Combined weight in ounces per yard.	Number of laps going through.	Diameter in inches of driving cone.	Diameter in inches of driven cone.
96	1.33	320	5.33	72	6	3.6	5.4
96	1.60	384	6.40	60	5	4	5
96	2.00	480	8.00	48	4	4.5	4.5
96	2.66	640	10.66	36	3	5.14	3.86
96	4.00	960	16.00	24	2	6	3

Fig. 42 shows a diagram of a pair of straight taper cones which serve for comparison with those of correct outline shown in the previous diagram. The large end of each is 6 inches in diameter, the small end 3 inches in diameter and the middle $4\frac{1}{2}$ inches in diameter; the speed of the driving cone is 480 revolutions per minute. While the speeds of the driven cone, with two and four laps going in, are 960 and 480 revolutions per minute

respectively and are correct, at all other points the diameters of the cones are such as to give incorrect speeds as will be seen by comparing the two diagrams.

Friction Let-off. The friction let-off, by which the laps on the picker are caused to be wound firmly, is constructed very similarly by all builders. Three views, a front elevation, a side elevation and a section of this device are shown in Fig. 43.

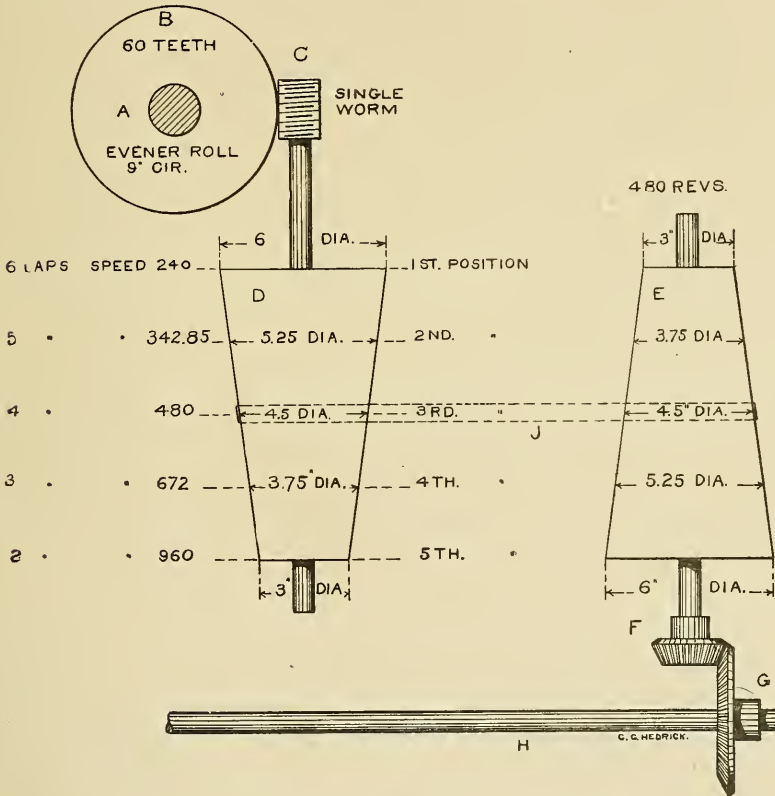

Fig. 42. Evener Cones with Incorrect Outlines.

The lap, which is wound upon the lap arbor, N³, is held in contact with the lap roll, Y, by the racks, K and K¹, which bear upon either end of the lap roll. The top of the racks is recessed to receive two rolls, A and B, which form roller bearings and which greatly reduce the friction and wear upon the lap roll. The lower end of the rack, K is in gear with the pinion, W, while K¹

is in gear with the pinion, D; both pinions are secured to the rack shaft, G. The gear, R, also on the rack shaft, is connected with the pinion, O, which is on the hub of the break pulley, N, by the gears, S and P. These gears turn loose on the shaft, L, and are held in position by the collars, F and H. The break pulley, N, is free to turn on the rack shaft and is held in position by the collar, C. Loose upon the shaft, L, is the break lever, E, which bears against the under side of the break pulley and is kept in con-

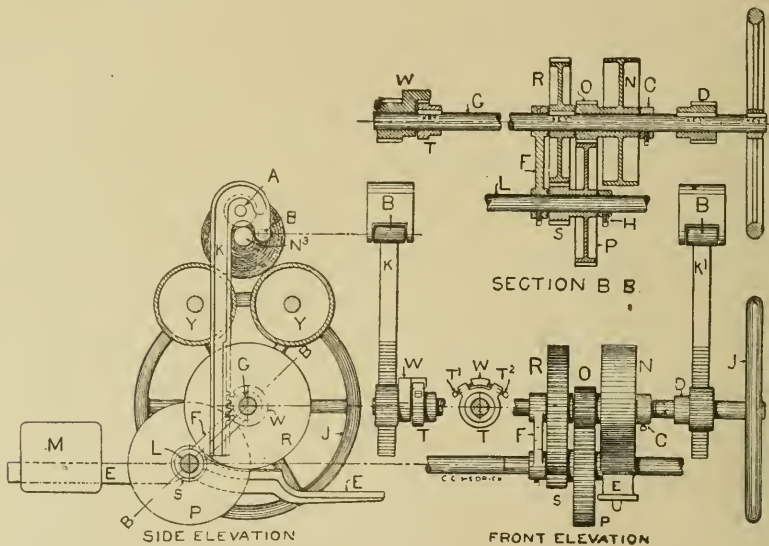
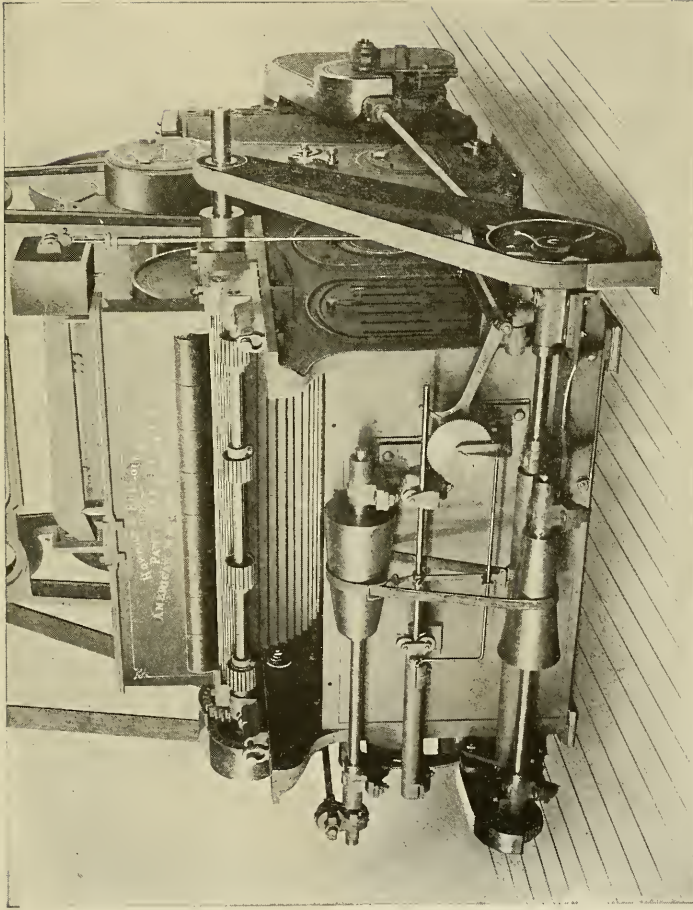

Fig. 43. Friction Let-off.

tact with it by the weight, M. The face of the break lever which bears against the pulley is lined with leather.

As the lap increases in diameter, it draws up on the racks which are kept from rising by the friction of the break lever against the break pulley. When it has been wound to its full diameter, the attendant presses down upon the break lever, releasing it from contact with the break pulley; then the rack can be raised by turning the handwheel, J, on the end of the rack shaft.

In order to bring both racks to the same height, so that the lap will be wound equally in diameter on each end, the pinion, D, which gears into the rack, K¹, is keyed directly to the rack shaft



IMPROVED EVENER WITH EVENER CONES LOCATED CONVENIENTLY UNDER FEEDING APRON
Howard & Bullough American Machine Co. (Ltd.)

while the pinion, W, which gears into the rack, K, is connected to the rack shaft by a lug projecting between the arms of a dog, or carrier, T, which is keyed to the rack shaft. In the arms of the dog are adjusting screws, T¹ and T², which bear against the projecting lug of the pinion and by turning these screws the pinion can be moved a slight distance around the rack shaft in either direction and the rack, K, brought exactly in line with the rack, K¹.

On warm, damp days, the leather facing of the break lever adheres closely to the break pulley and it is often necessary to move the weight, M, in from the end of the break lever, thus reducing the pressure of the lever against the break pulley. Sometimes it is necessary to remove the weight as too great pressure tends to break the lap rolls and to wind too hard laps, which may split when unrolled.

Care should be taken in oiling to avoid getting oil upon the break pulley as the friction is rendered well-nigh useless and the lap is consequently too soft.

Automatic Safety-stop. It is necessary that the laps, particularly those from the finisher picker, shall be as free as possible from foreign substances which, if by accident are wound into the lap, cause considerable injury to the card. Most pickers are provided with some form of device to prevent this. Two views of an automatic safety-stop are shown in Fig. 44, a side elevation and a partial front elevation.

The calender rolls, feed rolls and cages are all driven by the pinion, S, through the gear, R, which is upon one of the calender rolls, consequently, by disengaging these gears, the calender rolls and parts connected are stopped. This is accomplished in the following manner: The cotton, after leaving the cages, passes between the top and second calender rolls, L and N. Resting on the top of the bearings, at either end of the top calender roll, is a lever, F, called the top lever. The rolls, which are heavily weighted, are connected to the weight by the top lever, the rod, H, and the weight lever, G, upon which is the weight, J. The weight lever has its fulcrum at K. Directly above a part of the weight lever is the knock-off lever, A, which turns on the shaft, C, and has a screw, D, near its inner end by which it is adjusted and which

bears against a lug, projecting from the weight lever. When it is in its normal position, its outer end is just clear of the under side of the knock-off latch, E. This latch turns on the stud, T, and has a notch, B¹, in its upper end by which the drop lever, M, that carries the pinion, S, is held in position. Should any foreign substance be drawn between the calender rolls, the unusual thickness of the lap caused by it will lift the top calender roll, and, through the connection just described, the knock-off lever will be raised and its outer end brought in contact with the knock-off latch

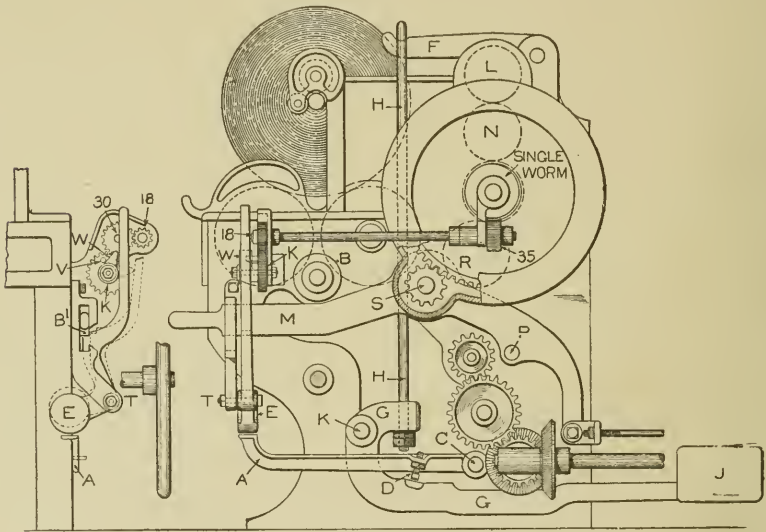

Fig. 44. Automatic Safety Stop.

which in turn will be moved to one side, allowing the drop lever to fall, disengaging the gears, R and S, and stopping the calender rolls. The adjusting screw enables the picker to be set so that a very slight increase of thickness in the lap will cause the picker to knock off, as it will also when the evener fails to take care of unusually heavy laps.

Knock-off Device. In order to get the best results, the laps should be as near the same weight as possible; not that each square yard of lap must weigh the same, but the total weight of each lap must be within one-half pound variation of a forty pound lap. In some cases, for very fine work, particularly with

single carding and the revolving flat card, each lap from the finisher picker is weighed, and, if found to vary from the limit, which has been established as a standard, is not allowed to pass to the card-room. Sometimes every other lap is weighed and often they are weighed every hour though in some mills it is not considered necessary to weigh them more than once or twice a day.

Calculations. The weight of the lap is governed by the number of yards it contains and is measured by the revolutions of the lap roll, the picker being stopped automatically after the required number of yards has been wound. The device, by which this is regulated, is called the knock-off, a diagram of the gearing of which is shown in Fig. 45, which should be used in connection with Fig. 44.

The knock-off, or change gear, K, is driven from the calender roll by the side shaft, B. Loose upon the hub of this gear is a dog,

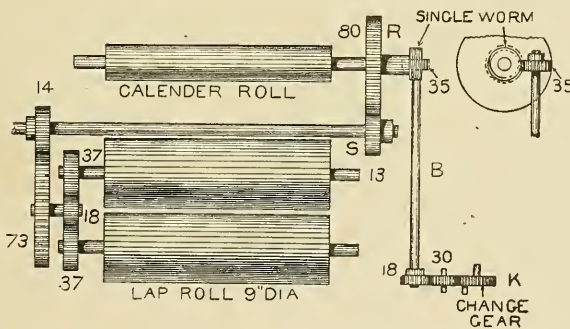

Fig. 45. Diagram of Knock-off Gearing.

W, driven by a pin, V, which forms part of the gear. As the latter turns, the dog is brought against the upper end of the knock-off latch, E, moving it out and allowing the drop lever, M, to fall, disengaging the pinion, S, and the gear, R, and, as the dog assumes a vertical position, by reason of being loose on the hub of the gear, the picker can be started immediately after it has knocked off and the lap has been removed. The knock-off gear makes one revolution for each lap wound, so a change in the number of teeth it contains gives a different number of yards in a lap.

When the weight per yard and the total weight of the lap

have been established, the constant number or factor, by which the number of teeth in the knock-off gear is calculated, can be figured. The lap rolls are 9 inches in diameter, or 28.27 inches in circumference, therefore 1.27 revolutions will be required to wind one yard, thus: $36 \div 28.27 = 1.27$.

On the end of the lap roll is a gear of 37 teeth which is driven from a pinion of 18 teeth. Compounded with the pinion is a gear of 73 teeth, which is driven from the calender shaft by a pinion of 14 teeth. On the right end of the calender shaft is a pinion, S, of 13 teeth which drives the gear, R, of 80 teeth. On the hub of the latter is a single-threaded worm which drives a gear of 35 teeth which is upon the side shaft. On the opposite end of the side shaft is a pinion of 18 teeth, which drives the knock-off, K, through the intermediate gear of 30 teeth.

Following are the rules governing the calculations for the picker:

Rule 1. To find the factor for the knock-off gear, multiply the drivers together and divide the product by the product of the driven gears multiplied by the number of revolutions of the lap roll necessary to wind one yard, leaving out all intermediate gears and the knock-off gear.

$$\text{Example: } \frac{35 \times 80 \times 14 \times 18}{18 \times 1 \times 13 \times 73 \times 37 \times 1.27} = .879$$

Rule 2. To find the number of yards in a lap, multiply the factor by the number of teeth in the knock-off gear, 30.

$$\text{Example: } .879 \times 30 = 26.37$$

Rule 3. To find the number of yards in a lap, without using the factor, multiply the number of teeth in the knock-off gear by the product of the drivers, and divide that product by the product of the driven gears multiplied by the number of revolutions of the lap roll necessary to wind one yard, leaving out all intermediate gears.

$$\text{Example: } \frac{30 \times 35 \times 80 \times 14 \times 18}{18 \times 1 \times 13 \times 73 \times 37 \times 1.27} = 26.37$$

Rule 4. To find the number of teeth in the knock-off gear divide the number of yards in the lap by the factor.

$$\text{Example: } 26.37 \div .879 = 30$$

The weight of the laps from the finisher picker depends upon the production required, the counts of yarn it is desired to make and the class of cotton used. It will run from 10 to 16 ounces per yard. The laps on the apron of the finisher picker will average about 15 ounces per yard, and as there are four laps on the apron at one time, the combined weight of the laps entering the finisher is 60 ounces per yard, and as the weight of the lap from the finisher is between 10 and 16 ounces per yard, it is evident that some means must be employed to reduce this weight to that required. This is accomplished by introducing a certain amount of draft between the feed rolls and the lap rolls. By the word draft, as applied to cotton machinery, is meant the ratio of the length of lap passing the lap rolls in a given time, to the length of lap which passes the feed rolls in the same time. If the circumferential velocity of the feed rolls is 25 feet per minute, while in the same time the velocity of the lap roll is one hundred feet or four times as much, there is a draft of four. It follows if the combined weight entering the feed rolls is 60 ounces per yard, the weight delivered will be one-fourth as much, or 15 ounces per yard.

To make this clear to those not familiar with the subject, we will call the weight of each of the laps on the apron of the finisher 16 ounces per yard and that of the lap delivered by the finisher 15 ounces per yard. The draft will be found in the following way:

Rule 5. To find the draft of the finisher, multiply the number of laps on the apron by the weight per yard and divide the product by the weight of the lap being delivered.

$$\text{Example: } \frac{4 \times 16}{15} = 4.2$$

Rule 6. To find the weight of lap being delivered, draft being known, multiply the number of laps on the apron by the weight per yard and divide the product by the draft.

$$\text{Example: } \frac{4 \times 16}{4.2} = 15.$$

After the draft has been calculated, which in this case we have found to be 4.2, the draft factor, or constant number, must

be found by which the number of teeth in the draft gear may be determined. A diagram of the gearing of a finisher picker is shown in Fig. 46.

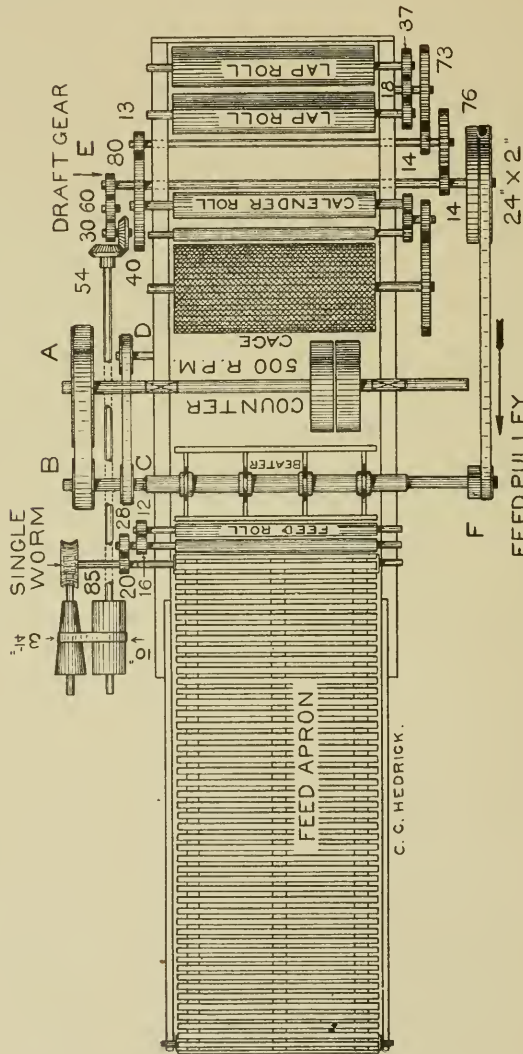

Fig. 46 Diagram of Gearing of Finishing Picker.

The feed roll is $2\frac{1}{2}$ inches in diameter and has upon the end a spur gear of 12 teeth, which is driven from the eyener roll by a gear of 16 teeth. Compounded with this gear is one of 28 teeth,

which is driven from the apron roll by a gear of 20 teeth. On the outer end of the apron roll is a worm gear of 85 teeth that is driven by a single-threaded worm which is upon one end of the evener cone. The diameter of the evener cone is taken at a point midway of the ends and is $3\frac{1}{4}$ inches. The cone is driven from a 10-inch diameter drum on the side shaft. On the front end of the side shaft is a bevel gear of 54 teeth, driven from a similar gear of 40 teeth compounded with a spur gear of 30 teeth, which is driven from the draft gear, E, (on the end of the driving shaft) through an intermediate gear of 60 teeth. On the other end of the driving shaft is a pinion of 14 teeth, which drives the lap rolls through gears of 76, 14, 73, 18 and 37 teeth. The last gear is upon the lap rolls which are nine inches in diameter.

Rule 7. To find the constant number, or factor, of the picker, multiply the diameter of the lap roll by the drivers and divide the product by the product of the diameter of the feed roll multiplied by the driven gears, leaving out all intermediate gears and the draft gear.

Example :

$$\frac{9 \times 18 \times 14 \times 14 \times 30 \times 54 \times 3\frac{1}{4} \times 85 \times 28 \times 12}{2\frac{1}{8} \times 37 \times 73 \times 76 \times 40 \times 10 \times 1 \times 20 \times 16} = 85.51$$

Rule 8. To find the number of teeth in the draft gear, divide the draft factor by the draft, 42.

$$\text{Example: } 85.51 \div 4.2 = 20$$

Rule 9. To find the draft, when the number of teeth in the draft gear is known, divide the draft factor by the number of teeth in the draft gear, 20.

$$\text{Example: } 85.51 \div 20 = 4.2$$

Rule 10. To find the draft, without first finding the factor, multiply the diameter of the lap roll by the drivers and divide the product by the product of the diameter of the feed roll multiplied by the driven gears and the draft gear, leaving out the intermediate gears.

Example :

$$\frac{9 \times 18 \times 14 \times 14 \times 30 \times 54 \times 3\frac{1}{4} \times 85 \times 28 \times 12}{2\frac{1}{8} \times 37 \times 73 \times 76 \times 20 \times 40 \times 10 \times 1 \times 20 \times 16} = 4.2$$

Rule 11. To find the speed of the beater; multiply the speed of the countershaft by the diameter of the pulley, A, (24 inches) and divide the product by the diameter of the beater pulley, B, (8 inches).

$$\text{Example: } \frac{500 \times 24}{8} = 1500.$$

Rule 12. To find the speed of the fan, multiply the speed of the beater by the diameter of the pulley, C, (5 inches) and divide the product by the diameter of the pulley, D, (8 inches).

$$\text{Example: } \frac{1500 \times 5}{8} = 937.5$$

Rule 13. To find the factor for the production of the picker, multiply together the number of revolutions of the beater shaft, the circumference of the lap roll and the drivers and divide the product by the product of the diameter of the pulley on the calendar head (24 inches), multiplied by the driven gears and 36 (number of inches in a yard).

$$\text{Example: } \frac{1500 \times 28.27 \times 14 \times 14 \times 18}{24 \times 76 \times 73 \times 37 \times 36} = .8435$$

Rule 14. To find the production of the picker, multiply the factor, the diameter of the feed pulley, F, ($4\frac{1}{2}$ inches) the minutes run per day (600) and the weight of the lap per yard (15 ounces) together and divide the product by ounces per pound.

$$\text{Example: } \frac{.8435 \times 4\frac{1}{2} \times 600 \times 15}{16} = 2135.10 \text{ lbs.}$$

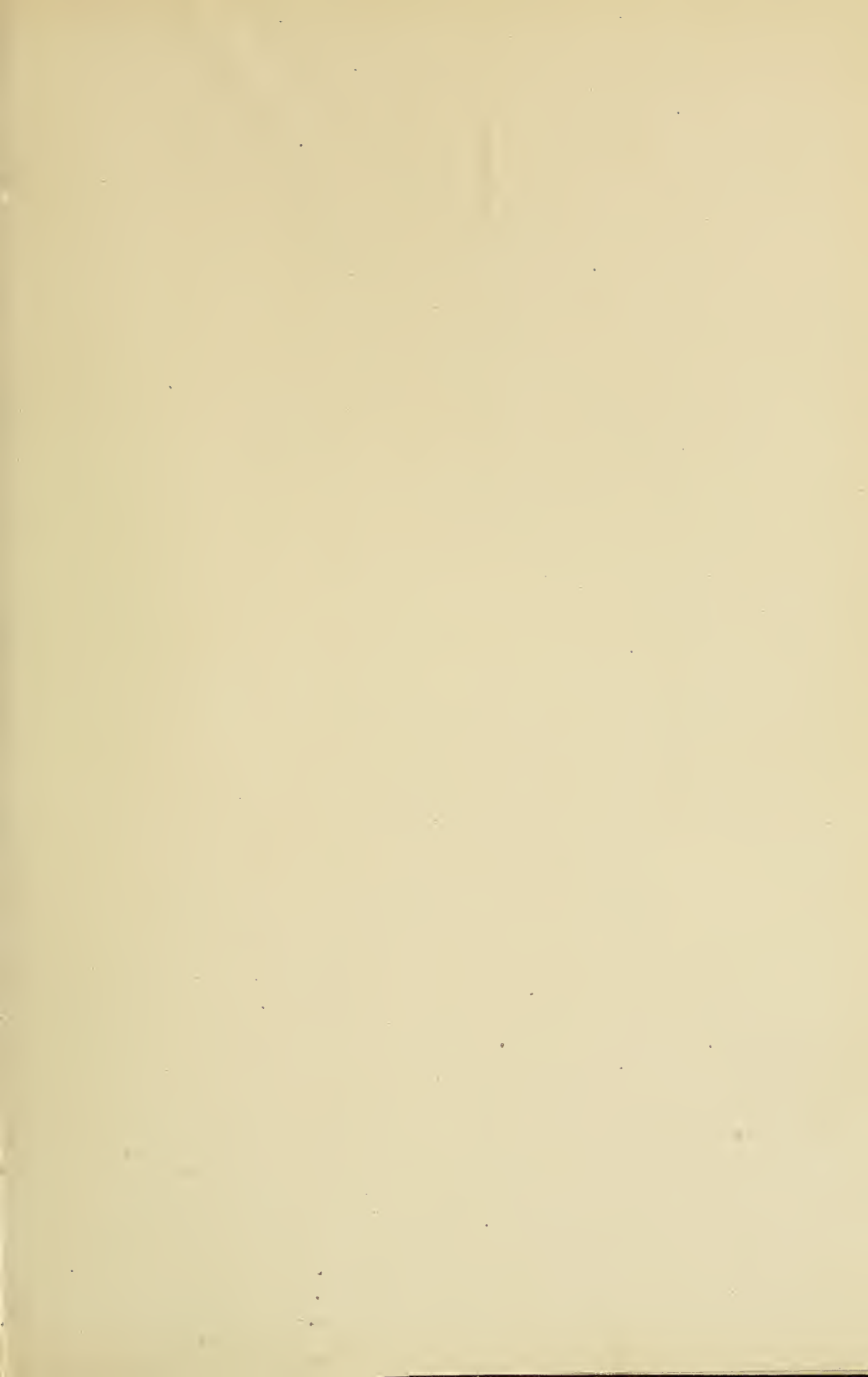

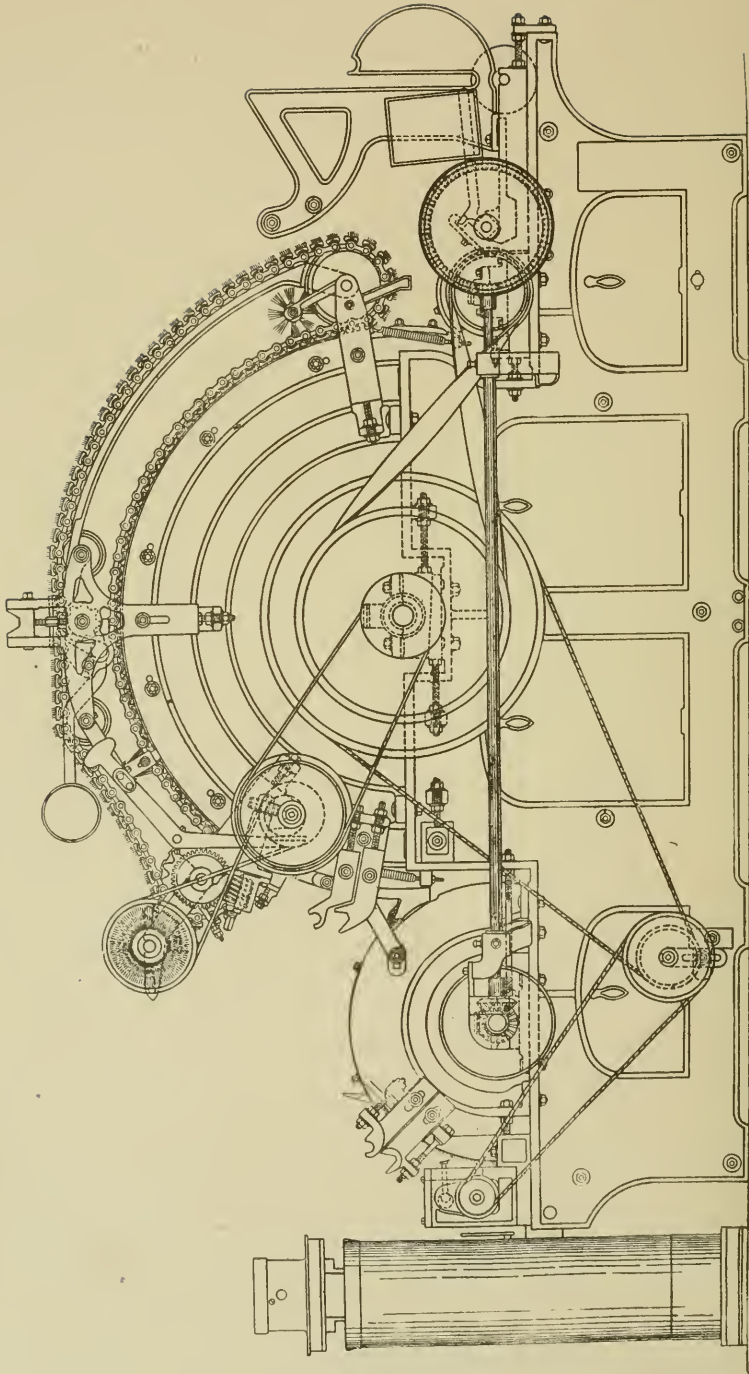

REVOLVING FLAT CARD, SHOWING DETAILS
Howard & Bullough Am. Machine Co. (Ltd.)

COTTON SPINNING.

PART II.

CARDING.

After the cotton has passed through the opening and cleaning process, there still remains a considerable amount of leaf, sand, particles of seed and small clusters of unripe fibers which must be removed before it can be spun properly into yarn. If we examine carefully a lap from the finisher picker, we shall see that in addition to these impurities, the fibers lie in different directions in small tangled tufts of unequal thickness and density, also that it is necessary to comb or card them to disentangle, straighten and clean them.

Arrangement of Card Room. The cotton card, like all other machines used in cotton spinning, has grown from a very primitive form. At the present time, the revolving flat card is used almost exclusively. Before entering upon a description of the card, some attention should be given to the placing of the machinery in the card room. An arrangement adopted in many mills is shown in plan in Fig. 47 and in sectional elevation in Fig. 48.

The cards are placed in rows, extending lengthwise of the mill, six to seven feet on centers except where a line comes between columns. The alleys should be about four feet wide if space will permit. This allows a lap truck to pass down the alley, clear of the machines, a point which should be considered, as laps are frequently torn by coming in contact with the machinery. The cards in two adjoining lines should be placed with the coilers towards each other, except when the width of the mill is such as to cause an odd number of rows, as shown in the drawings. In that case the odd row, is placed, usually, in the center of the room.

The shafting for driving the cards should be placed over the front or coiler alley, so that the driving belt will not interfere with the application of the flat grinder which is attached at the

back on most cards. In no case should the shafting be placed over the cards, as oil is very apt to work out of the hanger boxes and drop on to the clothing of the flats and destroy it completely.

The cards should be so arranged that each is driven from a separate pulley. This is more necessary than it seems at first

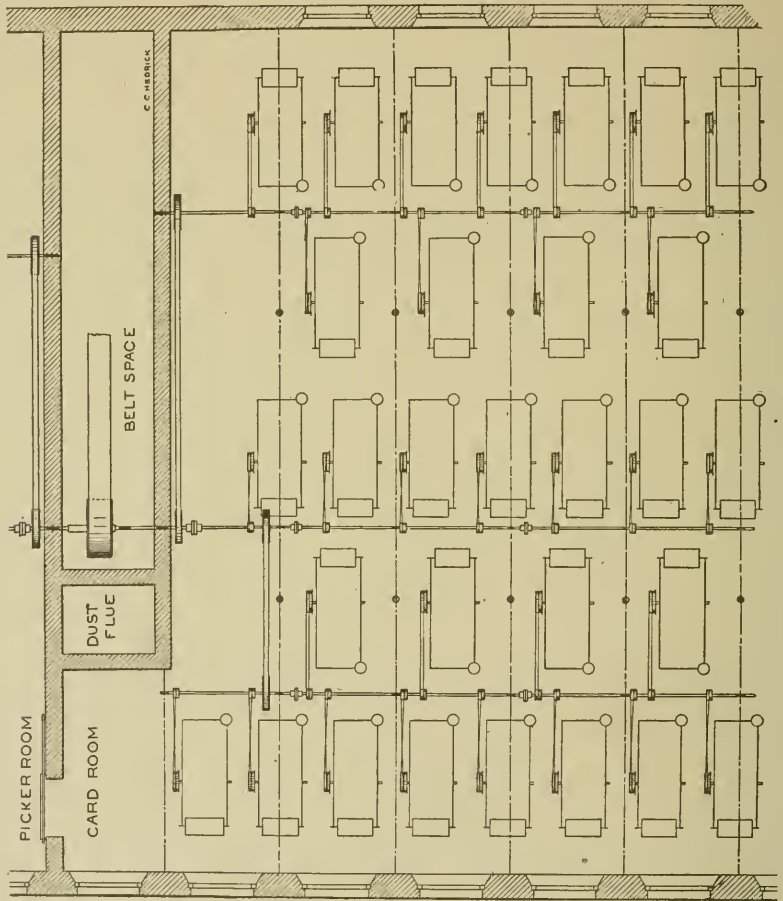

Fig. 47. Plan of Card Room.

thought. If the cards are not erected exactly parallelly with the shaft, the driving belt may run to one side of the face of the pulley and to overcome this the pulley is moved slightly along the shaft. If two cards were driven from the same pulley, this could not be done. With the old-fashioned top flat cards it was

customary to drive two from the same pulley, the pulley having a flange in the center of the face, which formed a division between the two belts. If the cards were not set parallelly with the shaft,

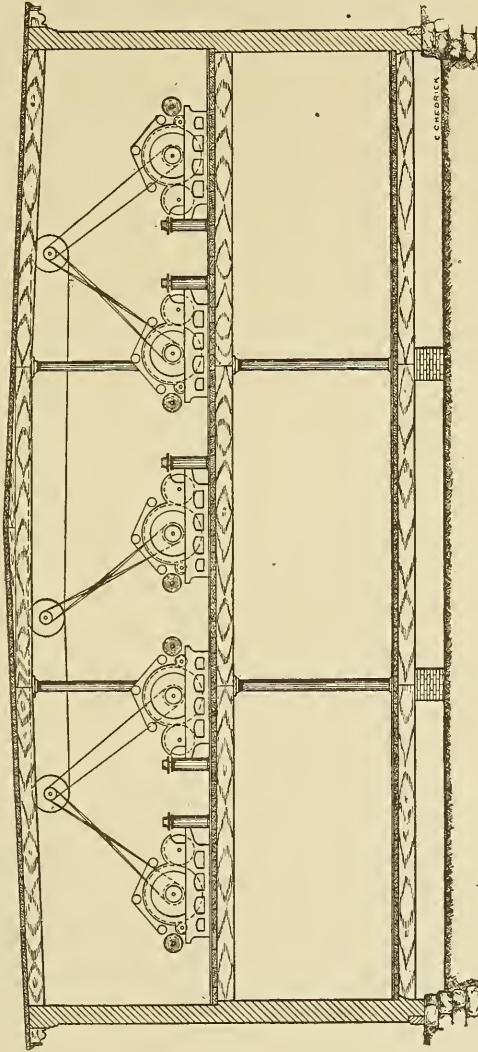

Fig. 48 Sectional elevation of Card Room.

the belt would run to one side. To remedy this, the cards, instead of the pulleys, were moved enough to cause the belt to run true, but

with the revolving flat cards, it is not considered advisable to move them, as the settings are easily disturbed.

Theory of Carding. In the sectional elevation shown in Fig. 49, the lap, A, from the finisher picker, is placed in the lap stands and rests upon the lap roll, B, by which it is revolved slowly, the surface speed of the lap roll being just sufficient to unwind the lap at the same speed that it is received by the feed roll. It then passes forward on the feed plate, C, and under the feed roll, E. As the fibers pass up over the curved part or nose of the feed plate, they come in contact with the teeth of the leader or licker-in, G, which is about $9\frac{1}{2}$ inches in diameter and is covered with steel teeth, inserted in its surface, which resemble the teeth of a saw. The action of the leader is twofold; that of removing dirt and that of combing and straightening the fibers. When the teeth of the leader (the surface speed of which is about 1,050 revolutions per minute) strike the fibers, the force of the blow strikes down and partially removes the dirt. The fibers, which have now advanced far enough beyond the bite of the feed roll, are removed and carried by the leader, while those which are held by the feed roll are combed and straightened. The fibers thus receive a very effectual cleaning, more dirt being removed at this point than in any part of the card. As they are carried around by the leader, the fibers are drawn over the top edge of the mote knife, D, which also aids in cleaning. Directly under the leader is a screen or grid, F, called the leader screen. The part of the screen with which the fibers come in contact first consists of a series of bars, running across from side to side of the card; the rest of the screen, from the last bar to a point where it is hinged to the cylinder screen, is perforated with small holes. The object of this screen is to prevent the cotton from leaving the leader, and to allow foreign substances, which, being heavier, are thrown out by centrifugal force, to drop through these perforations.

The fibers, which have been brought around by the leader, are now taken up by the cylinder, H, the surface velocity of which is a little more than twice that of the leader. The wire teeth (card clothing) of the cylinder are much finer than those of the leader, and as both surfaces run in the same direction, the

fibers are readily stripped from the teeth of the leader and are carried forward under the flats, B³, to the doffer, L. The flats are faced with card clothing, similar to that of the cylinder, and embrace a little more than one-third of its circumference and travel slowly in the same direction as the cylinder. As the fibers are carried under each successive flat, they become more thoroughly cleaned and straightened. The speed of the cylinder plays an important part in this operation. If the fibers are short, they will be removed by the flats, but if sufficiently long, they will hold to the cylinder and be combed by them. The fibers are now transferred to the doffer. Just how this is done may be perplexing to many, but if we stop to consider a moment, it will be found very simple. Although the surfaces of the cylinder and doffer run in the same direction, the clothing of each stands at a different angle, the doffer clothing presenting a series of hooks upon which the fibers are caught and drawn from the cylinder. If we examine the cylinder closely, we will see that many of the fibers stand out from its surface, not in straight lines parallel with the circumference, but in a loosely tangled mass which is effected partly by centrifugal force but more by the naturally irregular disposition of the cotton, and, as most of the fibers are carried around by the cylinder a great many times before they are transferred to the doffer, their repeated passing beneath the flats changes their position and finally results in their withdrawal from the cylinder. Then, too, the fibers cross and recross each other, so the withdrawal of one or more easily affects the others.

Beneath the cylinder is the cylinder screen, K, which extends from the leader screen almost to the doffer and which is made in two parts, hinged in about the center. For the greater part of the length, each half consists of a series of bars, running from side to side. If no screen is used under the cylinder, its high surface velocity (about 2,150 feet per minute) will cause the fibers to stand out and finally become detached but with a screen, this cannot happen while the heavier impurities, thrown out by centrifugal force, fall between the bars.

The doffer, which is $24\frac{3}{4}$ inches in diameter outside of the wire clothing, runs at a very slow speed, not over twenty revolutions per minute at the most. Consequently the fibers are

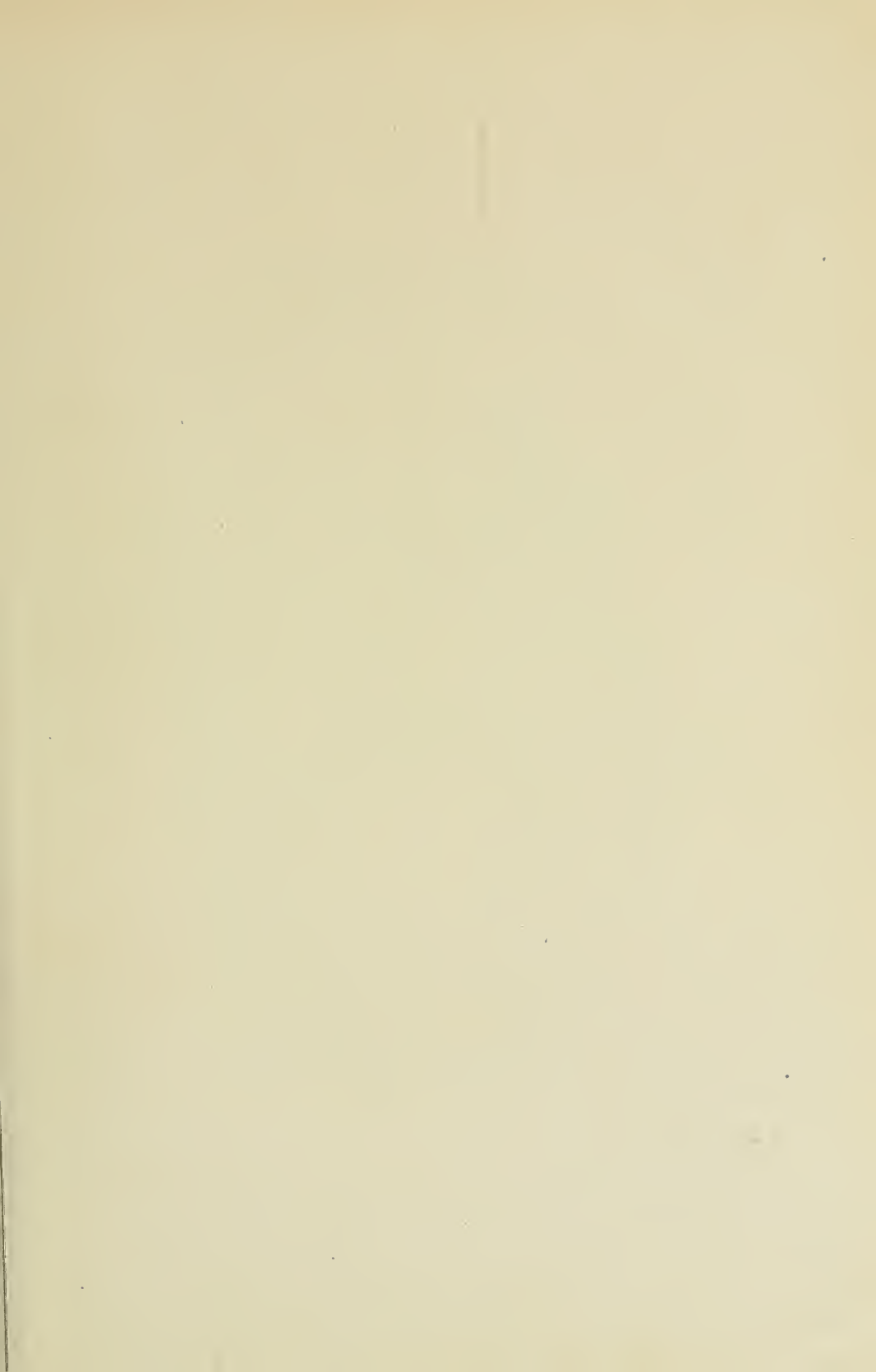

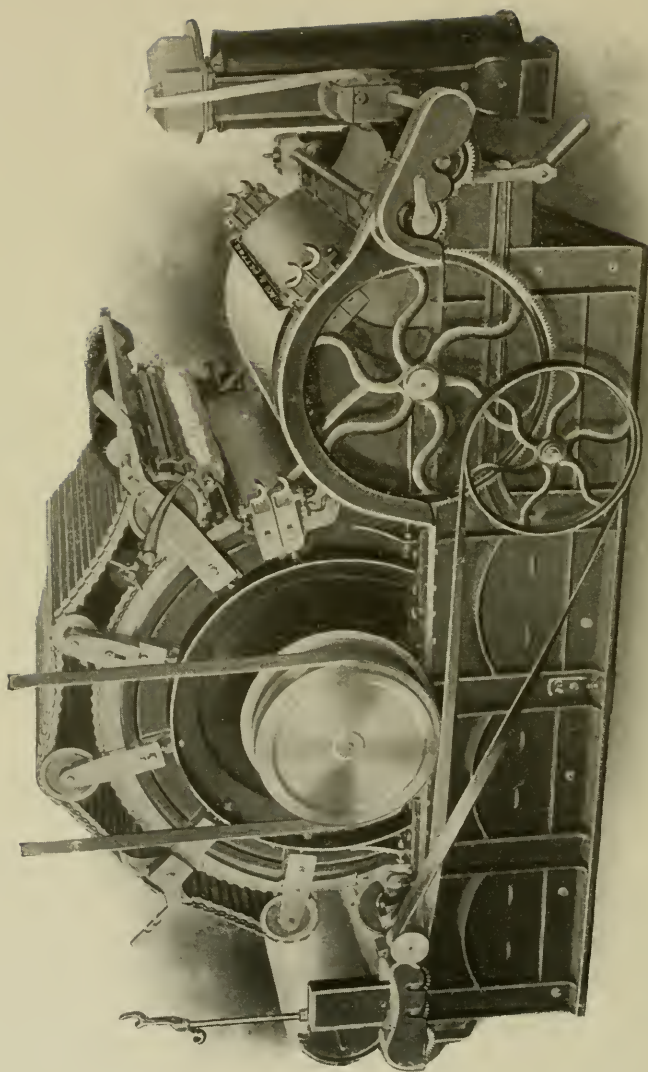

REVOLVING FLAT CARD—SIDE VIEW
Saco & Pettee Machine Shops.

deposited on its surface in a more condensed form than on the cylinder and they are carried around and combed off by the doffer comb, N, which draws them from the points of the teeth, and, as they lie very loosely upon the surface of the doffer, they are detached easily.

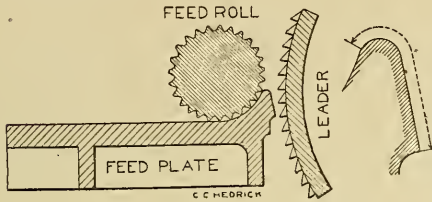

Fig. 50. Feed Plate for short staple cotton.

coiled very compactly into the can, S.

Feed Plates. The operation of carding having been considered in general, the details of the card will now be described, starting with the feed plate.

Figs. 50, 51, 52 and 53 show sections of different feed plates, which provide for the various lengths of fibers, so that they may be combed without injury to the staple. Fig. 50 shows a feed plate used for short staple and waste cotton. The distance

from the bite of the feed roll to the lower edge, or point where the teeth of the leader are nearest to the face, is quite short. The next plate, Fig. 51, is for medium length staple and the distance from the bite of the feed roll to the lower edge of the face of

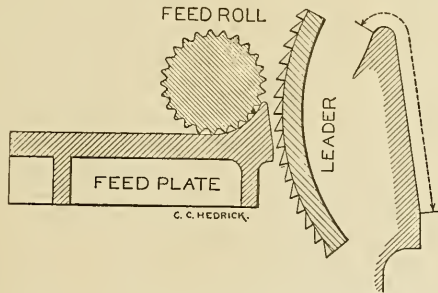

Fig. 51. Feed Plate for medium staple cotton.

the feed plate is considerably greater than in Fig. 50, and the nose much sharper. Fig. 52 is for long staple Egyptian cotton. It will be seen that the distance from the bite of the feed roll to the lower edge of the plate is greater than in either of the others and the nose is still more pointed.

The last plate, shown in Fig. 53, is for Sea Island cotton. In this style, the length of the face is greater than on the plates used for all other varieties of cotton. The exact size and outline of the nose and face of the plates are shown at the right hand of the drawing in all four views; the distance between the bite of the feed roll and the lower edge of the plate is indicated by dotted lines.

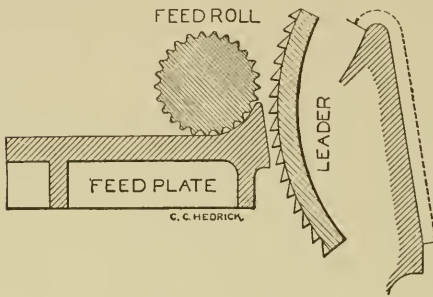

Fig. 52. Feed Plate for Egyptian Cotton.

In all cases, this distance should be slightly more (from $\frac{1}{8}$ to $\frac{1}{4}$ of an inch) than the average length of staple being worked, otherwise, the fibers will be broken by the leader teeth trying to take them away before they are liberated from the bite of the feed roll. The angle of the face of the feed plate should be such as to cause the teeth of the leader to comb the fibers for about two-thirds their length before they become detached.

In Fig. 54 is shown a section of an adjustable feed plate, intended to provide for different lengths of fibers. This plate consists of two parts; a top piece, A, which is movable and is adjusted by the screw, C, and a base piece, B, which is fastened to the side of the card. Strips of wood, D, of different thicknesses, are used to fill the space between the pieces. This plate possesses no merits, not giving good results when put into use.

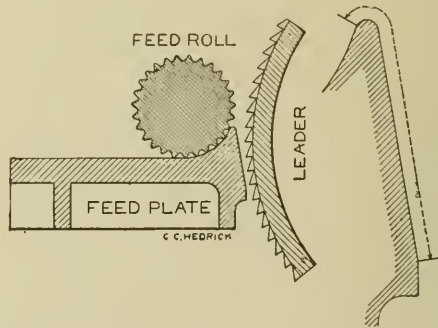

Fig. 53. Feed Plate for Sea Island Cotton.

Fig. 55 shows the method used for feeding the card before the feed plate became generally adopted. It may be found still on the old style of stationary top cards. Instead of a single feed

roll, two rolls were used which were about $1\frac{3}{8}$ inches in diameter. The cotton was carried forward between them to the leader, or cylinder, many of the older cards having no leader. The distance from the bite of the feed rolls to the point of contact with the

leader (indicated by radial lines A and B) was about $1\frac{1}{8}$ inches, and, unless the fibers were at least $1\frac{1}{4}$ inches long, they became detached from the bite of the rolls before they had received any combing and the cotton was delivered to the cylinder in small tufts. To

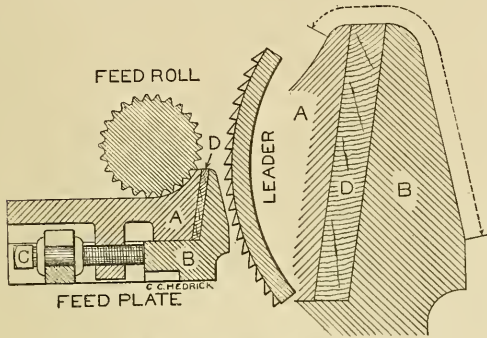

Fig. 54. Adjustable Feed Plate.

remedy this, the rolls were made small in diameter but this introduced another evil; the rolls would spring apart in the center and cause the lap to be fed very unevenly.

The half-tone in Fig. 56 shows two sections of laps taken from cards. The one marked A was from a card provided with a feed plate while B was

taken from an old style card with two feed rolls. The point, where the fibers were liberated, is indicated by a horizontal line and it will be seen that in section A, they were combed and cleaned for a much greater portion of their length than were those in section B which received very little combing, before being taken away by the leader. The fibers are always more or less broken by this method.

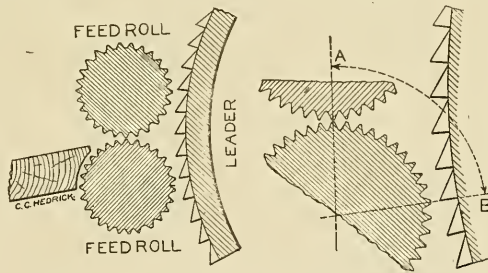

Fig. 55. Feed Rolls for old style cards.

Leader, Cylinder and Flats. A section of the leader, the cylinder and the parts connected and a section of a flat in relation to the cylinder are shown in Fig. 57.

The mote knife, *D*, is adjusted in either direction, horizontally by moving the bracket, *D*¹, by which it is attached to the leader shroud, and vertically by the screw, *D*². The correct distance from the teeth of the leader may be obtained in this way very easily, and as the leader shroud moves with the leader shaft when the position of the leader is changed, the mote knife moves with it, avoiding the necessity of resetting. Over the leader is a steel

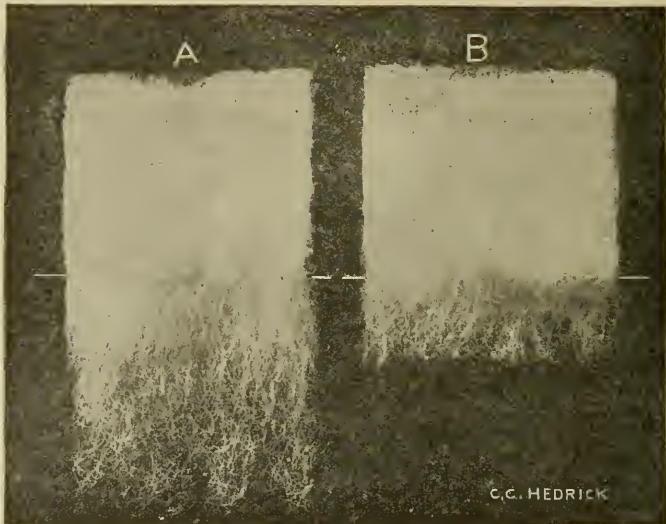

Fig. 56. Section of card sliver.

bonnet, *J*, called the leader bonnet. At the point where this cover and the back plate, *T*, come together is placed a round iron rod, *P*, covered with flannel, which serves as a fill-up piece, preventing the dust and short fibers from blowing out. Resting upon the feed roll and between it and the leader bonnet is another rod, *P*, similar to the one just described. At this point, the rod performs double duty, keeping the dust from blowing out and also acting as a clearer for the feed roll.

In the section of the flat and the cylinder, it will be seen that the space between the wires of each is greater at the toe, or point, where the cotton enters than at the heel where it leaves. By inclining the flat in this manner, the fibers receive combing from

the greater portion of its wires, and, as they stand out slightly from the surface of the cylinder by being drawn into a small space, are more easily dealt with than they would be if the flat were brought close at the toe.

Cylinder Doffer and Flats. In Fig. 58 is shown a partial section through the cylinder, doffer and parts directly connected. The flats, B³, pass around the front block, W¹, in the direction shown by the arrow and the short fibers, or strippings, which

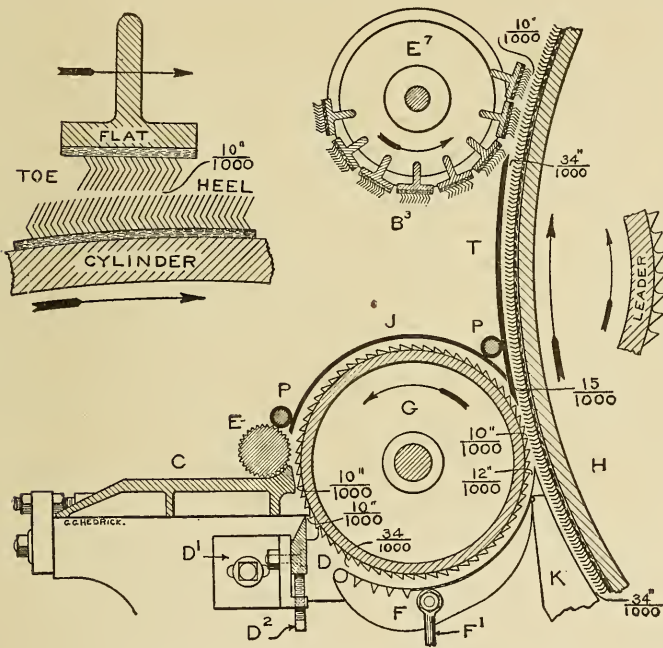

Fig. 57. Section of cylinder, leader and flat.

adhere to them, are removed by the stripping comb, W². Passing along toward the rear of the card, they are cleaned by a revolving brush, W³, called the stripping brush which is itself cleaned by a stationary comb, W⁴, called the stripping brush comb. Directly beneath the stripping comb is the strip roll, W⁵. This is a wooden roll about 1½ inches in diameter, covered with flannel and supported at either end by arms, W⁶. As the flats pass around the front block, the strippings, which are removed by the comb,

are wound upon the roll which revolves by being held lightly in contact with the flats.

It was the custom, formerly, to allow the strippings to drop upon the doffer cover in a loose mass and, when an amount had collected, it was removed. With the strip roll the strippings are wound in a neat and very compact form and can be removed very

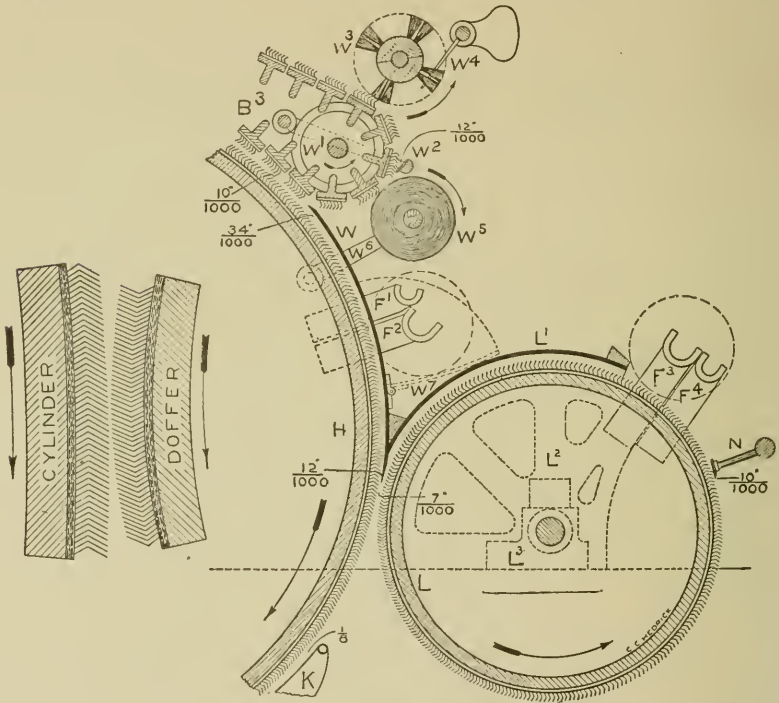

Fig. 58. Section of cylinder and doffer.

quickly, and by reason of the compactness, the removal does not have to be performed so often.

When it is necessary to grind, or strip, the cylinder, the door, W^7 , which is hinged to the front plate, can be turned down as shown by dotted lines. Over the doffer is a cover, L^1 , called the doffer bonnet, which is fastened to the doffer shroud, L^2 , which, in turn, is fastened to the doffer bearing, L^3 .

The main cylinder is made 50" in diameter by 40" or 45" face.

The doffer is made 24", 27" or 28" in diameter and 40" or 45" face. The clothing adds $\frac{3}{4}$ " to the diameter. The flats are $1\frac{3}{8}$ " wide and there are 104 or 110 in a chain. With 104, there are 39 at work and with 110, there are 44 at work.

Settings. A few words may be said now in regard to the settings of the various parts of the card, a detail which is very often slighted and the quality of the work suffers.

The construction of the revolving flat card is such as to require very fine adjustment and too much attention cannot be given to grinding, setting, stripping and cleaning, as the results of poor carding cannot be rectified in any of the subsequent processes. Very close setting, with the card freshly ground, will produce extra good work but the wires will become dull much quicker than with more open settings, which are productive of good average carding from one grinding to the next.

Gauges. For setting the doffer, leader, feed plate, screens and back and front plates, most machinery builders supply a four-leaf gauge of the following sizes: $1\frac{5}{1000}$ ", $1\frac{7}{1000}$ ", $1\frac{10}{1000}$ " and $1\frac{12}{1000}$ " thickness. For setting the tops, three gauges with detachable handles are used; these are $1\frac{9}{1000}$ ", $1\frac{10}{1000}$ " and $1\frac{11}{1000}$ " in thickness.

To understand fully the setting points, reference should be made to Figs. 49, 57 and 58. The settings given, although liable to slight changes under different conditions, are recommended.

Cylinder Screen. For setting the cylinder screen, openings are provided in the sides of the screen for inserting the gauge. The front part, or nose, of the screen is adjusted by the rod, K³, while at the back, where it joins the leader screen, the vertical adjustment is obtained by the rod, K¹, and the lateral movement is governed by the rod, K². The center of the screen is adjusted by the lever, K⁴, which turns upon a stud, K⁵. One end of the lever is connected to the screen by a pin, K⁸, the other end is tapped to receive an adjusting screw, K⁶, which is held between the projecting lugs of a stand, K⁷.

The usual setting of the screen, from the cylinder wire, at the back and center, is about $1\frac{3}{8}\frac{1}{1000}$ " (four gauges, 5, 7, 10 and 12). At the front, or doffer end, it is set from $\frac{1}{8}$ " to $\frac{1}{4}$ " from the cylinder wire. The setting of the front half of the screen controls the side waste and droppings under the doffer. By setting it away

from the cylinder, it allows the fibers to be drawn gradually between the screen and cylinder. If set too close, a great amount of waste is made as the fibers are thrown off the cylinder.

Back Plate. The back plate, T, which extends from the leader to the flats, is set, at its lower edge, about $\frac{1\frac{5}{10}}{100}$ " (two gauges, 5 and 10) from the cylinder wire. At the upper edge, the best results are obtained by setting it about $\frac{3\frac{4}{10}}{100}$ " (four gauges) from the cylinder wire. This allows the fibers to free themselves and stand out a little from the cylinder before they meet the flats.

Leader and Leader Screen. The leader is set to the cylinder with a $\frac{1\frac{0}{10}}{100}$ " gauge. The leader screen is set to the leader, at the point where it is hinged to the cylinder screen, with a $\frac{1\frac{2}{10}}{100}$ " gauge. The nose of the screen, with which the fibers first come in contact, is set away from the leader wires from $\frac{1\frac{2}{10}}{100}$ " to $\frac{3\frac{4}{10}}{100}$ ". This depends upon the condition of the cotton and the amount of fly it is desired to remove. By so setting the screen, the fibers are drawn gradually into a more compact space, as they pass around on the leader, and present a more even sheet to the teeth of the cylinder. When it is desired to use the cotton for a very fine grade of work, it is best to remove as much fly as possible, at this point, rather than let it fall out between the rolls of the drawing frame or during other processes. This may be accomplished by setting the nose of the screen close to the leader, but not too close, as it is possible to remove much good cotton. Correct setting depends upon the judgment of the carder. The screen may be adjusted by the rod, F¹, the lower end of which passes through a bracket fastened to the card side.

Mote Knife. The mote knife is set from the leader with a $\frac{1\frac{0}{10}}{100}$ " gauge, and care should be taken that it is set exactly parallel with the leader. The percentage of waste may be increased by changing the height of the knife which is adjusted by the screw, D².

Feed Plate. For setting the feed plate from the leader, the gauge used depends somewhat upon the weight of the lap being carded. For a lap weighing 12 ounces per yard or under, a $\frac{1\frac{0}{10}}{100}$ " gauge is generally used, while for laps above 12 ounces per yard, the setting is sometimes as great as $\frac{1\frac{7}{10}}{100}$ " (two gauges).

Stripping Plate. Extending from the doffer to the flats is a polished steel cover, W, called the front or stripping plate. Upon the correct setting of this plate, depends the removal of the strippings from the flats. Usually, it is set, at its lower edge, about $1\frac{1}{10}\frac{2}{10}$ " from the cylinder and about $1\frac{3}{10}\frac{4}{10}$ " at the top edge. If set too close at the top edge, the strippings will be removed from the flats by the cylinder when they reach the edge of the plate, and, on the other hand, if set away at the top, the fibers will cling to the flats and be combed off when they reach the stripping comb.

Doffer. The doffer is set $1\frac{7}{10}\frac{0}{10}$ " from the cylinder, close enough for any class of work.

Doffer Comb. For setting the doffer comb, the $1\frac{1}{10}\frac{0}{10}$ " gauge should be used, although with a very light sliver, a $1\frac{7}{10}\frac{0}{10}$ " gauge may be used.

Stripping Comb. The stripping comb should be set to the flats with a $1\frac{1}{10}\frac{2}{10}$ " gauge.

Flats. In setting the flats, it is necessary to remove five at certain intervals in the chain, so that the gauge may be admitted, at points nearly under the sprocket stand, back block, center block, quarter block and grinder bracket. The spacing varies, depending upon the number of flats in the chain and the make of the card.

The flats should not be set closer than $1\frac{1}{10}\frac{0}{10}$ " to the cylinder, and as the setting necessitates a thorough understanding of the principles and construction of the flexible bend, it should be considered in reference to it.

Gearing. The method of driving the various parts of the card will now be considered and illustrated by Fig. 59, an elevation of the right-hand side of a left-hand card, and Fig. 60, an elevation showing the left-hand side.

To determine the hand of a card, the custom, followed by all cotton machinery builders in this country, is to face the machine at the delivery, or doffer, end and whichever side the driving pulley is upon decides the question. Fig. 61 shows a right-hand card. Upon the leader is a pulley, B, driven from a large pulley, D³, which is upon the cylinder shaft, by the crossed belt, E. The doffer comb is driven from the groove in this pulley by the band, D¹, which passes to a double grooved carrier pulley, C¹, from

which passes another band, E^1 , to the comb pulley, H , also double grooved.

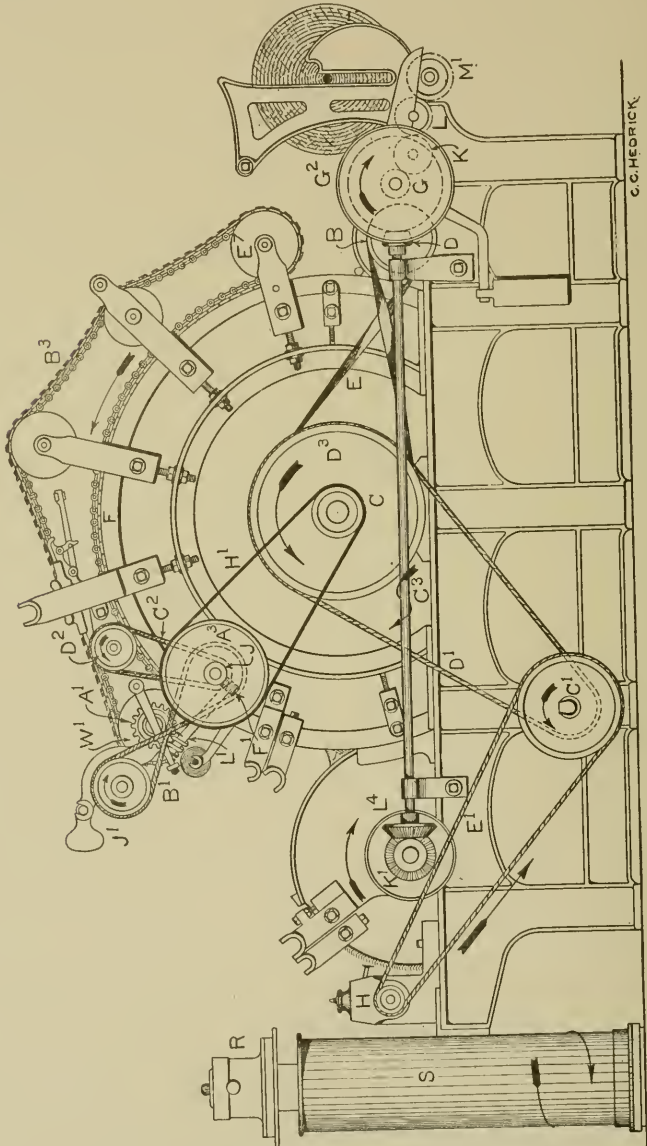

Fig. 59. Elevation of Card, R. H. Side.

The flats, B^3 , which pass slowly over the cylinder in the direction indicated by an arrow, are driven from a sprocket wheel

which is fastened to the inside of the front block, W¹. Motion is communicated to the latter from the small pulley, C, which is

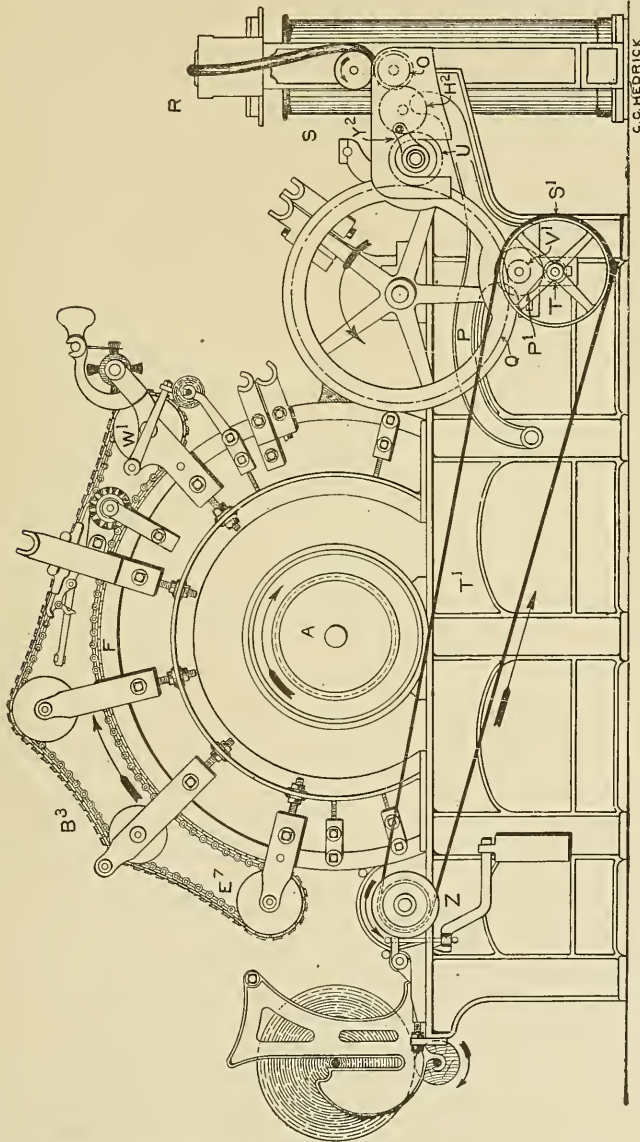

Fig. 60. Elevation of Card, L. H. Side.

upon the cylinder shaft, by the belt, H¹, the pulley, A³, the worm, J, the worm gear, F¹, the worm, L¹, and the worm gear

A^1 , which is upon the front block shaft. The usual speed of the flats is about three inches per minute.

The stripping brush is driven from a groove on the inside of the pulley, A^3 , by the band, B^1 , and the pulley, J^1 , while the dandy brush, by which the backs of the flats are cleaned before they pass around the front block, is also driven from a small groove on the inside of the pulley, A^3 , by the band, C^2 ; and the pulley, D^2 .

The feed roll is driven from the doffer by the gears, K^1 and L^4 , the side shaft, C^3 , and the gears G^2 and D . The front bearing for the side shaft is made so that it may be moved, horizontally, disengaging the gears, K^1 and L^4 , when it is desired to stop the feed roll. The lap roll is driven from the feed roll by the gears G , K , L and M^1 .

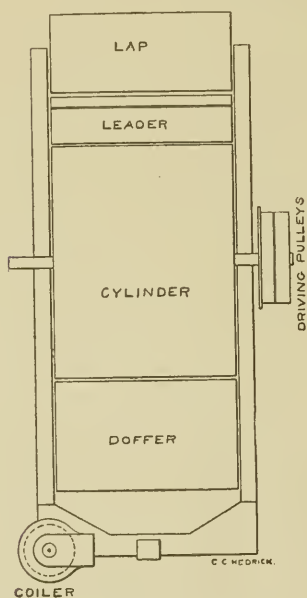

Fig. 61. Plan of R. H. Card.

On the opposite side of the card (Fig. 60) is the main pulley, A , by which the card is driven. The doffer is driven from a pulley, Z , which is upon the leader by the belt, T^1 , the barrow pulley, S^1 , the pinion, T , and the gear, P^1 . Compounded with P^1 is a pinion, V^1 , which drives the doffer gear, Q . The gears, T , P^1 and V^1 , and the barrow pulley are fixed upon studs which are carried by a lever, P , called the barrow bar.

By this, the driving of the feed roll, doffer, calender roll and coiler is controlled. When it is desired to stop these parts, the lever is dropped which disengages the pinion, V^1 , from the gear, Q .

The calender rolls are driven from the doffer gear, Q , by the gears U , H^2 and O . The gear, U , is called the rifle gear and revolves upon a sleeve, or bushing, which is connected to a handle, Y^2 . By turning this handle about one-quarter of a revolution, the rifle gear is drawn sideways and out of gear with Q which is

necessary when it is desired to stop the calender rolls and coiler and still have the doffer turning.

Coiler. We will direct our attention now to the gearing of the coiler, a vertical section of which is shown in Fig. 62. The cotton, after passing between the calender rolls, M and D, enters the coiler, R, through the trumpet, C⁴, and is drawn between the calender rolls, D⁴, and passes down an inclined hole (or spout) in the coiler gear, S², to the can, S, in which it is laid in even and regular coils.

The calender rolls are driven from the upright shaft, L², by the gears, N and N¹. L² is driven from the bottom calender roll on the card by the gears Y¹, R², V and Q¹. By the revolutions of the coiler gear, the inclined hole describes a circle of a little more than half the diameter of the can.

The can rests upon a plate, L³, called the turn-table, by which it is revolved slowly in the opposite direction from the coiler gear and just fast enough so that the coils shall not overlap and crowd each other.

On the under side of the turn-table is a gear, driven from the upright shaft, L², by the gears D³, O¹, P², Y, X and Z¹. O¹ and P² are compounded and run loose on an upright stud, and Y and X are compounded and run loose on the upright shaft. X drives the turn-table through the intermediate gear, Z¹. A plan of this gearing is shown in Fig. 63.

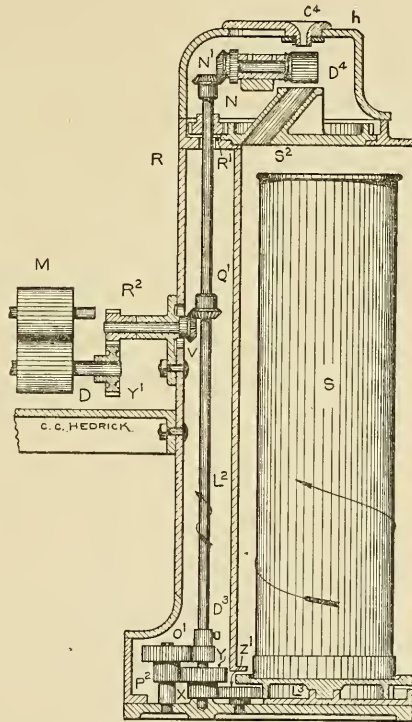

Fig. 62. Vertical section of coiler.

Fig. 64 is a plan of the coiler top. The trumpet, C^4 , is made in the form of a large, flat plate which covers almost the whole of the top. When it becomes necessary to oil the calender roll bearings, it can be done easily by pushing the plate to one side, as shown in the drawing. By this means, piecing is avoided, a feature which will be appreciated by all carders who have had to break the sliver to oil the coiler.

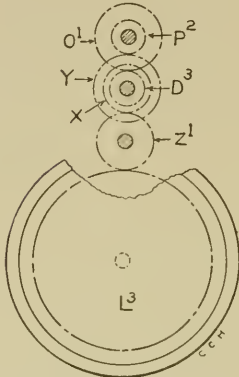

Fig. 63. Plan of turn-table gearing.

Fig. 65 shows a plan of a coiler with the top raised. The calender rolls are kept together by a spring, N^2 , on the end of which is a lever, L . When a wind-up occurs on the calender rolls, the tension upon the spring is removed by turning the lever.

Stop Motion. One of the recent improvements, which has been applied to the revolving flat card, is a calender roll stop-motion which stops the revolutions of the feed roll and doffer instantly, when from any cause, the sliver is absent from between the calender rolls.

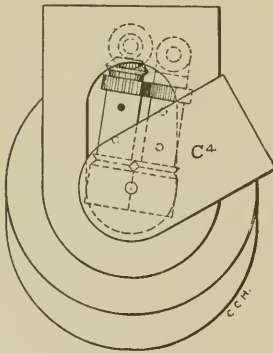

Fig. 64. Plan coiler top.

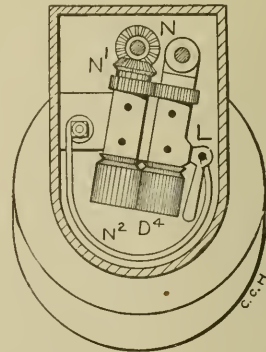

Fig. 65. Plan of coiler with top raised

It happens quite frequently that the comb band breaks or jumps from the score pulley, stopping the vibrations of the doffer comb. If this is unnoticed and the doffer runs for several minutes

the card wires get filled with fibers and the clothing of the cylinder, doffer and flats becomes badly strained.

When the sliver breaks down from any cause, it often happens that it will wind around the comb-blade. Should the doffer be allowed to run in this condition, a bad jamb in the wires of the doffer is likely to occur.

When the clothing is injured from causes of this kind, considerable time is spent in stripping and brushing out the card, straightening the wires and grinding. Frequently, the clothing is rendered useless, as the foundation for the wires is strained so badly that its elasticity is destroyed and it is necessary to redraw it on both the cylinder and the doffer.

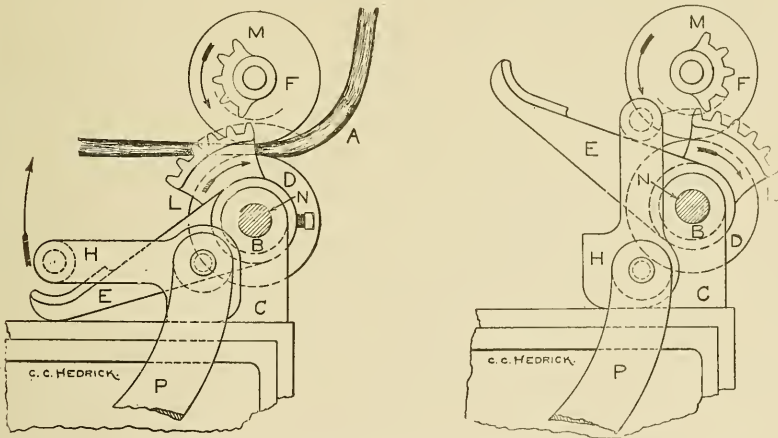

Fig. 66 and 67. Elevations of calendar roll stop motion.

The stop-motion is shown in three views, in Figs. 66, 67 and 68, which should be used in connection with Fig. 60. In Fig. 66, which is a side elevation, the sliver, A, is shown passing between the calender rolls, M and D. Upon the top calender roll, M, is a segment gear, F, which rotates with the calender roll, while a similar segment, L, is fastened to a sleeve, B, which is loose upon the bottom calender shaft, N. On the outer end of this sleeve is a lever, E, whose end rests under the handle of the lever, H, by which the barrow bar, P, is thrown in and out of gear. The barrow bar is raised and in gear, as shown by the horizontal posi-

tion of the lever, H, and, with the silver between the calender rolls, it will be seen that the teeth of the segment, F, are raised so that it may revolve without imparting motion to the segment, L. Should the sliver break or from any cause allow the calender rolls to come together, the teeth of F would engage with those of L and give to the latter a partial revolution, which would turn the sleeve, B, and with it the lever, E. This would cause the lever, H, to assume the position shown in Fig. 67 and to drop the barrow bar, P, and disengage the gears, driving the doffer. A plan of this device is shown in Fig. 68.

Flexible Bend. As the flats pass forward over the cylinder, they are supported, as we have already seen, by what is called the flexible bend. The surface of the bend is concentric with the cylinder. By this means, the distance between the wires of the flats

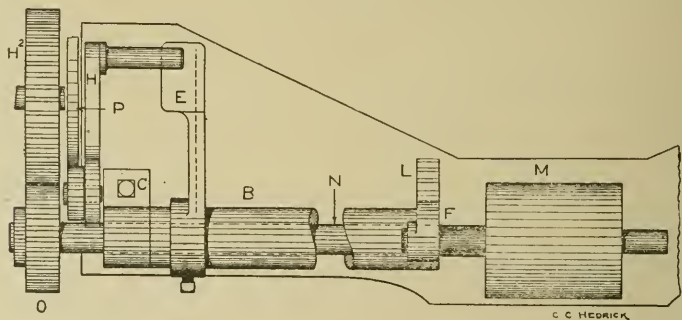
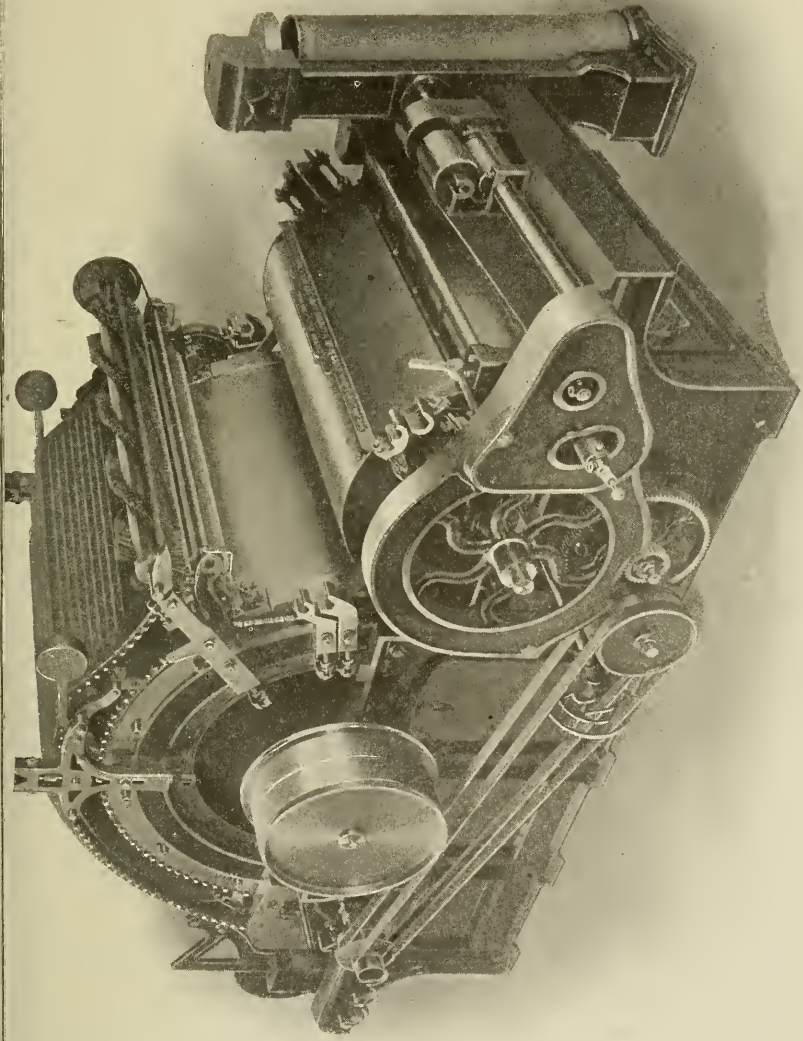
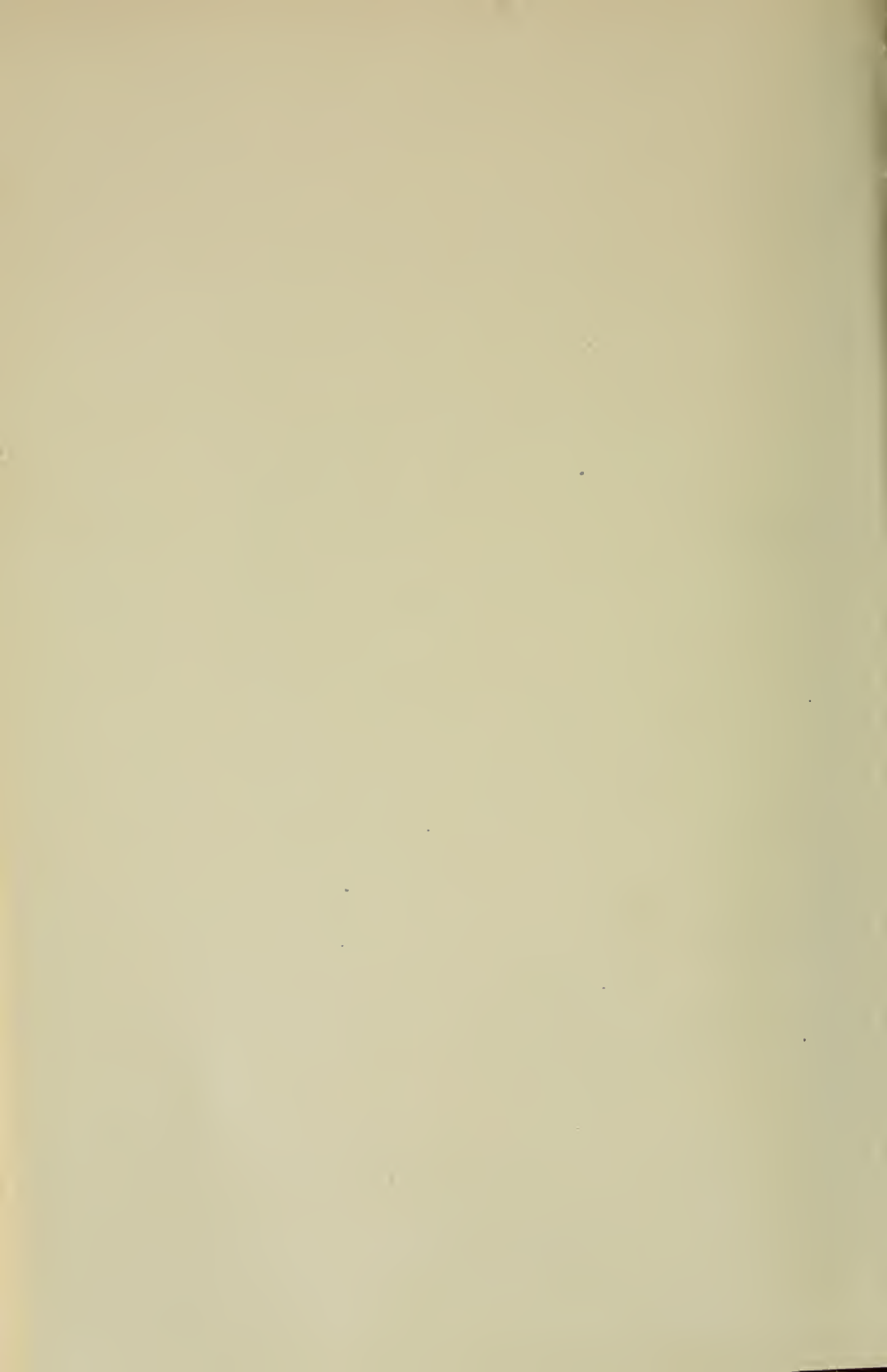

Fig. 68. Plan of calendar roll stop motion.

and the cylinder is maintained and upon the correct setting, or distance between the surfaces, depends, in a great measure, the successful working of the card. If the flats are set too far away, it will be found that the sliver contains little rolls of tangled fibers, called neps, and if set too close, it will show raw, uncarded places and look cloudy and rough, and the wires of the clothing will become faced from rubbing together. These defects are easily distinguishable in the fleece, as it passes from the doffer comb to the calender rolls. The flats should be set as close as possible without injury to the fibers. An average setting is $\frac{10}{1000}$ of an inch.



REVOLVING FLAT CARD WITH DOFFER SLOW MOTION
Howard & Bullough Am. Machine Co. (Ltd.)



The wire teeth of the flats and cylinder require grinding, from time to time, owing to their becoming dulled on the points, and, as the grinding operation shortens them slightly, the space between the wire surfaces is increased. In order to preserve the correct relation between these two surfaces, the flats have to be reset, and

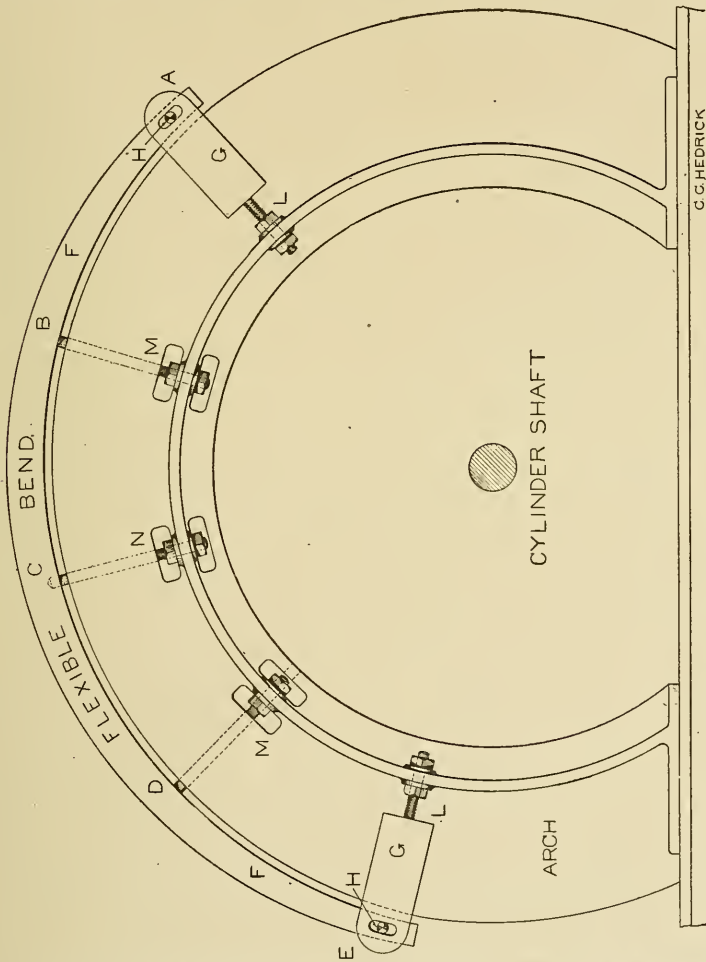

Fig. 69. Flexible Bend, five point adjustment.

as the grinding also affects each of the flats, it will be understood that they must be lowered, bodily, to the same extent towards the center of the cylinder. This is accomplished by changing the radius of the flexible bend.

The most common form of device for changing the radius is

called the five-point adjustment and is shown in Fig. 69. This differs slightly in design among machinery builders but the principle remains the same. The bend is supported at five equidistant points, the sprocket stand, A, quarter block stand, B, top block stand, C, grinder stand, D, and back block stand, E. At the points, A and E, a stud, H, is screwed into the bend, the outer end of which passes through a slot in the stands, G. In the lower end of the stands is an adjusting screw, L, which passes through the web of the arch upon each side of which are nuts. At the points, B and E, the bend is supported by another adjusting screw, M, which also passes through the web of the arch, the upper end bearing against the under side of the bend. At the center point, C, the bend is supported by an adjusting screw, N, which passes through the web of the arch, as at other points, and the upper end of the screw is screwed into the under side of the bend.

When it is necessary to change the setting of the flats, the screws and nuts on each side of the card, by which the bend is secured to the stands, are loosened. The screw, M, at B and D, should be dropped clear to the bend. The adjusting screws at each of the five points are operated upon in turn, the center point, C, first, then A and E, and last the points, B and D. By so doing, the radius of the bend is made smaller and the flats are drawn radially towards the center of the cylinder. It will be seen that at the center point, C, the adjusting screw enters the bend so that in lowering it this point must fall radially. But at the points, B and D, the adjusting screws simply support the bend, while at the ends, A and E, the studs, H, pass through slots in the stands, G, permitting a slight movement of the bend endwise. The reason for this is very simple. As the radius of the bend is made smaller, it occupies a greater proportion of the circle, and as the center point, C, falls in a radial line, the points A and E, and B and D, must partake of a combined movement, radial and circumferential. The slots in the stands at A and E permit this, while at B and D, the screw, by simply bearing against the under side of the bend, offers no resistance to this movement.

Another style, shown in Figs. 70 and 71, is called the scroll adjustment. The bend, D, is supported at three points by arms, A, B and C, instead of five, as in the first one shown, the bend

being made proportionately heavier and stiffer. The arms, A and C, are connected to the bend by a stud, F, which passes through a slot in the bend. The movement, endwise, is obtained by having the slot in the bend instead of the arm. The center arm, B, is not fastened to the bend, but acts as a support for it. A pin, E,

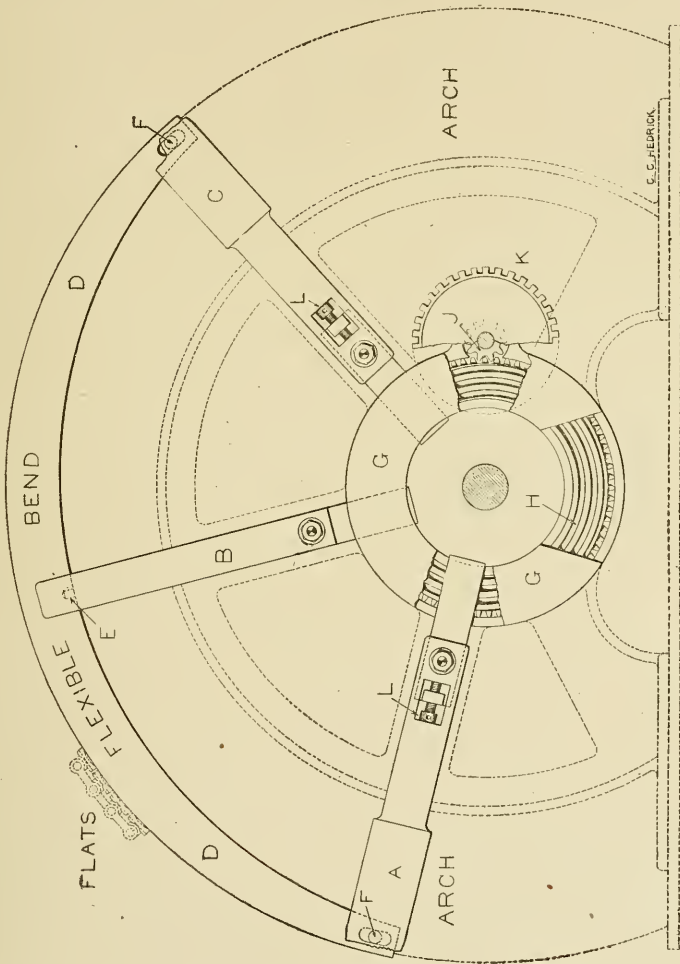

Fig. 70. Flexible Bend, scroll adjustment.

in the arm, prevents any circumferential movement of the bend. The arms are all made in two pieces, partly for convenience in manufacturing and in order to set them alike when the card is first erected. Adjusting screws, L, are provided for the two end

ones, which, after being set properly, are secured permanently by dowel pins. The lower end of the arms is provided with teeth, or threads, which work in the threads of a geared scroll, H, the pitch of which is one-half inch. The scroll turns in a recess in the arch which is concentric with the cylinder. Around the periphery of this scroll is cut a gear of 110 teeth, which is in gear with a pinion, J, of 11 teeth, which is fastened to one end of a stud, P; an index wheel, K, having 50 teeth, or notches, is fastened to the other end.

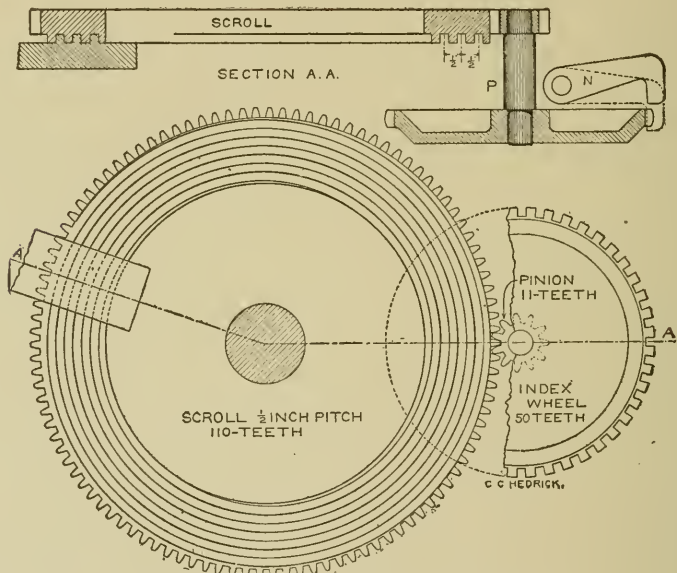

Fig. 71. Section and elevation of scroll.

It will be seen that, as the pitch of the scroll is one-half inch, two revolutions will be necessary to give the arms and bend one inch movement, radially, and, as the scroll has 110 teeth, to give it two revolutions, would require twenty turns of the 11 toothed pinion, which would be equal to 1,000 notches. Thus, if 1,000 notches are required to change the radius of the bend one inch, a movement of one notch will change the radius $\frac{1}{1000}$ of an inch. After the card has been adjusted, a latch, N, can be pushed between the notches of the index wheel and locked, preventing the setting from being changed.

Flat Chain. After the card has been run some time, the chain stretches so that it requires taking up. This is done, ultimately, by removing a link in the chain, but not until it has stretched enough for that; in the meantime, it is customary to put in a quarter block of larger diameter, which is replaced by the original when the link is removed.

A great deal of trouble comes from having the flat chain too tight. All that is necessary is to keep the flats against the back block. This point should not be overlooked. If the chain is slack and the flats hang off as they pass around the back block, they are liable to catch and give trouble, and on the other hand, if very tight, the links and bushings will soon wear out and the

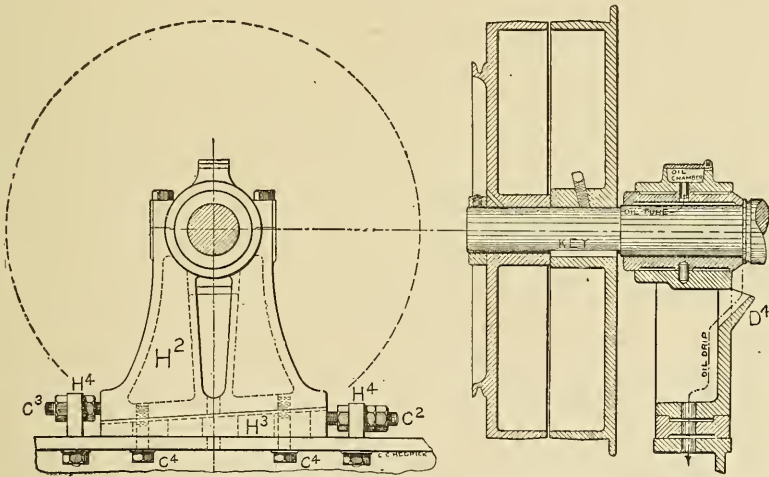

Fig. 72. Adjustable Cylinder Bearing.

flats will give trouble in grinding by not resting freely on the grinding former.

Adjustable Cylinder Bearing. While a great deal depends upon careful setting of the flats, many evils arise, such as the wearing of the bearings, due to the weight of the cylinder, the pull of the belt and various minor causes, all tending to alter the position of the cylinder and thus destroying its concentricity with the bend. When such wear takes place, some means must be provided to restore the cylinder to its concentric position.

In Fig. 72 a section and a side elevation of an adjustable cylinder bearing are shown. The cylinder boxes, or bearings, are supported by pedestals, H². The lower part of each pedestal rests upon a slightly tapered plate, H³. Upon either side of the pedestals are lugs, H⁴, which are securely fastened to the card frame. From the plate, H³, projects a screw, C², which passes through one of the lugs, while from the pedestal, H², projects a screw, C³, which passes through the other lug.

When a vertical adjustment of the cylinder is required, the tapered plate is given a horizontal movement by turning the nuts on the screw, C², but when a lateral adjustment is desired, the pedestal and plate are moved together, both parts being fastened to the card frame by cap screws, C⁴.

Sometimes, oil from the cylinder bearings runs down on the cylinder head, particularly if the card has been standing idle for several days. When this occurs, the oil may get upon the clothing of the cylinder, softening the cement with which the several layers in the foundation are stuck together and causing them to separate and puff up in places and destroy the holding power of the wire teeth. To prevent this, the pedestal is made with a lip, D⁴, projecting from the back side, directly under the bearing. Any oil that drops will be caught by this lip and carried to the outer side of the card frame, as indicated by the dotted lines.

Leader Clothing. The saw-tooth clothing, with which the licker-in is covered, is made from thin, flat, steel wire, about one-quarter of an inch in width and one-sixty-fourth of an inch thick, with a shoulder on one edge. The teeth are formed by cutting out a portion of the thin edge of the wire, making it resemble the edge of a saw. The wire is inserted in grooves which are cut spirally in the shell of the licker-in, and there are, usually, eight per inch, giving eight rows of teeth for each inch in the length of the face and about 112 teeth for each row in its circumference.

Two views of saw-tooth clothing are given in Fig. 73, showing a portion of the licker-in shell with the teeth inserted and a side elevation of the teeth with the shell in section.

Fig. 74 is an enlarged front view of the teeth, showing the depth to which the wire is let in to the shell, the shoulder of the wire coming just below the surface. After the wire is inserted, the edge

of the groove next to the shoulder is upset slightly, by passing a hardened steel disc over its surface, which prevents the wire from pulling out. A licker-in, covered with this style of clothing, requires no cleaning, stripping nor grinding and is superior in every respect to the licker-in covered with leather clothing, which is used on the old style stationary flat cards.

Clothing for Cylinders, Doffer and Flats.

The clothing for the cylinder, doffer and flats consists of a foundation made up of from three to five thicknesses of cotton, wool, linen or other materials cemented firmly together, in which is set the wires,

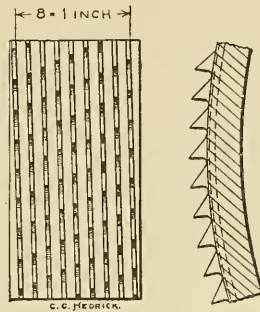

Fig. 73. Saw tooth clothing.

forming the teeth, as shown in Fig. 75 — a side elevation. The wire extends from the back side of the foundation at an angle, until a point nearly half way of its length, called the knee, is reached and then bends forward, the upper end returning to a point about over the lower end, as shown by the vertical line, A—B.

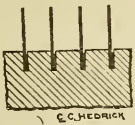

Fig. 74. Section of leader shell, showing saw tooth clothing.

Fig. 76, which is a front view, shows that the teeth, which are made from a coil of wire, are bent into the form of a staple. The two upward projecting prongs are called points and the horizontal part connecting them is called the crown.

Defects in Clothing.

A matter of great importance, one which is often overlooked, is the amount of angle or pitch given to the tooth and the position of the point in relation to the crown.

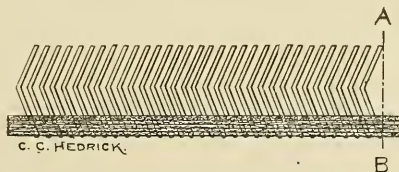

Fig. 75.

Fig. 76.

Clothing for cylinder, doffer and flats.



In one sense, the teeth are a series of hooks by which the

fibers are caught and carried forward. If the forward inclination of the point is not sufficient, the teeth lose some of their holding power, while if the inclination is too great, the holding power is such as to cause serious defects in carding. To explain this more fully, Figs. 77, 78, 79 and 80, which show several enlarged views of card teeth, will be considered.

In Fig. 77, the crown of the tooth is marked A, the knee is marked B and the point, C. The angle of that part of the tooth between A and B is about fifteen degrees from a vertical line, and this is the average of the wire for cotton card clothing. If the angle is increased, as shown in Fig. 78, it is evident that the tooth must have a much greater holding power, which will cause the short fibers, neps and dirt to be forced to a considerable distance

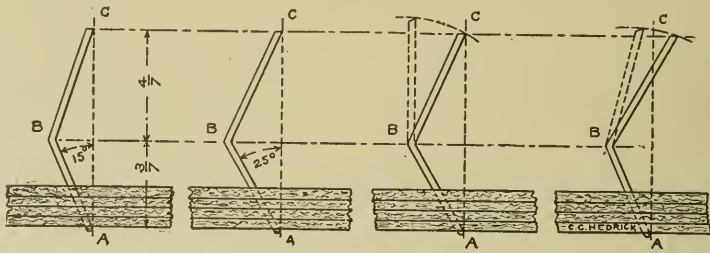

Fig. 77.

Fig. 78.

Fig. 79.

Fig. 80.

Enlarged views of card teeth.

beneath the point. Otherwise, they would be caught by the flats or thrown off, to fall through the screws. In this way, the spaces between the teeth fill rapidly, which necessitates stripping the card much oftener than would be required with the wire set properly and it also makes the removal of the strippings much more difficult.

Another point in connection with the angle of the wire being too great, is illustrated in Fig. 79. If the point of the tooth is pushed back by a tuft of cotton, there is a liability of its straightening at the knee, which, acting as a fulcrum, causes the point to rise into the position shown by dotted lines.

Quite a common defect in card clothing is shown in Fig. 80. If the point of a tooth stands too far forward of an imaginary vertical line, drawn through the crown, and the tooth is forced back while at work, it will rise above its natural plane to such an extent

as to cause the point to become faced by contact with the other wire surfaces of the card. The height of the tooth from crown to point is usually three-eighths of an inch and the knee is about three-sevenths of the distance from the crown. Many times, the causes of bad carding can be attributed to some of these faults rather than to the construction of the machine.

Foundation for Clothing. The foundation for the teeth should be of material that has the least possible amount of stretch, in order to hold the wire firmly enough to carry around the fibers which become attached and yet it should be flexible enough so that the wires shall spring back to their original position when they have been deflected by grinding, or by the strain put upon them when the card is in operation. If the foundation is drawn on too tightly, the wires are apt to break at the point where they leave the foundation.

The material, composing the several layers of the foundation, is varied somewhat to suit the different requirements. For the cylinder and doffers, it is generally four-ply: first a thickness of twilled cotton cloth for the crown side, then a layer of coarse linen threads, added to give strength and running lengthwise of the clothing, next a thickness of heavy woolen cloth and last another facing of twilled cotton cloth. Sometimes, an additional facing of rubber is used, which answers a double purpose, giving an elastic support to the wire where it leaves the foundation and protecting the foundation from dampness.

For the flats, a three-ply foundation is almost always used, called double covered or cotton wool and cotton. The crown and face sides are of the twilled cotton and between them is a layer of closely woven heavy woolen cloth. The rubber facing is seldom added, as the flats in passing back over the cylinder are often exposed to the sun's rays, which cause the rubber to harden and disintegrate.

A comparison of tests, made of several kinds of foundations, show that a strip two inches wide of the four-ply above referred to, when put under a tension of 300 pounds, became elongated 2 per cent. Four-ply foundation, cotton, wool and cotton, with rubber face, became elongated $6\frac{1}{2}$ per cent and leather foundation elongated $14\frac{1}{2}$ per cent.

Applying Clothing. The clothing for the cylinder and doffer is made in continuous strips and is called fillet. That used for the cylinder is usually 2 inches wide and that for the doffer is $1\frac{1}{2}$ inches wide. It is drawn on to the surface by a device called a clothing machine, which registers the tension put upon it, the cylinder being clothed under a tension of about 350 pounds and the doffer under about 275 pounds.

Fig. 81 shows a front and a rear elevation of a doffer. On account of the fillet being wound, spirally, around it, the teeth must strike the fibers at a slight angle. It is desirable that this angle be as small as possible, that the danger of the teeth breaking or being turned from their correct position will be reduced to

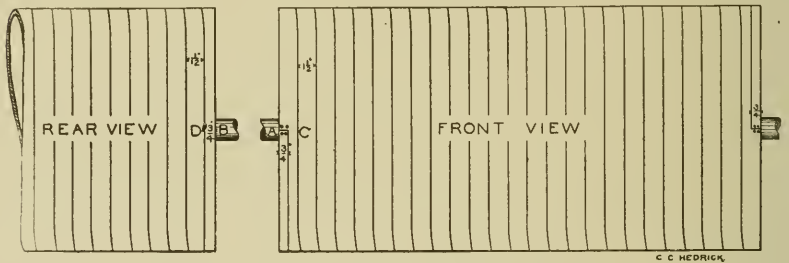

Fig. 81. Front and Rear Views of Doffer.

a minimum and, as the doffer is about one-half the diameter of the cylinder, the clothing is made narrower so that the angle of the spiral shall be nearly the same as that of the cylinder.

In putting on the fillet, it is usually cut so as to form what is called an inside taper, which leaves a straight edge extending the whole distance around on the outside of each end of the doffer. The clothing, which starts at A, is three-quarters of an inch wide and continues this width until half around the doffer, where, at B, it commences to widen, and when it has passed around to the point, C, beside the starting point, A, it is the full width, $1\frac{1}{2}$ inches. At C, the fillet is again cut down to half its width, the portion cut out tapering until it reaches a point half around the doffer at D. From here, it extends in full width to the opposite end of the doffer where it is tapered to finish in the same manner as at the starting point.

In Fig. 82 is shown a strip of fillet with the portion cut away for an inside taper. The letters of reference used are the same as in the preceding illustration.

The fillet for the cylinder is put on with an inside taper, also, and in the same manner, but, as the cylinder is more than twice the diameter of the doffer, a strip of considerable length has to be cut away before the full width is reached.

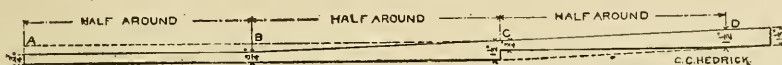

Fig. 82. Strip of Doffer Fillet.

Number of Wire and Points per Square Foot in Clothing.

The wire teeth are set into the foundation of card clothing in three different ways, known as open set, seldom used at the present time, twill set, which is used for the flats and rib set, which is used for the cylinders and doffers. The effect on the face of the clothing is about the same, as far as the arrangement of the points is concerned, in all styles of setting.

A plan of the back or crown side of a strip of fillet with the rib setting is given in Fig. 83. The crowns, extending across the width of the fillet, are four to the inch, consequently, across a strip of one and one-half inch width, there are six crowns, and, as the foundation is about one-sixteenth of an inch wider than the wire surface, a one and one-half inch fillet covers a surface about one and nine-sixteenths inches wide.

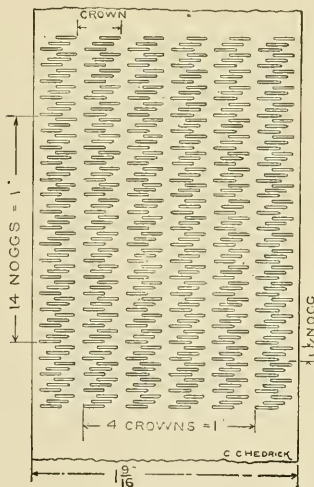

Fig. 83. Rib Set Fillet.

The nogs, which run lengthwise of the fillet, are from ten to twenty-eight to the inch. A nogg consists of a group of three crowns, and, of course, to each crown are two points. The points per square foot can be found in the following way:

Rule.— To find the number of points per square foot, multi-

ply together the number of noggs per inch, the crowns per inch, the crowns per nogg, points per crown and the number of inches in a square foot. Example: In Fig. 83, there are fourteen noggs to the inch; the points per square foot will be $14 \times 4 \times 3 \times 2 \times 144$, or 48,384.

Each nogg added per inch increases the number of points per square foot 3,456. Thus, by multiplying the number of noggs per inch by this number, the points per square foot can be found.

Example: $3,456 \times 14 = 48,384$.

The twill set is shown in Fig. 84. The crowns extend lengthwise of the strip and are four to the inch. The noggs are counted across and are from five to fourteen per inch. In each nogg there are six crowns instead of three, as in the rib set, but the number of points per square foot can be calculated in the same way. To illustrate this, it will be seen that in Fig. 84, there are only seven noggs per inch, but as there are just twice as many crowns to each nogg, the points per square foot will be the same as in Fig. 83, which has fourteen noggs per inch.

Example: $7 \times 4 \times 6 \times 2 \times 144 = 48,384$.

For the twill setting, each additional nogg per inch increases the number of points per square foot 6,912.

When carding low grades of cotton, the wires of the clothing are coarser and the number of points per square foot less, and when carding long staple cotton, the wire is finer and the number of points per square foot on all the clothed surface except the leader is generally increased.

Some machinery builders recommend that the cylinder and flats be covered with the same clothing, while others think that the doffer and flats should be the same. No rule can be given by which the number of points per square foot and the size of the wire can be determined that will fit all cases. For coarse work, No. 29 wire with 62,208 points per square foot is usually used for the cylinder and flats and No. 30 wire with 65,664 points per square foot for the doffer. For medium work, the cylinder and flats are usually covered with No. 30 wire, 65,664 points per square foot and the doffer with No. 31 wire, 72,576 points per square foot. For fine work, the cylinder and flats should have No. 31 wire, 72,576 points per square foot and the doffer No. 32 wire with 79,488 points per square foot.

The following tables give the points per square foot for both rib and twill set clothing:

RIB SET CLOTHING.

Noggs per inch,	Points per square foot.
10	34,560
11	38,016
12	41,472
13	44,928
14	48,384
15	51,840
16	55,296
17	58,752
18	62,208
19	65,664
20	69,120
21	72,576
22	76,032
23	79,488
24	82,944
25	86,400
26	89,856
27	93,312
28	96,768

Twill SET CLOTHING.

Noggs per inch.	Points per square foot.
5	34,560
5½	38,016
6	41,472
6½	44,928
7	48,384
7½	51,840
8	55,296
8½	58,752
9	62,208
9½	65,664
10	69,120
10½	72,576
11	76,032
11½	79,488
12	82,944
12½	86,400
13	89,856
13½	93,312
14	96,768

Kinds of Wire for Card Clothing. In considering the kind of wire to be used for the teeth, a question arises concerning which there are many opinions. With the leather foundation used on the old style stationary flat card, it is the universal practice to use round iron wire, but on the revolving flat card, this kind becomes dulled quickly on account of the extra amount of work done on this machine. We now use mild steel wire which has been subjected to a process of hardening and tempering. It is claimed by many that the round iron wire tooth is preferable when quality of production, and not quantity, is desired, as it deals more gently with the fibers, consequently they can be given a more thorough carding without excessive injury.

The various kinds of wire used are shown on a very much enlarged scale in plan and elevation in Fig. 85. The one marked A is the ordinary round wire. B represents the so-called needle-pointed, or side-ground wire, and is made from wire of round section by grinding two sides for a short distance below the point. C is the plough-ground wire, also made from a round section by grinding on opposite sides about fifty per cent of its original area as far as the knee. The grinding is done by drawing the fillet over a flat surface, crown side down, the teeth passing between a series of emery discs. The wire marked D is double convex and is oval in section. E is made triangular in section by rolling and is used for napping machines.

With regard to the respective merits of needle-pointed and plough-ground wire, the latter seems to find the most favor, and

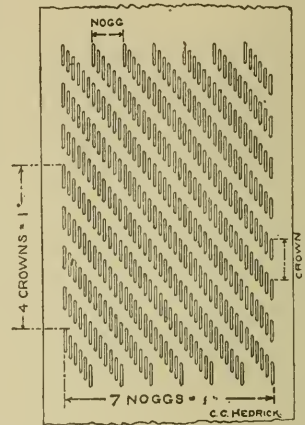

Fig. 84. Twill Set Fillet.

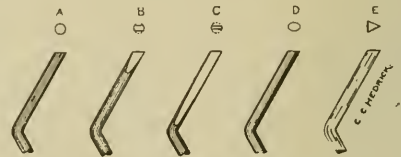

Fig. 85. Card Tooth Wire.

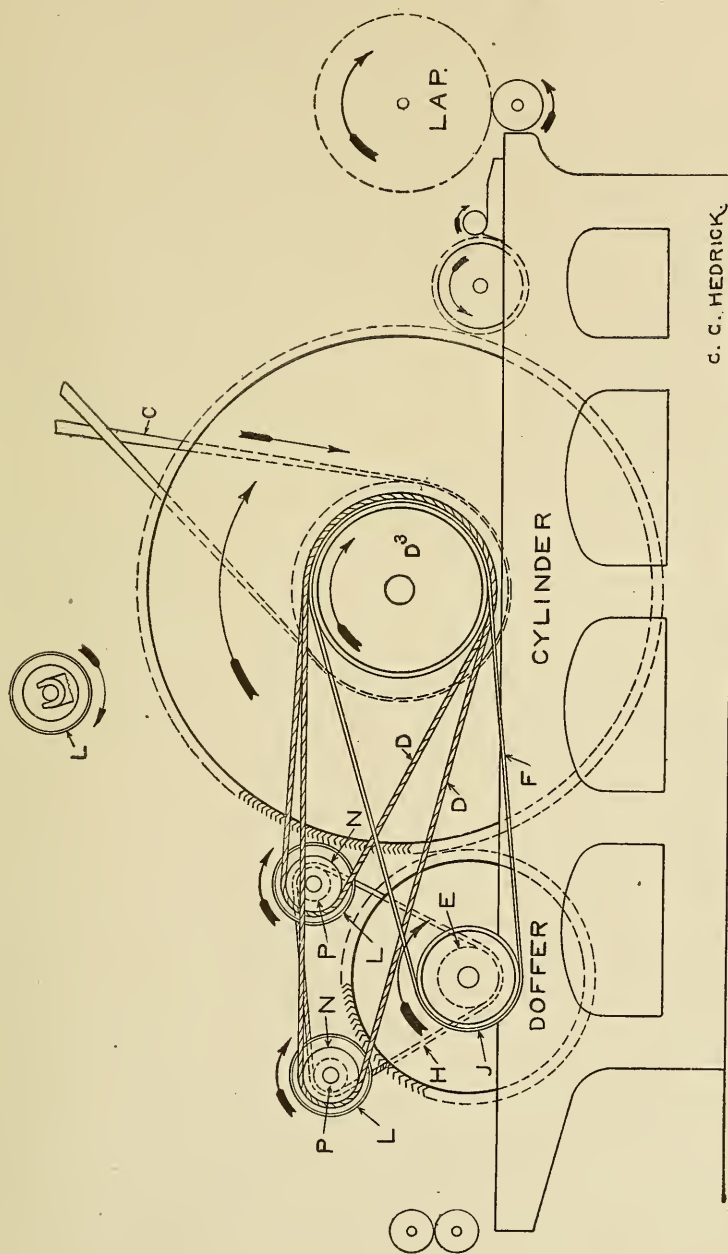

Fig. 86. Elevation of Card Showing Belting used in Grinding.

at the present time, is used almost wholly for the revolving flat card. It is a matter hard to decide, how much better results are obtained with it, but it certainly affords a trifle more space between the wires for the reception of dirt, nep and short fibers.

When the card is first put into operation, it is difficult to remove the strippings from plough-ground wire, but after the sides of the teeth become smooth, by constant stripping, they can be removed much easier and better than with any other wire.

Grinding. It is necessary to grind the cylinder and doffer after they are clothed to make the card work successfully. The first grinding requires generally about ten days, depending upon the condition of the clothing. If the wires are too hard, and if some are higher than others, it often takes much longer.

After the first grinding, it is necessary, in the ordinary running of the card, to grind the cylinder and doffer about once in four weeks. When carding long staple cotton, the time is reduced to three or even two weeks. The period depends oftentimes on the ability of the grinder to perform his allotted duty rather than the actual need of the clothing. It is considered that frequent and light grinding is better than to wait until the wires have become so dull that a severe grinding is necessary to restore the points.

Fig. 86 shows a side elevation of a card with the grinder rolls in position. The lap is withdrawn and the cylinder and doffer are stripped and brushed clean. The card is run until all the flats have passed the stripping brush and comb and have been made clean. The main belt, C, is then changed and the cylinder is run backwards or in the opposite direction from that which is required in carding. The side shaft is slid out of gear and the barrow bar is dropped, the doffer being driven by a belt, F, and pulley, J, from the pulley, D³, which drives the leader when carding. On the end of the grinder rolls are score pulleys, N, which are driven from two scores in the pulley, D³, by the bands, D and D. A score pulley, E, is placed on the opposite end of the doffer for driving the traverse motion of the grinder rolls by means of the band, H, and pulley, P.

Another method of driving the grinder rolls, which is more simple and is used considerably, is illustrated in Fig. 87. This also requires the belt, F, band, H, and pulleys, J and E, but

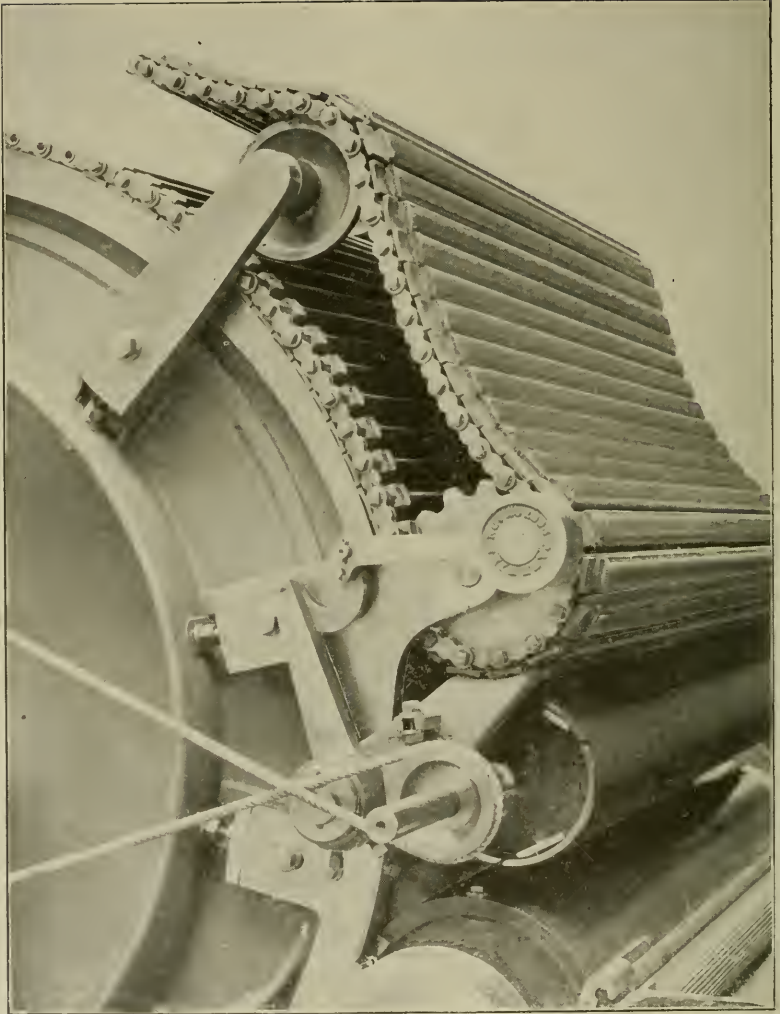

APPARATUS FOR GRINDING FLATS FROM THEIR WORKING SURFACES
Mason Machine Works.

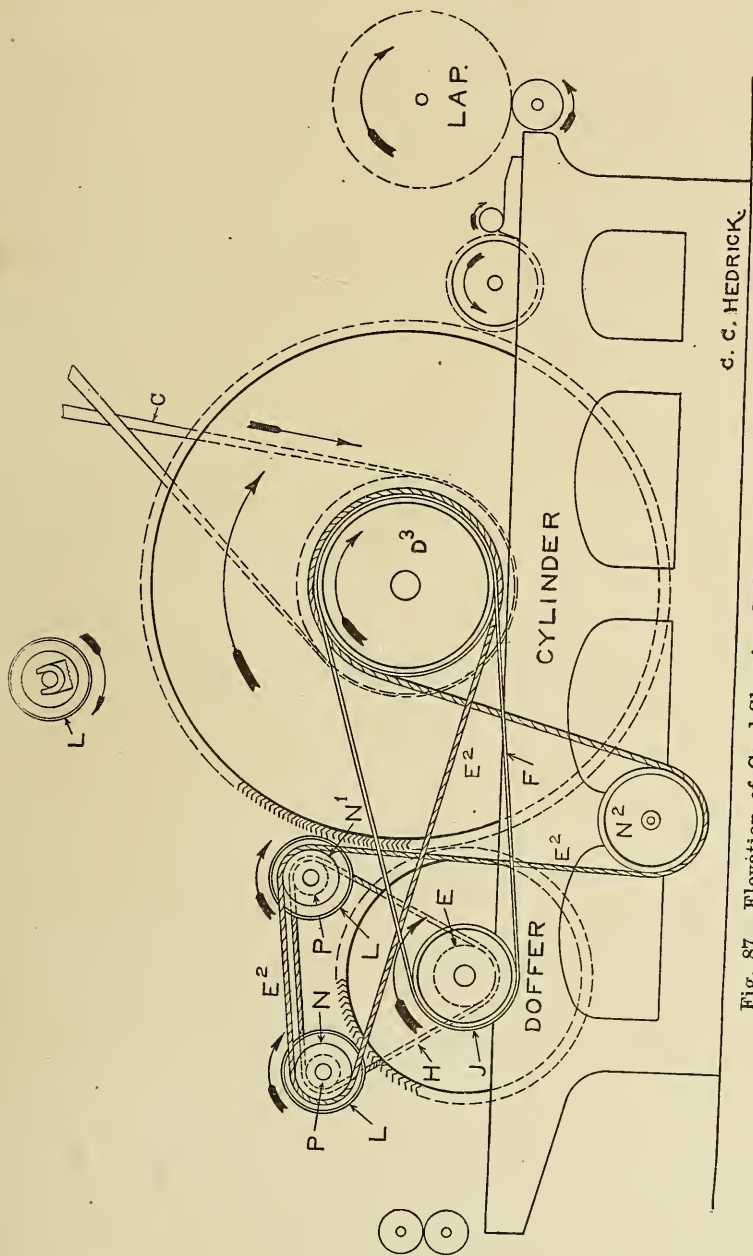

G. C. HEDRICK.

Fig. 87. Elevation of Card Showing Belting used in Grinding.

instead of using the two bands, D and D, for driving the grinders, a single band, E², is used that runs from the groove in the pulley, D³, around the pulley, N, on the doffer grinder, then around the pulley, N¹, on the cylinder grinder, and then down around the intermediate comb pulley, N², to the pulley, D³.

On some makes of cards, this cannot be done, as there is no intermediate pulley, the comb being driven directly from the groove in the pulley, D³.

Long-roll Grinder. For the first grinding, the long-roll grinder, shown in Fig. 88, is used. After this, in the periodical grinding, unless the wires become jammed or badly worn, it is seldom used.

It consists of an iron roll, seven inches in diameter, which extends across the whole width of the surface to the ground. The roll, which is wound with emery fillet, is supported at either end by bearings, B, which are mounted in the grinder brackets, C.

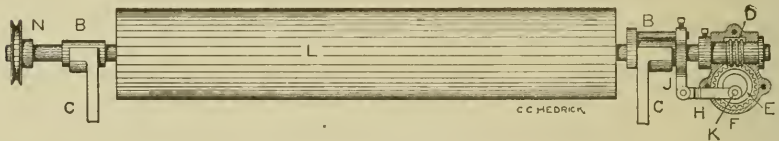

Fig. 88. Long Roll Grinder.

On one end is a score pulley, N, by which the roll is driven, and attached to the other end is a worm, D, which drives a worm gear, E. This gear is enclosed in a case, F, which is shown in section, and which forms a bearing for it to turn in. In the hub of the gear is a pin, K, which is set eccentrically, so that as the gear revolves, the pin describes a circle of about three-eighths of an inch radius. Attached to the pin is one end of a yoke, H, the other end of which is fastened to a downward projecting arm, J, of the bearing. The revolutions of the grinder roll cause the worm gear to turn, and, through the pin in its hub and the connecting yoke, the roll is given a movement, endwise, of about three-fourths of an inch. This is done to prevent the high wires of the clothing from receiving grinding from the same portion of the face of the roll at all times, this preventing the emery fillet from becoming worn and hollow in places.

Traverse Grinders. After the long grinder has been used a sufficient time, the short or traverse grinder, shown in elevation and section in Fig. 89, is used. The grinder roll, L, which is the same diameter as the long grinder, is about four inches wide on the face. It is mounted upon a shell, M, which has a slot, D, extending throughout its length. Within the shell is a reciprocating screw, A, to which the grinder roll is connected by a dog, E, which slides in its threads. A score pulley, N, by which the shell is driven, is fastened to one end while the screw is driven from the other end of the shell by a train of gears, H, J, S and T, which have 22, 16, 15 and 23 teeth, respectively. H is fastened to the shell and drives J which is compounded with S and runs loose on a stud, B. T is fastened to the screw and is driven by

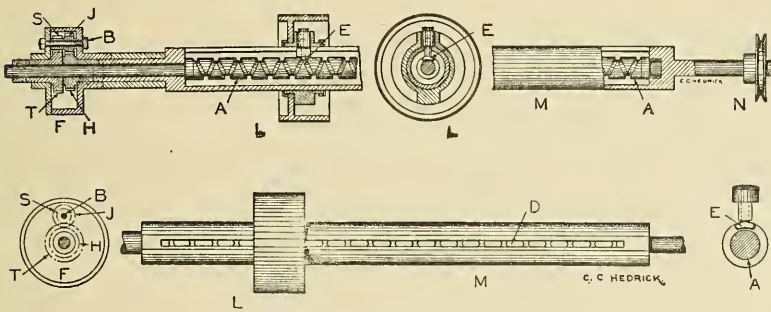

Fig. 89. Traverse Grinder.

S. The gears are enclosed in a case, F, which, to prevent its turning, is fastened to the grinder bracket, C, by a lug. By this means, the shell, which carries the grinder roll, is run at a greater speed than the screw, causing the grinder roll to move longitudinally along the shell, and as the screw is cut with right and left hand threads, a reciprocal movement is given to the grinder, which causes it to move back and forth from one side to the other of the surface being ground.

For each hundred revolutions of the shell, the screw turns 89.67 revolutions in the same direction (10.33 revolutions less than the shell) and as the screw is one and one-half inches pitch, 10.33 revolutions will move the grinder roll $15\frac{1}{2}$ inches along the shell.

Another style of traverse grinder is shown in Fig. 90, which consists of a roll, L, a screw, A, a dog, E, and a shell, M, with a slot, D, all of which are the same as on the grinder shown previously. On one end of the grinder is a pulley, N, which drives the shell; on the other end is a similar pulley, P, of slightly different diameter. The shell and screw are thus run at different speeds and the roll is traversed to and fro on the shell. This style of grinder requires the pulley, E, and band, H, as shown in Figs. 86 and 87 to drive the screw for the traverse.

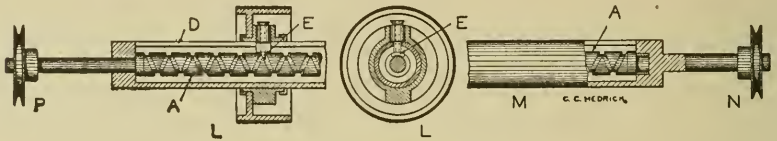

Fig. 90. Traverse Grinder.

Speed of Grinder Rolls. The surface speed of the cylinder is about 2,200 feet per minute and that of the doffer is 1,921 feet per minute. The surface speed of the grinders is about 900 feet per minute in the opposite direction from the cylinder and doffer. This gives a total surface speed for the cylinder grinder of 2,200 feet plus 900 feet, which makes 3,100 feet per minute, and for the doffer, it is 1,921 feet plus 900 feet, which makes 2,821 feet per minute. This is considered as high speed as hardened and tempered steel wire will stand. The doffer is run at a slightly slower surface speed as it does not require as much grinding as the cylinder.

When grinding the flats, there is no loss in production from stopping as the work is done while the card is in operation.

Flat Grinders. The flat-grinding device, which is a part of the card, is attached in different positions. Upon some cards, the grinding is done as the flats return over the top of the cylinder between the front sprocket and center block; other makers grind just back of the center block, while upon some cards, the flats are ground directly above the licker-in as they pass around the back block.

With the grinding device attached in either of the first two positions mentioned, the flats are ground in an inverted position.

By some, this is considered an evil, the claim being made that the flats deflect slightly in the center by their own weight and cause the grinding roll to bear harder on the ends and when they pass around on to the cylinder, the deflection is in the opposite direction, which produces a convex surface, making the wires in the center a trifle closer to the cylinder than at the ends. This makes an error in setting.

When the flats are ground as they pass around the back block, their working face is downward, in the same position as when they rest upon the bend. By grinding in this position, the

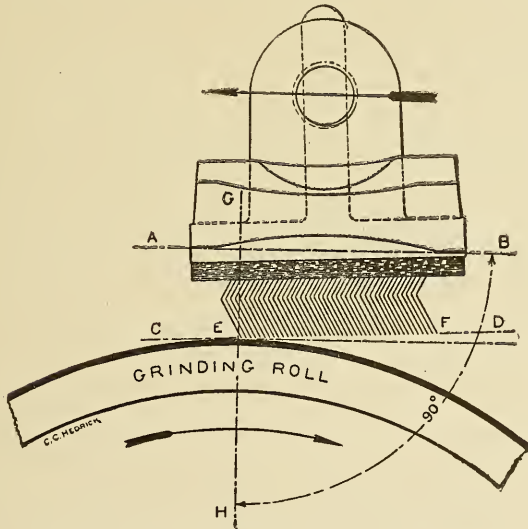

Fig. 91. Elevation of Grinder Roll and Flat.

disadvantage arising from deflection is eliminated. Opinions are divided in regard to which is in the best position. The existing evil, if it can be called such, caused by deflection, is often magnified and no perceptible difference in the working of the card can be seen.

To have the flats alike and perfectly accurate, they should be ground from the same surface which bears upon the bend, but owing to their being closer to the cylinder at the heel than at the toe, this surface is not parallel with the face of the flat. This presents a problem which has been given considerable attention

and which will be understood better by referring to Fig. 91.

The surface of the flat which bears upon the bend is indicated by the horizontal line, A — B, and the face by the line, C — D, the heel of the flat by E and the toe by F. The center of the grinding roll is indicated by the vertical line, G — H, which is at right angle to the line, A — B. As the flat which passes in the direction shown by the arrow, comes over the center of the grinding roll, the wires on the heel will receive grinding, but as it ad-

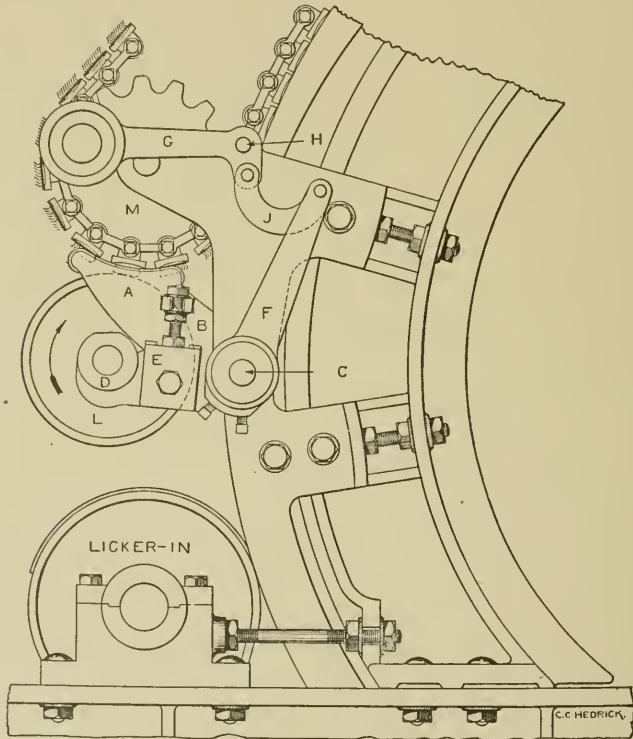

Fig. 92. Elevation Showing Position of Flat Grinders When in Use.

vances until the toe comes to this point, it is evident that it will receive no grinding, owing to the inclination of the wire face. The flats must therefore be tipped, as they pass the grinding roll, so that they shall be ground parallelly to their working face. This necessitates a special surface, called a "grinding former," for the flats to bear upon.

A device for grinding the flats with the face down is shown in Fig. 92. The grinding roll, L, is mounted in self-adjusting bearings, D, which are supported by brackets, E, and which are adjustable from the grinding former, A, by means of the screw, B. The grinding former and bracket, which are connected to the lever, F, are pivoted upon a stud, C. A weight lever, G, pivoted upon

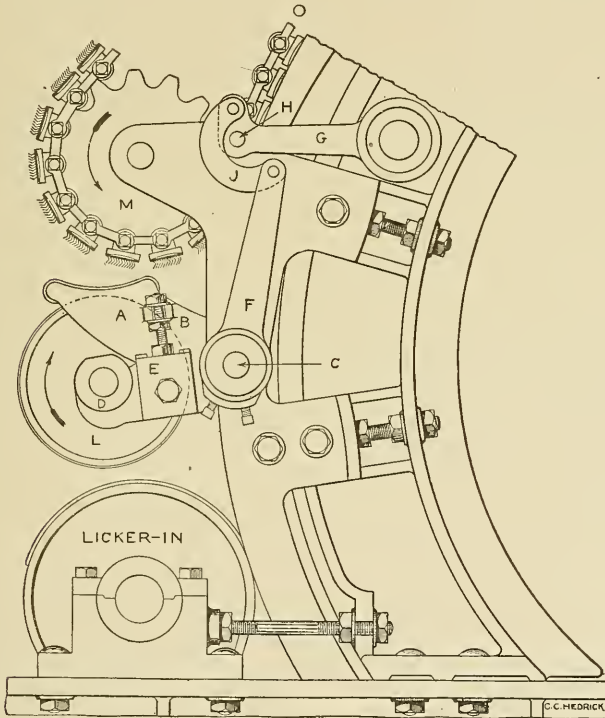

Fig. 93. Elevation Showing Position of Flat Grinder When Not in Use.

a similar stud, H, is connected to the lever, F, by a curved arm, J. The weight lever is thrown forward and holds the former firmly in position against the bearing surface of the flats as they pass around the sprocket wheel, M. The surface of the former is so shaped as to tip the flats enough to cause grinding to take place across the whole width of the face.

Fig. 93 shows the position of the grinding apparatus when

the card is not being ground; the weight lever is thrown back, dropping the grinding former out of contact with the flats.

An attachment for grinding the flats, in an inverted position over the cylinder, is shown in Figs. 94 and 95. The grinding roll, L, is mounted in bearings, A, which are adjusted from the grinding bracket, C, by the screws, B. The grinding former, D, is fastened securely to the grinding bracket with the bearing surface down-

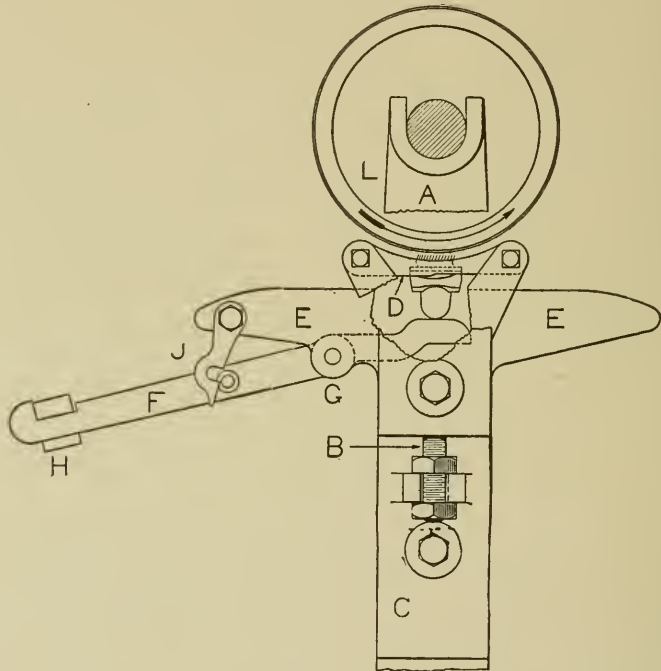

Fig. 94. Elevation Showing Flat Grinder.

ward. The flats are kept in contact with the former by a weight lever, F, which is pivoted upon a stud, G, and which has a weight, H, upon its outer end. As the flats pass along to the grinding former, they are supported upon the projecting arms, E, of the bracket, but as they come directly under the grinding roll, they are raised slightly by the rounding end of the weight lever, and, by means of the weight, are held firmly against the former.

Grinding Former. Figs. 96, 97 and 98 show the grinding

former with the flats in three positions. It will be seen that the former is made with an offset, directly under the center of the grind-

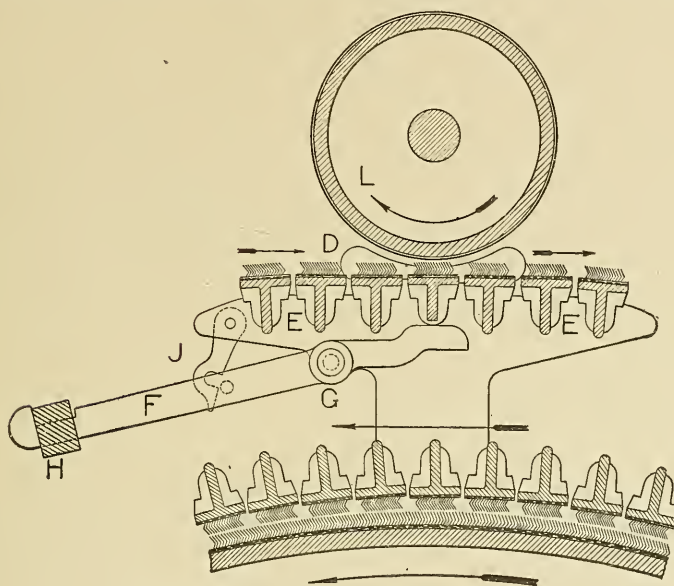

Fig. 95. Section Showing Flat Grinder.

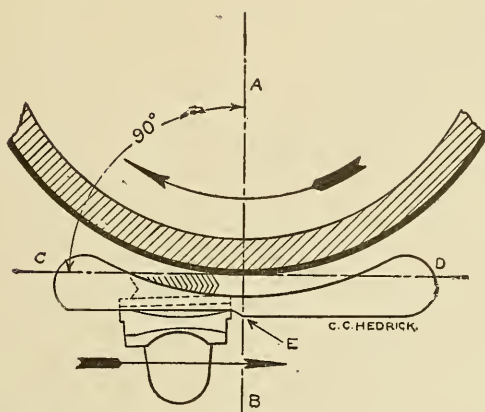

Fig 96. Position of Flat before Grinding.

ing roll, equal to the difference in the height of the bearing surface between the heel and toe of the flat.

In Fig. 96, the flat is shown advancing towards the grinding roll with the wire face at an angle. Fig. 97 shows the flat in contact with the grinding roll. The offset in the former tips the

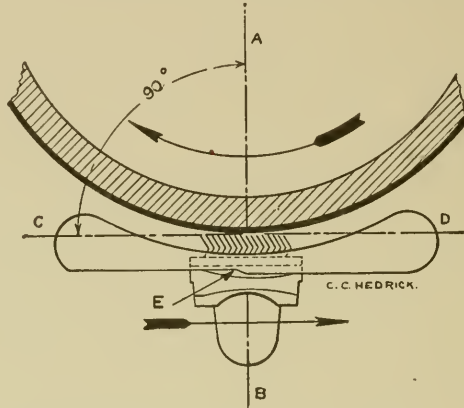

Fig. 97. Position of Flat when Grinding.

flat just enough to cause the wire face to pass horizontally beneath the grinding former. Fig. 98 shows the flat as having

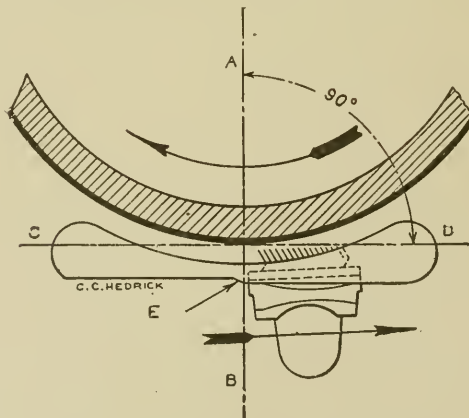

Fig. 98. Position of Flat after Grinding.

passed the grinding roll, its wire face assuming an angular position. When the flats are not being ground, the weight lever is raised and held up by the hook, J. (Figs. 94 and 95.) This

drops the short end of the lever out of contact with the flats which pass along clear of the grinding former.

Burnishing. It is necessary, usually, to burnish the teeth of the card clothing, after the card is first ground, to remove the burrs and rough edges which are formed sometimes upon the teeth, particularly when they are overground. Burnishing is also resorted to when the teeth become rusty. Otherwise, the sliver will show streaks of cloudy and uncarded cotton.

Burnishing is done by a revolving wire-toothed brush which is mounted in suitable bearings. Its teeth penetrate from $\frac{1}{32}$ to $\frac{1}{16}$ of an inch below the points of the card teeth and it is usually about seven inches in diameter over the points of the teeth. It is shown in end elevation in Fig. 99. The brush consists of a wooden roll, wound with straight wire fillet, number 32 wire being used, with about $6\frac{1}{2}$ noggs per inch. The wires are about $\frac{7}{8}$ of an inch high, above the crown, and stand radially from the center of the roll.

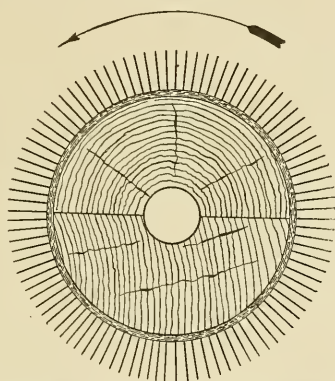

Fig. 99. Elevation of Burnishing Brush.

An elevation of the card with the burnishing brushes in position is shown in Fig. 100. The cylinder and doffer are burnished at the same time. The device for driving the various parts, although very simple, requires some explanation. The brushes, D, D, are supported at each end by stands which are adjusted from the arches of the cylinder and doffer. Upon the ends of the brush shafts are pulleys, E and E. In place of the usual barrow bar pulley is a pulley, H, the face of which has grooves for the bands, B, M and N.

In the face of the loose pulley, A, on the end of the cylinder shaft, is a groove which carries the band, B, for driving the pulley, H, while the burnishing brushes are driven from H by the bands, M and N. The doffer is also driven from the pulley, H, by the gears, T, P¹, V¹ and Q, the last being upon the doffer shaft. On the opposite end of the doffer, shown by dotted lines, is a pulley,

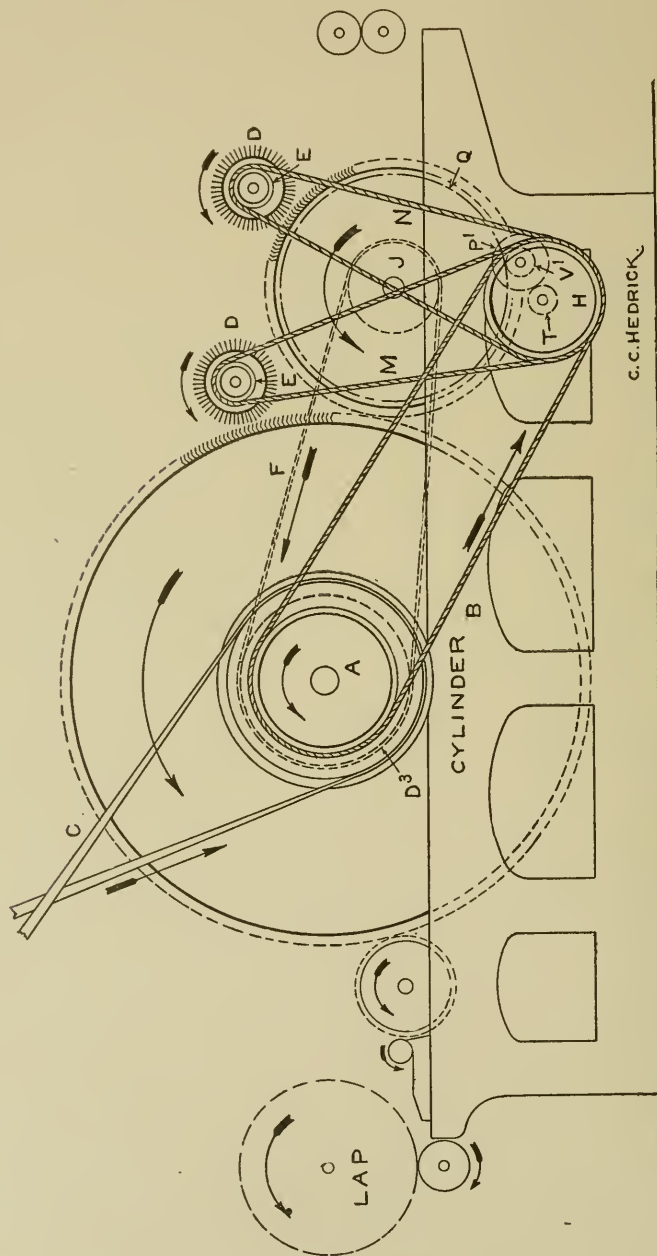

Fig. 100. Elevation of Card Showing Belting used in Burnishing.

J, by which the cylinder is driven through the belt, F, and pulley, D³. As motion is transmitted to all parts of the machine through the band, B, it must be kept reasonably tight.

The main belt, C, is run on the loose pulley, A, which should be caused to turn backwards, or in the same direction as the cylinder, when grinding and burnishing. This may seem, at a glance, to be unnecessary, as the band, B, can be crossed to give the proper direction to the cylinder and doffer, but should the belt by any cause be moved on to the tight pulley, considerable damage might be done to the teeth of the cylinder, as it would be turning in the opposite direction to the loose pulley, but with the loose pulley turning in the same direction as the cylinder, no accident can happen to the cylinder clothing if the belt should slip on to the tight pulley.

Stripping. Under ordinary conditions, the card requires to be stripped twice each day. For waste and very short and dirty cotton, it should be done four times a day.

The operation consists in removing the dirt and short fibers which become lodged in the wires of the cylinder and doffer while the card is at work.

The stripping brush, shown in end elevation in Fig. 101, is of about the same size and general appearance as the burnishing brush, except that the wires are bent, similarly to the card clothing teeth, instead of being straight.

Fig. 102 shows the card in elevation with the stripping brush mounted in the stands in position for cleaning the cylinder and doffer. It is set so that its wires penetrate about $\frac{1}{8}$ of an inch into the card teeth and it is driven from a groove in the loose pulley, A, by a band, P, and pulley, S.

The main belt, C, is run on to the tight pulley just far enough to turn the cylinder around very slowly, one revolution

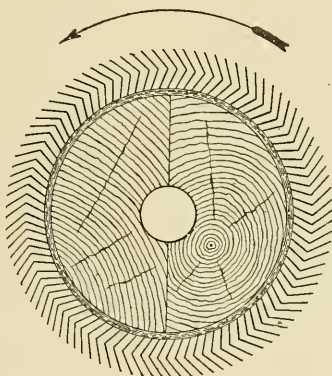

Fig. 101. Elevation of Stripping Brush.

being sufficient. The surfaces of the cylinder and brush, which are in contact, turn in the same direction, but, as the brush runs at a much greater speed, the dirt is removed very easily. The band is then taken off and the brush is placed in position for stripping the doffer, being driven by a band, E, in the same manner as is the cylinder. Previous to stripping the doffer, the driving belt is moved on to the tight pulley and allowed to remain while the brush is being placed in position and is then moved back on to the loose pulley for driving the brush. The barrow bar, which has remained down, is now thrown into gear; the doffer is allowed to make one revolution and is driven through the regular gearing, from the momentum acquired by the cylinder, while the belt was on the tight pulley.

It will be seen that the surface of the doffer runs in the opposite direction from the brush, but the wires of each are bent at such an angle that the work is easily accomplished. After the card is stripped, the brush itself needs cleaning, which is done by a hand card.

Calculations. The production of the card is governed by the weight of the sliver per yard and the number of revolutions of the doffer per minute. Although the doffer is not the actual delivery roll, it is considered in the calculations. To have this fully understood, diagrams, showing the gearing of four of the leading makes of revolving flat cards, are shown in Figs. 103, 104, 105 and 106. The gearing of all is very similar so that whatever calculations are made upon one may be very easily followed through upon another. These calculations are figured from the gearing shown in Fig. 106.

The doffer is $24\frac{3}{4}$ inches in diameter on the face of the clothing, therefore, each revolution that it makes will deliver a length of sliver equal to its circumference which is 77.75 inches. But after leaving the doffer, the sliver passes between the calender rolls on the card and then between the calender rolls in the coiler box, where in each case it is subjected to a slight draft. This additional draft, or elongation, reduces the weight of the sliver somewhat from what it weighed at the doffer, so that, as the calender rolls in the coiler are the actual delivery rolls, the length delivered by them at each revolution of the doffer should be

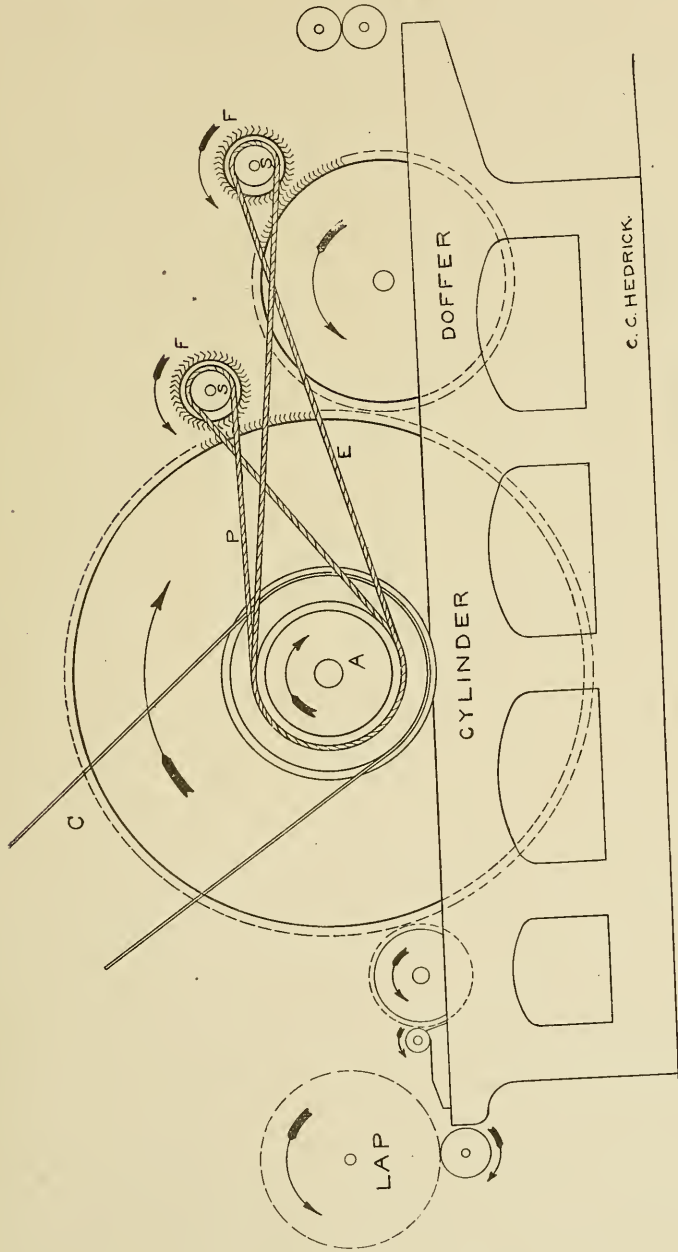

Fig. 102 Elevation of Card Showing Bands used in Stripping.

considered in figuring the production. These rolls are $2\frac{1}{8}$ inches in diameter and make 13.22 revolutions to one of the doffer. This gives a delivery of 88.25 inches for each revolution, instead of 77.75 inches, as when taking the actual circumference of the doffer.

Rule 1. To find the production of the card: Multiply together the number of revolutions of the doffer per minute (13), the number of inches delivered at each revolution (88.25), the weight of the sliver per yard (60 grains) and the number of minutes run per day (600). Divide the product by 7,000 (the number of grains in one pound) multiplied by 36 (number of inches in a yard).

$$\text{Example: } \frac{13 \times 88.25 \times 60 \times 600}{7000 \times 36} = 163.89$$

In the above example, the time run per day is given as 600 minutes, or ten hours, no allowance having been made for the time lost in stripping and cleaning, which, under ordinary circumstances, amounts to about 5 per cent.

Rule 2. To find the factor for the production of the card in 10 hours: Proceed as in Rule 1 but omit the revolutions of the doffer and the weight of the sliver.

$$\text{Example: } \frac{88.25 \times 600}{7000 \times 36} = .21011$$

Rule 3. To find the production with factor given: Multiply the factor by the number of revolutions of the doffer and the weight of the sliver.

$$\text{Example: } .21011 \times 13 \times 60 = 163.89$$

Rule 4. To find the speed of the doffer: Multiply together the driving gears and the number of revolutions of the cylinder (165 R. P. M.) and divide their product by the product of the driven gears. [The driving gears are D³, Z, T (change gear, 30 teeth) and V¹.] (The driven gears are B, S¹, P¹ and Q.)

$$\text{Example: } \frac{165 \times 18 \times 6 \times 30 \times 20}{7 \times 12 \times 40 \times 192} = 16.57 \text{ R. P. M.}$$

Rule 5. To find the factor for the speed of the doffer: Proceed as in rule 4, but omit the doffer change gear.

$$\text{Example: } \frac{165 \times 18 \times 6 \times 20}{7 \times 12 \times 40 \times 192} = .552$$

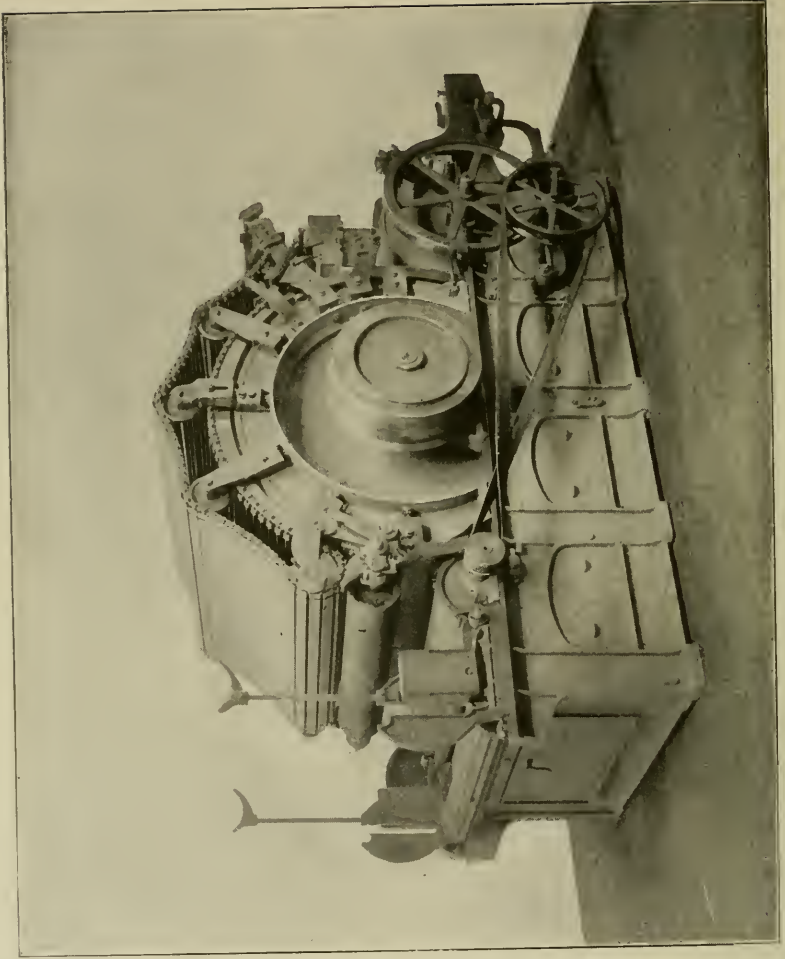

REVOLVING FLAT CARD, EXTRA HEAVY FRAME — FEEDER SIDE
Mason Machine Works.

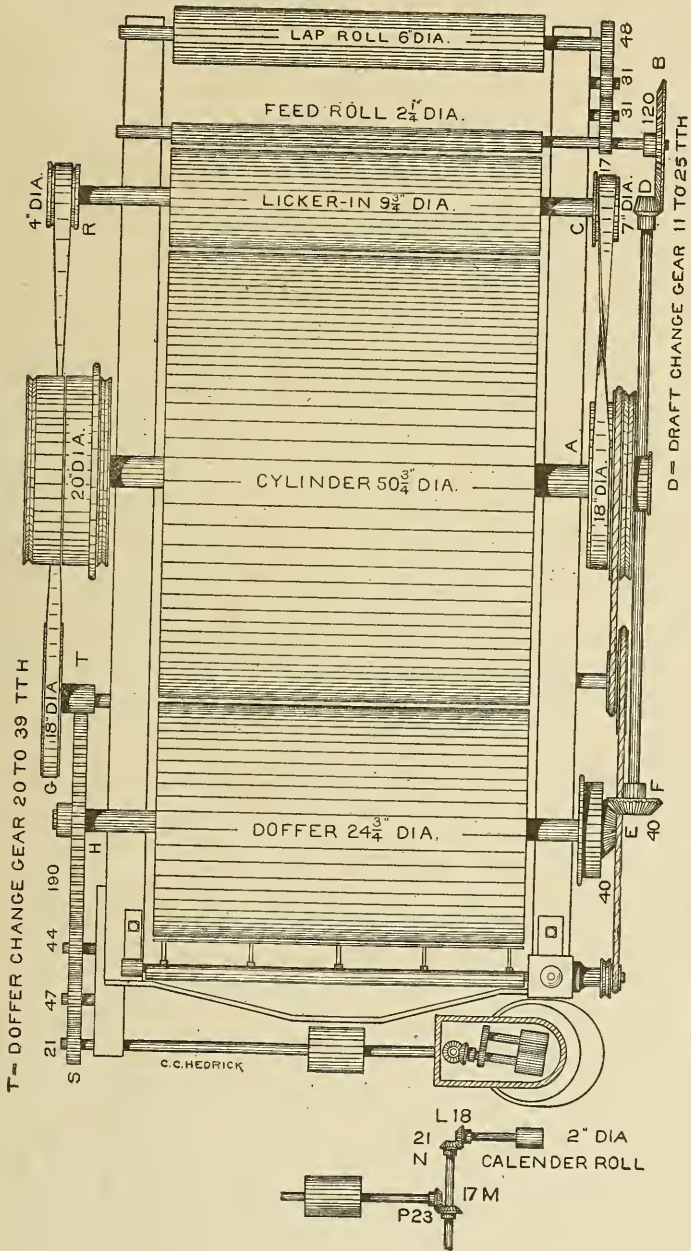

Fig. 103. Diagram of Gearing. Pettee Machine Works Revolving Flat Card.

Rule 6. To find the speed of the doffer: Multiply the factor by the number of teeth (30) in the doffer change gear.

$$\text{Example: } .552 \times 30 = 16.56$$

Rule 7. To find the number of teeth in the doffer change gear that will give the required revolutions of the doffer: Divide the required number of revolutions by the factor.

$$\text{Example: } 16.56 \div .552 = 30$$

In Rule 5, the factor for the speed of the doffer is figured with the cylinder at 165 R. P. M., but as the cylinder is often run at other speed, it is convenient to have a factor which can be used with the cylinder at any speed.

Rule 8. To find the factor for the speed of the doffer with the cylinder at any speed: Multiply together the driven gears and divide the product by the product of the driving gears, omitting the doffer change gear.

$$\text{Example: } \frac{7 \times 12 \times 40 \times 192}{18 \times 6 \times 20} = 298.66$$

Rule 9. To find the speed of the doffer: Multiply the number of revolutions of the cylinder by the number of teeth in the doffer change gear and divide the product by the factor.

$$\text{Example: } \frac{165 \times 30}{298.66} = 16.57 \text{ R. P. M.}$$

Rule 10. To find the number of teeth in the doffer change gear when the speeds of the cylinder and doffer are given: Multiply the factor by the number of revolutions of the doffer and divide the product by the revolutions of the cylinder.

$$\text{Example: } \frac{298.66 \times 16.57}{165} = 29.99$$

Rule 11. To find the draft of the card between the feed roll and the calender rolls in the coiler box: Multiply together the driving gears and the diameter of the coiler calender roll and divide the product by the product of the driven gears multiplied by the diameter of the feed roll, omitting all intermediate gears. [The driving gears are G², L⁴, Q, Y¹, V and N, and the driven gears are D, (change gear 16 teeth) K¹, O, R², Q¹ and N¹.] As L⁴

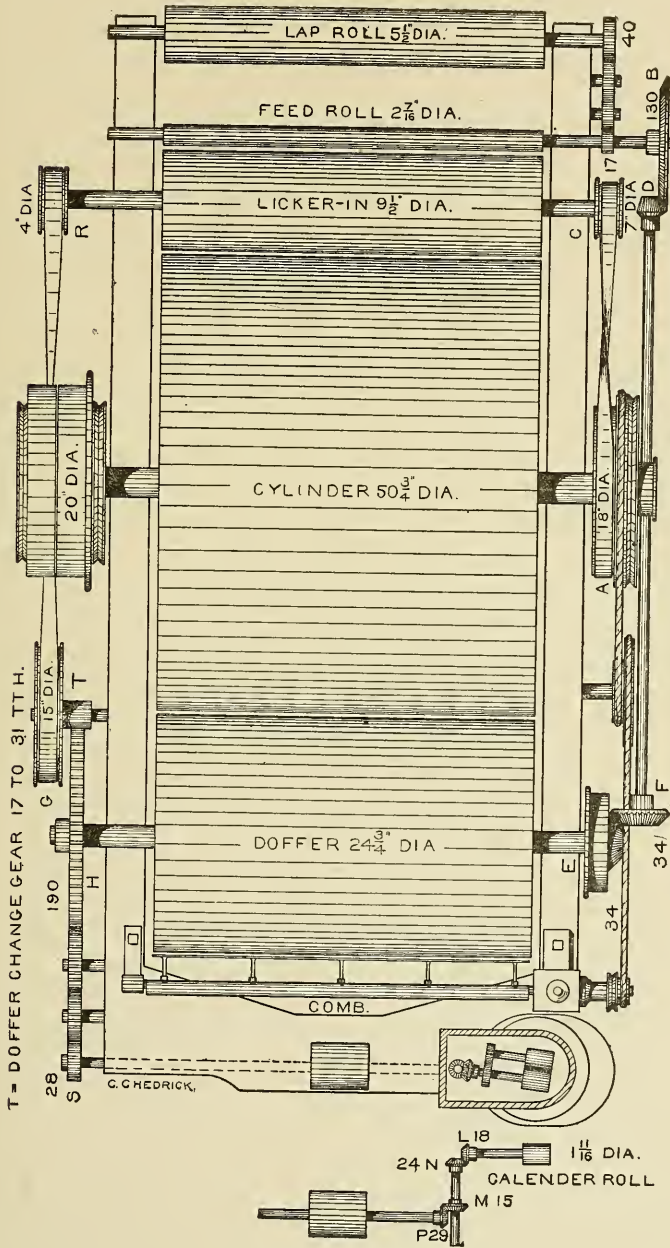

Fig. 104. Diagram of Gearing. Mason Machine Works Revolving Flat Card.

and K^1 , V and Q^1 and N and N^1 are in pairs, they may be omitted in the calculation. In order to avoid fractions, the diameter of the feed roll, which is $2\frac{1}{4}$ inches, can be called 18, as there are $\frac{1}{8}$ in $2\frac{1}{4}$ inches, and the diameter of the coiler calender roll, which is $2\frac{1}{8}$, can be called 17.

Example:
$$\frac{120 \times 192 \times 31 \times 17}{16 \times 30 \times 15 \times 18} = 93.68$$

Rule 12. To find the draft factor: Proceed as in Rule 11 but omit the draft change gear.

Example:
$$\frac{120 \times 192 \times 31 \times 17}{30 \times 15 \times 18} = 1499.02$$

Rule 13. To find the draft: Divide the factor by the number of teeth in the draft change gear (16).

Example: $1499.02 \div 16 = 93.68$

Rule 14. To find the number of teeth in the draft gear when the draft is given: Divide the factor by the draft.

Example: $1499.02 \div 93.68 = 16$

Rule 15. To find the draft of the card necessary to make a sliver of a certain weight from a lap of a given weight: Multiply the weight of the picker lap in ounces per yard (14) by the number of grains in one ounce (437.5) and divide the product by the weight of the sliver in grains per yard, that it is desired to make (60).

Example:
$$\frac{14 \times 437.5}{60} = 102.08$$

In the foregoing rule, no allowance has been made for the loss in weight in carding due to fly and strippings, which amounts, on an average, to 5 per cent, which should be considered.

Example:
$$\frac{14 \times 437.5 \times .95}{60} = 96.97$$

Rule 16. To find the length in feet of fillet necessary to cover a cylinder or doffer: Multiply together the length of the face of the doffer (41") by its diameter and 3.1416 and divide the

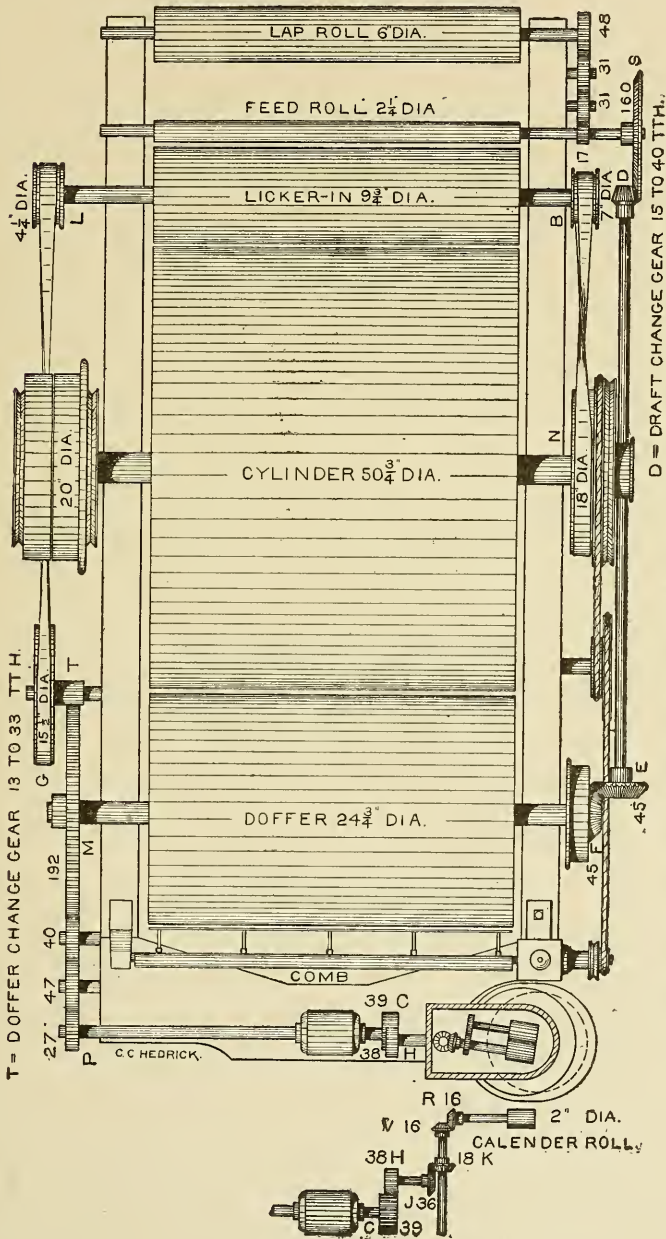

Fig. 105. Diagram of Gearing. Whittin Machine Works Revolving Flat Card.

product by the width of the fillet ($1\frac{1}{2}$ ") multiplied by 12 inches.

$$\text{Example: } \frac{41 \times 24 \times 3.1416}{1\frac{1}{2} \times 12} = 171.74$$

The following are the draft factors and factors for the speed of the doffer for the cards shown in Figs. 103, 104 and 105.

Fig. 103. Draft factor. The driving gears are B, F, H, P and N. The driven gears are D (change gear), E, S, M and L. E and F are in pairs. The feed roll is $2\frac{1}{4}$ inches in diameter and the coiler calendar roll is 2 inches in diameter. Their diameters can be called 9 and 8 respectively

$$\frac{120 \times 190 \times 23 \times 21 \times 8}{21 \times 17 \times 18 \times 9} = 1523.31$$

Factor for the speed of the doffer with the cylinder at 165 R. P. M. The driving gears are A, R and T (change gear). The driven gears are C, G and H.

$$\frac{165 \times 18 \times 4}{7 \times 18 \times 190} = .4962$$

Fig. 104. Draft factor. The driving gears are B, F, H, P and N. The driven gears are D (change gear) E, S, M and L. E and F are in pairs. The feed roll is $2\frac{7}{16}$ inches in diameter, or $\frac{39}{16}$, and the coiler calendar roll is $1\frac{11}{16}$ inches in diameter, or $\frac{27}{16}$. The diameters may be called 39 and 27, respectively.

$$\frac{130 \times 190 \times 29 \times 24 \times 27}{28 \times 15 \times 18 \times 39} = 1574.28$$

Factor for the speed of the doffer with the cylinder at 165 R. P. M. The driving gears are A, R and T (change gear). The driven gears are C, G and H.

$$\frac{165 \times 18 \times 4}{7 \times 15 \times 190} = .5954$$

Fig. 105. Draft factor. The driving gears are S, E, M, C, J and V. The driven gears are D (change gear), F, P, H, K and R. E and F and V and R are in pairs. The diameter of the feed roll and the coiler calendar roll can be called 9 and 8, respectively.

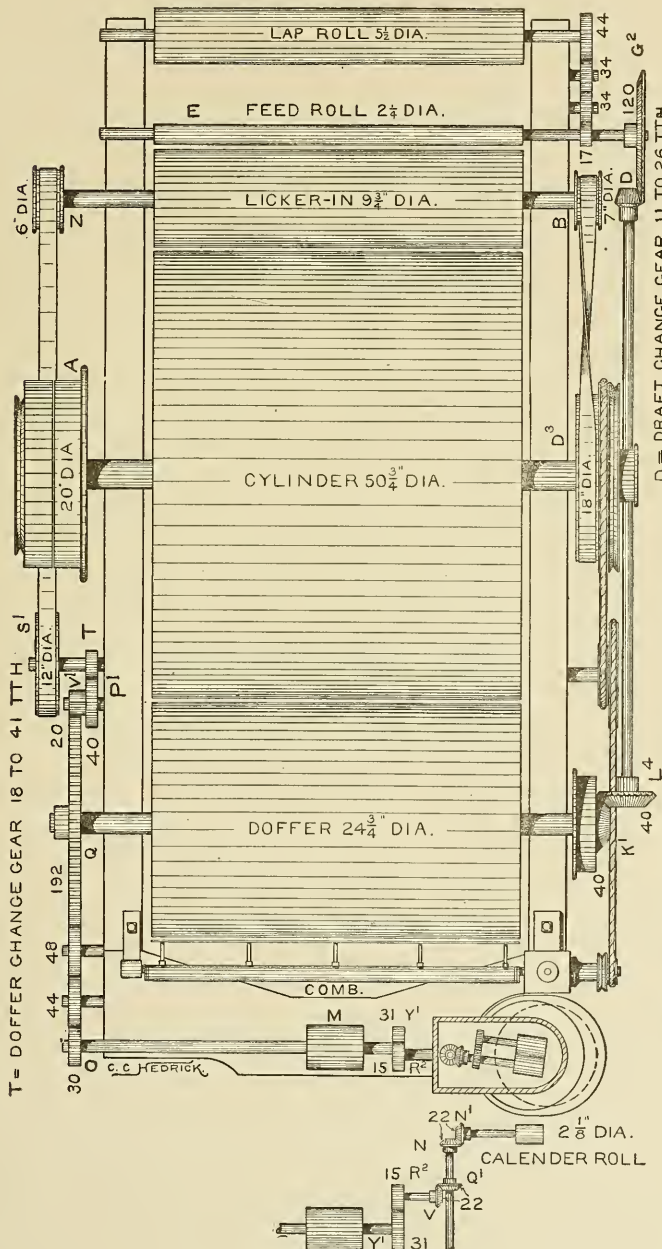

Fig. 106. Diagram of Gearing. Lowell Machine Shop Revolving Flat Card.

$$\frac{160 \times 192 \times 39 \times 36 \times 8}{27 \times 38 \times 18 \times 9} = 2075.94$$

Factor for the speed of the doffer with the cylinder at 165 R. P. M. The driving gears are N, L and T (change gear). The driven gears are B, G and M. The diameter of L, which is $4\frac{1}{4}$ inches, can be called 17, and the diameter of G, which is $15\frac{1}{2}$ inches, can be called 62.

$$\frac{165 \times 18 \times 17}{7 \times 62 \times 192} = .6059$$



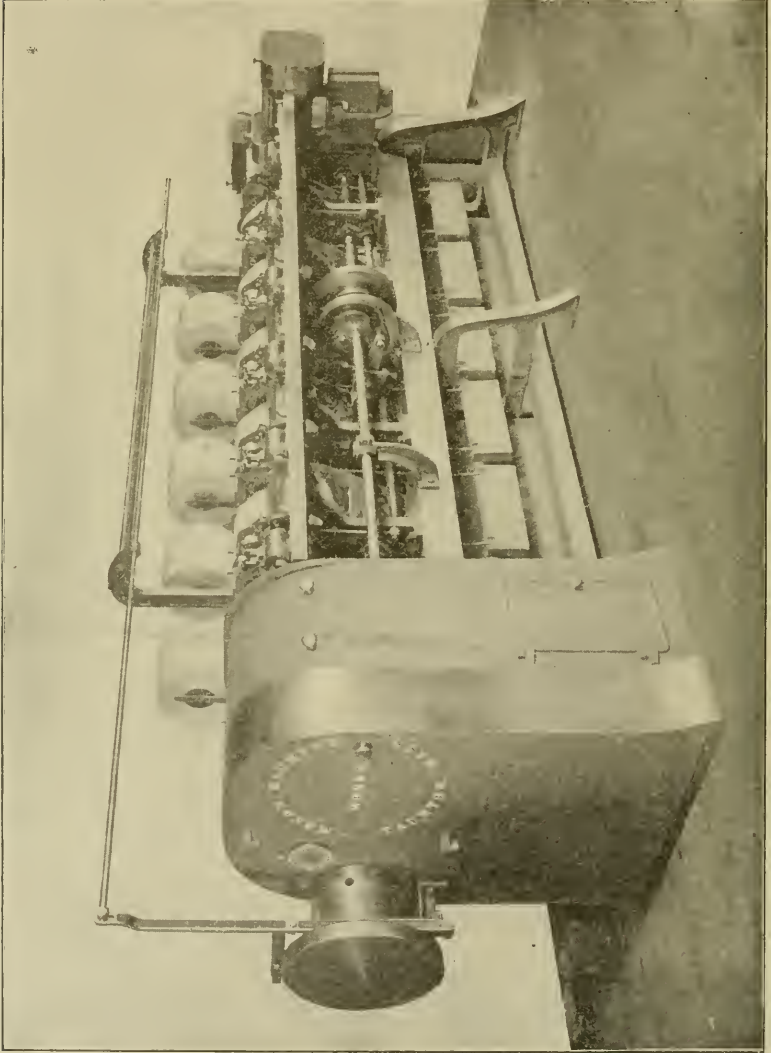

MASON-HEILMAN COMBER, FOR COMBING FINE COTTON
Mason Machine Works.

COTTON SPINNING.

PART III.

COMBING.

In the manufacture of the finer qualities of yarn which demand long staple cotton, the combing process, which is necessary, follows carding, although the card sliver is very often subjected to one process of drawing before it is combed. Briefly speaking, the operation of combing, which is entirely different from all other branches of cotton spinning, consists in removing the short fibers and neps which remain in the sliver after carding.

Combed yarns are used for various purposes, among which may be mentioned hosiery and underwear, sewing thread, laces and fine cotton fabrics.

In considering the uses for combed yarns, three important points should be kept in view in order to thoroughly understand the merits of combing; first, the length of the cotton fibers, second, the twist per inch in the yarn and third, the counts of yarn spun.

Yarn depends, mainly, for its strength upon the amount of twist it contains and the length of the fibres. For hosiery and underwear, it must be soft twisted so that it will be smooth to the touch, and, in order that it shall be sufficiently strong, long staple cotton must be used.

Yarn for thread and fine cotton fabrics is much harder twisted, and, as the fine numbers of yarn contain comparatively few fibers per cross section, they must be long enough to receive a sufficient number of twists. It will thus be seen that the fibers in combed yarn must be approximately uniform in length which result can be obtained only by combing.

Arrangement of Combing Machines. There are generally three machines used in the combing process, viz: The sliver lap machine, the ribbon lapper and the comb, although very often the ribbon lapper is not used. In that case, the slivers, after leaving the card, are put through one process of drawing and from the

drawing frame are put through the sliver lap machine and made into a lap for the comb. When all three machines are used, the drawing process is usually omitted before combing and the ribbon lapper, which corresponds to it, is used instead. But in all cases, the sliver lap machine is necessary to prepare the laps for combing and two or three drawing processes are necessary after combing.

To make this perfectly clear, the different arrangements of the machines used in combing are given below.

With the ribbon lapper the machines used are :

1. Sliver lap machine.
2. Ribbon lapper.
3. Comb.

When the ribbon lapper is omitted, the machines used are :

1. Drawing frame.
2. Sliver lap machine.
3. Comb.

When the drawing frame is used with the ribbon lapper, the following machines are used :

1. Drawing frame.
2. Sliver lap machine.
3. Ribbon lapper.
4. Comb.

Sometimes double combing is resorted to for the very best yarn. The machines are then arranged in one of the two following orders :

1. Sliver lap machine.
2. Ribbon lapper.
3. Comb.
4. Sliver lap machine.
5. Ribbon lapper.
6. Comb.

If the ribbon lapper is omitted.

1. Drawing frame.
2. Sliver lap machine.
3. Comb.
4. Drawing frame.
5. Sliver lap machine.
6. Comb.

Sliver Lap Machine. The sliver lap machine prepares the laps for the comb by laying the card or drawing frame slivers, as the case may be, in the form of a narrow sheet which is wound upon a wooden core, or spool, into a lap 12 inches to 14 inches in diameter. The number of slivers at the back of the machine

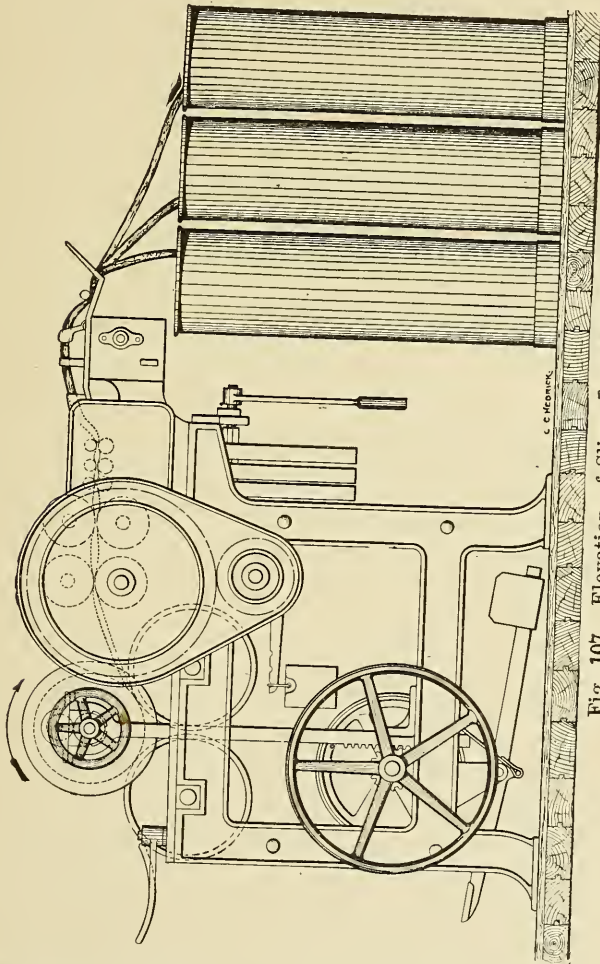

Fig. 107. Elevation of Sliver Lap Machine.

depends upon their weight and the width of the lap to be made. In the earlier types of these machines, the laps were made 7 to 9 inches in width but the present ones are built to make a lap 10 to 11 inches wide. This will require fourteen to twenty slivers,

and, as the laps must be free from thin places, the machine is provided with a stop motion, which instantly operates, when a sliver breaks or a can becomes empty.

An elevation of the machine is shown in Fig. 107 and a sec-

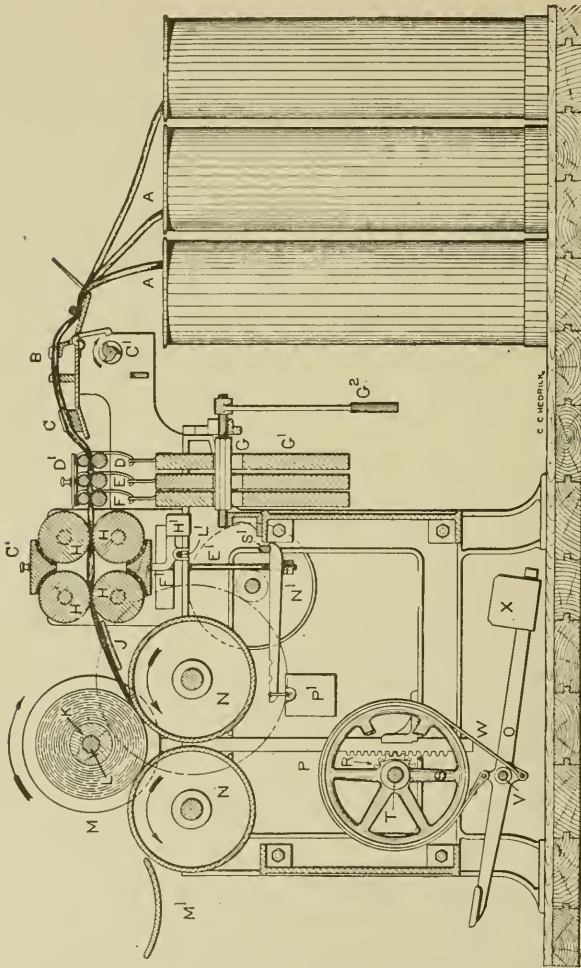

Fig. 108. Section of Sliver Lap Machine.

tion in Fig. 108. From the cans, A, the slivers are drawn over the stop-motion spoons, B, and through the guides, C, and between three pairs of draft rolls, D, E and F, where they are subjected to a slight draft, from two to three usually being sufficient, as all

that is required is to straighten the slivers slightly, so that the needles of the comb may deal more gently with the fibers, particularly when the ribbon lapper is omitted between the sliver lap machine and the comb. From the draft rolls, the slivers next pass between two pairs of heavily weighted smooth calender rolls, H H, and, H H, and are formed into a thin, fleecy sheet which is drawn forward and wound upon a wooden spool into a lap, which is revolved by contact with a pair of fluted lap rolls, N N. The ends of the laps are formed by a pair of plates, M, which revolve with the lap, making very even selvages.

Directly beneath the lap rolls is a friction or break pulley, S, which is keyed upon a shaft, T. Around this pulley is a leather strap, W, both ends of which are fastened to a foot lever, O, which is hung upon a stud, V. Upon the long end of the foot lever is a weight, X. The lever is balanced so that the weight keeps the strap tight at all times. Upon each end of the shaft with this pulley is a pinion, R, in gear with a rack, P, the end of which is connected to the lap roll arbor, L, which passes through the spool upon which the lap is wound. As the lap increases in diameter, it lifts the racks, the upward movement of which is retarded by the friction of the strap around the break pulley. By this means, the laps are wound very firmly and compactly.

In addition to the back stop-motion, the machine is provided with a full lap stop-motion, or measuring device, whereby the size and weight of the laps may be governed. This is operated by a projecting piece on one of the racks which comes in contact with the stop-motion arm as the lap reaches its full diameter. To remove the lap, the attendant presses upon the foot lever, releasing the strap from around the break pulley. The lap is then raised clear of the lap rolls by the hand wheel, N, and the arbor is withdrawn.

The draft rolls are dead weighted, each roll having an independent weight, G¹, hung by stirrups, in the usual manner. In each weight is a square hole through which extends the shaft, G, which has a cam-shaped projection along its face. This shaft is supported by bearings at each end and at one end is a handle, G², by which the shaft may be turned. When it is desired to remove the weight from the draft rolls, this shaft is given a quarter revo-

lution and its cam-shaped face brought against the upper side of the hole in the weights. In this manner, the weight may be entirely removed from the rolls and transferred to the shaft.

The top pair of calender rolls is provided with a top clearer,

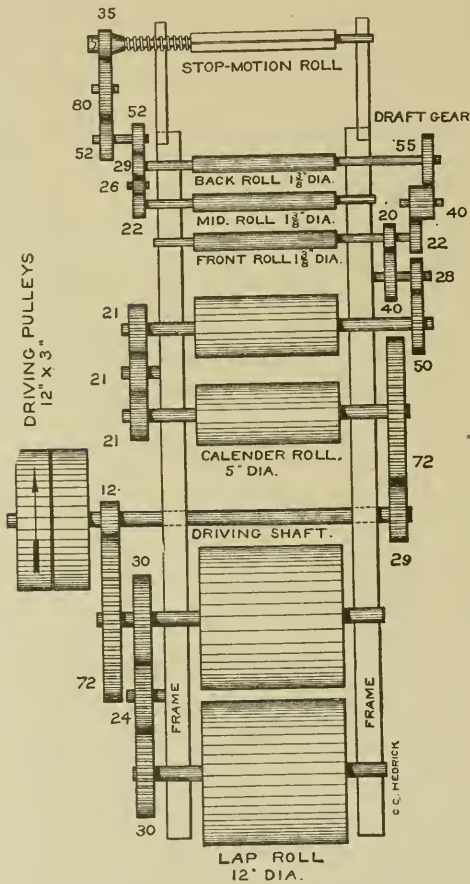

Fig. 109. Diagram of Gearing of Sliver Lap Machine.

C¹, which consists of a heavy iron piece, lined with clearer cloth. The underside of this piece is shaped to fit the outline of the calender rolls, its weight holding it firmly down upon them. The clearer, F¹, for the under pair of calender rolls is also shaped to fit the rolls but is of wood instead of iron. It is held up against the rolls by a counterweight, H¹, which is hung upon a stud, L¹. The draft rolls are also provided with a clearer, D¹. In addition to their own weight, the top calender rolls are lever weighted, the rod, E¹, connects the yoke which is over the bearings of the top rolls with the weight lever, N¹, upon which is the weight, P¹.

The fulcrum for the weight lever is a projecting lug, S¹, upon the frame of the machine.

Calculations. Fig. 109 is a diagram of the gearing of the sliver lap machine.

Rule 1. To find the draft: Multiply the number of slivers, entering at the back (16), by their weight in grains per yard

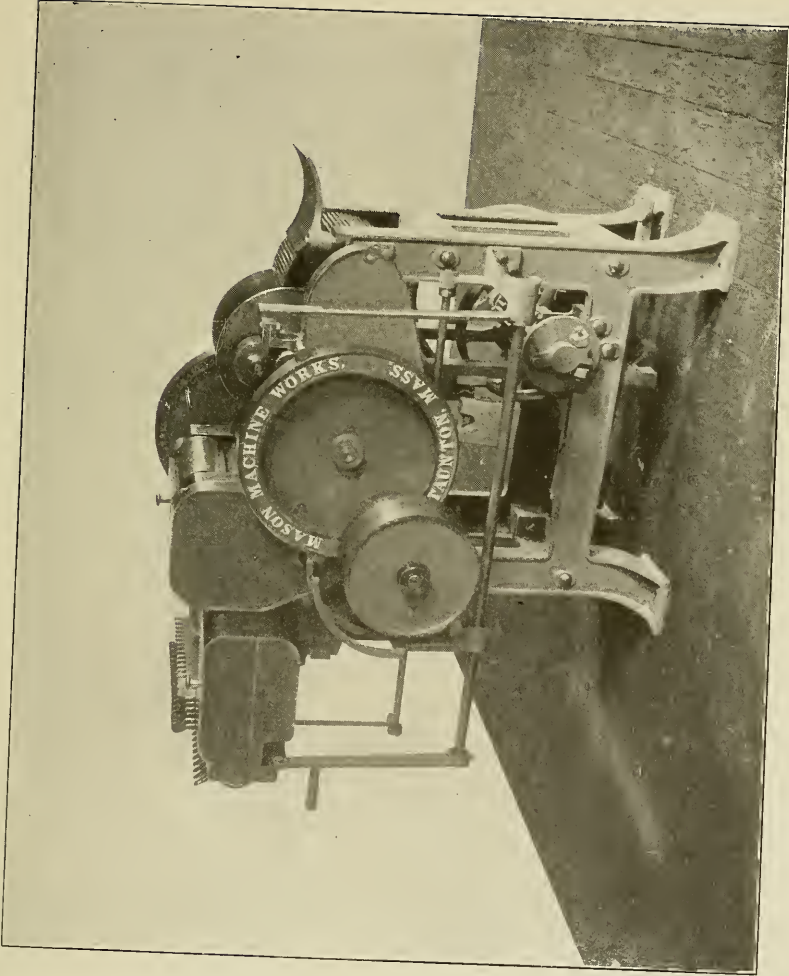

SLIVER LAP MACHINE
Mason Machine Works.

(42.5) and divide the product by the weight of the lap in grains per yard (272).

$$\text{Example: } \frac{42.5 \times 16}{272} = 2.5$$

This will require a draft gear of 55 teeth which is shown on the plan of the gearing.

Rule 2. To find the production of the machine: Multiply together the revolutions of the calender roll per minute (60), the circumference of the calender roll (15.70"), the weight of the lap in grains per yard (272) and the minutes run per day (600) and divide the product by 7,000 (the number of grains in one pound) multiplied by 36 (inches in one yard).

$$\text{Example: } \frac{60 \times 15.70 \times 272 \times 600}{7,000 \times 36} = 610.5$$

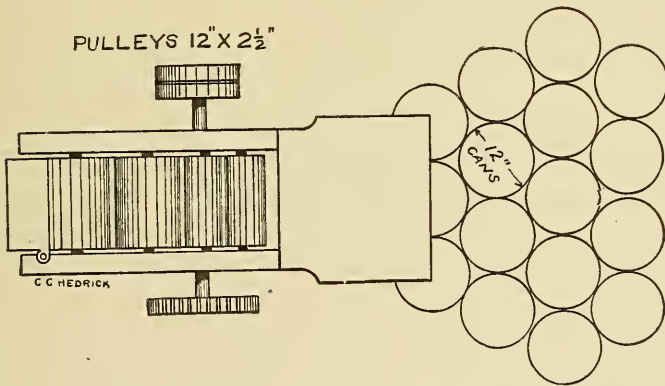

Fig. 110. Plan of Sliver Lap Machine.

From this amount should be deducted about ten per cent for time lost in doffing.

An examination of the gearing will show that on the driving shaft is a pinion of 29 teeth which drives the calender roll gear of 72 teeth. The driving pulleys thus make 2.48 revolutions to one of the five inch calender rolls. The speed of the driving pulley is from 125 to 250 revolutions per minute.

A plan of the sliver lap machine is shown in Fig. 110. The floor space, occupied with 16 cans at the back, is 9' 0" long by 4' 2" wide. The driving pulleys are always on the left hand side.

The following table gives the production of the sliver lap machine per day with the lap weighing from 200 to 310 grains per yard and the speed of the calender rolls from 50 to 100 revolutions per minute.

SLIVER LAP MACHINE.

Production Per Day of 10 Hours, Less 10 Per Cent for Cleaning, etc.

Rev. per Min. of Driving Pulleys.	Rev. per Min. of 5-inch Calender Rolls.	Weight of Lap in Grains per Yard.											
		200	210	220	230	240	250	260	270	280	290	300	310
		Lbs.	Lbs.	Lbs.	Lbs.	Lbs.	Lbs.	Lbs.	Lbs.	Lbs.	Lbs.	Lbs.	Lbs.
124	50	336	353	370	387	404	420	437	454	471	488	505	522
136	55	370	388	407	426	444	463	481	500	518	537	555	574
148	60	404	424	444	464	484	505	525	545	565	585	606	626
161	65	437	459	481	503	525	547	559	591	613	634	656	678
173	70	471	494	518	542	565	589	612	636	659	683	706	730
198	80	538	565	592	619	646	673	700	727	753	781	808	835
223	90	606	636	666	696	727	757	787	817	848	878	909	939
248	100	673	706	740	774	807	841	875	908	942	976	1010	1044

Ribbon Lapper. The ribbon lapper, which is used as an intermediate process, between the sliver lap machine and the comb, is, in one sense, a drawing frame, with the exception that the fibers, instead of being drawn in the form of a sliver, are spread out in a sheet.

The laps are placed upon the lap rolls, side by side, at the back of the machine, which is built usually to take six. The laps are drawn full width between four pairs of draft rolls, having a draft of about six. Passing downward around highly polished plates and under calender rolls, they are brought together, one above another, upon the sliver plate of the machine. This forms a lap of six thicknesses, but, as each lap has been subjected to a draft of about six, their combined weight is the same as was that of each lap at the back of the machine. The laps are drawn along the sliver plate by the calender rolls and then pass between two pairs of heavily weighted calender rolls, which consolidate the six laps into one sheet. This sheet now passes forward and is wound upon a wooden spool by contact with two lap rolls into a lap ready for combing.

The ribbon lapper occupies a floor space of 14' 2" length by 4' 7" width and is built both right and left hand.

For the production of the ribbon lapper, use the production table for the sliver lap machine, as the calender rolls for both machines are the same diameter.

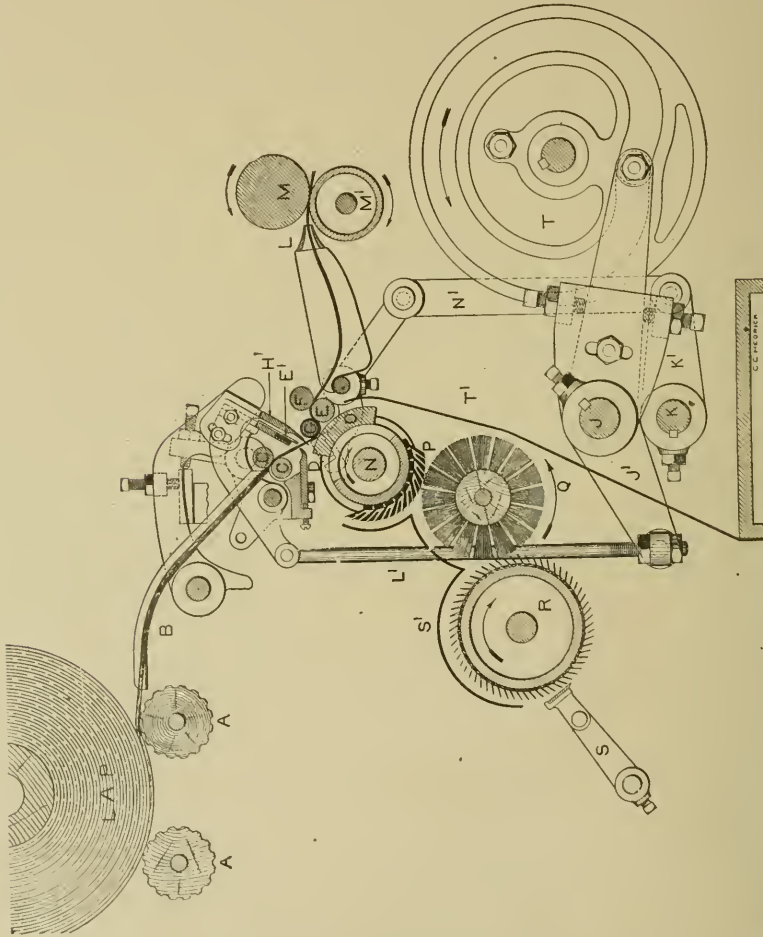

Fig. 112. Section through Comb.

Comb. After the laps have been formed on the sliver lap machine, or the ribbon lapper, they are taken to the comb upon which the actual operation of combing is carried on. The comb is divided into either six or eight heads, or sections, a six-headed comb being most generally used.

Each head is exactly like the others so that a description of the movements of one answers for all and it should be understood that, although the functions of one part depend closely upon those of another, each movement will be considered a separate action.

Fig. 112 is a section through a comb, showing enough of the principal parts to enable its workings to be explained.

The lap is placed upon the fluted lap rolls, A and A, by which it is slowly unwound. The cotton passes down a smooth plate, B, and is drawn between the feed rolls, C and C. The movement of these rolls is intermittent and is governed by the length of the staple of cotton being worked and the draft of the machine.

From the feed rolls, the lap passes down between the cushion plate, D, and the nipper, E¹, which are at this particular instant apart, to allow it to pass through.

When the length has been delivered by the feed rolls, their movements cease and the nipper is brought into contact with the cushion plate and the cotton, which is between them, is held firmly.

Just beneath the cushion plate is the cylinder shaft, N, upon which are the cylinders, one for each section. The cylinders are made up of two parts, the fluted segment, O, and the half lap, P, which are separated by a portion which is smaller in diameter.

The surface of the fluted segment is similar to a feed roll while the half lap is composed of a series of rows of needles each row finer than the preceding one. The rotary motion of the cylinders, unlike that of the feed rolls, is continuous and, as they revolve, the needles pass through that portion of the lap which projects downward from between the nipper and the cushion plate and removes the short fibers and neps.

Front of the nippers are the detaching rolls, E, F and G. E is a steel fluted roll which is driven from one end of the comb. F is a brass fluted top roll, driven by contact with E, and G is a leather covered roll heavily weighted also driven by contact with E.

All of these rolls have a rotary motion both backwards and forwards, while F and G have in addition a slight movement, circumferentially, about E. The functions of these three rolls, in connection with the fluted segment, are to detach the fibers, which

have just been combed, from the mass held between the cushion plate and nipper and to attach them to those which were combed, previously, so as to make a continuous sliver.

After the needles have passed through the cotton, the rolls, E, F and G, turn backwards a portion of a revolution so that the cotton, which is between them, will be in a position to be attached, or "pieced up." Meanwhile, the partial revolution of the cylinder has brought the front edge of the fluted segment around

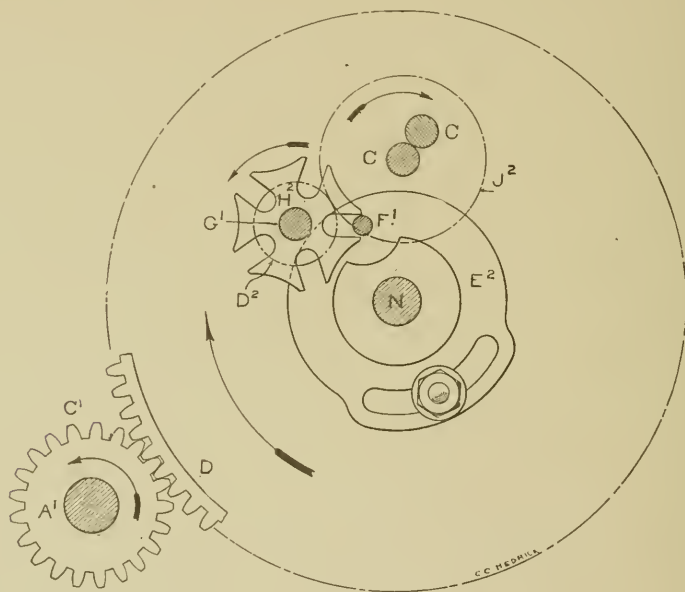

Fig. 113. Elevation of Feed Roll Gearing.

against the combed fibers which are hanging from between the cushion plate and nipper and as it continues to turn, they are made to lie upon its surface.

At this point, the detaching rolls, which have ceased their backward movement, now turn forward and the leather roll, G, which during its backward movement was clear of the cylinder, is moved circumferentially about the steel roll, E, until it comes in contact with the fluted segment. When these surfaces touch, the fibers are carried forward and are overlapped on the end of

those ahead and, as the forward movement of these rolls is considerably more than the backward, the fibers are drawn steadily onward.

At the same time that the rolls commence to turn forward, the top comb, H^1 , descends into the path of the cotton and the end of the fibers that were between the cushion plate and the nipper also receive a combing.

From the detaching rolls, the sliver is drawn forward through the trumpet, L , by the calender rolls, M and M^1 , and along the table with the other slivers where they pass through a draw box that usually has a draft of five. From here, they pass, as one sliver, through the coiler into a roving can.

The short fibers and neps are removed from the cylinder teeth by a revolving brush, Q , which is placed beneath the cylinder. The surface speed of the brush is slightly greater than that of the cylinder and, as the bristles extend about one-eighth of an inch below the points of the needles, these are thoroughly cleaned.

The fibers are removed from the brush by a slowly revolving doffer, R , which is covered with very coarse card clothing, and they are removed from the doffer in a thin fleece, by an ordinary doffer comb, S , the cotton falling into a box below. Sometimes, the comb is provided with a roll for winding the waste into a lap as is done by the stripping roll on a revolving flat card.

On each side of the cylinder and brush are covers, S^1 and T^1 , which prevent the fly from escaping. The brush is adjustable as the continual wear shortens the bristles very rapidly. The doffer and doffer comb are adjustable with respect to the brush.

Feed Motion. First in order, in considering the movements of the comb in detail, comes the feed motion. The feed rolls are driven from the main driving shaft of the comb and, as their motion is intermittent while that of the driving shaft is continuous, a device called a pin and starwheel is used which is shown in elevation in Fig. 113 and in section in Fig. 114. The cylinder shaft, N , is driven from the driving shaft, A^1 , by the pinion, C^1 , and the gear, D . Around the hub of the gear is an adjustable plate, E^2 , which carries the pin, F^1 . Upon one end of the stud, G^1 , is the five-toothed starwheel, H^2 , and upon the other, the draft change gear, D^2 , which ranges from fourteen to twenty teeth.

Running with the draft gear is another gear, J^2 , of thirty-eight teeth. This is keyed to the end of the bottom feed roll, C, any movement given to the starwheel would thus be communicated to the feed rolls.

During a portion of each revolution of the cylinder shaft, the pin, F^1 , which describes a circle of about five inches in diameter, engages one of the teeth of the starwheel, causing it to turn one-fifth of a revolution, when it remains stationary until it is advanced another tooth by the pin at the next revolution of the cylinder.

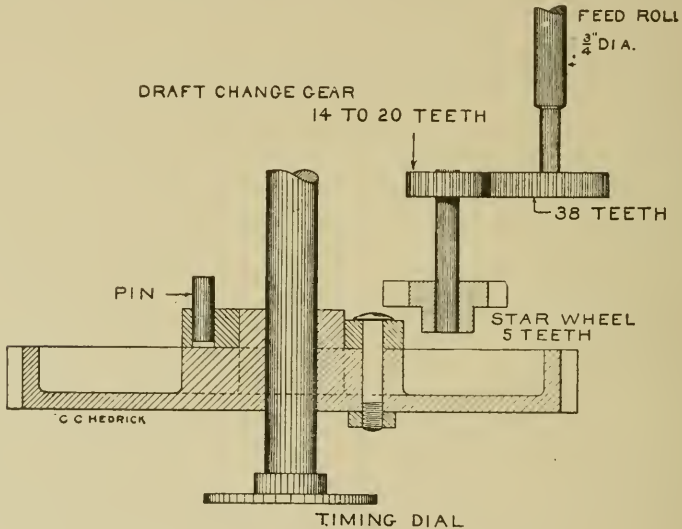

Fig. 114. Section of Feed Roll Gearing.

To prevent any movement of the starwheel, while it is not being acted upon, the face of its teeth are made concentric with the plate, E^2 , on the hub of the gear, D , with which it is in contact.

The movement of the feed roll, at each revolution of the cylinder shaft, is very slight. The largest draft gear (twenty teeth) will cause the feed roll, which is three-fourths of an inch in diameter, to deliver only about one-quarter of an inch of cotton.

The lap rolls, upon which the lap rests, are also given an intermittent motion, corresponding to that of the feed rolls, and are driven at one end of the comb from the bottom feed roll.

Timing Dial. All of the various parts of the comb are timed to operate in regular order and, as each part is dependent

upon the others, any great variation from the proper timing will cause bad work and is liable to injure the combs and needles.

The parts are set by the index, or timing dial, which is on the head end of the cylinder shaft and is shown in the section of the feed roll gearing and in the diagram of the nipper cam, Fig. 120.

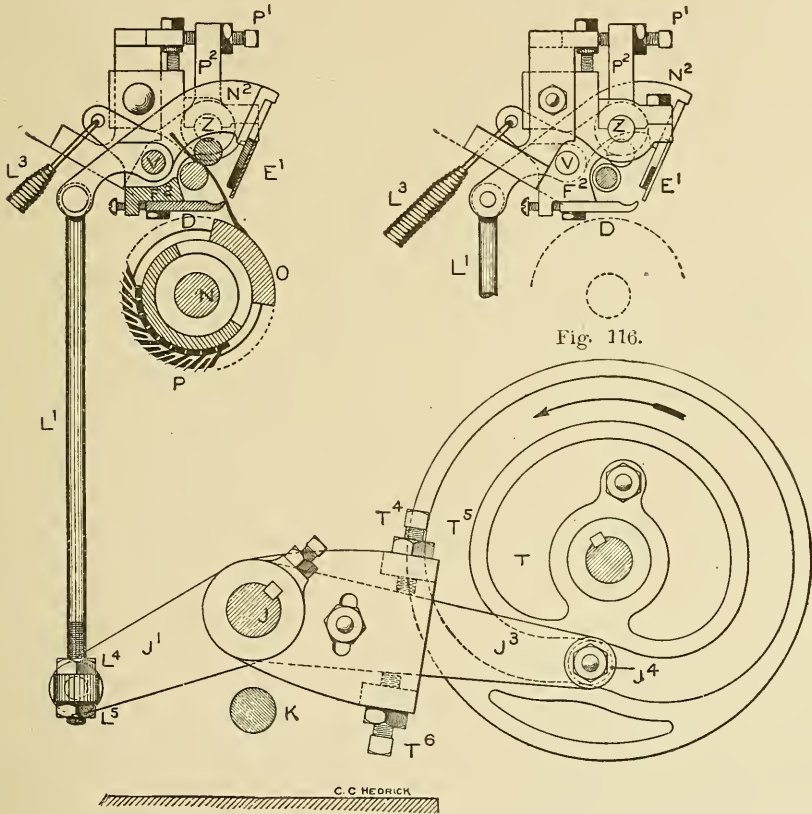

Figures 115 and 116. Nipper Cam and Levers.

The dial is divided into twenty parts, numbered 1 to 20, each part being subdivided into quarters. Above the dial is an index finger, fastened to the comb frame. In setting, the driving shaft is turned by hand until the index finger points to the proper figure. The feed rolls are usually timed to commence turning at $4\frac{1}{2}$.

Nipper and Cushion Plate. Fig. 115 shows the cam and levers for operating the nipper and cushion plate and Fig. 116 shows the parts detached from the cam.

The cushion plate, D, is generally of steel with a dull-pointed edge and the nipper knife, E¹, also of steel, is recessed to receive a cushion of leather or rubber. This cushion prevents the fibers from becoming cut, or otherwise injured, when the cotton is gripped between the

cushion plate and nipper.

Both the cushion plate and the nipper are carried by a cradle, F², which has a slight rocking movement around its fulcrum, Z. The nipper arm, N², is also hung upon a fulcrum on the cradle at V. In the upright cradle arm, P², is the nipper setting screw, P¹, which bears against a stop, formed by the frame of the machine. The cradle is held in its normal position, which is with the screw bearing against the

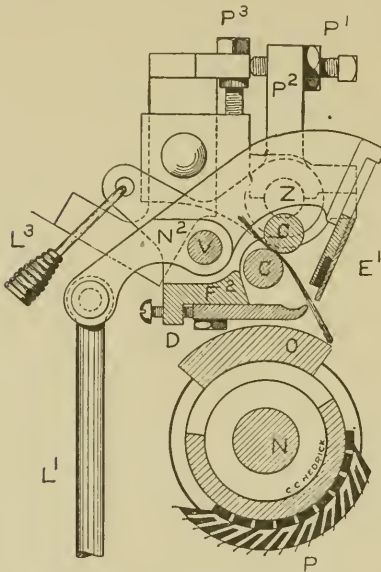

Fig. 117. Section showing Nipper and Cushion Plate.

stop, by a strong spring, L³, one end of which is fastened

to a horn on the cradle, the other to the frame of the comb. The connection to the nipper cam, T, by which the nipper and cushion plate are caused to open and close, is by means of the upright rod, L¹, the horizontal nipper shaft lever, J¹, and the nipper cam lever, J³. The last named carries a roll, J⁴, that runs in a groove, T⁵, in the face of the nipper cam.

The nipper cam lever, J³, is made in two parts which enables a very fine adjustment to be made by means of the screws, T⁴ and T⁶. The part carrying the screws is keyed to the nipper shaft, J. This shaft runs the whole length of the machine, and to it are also keyed the horizontal nipper shaft levers, J¹, which connect with the back end of the nipper arms, N², by the upright

rods, L^1 . The nipper cam makes one revolution to one of the cylinder and, at each revolution, the opening and closing of the nipper and cushion plate takes place which corresponds to the movements of the cylinder.

To follow these movements, Figs. 117, 118, 119 and 120 have been made. Figs. 117 to 119 are sections showing the different positions of the nipper and cushion plate in relation to the

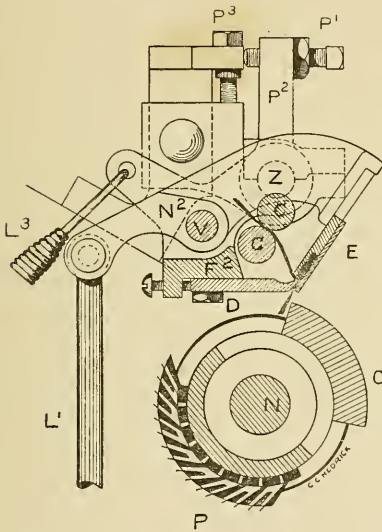

Fig. 118.

Sections showing Nipper and Cushion Plate.

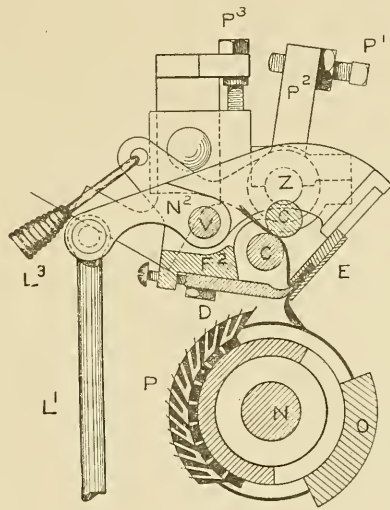

Fig. 119.

fluted segment and half lap. Fig. 120 is a diagram of the nipper cam showing certain points which correspond to the figures on the timing dial.

In Fig. 117, it is assumed that the needles have finished combing and the nipper and cushion plate are open to allow the fibers to be drawn forward by the fluted segment. The opening movement commences at about $3\frac{1}{2}$ by the timing dial. The front edge of the fluted segment comes against the fibers and is about half by when the nipper and cushion plate are wide open which is at $6\frac{1}{2}$.

By referring to the diagram of the nipper cam (Fig. 120), it will be seen that the point marked $6\frac{1}{2}$ is just at the cam roll and the index finger points midway between 6 and 7 on the dial. As

the cam continues to turn, the nipper cam lever, J^3 , is depressed owing to the shape of the groove in which the cam roll, T^4 , runs. This depression causes the nipper shaft, J , to turn slightly and an upward movement of the rod, L^1 , takes place through the nipper shaft lever, J^1 .

The upward movement of the rod, L^1 , causes the nipper arm, N^2 , to turn about its fulcrum at V which brings the nipper

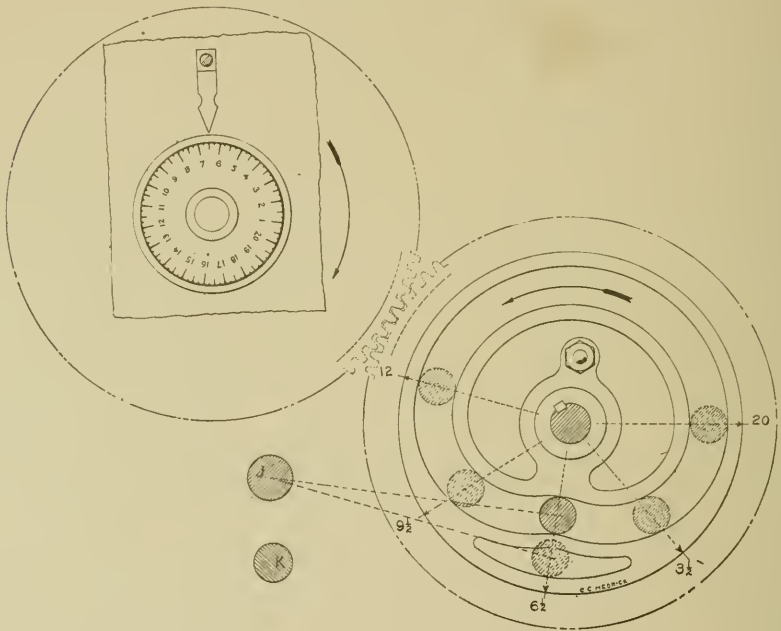

Fig. 120. Diagram of Nipper Cam.

knife into contact with the cushion plate, gripping the cotton firmly. This takes place when the dial is at $9\frac{1}{2}$ and the parts are in the position shown in Fig. 118.

The back edge of the fluted segment has passed by the front of the cushion plate and this brings that portion of the cylinder, which is smaller in diameter than the segment and half lap, just beneath the cushion plate and nipper and permits the end of the lap, which is held suspended between them, to assume a position so that the needles of the half lap may thoroughly comb the mass of cotton.

We have seen in Figs. 117 and 118, that the movement of the nipper arm, N^2 , is simply around its fulcrum, V , but, as the nipper cam continues to revolve, the nipper cam lever is moved away from the center of the cam, causing a still greater depression of the nipper knife. It is evident that it must bear with considerable more force against the cushion plate. This pressure causes the spring, L^3 , to yield and the cradle to move slightly around its fulcrum, Z , as shown by the position of the parts in Fig. 119.

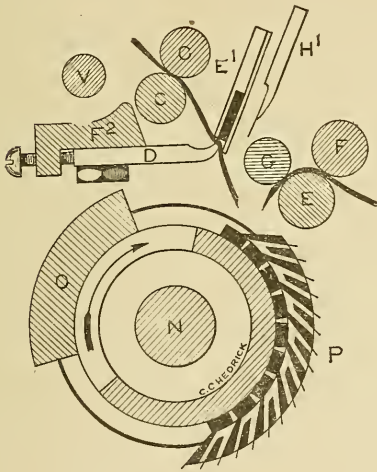

Fig. 121.
Sections showing Detaching Rolls and Cylinder.

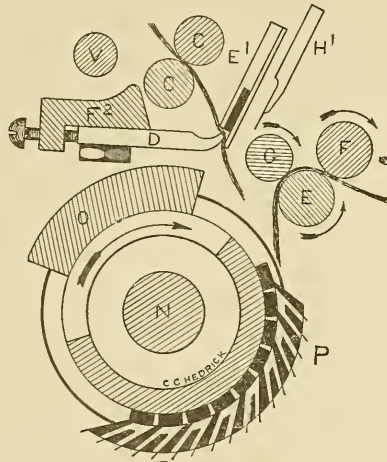

Fig. 122.

This double motion of the nipper knife, first around its own fulcrum and then around the fulcrum of the cradle, brings the cotton down near the needles just previous to the commencement of the combing action. This occurs when the timing dial is at about 12, the parts remaining in the position until all of the needles have passed through this cotton which is at about 20. The nipper and cushion plate then commence to raise, from the cylinder, into a position so that the cotton may be detached and they then open and the cycle of movements is repeated.

Detaching Roll Motion. Following in regular order, the next feature, and one which requires considerable explanation, is the detaching roll motion, by which the fibers are detached from be-

tween the nipper and cushion plate and attached to those fibers that have already been combed at a previous operation, as referred to in the general description of the comb.

It will be less confusing to first follow the movements of the detaching rolls and then the mechanism for obtaining these movements. Fig. 121 shows the rolls in stationary position with the end of the sliver protruding from between the leather covered detaching roll, G, and the steel detaching roll, E, in the position it was left when the rolls ceased their forward rotary motion. The

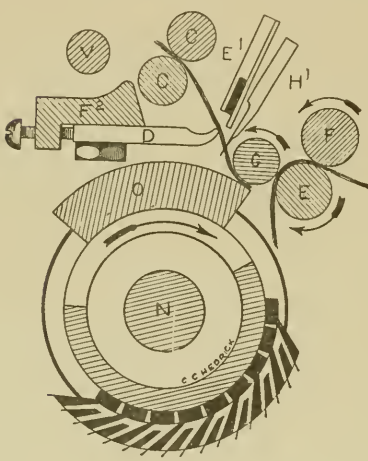

Fig. 123.
Sections showing Detaching Rolls and Cylinder.

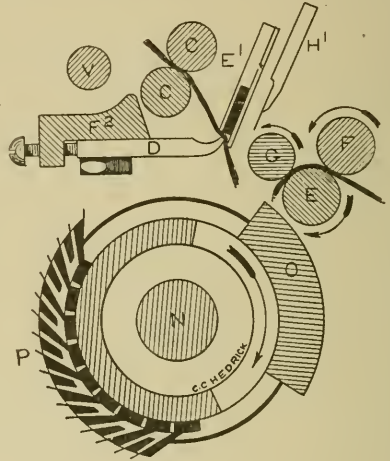

Fig. 124.

leather covered roll is raised to its highest position above the path of the fluted segment, O.

The first movement of the detaching rolls is to turn backwards to the position shown by the parts in Fig. 122. This movement occurs just after the needles have finished combing, and is sufficient to turn the sliver, which is shown hanging downwards in the space between the fluted segment and half lap, back about one and one-half inches. The front edge of the fluted segment is just coming into contact with the fibers which are hanging from between the nipper, E^1 , and the cushion plate, D, and the leather detaching roll has started to move around the steel roll in the direction of the nipper.

Fig. 123 shows the rolls at the commencement of the forward

movement. The fluted segment has continued to revolve and its front edge has swept along under the down hanging fibers which are to be detached. This action causes them to lie on the surface of the fluted segment and extended in the direction of the leather covered roll which has moved around the steel roll into contact with the fluted segment. The instant that these surfaces touch, the detaching rolls commence to turn forward and the fibers, lying on the surface of the fluted segment, are drawn forward between it and the leather covered roll.

The finish of the forward movement of the rolls is shown in Fig. 124. The front end of the fibers, between the fluted segment and the leather covered roll, are over-lapped on the top of those that were turned backward. The continued forward movement, which is about two and one-half inches, draws them upward between the rolls, G and E, and F and E, until their back end is in the same position as shown in Fig. 121. The pressure of the leather covered roll on the steel roll incorporates the newly combed fibers with those that were turned back.

The roll, G, moves around the roll, E, so that its surface is raised from contact with the fluted segment. The rolls all cease their forward movement and remain stationary, until the next revolution of the cylinder, when the operation of detaching, and piecing-up is repeated. The approximate gain in the distance the sliver is moved forward is one inch.

It would seem on closely studying Figs. 123 and 124 that the end of the sliver, which was turned back for piecing-up, would be rolled up between the roll, E, and the fluted segment, O, particularly as these surfaces turn in opposite directions, while O is passing E, but this cannot happen as there is a space of about one-sixteenth of an inch between them and the sliver simply touches lightly against the surface of O, as it is drawn upward between E and G.

Top Comb. At this point, reference should be made to the movements of the top comb, H¹, which are connected closely with the movements of the detaching rolls. When the fibers are being combed by the needles, it is evident that the end, held between the nipper and cushion plate, can receive no combing but as they are liberated by the opening of the nipper and are carried forward

for piecing-up, the top comb, H^1 , descends into the path of the cotton and it receives combing by being drawn through the teeth as shown by the position of the comb in Fig. 123. It is then quickly withdrawn and remains up, clear of the fibers, until the movements of the detaching rolls are repeated.

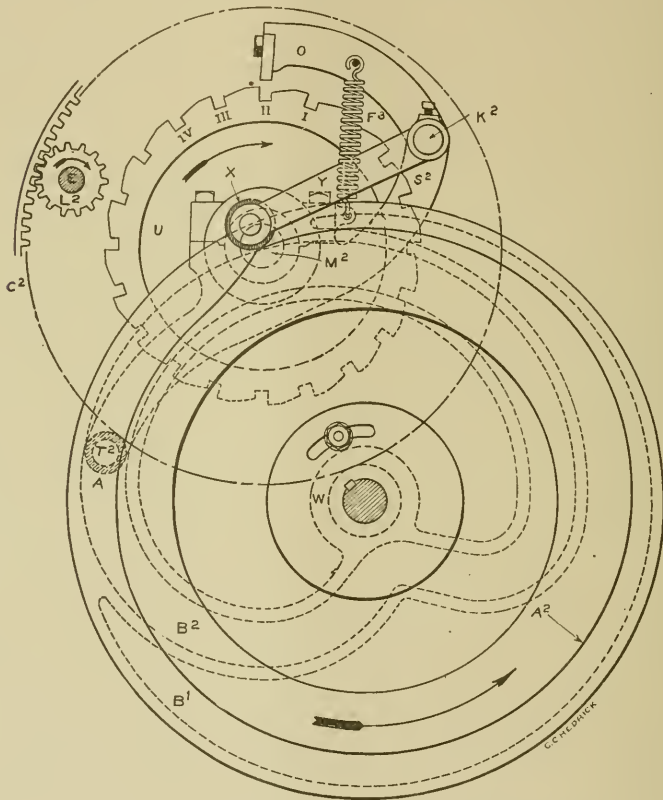

Fig. 125. Elevation Showing Detaching Roll Cams.

Detaching Roll Cams. To obtain the various movements of the detaching rolls, three cams are employed; those which impart rotary motion to all of the rolls are shown in Figs. 125 to 130 inclusive and the lifting cam which causes the rolls, F and G , to move around E is shown in Fig. 131.

Reference should be made first to Figs. 125 and 126 which show respectively the extreme forward and backward positions of

the detaching roll cam lever. On the cam shaft, W, is keyed a cam, B¹, in one side of which is a groove, B². In this groove runs a roll, T², which is carried by the detaching roll cam lever, S², the shaft, M², acting as a center around which, S², is free to turn. Upon this same shaft are fastened a wheel, U, having

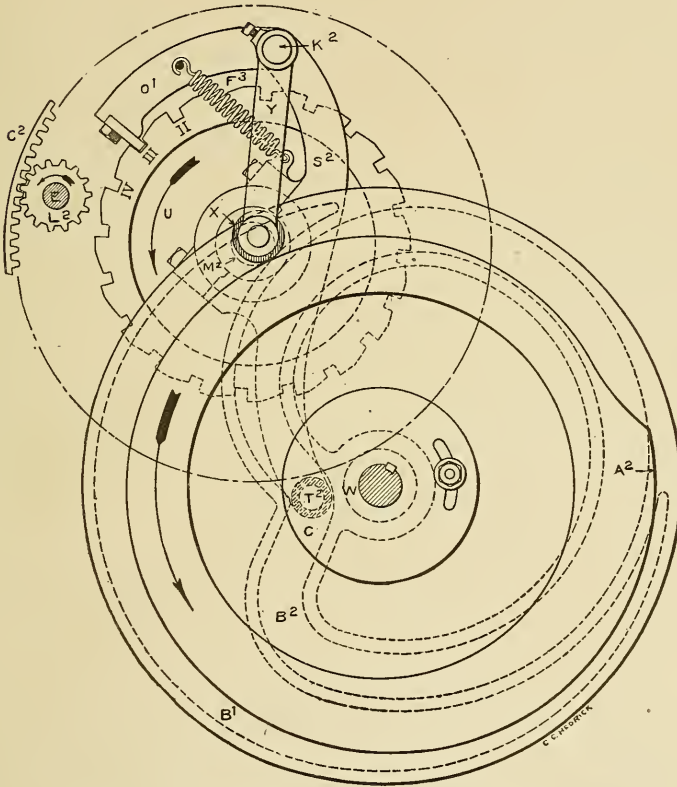

Fig. 126. Elevation Showing Detaching Roll Cams.

twenty teeth, or notches, and an internal gear, C², of 138 teeth. A pawl, O¹, which is fastened to a stud, K², and which is carried by the upper end of the detaching roll cam lever, engages in the notches of the notched wheel and is held in contact with them by a spring, F³, while the internal gear is in contact with the pinion, L², of eighteen teeth, which is fast on one end of the detaching roll, E.

As the cam revolves, the shape of the groove in it is such as to cause the pawl to move back and forth. The sides of the notches are square which permits the pawl to engage with them in either direction. This motion is communicated to the roll, E, by the notched wheel, the internal gear and the pinion causing it to rotate forward and backward.

By examining the drawings, it will be seen that on the side opposite from the groove in the cam, B¹, is another cam, A², on

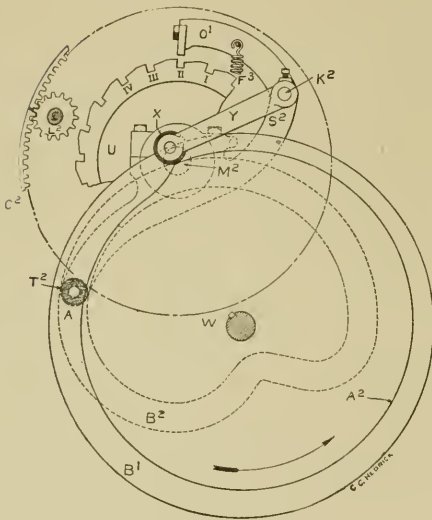

Fig. 127.

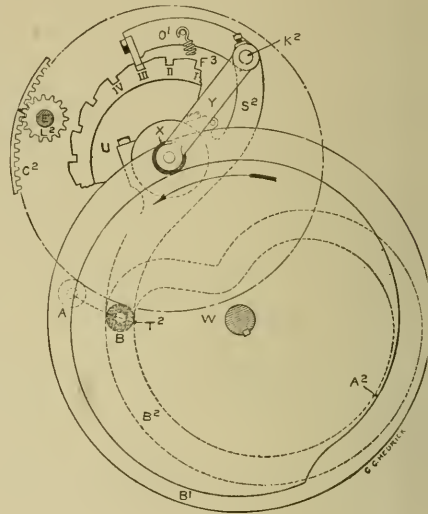

Fig. 128.

Diagrams of Detaching Roll Cams.

the periphery of which runs a roll, X, which is fastened to the lower end of the arm, Y. The other end of the arm is fastened to the same stud as the pawl, O¹. This cam simply acts on the pawl, moving it in and out of contact with the notched wheel at the proper time.

The next four drawings Figures, 127, 128, 129 and 130, show the positions at different stages. All the parts, not absolutely essential to explain these movements, are omitted. Fig. 127 shows the position of the cams after the detaching rolls have finished turning forward. The cam roll, T², is on the largest diameter of the cam which is indicated by the letter, A. The nose of the cam, A², has just come into contact with the roll, X, which

has lifted the pawl, O^1 , out of the notch in the notched wheel, marked by the numeral, II.

Fig. 128 shows the cams as having made about one-half of a revolution. This movement has advanced the cam roll from A to B and has caused the pawl to move from above notch II to III while the gradually decreasing diameter of the cam, A^2 , has caused the cam roll, X, to drop and allow the spring, F^3 , to draw the pawl into notch III. But it will be noticed that as yet no movements of the detaching rolls has taken place.

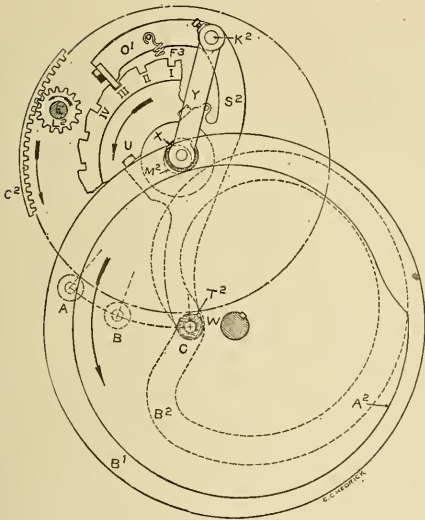

Fig. 129.

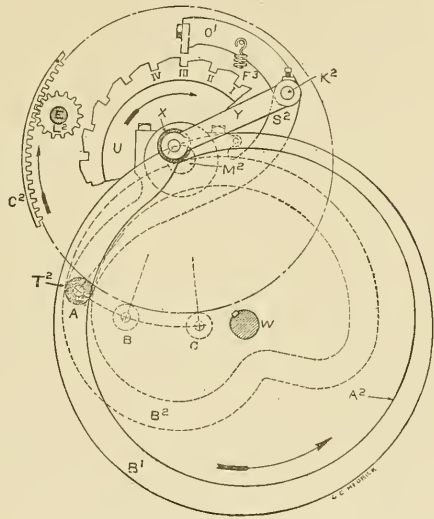

Fig. 130.

Diagrams of Detaching Roll Cams.

In Fig. 129, the cams are shown as having completed about three-quarters of a revolution. The cam roll, T^2 , is on the smallest diameter of the groove at C . The pawl, which is shown just entering notch III in Fig. 128, has engaged the whole depth of it and the continued revolution of the cams has turned the notched wheel to its extreme backward position, as indicated by the arrow. This movement through the internal gear, C^2 , and the pinion, L^2 , rotates the steel detaching roll, E , and turns back about one and one-half inches of sliver. The distance moved by the internal gear is shown by the relative positions of a dark spot marked upon the gears in Figs. 127, 128 and 129.

The completion of the revolution of the cams is shown in Fig. 130. The cam roll has moved from C back to A and the nose of the cam, A², has come into contact with the cam roll, X. This action lifts the pawl out of notch III, the parts remaining in the same relative positions as in Fig. 127, except that the notched wheel has advanced one notch, and at the next revolution of the

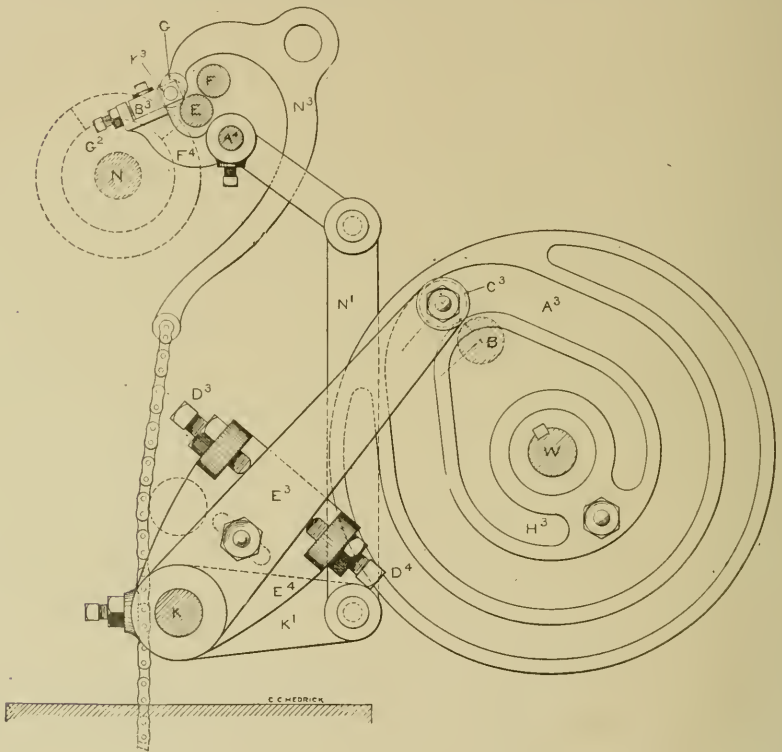

Fig. 131. Elevation showing Lifting Cam.

cam, the pawl will drop into notch IV. The point, marked by the dark spot, has advanced in the same proportion as the notched wheel, as will be seen by its position above the pinion.

The detaching rolls turn backwards at about $1\frac{1}{2}$ by the timing dial and continue until about 6. The forward movement then commences and continues until about 11.

Fig. 131 shows the device for moving the leather covered detaching roll in and out of contact with the fluted segment.

On the cam shaft, W, is fastened the lifting cam, H³, with a groove, A³, cut in its face. In this groove runs a roll, C³, which is carried in one end of the lifting cam lever which is made in two parts, E³ and E⁴. The part, E³, which carries the cam roll, is in reality loose on the lifting shaft, K, while the part, E⁴, is keyed to K. The two parts are connected by the adjusting screws, D³ and D⁴, which are screwed through lugs on E⁴ and bear against the sides of E³. This permits a very close adjustment to be made when setting the parts. The lifting shaft, K, extends the whole length of the comb and upon it are fastened the lifting shaft arms, K¹, which are connected to the top lifting lever, F⁴, by the upright arms, N¹.

On the back end of F⁴ is a block, B³, which bears against the bushing, K³, on the end of the roll, G. These bushings are made square on the outside so as to give ample wearing surface against the blocks. A set screw, G², in the end of F⁴, bears against the block which allows for adjustment. A weight, not shown in the drawing but connected to the stirrup, N³, by a chain, holds the bushing firmly against the block. It also keeps the roll, G, in contact with the steel roll, E, and the fluted segment.

The drawing shows the position of the cam and parts with the roll, G, in contact with the fluted segment, the outlines of which are shown by dotted lines. As the cam revolves, the groove in its face causes the roll, C³, to move from the position it is in towards the center of the cam to a point marked B, as shown by dotted lines. This movement causes the roll, G, to move around the roll, E, out of contact with the fluted segment. The cam roll continues on the small diameter of the groove until it is moved out at the next revolution.

Top Comb Motion. Fig. 132 shows the eccentric for operating the top combs. These combs, H¹, are carried by the comb arms, M³, which are centered on the top comb shaft, N³, at one end of which is an arm, W¹, which carries a roll, S³. This roll runs on an eccentric, O², which is fastened on the cylinder shaft, N. At each of the comb arms is a dog, N⁴, which is fastened to the top comb shaft and through a lug on the dog is a set screw, W², which bears against the comb arms. The arms are thus

free to be turned up out of the way for cleaning or repairing the needles. As the eccentric turns, the top comb shaft is turned slightly and the combs put in and out of contact with the cotton.

Timing and Setting. The successful working of the comb depends almost wholly upon the timing and setting of the various parts so that one movement will follow another at the proper time. These can be varied, slightly, according to the length and quality

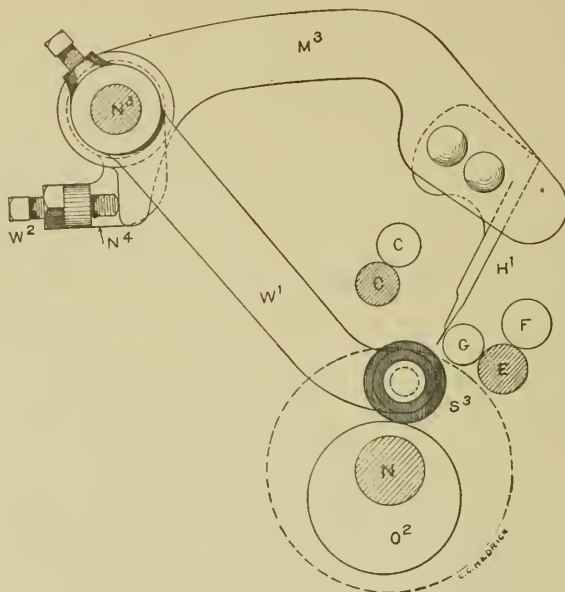

Fig. 132. Top Comb Eccentric.

of the cotton being used and the judgment of the one in charge of such work. The following are average timings and settings:

To set the cylinder: Turn the cylinder shaft around until number 5 on the timing dial comes beneath the index finger, then set the front edge of the fluted segment from the flutes of the steel detaching roll with $1\frac{1}{8}$ -inch gauge and tighten the cylinders on the shaft.

To set the feed roll: Use $1\frac{1}{16}$ -inch gauge between the flutes of the steel detaching roll and flutes of the feed roll, then tighten feed roll slides into place.

To set the cushion plates to the nipper knives: Put the cushion plate in place and set it up against the nipper knife with one

thickness of ordinary writing paper between it at each end. Press the nipper firmly against the cushion plate and see that each piece of paper is held securely. This sets the cushion plate parallelly with the nipper knife.

To set the cushion plates from the steel detaching roll: Use $\frac{1}{4}$ -inch gauge between the lip of the plate and the flutes of the detaching roll.

To set the nipper knives from the fluted segments: First disconnect the upright rods, L¹, and use number 20 gauge between the edge of nipper knife and segment. The nipper stop screw, P¹, must project through the arm about one-quarter of an inch and a $\frac{1}{4}$ -inch gauge must be placed between the point of the screw and the nipper stand. After setting the right-hand screw, remove the gauge and bring the left-hand screw up against the nipper stand. Next put a strip of writing paper between the point of each screw and stand and see that it draws with the same tension from each. The cylinder shaft should now be turned around until number 17 on the dial is under the pointer; the cam roll will then be on the largest diameter of the nipper cam. Put on the right-hand connecting rod and spring, try $\frac{1}{4}$ inch gauge between the nipper screw and stand, and adjust the nuts on the upright rod until the gauge will draw out with ease. After this, put on the left-hand rod and spring and have the gauge draw out with the same tension. Turn the cam back to the first position and try number 20 gauge, between the nipper knife and the half-lap, and see that everything is free.

To set the leather detaching rolls: Turn the cylinder shaft around until the dial is at $6\frac{3}{4}$, then put the rolls in position with the end bushings on and attach weights. Let the rolls rest against the fluted segment. Use number 23 gauge between the lifter block and bushing of roll. Set the right-hand side of one roll first; then turn the detaching roll cam around so as to bring the block up against the gauge. Next try the gauge between all of the other blocks and bushings and set the blocks up so that the gauge will draw from each with the same tension and tighten blocks in place. Put a strip of writing paper between the fluted segment and the leather detaching rolls at each end and adjust the cam lever so that the rolls will touch the segments at $6\frac{3}{4}$.

To time the nippers: Turn the cylinder shaft around until $9\frac{1}{4}$ comes under the pointer. Loosen the nipper cam and turn it around until the nipper stop screws leave the stands at $9\frac{1}{4}$ then make nipper cam fast on the shaft.

To set the top combs to the leather detaching rolls: Remove the end bushings from the leather roll and put $\frac{1}{32}$ inch gauge between it and the steel roll and have it touch, lightly, against the top comb, which should be inclined about thirty degrees, then remove the gauge from between the rolls and see that the leather roll is free from the comb.

To set the top combs to the fluted segments: Use number 20 gauge between the points of the comb needles and the segment. Set the comb by the stop screws with a strip of paper under each which should draw out with the same tension. Loosen the top comb eccentric and turn it around until the throw is downward and wedge the eccentric arm in place. Turn all the stop screws against the top comb arms and set each with a strip of paper. After setting all the combs, turn the shaft around to number 5 on the dial and set the top comb eccentric so that a strip of paper will not draw from between the nipper stop screw and stand.

To time the feed rolls: Turn the cylinder shaft around until the dial shows $4\frac{1}{2}$ under the pointer, then set the pin so that the feed rolls will start forward.

To time the detaching rolls: Turn the cylinder shaft around until the dial is at 6, then set the detaching roll cam so that the rolls will start to turn forward. The brass top rolls should be set from the leather rolls with number 21 gauge and their flutes should be in mesh with the flutes of the steel roll.

Owing to the naturally irregular disposition of cotton fibers, it is impossible to remove the waste without removing more or less long fibers, nor can the percentage of waste be known until after the cotton has been combed, as some varieties are much cleaner than others and contain fewer short fibers. The amount of waste is often increased by the faulty timing and setting of the parts.

There are various ways of controlling the amount of waste. In the top comb, the dropping varies from $4\frac{1}{2}$ to $6\frac{1}{2}$. If dropped at $4\frac{1}{2}$, more waste is combed out, as the comb needles enter the lap before it is drawn forward by the detaching rolls, while if

dropped at $6\frac{1}{2}$, they do not enter the lap until after it has started, consequently some of the fibers escape combing.

The angle of the top comb and its distance from the fluted segment also control the amount of waste. The comb needles, which act as hooks upon which the fibers are caught, enter the lap at about right angles to the direction that it is drawn. Now it is evident, that the more acute this angle the greater is the retaining power, so that more waste will be removed. The nearer the needles are allowed to approach the fluted segment, the more they penetrate the mass of cotton, thus giving it a more thorough combing.

The time of starting the feed rolls varies from 4 to 6; if started at 6 more waste will be made than if started at 4, as the later the feed rolls start, the more the lap is liable to curl and not pass freely between the nipper and cushion plate. Curling causes the lap to bunch in places and when these bunches are acted upon by the cylinder needles, more of the long fibers are combed out than would be the case if the lap were perfectly smooth and even.

The closing of the nippers takes place from 9 to 10. If closed at 10 more waste is made than at 9. The reason for this is very apparent. If the nipper does not close until the comb needles have commenced to work, the cotton will draw from between the nipper and cushion plate. This late closing, as it is called, should be avoided, as many of the long fibers will be combed out with the waste which would otherwise be carried forward with the sliver.

The leather detaching roll is brought into contact with the fluted segment at $6\frac{3}{4}$. If brought into contact before $6\frac{3}{4}$ more waste is made.

The length of time the leather detaching roll is allowed to remain in contact with the fluted segment also controls the waste. A number 25 gauge, used between the lifter blocks and the bushings of the leather roll, will give more waste than a number 21 gauge, as it is thinner and allows the leather roll to remain in contact with the fluted segment longer.

The leather detaching roll starts to turn forward at $6\frac{1}{4}$. If started before this, more waste is made than if started after, as the forward rotary movement of the roll together with the rotary movement of the fluted segment detaches the cotton from between

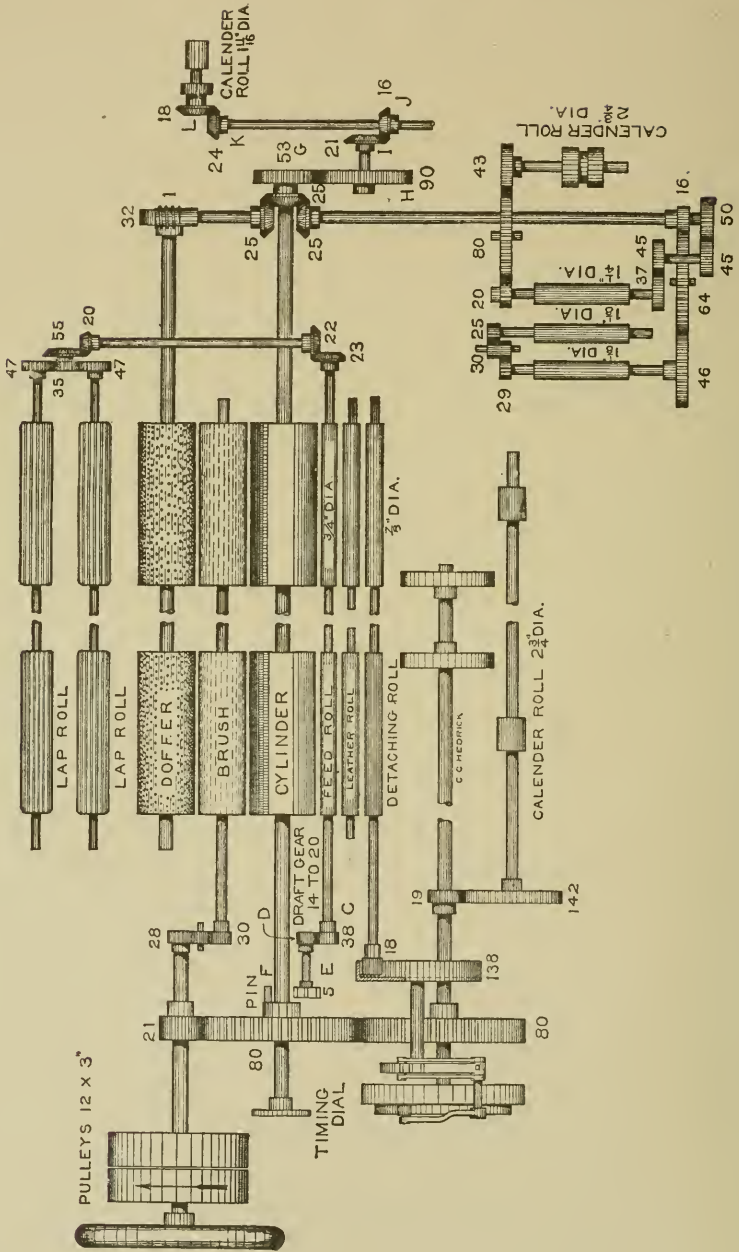

Fig. 133. Diagram of Comber Gearing.

the nipper and cushion plate, and, if this movement commences before the nipper is opened sufficiently to allow the cotton to be drawn forward, the fibers are broken.

Gearing. In order to work out the various calculations, a diagram of the comber gearing is given in Fig. 133. The usual speed of the driving pulleys, which are twelve inches in diameter by three inches face, is about 300 revolutions per minute. On the outer end of the driving shaft is a heavy balance wheel, which serves a double purpose, namely, to enable the cylinder shaft to be turned readily when setting the various parts and to prevent any fluctuations in the speed of the comb, as the cylinder shaft turns much harder while the needles are passing through the cotton than at any other time. Were it not for this balance wheel, the comb would run with considerable vibration, which tends to loosen the screws and bolts, as well as to disturb the settings.

On the inside end of the driving shaft is a gear of 21 teeth, in gear with one of 80 teeth which is fastened to the cylinder shaft. The speed of the cylinders is therefore about 78 revolutions or nips per minute.

The feed roll, which is $\frac{3}{4}$ of an inch in diameter, is driven from the cylinder shaft by a pin and a star-wheel having 5 teeth. On the same stud as the star-wheel is the draft or change gear, D, of from 14 to 20 teeth, by which the feed is regulated.

The calender rolls in front of the cylinders are driven from the cylinder shaft by a gear of 80 teeth which drives a similar gear of the same number of teeth. On the shaft with the latter is another gear of 19 teeth, which drives one of 142 teeth, which is upon the calender roll shaft.

The draft rolls are driven from the foot end of the cylinder shaft by a gear of 25 teeth, which drives another of 25 teeth. On this same shaft are two gears, one of 16 teeth, which drives the back roll through an intermediate of 64 teeth and one of 46 teeth which is upon the back roll.

The front roll is driven from the gear of 50 teeth, through the double intermediate of 45 teeth and the gear of 37 teeth. The calender roll in front of the draft rolls is driven from the other end of the front roll by the gears of 20, 80 and 43 teeth. The middle roll is driven from the back roll by the gears of 29, 30 and 25 teeth.

The coiler is also driven from the cylinder shaft, through the gears of 53, 90, 21 and 16 teeth, the last being upon the upright shaft in the coiler. At the top of this shaft is a gear of 24 teeth, driving an 18 toothed gear which is upon the calender roll.

The lap rolls are driven from the feed roll by the gears of 23, 22, 20, 55, 35 and 47 teeth. The first and last mentioned are upon the feed roll and lap roll respectively, and, as the motion of the feed roll is intermittent, the lap rolls receive a corresponding movement.

The doffer is driven by a single worm and worm gear of 32 teeth and a bevel gear of 25 teeth, from the same gear which drives the draft rolls. The brush and the doffer comb are driven from the driving shaft, the brush by the gears of 28, 35 and 30 teeth and the comb by a connecting rod, one end of which is fastened to an arm on the cam shaft and the other working on a pin set eccentrically in the 28 toothed gear on the driving shaft. By this means, the comb is given an oscillating motion.

Calculations. The production of the comb is governed by the weight of the laps per yard, the number of revolutions that the cylinder makes per minute, the draft of the comb and the amount of waste. A glance at the diagram of the gearing will show that the calender rolls in the coiler are the last through which the sliver passes, and the length delivered by them at each revolution of the cylinder should be taken into account in figuring the production. These rolls are $1\frac{1}{6}$ inches in diameter and make 1.03 revolutions to one of the cylinder, which gives a delivery of 5.3 inches for each revolution.

Following are the principal calculations for the comb.

Rule 1. To find the production of the comb in pounds: Multiply together the number of revolution of the cylinder per minute (80), the number of inches of sliver delivered at each revolution (5.3), the weight in grains of one yard of lap, less the percentage of waste (212.5), the number of laps (6) and the number of minutes run per day, less 10 per cent for time lost in cleaning (540). Divide the product by 7,000 (the number of grains in one pound), multiplied by 36 (the number of inches in a yard) and by the draft of the comb (24.47).

$$\text{Example: } \frac{80 \times 5.3 \times 212.5 \times 6 \times 540}{7000 \times 36 \times 24.47} = 47.34$$

In this example, the weight of the laps is given as 212.5 grains, or 250 grains less 15 per cent for waste which is a fair average.

Rule 2. To find the draft of the comb between the calender rolls in the coiler and the feed rolls: Multiply together the driving gears and the diameter of the coiler calender rolls and divide the product by the product of the driven gears multiplied together with the diameter of the feed roll. (The driving gears are C, E, G, I and K, and the driven gears are D, draft gear 18 teeth, F, H, J and L.) To avoid fractions, the diameter of the feed roll, which is $\frac{3}{4}$ of an inch can be called 12 as there are $\frac{12}{16}$ in $\frac{3}{4}$ of an inch and the diameter of the coiler calender rolls, which is $1\frac{11}{16}$ inches, can be called 27.

$$\text{Example: } \frac{38 \times 5 \times 53 \times 21 \times 24 \times 27}{18 \times 1 \times 90 \times 16 \times 18 \times 12} = 24.47$$

Rule 3. To find the draft factor: Proceed as in rule 2 but omit the draft change gear D.

$$\text{Example: } \frac{38 \times 5 \times 53 \times 21 \times 24 \times 27}{18 \times 1 \times 90 \times 16 \times 12} = 440.53$$

Rule 4. To find the draft: Divide the factor by the number of teeth in the draft gear (18).

$$\text{Example: } 440.53 \div 18 = 24.47.$$

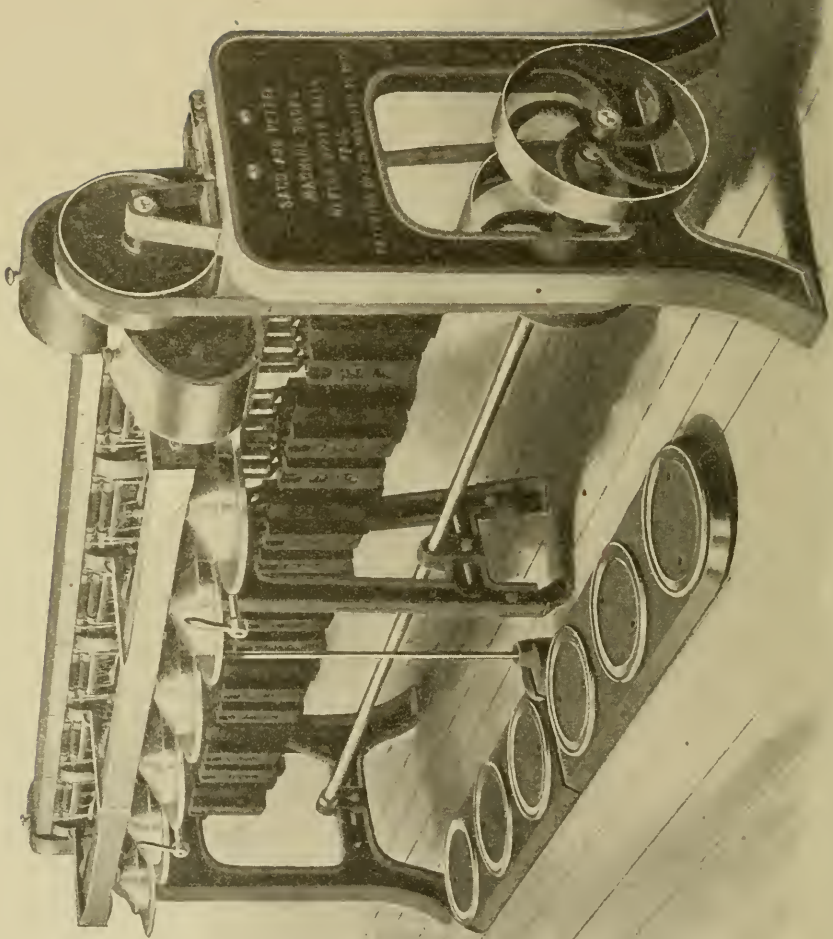

IMPROVED DRAWING FRAME.—FRONT VIEW

COTTON SPINNING

PART IV

DRAWING

In all the processes previously described, except when combing was introduced before drawing, the principal object has been to free the cotton from as much foreign substance as possible, and no attempt has been made to form a thread. When the sliver leaves the card, the fibers are in a very irregular and confused mass and it is evident that the fibers must be straightened and parallelized to reduce the sliver to a thread.

The object of the drawing process is threefold: To make the fibers lie in parallel order, to make the sliver as even in weight as possible by doubling a certain number at the back of the machine, and to reduce the weight of the sliver, if necessary, by a certain amount of draft.

Drawing is carried out on two distinct types of machine, the Railway Head and the Drawing Frame.

RAILWAY HEAD

Originally, the railway head was used in connection with the stationary flat card as the first drawing process, which was followed by a second and, usually, a third process in which the drawing frame was used. With the general adoption of the revolving flat card the railway head is gradually falling into disuse, but as many of the older mills are still equipped with them and as they are found, occasionally, in operation in some of the most recently constructed mills, it seems fitting that a brief description of the operations and arrangement of the machine and its connection with the stationary flat card shall be given.

Fig. 134 shows in plan two lines of stationary flat cards with a railway head at the end of each line. The slivers, from the calendar rolls of the cards in each line, are delivered into a railway trough or box, and on to an endless belt and are carried to the head end of the trough. Here they pass between a pair of rolls

and are drawn between guides and passed between the draft rolls of the railway head into a can which is then taken to the back of the drawing frame.

The railway head is built both single and double. A single head, or delivery, is designed to take care of the slivers from six to

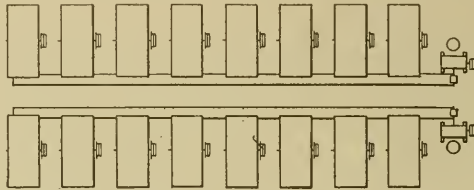

Fig. 134. Plan of Two Single Lines of Cards.

twelve cards. In the illustration (Fig. 134) there are eight cards in each line, delivering into one single railway head.

In most cases two single, or one double, railway heads are used with a double line of railway troughs, placed as shown in Fig. 135. This illustration shows two sections of seven cards in each line, delivering into separate boxes.

The doffers are driven from the railway head to which they are connected by feed shafts, running parallel to the troughs, and with the stopping of the railway head, the delivery from the cards

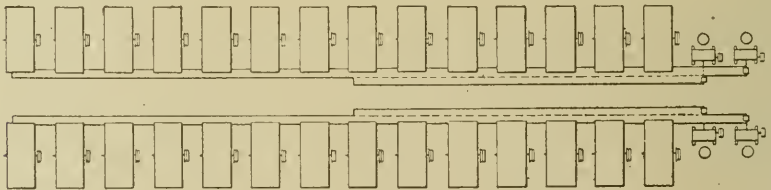
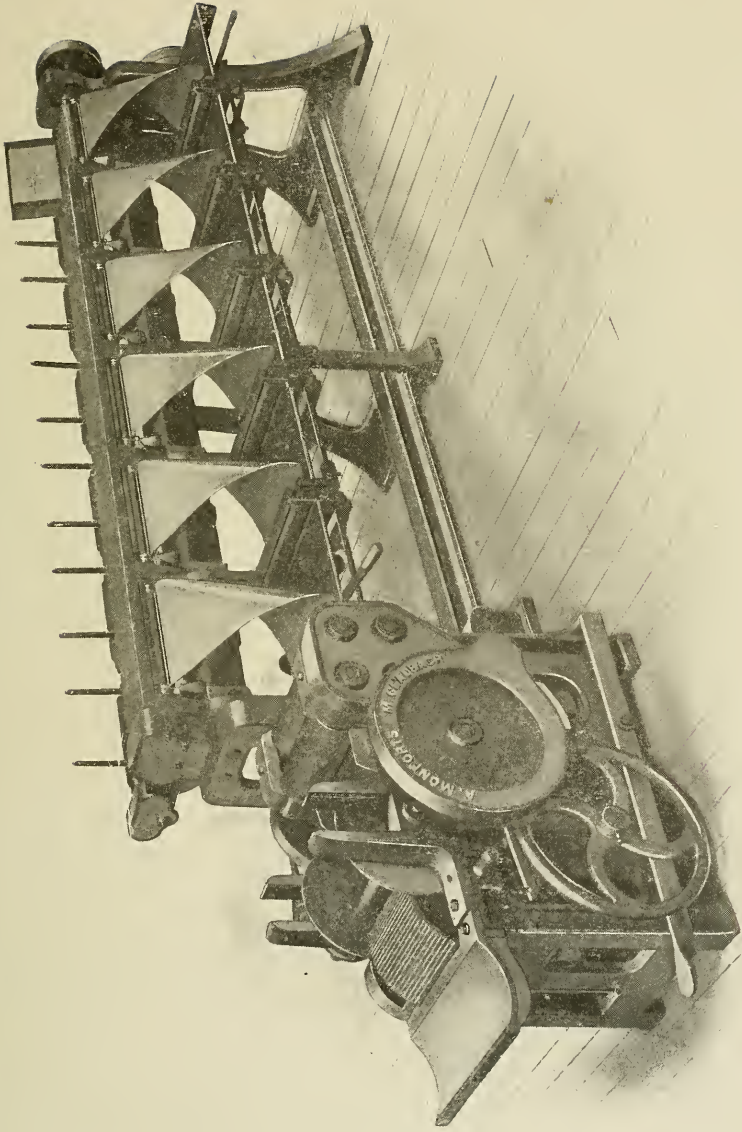

Fig. 135. Plan of Two Double Lines of Cards.

also must cease. This brings about a condition for which the railway head was primarily designed and which needs considerable explanation.

As the cards require grinding periodically, it is evident that one card at a time must be stopped. This reduces the number of ends, or slivers, entering the railway head, and causes a corresponding reduction in the weight of the sliver delivered. That is, if there are eight cards, each delivering a fifty grain sliver, we shall have four hundred grains entering the back of the railway head and



RIBBON-LAP MACHINE EQUIPPED WITH FULL LAP STOP MOTION
Mason Machine Works.

with a draft of eight the sliver delivered at the front will weigh fifty grains:

$$\frac{8 \times 50}{8} = 50$$

Now, if we drop out one sliver, we will have three hundred and

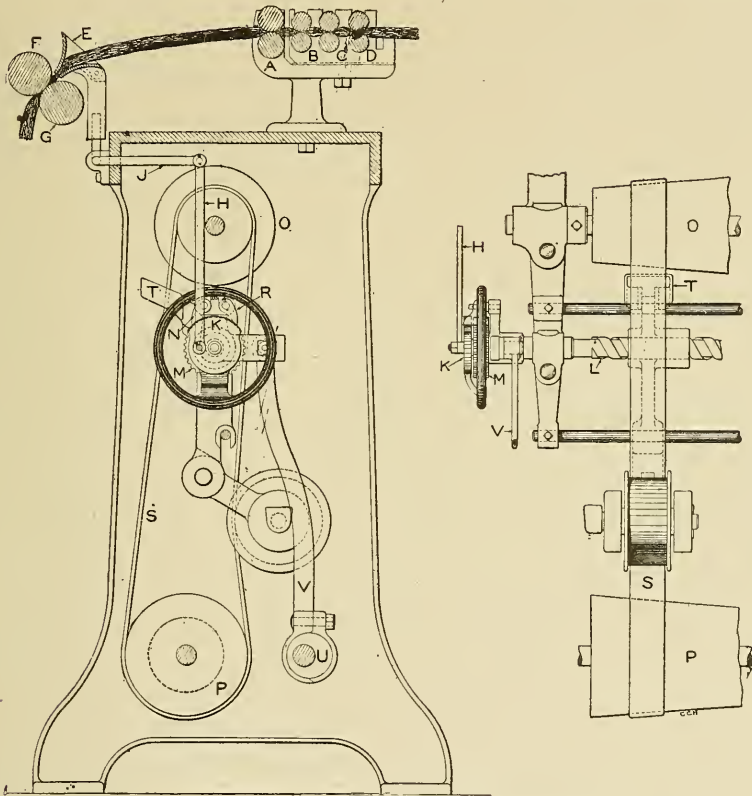

Fig. 136. Section of Railway Head Showing Evener.

fifty grains only, entering the railway head and with the same draft the delivered sliver will weigh 43.75 grains:

$$\frac{7 \times 50}{8} = 43.75$$

To overcome this difficulty, the railway head is provided with an evener motion which is shown in Fig. 136.

Evener Motion. The sliver from the railway troughs passes between the draft rolls, D, C, B, and A and then through the

trumpet, E, and between the calender rolls, F and G. The speed of the back roll, D, is constant as a certain relation must be maintained between it and the speed of the card calender rolls, and to increase or decrease the weight of the sliver, the speed of the front roll must be changed.

The front roll is driven through a pair of cones, O and P, by a belt, S. P is the driver, running at a constant speed, and drives the back roll gearing. The speed of O is changed according to the

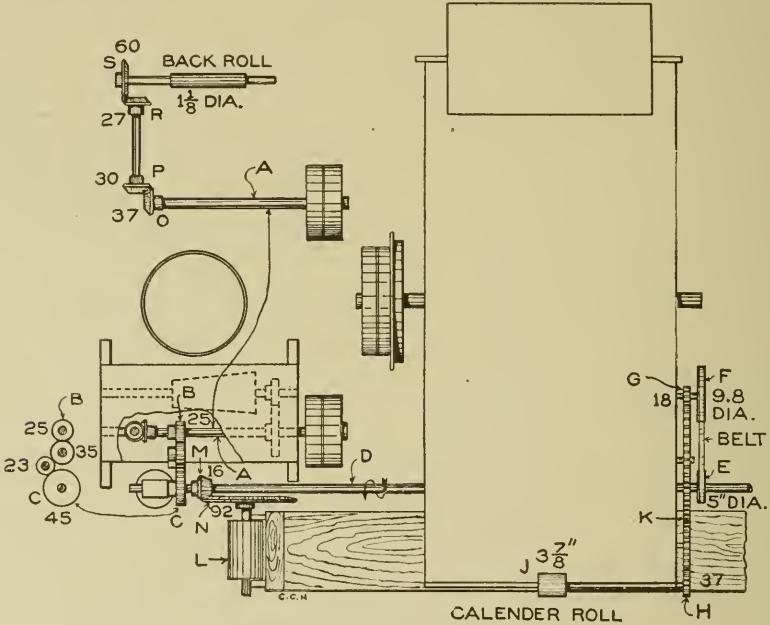

Fig. 137. Gearing Connecting Cards with Railway Head

position of the cone belt. If the sliver is too heavy, the front roll must run faster to increase the draft and reduce the weight, while if it is too light, a corresponding decrease in the speed must take place.

The cone belt, S, passes through a guide, T, which is mounted upon the screw, L. Fast upon one end of the screw is a gear, M, while loose upon the same end is a shield, K, and a pair of pawls, N and R. The pawls are given a reciprocal motion by the eccentric, U, and arm, V, and the shield is connected to the trumpet by the rod, H, and the lever, J.

The trumpet is balanced so that when the sliver is at its normal size, the shield, K, prevents either pawl from engaging the teeth of the gear, M. But should there be a thin place, from an end being out or from any cause, the trumpet will fall back immediately and, through the connections, allow the pawl, N, to engage the teeth of the gear. This turns the screw and moves the cone belt towards the large end of the driven cone, O, making a reduction in the speed of the front roll and a corresponding reduction in the draft, which will continue until the light portion of sliver has passed through the hole in the trumpet.

If the sliver is too heavy, the reverse action of the parts described takes place and the speed of the front roll is increased.

The action of the evener depends wholly upon the friction of the sliver in passing through the hole in the trumpet and, while no great change takes place in the weight of the cotton entering the back of the railway head, unless an end is out, the thick and thin places in the sliver keep the trumpet moving back and forth continually changing, to a slight extent, the speed of the front roll.

The defect in the evener motion is very apparent. As the evener is so slow in its movements, a considerable length of sliver must be delivered before the speed of the front roll is changed enough to rectify the weight.

Gearing. The gearing, connecting the cards with the railway head, is shown in Fig. 137. On the driving shaft, A, is a gear, B, of twenty-five teeth, which drives another gear, C, which has forty-five teeth, on the feed shaft, D, through two carrier gears of twenty-three and thirty-five teeth. On the feed shaft at each card is a feed pulley, E, five inches in diameter, which drives the doffer pulley, F, 9.8 inches in diameter, by a belt, and on the same stud with the doffer pulley is a gear, G, of eighteen teeth, which drives the card calender rolls, J, through the calender shaft gear, H, of thirty-seven teeth and the doffer gear, K, of one hundred and eighty teeth.

The railway trough drum, L, which is six inches in diameter, is driven from the feed shaft by the bevel gears, M, of sixteen teeth, and N, of ninety-two teeth, and the back roll of the railway head is driven from the driving shaft by the bevel gears O, P, R and S of thirty-seven, thirty, twenty-seven and sixty teeth respec-

tively, shown in the detached sketch in the upper left hand corner.

Between the back roll of the railway head and the railway trough drum, there is a slight draft and between this drum and the card calender roll, there is also a draft which may be ascertained in the usual manner.

Draft between railway head back roll and railway trough drum:

$$\frac{9 \times 27 \times 37 \times 45 \times 92}{60 \times 30 \times 25 \times 16 \times 48} = 1.07$$

Draft between the railway trough drum and the card calender rolls:

$$\frac{48 \times 16 \times 9.8 \times 37}{92 \times 5 \times 18 \times 31} = 1.08$$

The revolutions of the railway head driving pulley determine the speed of the card doffers and determine the production of the card. Thus, when a change in the production of the card is required and the weight of the sliver is to remain the same, the speed of the driving pulley must be changed. In Fig. 137, the driving pulleys are shown as making 35.28 revolutions per minute to one of the doffer.

$$\frac{180 \times 9.8 \times 45}{18 \times 5 \times 25} = 35.28$$

Fig. 138 shows a diagram of the draft gearing of the railway to which reference will be made under the head of calculations.

DRAWING FRAMES

Arrangement. When drawing frames are used, they are arranged in two and often three processes, or sets, usually placed across the mill as shown in plan in Fig. 139 and in elevation in Fig. 140. They are built with from two to eight deliveries to a head and from one to five heads to a frame. When more than one head is used to a process, they are coupled together and all are driven from an underneath shaft; thus in Figs. 139 and 140 each process consists of one frame of four heads with six deliveries to each head, or twenty-four deliveries to each process. On the right end of each frame is a pulley, A, which is driven from a similar pulley, B, on the main line by a belt, D. The pulley, A, is upon an underneath shaft, F, which extends the length of the frame, and upon it are the pulleys, C, for driving each individual head. The shaft, F, is in motion all of the time that the main line is running,

necessary movements shall be made by the tenders of the drawing frame.

Operation. The actual operation of drawing is very simple and consists of passing the slivers between several pairs of rolls, each pair running at a greater speed than the preceding one. The rolls are set at a certain distance apart, slightly more than the length of the cotton fibers, so that two pairs cannot have any direct contact with the same fibers at the same time.

What actually takes place may be described best by referring

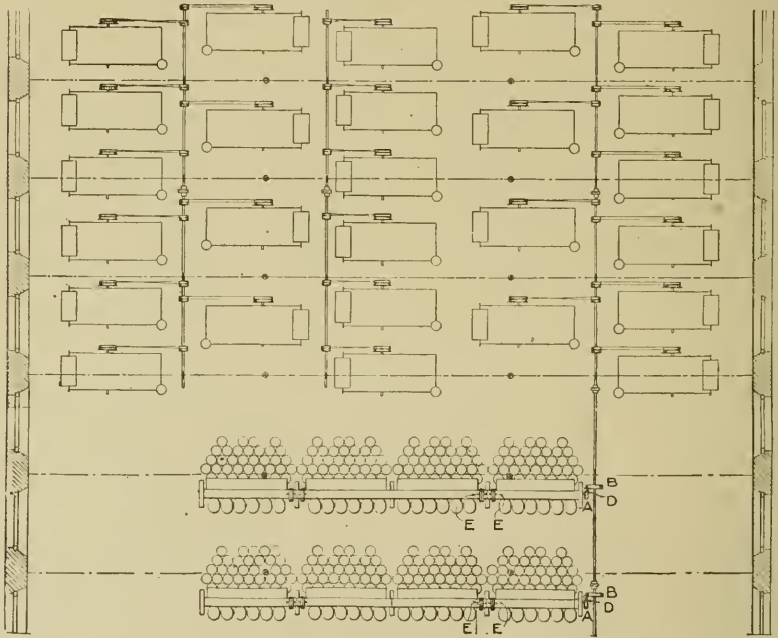

Fig. 139. Plan of Card Room Showing Drawing Frames.

to Fig. 143, which shows in section four pairs of drawing frame rolls.

The cotton enters between the back rolls, DD, and is drawn between the next pair, CC. Now as the speed of CC is slightly more than that of DD, it is evident that the fibers, which are under the influence of rolls, CC, will be withdrawn from the mass between DD, the friction existing among the fibers causing them to straighten in being drawn one by another. This action is still fur-

ther carried out as the sliver is drawn between the remaining rolls in the set.

Fig. 144 shows a general section of a drawing frame. The slivers, S, are drawn upward through the sliver guide, T, and be-

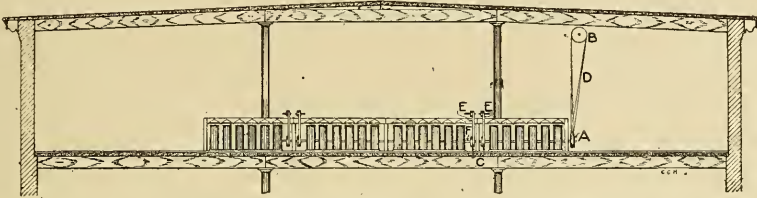

Fig. 140. Elevation Showing Drawing Frames.

tween the fluted carrier roll, P, and the top roll, N¹, then between the four pairs of draft rolls, D,C,B,A, where it receives a draft, usually as great as the number of cans put up at the back. Thus,

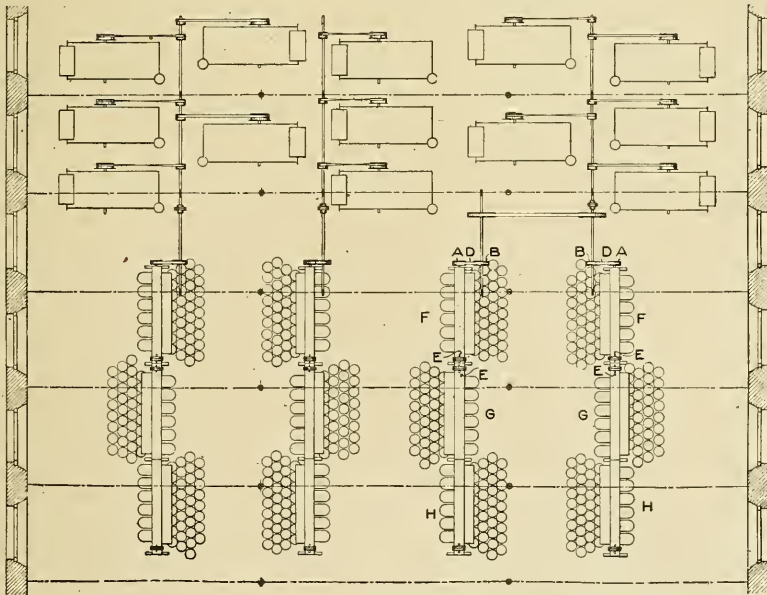

Fig. 141. Plan of Card Room Showing the Drawing Frames Arranged Longitudinally.

if there are six cans at the back, and the sliver from these cans is drawn through as one sliver, or doubled six into one, the machine is given a draft of six, so that the weight of the sliver being delivered is the same as the weight of that from each can. While

this is the usual practice, it is not a rule to follow, as general conditions and requirements determine the best draft and weight of sliver to be adopted.

Upon leaving the draft rolls, the sliver is drawn over the

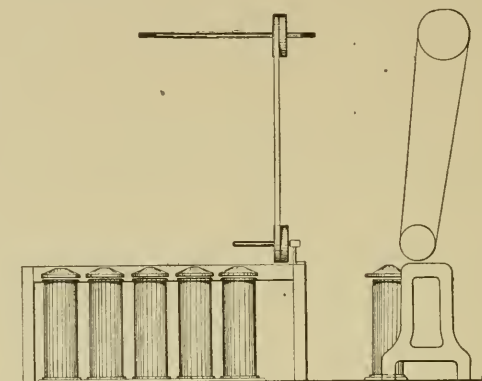

Fig. 142. Front Elevation of Drawing Frame Driven from Above.

sliver plate, J, through the trumpet, N, and between the calender rolls, E and F. From this point, it falls through the spout of the coiler, G, and is coiled in the can, H.

Stop Motions. The drawing frame is provided with four stop motions: A full can stop motion which operates when a set of cans

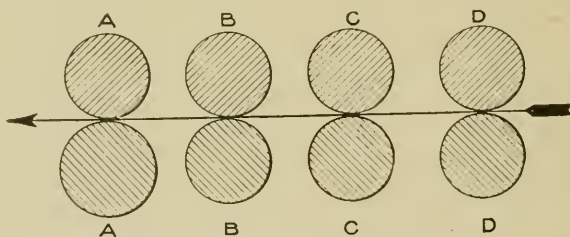

Fig. 143. Section Showing Draft Rolls.

at the front of the machine becomes full, two calender roll stop motions which operate when the sliver is absent from between the calender rolls or when a "wind-up" occurs on either of them, and a back stop motion which causes the head to stop when the sliver breaks at the back of the frame or a can becomes empty.

The necessity for a back stop motion becomes more apparent when we consider that after the drawing processes there is no opportunity to rectify, to any extent, the inequalities in the weight



DRAWING FRAME WITH ELECTRIC STOP MOTION
Howard & Bullough Am. Machine Co. (Ltd.)

of the sliver. When we realize that in doubling six into one, the breaking of an end means 16% difference in the weight of the sliver, we soon see the need of a stop motion. If six slivers, each

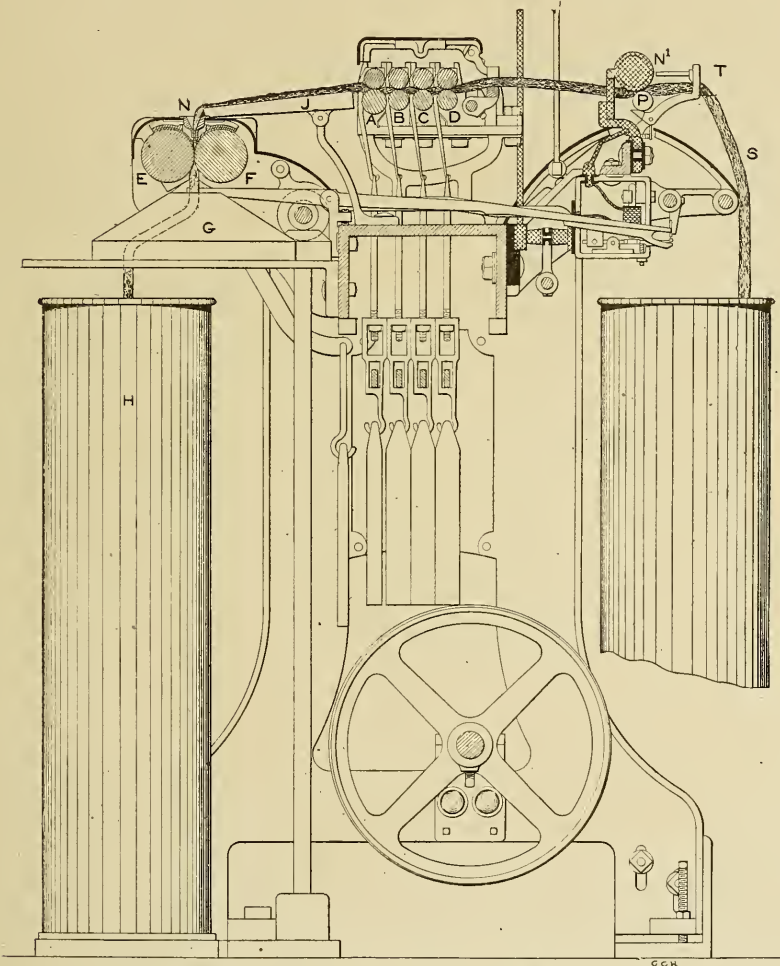

Fig. 144. General Section of Drawing Frame.

weighing sixty grains per yard, were doubled with a draft of six we should still get a sixty grain sliver, but if an end should break, the weight of the slivers would be fifty grains, or 16% lighter.

Of back stop motions, there are two styles used, mechanical and electrical. Opinions are divided as to which is the better one.

Electrical Stop Motion. The principle, upon which the elec-

tric back stop motion operates, depends upon the fact that cotton is an insulator or non-conductor of electricity and that the slivers, passing between two rolls connected with opposite poles of an electric generator, prevent the flow of the electric current. As long as the sliver is between these rolls, the stop motion remains inoperative, but should it break and allow the rolls to come together, the circuit is completed and the machine stops instantly.

Fig. 145 shows a section of the electric back stop motion magnet box which should be referred to in connection with Fig. 144. The electric current for operating this stop motion is con-

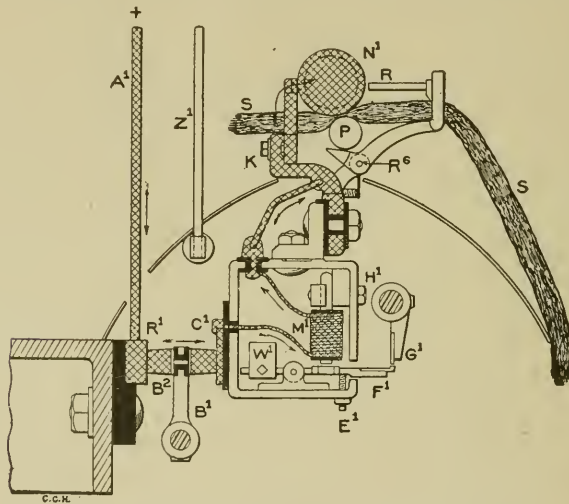

Fig. 145. Magnet Box for Electric Back Stop Motion.

ducted by means of rods, or wires, from the generator, which is conveniently located and is usually furnished for a certain number of deliveries of drawing.

The positive pole or wire, A^1 , is indicated by the sign + and the negative wire, Z^1 , by the sign -. The machine is practically divided into positive and negative poles by insulating material throughout, the terminals of the poles being at the rolls P and N^1 . The current flows from the generator, as indicated by arrows, to the contact block, R^1 , through the contact springs, B^2 , contact plate, C^1 , and the electro-magnet, M^1 . From the electro-magnet it passes upward on the wire connection to the stop motion roll stand, K, and terminates in the top roll, N^1 , which runs in con-

tact with K. The only point where the current can return to the generator is through the bottom or carrier roll, P, which is connected by the framing of the machine to the negative pole Z'. So long as the sliver is between the rolls N' and P, the circuit is broken and no flow of the electric current takes place, but, should a sliver break or run out, the top roll, N', falls into contact with the carrier roll, P, completing the circuit from A' to Z'. The instant that the current flows through the electro-magnet, it attracts the armature F' into the path of the vibrating arm G'. As a consequence, the movement of the arm is arrested and the stop motion spring released, shipping the belt on to the loose pulley. The device for releasing the spring rod is the same for the electric stop

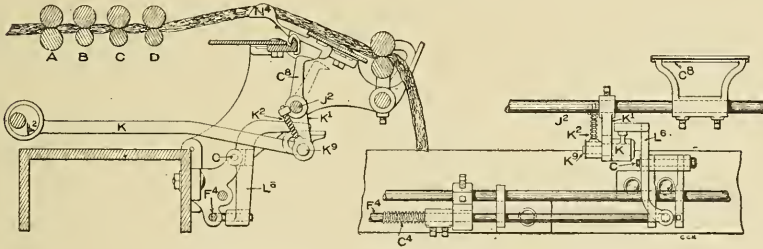

Fig. 146. Device for Releasing Stop Motion Spring.

motion as for the mechanical one and will be referred to in another paragraph.

The carrier roll, P, is fluted and extends the whole length of the head, but the top rolls, N', are made in short lengths with two bosses, one for each end of sliver. A lug on the stand, K, projects into a groove between the bosses and prevents any movement of the top rolls, longitudinally, on the carrier roll.

The sliver guide, R, which is pivoted at R⁶, has a longitudinally projecting arm, which is just clear of the underside of the carrier roll. If the cotton should collect and wind up on the carrier roll, its increased diameter would depress the horizontal arm, causing the sliver guide to turn about the center R⁶ and the adjustable pin R in its upper end will come in contact with the top roll. This completes the circuit and causes the frame to stop just as if the top rolls and carrier roll were brought into contact.

For explaining the device for releasing the stop motion spring, Figure 146 has been prepared. It shows a section of the drawing

frame and all parts not actually necessary in the explanation are omitted. The rocker shaft, J^2 , is operated by an eccentric, L^2 , and is connected with it by an eccentric arm K , and a rocker arm K^1 . A pin, K^9 , in the eccentric arm, rests in the bottom of a slot in the rocker arm and is held in place by a spring K^2 .

When any of the stop motions operate, the movements of the rocker shaft are arrested, and as the eccentric arm is positive in its movements, the stopping of the rocker shaft causes the pin in the eccentric arm to rise in the slot in K and in so doing, it is brought into contact with the latch lever, L^6 . This causes the latch lever, which turns on a pin at C , to be withdrawn from a groove in the

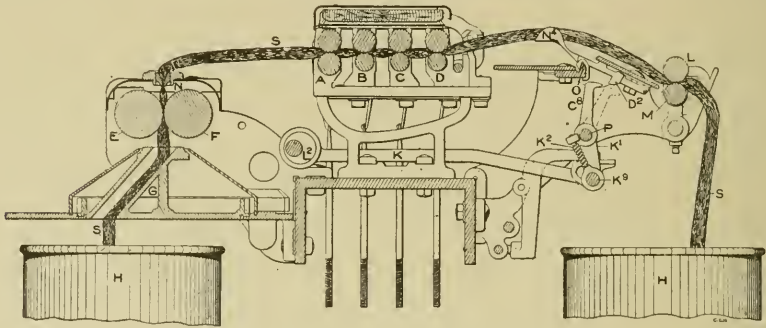

Fig. 147. Mechanical Back Stop Motion.

spring rod, F^4 , releasing the spring, C^4 , and moving the belt on to the loose pulley.

Mechanical Back Stop Motion. A drawing frame with a mechanical back stop motion is shown in section in Fig. 147. The slivers are drawn from the cans between two rolls, L and M . The roll, M , is continuous while L is made in short sections covering two slivers. From these rolls, the slivers pass forward over stop motion spoons, N^4 , and between the draft rolls, D , C , B , and A , and finally pass as one sliver through the trumpet, N , between the calender rolls, E and F , and are coiled up in the can, H , by the coiler gear G .

The stop motion spoons are mounted upon a knife edge, O , and they are so balanced, that when the sliver passes over them, the back ends, D^2 , are held clear of the path of the rocker arm C^8 . If a sliver breaks, the back end, which is heavy, falls instant-

ly into the path of the rocker arm and arrests its motion and the machine is stopped immediately.

All parts, forward of the spoons, are substantially the same as those shown and described for the electric stop motion, and need no further explanation.

Some drawing frames, with mechanical back stop motions, are built without the carrying rolls, L and M, shown in Figure 147. This works very well for the first and second processes of drawing after carding, but for stock which has been combed, it becomes necessary to have these rolls to lift the sliver out of the cans, as the slightest strain will cause it to pull apart. With very short

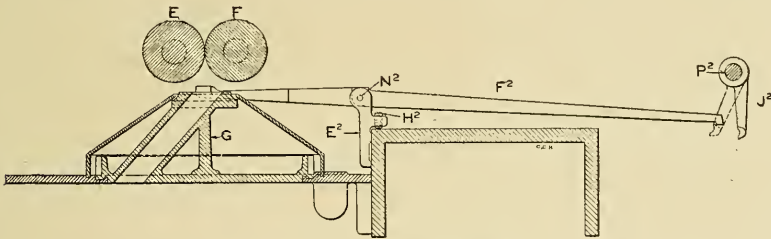

Fig. 148. Full Can Stop Motion.

cotton and waste, it is also a help toward preventing the sliver from parting.

Full Can Stop Motion. The full can stop motion, as the name implies, stops each individual head when the cans in that head become full. This stop motion, which is connected with one can in each head, serves as a guage for the others as the cans are usually emptied in sets.

The stop motion is shown in Figure 148, which may be considered with Figure 144. Bolted to the table is a slotted stand, E^2 , carrying a lever, F^2 , which is mounted upon a pin, N^2 . In its normal position, one end of this lever rests lightly upon the top of the coiler gear, G , and the other just above a projection, of the arm, J^2 , which is fastened to the rocker shaft, P^2 .

When the can becomes full, the cotton presses upward against the underside of the coiler gear, G , causing it to raise the short end of the lever, F^2 , and this lever turning about the pin, N^2 , its long end is lowered into the path of the arm, J^2 , thus arresting the motion of the rocker shaft, P^2 . This, as before described, releases

the stop motion spring which causes the belt to be shipped on to the loose pulley.

The screw at H^2 serves as a means for a very fine adjustment of the stop motion.

Figure 149 shows a device for stopping the drawing frame if the sliver should "wind up" on either of the calender rolls or "break down" before it gets to them. This stop motion, which is really two stop motions operated by one mechanical device, is caused to operate by the rising and falling of the outer calender roll, E. The bearing, E^1 , for the roll, is free to move in a slot in the calender stand, while the bearing for F is fast. Against the underside of E^1 is a lever, C^3 , pivoted at M^2 and heavier at its

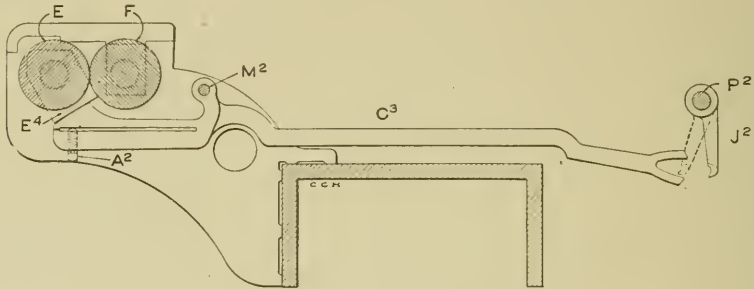

Fig. 149. Calendar Roll Stop Motion.

long end which is forked so as to engage the rocker shaft arm, J^2 , when either raised or lowered.

If the sliver winds up on either calender roll, the increased diameter caused will move the roll, E, away from the roll, F, and in so doing will allow the lever, C^3 , to rise and its long end to engage the rocker shaft arm, J^2 . While if from any cause the sliver breaks down, the roll, E, will fall slightly against F and depress the short end of the lever, C^3 , causing the long end to be brought into contact with J^2 .

In the short end of the lever, C^3 , which is split, is an adjusting screw, A^2 , for setting the stop motion.

Clearers. The electricity, generated by the friction of the rolls and belts of the drawing frame, causes the loose fibers and flyings to adhere to the draft rolls and unless some means are taken to prevent this happening, the accumulation becomes detached from time to time, and is carried along with the sliver. This makes the

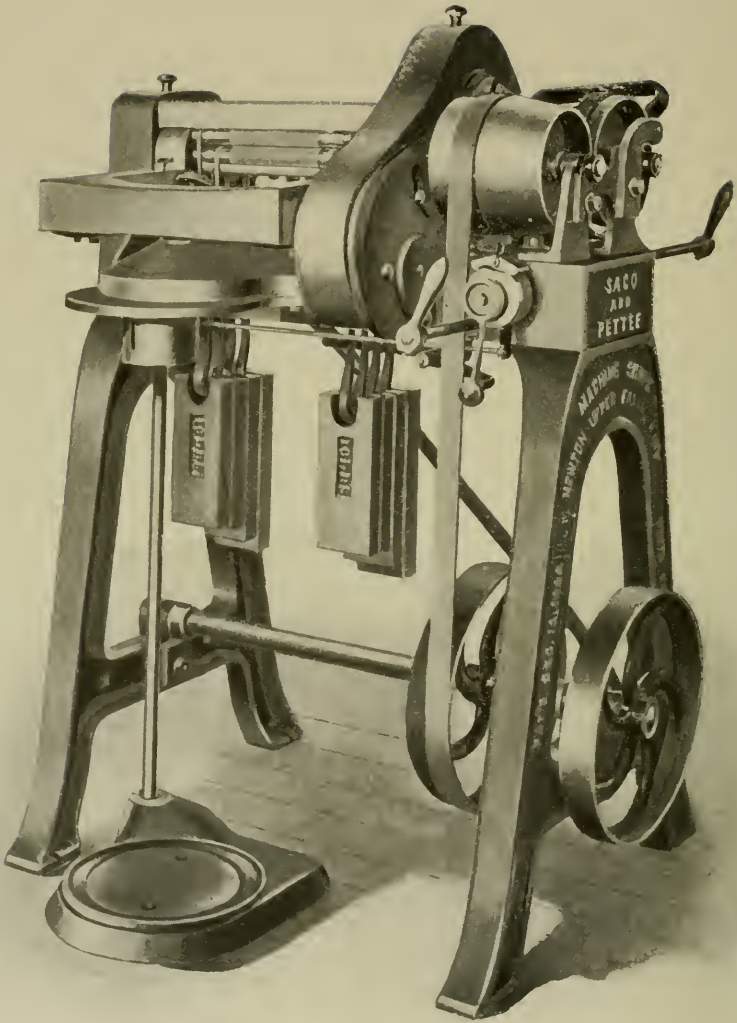

IMPROVED RAILWAY HEAD—FRONT VIEW
Saco & Pettee Machine Shops.

work dirty and uneven, and frequently causes the sliver to break.

The device employed to collect the loose cotton is called a clearer and several styles are in use. The one most commonly used is shown in Figure 150. For the top rolls, this consists of a flat piece of wood, A, with wires, B, driven into the underside and supporting a flannel apron C. The apron rests lightly against the top of the rolls, and as they revolve the loose cotton is gradually collected by the rough surface of the apron, which has to be cleaned or "picked" at regular intervals. If the accumulation is allowed to get too large it will become loose from the clearer and pass in with the sliver, hence the clearer should be cleaned as often as the case demands.

For the bottom clearer, strips of wood, D, covered with flannel are used. They conform in shape to the outline of the rolls and are held in contact with the flutes by weights, E. The straps holding the weights pass upward and around the bottom rolls.

Another style of clearer is shown in Figure 151. This consists of two wooden rolls,

A and B, supported in a frame, C. Around the roll is an apron, D, of heavy flannel or carpet. The roll, A, is covered with perforated tin and acts as a driver for the apron, while the roll, B, is a carrier with an adjusting screw, E, for keeping the apron tight. On the top of the frame is a comb, K, with the blade set close to the apron. Motion is given to the comb by an arm, F, from an eccentric, G. This arm also carries a pawl, H, which engages with the teeth of the ratchet gear, J, and through the gears, L and M, the roll, A, is turned slightly at each forward movement of the arm, F.

By this means the apron, as it moves around slowly, wipes

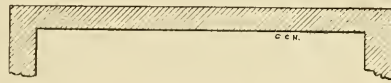
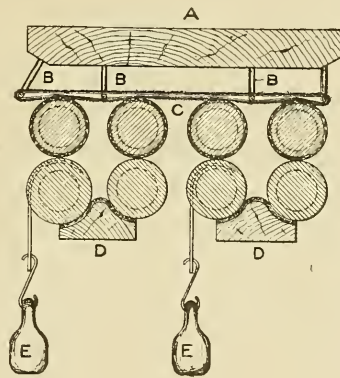

Fig. 150. Common Top Clearer.

the top of the rolls and the cotton, which is collected, is combed into a roll as it reaches the comb when it is removed very easily.

A set screw, N, is for adjusting the frame so that the apron shall just touch lightly on the top of the rolls, as any great pressure will cause them to slip on the bottom rolls and make uneven work. All that is necessary is to simply wipe them lightly and not retard their rotation.

Diameter of Fluted Rolls. The size of the fluted rolls, on most makes of drawing frames for ordinary length staple cotton, is shown in Figure 152. Sometimes this is varied and the back

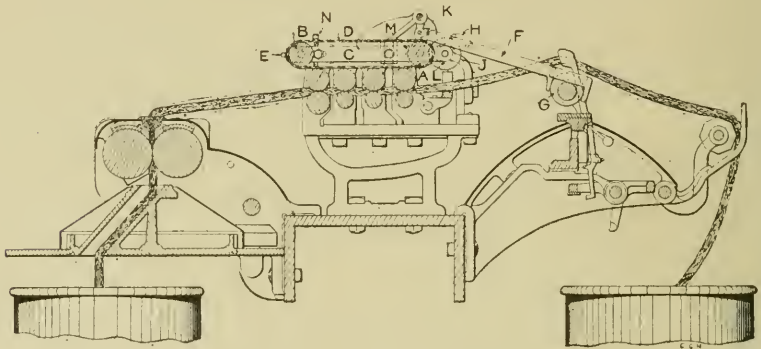

Fig. 151. Revolving Top Clearer.

roll is made one and three-eighths inches in diameter instead of one and one-eighth inches diameter.

As a rule, when the frame is to be used for long staple cotton, the rolls are made larger in diameter, as the large rolls lessen to some extent the trouble from roller laps. The most common sizes are shown in Figures 153.

For very short lap cotton, and when a large percentage of waste is to be used, the rolls are made of the diameters indicated in Figure 154.

Setting of Rolls. In regard to setting the fluted rolls, no exact rule can be given except that the distance between the centers of the front and second rolls should be from one-quarter to three-eighths of an inch more than the average length of staple being worked, and this distance is made greater between the centers of the second and third rolls, and still greater between the centers of the third and back rolls. Thus, in Figure 152, the distance be-

tween the centers of the front and second rolls is one and three-eighths inches, between the second and third rolls, one and one-half inches, and between the third and back rolls, one and five-eighths inches.

These distances vary under different conditions. If a sliver

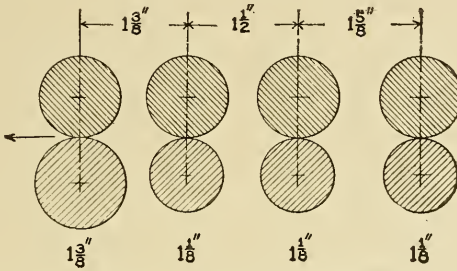

Fig. 152. Draft Rolls for Ordinary Length Staple Cotton.

of eighty grains is being run, the distance between the centers of the rolls should be greater than when running a fifty grain sliver. This is due to the fact that not only the fibers directly in contact with the bite of the roll are being drawn, but the surrounding ones are acted upon also, and as the mass of cotton in a heavy

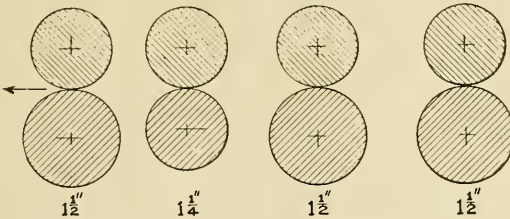

Fig. 153. Draft Rolls for Long Staple Cotton.

sliver is considerable, it is impossible to produce a sliver of even weight unless there is more space between the bite of the several pairs of rolls.

If the draft is short, the rolls may be set closer than when an excessive draft is used, but with a very long draft the rolls must be set more open. In all cases the speed must be reduced with a large draft or a large amount of waste will be made.

Top Rolls. There are two kinds of top rolls used, leather covered rolls and metallic rolls. The leather covered rolls are made in two styles, shell and solid. The shell roll, which is generally used for all four lines, is shown in Fig. 155. This roll is

made in three parts, the *arbor*, the *shell* and the *bushing*. The arbor is stationary and the shell revolves upon it. This gives a long bearing surface for the shell and a chance for a thorough lubrication of the arbor.

The ends of both arbor and bushing are made alike and are

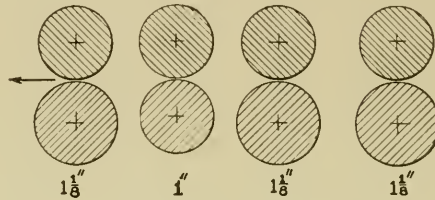

Fig. 154. Draft Rolls for Short Staple Cotton.

held in place in the slides of the roll stands. The shoulders, A, bear against the sides of the stands to prevent end movement to the rolls and the weight hooks are hung upon the necks of the rolls at B.

A section of the shell and bushing, in position upon the

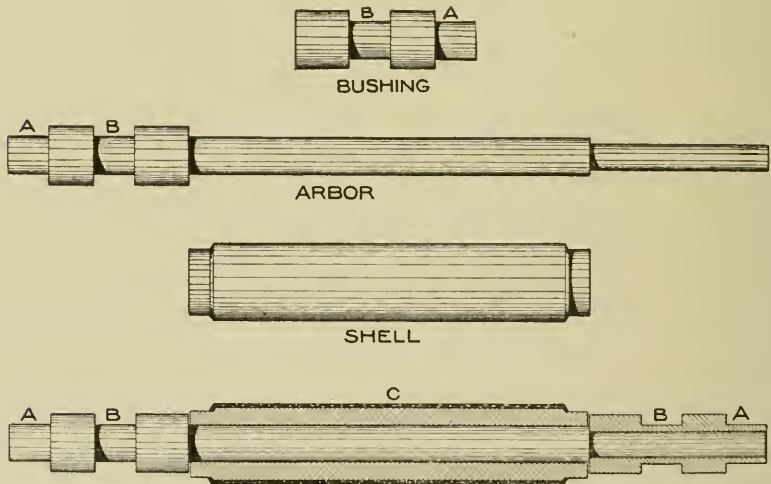

Fig. 155. Shell Top Roll.

arbor, is shown in the lower view of the drawing. The boss of the shell, C, is first covered with specially woven cloth and then with roller leather made from sheepskin.

The solid top roll, which is sometimes used, is the same in

outline as the shell roll. The weight hooks are hung in the same manner, but as the whole roll revolves, it necessitates oiling the neck of the roll where the weight hook bears.

The weighting is so arranged that the pressure may be removed from the top rolls when the machine is to stand idle for any length of time. This prevents the leather from becoming grooved by the flutes of the bottom roller.

As previously mentioned, the shell roll is generally used for all four lines, but for the back line a steel fluted roll, the same as the bottom roll, is sometimes used.

When metallic top rolls are used, the production of the drawing frame is greatly increased, owing to the fact that the flutes of the rolls interlock and the sliver, in passing between them, is made to follow the outline of the flutes. This point may be seen by examining Figures 156 and 157. The rolls are prevented from bottoming by collars, A, at each end of both top and bottom rolls.

If the sliver follows the exact outline of the flutes, a one and three-eighths front roll will deliver, in one revolution, five and seventy-four one-hundredths inches, while a common roll, of the same diameter, will deliver only four and thirty-one one-hundredths inches, which shows that the delivery of a metallic

roll is thirty-three per cent greater, but as a fact, unless the sliver is extremely light, it will not follow the outline of the flutes closely enough to deliver this amount. It is plain that on a heavy sliver, the thickness prevents the flutes from interlocking as deeply as with a light one; consequently, one revolution of the front roll will not

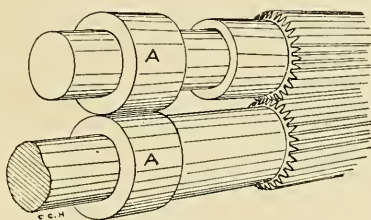

Fig. 156. Perspective View of Metallic Top Rolls.

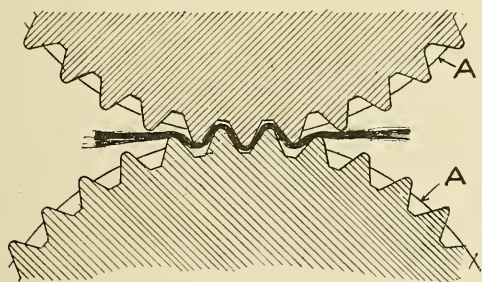

Fig. 157. Enlarged Section of Metallic Top Rolls.

deliver as great a length and, for this reason, it is impossible to figure the exact production of a drawing frame with metallic rolls. It is, however, safe to estimate from twenty-five to thirty-three per cent greater production than with the common roll.

The front metallic roll, one and three-eighths inches in diameter, is made with forty-four flutes, and in figuring the draft, this should be called $1\frac{1}{6}$ or $1\frac{5}{8}$ inches in diameter, which is thirty-three per cent greater than a common roll. The second roll, $1\frac{1}{8}$ inches in diameter, is made with thirty-six flutes and should be called $\frac{9}{8}$ or $1\frac{1}{8}$ inches in diameter. The third roll, $1\frac{1}{8}$ inches in diameter,

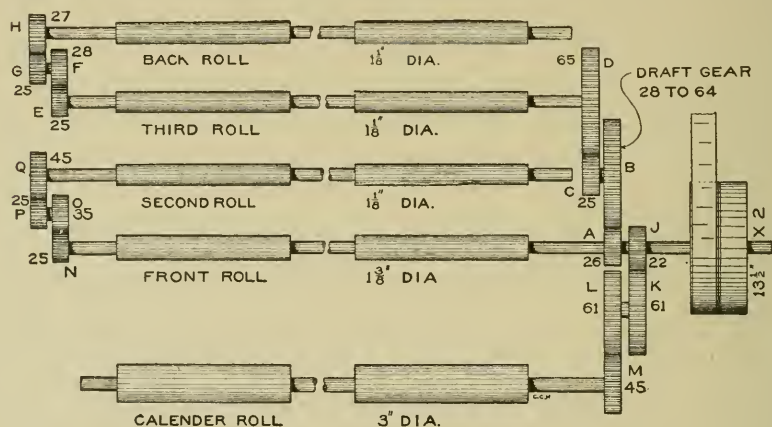

Fig. 158. Diagram of Drawing Frame Draft Gearing.

is made with twenty-seven flutes and should be called $\frac{9}{8}$ or $1\frac{1}{8}$ inches in diameter, and the back roll, $1\frac{1}{8}$ inches in diameter, is made with eighteen flutes and is called $1\frac{0}{8}$ or $1\frac{1}{8}$ inches in diameter. With these points, it is comparatively easy to figure the draft.

A diagram of the draft gearing is given in Fig. 158 from which the usual calculations may be made.

CALCULATIONS

Rule 1. To find the draft of the drawing frame between the calender rolls and the back roll: Multiply together the driven gears and the diameter of the calender rolls and divide the product by the product of the driving gears multiplied together with the diameter of the back roll. The driven gears are L, J, B, (draft change gear, 41 teeth) D, F and H, and the driving gears are M, K, A, C,

E and G. The diameter of the calender rolls is 3 inches and may be called 24, and the diameter of the back roll is $1\frac{1}{8}$ inches and may be called 9.

$$\text{Example: } \frac{61 \times 22 \times 41 \times 65 \times 28 \times 27 \times 24}{45 \times 61 \times 26 \times 25 \times 25 \times 25 \times 9} = 6.46$$

Rule 2. To find the draft factor: Proceed as in the above rule but omit the draft change gear, B.

$$\text{Example: } \frac{61 \times 22 \times 65 \times 28 \times 27 \times 24}{45 \times 61 \times 26 \times 25 \times 25 \times 25 \times 9} = 0.1576$$

Rule 3. To find the draft: Multiply the factor by the number of teeth in the draft change gear.

$$\text{Example: } 0.1576 \times 41 = 6.4616$$

Rule 4. To find the number of teeth in the draft gear: Divide the required draft by the factor.

$$\text{Example: } \frac{6.4616}{0.1576} = 41.$$

The draft of the drawing frame is divided between the rolls in the following manner: Between the front roll and the second roll, it is 3.08 draft and may be found by applying the same rule as for the total draft.

$$\text{Example: } \frac{45 \times 35 \times 11}{25 \times 25 \times 9} = 3.080$$

An examination of the diagram of the gearing, Fig. 158, will show that the draft between the front and second rolls is not affected by changing the total draft of the machine, and unless the total draft is made unusually short, the draft between these rolls is not changed, but, between the second and third rolls, the draft is affected when changing the draft gear, B. Thus, with a 41 tooth draft gear, which is correct for a total draft of 6.46, the draft between the second and third rolls is 1.626.

$$\text{Example: } \frac{25 \times 25 \times 41 \times 65 \times 9}{45 \times 35 \times 26 \times 25 \times 9} = 1.626$$

The draft between the third and back rolls is 1.209 and is not affected by changing the total draft as the back roll is driven from the third.

$$\text{Example: } \frac{27 \times 28 \times 9}{25 \times 25 \times 9} = 1.209$$

Between the front fluted rolls and calender rolls there is a slight draft which can be regulated by changing the gear, L. of 61 teeth.

Example:
$$\frac{24 \times 61 \times 22}{45 \times 61 \times 11} = 1.066$$

The total draft may be found by multiplying together the draft between the rolls.

Example: $3.080 \times 1.626 \times 1.209 \times 1.066 = 6.45 +$

Rule 5. To find the production of the drawing frame: Multiply together the number of revolutions of the front roll per minute (300), the number of inches delivered by the calender rolls at each revolution of the front roll (4.60), the number of minutes run per day (600) and the weight of the sliver in grains per yard (60). Divide the product by the number of grains in one pound (7,000) multiplied by the number of inches in one yard (36).

In figuring the production of the drawing frame, the number of inches, delivered by the calender rolls at each revolution of the front roll, should be considered as there is a draft of 1.066 between them with a 61 tooth gear at L. The calender rolls deliver 4.60 inches at each revolution of the front roll.

Example:
$$\frac{300 \times 4.60 \times 600 \times 60}{7000 \times 36} = 197.14$$

From the number of pounds given in the above example there should be deducted about 20 per cent for time lost in cleaning, oiling and piecing broken ends.

Rule 6. To find the factor for the production of the drawing frame: Proceed as in Rule 5, but omit the revolutions of the front roll and the weight of the sliver.

Example:
$$\frac{4.60 \times 600}{7000 \times 36} = .1095$$

Rule 7. To find the production with the factor given: Multiply the factor by the number of revolutions of the front roll and the weight of the sliver.

Example: $.1095 \times 300 \times 60 = 197.1$

Rule 8. To find the draft necessary to make a sliver of a certain weight: Multiply together the number of slivers entering at the back of the drawing frame (6) by their weight in grains per

yard (60) and divide by the weight in grains per yard of the sliver being delivered.

$$\text{Example: } \frac{60 \times 60}{60} = 6.$$

Rule 9. To find the weight of the sliver being delivered: Multiply together the number of slivers entering at the back (6) by their weight in grains per yard (60) and divide by the draft (6).

$$\text{Example: } \frac{6 \times 60}{6} = 60.$$

To find the draft of the railway head: Proceed as in Rule 1. A diagram of the gearing is given in Fig. 138. The draft change gear is on the end of the top cone shaft and the cone belt should be considered midway of the ends of the cones when the diameters of both are equal. The driven gears are S, P, E and G (draft change gear 40 teeth) front roll $1\frac{1}{2}$ inches diameter. The driving gears are R, Q, F and H, and the back roll is $1\frac{1}{8}$ inches diameter.

$$\text{Example: } \frac{60 \times 30 \times 72 \times 40 \times 12}{27 \times 32 \times 37 \times 36 \times 9} = 6.$$

It is usually customary to also change the draft between all of the rolls when changing the total draft of the railway head. Between the back and third rolls, this change is effected by changing the gear, B, and between the third and second rolls by changing the gear, C. The table shown herewith gives the correct gears for the changes in draft.

TABLE OF CHANGE GEARS

Draft.	No. of Teeth in Gear G.	No. of Teeth in Gear B.	No. of Teeth in Gear C.	Draft.	No. of Teeth in Gear G.	No. of Teeth in Gear B.	No. of Teeth in Gear C.
2.10	14	32	24	4.20	28	57	32
2.23	15	32	24	4.35	29	58	33
2.40	16	34	25	4.50	30	61	34
2.55	17	37	26	4.65	31	63	34
2.70	18	37	26	4.82	32	66	35
2.86	19	40	27	4.95	33	67	35
3.00	20	42	28	5.10	34	68	35
3.15	21	42	28	5.25	35	71	36
3.30	22	45	29	5.40	36	72	36
3.45	23	47	30	5.55	37	73	37
3.60	24	50	30	5.70	38	74	37
3.75	25	52	31	5.87	39	74	37
3.90	26	53	31	6.00	40	74	37
4.05	27	55	32				

FLY FRAMES.

In the process which follows drawing, the machines employed are called fly frames or roving machines. The fly frame continues the drawing process, but the cotton is manipulated in a

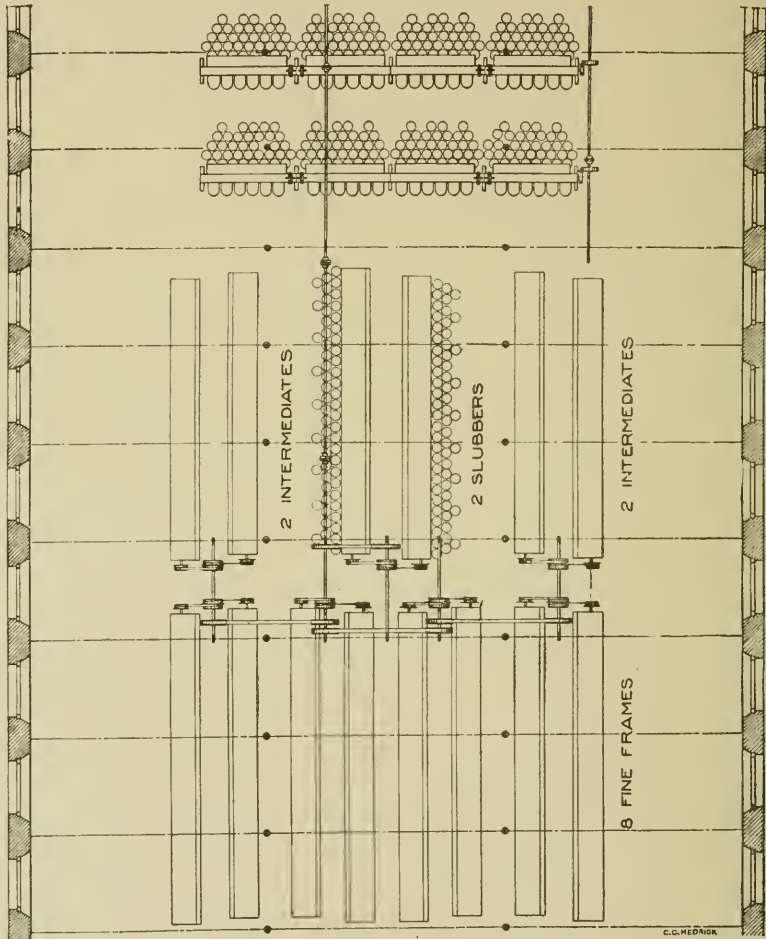

Fig. 150. Plan of Card Room Showing Fly Frames.

different manner. Two, three, and sometimes four machines are necessary, depending upon the number of yarn it is intended to finally spin, as the cotton from the roving machine goes directly to the spinning frame.

The machines are practically the same in mechanical detail, differing only in size and weight. The machine first used is called

the slubber, the second is the intermediate, and the third is called the fine frame. When a fourth is necessary to reduce the cotton to the correct weight, it is called the jack frame.

The fly frames may be arranged longitudinally or transversely of the mill. The most common arrangement is shown in Fig. 159. In this illustration there are three processes. The slubbers are placed, as a pair, directly in front of the drawing frames, the intermediates are placed on each side of the slubbers and the fine frames extend across the mill in an adjoining row.

When practicable, each pair of machines should be driven from the same counter shaft pulley, which has two faces divided by a flange. The counter shaft should be placed about over the

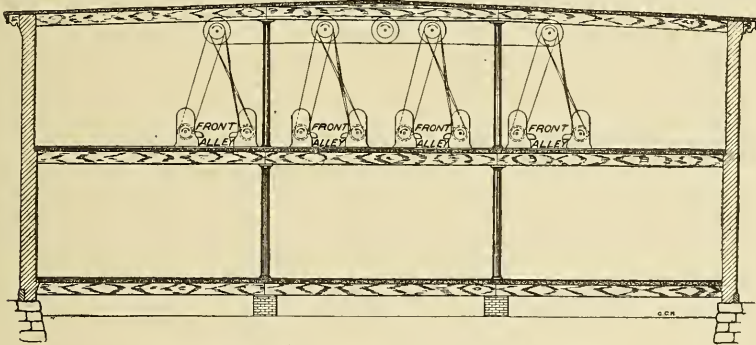

Fig. 160. Sectional Elevation Showing Fly Frames.

center of the front or work alley. The reason for this is very apparent if we examine Fig. 160, which is a sectional elevation showing the fine frames illustrated in the previous drawing. The driving pulleys, which are near the back side of the machine, turn toward the back, which necessitates a cross belt for one and a straight or open belt for the other. With the counter shaft over the work alley, the point where the belts separate is high enough to allow passage beneath, but if the shaft were in the back alley, there would not be passage room.

Before entering upon a description of the fly frame, the methods of numbering yarns and roving and the tables of weights and measures, used in cotton manufacturing, should be fully understood.

In all processes, up to the present one, reference has been made to cotton as weighing a certain number of grains or ounces

per yard. After it has passed through the slubber, it is called roving and the weight is based upon the number of hanks, of 840 yards each, there are in one pound.

The English table of weights is a combination of avoirdupois and troy weights and enables a very fine adjustment to be made.

TABLE OF WEIGHT.

24 grains	=	1 pennyweight (dwt.)		
437.5 "	=	18 "	+	$5\frac{1}{2}$ grains = 1 ounce.
7000 "	=	291 "	+	16 grains = 1 pound.

TABLE OF MEASURE.

1.5 yards	=	1 thread.
120 yards	=	80 threads = 1 skein.
840 yards	=	560 threads = 7 skeins = 1 hank.

If we measure 840 yards of roving and find that it weighs one pound, it is called one hank and weighs, per yard, 8.33 grains.

$$7,000 \div 840 = 8.33$$

If there are 1680 yards in one pound, it is called two hank, and weighs, per yard, just half as much as one hank, or 4.16 grains.

$$7,000 \div 1680 = 4.16$$

If 420 yards weigh one pound, it is half hank and weighs 16.66 grains per yard.

Number 1 roving, or one hank, and number 1 yarn weigh the same per yard, but as the roving is twisted so much less than the yarn, it appears to be much heavier.

For convenience and on account of the extreme delicacy of roving, it is customary, in actual practice, to measure twelve yards to ascertain the weight. The reason for taking just this length is as follows: There are 840 yards in a hank and twelve yards is $\frac{1}{70}$ of this amount and if we divide twelve yards by $\frac{1}{70}$ of a pound (100 grains), we get the same result as if we should weigh the whole hank.

12 yards	=	$\frac{1}{70}$ of a hank or 840 yards.
100 grains	=	$\frac{1}{70}$ of a pound or 7,000 grains.

The following table gives the weight and standard twist for roving from .25 hank to 20.00 hank.

ROVING TABLE.

Hank Roving.	Grains per Yard.	Twist per Inch.	Hank Roving.	Grains per Yard.	Twist per Inch.
.25	33.33	.60	2.00	4.16	1.70
.30	27.77	.65	2.25	3.70	1.80
.35	23.80	.70	2.50	3.33	1.90
.40	20.83	.75	2.75	3.30	1.99
.45	18.51	.80	3.00	2.78	2.08
.50	16.66	.84	3.50	2.38	2.24
.55	15.15	.88	4.00	2.08	1.40
.60	13.88	.92	4.50	1.85	2.55
.65	12.82	.95	5.00	1.67	2.68
.70	11.90	1.00	6.00	1.39	2.92
.75	11.11	1.04	7.00	1.19	3.18
.80	10.42	1.07	8.00	1.04	3.40
.85	9.80	1.11	9.00	.92	3.60
.90	9.26	1.14	10.00	.83	3.79
.95	8.77	1.17	11.00	.76	3.97
1.00	8.33	1.20	12.00	.69	4.15
1.10	7.58	1.26	13.00	.64	4.33
1.20	6.94	1.31	14.00	.59	4.49
1.30	6.41	1.37	15.00	.55	4.65
1.40	5.95	1.42	16.00	.52	4.80
1.50	5.55	1.47	17.00	.49	4.95
1.60	5.21	1.52	18.00	.46	5.09
1.70	4.90	1.56	19.00	.43	5.23
1.80	4.63	1.61	20.00	.42	5.37
1.90	4.38	1.65			

The Slubber receives the cans of sliver at the back, from the last drawing frame and it is put through the machine and wound upon bobbins. These bobbins are then placed in the creel of the intermediate frame and the roving is put through the same process and delivered to the creel of the fine frame, where the operations which occur on the other machines are repeated.

A section of a fine frame is given in Fig. 161. The bobbins, A, are placed in the creel, two ends for each spindle. The roving passes around the rod, B, and through the trumpets, or guides, C, and is drawn between the draft rolls, D, E and F. From the front roll it passes to the nose of the flyer, G, through the hole, H, and down one leg of the flyer and through the eye of the presser, K, and is finally wound upon the bobbin, L.

The flyers, of which there are two rows, fit snugly in the top of the spindle, J, and revolve with it. This causes the roving to be twisted, which gives it sufficient strength to enable it to be wound upon the bobbins.

The spindles are stationary so far as any vertical movement is concerned. They rest in steps, M, which are carried by the step rail, K¹.

The bobbins, which are driven separately, from the spindles, are carried by the bobbin, or bolster rail, N, which is made to traverse

up and down so that the layers of roving shall be wound evenly.

A drawing of the spindles, bobbins and flyers is shown in Fig. 162. The upper part of the spindle is supported by the bolster, P,

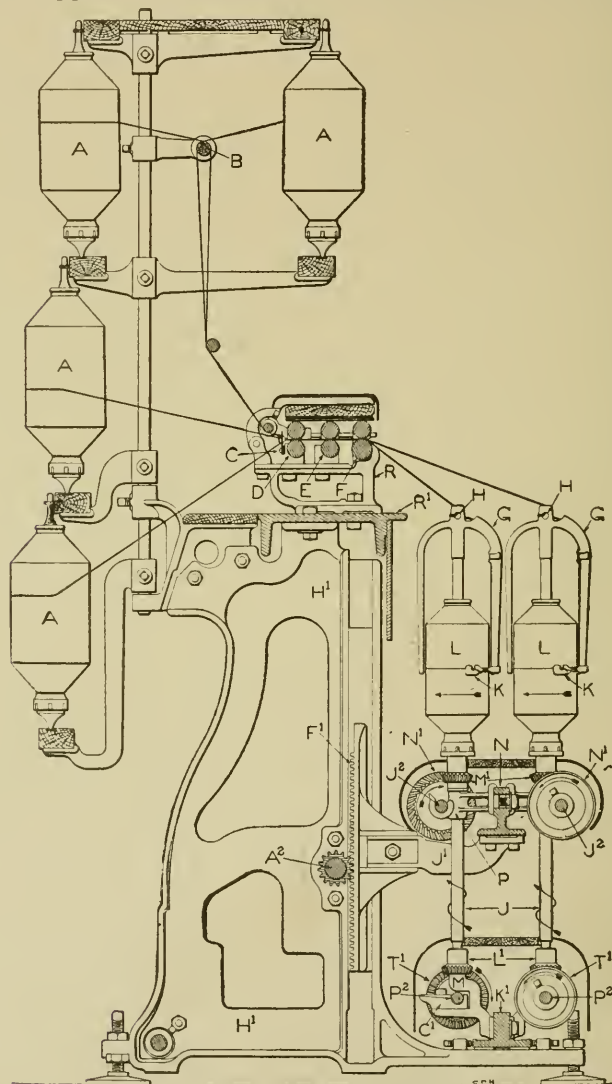

Fig. 161. Sectional Elevation of Fine Fly Frame.

which is fastened to the bobbin rail and the bobbin, which seems to be upon the spindle, is simply a loose fit around the bolster.

The spindles are driven from the spindle shaft, P², by the

bevel gears, L^1 and T^1 , and the bobbins are driven from the bobbin shaft, J^2 , by the bevel gears, M^1 and N^1 . The gear, M^1 , revolves upon the bolster and the bobbin, which is slotted on the bottom, is driven from the gear by a pin which fits into one of the slots. The bobbin revolves between the arms of the flyer and in the same direction as the flyer, but to wind the roving, it must run faster or slower than the flyer.

Flyer Lead and Bobbin Lead. The front roll delivers the roving at a constant speed which accords to the hank being spun, and the roving must be wound upon the bobbin at the same speed by which it is delivered. There are two ways by which this is accomplished: "The Flyer Lead" and "The Bobbin Lead". The first mentioned is the older method and is used upon the "Speeder", a machine which corresponds to the fly frame and may be found in operation in some mills at the present time.

With the "Flyer Lead", the flyer is run at a constant speed, which is greater than that of the bobbin and the roving is wrapped upon the surface of the bobbin by the excessive speed of the flyer. As the bobbin increases in diameter, its speed must be accelerated so that it shall wind the same length that the front roll delivers.

With the "Bobbin Lead" which is used upon the fly frame, the flyer is run at a constant speed but less than that of the bobbin. The roving is drawn onto the surface of the bobbin by the excess of its speed over that of the flyer, and as the bobbin increases in diameter, its speed must be decreased gradually.

It would seem that, with the "flyer lead," to increase the speed of the bobbin would cause a greater length of roving to be wound

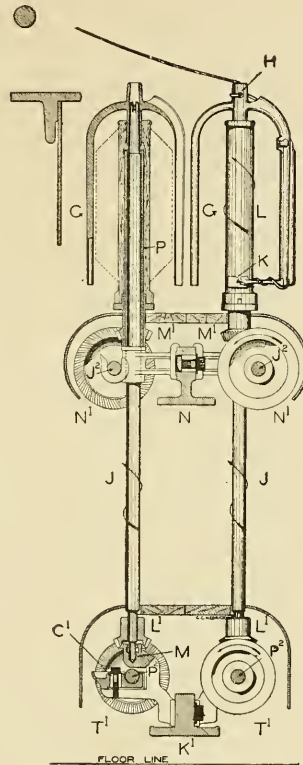

Fig. 162.
Enlarged View of Spindles.

and, as this is puzzling to many, it will bear further explanation.

We will call the speed of the flyer 200 R.P.M. and the speed of the empty bobbin, which is one inch in diameter, 100 R.P.M. As the circumference of a one inch bobbin is $3.14+$ inches, each revolution that the flyer makes, more than the bobbin, will wind $3.14+$ inches of roving, and while the flyer is making two hundred revolutions, $314+$ inches of roving will be wound upon the bobbin.

When the bobbin is two inches in diameter, its circumference is $6.28+$ inches, and if the flyer and the bobbin continue to run at

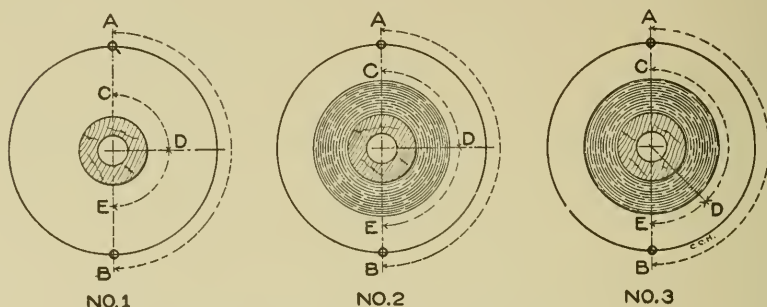

Fig. 163. Diagram Illustrating Flyer Lead.

the same relative speed, two hundred revolutions of the flyer will cause 628 inches of roving to be wound.

The diagrams, shown in Fig. 163, will help to make this plain. Number 1 shows the flyer as having made one-half of a revolution, from A to B, and the empty bobbin, which we will call one inch in diameter, one-quarter of a revolution, from C to D. The length of roving wound will be equal to the distance around the barrel of the bobbin from D to E, which is one-quarter of its circumference or about .78 of an inch.

Number 2 shows the bobbin as two inches in diameter; the flyer has made one-half of a revolution, from A to B, and the bobbin has made one-quarter of a revolution, from C to D. The length wound is indicated by the distance measured around the bobbin, from D to E, which is 1.57 inches; twice as much as the empty bobbin.

Now, as the speed of the flyer is constant and the length of roving delivered is always the same, it is evident that the amount, wound upon the bobbin, can be only what is delivered by the front roll and as the larger the bobbin grows the greater is its circum-



ROVING FRAME — FRONT VIEW
Howard & Bullough Am. Machine Co. (Ltd.)

ference, the only way that the same length of roving can be wound is by increasing the speed of the bobbin so that the same ratio in its

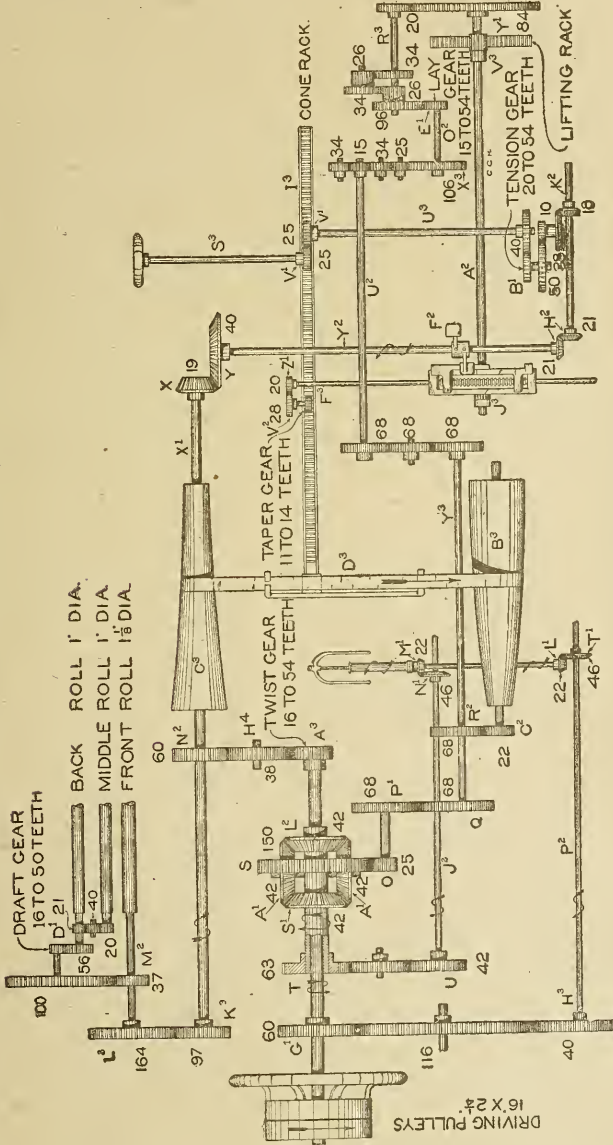

Fig. 164. Diagram of Fly Frame Gearing.

circumferential velocity shall be maintained at all times between it and the flyer.

Number 3 shows the bobbin as two inches in diameter, and, in order to wind the proper length of roving, it will have to make about three-eighths of a revolution. The length wound is represented by the distance, D-E, which, measured on the circumference of the bobbin, will be found to be the same as the distance D-E, in the first diagram.

The bobbin lead needs no further explanation than has been already given; the larger the bobbin grows, the slower it must run to wind the roving at the same speed, at all times.

Gearing. The reduction in the speed of the bobbin is accomplished by a pair of cones in connection with the differential gear, and to enable the student to follow clearly the gearing diagram, Fig. 164 has been made.

Speed of Flyer. The speed of the driving shaft, which is constant, is 400 R.P.M., and the flyers are driven from the driving shaft by the gears, G¹, H³, T¹ and L¹. They therefore run 1254.54 R.P.M.

$$\frac{60 \times 46 \times 400}{40 \times 22} = 1254.54$$

Speed of Front Roll. The front roll, which is 1½ inches in diameter, is also driven from the driving shaft by the gears, A³, N², K³ and L³. The speed of the front rolls remains constant, except when a change is made in the number of roving being spun. This is accomplished by changing the number of teeth in the twist gear, A³. For 3.50 hank roving, the twist gear should have 40 teeth. The speed of the front roll, therefore, is 157.72 R.P.M.

$$\frac{40 \times 97 \times 400}{60 \times 164} = 157.72 +$$

Speed of Empty Bobbin. The barrel of the empty bobbin is 1¾ inches in diameter and to wind onto its surface the roving delivered by the front roll, it must make 129.03 R.P.M.

$$\frac{157.72 \times 1.125 \text{ (diameter of the front roll)}}{1.375 \text{ (diameter of empty bobbin)}} = 129.03.$$

As we have seen, the speed of the flyer is 1254.54 R.P.M., and the speed of the empty bobbin, necessary to wind the roving, is 129.03 R.P.M.

Now, as the bobbins run at a greater speed than the flyers, the

actual speed of the bobbins must be added to that of the flyers. This will give 1383.57 R.P.M.

Revolutions of flyers	1254.54
Revolutions of empty bobbins necessary to wind roving	129.03
Actual revolution of empty bobbins	<u>1383.57</u>

When the bobbin is full, it is $3\frac{1}{2}$ inches in diameter and to wind the roving, it must make 50.69 R.P.M.

$$\frac{157.72 \times 1.125 \text{ (diameter of front roll)}}{3.5 \text{ (diameter of full bobbin)}} = 50.69 +$$

To this speed should be added, as before, the revolutions of the flyer, which makes the actual speed of the full bobbin 1305.23 R.P.M.

Revolutions of full bobbin required to wind roving	50.69
Revolutions of flyers	1254.54
Actual revolutions of full bobbin	<u>1305.23</u>

The next step is to find the revolutions of the sleeve gear, T, when winding upon the bare bobbin. The gears in the train are M¹, N¹, U and T. The sleeve gear makes 441.13 R.P.M.

$$\frac{1383.57 \times 22 \times 42}{46 \times 63} = 441.13$$

With the full bobbin, the revolutions of the sleeve gear will be 416.16 R.P.M.

$$\frac{1305.23 \times 22 \times 42}{46 \times 63} = 416.16$$

Now, we must find the revolutions of the sun wheel, S, but before this is done, it will be necessary to refer to the compound, or differential gearing shown in an enlarged view in Fig. 165. The purpose of this train of gears is to connect the positive driving of the flyers with the necessarily varying speed of the bobbins by a pair of cones and a belt.

The sleeve gear, T, runs upon a bushing on the driving shaft, and turns in the opposite direction from it, as indicated by the arrows. The two mitre gears, A¹, of forty-two teeth, are carried by a cross, the extended arms of which form bearings for the gears to turn upon. The sun wheel and cross are fastened together and

turn upon a bushing on the driving shaft, the same as the sleeve gear. The mitre gear, L^2 , is fast upon the driving shaft and the mitre gear, S^1 , is fast upon the hub of the sleeve gear.

The gears, S^1 and L^2 , turn in opposite directions and, if they are run at the same speed, the sun wheel will remain stationary. But if S^1 is run at a greater speed than L^2 , each revolution it makes in excess of L^2 will cause the sun wheel to make one-half of a revolution in the same direction as S^1 .

To illustrate this: If S^1 is given four revolutions and L^2 , two

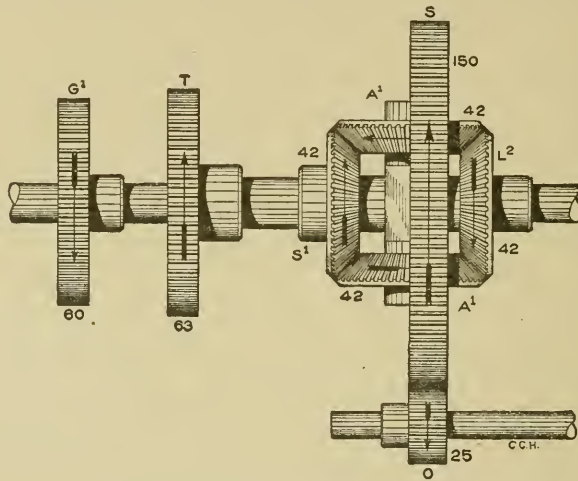

Fig. 165. Fly Frame Differential Gearing.

revolutions, in the opposite direction, the sun wheel will turn one revolution or one-half the difference between the revolutions of the gears, S^1 and L^2 , but in the direction of S^1 .

The speed of the driving shaft is 400 R.P.M. and, as we have found, the speed of the loose sleeve is 441.13 R.P.M. but in the opposite direction. The sun wheel, then, must make 20.56 R.P.M., which is one-half the difference between the speed of the driving shaft and the speed of the sleeve gear.

With the full bobbin, the sleeve gear makes 416.16 R.P.M., which is 16.16 revolutions more than the speed of the driving shaft. The speed of the sun wheel will be 8.08 R.P.M., a difference of only 12.78 revolutions between the full and the empty bobbin.

We must find next the revolutions of the bottom cone, B^3 , for

both the full and the empty bobbin. The sun wheel is driven from the bottom cone by the gears, C², R², Q, P¹ and O. Starting with 20.56 revolutions we get 187.04 + R.P.M. for the bottom cone.

$$\frac{20.56 \times 150 \times 68 \times 68}{25 \times 68 \times 22} = 381.29 +$$

With the full bobbin, the speed of the bottom cone will be 149.84 + R.P.M.

$$\frac{8.08 \times 150 \times 68 \times 68}{25 \times 68 \times 22} = 149.84 +$$

Cones. We will find next the sizes the cones must be to give the necessary range in speed. The top or driving cone, C³, is driven from the driving shaft by the gears, A³, H⁴ and N². A³ is the twist gear, as already mentioned. The speed of the top cone is 266.66 + R.P.M.

$$\frac{400 \times 40}{60} = 266.66 +$$

The diameter of the large end of the top cone is six inches and the small end three inches. The bottom cone is the same in diameter at the ends as the top cone. With the cone belt upon the large end of the top cone, the speed of the bottom cone will be 533.33 + R.P.M.

$$\frac{266.66 \times 6}{3} = 533.33 +$$

With the cone belt at the small end of the top cone, the speed of the bottom cone will be 133.33 + R.P.M.

$$\frac{266.66 \times 3}{6} = 133.33 +$$

With the cones of the diameter, at the ends, as given above, the difference in the extreme speeds of the bottom cone is 400 R.P.M. and the difference in the speeds, required to wind a full bobbin, is 231.45 R.P.M.

The cones may be made any diameter or length consistent with the allotted space in the machine, but the difference between the diameters of the small and large ends must be more than enough to give the extreme speeds necessary to wind a bobbin.

The faces of the cones are curved, the top cone concave and the bottom cone convex.

The cone belt is upon the large end of the top cone when the winding begins and, as each successive layer of roving is added, it is shifted a little distance along the cones, according to the hank roving, being spun. With coarse numbers, the size of the bobbin increases rapidly, and it requires a greater movement of the cone belt than when fine numbers are being spun.

To illustrate this: A pair of cones and four bobbins, in different

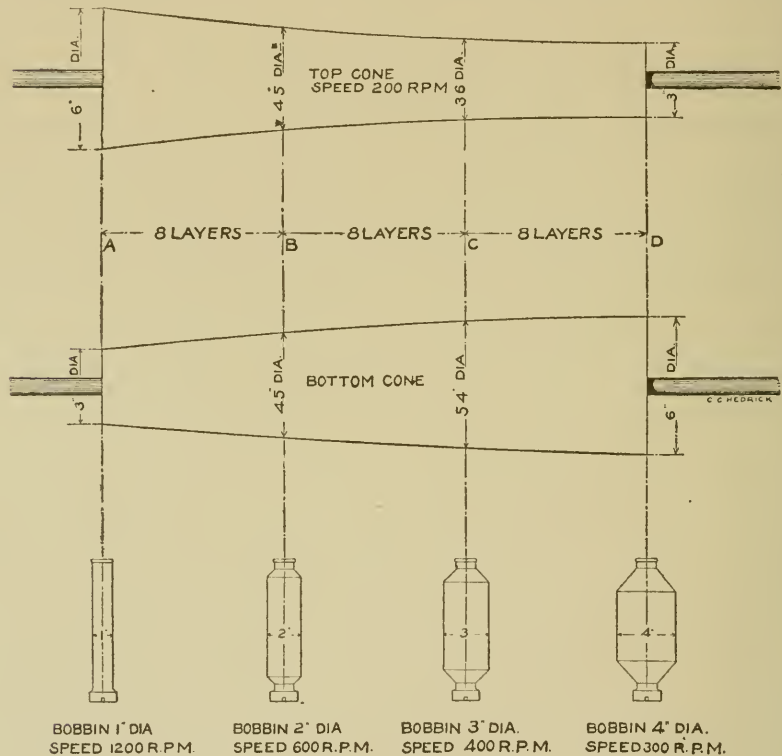

Fig. 166. Diagram of Cones.

stages of building, are shown in Fig. 166. The diameter of the empty bobbin is one inch and that of the full bobbin, four inches. The roving, which we will call one-sixteenth inch in diameter, will add one-eighth of an inch to the diameter of the bobbin for each layer wound.

We will call the speed of the empty bobbin 1200 R.P.M., which is three times that of the bottom cone and, as the bobbin is 3.14 +

inches in circumference, there will be wound 3768 inches of roving.

$$3.14 \times 1200 = 3768.$$

When eight layers have been added, the bobbin will be two inches in diameter or 6.28+ inches in circumference and to wind 3768 inches of roving, its speed must be 600 R.P.M.

$$\frac{3768}{6.28} = 600.$$

The belt will have made eight shifts along the cone, from A to B, and the speed of the bottom cone will be 200 R.P.M.

When sixteen layers of roving have been wound the diameter of the bobbin will be three inches and the circumference will be 9.42 inches. To wind 3768 inches, its speed must be 400 R.P.M.

$$\frac{3768}{9.42} = 400.$$

The belt will have moved from B to C and the speed of the bottom cone will be 133.33 R.P.M.

When the bobbin is full, twenty-four layers have been added to make four inches in diameter and its circumference will be 12.56 + inches. The speed must be 300 R.P.M.

$$\frac{3768}{12.56} = 300.$$

The movement of the cone belt, from A to B, is one-third the length of the cones, but the speed of the bobbin decreases one-half, from 1200 to 600 R.P.M. From B to C the distance is one-third and the bobbin decreases in speed from 600 to 400 R.P.M., only one-third. The remaining distance, C-D, is one-third and the speed decreases from 400 to 300 R.P.M. or one quarter the number of revolutions.

If the roving were twice the diameter, it would be necessary to shift the cone belt just twice as far along the cones and there would be four layers, only, for each inch added to the diameter of the bobbin.

Reversing Motion. The reversing motion, commonly called rail motion and traverse motion, is the mechanism employed to change the direction of the bobbin rail at each end of the traverse.

At the beginning of a set, the rail moves its greatest distance and the roving is wound nearly the whole length of the bobbin, as shown in

Fig. 167, by the distance C—D. As each layer is added, the traverse of the rail is shortened, slightly, until, at the completion of the building of the bobbin, it is a little more than one-half as much as at the start. This is shown by the distance E—F. The amount that the traverse is shortened is governed by the taper gear F^3 (shown in Fig. 168), and the speed that the rail is traversed, by the lay gear E^1 .

It is desirable to get as much roving upon a bobbin as possible, as the machine will not have to be doffed as often but, at the same time, if the traverse is not shortened enough, the ends of the bobbins will be too square, and the layers of roving will be apt to "slough off" and the roving break when unwound.

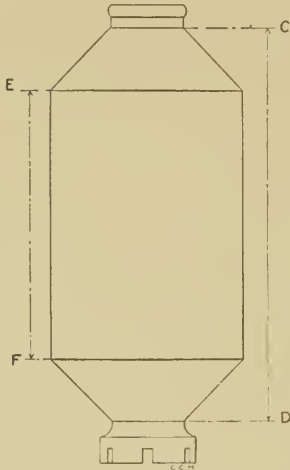

Fig. 167. Fly Frame Bobbin.

The reversing motion is shown in Figs. 168, 169, 170, 171 and 172.

On the end of the top cone shaft, X^1 , is a bevel gear, X , of nineteen teeth and upon the top of the tumbling shaft, Y^2 , is a bevel gear, Y , of forty teeth, called the gap gear from the fact that several teeth are omitted on opposite sides in its diameter, leaving spaces in which the gear on the cone shaft can revolve without imparting motion to the tumbling shaft.

Lower, on the tumbling shaft is the tumbling dog, F^2 , and on the extreme lower end is a mitre gear, H^2 .

On the horizontal shaft, K^2 , called the reverse shaft, is the reverse crank, T^2 , starting cam, W , and mitre gear, H^2 . The last is in gear with the gear, H^2 , on the tumbling shaft.

Builder. The builder, which should be described in connection with the reversing motion, consists of a main piece, B^2 , builder screw, D^2 , with right and left threads, builder rack, I^2 , and top and bottom jaws, V , and, X^2 . A gear J^2 , which is upon the lifting shaft, A^2 , is in contact with the builder rack. The rotations of the lifting shaft cause the builder to slide up and down on the guide rod, W^1 .

On the stem of the builder screw is a gear, Z^1 , of twenty teeth, which is driven from a similar gear, V^2 , of twenty-eight teeth, which is upon the stud with the taper gear, F^3 . Motion is given to the builder

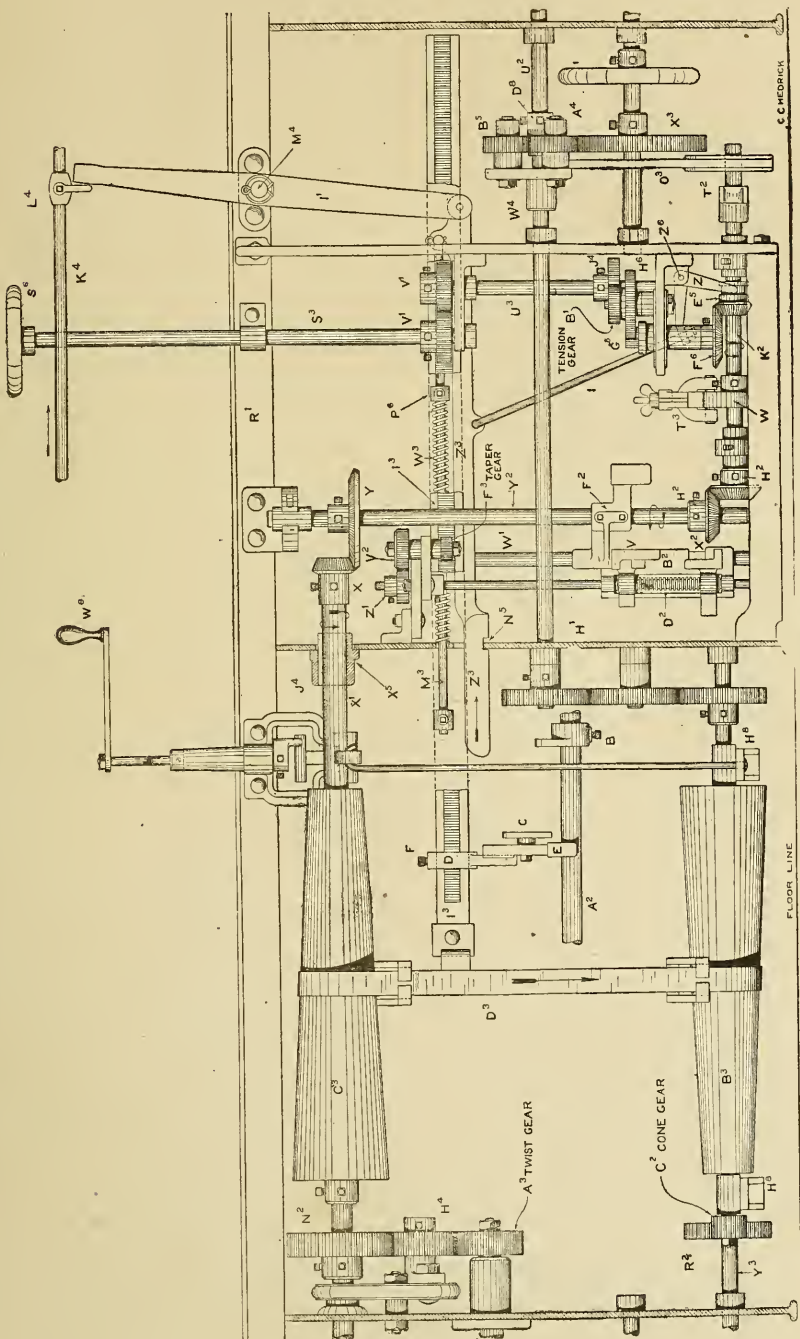

Fig. 168. Reversing Motion and Builder.

screw from the cone rack, I^3 , by the taper gear. At each end of the traverse, the builder screw is turned a trifle and the jaws are brought more closely together. The builder and parts directly connected are shown on an enlarged scale in Fig. 170.

When the bobbin rail is moving upward, the builder is moving in the opposite direction. In the drawing, Fig. 170, we will assume that the builder is going downward. The upper arm of the tumbling dog, F^2 , is pressed firmly against the top builder by the starting spring, U^1 . When the builder descends enough to clear the arm of the tumbling dog, several changes take place instantly.

The starting presser, T^3 , which is actuated by the spring, U^1 ,

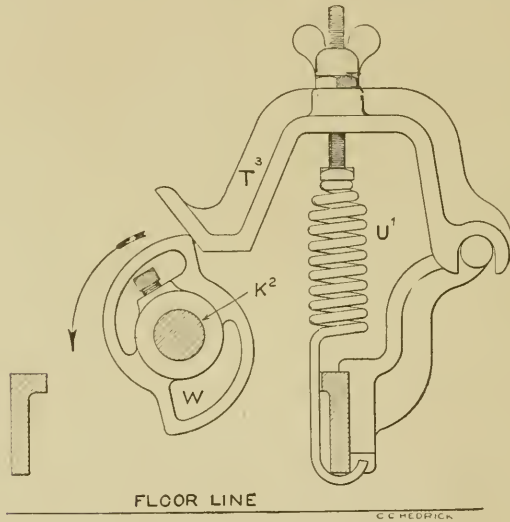

Fig. 169. Elevation Showing Starting Cam.

turns the tumbling shaft slightly so that the bevel on the top cone shaft, which is revolving rapidly, engages the toothed portion of the gap gear and gives the tumbling shaft one-half of a revolution.

The reverse shaft, which is driven from the tumbling shaft, also turns half around and shifts the reverse gearing, changing the direction of the bobbin rail.

The tension gearing, which is driven from the bevel gear, E^5 , on the reverse shaft, is turned a little and the cone rack is moved and shifts the belt along the cones.

The taper gear is driven from the cone rack, and is turned part of

a revolution, and the builder jaws are brought together more closely, thus shortening the traverse of the rail.

All these movements take place simultaneously, the half revolution of the tumbling shaft brings the opposite space in the gap gear

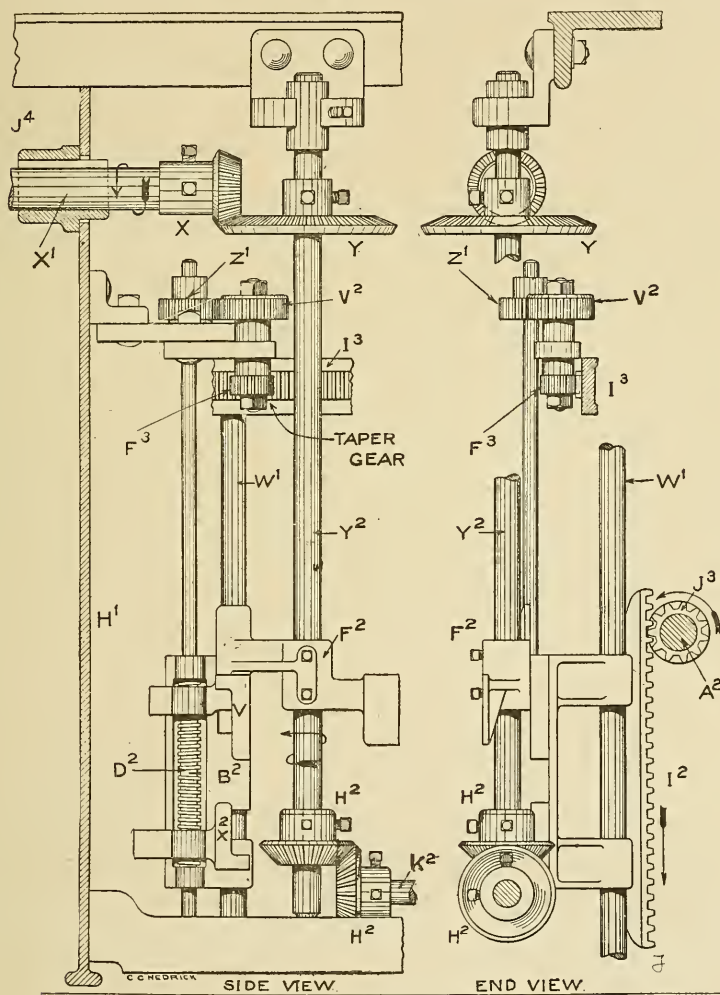

Fig. 170. Builder.

under the top cone shaft bevel, and the lower arm of the tumbling dog is brought up against the lower builder jaw, where it is held firmly by the starting cam and presser. This leaves the various parts in position to operate, when the end of the traverse is reached again.

The drawings of the reverse gearing, in Figs. 171 and 172, show the method employed to change the direction of the traverse of the rail.

On the reverse shaft, K^2 , is a crank, T^2 , which works in a slot in the end of the reverse arm, O^3 . The upper part of this arm is connected to a plate, W^1 , which is mounted upon the shaft, U^2 , and carries studs upon which are the gears, A^4 , B^5 and C^6 . The gear X^3 , is upon

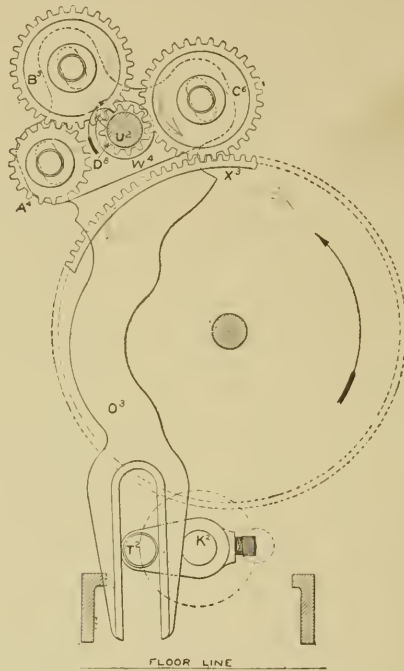

Fig. 171. Elevation Showing Reverse Crank and Gearing.

the lay shaft and D^8 is upon the shaft, U^2 . The connection of these shafts and gears with the lifting shaft is shown in the diagram of gearing (Fig. 164).

When the rail is rising, the lifting shaft is driven through the gears, D^8 and C^6 , and gear, X^3 , is turned in the direction, indicated by the arrow in Fig. 171. But when the reverse shaft makes the half revolution, the crank shifts the reverse arm, which turns about the shaft U^2 , as a center, to the position shown in Fig. 172. This throws C^6 out of contact with X^3 , and A^4 into contact with it, and X^3 is driven by the gears, D^8 , B^5 and A^4 , which results in changing the direction of the lay shaft, as may be seen by comparing the two drawings.

The teeth of X^3 , C^6 and A^4 are made pointed so that they may engage readily. This overcomes also, in a measure, the danger of breaking, always liable to occur with involute teeth if the points come into contact.

Tension gearing for fly frames is shown in Fig. 173 and, to make this drawing as simple as possible, all parts, which are not required in explaining the device, are omitted. Reference should also be made to Fig. 168.

The cone rack, I^3 , is driven from the reverse shaft, K^2 , by the gears, E^5 , F^6 , G^5 , H^6 , B^1 , J^4 and V^1 . The bevel, E^5 , is keyed to the reverse shaft but is free to slide in and out of gear with F^6 .

When the machine is started, the shipper rod, K^4 , is moved in the direction of the arrow and the dog, L^4 , comes in contact with the stop-motion arm, I^1 , which turns about the stud, M^4 . This moves the stop motion latch, Z^3 , so that the notch, N^5 , catches on the support, H^1 , and holds the latch in place.

The bevel, E^5 , is formed with an annular groove in which is a fork, Z , pivoted to a stand at Z^6 . The upright arm of the fork is connected with the stop motion latch by a rod, I . In starting the frame, the movement of the latch draws the gear, E^5 , into contact with F^6 . This completes the train of gears so that the half revolution of the reverse shaft, which takes place at each end of the traverse, causes the cone belt to be moved to a different place on the cone.

The gear, B^1 , is the tension gear, which is changed to give the correct distance that the cone belt must be moved, and, as this gear is a driver, the greater number of teeth it contains, the greater will be the distance that the cone belt is moved.

When the attendant wishes to stop the machine, the shipper rod

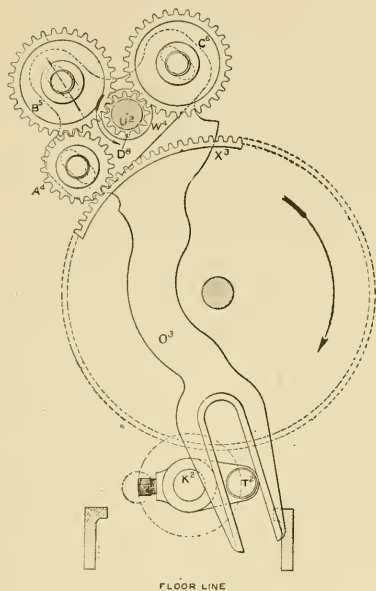

Fig. 172. Elevation Showing Reverse Crank and Gearing.

is moved in the opposite direction from that indicated by the arrow and the belt is shifted onto the loose pulley. This movement does not disconnect the train of gears, between the reverse shaft and cone rack as the stop-motion latch is not moved.

Full Bobbin Stop Motion. When the bobbin has reached its full diameter, it is stopped automatically, and while it is not necessary to

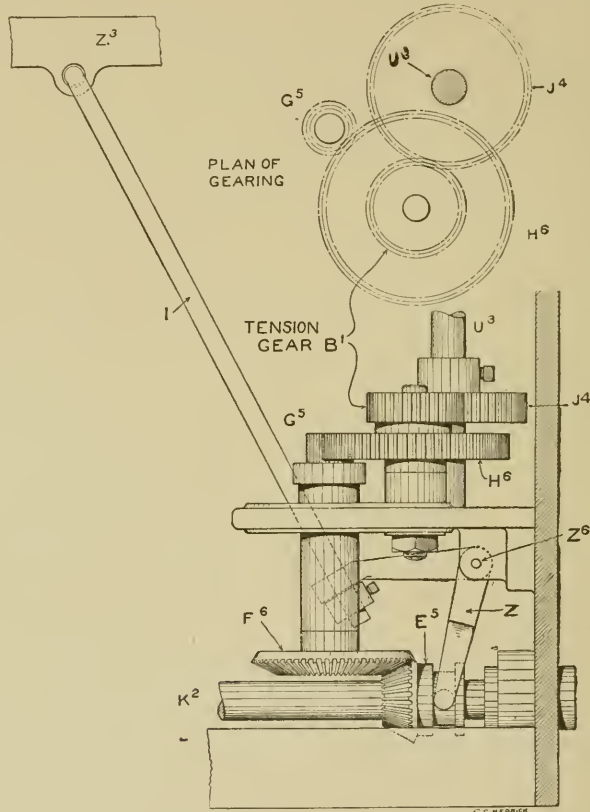

Fig. 173. Tension Gearing.

wait for this stop motion to operate before doffing, it acts as a safeguard, for, if the frame is allowed to run too long, there is danger of the builder jaws coming together, which often results in stripping the builder screw. There is also some difficulty in doffing, if the bobbin is too large.

This stop motion, which is shown in Figs. 174 and 175, and in the

drawing of the reverse motion and builder Fig. 168, consists of three pieces, a bracket, D, lifter, C, and cam, B.

The bracket, which is fastened to the cone rack, I^3 , by a screw, F, carries the lifter, and the cam is fastened to the lifting shaft, A^2 , at a point directly under the end of the stop-motion latch, Z^3 , which projects through the rectangular slot in the support, H^1 .

As the lifting shaft revolves, the cam is brought into contact with the lifter, forcing it upward against the underside of the stop-motion latch and lifting the latch so that the notch, N^5 , in its underside, is clear of the support.

The stop-motion spring, W^3 , is mounted upon the spring rod, M^3 . One end of the spring bears against the support and the other end

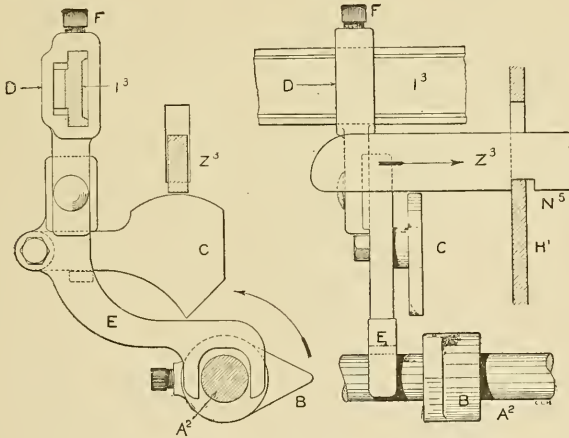

Fig. 174. Full Bobbin Stop Motion.

against a collar, P^6 , which is fastened to the rod and which may be set to increase or decrease the tension upon the spring. The free end of the spring rod passes through a hole in the support, and the other end is connected to the stop-motion latch.

When the notch in the latch is clear of the support, the spring rod pushes the latch in the direction shown by the arrow and this movement is communicated to the shipper rod by the shipper arm, I^1 .

When the frame is to be doffed, the attendant raises the bottom cone, B^3 , by turning the cone raise handle, W^8 , a half revolution. This leaves the cone belt free and the cone rack is moved back, for starting a new set of bobbins, by turning the hand wheel, S^6 . A collar on the

rack comes against a stop, which insures the belt starting in the same position, on the face of the cone, for each set.

When the stop motion operates, the movement of the lever, Z^3 , disconnects the tension gearing by sliding E^5 out of contact with F^6 . This allows the cone belt to be wound back which cannot be done with these gears in contact, and as the builder screw is driven from the cone rack, the winding back of the rack opens the builder jaws.

Before doffing, the frame is started with the bottom cone raised and a few inches of roving are delivered by the front roll to be used for

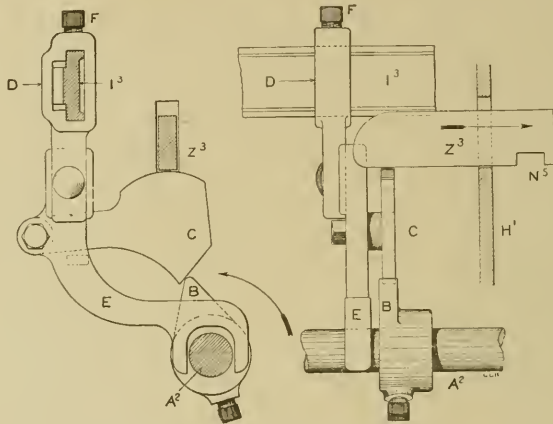
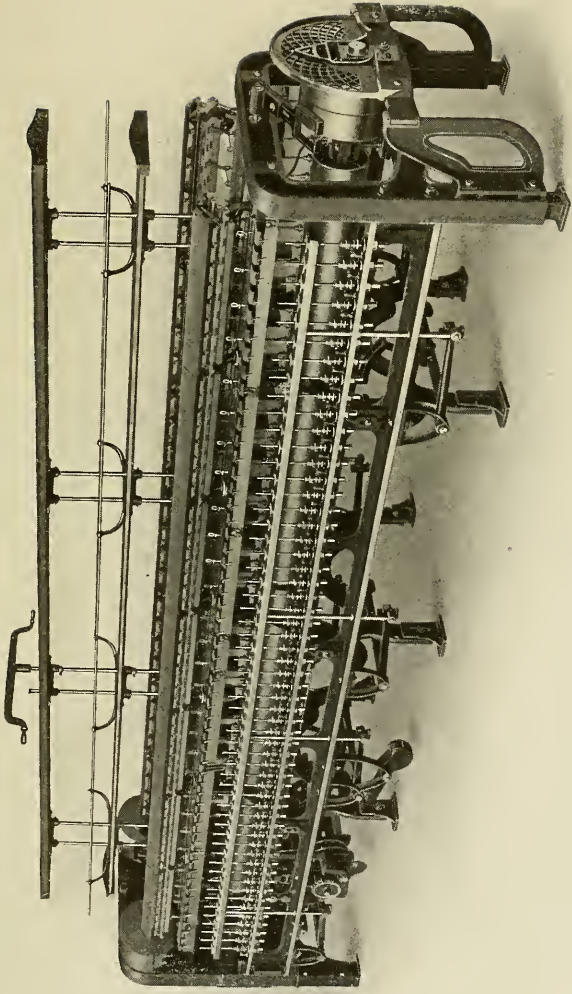

Fig. 175. Full Bobbin Stop Motion.

twisting around the empty bobbins. The bobbins are driven from the bottom cone through the differential gearing and, with the cone raised, they do not revolve, consequently, the roving is not wound.

The power for driving the bobbins and the traverse of the rail is transmitted through the cone belt and, for this reason, there must be as little slip as possible to this belt. The bottom cone is iron and it is carried in a frame, H^8 , called the cone swing frame. It is hung from the shaft, Y^3 . The weight of the cone hangs upon the cone belt, D^3 , and keeps it tight.

The connection, from the bottom cone to the gearing, is through the cone gear, C^2 , which has twenty-two teeth. This gear is sometimes changed when the diameter of the empty bobbin is so small that the difference in the diameters of the cones, with the belt upon the large end of the top cone, is not sufficient to wind the roving. When this is the case, a cone gear of more teeth is put on the cone, which causes



SPINNING FRAME DESIGNED FOR HIGH SPEED
Howard & Bullough Am. Machine Co. (Ltd.)

the bobbins to run at a greater speed. The cone belt is then shifted along the cones until the position of the belt is such that the roving "takes up" or winds correctly.

The taper gear, F^3 , has from eleven to fourteen teeth. This is a driven gear and the fewer teeth it has, the faster the builder jaws close. The end bearing, X^5 , for the top cone shaft, is open on the top so that the cone may lift, if the tops of the tee come together, when the gap gear is thrown in.

Back Stop Motion. Sometimes, a back stop motion is applied to the slubber, so the machine will stop when an end is out, but is not applied to any other fly frame. By many, a back stop motion is con-

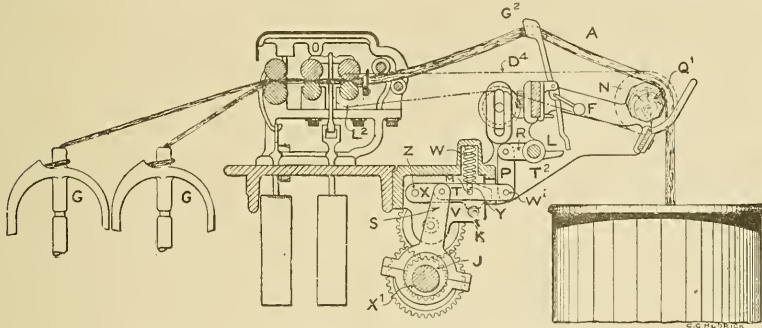

Fig. 176. Section of Fly Frame Showing Back Stop Motion.

sidered unnecessary because if there is none, the attendant will watch for a broken end in the sliver, and will anticipate a can becoming empty and piece the sliver onto a full can, whereas, with a stop motion, he knows the machine will stop when an end is out and he becomes inattentive and allows the machine to stand idle too long before piecing up.

Fig. 176 shows a section of a slubber fly frame fitted with a back stop motion. The sliver, A, is lifted out of the cans by the carrier roll, Q^1 , and passes over the stop-motion spoon, G^2 , and between the three pairs of draft rolls to the flyer, G.

Directly beneath the tail of each spoon is a finger L, mounted on the rocker shaft, T^2 . Motion is given to the rocker shaft from an eccentric, J, which runs loose upon the top cone shaft, X^1 , but is driven from the top cone shaft by a train of gears. By this means the eccentric is given a much slower speed than the cone shaft.

The carrier roll, Q^1 , is driven from the end of the back roll by the

sprocket chain, D^1 , and the sprocket wheels, L^2 and N . The connection between the rocker shaft and eccentric is through the eccentric arm, S , rocker, T , link, P , and, arm, R .

The rocker is hung in the bottom of a slot, Y , in the stand, V , and the pin, M , upon which the rocker is hung, projects into a hole in the lever, X , and in its normal position, is kept from rising by the spring, W . The arm, R , is keyed to the rocker shaft which is given a reciprocal motion by the revolutions of the eccentric.

The stop-motion spoons are mounted in stands and are so balanced that the friction of the sliver,

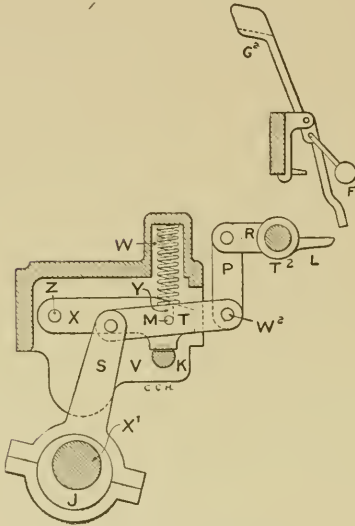

Fig. 177. Back Stop Motion.

in passing over them, holds the tails clear of the path of the finger, L .

When the machine is started the spring rod, K , which moves with the shipper rod, slides along until a slot cut in its upper surface is beneath one end of the lever, X . When this happens, X , which is pivoted at Z , drops into the slot and holds the rod stationary until X is lifted out of the slot.

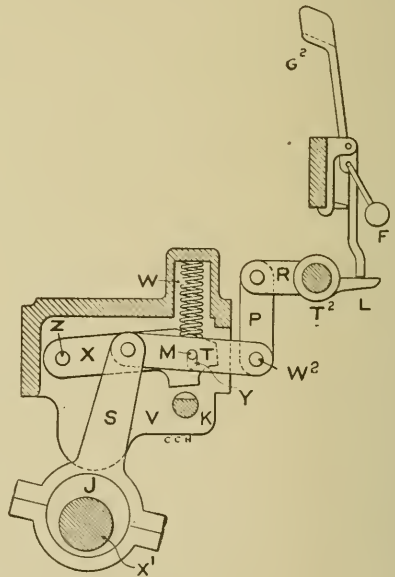

Fig. 178. Back Stop Motion.

If a sliver breaks or runs out, the spoon assumes a vertical position, immediately, and the tail is brought into the path of the finger which arrests the movements of the rocker shaft. As soon as this occurs, the fulcrum of the rocker, T , is transferred from the pin, M ,

in the slot of the stand, to the pin, W^2 , in the lower end of the link, P . The spring, W , yields and allows the eccentric to lift the pin, M , and with it the lever, X , withdrawing X from the slot in the spring rod, which is released and the belt is shipped.

Figs. 177 and 178 show the positions of the levers when the machine is running and when the stop motion operates. A weight, F , mounted upon a rod, may be moved in or out as a counterbalance for the spoon G^2 to accommodate a heavy or light sliver.

The roll stand, for carrying the steel fluted rolls, is shown in Fig.

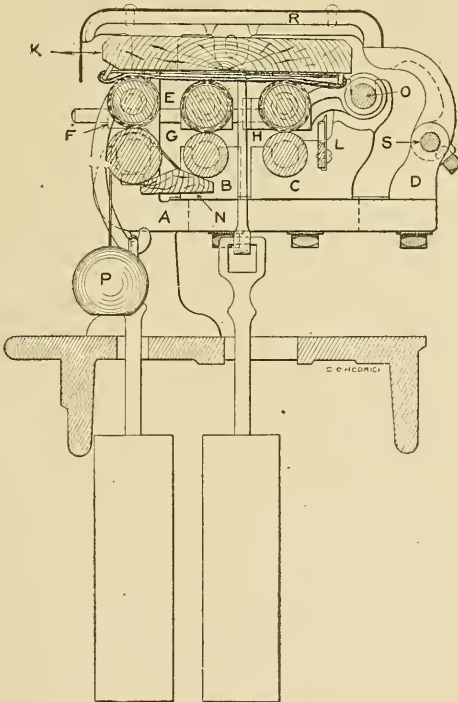

Fig. 179. Roll Stand.

179. This stand consists of four parts: the main piece, A , the two slides or bearings, B and C , for the middle and back rolls, and the bracket, D , upon which the top roll clearer is hinged. The bearing for the front roll is usually lined with bronze as the wear on the front roll's bearing is much greater than upon the bearings for the other rolls.

The slides are screwed to the main part of the stand and are ar-

ranged so that they may be adjusted to suit the various lengths of staple. The slide for the back roll is slotted for a bearing for the roving traverse rod, L, and for the rod, O, upon which the wires, E, supporting the cap bar nebs F, G, and H, are fastened. The front neb, F, is made with projections above and below. The upper one serves as a stop for the top clearer and the lower one as a support for holding the nebs on center with the axis of the top rolls. A detached view of the cap bar is shown in Fig. 180.

The wires, E, are flattened, slightly, upon the upper surface, where the screws bear, to hold the nebs in place, which insures their standing perfectly true with the top rolls.

The spaces in the nebs into which the gudgeons of the top rolls

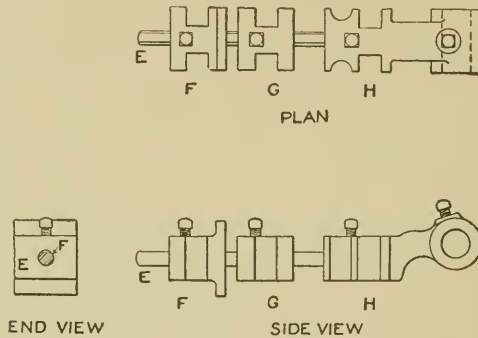

Fig. 180. Cap Bar.

project, are made wide enough to allow perfect freedom to the top rolls but with not enough play to allow them to get out of line with the steel rolls.

The top rolls, for the front line, are usually shell rolls and for the middle and back lines, solid rolls. The top roll clearer is shown in Fig. 179 and is similar to the common clearer used upon the drawing frame. A flat board, K, is faced on the underside with clearer cloth, supported by wires. The board, which is carried in a frame, R, is hinged upon the rod, S, and is hung so that it adjusts itself to the position of the top rolls. The under clearer, N, which is seldom used upon anything but the slubber fly frame, is held in place by straps which have a weight, P, suspended from the end.

Sometimes, self-weighted top rolls are used on fly frames intended for working long stock and for fine counts of yarn. A roll stand, with

top rolls of this kind, is shown in Fig. 181. The front and back steel rolls are one and one-quarter inches in diameter and the middle roll is one and one-eighth inches in diameter. The front top roll is the usual shell roll, weighed in the ordinary way by a hook, A, stirrup, B, and weight, C.

The middle top roll usually is made of thin, brass tubing, one and

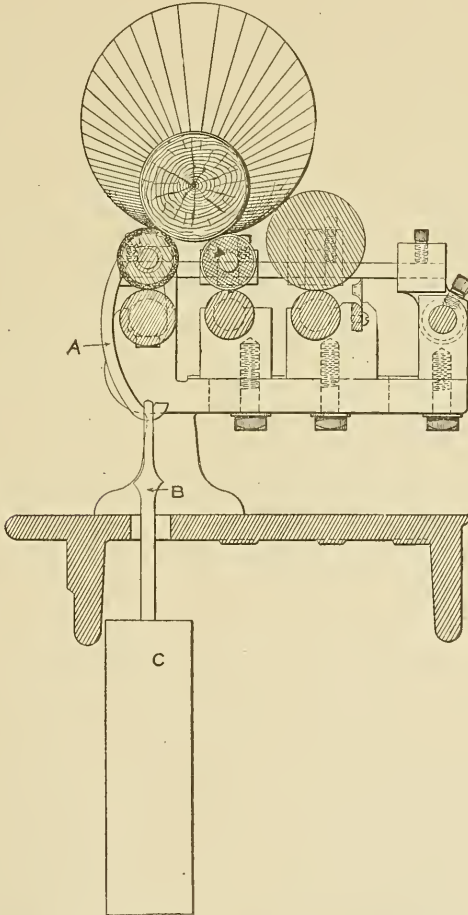

Fig. 181. Roll Stand for Self-Weighted Top Rolls.

one-eighth inches in diameter, filled with lead to give it additional weight, and sometimes of cast iron. The gudgeons, for this roll, are of iron wire put through the lead.

The back top roll is made of cast iron, two inches to two and one-half inches in diameter. Both of the top rolls are sometimes covered with leather.

The top clearers for self-weighted rolls are usually rotary, either conical or straight. They are shown in Fig. 182.

The conical clearer roll is made of wood, covered with clearer



Fig. 182. Top Clearer Rolls.

cloth. The large end bears upon all of the top rolls and the small end bears upon the middle and front rolls only. As the front roll runs at a much greater speed than the middle and back rolls, the clearer must partake of an intermediate speed to collect the loose fibers. When the frame is in operation, the conical shape of the clearer causes it to travel along the rolls slowly. Upon reaching the end of the frame, it is

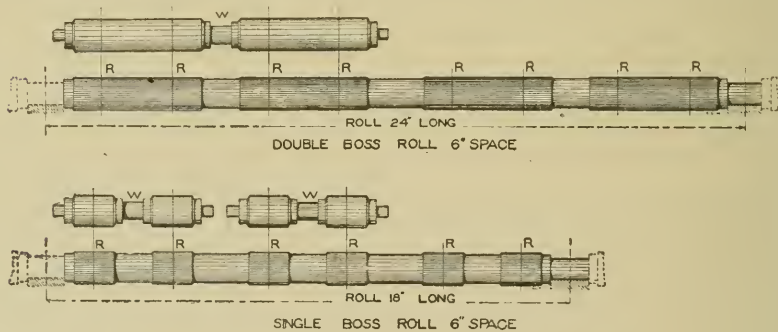

Fig. 183. Single and Double Boss Rolls.

reversed by the attendant and it works back to the other end. A straight roll is sometimes used with the conical roll, placed ahead and pushed along by it.

When straight clearer rolls are used, they are made of a diameter to bear upon all of the top rolls. They are made in short lengths, two for each roll stand.

Fluted Rolls. The fluted rolls, for slubbers and intermediate fly frames, are made "single boss." For fly frames of five and a quarter and six inch space, they are made either "single boss" or "double

boss", but for all fly frames under five and a quarter inch space they are made "double boss" only.

The terms "single boss" and "double boss" mean the number of ends of roving to each fluted boss of the roll. On a slubber, nine and one-half inch space, the rolls are nineteen inches long, which is the distance between the centers of the roll stands. There are four bosses

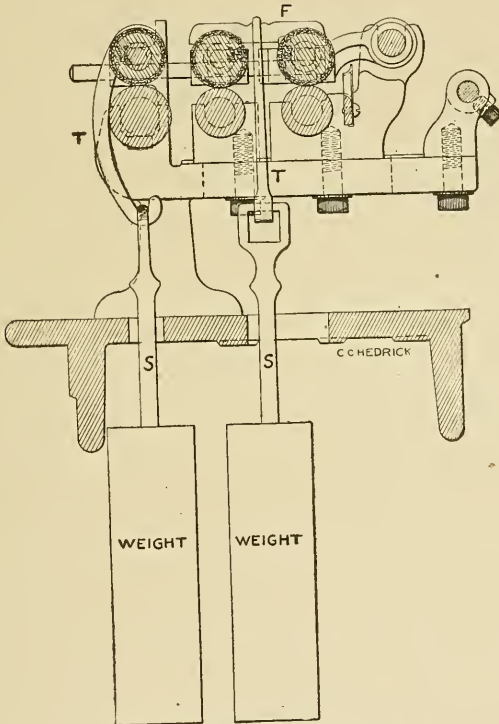

Fig. 184. Weighting for Top Rolls.

and four spindles in this length and one end of roving for each boss or single boss.

On a fly frame, four and one-half inch space, the length of the roll is eighteen inches. There are eight spindles in this distance, which is too short to allow eight separate bosses and still have room for the weight stirrups and saddles, which must hang between every two bosses. To provide for this, the rolls are made with bosses long enough to permit of two ends of roving, side by side, or "double boss."

Fig. 183 shows two steel fluted rolls for a six inch space fly frame

and the leather covered top rolls for each roll. The upper fluted roll is double boss and is twenty-four inches long and the lower one is single boss and is eighteen inches long. There are four bosses and eight ends for the double boss and six bosses and six ends for the single boss. The roving is represented by the lines, R, and the weight is hung between the bosses at W. There is one weight for four ends on the double boss and one weight for two ends on the single boss. The double boss rolls are seldom, if ever, used on any space more than six inches, as the length of the boss would be so great that the weights would have a tendency to spring the steel rolls enough to cause the top rolls to bear unevenly.

The usual method of weighting the top draft roll is shown in Figure 184. For the front roll a separate weight is used which is hung from a stirrup, S, and hook, T. For the middle and back rolls, the weight is divided. The stirrup is hung from a saddle, F, by a hook, T, and the saddle bears upon the middle and back top rolls.

For the slubbers, eight and one-half inch space and over, weights are usually eighteen pounds. For intermediate frames, they are seventeen pounds and for fine frames, seventeen pounds. For single boss rolls, six inch space, they are twelve pounds. For fine frames, five and one-quarter inch space or under, and all jack frames, the weights are fifteen pounds. Sometimes a separate weight is used for each roll. The weights may then be:

	Front Roll	Middle Roll	Back Roll
Slubber - - -	18	14	10
Intermediate - -	14	10	8
Fine and Jack - -	10	8	6
Double Boss Fine Frame	18	14	12

Fly frames are built both right and left hand. A frame is said to be right hand, when, in standing on the front or spindle side and facing the machine, the pulley is on the right hand end.

By the gauge or space of a fly frame is meant the distance between the centers of two adjoining spindles in the same row. The slubbers are built eight and one-half inch, nine inch, nine and one-half inch, and ten inch space. Intermediates are built seven inch, and seven and one-half inch space. Fine frames are built five and one-quarter

inch and six inch space; and jack frames, three and three-quarters inch, four and one-quarter inch, and four and one-half inch space.

Frame	Space	Size of Bobbin	Speed of Flyer	No. of Spindle per Roll	Weight of Cotton on Full Bobbin	Length of Roll	Traverse of Frame
Slubber	10"	6" x 12"	625	4	44 oz.	20"	12"
Slubber	9½"	5½" x 11"	700	4	32 oz.	19"	11"
Slubber	9"	5" x 10"	750	4	24 oz.	18"	10"
Slubber	8½"	4½" x 9"	800	4	18 oz.	17"	9"
Intermediate	7½"	5" x 10"	825	6	24 oz.	22½"	10"
Intermediate	7"	4½" x 9"	950	6	18 oz.	21"	9"
Fine	6"	4" x 8"	1100	8	14 oz.	24"	8"
Fine	5¼"	3½" x 8"	1250	8	12 oz.	21"	8"
Fine	5¼"	3½" x 7"	1250	8	10 oz.	21"	7"
Jack	4½"	3" x 6"	1400	8	7 oz.	18"	6"
Jack	4¼"	2½" x 5"	1600	8	4 oz.	17"	5"
Jack	3¾"	2½" x 4½"	1800	12	3 oz.	22½"	4½"

The fluted rolls for fly frames are made of the diameters shown in Fig. 185. Those most commonly used for medium staple cotton are shown in the upper view in the drawing. For Egyptian and Sea Island cotton, the rolls are usually larger and of the diameters shown in the middle drawing. For self-weighted top rolls, the usual diameters are shown in the lower drawing. The diameter of the back top roll is made from two to two and one-half inches to suit the weights of the sliver. A heavy sliver and a long draft require the largest sized roll.

Fig. 186 shows the sizes and dimensions of fly frame bobbins. The dimensions vary but slightly for the different makes of fly frames. The bottom of the bobbin is made with both four and six notches for the dog or bobbin driver. The bobbins shown in the diagram have six notches. To prevent splitting, the bottoms are either brass bound or wired.

It is very necessary that the diameter of the holes in the bobbins shall be exact, and to avoid any mistakes, most mills have a standard plug for each sized bobbin used, made similarly to the one shown in the upper right hand corner of the drawing. This plug is made the small end for the spindle hole, the large end for the bolster gear and the

intermediate for the bolster hole. The diameter of the spindle hole is about one sixty-fourth of an inch greater than the diameter of the spindle; the hole in the bottom of the bobbin is one thirty-second of an inch larger in diameter than the bobbin gear, and the bolster hole is about one-sixteenth of an inch larger in diameter than the bolster.

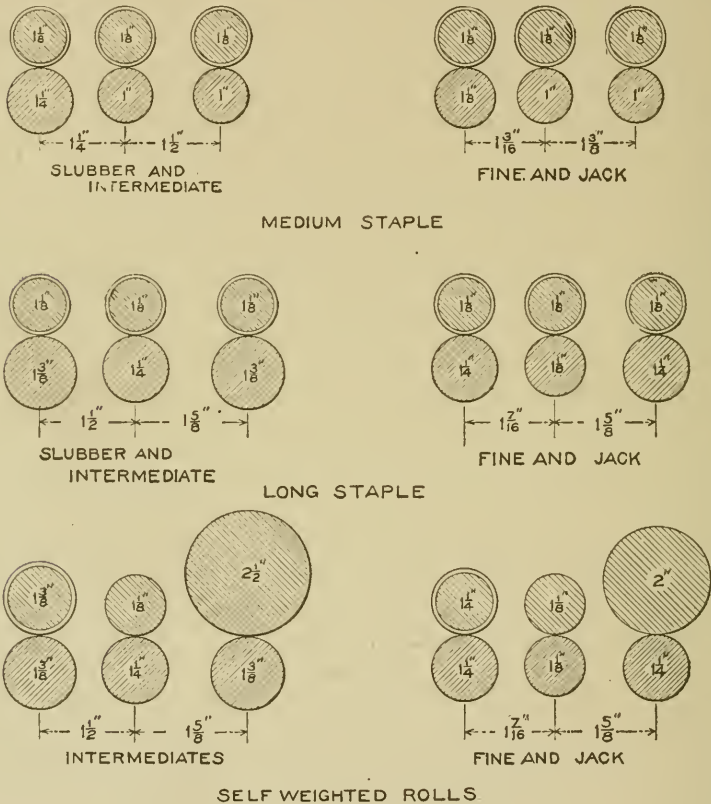

Fig. 185. Sizes of Steel Fluted Rolls.

To find the length of a fly frame: Multiply one half the number of spindles by the space in inches and add 38 inches.

The power required to drive fly frame spindles is as follows:

Slubbers	35 to 45 spindles per H. P.
Intermediates	65 to 75 " " "
Fine and Jack frames	95 to 105 " " "

Calculations. The general diagram of fly frame gearing, given

in Fig. 164, shows all of the gears necessary in calculations, but, to avoid confusion, the draft gearing is shown separately in Fig. 187 and the twist gearing in Fig. 188.

Rule 1. To find the draft of the fly frame: Multiply together the driven gears and the diameter of the front roll and divide the product by the product of the driving gears multiplied together with the diameter of the back roll. (The driven gears are E³ and O¹ and the driving gears are M² and D⁴.) The front roll is 1½ inches in diameter and the back roll is 1 inch in diameter.

$$\text{Example: } \frac{100 \times 56 \times 9}{37 \times 34 \times 8} = 5.00$$

Rule 2. To find the draft factor: Proceed as in the previous rule, but omit the draft change gear D⁴.

$$\text{Example: } \frac{100 \times 56 \times 9}{37 \times 8} = 170.27$$

Rule 3. To find the draft: Divide the factor by the number of teeth in the draft gear.

$$\text{Example: } \frac{170.27}{34} = 5.00$$

Rule 4. To find the draft gear: Divide the factor by the draft.

$$\text{Example: } \frac{170.27}{5} = 34$$

The draft between the back roll and the middle roll is very slight and is only the difference of one tooth in the gears, as will be seen by referring to the diagram. On the back roll is a gear of 21 teeth and on the middle roll is a gear of 20 teeth.

Sometimes the crown gear is changed, as well as the draft gear, when a very fine adjustment in the draft is needed, and a difference of one tooth in the draft gears makes too great a change in the draft.

The definition of the word twist, as used in reference to yarn and roving, is the number of turns that the spindles or flyers make to each inch of roving that is delivered by the front roll. If the spindles make 100 revolutions and the front roll delivers 40 inches of roving, the twist will be 2.5 per inch. $100 \div 40 = 2.5$.

Rule 5. To find the twist per inch: Multiply together the driven gears and divide the product by the product of the driving gears multi-

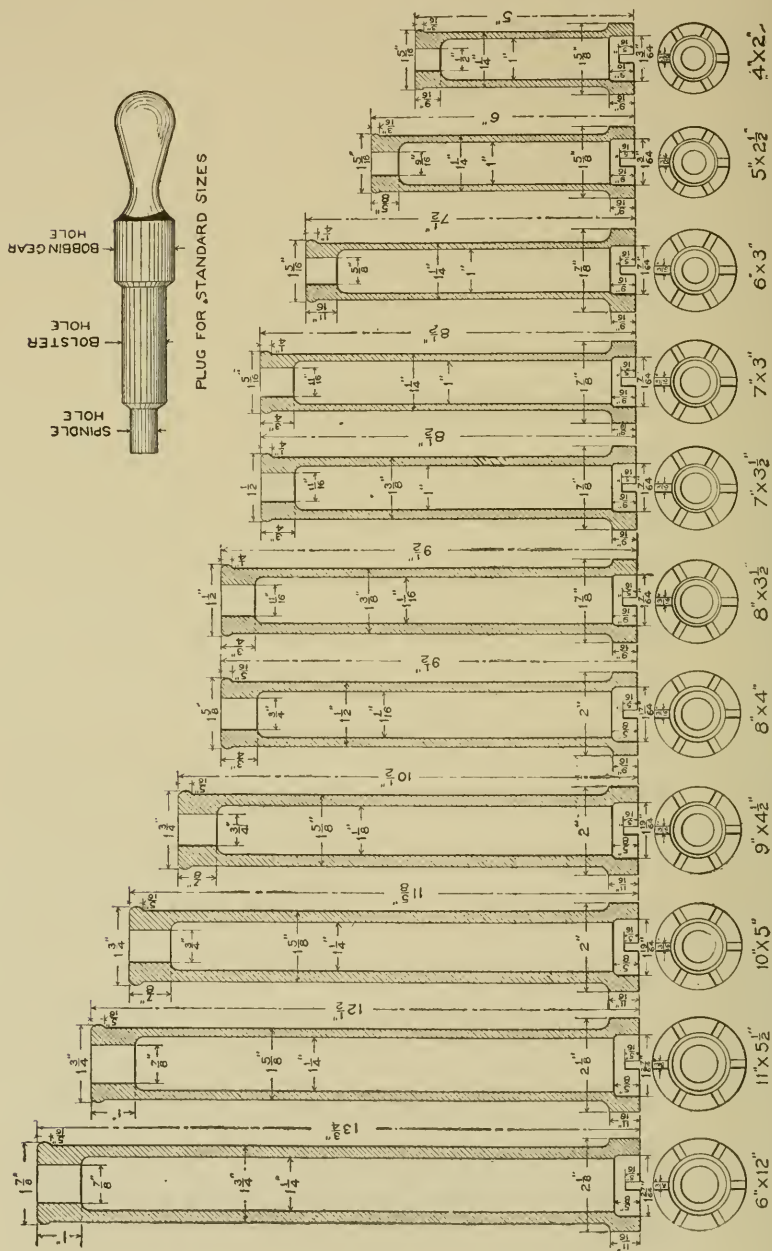

plied together with the circumference of the front roll. Assuming the twist gear to be a driving gear, the driven gears are L³, N², G¹, and T¹. The driving gears are K³, A³, H³, and L¹, and the circumference of the $1\frac{1}{8}$ inch front roll is 3.5343 inches.

$$\text{Example: } \frac{164 \times 60 \times 60 \times 46}{97 \times 40 \times 40 \times 22 \times 3.5343} = 2.25$$

Rule 6. To find the twist factor: Proceed as in the previous rule but omit the twist gear.

$$\text{Example: } \frac{164 \times 60 \times 60 \times 46}{97 \times 40 \times 22 \times 3.5343} = 90.02$$

Rule 7. To find the twist: Divide the twist factor by the number of teeth in the twist gear.

$$\text{Example: } \frac{90.02}{40} = 2.25$$

Rule 8. To find the number of teeth in the twist gear: Divide the factor by the twist per inch.

$$\text{Example: } \frac{90.02}{2.25} = 40$$

The standard twist for roving is the square root of the hank multiplied by 1.2, and is expressed thus $\sqrt{\text{Hank}} \times 1.2$

This multiplier is the one that is used by most machinery builders in the construction of twist tables and is correct for cotton of ordinary length staple, but for Sea Island, Egyptian and other long staple cottons, the multiplier may be as low as .8, and for very short staple as high as 1.5.

All that is required is sufficient twist to hold the roving together, as too much twist destroys the effectiveness of the drawing operation in the successive processes.

When there is very little twist put into the roving, the production of the machine is increased as the speed of the spindles is constant and the front roll must run faster to give less twist.

There are several things to be considered in figuring the production of the fly frame; revolutions of spindle, hank roving, twist per inch, weight of cotton upon full bobbin and time lost piecing-up and doffing. With these factors known, we can find the approximate production.

First, it is necessary to find the time required to spin a set of

bobbins, then the number of sets per day, and finally the production per spindle in a day of ten hours.

Rule 9. To find the time required in spinning a set of bobbins on $3\frac{1}{2}$ hank roving: Multiply together the number of yards in one hand (840), the number of inches per yard (36), the twist per inch (2.25), the number of roving (3.5), and the number of ounces of cotton upon a full bobbin (10), and divide this product by the number of revolutions of the spindles per minute (1250) multiplied by the number of ounces in one pound (16).

$$\text{Example: } \frac{840 \times 36 \times 2.25 \times 3.5 \times 10}{1250 \times 16} = 119.07$$

Rule 10. To find the number of sets of bobbins spun in ten hours: Multiply the minutes per hour (60) by the number of hours

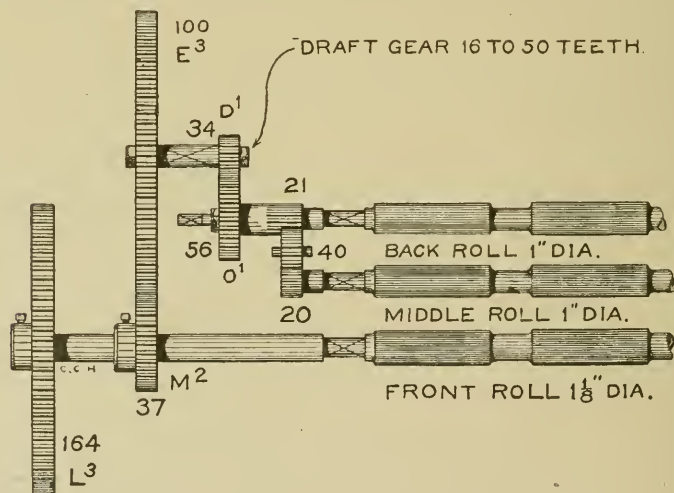

Fig. 187. Diagram of Draft Gearing.

run per day (10), less 10%, and divide this product by the number of minutes occupied in spinning one set plus the number of minutes required to doff a set (15).

$$\text{Example: } \frac{60 \times 9}{119.07 + 15} = 4.02$$

Rule 11. To find the production in pounds of a day of ten hours: Multiply together the number of sets spun in ten hours (4.02), by the number of grains of cotton on a full bobbin (10 oz = 4375 Grains)

and divide the product by the number of grains in one pound (7000)

Example:
$$\frac{4.02 \times 4375}{7000} = 2.51$$

The time required to doff a machine will vary from ten to twenty minutes according to the number of spindles in the frame and the skill

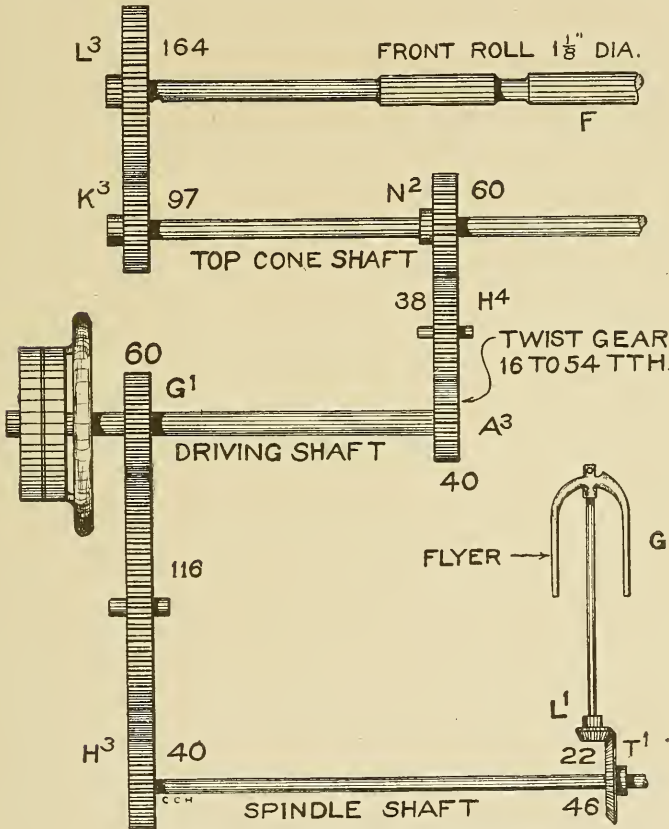

Fig. 188. Diagram of Twist Gearing.

of the attendant. The time, lost in piecing broken ends and cleaning, varies from 3 per cent on very fine work to as high as 25 per cent on slubber roving.

The number of teeth in the tension and lay gears cannot be figured with absolute certainty as the character of the stock, the amount of twist in the roving and atmospheric conditions affect the winding of the roving.

When the roving is hard twisted, it is smaller in diameter than when soft twisted and does not fill the bobbin as rapidly. This condition demands a tension gear with fewer teeth so the belt will not be shifted so far along the cones or the speed of the spindle be reduced to such an extent as to wind slack roving. The tension gear is a driver and the greater number of teeth it contains the more the speed of the bobbin is reduced at each shift of the cone belt.

The lay gear is also a driver, and, with hard twisted roving, the bobbin should have more coils per inch to be wound correctly. To accomplish this, the rail must be run slower, which requires a smaller number of teeth in the lay gear.

If the rail is not fast enough, the coils of roving will be crowded and overlap each other and a very uneven bobbin will be the result. If the roving winds properly at the beginning of a set, but gets too soft towards the finish, it is evident that a smaller tension gear is needed so that the bobbin will run faster. If, on the other hand, the bobbin becomes too hard, and the roving pulls apart towards the end of a set, it indicates that a larger tension gear is needed to reduce the speed of the bobbin.

On a particularly damp day, the cotton fibers are heavy, and lie closely together, which makes the roving smaller in diameter and in consequence the bobbins do not fill so rapidly. This causes the roving to drag and not take-up, which necessitates a tension gear of one, and sometimes two teeth less, so that the speed of the bobbin shall not decrease so rapidly.

In the practical operation of a mill, when starting up a fly frame to make a certain number of roving, the table of change gears is usually consulted for the correct tension and lay gears, and while two frames may not start up with gears exactly alike, a change of one or two teeth is most always sufficient to produce satisfactory results.

If no table of gearing is available, the following rules will be found useful.

Rule 12. To find the tension gear to make 6 hank roving: (Tension gear on frame 41 teeth. Roving being spun, 3.5 hank.) Find the square root of the present tension gear, squared, multiplied by the present hank, and divide this sum by the required hank.

$$\text{Example: } \quad 1 \sqrt{\frac{41^2 \times 3.5}{6}} = 32.06$$

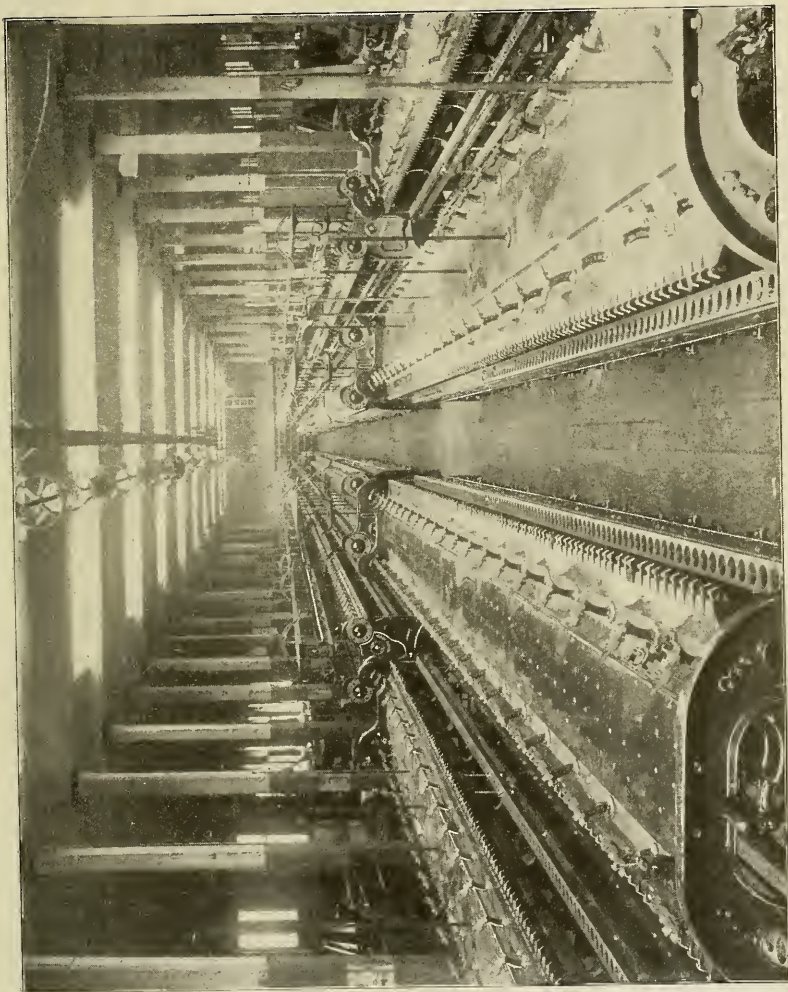

SPINNING FRAME ERECTING DEPARTMENT
Mason Machine Works.

Rule 13. To find the lay gear to make 6 hank roving: (Lay gear on frame, 35 teeth. Hank roving being spun 3.5.) Find the square root of the present lay gear, squared, multiplied by the present hank, and divide this sum by the required hank.

Example:
$$\sqrt{\frac{35^2 \times 3.5}{6}} = 27.31$$

Rule 14. To find the twist gear for 6 hank roving: (Twist gear for 3.5 hank, 40 teeth.) Find the square root of the present twist gear squared, multiplied by present hank, and divide this sum by the required hank.

Example:
$$\sqrt{\frac{40^2 \times 3.5}{6}} = 30.54$$

Rule 15. To find draft gear: (Draft gear, 34 teeth.) Multiply the present hank by the present draft gear and divide this product by the required hank

Example:
$$\frac{3.5 \times 34}{6} = 28.16$$

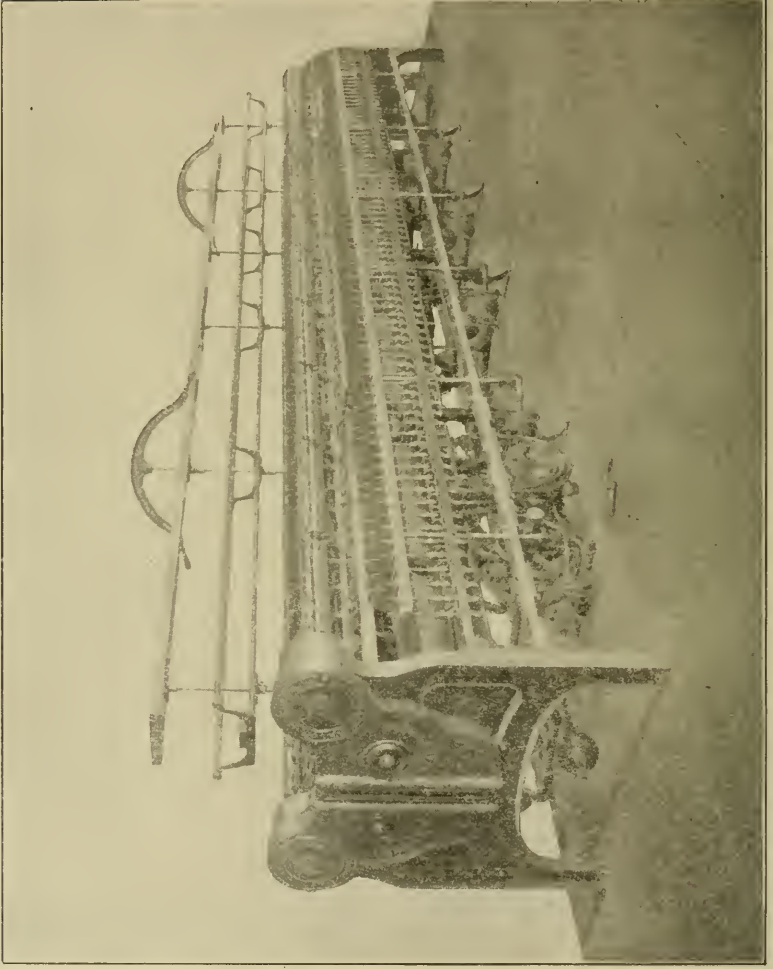

RING SPINNING FRAME
Mason Machine Works.

COTTON SPINNING

PART V

SPINNING

In the final process of forming the cotton into yarn, there are two wholly different types of machines used, the *ring frame* and the *mule*.

The ring frame is used more extensively than the mule, owing to its simplicity and the cost of operating being less. While the ring frame is not adapted for spinning as fine numbers or as soft twisted yarns as the mule, wherever ring-spun yarn can be used with satisfactory results, the ring frame is generally used.

RING SPINNING

The placing of ring frames requires careful consideration. There are two common arrangements. In a mill of a width of one hundred feet or less, the frames should be placed as shown in Fig. 189. This drawing shows a room seventy-five feet wide with two lines of columns, making three spans, each about twenty-five feet wide. Each span will accommodate four lines of ring frames with the proper alleys, which should be from twenty-eight inches to thirty-six inches wide.

There is one main line of shafting from which are driven the countershafts. The frames are offset so that two can be driven from a pulley which has a center flange. Each countershaft carries two pulleys for driving four frames. The head or pulley ends of the frames are about twelve inches apart, which is as close as they can be placed to give ample room for removing the driving pulleys when necessary.

When the room is intended for spinning only, the main line is placed so that it will come between two rows of ring frames, to be best adapted for driving.

When a mill is of sufficient width, the ring frames may be placed crosswise of the room as in Fig. 190. This drawing shows a room

about one hundred twenty-five feet wide with four rows of columns. There are four ring frames in each line, across the room, and a wide alley in the center, extending the length of the room, and also alleys along the side walls. The machines are arranged in pairs with the pulley ends toward each other for convenience in driving.

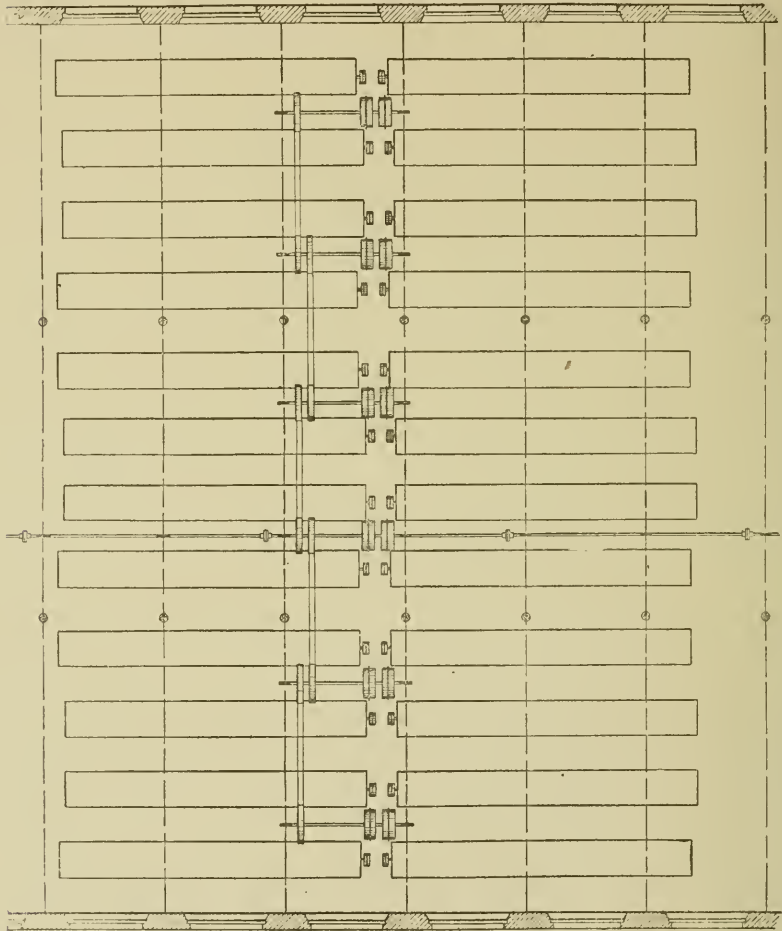

Fig. 139. Plan of Spinning Room with Frames Lengthwise of Room.

There are but two lines of shafting, which extend lengthwise of the room at right angles to the machines, and upon these main lines are the pulleys, each pair of frames being driven from one pulley by the same belt.

A plan and an elevation of a drive of this description are shown

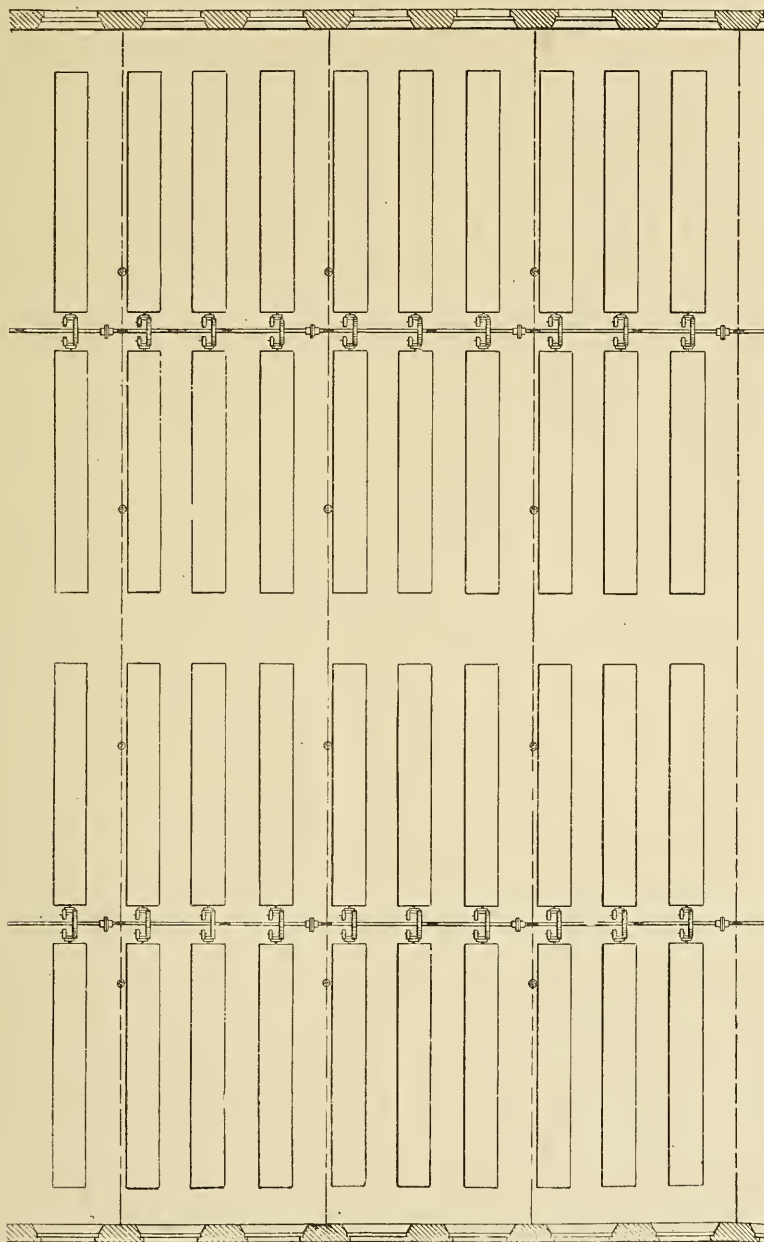

Fig. 190. Plan of Spinning Room with Frames Crosswise of Room.

in Fig. 191. The belt, A, drives downward from the pulley, B, on the line, C, and around the pulley, D, on the frame at the left hand, then upward over the carrier pulleys, E and F, downward around the

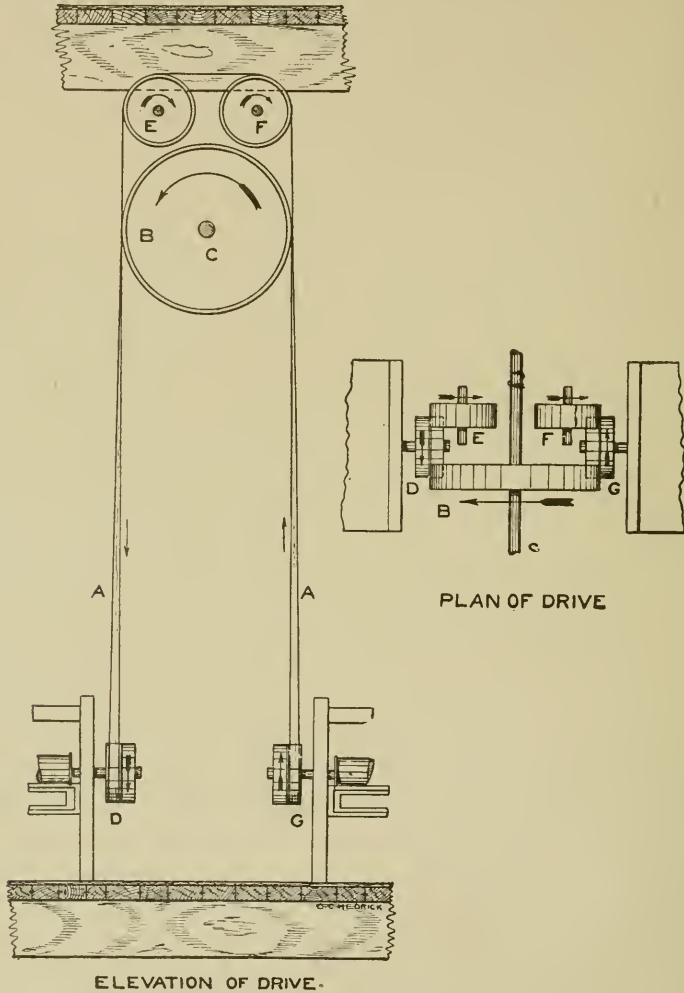

Fig. 191. Pulleys for Drawing Frames Placed at Right Angles to Main Line.

pulley, G, on the frame at the right hand, then up and around the pulley, B.

This method of driving two frames from one pulley makes a very neat and simple drive and saves shafting and belting compared

to the arrangement shown in Fig. 189, but the room should be wide enough to place four frames across the room so that an operative can tend at least eight sides.

A sectional elevation of a ring frame is shown in Fig. 192. The various parts of the machine may be referred to briefly as the creel, C, for supporting the bobbins of roving, the roll stands, F², carrying the steel fluted roll, the top rolls, cap bars, trumpet rod, clearers, weights, saddles, etc., thread board, G¹, with the thread guide or "pig tail", J², roller beam, H¹, for supporting the roll stands and

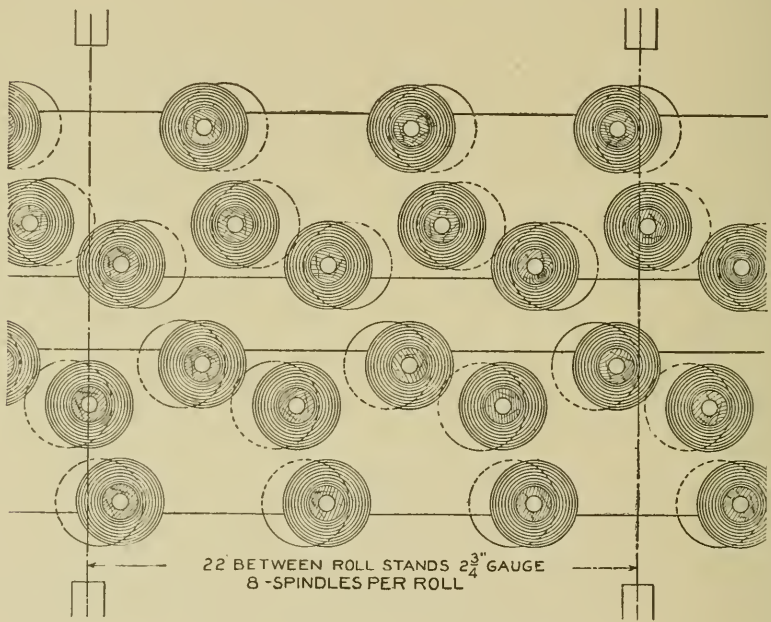

Fig. 193. Plan of Creel for Double Roving.

thread board, the ladder or spindle rail, I, spindle, N, ring rail, E², rings, L¹, drum, F¹, supports, P¹, creel rod, O², cross shafts, M¹, lifting rods, C², separators, N⁴, adjustable feet, J², and drum box, N².

The roving, A, from the top row of bobbins, is drawn over the rod, A², and down to the trumpet, B, while the ends from the lower bobbins draw directly to the trumpet. Both ends pass through the same trumpet, as one end, then between the draft rolls, D, E and F, and down through the thread guide, J², to the ring traveler, H, and are wound finally upon the bobbin, O.

The drum, F^1 , extends the whole length of the frame, and upon one end of it are the driving pulleys. The spindles are driven from the drum by the bands, B^2 , one for each spindle.

The ring rails are fastened to the top of the lifting rod, by which they are traversed up and down for winding the yarn evenly upon the bobbin.

Creels. The Creels are built one or two stories high and for single or double roving. If for single roving, there is only one bobbin

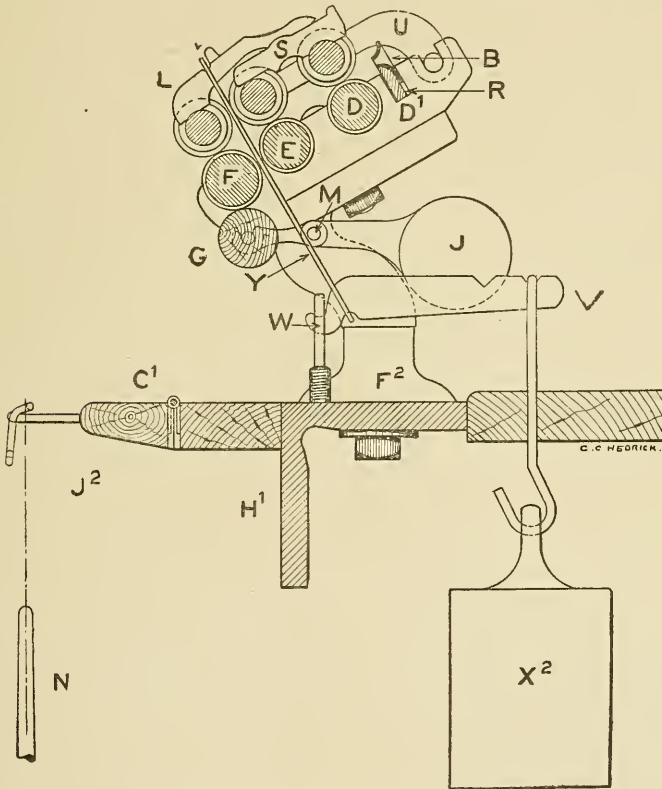

Fig. 194. Elevation Showing Roll Stand and Weighting.

for each spindle and the creel is one story, usually. For double roving, there are two bobbins or ends for each spindle and the creel is two storied.

A plan of a creel for a two and three-quarter inch spaced ring frame, for double roving with bobbins three and one-half inches

in diameter, is shown in Fig. 193 and an elevation is shown in Fig. 192. The creel consists of bottom, middle and top boards. The top board serves for a shelf upon which full bobbins can be placed. The skewers, A^1 , for holding the bobbins, A , rest in porcelain steps which

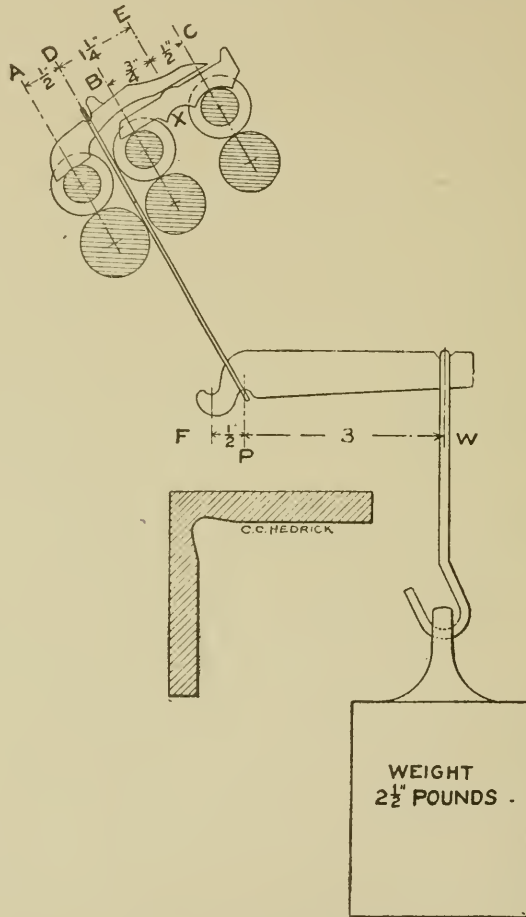

Fig. 195. Diagram of Weighting.

are flush with the boards, forming the creel. The porcelain offers little resistance to the rotation of the bobbins.

The bobbins in the upper tier are shown by full lines and those in the bottom tier by dotted lines. They are so spaced that the back row can be removed without disturbing the front ones, a point which

will be appreciated in a frame of this space and sized creel bobbins.

Roll Stands and Weighting. An elevation of a common roll is shown in Fig. 194. The stand consists of a main piece, F², which carries the front steel fluted roll, F, and a slide, D¹, in which are the bearings for the middle roll, E, and the back roll, D. The slide is adjustable so that the middle roll may be set to the front roll with respect to the length of the cotton staple.

The roving rod, R, carries the brass trumpets, B, through which the roving is drawn, and rests in a slot just behind the back rolls. It is traversed a distance, a little short of the length of the fluted portion of the steel roll, so that the wear will not come on the same part of the boss at all times.

The cap bars, U, for holding the top rolls in place, are pivoted in a slot in the extreme back end of the roll stand slide.

The scavenger, or waste roll, G, upon which the yarn collects when an end breaks, thus preventing a roller lap, is a wooden roll covered with denim or light weight flannel. In each end of the roll are wire gudgeons which rest in open bearings in the scavenger roll weights, J. The weights are pivoted at M and are balanced so that the roll is held, lightly, against the steel front roll.

Sometimes, a spring is used in place of the weights for holding the scavenger roll, as shown in Fig. 192, but this is not as satisfactory as it is apt to break.

The top rolls are both lever-weighted and self-weighted. In the drawing, a system of lever-weighting is shown by which all the rolls receive pressure from one weight.

There are two saddles used; front saddle, L, and back saddle, S. The back saddle rests upon the middle and back top rolls and the front saddle upon the front top roll and the back saddle. The weight, X², is hung from the lever, V, by a weight hook. The fulcrum of the lever is at the lever screw, W, and the stirrup, Y, serves to communicate the pressure from the weight to the front saddle. For single boss rolls, the weight is from two to three pounds and for double boss rolls about six pounds.

A diagram for use in figuring the distribution of weight on the different rolls is shown in Fig. 195.

Front Roll.....	A
Middle Roll.....	B
Back Roll.....	C
Front Saddle.....	D
Back Saddle.....	E
Fulcrum.....	F
Power.....	P
Weight.....	W

To find the weight in pounds upon the front saddle: Multiply the weight (2.5 pounds) by the distance, F-W, and divide by the distance, F-P.

$$\text{Example: } \frac{2.5 \times 3.5}{.5} = 17.5$$

To find the weight in pounds upon the front roll: Multiply the weight upon the front saddle (17.5 pounds) by the distance, E-D, and divide by the distance, E-A.

$$\text{Example: } \frac{17.5 \times 1.25}{1.75} = 12.5$$

To find the weight in pounds upon the back saddle: Subtract the weight upon the front roll from the weight upon the front saddle

$$\text{Example: } 17.5 - 12.5 = 5$$

To find the weight in pounds upon the back roll: Multiply the weight upon the back saddle by the distance, E-C, and divide by the distance, B-C.

$$\text{Example: } \frac{5 \times .75}{1.25} = 3$$

To find the weight in pounds upon the middle roll: Subtract the weight upon the back roll from the weight upon the back saddle.

$$\text{Example: } 5 - 3 = 2$$

Sometimes, it is desired to run the frame with no weight upon the middle roll. Then, the saddle is pushed back until the curved part, X, comes over the neck of the back roll arbor. This removes the flat part of the saddle from the middle roll and the weight is borne by the front and back rolls.

Roll stands are made with the rolls inclined from a horizontal line at various angles from twenty-five to thirty-five degrees. For spinning warp and other hard twisted yarns, the twenty-five degree pitched stand, shown in Fig. 196, is largely used. For ring frames to be used for spinning both warp and filling yarn, the thirty degree pitched stand, shown in Fig. 197, is sometimes used. While for

filling yarn and any soft twisted yarn, the thirty-five degree pitched stand, shown in Fig. 198, is often used.

The reason for inclining the rolls is very simple. As the yarn leaves the bite of the front roll, it is important that it shall receive twist at once, as the high speed that the spindles run and the tension upon the yarn due to drawing the traveler around the ring, tend to break the yarn. If the yarn, after leaving the bite of the roll, is caused to draw around a portion of its circumference, the twist will not readily pass this point of contact and the yarn, between this point of contact and the bite of the roll, receives little or no twist. The roll stands, therefore, are inclined enough to allow the twist to run nearly to the bite of the front roll. This is particularly necessary when spinning filling yarn, which has less twist than warp yarn, and not only are the stands inclined at a great angle, but sometimes, the front roll is set nearer over the spindles so that the yarn shall draw more nearly in a straight line from the front roll to the traveler.

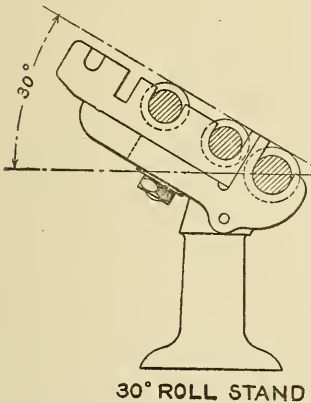

30° ROLL STAND

Fig. 197. Combination Roll Stand, 30° Pitch.

The front top roll, B, which is a shell roll one and three-eighths inches in diameter, is weighted by a weight, G, which extends from

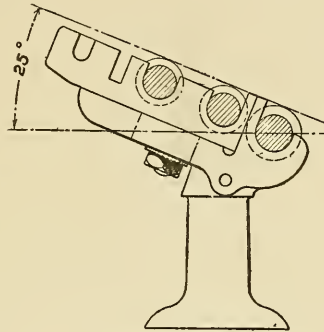

25° ROLL STAND

Fig. 196. Warp Roll Stand, 25° Pitch.

A roll stand of this type is shown in Fig. 199. The center of the spindle is about four and one-quarter inches from the face of the roller beam, and the center of the front roll is about midway of this space.

Self-Weighted Top Rolls. Ring frames, for spinning long staple cotton, are frequently provided with self-weighted top rolls for the middle and back lines. A frame with rolls of this kind is shown in sectional elevation in Fig. 200.

side to side of the frame and is connected to the top rolls by hooks, F, and stirrups, E. Holes are drilled in the roller beams to allow the hooks to connect with the stirrups. The hook shaped projection

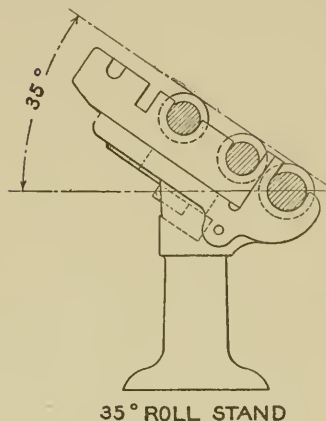

Fig. 198. Filling Roll Stand, 35° Pitch.

The top clearer is conical and is the same as those used on fly frames with self-weighted top rolls, as shown and described in a previous chapter.

Sometimes, a double cone clearer is used with a device at each end of the frame that tips the clearer, automatically, when it reaches the end, allowing it to work back.

In addition to the usual front scavenger roll, a second roll is sometimes used which bears against the underside of the middle and back steel rolls. It is one inch in diameter, covered with denim, and supported by springs held in sockets. The arrangement is such as to allow the rolls to be easily detached for cleaning.

The middle and back rolls are carried by the same slide and are set about one and three-fourths inches between centers. The adjustment is between the front and middle rolls.

on the top of the stirrups is to allow the operative to lift the weight clear of the top roll, when necessary, and the round eye, formed on the top of the hook, prevents the weight from dropping down upon the drum when the top roll is removed, as the eye is larger in diameter than the hole in the roller beam and can not pull through.

The top roll for the back line is one and three-quarters inches in diameter and for the middle line is three-quarters of an inch in diameter. The rolls are made of cast iron and are not covered with leather, a saving in repairs.

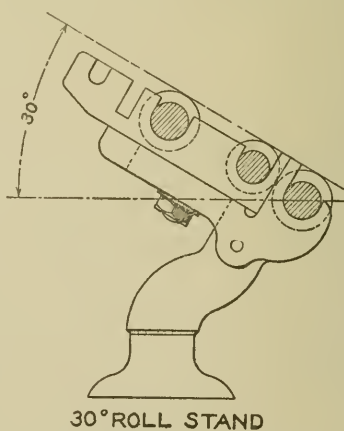

Fig. 199. Roll Stand, 30° Pitch, for Overhanging Front Rolls.

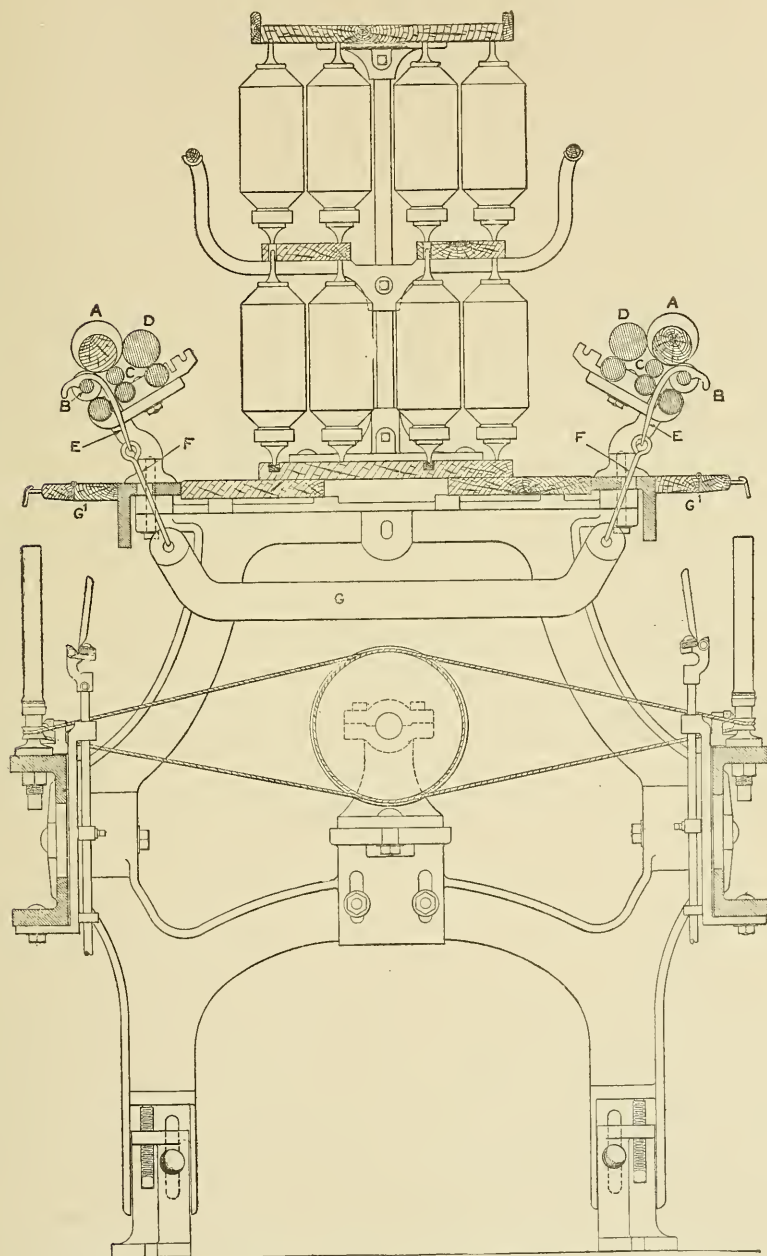

Fig. 200. Sectional Elevation of Ring Frame with Self-Weighted Top Rolls.

In setting a frame with self-weighted top rolls, it is the practice to "set on the staple," which means to make the distance between the centers of the front and middle rolls a trifle less (one-sixteenth to one-eighth of an inch) than the length of the cotton staple. This is just opposite to the method of setting weighted rolls, which are set from one-sixteenth to one-eighth more on centers than the length of the staple.

It is frequently argued that no great range in counts can be spun with self-weighted rolls, as the weight of a roll, correct for spinning 10's yarn is not right for 30's. This is, however, a mistake as from 10's to 80's can be spun with rolls of the sizes mentioned.

Thread Boards. The thread boards for supporting the thread guides are made of wood or metal. Figures 192 and 200 show a common wooden thread board, G^1 , consisting of a doffing strip, which is secured to the roller beam by hinged brackets, and blocks for holding the thread guides, which are hinged, to the thread board. The thread guide is made with various shaped eyes and is screwed into the block.

The metallic thread board is made of thin sheet metal, nickel plated and secured to the roller beam similarly to the wooden one.

Metallic boards are considered to be an improvement over wooden ones, as there is an adjustment for the thread guide in all directions in a horizontal plane, and the eye of the guide may be very easily set in the correct position over the spindle. With the wooden thread board, the eye can be adjusted only by screwing it in or out of the block, and for any side movement, the only way is to bend the guide to meet the spindle. This is apt to loosen the guide and cause it to work out.

A large per cent of broken ends is caused by faulty setting of the thread guides, a point which should not be overlooked. In setting the guide, it is customary to put a round, wooden piece called a "set" on the spindle. This is made with a pin in the top. The length of the set is such as to bring the pin up just under the thread guide. The guide is then set so that the thread will draw from the back side of the eye to the center of the spindle.

Spindles. A type of spindle, commonly used on modern ring frames, is shown in Fig. 201. It consists of a base, bolster, step, spindle blade, whirl and cup.

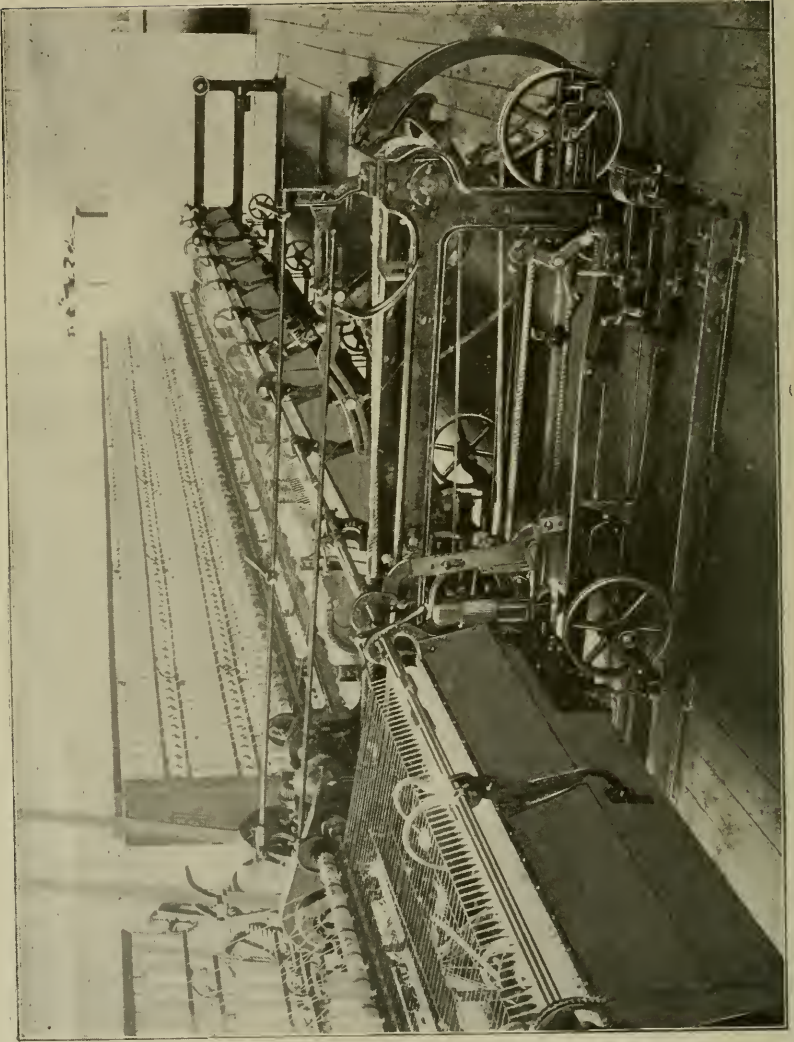

MASON SELF-ACTING MULE WITH ROPE DRIVEN CARRIAGE
Mason Machine Works.

The whirl is driven on to the spindle, and the cup, which helps center and rotate the bobbin, is forced on to the sleeve of the whirl. The lower part of the bolster is covered with packing, tied with a fine string. This gives greater steadiness to the running of the spindle and better wearing qualities.

The step is made of hardened steel, has a flat top, and is screwed into the bottom of the bolster.

The base is made with an upward projecting nose, or oil tube,

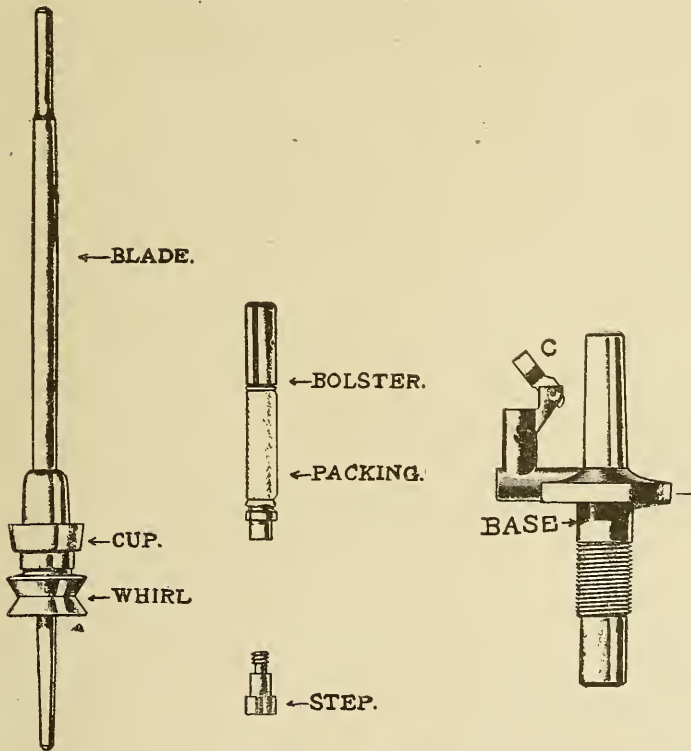

Fig. 201. Spindle Parts.

S, the cover, C, of which forms a lock to prevent pulling the spindle out of the bolster when doffing. The stem of the bolster is threaded to receive a nut for securing the base to the spindle rail.

The cups are usually of brass and are made several sizes to suit the different sized bobbins. They are called warp cups and filling cups. Many prefer to have the cups all one size, particularly

when frames are to be run for both warp and filling, so that the bobbins will be interchangeable.

Fig. 202 shows a spindle and bolster assembled.

Separators. Separators are usually applied to frames for spinning warp yarn and, sometimes, to those for filling yarn, as the high speed of the spindles, and the long traverse of modern frames, cause the ends to whip and break down.

The separator blades, N^4 , (Fig. 192) are thin, steel plates, of a size to suit the length of traverse, and are mounted upon light rods which extend parallelly with the ring rails. They are connected with the traverse motion from the cross shaft arm, M^1 , by the rods, L^8 , so they rise and fall with the ring rail, and are arranged so that they can be tipped back out of the way while doffing. The blades are placed midway of the spaces between the center of the spindles, and the ballooning yarns are kept from whipping together.

This ballooning is very apparent on warp frames, when the rail is at the bottom of the traverse, as there is considerable length of yarn between the thread guide and the traveler.

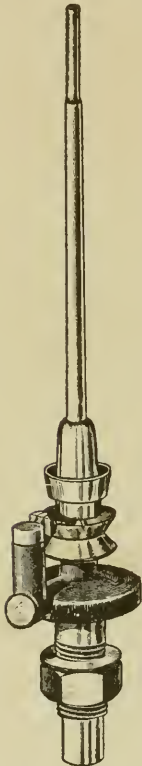

Fig. 202. Spindle Assembled.

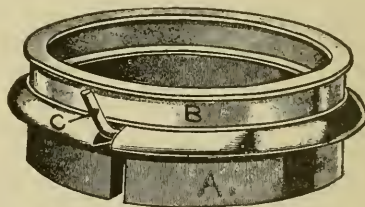

Fig. 203. Double Ring in Cast Iron Holder.

Spinning Rings. Rings that are supplied with new ring frames are usually double rings, set in either cast iron or plate holders. The ring shown in Fig. 203 is such, in a cast iron holder with wire traveler cleaner; A, is the holder, B, the ring, and, C, the cleaner. A recess is formed on the inside of the holder and the traveler cleaner lies around the recess, between the ring and holder.

The position of the upturned end of the traveler cleaner is such that, as the traveler rotates, the loose fibers and fly, which are always

floating about a spinning room, and which are bound to gather on the traveler, are wiped off and the traveler kept clean. Unless the traveler is kept free from this accumulation, uneven yarn will be caused.

The traveler cleaner is set just far enough away so that it cannot interfere with the rotation of the traveler. It cannot get out of place, because the tail is always set concentric with the ring.

Another style of "double ring", in a plate holder, is shown in Fig. 204. This is known as a double adjustable ring. It is in a plate holder with part of the plate turned up to form the traveler cleaner. A, is the ring, B, the plate holder, and, C, is the part of the plate which forms the traveler cleaner.

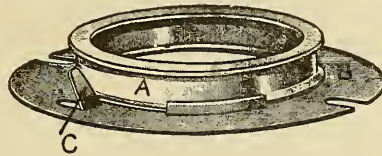

Fig. 204. Double Ring in Plate Holder.

The advantage claimed for a double ring, is, that when the top flange becomes worn, it may be reversed in the holder, the other side used, prolonging very much the wear of the ring.

The plate holders are made round, oval or square. A round holder is shown, with the ring, in Fig. 204, and an oval plate holder with a double ring is shown in Fig. 205.

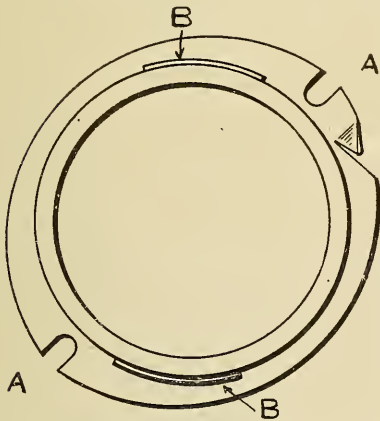

Fig. 205. Oval Plate Holder and Ring.

The oval holder has two screw slots at AA, for securing the holder to the ring rail, and two lugs at BB for fastening the ring to the holder. The slots permit the holder to be adjusted so the ring can be set concentric with the spindle.

A square holder is shown in Fig. 206. This one has also two slots, AA, for fastening it to the rail but has three lugs, BBB, for fastening the ring to the holder.

The cast iron holder is secured to the ring rail by three screws, two in front and one in the rear of the ring, and, by loosening one and

tightening the other two, the ring can be moved a slight distance for setting it in position. The cast iron holder is made with a split so that it can be sprung open, slightly, to remove the ring.

Rings, known as solid rings are also used. They are without holders and are made to fit the holes in the ring rail with a very slight adjustment by screws the same as the cast iron holders.

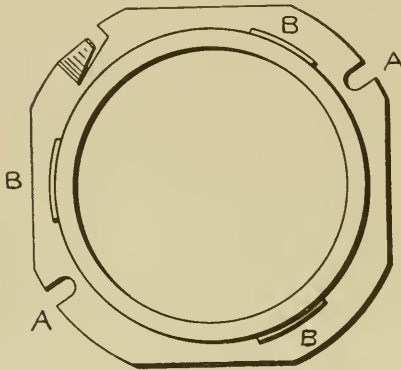

Fig. 206. Square Plate Holder and Ring.

Rings are often specified as one and one-half inch ring in a holder for one and three-fourths inch ring. This permits the holder to be removed and a one and three-fourths inch ring and holder to be used in the same place. The

hole in the ring rail is made large enough that a one and three-fourths inch ring may be used.

The flanges for the rings for ring frames are known as numbers 1, 2, etc. Number 1 flange is one-quarter of an inch wide, and is usually used for rings up to one and three-fourths inches in diameter, while number 2 flange, which is five thirty-seconds of an inch wide, is used for sizes up to two and one-fourth inches in diameter. This is not an absolute rule to follow but is recommended by some of the prominent ring makers.

Enlarged sections of flanges, numbers one and two with the respective sizes of the traveler, are shown in Fig. 207.

Ring Travelers. There is no rule by which the correct weight of travelers may be determined for a certain number of yarn, as the size of ring, speed of spindle, number of yarn and twist per inch, introduce elements which affect the size of the traveler, and, also, the different makes of travelers vary slightly in the numbers of different sizes.

The following table gives approximately the correct size of ring

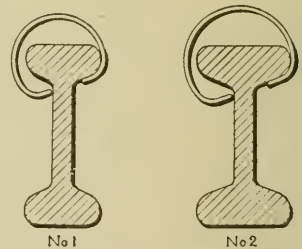

Fig. 207. Enlarged Section of Flange of Rings and Travelers.

travelers to use for spinning yarns of ordinary twist and of various sizes of rings. This table is given as a guide to select travelers, but it must be understood that the numbers will vary somewhat owing to circumstances as referred to above.

No. Yarn	1½" Ring	1½" Ring	1¾" Ring	No. Yarn	1½" Ring	1½" Ring	1¾" Ring
8	10	9	8	30	$\frac{8}{0}$	$\frac{4}{0}$	$\frac{5}{0}$
10	8	7	6	32	$\frac{4}{0}$	$\frac{5}{0}$	$\frac{6}{0}$
12	7	6	5	34	$\frac{8}{0}$	$\frac{6}{0}$	$\frac{7}{0}$
14	6	5	4	36	$\frac{6}{0}$	$\frac{7}{0}$	$\frac{8}{0}$
16	5	4	3	38	$\frac{7}{0}$	$\frac{8}{0}$	$\frac{9}{0}$
18	4	3	2	40	$\frac{8}{0}$	$\frac{9}{0}$	$\frac{10}{0}$
20	3	2	1	42	$\frac{9}{0}$	$\frac{10}{0}$	
22	2	1	$\frac{1}{0}$	44	$\frac{10}{0}$	$\frac{11}{0}$	
24	1	$\frac{1}{0}$	$\frac{2}{0}$	46	$\frac{11}{0}$	$\frac{12}{0}$	
26	$\frac{2}{0}$	$\frac{3}{0}$	$\frac{4}{0}$	48	$\frac{12}{0}$	$\frac{13}{0}$	
28	$\frac{3}{0}$	$\frac{4}{0}$	$\frac{4}{0}$	50	$\frac{13}{0}$	$\frac{14}{0}$	

Principle of the Traveler. The traveler receives its motion by being dragged, by the yarn, around the ring, and, in the passage of the yarn from the front roll to the bobbin, it is turned at a right angle at the point where it passes through the traveler. Therefore, all of the twist is introduced between the traveler and the front roll. In fact, the traveler performs a double duty, giving the twist to the yarn and guiding it on to the bobbin.

The size and weight of the traveler must be adapted to the number of yarn being spun. This is necessary so that the revolutions of the traveler shall fall behind the revolutions of the bobbin enough to maintain a tension upon the yarn, sufficient to wind the same length, that is delivered by the front roll, less a small amount due to contraction in consequence of the twist.

The smaller the diameter of the bobbin, the more revolutions are necessary to wind the same length, and, as the speed of the bobbin is constant, it is evident that the tension upon the yarn must relax and

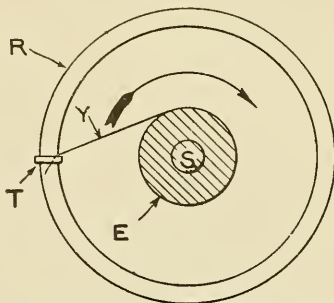

Fig. 208. Diagram Showing Principle of Traveler.

allow the traveler to fall behind the bobbin and cause more yarn to be wound. This may be understood by noting the two diagrams, Figs. 208 and 209. In these illustrations, R is the ring, T, the traveler, S, the spindle, F, the full bobbin, and E, the empty bobbin. The yarn is represented, as passing through the traveler, by the line Y.

With the full bobbin (Fig. 209), the pull of the yarn is nearly parallel with the ring, and the traveler is rotated with comparative ease, but with the empty bobbin (Fig. 208), the pull of the yarn approaches a radial line and is not as well suited to rotate the traveler.

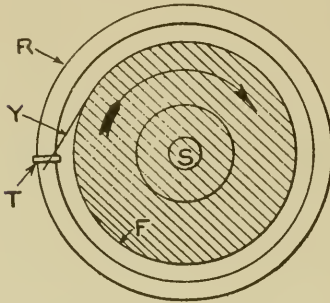

Fig. 209. Diagram Showing Principle of Traveler.

We will assume that the empty bobbin is three-quarters of an inch in diameter (2.35 inches circumference) and the full bobbin is one and three-quarters inches in diameter (5.49 inches in circumference). If the traveler is held stationary and the empty bobbin given one revolution, there will be wound 2.35 inches of yarn, while with the full

bobbin, one revolution will wind 5.49 inches.

If the rotations of the traveler were not retarded, it would travel around the ring a distance equal to 2.35 inches, for an empty bobbin and 5.49 inches for a full bobbin, and, as each rotation of the traveler gives one twist to the yarn, a considerable difference in the twist per inch will be produced, but as the traveler falls behind the bobbin only enough to cause the yarn to be wound, the difference in the twist is not appreciable.

If the bobbin makes one hundred revolutions and in the same time the front roll delivers ten inches of yarn, the twist can be called ten per inch.

The empty bobbin will have to make 4.25 revolutions.

$$\frac{10}{2.35} = 4.25$$

The traveler will make 95.75 rotations, or the speed of the bobbin less the number of revolutions, necessary to wind the yarn.

$$100 - 4.25 = 95.75$$

At each rotation of the traveler, the yarn receives one twist, so the *actual* twist per inch will be 9.57.

With the full bobbin, 1.84 revolutions are necessary to wind the ten inches of yarn, delivered by the front roll.

$$\frac{10}{5.49} = 1.84$$

The traveler will then make only 98.16 rotations.

$$100 - 1.84 = 98.16$$

The difference in twist per inch between a full bobbin, one and three-fourths inches in diameter and an empty one, three-fourths of an inch in diameter, is the difference between 9.81 and 9.57 or .24 of one turn in a length of ten inches.

Builders. There are three kinds of builders used upon the ring frame. The warp builder is shown in Fig. 210, the filling builder in

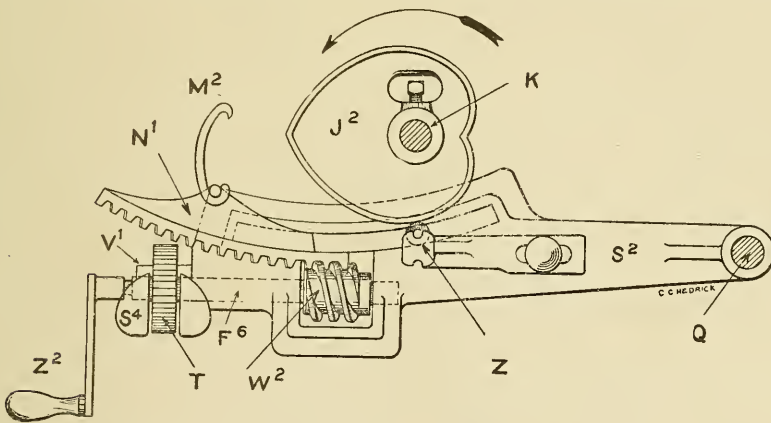

Fig. 210. Warp Builder.

Fig. 213 and the combination builder, which can be changed for either warp or filling wind, in Fig. 215.

With the warp builder, the yarn is wound the whole length of the bobbin at first and the length of the traverse is gradually shortened at each end as the bobbin increases in diameter, as shown by the distance A-B, Fig. 211.

The warp builder consists of a main piece or arm, S², rack, N¹, hook, M², worm, W², worm shaft, F⁶, ratchet gear, T, pawl, V¹, counterbalance weight, S⁴, and roll, Z. All these parts are mounted upon the builder arm which is hung upon a stud at Q. The worm is

fastened to one end of the worm shaft, and engages the teeth of the rack, and the ratchet is fastened to the other end of the shaft and its teeth are acted upon by the pawl.

The means for producing the up and down movement of the rail is by a uniform motion cam, J^2 , which bears against the cam roll and this motion is communicated to the ring rail by a chain from the hook fastened to the builder rack.

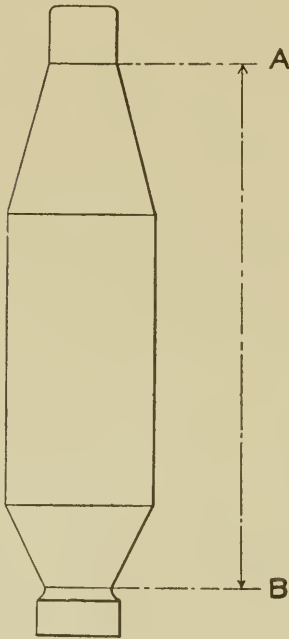

Fig. 211. Warp Bobbin.

The connection from the chain to the ring rail is shown in perspective in the drawing Fig. 212. The cross shafts, M^1 , by which the guide rods are operated, are supported in hangers, V^2 , which are bolted to the underside of the ladders. An upward projecting arm, X^1 , carries a swivel to which is connected the builder chain, Y^1 , and a horizontal arm, C^7 , carries a roll, Y^2 , which bears against a shoe on the lower end of the guide rod, C^2 . The ring rails, E^2 , rest upon brackets on the top of the guide rods. A counterbalance weight, not shown in the drawing but attached to each cross shaft and shown as G^2 in Fig. 192, keeps the builder cam roll up against the cam, so that there shall be no backlash at the end of the traverse.

The cam is fastened to the cam or heart shaft, K , which is driven from the foot or gear end, P^1 , to which reference will be made later.

The rack is shown wound out to the extreme end of the arm, and the ring rail moves the full length of its traverse, but at each upward swing of the arm, the pawl is brought into contact with the dagger, E^2 , which is fastened to the ladder. This gives the ratchet gear a partial turn, and the rack is drawn back toward the fulcrum of the arm and the traverse of the rail is shortened.

The ratchet gears are made with various numbers of teeth and the dagger is adjustable so that it can be set to take up more or less teeth.

When the bobbin is full, the rack is wound out to commence a new set by the crank, Z^2 , called the builder key.

The filling builder (Fig. 213) is connected to the ring rail in the same manner as the one just described, but with the filling wind, the rail starts at the lowest point in the traverse and, instead of winding

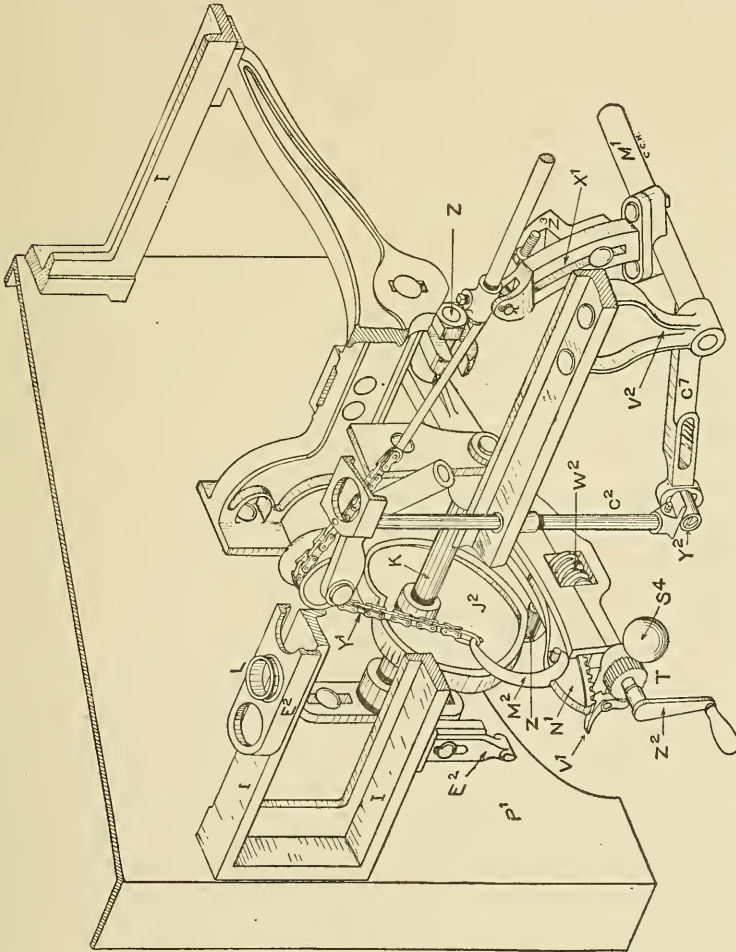

Fig. 212. Perspective View Showing Connection from Builder to Ring Rail.

the yarn the whole length of the bobbin, it is wound a short distance, as shown by A-B in Fig. 214. The length of the traverse remains the same throughout the whole length of the bobbin, but its position gradually goes higher until it reaches the top of the bobbin. This

is accomplished in the following way: The worm, W^2 , instead of engaging a rack as on the warp builder, is in gear with a worm gear, V^2 , the hub of which is made as a drum upon which the builder chain, T^5 , is wound. The ratchet gear is turned in the same manner as for the warp builder.

At the beginning of the set, when the rail is at its lowest position, the chain is wound around the drum, but as the ratchet gear is slowly

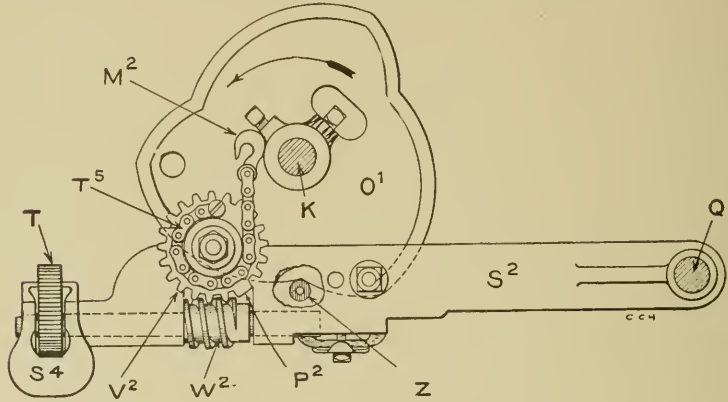

Fig. 213. Filling Builder.

turned, it is gradually unwound and the traverse is allowed to go higher on the bobbin. The builder is wound back with a key, the same as the warp builder.

The filling cam, O^1 , is made with three lobes, so each revolution of the cam shaft causes the ring rail to make three complete traverses against one complete traverse of the warp cam. Owing to the peculiar outlines of the filling cam, the rail is made to traverse in one direction faster than in the other. The cam can be put on to the cam shaft so as to give either a fast or slow down traverse to the ring rail. The slow down traverse is generally preferred, as the yarn draws off the bobbin much better and with less danger of breaking when afterwards used in the shuttle in weaving.

The object in having the rail run faster one way than the other is to permit the coils, wound on the slow traverse, to be covered by the coils of the fast traverse which wind more openly and this, in a measure, prevents the yarn from becoming tangled, and allows it to unwind from the bobbin more freely.

The combination builder (Fig. 215) may be used for either a warp, or a filling wind, by making a slight change in the arrangement of parts, but it is necessary to use both warp and filling cams to produce this change.

The drawing shows the builder arranged for a filling wind. The chain is fastened to the hook, formed in the end of the filling arm, K^1 , which is pivoted on the builder at Z^1 . Upon commencing to spin a set, the builder is drawn out until the roll, J^1 , which is fastened to the rack, N^1 , is brought against the neck of the filling arm in the position shown.

The builder arm is caused to traverse by the filling cam, O^1 , in the same manner as the other builders, and the rack is gradually moved back towards the fulcrum, of the builder arm, carrying with it the roll. This movement allows the filling arm to rise and the traverse of the rail to approach the top of the bobbin. The length of the traverse remains the same, as the position of the point, to which the chain is attached to the filling arm, is not changed.

When the builder is to be changed from filling to warp, the filling cam is loosened and slipped along the shaft, and the warp cam is put in its place; the chain is then unhooked from the filling arm and fastened to the pin in the rack.

In setting the warp builder shown in Fig. 210, the rack, N^1 , is first drawn out, as shown in the drawing, and the traverse is set by running the ring rail down, to bring the traveler to the position wanted on the bobbin. The rail is then raised to the desired point, and by adjusting the length of the chain arm, Z^3 (Fig. 212), the exact length of the traverse can be determined.

The length of taper, for the top or bottom of the bobbin, can be varied by raising or lowering the fulcrum, Q , of the builder arm. This may be understood by reference to Fig. 216. The builder is set for the same length of taper for both ends of the bobbin. The

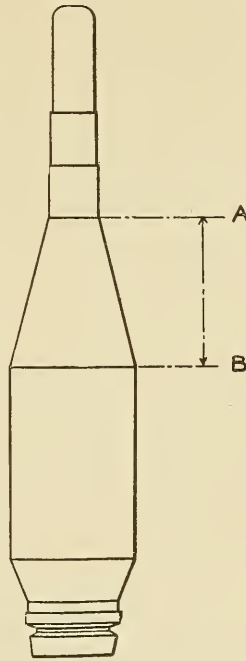

Fig. 214. Filling Bobbin.

fulcrum of the builder arm is at Q; the throw of the cam is shown by the distance between the center of the cam rolls, A and B.

When the rail is traversing its greatest distance and the rack is wound out, the hook is at G and the length of the traverse is repre-

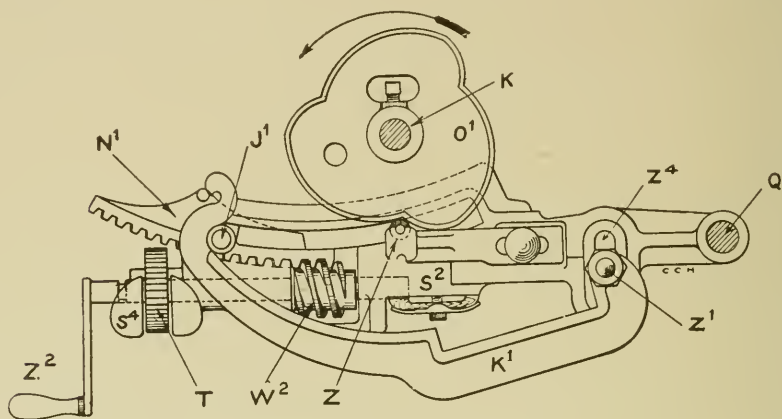

Fig. 215. Combination Builder.

sented by the distance between the horizontal lines, C-D. But when the bobbin is full and the traverse is shortened to its extent, the point, G, where the hook is attached, has moved in to H and the traverse of the rail is represented by the distance E-F. The distance between

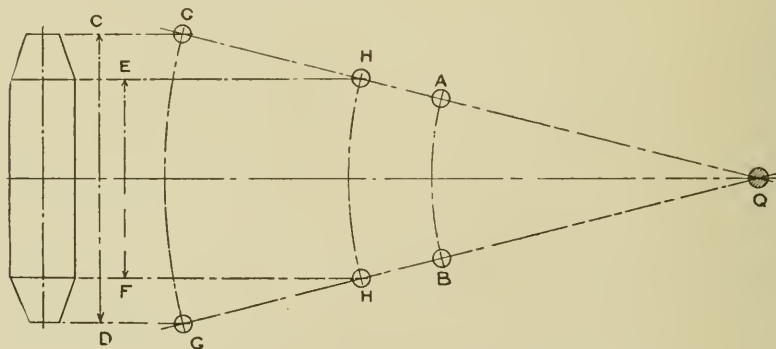

Fig. 216. Diagram Showing Taper at Top and Bottom of Bobbin.

C-E and F-D is the same and the bobbin has the same amount of taper at each end.

If it is desired to have a long taper upon the top of the bobbin, the fulcrum of the builder arm is dropped, as in Fig. 217, which

results in making a long nose on the top of the bobbin. The greatest traverse of the rail is represented by the distance, C-D, and the shortest traverse by the distance, E-F. Unlike the previous drawing, the distance between the horizontal lines, D-F, which represents the lowest position of the rail for both the long and the short traverse, is much less than the distance, C-D.

If the long taper is wanted upon the bottom of the bobbin, the fulcrum is raised. The length of the taper can be regulated to a certain extent by raising or lowering the dagger so as to let off a greater or lesser number of teeth.

In starting the filling builder, the chain should be wound up as shown in the drawing (Fig. 213) until the double tooth, P², comes around against the worm, which forms a stop, so that the rail shall

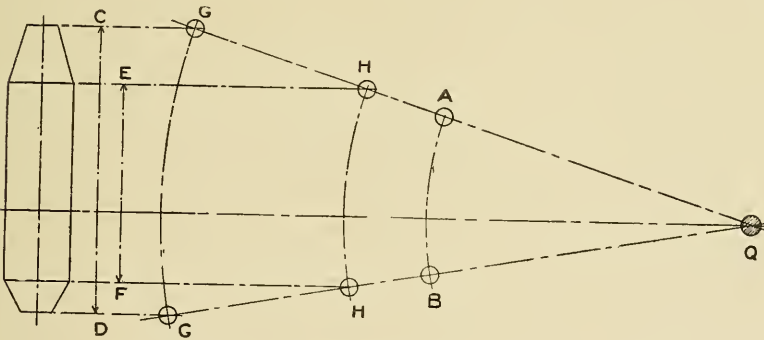

Fig. 217. Diagram Showing Taper at Top and Bottom of Bobbin.

start in the same position each time. The length of taper may then be regulated by raising or lowering the fulcrum of the builder arm and also by letting off teeth on the ratchet gear

In using the combination builder, for a filling wind, the fulcrum of the filling arm is raised or lowered in the slot, Z⁴, instead of raising the fulcrum, Q, of the arm.

A word in regard to the respective merits of stick doffing and twist doffing. The method, employed by most of the mills, throughout the country, where modern spindles are used, is "stick" doffing. This is done by running the ring rail to the lowest point in its traverse, and winding a few coils of loose yarn around the cup, so that when the full bobbin is drawn off, this loose yarn will wind closely around

the blade of the spindle. The empty bobbin is then pushed down on the spindle, and the loose yarn is caught between the spindle and the bobbin, so when the frame is started, the yarn is ready to wind on.

The system, called "twist" doffing, is used where old style spindles are used. This method consists in stopping the frame about in the middle of the extreme ends of the traverse on both warp and filling frames. When the full bobbin is removed, the empty one is twisted around the loose yarn and pushed down on the spindle. When the frame is started, a slight ridge is sometimes formed before the rail begins to traverse. This is a serious fault, on a filling wind, for as the yarn grows less on the bobbin and begins to draw from a point below the ridge, it breaks, causing frequent stopping of the loom when weaving.

The "stick" method cannot be used successfully, on the old style spindles, as the yarn cannot be wound around the base of the blade without seriously interfering with the putting on of the empty bobbins.

The "twist" doff takes considerably longer than the "stick" doff, and for that reason, the latter is used whenever possible.

Gearing. An elevation, showing the gear end of a ring frame, is shown in Fig. 218. The front rolls, F, are driven from the drum shaft, G⁶, by the drum gear, A⁴, the stud gear, C⁶, the twist gear, K⁶, intermediate gears, N⁶, and the front roll gear, S⁴.

The cam shaft, K, is driven from the sprocket gear, J⁴, on the hub of the intermediate gear, N⁶, by a chain, A⁴, a sprocket gear, D⁶, the bevel gears, E⁶ and F⁶, the worm, W⁶, and the worm gear, J⁷, which is upon the cam shaft.

The draft gearing is shown on the right hand side of the frame. The gear, A, on the front roll drives the crown gear, M⁶, and on the stud with the crown gear is the draft gear, D⁶, which drives the gear, K⁶, on the back roll. The gear, O⁶, on the back roll drives the middle roll through the carrier gear, P⁶ and middle roll gear, R⁶. The draft gearing is alike on each side of the frame and for extremely long frames a set of draft gears is used upon each end; "double geared", it is called.

The arrangement of the twist gearing is such that a combination of gears may be applied that will give a wide range of twist.

The drum and stud gears are of twenty-four and ninety-one

swung over so that the twist gear will engage the intermediate gear on the opposite side from that shown in the drawing.

The drums are seven, eight or nine inches in diameter and the whirl of the spindle is three-fourths, thirteen-sixteenths, seven-eighths of an inch or one inch in diameter. The sizes, most commonly

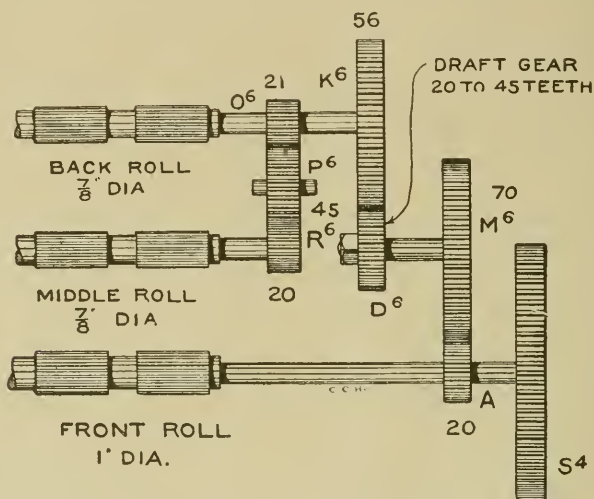

Fig. 219. Diagram of Draft Gearing.

used, are seven inch drum and three-quarters or thirteen-sixteenths inch whirl.

The spindle makes a certain number of revolutions to each revolution of the drum, and this is called "relation of drum to whirl". This relation must be known in figuring the speed of the spindle, hence the following table:

Revolutions of Spindle

Dia. of whirl	7" drum	8" drum	9" drum
$\frac{3}{4}$ "	8.12	9.20	10.72
$\frac{13}{16}$ "	7.58	8.61	9.94
$\frac{7}{8}$ "	7.05	8.10	9.45
1"	6.48	7.18	8.25

The speed of the cam shaft is often changed, as the filling wind is run at a greater speed than the warp wind. The traverse must also run at a greater speed for coarse yarn than for fine yarn. These

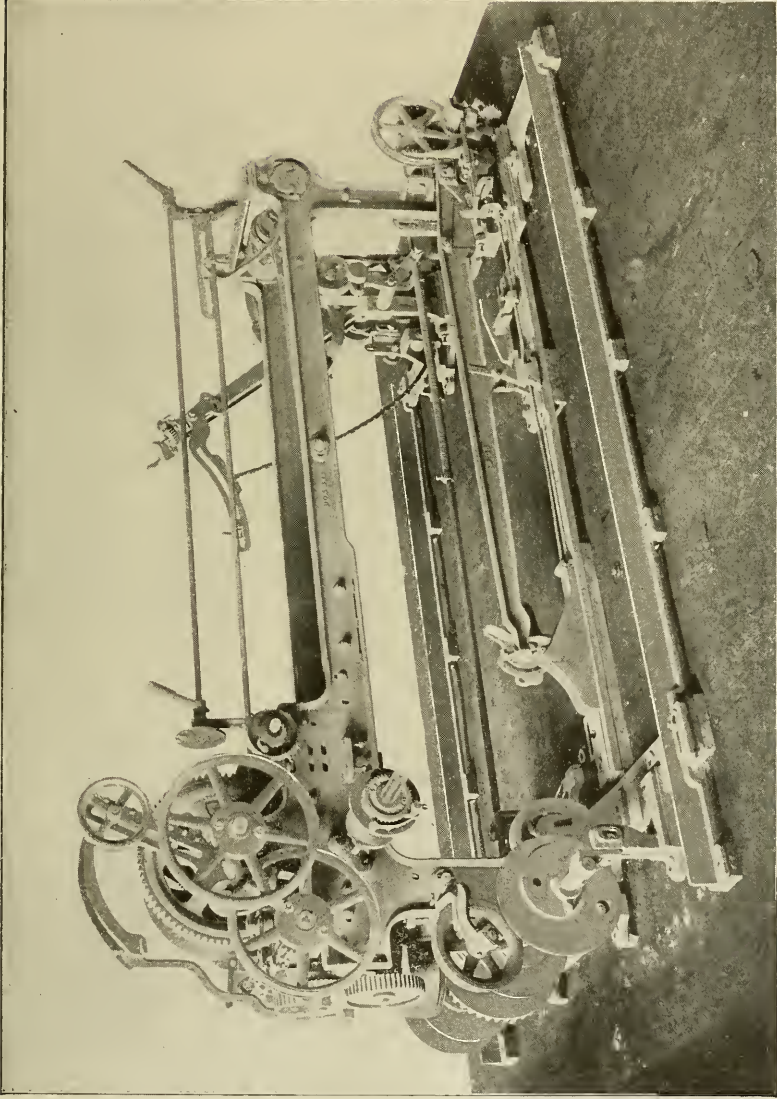

MULE HEAD — RIM AT THE SIDE
Mason Machine Works.

changes in speed are made by having a different number of teeth in either the upper or lower sprocket gear. The binder pulley, T⁶, which is carried by an arm, V⁶, is for taking up the slack of the chain when necessary.

To change the draft, various combinations are used. In the drawing, a front roll gear of twenty teeth and a crown gear of seventy

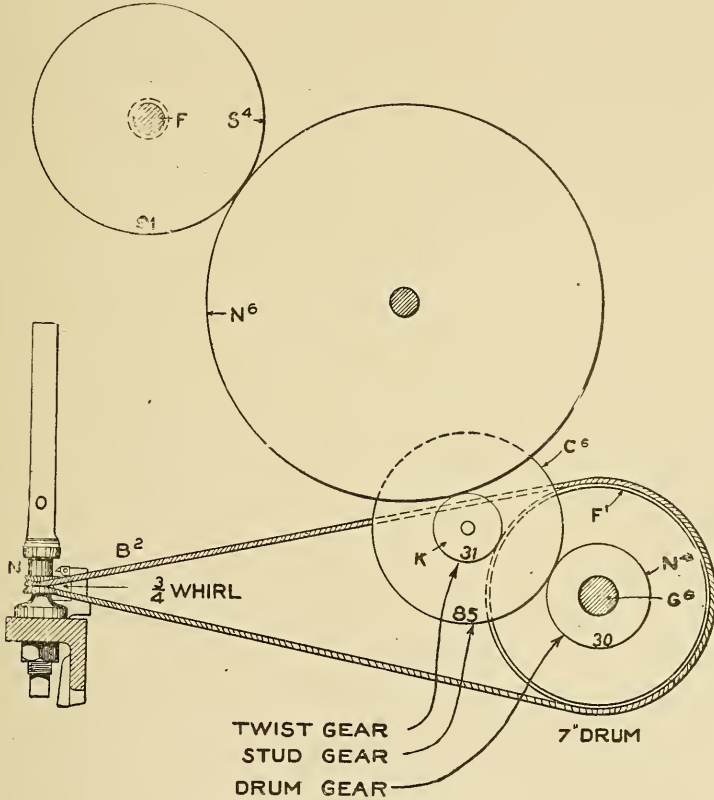

Fig. 220. Diagram of Twist Gearing.

teeth are shown. These may be changed to twenty and sixty-four teeth or thirty and one hundred four teeth.

The back roll gear shown has fifty-six teeth but it is also supplied with fifty, fifty-four or fifty-five teeth.

The regular draft gearing is sixteen pitch, but where a very fine range is wanted, the gears are made twenty-four pitch so that a change of one tooth will make a small change in the draft.

Yarn is made both right and left twist. When it is to be doubled on a twister, it is necessary to spin it with the spindle rotating in the opposite direction from that of the twister spindle. If two threads are to be twisted on a ring twister and given a right hand twist, they must have a left hand twist in spinning.

A diagram of the draft gearing is shown in Fig. 219 and the twist gearing is shown in Fig. 220.

Rule 1. To find the draft between the front and back rolls: Multiply the driven gears by the diameter of the front roll and divide the product by the product of the driving gears multiplied by the diameter of the back roll. The driven gears are M⁶ and K⁶ and the diameter of the front roll is 1 inch. The driving gears are A and D⁶ and the back roll is $\frac{7}{8}$ inches diameter.

Example:
$$\frac{70 \times 56 \times 8}{20 \times 28 \times 7} = 8.00$$

Rule 2. To find the draft factor: Proceed as in the previous rule but omit the draft change gear D⁶.

Example:
$$\frac{70 \times 56 \times 8}{20 \times 7} = 224.00$$

Rule 3. To find the draft: Divide the factor by the number of teeth in the draft gear.

Example:
$$\frac{224}{28} = 8.00$$

Rule 4. To find the number of teeth in the draft gear: Divide the factor by the draft.

Example:
$$\frac{224}{8} = 28.00$$

Rule 5. To find the twist per inch in the yarn: Multiply the driven gears by the ratio of spindle to drum and divide the product by the product of the driving gears multiplied by the circumference of the front roll. The driven gears are C⁶ and S⁴ and the ratio of a $\frac{3}{4}$ inch whirl to a 7 inch diameter drum is 8.12. The driving gears are A⁴ and K⁶ and the circumference of the front roll is 3.14.

Example:
$$\frac{85 \times 91 \times 8.12}{30 \times 31 \times 3.14} = 21.50$$

Rule 6. To find the twist factor: Proceed as in Rule 5 but omit the twist change gear.

Example:
$$\frac{85 \times 91 \times 8.12}{21.50} = 666.75$$

Rule 7. To find the twist gear: Divide the factor by the required twist.

Example:
$$\frac{666.75}{21.50} = 31$$

Rule 8. To find the twist per inch: Divide the factor by the number of teeth in the twist gear.

Example:
$$\frac{666.75}{31} = 21.50$$

The standard twist for warp yarn is the square root of the number of yarn multiplied by 4.75. For filling yarn, multiply by 3.20. For hosiery yarn, and other soft twisted yarn, the factor is as low as 2.50, and for extra hard twisted yarns, as high as 5.00. The standard twist tables are based on the multiple of 4.75 for warp and 3.20 for filling.

Rule 9. To find the number of hanks per spindle: Multiply together the revolutions of the front roll per minute (132), the circumference of the front roll (3.14") and the estimated number of minutes run in ten hours (570). Divide the product by the number of inches in one hank (30,240).

Example:
$$\frac{132 \times 3.14 \times 5.70}{30,240} = 7.81$$

Rule 10. To find the number of pounds per spindle: Divide the number of hanks per spindle (7.81) by the number of yarn (20).

Example:
$$\frac{7.81}{20} = .39$$

Rule 11. To find the revolutions of the spindle per minute: Multiply together the revolutions of the front roll (132), the twist per inch (21.24) and the circumference of the front roll (3.14).

Example:
$$132 \times 21.24 \times 3.14 = 8803.55$$

Rule 12. To find the weight in grains per yard of any number of yarn: Divide the weight per yard of No. 1 yarn (8,333 grains) by the number of yarn (20).

Example:
$$\frac{8,333}{20} = .416$$

The production of the ring frame is governed by the speed at which the front roll can be run, and this speed is determined by the

quality and counts of yarn being spun. All machinery builders publish tables giving the speeds of the front roll and the spindle for the different numbers of yarn. These speeds are based upon the result of experiments, and may be increased ten to fifteen per cent, when the nature of the stock is such that it will allow it.

In Rules 9 and 11, the speed of the front roll, which is 132 R. P. M., is the table speed for No. 20 warp yarn; and in Rule 11 the twist per inch, which is 21.24, is the standard for No. 20 warp yarn also.

The actual time that the frame is stopped for cleaning and doffing varies very much with the number of the yarn and the quality of the cotton. This amounts to from 2 to 12 per cent.

The tables given show the speeds at which the front roll and the spindles may be safely run, for both warp and filling yarn, from numbers 4 to 60.

WARP YARN

Number of Yarn	Revs. of 1 Inch Front Roll Per Minute	Revs. of Spindle Per Minute	Hanks Per Day Per Spindle	Pounds Per Day Per Spindle	Estimated Time Run Per Day in Minutes
4	155	4600	8.64	2.16	537
5	153	5100	8.57	1.71	538
6	152	5600	8.50	1.41	539
7	150	5900	8.43	1.20	540
8	148	6300	8.36	1.04	540
9	147	6600	8.29	0.92	541
10	145	6900	8.22	0.82	542
12	142	7400	8.08	0.67	544
14	139	7800	7.93	0.56	546
16	136	8200	7.78	0.48	548
18	133	8500	7.64	0.42	550
20	130	8700	7.49	0.374	552
22	127	8900	7.34	0.333	554
24	124	9100	7.19	0.299	556
26	121	9200	7.03	0.270	558
28	118	9300	6.88	0.245	560
30	115	9400	6.72	0.224	562
32	112	9500	6.57	0.205	564
34	109	9500	6.41	0.188	565
36	106	9500	6.25	0.173	567
38	103	9500	6.09	0.160	569
40	100	9500	5.93	0.148	571
42	98	9500	5.83	0.138	573
44	96	9500	5.73	0.130	575
46	94	9500	5.63	0.122	577
48	92	9500	5.53	0.115	579
50	90	9600	5.43	0.108	581
60	85	9800	5.20	0.086	590

FILLING YARN

Number of Yarn	Revs. of 1 Inch Front Roll Per Minute	Revs. of Spindle Per Minute	Hanks Per Day Per Spindle	Pounds Per Day Per Spindle	Estimated Time Run Per Day in Minutes
4	169	3400	9.22	2.30	525
5	168	3775	9.17	1.83	526
6	166	4100	9.12	1.52	527
7	165	4400	9.08	1.29	528
8	163	4650	8.99	1.12	529
9	162	4900	8.95	0.99	530
10	160	5100	8.85	0.88	531
12	158	5500	8.75	0.72	533
14	155	5850	8.65	0.61	535
16	151	6100	8.47	0.52	537
18	147	6300	8.28	0.46	540
20	144	6500	8.14	0.407	542
22	142	6700	8.03	0.365	544
24	136	6700	7.72	0.321	546
26	134	6900	7.67	0.295	548
28	130	6950	7.47	0.266	550
30	126	6950	7.25	0.241	552
32	123	7000	7.09	0.221	555
34	119	7000	6.91	0.203	557
36	116	7000	6.74	0.187	559
38	114	7100	6.68	0.175	561
40	112	7150	6.58	0.164	563
42	110	7200	6.49	0.154	565
44	108	7200	6.37	0.144	567
46	105	7200	6.25	0.135	570
48	103	7200	6.14	0.128	572
50	101	7200	6.04	0.102	574
60	93	7300	5.69	0.094	585

The draft of the ring frame varies much with the quality of cotton, the number of yarn being spun and whether the yarn is single or double roving.

It is a fault, with many mill superintendents, to have the hank roving, of the fine fly frame, coarse so the production will be large which makes the draft of the ring frame long. This is productive of uneven yarn, particularly when spun from single roving. In many cases, the roving should be made fine enough so that the draft will be from six to eight for single roving and from eight to twelve for double roving.

The following program is for a mill, making flat duck, seven to twelve ounces per yard, number ten warp, number five and one-half filling from single roving.

PROGRAM OF DRAFTS AND WEIGHTS

NO. 10 WARP. NO. 5½ FILLING

Weight of Picker Lap.....	16 ounces
Weight of Card Lap less 5 per cent.....	6630 grains
Draft of Card.....	102
Weight of Card Sliver.....	65 grains
Double on Drawing Frame, 1st process.....	6
Draft on Drawing Frame, 1st process.....	5.4
Weight of Drawing Sliver, 1st process.....	72.2 grains
Double on Drawing Frame, 2nd process.....	6
Draft on Drawing Frame, 2nd process.....	5.4
Weight of Drawing Sliver, 2nd process.....	80.2 grains
Draft of Slubber.....	4.80
Hank Roving of Slubber.....	.50
Double on Fine Frame.....	2
Draft on Fine Frame.....	4.00 and 5.20
Hank Roving of Fine Frame.....	1.00 and 1.30
Draft of Ring Frame.....	5.50 and 7.70
No. of Yarn.....	5.50 filling and 10 warp

The slubber roving is .50 hank, and on account of the extreme difference between the warp and filling yarn, it is necessary to make two numbers of roving, on the fine frame, namely, 1.00 hank and 1.30 hank.

The weight of the picker lap is given in ounces per yard, but the weight of the card lap is given in grains per yard, as the weight of the card sliver is expressed in grains and the draft can be figured more easily.

The weight of the card lap is figured as five per cent less than the picker lap. Actually, there is no difference, as the lap from the finisher picker goes directly to the back of the card, but as there is a loss of about five per cent in carding, it is customary to take this amount out of the weight of the lap.

The weight of slubber roving is given by the hank and, to find the necessary draft to make the required hank roving, the following rule may be used: Multiply the weight of the drawing sliver (80.2 grains) by the required hank roving and divide by the weight of number one hank roving (8.333 grains).

Example:
$$\frac{80.2 \times .50}{8.333} = 4.81 +$$

The next program is that of a mill, making cotton cloth, weighing about three yards to the pound, thirty-six inches wide, number fourteen warp and filling yarn, from single roving.

PROGRAM OF DRAFTS AND WEIGHTS

NO. 14 WARP. NO. 14 FILLING

Weight of Picker Lap.....	14 ounces
Weight of Card Lap less 5 per cent.....	5818 grains
Draft of Card.....	.97
Weight of Card Sliver.....	.60 grains
Double on Drawing Frame, 1st process.....	.6
Draft of Drawing Frame, 1st process.....	.6
Weight of Drawing Sliver, 1st process.....	.60 grains
Double on Drawing Frame, 2nd process.....	.6
Draft of Drawing Frame, 2nd process.....	.6
Weight of Drawing Sliver, 2nd process.....	.60 grains
Double on Drawing Frame, 3rd process.....	.6
Draft of Drawing Frame, 3rd process.....	.6
Weight of Drawing Sliver, 3rd process.....	.60 grains
Draft of Slubber.....	5.00
Hank Roving of Slubber.....	.70
Double on Fine Frame.....	.2
Draft of Fine Frame.....	5.70
Hank Roving of Fine Frame.....	2.00
Draft of Ring Frame.....	7.00
No. of Yarn.....	14.00

The third program is for a yarn mill also making fourteen yarn but from double roving.

PROGRAM OF DRAFTS AND WEIGHTS

NO. 14 HOSIERY YARN

Weight of Picker Lap.....	14 ounces
Weight of Card Lap less 5 per cent.....	5819 grains
Draft of Card.....	1.00
Weight of Card Sliver.....	.58 grains
Double on Drawing Frame, 1st process.....	.6
Draft of Drawing Frame, 1st process.....	.6
Weight of Drawing Sliver, 1st process.....	.58 grains
Double on Drawing Frame, 2nd process.....	.6
Draft of Drawing Frame, 2nd process.....	.6
Weight of Drawing Sliver, 2nd process.....	.58 grains
Draft of Slubber.....	3.5
Hank Roving of Slubber.....	.50
Double on Intermediate.....	.2
Draft on Intermediate.....	4.4
Hank Roving of Intermediate.....	1.10
Double on Fine Frame.....	.2
Draft of Fine Frame.....	5.5
Hank Roving of Fine Frame.....	3.00
Double on Ring Frame.....	.2
Draft of Ring Frame.....	9.4
No. of Yarn.....	14.00

Yarn, spun from double roving, produces a more even thread than that spun from single roving, owing to the doubling of the two ends. A thin or light place, in one end, will be offset by the other end, but if an end breaks or runs out, the yarn spun from the remaining end will be "single" and of incorrect weight.

The last program is for a mill making mule-spun hosiery yarn, numbers ten to twenty-four, from 2.30 and 4.00 hank roving, double.

PROGRAM OF DRAFTS AND WEIGHTS

FROM 10's TO 24's HOSIERY YARN

Weight of Picker Lap.....	14 ounces
Weight of Card Lap less 5 per cent.....	.5819 grains
Draft of Card.....	100
Weight of Card Sliver.....	.58 grains
Double on Drawing Frame, 1st process.....	.6
Draft of Drawing Frame, 1st process.....	.6
Weight of Drawing Sliver, 1st process.....	.58 grains
Double on Drawing Frame, 2nd process.....	.6
Draft of Drawing Frame, 2nd process.....	.6
Weight of Drawing Sliver, 2nd process.....	.58 grains
Double on Drawing Frame, 3rd process.....	.6
Draft of Drawing Frame, 3rd process.....	.6
Weight of Drawing Sliver, 3rd process.....	.58 grains
Draft of Slubber.....	3.83
Hank Roving of Slubber.....	.55
Double on Intermediate.....	2
Draft of Intermediate.....	4 and 5.2
Hank Roving of Intermediate.....	1.10 and 1.43
Double on Fine Frame.....	2 and 2
Draft of Fine Frame.....	4.4 and 5.7
Hank Roving of Fine Frame.....	2.42 and 4.00
Double on Mule.....	2 and 2
Draft of Mule.....	9.1 and 12.00
No. of Yarn.....	11.01 and 24.00

NO. OF YARN 10's

Hank Roving of Fine Frame... 2.30
Double on Mule..... 2
Draft of Mule..... 8.7
No. of Yarn..... 10.00

NO. OF YARN 16's

Hank Roving of Fine Frame... 4.00
Double on Mule..... 2
Draft of Mule..... 8
No. of Yarn..... 16.00

NO. OF YARN 11's

Hank Roving of Fine Frame... 2.30
Double on Mule..... 2
Draft of Mule..... 9.6
No. of Yarn..... 11.04

NO. OF YARN 18's

Hank Roving of Fine Frame... 4.00
Double on Mule..... 2
Draft of Mule..... 9
No. of Yarn..... 18.00

NO. OF YARN 12's		NO. OF YARN 20's	
Hank Roving of Fine Frame...	2.30	Hank Roving of Fine Frame...	4.00
Double on Mule.....	2	Double on Mule.....	2
Draft of Mule.....	10.5	Draft of Mule.....	10
No. of Yarn.....	12.07	No. of Yarn.....	20.00
NO. OF YARN 14's		NO. OF YARN 24's	
Hank Roving of Fine Frame...	2.30	Hank Roving of Fine Frame...	4.00
Double on Mule.....	2	Double on Mule.....	2
Draft of Mule.....	12.2	Draft of Mule.....	12
No. of Yarn.....	14.03	No. of Yarn.....	24

MULE SPINNING

Briefly speaking, the mule consists of three parts: The beam for supporting the rolls, creels, etc; the carriage which contains the drums spindles, fallers and parts directly connected; and the headstock, or mule head, which contains the various parts that control the movements of the machine. The mules are placed in pairs, as shown in Fig. 221, with the carriages toward each other, the headstock is located a little nearer one end of the mule than the other, thus making a long and a short side to the mule carriage, the short side always being to the right hand of the headstock.

In explanation, the operations of the mule may be divided into four stages. The first stage is called drawing and twisting; the

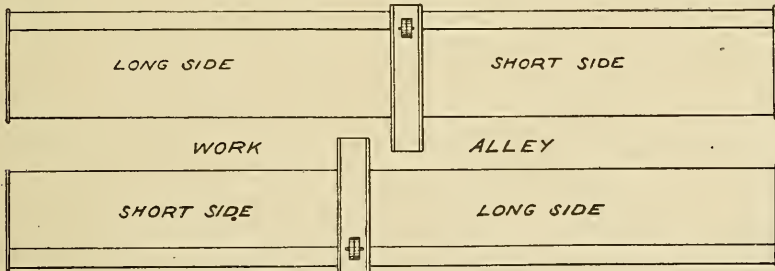

Fig. 221. Plan of a Pair of Mules.

second, backing off; the third, winding and the fourth, re-engaging.

The roving is placed in the creels and passes through the rolls by which it is drawn in the same manner as on the ring frame.

An elevation of the mule carriage is shown in Fig. 222 and a plan of the gearing, in Fig. 223. The spindles, L⁵, and the drum, C⁶, are in the carriage, E, which moves back and forth in a horizontal direction upon tracks, E⁶, which are called carriage tracks.

its outward run, or stretch, which is about sixty-four inches, it is stopped and held for a brief period.

On the outward run, the driving belt is on the tight pulley, A, and the spindles and rolls are revolving, the backing-off cone friction,

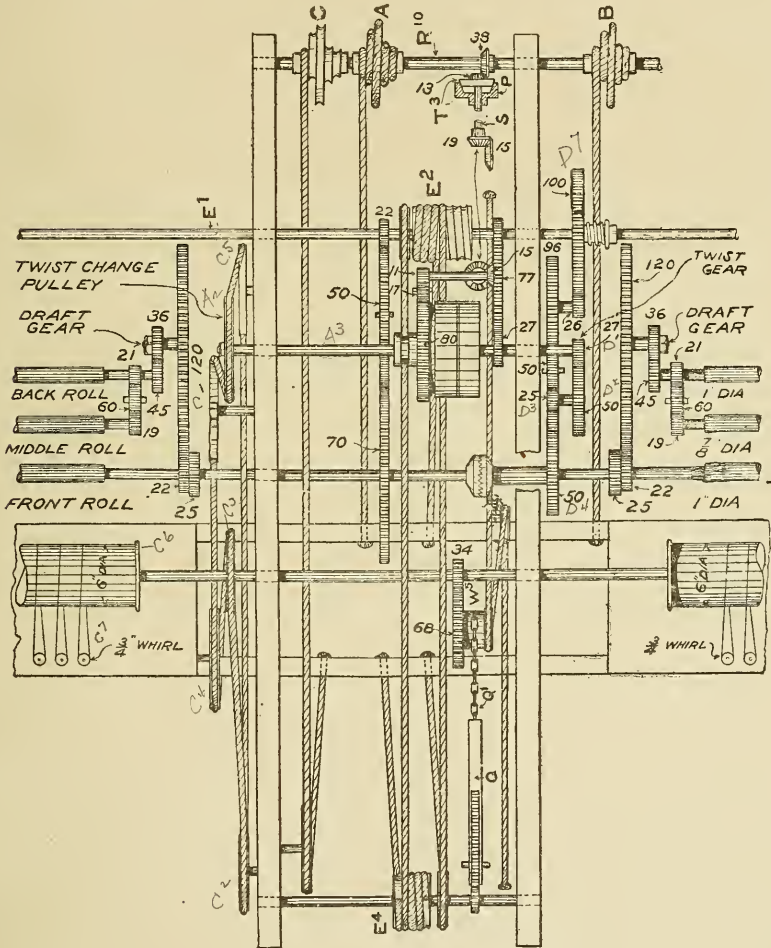

Fig. 223. Plan of Gearing of the Mule.

B, is out of gear as is also the drawing-up friction, T^3 . The backing-off friction is revolving, as it is driven from a gear on the hub of the loose pulley, which revolves all the time, as the driving belt is slightly wider than the face of the tight pulley and a portion of it runs upon the loose pulley.

The speed of the driving pulley is 500 R. P. M. The spindles are driven from the rim or twist pulley, A², which is eighteen inches in diameter and which is fast on the driving shaft, A³. The rim band, C, runs from the rim pulley around the carrier pulley, C¹, which is fastened to the headstock. From this point, it passes forward and around the carrier pulley, C⁴, which is upon the carriage, and then passes back and around the drum pulley, C³, which is ten inches in diameter. From here, the band passes forward around the carrier pulley, C², which is carried by an adjustable screw, E⁵, and which is used for keeping the band tight, then it passes back and around a carrier pulley, C⁵, and back to the twist pulley.

The drum, C⁶, is six inches in diameter and the whirl, C⁷, is three-quarters of an inch. The speed of the spindles will be 7105 R. P. M.

Example:
$$\frac{18 \times 6}{10 \times 7.5} \times 500 = 7105$$

The front roll, D, is driven from the main shaft by the twist gear, D¹, which has twenty-seven teeth, and the gears, D², of fifty teeth, D³, of twenty-five teeth and the front roll gear, D⁴, of fifty teeth.

The speed of the front rolls will be 135 R. P. M.

Example:
$$\frac{27 \times 25}{50 \times 50} \times 500 = 135$$

The front roll is one inch in diameter, therefore, 135 revolutions will give a delivery of 423.90 inches of yarn and during this time, the spindles have made 7105 revolutions.

The twist, therefore, will be 16.76 twists per inch.

Example:
$$\frac{7105}{423.90} = 16.76$$

The carriage, E, is drawn out by the back, or carriage shaft, E¹, which extends the whole length of the mule and has fast upon it three scrolls, E², one in the center and one at each end (the end ones are not shown), which are about seven inches in diameter but terminate at the ends in a smaller diameter.

The drawing-out bands, E³, which are fastened to the carriage, pass back and around the scrolls and around carrier pulleys, E². The center carrier pulley runs loose upon the quadrant shaft while the end ones turn on studs which are screwed to the ends of the mule

framing. From the carrier pulleys, the bands pass back and are fastened to the mule carriage.

The carriage shaft is driven from the front roll gear of fifty teeth and through the intermediate gear of fifty teeth and the gears of ninety-six and twenty-six teeth and the carriage shaft gear, D^7 , of one hundred teeth. The speed of the carriage shaft is 18.28 R. P. M.

Example:
$$\frac{50 \times 26}{96 \times 100} \times 135 = 18.28$$

The scrolls are about seven inches in diameter and the scroll band will be about seven and one-half inches in diameter when passed around the scroll.

The traverse of the carriage will then be 430.67 inches per minute.

Example:
$$7.5 \times 3.1416 \times 18.28 = 430.67$$

The stretch of the carriage is sixty-four inches and as the carriage runs at the rate of 430.67 inches per minute, each stretch of sixty-four inches will require about nine seconds time and as the rolls deliver the yarn at the rate of 423.90 inches per minute, in nine seconds, they will deliver $\frac{9}{60}$ of 423.90 which is 63.58 inches. This shows that the carriage travels a slight distance more than the inches delivered by the front roll. This excess in travel is called the "gain" of the carriage and amounts sometimes to two or three inches in each stretch, depending upon the quality and length of the cotton staple.

The advantage of the carriage gain is to subject the yarn to a slight draft after it has left the rolls and as the twist in the yarn always runs to the thin places, this additional drawing elongates the soft or untwisted places which are thicker or larger in diameter and thus a more even thread is produced.

Long staple cotton will permit of considerable draft, but with short cotton little or no draft can be given the yarn after it has left the rolls.

At the commencement of the outward run of the carriage, the drawing-out bands are wound upon the large diameter of the scrolls and the carriage runs at a uniform speed, but, as the scrolls terminate in a smaller diameter, the carriage moves at a relatively slower speed as it approaches the end of the run.

Backing-Off Motion. The next stage in the operations is called the backing-off. By this is meant the reversion of all the necessary parts from the position, occupied during the outward run, to the posi-

tion which they are obliged to assume during winding. The mechanism is shown in Figs. 224, 225 and 226.

At the end of the outward run, the carriage shaft clutch, H^1 , is thrown out of gear, the rolls and spindles cease to turn and the carriage is stationary. During this period, the spindles are caused to revolve a few turns in the opposite direction to that which they turned in

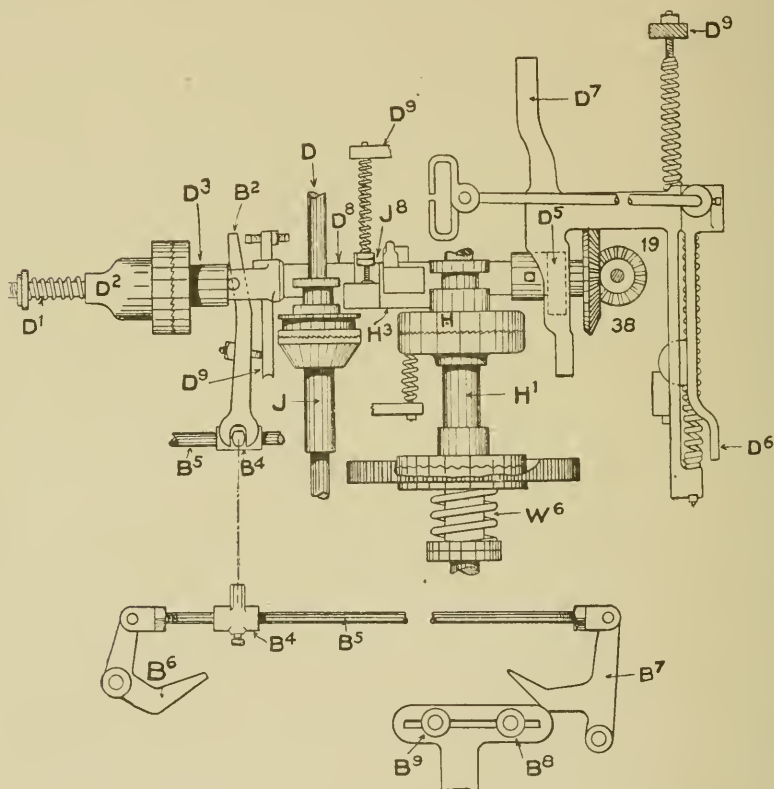

Fig. 224. Detail of Cam Shaft.

spinning. This unwinds the few coils of yarn that are around the spindle between the top of the cop and the point of the spindle. The winding faller, K^2 , which acts as a guide for the yarn, is brought down into position and the counterfaller, K^3 , ascends, until it meets the yarn, so as to maintain an even tension as it is wound upon the spindle. The fallers are shown in this position in Fig. 226. This is brought

about by the backing-off friction wheel, B, being brought into contact with the tight pulley, A (Fig. 222).

The cone clutch on the cam shaft is put in gear, and, just previous to the carriage arriving at the end of the run, the belt is moved on the loose pulley, allowing the carriage to finish the stretch by its momentum.

At this point, it will be well to explain just how the backing-off friction changes the direction of the rotations of the spindles.

The backing-off friction acts first as a stop for the rim, or driving shaft, and secondly, to impart motion to it in the opposite direction. The backing-off friction revolves all of the time because a part of the driving belt is upon the loose pulley at all times and as the latter drives the backing-off wheel by the gear of twenty-seven teeth, which is fast upon the hub of the loose pulley, and the gears of seventy-seven and eleven teeth, which are upon the backing-off shaft, W, and the backing-off wheel of eighty teeth. The last is driven in the opposite direction from the tight pulley at a very slow speed and, when suddenly thrown into contact with the tight pulley, the friction acts first as a brake and then turns the spindles a few revolutions, in the opposite direction, before it is drawn out of contact.

In Fig. 225, is shown the device by which the backing-off friction is operated. In the hub of the friction is a groove, in which runs a clutch lever, P¹, with its fulcrum at P². The long end of the lever is connected to a bell crank, P³. To the end of this bell crank is fastened one end of the backing-off rod, B¹, the other end being connected to the backing-off lever, O⁵, by the spring, O⁶. The backing-off lever is fastened to the headstock by a stud, S⁷.

As the carriage moves out, the tight pulley, A, and the backing-off friction, B, are disengaged, but when the carriage arrives at the end of the run, the backing-off arm, K⁷, comes against the roll, S⁶, which is upon the lever, O⁵, the last, being raised. By so doing, the rod, B¹, is drawn forward in the direction shown by the arrow, the friction is caused to engage with the tight pulley, and the spindles are rotated in the opposite direction.

After the spindles have unwound sufficient length of yarn, by their reverse movement, it is evident that they must be stopped else too much yarn will be unwound. This is accomplished by the locking of the fallers, whose movement causes the backing-off arm, K⁷, to be

back

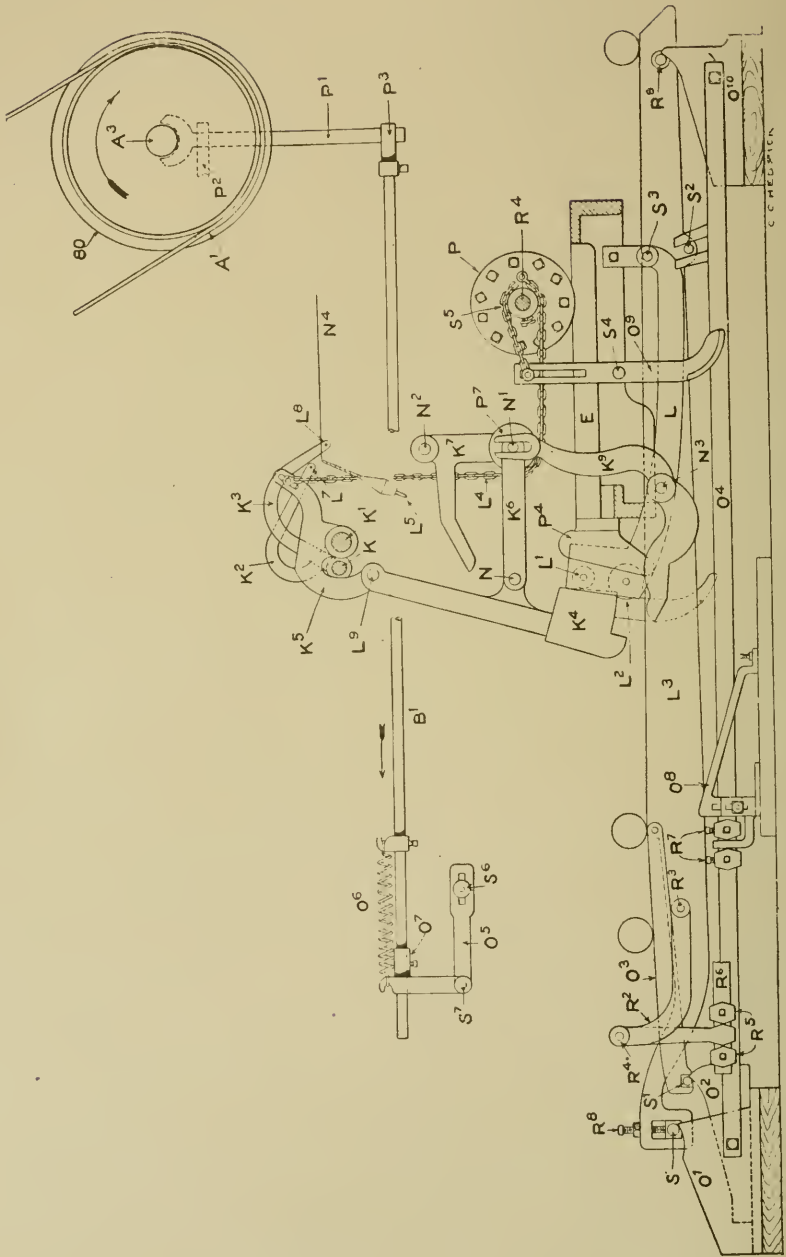
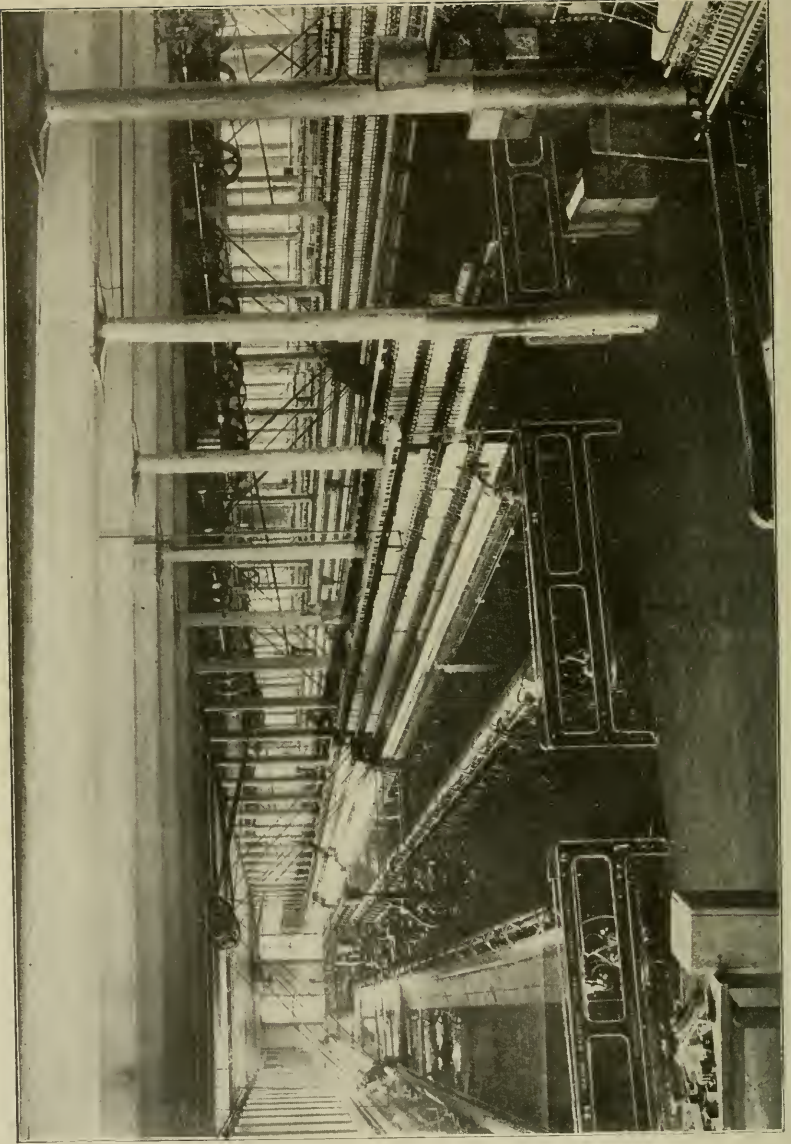

Fig. 225. Elevation Showing Details of Mule Carriage.

Front



POTOMSKA MILLS, MULE ROOM
Mason Mules on Fine Yarns.

dropped, suddenly, out of contact with the roll on the backing-off lever; this allows the spring, O^6 , to draw back on the lever which comes against the collar, O^7 , upon the backing-off rod, moving the rod back and the friction becomes disengaged.

The fallers are drawn down and locked in the following manner: Upon the drum shaft, R^4 , is a plate, P , to the hub of which is fastened one end of the backing-off chain, L^4 , the other end being fastened to an arm, K^5 , which is upon the winding faller shaft, K^1 . During the operation of drawing and twisting, the revolutions of the drum

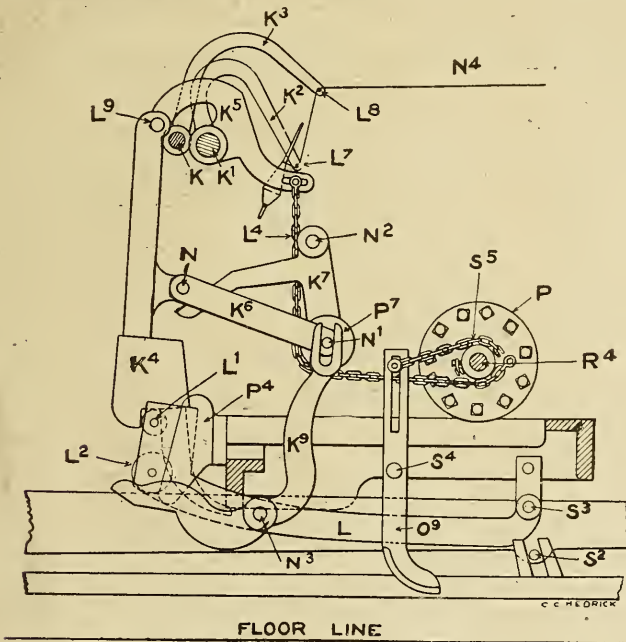

Fig. 226. Elevation Showing Details of Mule Carriage.

shaft have no effect on the plate, as it is loose upon the drum shaft. But when the direction of the drum shaft is reversed, to unwind the yarn from around the spindles, the plate also rotates, being driven by a pawl and ratchet. The chain is thus wound around the hub of the plate and the faller is drawn down into the position for winding as shown in Fig. 226.

Resting upon the top of the builder, or copping rail, L^3 , is the copping rail roll, L^2 , which is supported by an arm, L , called the

trailer and which is fastened to the carriage by a stud, S^3 . The forward end of this arm is free to swing up and down, and is supported by a guide, P^4 . Just above the roll, L^2 , is a similar roll, L^1 , called the locking roll against which rests the lower end of a lever, K^4 , which is called the faller lock. This lock is hung from the arm, K^5 , which is fastened to the winding faller shaft, K^1 .

When the carriage is on its outward run, the faller lock rests against the locking roll as shown in Fig. 225. But when the direction of the drum is reversed and the faller is drawn down into position for winding, the faller lock is drawn upwards, until the recess in its lower part is raised high enough to fall forward over the locking roll, as shown in Fig. 226, in which position the lock remains during the inward run.

In transferring the driving belt on to the loose pulley, just previous to the arrival of the carriage at the end of its outward run, a great saving in time is made by a quicker backing-off. The device which

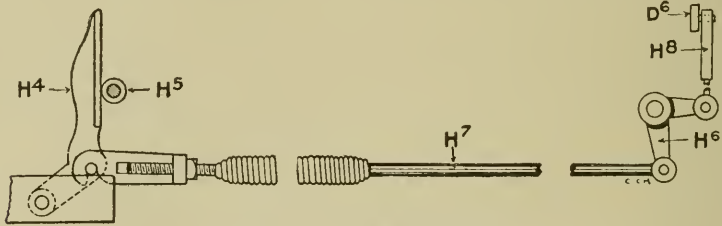

Fig. 227. Belt Relieving Motion.

controls this motion is called the belt relieving motion and is shown in Fig. 227. As the carriage comes out, a projecting part, H^5 , comes against the lever, H^4 , which through the rod, H^7 , bell crank, H^6 , and connection, H^8 , moves the belt guide, D^6 , on to the loose pulley.

During the backing-off and while the fallers are being locked, the carriage is held rigidly for a brief period to enable this motion to operate before the carriage starts on its inward run. If some means were not provided, the carriage, upon arriving at the end of the outward run, would start back before the backing-off and the locking of the fallers could take place. To prevent this, the mule is provided with a holding-out catch which is shown in Figs. 225 and 226. Fastened to the carriage by a stud, N^3 , is a lever, K^9 , called the holding-out finger, while upon the fore part of the headstock is a lever, R^2 , called the holding-out lever, one end of which is provided with a roll, R^3 , the

other end is fastened to the holding-out rod, R^6 , by collars, R^5 . This lever has, for its fulcrum, a stud, R^4 .

When the carriage arrives at the end of the outward run, the holding-out finger comes against the roll in the end of the holding-out lever and holds it firmly in position. By so doing, the drawing-up friction, by which the carriage is drawn in, is held out of gear. When the backing-off is completed and the fallers locked, the finger is lifted clear of the roll and the holding-out rod allows the drawing-up friction to drop into gear.

Backing-Off Chain Tightening Motion. We have seen, already, that at the end of the outward run, and after the carriage has come to a dead stop, the winding faller descends and guides the yarn

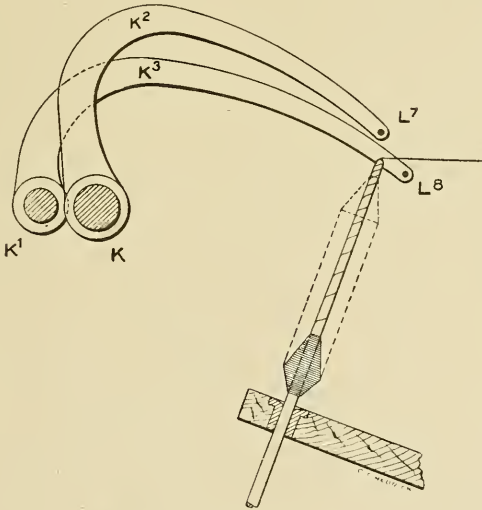

Fig. 228. Elevation Showing Fallers.

on to the spindle, while the counter faller rises until it meets the yarn, acting as a tension upon it. There remains to explain, in connection with the fallers, the different conditions under which they must work.

When drawing and twisting take place during the outward run of the carriage, the fallers are in the position shown in Fig. 228. The winding faller, K^2 , is above the yarn and the counter faller, K^3 , is below, both clear of the yarn. But during the operation of backing-off, the fallers are made to assume the position shown in Fig. 229.

The winding faller descends and guides the yarn on to the spindles, and the counter faller rises until it meets the underside of the yarn and acts as a tension upon it.

When the cop is in the early stages of formation, the length of yarn, unwound from the bare spindle between the cop and point, is considerable, as shown in Fig. 230 by the distance between the point of the spindle, A, and the top of the cop, B. In order to move the yarn from A to B, the winding faller wire must descend from C to D while the counter faller wire rises from E to F.

As the cop grows longer and the position of the winding gradually approaches the top of the spindle, the length of yarn to be unwound is considerably less as shown by the distance between G and H in

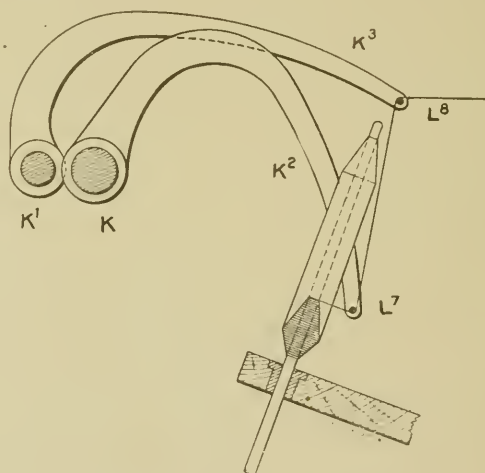

Fig. 229. Elevation Showing Fallers.

Fig. 231. The winding faller will move from K to L only and the counter faller, from M to N. It will thus be seen that the movements of the fallers, during the early stages of the building of the cop, are considerably greater than when approaching the finish and that the length to be unwound, from around the bare spindle, is considerably more, and it follows that the revolutions given to the spindle in a reverse direction must gradually decrease.

The gradual decrease in the revolutions of the spindle and the distance moved by the faller wires are regulated by the backing-off chain tightening motion.

chain tightening lever which causes the lever to unwind the tightening chain and to wind the backing-off chain on to the plate. By this movement, the slack, which exists in the backing-off chain during the early stages of the cop building, is gradually taken out and the fallers are drawn down a little earlier for each stretch of the carriage.

Winding. The third stage in the operations of the mule is called winding.

Immediately after the fallers have been brought into position and locked, the carriage commences its inward run, and the spindles rotate in the same direction as when twisting and, in so doing, wind on to the cops the yarn that is released as the carriage runs in. The winding faller descends rapidly, and guides a few coils down the cop and then rises very slowly and arrives at the starting point as the carriage reaches the end of its inward run.

Before describing the winding operation, it is necessary to know what causes the carriage to be drawn inward and also to understand the changes that take place by the partial rotation of the cam shaft sleeve.

In Fig. 224 is shown a detail of the cam shaft and in Fig. 232 an end elevation.

The cam shaft, D^1 , rotates all of the time that the mule is running and is driven from the backing-off shaft by the gears of nineteen and thirty-eight teeth.

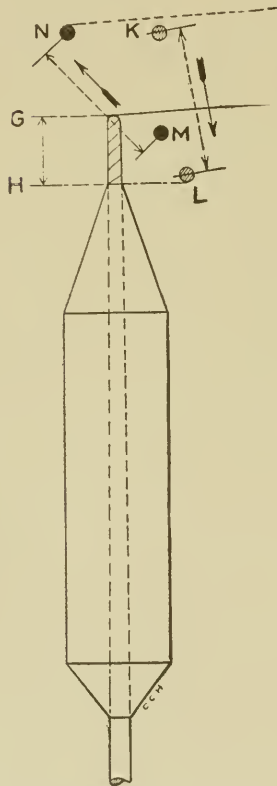

Fig. 231. Diagram Showing Movement of Fallers.

Covering almost the whole length of the cam shaft is a shell or sleeve, D^3 , called the cam shaft sleeve upon which are the various cams. The first one is the cam clutch and is made in halves, one piece, D^2 , is fastened to the cam shaft and the other half, D^3 , to the sleeve. The second cam is the front roll clutch cam, J^8 ; the third is the carriage shaft clutch cam, H^3 ; and the fourth is the shipper cam, D^5 .

On the outside of the headstock are two levers, B^6 and B^7 , called the front and back change motion levers and which are connected by a rod, B^5 , called the change motion rod. On the forward end of the rod is the shipper dog, B^4 , which operates the cam clutch lever, B^3 .

Just as the carriage reaches the end of the outward run, a roll B^9 , which is carried by a stand, forming part of the carriage, comes against the lever, B^6 , and causes the rod to move forward and with it

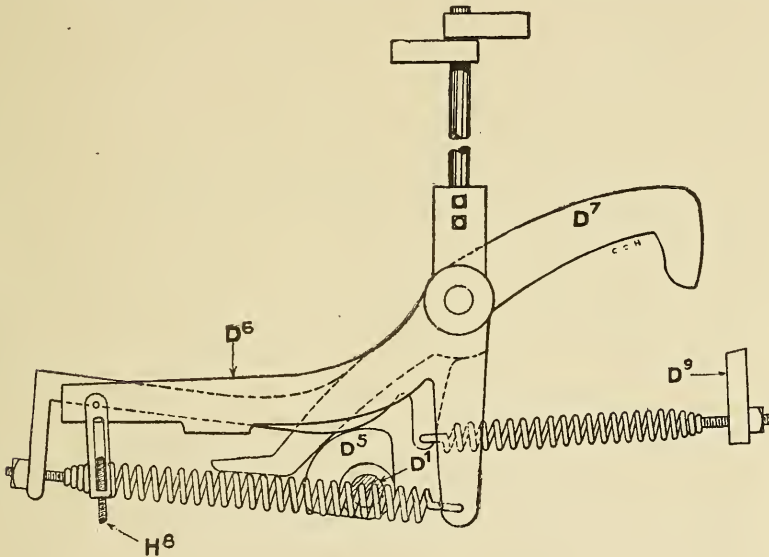

Fig. 232. End Elevation of Cam Shaft.

the cam clutch lever. This movement causes the two parts, D^2 and D^3 , of the cam clutch to engage and the cam shaft shell is given a half revolution, causing all of the cams to assume opposite positions to those which they occupied during the outward run.

When the cam sleeve has made a half revolution, the clutch is caused to be disengaged by the peculiar shape of the cam clutch lever.

In Fig. 233, it will be seen, that both parts, J and J^1 , of the front roll clutch, are engaged and we will assume that the front roll is revolving, which is the case when the carriage runs out, but when the cam sleeve changes, the position of the cam is directly opposite from that which is shown in the drawing. This disengages the clutch and stops the rotation of the front roll.

Fig. 234 shows both parts, H and H^1 , of the carriage shaft clutch

as engaged for drawing the carriage out, but with the changing of the cam sleeve, the clutch is disengaged and the revolutions of the carriage shaft cease. H^1 is made in two pieces with corrugated faces which are kept in contact by a heavy steel spring, W^6 . Should anything obstruct the outward movement of the carriage, this spring will "give" and allow the clutch to rotate without imparting movement to the carriage.

In the end elevation (Fig. 232) the belt shipper cam, D^5 , is shown in the position necessary on the outward run. The belt is upon the

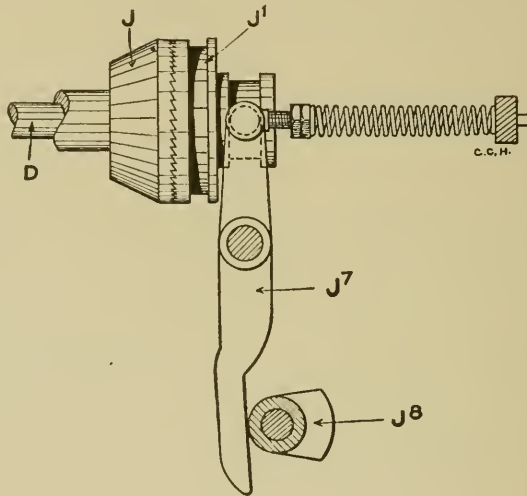

Fig. 233. Elevation Showing Front Roll Clutch.

tight pulley, but with the half revolution of the cam sleeve, the belt guide is locked into position over the loose pulley.

We have already seen that just before the carriage arrives at the end of the outward run, the belt is moved on to the loose pulley by the belt relieving motion, but unless the belt is locked into position by the shipper cam, it will be moved back on to the tight pulley by the inward run of the carriage.

The carriage is drawn in, in the following manner: On the scroll shaft, R^{10} , Fig. 223, are the scrolls, A, B and C, upon which are wound the drawing-up bands. The scroll shaft is driven from the backing-off shaft through the gears of fifteen, nineteen, thirteen and thirty-eight teeth.

On the lower end of the drawing-up shaft, S, is the drawing-up

friction, P, which rotates with the shaft. The bottom of the friction, T^3 , upon which is the bevel gear of thirteen teeth, is mounted loosely upon the shaft.

During the outward run, the scroll shaft is caused to rotate by the movement of the carriage, but when the outward movement ceases and the cam shell changes, the drawing-

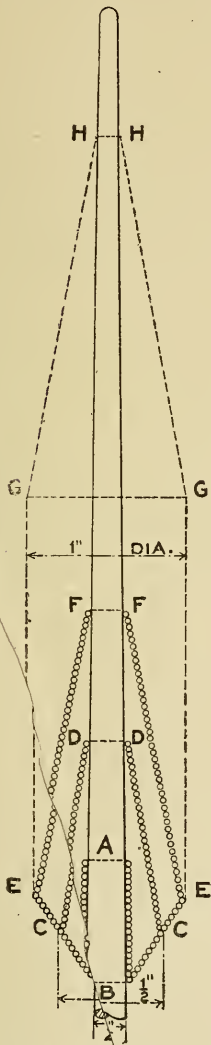

Fig. 235. Diagram of Cop Showing Winding.

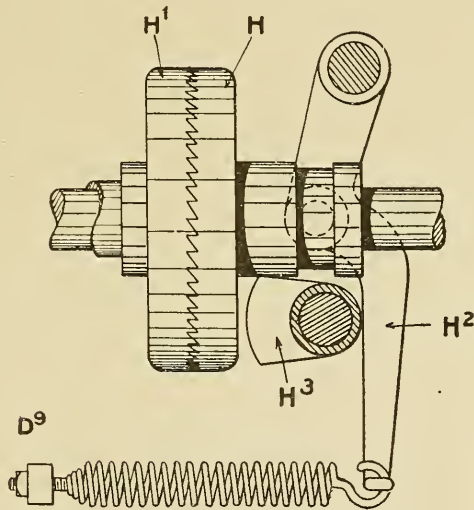

Fig. 234. Elevation Showing Carriage Shaft Clutch.

up friction, P, engages with the lower part, T^3 , and the carriage is drawn in. The scrolls, A and B, serve for this purpose, while the scroll, C, acts as a check upon the carriage. The scroll band unwinds from C while the other bands are winding around A and B.

It will be necessary to refer to Fig. 235 to understand the actual winding operation. During the outward run, sixty-four inches of yarn have been delivered and it is necessary that the spindles shall be given a sufficient number of revolutions, and at the correct speed, to wind on this length as it is released by the inward run.

We will assume, that while winding the first layer, the spindle

will be one-quarter inch diameter in the distance, A-B, and it must be revolved at a constant speed to wind the sixty-four inches, but as succeeding layers are added, and the diameter of the cop increases, the commencing point is higher each time and the finishing point is raised at a greater proportion. This lengthens the "chase", as the surface of the cop is called, which is shown by the line, C-D. There is produced a cone-shaped surface until, when the cop reaches its full diameter, as shown by the lines, E-E, the commencing and finishing points are raised in the same proportion at each stretch, which forms a straight cylindrical shape as shown by the outlines, E-E and G-G.

When winding the first layer, the speed of the spindle must be constant and, as its diameter is one-quarter of an inch, 81.48 revolutions will be necessary to wind sixty-four inches of yarn.

$$\frac{64}{.25 \times 3.1416} = 81.48$$

When the cop reaches the diameter shown at C-C, which we will call one-half of an inch, its speed at the bottom must be 40.74 revolutions.

$$\frac{64}{.5 \times 3.1416} = 40.74$$

As the winding moves up the cone, the speed of the spindle increases until at the point, DD, which is one-quarter of an inch in diameter, its speed is 81.48 revolutions.

When the cop reaches its full diameter at EE, which we will call one inch, its speed must be 20.37 R. P. M. or one-fourth as great as the speed of the bare spindle.

It will be seen that the increase in speed of the spindle must be proportionate to the decrease in its diameter, as the yarn is wound up toward the top of the chase, and the speed decreases for each new layer, while the bottom of the cop is being formed, until the full diameter is reached. From this point, the speed of the cop, at the commencement of each layer, is the same, 20.37 R. P. M., while the speed of the spindle, at the finish of each layer, is also the same, 81.48 R. P. M., except the number of revolutions necessary to compensate for the taper of the spindle which will be considered later.

Quadrant. When the carriage runs out, the spindles are driven by the rim band, but when winding, the spindles are caused to rotate

by the quadrant chain, Q^1 , one end of which is attached to the quadrant arm, Q , the other fastened to the winding drum, W^5 , as shown in Fig. 223. Connected to this drum is a gear of sixty-eight teeth, which

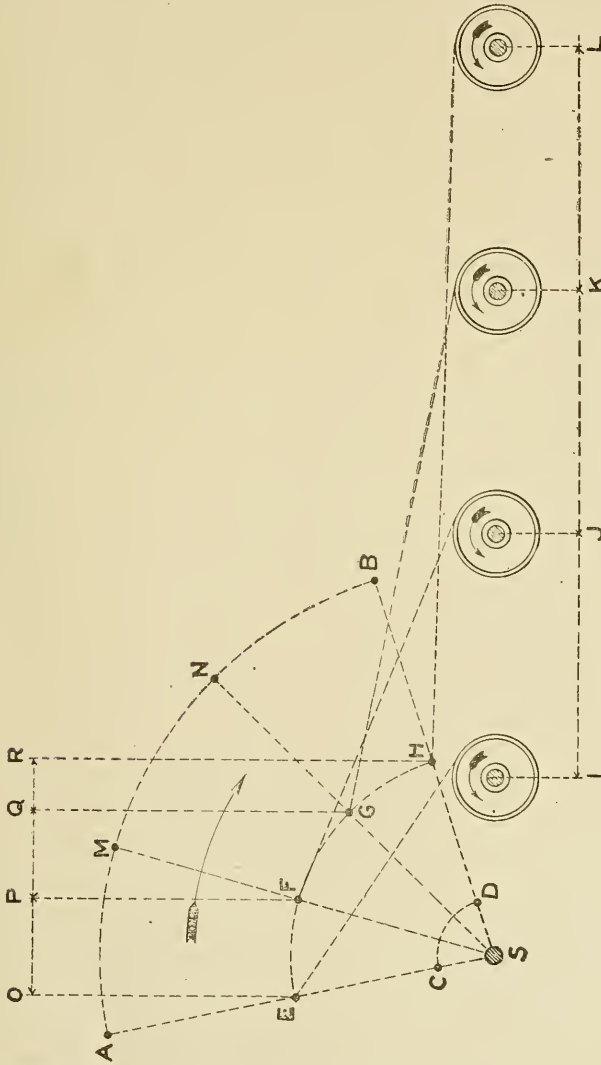

Fig. 236. Diagram of Quadrant Arm and Winding Drum.

drives a gear of thirty-four teeth, the latter connected to the drum shaft by a pawl and ratchet; the spindle drum makes two revolutions to one of the winding drum.

While drawing and twisting are going on, the winding drum is driven by a special band and the chain is wound.

Fig. 236 is a diagram of the quadrant arm and winding drum in several positions. The quadrant arm moves about ninety degrees, from A to B, while the carriage is making the whole of its run from I to L. While the first layer is winding, the nut by which the chain is attached to the arm is at C, its lowest position, nearest the fulcrum at S, and as the quadrant arm moves the ninety degrees, this point will move to D while the carriage moves the whole length of the inward run.

The movement of the nut as compared to the movement of the carriage will be very slight, and the spindles will be rotated at nearly a uniform speed.

When the cop has reached one-half inch diameter, the nut will have moved up the arm to a point at E. Here it is shown in four positions marked, E, F, G and H. The winding drum is shown also in four positions, marked I, J, K and L.

When the nut moves from E to F, the chain will have moved in a horizontal line, equal to the distance from O to P, and the drum will move from I to J. When it reaches G, the movement is less as shown by the distance, P-Q, and the drum moves from J to K, the same distance as before. As the nut reaches the point H, the movement will be considerably less, as shown by the distance, Q-R, and the carriage moves from K to L, the same distance as in each of the other stages.

During the early stages of the building of the cop, the horizontal movement of the quadrant nut is more uniform and the spindles are run at nearly a uniform speed.

When the carriage starts to run in, from I to J, the horizontal movement of the nut, from C to D, corresponds, nearly, to the movement of the carriage and the spindles run at a comparatively slow speed but as the carriage recedes from the starting point, the horizontal movement of the nut decreases in proportion to the movement of the carriage and the spindles are turned at a proportionately faster speed, by more of the chain unwinding from around the drum.

When the cop reaches its largest diameter, the nut is at its highest point, A, and remains at this point until the cop is finished. The speed of the spindles, at different points for each stretch, is the same.

Reference has been made to the fact of the spindle being larger at the base than at the point, and that some means must be employed to make up for this difference. If this is not done, the noses of the

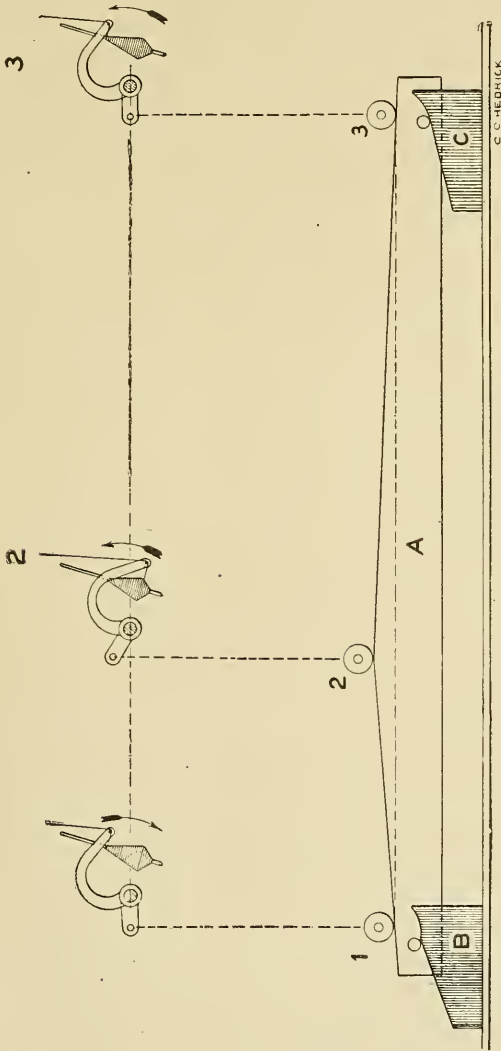

Fig. 237. Diagram Showing Winding.

cops will be soft, caused by slack winding. To overcome this, a device, called the automatic nosing motion, is used.

The winding drum is made with a straight face, for the greater

portion of its length, but terminates in a smaller diameter at the end of which the chain is fastened.

While the first half of the cop is building, the chain unwinds from the straight face of the drum, but as the cop approaches the finish, the chain is gradually shortened by winding around a drum formed on the quadrant nut. This causes the chain to unwind on to the smaller diameter of the winding drum and gives the spindles a few additional turns just as the carriage arrives at the end of the run.

Builder. By referring to Fig. 225, the builder, or copping rail, will be seen to consist of two parts, a main piece, L^3 , and a short piece, O^3 , called the loose incline.

The main piece is supported at the front by the builder shoe, O^1 , and at the back by the shoe, O^{10} . The forward end of the loose incline is supported by the shoe, O^2 . The shoes are connected by the

rod, O^4 . At each stretch, the shoes are moved back, causing the rail to drop a little and the fallers to rise a corresponding distance, thus bringing the winding higher upon the spindles.

Fig. 237 shows the copping rail, A, composed of one piece and supported at each end by shoes, B and C. The fallers are shown above in three positions, 1, 2 and 3.

When winding commences, the faller wire is in the first position but, when the carriage reaches the highest point in the rail, at the second position, the faller wire has descended to the lowest point. From here to the third position, the faller

rises slowly until it reaches the same height as the starting point. This will cause the yarn to wind on to the spindle, as shown in Fig. 238, by the distance C to D. The distance, C to D, is considerably greater than the distance, A to B, and the finishing point, D, has risen from A to D at a much quicker rate than the commencing, which has moved from B to C, only. It is evident that if the rail is composed of one piece, it will cause all of the layers to be wound the same height.

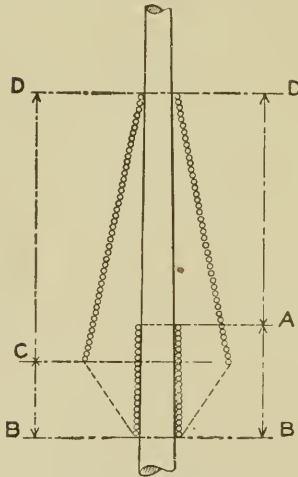

Fig. 238. Diagram of Cop Showing Winding.

The way to overcome this is to have a loose incline as shown in Fig. 239.

The builder rail, H, I and J, is made in two pieces, the surface, H-I, is hinged to J at I. By this means, it is possible to lower the points, H and J, as much as is shown by the distance, M, and as these points represent the start and finish of the stretch, it will be seen that the yarn must commence and finish winding at the same point, while the point, I, must fall to a less extent than either the points, J or H, as shown by the distance, L. The distance, L, represents the movement B to C in Fig. 238 and the distance, M, represents the movement A to D.

This continues while the bottom of the cop is building after which the points, H, I and J, fall to the same extent, as the winding gradually approaches the top of the spindle.

When the inward run is finished, the fallers are unlocked. The cam sleeve is given a half revolution and the parts are caused to re-en-

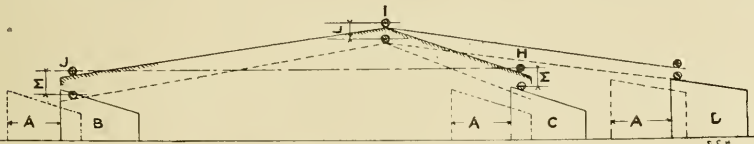

Fig. 239. Diagram Showing Loose Incline.

gage ready to commence the operation of drawing and twisting again. The front roll clutch is put in gear, the drawing-up friction is disengaged and the belt is moved on to the tight pulley.

During the run in, while the front roll clutch is disengaged, the front roll is caused to turn about one revolution, being driven from the carriage shaft by what is called the roller motion, shown in Fig. 240. This consists of a plate, A⁴, keyed to the front roll which carries a pawl, A⁶, held by a spring, A⁷, in contact with teeth formed on the inside of the roller motion gear, A⁵.

When the carriage runs out, the front roll is driven from the twist gear, as already described, but when it runs in, motion is communicated to the front roll, from the carriage shaft, through the gears of twenty-two, fifty and seventy teeth (Fig. 222) by the pawl engaging the teeth of the roller motion gear.

Snarls are produced in yarn in many ways. Following are some causes:

The quadrant nut may be too high.

The fallers may unlock too soon.

The nosing motion may not operate until the cops get too full.

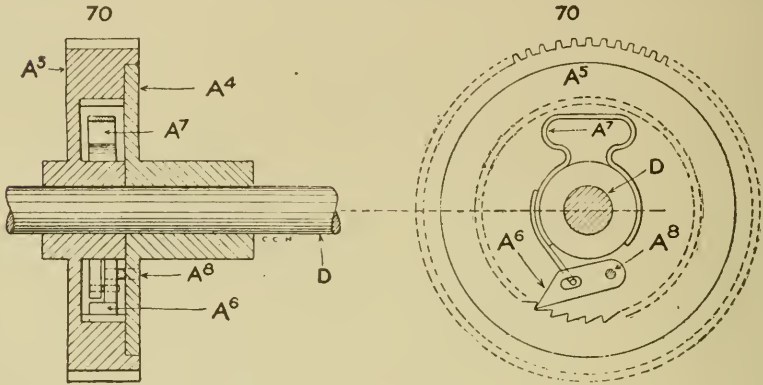

Fig. 240. Roller Motion.

There may not be enough gain in the carriage.

If the counter faller is too high on the outward run, it will lift the yarn from the points of the spindles.

The rim and spindle bands may be too slack.

If the ends are left down too long, snarls will be made, when the end is pieced up, by the cop not being pushed up the spindle.

The snarling motion may not be set correctly.

The bolsters and steps for the spindles may be badly worn.

Uneven roving will cause snarls by winding loosely on some spindles and tightly on others.

Snarling Motion. To overcome snarling of the yarn, the mule is provided with what is called a snarling motion, which is shown in Fig. 241.

Around the loose half of the front roll clutch, J^1 , passes a strap, J^3 , connected to the back end of which is a weight, J^5 ; on the front end is a smaller weight, J^6 . Both parts, J and J^1 , of the clutch are mounted loosely upon the front roll, D . A dog, J^2 , is keyed to the shaft. On the part, J^1 , of the clutch are two lugs which project between the ears of the dog, J^2 .

When the teeth of J^1 are caused to engage with the teeth of J , motion is communicated to the front roll by the lugs on J^1 turning until they come in contact with the ears of the dog. When J^1 turns, the friction of the strap carries the weight, J^5 , up, until it comes in contact with J^1 , where it remains until the end of the outward run

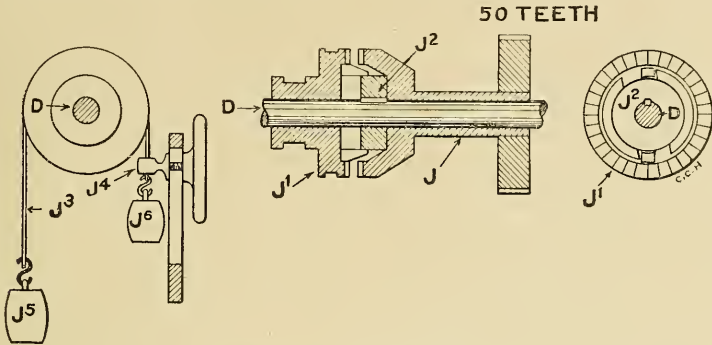

Fig. 241. Snarling Motion.

is reached. When the clutch is thrown out, the part, J^1 , is turned backward by the weight, J^5 , overbalancing J^6 , until the lugs come against the back side of the ears of J^2 . The carriage starts out at the same time that the clutch is thrown in, and, as no movement is given to the front roll until the lugs come against the ears of the carrier, the snarls are taken out of the yarn by the outward movement of the carriage.

INDEX

The page numbers of this volume will be found at the bottom of the pages; the numbers at the top refer only to the section.

	Page		Page
A			
Adjustable cylinder bearing	127	Calculation	
Applying clothing	132	of draft	170
Automatic feeder and opener	46	of production of machine	171
Automatic feeder, evener for	74	of weight of lap	93
Automatic safety-stop	91	Cap bars	277
B			
Back plate	114	Card clothing, kinds of wire for	136
Back stop motion of slubber	251	Card room, arrangement of	101
Backing-off chain tightening motion	317	Carding	101
Backing-off motion	311	theory of	105
Bale		Carrier roll	215
dimensions of	39	Change gears, table	227
opening of	32	“Churka”	17
Bale breaker	33	Cleaning trunk	43
Baling cotton	20	Clearers	218
Bessonette	21	Clothing	
“Lowry bale”	22	applying of	132
“round-lap” system	21	for cylinders, doffer, and flats	129
square bale	20	defects in	129
Beaters	57	number of wire and points per square	
Bessonette bale	21	foot in	133
Bobbin lead	233	Coiler	119
Botanical varieties of cotton	13	Color of cotton	31
Breaker picker	43	Comb	174
with condenser and gauge-box	51	Combed yarns	165
with screen section	61	Combination breaker and finisher	64
Builder	242, 328	Combing	165
Builders used on ring frame	289	Combing machines, arrangement of	165
Burnishing	149	Condenser	51
C			
Calculations		Cones	239
of card production	152	eveners for	186
for comb	198	Cotton	
C			
		baling of	20, 39
		botanical varieties of	13
		color of	31
		cultivation of American	15
		drawing of	201

Note.—For page numbers see foot of pages.

	Page		Page
Cotton		Empty bobbin, speed of	236
Egyptian	26	Even running as to length of staple	32
ginning of	17	Evener cones	86
grading of	27	Evener motion	203
Gulf	26	Eveners	74
invoicing of	32	for pickers	81
length of staple	30		
mixing of	34	F	
moisture in	31	Fan draft	54
motes in	28	Feed motion	177
neps in	28	Feed plates	107, 114
opening of	40	Filling cam	292
Peruvian	27	Filling yarn, table	303
picking of	16, 40	Flat chain	127
pulling of	130	Flat grinders	142
round bale	39	Flats	115
Sea Island	25	Flexible bend	122
strength of staple	30	Fluted rolls	256
Texas	27	diameter of	220
uniformity in length	30	Fly frames	228
Upland	27	Flyer, speed of	236
in the U. S.	12	Flyer lead	233
value of	24	Friction let-off	89
Cotton fiber	11, 36	Front roll, speed of	236
Cotton plant, history of	11	Full cam stop motion	217
Cotton spinning	39, 331	Full bobbin stop motion	248
Cotton wax	23	"Furnace test" for moisture in cotton	31
Creels	275		
Cultivation of American cotton	15	G	
Cut staple	19	Gauge-box	52
Cylinder doffer and flats	111	Gauges for setting doffer, etc.	113
Cylinder screen	113	Gearing	115, 296
D		comber	197
Detaching roll cams	186	Ginning cotton	17
Detaching roll motion	183	Gins	
Diameter of fluted rolls	220	prior	18
Doffer	115	roller	17
Doffer comb	115	saw	17
Double boss	257	Gossypium arboreum	13
Drafts and weights	304, 306	Gossypium barbadense	13
Drawing of cotton	201	Gossypium herbaceum	14
Drawing frames	206	Gossypium hirsutum	14
operation of	208	Grading of cotton	27
Dust-room	43	Grinder rolls	
E		driving of	138
Egyptian cotton	26	speed of	142
Electrical stop motion	213	Grinders	
		flat	142

Note.—For page numbers see foot of pages.

INDEX

III

	Page		Page
Grinders		Nipper and cushion plate	180
long-roll	140	Nipper cam lever	180
traverse	141	O	
Grinding of cylinder and doffer	138	Old style feeder	45
Grinding former	146	Opening bale	32
Gulf cotton	26	Opening cotton	40
H		P	
Horizontal cleaning trunk	50	Peruvian cotton	27
I		Pickers	
Inclined cleaning trunk	60	eveners for	81
Intermediate and finisher pickers	55	intermediate and finisher	55
Invoicing of cotton	32	Picking cotton	16, 40
K		system of	41
Knock-off device	92	Picking machinery on different floors	59
L		Pitch of scroll	126
Lap, weight of	93	Prior gin	18
Laps from the breaker	43	"Pulling cotton"	30
Leader, cylinder, and flats	109	R	
Leader and leader screen	114	Railway head	201
Leader clothing	128	Ratchet gears	290
Long-roll grinder	140	Reversing motion	241
Long-staple cotton	32	Rib set clothing, table	135
Lowry bale	22	Ribbon lapper	172
M		Ring spinning	269
Mechanical back stop motion	216	Ring travelers	286
Metallic top roll	223	Roll stands and weighting	277
Mixing of cotton	34	Roller gin	17
Moisture in cotton	31	Rolls	
Mote knife	110, 114	fluted	256
Motes in cotton	28	metallic top	223
Motion		setting of	220
backing off chain tightening	317	shell	221
detaching roll	183	solid top	222
evener	203	top	221
feed	177	Round bale	39
reversing	241	Round-lap bale	21
snarling	330	Roving table	231
stop	210	S	
top comb	191	Saw gin	17
Mule spinning	307	Scavenger	277
N		Scroll adjustment	124
Neps in cotton	28	Sea Island cotton	25
Neppy cotton	20	Self-weighted top rolls	279
		Separators	284
		Setting of rolls	220

Note.—For page numbers see foot of pages.

	Page		Page
Settings of parts of card	113	Tables	
Shell rolls	221	revolutions of spindle	298
Short-staple cotton	32	rib set clothing	135
Single boss	257	ring travelers	287
Sliver guide	215	roving	231
Sliver lap machine	167	sliver lap machine	172
Slubber	231	speeds of evener roll and driver cones	88
Snarling motion	330	twill set clothing	135
Solid top roll	222	warp yarn	302
Speed of grinder rolls	142	of weight	230
Spindles	282	Texas cotton	27
Spinning of cotton	39, 269	Thread boards	282
Spinning rings	284	Three-storied mill arrangement	63
Splitting of laps	54	Timing and setting	192
Square bale	20	Timing dial	178
Staple, length of	30	"TINGED" cotton	31
Stop motion	210	Top comb	185
electrical	213	Top comb motion	191
full bobbin	248	Top rolls	221
full cam	217	self-weighted	279
mechanical back	216	Traveler, principle of	287
Stringy or "tailed" cotton	20	Traverse grinders	141
Stripping comb	115	Twill set clothing, table	135
Stripping plate	54, 115		
Systems of picking cotton	41	U	
		Upland cotton	27
T			
Tables		W	
change gears	227	Warp builder, setting of	293
filling yarn	303	Warp yarn, table	302
grades of American cotton	29	Winding, in operation of mule	320
grades of Brazilian cotton	30		
grades of Egyptian cotton	29	Y	
of measure	230	Yarn	165

Note.—For page numbers see foot of pages.

LIBRARY OF CONGRESS

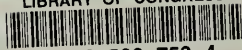

0 018 533 753 4

