



CONDUCTORS  
FOR  
ELECTRICAL DISTRIBUTION;  
THEIR  
MATERIALS AND MANUFACTURE,  
THE CALCULATION OF CIRCUITS, POLE-LINE  
CONSTRUCTION, UNDERGROUND  
WORKING, AND OTHER USES.

BY  
F. A. C. PERRINE, A.M., D.Sc.,  
FORMERLY PROFESSOR OF ELECTRICAL ENGINEERING,  
LELAND STANFORD, JR., UNIVERSITY.  
MEMBER AMERICAN INSTITUTE ELECTRICAL ENGINEERS.



NEW YORK:  
D. VAN NOSTRAND COMPANY.  
LONDON:  
CROSBY, LOCKWOOD & SON,  
7 STATIONERS' HALL COURT, LUDGATE HILL.  
1903.

Copyright, 1962,  
BY  
D. VAN NOSTRAND COMPANY.

ROBERT DRUMMOND PRINTER, NEW YORK.

72415  
AUG 5 1908  
TP  
P42

6935548

*TO MY WIFE, WHO HAS ALWAYS AND IN  
EVERY TASK AIDED ME AND  
KEPT MY COURAGE  
ALIVE.*

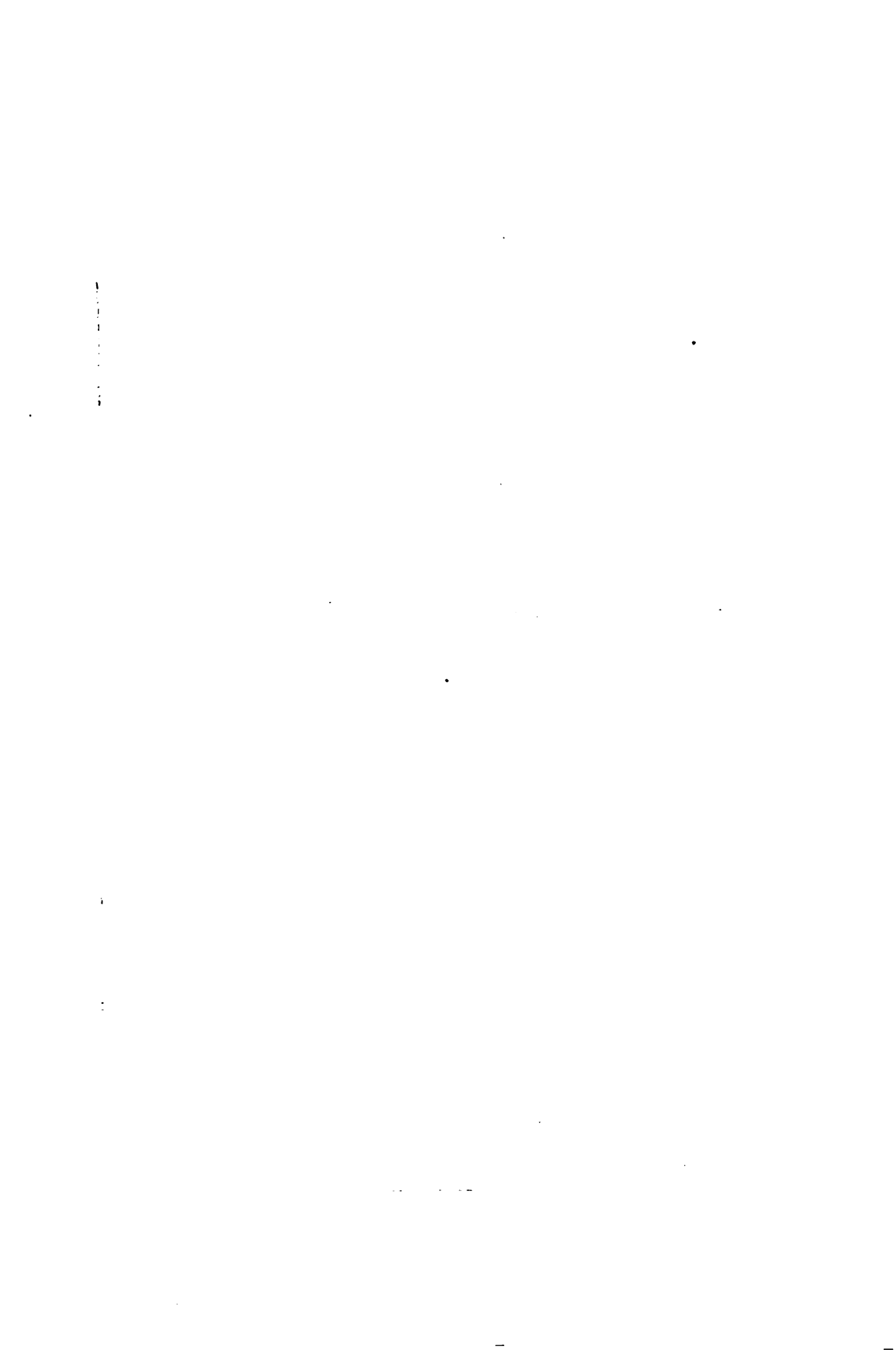

## PREFACE.

---

THIS book represents the results of over ten years of work as a manufacturer of insulated wires and cables, as an engineer advising concerning their installation and finally as a teacher of Electrical Engineering.

Over eight years has been consumed in actually writing and revising, and yet it is with hesitation that it is finally passed to the printer, for the writer well realizes its many deficiencies, but finally despairs at completing the whole task of writing up to the present condition of a rapidly moving art.

Through the courtesy of Mr. Fred Deland the original rough cast has been published in *Electrical Engineering*, and though the last chapter appeared there three years ago, the writer has been encouraged in making a final revision and presenting the whole as a book to his brother engineers, through the belief that by the previous publication he has been enabled to eliminate from its pages descriptions of materials and methods that are not founded on safe engineering principles.

In all of the task of preparation for the press the writer has had much aid from his pupil and friend, Mr. F. V. T. Lee, and he must also acknowledge great indebtedness in the preparations of the chapter on Alternating Current Distribution to another pupil and co-worker, Mr. F. G. Baum.

The presentation of the difficult and hitherto untreated subject of wire manufacture has been rendered easier by great courtesies from the manufacturing companies, particularly the New England Butt Company, the Waterbury Machine Company, the Washburn & Moen Company and the John A. Roebling's Sons Company.

And finally, the writer can but hope that the completed book may be of as great service to others as it has been a pleasure to him in preparing it.

FREDERIC A. C. PERRINE.

PITTSFIELD, MASS.,  
1902.

# CONTENTS.

---

## CHAPTER I.

	PAGE
CONDUCTOR MATERIALS—Energy Absorption—Temperature Coefficient—Copper—Copper Alloys and Impurities—Iron—Steel—Aluminum.....	1

## CHAPTER II.

ALLOYED CONDUCTORS—Important Properties of Alloys—Standard Resistance Materials—German Silver—Platinoid—Platinum Silver—Patent Nickel—Arsenical Copper—Manganin—Constanin—Nickel—Steel—Rheostats for Great Energy—Fusible Metals—Safety Fuses—Aging of Fuses.....	17
---	----

## CHAPTER III.

THE MANUFACTURE OF WIRE—Ingots—Rod-rolling—Garrett Mills—Continuous Mills—The Wire—Annealing—Cleaning—Wire-drawing—Draw-plates—Accuracy of Size—Continuous Drawing—Effect of Wire-drawing	37
---	----

## CHAPTER IV.

WIRE-FINISHING—Galvanizing Iron Wire—Stranding—Gauging Wire—The Circular Mill .....	69
---	----

## CHAPTER V.

WIRE INSULATION—Classification of Coverings—Magnet Wire—Annunciator Wire—Underwriters'—Weather-proof—Gutta-percha Covering—Rubber and its Sources—Rubber Manufacture—Rubber-covered Wires—Vulcanization—Rubber Substitutes—Rubber-covering Machinery—Testing and Standards for Rubber Wires .....	82
---	----

## CHAPTER VI.

CABLES—The Use of Cables—Lead-incased Cables—The Perfection of Lead-covering—Lead-covering Machinery—Insulators for Lead Cables—	v
--	---



	PAGE
Classification of Cables—Submarine Cables—Classification of Employment for all Conductors .....	116
CHAPTER VII.	
CALCULATION OF CIRCUITS—The Basis of Calculation—The Size from Fall of Potential—Wiring Charts—Badt—Hering—Perrine—Graphic Multiplication and Division—Application to Circuits—Slide Rules—Cox—Roberts—Smith and Manifold—Systems of Distribution—Series—Multiple Arc—Series Multiple—Multiple Series—Heating Limit—Concealed Wires—Exposed Wires—Cables.....	132
CHAPTER VIII.	
KELVIN'S LAW OF ECONOMY IN CONDUCTORS—Basis of Economy—Kelvin's Original Problem—Limiting Conditions—Variable and Constant Factor of Cost—Analysis of Complete Problem—Case of Fixed Current—Fixed Current and Power—Fixed Electromotive Force—Fixed Electromotive Force and Resistance—Fixed Electromotive Force and Power—Fixed Energy Generated and Electromotive Force Delivered—The Four Solutions for Economy .....	160
CHAPTER IX.	
MULTIPLE ARC DISTRIBUTION—Basis for Calculation of Multiple Arc Circuits—Subdivision of Circuits—Definition of Terms—Solution for a given Territory—Application to Feeder and Main System—Subdivision of Losses—Final Analysis of Complete Problem—Methods of Attachment of Wires—Relation between Loss and Carrying Capacity.....	179
CHAPTER X.	
ALTERNATING CURRENT CALCULATION—Ohms Law not Applicable—The Assumption Made—Line Capacity—Line Self-induction—The Complete Problem.....	193
CHAPTER XI.	
OVERHEAD LINES—Essential Elements of Design—Choice of Location—Rights of Way—Discussion of the Pole as a Support—Solution of Pole Strength—Strengths of Timber—Specifications for Poles—Guys and Struts.....	215
CHAPTER XII.	
THE POLE LINE—The Stresses to be Allowed For—Wind Stresses—Snow Load—The Curve of a Wire—Stresses in the Wire—The Tension per Unit Span Weight—The Solution for Factor of Safety and Dip—A Practical	

*CONTENTS.*

vii

	PAGE
Coefficient for Temperature Expansion—Effects of Uneven Ground— Equalizing Variable Span-lengths—Variable Levels and Spans.....	228

CHAPTER XIII.

LINE INSULATORS—Early Insulators—Introduction of the Present Shape—The Principles of Correct Form—Materials of Manufacture—The Good Qual- ities of Glass—The Making of Pottery and Porcelain—Effect of the Glaze.....	249
--	-----

CHAPTER XIV.

UNDERGROUND CONDUCTORS—The Necessities for Underground Construction— Systems of Construction—Solid or Built-in Systems—The Brooks System —Insulating Conduits—Drawn-in and Drawn-out System—The Character of Ducts—Iron-pipe Construction—Terra-cotta Ducts—Manholes and Junc- tion-boxes—Gas and Water Troubles—The Trench System.....	259
---	-----

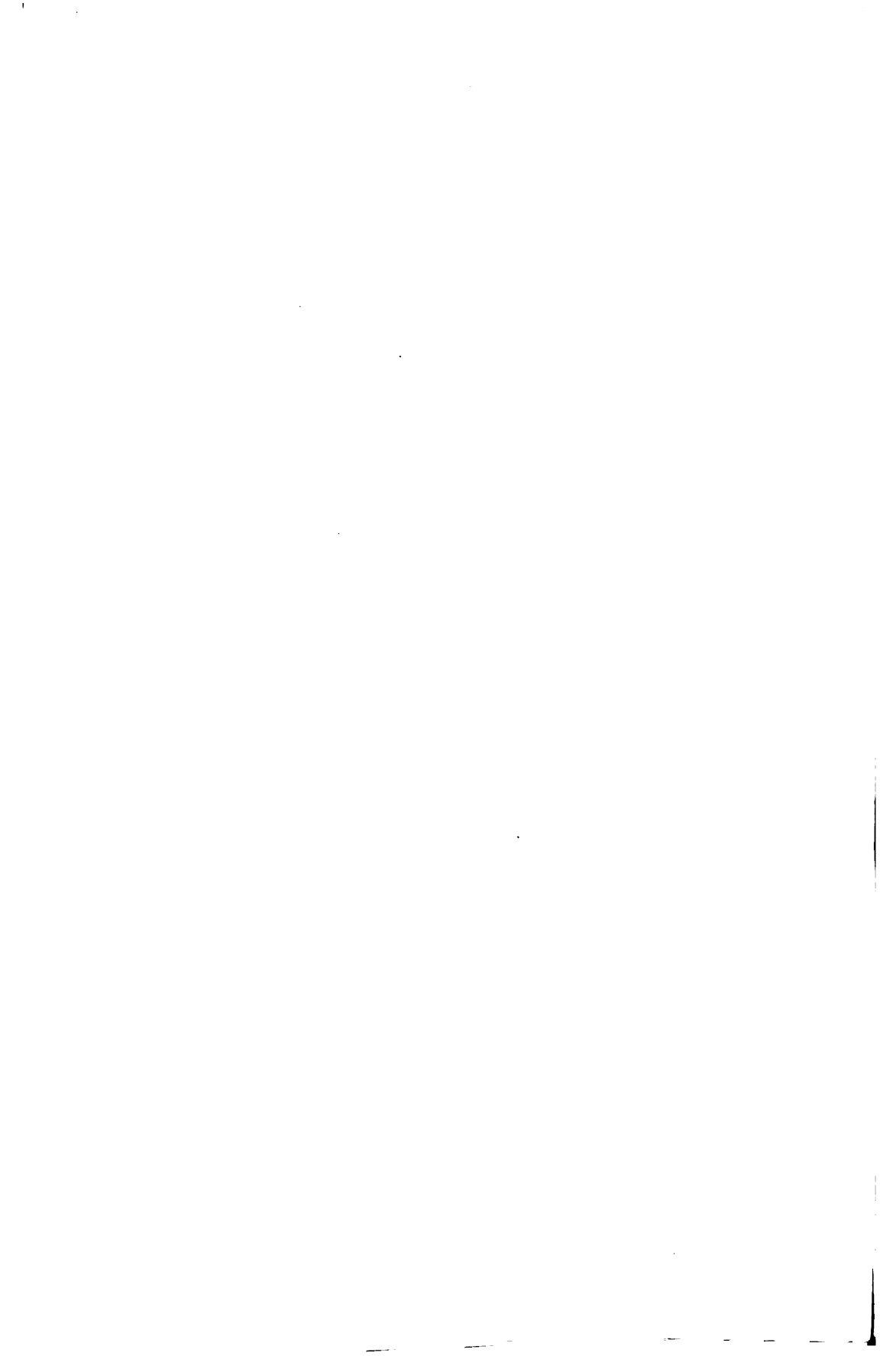

# CONDUCTORS FOR ELECTRICAL DISTRIBUTION.

---

## CHAPTER I.

### CONDUCTOR MATERIALS.

**WHATEVER** the source of electrical energy, and whatever translating devices may be used to convert the electrical energy into heat, light, chemical action, or mechanical motion, the transference from generating source to translating device is made by means of conductors. These conductors absorb energy in the transmission and, on whatever theory of conduction the action may be explained, we have the fundamental fact that the energy absorbed is a function of the conductor material.

The best conductor materials are the pure metals, after which we have alloys of the pure metals and metalloids, while the energy absorbed in the transference of a given quantity of electricity over organic bodies and most chemical combinations, such as oxides, sulphides, chlorides, is so great that they are called insulators.

Of the many elements capable of conducting electricity with a comparatively small loss of energy, commercial use is made in the pure state of only copper, iron, platinum, aluminum and mercury, though almost all the metallic elements have their places in one or the other of the many alloys which are used in conducting electricity on account of the small amount of energy absorbed, or on account of some property auxiliary to conduction, as on occasion for strength, high resistance, constancy of resistance with changes of temperature, or low melting point.

## 2 CONDUCTORS FOR ELECTRICAL DISTRIBUTION.

The function of material upon which the energy absorbed in the transmission of a given quantity of electricity over a conductor depends, is expressed in terms of the length and area of the conductor. The total quantity of electricity transmitted in a given time is  $Q = IT$ , while the energy is  $W = EIT$ , and as we know that  $E = IR$ , therefore we have energy of transmission  $W = I^2RT$ , and consequently the energy absorbed in any transmission is proportioned to  $R_c$ , where  $R_c$  is the resistance of the conductor.

Now,

$$R_c = \frac{L}{A}f(\text{material}).$$

The value of the factor  $f(\text{material})$  depends in consequence on the terms in which  $\frac{L}{A}$  is expressed. In the C. G. S. system of units,  $f(\text{material})$  becomes the specific resistance, or the resistance between the opposite faces of a unit cube, of the material used.

Expressing  $\frac{L}{A}$  for round wires, the areas of which vary with the squares of their diameters,  $f(\text{material})$  becomes the resistance of a unit length of a round wire one unit in diameter, or on the English system of measurement, where the lengths are expressed in feet and the diameters in thousandths of an inch, or mils,  $f(\text{material})$  becomes the resistance of one "mil-foot." This function, the resistance of a wire one foot long and one mil in diameter, we call  $M$ .

For telegraph lines, it is the custom to express  $\frac{L}{A}$  in terms of weight per mile, which gives us as the value of  $f(\text{material})$  "the weight per mile-ohm" which is the weight of a conductor one mile in length, measuring one ohm in resistance, and is the product of the resistance per mile in ohms by the weight per mile.

The value of this quantity  $f(\text{material})$  thus expressed in terms of the specific resistance, the resistance per mil-foot, or the weight per mile-ohm, is, of course, always the same quantity, involving the systems of linear units, and the specific

gravity of the material measured ; the terms in which it is expressed being convertible by the proper reduction factors.

It is, however, impossible to pass from an expression involving only the linear units to one involving the weight of the wire without knowing accurately the value of the specific gravity of the sample tested. This determination is not only important as affecting the weight of a conductor of a given size, but also for the reason that the specific resistance can be made to vary through considerable limits, by altering the specific gravity of the material measured. Comparisons of conductivities which are made without the determination of the specific gravities of the conductors tested are in general more practically reliable if a comparison is made of specific resistance than comparison of equal weight. While, without doubt, the comparison by weight gives a result which represents more nearly the quality of the material of which a wire or other conductor is made, the comparison by volume gives a better idea of the quality of the wire as a conductor, for in this light the absence of conducting material at flaws, or its attenuation by manipulation, introduces into the conducting circuit as much real resistance as though a material of high specific resistance had been used.

The value of this resistance function, as expressed by any one of these methods, is dependent for its absolute value on the temperature of the material, and for any given temperature the resistance is obtained by the equation

Resistance at  $t^\circ$  = Resistance at 0  $(1 + at + bt^2 + ct^3 + xt^n)$ .

This equation is derived from the parabolic equation experimentally obtained by Dr. Matthiessen for the change of conductivity with temperature,

$$C_t = C_0(1 - At + Bt^2).$$

Terms below the third are generally insignificant, and the resistance at any given temperature may be expressed with accuracy by  $R_t = R_0(1 + at + bt^2)$ , or by  $R_t = R_0(1 + at)$  for a near approximation.

These constants vary greatly in alloys with small differences of constitution, and even with the purest obtainable metals there are always present slight variations.

#### 4 CONDUCTORS FOR ELECTRICAL DISTRIBUTION.

Copper is preëminently the metal used for electric conduction, being at once among the best conductors, the most ductile, the strongest and the cheapest ; in each of these respects it is excelled by one or more of the other metals, but no other approaches it in the average of all qualities.

The conductivity of copper wire was first carefully investigated by Dr. Matthiessen and his colleagues, Von Bose, Vogt and Hockin, in the years 1859 to 1865, during the time that the construction and laying of the first successful Atlantic cable was in progress. Dr. Matthiessen's object was mainly the discovery of a possible alloy having a higher conductivity than copper, and the investigation of the various causes for low conductivities in several samples of commercially pure copper.

Before the preliminary determination of the ohm by the British Association in 1863, Dr. Matthiessen had proposed and constructed as a resistance standard a mile of pure annealed copper wire, one-sixteenth of an inch in diameter, at  $15.5^{\circ}$  C. Subsequent measurement of this standard proved it to have a resistance of 13.39 B. A. units, but the determination of the conductivity of the copper wire to which he apparently attached the most importance was one of a hard-drawn wire, having a resistance, for a meter in length weighing one gram, of .1469 B. A. units, at  $0^{\circ}$  C.

Unfortunately he left no determination of the specific gravities of the wires he used, and no direct determination of the resistance of any annealed copper wire. In his calculations, Dr. Matthiessen assumed a specific gravity of 8.89, which is very close to the best determination of the specific gravity of copper wire since made. For the conductivity of annealed copper, he determined that the resistance of the sample of hard copper used was 1.0226 times the resistance of the purest obtainable annealed wire, which gives the value of the commonly accepted Matthiessen standard of pure annealed copper wire to be

9.59 ohms per mil-foot at  $0^{\circ}$  C.,  
809.3 pounds per mile-ohm, or  
1594 C. G. S. resistance units for the specific  
resistance between the opposite faces of a centimeter cube.

The corresponding temperature correction given by Matthiessen's experiments is,

$$C_t = C_0(1 - .00387t + .000009009t^2), \text{ or}$$

$$R_t = R_0(1 + .00387t + .00000597t^2).$$

There are undoubtedly great variations from these figures in different samples of commercial copper, and it is a question whether the true constants for pure copper are not considerably different. All experimenters who have tested many samples of the best commercial copper at present manufactured report samples of wire giving two or three per cent lower resistance than this standard.

In fact, the wire measured by Matthiessen must have been only slightly better than the best commercial copper at present obtainable. In the year 1888-9 the author measured almost seven hundred samples of copper taken at random from the output of a large mill, and although there were a number of samples giving a conductivity greater than 100 per cent and some which fell very low, the average of the whole was 98.98 per cent.

Similar great variation has been found in the temperature coefficient by different experimenters, variation not simply of the values of the constants in the equation, but even in the form of the equation itself.

Siemens, in his Bakerian lecture for 1871, gives for the value of the specific resistance of copper at any temperature the equation  $R = 0.026577T^4 + 0.0031443T - 0.22751$ , where  $T$  is the absolute temperature reckoned from  $-273^\circ \text{C}$ .

This equation gives a curve for the temperature coefficient of copper wire concave to the axis along which the resistance is plotted, while Matthiessen's results give a curve convex to this axis.

More recently, Cailletet and Bauty,\* Kennelly and Fessenden † have made determinations of the temperature coefficient of samples of copper wire which indicate a linear coefficient with an equation of  $R_t = R_0(1 + 0.00406t)$ .

Not only is it impossible to add any substance to copper which will give it a higher conductivity, but also we find that

\* *Comptes Rendus*, 1885.

† *The Physical Review*, 1893.



there is no test for impurity so delicate as the determination of the electrical conductivity. In connection with the work of the Submarine Telegraph Committee, appointed by the British Board of Trade and the Atlantic Telegraph Company in 1861, Dr. Matthiessen undertook a very extensive series of experiments on the causes for the variation of conductivity in different commercial coppers.\* His first experiments showed plainly the effect of the suboxide of copper which molten copper will absorb most readily, and which is an ever-present and elusive impurity. By fusing a mass of copper under a borax and chloride of sodium flux, a sample of wire was obtained having a conductivity of 72.11 per cent at 23.9° C. referred to an annealed wire, drawn from unfused electrolytic copper. This wire was then fused for several hours in a current of hydrogen in a porcelain tube, and gave a conductivity of 89.76 at 18.9° C. Afterward the same copper was kept fused with a current of hydrogen blowing through it, at first for half an hour, and afterward for three hours, with the result that the conductivity rose after half an hour fusing to 93.14 per cent at 17.4° C., and after three hours' fusing to 96.67 per cent at 18.6° C. Or, considering that these wires tested were hard-drawn, we have a decrease in conductivity from about 99.2 per cent to 74.6 per cent by the absorption of suboxide under the ordinary conditions of melting as practiced in brass-foundries.

The readiness with which this suboxide is absorbed by molten copper, and the stubbornness with which it is retained, as exemplified by these experiments, together with its great effect on the conductivity of the wire, make it one of the most important impurities likely to be present in commercial coppers. Modern methods of melting in a Bessemer converter and the subsequent refining by electrolysis eliminate almost entirely all of the ordinary impurities, such as arsenic, phosphorus, lead, tin, iron, or silver; but unless the metal so refined is properly melted, the conductivity of wire made from such copper will be below that of pure copper. Even between different bars of the same melting there may be present vary-

\* Report of Submarine Telegraph Committee. Blue Book, London, 1861.

ing proportions of the suboxide, producing great and apparently anomalous variation in the conductivity of the wire.

This suboxide,  $\text{CuO}$ , is a malleable compound resembling copper itself, and for many years its presence in a small quantity was said to be necessary in order to make copper easily worked, and its absence given as an explanation of the brittleness of electro-deposited metal. The brittleness of electrolytic copper is, however, to be accounted for rather by the presence of a hydride of copper formed in deposition; while the brittleness and low conductivity of over-refined fused copper, "over-poled," as it is called, is undoubtedly due to the presence of a carbide of copper, which is formed in the presence of carbon as soon as the suboxide disappears. Electrolytic copper, which has been carefully melted, or which has been so deposited as to avoid the formation of the brittle hydride, invariably gives a conductivity several per cent above the standard of Matthiessen.\*

The suboxide of copper is not produced in an appreciable quantity by any means of heating, unless the mass of the metal itself is fused, since the compound is very unstable and can only be retained by solution in molten copper. Repeated tests, conducted under the author's supervision, made on copper bars, and on wire from these bars, after heating in various ways, show that the amount of suboxide present is undoubtedly a constant and not affected by any handling below a molten temperature.

Continuing his investigation, Matthiessen produced alloys of copper, free from suboxide, by passing a stream of hydrogen through the fused metals, the copper experimented upon being freed from impurities by electrolysis.

Alloys of many of the metals and metalloids were experimented upon by Matthiessen with the results shown in table on page 8.

It is thus seen that not only does the admixture of other metals not improve the conductivity of copper, but that a very serious reduction of conductivity is produced by even a small percentage of alloying material.

In the report on the experiments just quoted, Dr. Matthies-

\* *Electrician*, London, Vol. XXIII, page 173. A report of tests on wire made from Elmore's electro-deposited copper.

8 CONDUCTORS FOR ELECTRICAL DISTRIBUTION.

sen has pointed out an important apparent exception to this rule in the effect produced by a small percentage of lead or tin in copper containing a considerable proportion of suboxide, and we know that a like effect is produced by carbon and silicon, as will be described later.

TABLE SHOWING THE EFFECT OF ADMIXTURE OF COPPER WITH SPECIFIC QUANTITIES OF VARIOUS SUBSTANCES.

Substances alloyed with Pure Copper.	Conducting Power of Hard-drawn Alloy, pure soft copper being 100.	Temperature Centigrade.
Carbon :		Degrees.
Copper, with .05 per cent of carbon....	77.87	18.3
Sulphur :		
Copper, with .18 per cent of sulphur...	92.08	19.4
Phosphorus :		
Copper, with .13 per cent of phosphorus	70.34	20.0
Copper, with .95 per cent of phosphorus	24.16	22.1
Copper, with 2.5 per cent of phosphorus	7.52	17.5
Arsenic :		
Copper, with traces of arsenic.....	60.08	19.7
Copper, with 2.8 per cent of arsenic....	13.66	19.3
Copper, with 5.4 per cent of arsenic....	6.42	16.8
Zinc :		
Copper, with traces of zinc... ..	88.41	19.0
Copper, with 1.6 per cent of zinc.....	79.37	16.8
Copper, with 3.2 per cent of zinc.....	59.23	10.3
Iron :		
Copper, with .48 per cent of iron.....	35.92	11.2
Copper, with 1.06 per cent of iron.....	28.01	13.1
Tin :		
Copper, with 1.33 per cent of tin.... .	50.44	16.8
Copper, with 2.52 per cent of tin.....	33.93	17.1
Copper, with 4.9 per cent of tin.....	20.24	14.4
Silver :		
Copper, with 1.22 per cent of silver....	90.34	20.7
Copper, with 2.45 per cent of silver....	82.52	19.7
Gold :		
Copper, with 3.5 per cent of gold.....	67.94	18.1
Aluminum :		
Copper, with .10 per cent of aluminum	12.68	14.0

These materials in small quantities serve as a flux in reducing the suboxide without themselves apparently combining with the copper. For example, Matthiessen found that the addition of one-tenth per cent. of tin to copper having a conductivity of 87.25 increased the conductivity in one experiment to 93.45, and in another to 94.02, while the addition of the same amount of lead brought the conductivity of the copper to 93.02, though

in each case the quantity of lead or tin remaining with the copper was too small to be determined quantitatively.

A very remarkable series of results were reported at the Paris Exposition of 1889 by the firm of J. O. Mouchel, being the results of experiments made at their works in 1884 on alloys of pure copper with one part in one thousand of various metals.\* This firm also exhibited at the same time a sample of copper wire having a conductivity 104.69 per cent of Dr. Matthiessen's standard.

An examination of the following table, in connection with the copper conductivity just quoted, shows that both mechanically and electrically the various high-conductivity alloys only differ from pure copper by amounts so small that the difference may be accounted for by slight variations in the physical structure and annealing of the wire, and point to the probability that the alloying materials are either practically inert in so small quantities or that they act to some extent as a reducing agent on the suboxide of copper ordinarily contained in commercial wire. It is to be noticed that in no case has the conductivity of the pure copper manufactured by the same firm been equalled by any of the alloyed wires.

The first table on page 10 gives the Mouchel tests on wire of one-half millimeter in diameter.

In the comparison of pure copper with any one of the many bronzes or other alloys which are supposed to offer advantages as conducting materials, it is most important that mechanical as well as electrical and chemical tests should be made, in order to determine the comparative properties of the two metals.

In many cases conducting materials have been manufactured and sold on the basis of tests of one property and the assumption of others, or even on the basis of the determination of conductivity in one grade of alloy and mechanical tests made on another grade.

Turning now to the mechanical properties of copper and alloys, it is in general difficult, if not impossible, in the manufacture of hard-drawn wires to give as high a tensile strength to those of great diameter as may be given to smaller sizes, while for soft wire the annealing of the larger wires also pre-

\* *The Electrical Engineer*, Vol. IX, p. 344.

10 CONDUCTORS FOR ELECTRICAL DISTRIBUTION.

sents difficulties which tend to give them a higher tensile strength than is found with smaller annealed wires made of the same material.

EFFECT OF ONE-TENTH PER CENT ADMIXTURE OF VARIOUS SUBSTANCES WITH COPPER.

Alloying Material.	Conductivity compared to Soft Copper, 100.	Elongation Per Cent.	Tensile Strength in Pounds per Square Inch.
Lead.....	104.04	36.20	27,165
Molybdenum.....	103.28	33.50	31,163
Cobalt.....	102.77	38.15	29,342
Silver.....	102.60	4.25	41,295
Sulphur.....	102.59	37.55	30,608
Gold.....	102.54	32.45	29,342
Selenium.....	102.44	30.42	38,758
Thallium.....	102.42	36.10	30,253
Zinc.....	102.22	35.32	38,506
Antimony.....	100.08	30.00	32,601
Tellurium.....	99.84	1.82	58,841
Platinum.....	99.25	38.80	28,986
Nickel.....	98.37	39.00	29,712
Tungsten.....	96.77	36.35	30,609
Tin.....	96.31	3.65	46,133
Chromium.....	95.01	33.55	32,615
Magnesium.....	94.29	3.75	51,996
Aluminum.....	90.55	35.20	31,519
Iron.....	83.32	32.65	31,377
Arsenic.....	77.36	39.10	30,879
Silicon.....	67.55	20.65	26,083
Phosphorus.....	54.30	31.25	33,327

Bismuth, cadmium, sodium and potassium made unmanageable alloys.

Within the limits of the possibilities of manufacture expressed above, we find that copper wire as produced by American manufacturers possesses the following electrical and mechanical properties :

ELECTRICAL AND MECHANICAL PROPERTIES OF COPPER WIRE.

Wire.	Conduc-tivity.	Tensile Strength in Pounds per Square Inch.	Percentage Elongation.	Twists in 6 inches before breaking.	Right Angle bends before breaking.
Hard No. 8 B. & S. and larger.....	98%	60,000	1½	25 to 35	4 to 6
Hard No. 10 B. & S. and smaller.....	97%	65,000	1	40 to 45	6 to 8
Soft.....	99%	34,000	40	30 to 60	10 to 20

Comparing the published reports of the various copper bronzes and alloys with these figures, we may be able to evaluate the claims of high tensile strength and high conducting which have been so freely made.

ELECTRICAL AND MECHANICAL PROPERTIES OF BRONZES.

Wire.	Conductivity compared to Soft Copper.	Tensile Strength in Pounds Per Square Inch.	Percentage Elongation.	Twists in 6 inches.	Right Angle bends.
Weiller A bronze .....	97	64,000	1		
Weiller B bronze .....	85	71,000	1		
Weiller C bronze.....	80	79,700	1		
Weiller bronze, French telegraph	30	105,000	1	.....	10-6 meter radius
Mouchel, magnesium-copper.....	95.16	73,000	1	.....	20
Mouchel, magnesium-copper.....	81.60	87,000	1		
Mouchel, magnesium-copper.....	50.16	109,000	1	.....	30
Tempered copper.....	35	80,000	1		
American silicon bronze.....	38.77	79,000	2	25-100	
American silicon bronze.....	15.81	100,000	1	25-100	
Phosphorus bronze.....	26	102,000			

An inspection of this table, which contains the mechanical and electrical data of the principal high-conductivity alloys, shows at once that great tensile strength is only to be obtained by a sacrifice of conductivity, and where an alloy is produced having a conductivity equal to pure hard-drawn copper, the alloy is mechanically weaker and not stronger than the pure metal.

A further disadvantage of these strong alloys for conductor materials lies in the great difficulty in working them on a large scale in the ordinary mill equipped with machinery for rolling and drawing copper or iron wires. This difficulty tends not only to increase their cost when produced as wires, but also to render the wire liable to flaws, slivers and other imperfections.

For transmission lines in which low resistance and great carrying capacity are items of importance, the increased weight of material made necessary by the employment of any

of the low-conductivity alloys more than offsets the advantage as regards strength which it may possess over copper. While, therefore, such alloys possess many advantages where strength and ductility only are considered, their general introduction for conductor materials demands the discovery of a series having far more valuable properties of conductivity, strength and ductility than any of those so far investigated.

Of the other pure metals besides copper, iron is the only one which has been put to extensive use as a conductor material for transmission lines. While iron is no doubt the most abundant and the most extensively used of any metal, unfortunately it is only with the greatest difficulty that it can be obtained free from alloying materials, so that it is rare, if ever, that we find it commercially in as pure a state as copper.

As a conductor material, it is necessary to use the metal obtained from the purest ores and most thoroughly refined by smelting with charcoal, complete and careful puddling, and efficient hammering. Such a product is only to be found in the irons from Norway, Sweden or Russia; it is quite possible that other ores exist of sufficient purity to render an equivalent iron, but these countries are the only ones in which the necessary refining methods are employed on a commercial scale.

The resistance of pure iron wire is stated by the best authorities to be 5.95 times as high as the resistance of an equivalent copper wire, the specific gravity being 7.79.\*

This would give for pure iron : 57.06 ohms per mil-foot at 0° C. ; 4217.9 pounds per mile-ohm ; 9,484 C. G. S. resistance units specific resistance between the opposite faces of a centimeter cube.

The temperature variation of the resistance of iron wire is given by the authority already cited to be equal to

$$R_t = R_0(1 + .0048t).$$

As a conducting wire, iron is only used after having received a coating of zinc by the process of galvanization, which serves to protect it from rust when the wire is suspended in

\* Preece, *Electrician*, London, Vol. XXII, page 223.

the air, the increase of weight being from four to five per cent of the weight of the iron.

The tests of Mr. George A. Hamilton on a large quantity of iron wire drawn and galvanized by one of our American manufacturers from rods imported from several Swedish mills give the following average results :

ELECTRICAL AND MECHANICAL TESTS OF GALVANIZED IRON WIRE.

Date of Test.	Size B. W. G.	Quantity tested, Miles.	Weight per Mile.	Weight per Mile-ohm @ 68° F.	Breaking Weight.	Twists in 6 inches.	Elongation.
February, 1888, to January, 1889. ....	4	85	7.167	4,607	2,016	18.5	13.83
June, 1888, to December, 1888. ....	6	650	545	4,607	1,454	18.9	13.82
September, 1888, to January, 1889. ....	8	3,500	380	4,573	980	21.4	15.16
September, 1887, to November, 1889. ....	9	8,300	332	4,564	877	24.3	14.21

From these results it is seen that the best galvanized iron wire used in this country has a conductivity of 96.6 per cent for large sizes, and a conductivity of 97.3 per cent for the smaller sizes when compared to pure iron, while the breaking strength is for all sizes approximately 45,500 pounds per square inch of iron. Special qualities of charcoal iron have been imported from Sweden which give a conductivity above 98 per cent, but the increased cost of this iron has prevented its extensive introduction.

This high-conductivity iron wire has been used to a certain extent by the British Postal Telegraphs, by whom it is reported to have a weight of 4,480 pounds per mile-ohm with a tensile strength of 50,000 pounds per square inch, the elongation being 16.17 per cent, and the number of twists in six inches varying from 18 with a wire 209 mils in diameter to 31 with a wire of 121 mils.

Steel, as used for transmission lines, has a higher resistance as well as a greater breaking strength. Even the softest quali-



ties of Bessemer or open-hearth steel do not give better results than from 5,000 to 6,000 pounds per mile-ohm, with a breaking strength not greatly exceeding 60,000 pounds per square inch, while cast steel of 150,000 to 200,000 pounds per square inch breaking strength has a resistance as much as sixteen times that of copper, or approximately 12,000 pounds per mile-ohm.

The soft steels of 5,000 pounds per mile-ohm are considerably less expensive than the best soft iron, while their breaking strength and uniformity of character render them preferable to common puddled iron, which has about the same specific resistance. It is, therefore, the custom to use such steel wire for the construction of short telegraph and signal lines in preference to the more expensive high-conductivity wires.

The high-tensile-strength cast steels are only used where very long spans are necessary, as in crossing rivers where there are no bridges, and cables are impracticable, in which cases the high resistance of the wire is not an important factor, considering the short lengths employed.

Such spans have been erected in India and Egypt exceeding one mile in length, though in this country it is rarely, if ever, that the length of 2,000 or 3,000 feet has been exceeded. Stable spans of these lengths are to be found crossing the Delaware River at Trenton, New Jersey, and across the Susquehannah River at Harrisburg, Pennsylvania.

During the year 1898 aluminum was introduced as a third conductor material. Aluminum wire had previously been manufactured, its commercial use discussed, and its success predicted, but it was not readily obtainable in large quantities nor at a price at which it could really be compared with iron or copper in practical usefulness until that time. Since then, its advantages have been recognized and the experimental stage of use has passed so rapidly that it is already thoroughly established as a conductor material. Without regard to cost, its advantages are not strikingly apparent, for although its tensile strength is high in reference to its specific gravity, its conductivity per unit of cross-section is not so high as that of copper, and, in consequence, the area exposed to wind pres-

tures is large, which, as is shown in a later chapter, determines in general the strength of the pole-line construction.

As obtained from the inspection tests of a large amount of commercially pure aluminum made under the direction of the author it is found that the resistance of aluminum at 25° C. is 17.6 ohms per mil-foot or 422.64 pounds per mile-ohm and 2,657 C. G. S. resistance units specific resistance between the opposite faces of a centimeter cube at zero centigrade.

The coefficient of the resistance change with temperature for aluminum has never been determined with great exactness, but the experiments made up to the present time indicate that the temperature variation may be obtained with approximate accuracy by the equation

$$R_t = R_0(1 + .004t).$$

Indeed this temperature coefficient for resistance change may be applied with considerable accuracy to all of the pure metals excepting mercury and iron.

Mechanically, aluminum is a weak metal, the tensile strength amounting only to 32,898 pounds per square inch when hard drawn into wire about one-quarter of an inch in diameter, though when account is taken of its low specific gravity it may be considered strong, as a wire to be suspended between supports, on a pole line.

In direct comparison with copper the constants given above show that, for the same conductivity, a diameter 27% greater or an area 64% greater is required, while the tensile strength only amounts to about 63% of the equivalent copper wire; though on the other hand, its weight is but 50% that of the copper wire.

It may, therefore, readily be seen that with its relative advantages and disadvantages that aluminum must be considered, not as a material which may supplant copper as a conductor, but rather as one which must supplement it; the advantages becoming apparent where light weight and large radiating surface are desirable, whereas, should strength and small diameter be essential, its use is not permissible.

A question has been raised concerning the permanence of aluminum when exposed to atmospheric influences, since this

material, while not readily oxidizable nor attacked by the majority of mineral acids, is particularly susceptible to the influence of chlorine in all its unstable combinations, and to the fatty acids. So far as any conclusion may be drawn from the experience which has been gained up to the present time, it indicates that, under ordinary conditions of atmosphere, pure aluminum may be considered permanent, but that it is unsafe to use this material in positions exposed to the fumes of chemical works or garbage-dumps, and that all alloys containing a large percentage of aluminum must be looked upon with considerable suspicion.

Impure commercial aluminum must be carefully avoided, since the commonest impurity is sodium, which makes a remarkably unstable alloy with aluminum—one which is readily attacked and corroded in even slightly moist atmospheres. It must also be observed that aluminum is highly electropositive to almost all the other metals, and in consequence all joints with other metals must be carefully insulated in order to prevent the aluminum from being attacked by electrolysis at such junctions.

The satisfactory use of aluminum depends, therefore, upon a careful study of the conditions of the problem to determine its applicability in comparison with iron or copper, a careful inspection of the wire to be employed, and finally sufficient care in its erection and connection to circuits of other materials.

## CHAPTER II.

### ALLOYED CONDUCTORS.

WHILE there is no doubt but that conductors composed of the pure metals absorb less energy per unit of current and cross-section, it is also true that alloyed metals possess distinctive properties which render them important as a class of conductors.

The properties of alloys which are of the greatest importance when used as conductors are that, beyond any pure metals, they are possessed of mechanical strength, high specific resistance, low melting points and a small coefficient of change of resistance with temperature.

To be sure, no alloy can be made which is possessed of all of these properties in the highest degree, but in general it is true that every alloy has a greater tensile strength, a higher resistance, a lower melting point and a smaller coefficient of resistance change with temperature than the proportionate average of the same properties of its constituent metals. This principle is applied in the use of conductors whenever it is necessary for us to obtain one which shall stand a heavy strain, absorb a great amount of power, maintain its resistance at a permanent value under varying external or internal conditions, or shall easily melt under the influence of the current, and in melting shall not reach a sufficient temperature to occasion fires by the contact of the molten metal with inflammable substances.

The property of great mechanical strength, which is the first mentioned, has been already discussed, and it has been seen that no alloy at present manufactured has a tensile

strength equal to that of mild steel, or 90,000 pounds per square inch, with a conductivity as high as fifty per cent of that of pure soft copper.

Conductors intended to absorb a great amount of energy should not only have a high specific resistance, but also it is desirable that at the same time the resistance shall not change as the wire heats under the influence of the current, and it is most fortunate that in general the alloys of the highest specific resistance have at the same time the lowest temperature coefficient. These properties of high-resistance alloys make possible the absorption of a large amount of electrical energy by wires of short length and great cross-section, offering resistances which only vary by small amounts as the electrical energy is transformed into heat. For use in standards, such alloys present the advantages of giving the required resistance by the use of a minimum amount of wire and at the same time having small and determinable temperature coefficients which allow the reduction of observed results to those of a standard temperature.

The alloys which have been mainly used for the purpose of constructing standard resistances are platinum silver, german silver, platinoid and manganin; the first on account of its great permanence with age and variation of temperature, and the last on account of its almost negligible temperature coefficient.

German silver has been used for a longer time and more extensively than any other material in the construction of resistance coils. This alloy is very generally manufactured and consists essentially of copper, nickel and zinc, though the manner of preparation and the relative proportions are matters in which the various makers differ very widely with consequently great variation in the specific resistance and temperature coefficient of the metal. As manufactured in the United States, commercial German-silver wire is made with approximately the following proportions:

Copper.....	60	57	56	50
Nickel.....	8	12.5	20	30
Zinc.....	32	30.5	24	20
Specific resistance at 0° Cent.....	19,000	25,500	32,000	64,000

These alloys are known by the proportion of nickel which they contain, as the amount of this metal which is present in the alloy approximately fixes the proportions of the other constituents in order that the resulting material may be easily worked. The author has tested a large quantity of "eighteen per cent german silver," manufactured by the Coe Brass Company, of Torrington, Connecticut, and the average of a considerable number of tests gives a resistance of 192.5 ohms per mil-foot at 20° Cent., or approximately a specific resistance of 32,000 C. G. S. units between the opposite faces of a centimeter cube. The temperature coefficient of this wire is about .00025 per degree Centigrade at normal temperature. This material is higher in specific resistance and has a lower temperature coefficient than the standard of german silver commonly accepted, which is taken from Dr. Matthiessen's experiments made in 1862-5. Various experimenters have reported differently on this material on account of the difference in manufacture, but it is believed that the results expressed above will be found to conform to the material as at present made.

Platinoid is a material most closely related to german silver, differing from it only by the presence of a small amount of tungsten, which has been variously stated to be from one per cent to not more than a trace. It is said to be manufactured by adding to the ordinary constituents of german silver, while in the process of fusion, a small amount of phosphide of tungsten, and the completed alloy purified by repeated fusions which drive off all the phosphorus and most of the tungsten, and leaving a material not differing from twenty-five per cent german silver in either its mechanical or electrical properties. This material has been received with considerable favor in England, but it does not seem to have any advantages over the best german silver manufactured in the United States.

From the various authorities who have tested german silver and platinoid we have the results shown in the following table:

ELECTRICAL PROPERTIES OF RESISTANCE ALLOYS.

Material.	Resistance per Mil-foot.	Specific Resistance.	Temperature Coefficient.	Authority.
	At about 15 degrees Centigrade.			
German silver.....	125.75	20,912	.0004433	Matthiessen.
German silver (Coe 18 per cent) .....	192.5	31,993	.00025	Perrine.
German silver.....	180.4	29,982	.000273	Dewar and Fleming.
Platinoid.....	251.1	41,731	.00031	Phil. Mag., Sept., 1893.
Platinoid.....	204.6	34,000	.0002087	Bottomley.
Platinoid.....	192.5	32,000	.00022	Willyoung.
German silver.....	90.4	15,023	.0008	Mordey for temperature 62°-300° F.
Platinoid.....	203.6	33,836	.00044	Mordey.
German silver (1)...	180.5	30,000	.00036	Feussner and Lindeck.
Obermaier's Nickel (2).....	200.0	33,200	.0003	
Obermaier's Nickel (3).....	269.5	44,800	.00033	
Rheotan (4).....	315.9	52,500	.0004	

Chemical analyses of the last four alloys give constituents as follows :

	1	2	3	4
Copper.....	60.10	61.63	54.57	53.38
Zinc.....	25.37	19.67	20.44	16.89
Nickel.....	14.03	18.46	24.48	25.31
Iron.....	0.30	0.24	0.64	4.46
Cobalt.....	Trace	0.10	.....	.....
Manganese.....	Trace	0.18	0.27	0.37

These results show not only the great variation in the resistance and temperature coefficient of different qualities of german silver, but also that the presence of small amounts of metals, other than copper, zinc and nickel, in the alloy, are not generally of sufficient importance to warrant any considerable increase in the cost of manufacture in order to introduce them.

All experimenters have found that there is a continuous change in the resistance of coils wound with german silver wire produced both by repeatedly heating and cooling the coils, and also apparently by the lapse of time. Such a change obviously unfits the material for use in standards of great ac-

curacy. This variation has been judged to be due to the crystallizable character of the zinc \* as well as in some cases to strain produced in tightly wound coils by great changes in their temperature.

In order to avoid this defect in standard coils, as well as to obtain a material of more definite constitution and characteristics, Matthiessen used an alloy composed of two parts of silver with one of platinum. This material has a specific resistance, according to Matthiessen, of 24,369 microhms between the opposite faces of a centimeter cube, and of 146.6 ohms per mil-foot with a temperature coefficient of .00031 per degree Centigrade.

More recently, Dewar and Fleming have determined the specific resistance of an alloy containing 33 parts of platinum and 66 parts of silver to be, at about 15° Cent., 31,726 C. G. S. resistance units. The temperature coefficient at the same temperature being .000243.†

While it is true that the results of these experimenters vary widely as to the specific resistance and temperature coefficient of platinum silver, yet the tests carried on at the Cavendish Laboratory since the establishment of the B. A. standards, in about 1864, have shown that this metal is to be relied upon for the construction of standards of great accuracy and permanence.

Almost the only material which in recent years has disputed the position of platinum silver as a material for standards on the score of permanence is "patent-nickel" manufactured by Basse and Selve of Altena, Germany, and reported by Feussner and Lindeck.‡ Two wires of slightly different constitution and sizes were tested, and their results show that after the wire has been sufficiently annealed to overcome the slight hardening which takes place as they are wound and adjusted, there is every indication that patent-nickel remains

\* Feussner and Lindeck, *Zeitschrift für Instrumentkunde*, 1891.

† The Electrical Resistance of Metals and Alloys at Temperatures Approaching the Absolute Zero. Dewar and Fleming, *Philosophical Magazine*, Sept., 1893.

‡ Alloys for Resistance Coils. *Zeitschrift für Instrumentkunde*, 1891; also *Electrician*, London, Vol. XXVI, page 493.



22 CONDUCTORS FOR ELECTRICAL DISTRIBUTION.

absolutely constant under various changes of temperature and with time.

PATENT-NICKEL.

	A Diam. 0.6 mm.	B Diam. 1 mm.
Copper.....	74.41	74.71
Zinc.....	0.23	0.52
Tin.....	.....	Trace
Nickel.....	25.10	25.14
Iron.....	0.42	0.70
Cobalt.....	Trace	Trace
Manganese.....	0.13	0.17
Specific Resistance.....	34,200	32,800
Temperature Coefficient.....	.00019	.00021

Arsenical copper containing as much as ten per cent of arsenic has been proposed as an alloy for resistance coils, and such a material has been manufactured to a small extent in France by the firm of J. O. Mouchel, who report their alloy to have a resistance of 290.1 ohms per mil-foot, or 48,216 C. G. S. units specific resistance, the temperature coefficient being .000258 per degree Centigrade. While the results show a very high specific resistance and a low temperature coefficient, which are favorable to its employment in resistance standards, it is unfortunate that the material is both difficult to work and extremely brittle, as well as very oxidizable in the air. Mordey reports\* that when it is carried to a high temperature it gives off arsenical fumes and suffers a marked permanent increase in its specific resistance.

Perhaps the most remarkable resistance alloy which has been produced is manganin, invented by Edward Weston in 1889. It is composed of copper, nickel and ferro-manganese in varying proportions. The alloy is difficult to manufacture uniformly on account of the high melting point of ferro-manganese and the ease with which it is oxidized. This difficulty is so great that the author has found, when melting in a covered crucible with a brass furnace, only seventy-eight per cent of the original charge could be recovered as solid metal, the

\* High Resistance Metals and Alloys. W. M. Mordey, *Electrician*, London, Vol. XX, page 564

remainder being in the shape of a loose powdery slag which was probably oxide of manganese. When melted with care in this manner, a mixture composed of copper 65 parts, ferro-manganese 30 parts, and nickel 5 parts, gave a specific resistance varying between 67,200 and 73,600 C. G. S. units. The temperature coefficient is not more than .000025, and for a certain temperature falls to zero, while at higher temperature it is negative. The metal is easily worked, though the greatest care must be taken that it shall not become too hard before annealing, or else when heated it is inclined to be brittle and snap just below the temperature of redness.

Prof. Nichols,\* of Cornell, has shown that coils made of this material are apt to change their resistance when successively heated to 100 Cent. and cooled to 0° Cent., but Dr. Lindeck, working for the Reichsanstalt, states that when a completed coil is annealed at a temperature of 140° Cent. for five hours, no further difficulty is experienced from any aging change, whether produced by time or repeated heatings and coolings.

The results obtained by various experimenters on this alloy show considerable variations, but rather in the specific resistance than in the temperature coefficient, which is at all times small and almost negligible, while the experiments made at the Reichsanstalt show that if proper care is taken to obtain a material of constant chemical constitution, it may be depended upon for constant electrical properties.

On page 24 is given a table containing the best available determinations of the electrical properties of manganin.

A further advantage of manganin which has been noticed by Dr. Lindeck, when used for resistance coils, is its very feeble thermo-electric power when soldered to copper, as is almost always the case in standard coils. While for german silver the thermo-electric power is between 20 and 30 micro-volts per degree Centigrade, and for constantin, an alloy of copper 50 parts with nickel 50 parts, having a temperature coefficient between .00003 and .00004, a thermo-electric power of 40 micro-

\* The Resistance of Alloys of Ferro-manganese and Copper. *American Journal of Science*, June, 1890.

24 CONDUCTORS FOR ELECTRICAL DISTRIBUTION.

volts per degree Centigrade is found, the thermo-electric power of manganin is not above one or two micro-volts per degree.

ELECTRICAL PROPERTIES AND CONSTITUTION OF MANGANIN.

Authority.	Composition.				Resistance per Mil-foot.	Specific Resistance.	Temperature Coefficient.
	Cu.	Fe.	Mn.	Ni.			
Nichols .....	78.28	14.07	7.65				0.000011
Nichols .....	51.52	31.27	16.22				0.000039
Perrine .....	70.	25.	5.	} Mixture.	392	65150	
Perrine .....	65.	30.	5.		404	67200	
Perrine .....	65.	30.	5.		443	73600	
Feussner and Lindeck.	73.	24.	3.		287	47700	0.00003
Lindeck* .....	84.	12.	4.		253	42000	0.00014
Dewar and Fleming....	84.	12.	4.		287	47640	0.0000

Intermediate between the alloys of a constant character which may be used for resistance standards and those only valuable for their high resistance lie a series of nickel-steel alloys which have been introduced in Germany and the United States within the past three or four years. Possibly when the properties of these alloys have been investigated with sufficient care and their constants and permanence determined with exactness, it will be found that they may be used in standard resistances where they may supplant the other materials as thoroughly as they have already supplanted German silver as simple absorbers of energy.

At present, however, their cheapness and high specific resistance recommend them where they may safely be used, and the low temperature coefficient of certain grades warrants further study of their properties and further attempts at obtaining these alloys in such a manner as will insure uniformity of electrical properties.

No assays of these alloys nor formulas for their constitution are at hand, and it is probable that the ingots are not especially made for use as wire, but that the wire bars are cast

\* Alloys for Resistance Coils, by Dr. Stephan Lindeck. *Electrician*, London, Vol. XXX, page 119; translated from *L'Électricien*, Paris.

from furnace heats run primarily for the manufacture of armor plate or steel shafting.

These alloys are sold under trade names, such as "Krupp wire," "Superior," "Iaia," "Climax," "Advance," and two qualities are offered, the Krupp, Superior and Climax having a specific resistance varying between 85,400 and 86,500 resistance units at 20° C., with a corresponding variation in the temperature coefficient between .00067 and .00073 per degree Centigrade.

The Iaia and Advance wires, while of lower specific resistance, give also a lower temperature coefficient.

For these materials the specific resistance at 20° C. varies between 50,200 for hard samples and 47,100 in annealed wires with a temperature coefficient negative in the hard wire of — .000011, while for the soft wire the temperature coefficient is positive, but amounts only to .000005 per degree Centigrade. From a consideration of these figures it is readily seen that as such properties are combined with comparative cheapness, these alloys are most useful.

Conductors to be used in resistance coils for absorbing a great amount of energy are used under conditions very different from either those of low-resistance transmission conductors or of standard resistances. In the case of the conductor for transmission, the first consideration is that as small an amount of energy shall be absorbed as is consistent with economy of construction; therefore a material of a low specific resistance is used irrespective of any influence which temperature may have in the alteration of the resistance of the line. For standard resistances, as we have seen, the amount of current to be carried is small, while the fixity of the resistance under all possible varying conditions of external or internal temperature is the question which is most important to consider.

In designing that a great amount of energy shall be absorbed by a conductor, it may be advisable under certain circumstances to pay attention to the alteration of the resistance due to the heating of the wire; but in general it is more important to adopt a material which will give the required total resistance and carrying capacity at the lowest cost of installation.

In consequence, such conductors are used at as high a temperature as possible without interfering with the radiating power of the rheostat as a whole. It is often necessary that they should be placed in a small space and, above all, it is required that there should be no permanent alteration in the resistance due to annealing the material or to the oxidation of the surface.

All of the various alloyed conductors which have been described as suitable for standard resistances have been used for this purpose ; but manganin and arsenical copper are both unsuitable for use in the open air at high temperatures on account of the molecular changes which take place in them under these conditions.

The special circumstances of arrangement of the rheostat, in which resistance coils are used, determines very largely the size of wire and character of material necessary to carry a given amount of current and to absorb a definite amount of energy.

Recently, special devices have been provided for increasing the radiating power of resistance wires, the most familiar example of which is that presented by the enameled-wire rheostats. In these resistance wire is imbedded in a layer of porcelain enamel on the surface of a plate of cast iron and, when so arranged, the radiating power of the cast-iron plate is added to that of the resistance wire ; in consequence, currents may be safely carried which under ordinary circumstances would completely fuse a wire of the size used. Various tables have been presented for the carrying capacities of the different wires when used for absorbing large amounts of energy, but obviously the location of the wires, in relation to each other and surrounding bodies, influences these results to so great an extent that such tables have comparatively little value, save as a general guide for the beginning of an experimental determination of the size of wire to be used. Kennelly\* has shown that, with copper wire a very great variation in the carrying capacity of a wire, at a given elevation of temperature, is produced by the location of the wire : whether insulated and

\* "On the Heating of Conductors by Electric Currents"; A. E. Kennelly; *Electrician*, London, Vol. XXIV, p. 142 *et seq.*; *The Electrical World*, 1889.

encased in moldings, suspended in the confined air of a room, or freely suspended out of doors ; and an equivalent variation will be produced by the different methods of fixing resistance wires as adopted by the different rheostat manufacturers.

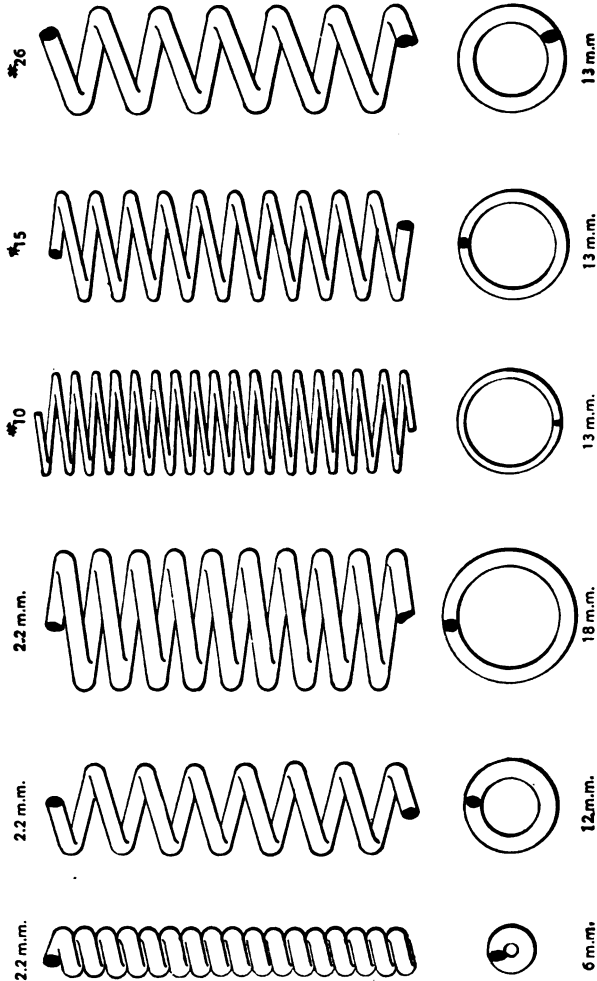

The Coils of Herr Dettmar, full size.

It is equally true that any calculations of the carrying capacity of resistance wire will lead to fictitious results, on account of the fact that the assumption must be made in any such calculation of the value of the radiating power of the sur-

face of the wire and of the quantity of heat lost by convection. As an example of this Mr. D. K. Morris\* states that a resistance wire will safely radiate one watt per 16 sq. cm. of surface, whereas Doctor Fleming has been able to get rid of one watt with 6 sq. cm. of surface from rods made of plumbago and plaster of Paris.

Herr Dettmar,† of Frankfort, has reported that for spiral coils placed vertically there is a particular spacing which will give the most rapid cooling dependent upon the external diameter of the coils. His experiments are not connected by any particular law, but the results are as follows :

DIMENSIONS OF RHEOSTAT COILS.

Wire.	Diameter of Coil.	Distance of Spacing.
2.2 mm. diameter,	6 mm. diameter,	Nearly touching.
2.2 mm. diameter,	12 " "	1½ turns per cm.
2.2 mm. diameter,	18 " "	2 turns per cm.
Various sizes.	31 " "	Twice the dia. of wire.

Many rheostats have been constructed of iron or german silver wire, wound in separate spirals and mounted together, with the coils clearing each other by an amount equal to their diameter. In such construction Mr. A. B. Herrick ‡ gives the accompanying table of carrying capacities as safe; first, in rheostats with wooden frames; and secondly, in rheostats with fireproof iron frames. It is stated that these tables are calculated for a heat limit or 39° Cent. for wooden construction and 48° Cent. for fireproof construction, the temperature of the surrounding air being assumed to be 22° Cent. D. K. Morris, in the article previously referred to, gives the following as the amount of energy which may be safely absorbed with any given wire :

Wire 20 mils in diameter will absorb 1 watt per meter.

Wire 40 mils in diameter will absorb 2 watts per meter.

Wire 54 mils in diameter will absorb 3 watts per meter.

Wire 80 mils in diameter will absorb 4 watts per meter.

Wire 104 mils in diameter will absorb 5 watts per meter.

\* "The Construction of Resistances"; *Electrician*, London, Vol. XXXIII, p. 607 *et seq.*

† *Electrotechnische Zeitschrift*, December 15, 1893.

‡ *Electrical Engineer*, Vol. IX, p. 210.

CARRYING CAPACITY IN AMPERES.

Diam. of Wire in Mils.	German Silver.	Galvanized Iron.		Tinned Iron.	
		Wood Frames.	Iron Frames.	Wood Frames.	Iron Frames.
244	....	55	63.8	....	....
225	....	48	55.6	....	....
207	....	41	47.5	....	....
192	....	30	34.8	....	....
177	....	26	30.01	....	....
162	....	23	26.6	....	....
148	....	20	23.2	....	....
135	....	17	19.7	....	....
128	....	....	....	17.4	20.3
120	....	14.5	16.2	....	....
114	....	....	....	14.6	17.1
105	....	12	13.9	....	....
102	8.5	....	....	12.3	14.3
91	5.4	10	11.6	10.3	12
81	4.6	8	9.28	8.7	10.1
72	3.8	6	6.96	7.3	8.5
64	3.2	5	5.8	6.1	7.1
57	2.7	3.7	4.29	5.1	6
51	2.3	....	....	4.3	5
45	1.9	....	....	3.6	4.2
40	1.65	....	....	3.0	3.5
35	1.21	....	....	2.52	2.9
32	.99	....	....	2.17	2.5
28	.88	....	....	1.82	2.1
25	.66	....	....	1.53	1.77
22	.55	....	....	1.28	1.49
20	.488	....	....	1.08	1.2
18	.434	....	....	....	....
16	.385	....	....	....	....
14	.343	....	....	....	....

It will be noticed here that these results do not depend upon the material of which the wire is made ; this is on account of the fact that the waste of energy is inversely proportional to the square root of the specific resistance, but at the same time the resistance of one meter of any given wire will vary directly as the square root of the specific resistance. Hence it will require, for instance, three and one-half times as much *current* to heat a copper wire of a given diameter as an iron wire of the same diameter, owing to the difference in resistance of the two wires, the expenditure of energy in overcoming the resistance being the same in both cases.

These tables are given as being the best at present obtainable, but, as we have already said, their applicability to any given case will depend so much upon the conditions under



which the wires are used that but little absolute reliance can be placed in the results. Cast-iron grids are at present largely used in rheostats where great amounts of energy are to be absorbed, but as this is a most variable material, its properties can be found only by a particular study of the brand actually employed.

The third use we have spoken of for alloyed conductors is that of safety fuses. Safety fuses are introduced into conducting circuits wherever it is desired to protect the circuit from any undue increase in the amount of current carried which might rise to such a value that dangerous heating would be produced in the conductor itself, or the generating machinery endangered by reason of the largely increased demand for current. In general, such safety fuses are so located that the use in them of any material melting at a high temperature would occasion fires from the flying particles of the melting fuse. In consequence, alloys fusing at low temperatures have been generally employed.

The principal metals used as constituents of these alloys are lead, tin, bismuth, mercury and cadmium. Alloys which may be made from the above materials have melting points varying from little above the temperature of the human body to 200° Cent. To cite a few of these we may select the following examples from many alloys which may be made :

FUSIBLE ALLOYS.

Tin.	Bismuth.	Lead.	Cadmium.	Mercury.	Melting Point.
....	20	20	....	60	20 degrees Cent.
4	15	8	3	...	65 " "
1	2	1	....	...	98 " "
8	8	12	....	....	132 " "
50	50	....	....	....	160 " "
24	8	22	....	....	164 " "
67	33	....	....	....	166 " "
80	20	....	....	....	200 " "

Very little data is obtainable concerning the resistance of these materials; and the amount of current which a wire made from any one of these alloys will carry before melting takes place depends upon the conditions under which a safety fuse

is installed. These conditions consist of the temperature of the room in which they are used, the location and size of the blocks to which they are connected, the lengths of the fuses, and the construction of the safety-fuse blocks, whether covered or open to the air. In order to avoid, as far as possible, the influence of terminal blocks, safety fuses for currents not exceeding ten amperes should have a length of about two inches; while for greater currents it is found that the cooling effect of the terminals is still more important, and in these a length of fuse amounting to six inches is allowed.

In order to obtain perfect reliability in the melting point of the fuse, it would be advisable to have all fuse blocks without covers, and a free circulation of air permitted; but as safety fuses are generally destroyed with more or less evolution of flame, the purpose of the fuse would be defeated if no cover were used, and in general it is necessary to cover fuse blocks, in spite of the uncertainty which such covers introduce in the melting point of the fuse.

It has been many times shown by various experimenters that the most reliable fuses are those constructed from materials having a high melting point, and, in any locality where the molten metal is not of itself a source of danger, more adequate protection for the circuits and generating apparatus is obtained from fuses composed of some one of the pure metals rather than from the low-melting-point alloys.

An extensive investigation of the current necessary to fuse wires of various diameters and materials has been made by Mr. W. H. Preece.\* His experiments prove that the law which regulates the production of heat in any given wire is expressed by the formula

$$I = ad^{\frac{1}{2}},$$

in which  $I$  is the current,  $d$  is the diameter, and  $a$  is the value of a constant depending upon the material of the wire.

The following table gives the value for the constant  $a$ , which he has determined by experiment:

---

\* "On the Heating Effects of Electric Currents," by W. H. Preece; *Electrician*, London, Vol. XX, p. 386 *et seq.*

## CONSTANTS FOR CURRENTS TO FUSE WIRES.

Materials.	"d" expressed in inches.	"d" expressed in cm.	"d" expressed in mm.
Copper .....	10,244	2,530	80.0
Aluminum .....	7,585	1,873	59.2
Platinum .....	5,172	1,277	40.4
German silver ....	5,230	1,292	40.8
Platinoid .....	4,750	1,173	37.1
Iron .....	3,148	777.4	24.6
Tin .....	1,642	405.5	12.8
Alloy (lead and tin 2:1) .....	1,318	325.5	10.3
Lead .....	1,379	340.6	10.8

Notwithstanding the care with which these experiments of Mr. Preece have been performed, we find that C. P. Feldmann\* has obtained values of the constant  $a$ , for fuse wires composed of lead and bismuth, which depend upon the size of the terminals, taking wires six inches in length and fusing them between terminals differing in weight. With terminals weighing 150 grams each, he has found that the value of  $a$  was 1,340, while with terminals weighing 30 grams the value of  $a$  for the same material was 1,155. However, his results indicate that a definite law connects the size of the wire and the current necessary to melt it when the terminals and method of connection of the terminals remain the same. Thus emphasizing the statement we have already made, that it is necessary to separately test each class of fuse wire for every condition of use in order to obtain the most accurate results. Feldmann† gives the following method for obtaining the size of the fuse wire to be melted with a definite current when the terminals are maintained at a constant size, but the length of the wires changed. In the article referred to, he states that: "If for any set of terminals the fusing current for the fuse wire of known length and diameter and the substance be known, the current necessary to fuse a wire of any other length and diameter, but of the same substance and clamped between the same terminals, may be found as the product of two constants :

$$I = af.$$

\* *Electrician*, London, Vol. XXIX, p. 87.

† "Fuse Wires," by C. P. Feldmann.—*Electrician*, London, Vol. XXX, p. 61.

“The constant  $a$  is the current necessary to fuse a wire of unit length and unit diameter, and is to be found by previously experimenting upon any wire whose constant  $f$  is known. The  $f$  itself is a function of the length and diameter  $d$  of the wire.” The values of  $f$  for wires of different lengths and diameters are presented in the figure on page 34.

In order to use this diagram for determining the constant  $f$  of any wire whose length and diameter are known: Follow the vertical line representing the diameter of the wire until it intersects the horizontal line representing the length of the wire, at which point a diagonal will be found giving the value of the constant  $f$ , which, multiplied by the constant  $a$  already determined, will give the current necessary to melt the wire in question.

The data here presented is all which we have at present available for the determination of the size of the fuse wire necessary to melt with a given current. According to the best authorities\* there is no difference between the amount of current necessary to melt fuse wire whether the current is continuous or alternating in character; and, therefore, we may feel assured that when the necessary constants for the melting points of fuse wires having a definite constitution and used in fuse blocks of a definite character have been determined, the results will be correct for all circumstances of similar use. This statement concerning fuses for alternating currents must be limited somewhat by the periodicity of the alternations and by the size of wire, as is shown by Fleming in his work on “Alternate Current Transformers,” Vol. I, page 240; but as it is rarely the case that fuse wires will be reliable under any conditions when made of sufficient diameter to be influenced by the consideration of the self-induction of the wire, the “skin effect,” as it is called, can be in general neglected.

The question of the aging of the fuse wire has been noticed by Salomons, Preece, and other observers, and it has been greatly disputed whether the effect is due to the change in the molecular constitution of the fuse metal or to some atmospheric

---

\* “Alternating Currents and Fuses.”—D. C. Jackson and R. J. Ochsner.—Trans. Am. Inst. Elect. Engineers, Vol. XI, p. 430.

34 CONDUCTORS FOR ELECTRICAL DISTRIBUTION.

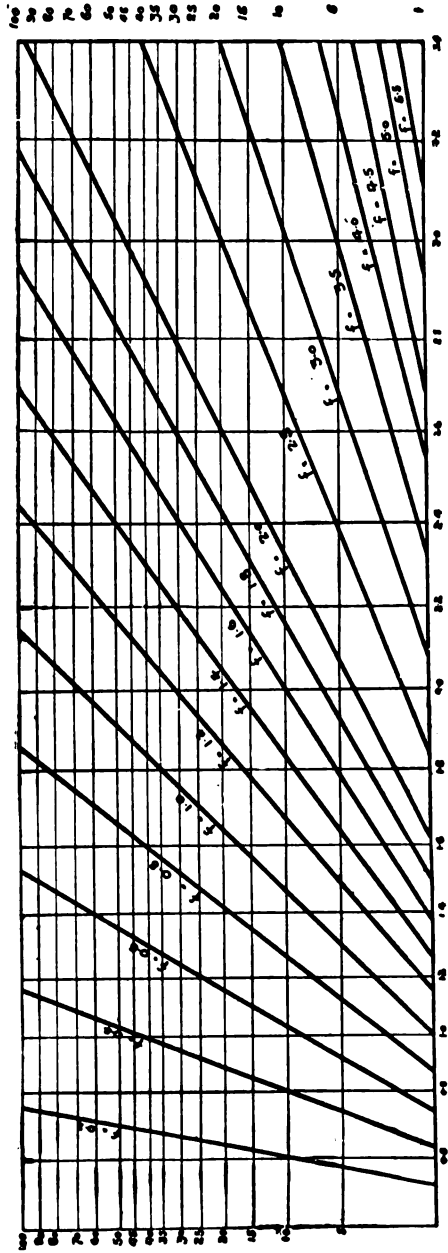

action on the surface of the fuse metal. The experiments of Jackson and Ochsner seem to indicate that even where a fuse has carried an alternating current for a very considerable period of time no molecular change in its constitution can be found to have taken place ; but it is undoubtedly a fact that in practice fuses are subject to variations which in some instances raise the fusing point and in others lower the value of the current for fusion by a very considerable amount. To avoid this effect Lord Kelvin has attached a spring to the end of the fuse so that when the melting point has been reached the fuse will be ruptured by the tension of the spring and Mr. A. C. Cockburn has used fuses weighted with a ball of lead at their center ; which ball, in spite of its cooling power, is claimed to have the effect of making the fuse more reliable in its action.

The best explanation of this trouble seems to be that the surface of the fuse is acted upon by the gases in the atmosphere, which form a coating over the fuse metal sufficiently strong to allow the metal to be held in place after it has become molten under the action of the current. This effect was first noticed by the author in about 1885, when experiments were being performed on very small lead fuses, and in this case it was found that the thin lead fuses would be completely destroyed by the action of the atmospheric gases after long exposure. It can hardly be supposed that such an action can be one of oxidation, though it has been so described by many of the best authors, for the reason that lead and tin are not readily oxidized in the atmosphere, and the small amount of oxidation which is ordinarily produced is generally sufficient for protection against further action. The experience of lead cable manufacturers and other users of lead have indicated, on the contrary, that, while oxidation is not a serious matter, the air of a city contains a sufficient amount of organic acid and carbonic acid to produce comparatively rapid corrosion of lead and its change into a carbonate. This action is far less rapid with tin, or with tin and lead alloys, than it is with lead or lead and bismuth alloys. While the introduction of an amount of tin exceeding three per cent will reduce this effect very appreciably, it is not possible to say that any of the fusible alloys which can be used in the manufacture of fuses will be granted

an entire immunity from such action by the addition of tin, and in consequence the only guard we have against fuses increasing their carrying capacity lies in fixing them in such a manner that they will be under more or less mechanical strain, as is the case in the ordinary fuse block where the fuse rises over a porcelain bridge in the block. If the corrosion proceeds to such a point that the carrying capacity of the fuse is materially lowered, there seems to be no remedy except that of a systematic replenishment of the fuses irrespective of whether they are burned out or not. A thin coating of shellac would undoubtedly reduce this action; but in general the replenishment of the fuse is the more efficient method, and one which includes a systematic inspection of all fuses and fuse blocks. Of whatever material fuse pieces may be constructed, their action depends entirely upon a balance of the amount of heat generated by the current in overcoming their resistance against the heat radiated from their surface. When the heat retained by the fuse is of sufficient quantity to raise the mass of metal to the temperature of fusion, the fuse is broken by melting.

It is consequently seen that the current for fusion becomes a function of the time, and fuse wires may only be properly adjusted for long-continued currents which are capable of producing a state of equilibrium between the energy absorbed and the heat radiated; and although the great current generated when a short circuit has taken place will ultimately melt a fuse, yet the function of rupturing a circuit which has been short-circuited is more properly performed by a more rapidly integrating apparatus, such as a magnetic circuit-breaker—the fuse being properly considered as a means of protection against the slower increases of currents brought about by leaks or excessive loads.

## CHAPTER III.

### THE MANUFACTURE OF WIRE.

OF whatever material the conductor may be made, it is necessary, before it is used in the construction of transmission lines, that certain mechanical operations be performed upon the ingot of metal, whether obtained as casting or forging.

The first of these operations is that of rolling the ingot into a wire-rod, which is afterward drawn into a wire. The distinction made between a rod and a wire being that the rod is a product of the rolling-mill in which the manipulation is performed upon the red-hot metal, while a wire is obtained by drawing cold through bored draw-plates. No reference whatever to the size limits the term either of rod or wire, provided only that if the thread of metal is produced in a hot condition by rolling it is always a rod; whereas, if the thread be produced by drawing cold through a draw-plate it is always a wire. These two products are separated in physical character by the difference in the uniformity of shape, the wire being generally the more truly cylindrical and more uniform in diameter throughout its length.

The raw material of the rod rolling-mill is obtained in the shape called a "wire-bar." These wire-bars differ in the various mills, and have varied in the history of rod-rolling from bars about two inches square and, from three to four feet in length, weighing from twenty to fifty pounds, to the bars which are at present used by the most advanced American manufacturers, which are four inches square and, from two and a half to three and a half feet in length, weighing from 135 to 200 pounds in the case of iron and steel. Wire-bars are obtained from rolling-mills where the large ingots are rolled, cut



and delivered to wire-rod mills in the sizes indicated. Ingots of copper and bronze are cast in the sizes required for wire-bars, and are subjected to no previous rolling.

Bars, as received by rod rolling-mills, are in general heated in Siemens reverberatory furnaces for a period of about twenty minutes, when they acquire the proper malleable temperature. In the case of iron and soft steels this temperature is also the temperature of welding, which facilitates very greatly the operation of rod rolling, as on this account small imperfections in the original bar and in the rods, as they pass through the mill, are eradicated by subsequent rolling.

For the purpose of thoroughly forging the metal, the grooves in the rolls of any rod rolling-mill are alternate squares and ovals until the last "pass" is reached, when as far as possible a cylindrical shape is given to the rod. With materials which are of a very soft nature when hot, as is the case with aluminum, brass, and certain of the bronzes, rolling is performed in Europe in what is called a Gothic mill, where the passes or grooves in the rolls are diamond shaped, and the reduction between the different passes is made as small as possible. This practice, however, is only adhered to in small mills, and is hardly at all practiced in America. It is more common in the United States where materials are to be handled that cannot be rolled in the ordinary type of mill to roll into flat sheets, which are afterward sawn into strips, and the square strips so formed drawn through plates which make the wire gradually approach a cylindrical shape. The difficulty of this process accounts very largely for the great expense necessary in producing wires of german silver and materials of a similar character. Rod rolling was formerly practiced in America, and is practiced to-day on a small scale, by passing the rod back and forth through a set of rolls and laying it out straight on the floor of the mill between each passage through the rolls. This operation is necessarily slow, and requires an extent of floor space great in proportion to the possible output of the mill; also, it is obvious that no great lengths of wire-rod can be handled in such a manner. Daniels\* states that for many years nine tons of No. 4 B. W. G.

---

\* "Wire Rod Rolling Mills and their Development in America." F. H. Daniels. Paper DXLIII, Mech. Engineering Section, World's En-

iron wire-rods in a single turn of ten hours was considered a very remarkable output for a mill working on this system. About the year 1870 the "looping-in" system of rod-rolling was introduced by John A. Roebling's Sons Company, of Trenton, N. J., and in the fall of the year previous what is called the "continous" wire-rod rolling was begun in the mill of the Washburn & Moen Manufacturing Company, of Worcester, Mass. These mills have been continually improved until, at the Joliet mill of the Illinois Steel Company, as much as 150 tons of No. 5 rods have been produced in ten hours by their Garrett train. Continuous wire-rod rolling is performed by means of a number of roll passes placed in line through which the wire rod passes continuously, being rolled at many points at the same time, each pair of rolls being so proportioned in size and speed that the rod is kept straight and each pass in advance takes up and reduces in size exactly the amount of material delivered to it by the pass behind, no slack being made between passes. The essential principle in the Belgian, or looping-in, train consists of the rolls being connected together on the same shaft-line so that all are moving at exactly the same speed, the rolls decreasing in size toward the finish. The rod passes in loops from one pass to the next, and in consequence each pass in advance delivers the metal at a slower rate than the pass behind it, since it is reducing the same amount of material but to a smaller size. This wire-rod rolling train, as perfected by Mr. William Garrett and installed in the rolling-mills of the Illinois Steel Company, Chicago; Oliver and Roberts, Pittsburg; Roeblings, Trenton, and other large wire-rod manufacturers, is divided into three distinct parts: the "roughing" train, for reducing a short billet to a square rod about one and a half inches on a side; the intermediate or "dutch" train, from which the rod leaves with an area of about one square inch, and the "finishing" train, in which there are eight passes and in which the wire rod is reduced to its final size, generally No. 5 B. W. G., or 220 mils. In order to avoid too great variation in the size of rolls, this finishing train is divided into two parts and driven by two shafts of different speeds, the last speed being 500 revolutions

per minute with a finishing roll twelve inches in diameter. As far as is possible the rods are guided from one roll to the next in open iron troughs called "repeaters," but as it has been found impossible to make a repeater that will take an oval rod lying flat and give it a quarter turn in order that it will be pre-

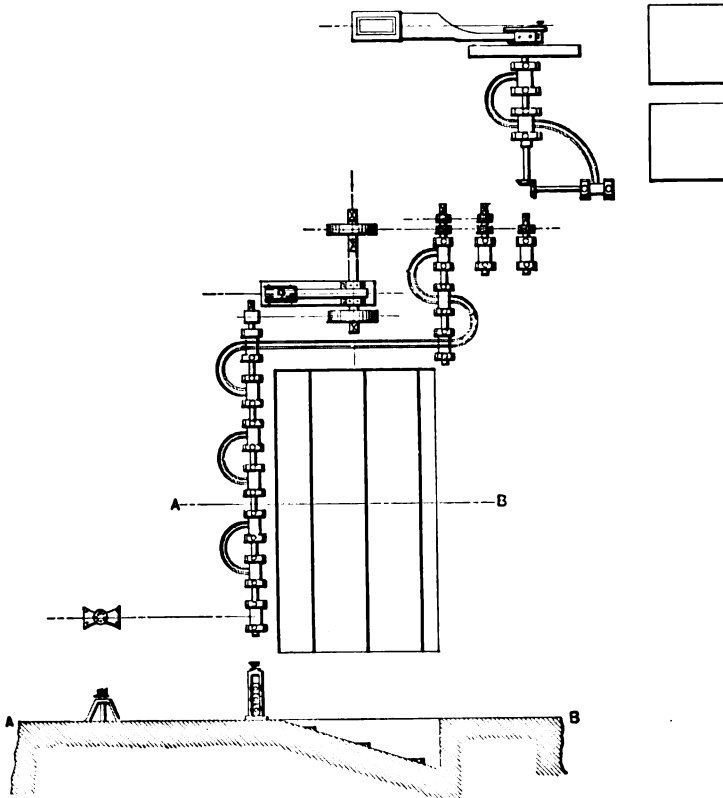

Garrett Rod-mill.

sented on the edge to the next pass, it has been found necessary to have this work performed by men who catch the end of the rod in small tongs as it emerges and stick it into the next pass. The roughing train consists of three rolls, one above the other, on the "three-high" plan, as it is called; in this there are in general either six or eight passes, alternating square and oval as we have already stated. Between these passes the bar is handled by the "roughing" men.

As the square rod leaves the roughing train it is guided in a repeater to the intermediate train, where it is reduced by five further passes. When delivered by the intermediate train to the finishing train, the rod has generally acquired such a length that it is being rolled by all of the eight passes in this train at the same time. In order that the long loop made between two passes shall be readily taken care of, the ground is excavated on both sides of the finishing train and an iron floor laid, sloping backward from the platform on which the rolls stand, into a deep pit about a hundred feet long and from fifteen to twenty feet deep at the farther end. Into this pit the loop between each pair of rolls is forced by the impetus given by the delivering roll, aided by the natural effect of gravity. Steps are placed in the floor of the pit so that when once the loop is forced down toward the bottom it will be impossible for it to return except by the end being delivered around the step. In this pit the loops lie straight and flat without further assistance. This advance in the construction of the rolling-mill has enabled Mr. Garrett to roll several rods at one time, so that in some of his larger mills as many as five rods are passing through the finishing rolls at one time, being finally finished and reeled together.

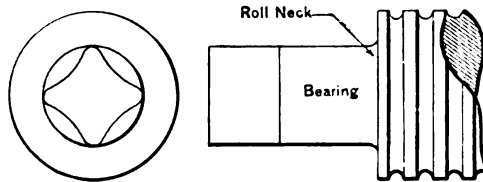

End of a Roll.

The rolls used throughout the mill are short cylinders of steel, sometimes with a chilled face, the average diameter being about twelve inches and the average length about eighteen inches. Beyond the cylinder of the roll there is a bearing from seven to nine inches in length and from six to eight inches in diameter; outside of this again the metal is grooved out to form a coupling in the shape of a four-pointed star with rounded corners. These rolls are all set in " housings " or stout iron arches bolted securely to the platform of the mill. In the

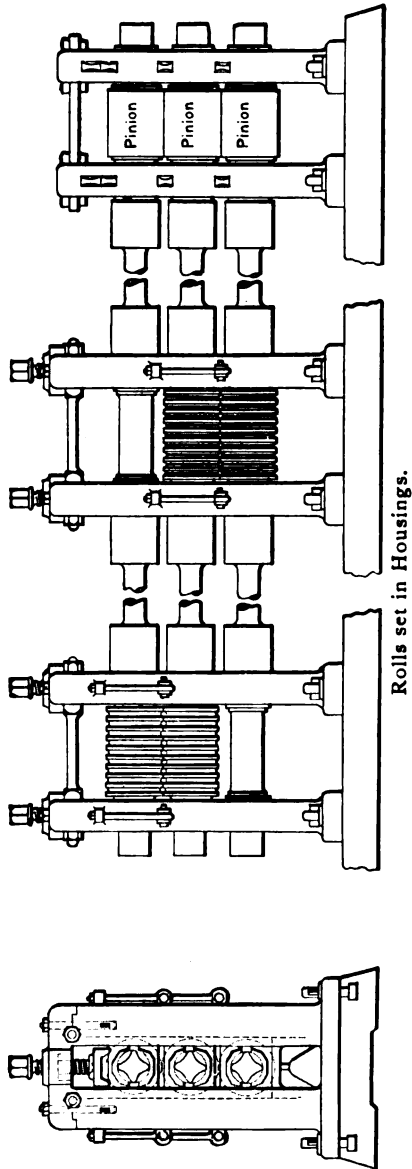

apertures of these arches brass bearings are adjusted on slides provided on the side pillars of the arches. Each pair of rolls is geared together with spur gears, but only one of each pair is driven by the main shaft; the roll which depends upon its fellow for its motion is alternately above and below the driven roll in adjacent pairs of housings; in this manner the rod is directed first out on one side of the mill and then across to the other side as it passes from one roll to the next. A stout screw, passing through the top of the arch of the housings, enables the adjustment of the distance of the rolls to each other, and in consequence, in a slight degree, the amount of reduction to which the rod is subjected.

It is not possible in rolling-mill practice to maintain a set of bearings accurately in the same line, as the strains are so great that even if the bearings were originally in accurate adjustment the wear to which they are subjected in a single day's run is often sufficient to produce a very serious change in their alignment, consequently no rigid coupling can be adopted between the various pairs of rolls. The star-shaped end of the roll allows the employment of a flexible coupling called a "wobbler." This wobbler has the advantage of allowing the power to be transmitted when the bearings coupled together are out of line without any great strain being placed upon the bearing by reason of their defective alignment; and furthermore, the ease with which these wobblers may be put in place admits of a rapid change of rolls in case of the accidents which are by no means infrequent in rolling-mill practice. This wobbler coupling consists of a steel shaft with

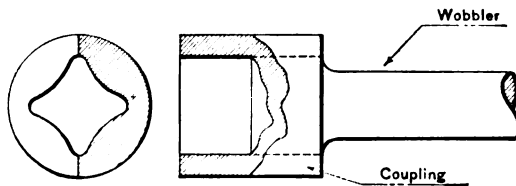

Wobbler and Coupling.

enlarged ends, corresponding in shape and size to the ends of the rolls; over the end of this, and of the roll to which it is connected, is slipped a collar, having the reverse or "female"

shape of the wobbler and roll end, this collar being sufficiently large to allow a very considerable amount of lateral motion.

After the wobbler is put in place and the two collars connecting each end of the wobbler to the two adjacent rolls are slipped into position, they are held in place simply by strips of wood which are bound fast to the central shaft of the wobbler itself. As will be seen, this extremely simple device can be applied easily, and when in place will transmit the power with no especial reference to the alignment of the journals. The bearings themselves, in order to withstand the great strain to which they are subjected, are made of solid pieces of brass, babbitt metal, or other hard anti-friction compound, and lubricated with tallow and streams of running water. The two halves of each bearing are separated from one to two inches in order to allow this method of lubrication to be easily applied. In order to keep the rolls themselves at a fairly low temperature, it is necessary that a stream of water be kept continually running upon them, otherwise they would heat and scar, and occasionally a rod would be carried completely around and welded fast as a band. The strain in rolling is often so great that when rods are rolled at too low a temperature the roll necks are frequently broken completely away, in spite of the heavy construction here described.

Besides the inclined pit, the method of reeling is the most essential feature in the handling of a great number of rods in a rolling-mill. The earlier rolling-mills, of which we have spoken, used a hand-reel for coiling up the hot rod, a method necessarily slow and imperfect. A later method consisted of a reel running vertically, having a double set of horizontal pins projecting from near the circumference of the horizontal reel hub, the diameter of the outer set of pins being about thirty-six inches. These reels, of which there were in general two, were driven by means of a loose belt which could be tightened by an idler pulley operated by a lever. When the rod emerged from the finishing roll it was flirited in loops over the large space of iron floor which was between the roll and the reel; a man running in would seize the end of the rod with a pair of tongs, and stick it between the spokes of the reel, then stationary; at once the workman in charge of the reel would start it

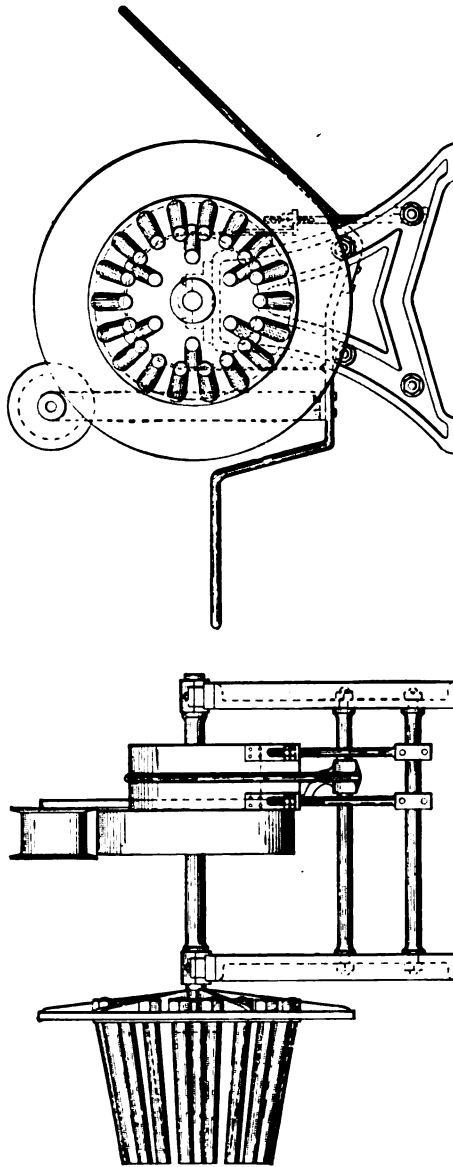

Loose Belt-reel.



up at a high rate of speed, taking up the slack until the rod was suspended, leaving the floor clear for the next rod. Such a method would hardly allow more than a single rod on the floor at the same time, therefore it became necessary to improve the reeling methods before the capacity of the mill became greatly increased. Three styles of automatic catch-

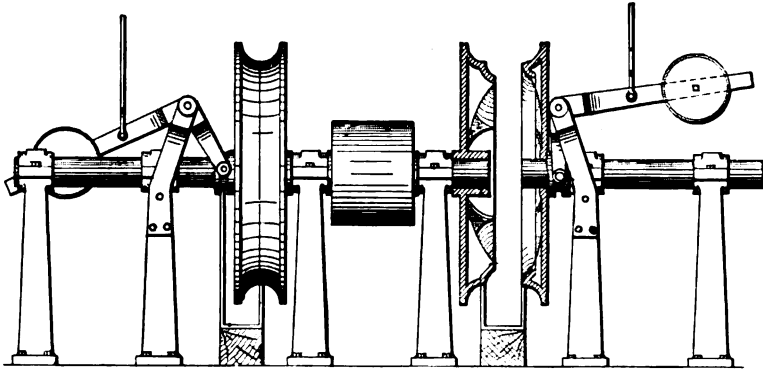

Direct-traction Reel.

ing reels are at present used by modern rod-mills. The first one is called the "direct-traction" reel, invented by Mr. Garrett. A pair of discs running at the same speed as the issuing rod seize the end as it comes from the rolls, and clamping it between them reels up the coil in the groove between the two discs. The reel of C. H. Morgan is placed horizontally with two circles of vertical pins, the rod being guided by a pipe into the space between the two rows of spokes. As the issuing end of the rod strikes the bottom plate of the reel, it is thrown by centrifugal force against the outer set of pins, and is so reeled up. The province of the inner row of pins being to draw out the rod after it has ceased being forced forward by the rolls. Mr. F. H. Daniels, in connection with Mr. Morgan, has invented a reel called a "pouring" reel. This consists of a bent pipe which is revolved by a belt, the lower end of the pipe projecting into an iron cylinder. As the rod issues from the pipe the coil is laid on the inside of the iron cylinder. By any one of these three methods the slack between the final roll and the reel is avoided, as well as the necessity of the issuing rod being

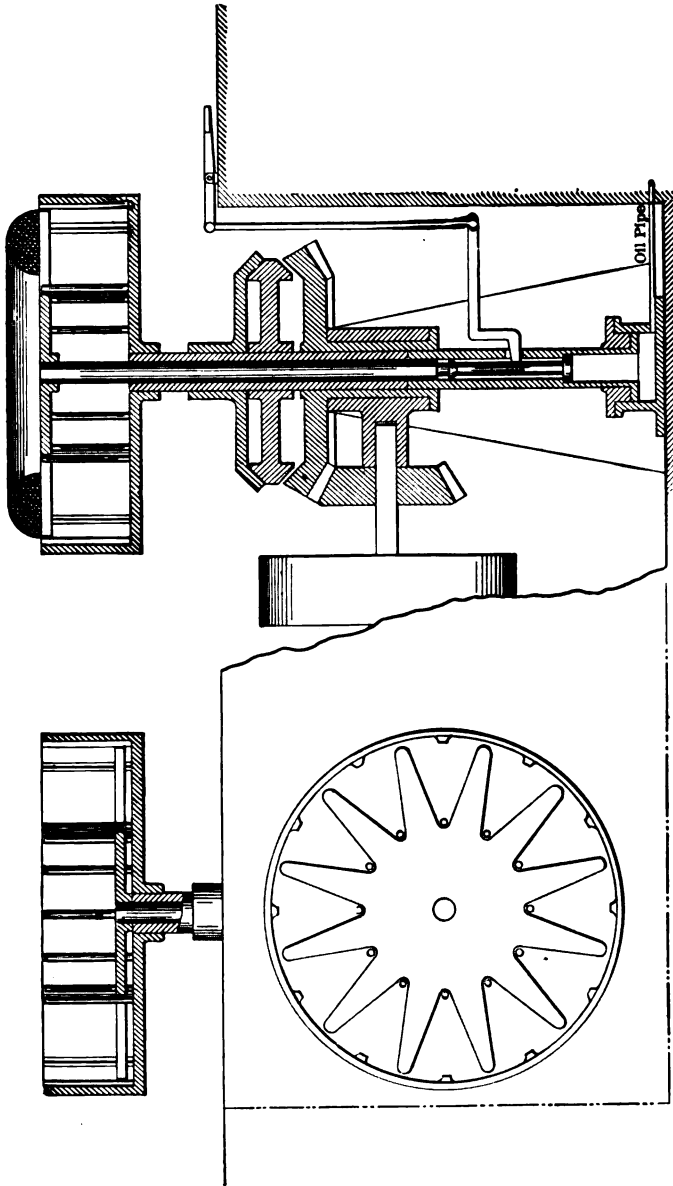

Morgan Reel.

handled by the workman, therefore as many rods can be taken care of as the mill can deliver, this amounting, as we have already said, to as many as five in the great Garrett mills.

The marvelous rapidity of all these operations may be understood when we see that the finishing roll will deliver its rod at the rate of 1,500 feet per minute, and when we take into account the fact that at the Joliet mills 400,600 pounds of No. 5 and 426,000 pounds of No. 4 wire rods have been produced in eleven hours, each coil weighing about 150 pounds, an average is obtained of something more than three rods per minute, each one of which must be caught and entered into its proper pass by the "stickers in" on the other side of the rolls. It is hardly possible to believe that a greater number of rods can be rolled in any mill without more than a single set of workmen than has already been accomplished.

While more than one-half of the total quantity of wire rods are manufactured by the mills operated on the Garrett system, almost one-fourth of all the wire rods rolled in the United States are produced in continuous mills employing a system perfected by Mr. F. H. Daniels, engineer of the Washburn & Moen Manufacturing Company. In these continuous-rod mills the rolls are located in line, facing each other in such a manner that the rod does not change its direction as it goes from pass to pass. For this system, as has been stated, the various rolls are so adjusted in speed that no slack is allowed in the rod between the various passes, and the rod is not handled by workmen at all as it passes through a train of rolls. At first sight it would seem that such a system is capable of producing wire rods in a greater quantity and at a lower cost than would be possible on the looping-in system of rolling, but in spite of the fact that a shorter length of the rod is exposed to the air in its passage from roll to roll, which diminishes the loss by oxidization from 7 per cent to 3 per cent, and notwithstanding the fact that a smaller number of workmen are employed for handling the hot rod, yet the mechanical complexity of the system increases the liability to disabling accidents to such an extent that there is probably no advantage as to cost of rolling attached to this system, and on account of the numerous and expensive breakages likely to occur, the continuous-rod rolling-mill has not been

a favorite with manufacturers. In the continuous mill the entire process of rod rolling is divided into two distinct parts. First, the reduction of the wire bar, four inches square, to that of the wire billet a little over an inch in cross-section; and, secondly, the further reduction of this billet to a round wire rod. The second, or finishing train, is generally arranged in duplicate on account of the fact that the capacity of the first or roughing train is easily double that of the finishing train, and in consequence a single roughing mill can economically feed two sets of finishing rolls at the same time. Each train in this system is driven by a single engine-shaft, extending parallel to the roll train and driving the individual rolls by means of bevel gears of variable ratio; in this manner any roll may be speeded to such a point that it will exactly reduce the metal delivered to it by the preceding roll without making any slack. The weak point in this system lies here in the necessity of continually varying the adjustment of the rolls, as it is impossible to heat the metal so exactly that any given roll will always have the same effect on it, and even two parts of the same rod may be of such different temper as to require readjustment of the rolls while the rod is passing; in consequence, the skill necessary on the part of the chief roller and his assistants is much greater than in the Garrett mill, where the slack may vary from ten or twenty yards to one hundred yards without interfering with the performance of the mill in any particular. Beside the extra skill necessary on the part of the workmen, the gearing of the continuous-rod mill is always a source of more or less trouble and a menace to its continuous operation. The finishing roll of a Daniels continuous train is operated at a speed of 1,200 revolutions per minute, and it is easily seen that the shocks which are transmitted to the gearing when the rod enters each pass are very great and often destructive to the bevel wheels; furthermore, the presence of a great number of heavy bevel wheels running at a high speed is exceedingly detrimental to the economy of the mill from the point of power used in driving. As we have said, the scale produced in such a mill is much smaller in amount than that produced by the Garrett mill, but on the other hand, a much larger number of bad rods and bad ends are produced in continuous-rod rolling.

As the rod must pass from one roll to the other without being handled, the necessity of a perfect end to facilitate its entrance into the various passes is very much increased; it is therefore necessary to produce a loss by shearing off the ragged ends of the rod as it passes from the billet mill to the finishing mill. The continuous mill does not produce a rod that is as nearly round or free from imperfections as the Garrett train, so that rods rolled in this manner are not so well adapted for drawing into wires to be used for electric conductors as more perfect rods would be. The reason being that any imperfection in rolling is continued in the wire throughout the wire-drawing process, the conductivity being thereby reduced and scars remain in the finished wire which may develop into weakening defects when the wire has been installed.

Passing now from the rod to the finished wire, we observe our definitions that the rod is always the product of rolling hot metal, and the wire the product of drawing the cold metal through drawplates. But before we proceed to this last operation it is necessary to consider several intermediate operations which bear upon the character of the finished wire used as a conductor.

In the first place we notice that the wire rod, as it leaves the rolling-mill, is invariably covered with a thick coating of scale, a black oxide of iron or copper which has been produced as the rod was cooling in the open air. A certain amount of this scale has been rolled into the metal itself, but as neither copper oxide nor iron oxide are in the least degree malleable, the amount of scale which has been introduced into the body of the wire is really very inconsiderable and amounts mainly to surface markings, which are easily removed. On account of the non-malleable character of this scale and its great hardness, it is necessary that it should be removed as completely as possible before the rod is subjected to any further operations.

We must observe also that since wire in drawing is subjected to a stress almost up to its elastic limit, there is, therefore, a necessity that as even a temper as possible throughout the entire rod be obtained before it is subjected to this operation. As delivered by the rolls, rods not only differ between themselves in temper and annealing, but also there are varia-

tions in different portions of the same rod. In order that these defects may be removed and in order that the temper of the metal become uniform, it is, in general, necessary to anneal wire rods before drawing is attempted. After they have been annealed and cleaned from all scale, some coating must be provided in order that no subsequent oxidization may take place, and that the power required by the wire-drawing operation shall be reduced as much as possible.

These various operations are not only performed upon the rod in any wire-drawing mill, but annealing, cleaning and coating, as the operations indicated are called, must be performed whenever it is necessary to effect great reductions in the diameter of a wire; and although these operations are explained here in reference to the rolled rod, the same methods are used, from time to time, as the drawn wire requires softening and preparation for further drawing.

Considering first the operation of annealing. This consists in raising the temperature of a mass of metal to a dull-red heat and subsequently allowing it to cool slowly. Wire annealing is performed in large cast-iron cylinders, generally made without closed top or bottom. These cylinders rest in cast-iron saucers filled with sand, which are cemented on the top of an arch above a furnace. The arch with its fire-box forms a brick-enclosed annular space outside of the cast-iron pipe or "annealing pot," as it is called, all being parts of the same furnace. These pots are arranged so that they may be closed by a cast-iron lid, either luted in place with clay or sealed by a layer of fine sand. Each pot, such as we have described, will contain about five tons of wire to be annealed at one time. This wire is thrown into the pots in coils, which are arranged around cast-iron cones provided with projecting steps at the bottom, inserted within the pots for the double purpose of keeping the hot wire in regular coils and for providing an easy means of withdrawing the wire after annealing has been completed, this operation being performed by hooking into a ring

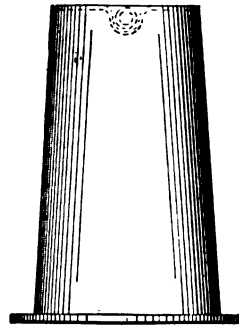

Annealing Cone.

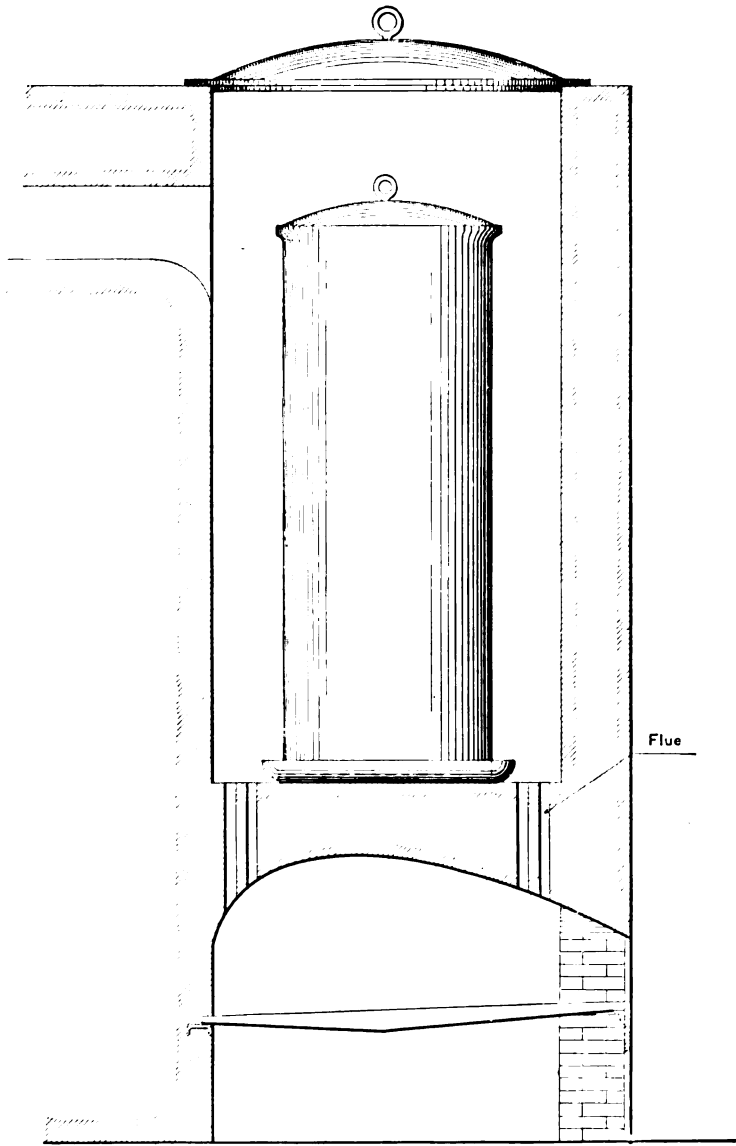

Annealing Pot and Furnace.

provided in the center of the cone at the top, with a crane capable of lifting out the cone bearing its load of wire. When the pot has been charged with its full complement of wire, the lid is sealed and the fires are started below the arch carrying the annealing pot, and continued until the whole mass has acquired a temperature somewhere about 600° or 700° Fahr., nearly six hours being necessary to bring the mass up to this temperature. As soon as the hot metal has reached the required temperature for annealing, the fires are withdrawn and the whole mass allowed to cool as slowly as possible, when the pots are opened and the annealed wire withdrawn: the average time allowed for cooling being about sixteen hours. In this operation a very considerable amount of scaling takes place, amounting to from 3 per cent to 7 per cent of the total weight of wire, depending upon the size of the wire which has been annealed.

It is readily seen that the form of pot used is not sufficiently tight to prevent the entrance of furnace gases during the operation of firing, or of air when the fire has been withdrawn and a partial vacuum produced in the pot by reason of its cooling. It is found that oxidation of iron takes place not only in the presence of air, but also with equal rapidity in the presence of carbonic acid, but that carbon monoxide is entirely inert in reference to red-hot iron. Advantage of this fact is taken in the annealing process patented by Mr. G. W. Cummins. In annealing under Mr. Cummins' patent, the pot is provided with a closed bottom and the top covered with a lid as before; near the top of the pot a hole is drilled for the injection of carbon monoxide gas, which is kept flowing through the mass of annealing iron during the entire period of firing and until the wire is sufficiently cool to be removed from the furnace without further danger of scaling taking place. The carbon monoxide being produced by means of imperfect combustion of charcoal or coke in a small cupola fired from beneath. While this method has proved to be very efficient for the prevention of scale in the annealing of iron wire, it has been found that copper, which has been heated in a stream of carbon monoxide for a considerable length of time, has its quality greatly impaired; but that carbonic acid gas and steam are both perfectly inert toward hot copper, and where it is desired that copper should



be annealed without the production of scale, it is the custom either to pack the copper wire in an annealing pot containing oxide of copper, which absorbs the oxygen of the entering air, or to inject either carbonic acid gas or steam into the annealing pots, in the manner described for the Cummins process of annealing iron.

After annealing has been completed, unless the operation has been performed in a manner that will prevent the formation of scale, it is necessary that all scale should be removed before drawing is attempted. Mechanical methods of pounding for the removal of scale have been from time to time attempted, but with only imperfect success, and, even where the greater portion is removed by pounding the wire in a stream of water, the final total removal of scale from annealed wire is performed by chemical solution, a process called "cleaning."

Cleaning consists in the immersion of the scaled wire in vats containing a hot solution of sulphuric acid diluted to about ten per cent, which acts upon the outside coating of scale and leaves the surface of the wire clean, a solution of sulphate of iron being produced in the vats. As soon as the scale has been entirely dissolved, the wire is removed, washed in water, and finally immersed in a bath of whitewash. This whitewash not only neutralizes the last trace of the acid, but also protects the wire on exposure to the air from further oxidation, besides having the property of furnishing a slight amount of lubrication for the next operation of drawing. On account of the difficulty with which copper is oxidized in the air, there is no necessity for coating copper wires with lime or any other material after they have been removed from the cleaning bath, but with all iron or steel wires such a coating is essential. An examination of a wire that has been cleaned in this manner will show that in the case of the copper wire no action further than that of the removal of the scale has taken place, but, on the contrary, when iron wire has been cleaned it is at once seen that it has been rendered very brittle by the operation and that a fracture will no longer be of a bright, clear color, but dark gray and lusterless. This effect is explained by the absorption of hydrogen gas in the operation of cleaning. Whether the hydrogen is simply occluded by the metal and remains adherent

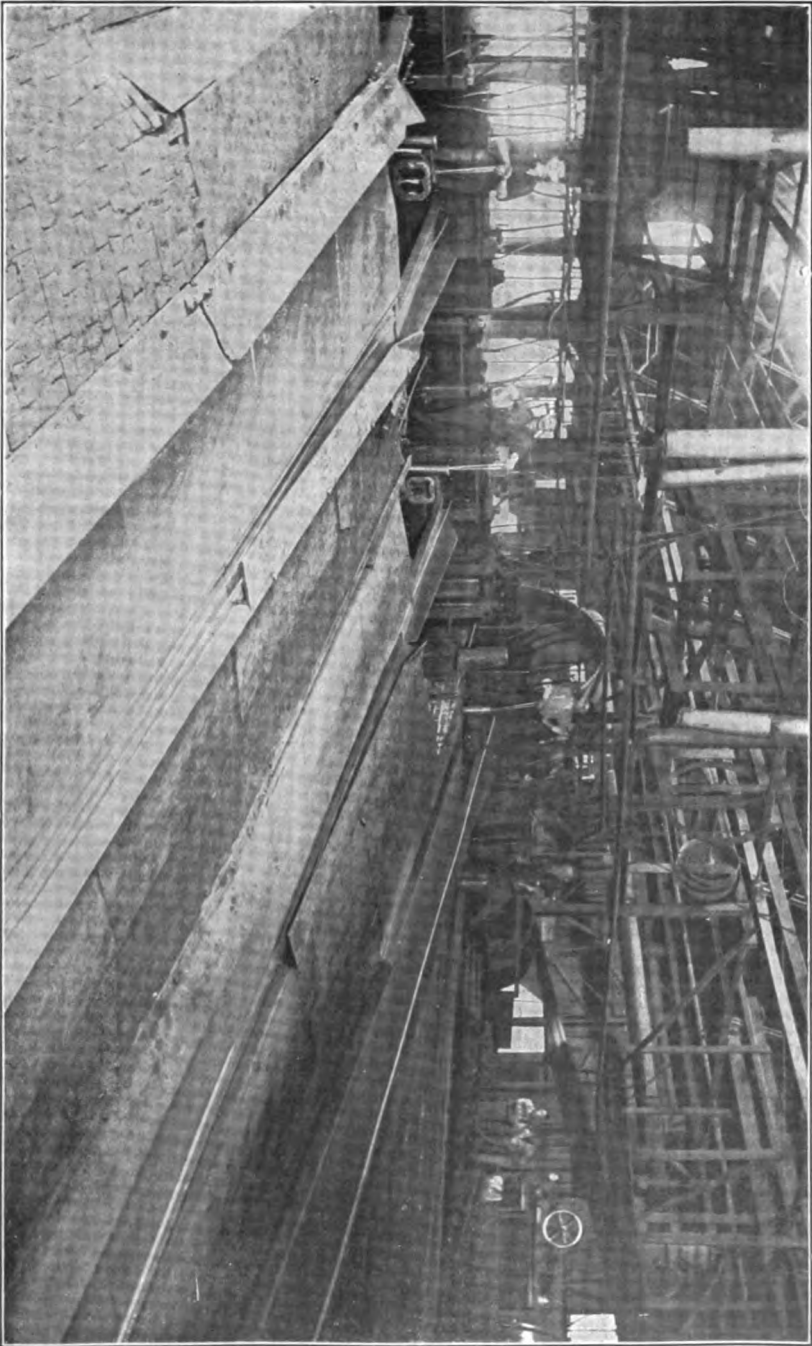

Belgian Rod Train at Roeblings, showing Inclined Planes and Troughs.

to the particles of the wire in its original state, or whether a chemical compound has been formed is disputed, though the best authorities are undoubtedly of the opinion that an unstable hydride of iron has been formed which is a true chemical compound. This compound is readily decomposed by the action of a gentle heat, and for many years it was the custom to expose wire, thus rendered brittle, to the action of sunlight and heat before the wire was further used. At the present time this operation of restoring the wire to its original toughness is hastened by baking in a furnace at a temperature close to 250° Fahr., though the experience of rope manufacturers has clearly proven that the iron cannot be completely restored by baking, but that manufactured wire rope will continue to improve in strength for a period of at least twelve months when the rope is exposed to bright sunlight. The question of the absorption of hydrogen by the various metals, and its effect in altering their characteristics, deserves much study and is as yet very imperfectly understood.

The surest manner by which hydrides may be produced seems to be in the operation of an electro-depositing cell. Most metals when deposited from a solution by an electric current—and undoubtedly this is true of both iron and copper—are found to be brittle and but slightly malleable, though after an electro-deposited metal has been melted it is of great purity and in its most malleable condition. When metals in a solid state are treated by various thermal or chemical processes, it is found that both iron and copper will readily form a hydride when molten, and that no such action ever takes place on solid iron when at a red heat, though copper will entirely lose its malleability by the absorption of hydrogen at this temperature. On the contrary, as we have already described, copper does not form a hydride while chemical solution is being performed upon the metal or its oxide, but under similar conditions iron and steel will invariably absorb a large amount of hydrogen and become exceedingly brittle.

Returning now to the subject of the manufacture of the wire, we have so far described all of the operations performed upon the metal before it has taken the shape which we technically call "wire." After the rod has been thoroughly an-

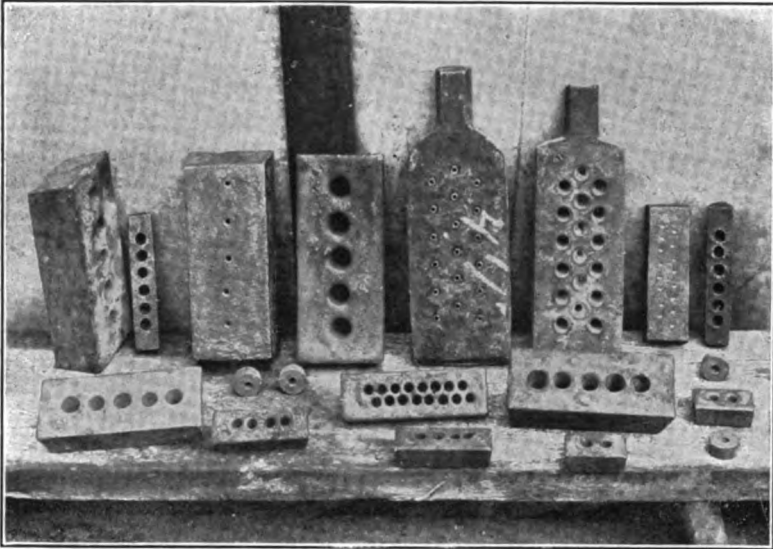

**Steel and Cast-iron Dies.**

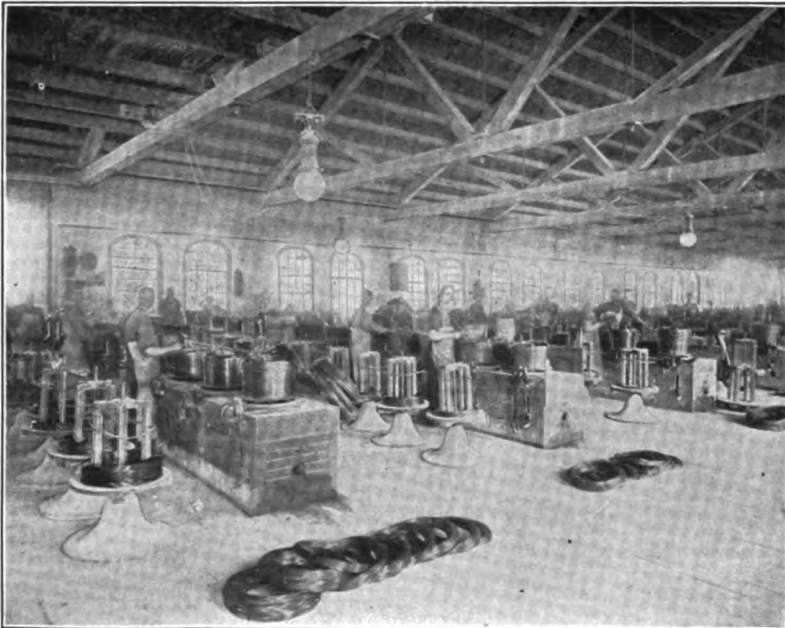

**Drawing Telegraph Wire.**

nealed and cleaned, it is ready for the operation of wire-drawing.

The dies used for drawing heavy wires are generally chilled cast-iron blocks, about three inches wide and six inches long, and from one and a half to two inches thick, pierced with from four to sixteen holes, which are roughly formed in the chill. The hole through such a die is slightly tapering for about three-quarters of an inch on the side from which the drawn wire is delivered; a large conical opening, four or five times the diameter of the wire, being cast in the drawplate on the back side, into which the rod to be drawn enters. This conical opening forms a chamber which is useful in retaining any form of lubricating material that may be used in the wire-drawing operation. The portion of the hole which is only slightly tapering on the face of the drawplate is reamed, by means of a three-cornered tapering reamer, to the size of the wire that it is required to produce. In drawing wire the uniformity of the product, of course, depends upon the accuracy with which the reaming operation is performed, and in any mill where the cast-iron dies, as described, are used, their care and formation is given entirely into the hands of experienced die-reamers, and the labor of the wire-drawer is reduced to that of entering the rod into its proper hole and attending to its efficient lubrication. Such dies are used in reducing the metal from rods about a quarter of an inch in diameter, to wires as small as one-tenth of an inch in diameter, a reduction produced by the passage of the metal through holes of five or six different sizes. For the wires of finer sizes, as well as for very large sizes, it is found that the manufacture of chilled plates is too uncertain and expensive, and, therefore, use is made of steel drawplates, which are bored and reamed by the wire-drawers themselves. These steel plates are either large rectangular blocks pierced with many holes for drawing to sizes not smaller than fifty mils or, for the finest sizes, are in the shape called "wortles," which are semi-cylindrical bars of cast steel having a diameter of from one to two inches, and a length of from six to eight inches. In these bars holes are bored, which are similar to those already described for chilled plates, but on account of the comparatively soft character of the metal itself, these "wortles" are

given sufficient resisting power to stand the operation of drawing by pounding them on the cylindrical face. This pounding closes the hole together, making it smaller than the wire which is to be drawn. After the "hammering-up" is completed, a smooth steel punch is used to swage out the hole to a size closely approximating that of the wire to be drawn, the final size of the hole being given as before by means of a triangular taper reamer. All of these operations are performed by the wire-drawer, and his skill and efficiency depend mainly upon the accuracy with which this work is done.

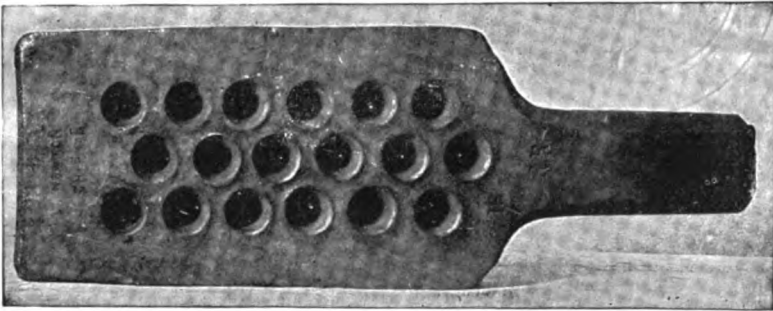

Drawplate for Wire-drawing.

For all sizes of wire, the tractive power necessary for drawing the wire through the drawplates is furnished by cylindrical drums called "wire blocks," which vary in diameter from thirty inches to six or eight inches, the size being determined by an approximate relation to the size of the wire which is to be drawn. In all cases these wire blocks revolve horizontally and are driven by vertical shafts through the medium of a simple clutch coupling engaged or disengaged by raising or lowering the block itself, one portion of the coupling being cast as a constituent part of the block. The operation of raising or lowering the block is accomplished by means of a treadle which is under the control of the wire-drawer. The form of the wire block is divided into three sections, each having a particular function in furnishing tractive power. At the bottom of the block we find a flange from one to two inches wide extending horizontally, the upper surface being slightly tapered up to the vertical surface of the block, which is three to four inches wide and in the

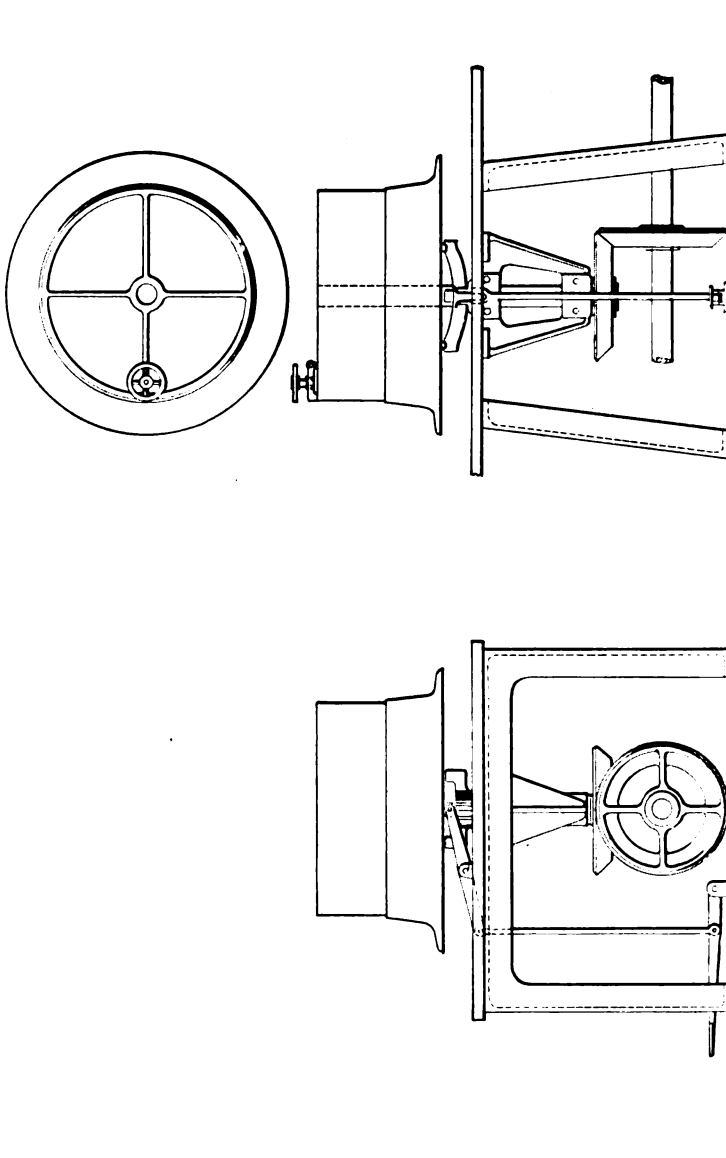

Wire-drawing Block.

shape of a truncated cone, with only a slight difference between the two radii. This conical portion of the block is from a quarter to half an inch in radius greater than the remaining section, which is generally nearly cylindrical and extends upwards for a distance from eight to twelve inches. In the operation of drawing, the hole in the drawplate is so located that the wire will

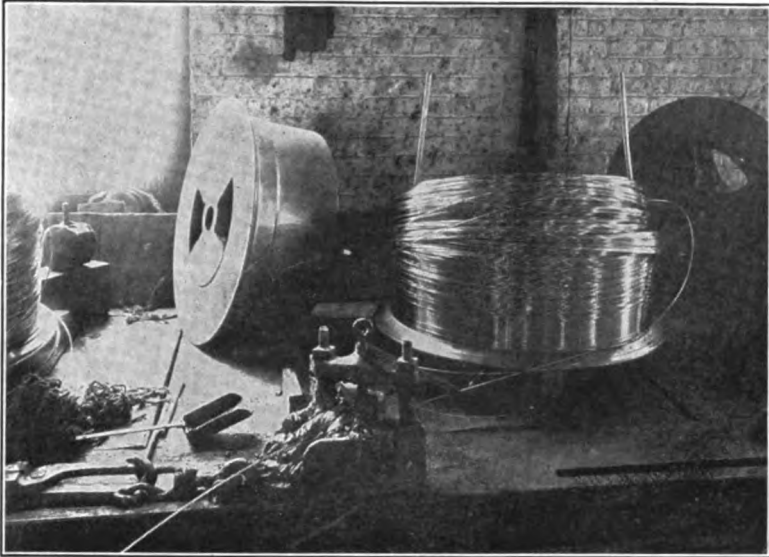

Wire-drawing Block.

strike upon the horizontal flange and be delivered by it to the second conical surface; around this the wire will pass a number of times, each turn being compelled to force upward the turns which were wound on before it. When this conical surface has been filled with turns of wire, the first coils find themselves loosely strung around the upper cylinder, which serves as a carrier on which there is not very much frictional resistance to the coils which are slipping upwards, nor does it aid materially in furnishing tractive power, this function being performed through the agency of the frictional resistance of the wires coiled upon the conical portion of the "wire block." Wire blocks are driven at such a speed that the wire will be delivered from 300 to 700 feet per minute.



As regards the accuracy with which any wire is drawn, dependence must be placed not only upon the reaming of the drawplates, but also upon the condition of the wire surface and the speed of drawing. In gauging any coil of wire it is found that the center of the coil will invariably be smaller than either of the two ends, this variation in size being explained by the fact that the die at the beginning of the operation is cold and free from any accumulation of scale. As the die begins to warm up, the hole changes slightly in diameter, but this change is not as important as the alteration in size caused by the accumulation of scale and dirt upon its inner surface. Finally, as drawing proceeds, the friction of the wire upon the drawplate wears it out, and as a consequence the last end of the wire is larger than the middle portion, which has been reduced in size by the accumulation of dirt and scale we have described. Obviously, much depends upon the condition of the wire surface and upon the lubricant used in drawing; if much scale remains upon the wire after it has been cleaned, the effect of clogging the die and changing the size is magnified, and the wire is liable to become seriously scraped by the sharp particles of scale adhering to the inner surface of the die. Even when the wire has been freed from scale as much as is possible, there yet remains enough dirt to fill and subsequently grind out the die unless the greatest care is taken in the lubrication. The lubricant used in wire-drawing must be so chosen that it will not seriously cake or hold particles of scale, and also it must be of such a character that it cannot be charred by the heat produced in wire-drawing, which is sufficient to raise the temperature of the die from 200° to 300° Fahr. For heavy iron wire which has been lime coated, the best lubricant is found to be dry flour. For the subsequent drawing of the wire produced by the first operation, a heavy petroleum grease is used, castile soap being used with the hardest varieties of steel. Fine wire is generally immersed in a bath of rye-flour paste, though a satisfactory lubricant is furnished by a solution of sulphate of copper. Copper wires are generally drawn in softer greases, as a lower speed is used in drawing, and in consequence the temperature of the wire does not attain so high a point. Soft petroleum



**Drawing Coated Wire.**

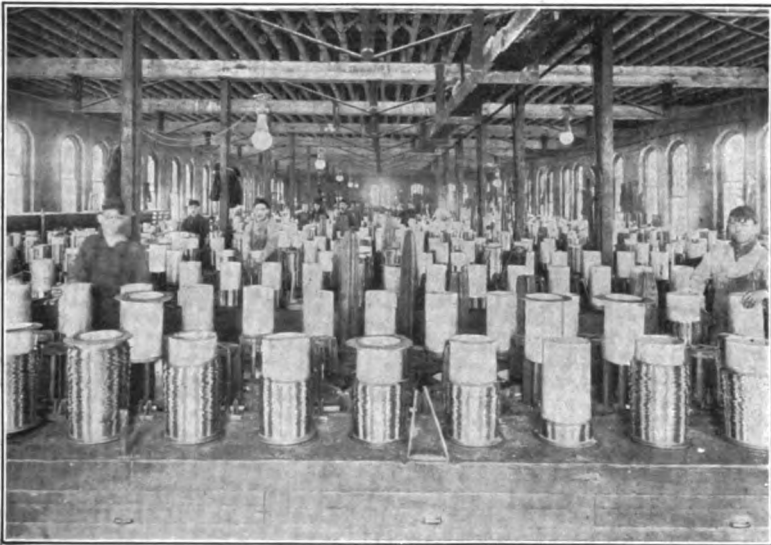

**Fine Wire-room.**

grease is used in drawing the larger sizes, and soft soap as a lubricant for the smallest sizes of wires.

The cost of the operation which we have described increases greatly as the size of the wire diminishes, since the limit is soon reached of the number of wire blocks which one workman can efficiently attend in drawing, the largest number handled by any one man being about seventy. In order to reduce the cost of drawing wire to small sizes, it has been demonstrated that the system called the "continuous" drawing may be efficiently employed; this consists in passing the single wire through a number of drawplates, one after another, and applying tractive force to the wire between every plate. The wire being wound around a drum which furnishes tractive power in such a manner that the wire will slip unless the end is tightened up; in consequence, the delivery of the wire through each drawplate depends upon the speed at which the wire is passing through the next succeeding plate. The simplest machine for continuous wire-drawing is that of Thomas Bolton & Sons, Staffordshire, England. In this machine the tractive force for each drawing is furnished by a cylindrical drum about eight inches in diameter, made of steel and constantly revolving at a speed of 150 revolutions per minute. The wire passes from a reel free to turn, through the first of a series of drawplates arranged on a bar parallel to the axis of the drum; from this it is passed two or three times around the drum and through the next drawplate, then around the drum and through a drawplate, again around the drum and through a drawplate until it is wound around a wire block from the last of the drawplates employed. When the terminal wire block is started in motion and the wire drawn through the last drawplate the end on the drum is tightened, which draws it through the next following plate with the effect that one section after the other is tightened upon the drum until all are drawing together, the amount of slip in each case being determined by the tightness on the drum. In this manner the wire can be drawn through as many as twenty drawplates at one time. As will readily be seen, little or no slip will take place on the last winding around the drum, but a great slip will be occasioned when the wire is being drawn to a larger size, and, in consequence, this portion of the drum will

be subject to a great amount of grinding and will rapidly scar. In order to avoid this effect, American continuous wire-drawing machines are furnished with drums geared together and running at different speeds, which contrivance decreases the

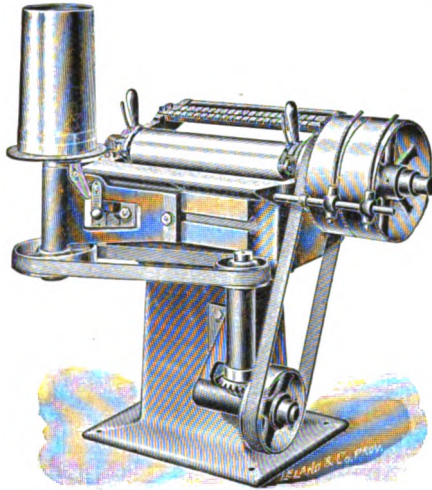

Bolton Type Continuous Machine.

wear on the drums but very materially increases the first cost of the wire-drawing machine.

The effect of wire-drawing on any material is not only to change its size and shape, but also to change the physical characteristics of the metal. The operation seems to form a sort of skin upon the metal, though according to the best authorities, the center is broken up by the process and, as a consequence, a moderate amount of wire-drawing will continuously strengthen the material but subsequently further drawing will not increase the strength, and will in general diminish its reliability. In tests made by the American Ordnance Board on wire for winding guns, it was reported that when wire was manufactured of steel having a tensile strength of 73,500 pounds and an elongation of 34 per cent with a reduction in area at the break of 54.6 per cent, the resultant wire drawn from a half-inch square rod to a square wire .10 of an inch in size had a tensile strength of 160,900 pounds with an elongation of .9 of 1 per cent, and a reduction in area at the

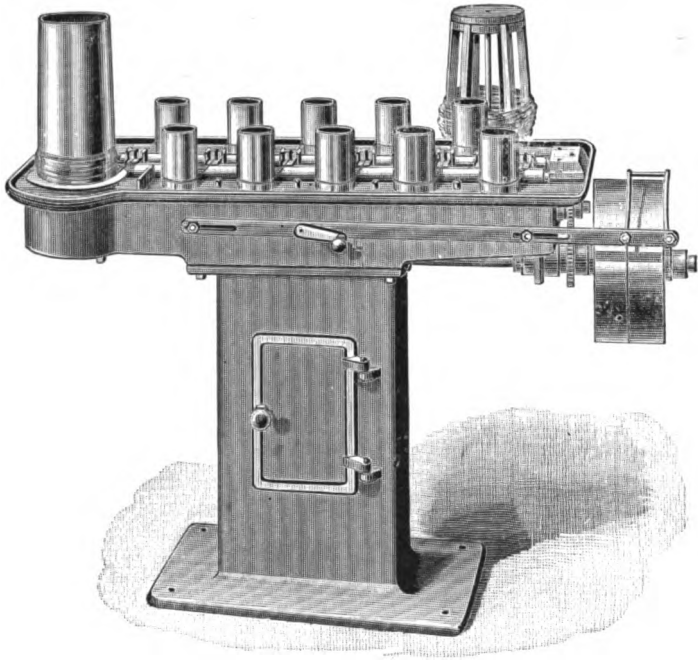

American Continuous Machine Geared.

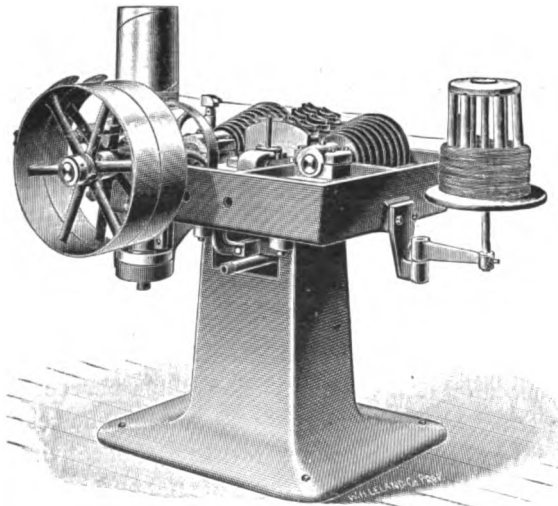

American Continuous Machine, Graduated Cones.

break of 16 per cent. We find also that commercial copper wire made from bars having from 30,000 to 40,000 pounds tensile strength is capable of affording a tensile strength of from 50,000 to 60,000 pounds per square inch. Tests made upon various wires are not very conclusive as regards the elastic limit, but they indicate that the elastic limit is about the same percentage of the breakage strength after drawing as it was before. The fact that imperfections are produced in wire by the drawing is also indicated by the change in the electrical resistance, an increase being undoubtedly produced, though the exact amount of this increase varies greatly with the different samples of wire and with different methods of treatment, the ordinary copper telegraph-wire being found to have about 2 per cent greater resistance than the same wire before drawing. Whatever may be the extent of these imperfections, they are undoubtedly of comparatively small importance, since it is found that the wire returns to its original character on annealing; besides, recent experiments in rod-rolling and wire-drawing indicate that a greater importance should be attached to perfection in rolling than to any action of the wire-drawing, since copper wire that has been rolled without being marked in any manner by the rolls or roll-guides has a higher conductivity and at least 10,000 pounds tensile strength greater than the wire which has been produced from the same material and through the same series of operations where less regard has been paid to the operation of rolling.



Heavy Wire-drawing Room at Roebblings.

## CHAPTER IV.

### WIRE FINISHING.

WHILE hard-drawn copper wire is immediately applicable to the construction of transmission lines after it has been subjected to the wire-drawing process described, iron and steel are found to be too readily oxidizable for such employment; consequently, before wires made of these materials can be used in the construction of transmission lines, it is necessary that they should be protected against the destructive action of the atmosphere. The earliest method put into practice for the protection of iron wire consisted in soaking the coil in a bath of boiled linseed oil. This covering was not found to be as durable or as cheap as that produced by a method of coating which has more recently been used exclusively, called "galvanization." The galvanizing of iron wire consists in coating it with a layer of zinc strong enough to prevent the action of atmospheric corrosives upon the iron itself. This is performed after the wire has been subjected to all of the processes included under the head of the general term "wire-drawing."

Before galvanizing can be performed, it is necessary that the wire should be carefully freed from scale, and therefore an annealed wire must be subjected to the cleaning process before it can be galvanized, though hard wires are ready for galvanizing immediately after they come from the wire-drawing block. In whatever manner their surface may be prepared, wires to be galvanized are thrown in coils upon a set of "swifts" which are arranged in lines behind the zinc baths, so that the wires may be drawn from them independently. From these swifts the wires are unreeled and carried parallel to each other, first through a bath of choride of zinc containing a small percentage



70 CONDUCTORS FOR ELECTRICAL DISTRIBUTION.

of free hydrochloric acid, and thence through a tank of molten zinc which is kept at the temperature necessary for galvanization by a fire located beneath it. As the wires come through the zinc bath they are finished either by carefully wiping off as much zinc as possible with asbestos wipers, or when a large

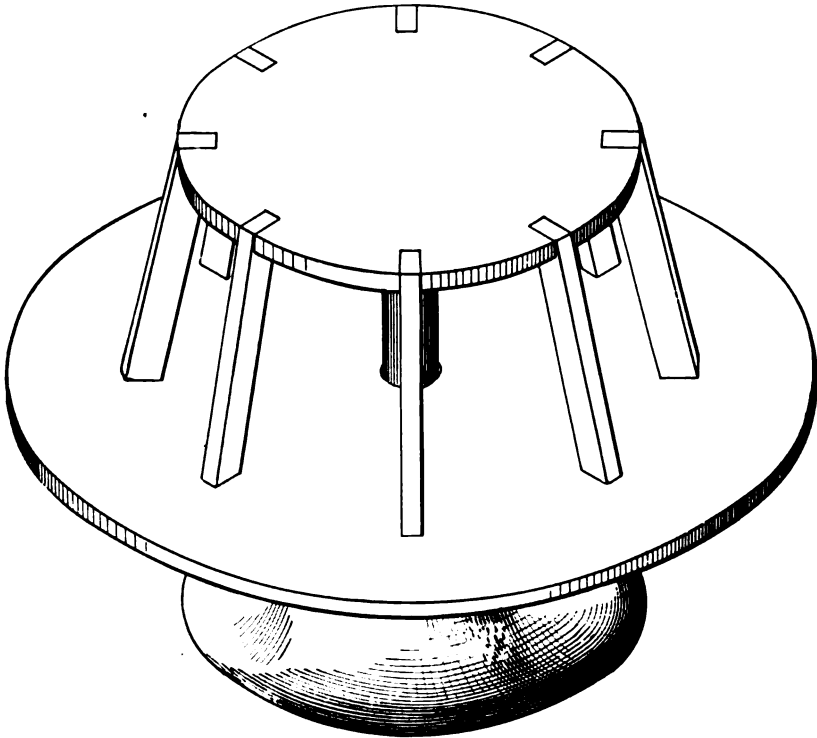

Pay-off Reel or "Swift."

coating of zinc is required on wires which are to be subject to the action of the elements, they are simply passed through a bank of sand lying upon the molten zinc, which strips back only the larger drops of loosely adherent metal. Cooling is performed in the first case by plunging the wire immediately into water as it leaves the wipers; while in the second case the wire is cooled simply by a long passage through the air before being reeled up.

The products of these two operations are different both in

character of surface and continuity of zinc. The first described produces that which is called "wiped galvanized wire," and the coating is capable of affording only a slight protection against the action of the elements, though the surface obtained is as smooth as that of the original surface of the wire. The quantity of zinc thus taken up by the wire amounts to about two per cent of the original weight of the wire. The coating is not perfectly continuous, but is as flexible as the original wire, and it is therefore used exclusively when some operation such as weaving must be performed. The other process to the product of which the term "galvanized wire" is applied without qualification produces the wire which is used on telegraph lines or for the armor of submarine cables, and affords the best protection we can obtain for bare iron wire suspended out of doors. The added weight of the zinc amounts to as much as from five to seven per cent of the original weight of the wire, though it is the custom to draw the wire for galvanization slightly smaller than the standard size of the bare iron wire, so that the completed wire differs but little in either diameter or weight from the bare iron wire of the same gauge number.

Since wiped galvanized iron wire is slightly cheaper to manufacture than the standard galvanized wire, the greatest care must be taken not to confuse these two products, and where wire is intended for suspension out of doors, the standard test for the quality of galvanization should invariably be applied.

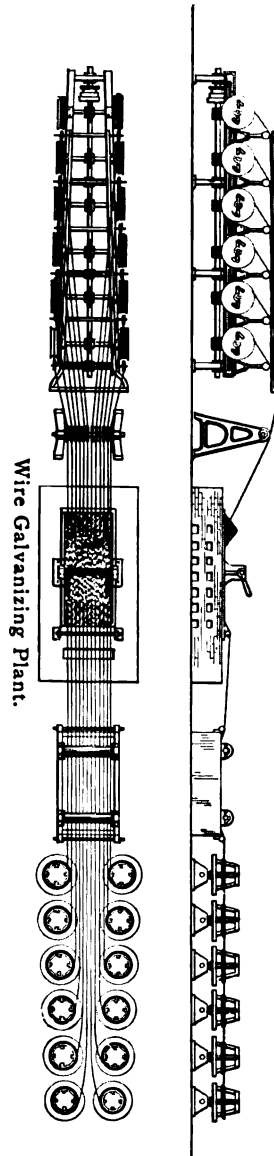

This test consists in the immersion of the wire which has been galvanized in a saturated solution of sulphate of copper for one minute, then after removal the wire is to be wiped dry and the same operation repeated four times. If the galvanization has been complete, no change other than a slight blackening of the surface of the zinc will be noticed, but if the galvanization is not complete, copper is immediately deposited upon the exposed iron by means of the strong local action between the zinc of the covering and the iron of the wire. The opposite error of excessive galvanization may be detected by the breaks in the zinc when the wire has been wound around its own diameter.

Galvanized wires such as we have described are used mainly in the construction of short telegraph-lines, for guy wires, pressure wires on constant-potential circuits, guard wires in electric-railroad construction, and trolley-suspenders in electric railroads where poles along the sides of the street are employed. When great conducting power must be obtained, iron is not so economical as copper, since the price of iron wire is rarely less than one-third that of copper wire of the same size ; while the conductivity of the copper wire is about seven times the conductivity of the best qualities of iron.

Solid copper wires are used in the construction of aerial lines until the size of wire required exceeds .46 inch. When a wire of this size is employed, the greatest length of a single coil that can be produced without joint in any of our existing wire-mills is about three hundred feet, and not only do these short lengths require many and expensive joints on the line, but also wires of such great diameter are likely to become considerably deformed by being repeatedly wound upon wire blocks or reels. The difficulty experienced in removing all bends from heavy wire while it is being strung is also very great, and in consequence conductors of great size may be more satisfactorily constructed by building up smaller wires into the form of a strand.

Wire strands are built up of a number of layers of small wires twisted one upon the other, the wires in each layer being laid parallel, and the layers crossing each other on account of the direction of their twist being reversed. Strands are

divided into "perfect" and "imperfect" strands according as the constituent wires all touch each other or are laid with open spaces between them. The perfect strands being confined to those having a center of either one or three wires. Two or four wires afford centers which may be reasonably included in this class, though the construction does not absolutely conform to our definition; a larger number of wires for the center of a strand, however, clearly belongs to the imperfect class, and should not be used for the reason that they do not give a round section unless wires varying in size are employed. In any strand the various layers lay round each other perfectly when the number of wires in each successive strand increases by six, except in the case of the first layer laid around a one-wire center, which allows only a total of seven wires, including the center and the first layer above it. Accepting two- or four-wire strands as perfect, we find that perfect strands are laid according to the following table:

WIRE STRANDS.

NUMBER OF LAYERS.	NUMBER OF WIRES IN STRAND.							
	One-wire center.		Two-wire center.		Three-wire center.		Four-wire center.	
	Per layer.	Total.	Per layer.	Total.	Per layer.	Total.	Per layer	Total.
1.....	1	1	2	2	3	3	4	4
2.....	6	7	8	10	9	12	10	14
3.....	12	19	14	24	15	27	16	30
4.....	18	37	20	44	21	48	22	52
5.....	24	61	26	70	27	75	28	80
6.....	30	91	32	102	33	108	34	114
7.....	36	127	38	140	39	147	40	154

Strands composed of more than seven layers as described in this table can only be laid with great difficulty, for the reason that few, if any, of the cable manufacturers are equipped with machines capable of laying more than forty wires at one time, which is the number in the seventh layer of the four-wire strand.

Where a very great flexibility is desired, this property may be obtained either by making the strand of a great number of small wires, or by twisting a number of strands together into a

rope, the latter construction having the defect that the exterior surface is not cylindrical in form, but the rope in section is composed of a series of intersecting circles having sharply reentrant angles.

The sizes of different conductors may be distinguished by reference either to the measurement of their diameters expressed in mils, in fractions of an inch, or in millimeters, but the custom of wire manufacturers has rendered the distinction of wire sizes by reference to certain gauge numbers much more common. These gauge numbers are all more or less arbitrary and are a relic of the time when the correct measurement of a wire diameter was not readily made and when wire-drawing was performed with great lack of uniformity. In order to compare various wires recourse was had to gauges of different forms, upon which numbers were stamped corresponding to different sizes determined arbitrarily. As the business has been developed the old gauge numbers have been expressed in decimals of an inch or in millimeters, and certain new gauge numbers have been adopted in which the variation in sizes of the different wires follow particular laws. The gauges above referred to were, in the earliest practice, plates of metal through which holes had been bored corresponding to the different sizes of wire. (Fig. 1, page 75.) Many disadvantages attach themselves to this method of gauging. In the first place, it is necessary to square the end of the wire before determining its size; secondly, any irregularities in cutting off the wire would lead to false results in gauging, and finally it is impossible to tell whether the wire is closely or only roughly a fit into its particular hole. The first advance upon this method was made by the introduction of a gauge formed of a circular plate of metal with slots corresponding to the different gauge numbers sawn into its edge. (Fig. 2, page 75.) This gauge was capable of being used upon any part of the wire and of determining with greater accuracy the variation of the wire from its true gauge number.

In about 1850 a new gauge was introduced which gave not only the gauge number, but with a reasonable approximation the variation of any particular wire from its gauge number. This gauge (Fig. 3, page 75) consisted of two straight edges of

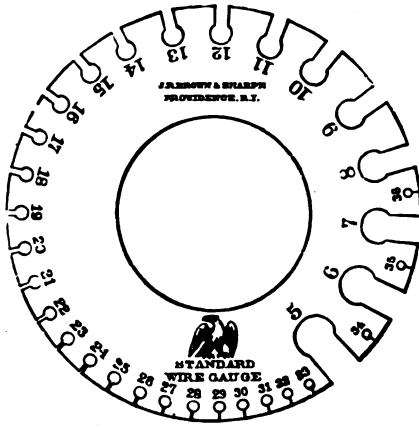

FIG. 2. Full size.

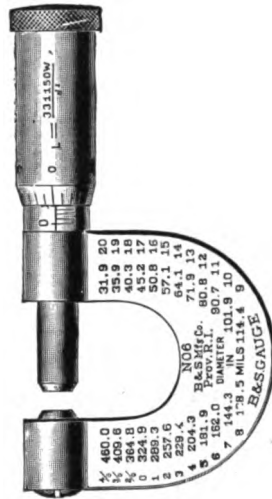
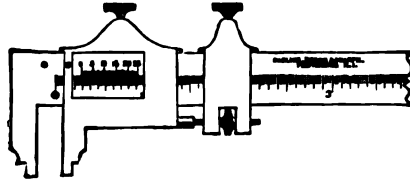

FIG. 5.

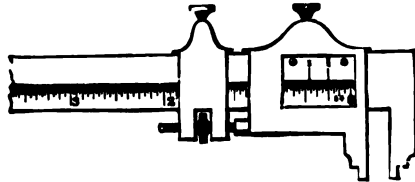

FIG. 3. 1/2 size.



Front.

FIG. 4 Half size.



Back.

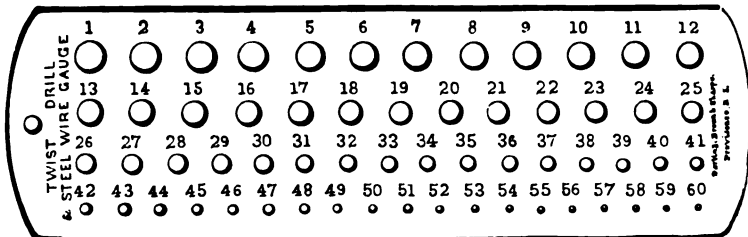

FIG. 1.—Old Style Gauge.  
WIRE-GAUGES.

metal clamped together in such a manner that an open "V" was inclosed by their straight edges, and along the sides of one or both of these edges straight lines were stamped corresponding to the different gauge numbers. In use the wire, the size of which one wished to determine, was slipped into the "V" until it firmly touched both sides, when the nearest line would determine its size, and the distance from that line would determine the variation from the true gauge number. Although these different gauges have been manufactured most carefully from time to time of hardened steel and ground with great accuracy, they were subject to variations in size produced by changes of temperature, and were especially liable to wear when frequently used upon a particular size of wire, thus introducing considerable confusion when wires were ordered to correspond to one instrument and manufactured from another, though both may have been identical when they were originally constructed. In consequence, these gauges have been and are at present used only for approximately determining the size that a wire is intended to be, but they cannot be constructed as instruments for determining the exact diameter of any wire. For ascertaining this quantity we now make use of measuring calipers which may be in the form of a sliding rule (Fig. 4, page 75), or more commonly in the form of a screw-vise (Fig. 5, page 75), the thread of the screw being accurately cut and the number of turns or fractions of a turn indicated upon the stem of the screw.

While the accurate determination of the size of any particular wire can only be made by some form of micrometer caliper, gauge numbers have a distinct advantage in enabling manufacturers to carry stocks of wires and allowing purchasers to choose for their use sizes of wire which may be obtained with reasonable promptness. The earliest gauge numbers were those adopted by different manufacturers, each wire-drawer having his own sizes, which were not respected by any other manufacturer, and even in many cases carefully avoided by his competitors, in order that each man's product might have its own individuality.

The first effort toward uniformity was made by the wire manufacturers around Birmingham, England, who adopted a set

of gauge numbers called the "Old English Wire-gauge," which was subsequently changed to the Birmingham Wire-gauge. This Birmingham wire-gauge formed the basis for most of the gauge numbers adopted by the American wire manufacturers with certain minor changes introduced by individual manufacturers, and up to the year 1857 this system continued with its consequent confusion and variations of size. During that year the Association of Brass Wire and Sheet Manufacturers requested the firm of Brown & Sharpe to make a number of "V" gauges numbered according to the Birmingham system, which they intended to adopt as their standard. In constructing this gauge it was at once seen by the Brown & Sharpe Company that there was a great lack of uniformity in the variations between the different sizes and numbers used in this system, and consequently Brown & Sharpe recommended to the association that they adopt a gauge the numbers of which would correspond to areas varying in geometrical progression. The advantage of such a system was at once seen by the brass manufacturers, and the gauge then proposed was adopted by them. Since that time the wisdom of the change has been proved throughout its continued use, especially for the users of electrical conductors, in which service the carrying capacity of the wire varying as the area is the most important point to be determined. A new gauge is now adopted as the standard in England and is called the English Legal Standard, or Imperial Wire-gauge. This gauge differs from the American, or B. & S. gauge, in not determining the gauge numbers from areas, but in merely being a correction of the Birmingham gauge in such a manner that the variation in the size of the various numbers proceeds uniformly. In the figure facing page 77 is shown the comparative sizes corresponding to the numbers of these three gauges.

Of recent attempts to change the system of numbering wire-gauges the most notable is that adopted some years ago by the Edison Company, in which the gauge numbers refer to the areas of the wires in circular mils, the different numbers representing even thousands of circular mils; the system embodying very considerable advantages with the sole disadvantage that its identification with one company has hindered its



general introduction. At the present time there seems to be no reason for desiring any change from the common system used in the determination of wire sizes, unless it would be possible to eliminate altogether the Birmingham wire-gauge from use and to introduce in this country both for iron and copper wires the more rational American gauge, which is the standard for users of electrical conductors, who are by far the largest purchasers of wire at the present time. This wire-gauge begins with No. 0000, having a size of 460 mils, and ends with No. 40, 3.14 mils in diameter.

Both the sizes and areas vary in geometrical progression. The ratio factor or multiplier for different sizes being obtained

from the equation  $R = \sqrt[n-1]{\frac{d_2}{d_1}}$ . Where  $R$  = ratio factor,  $d_1$  is

the diameter of a small wire,  $d_2$  is the diameter of a larger wire, and  $n$  = number of gauge sizes from  $d_1$  to  $d_2$  inclusive, from which we get the value of  $R$  by solving the equation for the two wires, No. 0000 and No. 40 to be

$$R = \sqrt[44-1]{\frac{460}{3.14}} = 1.123.$$

This number, 1.123, is the sixth root of 2, and in consequence the area of every number in this gauge is one-half the area of the third larger previous number. For example, we have the following table of relative number sizes and areas:

Gauge No.	Size in Mils.	Area in Circular Mils.
36	5 =	25
35	5 × 1.123 =	31.47
34	5.61 "	39.69
33	6.30 "	50.13
32	7.08 "	63.20
31	7.95 "	79.75
30	8.93 "	100.40

from which we see the geometrical progression of the areas to be as follows:

The area of 36 is  $\frac{1}{2}$  the area of 33  
 " 35 " 32  
 " 34 " 31  
 " 33 " 30, etc.

This property of the geometrical progression of the areas has been of exceeding great importance to electrical engineers, enabling them to subdivide wires for given areas without requiring sizes which do not correspond to the gauge numbers, and in this point lies one of the great elements of usefulness to be found in the American gauge.

Larger conductors than this No. 0000, as we have already said, cannot readily be manufactured or handled, and in consequence the sizes of conductors with a greater area are generally expressed by their areas in circular mils and are almost always built up of smaller wires twisted into the form of a strand. In order to determine the size of the wire for forming any strand of a particular number of wires, it is necessary only to divide the area of the strand by the number of wires, which will give the area of the constituent wires of the strand in circular mils, and the extraction of the square root will determine the diameter of the wires in mils; and conversely, the area of a strand in circular mils may be found by multiplying the square of the diameter of its constituent wires, expressed in mils, by the number of wires in the strand.

In order to determine the electrical and mechanical constants of wires drawn according to any one of the gauges we have described, reference must always be had to the terms in which the specific conductivity and specific weights of the materials are determined by various experimenters. The standard method being to express the specific conductivity in terms of the resistance between the opposite faces of a cubic centimeter, and the specific weight in terms of the specific gravity referred to water at 60° Fahr. as a standard. The resistance and weight of any wire being calculated from the contents of the wire considered as a cylinder.

In order to facilitate these calculations it is the custom of electrical engineers to employ as a unit of area the area of a circle one mil in diameter in place of the common unit, which is the area of a square one mil on a side; by this means the use of functions of the constant factor  $\pi$  is avoided in determining the relations between different wires of which the diameters are known. This unit of area we call the *circular mil*; it is not a simple mathematical convention, as has been often

stated, but is a true area unit by means of which circles may be directly compared, it being the area of a circle of unit diameter to which the areas of all other circles are related as the squares of their diameters and the circumscribing square in the ratio of  $\frac{4}{\pi}$  to one. Employing this unit we express the weight and resistance of any material in terms of its weight and resistance per mil-foot, which is the weight and resistance of a cylindrical wire one mil in diameter and one foot in length. This standard weight and resistance may be found from the specific gravity and specific resistance of a wire by means of the following equations :

$$\text{Weight per mil-foot} = \frac{\text{sp. gr.} \times 62.4}{144 \times 1,000,000} \times \frac{\pi}{4} =$$

$$.00000034034 \text{ sp. gr.,}$$

in which by the equation (sp. gr.  $\times$  62.4) is represented the weight in pounds of a cubic foot of the substance. Dividing this by 144 we obtain the weight of a square inch one foot long, which is multiplied by  $\frac{\pi}{4}$  in order to obtain the weight of a cylinder one foot long and one inch in diameter, and this is finally divided by one million, the number of mil diameter circles in one an inch in diameter.

In the same way we can obtain the resistance per mil-foot from the specific resistance, by first reducing the resistance between the face of a centimeter cube to the resistance of a square inch one foot long ; multiplying by  $\frac{4}{\pi}$  and dividing by one million, we obtain the resistance per mil-foot, which is represented by the following equation :

$$\text{Resistance per mil-foot in C. G. S. units} = \frac{\text{sp. r.} \times 30.48}{6.451} \times \frac{4}{\pi}$$

$$\frac{1,000,000}{1,000,000}$$

$$= \frac{\text{sp. r.} \times 30.48 \times 1,000,000}{6.451} \times \frac{4}{\pi} = 6,016,000 \text{ sp. r.}$$

From which equations, by proper substitution of the values for specific gravity and specific resistance, we may find the weight

per mil-foot or resistance per mil-foot of any given material ; and to determine the resistance and weight of any given wire, the weight per mil-foot would be multiplied by the product of the area in circular mils of the wire and its length in feet, since the weight of the wire increases as its volume ; while for the resistance of a wire we should multiply the resistance per mil-foot by the quotient obtained by dividing the length in feet by the area in circular mils, since the resistance of any wire is directly as its length and inversely as the area. If, as is generally the case, the resistance in ohms per mil-foot is desired, the coefficient of the specific resistance in the above equation must be multiplied by  $10^{-9}$  which gives

$$\text{Resistance per mil-foot in ohms} = .006016 \text{ sp. r.}$$

When wires are used in the form of a strand, the weight of the strand is found to be closely three per cent greater than the weight of the constituent wires, which would also indicate that the resistance of the strand would be less than the resistance of the solid wire equivalent to the strand in area ; but the change in resistance by twisting into a strand has never been accurately determined experimentally, and without any experimental determination it is impossible to predict whether any strand will have conductivity appreciably varying from the equivalent solid wire, for the reason that, while the weight of the strand is greater than the solid wire, the lengths of the constituent wires are also greater, and if the current is supposed to follow along the individual wires in the direction of their axes, the resistance would be increased in place of being diminished, and, by these two opposite possible suppositions, we are led to assume that the resistance of any strand will not greatly vary from the resistance of the equivalent solid wire.

## CHAPTER V.

### WIRE INSULATION.

IN all circumstances, except where wire is used on pole lines out of doors, it has been found necessary to cover it with some material for the purpose of insulation, the character of the insulation being determined by the use to which the wire is to be put. Insulating coverings for wires may be divided into three distinct classes :

First. Those in which the covering is simply intended to separate wires by a space. Leakage being prevented both by the properties of the covering and by the insulating properties of the air contained within the space.

Second. Those in which the covering contains two essential elements, the first a material having high enough specific resistance to be considered an insulator, but weak mechanically ; the second providing a mechanical support to keep the insulator in place and to enable the covering to resist pressure and abrasion.

Third. Those in which the covering is both high in specific resistance and is sufficiently strong to withstand mechanical abrasion or the action of the elements without auxiliary support.

Taking up these classes in order, we find that to the first class belongs a wire covering which is used for insulating in all magnetic apparatus and is commonly called *magnet wire*. This covering consists of a winding of cotton, silk or other fibrous thread, closely and uniformly applied to the wire in such a manner that the conductor will maintain its position relative to all other conductors without regard to mechanical strains applied to it. The characteristics essential to a satisfactory mag-

net wire are : that the covering of itself when dry should be of high insulating power, that it should be applied to the wire in such a uniform manner that it will allow the wire to be placed in a definite space, and that the covering should be sufficiently flexible to withstand a considerable amount of bending and abrasion. While other fibrous yarns might be used to obtain these qualities, it is found that finely spun silk and cotton are the only materials available. The silk used is spun in such a manner that while being free from ends the twist of the thread shall be so loose as to allow the covering machines to spread it in an even and thin layer over the surface of the wire ; the machine winding it upon the wire in a spiral of an exceedingly short pitch, amounting in general to not more than  $\frac{1}{100}$  of an inch per turn. Cotton is used in the form of spun-yarn, which is distinguished from thread by its comparatively loose twist and by the fibers being all twisted in the same direction, thread being composed of a number of yarns so twisted that it will maintain its cylindrical shape even when a considerable pressure is applied. The thickness of a single layer of silk, when wound as we have described, does not amount to more than 1 mil, while the smallest cotton yarn cannot be laid in a layer less than 2.25 mils in depth ; greater thickness being obtained in the case of silk by more than a single winding, laid on in such a direction that the yarn from the first covering crosses the yarn from the second covering on an opposite spiral.

With the cotton yarn we may increase the thickness of the insulation, as with silk, by increasing the number of layers ; but it has also been found practicable to use yarns of greater diameter, so that a single covering may be laid up to a thickness as great as 5 mils. Double winds are consequently used in cotton-insulated wire, for the purpose of obtaining insulation which will be perfectly continuous, and for strength rather than for obtaining a great amount of thickness which, as we have explained, could be produced by increasing the size of the yarn, though it is in general found to be inadvisable to use a yarn giving a greater thickness than 5 mils, on account of the fact that the thicker yarns are soft in character and do not make wire which will withstand mechanical strains. The manu-

facture of this class of insulated wire requires the greatest care and the most perfect machinery, for the reason that the finished product must be as nearly as possible uniform in size, completely covered, and the surface so hard that the wire when placed will not change its position. In order to obtain these qualities the wire must be drawn through the machine at a definite rate in relation to the speed of the spools containing

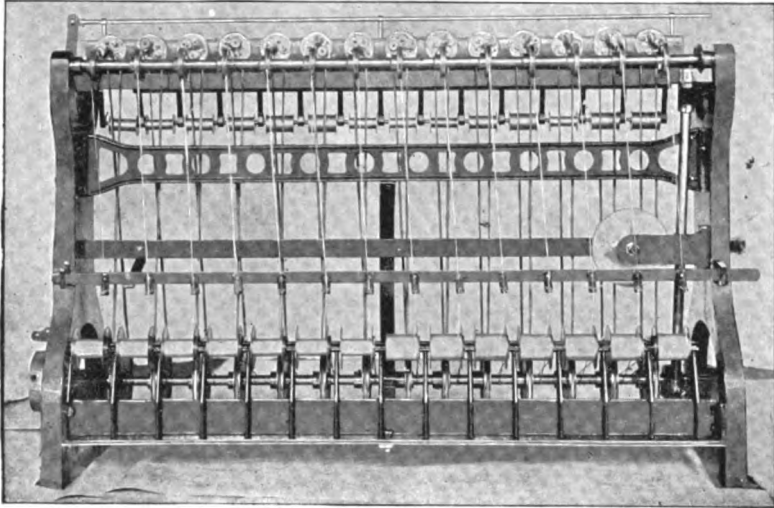

Fine Wire Insulating Machine.

the yarn. Where more than one covering is applied at the same time, the drawing-out mechanism and the different sets of winding-spools must all be so connected that there will not be any possibility of mechanical slip between the various parts. The yarn itself must be laid on under a considerable amount of tension which cannot be applied to a single strand of yarn, but only to many strands laid together, the tension being obtained partially by a spring retarding the spool from which the yarn is unwinding, and partially by the fact that the spools themselves revolve at a very high rate of speed as they wind the yarn onto the wire. All of these operations are performed so accurately in modern wire-winding machines that it is possible for manufacturers to guarantee absolute continuity of insula-

tion, and that the variations in the diameter of insulated wire will not exceed 1 mil from the standard size.

In use, magnet wire, when perfectly made, forms a satisfactory insulation for most purposes without the application of any additional insulating material; but where it is subject to considerable difference of potential between the different wires,

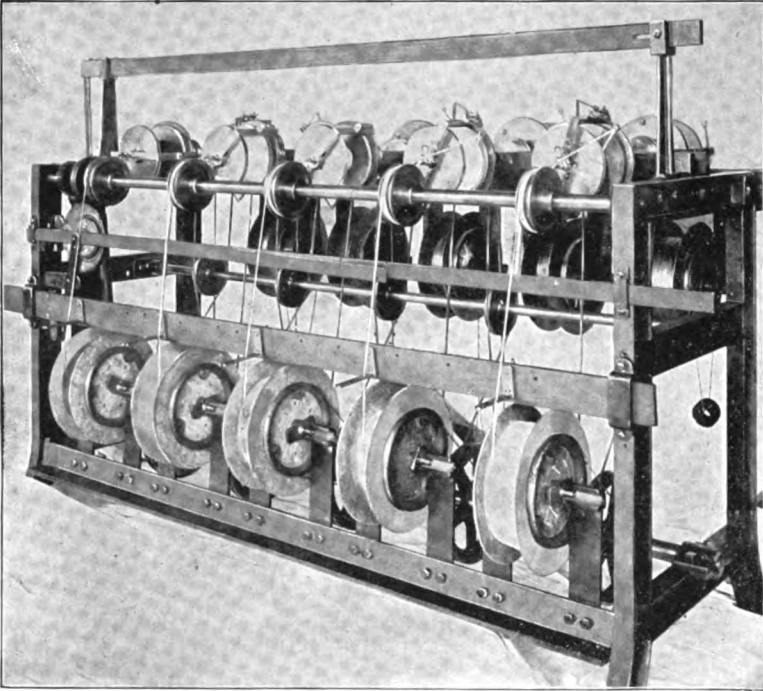

Heavy Wire Insulating Machine.

and where it has to stand severe mechanical strains, it is more generally the custom to saturate the insulation either with shellac applied in solution, asphaltum varnish, or to immerse the coil in an insulating oil. These additional precautions being mainly for preventing any absorption of moisture by the wire after it has been thoroughly dried than for increasing the insulating power of the dried cotton; the material used depending in value mainly upon its power of excluding moisture under all conditions.



As being most closely allied to the magnet wire, we will next describe those coverings which rely for their insulation upon materials high in specific insulating property, but so weak mechanically that they demand support. In this class are included all wires insulated with the various waxes or asphaltums which have been used from time to time. Mechanical support for the insulator is offered by a yarn applied to the wire either by winding in the manner we have described for magnet wires, or by a process of braiding similar to the covering of a whip, or as the ribbons are braided upon a pole in the familiar Maypole dance.

We should now carefully distinguish between the insulating properties of the yarn and that of the waxes, for which the yarn is designed solely as a support, the value of the covering depending upon the material with which the yarn has been saturated rather than upon any qualities inherent in the yarn itself. Consequently those insulations are the best which make use of insulating materials which have at the same time the greatest specific insulating qualities and are able most perfectly to saturate the yarn. Since these coverings are designed for use in positions exposed to air, and often to a considerable amount of moisture from rain and atmospheric humidity, a perfect wire can only be obtained when a material is used which will neither of itself absorb moisture nor allow moisture to be absorbed by the yarn which supports it. It has not been found possible to manufacture wire in this manner so that the insulation will not be destroyed by a continuous immersion in water; for the reason that no material has been discovered which saturates a fibrous yarn so perfectly that it will not absorb moisture in time, and, indeed, many of the waxes employed will themselves absorb and retain a very considerable amount of moisture after immersion, paraffin being particularly noticeable for this defect. In consequence, the common *annunciator* wire which is covered with a heavy cotton yarn saturated with paraffin wax is found to be most imperfectly insulated, and can only be used when installed in dry places, and even under such circumstances cannot be relied upon to maintain a high degree of insulation. The same defects belong to the cotton-braided wire saturated

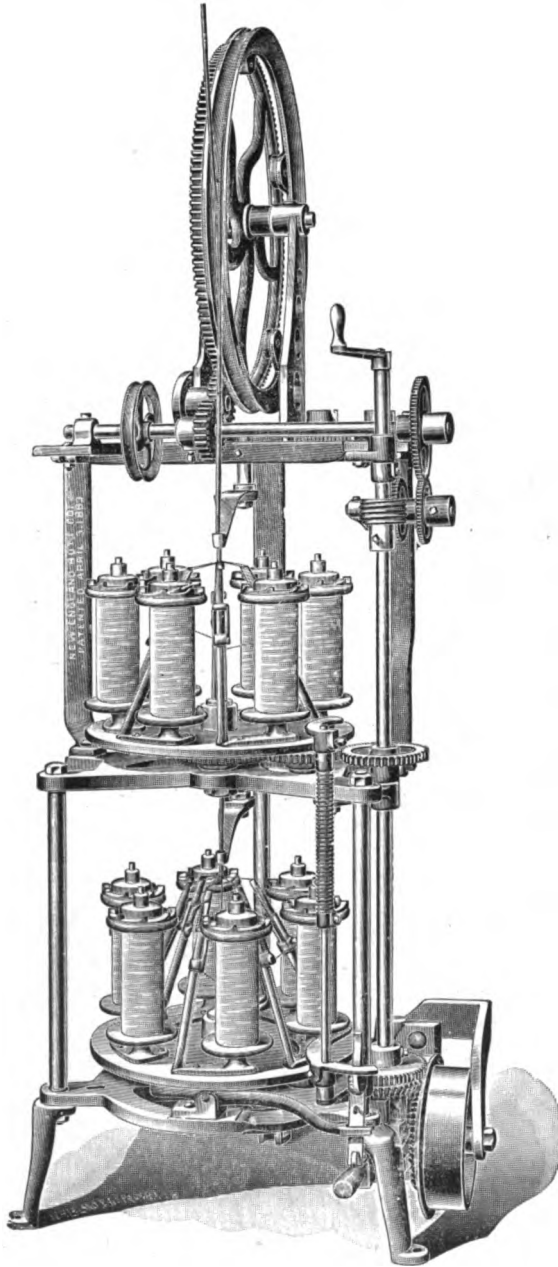

Annunciator Wire Winder.

with paraffin extensively used in telegraph practice and called *office wire*.

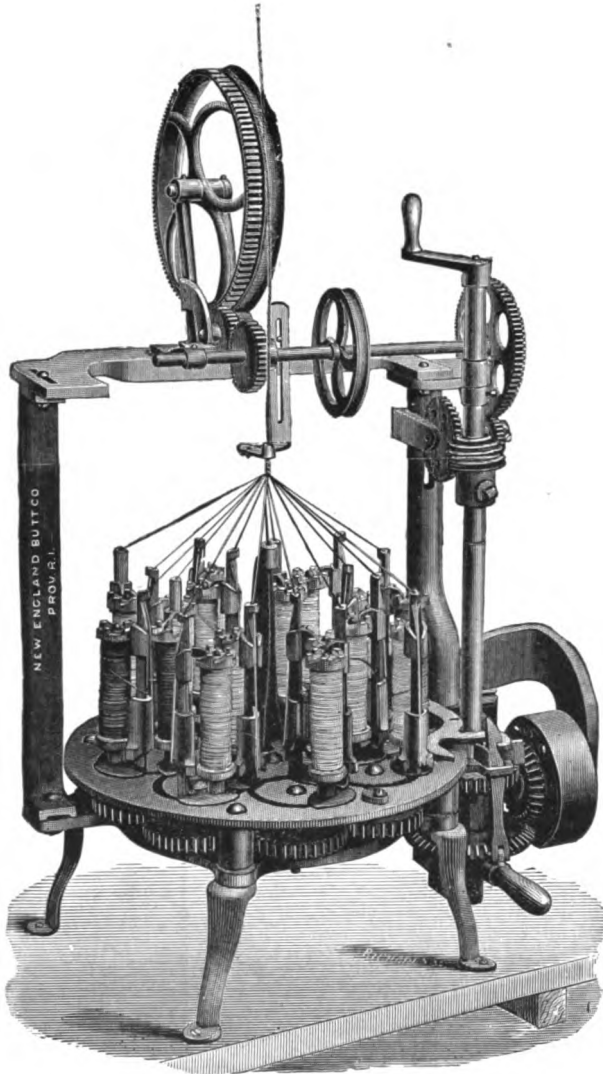

**Braiding Machine.**

For the purpose of line construction, where a moderate degree of insulating property only is necessary, wires covered

with a saturated braid have been extensively used, and their use has been successful where the wire was satisfactorily manufactured. The earliest of such wires is the common *underwriter's* wire, a covering composed of cotton braid saturated with white paint, the original idea being that the covering should not carry fire; and were it not for the fact that the covering used is incapable of withstanding the effects of the elements and that the materials employed can never completely saturate the yarn, this would form a satisfactory covering for the purpose of line insulation. The saturating power of asphaltum, especially when melted with some of the softer waxes, such as ozocerite, is found to be very much greater than paint, while the material itself does not absorb any considerable amount of water on continuous exposure, though it is still defective in its power of completely saturating the yarn which is used for its mechanical protection.

Wires which are covered with an asphaltum compound held in place by yarn are manufactured by passing the wire through a bath of the molten material, and immediately braiding upon the surface of the wire one or two independent braids; then after the wire has been again saturated in the molten wax it is passed through a machine provided with rapidly revolving steel plates, which rub the wax into the spaces between the yarns, and leave the surface brightly polished, thus furnishing a continuous outer surface of compound from which all projections have been removed that would increase the adherence of sleet and snow. A more perfect insulation is made by covering the conductor, as we have already described, by a single braiding laid over the asphaltum, and then passing the wire so covered again through the insulating pots, at the same time applying two cotton braids, which are finished by external saturation and polishing. In this manner a greater amount of wax is retained by the yarn, and the saturation made more perfect, with the result that the finished covering depends for its insulation upon the insulating wax rather than upon the braid covering; the amount of wax retained in the covering furnishing the criterion by which we should judge the quality of any such wire. A greater apparent saturation can be obtained by the application of the wax

when dissolved in a solvent than can be obtained by the processes we have already described by melting the compound with heat alone, but the subsequent evaporation of the solvent

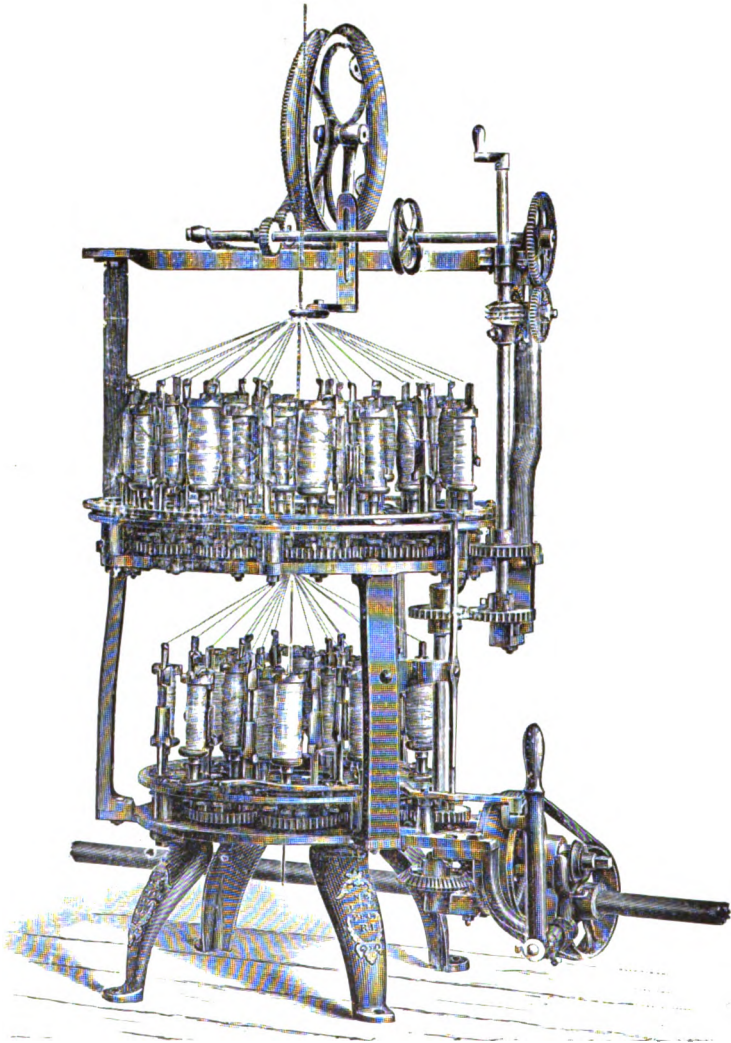

Double Braiding Machine.

leaves a wax of porous character which is in a condition to absorb moisture more readily than when the insulation has been applied without a solvent.

No one of these wires can be tested by the application of any of the ordinary insulation tests, nor is it possible to specify that the wire should have a certain insulation resistance when it is manufactured, since, as we have already described, the saturation of the yarn is never perfectly effected and on immersion in water the covering will immediately begin the absorption of water until the insulation is finally broken down. The test for quality being obtained by reference to the *rate of fall* of insulating power, rather than by the insulation resistance either immediately after immersion or at any particular subsequent period. We see, therefore, that the quality of any such wire depends upon the character of the wax, the manner in which it has been applied, and the relative amounts of insulating material and yarn; that conductor being considered insulated in the best manner which has the largest amount of insulating material and the smallest amount of yarn.

The question has often been discussed whether such wire should be purchased according to a price per foot, or according to a price per pound, as is the common practice throughout the country. Should such wire be sold by the foot, the wire of the lowest price would be that in which the smallest amount of matter of all kinds were used as insulation, while the lowest price per pound is obtained by the use of the minimum amount of cotton and the maximum of wax or insulation, which is equivalent to an increase in the insulating property of the wire, since the cost of the insulating materials is less than either copper or yarn. We must also consider in this question of the prices for such wire that it is impossible to apply these insulating materials in an absolutely uniform manner unless the total amount of insulating material is made small in relation to the amount of yarn, which also leads us to consider that the best product will be obtained by purchasing on a standard of weight rather than upon a standard of length.

In the classes of insulation referred to as being of sufficient mechanical strength to withstand pressure and abrasion without auxiliary support, reference is made to those insulations which give the most complete electrical protection. In these no auxiliary material must be introduced into the body of the insulator, and in consequence there are present in the body of

the insulation neither substances capable of becoming conductors by the absorption of water nor any discontinuity of covering; but on the contrary, with these materials we may protect a wire by a continuous coat of a material both high in specific insulating power and impervious to any conducting liquid. In this class are included insulations composed of all forms of gutta-percha, rubber and other gums that have been used for covering wire.

Of the many natural gums and resins that we have at command for such purposes it is found that only two are capable of giving entire satisfaction; the first of these being gutta-percha, a gum which is suitable for insulating wire without any preparation beyond that necessary for purifying it from all foreign matters.

The other gum referred to includes a great number of different natural gums, under the general name of rubber or caoutchouc, the different varieties being of decidedly unlike characteristics, but having between themselves certain common properties and being of similar constituents.

Of the many varieties of gutta-percha, which might be used, wire insulation is only at its best when performed with the gum obtained from the Isondra gutta-tree found in Sumatra and portions of the Island of Borneo and somewhat upon the Peninsula of Malacca, but principally marketed from Singapore. In certain parts of Venezuela a gum called Ballata is found, which seems to be closely allied to the true gutta-percha, but it is unfortunately obtained only in such small quantities that it has not been extensively used as an insulator.

The gum from the Isondra gutta-tree is obtained by the natives making incisions in the bark of the branches of the tree, through which the sap exudes, and, drying in the sun, forms a waxy coating on the leaves and smaller twigs. The gum is then scraped off and rolled by hand into balls four or five pounds in weight, containing consequently many impurities from the inclosed twigs and pieces of bark, as well as occasionally a greater or less quantity of sand and gravel added for the purpose of adulteration. In the preparation of the gum these impurities must be removed with the greatest care in order to apply to the wire a perfectly continuous coating. This purifi-

cation is performed by shredding the gutta-percha under a stream of warm water into fine pieces by passing it through two sets of cutting machines, which thoroughly separate the gum and enable the impurities to be removed by washing. After this has been satisfactorily performed the clean gum is masticated by a corrugated roll revolving within a confined space

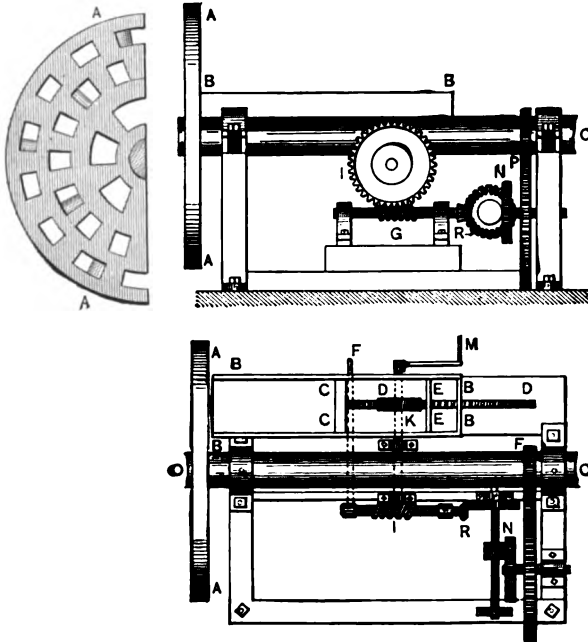

Gutta-percha Cutting Machine.

containing the gum immersed in warm water ; finally the clean and masticated gum is dried in a press consisting of a heated cylinder, through a sieve at the end of which the gum is pressed by a piston, and lastly it is consolidated in a dryer containing a pair of corrugated rolls by means of which the gum is pressed firmly together and the last particle of moisture is removed. In this state the gutta-percha is ready for direct application to the wire or to be run out into a sheet through a set of calender rolls, if it is necessary to use the gum in a uniform thin sheet. Wire-covering, however, is rarely performed with sheet gutta-percha, since such a covering would necessarily in-



94 CONDUCTORS FOR ELECTRICAL DISTRIBUTION.

volve a seam in the coating of insulation that might be imperfect and admit moisture through infinitesimal openings in it, but more generally the compressed gum is placed in a large

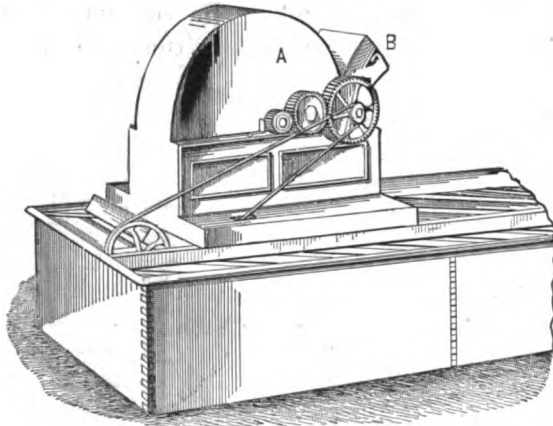

Shredding Machine.

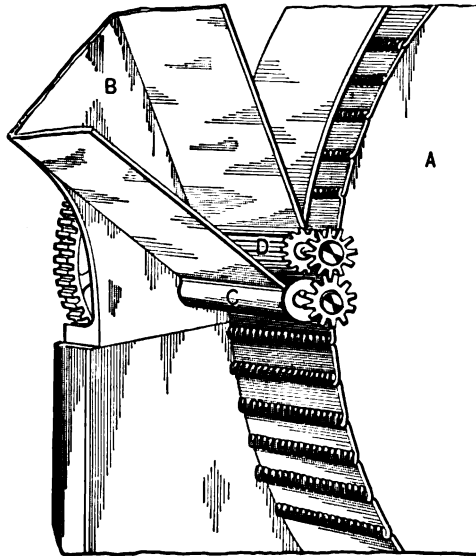

Detail of Shredding Machine.

cylinder jacketed with steam, out of which the gutta-percha is forced by either screw or hydraulic pressure and the wire covered with a continuous tube formed by a set of annular cores

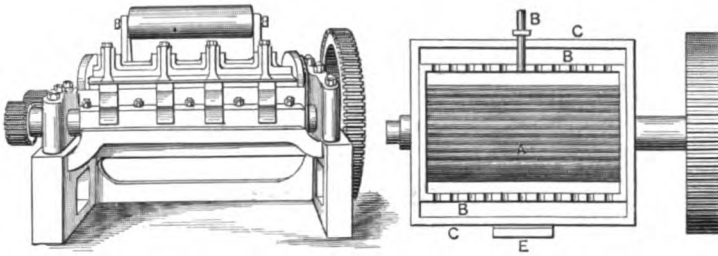

Washing Machine.

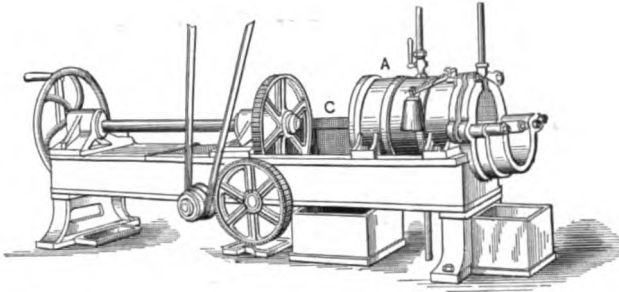

Cylinder Dryer.

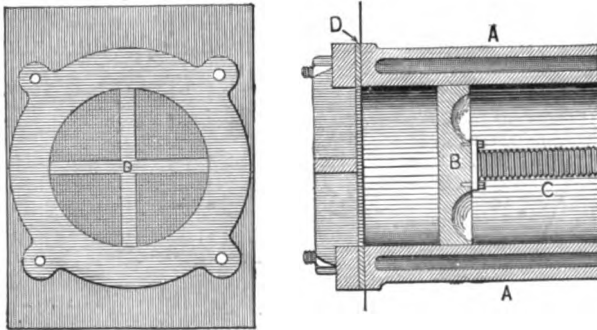

Detail of Cylinder Dryer.

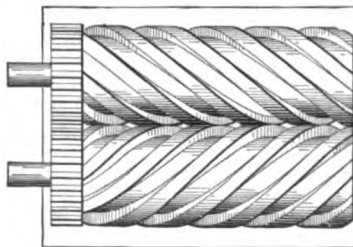

Dryer Rolls.

and dies, the core fitting snugly over the wire and the die determining the outside diameter of the gutta-percha coating.

Gutta-percha is principally employed in the construction of insulated core for submarine cables, the greatest care being taken to insure a perfectly continuous coating of insulator, and

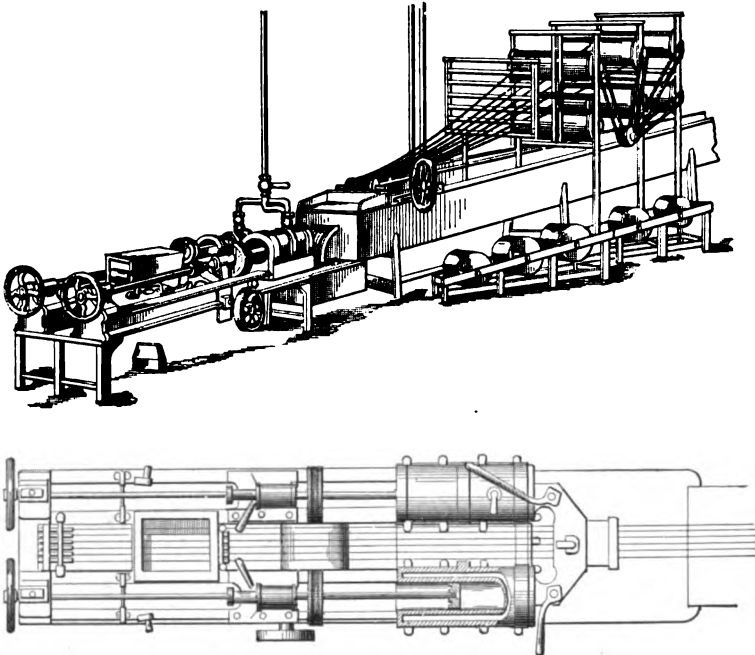

**Gutta-percha Covering Machine.**

a thoroughly solidified mass of copper and gutta-percha covering, which will not absorb water through its end, even should the cable be broken at the bottom of the sea where the water pressure amounts to as much as six or eight thousand pounds per square inch.

For cables, the conductor is composed of a strand of seven small wires in order to obtain great flexibility and a certain amount of longitudinal elasticity, so that when strained the conductor and its covering will elongate and contract in unison. This strand is passed through a heated tank containing Chatterton's compound, made of :

Gutta-percha . . . . .	3 parts
Rosin . . . . .	1 part
Stockholm tar . . . . .	1 part

which effectually fills up the spaces in the strand and cements the covering of gutta-percha to the wire. Over the strand so saturated three separate layers of pure gutta-percha are applied, as we have already described, these various layers being sometimes cemented together with a thin layer of Chatterton's compound. Until recently this was the only approved method of manufacture, but at the present time most of the makers consider that the rosin in the compound is subject to crystallization, and that a better core is produced when the separate layers are laid without filling, firm contact between them being insured by cleansing and heating just before a new coat is applied. When the whole is complete, the core is tested for insulation by immersion in water, and finally strained in pressure and vacuum tanks for the purpose of developing any mechanical imperfections that may have been previously formed in the covering.

A gutta-percha core so constructed is thoroughly insulated so long as the gum is protected from the oxidizing action of the air, as will be the case if it is immersed in water, but if left exposed to the air or sunlight it is found that the gum will oxidize to a brittle resin, and the valuable properties of high insulation and great flexibility will be lost. Before such a cable core can be immersed in the sea, it is necessary to provide sufficient mechanical protection and weight for it to withstand the rough handling incident to the laying of a long cable, and to insure its sinking promptly and lying quiet at the bottom of the sea. This protection is provided by coating the insulated core first with a bedding of tanned jute and finally by surrounding this juted core with a strand of galvanized iron wire, which must lastly be overwound with asphalted jute yarn in order to protect the galvanized iron wire from the action of the salts at the bed of the ocean, which occasionally have a serious corrosive action upon the armor.

While the extent of the territory through which gutta-percha is found is comparatively limited, and in that territory

the best gum is obtained only from the trees of a single species, india rubber is found in greater or less quantities through all climates, and is obtained from the juices of a very great number of entirely dissimilar plants; indeed, the commercial supply of india rubber does not even come from a single natural botanical order, nor does that of the highest quality come from a single species, it being often the habit to collect the juices of several species together and to use the gum obtained from the mixture.

The World's supply of india rubber is obtained from plants belonging to four entirely dissimilar natural botanical orders: Euphorbiaceæ, Moraceæ, Artocarpaceæ, Apocynaceæ. Some of these, as the *Havea Brasilensis*, from which the "Para" rubber of Brazil is collected, are trees rising to upward of sixty feet in height, while the rubber of Madagascar is obtained from a series of climbing shrubs or vines. In some countries rubber is obtained from a species of fig, and in our own country the common milkweed yields a very considerable amount of crude rubber which, however, has never been used commercially. As might be expected the rubbers from these different sources vary greatly in external character, though it is surprising to know that the chemical constitution of the many different rubbers is almost identical, while the great variation in the physical qualities is due to the fact that all rubber is composed of two constituent elements which occur in varying proportions in the different varieties. The first of these is a dry, fibrous, elastic material, not being readily soluble in benzole or its homologs; the other, a sticky semi-fluid substance readily and completely dissolved. The most useful are those which contain the largest amount of the dry fibrous substance, while in the inferior rubbers the proportion of the sticky gum preponderates. A further difference in the qualities of the various rubbers is due to the fact that the gum as it exudes from the tree or shrub is held in suspension by a considerable quantity of liquid ammonia from which it must be separated by coagulation, and the manner in which this separation is performed very often determines the quality of the rubber. All of the rubbers of commerce are collected in the forest by the natives of the territory where the trees grow, and as those plants

which yield a large amount of rubber are almost exclusively tropical, the manufacturing processes partake of the indolent nature of the natives who collect the juice. This is done by making incisions in the plant and coagulating by many different methods, in some cases by allowing it simply to dry upon the arms of the collectors, in others the juice is heated over a hot smudge, while others perform the coagulation in vats by means of a solution of alum or by the aid of some acid plant juice. On account of these different methods of collecting, we are in doubt whether the inferior grades might not be vastly improved by the application of more intelligent methods in collecting, and indeed, we are led to believe that this might be so from the fact that the rubber coming from Peru seems vastly inferior to that coming from Brazil, although the trees are of the same species; that coming from Brazil being coagulated by the means of hot smoke, while that coming from Peru is coagulated by the means of an acid plant juice. However collected, rubber contains a great amount of impurities in the form of stones, twigs and chemical solutions which must be removed before it can be applied in any manufacturing process.

Of the many rubbers on the market those bearing the name of "Para" are collected from three different species of Euphorbiaceous trees, and contain the largest amount of elastic material and are coagulated in the best manner, being cured, as we have already stated, by the hot vapor rising from a smudge made from oily nuts; the next in quality is called Ceara, obtained from another tree of the same order in the Province of Rio de Janeiro; following these in quality is the gum from the shrubs of Madagascar, coagulated by the means of an acid juice—the difference between the three grades being less striking than would otherwise be expected. From the Artocarpaceæ we obtain the Cartàgena and Guayaquil rubbers, coming respectively from New Granada and Ecuador, which varieties contain a larger amount of the inelastic sticky material and are consequently regarded as being of an inferior quality. From the Apocynaceous trees we obtain a rubber bearing the name of Pernambuco, a quality still more sticky in character and containing a very large amount of water on account of the fact that coagulation is performed by the means of a saline solution.

From Assam a good quality of rubber is obtained from the fig-tree called *Ficus Elastica*, a common plant of our greenhouses and the only one generally known to us as a Rubber plant. Besides those we have mentioned, rubbers are obtained in the West Indies, Mexico, and most of the Central and South American countries; inferior grades are also obtained over a large part of central Africa, and from Asia, Borneo, Malacca, Java and the surrounding countries, greatly varying in their qualities, though all except those we have mentioned are decidedly inferior to the Para rubber collected in Brazil.

On account of the wide range in quality of the gums available, the art of the rubber manufacturer consists in selecting those sorts which are best adapted to the service and from them producing a manufactured product which will be at the same time the most durable and the cheapest. Pure rubber is a gum which is perfectly odorless and nearly white, having a specific gravity of .915, though it is never obtained without color or odor on account of the means used for coagulating the juice, and although the odors can never be commercially removed from the rubber which has been so treated, it is possible to purify by washing so completely that the physical properties of the cleaned gum approach closely those of pure rubber. Certain acid coagulants, however, seem to have a permanent effect in deteriorating the quality of the gum, and in consequence these kinds are not well considered even when they are obtained free from dirt and are otherwise satisfactory. The different sorts of rubber are received in various forms given them by the natives who collect the juice, these forms being sometimes bottles, balls, loaves, sheets or irregular pieces, but in most cases containing a certain amount of mechanically mixed impurities. In order to remove these and grade into "fine and coarse," the rubber is first cut by hand under warm water, and after the larger pieces of foreign matter are removed the cut gum is masticated between a pair of corrugated rollers under a stream of warm water which removes the impurities, whether chemical or mechanical, and at the same time dissolves the resin which has been formed by a partial oxidization of the gum. While undergoing this process, gums, as received from the importers, lose from ten to twenty-five per cent of their

weight and at the same time take up a very considerable quantity of water in the pores of the washed gum. This water must be removed by drying, for which purpose the gum is finally run through masticators into the form of sheets, twelve to eighteen inches long and from six to ten inches wide, which are then hung in dark lofts where they dry for as long a period as is possible, remaining sometimes in the drying room for upward of a year after the rubber has been thoroughly cleaned. After rubber has been thoroughly masticated and dried it is readily

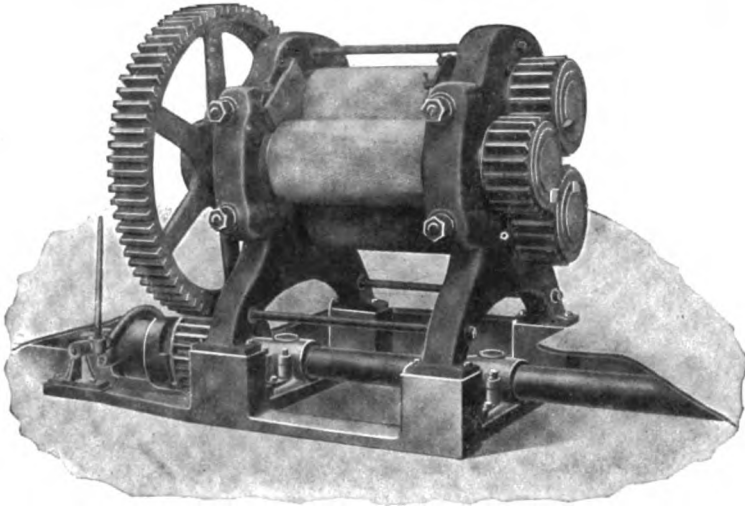

Rubber Washing Rolls.

consolidated into a mass by the application of pressure. Pure rubber sheet is obtained by cutting rubber which has been consolidated in this manner into large solid blocks, the cutting being performed by very rapidly moving knives acting under water.

Pure gum so derived is cellular in texture, absorbent and very adherent, all pieces freshly cut joining together so completely under the influence of their own weight that they cannot be again separated. In this state the dried gum will absorb from ten to twenty per cent of pure water, and from three to five per cent of sea water on continued immersion. Under the influence of light and heat pure rubber becomes oxidized, in



time, into an inelastic brittle resin not readily adherent, and in consequence it is not possible to use the pure gum for the purposes of insulation, or for other purposes where its absorbent qualities will interfere with its usefulness, or where it is exposed to sunlight or heat.

The earliest attempts at insulating wire were made with pure rubber strip obtained in this manner, the strips being spirally wound upon the wire, and afterward consolidated by a slight amount of heat into a solid mass ; but all of such attempts were failures on account of the readiness with which the rubber would absorb moisture, become oxidized, and be softened at an elevated temperature. A curious action between the rubber and the wire was also observed at the time of these attempts, the copper wire becoming slightly oxidized and the rubber rendered liquid at the surface of the conductor. It was subsequently found that this was due to the medium used for preventing adherence between the sheets of rubber, for which purpose use was made of soap and potash, substances which subsequently liberated oxygen and grease, one of which would attack the wire, and the other the rubber.

Gradually this method of insulation has been abandoned in favor of the use of vulcanized rubber, which has more recently given place to a vulcanized compound of rubber which is called in the American trade "mechanical rubber."

Vulcanization consists in adding to pure rubber a certain proportion of sulphur, and heating the combined product. When this has been done the rubber loses its adherent properties, is less readily absorbent, and is rendered indifferent to changes of temperature, retaining its elasticity from temperatures below the freezing point to temperatures considerably above the boiling point. This mixing with sulphur may be performed either by heating the gum packed in finely divided sulphur, by painting the surface with a solution of chloride of sulphur in bisulphide of carbon, or by mechanically mixing the two substances together between heated rollers. The first method of packing in sulphur will obviously produce a very irregular product, and in consequence has been altogether abandoned in favor of the other more certain methods. The second method described, that of painting the surface with a mixture of chloride of sul-

phur and bisulphide of carbon, is not capable of producing uniformly vulcanized rubber in any except the thinnest sheets, and in consequence the method is now rarely used except for the vulcanization of thinly rubber-coated cloth, such as used in the manufacture of gossamer waterproofs. In the mixing process rubber which has been masticated and dried is weighed out with the proper amount of sulphur and other ingredients, and then passed many times between a pair of smooth steam-

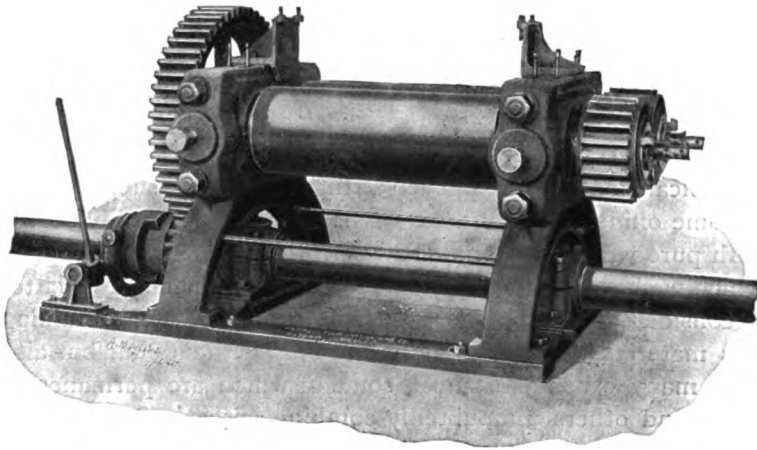

Grinding Rolls for Mixing Rubber.

heated rolls called grinders, where it is mixed until the material becomes thoroughly uniform in character, when it is ready for application to wire for insulating, to be molded or to be rolled into any desired shape, and finally to be vulcanized. The amount of sulphur used in this mixture varies from five to twenty per cent of the entire mass, though so small an amount as three per cent is occasionally used, the amount of sulphur determining the hardness of the vulcanized product, it being possible with a large admixture of sulphur to produce a hard inelastic material commonly called "hard rubber," "vulcanite," or "ebonite."

The final process of vulcanization consists of heating this mixture after it has been molded into its final shape in either a dry heat or a steam bath at a temperature of between 130° and

150° Cent. for a period of from half an hour to an hour and a half. During this heating the rubber at first expands greatly and tends to become very porous, but finally assumes a permanent character which is not affected by any moderate change of temperature, either of heat or cold. In consequence of this tendency to become porous, it has been found necessary in vulcanizing to support the rubber in position, and thus obtain a perfectly solid product.

While vulcanized rubber is thus stable in character, as we have stated, it is only so when the sulphur remains in a permanent state of combination with the rubber, but it is not always possible to assume that this will be the case, on account of the fact that there seems to be a tendency of the sulphur to evaporate and crystallize out of combination with the rubber, leaving the vulcanized product in such a state that it may subsequently become oxidized and brittle. This action more readily occurs with pure vulcanized gum than with the mechanical rubber of which we have already spoken, and in consequence the latter is considered to be a more durable product. For obtaining this material the gum is mixed not only with sulphur but also with many other substances, some of which are permanently inert, and others undoubtedly combine with the rubber and sulphur into a new compound. Of the inert substances used may be mentioned the finely ground minerals, such as talc, mica, chalk, etc. The possibly active materials in such mixtures are oxides of lead, zinc or other metals which probably combine with the sulphur to some extent, or may influence the rubber itself. Of those which undoubtedly combine with the rubber, and in some cases clearly improve its lasting qualities, may be mentioned many resins, some of which are pure natural resins, and others are resins obtained by the oxidization of drying oils similar to linseed or nut oil, and in some cases even mineral waxes are employed, though there is much dispute among rubber manufacturers as to whether these substances improve or deteriorate the quality of the rubber.

Many manufacturers make advantageous use of rubber substitutes which by others are considered adulterations and injurious to the quality of the manufactured product; these consisting principally of oxidized oils, paraffin, resins and

rubber shoddy; and though it is undoubtedly a fact that all such substances are capable of great abuse, it is nevertheless true that the skillful employment of these substitutes will produce a product of good quality and will sometimes even result in a superior article to that which can be produced with the ordinary qualities of pure gum. Purification of resins for this purpose consists in the entire elimination of all organic acids, and by their employment a rubber compound is produced more readily softened by heat than can be obtained with any pure gum. Their legitimate application consists of their use in the manufacture of rubber-coated cloth called "friction-cloth," and which forms the taping material for finishing the outside of large cables and rubber wires. The oxidized oils are produced by a continued heating of drying oils in the presence of some metallic oxide readily reducible, such as red lead, the product being a flexible resin of a gummy nature, often hard to distinguish from the inferior grades of rubber. Rubber shoddy is a compound obtained by subjecting old rubber which has been mixed with sulphur and vulcanized, to a treatment with steam, sulphuric acid and chloride of zinc, the effect being that most of the vegetable fibers and the sulphur contained in the compound are removed. When the rubber compound thus manufactured consists of clippings from articles to be vulcanized and treated before vulcanization, the shoddy obtained differs but little from pure rubber; the treatment amounting to nothing more than a chemical solution of the fibers of cloth or other foreign substances retained in the clippings. This class of shoddy is obtained in only very limited quantities, and it is perhaps unjust to class such a material with the more common rubber shoddy which is produced by the devulcanization of completed mechanical rubber goods, such as are purchased by the rubber-shoddy manufacturers from the rubber-junk dealers; this latter form of shoddy is more difficult to obtain entirely free from fibrous materials, while the devulcanizing process, although removing the greater part of the sulphur of vulcanization, does not return the rubber to its original condition, nor does it remove the mechanical admixtures of earth and oxides employed in manufacturing the original articles. In consequence, the proportion of rub-

ber in rubber shoddy is an uncertain quantity, so that its employment is attended with a considerable danger of producing an irregular product. In spite of this difficulty, however, it is undoubtedly true that certain grades of rubber shoddy may be so employed by skillful rubber mixers as to increase the mechanical strength of the resultant compound, and many rubber manufacturers using a compound containing an admixture of high-grade rubber shoddy obtain a covering which gives good service when exposed to the action of the elements, while others who never employ this material are unable to obtain a wire insulation which will withstand the oxidizing action of the air in sunlight to an equal extent, the reason for this apparently being that the previous vulcanization has rendered the rubber unchangeable under the ordinary influences which will deteriorate compounds of pure gum.

Among the earliest discoverers of this principle may be mentioned A. G. Day, the inventor of "Kerite" insulated wire and of hard rubber, who, after very many years of experimentation on the vulcanization of linseed oil, abandoned the material as well as pure vulcanized rubber for a vulcanized compound of oxidized linseed oil and rubber combined with various vegetable oils; thus producing a material which, while having a specific insulation resistance somewhat less than pure rubber, still obtained an insulation mechanically more durable than any previously manufactured from pure rubber. Following the method of Day, many manufacturers have employed these substitutes for the improvement of vulcanized rubber in wire covering, and have evaded the implication of dishonesty by applying to their products special trade names: Nigrite, Voltite, Bitite, etc., some of which materials contain oxidized oils, special varieties of rubber shoddy, petroleum residuum, ozocerite and special grades of bitumen, all mixed with rubber and subsequently vulcanized.

Pure rubber without the admixture of sulphur and vulcanization is rarely employed as an entire insulator for a wire, though one of the best of the rubber cores was formerly manufactured by covering the wire directly with a taping of pure rubber surrounded by a layer of rubber compound containing no sulphur, and finally protected from external influence by a

vulcanized sheath. This wire is generally known as Hooper's core, and was invented as early as 1860 by M. W. Hooper, of England, the construction aiming to remove the sulphur so far from the copper wire, by the interposition of two unvulcanized layers, that no action would take place between the material of the wire and the sulphur of the outer covering. This method of protecting the copper is exceedingly expensive and presents no distinct advantages over the more modern process of tinning the copper wire, a device which is found to effectually protect it against the action of the sulphur. Some manufacturers, however, continue to employ an inner coating of unvulcanized rubber compound, and, indeed, some such method seems necessary with very small wires, in which case ordinary tinning does not grant perfect immunity from the action of the sulphur. It is also argued in favor of this method of manufacture that the unvulcanized inner coating forms an additional insulation, reducing the possibility of mechanical defects in wires covered with a single coating, but this seems to be a doubtful claim on account of the fact that an unvulcanized rubber compound will absorb water quite readily even were it possible to assume that the compound itself did not retain water after the wire had been vulcanized in a steam bath. Considerable amounts of water have, in fact, been found by the author in such a coating where the coating by itself had been removed and carefully desiccated. A better method of protecting the wire against the action of sulphur and at the same time of obtaining a high value of insulation seems to consist in tinning the wire with chemically pure tin and then coating it with more than a single covering of rubber compound capable of being vulcanized, the mixing being so carried out that those toward the inside are prepared with a smaller amount of sulphur than the outside coatings destined to withstand mechanical strains.

Before vulcanization, rubber compounds are comparatively inelastic and very plastic, readily united by pressure across freshly cut surfaces. Taking advantage of these facts two general methods are employed in covering wires with rubber for the purpose of insulation. In the first method the rubber compound which has been thoroughly mixed by the grinding

rolls is passed through a series of calender rolls which deliver the product in a thin uniform sheet. These rubber sheets are

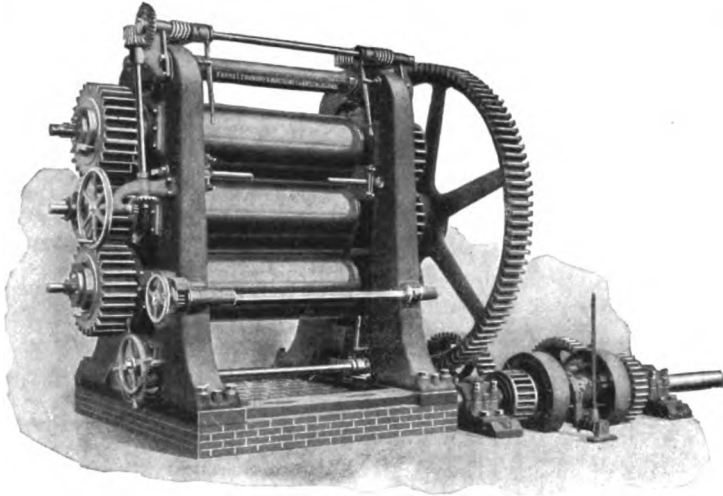

Calender Rolls.

then cut into strips of such a width as to easily surround the wires to be insulated and applied to the wire by a machine which guides the rubber strip around the wire and afterward consolidates it into a tube by pressure from a pair of grooved wheels furnished on one side with a cutting edge destined to remove any excess of rubber compound occasioned by an

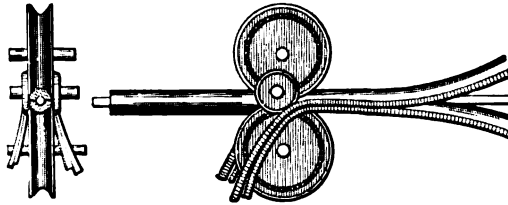

Rubber-covering Wheels.

extra width of the strip. Provided the surfaces joined together are clean, this method of covering produces a continuous insulating tube, and has the additional advantage that the rubber may be applied at the temperature of the workroom when it is sufficiently strong to maintain the wire accurately in the center of the insulation, an object difficult to attain when covering

the rubber compounds at a higher temperature. Wires manufactured in this way may be readily distinguished by the presence of a longitudinal seam, which remains in the finished product, where the wheels have joined together the strips and removed the superfluous rubber. The ease with which the wire is centered in this process attains particular importance in the covering of heavy copper wires. The defect of the process is that unless the surfaces of the rubber are absolutely clean minute leaks occur through an imperfect union, and in consequence many manufacturers prefer to employ a tubing machine for wire covering, particularly in small sizes.

This tubing machine, as manufactured in this country, consists of a hollow iron cylinder containing a long pitch screw revolving about the axis of the cylinder and inclosed entirely within it, the cylinder at the front of the screw terminating in a chamber containing a core and pierced with an opening where a die is held, the die having an internal diameter equal to the external diameter of the insulation, while the core is bored out to the size of wire employed and held so that it projects within the die in such a manner that when the rubber is forced between the core and the die a tube is formed closely surrounding the wire with an external diameter equal to the internal diameter of the hole in the die. In such a machine the rubber is fed at the back of the screw which carries it forward into the chamber containing the core and die until in due course it is forced out as a tube, carrying the wire with it held in the center. This machine, on account of its method of operation, applies a very considerable amount of pressure to the rubber compound as it is molded around the wire and makes a very compact and continuous coating. It is, however, impossible to force the rubber through a machine of this character unless the temperature is raised slightly above the temperature of the air, and where the wire is heavy and the completed product as delivered from the machine is not completely cooled before being reeled up, serious decentering of the wire within the core occasionally takes place, although, as we have said, this is not a difficulty to be feared with small wires, nor is it likely to occur when the rubber is applied in a series of thin coatings in place of a single thick layer.



**110 CONDUCTORS FOR ELECTRICAL DISTRIBUTION.**



**Cores, Guider-tube and Dies.**

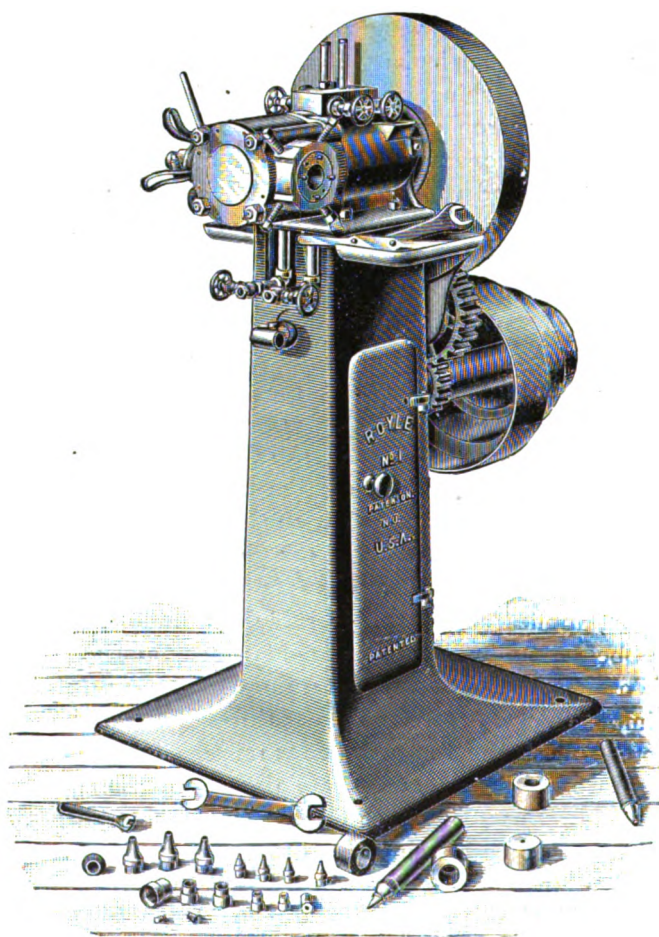

**Side-delivery Insulating Machine.**

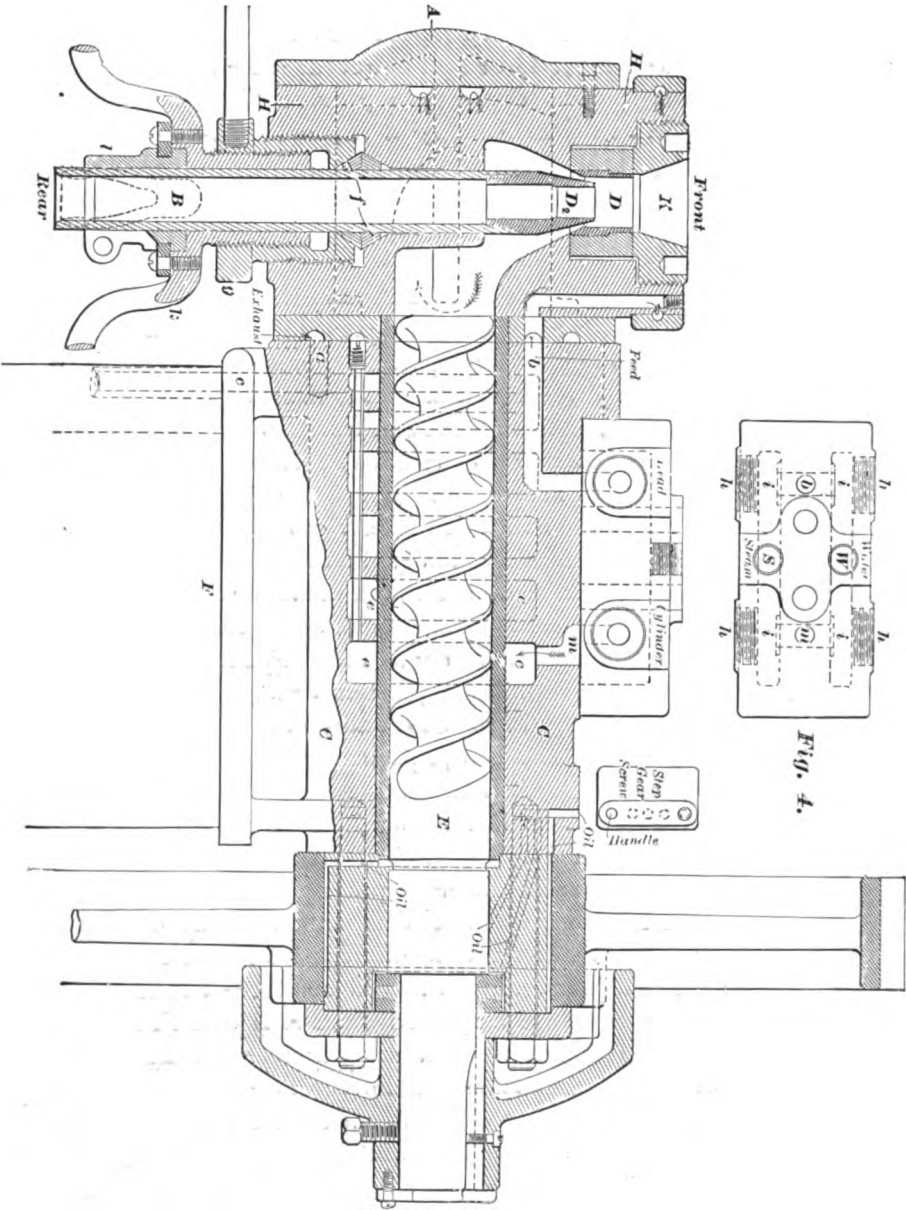

Plan of Side-Delivery Insulating Machine.

However, the rubber covering may be applied to the wire before final vulcanization it is necessary to give some external support to the rubber in order to prevent it from swelling up and becoming porous during the process of vulcanization. With small wires sufficient support is provided by coiling the wires helically within a pan and packing closely in powdered chalk or talc, but for larger sizes it has been found necessary to cover the wire with either a tape or braid closely applied. One manufacturer who applies rubber in strips by the means of wheels, as described above, surrounds the completed wire with a coating of tinfoil which is removed after vulcanization; applied in this manner a thoroughly compact vulcanized rubber is obtained, though there is a certain amount of danger in removing the tinfoil, of cutting the insulation and making defects which must be repaired when the wire is finally tested for insulation resistance before shipment.

The final operation to which rubber-covered wires are subjected, repeatedly referred to under the name of vulcanization, consists in effecting a combination between the rubber and the sulphur, with which it has been mixed, under the influence of heat, at temperatures between  $120^{\circ}$  and  $140^{\circ}$  Cent., continued for periods varying from three-quarters of an hour to five or six hours, the variation in the time and temperature being the means of rendering the complete material of any required hardness and elasticity within limits determined by the quantity of sulphur present. For ordinary wires the application of a temperature about  $130^{\circ}$  Cent., during a period of one hour, may be considered as the average practice; a lighter vulcanization can be used only when the completed rubber is designed to have properties but slightly different from those of pure gum, while the higher temperatures in connection with larger amounts of sulphur are employed when it is desired to produce an inelastic solid material such as is generally called ebonite or vulcanite. Some manufacturers prefer to use for vulcanizing chambers hot ovens warmed by steam coils, and for a long time it was thought that this was the only safe method to use in the manufacture of a wire coating to have a high insulation resistance, but more recent experiments have proved that the presence of dry steam is not only not injuri-

ous to the insulating properties of rubber compounds, but that it even tends to make the rubber coating more solid and more flexible. In consequence, most manufacturers now perform vulcanization in large iron tanks, closed with a removable cover into which dry steam is admitted, directly surrounding the rubber articles to be vulcanized. A proper union between the sulphur and the rubber will not take place if there is any considerable amount of moisture present in the steam, and especially if water of condensation remains within the vulcanizing tanks, and, in consequence, rubber wires are occasionally found which show imperfect vulcanization in certain parts of the coil, where the wire, during the heating process, has lain in water condensed within the vulcanizer and not properly drained away, a defect which is often difficult to discover, even on an immersion test, but which unfailingly renders the rubber liable to oxidation when exposed to the air or sunlight.

The combination between rubber and sulphur seems to be only partially of the nature of chemical composition, and, indeed, if vulcanized rubber is to be considered as a definite chemical compound, the combination is not only unstable but also difficult to form completely, and in consequence thin rubber, when examined under a microscope, will be found to separate into crystals of sulphur and particles of gum as it

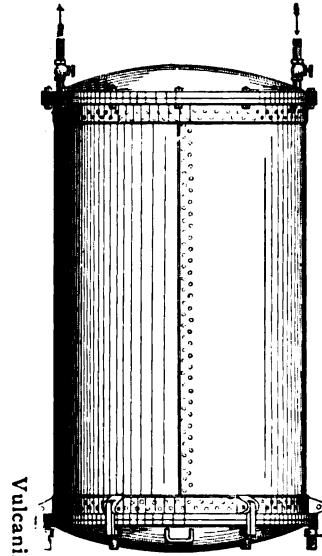

Vulcanizing Tank.

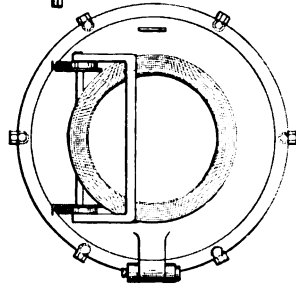
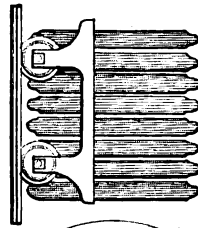

is subjected to atmospheric influences. Furthermore, subsequent high heating will always increase the vulcanization of elastic rubber and rubber compounds, rendering them inelastic and brittle.

These peculiarities vary at different times and with different compounds, so that the complete test of a rubber-coated wire includes not only measurements of the insulation resistance when immersed in water, but also mechanical tests as complete as is possible; and particularly a test to determine the action of the atmosphere on a strained and deformed portion of the rubber covering, such as may be obtained by winding a wire about its own diameter and leaving it for a considerable period of time in a position exposed to all possible atmospheric influences.

In order to protect such an insulated wire from the effects of frost and sunlight as far as would be possible, most manufacturers prefer to finish the outside with a braided or taped covering with a polished asphaltum surface, such as has been described in the manufacture of weather-proof wire, this surface being called by rubber manufacturers a "slicker."

The reasons for the non-uniformity in weight per foot and thickness, which render the sale of weather-proof wire by the pound advisable, do not exist in the case of wires insulated with rubber coatings, and in consequence they are sold by the foot, reference being made at the same time to the thickness of the insulation and to its specific insulation resistance. We should not confuse the value of the insulation resistance in megohms with the insulating power of a wire in service, since the loss of energy through the insulation is at all times an inappreciable amount of the total quantity of energy transmitted, and in consequence we must consider the mechanical properties and power to remain constant of much greater importance than the tested value of any particular insulation. It is for this reason that we have called attention to the fact that the purest rubbers are not always the best insulators, since it is found that the mechanical properties of rubber wires are improved by the presence of certain rubber substitutes, though it may be also true that these substances reduce the specific resistance of the insulating material.

The thickness of insulation necessary with rubber-coated wires to withstand different electric pressures has been much discussed by the various boards of trade and underwriters' associations of this and other countries, but no definite conclusions have been reached or rules laid down beyond the arbitrary instructions of the British Board of Trade, which state that all conductors carrying currents at less than two thousand volts shall be covered with an insulation at least one-tenth of an inch thick, and that the insulations for heavy voltages shall be measured in inches of thickness by the quotient expressed in dividing the voltage by twenty thousand. This rule is entirely an arbitrary one and imposes a considerable tax on distribution at low voltages, besides rendering the insulation of a small wire unnecessarily bulky. As a substitute it has been proposed that the insulation should not be less than one-half the diameter of the wire where the voltage does not exceed two thousand, proportionate increase being made for higher voltages, though this also takes no account of the actual factor of safety in any particular installation. We are beginning now to recognize the fact that the thickness of insulation for any wire may be obtained by breaking-down trials, allowing a satisfactory factor of safety in the case of each insulation thickness. Wire coated with a rubber coating three-sixteenths of an inch thick will not be pierced with a voltage smaller than about fifteen thousand, and we would accordingly consider that one-sixteenth of an inch of rubber will give a factor of safety of five for one thousand volts of strain, though without further experiment it is not possible to state distinctly that the protection offered by an insulation varies directly with its thickness. Indeed, other trials involving a piercing of dielectrics seem to indicate that their resisting power is proportioned more nearly to the square than to the first power of their thickness. Though in insulating wires used for transmitting alternating currents it is unsafe to assume that the resisting power varies more rapidly than the first power of the thickness on account of a general uncertainty concerning the relation of maximum value of the electromotive force to its average value on account of great variations in the forms of different electromotive force curves generated by commercial machines.

## CHAPTER VI.

### CABLES.

IN the pages which have preceded, in a series the general types of insulations which are regularly employed for protecting wires have been described, and while the method of manufacture is the same for each material in every form of use, special combinations in construction and in manufacturing methods have been introduced in order to adapt these general insulating plans to definite and particular requirements—the products of these various specialized processes being known by the title of the department of construction in which they are to be employed; as we may speak of overhead-line wires, underground cables, aerial cables and submarine cables without necessarily indicating wires different in construction. For use in overhead lines any one of the insulated wires which we have described may be employed without further modification, excepting only gutta-percha wire, which is much too readily influenced by the oxidizing action of air in sunlight to be employed for such purposes. The manufacture of the overhead-line conductor has therefore been already completely discussed; but for use underground and for submarine work these wires must all be protected in special ways in order to prevent injurious mechanical and chemical action upon the insulators.

For general use in this country in building underground lines, highly insulated cables have been employed, the insulating material being further protected by a covering of lead pipe. This system of cable construction was one of the very first attempted for the construction of telegraph lines; indeed, we find that in 1838, the year following the introduction of the telegraph into England, an English patent was issued to W. T. Cook, in which he describes his conductors “as laid

within solid lead pipes." In 1845 two further patents were issued: the first, to Wheatstone and Cook, in which the modern method of lead-incasing cables with a lead-pipe machine is described; the second, issued to W. Young and A. McNair, specifies the same system of lead-incasing and according to the same processes.

Lead cables were laid in the streets of London in 1844, identical in construction with those made at the present time.\* Indeed, the various early inventors described all possible processes of covering cables with lead: by drawing them into pipes, by forming the lead pipe around the cable, by taping the lead spirally or longitudinally and soldering the joints, by drawing down a large lead pipe tightly over the cable by the means of dies or rollers. We see, therefore, that the construction of a lead-inclosed cable was adopted from the earliest times and that this system has had an opportunity of an exceedingly long trial. The necessity for some sort of protection to insulated wires laid underground was noticed from the first on account of the very injurious action of the various acids and solids found in the soil, and particularly the injurious activity of acetic acid. The different acids and oils destructive to insulation are so varied in character and action that no effectual compound has been found which is capable of withstanding their influences. In consequence, wherever an underground cable is insulated with any non-conducting material the permanence of the insulator depends upon the existence of a hermetically metallic sealed sheath. Furthermore, on account of the fact that this sheath must be perfectly made and continuous for the whole length of the conductor, it is possible to employ in the insulating of underground conductors materials which, while high in insulating property, are readily saturated by moisture and which cannot be relied upon as insulators without the inclosing sheaths; and in this form of construction much use has been made of loosely wound yarns saturated with soft waxes, of paper and of cotton, both dry and impregnated.

Machines for forming this lead-incasing are exactly similar in principle to the core and die machines already described as

\* "Manual of Telephony," Preece & Stubbs, page 451.



used for covering wires with rubber, the difference in the construction of the machines being entirely due to the greater pressures necessary in forming lead pipe. Two distinct systems of machine construction are employed, depending upon the condition of the lead when it is forced through the dies and onto the cable. In the first system, used in France but not employed in this country, a pipe of molten lead is forced out, surrounding the cable and immediately cooled as it issues from the lead press. In using this method there is constant danger of scorching the insulation of the cable, also of making imperfect pipe, and, in consequence, where it is employed two coatings of lead are considered necessary, separated the one from the other by a layer of asphaltum or pitch compound.

In this country lead manufacturers use the lead either cold or at a temperature just below the melting-point. When manufactured in this manner the pipe will be perfect unless the lead should contain particles of foreign matter. Fortunately we can be sure of the perfection of lead pipe manufactured in this manner on account of a peculiar phenomenon exhibited by lead when passing from the molten to the solid state—a property due to its exceedingly great brittleness at the temperature of solidification. This phenomenon may be easily seen by any one who will take a quantity of molten lead in a wooden basin and agitate it by rocking the basin as it cools; it will then be noticed that at the temperature of solidification the mass of liquid lead which has moved around in the basin suddenly falls into minute fragments which cannot again be united without remelting. This is sometimes described as oxidation and the finely divided lead obtained called an oxide, but the ease with which this may be remelted into a solid mass disproves this supposition and shows that at the temperature of solidification the metal becomes so brittle that it will not withstand even a slight stress. If the lead is not agitated until after solidification has taken place, it is readily malleable, and, indeed, may be readily welded without further heat under the influence of a heavy pressure. These properties, as we have said, insure the perfection of forced lead pipe, since it is impossible to make a pipe at all at a temperature higher than that at which the lead becomes malleable when it is also readily

weldable at the pressures employed. No theory is given here, but rather the actual experience obtained from the practice of lead-pipe manufacturers who find their pipes to be perfect unless foreign matters become mixed with the molten lead in the machine cylinders.

The presses used in lead-incasing cables consist of a pair of heavy steel castings strongly bolted together one above the other, the lower casting being bored out to a diameter of from fifteen to twenty inches and lined with copper, thus forming the cylinder of a hydraulic press. The ram of this press carries on its head a steel chamber called a "core-box," containing a core and die of exactly the same nature as the core and die already described for the manufacture of rubber-covered wires. Above this chamber is bolted a lead-containing cylinder opening into the core-box. This cylinder is open at the top, the lead ram being bolted to the upper steel casting of the press, the lead rams and cylinders used varying in diameter from five to eight inches, depending on the size of the lead pipe to be formed. In operation the hydraulic ram is lowered as far as possible, carrying with it the core-box and lead cylinder, till a charge of lead can be run into the latter; the water-pressure is then applied and the lead cylinder raised until its ram is brought down on the top of the molten lead with a slight pressure, where it remains until the lead has become solidified, then the hydraulic pressure is increased to between six and eight thousand pounds per square inch, equivalent to a pressure on the lead of between fifty and sixty thousand pounds per square inch, when the solid lead flows between the core and die and passes out from the machine as a continuous pipe. As soon as the entire charge within the cylinder has been forced out, the lead cylinder and water ram are lowered as before, withdrawing the lead plunger and allowing a second charge of lead to be run into the lead cylinder, which unites with the portion of the first charge remaining within the core-box, and, as pressure is again applied, the pipe is delivered without the least break at the point of union between the two charges of lead. This operation may be repeated as many times as will be necessary to cover a particular length of cable, as it is found that cold lead unites into a solid mass under a pressure

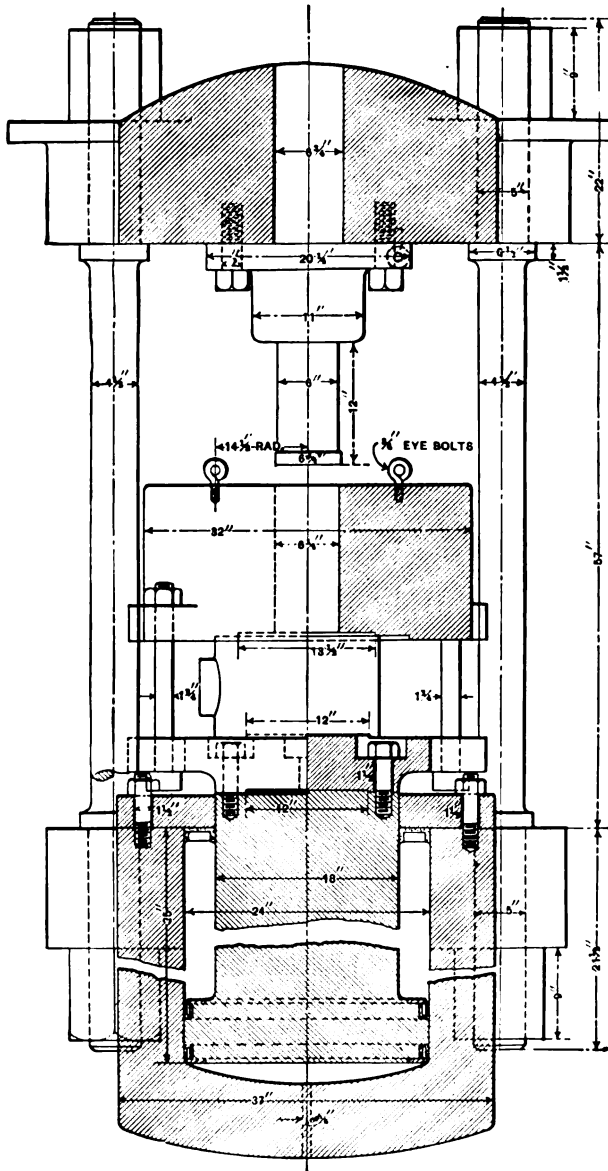

Lead-incasing Press.

Core-box with Core and Die.

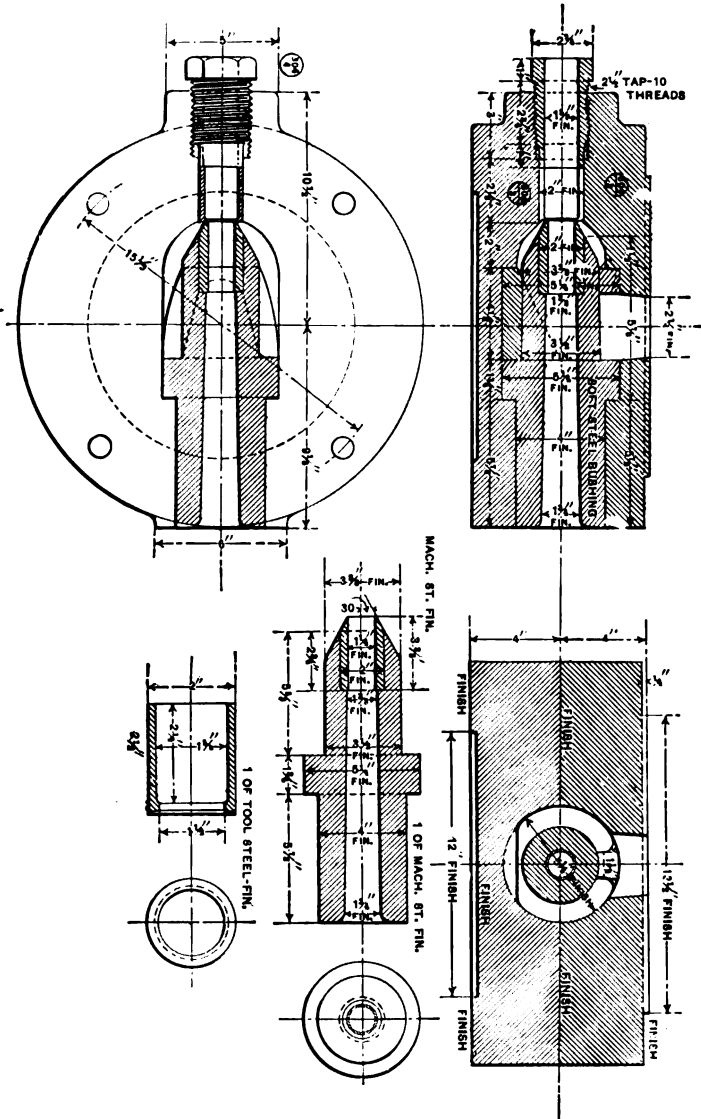

of thirteen tons per square inch and flows at a pressure of thirty-three tons per square inch.\*

From this it is seen that lead may be worked and will form a continuous pipe at any desired temperature below its melting-point, and that this operation does not necessarily injure any insulating material by reason of the high temperature required in the operation; nor is more than a single coating necessary for a perfectly solid pipe.

Gutta-percha wires are rarely lead-incased by this process, but such cables are made having india rubber as an insulation, and, as we have stated, fiber and paper are also used. While these fibrous coverings are similar in character to the weather-proof wires we have already described, certain essential modifications are made in them when they are employed for cables. In the first place, as no particular mechanical strength is required for the insulating material, yarns are rarely braided upon the wires, but they are more generally applied by the cheaper process of winding, larger diameters of yarn being also employed, the general practice being to apply at least one-sixteenth of an inch of insulation in a single winding. In order to obtain the high values of insulation required in cable working, these yarns are applied without compound and thoroughly dried in ovens before saturation is effected.

For the purpose of saturation, waxes rendered liquid by solvents are not used, but, on the contrary, materials softened by heat are invariably employed. Any wax or gum capable of being rendered so liquid by heat that it will saturate the yarn may be employed; but in this country use has only been made of paraffin, ozocerite, asphaltum, petroleum residuum, and rosin, though sometimes manufacturers prefer to soften these materials by an oil admixture rather than to use them alone; rosin with cotton-seed oil or rosin with rosin oil being the favorites. The values of these oils consist in their power of making the waxes viscous at all temperatures and allowing any cracks made in the cable under the lead covering to be naturally healed. Should such a crack be formed within the

\* See "Experiments," by Professor Spring, of Liège; "Mixed Metals," A. H. Hiorns, page 73.

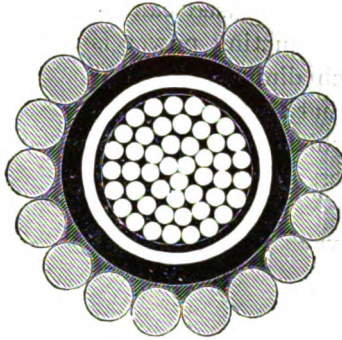

**Bishop-Hooper Type of Power Feeder Cable.**

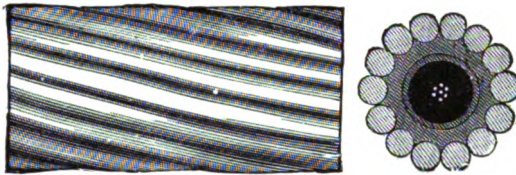

**Bishop Ocean Cable, without Wrapping of Jute.**



**Bishop Lead-encased Cable, with White Core, Rubber Insulation.**

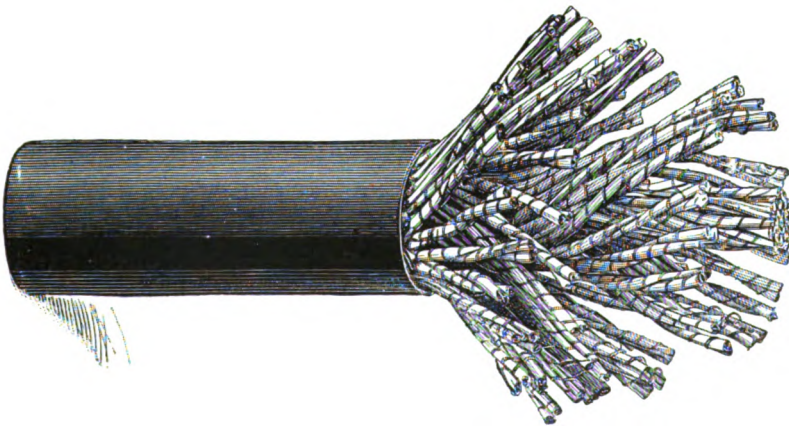

**Roebing's Paper-insulated Telephone Cable.**

insulation of any lead-incased cable a partial vacuum of comparatively high conducting power is obtained and the insulating power much diminished. This fact, perhaps, explains the curious fact that such insulation seems to possess a breaking-down point which cannot be greatly increased by an increase in thickness of insulation, the reason being that all fibrous materials will retain a certain amount of air unless saturated in a vacuum, and on cooling the air contracts, leaving vacuous spaces which by their number and the air pressure within them determines the insulating power of the covering materials.

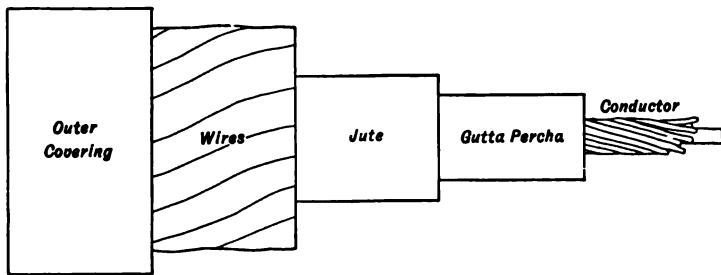

Commercial Cable Co.'s Submarine Telegraph Cable.

Both paper-covered cables and yarn-covered cables for special purposes have been employed under a lead sheath without auxiliary insulating material. Such construction is admirable for telephone purposes, since high insulation with low specific inductive capacity can thus be obtained, but where high potentials are to be withstood these dry materials have not been found to be as reliable as the same substances when saturated. It seems curious that dry paper or dry cotton, giving a much higher insulation resistance than the same materials saturated, should be more readily pierced by the application of a high electromotive force; but when we consider that such cables are generally lead-covered directly from the drying ovens we see that at normal temperatures the air pressure within them is low, approaching that of a Geissler tube, and also we know that the loose free fibers of the insulation may carry a charge from the wire to the lead, exactly as though they were a series of suspended pith balls. Taken to-

gether, these two facts will explain the fact and justify the exclusive use of saturated fibers for high potential cables.

Cables for suspension in the air have sometimes been protected externally by a wrapping of rubber laid either spirally or with a longitudinal seam, but in almost all cases lead-incased cables are now used for carrying electric light, telephone and telegraph currents, whether overhead or underground. We may tabulate such cables according to the following plan :

TYPICAL CABLE CONSTRUCTION.

Cables.	No. of Conductors.	Character of Conductor.	Size of Individual Wires.
Electric light less than 500 volts .....	Single.	Stranded.	No. 10 B. & S. or smaller.
Arc lighting .....	Single.	Solid.	No. 6 or 4 B. & S.
High tension power transmission .....	Single, concentric or duplex.	Stranded.	No. 10 B. & S. or smaller.
Telegraph, submarine	Multiple wires.	Stranded.	No. 19 B. & S.
Telegraph, short cables .....	Multiple wires.	Solid.	No. 14 B. & S.
Telephone .....	Multiple wires.	Solid wire.	No. 18 or 19 B. & S.

	Thickness of Insulation.				Thickness of Lead.
	Rubber.	Saturated Fiber.	Saturated Paper.	Dry Paper.	
Electric light less than 500 volts .....	inch. $\frac{3}{32}$	inch. $\frac{5}{32}$	inch. $\frac{5}{32}$	inch. $\frac{5}{32}$	inch. $\frac{1}{8}$ to $\frac{1}{10}$
Arc lighting .....	$\frac{5}{32}$ to $\frac{3}{16}$	$\frac{5}{32}$	$\frac{5}{32}$	$\frac{5}{32}$	$\frac{1}{10}$
High tension power transmission .....	$\frac{5}{32}$ to $\frac{3}{16}$	$\frac{5}{32}$	$\frac{5}{32}$	$\frac{5}{32}$	$\frac{1}{10}$
Telegraph .....	$\frac{5}{32}$	$\frac{5}{32}$	$\frac{5}{32}$	$\frac{5}{32}$	$\frac{3}{16}$
Telephone .....	$\frac{1}{8}$	$\frac{5}{32}$	$\frac{5}{32}$	$\frac{5}{32}$	$\frac{1}{10}$ to $\frac{1}{8}$

It is not to be understood that these dimensions are in any sense exact, as will be at once apparent to a practical engineer, but the principal difference between the various types of cables are here sufficiently well laid down to enable a comparison of the various systems of construction. In the case of paper-insulated electric light, telephone and telegraph cables we find the paper sometimes applied spirally without the use of any binder ; but where a low specific inductive capacity is sought



in telephone working the paper is laid upon the wire longitudinally and held in place by a spiral wrapping of cotton yarn, a system of construction which is found to give the proper distance between the wires with the use of a minimum amount of paper and a maximum amount of air in the insulation. Outside the lead of cables designed for use underground, some protecting material is generally applied either in the form of a braid or tape, thoroughly saturated with asphaltum. This protection is necessary on account of the fact that pure lead becomes easily corroded under the action of organic acids always present in the soil and always entering the cable ducts. Further resisting power is also given to the cable covering by an admixture in the lead of three per cent of tin, but as this material hardens the lead coming from the press it is often omitted by the workmen, even when they are instructed to introduce it, particularly where they are paid upon the amount of cable constructed. Argentiferous lead also resists the action of inorganic acids for a long time, but under present methods of refining, such lead is rarely found in the market.\*

For submarine use, lead cables have been sometimes employed across bays to a length of about two miles; but as the protection offered by the lead pipe is not sufficient to withstand serious mechanical injury, and as the weight of leaded cable is very great, their use is not extended beyond short distances, and only in such cases where a particular type of cable of low static capacity is employed which could not be efficiently protected in any other manner. The general type of submarine cable for bays and rivers consists of one or more rubber-covered stranded wires twisted together and then protected by an external bedding of tanned jute around which a number of heavy iron wires are spiralled to form a heavy, strong armor, the size and number of iron wires employed depending upon the diameter of the cable and the liability of disturbance from ships' anchors or keels. Tarred jute was formerly employed as a bedding for the iron wires, but it is now abandoned on account of its semi-insulating properties interfering with testing for fault location, while the tanning

\* "Corrosion of Lead Pipes," Oscar Kirby; *Machinery*, London, August 15, 1896.

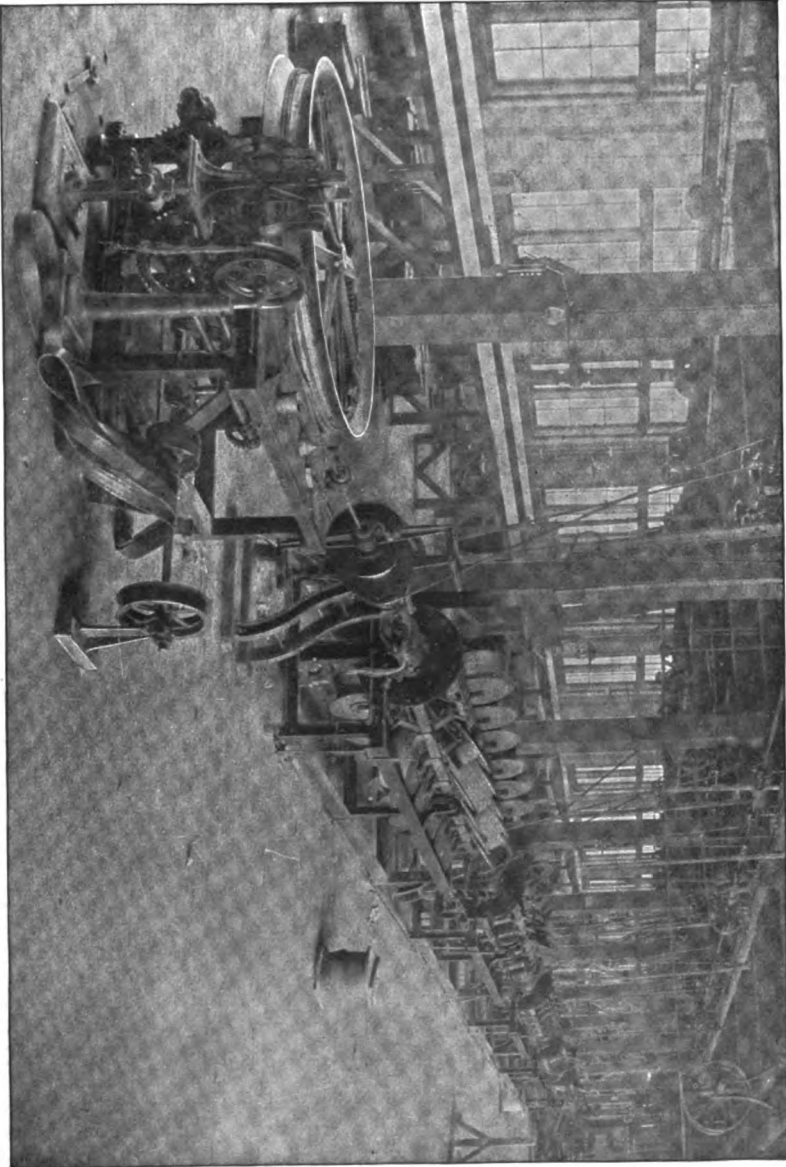

Cable Armoring Machine.

protects it just as effectually against decay. The common type of telegraph cable used in the United States contains from three to ten conductors, surrounded with a jute coating about a quarter of an inch in thickness, and armored with galvanized iron either 165 or 204 mils in diameter, but where there is great likelihood of interference from ships the iron wire is

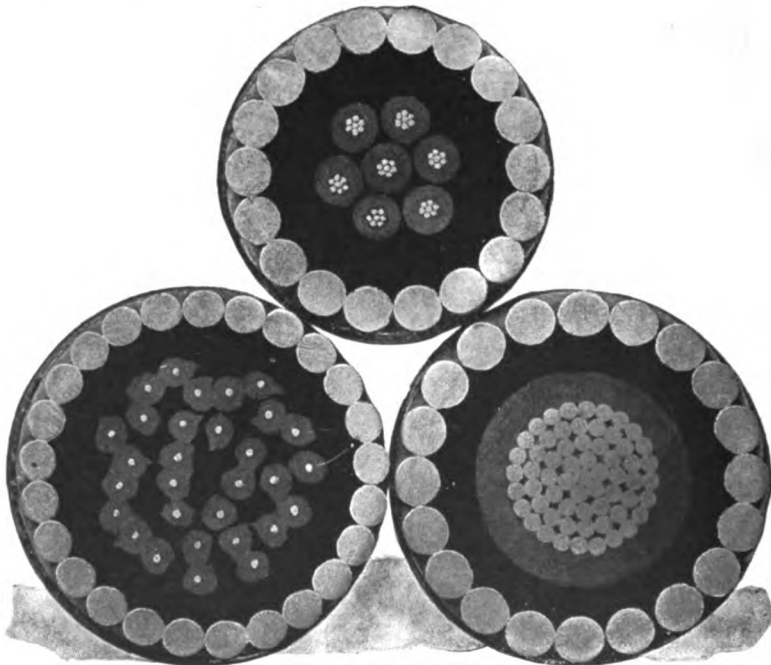

Cables for Bays and Rivers.  
Submarine Telegraph Cable,  
7-Conductor.

15 Pair (30 Conductors Twisted)  
Submarine Telephone Cable.

Submarine Feeder for  
Electric Railway Circuits.

increased in size up to a diameter of 300 mils. These cables are generally laid without further protection for the iron beyond a heavy coating of galvanization. For the longer cables used in ocean transmission rubber insulated wires have been employed of the type called Hooper's Core, already described, but it is more usual to insulate seven strands of wire, varying from No. 22 to No. 19 B. & S., with three or four layers of gutta-percha, making the external diameter about

from  $\frac{1}{4}$  to  $\frac{3}{8}$  inch. This core being used singly and protected by a wrapping of tanned jute around which iron wires are spiralled in three sizes, depending upon the ultimate destination of the cables, the deep sea portions having an armor varying from eleven galvanized iron wires, each 143 mils in diameter, to ten wires, each 143 mils in diameter; the shallow water portions are armored with twelve wires, each 238 mils in diameter, the shore ends consisting of the lighter deep sea portion further armored with twelve strands of three wires, each 230 mils in diameter. In every case the armor wire is protected by two wrappings of jute yarn, impregnated with a material called Clark's Compound, consisting of sixty parts of mineral pitch or asphaltum and forty parts of finely ground sand, this last covering being intended to protect the armor wires from the action of salts contained in the sea water and in the ocean bed where the cables lie, the deep sea cables being about from  $\frac{7}{8}$  to  $1\frac{1}{8}$  inches in diameter, the intermediate cables  $1\frac{1}{4}$  and the shore ends  $2\frac{1}{2}$  inches in diameter. These specifications are greatly varied by different manufacturers and by the different requirements of insulation and static capacity demanded, some of the most recent cables having much heavier conductors and gutta-percha and a lighter armor for the portions lying in the deepest portions of the sea.

Good practice in the installation of insulated conductors is shown below in a table, from which may be seen the proper use to be made of the different kinds of insulation under varying conditions, and the precautions to be taken in installation. In each case by reference to the second part of the table the numbers will give the proper care to be observed in installation; as,  $\frac{2-4}{3-1}$  means that the wire under the given conditions is not to be allowed where there are trees, but that it may be installed for any pressure on glass insulators where the spans are clear from possible crosses. Again,  $\frac{12-4}{13}$  and  $\frac{2-4}{13}$  shows that where the pressure is low the wire may be installed on glass insulators, or it may be used on glass insulators for high pressures where the spans are clear. 13-5 or 6 or 8 means that for high pressures—and consequently low—where the wire is in-

TABLE SHOWING CLASS OF CONDUCTORS TO BE USED IN VARIOUS POSITIONS.—PART 2.

DESCRIPTION OF CONDUCTOR.	POSITION.						
	Open air.	Dry rooms.	Damp rooms.	Concealed under floor or wall.	Rooms containing gases or vapor.	Under water.	UNDERGROUND. Buried. In conduit.
Bare wire .....	{ 2-4 } { 3-1 }	I	I	I	I	I	I
Underwriters' insulation .....	I	{ 2-5 or 6 } { 13-1 }	I	I	I	I	I
Double weatherproof .....	{ 12-4 } { 13 and 2-4 }	2-5 or 6 13-1	12-4 13-1	I	I	I	I
Triple weatherproof .....	13-4	13-5 or 6 or 8	{ 12-4 } { 13-1 }	12-8 13-1	12-4 13-1	I	I
Plain rubber .....	{ 13-4 } { 3-1 }	13-5	{ 12-5 } { 13-4 }	13-8	{ 12-5 } { 13-4 }	I	I
Taped or braided rubber .....	13-4	13-5	{ 12-5 } { 13-4 }	13-8	{ 12-5 } { 13-4 }	I	I
Taped or braided cored rubber .....	13-4	13-5 or 9	{ 12-5 } { 13-4 }	13-8	{ 12-5 } { 13-4 }	I	I
Gutta percha, armored .....	I	I	I	I	I	I	I
Rubber, leaded .....	10	9	I	8	I	I	I
Paper, leaded .....	10	9	I	8	I	I	I
Fiber, leaded .....	10	9	I	8	I	I	I
Any insulation, leaded and asphalted	10	9	6	8	6	I	10

stalled on porcelain knobs, in porcelain cleats or in insulating tubes the given type of insulation is allowable for the required service. A study of this tabulation will show at once the advantages of the different methods of manufacture and of the various types of insulators.

TABLE SHOWING CONDUCTORS TO BE USED UNDER VARIOUS CONDITIONS.—PART I.

Reference No.	REMARKS.	Reference No.	REMARKS.
1.	Not allowed.	8.	In insulating tubes.
2.	Clear spaces.	9.	In wood moldings.
3.	Through trees.	10.	Without further precaution.
4.	On glass insulators.	11.	If necessary.
5.	On porcelain knobs.	12.	Below 350 volts.
6.	In porcelain cleats.	13.	Above 350 volts.
7.	In wood cleats.		

## CHAPTER VII.

### CALCULATION OF CIRCUITS.

WE have already seen that in the transmission of energy over a conductor there is a certain amount equal to  $I^2 R t$  absorbed in the transmission on account of the resistance of the conductor, the total amount of this energy absorbed in the transmission and its relation to the total energy transmitted depending, therefore, on the specific resistance of the conductor material and the size of the conductor used. For the purpose of transmitting large amounts of electrical energy, use is made of heavy conductors of copper having a specific resistance at a temperature of  $75^\circ$  Fahr. expressed in terms of the resistance per mil foot, as

$$M = 10.5 \text{ ohms.}$$

The problem of selecting a conductor for carrying a definite amount of energy, is, therefore, solved by determining the size of wire to be used. This determination may be made with reference to the amount of energy absorbed in transmission, either as an absolute quantity or as a definite proportion of the total energy so transmitted. Again, the wire may be chosen with reference to the variations of potential in different parts of the circuit, since the fall of potential over a wire carrying a given current determines its size; as may be seen by transforming the equation of the energy absorbed in transmission,  $I^2 R t$ , into the equivalent expression  $E I t$ , where  $E$  represents the fall of potential in transmitting the current  $I$ . In applying either of these two methods of solution for the transmission of any amount of energy over a particular wire

we find two limiting conditions which must be considered in the calculation of wire for a circuit—the first being placed by the amount of current which the wire will carry without becoming heated beyond a certain arbitrarily assumed temperature; the second limit being placed by the electromotive force, which can be safely sustained by the insulation. We may consider that the E. M. F. and currents safely carried within these limits are determined from the piercing E. M. F., and the fusing current by the introduction of a definite factor of safety.

In any circuit transmitting energy, each wire forming a constituent part of the circuit must be considered separately, and in order to determine the size of each individual wire we require to know the electrical conditions in the circuit; these conditions are the total amount of power to be transmitted, the E. M. F. applied to the circuit at its origin, and the current to be carried. From these quantities as ascertained for the whole circuit we obtain the size of individual wires by determining the fall of potential, the current carried, and the length for each. The fall of potential over any particular wire gives also the amount of energy it absorbs, since when we know the current to be carried and the relation of the energy absorbed to the total amount of current energy transmitted, we have

$$W : W' :: E : E'$$

when  $I$  and  $t$  are constant, as must be necessarily the case in transmitting the given current for a definite length of time. Using then  $E'$  as the fall of potential over the line, the resistance of the line is given by

$$R = E'/I,$$

and since we know the resistance of the line is also equal to

$$\frac{lM}{d^2},$$

we have, by equating and solving for the diameter of the wire,

$$d = \sqrt{\frac{lIM}{E'}}$$



and the diameter of a copper wire for transmitting a definite amount of energy with the current  $I$  is thus determined by determining  $E'$ , which may be taken, as has been said, either as an absolute quantity or as a proportion of the total amount of energy transmitted. In every case, therefore, the energy transmitted  $W''$  is equal to the amount of energy delivered to the line  $W$ , less the amount of energy absorbed in transmission  $W'$ ; or,

$$W'' = W - W'.$$

We see, therefore, that  $W'$  is not necessarily a function of either  $W$  or  $W''$ , but may be assumed arbitrarily for any given transmission. Thus we may assume a small amount of energy absorbed in the line as in an electric lighting circuit, or we may absorb the principal proportion of the total energy in the transmission as is done by a rheostat or in the average telegraph line. By the equation we have given for the diameter of the wire

$$d = \sqrt{\frac{IIM}{E'}}$$

the actual diameter for a definite absorption of energy is furnished without reference to gauge numbers or stock sizes of wire, but when the determination of the nearest gauge number only is desired the calculation may be somewhat simplified by reference to a table, given in most of the trade catalogues, of resistance per thousand feet of wires corresponding to the gauge numbers—the resistance per thousand feet of any required line being obtained by dividing the E. M. F. by the current times the length in terms of thousand feet; or

$$R \text{ (per thousand feet)} = \frac{E'}{II}$$

and adopting the size of wire having a resistance per thousand feet nearest to the value so determined. Since the calculation is not one requiring great accuracy, we may readily perform the arithmetical operations involved by a graphical method of no difficulty.

Many writers have prepared special charts in which these calculations have been already performed, the determination

of the wire size involving the observance of certain rules furnished with the charts for following the lines. The earliest chart to be used in this way was published in 1887 by Mr. Edgar E. Stark, the chart consisting of a plate of cross-section paper on which parabolas with the equation :

$$d = \sqrt{\frac{2KITL}{E}}$$

radiating from an origin were ruled. Intersecting all these parabolas were a series of equidistant circles drawn from the origin, the ordinates of the cross-section paper then representing diameters of wire, the abscissæ representing currents in amperes, while the circles drawn would represent the fall of potential over the wires and their intersections with the parabolas would give the distance in feet.

In order to determine the size of the wire for carrying a given current with a particular fall of potential, a circle corresponding to the fall of potential should be followed until it intersects the ordinate from the required current; the parabola so obtained should be then followed until the distance in feet was found, when the size of wire was at once seen. This chart was unnecessarily complicated by a desire to represent wire diameters along an even scale.

In 1889, Lieutenant Badt, in his "Incandescent Wiring Handbook," presented a series of charts by the means of which the size of wire for a definite number of lamps could be found after multiplying the number of lamps by the distance in feet. This chart was afterward improved in 1891 by Carl Hering, who draws a series of lines radiating from an origin in three adjacent quadrants, by the means of which the current to be carried could be found by geometrically multiplying the current for each lamp by the number of lamps, the resistance being obtained by dividing the E. M. F. by this quantity in the second quadrant, and the size of wire by multiplying this resistance with the length in the third quadrant.

In the same year the author published a diagram for performing these last two operations all in a single quadrant and by reference to two sets of values of the ordinates and abscissæ.

The use of any such chart is, however, exceedingly limited on account of the fact that the calculation is apt to be confused by a great number of lines on the chart, while the graphical method involved in the construction of the chart can be more simply applied to the calculation itself than by reference to any chart.

Before attempting to explain the application of a graphical method to the calculation of wires it is necessary to understand the operation of graphical multiplication and division.

From coördinate geometry we know that in any rectangular system of coördinates the equation of any straight line through the origin is

$$y = mx,$$

$$\text{from which we get } \frac{y}{x} = m,$$

a statement that for any such straight line the ratio of  $y$  to  $x$  is a constant, and in consequence in order to graphically divide  $y$  by  $x$  we need only to determine the value of their constant ratio. This may be obtained by drawing, parallel to the axes of  $x$  and  $y$ , straight lines with the constant coördinates  $x = 1$  and  $y = 1$ ; the intersection of a straight line through the origin with these lines giving respectively the values of the ratios  $y/x$  and  $x/y$ .

Multiplication of  $x$  by  $m$  and  $y$  by  $m$  is now performed by drawing a straight line through the origin and a point on either of the two previous lines representing the value  $m$ , and obtaining on these lines the value of  $x$  or  $y$  corresponding to the given value of the other coördinate.

As, for example (Fig. 1): From the origin is drawn the two rectangular coördinates  $OX$  and  $OY$ ; through the point  $x = 1$  draw the line  $IA$  parallel to  $OY$ . Through the point  $y = 1$  draw  $IB$  parallel to  $OX$ . Assume any two quantities  $x'$  and  $y'$  to be divided one by the other. From the point on the plane whose coördinates are  $x'$  and  $y'$  draw through the origin the line  $OM$ . Its intersection with the line  $IA$  will give the value of  $y'/x'$  and its intersection with  $IB$  will give the value of  $x'/y'$ . This may be proved geometrically by projecting these points on the axes of  $X$  and  $Y$  respectively, and calling the points so

found  $y''$  and  $x''$ . We have, by similar triangles, the proportion:

$$\frac{y'}{x'} = \frac{y''}{1} \quad \text{and} \quad \frac{x'}{y'} = \frac{x''}{1}.$$

Similarly, to obtain the product of  $x'$  and  $m'$ : Obtain on  $1A$  the point representing the value  $m'$ , through this point and the

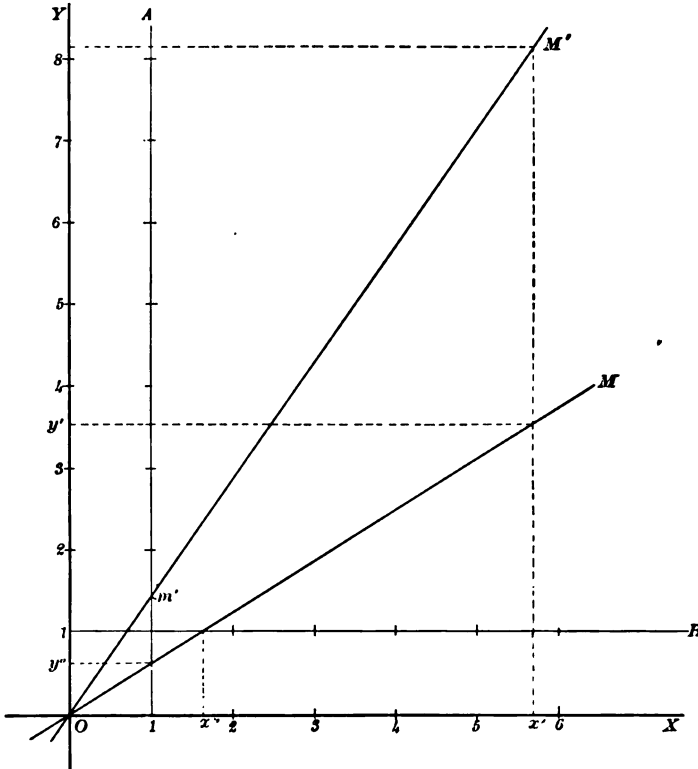

FIG. 1.

origin draw the line  $OM'$ , obtain the point on this line whose abscissa is equal to  $x'$ ; the ordinate will then represent the value of  $m'x'$ , as may easily be seen by an application of the same geometric law.

Applying this method to the calculation of an electric line we see from the equation  $E'/I = lM/d^2$  that the calculation of the line implies the determination of its resistance: first, in

terms of current and E. M. F., and secondly, in terms of the length and diameter of the wire used. Accordingly if we find this resistance by plotting the E. M. F. fall along the axis of  $Y$  and the current carried along the axis of  $x$ , and drawing a line through the origin and the point so determined, the diameter of the wire may be ascertained from this same line by obtaining the value of  $d^2$  along the axis of  $X$ , corresponding to any given value of  $l$  plotted along the axis of  $Y$ , since for any

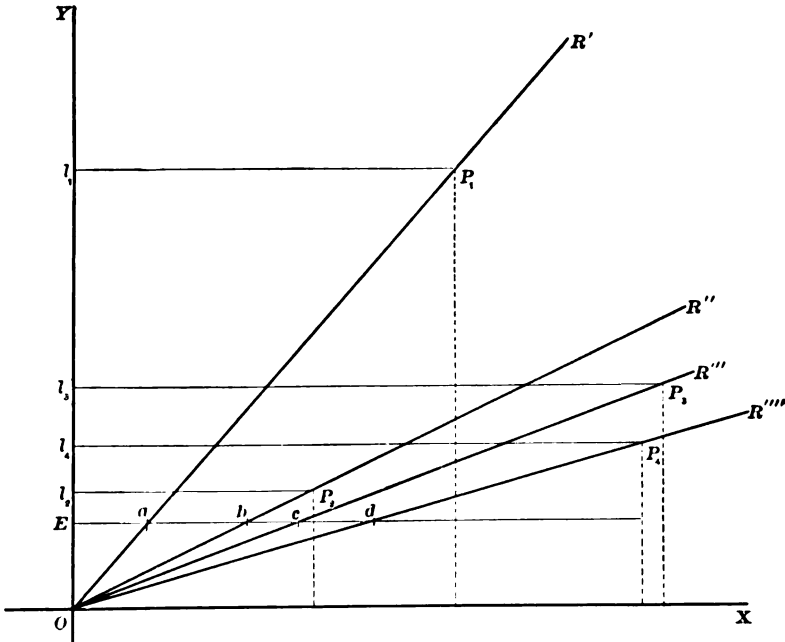

FIG. 2.

given straight line the ratio of  $y$  to  $x$  is always a constant. The method is principally of service in determining the sizes of a number of wires to be used in transmitting different currents over different distances, all with the same loss of E. M. F.

Let us assume that in the diagram shown (Fig. 2)  $OE$  represents the common E. M. F. fall;  $Ea, Eb, Ec, Ed$ , the currents to be carried over the distances  $Ol_1, Ol_2, Ol_3, Ol_4$ ; then drawing the lines  $OR', OR'', OR''', OR''''$ , we have the areas of the wires given by the lengths of the lines  $l_1P_1, l_2P_2, l_3P_3, l_4P_4, \dots$  as above.

A convenient scale can be found for any such problem by using a common engineer's scale of twentieths, giving 240 divisions in twelve inches, and assigning values to the divisions which will enable the diagram to be drawn for all of the circuits in question on a convenient sheet of paper. The scale most convenient in any case may generally be determined by confining the currents carried and the lengths of circuits used to twelve inches, and assigning a value of 1,000 circular mils for each division of the scale, and calculating the value of a division in terms of E. M. F. by the equation :

$$\frac{I' l' M}{d'^n} = E,$$

where  $I'$ ,  $l'$ ,  $M$  and  $d'^n$  represent the values per division of the scale assumed for current, length and area, and  $M$  represents the resistance per mil foot of the conductor, which we have already taken for 75° Fahr., at 10.5. As, for example, in circuits carrying not over 250 amperes, in length not over 500 feet, we might allow one division to equal 1,000 circular mils, one division equal two feet, one division equal one ampere. Then by the equation we have one division equals .021 volts. Four, or at most six, of these sets of values of scale divisions will in practice cover all of the ordinary cases, and will allow the employment of the method of calculation on a common sheet of drawing-paper in such a manner that the calculations of any set of circuits may be preserved for reference and verification.

These calculations lend themselves easily to computation by means of specially constructed slide rules. On account of the fact that the calculations consist in the determination of a fourth member in the proportion  $\frac{E'}{I} = \frac{LM}{d'^n}$ , which by expansion becomes  $E'd^n = ILM$ , and therefore if a slide rule be constructed to multiply these two pairs of quantities simultaneously all wiring calculations may easily be performed with its aid. The first slide rule designed for this work was published by William Cox in 1892, in the form of a large circular



slide-rule construction. This form of rule is useful not only on account of the fact that wiring calculations may be readily performed with its aid, but also on account of the fact that it has been graduated in such a manner as to admit the calculation of many other electrical problems.

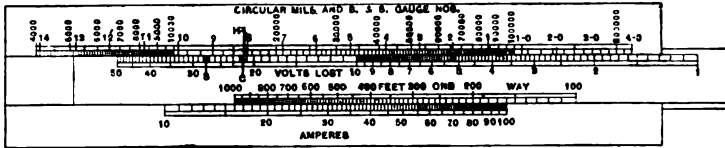

Smith & Manifold Slide Rule.

As has already been said, we must first determine the current, E. M. F., and power to be transmitted over any circuit before attempting to calculate the sizes or locate the wires. These quantities depend upon the system of distribution used, whether the power is transmitted to translating devices arranged in "series," in "multiple arc," in "multiple series," or in "series multiple." These names have been adopted as

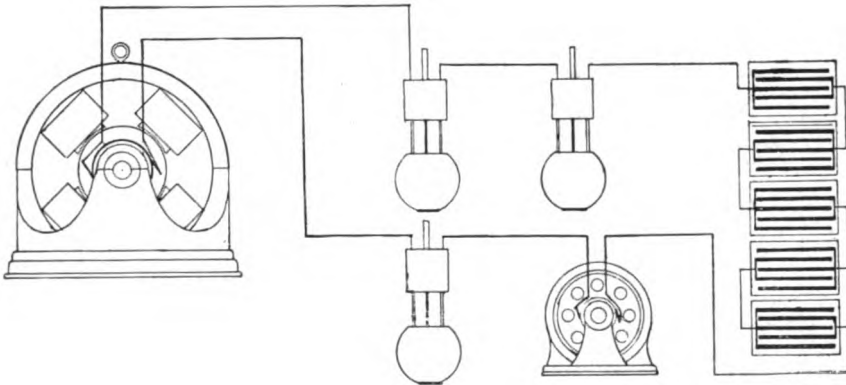

Series Connection.

means of indicating both the manner of connecting the translating devices to the wires, and also in arranging the wires upon the circuits.

In the "series" system but one wire is employed, the translating devices being connected one after the other in



such a manner that the same current is carried by the wire and by each translating device. Referring to the current this is also called the "constant-current" system, for the reason that the value of the current transmitted is the same in every part of the circuit, the E. M. F., and consequently the power, depending upon the number and character of the translating devices used. The current thus being equal to the current required by one translating device, the total E. M. F. is equal to the sum of the E. M. F.'s demanded by each translating device and by the resistance of the line.

In the "multiple-arc" system the translating devices are supplied at a constant potential with a varying value of the current, all of the translating devices being connected to the opposite sides of the circuit in such a manner that the full potential difference is applied to each translating device, from which fact it also receives the name of "constant-potential" distribution. The E. M. F. being now equal to that required by any one translating device, the current transmitted is equal to the sum of the currents required by the

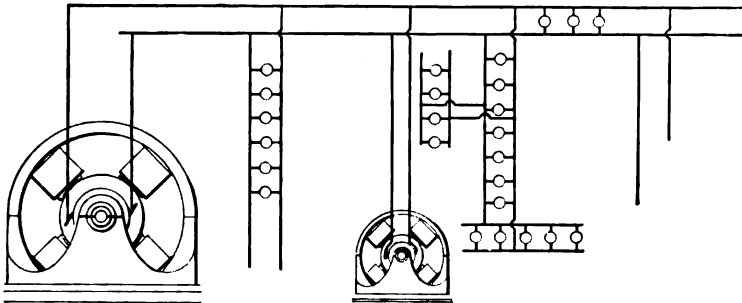

Multiple Arc Connection.

various translating devices. The actual value of the potential used in these different systems does not, therefore, determine the method of distribution, but only the manner of connecting the translating devices.

The "series-multiple" system is a modification of the series distribution, allowing the connection to the mains at any one point of more than a single device, the collection of devices at any such point being so arranged that the sum of the currents they consume is equal to the current delivered

over the circuit, from which it is also seen that the E. M. F. required by each translating device of any set must necessarily be the same, since the potential difference between their common terminals is necessarily a constant for the set, though it is at the same time possible to connect such sets in series with other sets, or with single translating devices requiring different E. M. F.'s, but consuming the same value of the current.

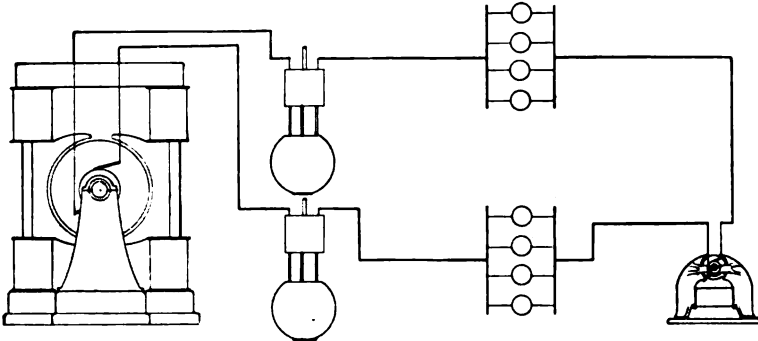

Series Multiple Connection.

The current, as before in a series system, is the current required by any single translating device, or any one multiple of translating devices, the E. M. F. being equal to the sum of the various E. M. F.'s demanded by the different translating devices and multiples along the line.

In the "multiple-series" distribution it is possible to connect across the opposite sides of the circuit translating devices in series so adjusted that the total E. M. F. required by each series will be the same. The current required by the different translating devices in any one series must be equal, though there is no necessity for equality of current between the different series. When so arranged, single translating devices, capable of consuming the full value of the E. M. F., may be connected across the circuit in parallel with a series of translating devices, and the E. M. F. carried on the circuit is the E. M. F. required by any single translating device or any one series, the value of the current being given by adding together the currents demanded by the different series and translating devices.

Each of these four systems of distribution presents its own method of regulation and special advantages. The four taken

together represent all possible distinct types of distribution. In the two series systems, the plain series and the series mul-

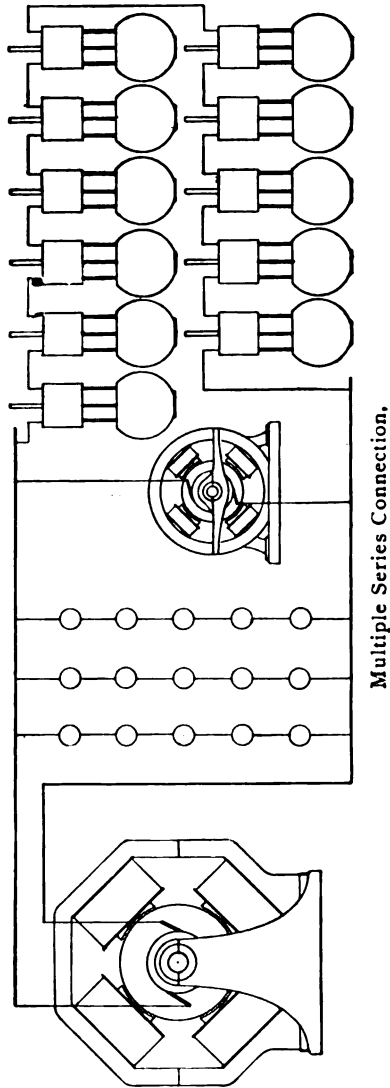

tiple, regulation is effected by maintaining the current at a constant value ; variations of power being produced by chang-

ing the E. M. F. of the generator to suit the demands made upon the circuit by the varying operation of the translating devices. Such regulation can be effected entirely at the generating plant, since the current at every part of the circuit is absolutely the same.

In multiple arc and multiple series distribution the current is variable with the demands for power; regulation being effected by maintaining the E. M. F. at a constant value. Thus regulation depends not only upon the E. M. F. generated, but also upon the currents carried in the wires of the main circuit, since, as we have already seen, the resistance of every wire causes a fall in the potential proportional to the current carried which obviously varies with variations in the power required by the translating devices, and in consequence the resistance of the wires is a factor in regulating the constancy of the potential at all parts of the circuit.

Multiple wire distributions are special adaptations of the multiple series systems designed to render the translating devices in series with each other more independent. This is easily explained by considering the means adopted for stopping the delivery of energy to any one translating device on a particular circuit. As the current must be maintained constant in series or series multiple distribution, the delivery of power to any translating or multiple of translating devices can only be stopped by removing the translating devices from the circuit, and at the same time replacing them by a wire enabling the current to flow across the gap they leave; but if this is done with one translating device in a multiple of a series multiple system, the current in the other devices of the multiple can only remain at its constant value when the translating device taken out is replaced by a wire of equal resistance, and in consequence the total amount of energy delivered to the circuit remains unchanged, although the whole multiple may be taken out and replaced by a wire of inappreciable resistance requiring an inappreciable amount of power.

In a multiple arc system the delivery of power to any translating device is stopped by removing the translating device from the circuit, and in a multiple series system the whole series may be removed in the same manner; but if one

translating device is to be removed from a series in any multiple series system it is necessary to replace it by a wire of equal resistance in order that the amount of current delivered to the other devices in the same series will be unchanged. This becomes unnecessary in the multiple wire systems, since a variation in the power in a series is allowed by intermediate wires connected to intermediate points in the generating system.

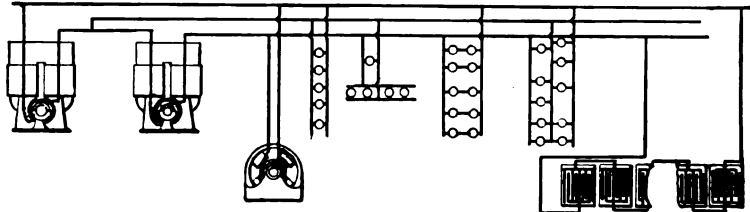

Multiple Wire Distribution.

Having determined the system of distribution, we are thus enabled to calculate the total value of the current in a circuit, the E. M. F. supplied and the power generated. Proceeding to calculate the sizes of the wires to be used in forming the circuit, we notice that in a series circuit we are not concerned with the regulation but only with the amount of energy consumed in the transmission ; but in a multiple arc system regulation must be considered, especially as the E. M. F. of the generator may be maintained constant either at the terminals of the generator or at any point on the circuit, but not at more than one point of the same wire. The point for which the E. M. F. is regulated is called, in general, a distributing point, and all wires are calculated with reference to this one place in the system. In consequence, wires for multiple arc distribution may be distinctly divided into three sections: first, from the generators to the distributing point, called the feeders; secondly, from the distributing point over the whole system, called mains; and thirdly, from these mains to the translating devices, called service wires, subfeeders being also used at times to carry current from the distributing point to sub-distributing points along the mains; the difference between these three sets of wires being found in the fact that the feeders do not determine the potential variations in the circuit,

which is determined by the size of the mains and service wires. The feeders may therefore be calculated, as are the wires in a series circuit, by reference only to the amount of power consumed by them.

For any wire on a circuit we find the limiting value of the current fixed by the safe heating limit. When we speak of the safe heating limit of a wire we must not be understood simply to mean that the wire must never reach the temperature of fusion, or even one which will cause it to char the insulation surrounding it, but that such temperatures should not be approached within a definable limit. It is seen that we are thus introducing a factor of safety exactly similar in nature to the factors of safety employed in mechanical engineering for determining the safe working load on machine parts. The means of calculating the carrying capacity of a wire differs essentially from determining mechanical strength within a factor of safety, since we do not attempt to find the current necessary for fusion and carry a definite proportion of that current, but, on the contrary, assign a limit for temperature elevation which shall not be exceeded. Different values for this temperature elevation have been proposed from time to time varying between 20° and 100° Cent. In 1890 the insurance underwriters, adopting the recommendation of A. E. Kennelly, demanded that the rule made by the Institution of Electrical Engineers (London) in 1888 should be observed,\* which requires conductors to be so proportioned that double the current normally carried will not raise their temperature above 150° Fahr., from which, by assuming the average temperature of the air to be 75° Fahr., we see the requirement is that the temperature elevation of a conductor with double its normal current shall not be more than 75° Fahr. This proportions a conductor such that it will carry the current without danger of excessive heating, since injury to the insulation will not take place below 250° Fahr. and, as conductors are rarely installed where the temperature of the air rises above 130° Fahr., their temperature could hardly be expected to increase above 200° Fahr. even in hot locations with double the normal current.

\* "On the Heating of Conductors," by A. E. Kennelly. A paper read before the Association of Edison Illuminating Companies, August, 1889. See *Electrical World* and *Electrician* (London), December, 1889.

The problem of the heating of a conductor was originally investigated by Prof. George Forbes in 1884, in a paper presented to the Institution of Electrical Engineers (London).\* In 1888, Sir W. H. Preece presented a paper to the Royal Society concerning the currents necessary to fuse short lengths of different conductors.† But while the paper by Preece gave only the fusing currents for short lengths connected to heavy electrodes, the calculations of Forbes were of a theoretical nature, proceeding on the assumption that the radiation from wires is a constant per unit of surface as it is proved to be for balls in the experiments of D. McFarlane; ‡ an assumption found to be untrue in experiments upon wires made by Dr. A. E. Kennelly. These last experiments were undertaken with a view of ascertaining the effects of currents in heating wires; first, when they were incased in wood moldings, as was the common practice in interior installation at the time; second, when they were suspended in a room exposed to the air as in unconcealed construction, and third, when they were freely suspended out of doors. In the first case insulated wires alone were employed; in the second, copper wires and strips were experimented on with a view to ascertaining the safe carrying capacity in central station practice; in the third, both bare and insulated wires were used; the sizes of the wires employed varying from  $18\frac{1}{2}$  mils to 445 mils.

Plotting the curves of temperature and current for different wires inclosed in moldings, Kennelly found that for any one wire the temperature elevation varied as the square of the current, which was to be expected from the fact that while the heat generated varies as the square of the current, the radiating surface is a constant. And while it was possible to plot the curve of temperature rise for any one wire by knowing its temperature at one value of the current, it was impossible to determine any exact law showing the relation between the temperature and diameter of the wire when the current was maintained constant, but that closely approximate values of the currents necessary to raise all wires to one definite

\* George Forbes on the "Heating of Conductors," *Electrician* (London), April 5, 1884.

† *Electrician* (London), February and April, 1888.

‡ D. McFarlane, Proceedings Royal Society of Edinburgh, 1872.

temperature could be assigned. Assuming this temperature to be the one normally attained by a wire under the condition before stated, that the temperature elevation shall not exceed 75° Fahr. with double the normal current, it is seen to be 19° Fahr. Since the temperature elevation varies as the current squared, and the normal current is assumed to be one half of the maximum current, the normal temperature elevation is therefore one quarter of the maximum temperature elevation. From these experiments Kennelly deduces the following empirical formula :

$I = 560 d^{\frac{2}{3}}$	if $d$ be in inches.
$I = 0.01775 d^{\frac{2}{3}}$	if $d$ be in mils.
$I = 138 d^{\frac{2}{3}}$	if $d$ be in centimeters.
$I = 4.375 d^{\frac{2}{3}}$	if $d$ be in millimeters.

and reciprocally :

$d = 0.0147 I^{\frac{3}{2}}$	if $d$ be in inches.
$d = 14.7 I^{\frac{3}{2}}$	if $d$ be in mils.
$d = 0.0374 I^{\frac{3}{2}}$	if $d$ be in centimeters.
$d = 0.374 I^{\frac{3}{2}}$	if $d$ be in millimeters.

From which for the Brown & Sharpe sizes of wire we obtain the following carrying capacities of wires impaneled in moldings:

CARRYING CAPACITY OF WIRES IMPANELED IN MOLDINGS.

Size B. & S. gauge.	Circular mils.	Safe current.	Size B. & S. gauge.	Circular mils.	Safe current.
.....	600,000	381	5	33,102	43
.....	550,000	357	6	26,250	36
.....	500,000	332	7	20,817	31
.....	450,000	307	8	16,509	25.7
.....	400,000	281	9	13,904	21.6
.....	350,000	254	10	10,381	18.2
.....	300,000	227	11	8,234	15.3
.....	250,000	198	12	6,530	12.8
0000	211,600	174	13	5,178	10.8
000	167,805	146	14	4,107	9.1
00	133,079	123	15	3,257	7.6
0	105,534	103	16	2,583	6.4
1	83,694	88	17	2,048	5.4
2	66,373	73	18	1,624	5.1
3	52,633	61	19	1,288	3.8
4	41,742	52	20	1,022	3.2



At the present time the fire underwriters do not consider it necessary to allow for the safe carrying of twice the normal current, but demand that the circuits be so installed and protected by fuses that such great currents will not be allowed to pass for any considerable length of time, and as they require all circuits to be so fused that no more than 10 per cent of current above the normal will ever be carried, they consequently admit the possibility of greater normal values of current without increasing the maximum occasional values. A higher normal temperature is admitted, but as the possible increase is restricted the maximum possible temperature remains unchanged. This change is found to give greater general satisfaction, since, while the underwriters interests are protected by limiting the maximum temperature elevation, the normal current per wire is allowed to be greater, and in consequence the cost of installation is correspondingly diminished.

It has also been found that heavily insulated wires in non-conducting armored conduits radiate heat more readily than do wires protected by moldings. Mr. Kennelly experimented upon impaneled wires and in consequence of the two facts, that wires installed in armored conduits do not heat to such an extent and that double the normal current is never allowed, the carrying capacities he recommended may be almost doubled without undue fire risk. There is, however, an insulation risk to be encountered where rubber-covered wires are employed, since vulcanized rubber changes its character and becomes brittle when subjected to high temperatures, and in consequence wires so protected must not be allowed to reach a high normal temperature, and to insure the permanence of the covering where rubber insulated wires are employed they must not be permitted to rise to so high a temperature as that which can be allowed when the wires are protected by an asphaltum braid. In accordance with these views, the framers of the "National Electrical Code" have given the following table for the carrying capacities of insulated wires concealed in armored conduits: \*

\* "National Electrical Code," printed by the National Board of Fire Underwriters, 1897, p. 16. "Table of carrying capacities of wires in stalled in armored conduits."

## CARRYING CAPACITIES BY NATIONAL ELECTRICAL CODE.

Size, B. & S. Gauge.	Carrying Capacities, in Amperes.		Size, Circ. Mils.	Carrying Capacities, in Amperes.	
	Rubber- covered.	Weather- proof.		Rubber- covered.	Weather- proof.
18	3	5	200,000	200	300
16	6	8	300,000	270	400
14	12	16	400,000	330	500
12	17	23	500,000	390	590
10	24	32	600,000	450	680
8	33	46	700,000	500	760
6	46	65	800,000	550	840
5	54	77	900,000	600	920
4	65	92	1,000,000	650	1000
3	76	110	1,100,000	690	1080
2	90	131	1,200,000	730	1150
1	107	156	1,300,000	770	1220
0	127	185	1,400,000	810	1290
00	150	220	1,500,000	850	1360
000	177	262	1,600,000	890	1430
0000	210	312	1,700,000	930	1490
			1,800,000	970	1550
			1,900,000	1010	1610
			2,000,000	1050	1670

It is unfortunate that the framers of the Code have given neither the formula on which this table is based nor the methods used for determining temperatures in the experiments from which it was deduced, but we can easily see that if we express the diameter of the wires in mils, the currents may approximately be found by use of the equations:  $I = 0.0215d^{\frac{3}{2}}$  for rubber-covered wires,  $I = 0.0315d^{\frac{3}{2}}$  for weather-proof wires, and from Kennelly's experiments we can also see that the temperature elevation allowed for rubber-covered wires is about 30° Fahr., while the temperature elevation allowed for weather-proof wires approaches 70° Fahr., though it is stated that temperature elevations of only twenty-five degrees were observed in the experiments made by the underwriters.

From the formulæ given we see that the current-carrying capacity of a wire varies as the  $\frac{3}{2}$  power of the diameter, while we know that the area varies simply as the square of the diameter, and in consequence it is plain that any rule for the carrying capacity of a wire which refers simply to its area or its diameter will give different temperature elevations for dif-

ferent sizes of wire. As, for instance, a rule has been often used allowing 1,000 amperes per square inch for the carrying capacity of a wire, which determines a wire 713 mils in diameter for a current of 400 amperes; while, according to Kennelly's formula, a wire of 800 mils should be used for this current. One thousand amperes per square inch requires a wire 225 mils in diameter to carry 40 amperes; whereas a smaller wire of 172 mils is seen to be sufficient according to Kennelly's rule, the two methods of calculation giving the same size only for 196 amperes, requiring a wire 500 mils in diameter; the rule allowing 1,000 amperes per square inch entailing a less temperature elevation than  $19^{\circ}$  Fahr. for smaller currents, and a higher temperature elevation for larger currents. Furthermore, we see from Kennelly's investigations that many small wires will carry more current than a single large wire of equivalent area with the same temperature rise; the difference between one wire for carrying a definite current and two wires for transmitting the same current amounting to a reduction of 20 per cent in the total area, and, in consequence, where wires are run at their highest carrying capacity, it is advisable to use two small wires in place of one large wire where 20 per cent of the cost of the copper installed will pay for insulation and installation of the second wire. We also see that where the required voltage loss determines a wire too small in carrying capacity, the proper carrying capacity without change in the loss of voltage may often be obtained by subdividing the wire into two or more conductors of equivalent area, the possible reduction in area, without increase in temperature elevation, by subdivision into any number of wires up to ten, being given in the curve on page 153.

Proceeding now to investigate the heating of wires freely suspended in a room, Kennelly found that as the external surface for radiation and convection could be more definitely calculated than where the wire insulation itself was in contact with a semi-conducting body, as a molding, it was possible to obtain from experiments the law of true variation between the diameter of the wire and the current to be carried for a definite elevation of temperature, which in the former case could be only reached approximately, and that he could apply to the

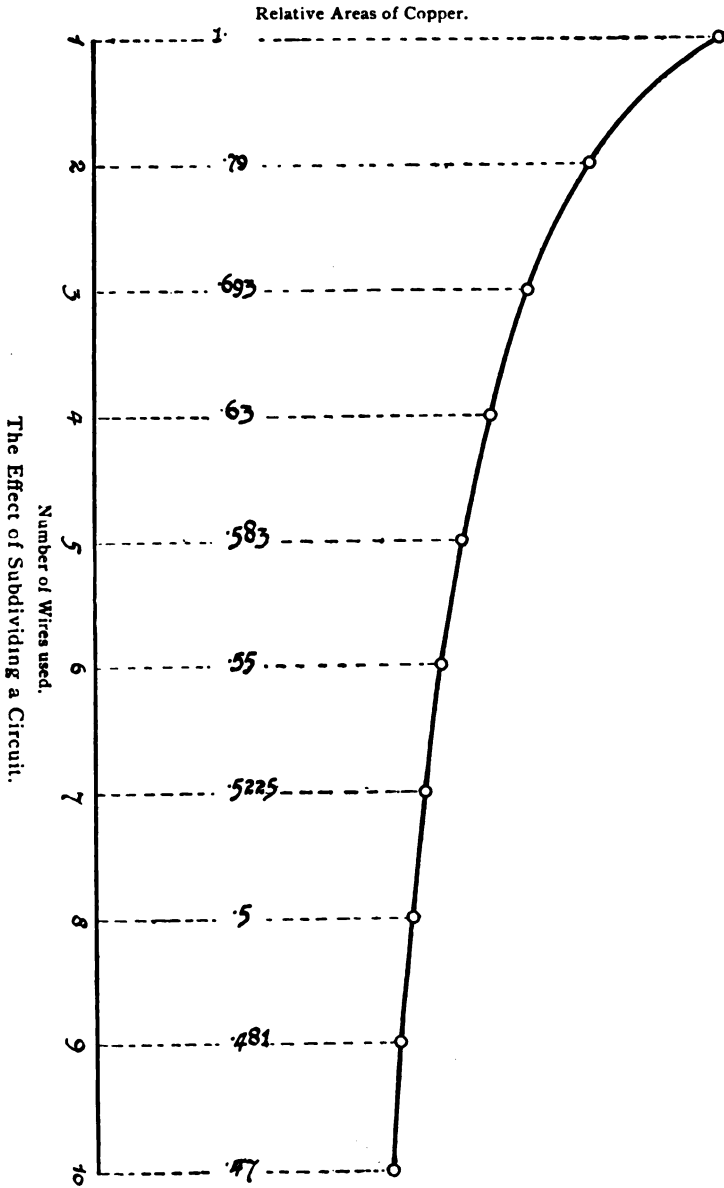

154 CONDUCTORS FOR ELECTRICAL DISTRIBUTION.

results of his experiments the law of radiation as announced by Dulong and Petit in 1817, that :

$$h = c[1.0077^\theta(1.0077^t - 1)]$$

where  $h$  is equal to the quantity of heat lost per square centimeter of surface ;  $c$  is equal to a constant depending upon the surface ;  $\theta$  the temperature of the surrounding bodies ;  $t$  the temperature elevation of the hot body above its surroundings. Experimentally for wires  $c$  was found to be equal to .05625, and assuming the average temperature of the air as 26° Cent., we have :

$$h = .5625[1.0077^{26}(1.0077^t - 1)] = .0687(1.0077^t - 1).$$

Applying this to the various experiments tried with small wires, large wires and flat strips, the loss of heat not represented by the radiation, but due to convection, was found to be approximately the same for all wires, and was represented by .00175 watts per linear centimeter per degree Centigrade temperature elevation. Taking now  $r$  as the specific resistance in ohms of the material used, we have for the energy developed per centimeter of length of a wire by  $I$  amperes :

$$\frac{4I^2r(1 + .00388T)}{\pi d^2}$$

where  $T = t + \theta$  or the temperature attained by the wire, and as the energy developed is equal to the energy lost by radiation added to the energy lost by convection when a wire has attained a standard temperature, we have :

$$\frac{4I^2r(1 + .00388T)}{\pi d^2} = .00175t + \pi dm[.0687(1.0077^t - 1)]$$

where  $m$  is a coefficient of the surface of radiation equal to 1 for bright wires and 2 for blackened wires. Solving this, we have :

$$I = 28.9d\sqrt{\frac{570\pi d[.0687(1.0077^t - 1)] + t}{1 + .00388T}},$$

and for blackened wires, where  $m$  is equal to 2 :

$$I = 28.9d\sqrt{\frac{1140\pi d[.0687(1.0077^t - 1)] + t}{1 + .00388T}}.$$

The calculation according to this formula may be much simplified by the use of a table giving the values of the heat radiated for definite temperature elevations, which is given by Kennelly as follows :

RADIATION TABLE IN WATTS PER SQUARE CENTIMETER FOR BRIGHT COPPER.

Temperature elevation. Degrees Cent.	$(1.0077^t - 1)$	Radiation.	Temperature elevation. Degrees Cent.	$(1.0077^t - 1)$	Radiation.
5	.0391	.002665	55	.5249	.0358
10	.0797	.00543	60	.5844	.0398
15	.1219	.00831	65	.6464	.0441
20	.1658	.0113	70	.7108	.0484
25	.2114	.0144	75	.7777	.0530
30	.2587	.0176	80	.8471	.0577
35	.3080	.0210	85	.9194	.0627
40	.3091	.0245	90	.9944	.0678
45	.4123	.0281	95	1.0724	.0731
50	.4675	.0319	100	1.1534	.0786

According to this table the carrying capacities of wires have been calculated for a temperature elevation of 19° Fahr., and are presented in the following table :

CARRYING CAPACITY OF WIRES SUSPENDED IN A ROOM (KENNELLY).

Size B. & S. gauge.	Cir. mils.	Safe Current.		Size B. & S. gauge.	Cir. mils.	Safe Current.	
		Bright wires.	Black copper.			Bright wires.	Black copper.
....	600,000	288	370	5	33,102	48	55
....	550,000	272	349	6	26,250	42	47
....	500,000	255	329	7	20,817	37	41
....	450,000	238	303	8	16,509	32	36
....	400,000	220	280	9	13,094	28.2	31
....	350,000	202	255	10	10,381	24.9	27.2
....	300,000	183	229	11	8,234	21.9	23.8
....	250,000	163	203	12	6,530	19.3	20.8
0000	211,600	146	181	13	5,178	17	18.3
000	167,805	127	155	14	4,107	15	16
00	133,079	110	133	15	3,257	13.3	14.1
0	105,534	95	114	16	2,583	11.8	12.4
1	83,694	83	98	17	2,048	10.4	10.9
2	66,373	72	85	18	1,624	9.2	9.6
3	52,633	63	73	19	1,288	8.2	8.5
4	41,742	55	63	20	1,022	7.2	7.5

In experimenting with wires exposed to the air out of doors Kennelly found that it was exceedingly difficult to obtain accu-

rate results, as the slightest variation in the velocity of the wind would materially alter the convection of heat from the wire. In this case it was not possible, as before, to assume that the convection was constant for all sizes of wire, but that the total value of the convection could be obtained by adding to the constant term a term depending upon the diameter of the wire. The constant term being as before, .00175 watts per linear centimeter per degree Centigrade; the variable term being .013  $d$  per degree, and for the total convection per linear centimeter per degree Centigrade elevation we have .00175 + .013  $d$  watts. Substituting this in the above equations we have for the carrying capacity of a bright copper wire suspended out of doors

$$I = 28.9d \sqrt{\frac{570\pi d [.0687(1.077^t - 1)] + 7.4d t + t}{1 + .00388 T}}$$

The following table represents the carrying capacities of different wires suspended in the air calculated from the formulæ determined by these experiments :

CARRYING CAPACITIES OF WIRES SUSPENDED OUT OF DOORS.

Size B & S. gauge.	Cir. mils.	Safe Current.		Size B. & S. gauge.	Cir. mils.	Safe Current.	
		Bright copper.	Black copper.			Bright copper.	Black copper.
...	600,000	706	744	5	33,102	88	91
....	550,000	662	698	6	26,250	75	78
.....	500,000	618	652	7	20,817	63	66
.....	450,000	572	602	8	16,509	54	56
...	400,000	524	552	9	13,094	46	48
....	350,000	476	500	10	10,381	40	41
.....	300,000	425	477	11	8,234	34	35
.....	250,000	372	391	12	6,530	29	30
0000	211,600	329	346	13	5,178	25	25.8
000	167,805	278	292	14	4,107	21.5	22.2
00	133,179	236	247	15	3,257	18.5	19.1
0	105,534	199	209	16	2,583	16	16.5
1	83,694	169	177	17	2,048	13.8	14.2
2	66,373	141	148	18	1,624	12.0	12.3
3	52,633	121	127	19	1,288	10.4	10.7
4	41,742	103	108	20	1,022	9	9.2

The value of  $m$  is commonly taken in these tables to be as 1 for bright copper, and 2 for blackened copper, but this dif-

ference in value can only be allowed when the blackening is very thoroughly done, as shown by the following experiments of Kennelly :

EFFECT OF COATINGS ON RADIATION.

Conductor.	Coating.	m.
Wire .....	Thin brown shellac .....	1.62
Wire .....	Thick copper sulphide .....	2.34
Wire .....	Thick lampblack with molasses .....	2.05
Strip .....	Thin brown shellac .....	1.84
Strip .....	Thin copper sulphide .....	1.54
Strip .....	Lampblack from smoking candle .....	1.42
Strip .....	Thin lampblack with varnish .....	2.02

The irregularities in the amount of radiation from surfaces in partial contact with heat-conducting bodies, which have given rise to points for discussion in the experiments of Kennelly, and have caused the underwriters to issue a new table for the carrying capacities of concealed wires, have made the calculation of current-carrying capacities of cables lying in underground conduits even more uncertain. Experiments have been made by Mr. W. H. Fisher on the heating effects of currents upon lead-encased cables \* which furnish us with data for making calculations that may be applied to cables in general which would at least approximate correctness. In the experiments referred to the cables were coiled upon a wooden floor in large elliptical spirals of four turns for each cable, and after an empirical formula had been obtained from the temperature rise observed for a No. 0000 B. & S. cable carrying currents varying between 85 and 415 amperes, the formula was verified by calculations for the temperature change in other cables, which were experimentally shown to be reasonably accurate. The empiric equation taken for the curve of temperature change, with varying values of the current, was:  $t = \frac{A^x}{K}$ . Where  $t$  = rise of temperature in degrees Fahr.,  $A$  = corresponding current value in amperes,  $K$  and  $x$  are constants. In the case of a No. 0000 cable these constants were derived by experiment and the equation found to be:  $t = \frac{A^{2.1}}{250}$ , which we see

\* "Carrying Capacity of Cables," by Henry W. Fisher: Handbook No. XV, Standard Underground Cable Co., Pittsburg, Pa., 1897.



158 CONDUCTORS FOR ELECTRICAL DISTRIBUTION.

corresponds closely with the results of Kennelly's experiments quoted on p. 148, namely, that the temperature rise for any one wire or cable varies nearly as the square of the current value. The constant factor,  $K$ , changes with different cables, and Mr. Fisher's experiments have determined it to be:  $K = 5250 F$  where  $F$  is a factor depending on the character of the cable conductor, found from the equation:  $F = \frac{CM^7}{5315}$ ,  $CM$  being the area of the cable conductor in circular mills.

The experimental results referred to and the corresponding values calculated for the factor  $F$  from the experiments made with a No. 0000 cable are given in the following table:

CARRYING CAPACITIES OF CABLES.

Heating effect in a piece of No. 0000 B. & S. Cable.		Factors for determining the size of conductor in cables for definite temperature rise.		Carrying capacity standard underground cables for 25° Fahr. rise.
Rise in temperature above surrounding air in ° Fahr.	Amperes required.	Size of conductor.	Values of Factor F.	
2	84	10 B. & S.	.11	30
4	116	9	.13	36
6	138	8	.16	44
8	160	7	.19	52
10	178	6	.23	63
12	194	5	.27	74
14	208	4	.33	91
16	221	3	.39	107
18	234	2	.45	124
20	246	1	.52	143
22	258	0	.61	168
24	269	00	.71	195
26	280	000	.86	237
28	290	0000	1.	275
30	300	250 M. circ. mils.	1.16	311
32	309	300	1.29	355
34	318	350	1.41	397
36	326	400	1.55	438
38	334	450	1.71	477
40	342	500	1.85	515
42	350	550	1.99	552
44	358	600	2.15	589
46	366	650	2.31	624
48	373	700	2.46	659
50	380	750	2.59	693
52	387	800	2.72	726
54	394	850	2.89	759
56	401	900	3.02	791
58	408	950	3.15	823
60	415	1000	3.26	854

In the above table are given the carrying capacities of the special cables experimented upon at a temperature elevation of 25° Fahr. above the air, but for any other temperature elevation the size of the cable may easily be determined by dividing the current to be carried by the current necessary to heat the No. 0000 cable to the desired temperature, which gives the value of the factor  $F$ , and the cable having this value for its  $F$  factor is the one to be chosen, as, for example, if we wish to determine the cable capable of carrying 350 amperes with 30° Fahr. temperature rise, we have:  $F = \frac{350}{300} = 1.17$ , which, as we see from the fourth column, is a cable having an area equal to 250,000 circular mils. Perhaps with cable of a different make and installed in a different manner these figures will be slightly changed. At the same time, the carrying capacities given by this method of calculation are sufficiently accurate for practical installation.

Further than these experiments we have no satisfactory data at hand for determining the carrying capacity of a wire located in an interior conduit or in an underground cable duct, which is unfortunate, particularly on account of the fact that the practical variations in the manner of installing conductors must necessarily introduce great changes in the carrying capacities, especially where wires are laid underground and where concentric cables are used; when the thickness of insulation varies very greatly from the thickness here experimentally used, or where the character of the external objects for absorbing radiation materially changes. In the case of underground lead-covered cables, it is probable that greater carrying capacities can often be allowed than those shown in these experiments, except when one conductor is situated near another, as in a multiple or concentric cable, where it is not unlikely that we will find the carrying capacity reduced on account of the fact that in such construction the external radiating surface does not increase in the same ratio to the conducting area as when round wires singly insulated are used.

## CHAPTER VIII.

### KELVIN'S LAW OF ECONOMY IN CONDUCTORS.

THE choice of a conductor to transmit electric energy with the most perfect uniformity of voltage and the least heating effect finds its limit in the economical capital outlay on the conductor, its insulation and supports. While it is true that we cannot install heavy conductors without reference to economy, it is also true that the considerations of economy point to a lower limit beyond which it is inadvisable to reduce the size of the conductor to be installed. We have, therefore, before us the problem of finding the limiting sizes of conductors to convey given amounts of energy without transgressing the bounds of economical installation. In this problem two conditions are presented to us which are related to each other inversely: the cost of the conductor, which varies as the area, and the value of the waste energy, which is directly as the loss along the line. The waste energy in watts is given by the current squared times the resistance, and as the resistance is inversely as the area of the conductors, the energy wasted over any line in carrying a given current is also expressed as an inverse function of the area. Reducing these conditions to a graphic construction, we see at once that the charges dependent on cost of the conductor are represented by a straight line passing through the origin, while the cost of the waste energy is a curve concave to the axis of  $x$  and  $y$  and asymptotic to these axes.

In order that the solution may be practically applicable, it is necessary to reduce the two equations, for the charges dependent on line cost and the value of the waste energy, to terms of the same variables, and to eliminate all other variables in the expressions. The two common variables are those of

the money charges and the areas of the conductors; all other quantities in the equations must be assigned constant values. In the equation for the charges dependent on the line cost, the quantities of constant value are the cost price of the conductor per unit of area, the length of the line and the interest and depreciation charges, which are functions of time. In the equation for the value of the waste energy the length of line is obviously the same as in the preceding equation, while the value of the current flowing must be fixed by the conditions of the problem.

In the case given (Fig. 1), *A* represents the annual charges dependent on the area of the conductor; *B* the annual value

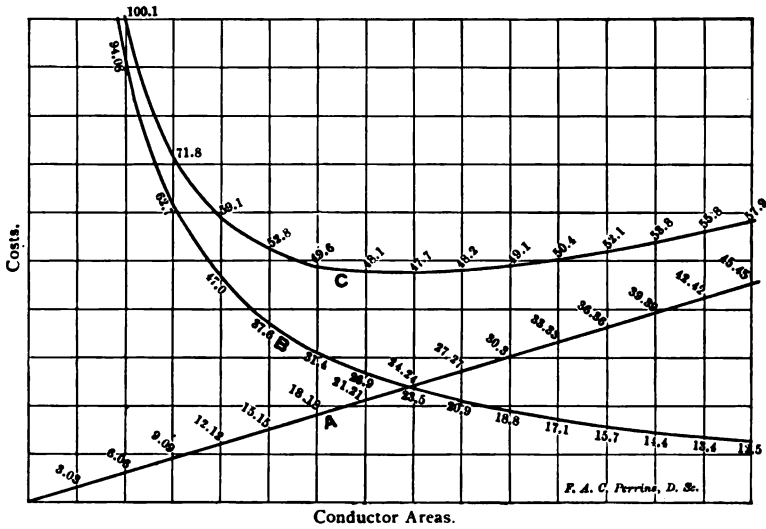

FIG. 1.

of the energy consumed in transmitting a given current over conductors whose areas are determined by *A*; and *C* is the curve of the total annual expense of transmitting the given current.

This latter curve clearly presents a minimum at the point where the two curves *A* and *B* cross each other, which is to say that the total expense of transmitting a given current is the least when the annual cost of energy consumed in the conductor is equal to the annual expense of the conductor itself. The solution of this problem was first presented analytically by

Lord Kelvin in a paper before the British Association in 1881. In the paper referred to the problem is treated as though a constant current was flowing continuously, and as though the cost of the conductor was a simple function which varied directly as the area.

Neither of these conditions is generally met in an engineering undertaking, and as the problem has been so far presented it is not applicable to the solution of any case except that of the choice of the most economical size of bare copper wire to be used for a constant current circuit, and not even for this simple case is the solution complete, no account being taken of any expense of erection or maintenance of the line not directly variable with the area of the conductor.

The annual cost of any conductor for the transmission of energy by the means of electricity may always be reduced to a number of terms, in each of which there is a constant factor besides the one dependent on the area of the conductor. These terms are those of the cost of conductor with its insulation, the cost of line right of way and construction, and the cost of maintenance. The general form of the equation for each of these elements is:  $K = a + bd^2$ , where  $K$  represents the total cost,  $a$  and  $b$  are constants and  $d$  is the diameter of the wire. The values of the constants  $a$  and  $b$  must necessarily be determined empirically. For insulated wires of a given manufacture the values of these constants may easily be determined by obtaining two simultaneous equations involving these constants for wires of different sizes and solving for the values of  $a$  and  $b$ . If the price is expressed in cents per pound, as is generally the case with the saturated fiber wires, the equation reduces to:  $wt. c. = a + bd^2$ , where  $wt.$  may represent the weight per 1,000 feet and  $d$  the diameter in mils and  $c$  the price per pound.

When the price is expressed in this way the values of the constants per 1,000 feet of line are :

$$a = \frac{(wt_1 d_1^2 - wt_2 d_2^2)c}{d_1^2 - d_2^2}$$

$$b = \frac{(wt_1 - wt_2)c}{d_1^2 - d_2^2}$$

the suffixes referring to wires of two different diameters. If the price is expressed in cents per foot the values of the constants per 1,000 feet are:

$$a = \frac{Kt_1 d_1^2 - Kt_2 d_2^2}{d_1^2 - d_2^2}$$

$$b = \frac{Kt_1 - Kt_2}{d_1^2 - d_2^2}$$

where  $Kt$  represents the cost per 1,000 feet.

The numerical values of the constants in the latter case depend entirely upon the market price of the wire or cable, but where the price is expressed in cents per pound one may find general values for  $\frac{a}{c}$  and  $\frac{b}{c}$ , from which  $a$  and  $b$  may be at once derived in any given case.

The following values may be taken as representing the majority of the wires sold by the pound in this country:

TABLE OF FACTORS FOR DETERMINING WIRE WEIGHTS.

	Bare Wire.	Under-writer's Wire.	Double Braid, Weather-proof, Solid.	Triple Braid, Weather-proof, Solid.	Double Braid, Weather-proof, Stranded.	Triple Braid, Weatherproof, Stranded, Larger than 200,000 C. M.	Bare Straude 1.
$\frac{a}{c}$	0	14.00	14.05	27.05	118	162	0
$\frac{b}{c}$	.0030303	.00328	.0032837	.0033741	.003125	.03165	.0032

In a similar manner it will be found that in any given case of line building, the cost of line right of way and construction and the cost of maintenance may each be divided into two elements, one of which is independent of the area of the conductor and the other variable with it.

It is impossible to state generally the values of the constants  $a$  and  $b$  for these items of cost, as they vary widely with the conditions of various problems, and even with similar problems of transmission the value of these constants vary with special circumstances dependent on locality alone.

Where the variation in the values of  $d^2$  do not necessitate

the erection of additional poles, we have for the cost of line right and construction of an overhead line :

$$\begin{aligned}
 a &= \text{cost of right of way } +, \\
 &\quad \text{cost of poles and erection } +, \\
 &\quad \text{cost of one cross-arm, pins and insulators.} \\
 b &= \text{cost of cross-arms, pins and insulators per C. M. of con-} \\
 &\quad \text{ductor } +, \\
 &\quad \text{cost of carriage per C. M. of conductor } +, \\
 &\quad \text{cost of erecting per C. M. of conductor.}
 \end{aligned}$$

The method of this analysis of the cost elements is to be followed in determining the constants for the cost of construction of an underground line, and for the cost of maintenance, but in these cases it would be of little practical value to set down the elements, as they necessarily vary so much with the conditions of particular problems.

We have now seen that the annual cost of the conductor per unit of length for the transmission of electricity may be expressed by the sum of three similar equations :

$$\begin{aligned}
 pc(a_c + b_c d^2) &= \text{annual cost of wire.} \\
 p(a_c + b_c d^2) &= \text{annual cost of line building.} \\
 a_m + b_m d^2 &= \text{annual cost of maintenance.}
 \end{aligned}$$

Therefore  $(a_c pc + a_c p + a_m) + (b_c pc + b_c p + b_m) d^2 =$  annual cost of conductor where  $p$  is the annual rate of interest, which is a constant in any given case.

This equation is obviously of the form  $A + Bd^2$ , where  $A$  and  $B$  are constants, determined as above.

The total annual cost of the transmission of a given current is, therefore,

$$IRwt + L(A + Bd^2),$$

where  $L$  is the length of the line,

$w$  is the cost of one watt hour,

$t$  is the number of hours the current is used annually.

Substituting for  $R$  its value  $\frac{LM}{d^2}$  we have  $\frac{I^2 LMwt}{d^2} + LA + LBd^2 = K$ .

Differentiating in respect to  $d^2$  and equating to zero,

$$-\frac{I^2 LMwt}{d^3} + 0 + LB = 0.$$

Multiplying, though, by  $d^3$  and transposing,

$$LBd^3 = \frac{I^2 LMwt}{d^3}$$

this is the solution of Kelvin as modified to cover the case, in which the annual cost of the conductor includes an element independent of the size of the wire, and which shows that for any given transmission of a constant current the minimum annual cost of energy absorbed in transmission plus the annual line cost is obtained when the annual cost of energy absorbed equals the annual cost of that portion of the conductor, which varies as the area of the wire.

It is to be observed that this solution is altogether independent of the voltage and consequently of the total amount of energy to be transmitted, and therefore it is erroneous to suppose that the equations which might be derived from it for the value of  $I$  would be true for  $I$ , a variable. This treatment of the solution has been several times erroneously cited as a proof that the solution is not a general one. The equation does not involve  $I$  as a variable nor does it involve the total amount of energy to be transmitted, but is simply the statement of the size of wire which will transmit a given current at the lowest total annual cost.

The cases of transmission to which this solution is applicable are: First, constant current transmission to translating devices in series. Second, transmission to constant potential apparatus where the amount of energy to be delivered is specified.

The maximum amount of energy which may be economically transmitted with a given value of current over a certain wire, as determined above, may further be limited by the increased cost of generating plant and line occasioned by the construction necessary to withstand high electro-motive forces, but the variation in cost of either line or generating apparatus with voltage is not sufficiently well determined to admit of any general treatment.



Extending our investigations to other cases of transmission we at once find that it is not always possible to solve the general problem for the least expense of line and transmission, but that each problem presents its own conditions of maximum economy.

The quantities involved in a transmission, any one or two of which may be fixed by the conditions of the problem, are as follows:

$I$  The current on the line.

$E_1$  The electro-motive force at the generator.

$E_2$  The electro-motive force at the translating devices.

$R$  The resistance of the line  $= \frac{LM}{d^2}$ .

$P_1$  The power available at the generator.

$P_2$  The power delivered at the translating devices.

Taking these quantities in order, we have the following set of problems:

If  $I$  is fixed and all the other quantities unlimited, the most economical line is given as above, when

$$d^2 = I \sqrt{\frac{Mwt}{B}}$$

and the best financial returns are from the transmission in which  $E_1$  has the highest attainable value, the other quantities being fixed by the equations:

$$E_2 = E_1 - IR,$$

$$P_1 = E_1 I,$$

$$P_2 = IE_2 = IE_1 - I^2 R, \text{ or}$$

$$P_2 = P_1 - I^2 R.$$

Or, since  $I^2 R$  is a constant, the energy delivered increases with the value of  $E_1$ . Obviously the solution given above for  $d^2$  is correct, if in addition to  $I$  we have also given  $E_1$  or  $P_1$ , since in the case of either quantity being given the other is also fixed, and no further variation of  $E_1$  is possible than that which will give the least total cost for transmitting  $I$ .

If in addition to  $I$  we have as constants  $E_1$  or  $P_1$ , then it is possible that the value of  $R$ , as determined above, may give the value of  $E_2$ , and hence of  $P_2$ , so small that the total annual

income will be below the cost of generating and transmitting the energy available, and although the total annual cost of the energy used in transmission and the annual line cost is a minimum, yet the plant will show a net financial loss.

The maximum economy in this case is not that in which the cost of energy of transmission and annual line cost is a minimum, but is given by obtaining the maximum value of the difference between the selling price of the energy delivered and the total cost of transmission. In this case the cost of the energy generated is a constant, and the total annual cost of the transmission is equal to the sum of the total annual cost of energy generated and the annual cost of the line construction, or  $IE_1tw_1 + d^2BL$ , while the annual value of the energy delivered is  $(IE_1 - I^2R)tw_2$ . Subtracting these expressions and differentiating we have

$$\frac{d\{(IE_1 - I^2R)tw_2 - [IE_1tw_1 + d^2BL]\}}{d(d^2)} =$$

$$\frac{d\{IE_1tw_2 - I^2MLtw_2 - IE_1tw_1 - d^2BL\}}{d(d^2)} =$$

$$\frac{I^2MLtw_2}{d^4} - BL.$$

Equating this expression to zero, we have for the maximum value

$$\frac{I^2MLtw_2}{d^4} = d^2BL$$

$$\therefore d^2 = I\sqrt{\frac{Mtw_2}{B}};$$

which is to say that the maximum difference between the selling price of the energy delivered and the cost of transmission is obtained by the use of a wire which will give an equality between the annual selling price of the energy absorbed in transmission and the annual cost of the conductor, or, extending the investigation to the case where the cost of the conductor is expressed by  $K = A + Bd^2$ , to the annual cost of that portion of the conductor which varies as  $d^2$ .

Graphically the same solution is expressed in Fig. 2, and it is at once seen that while the cost of the energy generated does not influence the determination of the size of the wire for obtaining the maximum economy, it determines the financial value of the transmission as giving the ratio between the whole

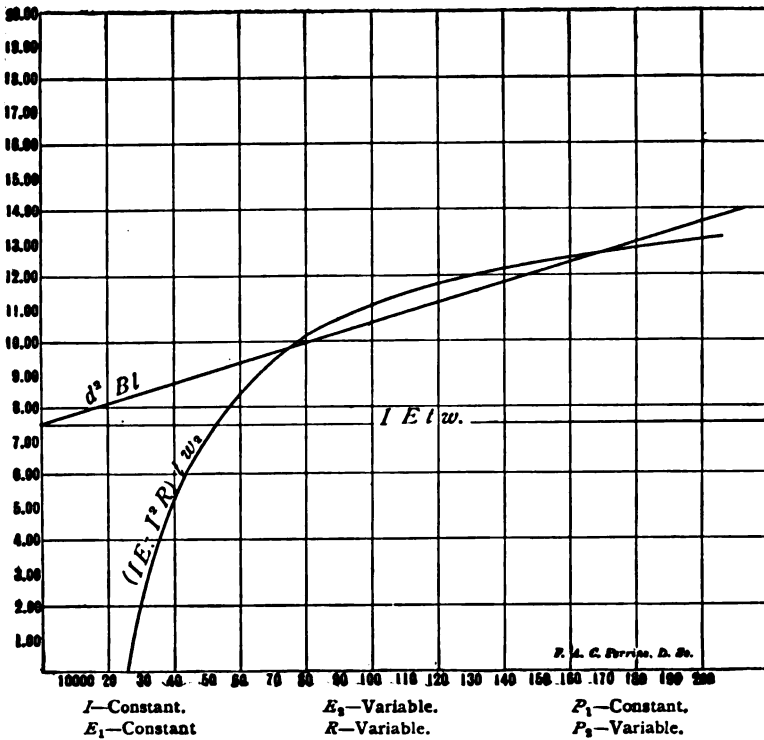

FIG. 2.

cost and the total selling price of the energy delivered, while the slope of the line of annual conductor cost determines the most economical size of wire, since the difference between the annual selling price and annual cost of transmission is the greatest at the point where a tangent to the line of annual selling price of the energy delivered is parallel to the line of annual conductor cost.

If in addition to  $I$  the value of  $R$  is fixed, we have as determined quantities the annual cost of conductor and the annual cost and selling price of the energy absorbed in transmission,

and the greatest economy is obviously obtained by the transmission which makes  $P_1$  the largest possible. Since  $P_1 = IE_1 - I^2R$ , and both  $I$  and  $I^2R$  are determined,  $P_1$  is a maximum when  $E_1$  is a maximum. The maximum value of  $E_1$  must be determined from the conditions of cost of the generating plant, the insulation of the line and the amount of power available, or the amount of power for which there is a demand.

While it may be considered that the case in which  $E_1$  is given and all other quantities are unlimited is too far hypothetical to be of practical value, since it is the case of an unlimited available power, yet the solution proves to be a perfectly intelligible one. The greatest economy in this case is obtained when a value of  $I$  gives the maximum value of  $P_1 tw_1$ . Since we have already proved that for each value of  $I$  there is a corresponding value for  $d^*$  which gives the greatest economy irrespective of the value of  $E_1$ , we have, in consequence, a series of values of  $d^*$  for the differing values of  $I$ , and as  $I$  varies we have corresponding values for  $IE_1 tw_1 + d^*BL$ , and accordingly definite values for  $P_1 tw_1 - (P_1 tw_1 + d^*BL)$ , which increase directly with  $I$ , and hence the greatest economy is obtained when  $I$  has the greatest possible value, and  $d^*$  is obtained by the equation  $d^* = I \sqrt{\frac{tw_1 M}{B}}$ .

The cases in which we have  $I$  and  $P_1$  as constants in addition to  $E_1$ , have already been solved, and we turn next to the solution for  $E_1$  and  $R$  constants. This case is met in constant potential practice when it is desired to know if it is more economical to install a new wire than to increase the current on one already existing. In general the heating of the wire will set a superior limit to the value of  $I$ , but on very long lines it is perfectly possible to increase the current till we have  $IR = E_1$  without overheating. But for such a current we have obviously no power delivered, and between this value of  $I$  and 0 there must be some point at which the value of  $P_1$  is a maximum.

We know that  $P_1 = P_1 - I^2R = E_1 I - I^2R$ . Differentiating in respect to  $I$  and equating to zero we have  $\frac{dP_1}{dI} = E_1 - 2IR = 0$ , from which we see that  $E_1 I = 2I^2R$  for the maximum value of

$P_1$ , or that the greatest power which it is possible to deliver over a given line at a constant impressed electro-motive force is obtained when the energy consumed on the line is exactly one-half of the total energy delivered to the line. This solution is exhibited in Fig. 3, which shows at once that although the greatest power is delivered when  $I^2R$  is one-half  $IE_1$ , yet the greatest ratio of  $IE_1$  to  $I^2R$  is when  $I$  has the smallest value possible.

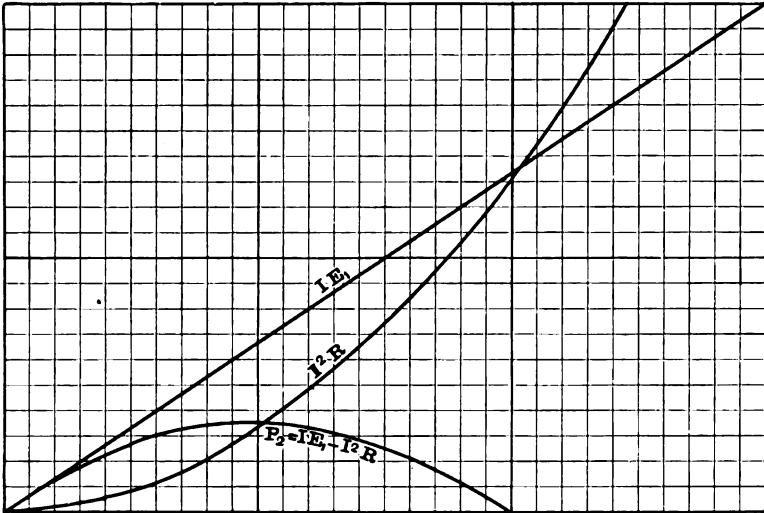

FIG. 3.

It must be clearly understood that in this problem  $R$  is a constant, and though the greatest possible power is transmitted according to this solution, an entirely different principle of economy is to be applied when the size of the line may be varied at will, the case being then that in which  $E_1$  is the only constant quantity.

We have now to consider the remaining case in which  $E_1$  is the principal constant, namely, that in which the energy to be delivered is also fixed. This very important case is met whenever it is required to know whether a definite amount of power can be economically furnished at a given price from an existing generating plant, and the solution shows at once the most economical size of line, as well as the best voltage at which to

run the receiving apparatus. Since  $P_2$  has a constant value, the value of  $P_2 tw_2$  is also fixed, while varying  $I$  makes the quantity  $E_1 I tw_1$  progressively increase. Transmission first becomes possible when  $E_1$  is greater than  $E_2$ , or when  $E_1 > \frac{P_2}{I}$ , at which point a line loss is permissible, when the quantity

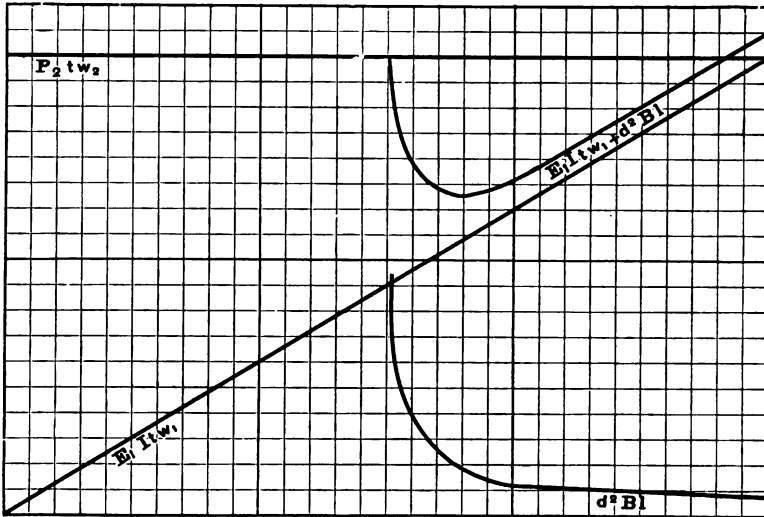

FIG. 4.

$I^2 R tw_1$ , first has a positive value and  $R$  becomes greater than zero. The quantity  $R$  is determined by the equation  $R = \frac{E_1 - E_2}{I}$ , from which we also arrive at  $d^2$  by the relation

$$d^2 = \frac{LM}{R} = \frac{LMI}{E_1 - E_2}.$$

Plotting the curves given by these equations we obtain the construction of Fig. 4, from which we see that the sum of the various quantities which go toward making up the total cost of transmission shows a definite minimum, at which point the revenue from the transmission is also a maximum. The algebraic solution for the values of  $I$  and  $d^2$  may be presented as follows:

The equation for the revenue derived from the transmission is

$$\begin{aligned}
 P_2 tw_2 - (E_1 I tw_1 + d^2 BL) &= P_2 tw_2 - E_1 I tw_1 - \frac{L^2 MBI}{E_1 - E_2} \\
 &= P_2 tw_2 - E_1 I tw_1 - \frac{L^2 MBI}{E_1 - P_2} = P_2 tw_2 - E_1 I tw_1 - \frac{L^2 MBI^2}{E_1 I - P_2}
 \end{aligned}$$

Differentiating the above equation in respect to  $I$  and equating to zero, we have

$$-E_1 tw_1 - \frac{2L^2 MBI(E_1 I - P_2) - L^2 MBI^2 E_1}{(E_1 I - P_2)^2} = 0,$$

from which we have, by expansion and changing signs,

$$E_1 tw_1 (E_1 I - P_2)^2 + L^2 MBI (E_1 I - 2P_2) = 0,$$

an equation from which may be obtained the value of  $I$ , giving the greatest net revenue possible to secure from the transmission.

When the value of  $I$  is thus calculated, the size of the wire is found from the equation above :

$$d^2 = \frac{LMI}{E_1 - E_2}$$

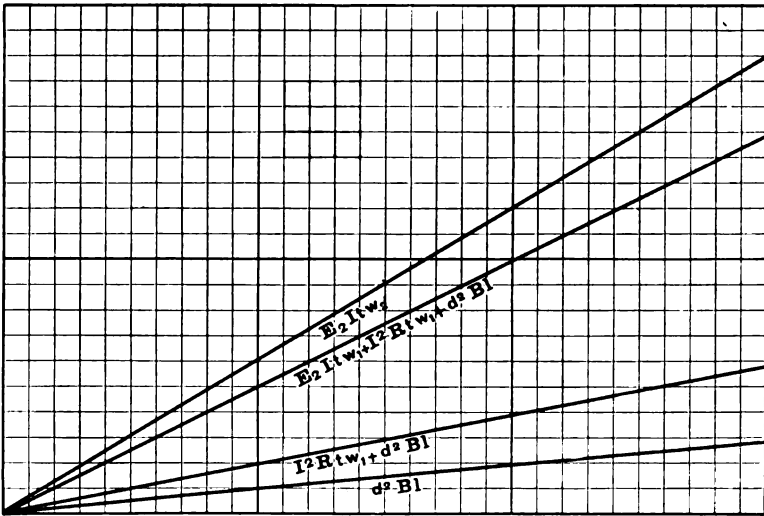

FIG. 5.

The solution when  $E_2$  is the only constant is almost identical with the case in which  $E_1$  is the only known quantity. For

each value of the current we have already determined the size of conductor and the consumption of energy by the equations  $d^2 = I \sqrt{\frac{Mwt}{B}}$  and  $I_1 R = \frac{LM}{d_1} I^2$ . From which we have the annual conductor cost and the annual cost of energy consumed in the transmission equal to  $d^2 BL + I^2 Rtw_1$ , and immediately we see that all the quantities involved of profit and loss vary directly with the value of  $I$ ; hence the net profit is a progressively increasing function of  $I$ , a conclusion easily derived from the inspection of Fig. 5.

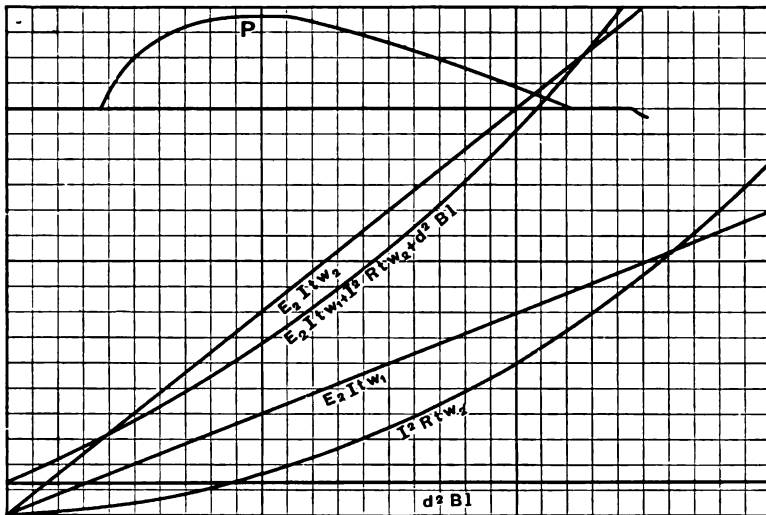

FIG. 6.

We have already discussed the cases in which  $I$  and  $E_1$  are fixed at the same time that  $E_2$  is a constant, and next turn to the solution of the economy when  $R$  and  $E_2$  are the determined quantities.

It will be at once seen that this problem is one of the greatest importance in every supply station, since it represents the condition of a distribution to translating devices requiring a constant potential, and its solution points to the most economical amount of energy to be transmitted over a given feeder.

Referring to Fig. 6, in which the solution of this problem is presented, we see that by assuming  $I$  as our principal variable



all other quantities may be expressed in terms of it and of determined constants.

Separate equations express the total revenue derived from the power transmitted, the cost of the power generated and delivered, the value of the energy used in transmission and the annual conductor expense.

The last named is of course a constant with all values of the current, since  $R$  is determined by our hypothesis and the gross revenue from the transmission varies directly with the value of  $I$ ; the other two elements of the cost of the transmission show varying values, and the sum of all the elements of cost gives two points at which the total cost equals the total revenue, with a well-defined maximum point of economical distribution.

It is important to notice the wide range through which the net income is approximately a constant; this points at once to a difference between the maximum net income and the maximum percentage of profit, the latter of which is reached at a much smaller value of the current. The curve  $P$  at the upper left-hand corner of the figure presents the variations in the percentage of profit with values of  $I$ , the same as in the lower curves.

The equations from which this construction has been derived may now be presented separately. As we vary  $I$  the equation for the gross revenue is  $E_2Itw_2$ , the cost of energy generated and transmitted is  $E_1Itw_1$ ; hence the cost of the total energy generated is equal to  $E_1Itw_1 + I^2Rtw_1$ , since the energy used in transmission decreases the net revenue by the amount of  $I^2Rtw_1$ . Lastly, the annual conductor cost is a constant, equal to  $d^3Bl$ , from which we obtain the net revenue equal to

$$E_2Itw_2 - (E_1Itw_1 + I^2Rtw_1 + d^3Bl) = \\ E_2Itw_2 - E_1Itw_1 - I^2Rtw_1 - d^3Bl.$$

Differentiating and equating to zero we have the following equation for the value of  $I$  to make the net revenue a maximum:  $E_2tw_2 - E_1tw_1 - 2IRtw_1 = 0$ , from which the value of  $I$  is readily derived.

This equation gives also the relation  $E_2Itw_2 - E_1Itw_1 = 2I^2Rtw_1$ , or the maximum value of the net income in any transmission when the values of the resistance of the line and

the electro-motive force delivered are fixed is at such a value of the current that the gross income, less the cost of the energy generated and delivered, equals twice the value of the energy used in the transmission; or that transmission is the most economical in which one-half the difference between the selling price and cost of the energy is equal to the value of the energy used over the line.

When the source of energy is limited in extent and the transmission furnishes power to devices of a definite character, we have to solve the problem of the most economical current and line for a transmission in which the value of the electro-motive force delivered and energy generated are fixed.

Now, if  $E_s$  and  $P_s$  are constant, then we have for  $I$  a variable

$$E_s I = P_s, \quad E_s = \frac{P_s}{I}$$

$$R = \frac{E_s - E_g}{I} = \frac{P_s}{I} - E_g = \frac{P_s - E_g I}{I}$$

From which we can derive  $d^2$  by the equation

$$d^2 = \frac{LM}{R} = \frac{LM}{\frac{P_s - E_g I}{I}} = \frac{LMI^2}{P_s - E_g I}$$

The equation for the net revenue derived from the transmission is  $P_s tw_s - [(P_s tw_s - I^2 R tw_s) + I^2 R tw_s + d^2 BL]$ .

Expanding by substituting the values obtained above for  $P_s$ ,  $R$ , and  $d^2$ , we arrive at the following equation involving only  $I$  and constants:

$$E_s I tw_s - P_s tw_s + \frac{P_s - E_g I}{I^2} I^2 tw_s - \frac{P_s - E_g I}{I^2} I^2 tw_s - \frac{L^2 MBI^2}{P_s - E_g I}$$

or,  $E_s I tw_s - P_s tw_s + P_s tw_s - E_s I tw_s - P_s tw_s + E_s I tw_s - \frac{L^2 MBI^2}{P_s - E_g I}$

Differentiating and equating to zero, we get the equation for the value of  $I$  to make the net revenue a maximum:

$$E_s tw_s - E_s tw_s + E_s tw_s - \frac{2L^2 MBI(P_s - E_g I) + L^2 MBI^2 E_s}{(P_s - E_g I)^2} = 0,$$

or  $2E_s tw_s - E_s tw_s - \frac{2d^2 BL}{I} - d^2 BL \frac{E_s}{(P_s - E_g I)} = 0.$

$$E_s I (tw_s - \frac{1}{2} tw_s) = d^2 BL + d^2 BL \frac{E_s I}{2(P_s - E_g I)}$$

It is at once seen that this value for the maximum net revenue is not identical with the minimum expense of transmission, for which the differential equation would be

$$E_2 tw_2 - E_1 tw_1 - \frac{2^2 L^2 MBI (P_1 - E_1 I) + L^2 MBI^2 E_1}{(P_1 - E_1 I)^2} = 0.$$

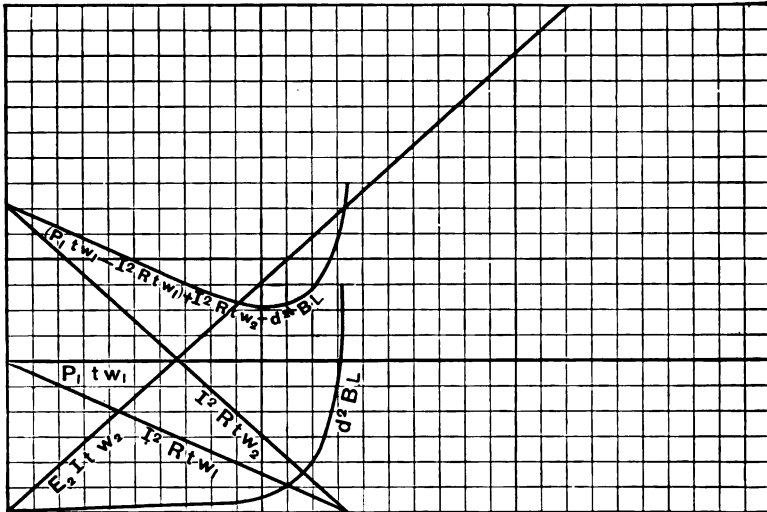

FIG. 7.

Hence

$$E_2 (tw_2 - tw_1) = \frac{2d^2 BL}{I} + d^2 BL \left( \frac{E_1}{P_1 - E_1 I} \right)$$

$$I^2 R (tw_2 - tw_1) = \frac{2dBL (E_1 - E_2)}{E_1} + d^2 BL$$

$$I^2 R (tw_2 - tw_1) = 2dBL \frac{E_1}{E_2} d^2 BL.$$

Neither of these equations present the solution with the same clearness that the graphic construction of Fig. 7, in which we see clearly the meaning of the difference between the maximum net revenue and the minimum cost of transmission, since the maximum net revenue occurs when the curve of transmission cost becomes parallel to the line  $E_1 tw_1$ , while the minimum cost of transmission is at a much earlier point of the curve when it is parallel to the axis of  $X$ .

It has already been noticed that a transmission in which the values of  $E_1$  and  $P_1$  are fixed is identical with that in which  $I$  is the only constant, and the economy is therefore determined by Kelvin's solution.

Considering  $R$  as our principal constant, the cases of  $R$  and  $I$ ,  $R$  and  $E_1$ , and  $R$  and  $P_1$  have already been investigated. If  $R$  alone is fixed, we see at once that since the annual cost of transmission is equal to  $I^2Rtw_1 + \frac{LMBI}{R}$ , that the greatest economy is obtained by making  $I$  as small as possible and giving  $E_1$ ,  $I$  or  $P_1$  the largest possible value: hence no maximum of economy is attained below the highest practical values for the power and electro-motive force generated.

In a like manner the remaining possible cases of transmission are all solved in determining the current by considerations foreign to the question of the most economical cost of transmission, and using the line to carry the current so determined as given by the conditions of Kelvin's law.

In each case it is obvious that the cost of transmission varies directly with the value of the current, which points to the economy in the use of a high electro-motive force.

There is included in this conclusion transmission in which either  $R$  and  $P_1$ ,  $R$  and  $P_2$ ,  $P_1$  and  $P_2$ , or  $P_1$  are considered as having constant values.

It has been incidentally pointed out in the discussion of the possible cases of transmission here treated that various solutions of each case would be admissible on other bases of economy than those which have here been used. The lowest possible cost of transmission will in general give a different result from that which has been obtained by the determination of the maximum net revenue, while equally well we might obtain a maximum value for the percentage which the net gain bears to the amount of capital used in the installation; or again we might determine the maximum value of the ratio of the net gain to total amount of capital annually used in the transmission.

These four cases of economy may be represented as follows:

1. For the least possible cost of transmission obtain the value of  $I$  or  $d^2$ , which makes  $I^2Rtw + d^2BL$  a minimum.

2. For the greatest net revenue obtain the value of  $I$  or  $d^2$ , which makes  $P_1tw_1 - (P_1tw_1 + I^2Rtw + d^2BL)$  a maximum.

3. For the greatest percentage gain on capital involved obtain the value of  $I$  or  $d^2$ , which makes

$$\frac{P_1tw_1 - (P_1tw_1 + I^2Rtw + d^2BL)}{d^2 \frac{BL}{p}} \text{ a maximum.}$$

4. For the greatest percentage gain on the total amount of capital annually involved obtain the value of  $I$  or  $d^2$ , which makes

$$\frac{P_1tw_1 - (P_1tw_1 + I^2Rtw + d^2BL)}{P_1tw_1 + d^2 \frac{BL}{p}} \text{ a maximum.}$$

The method of the graphical solution for each of these cases is of the same type as the examples already given, and therefore it is not necessary that they should be more distinctly indicated.

The solution in any particular case on the basis of either of these methods presents no great difficulty by either the differential equation or the graphical diagram provided, only that care be taken to assign to each factor its true value in terms of revenue or cost, all factors which decrease the possible revenue being calculated in terms of revenue, while those which simply increase the cost of transmission being considered accordingly.

## CHAPTER IX.

### MULTIPLE ARC DISTRIBUTION.

WHILE it is always necessary to use wires of sufficient size to prevent overheating with the required current, the ultimate size of wire for carrying a definite current may be determined by reference to the relation between the cost of the energy used in transmitting the current to the annual line cost, when the wires form such a part of any circuit that their size does not influence the regulation, as is the case with the feeders or with the wires in a series circuit. But in a multiple arc circuit, where the distribution of potential to the various lights is partially determined by the size of the wire, it is generally necessary to determine the wire size on the basis of the allowable fall of potential over the wires of the circuit. This is true of all wires leading from distributing points at which the potential is maintained constant, and includes those wires which have been called subfeeders, mains and service wires.\* Obviously the fall of potential to any particular translating device is determined by the resistance of the subfeeders, mains and service wires carrying current to it, but is independent of the resistance of the feeders, since the E. M. F. at the feeding points may be maintained constant and the variation of potential as the load changes throughout the system is determined for any one translating device by the changes of current in the mains and service wires supplying it. We have therefore to consider in any wiring system both the ultimate fall of potential from a distributing point to a translating device, determined by the resistance of the wires, and the variation of potential at that device, which is determined by the variations of current in the

\* Page 146.

various wires, the extreme variation being within limits set by the ultimate fall of potential, since this amount is the amount of the greatest possible variation. Since, therefore, the constancy of the potential at one point depends upon the resistance of the wires from the distributing points to the point in question, and upon the currents carried by the wires having this resistance, the condition of perfectly even distribution of potential and no variation can only be obtained when independent wires of equivalent resistance are laid to each translating device from the nearest distributing point; but as this can rarely be accomplished with economy it is necessary to allow a variation of potential between different devices and at each particular device, which may be accomplished by subdividing the system as far as may be economically allowed, and by approaching as near as possible to an independent system.

The possible subdivision of circuits in approaching an independent system is determined largely by the configuration of the system in its relation to the load carried on the different wires, those systems admitting the greatest extent of subdivision in which the loads are heavy and radiate in many directions from the point of distribution, since in such cases many wires may be installed without unnecessarily increasing the cost of insulation and installation, but where loads are light and located along one or two lengths from the distribution center, the greatest subdivision would entail the use of many small wires, each one separately insulated, and the cost of the circuit would be greatly increased. Consequently, in attempting to obtain an even distribution of potential over a circuit, we must only subdivide to the extent that the load carried will allow the use of wires of a reasonable size. In a subdivided circuit, beginning at the points of distribution where the potential is maintained constant for all loads, and to which feeders from the generating plant are run, subfeeders are laid to "distribution centers" along the mains, while from the mains are carried service wires to each collection of lights for which the average distance from the mains is nearly constant. The "distribution centers" at which the mains are fed are points for which the distribution moments over the main between points of distri.

bution reduce to zero, the "moment of distribution" about a center being defined as the product of the current at each service point into the resistance of the main from the center, or approximately the product of the currents at each service point into the length of the main to the center. The distribution center may thus be considered as analogous to the point of application of the resultant of a series of parallel forces acting at different points along a straight line, the values of the currents representing the forces and the resistances of the main to the service point distances along the line; or it may be considered as analogous to the center of gravity of a bar of length proportional to the resistance of the main and weighted proportionally to the values of the current at the service points. The value of these analogies consists in the instruction they give for determining the distribution center of any main, since it may be found by any method for obtaining the center of gravity of a similar system or the point of application of the resultant of a series of parallel forces, the distribution center being found from either end of the main by summing the products of the currents and the resistances of the main and dividing this quantity by the sum of the currents,

$$\frac{\sum IR}{\sum I} = \text{resistance of main to distribution center ;}$$

but since before the main is laid out the resistances are unknown, we may obtain the approximate feeding point by dividing the sum of the products of the currents into their distances along the main by the sum of the currents, and the distance from the end of the main to the feeding point will be equal to

$$\frac{\sum II'}{\sum I'}$$

In the case of branching mains, as for a distribution to a section of a town, it is better to consider the currents as a series of parallel forces applied to an irregular body and obtain the distribution center by separately obtaining the resultants of each straight section of the main and subsequently determining the total resultant and point of application from the various resultants of the straight sections.



As, for example, in a territory in which services are led to a branching main at the points  $A, B, C, D, E, F, G, H, I, K, L, M$ , we would first obtain the resultant point  $A'$  for the loads  $A, B, C, D$ ;  $B'$  for the loads  $H, F, G, I$ ;  $C'$  for the loads  $A', E, B'$ ;  $D'$  for the loads  $K, L, M$ ; and the final point  $E'$  for the loads  $D', C'$ , according to the following calculation :

$$AA' = \frac{ab \times B + ac \times C + ad \times D}{A + B + C + D}$$

$$HB' = \frac{hf \times F + hg \times G + hi \times I}{H + F + G + I}$$

$$B'C' = \frac{b'e \times E + b'a' \times A'}{B' + E + A'}$$

$$KD' = \frac{kl \times L + km \times M}{K + L + M}$$

$$D'E' = \frac{d'c' \times C'}{D' + C'}$$

In the case where the load is variable at different times along the main, the correct feeding point will obviously vary in position at different times as the load varies in the different parts of the circuit. In such a case, when it is possible to determine the loads at different times or for periods of time, the true feeding point may be obtained by solving for the various distribution centers at the different times and determining the point for which the moments of the ampere hours reduces to zero, considering the products of the loads and times at the different distribution centers as forces and the distances between them as lengths, which will give a new distribution center, correct for the average time of supply.

If, for example, the currents  $I_1, I_2, I_3, I_4$  are fed during the times  $t_1, t_2, t_3, t_4$  from the feeding points  $A, B, C$  and  $D$ , the distances between  $A$  and  $B$ ,  $A$  and  $C$ , and  $A$  and  $D$  being  $l_1, l_2, l_3$ , we obtain the true feeding point  $X$  by the equation

$$AX = \frac{I_1 t_1 l_1 + I_2 t_2 l_2 + I_3 t_3 l_3}{I_1 t_1 + I_2 t_2 + I_3 t_3 + I_4 t_4}$$



and in general the distance of the average distribution center from any point is equal to

$$\frac{\sum Il}{\sum I}$$

This system of calculation, which has been explained in its application to the several feeding points of a main, may be employed in determining the accurate location for the main feeders in any system, and hence the distribution points at which the potential is maintained constant—the solution of the wiring problem for any system, involving first the determination of the main feeding points or distribution points, which will give the location and lengths of the different mains to be subsequently subfed at their distribution centers from these constant potential points in the system. The sizes of the subfeeders and the mains, together with the service wires, obviously determine the total fall of potential, while this total amount must be apportioned in different parts of the circuit to give a minimum variation of potential with any given total fall; the total fall being fixed on a basis of what may be considered as a good working potential for the lamps, the variation allowed being determined by a desire to render the delivery of power at a steady potential.

The general specification for a lighting system as shown in good practice being that the maximum fall of potential from the feeding points to the ends of the service shall not be more than 5 per cent, while a maximum variation of more than 3 per cent is not considered good practice. In order to obtain the minimum variation at any particular translating device, it is necessary to allow in each wire, whether main, subfeeder or service wire, carrying the current a proportion of the total loss of potential inversely proportional to the total variation in the current carried in each individual wire. Commonly we find the rule stated that the loss in subfeeders should be taken at 3 per cent, the loss in mains at 1.5 per cent and the loss in service wires at 0.5 per cent, making a total loss in the system of 5 per cent. This assumes that the variations in demand are greatest in the service wires and least in the subfeeders, an assumption generally correct in town distributions or in resi-

dence-lighting circuits, but which can never be assumed without previous knowledge of the probable variations in the system considered, as it is quite as likely that the variations should be opposite to those considered and in consequence that the best service would be obtained by reversing the order of the proportionate losses. The correct method of proportionating the losses in the different parts of the circuit consists in obtaining, either by an assumption from knowledge of probable use or by experience in similar systems, a load curve for each wire, from which the variation can be determined and the proportionate losses properly located. The labor of obtaining an exact curve of the load is unnecessary, as the maximum variation in the wire is the determining factor, the loss being chosen, as we have already stated, in an inverse proportion to the variation in lighting. Thus, for a city block or for an office building where the current in the mains and subfeeders rarely reaches full load or falls to zero, and where such variations are frequent in the service wires, the greatest loss should be allowed in the subfeeders and mains; but in such a plant as might be considered for stage lighting, the services at many different parts of the stage will from time to time be used only under full load, while the load in the subfeeders and mains will continually vary, and in consequence the most satisfactory distribution will involve the greatest loss in the service wires of such a plant, with a loss as small as possible to be allowed in the subfeeders and mains.

In the preceding pages we have pointed out in detail the method to be followed in planning a constant-potential system in order that the maximum allowable fall of potential and the extreme advisable variation of E. M. F. may not be exceeded. The steps to be taken may be recapitulated as follows:

1. The main feeders, from the generating plant to the most convenient distribution points, are laid of such a size that the total expense per year for copper and energy of transmission shall give a maximum financial economy, the feeding points themselves being largely determined from the configuration of the system with a view to the convenience of distribution.
2. Over the territory to be supplied, from feeding point to

feeding point, mains are laid of such a size that the fall of potential from the feeding points to the distribution center shall be within the limits chosen for this part of the circuit, the calculations being performed as though the mains were cut at each distribution center, since we see by plotting the fall of potential

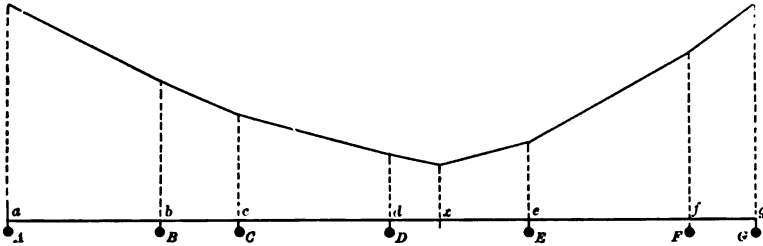

FIG. 2.

between two adjacent feeding points, that the distribution centers are points for which the fall of potential in both directions is the same, and in consequence they are points in the circuit at which there is no flow of current along the main, as, for example (Fig. 2): Let there be a main,  $AG$ , carrying loads  $A, B, C, D, E, F, G$ , at the points,  $a, b, c, d, e, f, g$ , with the distribution center at the point  $x$ . Then for the point  $x$

$$(xd \cdot D + xc \cdot C + xb \cdot B + xa \cdot A) - (xe \cdot E + xf \cdot F + xg \cdot G) = 0$$

and

$$xd \cdot D + xc \cdot C + xb \cdot B + xa \cdot A = xe \cdot E + xf \cdot F + xg \cdot G;$$

but if the wire is uniform the distances may represent the resistance of this length of the circuit, and the two members of the equation will represent the E. M. F. fall from the point  $x$  if it is the feeding point, and the E. M. F. rise when we have  $a$  and  $g$  as the feeding points. In consequence, since the E. M. F. rise or fall from  $x$  is the same in both directions, no current will flow along the main at the point  $x$ , and the wire may therefore be cut at this point without disturbing the flow of current along the wire, which fact allows its calculation in two sections, from the points  $a$  and  $g$ . From this it is also seen that as this distribution center is the point of the lowest potential of the main, it is the proper point for a connection of a

single feeder, should only the section *ag* be considered. It is also the proper point for the connection of an additional sub-feeder from one of the main feeding points, should such an auxiliary wire be necessary.

3. From the service points along the mains the secondary wires to the translating devices are run as a new "feeder and main" system calculated according to the same method. The drop to each section of this new feeder and main system being proportioned in such a manner as to give the least possible variation of potential at any translating device, the difference being that while in the original construction the feeding points are actually maintained at a constant potential by regulation at the station, the new feeding points on the secondary system can only be assumed to have a constant potential, which is true within the limits set by the calculations which have preceded.

No account has here been taken of any possibility of reducing the E. M. F. variation by the manner in which the feeders are connected to the mains, or that in which the translating devices are connected to the services, which, as we will see, has a very great influence on the potential distribution of the system. In order to discuss this question we divide all possible systems into two classes, according as the translating devices are to be operated together or are to be considered as independently operated, the difference between the two classes being that in the first the variation of E. M. F. is to be considered as the variation between different devices at any one time; while in the second case the variation at any one device is dependent upon whether the other devices are in operation or not, and is different at different times. In either case the distribution considered depends upon both the manner of connection and the sizes of the wires used.

As regards the manner of connection to any circuit, we may connect the (+) or (-) wires from the generating plant at the same end of the circuit when we call the connection "parallel," or we may feed at opposite ends, a connection which is said to be "anti-parallel." In either of these two methods of connection we may use conductors of a uniform size, or at each translating device the size of the conductor may be varied in

proportion to the load carried, when they are said to be "graduated." In the simplest case, where all the translating devices are operated together, the feeding parallel and the conductors graduated in proportion to the current carried, the fall of potential between the translating devices will be uniform from one end of the circuit to the other, and the total fall of potential at the last device equal to the fall between any two, multiplied by the number of devices. If, now, these graduated conductors be reversed and fed from opposite ends on the anti-parallel system, the various translating devices will all be operated at the same potential, since the sum of the total fall of potential over the two wires, by which any one device is fed, must necessarily be constant.

Using uniform wires and feeding both from the same ends of the circuit, on the parallel system, the fall between devices will gradually decrease as we pass toward the end, since, while the resistance is proportional to the distance between devices, the current carried is continually decreasing, the total fall being at first rapid and finally small in amount. Should this same system of uniform wires be fed anti-parallel, the fall will be greatest at the distribution center and least at the two ends. With uniform loading, the value of the fall at the center being equal to

$$\frac{RII}{4},$$

$R$  being the resistance of the wire per unit length  $I$  the current per unit length, and  $l$  the length of the main.\* The case of uniform loading is, however, very special, and in consequence it is rare that this simple formula is exactly applicable.

It is thus seen that anti-parallel feeding with graduated conductors is the best method for the connection of devices to a circuit when the translating devices are all operated together, and it is also the best method for connecting feeders under a similar condition.

From the accompanying diagram (Fig. 3) the relative fall under these different conditions with the same weight of copper and loading may be readily seen, the fall being in each case

\* Abbott, "Electrical Transmission of Energy," p. 420.

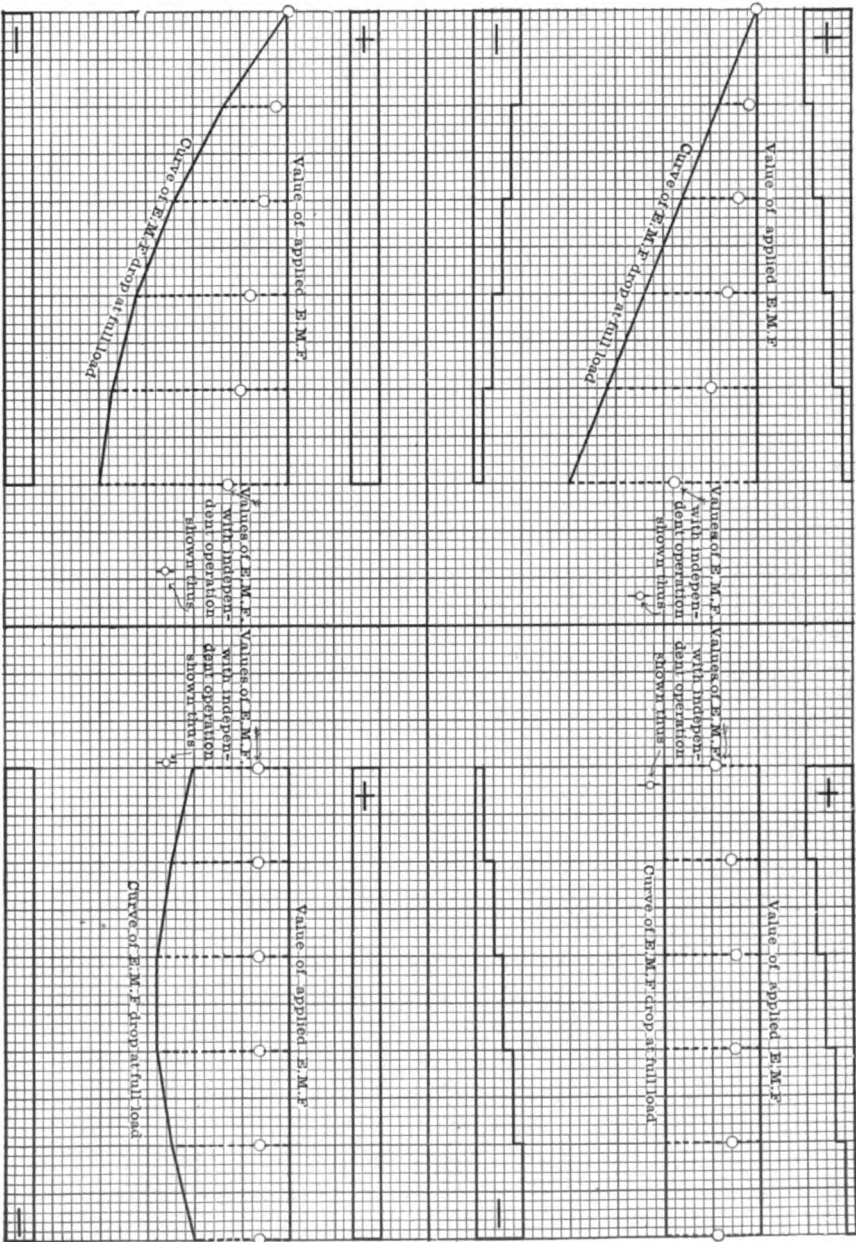

FIG. 3.



along the line marked "curve of E. M. F. drop at full load." In the same figure the points marked "values of E. M. F. with independent operation" show the fall at each device when they are operated one at a time. By comparing the E. M. F. at full load and with independent loading at each device we are also able to compare the E. M. F. variation obtained by the use of the various systems in either case of parallel or anti-parallel feeding. Graduated conductors give the best feeding, since the variation of potential at any one point is less by their use than with uniform conductors. But we also see that where but one translating device is to be operated at a time, uniform conductors give the least variation between the different devices, and in consequence the advantage to be derived from the use of graduated conductors is not great unless the total load is heavy and the variations of the current carried are extreme, and we conclude that the conductor to be used must be chosen with reference to the total current carried and to the probable variations of loading along the circuit, the extra expense entailed by changing the size of the conductor to produce graduation being only warranted where the currents are large and liable to extreme variation.

In planning any system of wiring it is obviously always advisable to provide for a reasonable demand for extensions and alterations, which makes it rare to find any plant operated at full load continuously, and in consequence it is admissible to calculate the wiring for the total fall required and the proper variations of potential according to the data given by the condition of probable loading, even though it may be but a small proportion of the total load which may be carried on rare occasions; but by no means should any circuit be installed which is not heavy enough to transmit the full possible currents without overheating, and where the E. M. F. variation is determined for a fraction of the full possible load the heating at full load must be very carefully considered.

For circuits of no great length, where the maximum current per foot of wire is large, as in a residence or office building, or a theater, the condition that the wires should be sufficient for the full possible current generally demands conductors of such a size that the maximum fall of potential and the

extreme variation with the probable load are well within the demands of the translating devices, and in such cases when the wires are installed of sufficient size to carry the maximum possible current, it is only necessary to check the values of the fall and variation under the assumed conditions of probable loading. This may be done readily by determining the probable current per foot of circuit, and in order to facilitate such a method of checking, the following table is given for the length of circuit (one half the length of the conductor) to give one volt drop when concealed wires are loaded to their full carrying capacity :

CURRENT PER FOOT AND LENGTH OF CIRCUIT TO GIVE ONE VOLT DROP WHEN LOADED TO FULL CARRYING CAPACITY.

Size Wire, B. & S. Gauge.	Kennelly's Formula.		National Electrical Code.			
	Length of Circuit.	Current per Foot.	Rubber.		Weatherproof.	
			Length of Circuit.	Current per Foot.	Length of Circuit.	Current per Foot.
No.	Feet.	Amperes.	Feet.	Amperes.	Feet.	Amperes.
0000	57	3.	48	4.4	32	9.7
000	56	2.5	45	3.9	31	8.4
00	51	2.4	42	3.6	29	7.6
0	48	2.2	40	3.2	27	6.8
1	46	2.	37	2.9	26	6.
2	45	1.6	35	2.6	24	5.5
3	42	1.4	33	2.3	23	4.8
4	39	1.3	31	2.1	21.5	4.3
5	36	1.2	29	1.9	21	3.7
6	34.5	1.15	27	1.7	19	3.4
7	33	.95				
8	30	.85	24	1.4	17	2.7
9	29	.74				
10	27	.67	20	1.2	15	2.1
11	25	.61				
12	24.5	.52	18.5	.92	13.5	1.7
13	24	.45				
14	23.5	.39	16	.75	12.5	1.3

Where the distribution is over an extensive circuit, and in consequence the current per foot of circuit small, the consideration of the allowable loss generally overbalances the question of heating, and in such cases the wires are calculated to give the proper voltage loss and checked for heating by the allowable current at full load. But, as we have said, where the circuits are short and heavily loaded, the opposite procedure is more general.

We have here given all the steps necessary in the determination of the sizes of wires and the location of feeding points in any circuit, though it is not intended to infer that the actual procedure laid down is at all times necessary. Practice often enables an engineer to decide upon the correct feeding points and the proper proportion of the total fall over the various wires, as well as upon the true methods of connecting wires, without the labor of definite calculation ; but it is only by the application of the principles that have been here laid down that a correct system of distribution can be obtained, whether or not the actual numerical calculations are performed or used in planning a system. Where a correct circuit is determined by inspection, it must be inferred that experience has enabled the application of these principles without the labor of many otherwise necessary numerical determinations.

## CHAPTER X.

### ALTERNATING-CURRENT-LINE CALCULATION.

THE methods of connecting translating devices to the lines and the principles of distribution for regulation are the same when alternating currents are used as have been described for direct-current circuits, though it must not be forgotten that Ohm's law no longer applies. Ohm's law deals only with steady values of current and applies after all effects of self-induction or capacity are eliminated, and, in consequence, to calculate the direct-current line we deal only with currents, electro-motive forces and resistances.

In calculating alternating-current lines the effects of self-induction and capacities of both lines and translating devices must also be taken into account, which renders the calculation more difficult and complicated. The fact that the character of the translating devices must be considered is especially important to remember, as it is often the custom to assume that calculations based solely on the properties of the lines are sufficient to enable one to determine the regulation of any system of circuits. While this assumption results in a comparatively simple solution of the problem, it cannot be too carefully understood that such calculations are entirely erroneous and delusive.

For the true solution of this problem it is necessary to know the periodicity of the current, the self-induction and capacity of the translating devices, the self-induction and capacity of the lines in addition to the current, electro-motive force and resistance in order to make correct calculations of the regulation or electro-motive-force drop and the effect of the load on the action of the generating apparatus.

The exact calculation of these quantities and the applica-

tion of the line capacity and self-induction as distributed over the whole line may be performed, as has been shown in the works of Maxwell, Heaviside, Kennelly and Pupin, but the operations involved are too difficult and cumbrous for ordinary use.

A simpler calculation has been introduced by Steinmetz, who considers the line capacity as being located as a load at either one point on the line or at several points in subdivisions representing the effects of distributed capacity and calculating the electro-motive-force change, step by step, at each one of these points, but for long lines the resulting operations are laborious and confusing.

The simplest and most practical method is that presented by the author in conjunction with F. C. Baum, which is here reproduced.\*

Only one assumption is made that is not absolutely correct: The charging current per unit length of line is the same at all points of the line.

The error involved in this assumption can be very easily determined. The rise in voltage, with receiver circuit open, over a transmission line about 60 miles in length and about 30 inches between wires, is about 1 per cent: at 60 p. p. s.; the percentage rise being practically independent of the voltage applied to the line. The percentage rise in voltage varies, as will be shown, practically as the square of the length of the line and the square of the frequency. For the same frequency there will be a rise of about 4 per cent over a line 120 miles long. This means, of course, that the charging current per unit length of line will be 4 per cent greater at the receiver than at the generator. The percentage rise in voltage, if this extra current be taken into account, will be *less than*

$$\epsilon < 4\% (1 + .04) < 4.16\%;$$

that is, the error made is less than .16 of 1 per cent of the line pressure. The error will reach 1 per cent when the transmission line has a length of about 200 miles.

\* The Use of Aluminum Line Wire and some Constants for Transmission Lines. F. A. C. Perrine and F. G. Baum, *Trans. Am. Inst. Elec. Eng.*, May 18, 1900.

Aside from the above the regulation of step-up and step-down transformers and generator enter the calculations for the regulation of the system, and since the self-induction of these is usually several times larger than the self-induction of the line and is known only approximately, it is needless to strive for great accuracy in the line calculations.

From the above considerations it will be evident that for an open-circuited line the charging current may be considered the same at all points of the line.

Before entering in detail into the question of the application of the quantities, self-induction and capacity, it is useful to inquire more carefully into their calculation and action. And primarily, as we are to assume that the line capacity effects the same results as though there were definite condensers connected to the lines at particular points in place of being distributed over their entire length, we must first ascertain the system of connection of these condensers.

When but two wires are under consideration, there is but one possible method of connection, but in a complicated network of conductors the connections may be made in a number of ways.

In order to determine the correct connection, a three-phase line with the wires arranged at the corners of an equilateral triangle was experimentally investigated. This case permits a crucial test, since in such an arrangement there is a central or neutral point to which one may assume the condensers to be connected when they are said to be in "star" connection, and the charging current of one wire will be equal to  $\frac{2}{\sqrt{3}}$  times the charging current of a single-phase line for the same length, voltage and distance between the wires. Should the condensers be not so connected they must be connected directly between the wires or in "delta," when the charging current on one wire will be  $\sqrt{3}$  times the charging current of a single-phase line of the same length, voltage and distance between wires.

A number of experiments have been made to determine this question, with the result that in every case the capacities

obtained experimentally agreed with the assumption of star connection, or, in other words, the *capacities of a network of conductors were found to be equal to the capacities which would be obtained by assuming the line capacities as concentrated and connected between the wires and the neutral point of the network.*

The determination of this fact greatly simplifies the calculation and results, as we will see in some extremely valuable and simple general propositions.

In calculating the capacity of a condenser, the plates are assumed charged with equal and opposite quantities of electricity and the potential difference between the plates is calculated ; the capacity of the condenser being defined as the ratio of the quantity of electricity on one of the plates to the difference of potential between them.

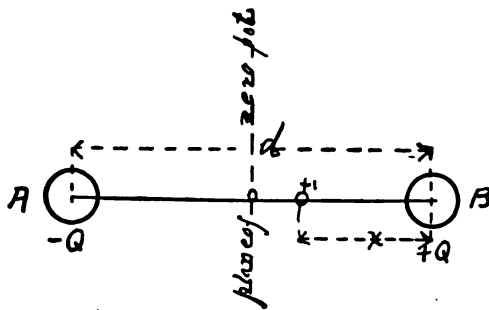

FIG. 1.

Take, first, the simple case of two wires suspended in free space (Fig. 1). Charge wires with  $+Q$  and  $-Q$  units of electricity per unit of length of line. The potential difference between wire A and B may be found by moving a unit quantity of electricity from the surface of A to the surface of B, or, since there is a plane of zero potential midway between A and B, we may move the unit charge from  $o$  to the surface of B. This will give the capacity between B and the mid-plane.

The force acting on the unit quantity at the distance  $x$  from B is

$$F = -\frac{2Q}{x} - \frac{2Q}{d-x} \dots \dots \dots (1)$$

Multiply by  $-dx$  and integrate between the limits  $x = \frac{d}{2}$  and  $x = r$  ( $r =$  radius of wire). We get

$$\begin{aligned}
 V &= \left[ 2Q \log x \right]_r^{\frac{d}{2}} - \left[ 2Q \log (d-x) \right]_r^{\frac{d}{2}} \\
 &= 2Q \log \left( \frac{d}{2} \right) - 2Q \log (r) - 2Q \log \left( \frac{d}{2} \right) + 2Q \log (d-r) \\
 &= 2Q \log \left( \frac{d-r}{r} \right) \dots \dots \dots (2)
 \end{aligned}$$

Or, since for aerial lines  $r$  is small in comparison with  $d$ , we have  $V = 2Q \log \left( \frac{d}{r} \right)$ , and the capacity in electro-static units between  $B$  and the mid-plane per unit length of line is

$$C = \frac{1}{2 \log_e \left( \frac{d}{r} \right)} \dots \dots \dots (3)$$

The total potential between the two wires is

$$V = 4Q \log_e \left( \frac{d}{r} \right),$$

and therefore the capacity between the wires

$$C_{ab} = \frac{1}{4 \log_e \left( \frac{d}{r} \right)} \dots \dots \dots (4)$$

Applying our experimental determination of the connection in a network to this case we find a capacity of

$$C = \frac{1}{2 \log_e \left( \frac{d}{r} \right)}$$

between each wire and the neutral line as represented in Fig. 2.

From the above proof it follows that in calculating the capacity of different systems the following general proposition



may be made regarding the work done in moving unit quantity of electricity from one point of an electrostatic field to

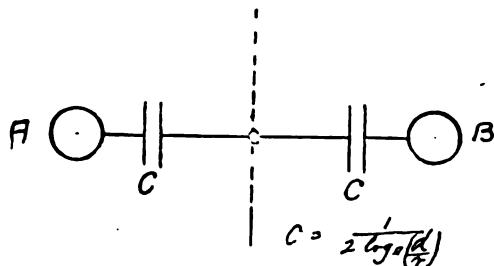

FIG. 2.

another, the field being due to a charged wire, the wire being considered infinite in length :

*The work done in moving unit quantity of electricity from one point of an electric field to another against the force due to a charged wire is equal to twice the quantity of electricity on the wire times the logarithm of the ratio of the initial to the final distance of the unit charge from the wire. If there are several wires in the field the algebraic sum of all the terms formed as above will give the work; the sign of each term is determined by the sign of the quantity of electricity on the wire in question.*

As an illustration of the above let us find the effect of the earth on the capacity of two wires distanced  $h$  above its surface (Fig. 3). Move the unit quantity of electricity from the surface of  $A$  to  $B$ . The work done against the force due to  $A$  is

$$- 2Q \log \left( \frac{r}{d} \right) = + 2Q \log \left( \frac{d}{r} \right); *$$

the work done against  $B$  is

$$+ 2Q \log \frac{d}{r};$$

the work done against  $A'$  is

$$+ 2Q \log \left( \frac{2h}{\sqrt{(2h)^2 + (d)^2}} \right) = - 2Q \log \left( \frac{\sqrt{(2h)^2 + d^2}}{2h} \right);$$

\* This should be  $- 2Q \log_e \left( \frac{d-r}{r} \right)$ , but  $r$  may always be neglected in comparison with  $d$  for aerial lines. This assumption is made throughout the chapter.

the work done against  $B'$  is

$$- 2Q \log \left( \frac{\sqrt{(2h)^2 + d^2}}{2h} \right).$$

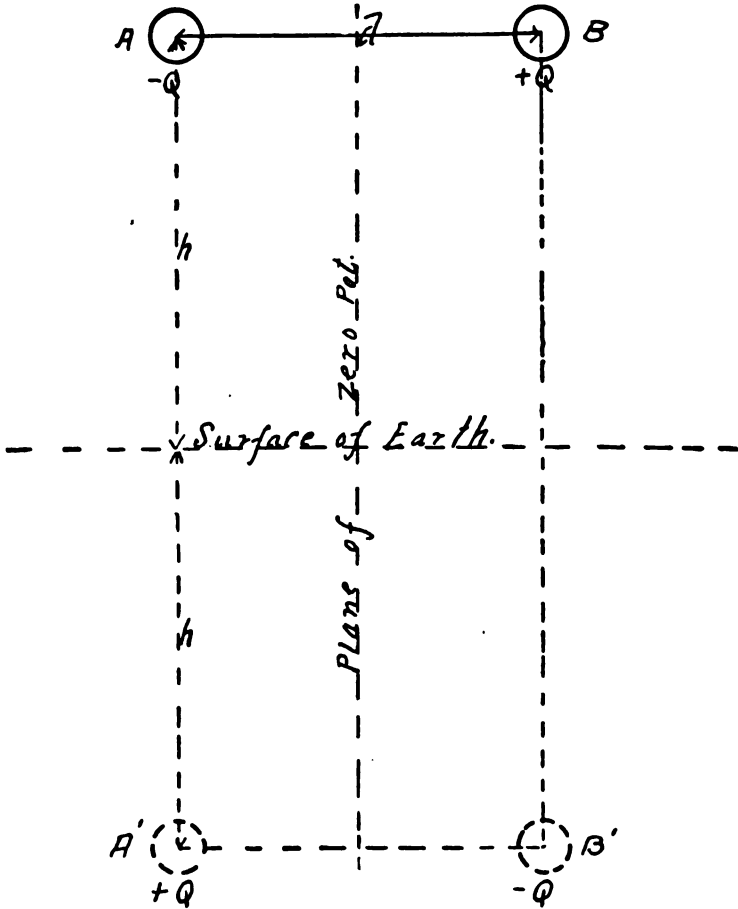

FIG. 3.

The potential between  $A$  and  $B$  is the sum of the above four terms; this gives us

$$V = 4Q \left[ \log \left( \frac{d}{r} \right) - \log \sqrt{1 + \left( \frac{d}{2h} \right)^2} \right], \text{ giving}$$

$$C = \frac{1}{4 \left[ \log \left( \frac{d}{r} \right) - \log \sqrt{1 + \left( \frac{d}{2h} \right)^2} \right]} \dots \dots \dots (5)$$

As will be seen by comparing with equation (4) the influence of the earth on the capacity of aerial lines may be generally neglected.

Whenever the wires of the circuit are symmetrically placed with respect to a plane, this is a plane of zero potential ; whenever the wires are placed symmetrically with respect to a line, this will be a line of zero potential. It is assumed in the above that there are no other wires very near the wires of the circuit. In such cases—practically all transmission lines—it is usually simpler to calculate the capacity between one wire and the plane of zero potential or between one wire and the line of zero potential.

Three-phase transmission lines are usually arranged with the wires on the corners of an equilateral triangle ; this arrangement gives a line of zero potential at the center of the triangle. For this case we may calculate the capacity between one wire (*A*) and the center point *O*, Fig. 4. The instantaneous quantities of electricity on wires *A*, *B* and *C* will be  $Q \sin \omega t$ ,  $Q \sin (\omega t - 120^\circ)$  and  $Q \sin (\omega t - 240^\circ)$  respectively. With the aid of the

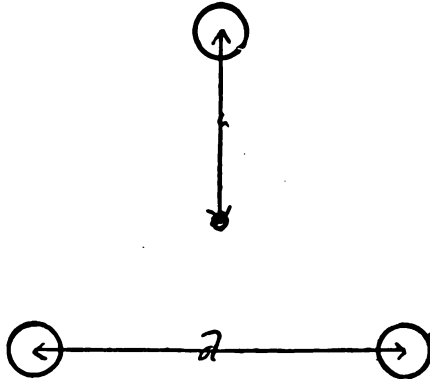

FIG. 4.

above corollary, calculate the work done in moving unit charge from *O* to *A*.

This gives

$$V = 2Q \sin \omega t \log \left( \frac{a}{r} \right) + 2Q \sin (\omega t - 120^\circ) \log \left( \frac{a}{d} \right) + 2Q \sin (\omega t - 240^\circ) \log \left( \frac{a}{d} \right)$$

$= Q \sin \omega t \log \left( \frac{d}{r} \right)$ ; and the capacity per unit length of line is

$$C = \frac{1}{2 \log_e \left( \frac{d}{r} \right)}$$
; the same result for *B* and *C*.

The result gives the capacity arranged as in Fig. 5, which agrees with experiment.

TABLE IV.  
CAPACITY IN MICRO-FARADS AND CHARGING CURRENT PER MILE OF  
CIRCUIT FOR THREE-PHASE SYSTEM.

Line E. M. F.—10,000 volts.

60 p. p. s.

Size B. & S.	Diam. in inch.	Dis- tance <i>d</i> in inch.	Capacity C in M. F.	Charg. cur. in Amperes.	Size B. & S.	Diam. in inch.	Dis- tance <i>d</i> in inch.	Capacity C in M. F.	Charg. cur. in Amperes.
0000	.46	12	.0226	.0492	4	.204	12	.01874	.0408
		18	.0204	.0447			18	.01726	.0377
		24	.01922	.0418			24	.01636	.0356
		48	.01474	.0364			48	.01452	.0317
000	.41	12	.0218	.0474	5	.182	12	.01830	.0399
		18	.01992	.0414			18	.01690	.0368
		24	.01876	.0408			24	.01602	.0349
		48	.01638	.0356			48	.01426	.0311
00	.365	12	.0214	.0465	6	.162	12	.01788	.0389
		18	.01946	.0423			18	.01654	.0360
		24	.01832	.0399			24	.01560	.0342
		48	.01604	.0349			48	.0140	.0305
0	.325	12	.02078	.0453	7	.144	12	.01746	.0389
		18	.01898	.0413			18	.01618	.0352
		24	.01642	.0379			24	.01538	.0335
		48	.01570	.0342			48	.01374	.0290
1	.289	12	.02027	.0440	8	.128	12	.01708	.0372
		18	.01952	.0403			18	.01586	.0341
		24	.01748	.0380			24	.01508	.0328
		48	.0154	.0337			48	.01350	.0294
2	.258	12	.01972	.0372	9	.114	12	.01660	.0364
		18	.01818	.0305			18	.01552	.0337
		24	.01710	.0372			24	.01478	.0317
		48	.01510	.0328			48	.01326	.0289
3	.229	12	.01938	.0421	10	.102	12	.01636	.0356
		18	.01766	.0385			18	.01522	.0329
		24	.01672	.0364			24	.01452	.0310
		48	.01480	.0322			48	.01304	.0284

BASIS OF TABLE.

$$C = \frac{1}{2 \log_e \left( \frac{d}{r} \right)}$$

in electro-static units per cm. of circuit.

$$C = \frac{0.0776 \times L}{2 \log_{10} \left( \frac{d}{r} \right)}$$

in micro-farads between one wire and neutral point for *L* miles of circuit.

202 CONDUCTORS FOR ELECTRICAL DISTRIBUTION.

$$\text{Charging current per wire} = \frac{E \times C \times 2\pi \times f \times L}{\sqrt{3} \times 10^8}$$

- $d$  = distance between wires (inch).
- $r$  = radius of wire (inch).
- $L$  = length of circuit in miles.
- $E$  = E. M. F. between wires.
- $f$  = cycles per sec.
- $C$  = capacity in M. F. between one wire and neutral point.

Charging current three-phase =  $\frac{2}{\sqrt{3}}$  (= 15.5%)  $\times$  charging current single-phase same  $d, r, L$  and  $E$ .

If the wires are arranged on a straight line and not transposed, the line of zero potential moves harmonically between the two points midway between the two outside wires. The capacities between any two of the wires may be found by the method given, the unit quantity being moved from the surface of one wire to the surface of the other. If the wires are transposed, the capacity of the line may be approximately determined by adding the capacities of the several sections. The capacity for any arrangement will not differ greatly from that given for the wires arranged as in Fig. 5. Table 4 has been prepared for convenience; the capacity in micro-farads and the charging current per mile with 10,000 volts between wires are given for a frequency of 60 p. p. s.

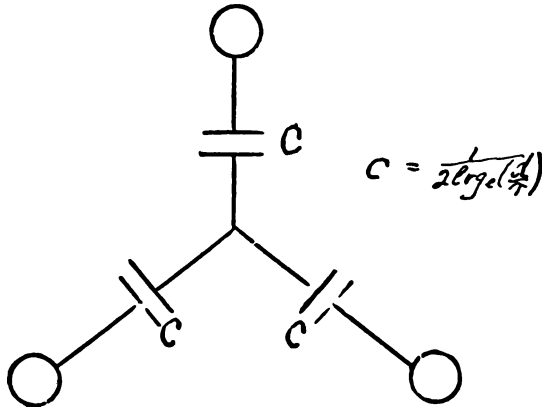

FIG. 5.

The self-induction of one wire of a three-phase circuit arranged on the corners of an equilateral triangle is usually calculated by assuming the other two wires as a return at a

distance,  $\frac{d}{3}$ . To get the inductive drop between two wires, the self-inductions are combined geometrically. A proof of this assumption is here given :

The wires are arranged as in Fig. 4, the currents in *A*, *B* and *C* being  $I \sin \omega t$ ,  $I \sin (\omega t - 120^\circ)$  and  $I \sin (\omega t - 240^\circ)$  respectively. The number of lines of force threading *AB* per unit length of line at time *t* is

$$N_{ab} = 2I \sin \omega t \log \left( \frac{d}{r} \right) + \frac{I \sin \omega t}{2} - \left[ 2I \sin (\omega t - 120^\circ) \log \left( \frac{d}{r} \right) + \frac{I \sin (\omega t - 120^\circ)}{2} \right]$$

(Wire *C* has no effect on loop *AB*.)

$$= 2 \sqrt{3} \left[ \log \left( \frac{d}{r} \right) + \frac{1}{4} \right] I \sin \left( \omega t + \tan^{-1} \frac{1}{\sqrt{3}} \right), \quad (6)$$

giving for the self-induction of *AB* for length of line *L*

$$L_{ab} = 2 \sqrt{3} \left[ \log \left( \frac{d}{r} \right) + \frac{1}{4} \right] \times L. \quad (7)$$

Table 5 gives values for  $L_{ab}$  for one mile of circuit for 66 p. p. s.

The self-induction of one wire considering the return at a distance *d* is

$$L_a = 2 \left[ \log \left( \frac{d}{r} \right) + \frac{1}{4} \right] \quad (8)$$

Equation (7) may be obtained from (8) by combining  $L^a$  and  $L$  geometrically.

If the wires forming the circuit are arranged in a straight line and transposed, each wire taking the center pin for  $\frac{1}{3}$  the distance, wire *C* will have no effect on the loop *AB*. Arranged in this way the wires *AB* will be apart a distance *d* for two thirds of the length of the line and  $2d$  for the remaining one third. The self-induction of the loop *AB* is, then :

$$L_{ab} = 2 \sqrt{3} \left\{ \left[ \log \left( \frac{d}{r} \right) + \frac{1}{4} \right] \frac{2}{3} L + \left[ \log \left( \frac{2d}{r} \right) + \frac{1}{4} \right] \frac{L}{3} \right\} \quad (9)$$

This shows that aside from the question of transposing there is some advantage in arranging the wires on the corners of an equilateral triangle.

204 CONDUCTORS FOR ELECTRICAL DISTRIBUTION.

TABLE V.

INDUCTANCE PER MILE OF CIRCUIT FOR THREE-PHASE SYSTEM. 60 P. P. S.

Size B. & S.	Diam. in inch.	Dis- tance <i>d</i> in inch.	Self-ind. <i>L<sub>ab</sub></i> Henry's.	Induc- tance <i>L<sub>ab</sub></i> × 2π × 60 Ohms.	Size B. & S.	Diam. in inch.	Dis- tance <i>d</i> in inch.	Self-ind. <i>L<sub>ab</sub></i> Henry's.	Induc- tance <i>L<sub>ab</sub></i> × 2π × 60 Ohms.
0000	.46	12	.00234	0.884	4	.204	12	.00280	1.057
		18	.00256	.967			18	.00300	1.133
		24	.00270	1.015			24	.00315	1.189
		48	.00312	1.178			48	.00358	1.351
000	.41	12	.00241	.910	5	.182	12	.00286	1.080
		18	.00262	.989			18	.00307	1.159
		24	.00277	1.046			24	.00323	1.220
		48	.00318	1.201			48	.00356	1.344
00	.365	12	.00248	.937	6	.162	12	.00291	1.098
		18	.00269	1.016			18	.00313	1.182
		24	.00285	1.076			24	.00329	1.243
		48	.00330	1.246			48	.00369	1.393
0	.325	12	.00254	.959	7	.144	12	.00298	1.125
		18	.00276	1.042			18	.00310	1.204
		24	.00293	1.106			24	.00336	1.269
		48	.00331	1.250			48	.00377	1.423
1	.289	12	.00260	.983	8	.128	12	.00303	1.144
		18	.00281	1.061			18	.00325	1.227
		24	.00308	1.125			24	.00341	1.288
		48	.00338	1.276			48	.00384	1.450
2	.258	12	.00267	1.008	9	.114	12	.00310	1.171
		18	.00288	1.088			18	.00332	1.253
		24	.00304	1.148			24	.00348	1.314
		48	.00314	1.299			48	.00389	1.469
3	.229	12	.00274	1.035	10	.102	12	.00318	1.201
		18	.00294	1.110			18	.00340	1.284
		24	.00310	1.171			24	.00355	1.340
		48	.00351	1.335			48	.00396	1.495

BASIS OF TABLE.

$$L_{ab} = 2 \sqrt{3} \left[ \frac{\log \left( \frac{d}{r} \right)}{0.434} + \frac{1}{4} \right] = \text{self-induction in C. G. S. units for loop } ab \text{ (pec. cm.).}$$

$$L_{ab} = 0.000558 \left[ 2.303 \log_{10} \left( \frac{d}{r} \right) + .25 \right] L \text{ in henrys.}$$

Inductive drop in loop  $ab = L_{ab} \times 2\pi \times f \times I$ .

$d$  = distance between wires (inch).

$r$  = radius of wire (inch).

$L$  = length of circuit in miles.

$f$  = cycles per sec.

$I$  = current in one wire.

For self-induction of one wire divide  $L_{ab}$  by  $\sqrt{3}$ .

REGULATION OF TRANSMISSION LINES.

The question of the regulation of the system for possible power factors is important. Knowing the probable power factor of the load the line-drop may be calculated, thus determining the amount.

Having now determined the capacity and self-induction of any line by the principles explained above, it now becomes necessary to explain the method of applying these quantities in the calculation of any particular case of regulation for which it is desirable to solve.

Especial attention is called to the fact which has already been stated in part, that we here prove that with satisfactory practical accuracy we may represent the capacity of any line, up to at least 200 miles in length, as concentrated and applied at the center of the line.

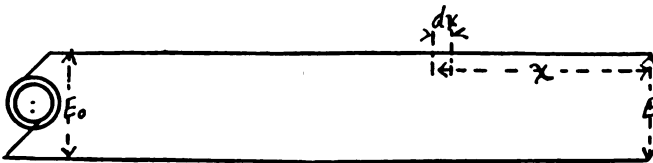

FIG. 6.

In Fig. 6 let

- $r$  = resistance per unit length of line.
- $l$  = self-induction per unit length of line.
- $c$  = capacity " " " " "
- $i$  = charging current per unit length of line.
- $E_0$  = E. M. F. at terminals of generator.
- $E$  = receiver E. M. F.
- $\omega$  = frequency.  $\times 2\pi$
- $L$  = total length of line.

The charging current crossing the element of line  $dx$  at distance  $x$  from the receiver is

$$i_x = + E_j c x \omega$$

( $+j$  is an operator to show that the current is  $90^\circ$  in advance of the pressure).

The E. M. F.  $de$  consumed by the element of line  $dx$  is (receiver open-circuited)

$$de = + j E c \omega x (r + j l \omega) dx . . . . . (10)$$



Integrating this between the proper limits we get

$$\begin{aligned} \epsilon &= +j\frac{ix^2}{2}(r + jl\omega) \\ &= +j\frac{ix}{2}(rx + jl\omega) \\ &= +j\frac{I_c}{2}(R + jL\omega) \dots \dots \dots (11) \end{aligned}$$

In the last equation  $I_c$  is the charging current,  $L$  is the self-induction, and  $R$  is the resistance of the total length of line.

From equation (11) we see that if the charging current were the same for each unit length of line it would be mathematically correct to assume the line capacity concentrated at the center of the line, that is, at the center of gravity of the capacity load.

The percentage rise of potential will be practically equal to

$$\epsilon = \frac{C\omega L\omega 100}{2},$$

in which  $C$  is the total capacity of the line.  $C$  and  $L$  are proportional to the length of line, and hence the percentage rise in potential varies practically as the square of the length of line and the square of the frequency.

From equation (11) we get for the generator pressure

$$E_s = E + \epsilon = E + j\frac{I_c}{2}(R + jL\omega) \dots \dots (12)$$

As has been shown,  $I_c$  may be calculated by the equation

$$I_c = EC\omega \quad \text{or}$$

$$I_c = E_s C\omega$$

without appreciable error in the result of the percentage rise in pressure.

Graphically, equation (12) is as represented in Fig. 7

$$oa = E \text{ receiver.}$$

$$ab = +j \frac{I_c R}{2}.$$

$$bc = -\frac{I_c L \omega}{2}.$$

$$oc = E, \text{ at terminals of generator.}$$

Suppose, now, we consider the receiver circuit loaded, and calculate the error made by assuming the charging current the same at all points of the line. Let the generator pressure be  $p$  per cent higher than the receiver pressure, that is,

$$E_o = E \left( 1 + \frac{p}{100} \right),$$

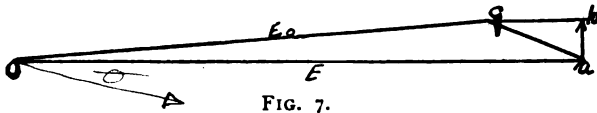

FIG. 7.

and assume that the potential along the line falls on a straight line from generator to receiver. (The true error will be less than that calculated with this assumption, since the pressure falls more rapidly at the generator than at the receiver.)

The charging current per unit length of line at a distance  $x$  from the receiver circuit will be

$$i_x = i \left( 1 + \frac{px}{L100} \right).$$

( $L$  is the total length of line;  $i$  is the charging current at receiver circuit)

Suppose the angle of lag of the receiver load to be  $\theta$ , then the total load current may be written

$$I = I \cos \theta - jI \sin \theta.$$

The current crossing the element of line  $dx$  is

$$I_x = I \cos \theta - jI \sin \theta + ji \left( 1 + \frac{px}{L100} \right) dx.$$

The E. M. F. consumed by the element of line  $dx$  is

$$de = \left[ I \cos \theta - jI \sin \theta + j\dot{i} \left( 1 + \frac{px}{L100} \right) x \right] (r + jL\omega) dx.$$

Integrating, we get for the E. M. F. consumed over the line

$$e = I \cos \theta (R + jL\omega) - jI \sin \theta (R + jL\omega) + j\frac{I_c}{2} \left( 1 + \frac{p}{3 \times 100} \right) (R + jL\omega). \quad (13)$$

The percentage rise due to charging current will be *less than*

$$\epsilon = \frac{C\omega}{2} \left( 1 + \frac{p}{3 \times 100} \right) L\omega 100.$$

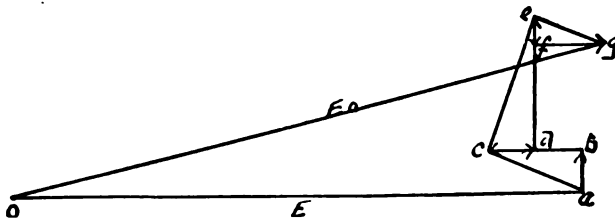

FIG. 8.

If we take  $C\omega \times \frac{L\omega}{2} \times 100 = 4$ , that is, a line about 120 miles in length, and give to  $p$  a value as high as 20—the generator pressure is 20% higher than the receiver pressure—we get

$$\epsilon = 4\% \left( 1 + \frac{20}{300} \right) = 4\% (1 + .06) = 4.24\%.$$

The error made by assuming charging current constant is about one-fourth per cent of the line pressure.

It is evident, then, that either for a loaded or unloaded line the charging current may be considered constant. Equation (13) may therefore be written

$$e = I \cos \theta (R + jL\omega) - jI \sin \theta (R + jL\omega) + j\frac{I_c}{2} (R + jL\omega).$$

The pressure at generator terminals is

$$E_0 = E + e = E + I \cos \theta (R + jL\omega) - jI \sin \theta (R + jL\omega) + j\frac{I_c}{2} (R + jL\omega).$$

This equation is represented graphically in Fig. 8.

$$ab = +j \frac{I_c R}{2}.$$

$$bc = - \frac{I_c L \omega}{2}.$$

$$cd = + I \cos \theta R.$$

$$de = + j I \cos \theta L \omega.$$

$$ef = - j I R \sin \theta.$$

$$fg = + I L \omega \sin \theta.$$

Instead of combining the current geometrically as we proceed from receiver to generator we see that we may consider

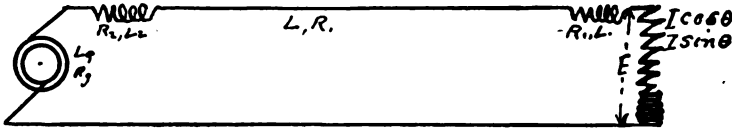

FIG. 9.

each component of the receiver current as flowing over the entire line impedance, and the capacity current as flowing over the impedance from the center of the line to the generator. Looking at the matter from this point of view the E. M. F. at the terminals of the generator, or the total E. M. F. generated may be at once written out for any line. Let in Fig. 9

- $R_1$  = equivalent resistance of step-down transformers.\*
- $R_2$  = " " " step-up transformers.
- $L_1$  = " self-induction of step-down transformers.
- $L_2$  = " " " " step-up transformers.
- $R_g$  = " resistance of generator.
- $L_g$  = " self-induction of generator.
- $R$  = resistance of line.
- $L$  = self-induction of line.

\* It is customary to convert all pressures to equivalent full-line pressure. If  $r_1$  is the resistance of primary transformer and  $r_2$  the resistance of the secondary, the equivalent resistance  $R_1$  is calculated by the formula

$$R_1 = r_1 + r_2 n^2, n \text{ being the ratio of transformation.}$$

The equivalent self-induction of transformers is determined from the ohmic pressure-drop and the short-circuited regulation.

Also let

$$\begin{aligned}L_t &= L_1 + L_2 + L_r + L. \\R_t &= R_1 + R_2 + R_r + R.\end{aligned}$$

The E. M. F. generated is

$$\begin{aligned}E_g &= E + I \cos \theta (R_t + jL_t \omega) - jI \sin \theta (R_t + jL_t \omega) \\ &\quad + jI_c \left[ \left( \frac{R}{2} + R_2 + R_r \right) + j \left( \frac{L}{2} + L_2 + L_r \right) \omega \right]. \quad (14)\end{aligned}$$

The figures representing this will be similar to Fig. 8. Each component current is represented by the pressure triangle corresponding to the impedance over which that current flows. That is, each component current may be considered as producing the same effect as though no other current flowed over the line. The advantage of this way of looking at the matter is that we see by a glance at the equation or the figure how a change in any component current will affect the pressure relations of receiver and generator. To illustrate this, let us assume the load to remain constant and determine how the generator pressure must vary to give constant receiver pressure for any change in power factor of the load.

The charging current remains constant; therefore the triangle  $ABC$ , Fig. 8, does not change in magnitude or position. Since the load is assumed constant, the value  $I \cos \theta$  is constant and consequently the triangle  $CDE$  does not change. The only variables are  $I$  and  $\sin \theta$ . We have, however,

$$EI \cos \theta = W \text{ (a constant),}$$

$$I = \frac{W}{E \cos \theta},$$

and

$$I \sin \theta = \frac{W \tan \theta}{E}.$$

The triangle  $EFG$  always remains similar to triangle  $CDE$ . The point  $g$ , therefore, moves on the straight line  $eg$  (if the load current is leading,  $eg$  must be drawn in the opposite direction) for variable power factor. The length  $eg$  increases directly as  $\tan \theta$  and is drawn at right angles to  $ce$ .





In Fig. 12 suppose

$$I \cos \theta(R_t + jL_t\omega),$$

which is proportional to the power intake of the motor, is represented by the triangle  $ce$  as full load, by  $ce'$  at average load and by  $ce''$  at no load. With  $oe'$  as radius draw with  $o$  as center the arc of a circle through  $e'$ . Then at full load the motor must be over-excited so that the length

$$cg = I \sin \theta(R_t + jL_t\omega)$$

will reach the circle. Similarly at no load the motor must be under-excited so that  $e''g'$  will reach the circle.

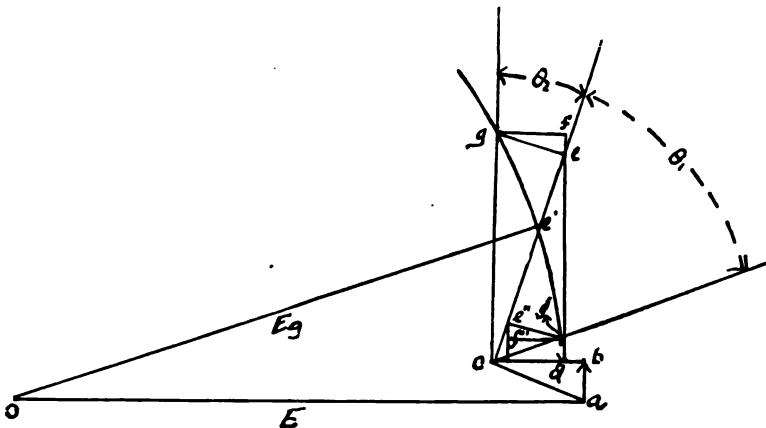

FIG. 12.

By laying off the pressure to a large scale the angles  $\theta_1$  and  $\theta_2$ , Fig. 12, by which the current must lag and lead at no-load and full-load respectively may be very closely determined. From the constants of the motor it will be possible by the aid of the synchronous motor diagram to determine the excitation for no-load and full-load to give constant receiver-pressure with constant generator-pressure. The motor may then be run as a generator and the no-load excitation set to the value determined. The current in the series field coil corresponding to full-load on the motor could next be adjusted by the series field shunt until the pressure developed by the motor as a



generator corresponded to the full-load excitation as found above. The motor would then carry its load without causing much variation in the receiver-pressure. It is necessary to know only the no-load power of the motor and the self-induction and resistance of the entire circuit, including that of the generator and motor.

By this method it is at once possible to obtain the regulation of any circuit in which we know the length and size of the circuit, the arrangement on the poles and the character of the translating devices to be attached to it either algebraically by equation 14 and its modifications, or graphically by a construction similar to Fig. 8, thus rendering the calculations for alternating current lines as direct and as readily applied as those for direct current circuits.

## CHAPTER XI.

### OVERHEAD LINES.

WHEN electrical transmission lines are run through the open country or small towns, they are generally supported overhead at the top of tall poles by insulators set on pins placed in cross-arms. This construction affords an easy and cheap means of providing for the satisfactory conduction of the electricity by supporting the wires at such a height above the ground that they are free from probability of disturbance, thus avoiding interference with surface traffic, while at the same time a good value of insulation is maintained under all variations in atmospheric conditions. In some cases it might be possible to substitute underground wires for this class of construction, but only at a greatly increased cost and increased static capacity, both of which would interfere with economy in extensive transmissions. The greater cost of the underground wire rapidly diminishing the extent of commercially successful transmission and the increase of static capacity multiplying enormously the engineering difficulties of transmission with variable currents. The insulation and permanence of underground lines are undoubtedly greater than can be obtained by any overhead system of construction, but at the same time engineers should not consider that pole lines completely sacrifice insulation and stability to the sole advantage of cheapness, for it is not necessary to do so when lines are properly designed and constructed.

Four elements have to be separately considered in the engineering design of any overhead line. First, the line must be properly located in relation to the surface of the ground and neighboring obstructions, whether natural or artificial; second, the supports must be calculated to safely withstand the strains produced by the line itself and by atmospheric influences;

third, the insulators must be adapted to the voltage carried and the atmospheric conditions to which they are subjected; fourth, the wire must finally be so installed that uneven strains along the line are not produced, and the wire itself at no point or at no temperature excessively strained.

In choosing the proper location of an overhead electric line, the territory to be traversed must be considered in respect to convenience and contour, straightness in direction, freedom from interference with neighboring structures, and the possible infringement of the rights of adjoining property owners; the survey made and the location chosen involving the consideration of each of these questions separately. In some cases the right of way for an electric line may be secured along a railway, canal bank or turnpike road by contract with the company which has already secured the property from the original owners of the right of way, and as the rights of adjoining property owners have already been settled in such cases, the problem of location thus becomes exceedingly simple, although these rights are not altogether without importance, except where the line is located on the property of a railroad or canal company. Absolute property rights being rarely vested in the supervisors of county roads or the owners of turnpikes, their powers only extending to the use of the road for the definite purposes of traffic, this question of the rights of adjoining property owners is one of very great delicacy and one demanding extreme judgment on the part of those securing the desired right of way, especially as the statutes governing road rights differ greatly in the various parts of the country, and at the present time are very generally in a transition stage. Many new laws have been introduced during the past few years tending to diminish the rights of adjoining property owners, and to throw the control of the roads more and more in the hands of the supervisors and boards of public works, but as these laws are as yet untested in the higher courts, and seem often to infringe old legal precedents, it is a defect in policy to presume too much upon their rulings or attempt to entirely ignore the ancient vested rights. This is especially true on account of the fact that while the new laws have defined more particularly the powers of those maintaining the road for traction purposes, they are not clear

on the question of interference between electric lines and trees or artificial structures erected by the adjoining property owners. In consequence any attempt to interfere with these, without the consent of the owners, may easily result in expensive lawsuits carried to the highest courts, which will ultimately define the rights clearly, though it is impossible to assume that such definition will be invariably against the interests of property owners and in favor of the line constructor, as, while additional power in the hands of those maintaining the roads may not be considered as a new "servitude" on the right of way by the courts, the use of this right of way for an altogether different purpose than the convenience of traffic may be so considered, and ruled to be illegal.

Where it is necessary to consider these property rights, either on account of possible tree trimming or interference with artificial structures, and where it is desired to run the lines over lands not traversed by roads, it is generally possible to secure from the owners separate specific contracts which will insure future non-interference, defining the rights of both parties, and, at the same time, the cost of such contracts will be very inconsiderable when compared with the expense of possible occasional lawsuits.

In general, the compensation demanded for the rights granted to the line constructors will be merely nominal, and oftentimes the furnishing of some slight service may economically cover all demands and insure the coöperation of the property owners in the maintenance of the line; such a compensating service as that furnished by building telephone lines between neighbors having been found in many cases to be a sufficient remuneration, and one which at the same time enables the property owners to signal concerning accidents to the line, and otherwise aid in its maintainance. Of course, it may be easily imagined that the demands for a right of way would exceed a reasonable amount, and in such cases the regular legal condemnation of property may be contemplated, or the direction of the line may be changed to avoid those making unreasonable demands; all of which points to a demand for great tact on the part of those securing the right of way which must be obtained at the least possible cost, and under contracts which will be

stable for a long time in the future. Indeed, the compensation here spoken of does not contemplate anything beyond what is ordinarily granted by the transmission company where a right of way is secured on the property of a railroad or canal company, since this is only given by the company in consideration of some specific service for signaling or for furnishing power, though in these cases the service is more readily rendered by the owners of the transmission lines on account of the fact that the transportation company furnishes, in exchange for the service, inspection of the line and generally free transportation of repair material, thus rendering maintenance both more certain and less expensive.

At the time that the location of the line is being chosen and the right of way secured, a preliminary survey is also completed; this survey consisting in approximately locating the poles, noting the character of the ground, and estimating the changes of level in order that the poles and other supplies may be so delivered as to provide for proper erection without undue subsequent handling. A satisfactory line survey contemplates the smallest possible amount of unbalanced strains by reason of changes in the ground level or alterations in level or direction of the line, variations in ground level being compensated for as nearly as possible by corresponding alterations in pole heights, and greater stability at turns secured by varying the size of the poles to conform with the probable unbalanced strains in the erected line.

The supports for an aerial line through an open country consist of poles either naturally grown, sawn, or of composite structures. Trees are occasionally made use of, and in towns brackets to house walls or housetops are employed; but in general the supports are, as we have stated, poles with their butts in the ground, supporting the wires on cross-arms attached near the top. The stresses applied to a pole consist of the weight of the wire, its insulation and any adherent ice or snow inducing a compressive force, and tension in the wire due to its weight, sag or wind stresses inducing a flexing strain. In consequence any pole may be regarded as a beam loaded under the influence of these two stresses of compression and tension, the load being concentrated at one end, and the other end

being firmly fixed in the ground, the weight of the pole itself being a negligible quantity, since it tends only to increase slightly the compression strain. The forces tending to produce compression strains in any pole line are rarely of importance when the pole is sufficiently strong to withstand the possible flexing stresses, which must, therefore, be the determining quantity in the choice of the proper size of the pole for the construction of any line. We may, therefore, consider it as a beam without weight rigidly fixed at one end, and loaded at the other under the influence of a flexing stress. In order that the least material should be used in such a pole, the proper shape we know to have a parabolic section, and as the poles are either round or square the section of this is a cubic parabola \* whose equation is :

$$y = ax^{\frac{1}{2}}.$$

This exact section is impractical, and as approaching it most nearly the truncated cone or pyramid is employed, the equation of the section being

$$y = d_1 + x \frac{(d_2 - d_1)}{l},$$

where, as before,  $y$  is the diameter of any section,  $x$  its distance from the origin taken at the top of the pole,  $l$  the length of the pole and  $d_1$  and  $d_2$  the diameters at the top and bottom. Obviously the smallest value of  $y$  is at the top, when it is equal to  $d_1$ , and for any other section it is the taper  $\frac{(d_2 - d_1)}{l}$  multiplied by the distance from the top, which is  $x$ , added to the diameter at the top, or  $d_1$ . This equation will determine a pole of greater strength than the pole of uniform strength at every section  $x$  distance from the top, until the point is found where the two equations are coincident, and where the curves of the two poles are tangent. Differentiating, therefore, with respect to  $x$ , in order to obtain the values of the tangents to the two curves, we have from the first equation :

$$\frac{dy}{dx} = \frac{1}{2}ax - \frac{1}{2},$$

\* Stoney, "Theory of Stresses," 1886, p. 81.

and from the second :

$$\frac{dy}{dx} = \frac{d_2 - d_1}{l}$$

Equating the two values of  $y$  and of  $\frac{dy}{dx}$  we have two simultaneous equations determining the common point of tangency and giving the value of  $x$  for the conical or pyramidal pole, which is equal in strength to that of parabolic form, or

$$ax^{\frac{1}{2}} = d_1 + x \frac{(d_2 - d_1)}{l}$$

$$\text{and } \frac{1}{2}ax^{-\frac{1}{2}} = \frac{d_2 - d_1}{l}$$

Dividing the first by the second, we have

$$3x = \frac{d_1 l}{d_2 - d_1} + x \therefore x = \frac{d_1}{2(d_2 - d_1)} l.$$

As the origin has here been taken at the top  $x$  may equal  $l$  at the ground, and when this is assumed the conical or pyramidal section will be tangent to the pole of uniform strength at the ground line, where will be found the weakest section and the point of probable breaking. Introducing this value of  $x$  in the above equation we have

$$\frac{d_1}{2(d_2 - d_1)} = 1, \text{ and } d_2 = \frac{3}{2}d_1,$$

which gives the proper taper for any pole, whether natural grown as a truncated cone or sawn into a truncated pyramid. If the diameter at the ground is greater than  $\frac{2}{3}$  the diameter at the top, the pole will tend to break at some point below the ground line, and an unnecessarily large pole has been used; while if the diameter at the ground is less than  $\frac{2}{3}$  the diameter at the top, the pole will tend to break above the ground line, and the pole will not be as strong as should be expected from the size of the butt, which also means that the material is improperly distributed and to a certain extent wasted.

Now, having determined the proper shape of pole section,

whether naturally grown or sawn, we may more readily calculate the proper size of pole to withstand any given stress applied to its top. Treating this problem again as though we had a beam fixed at one end and loaded at the other, we have for the moment of resistance

$$M = \frac{SI}{c}$$

where  $S$  is the stress in the section,  $I$  the moment of inertia of the section, and  $c$  the distance from the center to the fiber under maximum stress. The moment of the force applied is equal to  $Pl$ , where  $P$  is the tension in the wires due to every force tending to produce tension in them.

For a circular section

$$I = \frac{\pi d_1^4}{64}$$

and  $c = \frac{d_1}{2}$ .

Equating the bending moment and the resisting moment, we have

$$\frac{SI}{c} = Pl$$

and

$$Pl = \frac{S\pi d_1^4}{64} \div \frac{d_1}{2} = \frac{S\pi d_1^3}{32}$$

or  $S = \frac{32Pl}{\pi d_1^3}$ .

For a square section  $I = \frac{d_2^4}{12}$ ,  $c$ , as before,  $= \frac{d_2}{2}$  and

$$\frac{Sd_2^3}{6} = Pl \text{ or } S = \frac{6Pl}{d_2^3}$$

But these stresses should never exceed a certain amount or proportion of the ultimate strength of the material, and in



consequence the proper tension  $P$  may be found by substituting for  $S$ ,  $\frac{T}{n}$ , where  $T$  is the tensile strength of the material and  $n$  a factor of safety, from which we have, for round sections,

$$\frac{T}{n} = \frac{32Pl}{\pi d^3}$$

$$\text{and } P = \frac{T}{n} \cdot \frac{\pi d^3}{32l},$$

and for square sections

$$\frac{6Pl}{d^3} = \frac{T}{n}$$

$$\text{and } P = \frac{T}{n} \cdot \frac{d^3}{6l}$$

$n$  is ordinarily taken in wooden structures at a value not less than ten, but this value of the factor of safety is considered to be an excessive figure in pole-line construction, though the practice is to be condemned on account of the fact that most lines have less stability than should be obtained, and this fact explains the frequent destruction of pole-line installations where the wind stress is no more than might have been anticipated.

Another reason for the weakness found in many pole lines may be explained by the uncertainty in the value of  $T$  for the material used. The timbers most commonly employed in pole-line construction are those which are readily obtained in long lengths free from knots, and which at the same time resist the action of the atmosphere and soils for a long time without the application of paint or other preservative, even though they may be impregnated with a preservative compound as an additional precaution. In this country we make most use of naturally grown poles of cedar or chestnut, the trees being cut when they are of a mature age and of a suitable size, and where sawn poles are used the timbers chosen are most generally California redwood or yellow pine from the Southern forests.

The tensile strengths most commonly accepted for these materials are as follows :

Chestnut, 7,000 to 13,000 pounds.

Cedar, 11,500 pounds.

Yellow pine, 5,000 to 12,000 pounds.

Redwood, 11,000 pounds.

Occasionally spruce and Northern-grown yellow pine are also employed, but these materials are only used where the other timbers are not available, and they are not in favor on account of the short life of the ground section. In England and on the Continent red pine from the south of France and fir from Scandinavian forests are most in favor, the tensile strengths being respectively taken as about equivalent to our yellow pine or cedar.

The tensile strengths here given have been derived from experiments made upon small sections not over three inches square and about four feet long, and as these test pieces are generally selected from clear wood they do not represent the true strength of materials when obtained in the form of long poles, particularly those which are naturally grown and not sawn.

Tredgold, Edwin Clark and others have experimented upon full-sized beam actions and have proved that the tensile strengths given above are far too high for actual practice. The tensile strengths in their experiments have been reduced from the empirical formula of Tredgold, that for round sections

$$P = \frac{K(4.7r^3)}{l}.$$

The formula we have given above for  $P$  reduced to radius gives

$$P = \frac{.7854 Tr^3}{l}.$$

Equating these two expressions for  $P$ , we have

$$\frac{4.7 Kr^3}{l} = \frac{.7854 Tr^3}{l}$$

or  $T = 6K$  approximately.

Tredgold gave for English red pine  $K = 1,341$  and  $T = 8,046$ . Using larger timbers up to twelve inches square, Edwin Clark found  $K$  to be only 810, and  $T$  to be 4,860, which was a value further confirmed by the experiments of the Mersey Dock Board on Baltic fir, and by Mr. Gavey, of the British Postal Telegraphs, on Norwegian red fir. The tests most directly applicable to pole-line construction were those reported on by Mr. Preece, of the British Postal Telegraphs, before the Aberdeen meeting of the British Association for the Advancement of Science in 1885,\* in which the value of  $K$  was deduced from the breaking tests made on a number of full-sized natural-grown Scandinavian red fir poles, both treated and untreated with preservative compound.

The value of  $K$  is found by him to vary between 1,190 and 1,484 pounds, the mean being approximately 1,300, which gives the average value of the tensile strength to be 7,800 pounds, which shows that while the strength of round timber naturally grown is not as great as might be inferred from tensile tests made upon small pieces, it is yet much greater than can be obtained by the use of sawn sections. The value of  $\frac{T}{\text{''}}$  should not therefore be used at higher values than 800 for natural-grown poles, and about 600 for those which have been sawn from large timber. Sawn poles can always be readily obtained of any specific shape, but it is impossible to secure natural-grown timber of exactly the proper taper for the maximum strength at the ground line, since, as we have already said, there is a great variation in the shape of the trees from the different forests, though the specifications for the poles should conform to the ideal shape as nearly as possible.

As an example of the change in specifications made necessary by the difference in timber we may compare American specifications of two kinds of American cedar with those for English larch, Norwegian fir and French pine poles.

It is to be noted that while these dimensions are given as diameters for the purpose of facilitating calculation, specifications are more frequently written in terms of circumference

\* *Electrician* (London), Vol. XV, page 346.

with notes concerning the maximum and minimum diameters allowed at each section.  $d_1$  is not taken at the bottom of the pole, but at the ground line, 6 feet from the base in poles longer than 30 feet, and 5 feet from the base in shorter poles.

COMPARATIVE SPECIFICATIONS FOR NATURALLY GROWN POLES.

Length in Feet.	Michigan Cedar.		Canadian Cedar.		English Larch.		Norwegian Red Fir, Light.		Norwegian Red Fir, Stout.		French Pine.	
	$d_1$	$d_2$	$d_1$	$d_2$	$d_1$	$d_2$	$d_1$	$d_2$	$d_1$	$d_2$	$d_1$	$d_2$
20	5¾	9½	5¾	9	.....	.....	.....	.....	.....	.....	4¾	6¾
25	5¾	10¾	5¾	9½	.....	.....	5	7¼	5¾	8¼	4¾	8
30	6½	11¾	6½	10¾	5	9	5	8	6	9	.....	.....
35	7½	12½	6¾	13	5½	10	5½	9	6½	10	4	9½
40	7½	14	6¾	14	5½	10¾	5½	9¾	6½	10¾	4	10½
45	7½	15	6¾	15	5¾	11½	5¾	10½	6¾	11½	.....	.....
50	7½	16	6¾	16	6	12¼	6	11¼	7	12¼	4	12
55	.....	.....	.....	.....	6	13	6	12	7¾	13	.....	.....
60	.....	.....	.....	.....	6	13½	6	12½	7½	13½	.....	.....
65	.....	.....	.....	.....	6½	14	.....	.....	.....	.....	.....	.....
70	.....	.....	.....	.....	6½	14½	.....	.....	.....	.....	.....	.....

In the consideration of the line it is not the custom to separately determine poles for different parts of the line from a consideration of the stresses applied, but a single general type of pole is chosen for the whole construction, the calculations underlying the choice of this pole consisting in the determination of sufficient strength to withstand the stresses produced by the weight of the wire, action of the wind, slight changes in direction, and other quantities easily foreseen. With the small factor of safety commonly employed the pole line so determined may not be subjected to greater stresses than those to be expected in a line reasonably straight without additional support, which must be provided whether the line changes materially either in horizontal or vertical direction. When such changes are encountered the additional stresses are distributed as far as possible over a number of poles and these strengthened either by the use of guy wires or struts. The guy consists of a strand of three or more wires fastened at or near the top of the pole and carried off in the plane of the resultant forces to a little distance from the bottom of the pole, where its lower end is attached either to a convenient tree or

to a short length of pole set in the ground, called a stub. These stubs are set, for resisting the tension in the guy wire, either at an inclination away from the pole sufficient to make their angle with the guy ninety degrees, or are set in the direction of the guy and held by a sand anchor framed into the lower end. Where it is impossible to carry the ground fastening of the guy at a distance from the pole sufficient to make the angle of the pole with the guy at least twenty degrees, the tensile strain in the guy generally becomes so great that the fastenings of the guy to the stub are unreliable, and in such cases struts are used in preference. A strut consists of a pole slightly lighter than that used for line construction, framed into the pole to be strengthened near the top and set into the ground a little way from the base of the original pole in the plane of the resultant force and in its direction so that the strut is under the influence of a compressive stress. Guys or struts are used whenever the resultant stresses in the pole line exceed the safe working load, and are rarely calculated with reference to the particular conditions, but are furnished as standard line construction material of a uniform size, as in the case of the poles themselves, the most common guy consisting of a strand of three No. 9 B. W. G. galvanized steel wires, the guy construction being much more common and used in every case where it is possible to obtain satisfactory strength by this means. When the stress exceeds but slightly the safe working stress of the pole, a single guy is attached either to the top of the pole or at the lowest cross-arm, though a stronger construction could be obtained by an attachment to the middle arm—the point of application of the resultant of all the wires. The reason that this attachment is not generally used is that when so connected the guy wire might interfere with the transmission circuits or with the working of linemen. For heavier strains additional support is necessary, and though this might be afforded by additional guy wires, it is found difficult to apply these new guys so that the strains in them will be equalized, and in preference a “Y” guy is often made use of. This guy is formed by making attachment at the top and bottom arm and uniting the two guys at a little distance from the pole into a single line which is fastened to the stub.

We have already seen that the strength of the line pole may be calculated by considering the pole as a beam fastened at one end and loaded at the point of application of the resultant of the forces from the various wires, the load inducing a compressive strain due to the weight of the wire and the vertical component of the stresses in them, together with a bending strain due to the horizontal component of all the stresses, whether those are in the wire itself or induced by wind stresses or other similar loads. When a pole is guyed these conditions are altered, the reactions in the pole being altogether different; for if a single guy is used the pole may be considered as a beam fastened at one end and supported at the other, the loads being applied at the cross-arms. A reaction at the top will now be introduced which may be resolved into two components, a tension in the guy and a compression in the pole; while at the bottom the reaction consists of a horizontal reaction solely. On account of the fact that the load is not applied at the point of attachment of the guy, there is also a bending stress due to the unequal loading which must be considered. If the pole is guyed in more than one place, as by double guys or a "Y" guy, the pole must be considered as a beam fastened at one end and supported at two points, the reactions being, as before, tension in the guy and compression in the pole; but the bending stresses are, as before, at the cross-arms, and in consequence are all located between the points of support. Applying the principles of mechanics to these cases, we are enabled to determine the equation of the curve of the mean fiber or elastic curve in the pole and to compare the relative strengths of the different classes of structures, as well as to design a pole, whether guyed or unguyed, for any particular value or distribution of the load. The equations ordinarily determined for these quantities refer to a uniform cross-section, where the moment of inertia is constant; but as this is not the case with a pole in general, and especially where a composite pole with strengthening truss is used, it is to be noted that the true design can only be arrived at by considering the pole in sections of such length. Throughout each section the moment of inertia may be considered constant without the introduction of a sensible error.

## CHAPTER XII.

### THE POLE LINE.

THE stresses sustained by a pole line may be separated into three classes: first, that due to the weight of the wire, in which is included, the weight of the insulation, and of any accompanying load of snow or sleet; second, that produced by the tension in the wire itself, which varies with the configuration of the line, both as regards the direction and the elevation; the third class of stress being that produced by the effect of the wind upon the wires, cross-arms and poles. The wind stress upon any pole line varies both with the velocity and the direction of the wind. For every different velocity there is a consequent pressure exerted always normally to the surfaces of the various parts in any structure, the amount of pressure with different wind velocities being given from the results obtained by Langley\* to be equal to  $p = 0.0036v^2$ , or  $p = \frac{v^2}{280}$ , where  $p$  is equal to the pressure in pounds per square foot of surface and  $v$  the velocity of the wind in miles per hour. From which we obtain the following relative values of pressure and velocity:

WIND PRESSURES AND VELOCITIES.

$p$	$v$	$p$	$v$	$p$	$v$	$p$	$v$
5	37.4	20	75	35	99	50	119
10	53.0	25	83.6	40	105	55	124
15	65.0	30	91.8	45	112	60	130

These are the pressures supposed to be exerted by the wind upon a flat surface set normal to the direction of the

\* "Experiments in Aerodynamics," 1888.

wind; for a cylindrical surface, as for a wire or a pole, the amount of the pressure is two-thirds of that exerted upon a flat surface of area equal to the diameter of the cylinder. As the direction of the wind varies the wind pressure is lessened; in ordinary structures the variation of pressure with the angle of the wind has been experimentally determined by Duchemin \* to equal to

$$\frac{2 \sin a}{1 + \sin^2 a} \times p_n$$

where  $p_n$  is the pressure normal to the wind at the velocity taken and  $a$  is the angle the wind makes with the surfaces. This equation, as we have said, is entirely an experimental one, and consequently can only be assumed to represent approximately the pressures upon the wires or poles of a line. This case has not as yet been experimentally treated, and in consequence it is difficult to determine the exact value of the maximum wind stress upon any pole line. The values of this stress varying between that due to wind blowing along the direction of the line normal to the poles and cross-arms and that produced by a wind at right angles to the line blowing normally upon the poles and wires. Without great error we may, however, assume that the maximum wind pressure for which calculation is necessary is that at right angles to the line, since in general the surface of the wires is much more than the surface of the cross-arms, and also the resistance to strain in this direction is much less than it is in the direction of the line; for the wires themselves connect the poles together and furnish a certain amount of support against longitudinal wind stress.

The wind pressure ordinarily allowed for in the calculation of roofs and bridges is as high as fifty pounds per square foot, but it is not found necessary to allow greater than thirty pounds on a pole line even in the most exposed positions, since the wire is not far from the ground and the velocity of the wind is moderated by ground friction. In ordinary localities, where the line is also sheltered by trees and neighboring houses, a pressure of twenty pounds per square foot has been considered sufficient, this being approximately the pressure adopted by

\* Langley, "Experiments in Aërodynamics," p. 24.



the engineers of the British Postal Telegraphs and justified by the stability of their lines through many years of working.\* These pressures do not give absolute stability in all storms, but are almost always sufficient for the value of simple wind stress, though when a line is heavily loaded with sleet and ice the surface of the wire is so greatly increased and the sum of all the stresses upon the line so much magnified that even a well-constructed line will frequently be blown down; and, furthermore, it seems impossible to allow for a wind stress upon a great accumulation of ice and snow carried by the wire, since the load that any line may be compelled to sustain under such conditions is almost indeterminate and the maximum load in this manner possible is only rarely applied. In consequence the occasional repair of a line after a great sleet and wind storm is less expensive than would be an original construction sufficient to withstand every possibility of such varying loads. The pressures upon the various sizes of pole and the different sizes of wire for the ordinary spans have been calculated and are given in the accompanying tables.

In considering the strains in a pole line produced by the wire itself we see that only in rare instances is it necessary to consider the weight of the wire and its accompanying load as producing a crushing strain in the pole, since any pole, sufficiently strong to sustain the bending strains, which are much greater than the crushing stresses, will withstand the latter more readily since the strength of the pole against crushing is much larger than its strength under flexure; an exception being made where a large number of heavy cables or lead-incased wires are supported in short spans, when the crushing strains must be taken into account. When this is the case it is to be noted that the weight applied to the pole must not only be considered as equal to the weight of the wire, its insulation, and incasing covering, but also the weight of a cylinder of ice  $\frac{1}{8}$  inch thick over the external surface of the conductor should be allowed for the accumulation of "rhime" during a sleet storm. This load during most severe storms presents the phenomenon of clinging in almost equal

\* *Electrician* (London), Vol. XV, page 348.

thickness on all sides of a suspended wire, and of being about the same thickness on all wires without regard to their size, and though much greater amounts have been observed it is rare to find a thickness greater than  $\frac{1}{8}$  inch accumulated upon a single suspended conductor.

WIND LOAD PER LINEAR FOOT (AVERAGE).

MICHIGAN CEDAR.

Length, feet.	$d_1$ inches.	$d_2$ inches.	Wind, 20 lbs. per square foot.		Wind, 30 lbs. per square foot.	
			Total distributed pressure.	Average pressure per linear foot.	Total distributed pressure.	Average pressure per linear foot.
20	5 $\frac{3}{4}$	9 $\frac{1}{2}$	167.6	8.38	251.4	12.57
25	5 $\frac{3}{4}$	10 $\frac{3}{4}$	230	9.2	345	13.8
30	6 $\frac{1}{2}$	11 $\frac{1}{2}$	300	10	450	15
35	7 $\frac{1}{2}$	12 $\frac{1}{2}$	388.6	11.1	582.9	16.66
40	7 $\frac{1}{2}$	14	475.2	11.88	712.8	17.82
45	7 $\frac{1}{2}$	15	564	12.53	846	18.8
50	7 $\frac{1}{2}$	16	654	13.1	981	19.6

WIND STRAINS ON WIRE.

No. B. & S. Gauge.	$d$ inches.	35 Poles per mile, $l = 150.8'$		40 Poles per mile, $l = 132'$		45 Poles per mile, $l = 117.3'$	
		Wind at lbs. pressure.		Wind at lbs. pressure.		Wind at lbs. pressure.	
		20	30	20	30	20	30
10	.102	17.1	25.64	14.95	22.43	13.28	19.9
9	.114	19.11	28.66	16.712	25.069	14.84	22.26
8	.128	21.45	32.18	18.76	28.146	16.67	25
7	.144	24.13	36.20	21.11	31.67	18.75	28.12
6	.162	27.15	40.73	23.75	35.62	21.07	31.64
5	.182	30.50	45.75	26.68	40.02	23.7	35.54
4	.204	34.19	52.29	29.91	44.86	26.56	39.84
3	.229	38.38	57.57	33.57	50.36	29.82	44.72
2	.258	43.24	64.86	37.82	56.73	33.59	50.39
1	.289	48.84	73.26	42.37	63.55	37.63	56.44
0	.325	54.47	81.71	47.65	71.47	42.32	63.47
00	.365	61.17	91.76	53.51	80.26	47.52	71.28
000	.410	68.72	103.07	60.10	90.16	53.38	80.07
0000	.460	77.10	116.64	67.44	111.15	59.89	89.84

The most important strain-producing factor in a pole line is that of the tension in the wire, inducing flexure. For the discussion of this tension it is necessary to determine the form of the curve assumed by a wire between the points of suspension. This curve may be a parabola if the load carried is

proportional to the span and the wire inextensible, which is the curve assumed in the calculation of suspension bridges. If the wire is considered inextensible and loaded in proportion

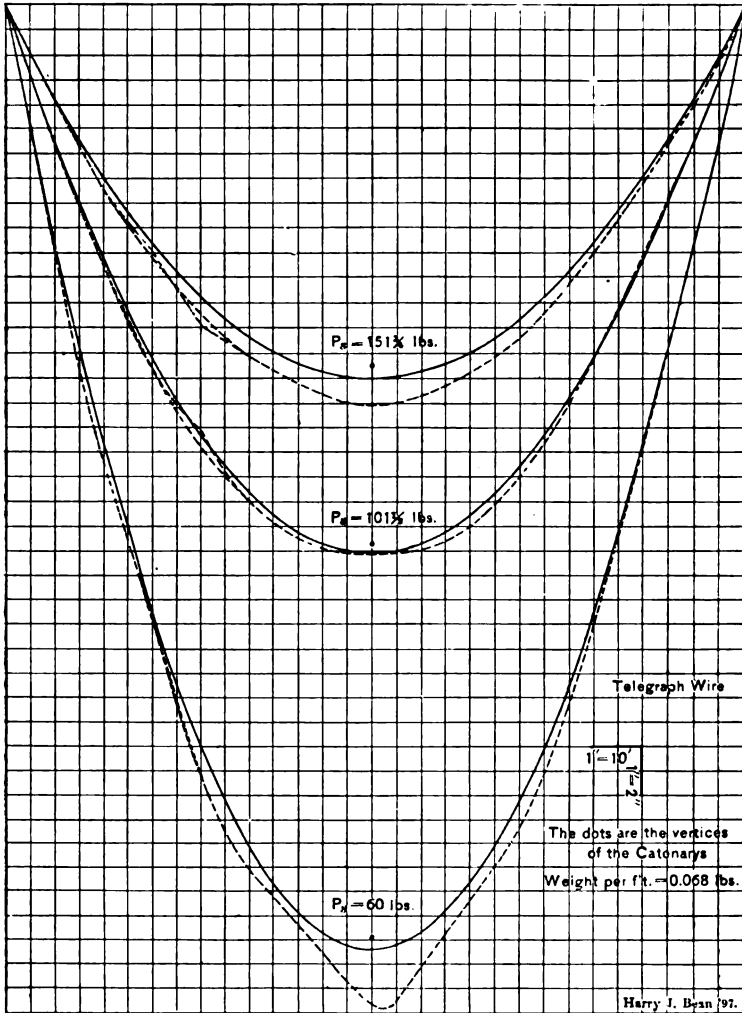

Curves of Suspended Wires by Calculation and Experiment.

to its length along the entire span, as would be the case with any suspended wire or cable, the curve will be the common catenary; but if in the same case of uniform loading along the length of the wire it is considered that the wire, which has a cer-

tain expansion coefficient, is lengthened by the strain, the curve becomes that of the extensible catenary. The last is obviously the true curve assumed by any suspended wire or cable, since no such material is ever even approximately inextensible under strain, and a complete discussion of the strains in any suspended wire would involve the use of the equation of this curve, which is exceedingly complicated and difficult to handle.

For long spans and great deflections the differences between the results obtained from a consideration of these three curves might be very great, but for ordinary work, where deflections no greater than  $\frac{1}{100}$  of the span are allowed, in order that swaying in the wind may be diminished, we find that the difference in the three curves becomes approximately negligible; and as, for deflections so slight, the load is practically proportional to the length of the span, we may without great error assume that the wire hangs in a parabolic curve. This question has been experimentally considered by the author, the results showing that small differences due to the stiffness of the wire at its points of support amount to as much as the differences between the three curves for such slight deflections. Indeed it is not even necessary to employ the complete parabolic equation for the strains in any wire, but we may, without sensible error, employ the approximate equations given by Rankine and others.

The following equations represent, to a close approximation, the strain in a suspended wire and its length for a given deflection:

$$P_k = \frac{hw}{8l}, \quad S = l + \frac{8l^3}{3l};$$

where  $P_k$  is the horizontal tension at the center of the span,  $S$  equals the length of the wire,  $l$  the span,  $h$  the deflection, and  $w$  equals the weight per unit length of wire.\*

\* The following is the solution for these equations by Rankine (see "Analytical Mechanics," p. 164). The stress diagrams at the center of any suspended chord to which vertical loads are applied proportional to the length of the span may be represented by the figure where  $h = OA$ , the horizontal tension along the chord at  $A$ ;  $r = OB$  = the pull along the chord at  $B$ ;  $P = AB$  = load on chord between  $A$  and  $B$ ;  $i = \text{angle } AOB = \text{inclination of chord at } B$ . Then,  $P = h \tan i$ ;  $r = \sqrt{P^2 + h^2} = h \sec i$ . To deduce from these formulæ an equation by which the form of the curve assumed by the chord



234 CONDUCTORS FOR ELECTRICAL DISTRIBUTION.

For the tension at either support we should add to the value of  $P_h$ , given above, a quantity equal to the weight of the can be determined when the description of the load is known. Let that curve be referred to rectangular coördinates measured from the lowest point  $A$ , the coördinates of  $B$  being  $AO = x$ ;  $AB = y$ . Then,  $\tan i = \frac{dy}{dx}$ .

Hence we obtain  $\frac{dy}{dx} = \frac{P}{h}$ , a differential equation which enables the form assumed by the curve to be determined when the description of the load is known. When the chord is loaded in such a manner that the load is proportional to the span and to the value of  $x$ , we have  $P = px$ , where  $p$  is a constant quantity denoting the intensity of the load in units of weight per horizontal length. Substituting this value in the differential equation above we have

$$\frac{dy}{dx} = \frac{px}{h},$$

which being integrated with due regard to the condition that when  $x = 0$ ,  $y = 0$ , we have

$$y = \frac{px^2}{2h},$$

the equation of a parabola whose focal distance is

$$M = \frac{x^2}{4y} = \frac{h}{2p}.$$

If the elevations  $y_1$  and  $y_2$  of the two points of support of the chord above its lowest point are given, and also its horizontal distance between its points of support  $a$ , and it is required to find the horizontal distance  $x_1$  and  $x_2$  of the lowest points of support, also the modulus  $M$ :

In a parabola,  $y_1 : y_2 = x_1^2 : x_2^2$ ;

therefore  $x_1 = a \left( \frac{\sqrt{y_1}}{\sqrt{y_1} + \sqrt{y_2}} \right)$ ,  $x_2 = a \left( \frac{\sqrt{y_2}}{\sqrt{y_1} + \sqrt{y_2}} \right)$ ;

also  $M = \frac{x_1^2}{4y_1} = \frac{x_2^2}{4y_2} = \frac{a^3}{4y_1 + 4y_2 + 8\sqrt{y_1y_2}}$ .

When the points of support are at the same level

$$y_1 = y_2, x_1 = \frac{a}{2} \text{ and } M = \frac{a^3}{16y_1}.$$

If it is required to find the horizontal tension  $h$ , we have from our previous equation

$$h = 2pM = \frac{pa^3}{2y_1 + 2y_2 + 4y_1y_2},$$

and when  $y_1 = y_2$  this reduces to

$$h = \frac{pa^3}{8y_1}.$$

In the discussion above we have used  $l$ , the length of the span,  $= a$ ;  $P^h$ , the horizontal tension,  $= h$ ;  $w$ , for the weight per foot,  $= p$ , and  $h$ , for the deflection,  $= y_1$ .

wire for a length  $h$  equal to the deflection. This quantity, obviously very small for such deflections as we are considering, may in almost every case be neglected, especially as its importance compared to the strain due to bending the wire as it sways in the wind is very slight. No method can be given for determining the effect of this bending, and it is important only in determining the specifications under which the wire should be manufactured, at which time it is necessary to assure sufficient flexibility to prevent failure from this cause.

Adding to the tension at the center the quantity  $wh$ , equal to the weight of the wire for the given deflection, we have for the tension at the support  $P_s = \frac{l^2 w}{8h} + wh$ . This equation is sufficiently simple for obtaining the value of the tension at the support, but if the deflection corresponding to any particular tension is desired, the solution is not so simple arithmetically, and accordingly it is advisable to transform this expression into one more readily handled, which may easily be done by introducing a quantity, the *ratio of deflection*  $\frac{h}{l}$ , in the following manner: From the equation above we have

$$P_s = wl \left( \frac{1}{8} \frac{l}{h} + \frac{h}{l} \right).$$

The quantity in parenthesis is for any ratio of deflection a constant for all wires and for all spans. If we write this equal to  $k$ , we have  $P_s = wlk$ , in which  $wl$  is obviously the total weight of a wire equal to the span in length, and in consequence  $k$  may be considered as the *tension per unit span weight*. The introduction of this quantity simplifies all determinations of tensions and deflections in the calculation of suspended lines, since it is possible to obtain the value of  $k$  for all reasonable proportionate deflections, and when this value is obtained we can obtain the total tension by multiplying it by the weight of the wire a span in length, and can obtain the deflection in any span corresponding to a particular value of the tension by solving the equation  $P_s = wlk$  for the value of  $k$ , and by referring to the corresponding table find the ratio of the deflection, and consequently its amount.

In the equation  $P_t = wlk$  we may substitute for  $P_t$  its value in terms of the ultimate strength of the wire and the factor of safety used, whence  $P_t = \frac{T_u}{n} = wlk$ , where  $T_u$  is the ultimate tensile strength of the wire and  $n$  is the factor of safety. The value allowed for this factor in line construction varies between 2 and 6 under the conditions when erection is being done, but, when we consider the fact that the stresses in any suspended wire vary with the temperature we see that it is possible for great changes to take place in the actual factor of safety at any instant; the maximum being when the wire is at its highest temperature, the minimum when the lowest temperature is reached. The amount of this variation is in consequence one of the most important questions to consider in calculating the strength for any given electric line, and every determination of deflection for a given span should be based upon the minimum possible factor of safety in the span rather than upon any assumed value of the strain in the wire at the time of erection. The value of  $T$  or the tensile strength of the material of any wire is often obtained in terms of the weight per unit length of wire. When this unit is taken as a mile of the wire,  $T$  is equal to  $c$  times the weight of a square inch of the material one mile long, and  $T_u$  equals  $c$  times the weight per mile of the wire considered. Substituting these values in the equation above we have

$$\frac{cw5280}{n} = wlk, \quad \text{and} \quad lkn = c5280,$$

if  $l$  is given in feet; but if the value of  $l$  is expressed in miles we have  $kn = c \frac{1}{l}$ . But  $\frac{1}{l} =$  the number of poles per mile, and for the factor of safety, using any particular material for the span, we have in consequence the simple equation

$$n = \frac{c}{k} \frac{1}{l};$$

a remarkably simple equation involving only the factor of safety, the tensile strength and density of the material, the value of  $k$  and the number of poles per mile. In using this equation it is of course necessary to determine the value of  $c$

TABLE OF VALUES OF  $c$ .

Values of $T$ in pounds.....	40,000	45,000	50,000	55,000	60,000	65,000	70,000	75,000	80,000	85,000	90,000	95,000	100,000	105,000	110,000	115,000	120,000	125,000	135,000	
Iron .....	17853.98	2.2401	2.5201	2.8002	3.0802	3.3602														
Galvanized iron ..	18746.68	2.1337	2.4004	2.6671	2.9338	3.2005														
Steel... ..	17853.98	.....	.....	2.8002	3.0802	3.3602	3.6402	3.9202	4.2003	4.4803	4.7603	5.0403	5.3203	5.6004	5.8804	6.1604	6.4404	6.7205	7.0005	
Copper.....	20371.878	1.9634	2.2089	2.4543	2.6998	2.9452	3.1906													
Bronze.....	20371.878	.....	.....	.....	.....	.....	.....	3.4361	3.6815	3.9269	4.1724	4.4178	4.6632	4.9087	5.1541	5.3996	5.6450	5.8904	6.1359	

Values of $T$ in pounds.....	20,000	22,500	25,000	27,500	30,000	32,500	35,000	37,500	40,000	42,500	45,000	47,500	50,000	52,500	55,000
Aluminum .....	Sp Gr.	2.7	6.178-54	3.24	4.05	4.86	5.23	5.67	6.08	6.48	6.89	7.29	7.70	8.09	8.91

This table is calculated on a basis of water weighing 62.425 pounds per cubic foot, the specific gravities being taken as 7.8 for iron and steel, 8.9 for copper and bronze, 10 per cent being added to the weight of iron for the added zinc in galvanized wire.



for all materials to be used, and the value of  $k$  for the given deflection ratios. If  $u$  is fixed, then the equation must be solved for the value of  $k$ , and the deflection and the total strain to be applied to the wire obtained by reference to a set of tables giving the deflection ratios for all values of  $k$ , the strain corresponding being obtained as above by the multiplication of  $k$  with the weight of the wire used whose length is equal to the span.

The quantity  $\frac{k}{l}$  which has been thus used in determining the value of  $k$  is also of importance in obtaining the length of the wire for any given span or deflection, and this is especially important, as by its use we are able to simplify greatly the application of the correction to be made in our calculations for the effects of temperature change. Dividing the second member of the equation

$$s = l + \frac{8}{3} \frac{k^2}{l}$$

by  $l$  we have

$$s = l \left[ 1 + \frac{8}{3} \left( \frac{k}{l} \right)^2 \right],$$

from which we see that for every given deflection ratio the length of arc is equal to a constant times the length of the span, the value of this constant being  $\frac{s}{l}$ , which is given by the table on page 239.

The length of arc in any given span is of but small importance in the calculation of any wire line except when the effect of temperature is to be determined. This effect is to shorten the wire as the temperature falls and to lengthen it as it rises, changing the consequent ratio of  $\frac{k}{l}$ , the value of  $k$ , and also the value of  $P$ , since for a particular wire neither the specific gravity nor the tensile strength changes materially with the change in temperature, and accordingly  $c$  and  $wl$  remain always constant. The change thus produced in  $k$  will obviously vary the value of the factor of safety, and as this quantity should never be lower than a safe quantity for any given

CONSTANTS FOR TENSIONS AND LENGTHS OF SPANS.

Ratio between deflection and span. $\frac{h}{l}$	Tension per unit span weight. $t$	Ratio of length of wire to span. $\frac{s}{l}$
I-20 = .05.....	2.550	I.00667
I-25 = .04.....	3.165	I.00427
I-30 = .033.....	3.783	I.00297
I-35 = .028.....	4.403	I.00218
I-40 = .025.....	5.025	I.00167
I-45 = .022.....	5.647	I.00132
I-50 = .02.....	6.270	I.00107
I-55 = .018.....	6.875	I.00088
I-60 = .017.....	7.516	I.00074
I-65 = .015.....	8.125	I.00064
I-70 = .014.....	8.764	I.00054
I-75 = .013.....	9.375	I.00047
I-80 = .0125.....	10.012	I.00042
I-85 = .0118.....	10.625	I.00036
I-90 = .011.....	11.261	I.00033
I-95 = .0105.....	11.875	I.00029
I-100 = .01.....	12.510	I.00027
I-105 = .0095.....	13.134	I.00024
I-110 = .009.....	13.759	I.00022
I-115 = .0087.....	14.383	I.00020
I-120 = .0083.....	15.008	I.00018
I-125 = .008.....	15.633	I.00017
I-130 = .0077.....	16.254	I.00016
I-135 = .0074.....	16.882	I.00015
I-140 = .0071.....	17.508	I.00014
I-145 = .007.....	18.131	I.00013
I-150 = .0066.....	18.756	I.00012
I-160 = .006.....	20.006	I.00010
I-170 = .0059.....	21.255	I.00009
I-180 = .0056.....	22.505	I.00008
I-190 = .0053.....	23.755	I.00007
I-200 = .005.....	25.005	I.00006
I-225 = .0044.....	28.129	I.00005
I-250 = .004.....	31.254	I.000043
I-275 = .0036.....	34.378	I.0000346
I-300 = .0033.....	37.503	I.000029
I-325 = .0031.....	40.6281	I.00002563
I-350 = .0029.....	43.753	I.0000224
I-375 = .00267.....	46.877	I.000019
I-400 = .0025.....	50.002	I.0000167
I-425 = .00235.....	50.3149	I.0000137
I-450 = .0022.....	56.252	I.0000129
I-475 = .00211.....	59.627	I.0000119
I-500 = .002.....	62.502	I.00001067
I-525 = .0019.....	65.627	I.0000096
I-550 = .00182.....	68.752	I.0000088
I-575 = .00174.....	71.877	I.00000807
I-600 = .00167.....	75.0017	I.00000744
I-625 = .0016.....	78.1516	I.00000683
I-650 = .00154.....	81.5015	I.00000616
I-675 = .00148.....	84.255	I.00000584
I-700 = .00143.....	87.5014	I.00000545

construction, the method of calculating the strain in a given wire at a particular temperature should be to assume the lowest possible factor of safety at the minimum temperature attained, and from the equation  $n = \frac{c}{k} \frac{I}{l}$  determine the corresponding value of  $k$ , which by reference to the table will at once give us a value for the quantity  $\frac{s}{l}$  at the minimum temperature,  $s$  being found by multiplying this value of  $\frac{s}{l}$  into the length of the span. For a higher temperature a new value for  $s$  may be obtained, which will change  $\frac{s}{l}$ , and again by the table the value of  $k$  for the new fraction  $\frac{s'}{l}$  will be seen as well as the value  $\frac{h'}{l}$ . Multiplying this value of  $k$  by the weight of wire equal to the given span in length will give the tension at the supports and the deflection  $h$  for this span, at the temperature of the air, will be easily obtained by multiplying the value of  $\frac{h}{l}$  by the length of the span. The value of  $s'$  at any elevated temperature is obtained by adding to the length of the wire at the minimum temperature the expansion due to the temperature change, and if we call  $\eta$  the linear coefficient of expansion of the material per degree we have

$$s' = s + s\eta(t_2 - t_1),$$

or

$$s' = s[1 + \eta(t_2 - t_1)],$$

the values of  $\eta$  being .0000120 for iron, .0000108 to .0000114 for steel, .0000172 for copper.\*

This change in the length of span will, to a certain extent, be increased by the diminution of strain reducing the elongation of the wire on account of its coefficient of elasticity, but as we have found this quantity could be neglected in determining the original dip and strain in the wire it is unnecessary

\* Church's "Mechanics of Engineering," Vol. I, p. 199; ed. 1889.

to take it under consideration at this juncture, although we find many authors make this correction for the change due to temperature, while at the same time not taking it into account in the calculation of the original strains.

By experimentally determining the value of the linear coefficient of expansion  $\eta$  from the temperature effect on suspended wires the method here described may be applied with an accuracy well within all practical limits of usefulness.

For obtaining the value of  $\eta$  in this manner it is necessary simply to suspend the wire to be examined between supports whose distance apart is known, and to observe the deflection at a number of different temperatures, taking care that the wire be suspended with enough sag at the higher temperatures to avoid stress exceeding the elastic limit at the lowest temperature to be observed.

From the value of  $l$ , which is known, and of  $h$  and  $t$ , which are observed, it is possible by elimination in the equation for  $S$  and  $K$  to eliminate and obtain the value of  $\eta$  for the particular metal under observation.

The value of the linear coefficient of expansion so obtained may be used in determining the proper deflection to be used in erecting lines of wire which shall be stable at all temperatures, and the errors in the calculation will be found to be much less than the practical errors in erection.

No complete series of values for this coefficient has ever been obtained. The results that have been obtained, however, indicate that for the stronger metals the coefficient as found in the manner described is about one-half of the true linear coefficient of expansion, while for the softer and more readily extensible metals one-third of the true value is given by such experiments.

Within these limits the value of  $\eta$  may be estimated without making an important error.\*

As an example of calculation by this method let us determine what will be the deflection and strain to be allowed in a span of No. 9 B. W. G. galvanized iron wire when the poles are spaced thirty-five to the mile. Using E. B. B. wire the

\* Perrine and Baun, "Aluminum Line Wire," *Trans. Am. Inst. Elect. Eng.*, June, 1900.

weight will be 330 pounds per mile, and the tensile strength of the material is 45,000 pounds per square inch. If we wish to allow a factor of safety of 3 at 0° Fahr. we have from the equation

$$n = \frac{c}{k} \frac{1}{l};$$

$$3 = \frac{2.4}{k} 35, \text{ or } k = 28.$$

Referring to our tables we see that this corresponds to the values  $\frac{h}{l} = .0044$  and  $\frac{s}{l} = 1.00005$ , or  $h = .66$  feet,  $P_s = 266$  pounds,  $s = 150.80754$ , since  $l = 150.8$  and  $w/l = \frac{330}{35} = 9.5$ .

If now the temperature is raised 80°, which we will assume to be the temperature of the air at the time of erection, we have  $s' = s(1 + .000011 \times 80) = 150.80754 \times 1.000088 = 150.820811$ , from which we get  $\frac{s'}{l} = 1.00014$ , which by the tables corresponds to  $\frac{h}{l} = .0071$  and  $k = 17.508$ , or  $h = 1.07$  feet and  $P_s = 166$ , which values are to be used in stringing the wire when the value of the factor of safety will be

$$n = \frac{24}{17.508} \times 35 = 4.8.$$

Attention should be called to the fact that in this example an average value of the linear coefficient of expansion has been used for want of an experimental value derived as described above, which coefficient, for the wire assumed, would have a value of .000005 approximately.

In the preceding discussion it has been assumed in the line considered that all poles are of equal length, set at a constant distance apart, the ground is perfectly level, and that the line makes no deviations either vertically or laterally. Under these conditions the equations given correctly determine the strains and factors of safety for a particular type of construction. When so erected the wire is at every point in equilibrium as

regards tension along its length, and, though of course it is greater at the poles than at the centers of the spans, the tension in the wire is the same in different spans for all corresponding points, and when once the stress at the poles has been determined for a given deflection, any number of spans may be adjusted at one time by applying the stress calculated to the end of the wire. Obviously there is then no strain on the poles in the direction of the wires produced by tension in them, since the stresses at each pole due to the spans on either side of the pole are equal and opposite; but when there are obstructions to be overcome so that the poles may no longer be set at equal distances and when the ground is uneven so that the pole heads will no longer be in a level line, unbalanced stresses may be encountered unless the special conditions are observed in the erection, and, as we should always endeavor to erect a line which is in equilibrium as regards the strains in the wires, it is necessary to consider, first, a level pole line with the poles set at unequal distances, and secondly, a line in which the pole tops are no longer level and the lengths of the spans are uneven. This should be done in such a manner that the factor of safety  $n$  and the tension at the supports  $P$ , shall always have constant values without regard to either variations in the lengths of span or changes in the level of the pole tops.

From the consideration of the two equations

$$n = \frac{c}{k} \frac{1}{l}$$

and

$$P_s = kwl$$

it is at once seen that perfect equilibrium may be obtained in a level line with variable spans by solving for the value of  $k$  in each span where the wire is of uniform size, or if the wire is of variable section perfect equilibrium will be obtained by solving these equations for the values of  $k$  and of  $w$ , when values of the deflections will be obtained which will allow both  $n$  and  $P_s$  to be constant throughout the entire line. Even though the

material in the span may be changed, it is still possible to maintain perfect equilibrium by maintaining

$$n = \frac{c'}{k'} \frac{1}{l'} = \frac{c''}{k''} \frac{1}{l''}$$

and choosing a wire of such a size that  $P_s = k'w'l' = k''w''l''$ , as, for example, if we erect a line with poles thirty-five to the mile, using galvanized E. B. B. iron wire, No. 9 B. W. G., the factor of safety being 4, and we come to a river where the span must be 528 feet, for which we desire to use a galvanized steel wire 90,000 pounds tensile strength, we have

$$n = 4, c' = 2.4, c'' = 4.8, \frac{1}{l'} = 35, \frac{1}{l''} = 10.$$

Substituting in the formula

$$4 = \frac{2.4}{k'} 35 = \frac{4.8}{k''} 10, \text{ or } k' = 21, k'' = 12,$$

from which, by reference to our table, we have

$$\frac{h'}{l'} = \frac{1}{170}, \frac{h''}{l''} = \frac{1}{95} \therefore h' = .89 \text{ feet, } h'' = 5.6 \text{ feet.}$$

No. 9 galvanized E. B. B. wire weighs 330 pounds per mile. Therefore we have

$$P_s = kwl = 199.5 = 21 \times 330 \times \frac{1}{35} = 12 \times w'' \times \frac{1}{10},$$

where  $\frac{1}{35} = l'$  in miles,  $\frac{1}{10} = l''$  in miles; solving for  $w''$  we have  $w'' = 166.3$  pounds per mile, which is the weight of a No. 12 B. W. G. galvanized steel wire, or we have found that with a constant factor of safety 4 and a constant stress at the poles of 199.5 pounds the deflections for the short spans where galvanized iron wire is used will be .89 feet, and for the long span of steel wire it will be 5.6 feet.

It is obvious that if we apply this method and maintain both the factor of safety and the tension constant for all spans it would be necessary to use either very strong wire or very small sizes where great lengths of span were encountered. But as this may at times be undesirable, it would seem that it

would be often preferable to assume the tension as the only constant, since this would still maintain an equilibrium of tensions in the line, and would furnish a greater factor of safety for long spans where a high factor of safety is certainly to be preferred. As, for example, if we use the same size of steel wire for the long span as the iron wire in the short spans, we have as before

$$P_1 = kwl = 21 \times 330 \times \frac{1}{38} = k''330 \times \frac{1}{16}, \text{ and } k'' = 6.05,$$

which, from the table, we see corresponds to

$$\frac{h''}{l''} = \frac{1}{47}, \text{ or } h'' = 11.3,$$

where the value of  $l'' = 528$  feet. In this case the factor of safety will not be 4 as previously, but will be

$$n'' = \frac{c''}{k''} \times \frac{1}{l''} = \frac{4.8}{6.05} \times 10 = 8,$$

or twice the factor of safety for the longer span than was used in shorter spans. If the deflection so obtained is greater than is allowable, an intermediate value may be obtained by using a wire of size between No. 12 and No. 9, when also the value of  $n$  will lie between 4 and 8.

In discussing the cases of spans where the pole tops are not in a level line, we should observe first that as the wire in any span is everywhere in equilibrium as regards tension in the wire, the wire may be tied to a pole at any point intermediate between its ends without disturbing its equilibrium in any way, and in consequence the pole at either end may be removed without changing the curve in which the wire would hang; as, for example, if we have a span  $AB$  supported from two poles at the extremities, the top of the poles being level, at a third point between them,  $C$  a pole may be erected and the wire attached to it without disturbing the equilibrium, and if this is done the section of the wire  $CB$  may be suppressed without interfering with the tension in the remaining section  $AC$ . Accordingly it is seen that we may erect a line with the level of the pole tops constantly changing by allowing from the line  $AB$  a deflection  $H$  equal to the deflection which would



give the proper tension in a span with level poles whose length is the length  $AB$ .

The problem of erecting a line along ground in which the level changes which shall be in equilibrium with the remainder of the line in which the spans are of a constant length and the pole heads level must be treated in two sections. First, where the spans are constant in length, but with varying levels, and second, where the spans and levels are both varying. In either case the problem resolves itself into the determination of an assumed span in which the pole heads are level and in which the wire will pass through the point of suspension of an intermediate pole. This assumed span may be either a span determined from the point  $A$ , or a shorter span  $CD$ , level with the lower point  $C$ .

In order to determine an assumed span with the correct deflection, while maintaining an equilibrium of tension in all the poles when the level is changing, let us assume that we have a line fastened to the poles  $a$  and  $b$  on level ground, and to the pole  $c$  at a lower level, the vertical distance between the top of  $b$  and  $c$  being equal to  $v$  and the horizontal distance between  $b$  and  $c$  being equal to the distance between  $a$  and  $b$ , which we shall call  $l$ . In order that the tensions on the opposite sides of  $b$  shall be the same, it is necessary that the top of  $c$  lie upon the natural curve of a wire supposed to be suspended between  $b$  and  $d$ . Where the horizontal distance  $bd$  is the length of an assumed span with an assumed deflection at the center equal to  $H$ , such that the tension at the center of the span  $bd$  would be equal to the tension at the center of the span  $ab$ . If now we choose a point  $e$  in this assumed span such that the horizontal distance between  $e$  and  $d$  shall be equal to  $l$ , the elevation of  $d$  above  $e$  will then also be equal to  $v$ , and we have two spans,  $bd$  and  $ce$ , which are coincident, and in which in consequence the tension at the center is the same, or  $P_c$ , which also is the tension at the center of the span  $ab$ . We have therefore two equations for  $P_c$  at the center of the spans  $bd$  and  $ce$  which are simultaneous, and two unknown quantities, namely, the length of the span  $bd$  and the deflection in the span  $ce$ , which may in consequence be determined from the two equations for the value of the center tension  $P_c$ , for if we



span the pole  $c$  is located. As might have been foreseen by observing that we have for the values of the span  $ce$  in the one case  $b = l' - 2l$  and in the other  $b = 2l - l'$ , which values are two equal and opposite roots of the same equation. It is to be observed that since the span  $bd$  has been calculated to have a tension at its center equal to the center tension in the normal span along the line, that the tension at the poles as the level is changing will not be exactly equal, but will differ by an amount equal to the weight of the wire for a length equal to the difference in the height of the poles, or by an amount  $vw$ , which is rarely a considerable quantity; but at the same time, while the tensions along the line are not absolutely equal, the wire has no tendency to drag up or down on the insulators, as it would have if the poles were not set with reference to the tension in the assumed span  $bd$ . The choice of the distance  $bc$  between poles as the ground level is varying and the length of the poles required depends upon the value of the deflection  $H$  found for the assumed span, since  $H$  must never be taken so great that the height of the wire at its lowest point would be too small for the convenience of possible traffic under the line, nor should the sag be ever so great as to allow the wire to sway in the wind and break under this bending influence.

These are also the considerations which determine the distance between poles on the level, where it is generally even more important to provide ample head room underneath the wires. The lengths of the normal spans, the heights of the normal spans and the pole heights and spans as the ground level is varying may be determined by the considerations which have been here explained, and when poles are set on the basis of these calculations the wire may be strained over many poles at one time and tied while it is in equilibrium without reference to changes in the ground level, and when so calculated and strung there will be no unbalanced strains tending to overturn the poles or to break their connections to the insulators by undue vertical or horizontal stresses.

## CHAPTER XIII.

### LINE INSULATORS.

IN the discussion of the pole line we have considered only its mechanical features, our attention having been devoted to the study of the best means for maintaining wires in position where they will be permanent under all atmospheric conditions, and where they will be reasonably free from all interference.

The essential point in the electrical study of this line is a consideration of the best means for cheaply preventing electrical leakage from any wire to the earth or to neighboring wires, and in consequence this subject has been one to which much ingenuity has been devoted since the earliest days of the construction of overhead lines.

In the first lines erected by Morse the insulating properties of the wooden poles were thought to be sufficient, but it was soon found that while satisfactory transmission without excessive leakage would take place during dry weather, something more than even a layer of good wire insulation was necessary when the poles and cross-arms became saturated with moisture. At first the want of additional insulation was filled by the use of small blocks of porcelain or earthenware, which could be screwed to the poles, and which supported the wires, laid in grooves or strung through holes provided for this purpose.

In the early days of telegraph working, many miles of wire were supported in this manner both in American and European construction, but it did not take long for telegraph engineers to find that this form of insulator possessed several important

defects. As long as the insulators were clean and fresh from the factory they gave perfect satisfaction in dry weather and reasonably good results when it was wet; but as soon as a layer of dust had accumulated over the surface the slightest amount of moisture would convert this dust into a conducting film and reduce the insulating properties very seriously. Furthermore, when the wires were strung through holes in the insulators the difficulty of originally placing the insulators was very great, while a broken insulator could only be replaced by cutting the wire and interrupting the service, on the other hand when the wires were simply laid in grooves they were easily thrown off during storms. Besides, these insulators gave no support when any one pole was overstrained or weakened in any way, since they simply carried the wires, which were not tightly attached to them.

The first efforts toward improvement were of the nature of attempting an increase of surface by making the insulators long, in the shape of a double hollow cone. This materially increased the length of the leakage surface, and especially maintained a reasonably dry interior, except during the hardest storms, but as no method of tying to the insulators had been provided in this form, they were soon abandoned in favor of a simple spool of porcelain held by a screw, with the wire twisted around the groove. This gave additional mechanical support to the line, and facilitated the replacement of broken insulators, but retained the defect of a ready path for leakage over the surface. In consequence the porcelain spool was soon relegated to indoor services, where it still exists in the form of the porcelain knob, which, as we know, is a satisfactory insulator for indoor construction where it will remain dry and clean. Before this insulator was abandoned, attempts were made to protect it from moisture by covering each insulator with a wooden or metallic hood of such a shape as to readily shed rain away from the point of connection between the line and the pole, and while this was effectual to prevent a drenching of the insulator during rainstorms, it did not prevent an accumulation of moisture from fog or mist on the dirty surface of the insulator, while it was especially defective in preventing a complete washing of the insulator by a drenching

rain, which from the very first was found to be one means of improving the insulation resistance of a dirty insulator. At the same time, the complete abandonment of the hood was not attempted until it was found possible to make the hood a part of the insulator itself. In consequence the next step in improvement consisted of making a porcelain or earthenware hood with two lugs, by which it could be fastened to the pole, while the wire was supported by means of a metallic pin cemented in the interior of the hood. The insulator resembled closely an inverted coffee-cup, with the wire supported by a pin cemented on the inside of the cup. This form still exists in the insulators used for supporting trolley wires, in all metallic-sheathed insulators, and in the so-called "paraffin" insulators, which are often employed where wires are entering telegraph offices. The porcelain lug, by means of which the insulator was fastened to the poles, was found to be defective mechanically, and although this was replaced by a groove and the insulator tied to the pole with a wire, the construction of lines carrying many wires was soon found to require some form of insulator which might be attached to a cross-arm. By reversing the positions of the insular support and the support of the wire, this result was accomplished. The wire was fastened in the groove around the outside of the insulator, while the insulator itself was supported by means of a pin set in the cross-arm, the pin itself being cemented or screwed into the interior of the insulator. This form is the common form of insulator employed at the present time, improvements which have been made consisting mainly in an extension of the surface, along which leakage can take place by a multiplication of watersheds, or, as they are commonly called, "petticoats."

Since the establishment of this design various materials have been employed in construction, and individual designers have changed the depth or location of the groove, and have varied other mechanical details, but it is now considered that all good designs for line insulators to be supported by pins on cross-arms adhere to the following conditions:

The material used must have high specific insulation resistance, and present a surface not readily destroyed and on which no **great** amount of moisture is condensed from dampness in

the atmosphere, while the mechanical strength, both under the influence of strains and vibratory shocks, must be as great as possible. In designing a particular form of insulator, the groove for the wire should be of sufficient depth that it will hold the wire securely in place when the wire is tied, by means of a loop or tie wire. The location of this groove should be such as to transmit the strain through the insulator to the pin, without inducing shearing strains in the body of the insulator. The form above the groove and of the outer petticoat should be such that during a heavy rain the space under the petticoat will be kept as dry as possible, while the external surface of the insulator is being thoroughly washed. The space under the petticoat should not be so narrow that a ready circulation of the air be hindered, and the insulator caused to dry slowly after being dampened by mist. Finally, as little shelter as possible should be provided for insects that seek dark places in which to lay their eggs and form their cocoons. These conditions are largely of a mechanical nature, and it is obvious that the manner of their fulfillment depends largely upon the character of the material used, since each insulating material presents certain mechanical advantages and difficulties.

The principal materials that have been used in the construction of line insulators are glass, porcelain, pottery, hard rubber, "compressed mica," and lava. Of these, rubber is only suitable when it is possible to protect it from atmospheric influences, since all forms of rubber and ebonite are found to decompose on the surface and produce an external conducting film of sulphuric acid when subjected to the influence of the sunlight, and consequently this material can only be properly employed in those insulators which have an external sheathing of iron or other metal, although when so employed rubber has the advantage of withstanding easily severe vibratory strains that might be fatal to the more brittle glass or porcelain. Furthermore, it is easier to make the connection secure between the rubber and the iron sheathing than is possible with any of the harder insulating materials.

Lava of certain especial qualities, carefully selected and tested, seems to produce good insulators, which are exceedingly tough and strong, but its use has not been very extended

on account of the fact that the lava insulator has to be machine turned from a large block of the material, and although lava works with comparative ease, the expense of this machine work is so great that its advantages are not generally considered to be commensurate with the increased cost of turned insulators.

The term "compressed mica" is a trade name for a composition of ground mica and shellac, molded under the influence of heat and pressure, the outside surface of shellac being smoothly glazed. This material has been very effectively used where great shocks are to be sustained, as for the insulators supporting trolley wires, but as the smooth shellacked surface of this material has no great weathering properties it is not thoroughly suitable for line construction unless covered by a metallic sheathing, and even in such service its insulating properties, after repeated wettings by the rain and mists, are not sufficient for it to be considered as a satisfactory material for insulator construction, except in resisting low potentials on lines subjected to great vibratory strains, where the disadvantage of the slight leakage over the surface of the insulator is more than counterbalanced by its mechanical strength.

[ The material called "pottery," which is made from common clay or hydrated silicate of alumina, from which the water of crystallization has been driven away by baking, is quite porous and only considered to be a good insulator when kept dry by means of a heavy external glaze. On this account the material is not in favor in this country, although many telegraph lines abroad are supported on pottery insulators, where it is favored on account of its great cheapness, as well as on account of the readiness with which colored glaze may be applied, different colors being preferred by different telegraph superintendents. But although, as has been said, the insulating properties are good when the glaze is intact, our engineers consider that the glaze is too readily ground off by the swaying of the wire or cracked away by carelessness in construction, for this material to be valued in the construction of insulators.

In place of pottery, glass is here commonly used, being preferred on account of its cheapness, its strength, its smooth surface and its transparency. The particular glass usually em-



ployed is a cheap form of soda glass made of reasonably pure sand, but without attempt to remove the last traces of metallic impurities. In consequence of the presence of a small amount of iron oxide, these insulators have a green color, although not of such a depth as to render them opaque.

This glass, while more deeply colored than lead glass, is much cheaper and at the same time stronger, while its surface is less hygroscopic and more enduring, both under the influence of the solvent action of moisture and the grinding action of the line wires. In this country it is considered that the transparency of glass presents a decided advantage, as in consequence of this property there are no dark recesses within the insulator, and there are, therefore, no places especially attractive to insects, whose nests and cocoons cause serious inconvenience and loss of insulation where opaque insulators are employed. In some sections of the country this property is so important that efforts are made to obtain a glass nearly white, while all over the United States the presence of vast numbers of insects is of sufficient importance to render this property of glass valuable. The principal objections to the use of glass are that the material itself is quite brittle, and the surface condenses and retains moisture more readily than that of other insulators.

By properly proportioning the size of the insulator to the strains likely to be endured along the line, the influence of the fragility is reduced to a minimum, although this is always a disadvantage where the lines are likely to be interfered with by falling wires, trees, or by malicious breaking of the insulators by stones or shot. On long transmission lines the injury from malicious influence is often of great importance, and this liability need be particularly considered where wires are run through the suburbs of a large city. If possible it would also be desirable to obtain for good insulation a material less hygroscopic than glass. It is common to consider that the hygroscopic character of the surface is of less importance in this country than the presence of insects, and until this problem shall be solved in some other manner, glass is likely to continue to be the standard material for the construction of small insulators, which cannot be made of an opaque

material without dark recesses. For heavy mechanical strains and high potentials, some of the principal objections to the use of glass are obviated in insulators made of porcelain. Porcelain is a material which consists essentially of a hard body, made by the dehydration of hydrated silicate of alumina, in which the pores are filled by a suitable glass, producing a solid non-porous substance of considerable strength and toughness. This material differs from pottery in being more dense, whiter, and less fusible, but particularly in being translucent. Indeed, many consider that the quality of translucency is the only one by means of which porcelain may be distinguished from pottery. Pottery, as we have said, is a ceramic ware, molded from paste of impure hydrated silica, containing certain amounts of free silica, lime, and iron, together with a frequent admixture of organic matter. After this is baked to drive off the water of hydration, the product is opaque and invariably porous on account of the removal of the volatile ingredients contained in the wet clay from which the ware is molded. Porcelain, on the other hand, consists partly of an almost pure silicate of alumina, but slightly hydrated, inclosed within a matrix of a hard silicate glass, the glass serving to fill up the porosities in the dehydrated silicate of alumina, and to make the material thoroughly non-absorbent. Porcelain as used in the arts, however, is not a constant material, but varies from the variety called "hard-paste" (originally invented in China) to an altogether different material discovered by the French, and called "soft-paste" porcelain. The true or hard-paste Chinese porcelain is composed of a mixture of kaolin with a natural silicious glass found in China and called Petunese, while the soft-paste consists simply of a mixture of the kaolinic clay with an artificial glass composed of niter, soda, gypsum, and salt, the proportion of kaolin to the glass being much less than in the Chinese product, and in consequence the resultant product partakes more of the character of glass in brittleness, although it is as free from porosity as is the true porcelain. Between these two are found the mixed or "bastard" porcelains, which are uncertain in character, but are all composed of kaolin, inclosed within a more or less fusible glass, and consequently varying in properties.

Porcelain insulators are rarely "thrown" on the potter's wheel from masses of clay, as was the ancient custom in ceramic manufacture, but are made by pressing the clay into a matrix by means of a die. For this purpose the clay, which has been thoroughly ground and mixed in water, is dried to the condition of a damp powder, which is then filled into the matrix and pressed into the form of the finished article by means of a die. In this method of working a minimum amount of water may be used, and in consequence the proportion of fusible material may be decreased with the result that the finished article is made more dense and tough, but at the same time it is impossible for the moisture to be entirely eliminated from the clay until it is subjected to the heat of a potter's kiln. That this process removes a very considerable amount of water from the mass is shown from the fact that the shrinkage in baking amounts to as much as a shrinkage of one-eighth in the linear dimensions. The spaces left by this water are filled by the fusion of the glass with which the kaolin is mixed. When this mass of clay is baked to drive off the water of hydration, and the biscuit thus produced is dipped into a thin paste of glaze and again fired until all the fusible material is thoroughly vitrified, the resultant insulator presents a smooth glazed surface and a body without porosity. When so manufactured, there is no doubt that an insulator is made which is tougher and stronger than any that may be made from glass entirely. Besides, the surface of the glaze, although this is indeed a glass, is found to condense water from the atmosphere much less readily than the surface of solid glass. The proper porcelain for insulation, therefore, is that in which there is only such an amount of glass present as is necessary to fill up the porosity of the dehydrated silicate of alumina, since when this proportion is attained the greatest strength consistent with non-porosity is reached. Should the amount of glass be increased beyond this point, or should a more readily fusible glass be used, the porcelain will become brittle, although it will still remain non-porous, but non-porous just as glass is non-porous, and hence without the advantage over common glass supposed to be possessed by a hard-paste porcelain. If the amount of glass present is only so much as will fill up the pores left by the escaping water as the

silicate of alumina is dehydrated, we can readily see that such porcelain has no property by means of which wide cracks in the molded clay can be filled, since at no temperature available within the pottery kiln will the mass fuse and run. We may indeed say that the glass is drawn into itself by the porous silicate of alumina through capillary attraction, and when spaces are present which are not capillary, these spaces cannot be filled. The solidity of the finished article in hard-paste porcelain manufacture depends, therefore, upon the solidity of the molded clay. Hard-paste porcelain is made of materials expensive in themselves, difficult to mold and fusible only at a very great heat, therefore the temptation to increase the amount of glass in the material and to use glass fusible at a comparatively low temperature is very great, although the material resultant from such change is found to possess the valuable properties of porcelain in a very seriously diminished degree. In consequence many of the bad results found in insulators are due to a fragility and excessively hygroscopic character caused by a degradation of the material. This degradation is exceedingly difficult to detect, since the highest experts on porcelain wares are often at a loss to determine whether the body of a finished article is hard- or soft-paste porcelain without determining its crushing strength, and, of course, a mechanical test is very hard to apply to such an irregular body as a line insulator. Even where the best materials are invariably used, certain forms of insulators cannot be molded in the matrix and die, for the reason that the clay when pressed is not a liquid body, and in consequence pressure applied all in one direction is likely to produce cleavage lines in the insulator, which are especially apt to occur where irregularities of pressure are sustained due to a variation in the thickness of the parts of the insulator. This difference in thickness of the various parts of the insulator is also a source of danger during baking, an effect of the great shrinkage already mentioned.

Another difficulty in the manufacture of porcelain insulators is found in the choice of a proper glaze. The glaze must not only present a smooth surface, but also be of nearly the same coefficient of expansion as the body of the insulator in order that minute cracks may not occur when the finished

articles are taken from the kiln and exposed to the action of the atmosphere. It is true that the glaze does not prevent leakage through the body of the insulator itself, but we depend upon it for preventing the retention of moisture upon the surface, and the nonhygroscopic character of porcelain depends, therefore, upon the character of the glazed surface, and also upon its mechanical perfection. To obtain a glaze which will not be roughened by the action of weathering and will not be worn away by abrasion from the line wire is, indeed, an impossibility; at the same time, care should be taken that these defects are not accentuated by minute cracks within the glaze itself. The proper porcelain insulator is, therefore, one which is made of hard-paste porcelain of great mechanical strength, formed so that internal cracks are not produced during manufacture, and which has been finally glazed with a thin coating of a smooth, hard glass.

The difficulties encountered in the manufacture of a porcelain insulator, due to the varying thicknesses of the parts, are overcome in certain forms by manufacturing the insulator in more than one part, the different parts being fastened together by means of cement or by means of a thick coating of glaze. This method of manufacture was attempted in the earliest history of the use of insulators, and while this may overcome certain difficulties in the manufacture, there seems to be no essential difference between the resultant multi-part insulator and that which has been properly made from one piece. In either case the insulators are found to withstand high voltages and to properly sustain the line whenever the leakage surface and the thickness of the insulator is made sufficient.

## CHAPTER XIV.

### UNDERGROUND CONDUCTORS.

FOR many years the overhead construction, so serviceable through open country, was attempted in towns and cities. Here it was successful during that period when telegraph lines were the only electrical transmission lines, but with the general introduction of the telephone, fire alarm and electric light it quickly became evident that overhead construction was becoming more and more of an inconvenience. In some cases it approached even an impossibility. The multitude of overhead wires made an unsightly network which was a source of danger to firemen and even oftentimes to the casual passer-by. Furthermore, the presence of numberless overhead wires reduced the reliability of any service, both through natural accidents and through rendering malicious interference especially easy to accomplish. As time advanced, these disadvantages continually multiplied, and were accentuated by the presence of many abandoned wires in the midst of those in actual service. These "dead" or useless wires were sometimes abandoned on account of faulty original installation, and as they were not then removed, their faulty construction made itself evident during periods of high winds by their falling on serviceable lines beneath them, oftentimes resulting in a complete disorganization of the electrical transmission systems in the greater business centers.

At the time that this interference with good service was becoming unbearable, the removal of overhead wires in large cities became the business of all, since they were marring the appearance of the streets, and even in some cases obstructing

the light in offices. Although for a time their removal was opposed by the transmission companies on account of the expense and on account of the unknown engineering difficulties, the final outcome has been that the expense was borne and the engineering difficulties met, with the general result that a more satisfactory service is now given by the transmission companies and fewer interruptions encountered than ever before. Repairs and renewals are also much more readily accomplished, although it is still an undoubted fact that the annual cost of underground lines is greater than the annual cost of overhead lines, provided the increased revenue from the continuous character of underground service be not taken into account.

This indicates that the economical limit in the burying of wires is to be found in towns of such size that the number of wires for transmission purposes installed in the streets is not so great as to produce serious mutual interference, or interference with firemen or others whose work causes them to need a clear space above the street-level. Simply the beautifying of a town will rarely compensate for the extra cost and difficulties encountered in underground construction, since the sight of the overhead wires does not become unbearable, until, at the same time, they are so numerous as to mutually interfere with each other.

Three general systems have been used for the installation of underground wires. The first and simplest is the "solid" or "built-in" system, where the wires, which are insulated thoroughly and thoroughly protected from mechanical disturbances, are buried in the ground. Secondly, we have the various "draw-in and draw-out" systems. In these systems a passageway is provided underground for insulated cables, the passageways being simply tubular holes terminated at convenient distances by large underground working boxes or manholes, all connections of the cables being effected in the manholes, the cables themselves being drawn from manhole to manhole through the ducts, in which the cables loosely lie and from which they may be readily removed for repairs. The third or "trench" system is an attempt to use the method of overhead construction in small closed trenches below the

street-level; the wires, which may be either bare or insulated, being supported on special forms of pins and insulators, thus reproducing underground the common form of overhead construction. In some favored localities underground wires may be run fastened to the roofs or sides of tunnels, but this system of construction cannot be contemplated throughout a city unless the tunnels already exist under the streets for other purposes than as passageways for the wires, since the cost of an expensive system of tunneling would be entirely prohibitory.

The simplest of the "built-in" systems are those in which each wire or cable is separately insulated and mechanically protected by some metallic covering in such a manner that it need not be feared that street disturbance will destroy the insulation. Across private grounds, where the cables may be laid and their location always indicated to workmen, this form of construction can be accomplished by the use of lead incasing pipes, provided only the lead be protected from the action of organic acids in the soil by means of a heavy coating of asphaltum held in place by a thick wrapping or braiding, but in public roads and through city streets such a method of wire installation would not be permissible, since the lead coating is not mechanically strong enough to resist even a slight amount of mechanical injury, and where independently protected cables are to be buried directly in the ground a heavier iron sheathing is then necessary.

This form of protection is accomplished in the Edison system by the use of iron pipes, and in the Siemens-Halske system by a double wrapping of iron tape. The Edison system of "built-in" conduits is especially adaptable to an extensive house-to-house distribution, on account of the fact that the lines are constructed in such short lengths as cast- or wrought-iron pipes may be made, namely, lengths not exceeding twenty-five feet. The form of conductor, insulation and protection here used permits perhaps the cheapest installation that can be accomplished in any method, but as frequent joints must be made in the conductors and pipes the final cost of the system is not low, unless from each joint there is a necessity for carrying away service wires, which is the condition encountered in a



house-to-house distribution. The conductors used in this system are solid copper rods, either circular or semicircular in section, the circular conductors being used almost exclusively for the common three-wire Edison distribution systems. These copper rods are loosely wound with jute rope and slipped dry into the iron pipes, which are then filled with a hot compound of petroleum residuum and asphaltum, the filling being accomplished at a temperature sufficient to drive away most of the moisture contained in the jute rope, which finally becomes well saturated with the compound. These lengths of pipe are connected together with spheroidal junction boxes, made in two halves, allowing sufficient room for connections between the conductors, and provided with outlets, where it is contemplated to connect service wires. At important junction points large cast-iron junction boxes are used, which permit the interconnection of the different circuits and admit of the introduction of fuses, which protect the main circuit from accidents occurring to sections of the service wires, and furthermore provide ready means for testing and fault location. This method was one of the very first practical systems of underground construction, and has given great satisfaction where the potentials are not higher than those commonly used on Edison three-wire circuits, although it is doubtful whether these cables would be satisfactory for higher potentials, since the method of filling the pipes does not admit of a thorough removal of moisture from the jute wrapping, and also it has been found impossible to so thoroughly protect the ends of the pipes by any economical method that a small amount of water will not penetrate the insulating material if any construction work is done during bad weather.

For trunk mains and long feeders the Siemens-Halske system of iron taped cables is more satisfactory, as these cables can be made in continuous lengths of 500 or 600 feet, although even lengths as great as these are exceedingly difficult to handle on account of their weight. In this system, as the iron taping is not entirely impervious to moisture, the insulated cables are lead incased, the iron taping being applied over a bedding of jute and further protected exteriorly by a wrap-

ping thoroughly saturated with an asphaltum compound similar to that employed for the protection of submarine cables.

At various times other solid systems have been contemplated, underground cables being sometimes laid in wood trenches, which are subsequently filled with melted asphaltum. A few attempts have also been made at installing copper rods or pipes, insulated entirely by means of the asphaltum with which the trenches were filled, but it is found in practice that asphaltum does not resist the penetration of moisture, especially as this material has a high coefficient of expansion with temperature, and in consequence during cold weather cracks occur, while in warm weather the material is not sufficiently strong to maintain the conductors in their proper relative position, unless they are supported in the trenches on wood balks. These balks cannot be so thoroughly saturated with any compound that they will not subsequently absorb moisture and short-circuit the system. At one time the Calender Insulated Wire Company installed a large amount of cable, insulated with a compound of rubber and asphaltum which was partially vulcanized, the cables being supported on wood balks and the trenches filled with asphaltum; but even here the conductors sunk into contact with the balks and short-circuiting ultimately took place. These difficulties might be overcome by installing rubber-covered cables suspended by a jute wrapping from iron wires parallel to them and carried on insulating balks, and if the trench in which these cables were carried should be filled with asphaltum the construction would doubtless give great permanence, but the supreme difficulty with any such system is encountered when repairs or extensions are contemplated, since no cable of the system can be removed without disturbing all the cables in the trench, and in spite of the fact that such a built-in system is without doubt more economical to install than any other, this disadvantage has prevented the possibility of an entire solution of the insulation difficulties in solid systems being attempted.

In the smaller cities, where the installation of sufficient conductors to accommodate probable extensions of business may be economically attempted, and where interference with street

traffic by open trenches for repairs would not be a great objection, such a system may eventually prove effectual.

Intermediate between the draw-in and draw-out systems lies a method of construction designed by David Brooks, which has been employed to a greater or less extent since its first conception in about 1881. Brooks desired to employ oil as an insulation for cables, as he had found that wires insulated with rosin oil were exceedingly difficult to short-circuit, even under the influences of high values of potential; but, of course, no pure oil could be used in the construction of a cable, even were it lead incased, for opening the lead casing while jointing would allow the escape of the oil. The method which he proposed, therefore, consisted of laying an iron pipe-line over the whole distance to be traversed, in which the pipes were terminated by hermetically sealed boxes, the cables to be drawn into these pipes being lightly wrapped with jute, and, after being boiled in oil, were drawn into the iron ducts, which then remained full of oil. In order that leaks in the pipe should not admit small amounts of moisture where the pipe was laid through damp ground, Brooks proposed having the oil in the pipes under pressure from a standpipe or pump, the theory being that small leaks would allow the oil to escape and on account of the pressure behind the oil no water would enter. However, this principle was not found to be operative on account of the fact that exceedingly heavy oils were necessarily employed for obtaining the best values of insulation, and in these oils the pressure from the standpipe or pump could not be transmitted over a considerable distance when there was movement of the oil column, on account of the friction between it and the pipes with their inclosed cables.

In the United States there are not at present any examples of the Brooks method of construction, although at one time extensive experiments were made by the Western Union Telegraph Company and the Pennsylvania Railroad Company between Jersey City and Newark across the marshes. But in England the system has been developed by Messrs. Johnson & Phillips, who have succeeded in obtaining a highly satisfactory system by abandoning the principle of oil under pressure and paying great attention to the details of the laying of pipes

without leaks and hermetically sealing all junction boxes and pipe ends. For certain classes of work, as for electrical lines traversing private grounds, and for long trunk cables, where there is not much probability of cables ever being disturbed after they are laid, this system presents many advantages, although when the construction is satisfactorily done the cost is not materially less than with other plans which might easily be adopted in its place, but where the cables must be disturbed either for repairs, extensions or subsidiary connections this system meets with many disadvantages. In the first place, handling the cables, which have been saturated with a heavy oil, such as rosin oil, is extremely objectionable to the workmen, who are thus not able to take the same pains with their work as would be possible when working with comparatively clean hands, and furthermore, where a little oil has leaked out of the pipe after it is cut for introducing a new junction box, it is exceedingly difficult to fill the pipe again without removing the entire length of cable and refilling just as if new cable were being installed. These disadvantages, increasing the cost for repairs, cause the system to be uneconomical in operation and to sacrifice whatever advantages of cheapness it may have in the original installation.

The largest installations of insulating ducts have been constructed on the systems of Dorset and of the Interior Conduit Company. Dorset's plan never contemplated the installation of cables entirely without insulation, although at the time it was first used it was hoped that the character of the duct system would materially reduce the cost of covering the cables themselves. This conduit consisted of blocks of asphaltic concrete molded in lengths of about four feet, the cross-section being one foot square, each block pierced from end to end by a series of duct holes two and a half inches in diameter, formed by mandrels, around which the blocks of asphalt were cast. These lines of conduit were laid with abutting ends, and, after being held in alignment by mandrels in the duct holes were cemented together by hot pitch poured between the sections of conduit. This is a system of construction which was largely used in New York and Minneapolis, but proved to be a complete failure on account of the fact that it was impossible

to be sure that the pitch between the sections of conduit effected a thorough cementing, and in consequence, after construction, the blocks were found to have cracked apart and fallen out of alignment, thus not only sacrificing all the insulating properties of the conduit, but reducing the size of the ducts, on account of the holes in the different sections not being strictly in the same straight line.

General Weber, of the British Postal Telegraph, has modified this system until he has been able to construct a satisfactory cable-carrying conduit with its use, although he has never been able to render the conduit entirely impervious to moisture, and in consequence, where it is used by him it has been employed without much reference to its insulating properties. Weber's modification of the Dorset system consists in laying the sections of molded conduit with a space of four or five inches between them, into which melted material of the same constituents as that of the original conduit is poured. This melts back the molded portions for a short distance and produces a conduit entirely homogeneous and satisfactory as a cable duct, although not admissible for the employment of uninsulated wires.

The system attempted by the Interior Conduit Company was installed for the feeders of the street railroad company at Minneapolis, and consisted of paper tubes thoroughly impregnated with petroleum residuum, laid in a trench, with paper ferrules at their joints, the whole trench being filled with asphaltic concrete composed of residuum, asphaltum and coal tar, poured hot into the trenches and entirely covering the paper ducts. Into these paper ducts a bare copper strand was drawn, small manholes being provided at the feeding points, which consisted of double wooden boxes, sealed by compound poured between them and covered with water-tight covers. After a couple of years of fairly satisfactory work it was found necessary to abandon this construction, although it is probable that the failure was largely due to the original use of unsatisfactory materials. The paper ducts themselves were not thoroughly impervious to moisture, and being supported on wood balks to prevent their sinking through the compound with which the trench was filled, these wooden balks became

saturated with moisture and short-circuited the cables through the paper of the conduit tubes. Furthermore, the manhole construction was not thoroughly water-tight, and in many instances the whole duct system was found to be filled with water after heavy storms. Profiting by the experience gained in this construction the Interior Conduit Company has proposed a similar system with a number of paper tubes, telescoped one within the other and designed to be laid with broken joints, the exterior surface of the tubes being protected either by an iron pipe or laid as before in asphaltic concrete and supported on blocks made of pottery, thoroughly water-tight iron manholes being designed in place of the double wooden boxes.

The latest system of insulated ducts is that of Cummings, in which large iron pipes are employed for inclosing a number of ducts, four wooden ducts being inclosed in each pipe, the space between being filled in with an asphaltic compound. This system has found a limited use for low-pressure construction where but a small number of cables are to be installed, and will not probably find wider application, on account of the fact that it is doubtful whether such construction is less expensive than a noninsulating duct system, where many cables are used and connections or repairs are frequent.

In consequence of the ease with which repairs may be effected in the "draw-in and draw-out" systems, these have come to be considered as the standard method of installation for underground lines throughout the United States. When first contemplated it was thought that the cost of the total system might be decreased by providing an insulating conduit, into which conductors lightly insulated might be drawn, or even in special cases uninsulated wires might be laid; but all attempts at such construction have resulted in failure, since, as has been said, it was found impossible to construct a conduit that would afford of itself insulation sufficiently high in value when laid under the conditions in which street work must be accomplished. Even where a good insulating material has been used for the ducts, the relative differences of temperature between the external atmosphere and that of the ducts has caused heavy condensation of moisture within the ducts them-

selves ; and furthermore, it has been found generally impossible so thoroughly to seal the manholes as to entirely prevent the entrance of storm water. In addition no insulating duct has yet been found which can be constructed with sections of great length, and the difficulties of laying the ducts in short lengths with perfect alignment have not been overcome. In consequence engineers have decided that an underground duct system can only be called upon to fulfill the following requirements :

First, the ducts should be internally smooth and free from projections, so that the lengths of cable may be easily introduced and at any time withdrawn.

Second, the ducts should be reasonably water- and gas-tight, even though no attempt at effecting an absolutely hermetically sealed duct has ever been successful.

Third, the duct construction must be sufficiently strong to withstand both the surface street traffic and accidental interference when other street work is in progress.

These conditions have been filled by ducts made of wood, iron, terra cotta and cement, a choice of the particular duct to be used depending upon the weight of the street traffic, the chances of interference from other workmen and finally the cost per cable in the different localities. The materials used for these ducts might be divided into insulating, semi-insulating and metallic, but as the insulating properties of ducts are not now considered of importance such subdivision would have no significant character. For wooden ducts use has been made of planks with semicircular grooves, so laid together that two planks make a conduit; or they have been constructed of independent pump logs, and where care is taken in thoroughly seasoning the lumber and subsequently impregnating it with an antiseptic compound, this construction is satisfactory, especially since no duct material offers less resistance to the drawing in and drawing out of the cables, and in no other form of construction can so great lengths of heavy cable be used. As a consequence many miles of properly prepared wood ducts are in use, giving daily satisfaction ; but when the removal of the sap from the wood and its subsequent impregnation with a preservative compound is done imperfectly, the

natural wood acids and the acids which form as the wood decays are found to be very injurious to the rubber of insulation, if rubber-covered wires are used, or to the lead covering when lead-incased cables are employed. Indeed, in this form of duct, lead-incased cables are destroyed very rapidly, the lead being transformed, by the acetic acid from the wood and the carbonic acid which is always present in the air of a city, into lead carbonate or white lead. It was at one time thought that this action was due to the creosote commonly employed in wood preservation, but careful experiments have proved that where the wood was thoroughly dry and freed from every acid, and where the impregnation was honestly done with "dead oil" or creosote obtained from coal tar, and not with wood-tar creosote, no such action took place, and in them the cables have as long a life as in any other form of duct.

The strongest of all conduit systems is the one which is most commonly used in larger cities, where the surface traffic is heavy and street disturbance frequent. This consists of wrought-iron pipes laid on a bed of concrete. The common form of two-inch steam-pipe is most commonly employed, connected by ferules with a taper thread according to the ordinary methods of steam-fitters. These pipes are laid in horizontal rows on a four-inch bedding of cement about one and a half inches apart, and as many tiers of pipe rows as is necessary for the duct system, laid one above the other, the concrete being well pounded in between the ducts. Over the top of the final row of pipes a four-inch layer of concrete is laid, and the whole finally protected by a planking. This form of construction leaves nothing to be desired as regards durability, although it is necessary that great care be taken in the inspection of the pipes that no internal burs remain from the welded seam or from cutting and laying the pipes. In cutting, the greatest care must be taken that a flange is not turned up on the end, since any internal bur would be likely to injure the insulation of the cables as they are drawn in; and furthermore, the flange left by the pipe-cutter is apt to diminish the area of the duct.

This system is one which is exceedingly expensive, and in consequence various attempts have been made to produce a



concrete duct without the use of iron pipe, since if a strong concrete be employed the iron pipe can be regarded simply as a former for obtaining a truly cylindrical hole. Zinc tubes were first proposed for effecting this, but it was found that in handling the zinc was apt to become dented and reduce the area of the tube. The Chenoweth system contemplates the formation of a cement tube by ramming the concrete around a mandrel wrapped with a metallic tape, which may be subsequently withdrawn by first slipping out the tapered mandrel and then withdrawing the spiral of tape; but no great success has been obtained by this system, since if the ducts be made thoroughly smooth the expense of construction is not materially less than where iron pipes are employed.

Cement-lined iron pipe, however, has been found to surmount all these difficulties.

Cement-lined iron pipe consists of sections of thin wrought-iron pipe eight feet long, with a riveted seam, lined with five-eighths inch of pure Rosendale cement, without sand, molded within the iron pipe by placing in it a brass pipe the size of the desired duct, and pouring the cement into the surrounding annular space, the brass pipe being readily withdrawn after the cement has slightly hardened. The sections of this duct are connected by molding in the cement at the ends of the sections an external and internal joint of spherical form, so that a considerable amount of change in direction between two sections is permitted without throwing the ducts out of alignment—the external and internal joints fitting each other on the ball-and-socket principle. This form of conduit is laid in a bed of concrete, exactly as has been described for the iron ducts, the construction being designed to take the place of the iron ducts, with the advantage that the construction is cheaper and the ducts are internally smoother, so that a greater length of cable may be drawn into the ducts at one time without an unnecessarily heavy tension being applied to the cable ends. It is also claimed for this conduit that the cement can have no effect upon the insulation or the lead of cables drawn in, but use has not indicated that the system has any advantage in these respects over an iron pipe, since whatever effect of corrosion may take place on the insulation or the lead of the cable covering is due rather to

corrosive principles present in the water, which may filter in or condense within the ducts themselves, and protection from this effect is now so well understood that such corrosion is not to be feared in any satisfactory system of duct construction.

The telephone companies throughout the country employ a very large amount of conduit made with terra-cotta ducts. The first system of this kind was that of the Lake conduit, originally used in Washington, D. C. The Lake conduit is made of glazed earthenware about one inch thick, with two or four rectangular ducts, each three by four inches, the lengths of the sections of conduit being not over four feet. These lengths are laid with abutting ends and served with wrapping of burlaps, which is then impregnated with hot asphaltum, care being taken that the temperature of the asphaltum is not so great as to destroy the strength of the burlaps. These ducts are then laid upon a bedding of concrete and protected at the sides and over the top by concrete, liquid cement being poured in between the various parallel sections of conduit, in order to cement the whole into a solid mass. This makes a duct which is internally very smooth, and into which cables may readily be drawn although on account of the large size of the ducts it is uneconomical to lay but one cable in a duct, which at times necessarily interferes with the ready withdrawal of single cables for repairs. In this construction the McRoy conduit has succeeded the Lake, being constructed of better materials and more carefully, so that it is stronger, smoother and more impervious to water.

The most recent improvement in this system consists in the use of a single duct of terra cotta or hollow tile. These hollow tiles are made of earthenware, square in cross-section, from eighteen inches to two feet long, pierced by a duct about two and a half inches in diameter, with an internal and external shoulder at the opposite ends for joining the different pieces of tile and keeping them in perfect alignment. This system is laid on a bed of concrete, the separate tiles being laid up in cement, making a solid tiling wall, and the construction is found to have the great advantage of internal smoothness, together with the advantage of having a separate duct for each cable, which is not possessed by the Lake construction,

although for the same number of cables it is slightly more expensive than the rectangular earthenware pipe. In any system where terra cotta is used it is necessary to avoid easily fusible materials containing a large proportion of sodium, since such materials are readily decomposed by escaping currents producing metallic sodium which may cause gas explosions in the ducts.

It has been already stated that while attention might be paid to the relative insulating properties of these various conduits, at the same time this property does not determine the character of the cable to be employed. It has, however, been found that this insulating property must be considered in all service, for when a metallic duct is used and a cable is defective at any point, the cable is immediately grounded where it is defective; but where ducts of cement, terra cotta or wood are employed the cable is not well grounded in every part, and in consequence difficulties are sometimes encountered with lead-incased cables grounding on each other, rather than through the ducts, causing the destruction of good cables where they touch defective cables, unless care is taken to solidly connect the lead sheathing of each cable with some form of ground at frequent intervals.

- In all underground systems it is necessary to provide boxes or vaults for the making of connections between cables and for the attachment of feeders. Even trunk cables cannot be handled in lengths greater than 1,000 feet, drawn into the duct 500 feet in either direction from a center, and in consequence all duct systems must be made accessible at distances not greater than 500 feet apart. These frequent points of accessibility are not absolutely necessary in the built-in construction, although it is difficult to handle lead-incased cables in lengths much greater than 1,000 feet, except for the smallest cables, since the weights of longer lengths prove to be sufficient for the upper layers to crush the insulation of the underlying layers on shipping reels. Where solid or built-in systems are employed, points of accessibility are provided in small junction boxes, containing a system of contacts which may be interconnected in any desired manner by wires or fusible strips, the junction boxes themselves being made small and thoroughly

water-tight, the common form being that of iron boxes cast in a single piece, with a lid made tight by a gasket. As this form of construction contemplates only one system of cables in each junction box, the various cables of the system being interconnected merely by uninsulated conductors, there is no necessity for the junction box to be larger than will be required by the presence of the conductors—the workman making a change never being required to enter the box itself. Several forms of such junction boxes have been developed, but those systems which are most complete are the ones adapted to the Edison and Siemens-Halske underground systems.

In the draw-in and draw-out systems larger junction boxes must be provided, since in general the ducts of these systems are far below the street level, and in consequence the splicing of the cables must be done by a workman standing within the junction box itself. These are then called "splicing vaults" or "manholes." The size of a splicing vault depends largely upon the depth of the conduit. In certain localities where the ground does not freeze to a great depth during the winter and where the traffic is light, it is possible to lay the conduits at a shallow depth and near the curbs, or under the sidewalks. When this is possible, it is easily seen that the presence of workmen on the streets splicing cables is not so objectionable as where the work must be done in the center of the streets. Accordingly, for this class of construction the splicing vaults are made small and called "handholes," as, for example, where the ducts are laid about two feet below the street surface, handholes four feet square by four feet deep are found to be sufficient, the workman splicing the cable sitting on the street with his legs hanging into the handhole, splicing with the cable in his lap; but where this shallow construction is not possible the splicing must be done at the bottom of the hole, and for this reason the splicing vault must be large enough for the splicer to work rapidly and without interference with neighboring cables, the size of the vault depending somewhat on the number of cables and upon their character, although a splicing vault should never be less

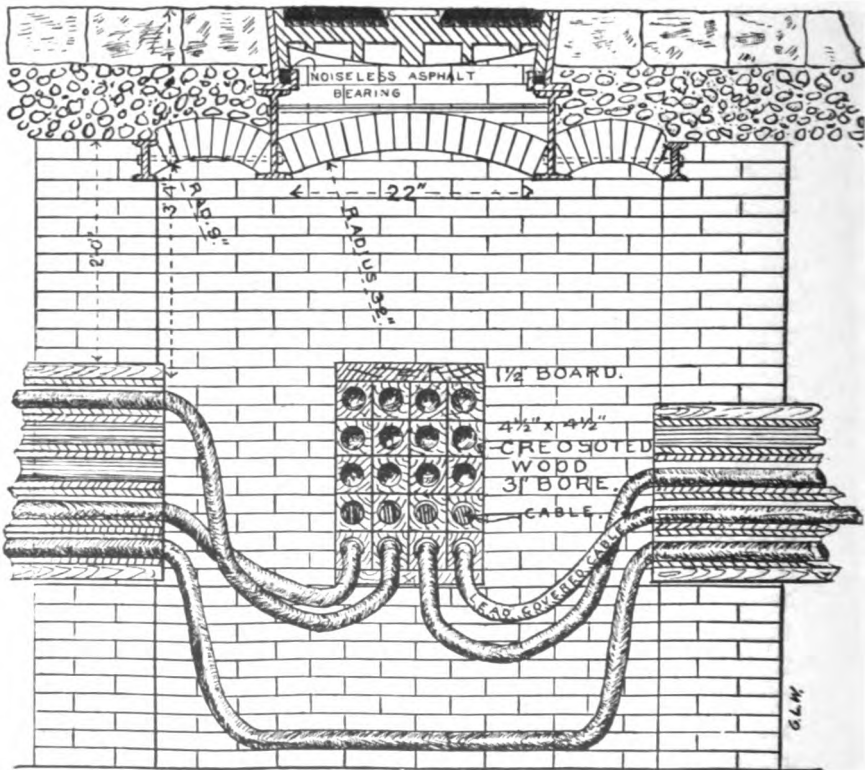
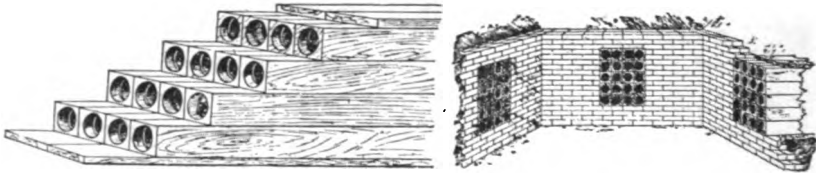
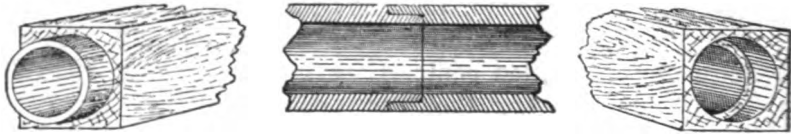

4'-13" x 4'-6" x 13"  
SECTION OF MANHOLE, WITH CREOSOTED WOOD CONDUITS.

than four feet square, from which size they increase to eight feet square in some of the larger systems.

Even where but few cables are to be installed, a splicing vault four feet square is found to be an inconvenient place in which to work, and where three or four ducts lead into the vault they are rarely made less than five feet square—six feet being considered the standard size in the larger cities. The depth, of course, depends upon the depth of the ducts, although the floor of the splicing vault should always be at least eighteen inches below the lowest cable ducts, on account of the convenience of the workmen, who should not be obliged to work in an exceedingly uncomfortable position, and on account of the fact that these splicing vaults form catchbasins for any water which finds its way into the conduit system, the ducts being generally laid with a grade toward the splicing vaults. If a good depth of vault below the lowest duct is provided, then any moderate amount of water accumulating within the system will lie harmlessly in the bottom of the vaults, and can easily be removed by pumping. Where the ducts are on a line with the bottom of the splicing vaults the cables will often lie in water, and the deterioration of their covering is hastened.

Cast-iron splicing vaults have been proposed and are used to a limited extent where small vaults are required, but there is no especial advantage in the employment of cast iron, since it is found to be very difficult to make these cast-iron boxes thoroughly gas and water tight at the points where the cable ducts enter. Accordingly, the common construction consists of a brick wall laid upon a concrete floor, the brick being laid in cement and coated internally with a plaster of cement. Such a form of floor is penetrated by dampness, but a large amount of water cannot pass through the walls nor are the walls extremely permeable to gases. In any system, therefore, the size of splicing vault should be as great as a reasonable cost of construction will allow, although an excessive size increases the cost of cable-laying, for the cables cannot be carried straight across the vaults from duct to duct, but must follow the walls and be hung upon hooks set in the brickwork, in order that each cable may be readily accessible for renewals or

repairs; and where very large vaults are provided there is a waste of cable, increasing resistance and cost, as the cable is carried around the walls.

At one time it was thought possible to splice all cables on the street, without reference to the depth of the ducts, the cables of different ducts being both carried up to the street level, and spliced in a head, which was then fastened to the side-wall of the ducts; but not only did this form of construction increase the length of useless cable, but also such "heads" formed convenient steps for workmen entering the splicing vaults, and where the vaults were frequently entered the cables were soon injured by being used in this improper manner. Often where the cables are carried around the side-walls there is a great temptation for the workmen to use them in entering and leaving the vaults, unless they are so located that they are inconvenient for this purpose, and in consequence they should be so placed where it is possible; the manhole for entering the vault being on one side of smaller vaults, or in the center of large vaults, so that a man cannot readily let himself down through the manhole and rest his feet on the cables.

The two great difficulties found in underground construction arise from the presence of water and gas within the ducts. Water may enter either from condensation of moisture from air which is admitted whenever the construction is opened, or from overflowing of the streets where the manhole covers are not thoroughly tight. Gas penetrates the conduits through the walls of the splicing vaults, and even through the ducts themselves when there are gas leaks in the neighborhood. In the oldest cities such gas leaks are almost always present, and it has been found to be practically impossible to keep the ducts entirely free from its presence. There is a difference of opinion among engineers as to the best methods of removing these difficulties. In New York, where both water and gas have given a great deal of trouble, it has been found necessary to connect splicing vaults throughout the territory where gas leaks are plentiful by six-inch pipes, through which a current of air is continually blown. Storm water is kept out by the use of perfectly tight manhole covers, and as it is impracticable to securely fasten the covers on the street level, where they are

continually subjected to vibrations by the traffic passing over them, double manhole covers are employed, the inner cover being seated on a gasket and screwed tightly in place, while the outer cover is held down simply by its own weight, which in these cases amounts to 300 or 400 pounds.

When a tight conduit construction of this kind is employed and an air pressure kept on the inside of the ducts by blowing through the six-inch pipe, gas does not seriously enter, nor is there trouble from storm water, while the water of condensation is continually removed by the blast of air, which serves the double purpose of keeping the ducts free from gas and moisture ; but as this entails a considerable expense, both for the original laying of the ventilating pipe and for the operation of the blowing system, it cannot be contemplated except where a large number of ducts are laid and where the difficulties from water and gas are serious. Small amounts of gas are readily removed, either by ventilation through the manhole covers themselves, or by means of auxiliary pipes, led up to the tops of neighboring buildings. Such pipes have sometimes been attached to neighboring arc light poles, but this is at the present time considered to be a source of danger, for the gas within the duct may be ignited by the arc whenever an explosive compound flows out through the ventilating pipe.

In Chicago it is found that single heavy manhole covers, pierced with holes, afford ventilation and prevent the presence in the ducts of an excessive amount of gas, although many engineers hold that this is again a source of danger, on account of the possibility of gas coming out through the covers and being ignited by means of lighted cigars falling upon the covers. Indeed, no form of a ventilated duct seems to free the construction so completely from gas that it is safe for workmen to enter the splicing vaults until the gas has been well pumped out by means of a hand blower, and in such ducts it is generally necessary to continually force into the vault a supply of fresh air for the workmen whenever there is a likelihood of a large amount of gas being present.

On account of the great expense of construction of the splicing vaults in the draw-in and draw-out systems, auxiliary cable ducts must be laid for house-to-house feeding systems.



These auxiliary duct systems contain only a few ducts and are provided with handholes at every alternate house ; the form of conduit construction which has been found to be most satisfactory for this purpose being a cast-iron duct made in two halves containing from six to eight separate ducts, the conduit itself being laid in sections of about six feet, the halves cemented together by plumbers' putty, and cast-iron manholes being placed at every junction point.

In this country the only systems that have been satisfactorily employed are the solid constructions of Edison and Siemens, in which the cables are each inclosed in their own protection, and the draw-in and draw-out systems with auxiliary ducts for service ; but in England and on the Continent wires have been satisfactorily laid in trenches, the attempt being to apply the principles of overhead construction in inclosed trenches underground. The most satisfactory construction of this character is that developed by Crompton in England, who provides a water-tight trench laid as near as possible to the surface of the street, the wires being supported on insulators located about twenty yards apart and made accessible by handholes. In order that spans of twenty yards can be allowed and the expense of tying the conductors to the insulators be not too great, at points about 200 yards apart the conductors are firmly held by clamps, into which they are fastened after the conductors are strained until they hang at a safe distance above the bottom of the conduit. In this system no auxiliary service conduits are necessary, since all service wires may be connected at the handholes.

On the Continent a similar construction has been adopted, but the straining of the conductors has not been attempted, and in consequence they are necessarily supported at more frequent intervals. In Crompton's construction the supports are glass insulators held in wood balks, which are set into the concrete of the trench, while the Continental system employs balks made of pottery. These have been found to give trouble from the fact that no petticoat is provided for the pottery balks, and furthermore, the character of the pottery is such that on account of the porous material used they become saturated with moisture ; and it is further stated that the escape

of current has in some cases formed a deposit of sodium, which ignites in the presence of moisture and causes gas explosions. Such excessive leaks and gas explosions have not been encountered in Crompton's system, which has stood the test of severe service and potentials up to 500 or 1,000 volts.

In America the smaller towns have not as yet demanded underground construction where a house-to-house distribution is contemplated, merely the trunk lines and feeders being buried, which can be done cheaply with insulating cables laid in wood ducts, and in consequence the trench system has not as yet found a foothold here, but with the extension of electric lighting and power plants, it certainly seems that this form of construction should be more carefully considered, as it is especially adaptable in those cities where frost does not penetrate to a great depth, and where the weight of the surface traffic is not likely to injure the trench construction, especially since in such cities it is difficult to obtain workmen who are capable of satisfactorily splicing insulated cables and making connections to surface wires. The particular form of trench construction and the insulators employed by Crompton are those which are adapted to the materials to be had in England, and in consequence the employment of the Crompton system would not always lead to the cheapest form of trench to be used in this country, since the materials available for trenches and insulators will necessarily vary with the localities, while the character of the trench itself will vary with the character of the soil in which it is laid and the difficulties to be encountered from the probable presence of other underground construction, as well as with the street traffic which must be borne.

It is seen, therefore, that we have up to the present time developed very thoroughly a satisfactory system of underground construction for the larger cities, although we have not as yet attacked the problem of underground work and house-to-house distribution in the secondary towns. These points must carefully be borne in mind in comparing the work which is considered as standard in this country with the various systems which have been satisfactorily employed abroad, and as the laying of wires underground shall proceed it is not safe to presume that we have as yet exhausted the possibilities of

*280 CONDUCTORS FOR ELECTRICAL DISTRIBUTION.*

satisfactory service with economical construction, for it is probable that in some cases built-in systems can be developed and in others that insulated conduits may be employed, and that in some cases the best service could be obtained by the use of a form of trench.

## INDEX.

- A.
- Accuracy, Magnet-wire, 85
    - Wire-drawing, 62
  - Advance wire, 25
  - Aging fuses, 33
  - Alloy for cable covering, 126
  - Alloys, Copper, 6, 7, 8
    - Conductivity high, 9
    - Fusible, 30
    - High conductivity, 9
    - Mechanical properties of, 11
    - Properties of mechanical, 17
    - For standard resistance, 18
    - Resistance for standard, 18
  - A. C. calculation, Error in, 194
    - law, General, 198
    - lines, Calculating, 193
    - regulation, 205
    - solution, Graphical, 208
  - Aluminum, 14
    - Atmospheric influences, 16
    - Comparison with copper, 15
    - Mechanical strength, 15
    - Resistance of, 15
    - Temperature coefficient, 15
  - American gauge, 77
  - Annealing, 51
    - Cone, 51
    - Copper, 54
    - Pot, 51
  - Annunciator wire, 86
  - Anti-parallel connection, 187
  - Arc circuits, Multiple, 142
  - Arsenical copper, 22
  - Atlantic Telegraph Company, 6
  - Atmospheric influences on aluminum, 16
- B.
- Badt, 135
  - Beauty & Cailletet, 5
  - Belgian system, 39
  - Birmingham gauge, 77
- Blocks, Wire, 59
- Board of Trade, British, 6
  - Bolton machines, 64
  - Boxes, Junction, 273
  - Braiding, Triple, 89
  - Branching mains, 181
  - British Board of Trade, 6
  - Bronze, Phosphorous, 11
    - Silicon, 11
    - Weiller, 11
  - Brooks cables, 264
  - Brown & Sharpe gauge, 77
  - "Built-in" underground system, 260
- C.
- C. Values of, 237
  - Cable construction, Typical, 125
    - covering, Alloy for, 126
    - coverings, Fiber, 122
    - insulation thickness, 125
    - Telegraph, 128
  - Cables, Brooks, 264
    - Carrying capacities of, 158
    - Drawing in, 272
    - Iron-taped, 262
    - Lead-incased, 117
    - Paper, 124
    - Paper telephone, 126
    - Protecting, 97, 98
    - Submarine, 129
    - Submarine lead, 126
    - Telegraph, 128
  - Calculating A. C. lines, 193
  - Calculation, Graphical, 136
    - main feeders, 185
    - mains, 186
    - of power, 210
  - Calender conduit, 263
  - Capacities in conduits, Carrying, 150
    - in moldings, Carrying, 149
    - out of doors, Carrying, 156
  - Capacity for carrying, 28

- Capacity of charging current, 201  
of rod-mill, 48  
Cailletet & Beauty, 5  
Carrying capacities freely, 152  
in conduits, 150  
in moldings, 149  
of cables, 158  
out of doors, 156  
Rules for, 152  
Underground, 159  
Carrying capacity, 28  
and drop, 191  
Cartagena rubber, 99  
Cast iron, 30  
Cast-iron dies, 58  
 Ceara rubber, 99  
Cedar, 223  
Cement-lined conduits, 270  
Centers, Distribution, 180  
Charging current, Capacity and, 201  
Charts for wiring, 135  
Chatterton's compound, 96  
Chenoweth conduit, 270  
Chestnut, 223  
Choice of conductor size, 132  
Circuits, Constant current, 142  
Constant potential, 142  
Inductance of, 204  
Multiple arc, 142  
Series, 141  
Series multiple, 142  
Circular mil, 79  
Classification, 1  
Cleaning, 54  
Hydrides in, 56  
Climax wire, 25  
Cloth, Friction, 105  
Coating, Linseed-oil, 69  
Coatings, Effects of, on radiation, 157  
Code, National electrical, 151  
Coefficient of span, 240  
Coils, Resistance, 25  
Commercial resistance of copper, 5  
Committee, Submarine telegraph, 6  
Comparison of aluminum with copper, 15  
Compound, Chatterton's, 96  
Compressed lead, 122  
mica, 253  
Condenser, Connection of, 195  
Conditions, Overhead-wiring, 259  
Conductivity, copper alloys, High, 9  
Conductor installation, Practice in, 129  
size, Choice of, 132  
Conductors, Economical, 160  
Graduated, 190  
Conduit calender, 263  
Chenoweth, 270  
Company, Interior, 265  
Cummins, 267  
Dorset, 265  
Conduit, Hollow-tile, 271  
Iron-pipe, 269  
McRoy, 271  
Weber, 266  
Conduits, Carrying capacities in, 150  
Cement-lined, 270  
Gas in, 276  
Lake, 271  
Requirements for, 268  
Water in, 276  
Wood, 268  
Cone annealing, 51  
Connection of condensers, 195  
of feeders, 188  
Constant current circuits, 142  
potential circuits, 142  
Construction, Typical cable, 125  
Continuous system, 39-48  
wire-drawing, 64  
Copper, Alloys of, 6, 7, 8  
Annealing, 54  
Arsenical, 22  
Commercial resistance of, 5  
Compared with aluminum, 15  
Hard drawn, 10  
High conductivity, 9  
Hydride of, 7  
Impurities, 6  
Mechanical properties of, 10  
Resistance of, 4  
Standard of, 4  
Sub-oxide, 6  
Temperature, coefficient, 5  
Tempered, 11  
Core, Hooper's, 107  
Corrosion of fuses, 35  
Cost, Insulation, 162  
Covering with rubber, Strip, 108  
Coverings, Fiber cable, 122  
Cox, 139  
Creosoting wood, 269  
Crompton trench, 278  
Cummins conduit, 267  
Cummins, G. W., 53  
Current per foot, 191  
circuits, Constant, 142  
Fixed economy, 166  
Currents for fusion, 31  
Curve of wire, 232  
D.  
Daniels, F. H., 38  
Day, A. G., 106  
Deflection, Ratio of, 235  
Dettmar, 28  
Dies, Cast-iron, 58  
Steel, 58  
Wire-drawing, 58  
Direct traction reel, 46

Distribution centers, 180  
 General, 182  
 Moment of, 181  
 Multiple wire, 145  
 point, 146  
 Dorset conduit, 265  
 Draw in and draw out, 267  
 Drawing wire, 58  
 in cables, 272  
 Drop and carrying capacity, 191

## E.

Ebonite, 103  
 Economical conductors, 160  
 Economy, current fixed, 166  
 four cases of, 177  
 solution for, 165  
 $E_1$  alone fixed, 169  
 $E_1$  and  $P_1$  fixed, 171  
 $E_2$  fixed, 172  
 $E_2$  and  $P_1$  fixed, 175  
 $E_1$  and  $R$  fixed, 169  
 $I$  alone fixed, 166  
 $I$  and  $R$  fixed, 168  
 $R$  and  $E_1$ , 173  
 $R$  alone fixed, 177  
 Edison "built in" system, 261  
 gauge, 77  
 tubes, 262  
 Effect of, Vulcanization, 104  
 wire-drawing, 65  
 Electrical code. National, 151  
 Energy loss, 2  
 English gauge. Old, 77  
 legal standard gauge, 77  
 Error in A. C. calculation, 194  
 potential, 200

## F.

Feeder and main system, 187  
 Connection of, 188  
 Feeders, 146  
 Feldmann, 32  
 Fessenden & Kennelly, 5  
 Fiber cable coverings, 122  
 Fisher, 157  
 Fleming, 28  
 Forbes, 148  
 Foot mil, Resistance per, 80  
 Weight per, 80  
 Friction cloth, 105  
 Function of fuses, 36  
 material, 2  
 Fuse-blocks, 31  
 Fuses, Aging of, 33  
 Function of, 36  
 Safety, 30

Fuses, Weighted, 35  
 Fusing wires, 31  
 Fusible alloys of copper, 30

## G.

Galvanization, 69  
 test, 72  
 Galvanizing, Wiped, 71  
 Garrett mill, 41  
 Gas in conduits, 276  
 Gases, Occlusion, 54  
 Gauge, Old English, 77  
 Birmingham, 77  
 American, 77  
 Brown & Sharpe, 77  
 English legal standard, 77  
 Edison, 77  
 Gauges, 74  
 General A. C. Law, 198  
 distribution, 182  
 German silver, 18  
 Tests of, 19  
 Matthiesen, 19  
 Glass, 254  
 Glaze for insulators, 253  
 Gothic mill, 38  
 Gravity, Specific, 3  
 Graphical, A. C. solution, 208  
 calculation, 136  
 Graduated conductors, 190  
 Guayaquil rubber, 99  
 Gutta-percha, 92  
 Guy wires, 225  
 Y, 226

## H.

Hamilton, G. A., 13  
 Hard-drawn copper, 10  
 Hard rubber, 103  
 Hard-paste porcelain, 255  
 Handholes, 273  
 Heating safe, 147  
 under moldings, 148  
 Herrick, 28  
 Heavyside, 194  
 Hering, 135  
 High conductivity of copper, 9  
 Alloys of Copper, 9  
 iron, 13  
 Hochin, 4  
 Hollow tile conduit, 271  
 Housings, 41  
 Hooper's core, 107  
 Hydride, Copper, 7  
 in cleaning, 56  
 Hydroscopic insulators, 254

- I.
- Iaia wire 25,  
Ice load, 230  
Imperfect vulcanization, 113  
Incased lead cables, 117  
Incasing lead, 118  
Increasing lag, 212  
  lead, 212  
India rubber, 98  
Inductance of circuit, 204  
Insulator glaze, 253  
  glass, 254  
  Multiple part, 258  
  Petticoats, 251  
Insulators, Earliest, 249  
  Molding, 256  
  Properties of, 250  
Insulating cost, 162  
Insulation, 82  
  thickness, Cable, 125  
  Wax, 89  
  Saturated, 87  
Installation, Good practice in, 129  
Interior Conduit Co., 265  
Iron-taped cables, 262  
Iron, Commercial wire, 13  
  High Conductivity, 13  
  Resistance of, 12  
  Temperature coefficient, 12  
  Tests on, 13
- J.
- Johnson & Phillips, 264  
Junction boxes, 273
- K.
- Kelvin law, 161  
Kennelly, 26, 194, 147  
  & Fessenden, 5  
Kerite, 106  
Krupp wire, 25
- L.
- Lake conduits, 2  
Lava, 252  
Lead-incased cables, 117  
  incasing, 118  
  press, 119  
  Compressed, 122  
  Cables, Submarine, 126  
Legal standard gauge, English, 77  
Length of spans, 239  
Level, Variations in spans, 246  
Line location, 215  
  wires, Testing, 90  
Lines, Overhead, 215
- Lines, stresses, 218  
  Three-phase, 195  
Linseed-oil coating, 69  
Load on poles, 218  
Location of line, 215  
Long spans, 14  
Looping-in system, 39  
Loose belt-reel, 44  
Lubricants, Wire-drawing, 62
- M.
- McFarlane, 148  
McRoy, 271  
Machine tubing, 109  
Machines, Bolton, 64  
Madagascar rubber, 99  
Magnet wire, 82  
  accuracy, 85  
Main Feeders, Calculation of, 185  
Mains, 146  
  Branching, 181  
  Calculation of, 185  
Manhole covers, 277  
Manholes, 273  
Manganin, 22  
Material for poles, 222  
Material, Function of, 2  
Matthiesen, copper resistance, 4  
  Alloys, copper, 6  
  German silver, 19  
  Copper impurities, 6  
  Platinum silver, 21  
  Resistance, standard, 4  
  Temperature equation, 3  
Maximum potential falls, 184  
  operation, 184  
Maxwell, 194  
Measurements, Wire, 74  
Mechanical properties of copper, 10  
  alloys, 11  
  strength of aluminum, 15  
  Rubber, 102  
Micrometer, 76  
Mill, Gothic, 38  
  Garrett, 41  
Mica, Compressed, 253  
Mil-circular, 79  
Mil-foot, 2  
  Resistance per, 80  
  Weight per, 80  
Mille-ohm, 2  
Morris, 28  
Morse, 249  
Molding insulators, 256  
Moldings, Carrying capacity in, 149  
  Effect of heating, 148  
Moment of distribution, 181  
Morgan reel, 47

Multiple wire distribution, 145  
 Arc regulation, 179  
 Part insulator, 258  
 Arc circuits, 142  
 Circuits, series, 142  
 Series circuits, 143

## N.

National Electric Code, 151  
 Nichols, 23  
 Nickel, Patent, 21  
 steel, 24  
 Nickelin, 20

## O.

Occlusion gases, 54  
 Office Wire, 88  
 Oil, Rosin, 264  
 cables, Brooks, 264  
 Old English gauge, 77  
 Overhead lines, 215  
 wiring conditions, 259

## P.

Paper cables, 124  
 telephone cables, 126  
 Para rubber, 99  
 Paraffine insulators, 251  
 Parallel connection, 187  
 Patent nickel, 21  
 Phillips & Johnson, 264  
 Phosphorous bronze, 11  
 Pipe conduits, 269  
 Platenoid, 19  
 Platinum silver, 21  
 Point, Distribution, 146  
 Pole, Wind strain on, 231  
 Poles, 194, 218  
 Load on, 218  
 Material for, 222  
 Safety factor of, 222  
 Specifications for, 225  
 Porcelain, 255  
 Pot annealing, 51  
 Potential circuits, Constant, 142  
 error, 200  
 Pottery, 253  
 Pouring reel, 46  
 Power, Calculation of, 219  
 Practice in conductor installation, 129  
 Preece, 31-33, 148  
 Preliminary survey, 218  
 Preparing rubber, 101  
 Press lead, 119  
 Pressure of wind, 229  
 Properties of mechanical alloys of copper, 11

Protecting cables, 97, 98  
 Pupin, 194  
 Pure gum rubber, 100

## R.

Radiation. Effect of coatings on, 157  
 of heat, 28  
 Rankine, 233  
 Ratio of deflection, 235  
 Redwood, 223  
 Reel, Direct traction, 46  
 Loose belt, 44  
 Morgan, 46  
 Pouring, 46  
 Reeling rods, 44  
 Regulation, A. C., 205  
 Multiple arc, 179  
 Repeater, 40  
 Requirements for conduits, 268  
 Resistance, Copper, 4  
 Specific, 2  
 Standard, 4  
 for standard copper alloys, 18  
 of aluminum, 15  
 of iron, 12  
 per mil foot, 80  
 coils, 25  
 Rheostat coils, 26  
 Rhime, 230  
 Rights-of-way, 217  
 Roberts, 140  
 Rod definition, 37  
 Rod-mill, Capacity of, 48  
 waste, 48-50  
 Rods, Reeling, 44  
 Rolling speed, 48, 49  
 Rolls, 41  
 Rosin oil, 264  
 Roughing train, 40  
 Rubber, Cartagena, 99  
 Ceara, 99  
 Guayaquil, 99  
 Hard, 103  
 India, 98  
 Madagascar, 99  
 Mechanical, 102  
 Para, 99  
 Preparing, 101  
 Pure gum, 100  
 Shoddy, 105  
 Vulcanized, 102  
 Rubber substitutes, 105  
 Rule for wire sizes, Slide, 139  
 Rules for carrying capacities, 152

## S.

Safe-heating limit, 147  
 Safety factor of poles, 222



- Safety fuses, 30  
 Saturated insulation, 87  
 Series circuits, 141  
   multiple circuits, 142  
 Service wires, 146  
 Shoddy rubber, 105  
 Siemens, 5  
   "built-in" system, 261  
 Silicon bronze, 11  
 Silver, Platinum, 21  
 Size of conductor, Choice of, 132  
 Slicker, 114  
 Slide rule for wire sizes, 139  
 Smith & Manifold, 140  
 Soft-paste porcelain, 255  
 "Solid" underground wires, 260  
 Solution for economy, 165  
 Span, Coefficient of, 240  
   weight unit, 235  
 Spans, Lengths of, 239  
   Temperature effect in, 241  
   Tension in, 239  
   Variable, 242  
   of changing level, 246  
 Specific gravity, 3  
   resistance, 2  
 Specifications for poles, 225  
 Speed, Rolling, 48, 49  
   Wire-drawing, 61  
 Splicing heads, 276  
   vault, 275  
 Standard of copper, 4  
 Standard legal gauge, English, 77  
   resistance, 4  
   Alloys for, 18  
 Steel, 13  
   dies, 58  
 Stark, 135  
 Steinz, 194  
 Strand, Weight of, 81  
 Strands, 73, 79, 81  
 Stresses, Line, 218  
 Strip covering with rubber, 108  
 Strut, 226  
 Stub, 226  
 Subfeeders, 146  
 Submarine cables, 129  
   lead cables, 126  
   telegraph committee, 6  
 Suboxide of copper, 6  
 Superior wire, 25  
 Survey, Preliminary, 218  
 Swift, 70
- T,
- Tanks, vulcanizing, 112  
 Telegraph cable, 128  
   Company, Atlantic, 6  
 Telephone cables, paper, 126
- Temperature effect in spans, 241  
   coefficient of iron, 12  
   aluminum, 15  
   copper, 5  
   equation, 3  
 Tempered copper, 11  
 Tension in wire, 233  
   spans, 239  
 Test, galvanization, 72  
 Testing line wires, 90  
 Tests on iron, 13  
   of German silver, 19  
 Thickness, Insulation, 115  
   Cable insulation, 125  
 Train, Roughing, 40  
 Three-phase lines, 195  
 Trench conduits, 260  
   Crompton, 278  
 Triplet braiding, 89  
 Tubes, Edison, 262  
 Tubing-machine, 109  
 Typical cable construction, 125
- U.
- Underground carrying capacities, 159  
 Underwriters, Wire, 89  
 Unit-span weight, 235
- V.
- Value of  $c$ , 237.  
 Variable spans 242  
 Vault splicing, 275  
 Vogt, 4  
 Von Bose, 4  
 Vulcanite, 103  
 Vulcanization, 102-112  
   Effect of, 104  
   Imperfect, 113  
 Vulcanized rubber, 102  
 Vulcanizing-tanks, 112
- W.
- Waste, Rod-mill, 48, 50  
 Water in conduits, 276  
 Wax insulations, 89  
 Way, Rights of, 217  
 Weatherproof wire, 89  
 Weber conduit, 266  
 Weiller bronze, 11  
 Weights, Wire, 163  
 Weighted fuses, 35  
 Weight per mil-foot, 80  
   of strand, 81  
 Weston, Ed, 22  
 Wind strain, 228

- Wind strain on pole, 251  
     wire, 231  
 Wiped galvanizing, 71  
 Wire, Climax, 25  
   Definition of, 37, 50  
   bar, 37  
   Drawing of, 58  
   -drawing dies, 58  
   blocks, 59  
   underwriters, 89  
   Weatherproof, 89  
   distribution, Multiple, 145  
   weights, 163  
   office, 88  
   annunciator, 86  
   magnet accuracy, 85  
   -magnet, 82  
   -drawing, Effect of, 65  
   -measurement, 74  
   -drawing, Continuous, 65  
   Wind strain on, 228
- Wire, Krupp, 25  
   Curve of, 232  
   Superior, 25  
   drawing speed, 61  
   -drawing, Accuracy of, 62  
   -drawing lubricants, 62  
   Tension in, 233  
 Wires, Service, 146  
   testing line, 90  
   Testing line, 90  
 Wiring charts, 135  
   conditions, Overhead, 259  
 Wobbler, 43  
 Wortles, 58  
 Wood conduits, 268  
   creosoting, 269
- Y.
- Y guy, 226  
 Yarn, 83  
 Yellow pine, 223.

