

Electric Railways

THEORETICALLY
AND
PRACTICALLY TREATED

BY
SYDNEY W. ^{*Putmore*} ASHE, B. S.

DEPARTMENT OF ELECTRICAL ENGINEERING, POLYTECHNIC INSTITUTE OF
BROOKLYN. LATE INSTRUCTOR IN ELECTRIC TRACTION FOR
THE BROOKLYN RAPID TRANSIT CO. ASSOCIATE
MEMBER AMERICAN INSTITUTE OF
ELECTRICAL ENGINEERS

AND

J. D. KEILEY

ASSISTANT ELECTRICAL ENGINEER, N. Y. C. & H. R. R. R.



NEW YORK
D. VAN NOSTRAND COMPANY
LONDON
ARCHIBALD CONSTABLE AND COMPANY, Ltd.

1905

COPYRIGHT, 1905, BY
D. VAN NOSTRAND COMPANY

Stanbope Press
F. H. GILSON COMPANY
BOSTON, U.S.A.

PREFACE.

THE absence of a modern text-book on electric railways embodying the recent developments in electric traction has led the authors to prepare this volume. Their aim has been to treat the subject from a theoretical as well as from a practical standpoint, so as to produce a book which could be used as a text in Technical Institutions as well as a general engineering reference book for those interested in railway problems. With this object in view, the use of calculus has been avoided, the differential coefficient being employed but occasionally. Where calculus methods appear, the same formulæ are expressed in addition in algebraic form.

Realizing the extent of the traction field and the great demand for information concerning rolling stock, the volume has been restricted to that part of the subject.

Opportunity is hereby taken to acknowledge as sources of much information the Transactions of the American Institute of Electrical Engineers and particularly the papers of Messrs. Mailloux, Armstrong, Scott, Potter, Arnold, and Lamme.

The thanks of the authors are especially due to Dr. Samuel Sheldon, for many valuable suggestions, and to Mr. Walter I. Tamlyn of the Brooklyn Polytechnic Institute, for assistance in proof-reading.

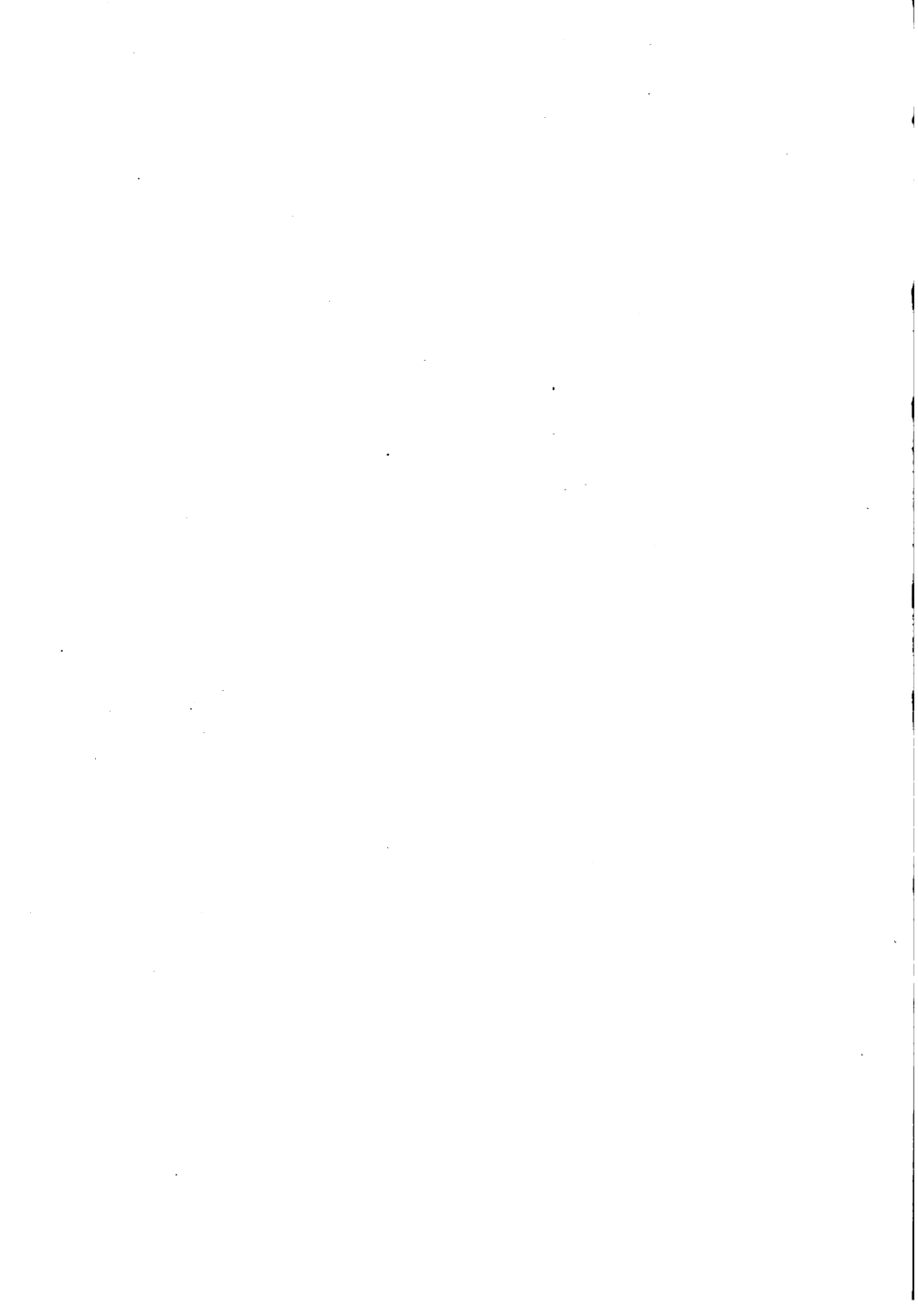

CONTENTS.

CHAPTER	PAGE
I. UNITS.—CURVE PLOTTING.—INSTRUMENTS	1
II. ANALYSIS OF TRAIN PERFORMANCE	13
III. TRAIN RECORDING AND INDICATING INSTRUMENTS	47
IV. DIRECT CURRENT SERIES RAILWAY MOTOR	61
V. ALTERNATING CURRENT SINGLE PHASE MOTORS	86
VI. TYPES OF CONTROL AND THEIR OPERATION	102
VII. CAR BODIES	165
VIII. TRUCKS	188
IX. BRAKES AND BRAKING	204
X. ELECTRIC LOCOMOTIVES	252
XI. ELECTRICAL MEASUREMENTS	265

ELECTRIC RAILWAYS.

THEORETICALLY AND PRACTICALLY TREATED.

CHAPTER I.

UNITS.—CURVE PLOTTING.—INSTRUMENTS.

Velocity is defined as the rate of change of position of a body.

Acceleration indicates the rate of change of velocity. The acceleration due to gravity is usually taken as equal to 32.2 feet per second, per second.

Force is that which tends to change, alter, or destroy motion. It is equal to the product of the mass, m , of a body into its acceleration, A .

$$F = m A.$$

The units of force are the pound and the dyne. The dyne equals such a force as will accelerate one gram one centimeter per second.

Work is equivalent to the product of force into the distance through which it is exerted. The units of work are the erg and the foot pound. Exerting a force of one

pound over a distance of one foot represents one foot pound. A force of one dyne acting through a distance of one centimeter is equivalent to one erg. One joule equals 10^7 ergs.

Energy is the ability to perform work. It may be of two kinds, — energy of position, termed potential energy, or energy of motion, termed kinetic energy. Kinetic energy is represented in terms of weight, velocity, and gravity, as follows :

$$\text{Kinetic energy} = \frac{W v^2}{2g} = \frac{W v^2}{64.4}.$$

Power is the rate of performance of work. The mechanical unit is the horse-power representing an expenditure of 550 foot-lbs. per second. The electrical unit is the watt equivalent to 10^7 ergs per second. (746 watts = 1 *h. p.*)

Electrical Units. — The absolute *C.G.S.* units of electricity include the units of pressure e , current strength i , and resistance r . These units bear a fixed relation to more practical or commercial units ; for instance, pressure as indicated in volts = $10^8 e$, current strength in amperes, $I = \frac{1}{10} i$, and resistance in ohms, $R = 10^9 r$. The absolute unit of current is such that, if passed through a conductor one centimeter in length bent into an arc of a circle of one centimeter radius, it will exert a force of one dyne on a unit magnet pole placed at its center. A current of one ampere will electrolytically deposit silver at the rate of .001118 gram per second. The absolute unit of pressure is such that it requires the performance of one erg of work to transfer a unit quantity of electricity from

one point to another when these points are at potential difference e . The absolute unit of resistance requires unit pressure to force unit current through it. The relation between the commercial units, volts, amperes, and ohms, is exhibited by Ohm's law.

$$I = \frac{E}{R}, R = \frac{E}{I}, E = IR.$$

A current of one ampere traversing a resistance of one ohm performs work to the extent of one watt.

$$\text{Watts} = EI = I^2R.$$

Heat Development.—One watt of electrical energy expended per second will generate a quantity of heat equivalent to one joule, equal to 10^7 ergs.

The French unit of heat is the "calorie," being the amount of heat required to raise the temperature of a mass of 1 gram of water, at its maximum density, 4°C ., one degree C. The heat generated in calories, by a current of electricity, is represented by the equation,

$$\text{Calories} = I^2Rt \times .24$$

where I = the current strength in amperes,

R = " resistance in ohms,

t = " time in seconds,

.24 = Joule's coefficient.

To raise the temperature of 500 grams of water, 10°C ., would require practically 5,000 calories, the value of the calorie varying slightly with the temperature. The calorie is equivalent to 3,087 ft.-lbs.

The **British Thermal Unit** is sometimes employed, representing the quantity of heat necessary to raise one pound of water one degree Fahr. when at its maximum density, 39.1° F. The *B.T.U.* is equivalent to 778 ft.-lbs. and is equal to 252. calories.

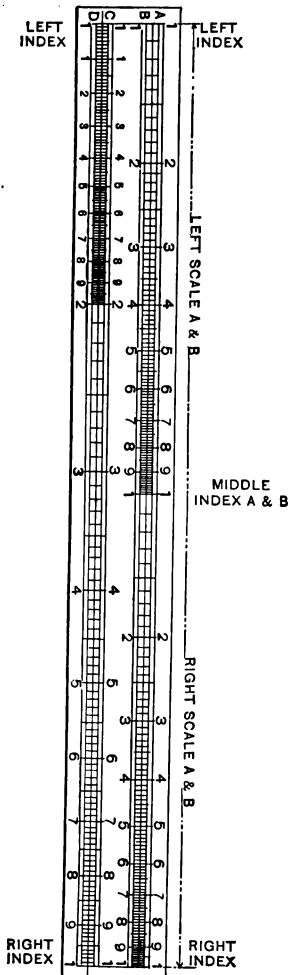

Fig. 1. — SLIDE RULE.

SLIDE RULE.

Theory. — Rapid computation, accurate to $\frac{1}{300}$ or .33%, may be readily accomplished with a slide rule. This instrument, while not as accurate as logarithms, is a great labor-saving device, and is therefore widely used by engineers. The rule is especially applicable to multiplication, division, extracting square roots, and squaring numbers. Referring to Fig. 1, this rule consists of two parts, one movable with respect to the other. The rule is provided with a movable frame enclosing a glass plate, upon which is ruled a vertical black line, so that graduations on one scale may be referred to graduations on the other scale. The rule has two sets of graduations, both of which extend over the sliding element. Both scales contain logarithmic

graduations. The sliding element serves as a means of adding or subtracting logarithms.

Multiplication. — To multiply two numbers together their logarithms should be added. Referring to Fig. 2, to multiply 2 on the lower scale by 1.5 on the adjoining scale of the

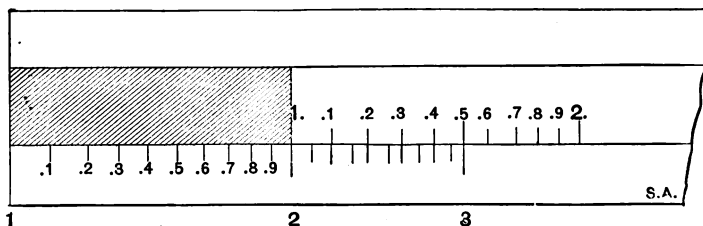

Fig. 2.—MULTIPLICATION WITH SLIDE RULE.

slide, the index 1 of the sliding element should correspond to number 2 on the lower scale. Opposite number 1.5 on the sliding element, may be found on the lower scale the number 3.

Division. — Division may be accomplished by subtracting logarithms, the process on the rule being the reverse to multiplication. The dividend is taken on the lower scale, divisor on the sliding scale, and quotient, or answer, is found opposite index 1 of the sliding element.

Square Roots. — To extract square roots, the logarithm of the number should be divided by 2. The square roots of the numbers on the upper scale may be found directly under on the lower scale. The process of squaring numbers is directly opposite, the number to be squared being referred from the lower scale to the upper scale where the resulting answer is indicated. The slide rule is a great

labor-saving device, and is warmly recommended by the authors.

CURVE PLOTTING.

Theory. — Analytical Geometry teaches that a point may be located on a plane surface by means of two dimensions, which may correspond to the simultaneous values of two variables. A system of points plotted so as to represent a number of relative values of two variables

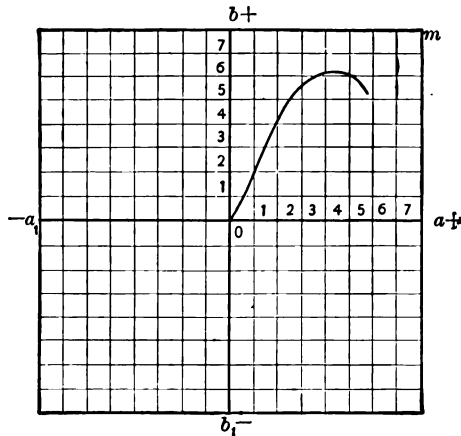

Fig. 3. — PROCESS OF CURVE PLOTTING.

constitutes a curve when connected together by a line. Curve plotting is accomplished by means of a series of perpendicular and parallel lines, Fig. 3, termed coördinates; the zero lines a , a' and b , b' being termed respectively the abscissa and the ordinate. These lines cross at a point termed the origin, which is the zero point for both sets of coördinates. The numerical values on the

abscissas and upon the ordinates begin at zero, the origin, and increase with positive values in one direction and negative values in the opposite direction, as indicated. The main coördinates when crossing form four sections, termed quadrants. The majority of train or motor curves

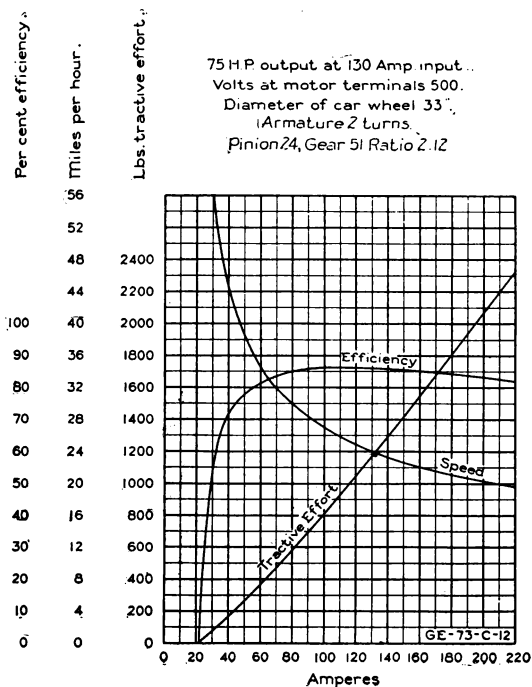

Fig. 4. — CHARACTERISTIC CURVES OF DIRECT CURRENT RAILWAY MOTOR.

are plotted in terms of positive values, and therefore only one quadrant, *o, a, m, b*, Fig. 3, is employed, although occasionally negative values occur as with train accelera-

tion, which may be positive or negative, in which case two quadrants are employed.

Considering only one quadrant, Fig. 3, a sufficient number of equidistant parallel lines are ruled both horizontal and vertical, to form what is termed cross-section paper. The distances between the lines must be equal, for each set of ordinates, but not necessarily equal for both; that is, abscissa equal to ordinate, although such is usually the case.

A curve is plotted in terms of two variables in the following manner: A suitable unit is selected, its magnitude depending upon the maximum value of each set of variables, so that when the values are plotted, as, for instance, so many divisions per ampere, there would be enough divisions to include the maximum amperes, or similarly any other variable. To plot a point the intersection of two coördinates is located, the coördinates corresponding to the simultaneous values of the two variables. When several points have been located a curve is passed through them. The method is obvious from curve sheet, Fig. 4, for a G. E. 73 motor, where a series of curves are plotted, one in terms of amperes and speed, another amperes and tractive effort, and a third, amperes and efficiency. With a current input of 100 amperes the tractive effort is 800 lbs., the speed 27 miles per hour, and the efficiency of the motors 87%. The points of the curves are always located where the coördinates intersect.

PLANIMETER.

Theory. — Numerical values, representing the equivalent area enclosed by irregular curves, may be rapidly and accurately determined by means of an instrument termed

a planimeter. This instrument consists primarily of two arms joined together by a pivoted joint so as to form a V-shaped, adjustable mechanism. The mechanism, Fig. 5, is provided with three supports near its three extremities so that it will remain upright when placed upon a flat surface. These supports consist of a graduated roller *D*, with a vernier attachment located on one arm near the fulcrum; a projection with a sharp point, capable of piercing a curve sheet, is situated on the extremity of one arm *E*; and a rounded projection *F*, which may move over the locus of the curve, is mounted upon the extremity of the other arm.

One arm is fastened in the fulcrum so that its length is adjustable between the fulcrum and the pointer. This enables the planimeter to record in square inches, square centimeters, or square millimeters, a constant being associated with each graduated length upon the arm. To use the instrument the pointer is allowed to pierce the curve sheet, becoming fixed. The position of the pointer *E* must be such that the rounded projection *F*, situated on the other arm, is free to move over the locus of the curve, the wheel at the fulcrum rolling over the curve sheet with the motion of the arm. Prior to making observations, the

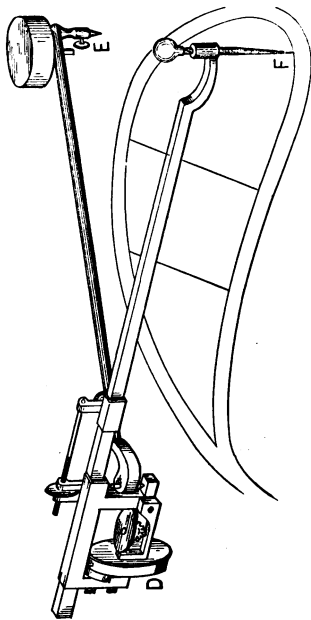

Fig. 5. — PLANIMETER.

pointer E is fixed in a definite position; the projection F on the other arm is located at zero of the curve sheet, or some definite position on the curve, which may be taken as zero in case the curve does not pass through the origin; and the wheel D of the planimeter must indicate zero reading. The projection F is then moved in a clockwise direction over the locus of the curve until its original zero position is reached. The value of the area, in appropriate units, is then indicated on the vernier scale of the planimeter.

As mentioned above, it is immaterial where the pointer E is located, provided F can be conveniently moved over the locus of the curve to be measured. As a rule, however, E should be located outside of the given area, and the value of this area is then obtained directly from the reading of the wheel D . Such an arrangement is sometimes impossible because of the shape or size of the figure. Under such circumstances E may be placed inside of the area, but the reading of the wheel D must now be increased by some constant which is different for each different length of the movable arm. The constants are marked on the arm. If an area is so large that it cannot be measured by the latter method, it is an easy matter to divide it into smaller areas by suitable lines. The sum of these smaller areas, found as above, is of course equal to the required area. The planimeter is a very useful instrument, for without its aid the areas of irregular figures can only be approximately determined after long and tedious calculation. The theory of the instrument is so complicated that a discussion of it would be entirely out of place in this book.

A curious property possessed by the planimeter, and

one which is made use of in practical work, will now be discussed.

If the curve cross at any point, forming a double area, such as is the case sometimes with an indicator diagram, and it is desirable to subtract the additional area from the original area, the planimeter may be passed over this additional area in a counter-clockwise direction when the pointer reaches the intersection point of the two curves, the motion of the pointer being then continued over the remaining portion of the original area. The instrument will then automatically subtract one area from the other, yielding as an indicated value the net result.

The value of one square inch of the curve sheet should be determined in terms of the units with which the curve is plotted, so that the value in square inches, or whatever units the area is recorded in, may be transformed to a definite numerical value. As an illustration, suppose the area of a curve, plotted in terms of speed and time, is desired. Assume one inch of cross-section paper along the time axis as equivalent to 10 seconds, and also assume one inch of curve sheet on the speed axis as representing 20 miles per hour. One square inch of cross-section paper would indicate a speed of 20 miles per hour for 10 seconds, representing a distance covered of $(1.47 \times 20 \times 10 = 294 \text{ ft.})$, one mile per hour being equivalent to 1.47 feet per second. Suppose the area of the curve when passed over by a planimeter was found to be 10 square inches. This would indicate a distance traversed of $294 \times 10 = 2,940 \text{ feet.}$

The area could also be divided by the base line of the curve into inches and the mean ordinate in inches obtained. This value in inches plotted upon the speed

axis will yield the average speed during the whole time interval.

A form of cross-section paper ruled with fine lines $\frac{1}{10}$ of an inch apart and heavy lines one inch apart, may be obtained from standard manufacturers, which greatly facilitates curve manipulation. The lines on this curve paper are ruled with red ink, the paper itself consisting of tracing cloth, enabling curves and cross-section lines to be readily blue-printed.

CHAPTER II.

ANALYSIS OF TRAIN PERFORMANCE.

WHEN considering the performance of a train between stations it is desirable to have some means of comparing at any time interval, the distance covered by the train; its speed; its rate of acceleration, whether positive, zero, or negative; the power consumption of the motors, and the rise of temperature of the armature coils and field coils of the motor windings.

This comparison is possible by means of a series of curves, all plotted with time as their abscissa, Fig. 6. They are termed a distance-time curve, a speed-time curve, an acceleration curve, a voltage curve, a current curve, a power curve, and a curve of current squared values from which the effective or heating value of the current is obtained. In addition to these curves the percentage grade and the percentage curvature of the tracks are plotted upon the same performance sheet from the profile and contour maps, Fig. 7, of the road. Nearly all of these curves may be found in Fig. 6.

Distance-Time Curve. — A distance-time curve is a curve connecting a series of successive values of distance traversed at various times. Such a curve when applied to a train representing its performance between stations has a zero value at its beginning; a continuously increasing value when the train is under headway, the slope of the curve

ELECTRIC RAILWAYS.

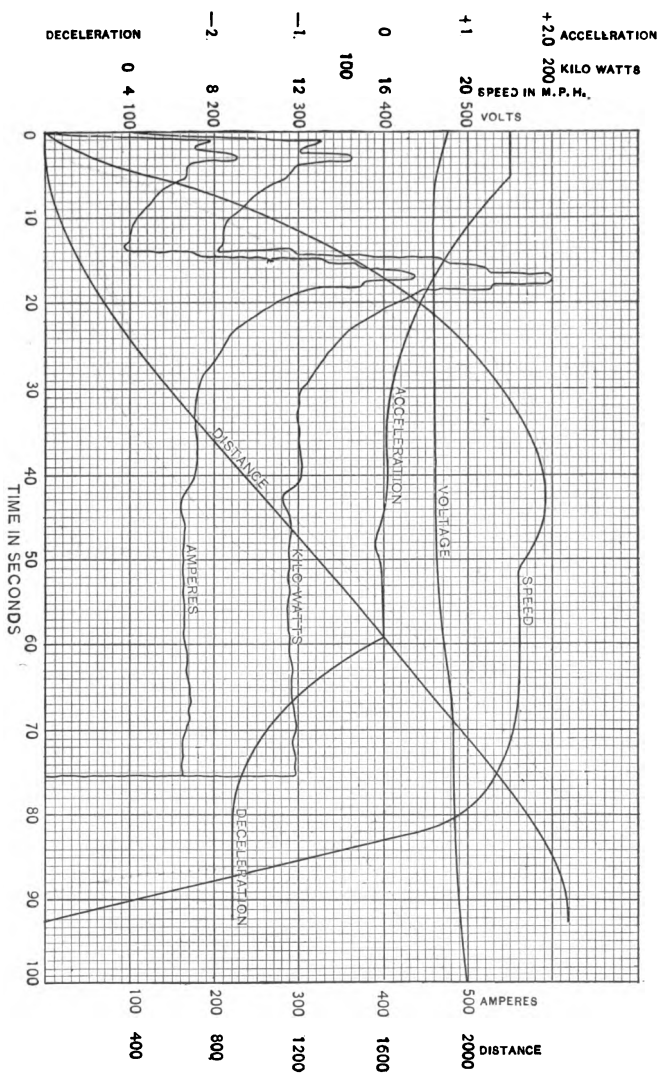

Fig. 6. — TRAIN TEST DIAGRAM.

depending upon the speed of the train; and a maximum value when the train has arrived at the second station, at which time the curve becomes parallel to the time axis indicating zero speed. Methods of obtaining distance-time curves from actual tests will be described later.

Speed-Time or Velocity Curves. — The terms speed and velocity are used as synonymous when considering train

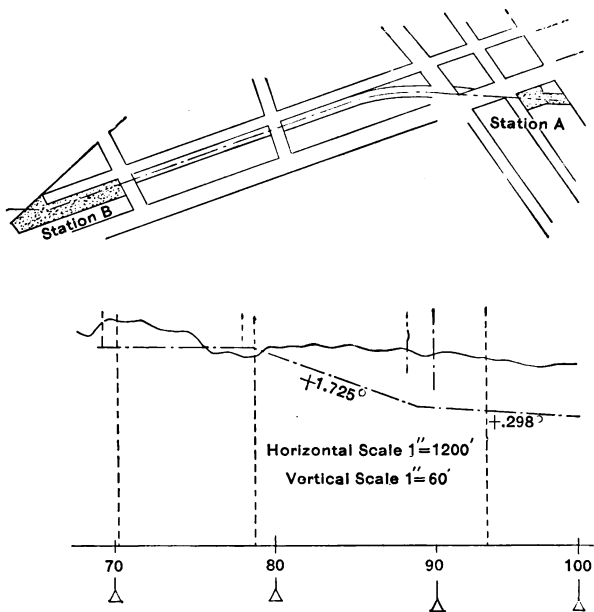

Fig. 7.—PROFILE AND CONTOUR SHEET.

motion, although a difference exists as is brought out in the study of kinematics.

Velocity is defined as the rate of change of position of a body. A velocity time curve or a speed-time curve may be plotted by drawing a series of tangents to a distance curve,

obtaining the distances traversed in unit time and plotting a curve through the points.

Speed is usually expressed in miles per hour, one mile per hour being equivalent to a distance traversed of 1.47 feet per second. The relation between distance, s , time, t , and velocity, V , is represented by the equation,

$$V = \frac{ds}{dt}.$$

A speed-time curve in its elementary form is composed of three characteristic parts (Part I., Fig. 8): part "A"

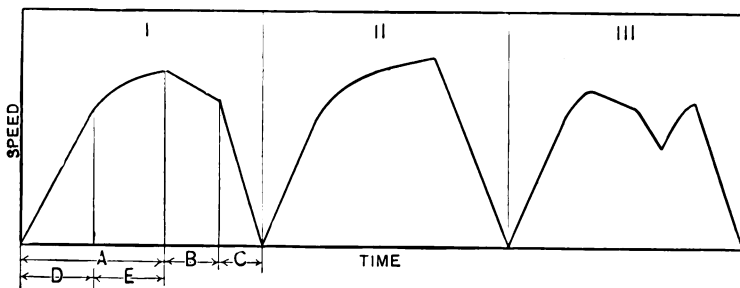

Fig. 8. — ELEMENTARY SPEED-TIME CURVES.

during which time power is being applied to the train, termed the "acceleration" portion; part "B" when the supply of power has been discontinued, the train moving due to its inertia, designated as "coasting"; and part "C" when the brakes have been applied, the speed of the train being rapidly reduced, represented by the term "braking." Referring to Part I., Fig. 8, the acceleration portion of the speed-time curve may be sub-divided into two parts, D and E . Part D represents the acceleration while on resistance; part E , the time interval that the train is operating directly on the line voltage. The profile and general contour of a

road may be such that it will be necessary to make several applications of power producing a speed-time curve (Part III., Fig. 8), composed of many parts. It may also be desirable to utilize a motor equipment to its maximum capacity, thus covering a given distance in the shortest possible time. Under these circumstances the speed-time curve will consist of only two distinct parts (Part II., Fig. 8), being composed entirely of acceleration and braking, the coasting portion being eliminated.

A speed-time curve may have two functions. It may be plotted as a desired schedule to be made over a road of given contour and profile, assuming a given rate of acceleration, a maximum speed, a given rate of braking, and a definite number of applications of power to a particular equipment. From such a speed-time curve or series of curves representing a complete schedule for a day, may be deduced other curves from which is selected the particular motor which can perform the day's schedule without heating excessively. Conversely, the speed-time curve may be plotted from the characteristic curves of a given motor as equivalent to the performance of that motor when mounted under a car and applied to a given set of conditions of grades and curves between stations.

Acceleration. — Acceleration is the rate of change of velocity. It may be expressed as the change of velocity in unit time, equation *a*; as the first derivative of velocity referred to time, equation *b*; or as the second derivative of distance with respect to time, equation *c*:

$$a = \frac{V - V^1}{t} \quad (a)$$

$$a = \frac{dv}{dt} \quad (b)$$

$$a = \frac{d^2s}{dt^2} \quad (c)$$

The unit of acceleration is the mile per hour per second (*M. P. H. per S.*). A train accelerating at the rate of one mile per hour per second will increase its speed 1.467 ft. per second, being equivalent to the distance passed over in one second by a train moving at the rate of one mile per hour ($5,280 \div 3600 = 1.467$ ft.).

Acceleration is produced by the application of force. A constant force applied will tend to result in constant acceleration. Such a constant force may be obtained by passing a current of electricity of a constant value through the armature and field coils of a series railway motor. The pull transmitted by the gears from the armature shaft to the base of the car wheel is termed *tractive effort*, meaning horizontal pull. It is sometimes referred to as the draw bar pull. It bears a fixed relation to the *torque* or turning moment of the motor armature. The force of gravity will accelerate one pound 32.2 ft. per second.

The relation between acceleration *A*, force *F*, and mass *m*, is expressed by the formula,

$$F = m A.$$

$$\text{Substituting for mass its equivalent } \frac{w}{g} = \frac{w}{32.2},$$

$$A = \frac{F \times 32.2}{w}$$

where A = the acceleration in feet per second per second,
 F = the tractive effort, or force applied in pounds,
 w = the weight in pounds being accelerated.

Substituting for A the acceleration in feet per second per second its equivalent "a" in miles per hour per second, we obtain,

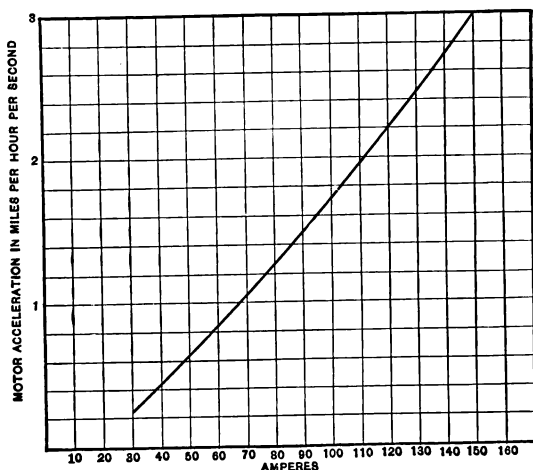

Fig. 9. — MOTOR ACCELERATION CURVE.

$$a = \frac{A}{1.467} = \frac{32.2 F}{w \times 1.467}.$$

$$\text{Let } W = \text{the weight in tons} = \frac{w}{2000},$$

$$a = \frac{32.2 F}{W \times 1.467 \times 2000} = \frac{F}{91.1 W} = \frac{.01098 F}{W}.$$

It is obvious from the preceding equations that 91.1 lbs. tractive effort will accelerate one ton at the rate of 1 *M.* per *H.* per *S.* It is also evident that the rate of acceleration

varies directly as the force applied and inversely as the weight of the body undergoing acceleration.

Motor Acceleration. — A curve, termed motor acceleration curve, Fig. 9, may be plotted for a particular motor

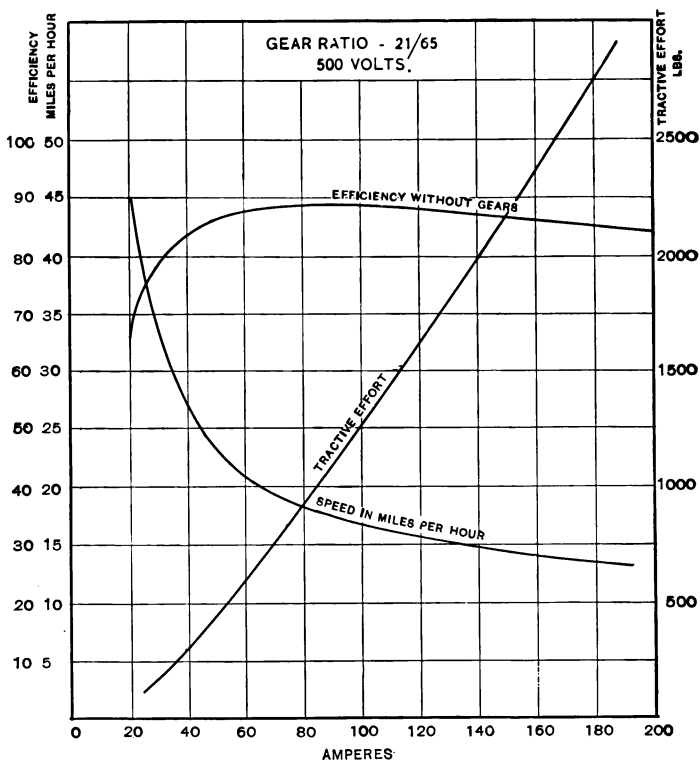

Fig. 10.—MOTOR CURVES FROM WHICH FIG. 9 IS CALCULATED.

equipment as follows. The complete weight of the train in tons, including trucks, motors, brake equipment, and the number of motors to the car, is determined. From

this data is obtained the gross tons per motor. The acceleration values corresponding to the tractive effort per ton per motor is determined at the various current inputs and a curve of acceleration and current plotted. As an example, assume a car weighing 32 tons including passengers, equipped with four type 81 Westinghouse motors. Each motor will accelerate 8 tons. Referring to the tractive effort curve for this particular motor, Fig. 10, it is obvious that with a current input of 100 amperes, the motor will exert a tractive effort of 1,260 lbs. or 157.5 lbs. per ton, which is equivalent, from acceleration equation, to an acceleration of 1.73 *M. per H. per S.* In a similar manner values are obtained for a number of other current inputs and a curve plotted as in Fig. 9, representing the motor acceleration for that particular equipment. This curve is modified in actual practice by the consideration of curves, grades, and a factor termed train resistance.

Deceleration. — Acceleration may have a negative value which is termed deceleration. This occurs with a decrease of speed. Deceleration is produced by curves, grades, and the factor previously mentioned, termed train resistance. The application of brakes will also produce deceleration. The train acceleration may be obtained by subtracting the deceleration due to the previous mentioned factors, from the motor acceleration.

Effect of Grades. — A grade of one per cent indicates an increase in height or altitude of one foot for every 100 feet of track. This is equivalent to exerting a negative force equal to $\frac{1}{100}$ of the train weight, or 20 lbs. per ton. The force *g*, in pounds due to grades, is expressed as follows:

$$\begin{aligned} -q &= -20 p \quad . \quad . \quad . \quad \text{up-grades,} \\ +q &= +20 p \quad . \quad . \quad . \quad \text{down-grades,} \end{aligned}$$

where p equals the per cent grade.

The deceleration or acceleration $a = \pm 20 p \times .01098$.

Effect of Curves.—It is usual in America to express the value of a railway curve in terms of the degrees of central angle subtended by a chord of 100 feet of track. A curve of one degree would therefore have a radius of 5,730 feet; a 2° curve, 2,865 feet, or $\frac{1}{2}$ of a 1° curve; a 3° curve, 1,910 feet, or $\frac{1}{3}$; the radius decreasing in the ratio, 1, $\frac{1}{2}$, $\frac{1}{3}$, $\frac{1}{4}$, etc., or

$$\text{degrees} = \frac{5730}{\text{radius}}.$$

In the construction of railway curves it is customary to raise the outer rail a definite amount depending upon the radius of curvature of the tracks. Gravity, therefore, acting upon the inclined car in motion alters the center of gravity of the system and counterbalances the centrifugal force of the car, eliminating its tendency to leave the tracks.

Experiments have been performed at various times to determine the equivalent traction due to curves. Mr. Latrobie in 1844 experimented upon the Baltimore and Ohio Railroad, and as a result determined that a curve of one degree exerted a resistance of .52 lb. per ton. The Pennsylvania Railroad later adopted the value .56 lb. per ton, for a curve of 1° , and the New York and Erie Railroad similarly employed the value .7 lb. per ton. The Westinghouse Mfg. Company uses the factor of 1 lb. per ton, when considering curves occurring in railway lines located in mines. A fair average value is 0.60.

Train Resistance.—In addition to the negative force exerted by curves and up grades, there are several other factors which influence the rate of acceleration of a train. These factors combined are termed train resistance. Train resistance includes friction due to tracks ; wind pressure, the effect of which varies with the dimensions and shape of the car ; the inertia of the moving train, and the rotational effect of the armatures. The fly wheel effect of the wheels and armatures may amount to as much as 5% of the inertia weight of the train. The formulas for train resistance, f , are legion. Several of the more important are as follows, where f is expressed in lbs. per short ton.

Aspinwall: $\left(2.5 + \frac{V^3}{50.8 + 0.0278 L}\right) \cdot 892$. Observed up to 80 miles per hour.

Baldwin Loc. Co.: $3 + 0.167 V$ Any speed.

Blood: $4 + 0.15 V + 0.3 \frac{V^{1.8}}{T}$ Observed to 100 miles per hour.

Engineering News ('94): $2 + 0.25 V$ Any speed.

Lundie: $4 + V \left(0.24 + \frac{4.8}{T}\right)$ Observed up to 30 miles per hour.

Davis: $5 + 0.13 V + \frac{0.004 A V^2}{T} \left[1 + 0.1 (N - 1)\right]$.

Wellington: $4 + 0.005 V^2 + (0.28 + 0.03 N \frac{V^2}{T})$

where

V = speed in miles per hour,

A = effective area of car = width outside \times (height from rail to roof — radius of wheels),

L = length of train in feet,
 T = weight, short tons,
 N = No. units in the train,
 $.004$ = coef. of wind pressure.

The curves represented by these equations have been plotted, Fig. 11, for a five car train of the following dimensions:—

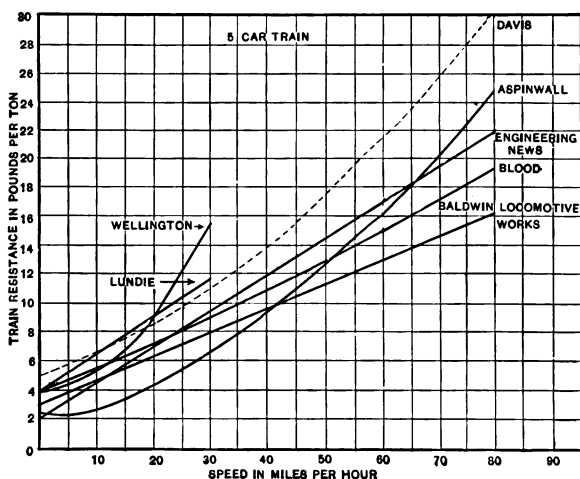

Fig. 11. — TRAIN RESISTANCE CURVES FOR 5 CAR TRAIN.

Length of car, 51' 5".
 Height, 8' 9 $\frac{7}{8}$ ".
 Diameter of wheels, 33".
 Effective area, 96 square feet.
 No. of units, 5.

In the derivation of these train resistance equations the starting resistance of the train, amounting to as much

as 18 lbs. per ton, has evidently not been considered. Many of the formulæ are not affected by the number of units to the train. This variation amounts to over 300% when considering single car operation, as may be readily observed by Fig. 12. Referring to the Davis standard

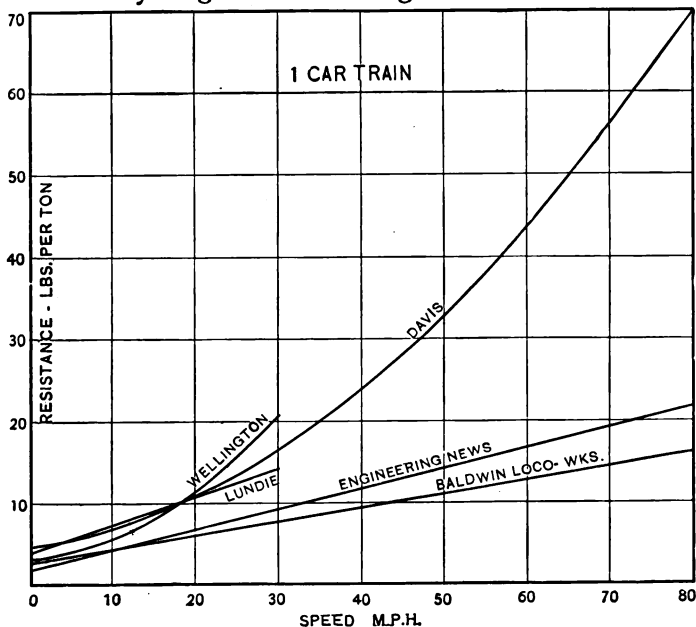

Fig. 12.—TRAIN RESISTANCE CURVES FOR 1 CAR TRAIN.

formula, and to Fig. 12, it is obvious that with the single car operation the train resistance reaches the value of 20 lbs. per ton at 35 miles per hour. This is equivalent to a one per cent grade. Above this speed train resistance soon arrives at such values as make single car operation prohibitive. The relation between single car operation and five car operation may be readily observed from the two curve sheets, Figs. 11 and 12.

Train Acceleration. — The resultant acceleration a , obtained from a consideration of gross traction per ton per motor, of curvature of tracks, of grades, and train resistance, is expressed by the following equation: —

$$\text{Down grades, } a = .01098 (t - c - f + g),$$

$$\text{Up grades, } a = .01098 (t - c - f - g),$$

Where a = the acceleration in miles per hour per second,

c = the equivalent traction due to curves in lbs. per ton,

f = the equivalent traction due to train resistance in lbs. per ton,

g = the equivalent traction due to grades in lbs. per ton,

.01098 = the acceleration coefficient, and

t = the tractive effort per ton per motor expressed in lbs. per ton.

Example. — Given a 35-ton single car equipped with two motors ascending a 1% grade at a speed of 20 miles per hour. Assume that the car is passing around a 1° curve, and such a current is traversing the motors that each will exert a tractive effort of 2,100 lbs., then the tractive effort per ton will be 120 lbs.

$$\left(\frac{2100 \text{ lbs.}}{17.5 \text{ tons}} = 120 \text{ lbs.} \right)$$

Following are the various traction values and the resultant net acceleration.

Tractive effort per ton t ,	= + 120 lbs.
Traction, g , due to up-grade, per ton,	= - 20 "
Traction, f , due to train resistance, per ton,	= - 13 "
Traction, c , due to curves, per ton, (factor .6)	= - .6 "
	—————
Total train traction,	+ 86.4 lbs.

$$a = .01098 \times 86.4 \text{ lbs.} = .949 \text{ } M. \text{ per } H. \text{ per } S.$$

Under these conditions the train will accelerate at the rate of .949 miles per hour per second.

Coasting. — When coasting, the motion of the train being due entirely to its inertia, the resulting acceleration or deceleration will depend upon the train resistance, the profile, and curvature of the road. The equation for train acceleration will then reduce to the following :

$$a = .01098 (-c - f \pm g)$$

where

a = the rate of change of speed, or acceleration.

If the train be passing over a steep down grade, the traction due to this grade may be sufficient to overcome the curvature and train resistance producing acceleration.

Braking. — During the process of braking a car it is necessary to consume about 60% of the energy which has been imparted to it while accelerating. High speed inter-urban railway practice tends toward rapid acceleration, small amount of coasting, and high rates of braking. Under these conditions, a pressure of approximately 150 lbs. per ton is applied to the car wheels through the brake shoes. Too high a rate of braking will raise the car body

from the rear truck, due to a tendency of the center of gravity of the car to revolve over the forward truck. It will also cause the wheels to slide, producing skidding.

The negative acceleration, or deceleration, a , due to braking, is expressed by the formula :

$$a = .01098 (-B - c - f \pm g)$$

where B = the braking force in lbs. per ton.

c = the equivalent traction due to curves in lbs. per ton.

f = the equivalent traction due to train resistance in lbs. per ton.

g = the equivalent traction due to grades in lbs. per ton.

Energy of a Moving Train. — The kinetic energy of a moving body is represented by the equation :

$$e = 1/2 mv^2$$

where e is expressed in ft. lbs., and $m = \left(\frac{w}{g}\right)$.

w is expressed in lbs.

v = the velocity in ft. per second.

Miles per hour $\times 1.47$ = feet per second.

To consume this energy, and stop the motion of a moving train, it is necessary to perform a given amount of work, or exert a force p , over a distance s . Expressed as :

$$e = ps$$

where p = the pounds pressure applied, and

s = the distance in feet passed over before zero speed occurs.

These equations being equal to each other, the relation is expressed, substituting for m , its equivalent $\frac{w}{g}$:

$$s = \frac{w v^2}{2 g p}.$$

Thus, a 30-ton car coasting from a maximum speed of 20 miles per hour, on a level track with no curvature, will

reach zero speed in $\frac{30 \times 2000 \times (20 \times 1.47)^2}{2 \times 32.2 \times 15 \times 30} = 1789$ ft.,

assuming an average train resistance of 15 pounds per ton for p . By means of instruments recording speed and time, and allowing a train to coast, values may be obtained for train resistance, from the above formula.

Change of Gear or Voltage. Their Effect.— The characteristic curves of a motor are usually obtained from a stand test of 500 volts. The tractive effort, horizontal pull, is usually expressed on the curve sheet for a definite gearing, the tractive effort representing the force exerted at the rim of the car wheel. The torque of the motor is usually measured by some form of dynamometer or brake, and these values converted to tractive effort with a knowledge of the gear ratio, and diameter of the car wheel.

A change of speed will not affect the tractive effort of the motor, which depends entirely upon the current input. The speed of a direct current series motor is practically proportional to the difference of potential at the motor terminals. A change in line voltage will therefore alter the speed proportionally.

Altering the gear ratio will affect the speed and change

the tractive effort by an amount equivalent to the reciprocal of the change in speed. As an example, assume that such a change in gearing was made that the speed was increased 2.5 times, the tractive effort values would have to be multiplied by the factor .4 to obtain the resulting tractive effort.

$$\frac{1}{2.5} = .4.$$

A change of voltage and a change of gearing will produce a change of speed proportional to the product of the individual change due to each.

Current Curve. — This curve, when applied to a motor equipment, represents the current input during one cycle of operations. The current curve, when obtained from actual test, would have the characteristic notched appearance represented by Fig. 13. Such a curve, when taken from a series parallel control equipment, is composed of three distinct parts, — *A*, *B*, *C*, Fig. 13. Part *A* represents the current input during the time that the motors are in series, part *B* similarly indicates the time when they are in multiple, and part *C* is termed the free-running position. Part *A* also includes free running with motors in series, no resistance in circuit.

The current input should be approximately constant to the point where all resistance is removed from the circuit if a constant rate of acceleration is desired. Referring to Fig. 13 the resistance is removed from the circuit, point by point, producing a notched curve, each notch representing one point on the controller. In the multiple position the current input is double that of the series position, as both motors are operating in parallel. Considering part *C*,

all resistance has been removed from the circuit and the motors are operating in parallel directly upon the line circuit. As the speed of the motors increases, their counter-electromotive force increases proportionally, reducing the current input. This is obvious when we consider that the current value is represented by the difference existing be-

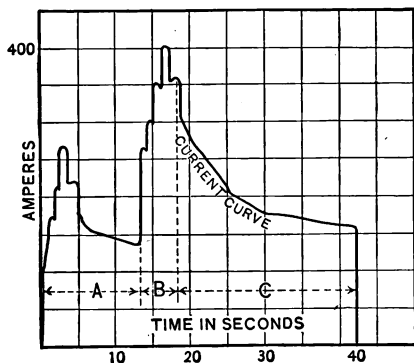

Fig. 13. — TRAIN CURRENT CURVE.

tween the line armature pressure E and the counter-electromotive force E' , divided by the resistance of the motor armature R .

$$I = \frac{E - E'}{R}.$$

Integrating the area of the current curve, with a planimeter, and dividing by the base line, the mean current value may be obtained. This value multiplied by the time of the complete cycle will yield the coulombs used.

Voltage Curve. — The voltage curve, when representing the line pressure, is usually a broken line, dropping at the point where heavy currents enter the train during acceler-

ation. This curve does not represent the pressure on the armature terminals of the motor, but indicates the line voltage. The object of using this voltage is to determine power values by multiplying together the line pressure and the current input of the motors. These power values represent the energy consumed by the train, including that

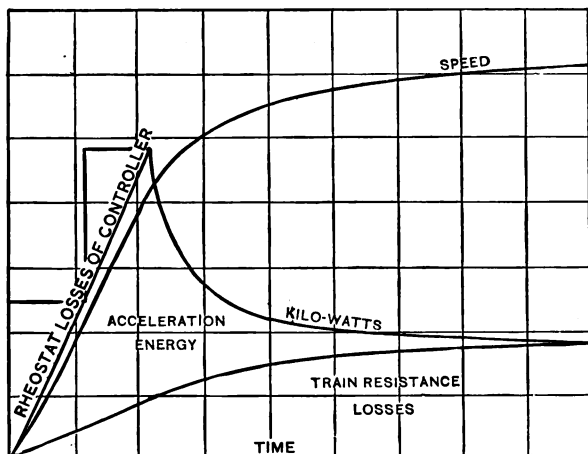

Fig. 14. — TRAIN ENERGY CURVES.

portion which enters into the I^2R losses of the control resistances. (See Fig. 14.)

Power Curve. — This curve may be obtained by multiplying the instantaneous current values, represented by the current curve, into the corresponding instantaneous pressure values. When the resulting values are plotted, a kilowatt curve is obtained. The area of this curve in appropriate units will represent the kilowatt hours consumed during one cycle of operations. The shape of the power curve will be somewhat similar to that of the current curve,

depending upon the fluctuations of the voltage curve. Power consumption of trains is usually expressed as the watt hours per ton per mile. (Watt hours per ton mile.) The various losses representing the energy consumed by train resistance, and the losses due to the control rheostats, may be represented as in Fig. 14. From these curves may be obtained the net acceleration energy stored in the moving train.

Effective Current or its Heating Value.— In order to determine the heat generated in the windings of a motor, it is necessary to obtain the effective or heating value of the fluctuating current. This value is equivalent to the square root of the mean square current value, or

$$I = \sqrt{\text{mean } I^2}.$$

The effective value may be obtained as follows: The instantaneous current values represented by a train current input curve, Fig. 13, are each squared and a curve of current squared values plotted. The area of the current squared curve may be obtained with a planimeter. This area divided by the base line will yield the mean square ordinate. Plotting this ordinate upon the current squared axis will indicate the corresponding current squared value. Extracting the square root of this quantity the effective or heating value may be obtained.

The above method is applicable where a current test curve is at hand, in the absence of which the following method, developed by Mr. Chas. F. Scott and described in the A. I. E. E. transactions by Mr. C. Renshaw, may be used.

An integrating wattmeter armature is wound with coils of low resistance to create a reasonable torque upon the

field for a low voltage impressed upon the armature terminals. These terminals are shunted across the field coils of one of the motors of an equipment. The field coils of the wattmeter are connected in series with the field coils of the same motor.

The wattmeter will then register the watt hours consumed by the resistance of the motor field coils.

These watt hours may be represented by the equation,

$$\text{Watt hours} = I^2 R T.$$

$$\text{Therefore, } I^2 = \frac{\text{Watt hours}}{R T}$$

where R = the resistance of the motor field coils,
 T = the time in hours line current is passing through field coils, and
 I^2 = effective current squared.

The resistance of the motor field coils must be determined very accurately before the test. The time T , that the controller is "on," is noted. Inserting the values R , T , and the watt hours registered by the wattmeter, the mean square current value, I^2 , may be readily determined. Extracting the square root of this quantity, the effective current value is obtainable. The wattmeter may be allowed to register for a day's schedule and the effective current value for the day's service determined.

Selection of Motor Equipment. — The selection of a suitable motor for a given service involves the consideration of a number of conditions, principal of which is motor capacity. The ultimate capacity of a motor is determined by its heating and commutation, minor of which is commutation which affects the momentary output only. Commercial

conditions of operation, and design of equipments, introduce factors such as induction of windings, safety devices, contact resistance of rails, etc., which modify the limiting value of commutation.

Considering the heating of a railway motor as the limiting factor to its capacity, its ultimate temperature will depend upon the relation existing between the heat developed and the heat dissipated. It has been stated that a railway motor will carry its rated output for 25 per cent of the total time. If its heat losses amount to 12 per cent, it will therefore dissipate 3 per cent of its rated capacity continuously. Consideration must also be taken of the fact that the generation of heat in the motor windings is not continuous as is the case with the dissipation of heat. In an enclosed motor the greater portion of heat generated by the armature coils must pass through the field coils and frame to escape to the atmosphere, resulting in a non-uniform distribution of heat, eliminating a mathematical basis for the calculation of the ultimate temperature, unless a knowledge of the ratio of distribution of heat is at hand. This fact was brought forward by Mr. F. H. Armstrong, who suggested that curves be plotted from actual tests, exhibiting the degrees Centigrade rise per watt loss in armature and field coils operating under commercial conditions. The ultimate temperature of the motor windings could then be easily determined.

The A. I. E. E. recommends as a method of rating railway motors a stand test continued for one hour, motors operating under a pressure of 500 volts, such a current passing through the motor windings as will raise its temperature 75° C. above that of the atmosphere, which is assumed to be 25° C.

The Westinghouse Manufacturing Company publish curves exhibiting the temperature rise of motors, obtained from a stand test. These curves (Fig. 15) indicate the current in amperes that a particular motor will carry contin-

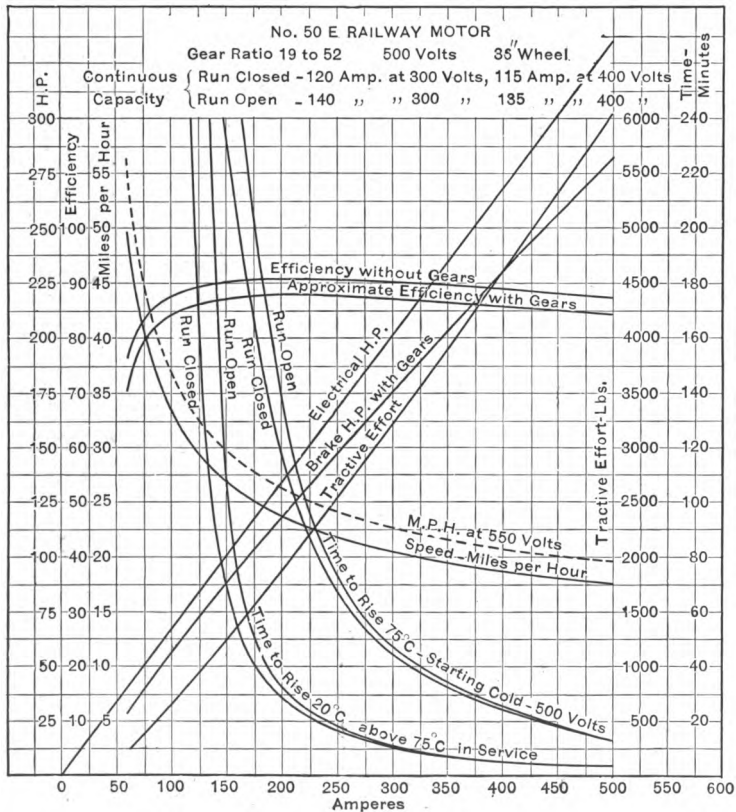

Fig. 15. — MOTOR CAPACITY CURVES.

uously under a pressure of 300 volts. This voltage is assumed to correspond to normal pressure of operation.

Given the continuous current capacity of a motor and its

characteristic curves (Fig. 15), to determine whether it is suitable for a given service, the following method of procedure may be adopted. Speed-time and current curves should be plotted between all stations for a train equipped with the motors under consideration. The number of speed-time curves plotted should be sufficient to represent a day's schedule, which would consist of one continuous run in each direction as the number of units to the train could be adjusted to provide for an approximately constant passenger load. The effective current value for each curve sheet should be obtained, and the effective current value for the day's schedule determined. If this current value corresponds to the continuous current value indicated by the temperature curve, such as in Fig. 15, the motors are of the proper capacity. If the effective current value be greater, the motors will be of insufficient capacity and will heat excessively. If the effective value be smaller than the continuous value, the motors are too large for the given service.

Plotting of Theoretical Speed-Time Curve. — When plotting speed-time curves for a given motor, the following data is essential:

The motor characteristic curves, motors operating on line voltage, geared in the desired ratio.

The profile and general contour of road.

The total weight per car, including car body, trucks, motor equipment, control, brake apparatus, and passenger load.

The number of motors to a single car equipment.

The maximum speed desirable, and the proposed schedule speed between stations.

The rate of acceleration and the rate of braking.

Examples. — As a specific example of the process of plotting a speed-time curve, assume the following data given:
 Motor Curve Type 81, Westinghouse Motors (Fig. 16).
 Four-motor equipment having 33" wheels.

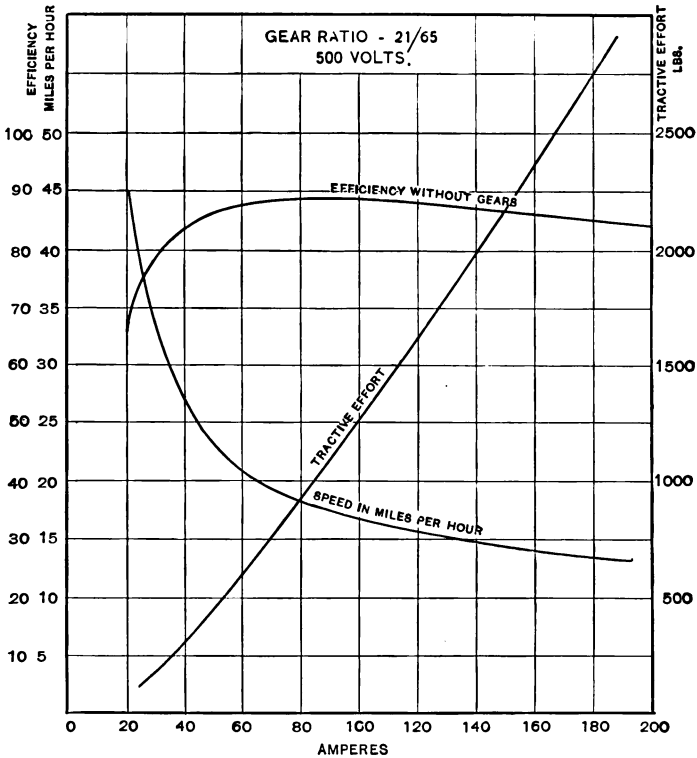

Fig. 16. — CURVES OF TYPE 81, WESTINGHOUSE MOTOR.

Distance between stations, 2,480 feet.

Schedule speed, 18.5 miles per hour.

Rate of acceleration and braking, 1.5 *M.P.H.* per *S.*

Total train weight, 32 tons.

Profile and general contour as follows :

From station A to station B = 2,480 feet.

“ “ A, first 600 feet, an up grade of 1%.

“ 600 to 1,200 an up grade of 1% and a 2° curve.

“ 1,200 to 2,480 feet, level track.

A table should be prepared (Fig. 17) representing the equivalent traction due to grades and curves referring to previous equations.

EQUIVALENT TRACTION IN POUNDS PER TON.

Distance.	GRADES.		CURVES.		NET.
	Per Cent Grade.	Traction due to Grades.	Degree of Curvature.	Traction due to Curves.	Total Traction in lbs. per ton.
0 to 600	+1	-20	0	0	-20
to 1,200	+1	-20	2°	1.2	-21.2
to 2,480	0	0	0	0	0

Fig. 17.

If there are several speed-time curves to be plotted, which is usually the case, the work may be facilitated by the preparation of a curve plotted with speed as abscissa and the tractive effort per ton per motor at various speeds, as ordinate values (Curve A, Fig. 18). The train resistance (Curve B, Fig. 18) in pounds per ton at various speeds should also be plotted upon the same curve sheet. The difference between the ordinates of these two curves will represent the pounds tractive effort remaining, per ton, to overcome grades, curves, and produce train acceleration (Curve C, Fig. 18). To plot the horizontal dotted portion of the tractive effort curves (Curve C, Fig. 18), due allow-

ance should be made for train resistance, grades and curves; the maximum tractive effort in this case will necessarily have to be such as will produce an acceleration of 1.5 *M.P.H.* per second with the given conditions. The hori-

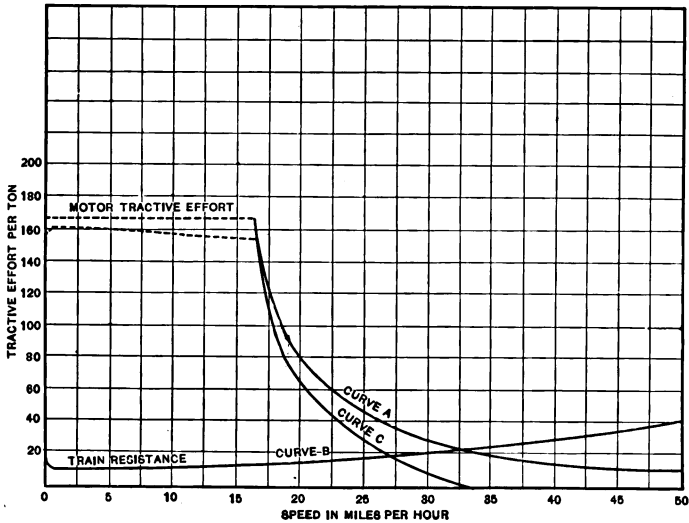

Fig. 18.—SPEED TRACTIVE EFFORT CURVES.

zontal dotted portion of the curve may then be plotted by assuming a fair average value for train resistance, so that when the tractive effort value is fixed by limiting the current input into the motors by the controller, the net tractive effort will be sufficiently high to produce the desired acceleration. Assume in this case an average value of 10 lbs. per ton for train resistance as speed values are low.

To accelerate one ton at the rate of 1.5 *M.P.H.* per S. would require a tractive effort "T" of 136 pounds per ton:

$$T = \frac{a}{.01098} = \frac{1.5}{.01098} = 136 \text{ lbs.}$$

With a train resistance of 10 lbs. per ton and a 1% grade, a total tractive effort of $136 + 10 + 20 = 166$ lbs. will accelerate one ton of train at the rate of 1.5 *M.P.H.* per S. With this value the horizontal dotted portion of curve A (Fig. 18) should be plotted. The actual train resistance values, curve B, should then be subtracted from this curve, resulting in curve C.

Upon each ton of car weight must be exerted a tractive effort of 166 lbs., while accelerating on resistance. Considering 8 tons per motor, this corresponds to 1,328 pounds tractive effort at a current input of 102 amperes per motor (see motor curves, Fig. 16). To produce a constant rate of acceleration, a constant current must pass through the motors, giving uniform tractive effort. This is the function of the controller and resistance, upon the proper manipulation of which depends the character of the acceleration. Referring to the motor curve (Fig. 16), a current input of 102 amperes corresponds to a speed of 16.5 miles per hour. When the car reaches this speed the controller handle will be in the full multiple position, the motor operating directly upon the line voltage, all resistance having been removed from the circuit. The current value at this instant of time should correspond to the one-hour rating of the motor. As the speed of the motor increases beyond 16.5 miles per hour, the current input will fall below 102 amperes, due to counter *E.M.F.* Therefore, up to a speed of 16.5 miles per hour the tractive effort will be approximately constant, providing no change of grade or curvature occur, producing practically uniform acceleration.

At a schedule speed of 18.5 miles per hour, it would require 91.4 seconds to pass over a distance of 2,480 feet. This will locate the maximum abscissa on the time axis of the speed-time curve. (See Fig. 19.)

PLOTTING OF CURVE.

Proceeding to plot the speed-time curve, locate the coördinates of the first point as follows: Assume a speed value, say five miles per hour, and locate the corresponding time increment, 3.33 seconds, necessary to bring the speed of the train from zero to 5 miles per hour by the equation,

$$a = \frac{dv}{dt}, \quad dt = \frac{dv}{a} = \frac{5}{1.5} = 3.33 \text{ seconds,}$$

where a = the acceleration in miles per hour per second,
 dv = the speed in miles per hour (speed increment).

The first speed-point will then be 5 miles per hour at 3.33 seconds. At an average speed of 2.5 miles per hour, a distance of 12.2 feet will be passed over in 3.33 seconds ($1.467 \times 2.5 \times 3.33$), locating the first point on the distance curve. The speed-time curve and distance-time curve should be plotted simultaneously. As the plotting of the speed-time curve proceeds, constant reference must be made to the table of distances and the tractive effort curve to obtain net tractive effort values, as the acceleration coefficient, in this case 1.5, will change with grades, curves, and train resistance.

Continuing the plotting (Fig. 19), the acceleration curve in this case will be approximately a straight line up to a speed of 16.5 miles per hour at 11 seconds, at which

point, *A*, the motor is beyond the resistance points of the control, the current changing in magnitude. In practice the shape of the acceleration portion of the speed-time curve sometimes changes, due to abnormal starting conditions (see Fig. 6). The area of the speed-time curve should be occasionally obtained with a planimeter, and its value in

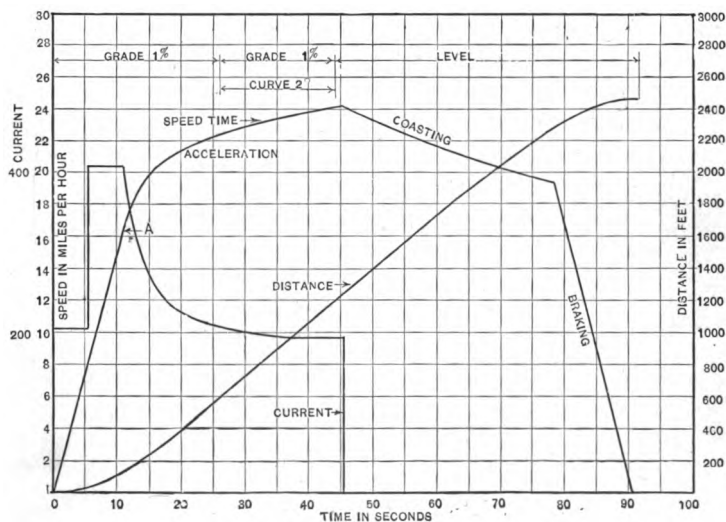

Fig. 19. — CALCULATED TRAIN CURVES.

terms of distance covered checked up with the distance curve.

Having plotted the speed-time curve to the point where the controller is on the full multiple position (Point *A*, Fig. 19), to plot the next point, corresponding to 18 *M.P.H.*, proceed as follows :

Referring to the tractive effort curve (Curve *C*, Fig. 18),

the tractive effort corresponding to 18 miles per hour is located, which is 96 lbs. Allowing 20 lbs. for a 1% upgrade, 76 lbs. train tractive effort remains, corresponding to an acceleration of .835 *M.P.H.* per *S.*

As the speed point, 18 *M.P.H.*, is 1.5 *M.P.H.* above 16.5 miles, the speed increment will be 1.5 *M.P.H.* The corresponding time increment will therefore be

$$\frac{dv}{a} = dt = \frac{1.5}{.835} = 1.792 \text{ sec.}$$

The point at 18 *M.P.H.* will therefore be displaced 1.792 seconds. It will consume a time interval of 1.792 seconds for the train to reach a speed of 18 *M.P.H.* from a speed of 16.5 *M.P.H.* The speed-time curve may then be drawn through the 18 *M.P.H.* point, the coördinates being 18 *M.P.H.* and 11 + 1.792 = 12.79 seconds. The time increment may be obtained directly from the tractive value when the speed increment is known by combining the equation in the form

$$\frac{dv}{T \times .01098} = dt.$$

The distance passed over being expressed as equal to :

$$dt \times V \times 1.47,$$

where *V* = average speed between point being located and last point.

The plotting of the curve should continue until the distance curve indicates that a space has been passed over equivalent to the first section of the road, where a change of grade occurs. In this case at 600 feet from the start-

ing point the train enters a 2° curve, continuing the up grade of 1%. This changes the total traction due to grades and curves from 20 lbs. to 21.2 lbs. Before deciding how much coasting is necessary to cover the ground in schedule time, it is desirable to draw the braking curve.

Braking. — The braking curve should be drawn as a straight line, which it approximates, from 91.4 seconds, the stopping point, with a deceleration of 1.5 per hour per second; the slope would be similar to the acceleration curve in this example. The acceleration portion of the speed-time curve and also the braking curve should be plotted until they intersect as in Part II., Fig. 8. Then proper judgment will decide how much of the area of the speed-time curve to cut off by the coasting curve in order that the area of the resulting curve will check with the distance to be traversed, namely 2,480 feet.

Coasting. — The controller is assumed turned off in this case at 45.5 seconds, a distance having been covered of 1,240 feet.

When locating the coasting points the acceleration will usually be negative, unless a heavy down grade is encountered. The tractive effort values then become negative, being due to train resistance, grades and curves. See previous equation for coasting. To plot the first point on the coasting curve in this case, or to determine the time in seconds necessary for the speed to fall from 24.2 miles per hour to 23.2 miles per hour, proceed as follows:

Train resistance at 23.7 miles per hour =	— 18 lbs.
Grades and curves,	0
Total traction =	— 18 lbs.

$$\text{Time increment} = \frac{24.2 - 23.2}{18 \times .01098} = 5.06 \text{ seconds.}$$

$$\text{Distance} = 5.06 \times 23.7 \times 1.47 = 176.3 \text{ feet.}$$

Plotting the Current Curve. — While accelerating on resistance, the current input into the motors may be assumed constant, providing no change of grade or curvature occur. The current input in this case is $102 \times 2 = 204$ amperes to full series position, and $204 \times 2 = 408$ amperes to full multiple position, this being a four motor equipment arranged in two groups, each consisting of two motors in multiple.

From the multiple position (Point A, Fig. 19) the current input at the various speeds may be obtained from the speed current curve of the motor, Fig. 16. The power being cut off at 45.5 seconds, the current falls to zero at this point.

Voltage. Power Curves. — The voltage may be plotted on this sheet, and a power curve obtained by multiplying together the simultaneous ordinates of current and voltage. This may be accomplished directly when the current values have been determined without resorting to the plotting of either voltage or current curve. Integrating the power curve with a planimeter will yield the watt hours, which may be readily reduced to watt hours per ton mile.

CHAPTER III.

TRAIN RECORDING AND INDICATING
INSTRUMENTS.

The Keiley Testing Apparatus. — A ready method of obtaining data for speed-time and also power curves is by means of an instrument (Fig. 20) devised by one of the authors. This instrument affords a means of obtaining simultaneous continuous records of speed and power; and an account of a series of train tests with it appears in the "Street Railway Journal" of May 21, 1904, as follows:

"The instrument when operative consists of a strip of paper in roll form drawn by a spring motor at uniform speed over a drum. The motor is fitted with a delicate governor, by means of which the speed may be changed at will. The paper passes over the drum under three pencils, the pencils pressing the paper against the drum and producing a record of time, current input, and wheel revolutions of the car. The pencils recording time and wheel revolutions are actuated by electromagnets, the pencils producing serrated lines when the paper is in motion.

"A clock mechanism mechanically closes a local storage battery circuit through the time relay magnets at successive half-second periods. It is obvious that the length of line produced by the time pencil on the paper will be the same between contacts, providing the paper move at a uniform rate.

"Upon one extremity of one of the axles of the car is fitted a wooden drum containing a metal strip. A brush

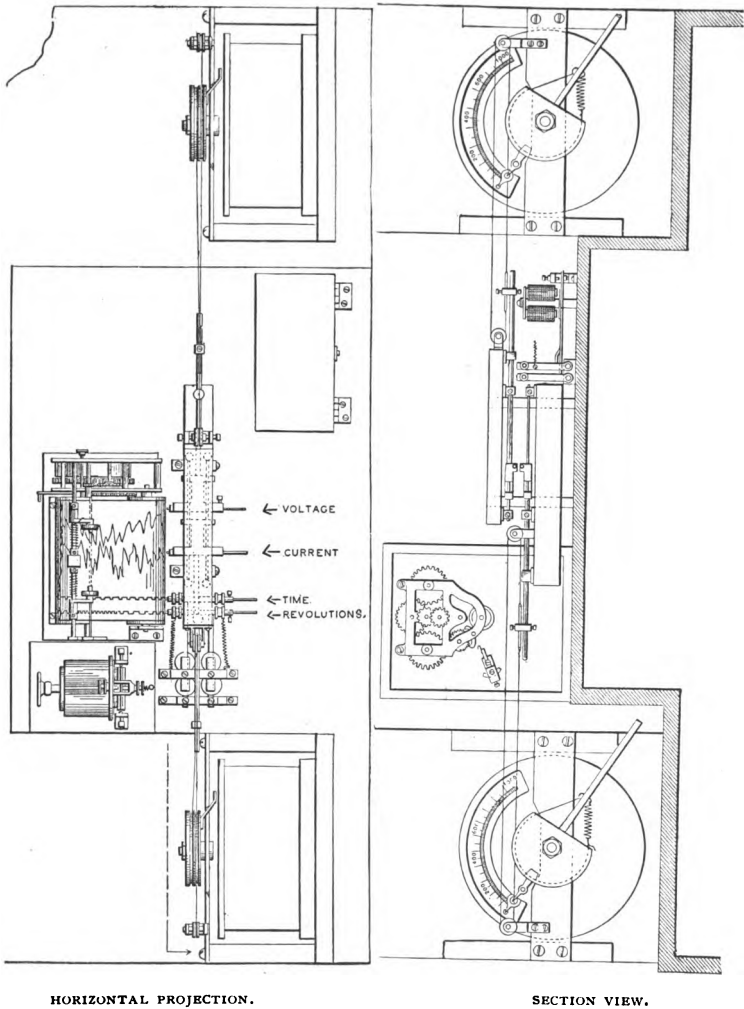

Fig. 20. — KEILEY RECORDER.

pressing upon the drum makes contact with the metal strip with each revolution of the car wheel, thereby closing a

local storage battery circuit through the second pair of magnets. The length of line produced by the revolution pencil varies with the car speed between successive contacts. At starting, the car wheel may make the first revolution in approximately one-half second. At a speed of 22 miles per hour approximately four contacts will be made in one-half second. The duration of time per revolution provides a means of plotting a speed-time curve when the circumference of the wheel is accurately known.

“The third feature of the instrument, and by far the most important, is the device for recording current. It consists of an ammeter connected in series with the power line of the train. The range of this instrument is of sufficient magnitude to permit of a deflection equivalent to the maximum current input of the motors, without banking. Mounted rigidly upon a spindle in front of the ammeter is an arm with a pointer on one extremity and a handle on the other end.

“This handle can be moved by the operator with a little practice so that the pointer may accurately follow the variations of the ammeter needle. By means of a fine wire passed several times around a pulley mounted upon the fulcrum of the handle, the motion of the pointer may be transmitted to a sliding rest upon which is mounted the current recording pencil. The wire is kept taut by passing it around two additional pulleys in a manner similar to that of an endless belt. The instrument as now developed by Mr. Keiley has an additional attachment similar in every respect to the current recording device, to record voltage (Fig. 21), requiring the services of an additional operator. In the tests made by Mr. Ashe, voltmeter readings were obtained by inserting a voltmeter in the lamp circuit with

an attachment plug, the drop due to the lamps being allowed for."

PLOTTING OF OBSERVATIONS.

"Prior to plotting a speed-time curve it is desirable to plot a distance-time curve. This is readily accomplished by counting the number of contacts representing wheel revolutions up to the given time, and multiplying by the circumference of the wheel in feet. Securing points

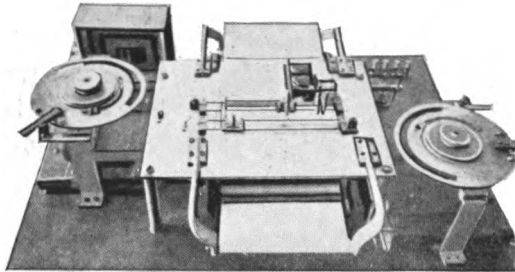

Fig. 21.—LATER TYPE OF RECORDER.

every five seconds and plotting the same, a distance curve is produced. To plot the current curve from the test sheet, vertical, parallel lines are drawn across the paper intersecting the current curve, separating it into half-second intervals as determined from the time record. The current attachment of the instrument is calibrated by placing the pointer on the successive 50 ampere points while the paper is passing under the current recording pencil, producing a series of parallel lines, one beginning where the previous one ended, from which a scale may be deduced. A zero current line is then drawn on the test sheet. The number of amperes, equivalent to the distance, between the current curve and the zero line, is readily

determined by means of the scale. The successive current values at every one-half second period are then plotted.

“The voltage as observed every three seconds is plotted above the current curve. On a curve sheet, the voltage curve should drop at each notch of the controller instead of remaining uniform.”

Mercury Accelerometer. —

When testing the operation of controllers it is essential to have some means of indicating what the acceleration is at any instant of time, without recourse to a series of calculations. A simple device which indicates acceleration, has been in use for a number of years

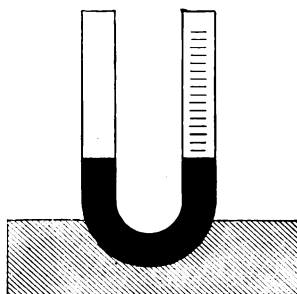

Fig. 22.—MERCURY ACCELEROMETER.

by the larger manufacturing companies. It consists of a U-tube (Fig. 22), the bore of which has been very carefully calibrated. The tube of the instrument is partially filled with mercury, and the tube mounted so that its plane is parallel to the direction of motion of the car. The acceleration of the car will increase the level of the mercury in one branch above the level in the other. The tube is graduated to indicate acceleration directly, as follows: The tube is partially filled with a known weight of mercury, and the zero point representing the level of the mercury in each branch is marked upon the glass. A given number of centimeters rise of the mercury in either tube will represent the lifting of a definite weight of mercury. The force necessary to raise this weight corresponds

to a definite amount of acceleration, which is determined from the formula :

$$\text{force} = \text{mass} \times \text{acceleration},$$

where mass represents the mass of mercury raised, and force equals the weight of the remaining mercury.

The determination of the bore of the U-tube can be readily accomplished by filling the tube to a given length with mercury, and weighing the mercury. The cross-section of the tube may then be obtained with a knowledge of the specific gravity of mercury (13.59 at 4° C.).

Sheldon's Accelerometer.—In the ordinary method of plotting a speed-time curve from observed data of speed and time, much difficulty is experienced and great inaccuracy often results, especially when acceleration and power curves are obtained from the speed-time curves. Any instrument, therefore, which will accurately record acceleration, will prove a great advantage and save much labor, beside yielding more accurate results.

An instrument has been recently devised by Dr. Sheldon of the Polytechnic, with the assistance of Mr. Browning Baker, one of his students, which indicates acceleration directly. This instrument is now under course of development, and by the addition of some method of recording similar to that adopted by Mr. Keiley in his instrument, a continuous accurate record of acceleration will be obtained. Its operation is due to inertia, the principle being similar to that first shown for this purpose by Desduits in 1883. The moving element of the accelerometer consists of a rectangular block of lead of known weight. The motion of this weight is transmitted by means of a

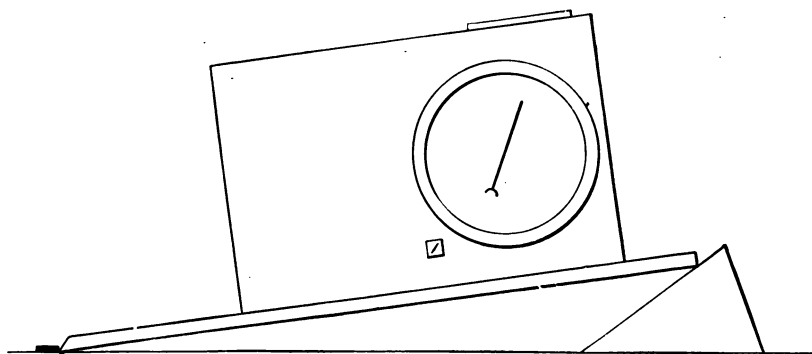

Fig. 23a. — METHOD OF CALIBRATION.

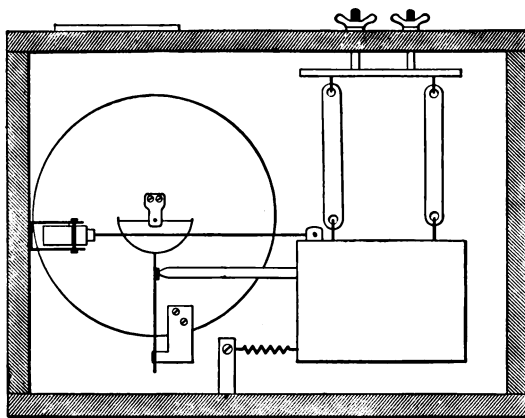

Fig. 23b. — THE SHELDON ACCELEROMETER.

spring and a silk cord (Fig. 23b) to the spindle of a pointer which moves over a dial. The instrument is calibrated by placing it upon an inclined plane of known grade, Fig. 23a, and the deceleration or acceleration corresponding to the pitch of this grade being marked upon the scale. A grade of 1% corresponds to a force of 20 lbs. per ton as previously explained. This force applied to the moving weight will tend to produce an effect corresponding to the equivalent acceleration. The motion of the moving element is impeded by a very carefully constructed dash-pot resulting in a constant deflection for a given acceleration. This instrument has been tested on the Manhattan "L," N. Y., and the curve inserted (Fig. 24) was obtained from the observed values of acceleration.

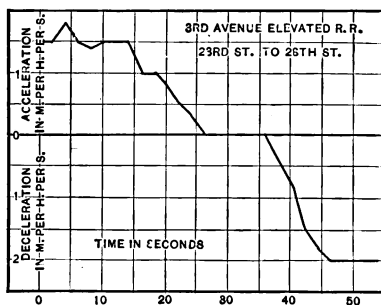

Fig. 24. — TEST CURVE OBTAINED WITH ACCELEROMETER.

G. E. Recording Ammeter. — This recording ammeter was described by Mr. A. H. Armstrong in a paper presented at the 180th meeting of the American Institute of Electrical Engineers. In brief, it is constructed upon the dynamometer principle, consisting of two coils, one fixed, the other stationary. The inner, or movable coil, surrounds

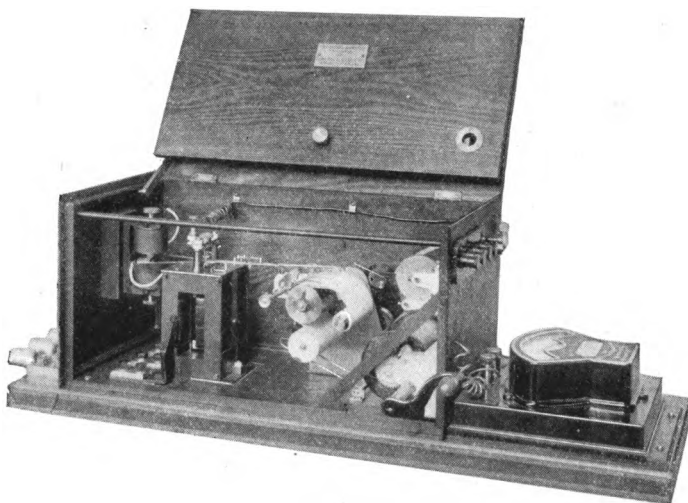

Fig. 25a. — G. E. RECORDING AMMETER.

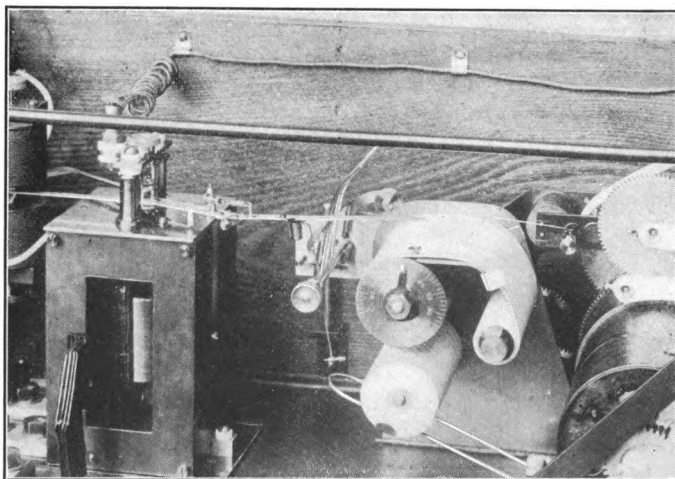
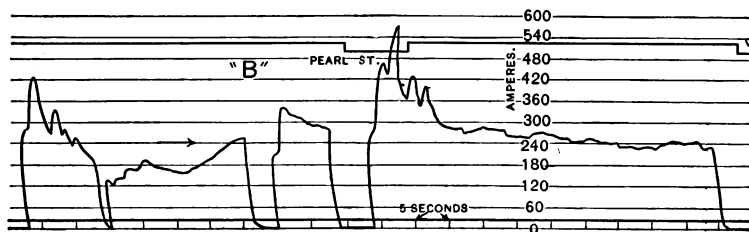

Fig. 25b. — INTERIOR MECHANISM OF G. E. RECORDING AMMETER.

a cylindrical iron core, and is wound with approximately 80 ampere-turns. This coil is energized by a constant current obtained from a local storage battery circuit. Surrounding the movable coil is the fixed coil, wound with approximately 2,400 ampere-turns. The fixed coil is energized by current obtained from the train line. By such a construction a torque averaging about 140 times that of the



-Current curve taken by graphic recording ammeter on a car equipped with multiple unit control with automatic accelerating device.



-Current curve taken by graphic recording ammeter on one of the Schenectady-Albany cars equipped with four GE-73 motors. This car was climbing a heavy grade and the motors were in series.

ordinary type of portable instrument is obtained. The instrument records with ink, the pen consisting of a capillary tube through which the ink is siphoned, producing a permanent record. This instrument will record violent fluctuations of current and will stand heavy vibrations. Attached to the needle at its rear extremity is a flat projection of copper which moves in the field of two electromagnets. This

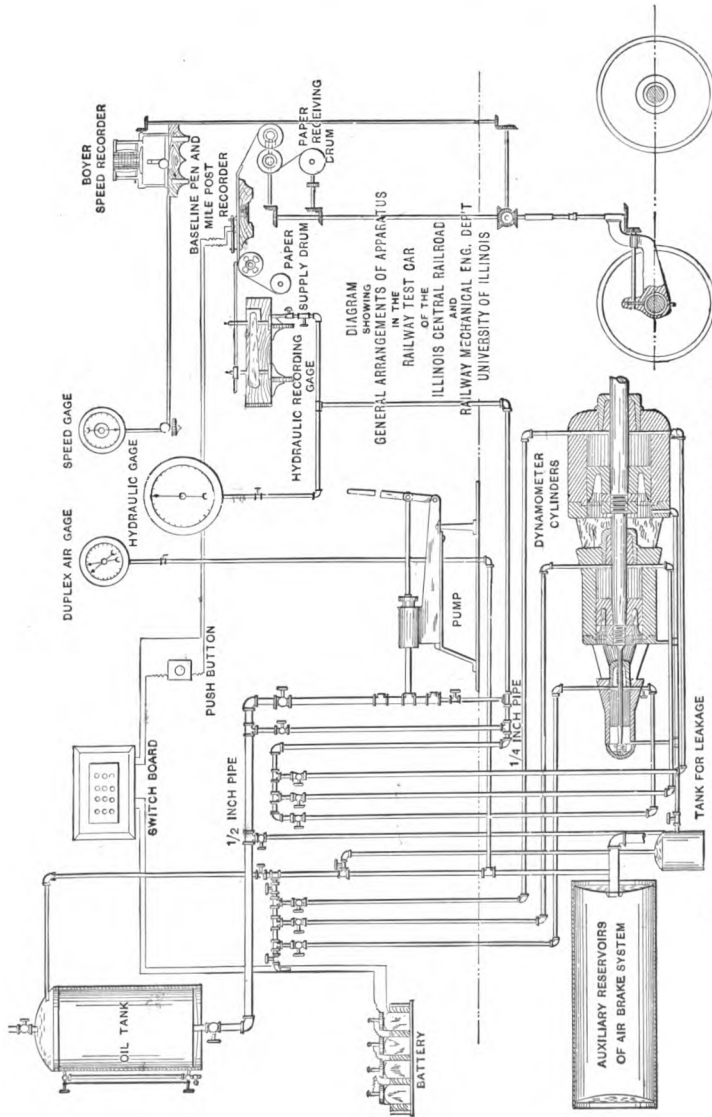

Fig. 26. — ARRANGEMENT OF APPARATUS IN ILLINOIS DYNAMOMETER CAR.

tends to make the instrument "dead-beat." The system of drawing the paper under the stylus is similar to the Keiley recorder. The paper is in roll form, 65 feet in length, $3\frac{1}{2}$ inches in width, and moves at the rate of six inches per minute. The illustrations, Fig. 25, and the curves inserted in the text on page 56, were obtained from Mr. Armstrong's article.

Dynamometer Car.—A dynamometer car is usually equipped with apparatus which will record draw-bar pull and speed in miles per hour. A dynamometer test-car owned jointly by the Illinois Central Railway Company and the University of Illinois was used by Mr. Bion J. Arnold in studying the conditions of operation of the New York Central Railroad. Fig. 26 illustrates the system of cylinders and pressure gauges used in producing the continuous records. The pull on the draw-bar produces a pressure on a piston fitted in a cylinder filled with oil. The pressure is transmitted by a system of piping to a pressure gauge which records proportionally to the draw-bar pull. It is obvious that the cylinders and piston head must be very snugly fitted to prevent leakage of oil. The pressure of oil in the cylinder varies from 300 to 1,000 lbs. per square inch. The speed is obtained from a shaft connected to the car axle by a system of gears, the motion of the shaft being transmitted to the speed recorder. A very elaborate description of this car and the results obtained by means of it may be found in the A. I. E. E. transactions of June 19, 1902. In connection with Mr. Bion J. Arnold's investigation a comparison between steam and electric traction was made, the conditions being as similar as possible. Using the dynamometer car for the steam tests, and automatic

electric recording instrument for the electric tests, the result of these tests, as published by Mr. Arnold and Mr. Potter in the American Institute transactions, were to the effect that electric motors could accelerate more rapidly for the same weight upon the drivers than steam locomotives, and that covering the same distance in the same time a lower maximum speed could be used with less energy consumption with the electric motor. Fig. 27 illustrates one of the test sheets obtained from Mr. Potter's paper.

CHAPTER IV.

DIRECT CURRENT SERIES RAILWAY MOTOR.

Theory.— The function of a motor is to receive electrical energy and to convert it into mechanical energy. Motors designed for railway purposes must be capable of exerting a large tractive force at starting, and must operate efficiently over a wide range of speed. The operation of a motor is due to the principle of electromagnetic induction, discovered by Michael Faraday in 1831. If a current of electricity be passed through a coil of wire wound longitudinally upon a cylindrical iron core, the latter will become magnetized, the two sides of the core having poles of opposite polarity. Suppose such a core mounted, so that it is capable of rotation, between the poles of a magnet which similarly possesses a north and a south pole. The north pole of the stationary magnet would attract the south pole of the core, causing it to partially rotate, until opposite poles of core and magnet would be adjacent to each other. To produce continuous rotation of the core, means must be provided so as to continually shift its magnetic properties, maintaining the north pole of the core in such a relative position to the south pole of the stationary magnet that it will exert a continuous tractive force upon it. This continual shifting is accomplished by means of a device called a commutator, which is mounted upon one extremity of the rotative core.

A motor consists of two distinct parts: the rotative ele-

ment, termed the armature, and the field magnets, consisting of iron cores wound with coils of wire, which, when energized, produce the field which causes the armature to rotate. Upon one extremity of the armature is mounted a commutator, which is composed of many segments of copper connected to the terminals of the armature coils.

Armature. — A direct current armature consists essentially of an iron core mounted upon a shaft, a number of conductors wound upon the surface of the core or embedded in slots near the surface, and a commutator.

CORE.

The object of the core is to facilitate the passage of lines of force from one adjoining pole of the field magnet to the next pole, iron being a better conductor of lines of force than air. As an illustration, a sample of iron may carry 2,500 times the number of lines of force that would be carried if air were substituted for it.

The core is composed of iron disks punched from sheets. These sheets are slotted around their periphery and assembled in such a manner as to make the slots continuous along the armature surface so that they may contain the armature conductors. The disks are assembled with their planes perpendicular to the armature shaft so as to diminish as much as possible eddy current loss. This loss is due to the revolving iron core cutting the magnetic flux. The core may be considered equivalent to a short-circuited conductor. An *E.M.F.* is generated in the core, which tends to send a current parallel to the axis of the shaft.

Armature Windings.—The wires distributed over the periphery of the core of an armature constitute the generating part of a direct current machine. Armatures in which the windings are only upon the periphery are termed drum armatures. Where the windings are wound in and out around the core, which is in the shape of a ring, the armatures are termed ring armatures. Due to the convenience of winding, and also because more wire is active in exerting torque, the drum armature is now employed almost exclusively for railway purposes.

An economical method of winding drum armatures con-

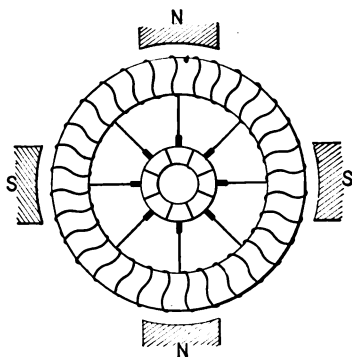

Fig. 28. — SPIRAL WINDING.

sists in the use of formed coils. These coils are wound upon a collapsible form of proper dimensions, and after being thoroughly insulated are inserted into position in the armature slots. The distance between the two sides of the loop of each coil, or the number of armature slots spanned by the loop, should be approximately equivalent to the distance between the centers of two adjacent poles of opposite polarity.

There are three distinct types of armature windings for railway motors, according to the manner in which the armature coils are connected with reference to the commutator segments. These windings are termed, respectively, spiral winding, lap winding, and wave winding.

SPIRAL WINDING.

This form of winding (Fig. 28) is seldom employed in modern practice, as it is applicable only to ring armatures. It consists of one continuous spiral winding around the ring core, being tapped off at stated intervals to the commutator segments.

LAP WINDING.

The lap winding is applicable to drum armatures where formed coils are employed. With this form of winding,

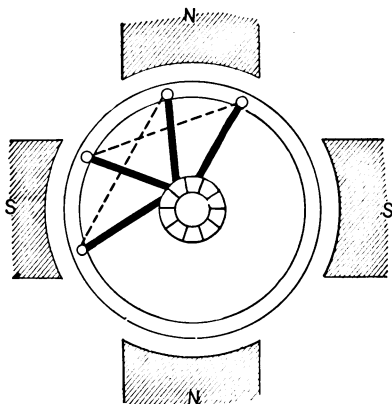

Fig. 29. — LAP WINDING.

the first coil is inserted in the armature slots and the terminals of the coil connected between two adjoining com-

mutator segments. The next coil is then inserted, one terminal connecting to the last terminal of the previous coil, producing essentially a series winding (Fig. 29). Referring to Fig. 29, the dotted lines represent one end of the armature coils as they pass across the rear of the armature, the full lines indicating the terminals of the coils at the commutator end. This form of winding obtains its characteristic name from the fact that the coils overlap.

WAVE WINDING.

With the wave winding (Fig. 30), the coils continually advance around the armature, there being two coils in series between each pair of commutator segments. The

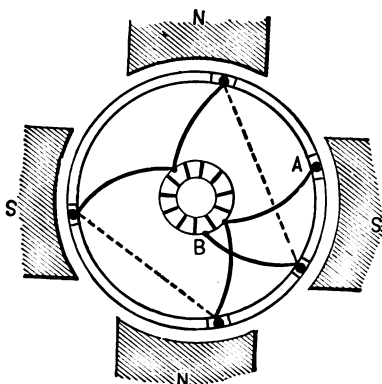

A AND B ARE ELEMENTARY COIL TERMINALS.

Fig. 30. — WAVE WINDING.

coils are connected at their common junction to the commutator at the opposite side. This winding is somewhat different from the lap winding where the windings overlap. The great advantage in this form of winding lies in the fact that it necessitates but two sets of brushes.

EICHEMEYER WINDING.

A convenient method of inserting the formed coils in position on an armature is by means of a method which was devised by Rudolph M. Eichemeyer. Referring to this winding (Fig. 31), it may be observed that the winding at the end of the armature may be divided into two layers, represented by the full lines and the dotted lines in the figure. The halves of the connector extend in opposite directions, one-half forming the upper layer, and the other

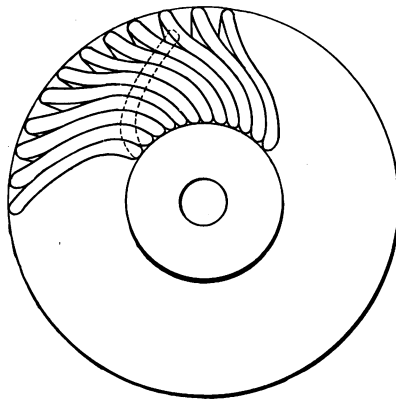

Fig. 31. — EICHEMEYER WINDING.

half the lower layer. This form of winding may be found in the G. E. 800 motor.

To produce a symmetrical armature a form of winding was developed, termed the straight-out winding. With this winding the terminals of the armature coils project in a straight line parallel to the shaft, producing a winding in which the coils are easily removable. It has the additional

advantage that more wire is active than in the Eichemeyer winding.

Fig. 32 represents a Westinghouse formed coil.

Commutator. — A commutator, Fig. 33, consists of an assemblage of drop forgings or castings of copper, termed segments, which are insulated from each other with mica. These segments are usually assembled around a tube, threaded at both ends to receive nuts to hold the segments in position. Mica is used for insulating purposes, as it has high insulating properties, and wears under the action of the brushes at about the same rate that the copper does. This maintains at all times a smooth surface upon the commutator. The maximum voltage between commutator segments seldom exceeds 20 volts. Assuming that the voltage is uniformly distributed, a 500 volt machine with a closed series winding would then possess 25 bars between

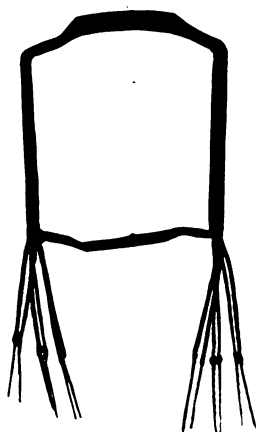

Fig. 32. — FORMED
ARMATURE COIL.

adjacent poles, or for a four pole machine 100 bars. The G.E. 55 railway motor has 141 commutator segments, the G.E. 64 motor 105 bars, the G.E. 1,000 motor 93 bars, the Westinghouse 50 E motor 165 bars, the Westinghouse 56 motor 117 bars, the motors of greater capacity having the greater number of segments. A large number of commutator segments is desirable for a railway motor to prevent flashing over of the commutator, which sometimes occurs when the motor circuit is momentarily interrupted.

The terminals of the armature conductors are usually soldered into projections of the commutator segments. Sometimes in practice, when repairing armature coils, a

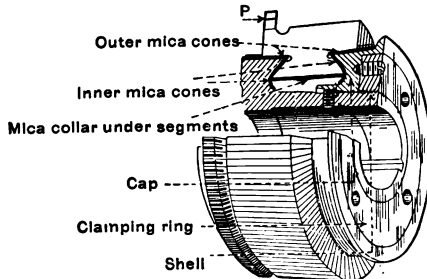

Fig. 33a. — SECTION VIEW OF COMMUTATOR.

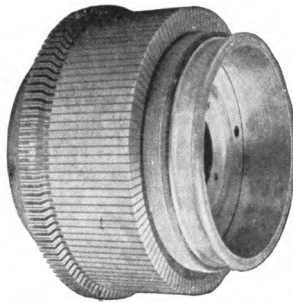

Fig. 33b. — COMMUTATOR COMPLETE.

drop of solder will short circuit two adjoining commutator segments, resulting in the burning out of an armature coil when the motor is started into operation. This is due to the counter *E. M. F.* developed in the coil, forcing heavy currents through the coil itself, overcoming its small resistance. On other occasions the terminals of two coils in series will be accidentally connected to the same commuta-

tor segment, resulting likewise in the destruction of the coil when operated.

The commutator complete is usually fastened to the armature shaft by means of a key. Occasionally a new commutator is fitted to an old motor ; so to provide for such a contingency, and also to reduce cost of construction, the commutator is usually built up separately and then keyed to the shaft.

Field Magnets and Field Frame. — The field magnets produce the magnetic field in which the armature rotates. This flux is created by a current of electricity traversing many turns of wire, which are wound upon bobbins and mounted upon iron cores. To reduce the I^2R losses to a minimum the field coils of railway motors are wound with strip copper; for instance, the Westinghouse 50 E motor is wound with copper strip $\frac{5}{8}$ " \times $1\frac{1}{2}$ ". When we consider that all of the current



Fig. 34. — FIELD COIL.

passing through a series motor enters the field coils, and also consider that it is desirable to build machines of reasonable efficiency which will not heat excessively, the reason for employing copper strip is obvious. It is the custom of the G. E. Company to employ metal spools on which to wind field coils. In the construction of some of their larger types of motors it has been necessary to slit these bobbins, as they act as the closed secondaries of transformers. Fig. 34 represents a Westinghouse field coil, and Fig. 35 a Westinghouse pole piece, field coil removed.

Railway motors usually have four poles, two north and two south, the polarity changing consecutively from pole to pole. The laws governing the flow of magnetic flux are similar to the laws of current flow. The flux which will flow in a magnetic circuit is equal to the magnetizing force, termed magnetomotive force, divided by the reluctance of the circuit. Reluctance is a property analogous to the resistance of an electrical circuit.

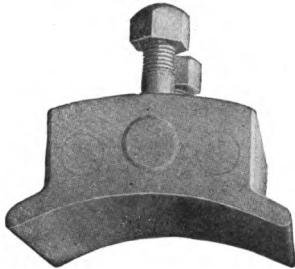

Fig. 35. — POLE PIECE.

$$\text{Flux} = \frac{\text{Magneto-motive Force}}{\text{Reluctance}}$$

The reluctance varies directly as the length of the circuit, directly as the reluctivity of the material, and inversely as its cross-section. The magnetomotive force is represented by the quantity

$$\frac{4\pi NI}{10}$$

where NI is termed ampere-turns. Thus 10 amperes at 5 turns would equal 50 ampere-turns. The ampere-turns multiplied by 1.257 yields the magnetomotive force.

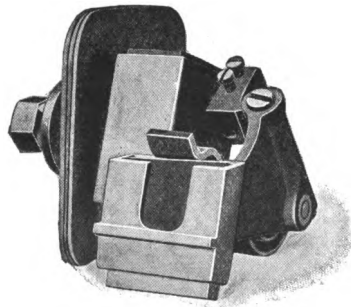

Fig. 36. — BRUSH AND BRUSH HOLDER.

Brushes and Brush Holder. — Current enters the commutator of a motor by means of brushes, Fig. 36. For railway motors, brushes are usually made of carbon, which is used because it is cheap, wears well upon the commutator and has a suitable resistance for successful commutation.

DATA CONCERNING MOTOR WINDINGS.

Motor.	H. P.	No. of Com. Bars.	No. of Arm. Slots.	Coils per Slot.	Size of Arm. Wire.	No. Turns Field.	Size Field Wire.
G. E. 55	150	141	47	3	9		
G. E. 64	50	105	35	3	7	90	.04 × .1625
G. E. 1,000	35	93	93	4	9	143.5	No. 4
West. 50 E.	150	165	55	3	$\frac{5}{64}'' \times \frac{5}{8}''$	36	$\frac{5}{64} \times 1 \frac{1}{2}$
" 56	50	117	39	3	10	71	1

E. M. F. Generated.—Consider a loop of wire of an armature in rotation, cutting the flux emanating from the poles of a field magnet, then, according to Faraday, a pressure, termed electromotive force, will be induced in the wires composing the loop and the external circuit. This pressure will tend to send a current of electricity around the loop. The magnitude of the *E. M. F.* developed will depend upon the number of revolutions per minute, V , made by the loop, the number of lines of force cut, ϕ , and the number of wires, S , composing the loop. The value of this *E. M. F.* developed, measured in volts, E , is expressed by the following formula :

$$E = \frac{V}{60} \times \frac{\phi S}{10^8}.$$

Dividing by 10^8 , reduces the pressure value in *C. G. S.* units to volts. It is obvious from the preceding equation that a moving conductor cutting one line of force per second will therein generate $\frac{1}{100,000,000}$ of a volt. Where the windings are upon the periphery of an armature, as with the drum winding, S should be taken as equivalent to twice the number of loops. If an armature be rotated by mechanical force in a magnetic field, it will therefore become a dynamo, and generate volts.

Counter *E. M. F.* — Consider an *E. M. F.* impressed upon the terminals of a series railway motor. This pressure will force current through the armature and field windings of the machine, creating torque, causing it to rotate. The armature rotating conductors will cut the flux created by the field magnets, and create an additional *E. M. F.*, which will tend to send a current in the opposite direction to that of the line pressure. This *E. M. F.* is termed counter electromotive force. The difference between the counter *E. M. F.* and the line *E. M. F.* will represent the available pressure to overcome the resistance of the windings. The line *E. M. F.*, represented by *E*, may then be considered composed of *E'*, which opposes and neutralizes the counter *E. M. F.*, and *IR* representing the volts consumed by armature and field resistance when current passes.

$$E = E' + IR.$$

$$I = \frac{E - E'}{R}.$$

Therefore the magnitude of the current passing through a series motor operating upon a constant voltage circuit, is determined by the magnitude of the counter *E. M. F.* developed. This current will have a maximum value when *E'* is zero and the motor is stationary, such a condition arising when a stationary series motor is connected directly to a line circuit. As the resistance of both armature and field circuits usually has a very small value, it is necessary to start a series motor into operation, by means of a resistance. This resistance is gradually removed as the speed of the motor increases, thus increasing the counter *E. M. F.*, represented by *E'*. Such is the function of a controller.

Torque of Armature.— When the field magnets of a series motor have become saturated, the torque or turning moment (radius in feet \times tangential pull in pounds) of

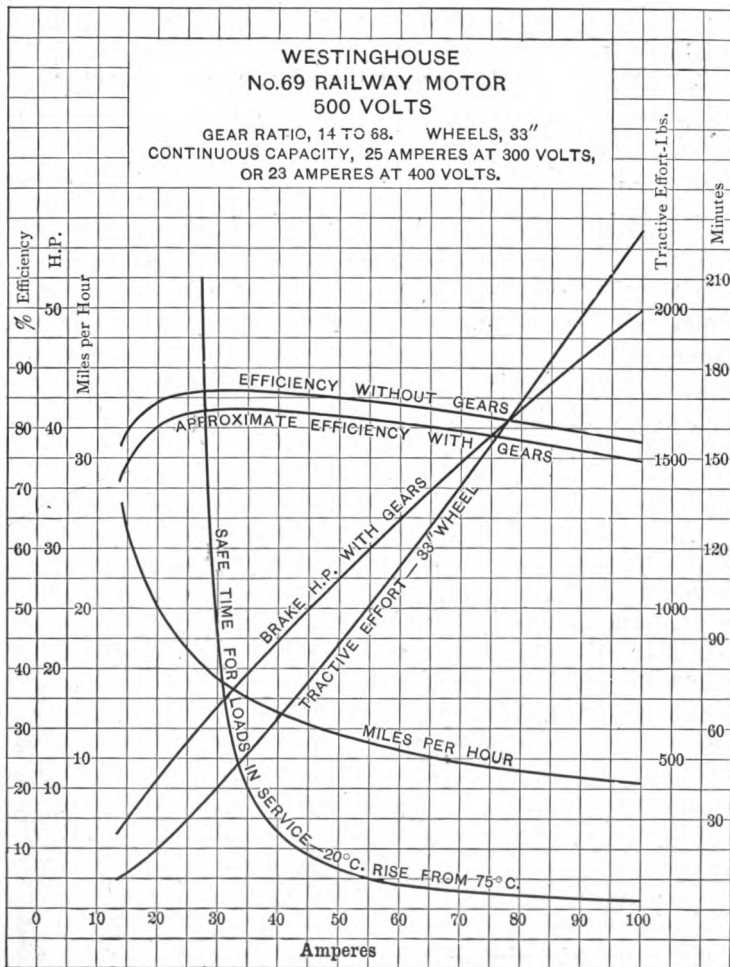

Fig. 37. — MOTOR CURVE.

the motor is almost directly proportional to the current input. In preference to the term torque, the word tractive effort is usually applied to railway motors, meaning the horizontal pull at the base of the car wheel. Referring to curve sheet (Fig. 37), the tractive effort values at the base of a 33 inch wheel, expressed in lbs., are represented in terms of the current input. The relation between torque and current input may be observed from the following equations. The mechanical horse-power (*h.p.*), developed by a rotating armature, is represented by the equation,

$$h.p. = \frac{2\pi N T}{550} \quad (a)$$

where T = the torque in ft.-lbs.,
 N = the revolutions per second.

The electrical horse-power, *h.p.*, consumed by the armature in performing useful work, is represented by the product of the current passing through the armature into the counter *E.M.F.*, E' , developed, divided by 746. This eliminates the I^2R losses.

$$h.p. = \frac{\text{useful watts}}{746} = \frac{E' I}{746}. \quad (b)$$

Placing these two equations, (a) and (b), equal to each other,

$$\frac{2\pi N T}{550} = \frac{E' I}{746}.$$

$$I = \frac{2\pi N T \times 746}{550 \times E'}$$

Substituting for the counter *E.M.F.*, E' , the value for the *E.M.F.*, developed by a conductor,

$$E = \frac{V}{60} \times \frac{\phi S}{10^8}.$$

It follows that

$$I = \frac{2\pi N T \times 746}{550} \times \left[\frac{I}{\frac{V}{60} \times \frac{\phi S}{10^8}} \right] \quad (c)$$

It is obvious from equation (c) that with a constant flux passing through the armature, caused by a saturated field, the torque T is directly proportional to the current input. In practice, as the speed of a series motor increases the counter *E.M.F.* increases, decreasing the current input I , which, in turn, weakens the field excitation, decreasing ϕ . This causes the speed to further increase to such a point that the power received by the motor is equal to the mechanical power developed, plus the fixed losses, plus the variable losses. It is therefore obvious that the torque is not directly proportioned to the current input as generally presupposed, but only approximately so.

Speed Variation. — The speed of a series motor is generally assumed proportional to the impressed voltage. In other words, a motor designed to operate upon a 250 volt circuit will operate at twice the speed for the same current input when connected to a 500 volt circuit. This is not strictly true, however, due to a slight change of flux. If the flux, ϕ , through the armature be maintained constant, then increasing the armature voltage, E , will increase the speed, V , proportionally

$$\left(\text{remembering that } E = \frac{V}{60} \times \frac{\phi S}{10^8} \right).$$

Suspension of Motors. — As the suspension of a railway motor from a car truck is of considerable importance,

much care is usually devoted to the selection of the proper method. Usually the motors are constructed with additional bearings in one side of the motor frame. In these bearings the axle of the car wheels rotates. Mounted upon this axle is a large gear (Fig. 38), that meshes tangentially with the smaller gear (Fig. 39), termed the pinion, which is driven on the motor armature axle. Both gears, therefore, always mesh irrespective of their

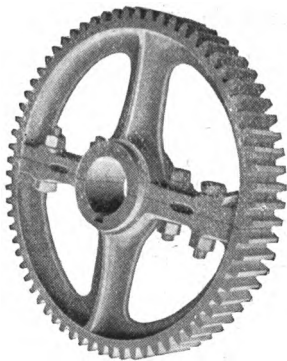

Fig. 38. — GEAR.



Fig. 39. —
PINION.

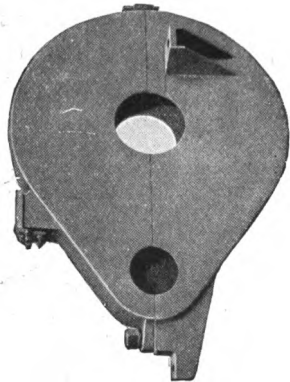

Fig. 40. — GEAR CASE.

relative positions. The gears are usually protected by a casing termed the gear case (Fig. 40). The side of the motor, opposite to that containing the car axle, is usually fastened to a bar, which is in turn mounted upon springs connecting it to the car truck. Various forms of suspension are employed, characterized as cradle suspension, nose suspension, side, or parallel bar, suspension, and yoke suspension. The parallel bar suspension (Fig. 41) consists of two parallel bars fastened to the car truck, supporting the motor on springs at its center of gravity. The cradle suspension (Fig. 42) is somewhat similar to the parallel bar,

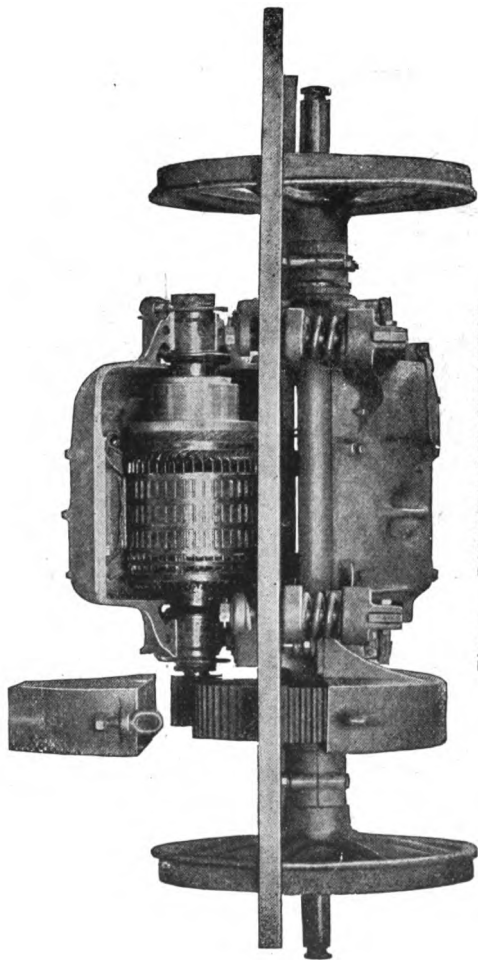

Fig. 41. — PARALLEL BAR SUSPENSION.

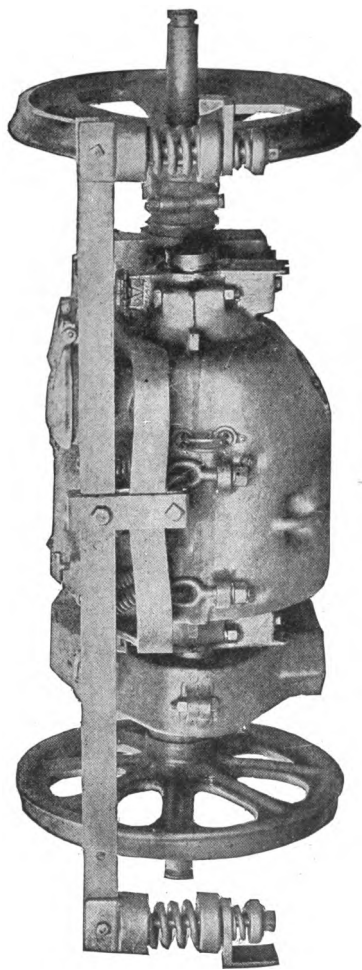

Fig. 42. - CRADLE SUSPENSION.

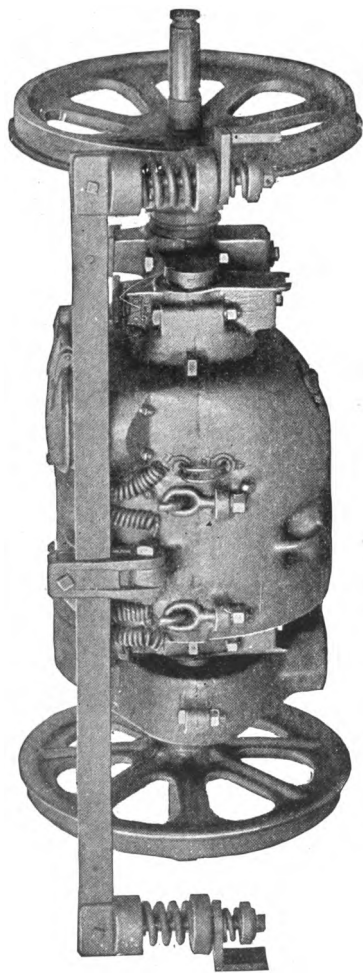

Fig. 43. - NOSE SUSPENSION.

the cradle consisting of a U-shaped bar fastened to the truck at the middle of the U. This form of suspension is designed to relieve the bearings of the weight of the motor. With the nose suspension (Fig. 43), a cast projection on the motor frame, termed the nose, is fastened through a heavy link to the motor truck. With the nose suspension, the weight of the motor is distributed between the truck and the car axle.

Box Frame Type of Motor. — The rapid development of heavy inter-urban railways created a demand for a motor of large capacity, which could be mounted under a car in a limited space. To meet this contingency the General Electric Company developed the box frame type of railway motor. This type of motor differs from the ordinary split frame motor, in that the magnet frame consists of a one piece hollow casting, open at both ends. The armature is inserted into position from the side, being retained in place by end plates, which fasten to the field frame. One of the advantages of the box frame motor is the continuous magnetic circuit which exists throughout the frame. Additional advantages consist of a long commutator, ample room for ventilation, and absence of leakage of oil and water into the motor body. The armature may be removed from the motor frame at one side, obviating the necessity of employing a pit. Fig. 44 illustrates the various parts of the General Electric, No. 66, box frame type of motor ready for assembling.

G. E. 66 Series Railway Motor. — This motor is of the box frame type, as previously described. It has a capacity of 125 h.p., based upon 75° rise of temperature above the

surrounding atmosphere, after an hour's run at full load. Temperature of atmosphere assumed as 25° C.

The general construction of the motor frame may be readily observed from Fig. 45. The magnet frame is of soft steel, made in a one piece casting, having a cubical shape. The armature and field coils are readily inserted through openings bored into the extremities of the cube. The frame heads containing the bearings are bolted into the openings, forming a compact water-tight motor. The bearings are provided with oil deflectors, which prevent oil from entering the motor body.

The armature is of the series drum barrel type, the windings consisting of 39 coils, each composed of five single coils of one turn. These conductors are insulated with mica in groups of five, all of the coils in a slot having an outside protection of mica and tape. The windings are claimed to be semi-fireproof and to be able to withstand high temperatures without deteriorating. The armature conductors are cross-connected at the rear of the armature, the top and bottom conductors joined by turned copper clips, easily removable, to provide for rewinding.

The commutator is composed of 195 segments of hard drawn copper, insulated with mica.

Each motor is provided with four field coils, each coil being wound on a metal spool, with strip copper, and insulated with mica cloth and asbestos. This form of construction renders the coils impervious to moisture and practically fireproof.

The motor is of the nose suspension type, and when mounted upon 33" wheels has a clearance of $3\frac{1}{2}$ ". The weight of the motor complete without gear and gear case is 3,966 lbs.

Westinghouse No. 56 Railway Motor. — This motor has a continuous capacity of 50 amperes, operating on a pressure of 300 volts. This pressure is assumed to typify normal pressure per motor, train operating at line pressure of 500 volts.

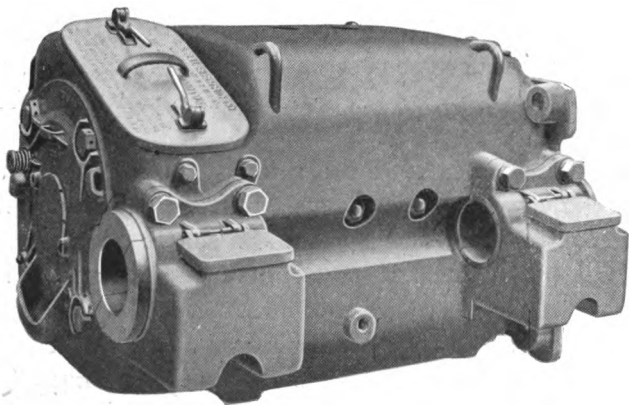

Fig. 45. — G. E. 66 RAILWAY MOTOR.

The armature is wound with a two circuit winding, the standard form adopted by the Westinghouse Company. Each slot contains three individual coils wound together and thoroughly insulated. The conductors are retained in position by steel band wires which are depressed into the core to prevent ripping should babbit in bearings melt and armature strike pole tips. The weight of the armature and commutator complete is 720 lbs.

The commutator is composed of 117 hard drawn copper segments, insulated with mica. Due to the large size

of commutator this motor is not subject to flashing over, a characteristic of small armatures.

The motor is of the split frame type, the halves of the

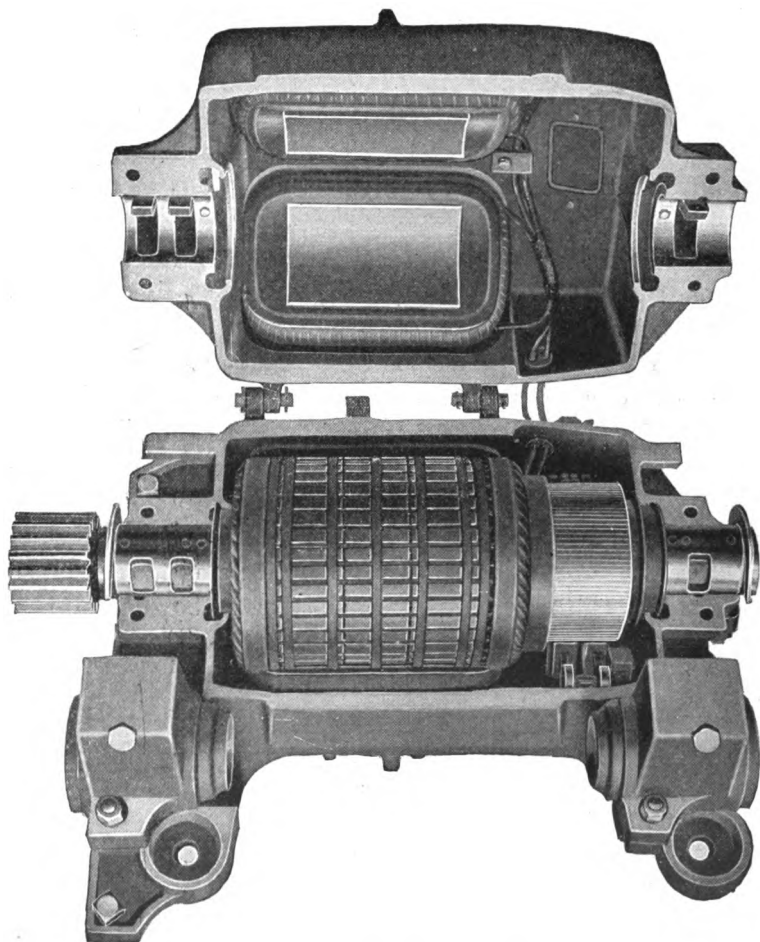

Fig. 46. — WESTINGHOUSE No. 56 RAILWAY MOTOR.

yoke being hinged together, so that with the removal of four bolts, the motor frame may be swung apart, permitting access to the motor body. See Fig. 46.

The field frame is composed of cast steel, to which is bolted four removable pole pieces of laminated steel. The field coils are wound upon moulds. They are thoroughly insulated before inserting into position, and are retained in place by the spreading of the pole tips. The motor weighs 2,680 lbs. The type of suspension employed is a modification of the cradle method.

Gearless Motor.— A special type of gearless railway motor has been developed by the General Electric Company for the N. Y. C. & H. R. R.R., to be used in connection with electric locomotives. These motors each have a capacity of 550 h. p. Each locomotive is equipped with four motors producing a nominal rating of 2,200 h. p. The laminations of the armatures of the motor are mounted upon a quill casting which is forced on to the car axle. The armatures are centered between the poles, the axles passing through the car wheels into bearings. The brush holder is mounted upon a saddle over the journal box. The motor (Fig. 47) is bi-polar, the pole pieces being cast into a rectangular frame, forming a magnetic circuit through the side and end frames. The pole pieces are so shaped that as the motor frame moves up and down with the motion of the car, ample clearance is provided. Should the springs supporting the motor frame break, provision is made to prevent the armature from striking. The armature is of the standard drum barrel type. A high efficiency is claimed for the motor, due to the elimination of gear losses. The illustration is somewhat deceptive

owing to the section of magnetic circuit shown, having in reality a much greater cross-section of field frame than is evidenced by the illustration. The reluctance of the magnetic circuit of this type of motor is greater than usual, due to the peculiar shape of the pole faces,

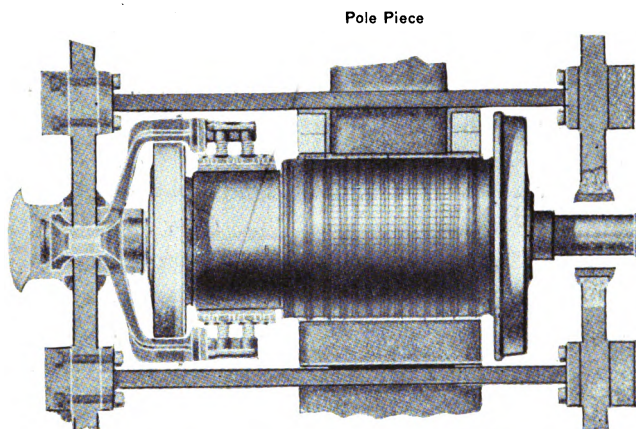

Fig. 47. — GEARLESS MOTOR FOR N. Y. C. & H. R. R. R. ELECTRIC LOCOMOTIVES.

resulting in large air gaps. This necessitates increased ampere-turns on the field coils to force the desired flux through the armature. The locomotives will be capable of operating up to a speed of 75 miles per hour. Their total weight is 190,000 lbs. each.

CHAPTER V.

ALTERNATING CURRENT SINGLE PHASE MOTORS.

Alternating Current Single Phase Motors.— With the advent of electric traction into the long-distance railway field, commonly known as trunk line service, there arose a demand for a new system, inasmuch as the direct current system involved too great an expense for successful commercial operation. The condition which engineers had to meet was to produce a system embodying the advantages of alternating current for power transmission, the system to be of such a nature that the alternating current could be applied directly to the motors. This would eliminate the rotary converters in the sub-stations and their attendant expenses.

Alternating current had been used abroad for some years past, but American engineers were loath to equip railways in a similar manner. The system employed abroad, known as a three-phase induction motor system, required a triple trolley, was quite complicated, and the motors did not possess the speed-torque characteristics of a direct current series motor. American engineers, therefore, devoted their attention to developing a single phase railway motor, which would possess speed-torque characteristics somewhat similar to the direct current series motor, in which the speed increases with a decrease in load, and the torque per ampere is constant with a given impressed *E. M. F.* With such a motor the questions of single circuit, car control, and

power transmission would be extremely simplified. With this end in view, several types of A. C. motors were produced, to which the following theory will apply.

Theory. — The direction of rotation of a series motor is independent of the direction of the impressed *E. M. F.*, the direction of rotation only changing when either armature

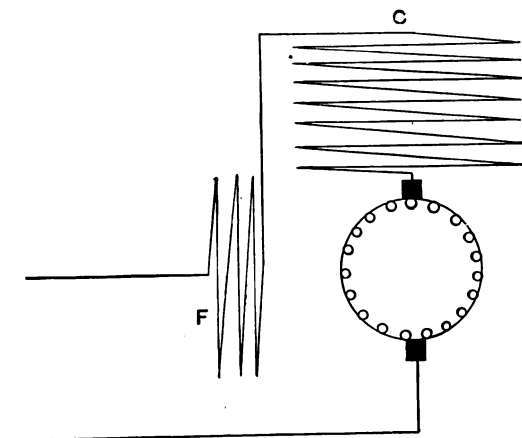

Fig. 48.—SINGLE PHASE MOTOR WITH REVERSE SERIES COMPENSATING WINDING.

or field circuit is reversed with respect to the other. It is therefore possible to operate a direct current series motor upon an alternating current source of supply, inasmuch as the current in the armature and field coils will reverse simultaneously. The ordinary type of direct current series motor when operated upon an alternating current has a low power factor and low efficiency, due to the fact that additional *E. M. F.*'s of self-induction are set up in the windings by the alternating magnetic flux. In addition to these inductive *E. M. F.*'s, large hysteresis losses are present.

The *E.M.F.*'s of self-induction also exist in the alternating current single phase motor, but their effect in such machines is diminished by proper design. The usual method of procedure is to eliminate the armature inductive *E.M.F.* and to reduce the field inductive *E.M.F.* to a minimum. One method of neutralizing the armature inductive *E.M.F.*, consists in placing an additional winding at right angles electrically to the field coils. This additional winding, called the compensating coil, may be connected in reverse series with the field coils, Fig. 48, or short circuited upon itself as in Fig. 49. With either method the self-induction of the armature may be neutralized.

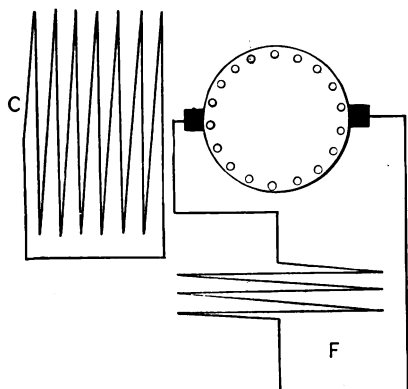

Fig. 49. — SINGLE PHASE MOTOR WITH SHORT CIRCUITED COMPENSATING WINDING.

cited upon itself as in Fig. 49. With either method the self-induction of the armature may be neutralized.

The self-induction of the field windings may be diminished in several ways, as will be discussed later.

The proportion of armature turns to field turns is usually so adjusted that with large armature turns and few field turns the *E.M.F.* of the field coils is small compared with the *E.M.F.* of the armature. The field *E.M.F.*, being in-

ductive, is at right angles to the armature *E.M.F.* (Fig. 50). Upon their relative magnitude depends the power factor of the motor. The armature *E.M.F.* represents the energy component, whereas the field *E.M.F.* represents the wattless component. Referring to Fig. 50,

$$\text{power factor} = \frac{AB}{AC}$$

Phenomena. — The alternating flux in an alternating current motor produces many phenomena, the more important of which may be classified as follows:

a. An *E.M.F.* generated in the armature windings due to the movement of the armature coils through the field flux. This phenomena is also present in direct current machines, where it is termed counter *E.M.F.*

b. An *E.M.F.* of self-induction set up in the armature windings by the alternating magnetic field. This affects successful commutation for the brushes when passing over two adjoining commutator segments short circuit coils, in which an alternating *E.M.F.* is present.

c. Large hysteresis loss in armature and field circuits, due to alternating magnetic flux.

d. An *E.M.F.* of self-induction, induced in the field coils. Should a field coil become accidentally short circuited, the short circuited section of the winding would burn out, caused by this condition, the trouble being similar to a short circuited secondary of a transformer.

To reduce the above effects to a minimum, several departures have been made from the ordinary type of direct

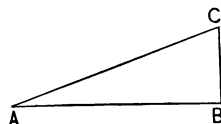

A-B—Armature e. m. f.
B-C—Field e. m. f.

Fig. 50. — RELATION OF
ARMATURE E. M. F.
TO FIELD E. M. F.,
SINGLE PHASE MOTOR.

current series motor, resulting in three distinct types of alternating current motors.

They are termed :

- a.* The straight series motor.
- b.* The transformer series, in which the transformer is separate from the armature.
- c.* The repulsion motor, in which the transformer is embodied in the armature.

It is obvious that cases *b* and *c* belong to a distinct class, which may be termed transformer type of motors, as

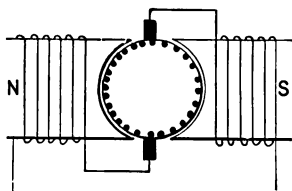

Fig. 51. — STRAIGHT SERIES DIRECT CURRENT MOTOR CIRCUITS.

transformer action is present in both cases. The straight series motor is of the commutator type, current entering the armature by brushes, whereas, with the transformer type of motors, the brushes are short circuited, the current entering the armature circuits

by means of induction. We are indebted to Professor Elihu Thomson for the repulsion motor.

Straight Series A. C. Motor. — This type of motor is quite similar in design to the direct current series motor (Fig. 51), inasmuch as the armature circuit is connected in series with the field circuit, the current entering the armature by means of brushes after it passes through the field coils.

The armature is wound with a relatively large number of turns, compared with the field coils, producing a high power factor. It is also provided with a compensating winding. The magnetic circuit is laminated throughout

field and armature, and the armatures are especially designed to provide for satisfactory commutation. The output of an alternating current motor is the product of the efficiency, the power factor and the input :

$$\text{Input} \times \text{Power Factor} \times \text{Efficiency} = \text{Output.}$$

As previously stated, high power factors may be obtained by increasing the armature *E.M.F.* and decreasing the field *E.M.F.* Armature *E.M.F.*'s of large magnitude may be obtained in three ways: *a*, increasing the armature speed; *b*, increasing the flux through the armature; *c*, increasing the length of active conductor in series, upon armature core. Increasing the flux through the armature would mean increasing the field flux, which would correspondingly increase the field *E.M.F.* To increase armature *E.M.F.* without affecting the field *E.M.F.*, methods *a* and *c* may be employed.

Small field *E.M.F.*'s may be obtained by decreasing the turns of the field coils, or by decreasing the flux through the field coils, which would affect the armature *E.M.F.* Reducing the field turns would necessitate decreasing the reluctance of the magnetic circuit to maintain the same flux.

$$\text{Flux} = \text{Magnetomotive Force} \div \text{Reluctance.}$$

Decrease of reluctance may be accomplished by decreasing the air gap, which decrease is limited by commercial conditions of operation, or by increasing the cross-section of the magnetic circuit, maintaining its length constant. This increases the weight of the motor.

High power factors may then be obtained in the straight series alternating motor by a proper adjustment of the factors, high armature speed, increased length of armature

conductors, few field turns, and increased cross-section of field magnets.

Fig. 52 represents the characteristic curves of one of the later designs of Westinghouse alternating current series motors. The curves are calculated, but they show

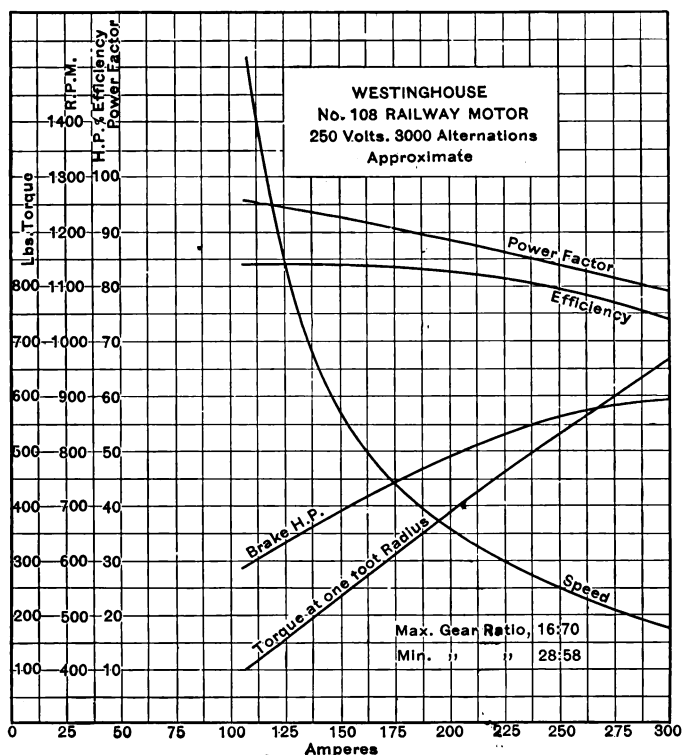

Fig. 52.—CALCULATED CURVES OF A. C. MOTOR.

the relation between power factor, efficiency, torque, brake horse-power, and speed, existing in these machines.

Transformer Series. — The field of this motor is in series with the primary of a transformer, the secondary of the transformer being connected to the armature terminals (Fig. 53). This type is sometimes termed the repulsion series motor. It was developed by Winter Eichberg, and

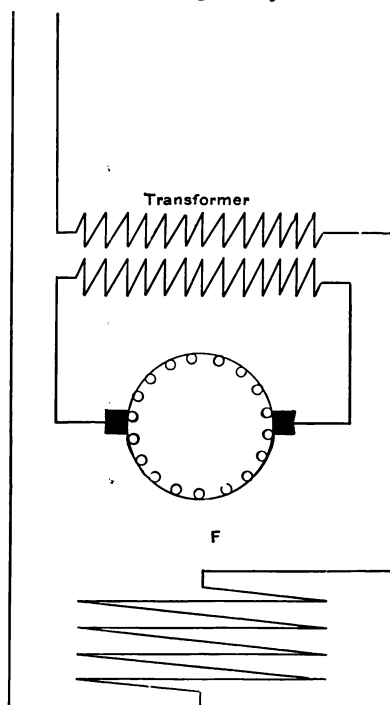

Fig. 53. — TRANSFORMER SERIES A. C. MOTOR.

is manufactured by the Union Electric Company of Berlin, Germany. With this type of motor, the voltages across the primary and secondary, corresponding to armature, are non-inductive, and bear a 90° relation to the field winding, which is inductive.

Considering the transformer feature, it is obvious that the current input of the transformer will be lowest at starting. The magnetic fields set up by the transformer and the field winding will be at right angles electrically to each other, as in the repulsion motor described later. This motor is not employed to any great extent in the United States.

Repulsion Motor.—The repulsion motor consists primarily of an armature resembling, in appearance and construction, the armatures designed for direct current

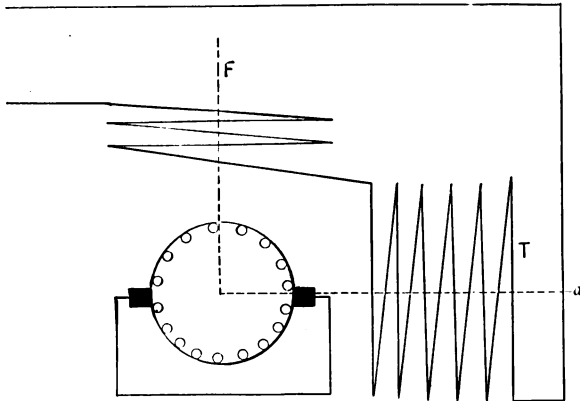

Fig. 54.—TRANSFORMER REPULSION MOTOR.

machines. The armature moves in a rotating field produced by stationary windings, the rotating field being similar to that of an induction motor, having a distributed single phase winding. The armature terminals are short circuited at the brushes, there being no electrical connection between armature and field coils. The rotating field may be produced by winding two coils at right angles to each other (Fig. 54), one being the field proper with few

turns, and the other winding a transformer secondary with many turns. The ratio of these turns corresponds to the ratio of the armature *E.M.F.* to the field *E.M.F.* This form of repulsion motor is termed the compensated type. As with the straight series motor, high power factors may be obtained with the compensated motor by a large number of transformer turns and few field turns. The two exciting coils obviously produce a resultant field for which a single coil (Fig. 55) may be substituted. This repulsion motor was developed by Professor Elihu Thomson.

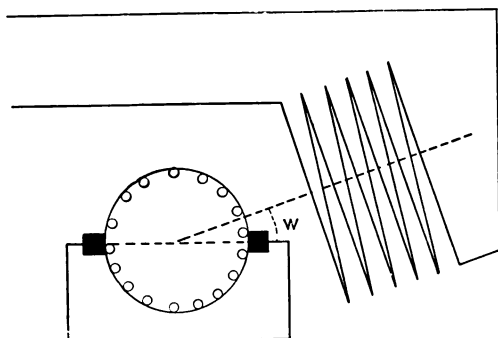

Fig. 55. — THOMPSON REPULSION MOTOR.

The action of the repulsion motor corresponds to that of a transformer with stationary secondary, and movable primary, the primary being placed at a definite angle to the secondary, the repulsion existing between the primary and secondary causing rotation. The displacement of the short-circuited brushes, *w*, Fig. 55, corresponds to this relative angle existing between primary and secondary of the transformer. The smaller this angle the higher will be the power factor. An angular brush displacement of 15° appears to be the minimum limit, yielding power factors of from .90 to .97.

A clearer conception of this repulsion motor may be obtained by considering the compensated type (Fig. 54). With this motor two *E.M.F.*'s, E_F and E_T , are induced in the armature conductors. E_F is caused by the flux from

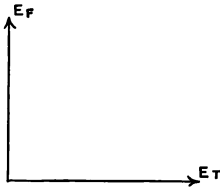

Fig. 56. — RELATION OF ARMATURE *E.M.F.*'S.

the field exciting coil F , and is directly proportional to the rotational speed of the armature. The second *E.M.F.*, E_T , is due to transformer action of the compensated coil T , and is therefore proportional to the impressed frequency, and is in quadrature with the *E.M.F.* in the compensated coil.

These two *E.M.F.*'s, E_F and E_T , are therefore at right angles to each other (Fig. 56), producing a resultant *E.M.F.*, which causes a magnetizing current to flow through the armature. These *E.M.F.*'s produce a rotating field, elliptical in shape (Fig. 57), which becomes circular at synchronism. At synchronous speed the *E.M.F.*'s, E_F and E_T are equal, resulting in satisfactory commutation. One great advantage with the repulsion motor with its distributed winding is the large pole span which may be employed, practically 180° . This increases the cross-section of air gap, permitting increased length of gap, or resulting in higher power factors with small gap.

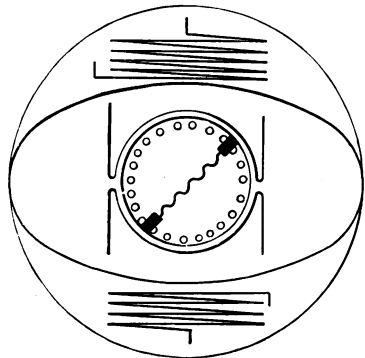

Fig. 57. — DIAGRAM OF REPULSION MOTOR FIELD.

The repulsion motor has steeper speed and torque char-

acteristics than the direct current motor, as is illustrated by the curve sheet, Fig. 58. These curves were prepared by Walter I. Slichter in a paper presented to the

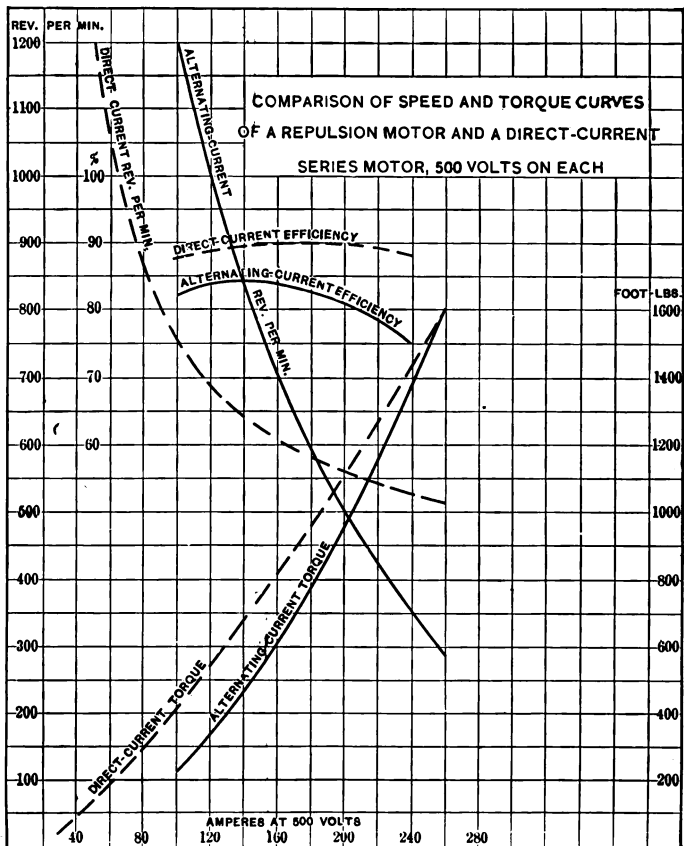

Fig. 58. — COMPARISON OF CHARACTERISTIC CURVES OF D. C. AND A. C. MOTORS.

A. I. E. E. in January, 1904. It is obvious from these curves that the efficiency of the direct current motor is

much higher than the A. C. motor, operating conditions being similar in every respect.

A compensated single phase motor was developed in 1891 by Rudolph Eiche Meyer. In this motor the armature and the field turns were in the ratio of 24 to 7. In addition, the armature was surrounded with a stationary coil, mounted so that its flux would be at right angles to the field flux. This coil, when short circuited upon itself or

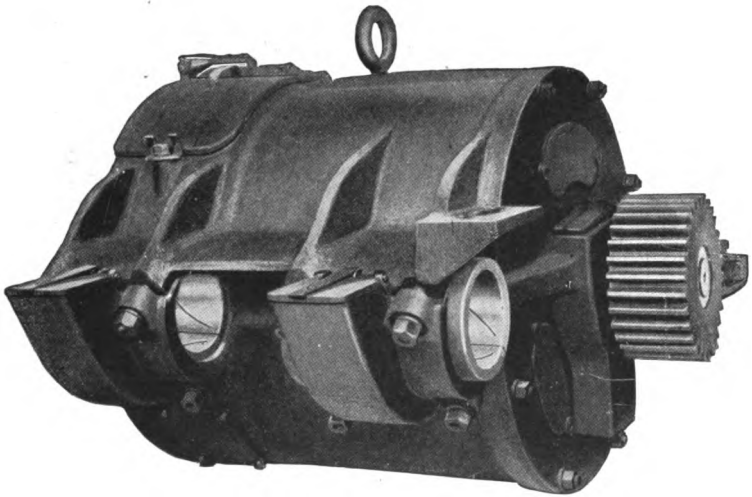

Fig. 59. — WESTINGHOUSE TYPE 91 A. C. MOTOR.

connected in reverse series with the field, neutralized the self-induction of the armature. This motor had an efficiency of 75.5 per cent and a power factor of .79.

Lamme Single Phase Motor. — This motor, termed type No. 91 of the Westinghouse Company, was designed as part of the equipment of the Washington, Baltimore, and

Annapolis Railway. The motor is of the straight series type, in which all of the current which enters the field coils passes through the armature. In general design and appearance it resembles the standard direct current commutator motor, as may be evidenced by Fig. 59.

A. C. single phase straight series motors of this type are subject to large hysteresis loss and severe sparking at the commutator as previously mentioned. These condi-

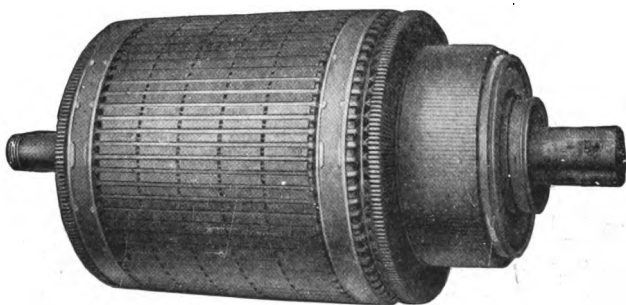

Fig. 60.—ARMATURE OF TYPE 91 MOTOR.

tions are remedied in this motor by laminating the magnetic circuit of the machine throughout, reducing hysteresis loss, and, by modifying the armature windings, reducing sparking to a minimum. The armature winding is of the closed coil type, relatively high resistance being inserted between the winding leads and the commutator segments. When an armature coil is undergoing commutation, high *E.M.F.*'s are short circuited in the windings, their presence being due to the alternating magnetic flux. The high resistance inserted in the circuits prevents the excessive current flow, which would otherwise occur.

The general appearance of the armature may be observed from Fig. 60.

The poles of the machine have been increased to eight

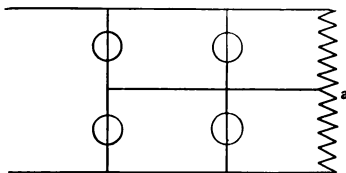

Fig. 61. — EQUALIZING TRANSFORMER.

in number, all of the field coils being connected in parallel. The armature terminals of a four motor equipment are

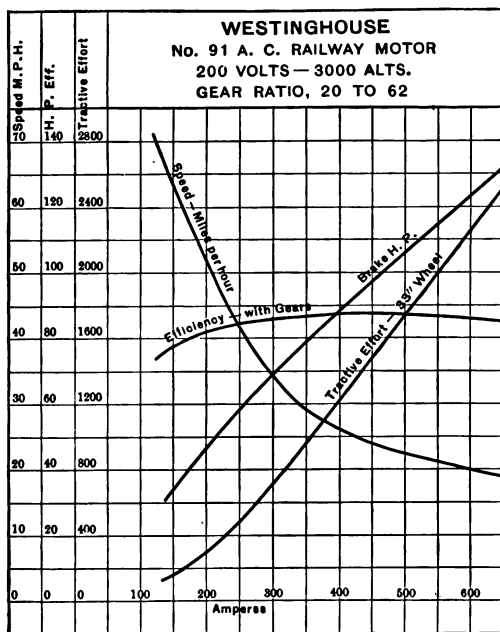

Fig. 62. — CURVES OF TYPE 91 A. C. MOTOR.

NOT

connected together with a series parallel combination, Fig. 61. Balancing coils, otherwise known as equalizing transformers, are connected across the armature circuits to equalize the pressures upon all of armature circuits and provide for uniform torque, thus preventing independent slipping of wheels.

Referring to the characteristic curves for this motor, Fig. 62, it is obvious that the speed-torque curves are quite similar to those of the ordinary direct current motor. The efficiency is high over a wide range of load, approximately 88 per cent. The power factor at normal load is 88 per cent, decreasing with increase of load. Assuming full load rating of 100 h.p. with a power factor of 88 per cent motor operating at a pressure of 200 volts, the current input would be 423 amperes, the tractive effort 1,300 lbs., and the speed 25 miles per hour. (For information regarding control for this system, and also illustration of later type of Westinghouse A. C. 150 h. p. motors, see paragraph on A.C. Control.)

CHAPTER VI.

TYPES OF CONTROL AND THEIR OPERATION.

Function of a Controller.—A series motor, as previously mentioned, should be started into operation by impressing upon its terminals a low voltage, the value of which should be increased in suitable steps until the motor is operating upon the line voltage. This is the function of a controller when operating a train equipped with series motors. A controller is manipulated by means of a handle, the motion of which either directly or indirectly permits current to enter the motors through resistance. With a continued motion of the controller handle this resistance is cut out step by step until the handle is in what is termed a running position. In this position all of the resistance is removed from the motor circuit. As train resistances are not designed to carry large currents continuously, the controller hand should not remain for a great interval of time in any but a running position. A series multiple system of control has two running positions, termed series and multiple. With the controller handle in the series position, both motors of a two motor equipment are in series with the 500 volt circuit, (*a*), Fig. 63, each motor therefore operating under a pressure of 250 volts. When in the multiple position, (*b*), Fig. 63, both motors are connected in parallel to the 500 volt circuit, operating at twice the speed of the former position. With a four motor equipment in the series position, the motors are

connected together in two groups in series, each group consisting of two motors in parallel, (c), Fig. 63. When in the multiple running position these motors are all operating in parallel on the 500 volt circuit, (d), Fig. 63.

The direction of motion of a car may be changed by means of a second handle on the controller termed the reverser. The reverser has three positions: a "neutral"

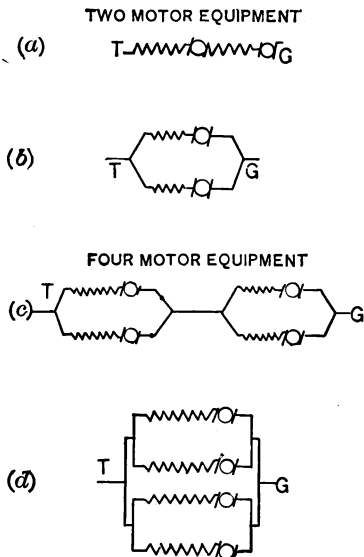

Fig. 63. — MOTOR CONTROL COMBINATIONS.

position, where the armature terminals of the motors of the car are disconnected from the field terminals; a "forward" position, where the armature terminals are connected in series with the field terminals and also with resistance; and a "reverse" position, where the previous connection of the armature terminals are reversed, changing the direction of the current through the armatures, thereby reversing their direction of rotation. With some of the recent types

of control the controller is equipped with only one handle, the motor circuits being so arranged that it embodies the function of the reverser.

With most types of control, both controller handles are arranged with interlocking devices, so that it is impossible to reverse the motors when the power handle is in any but an off position. It is also impossible to remove the reverser handle from the controller case unless the handle is in the neutral position. With the modern forms of Sprague General Electric Control, it is customary to press down a spring on the grip of the controller handle before moving it. If the motorman should remove his hand from the controller grip, this spring automatically opens the controller circuit, removing the power from the motors (see Fig. 67, auxiliary contacts).

Types of Control.—The various types of control are designated either as “hand control” or “automatic control,” depending upon whether the manipulation of the resistances and motor connections is accomplished by hand or with automatic mechanism. Both cases, however, require the services of a motorman. With the hand control the motorman turns the controller handle notch by notch, using his judgment and mental inertia as to the proper amount of resistance to cut out to maintain a constant train acceleration. The operation of automatic control depends entirely upon the magnitude of the current passing through the motors. The motorman may notch his controller up point by point if he so desires, but he usually throws his handle over to the series running position or to the full multiple running position, the controller notching up automatically. Hand control is used extensively for trolley

service, and automatic control is employed in connection with heavy railway trains where it is desirable to maintain a maximum schedule and a uniform rate of acceleration. There are some systems, such as that of the Manhattan Elevated Railway Company of New York, which employ special forms of hand control, the operation of which will be discussed later.

Multiple Unit System of Control.—The operation of a train composed of two or more cars necessitates the use of some means of simultaneously regulating the current input of the motors of all the cars. Such a method of control operation is termed the multiple unit system. With

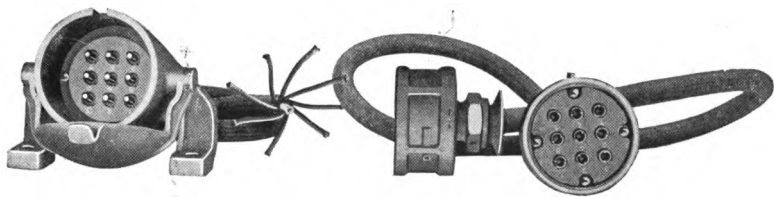

Fig. 64.—TRAIN LINE COUPLER.

this system all of the motors of a train may be operated simultaneously, from any controller located on any car. This is accomplished in the following manner. Extending throughout the train are several wires bound together in the form of a cable, termed the train line. This cable terminates at the extremity of each car in a jumper. By means of a coupler (Fig. 64), the train line may be made continuous from the first car to the rear car. Where trailer cars partly compose a train, they must also be provided with a train line to preserve its continuity. All of the controllers throughout the train, usually two to a car, are connected to the train line in the same manner. The reg-

provided with contact shoes or trolley admitting current to the motors through the resistances, when the proper combinations of regulating devices are made. Such a system, as developed by the General Electric Co., is illustrated in Fig. 65. It is termed the Sprague General Electric Type M control system. It consists of a combination of motor rheo-

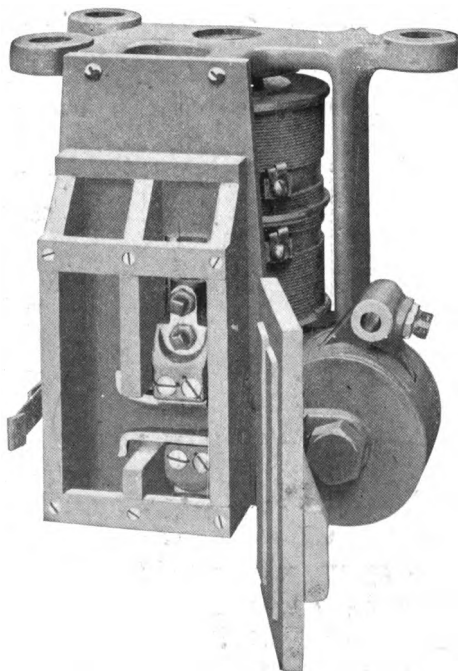

Fig. 66. — CONTACTOR, TYPE M CONTROL.

stats, contactors, reverser, controller train line, and auxiliary apparatus, which are described in the following manner :

SPRAGUE G. E. TYPE M CONTROL.

Contactor. — The contactor (Fig. 66), type M control system, consists of a magnet energized by a small line

is associated a magnetic blow-out coil. This coil is connected in series with the main line circuit, and extinguishes the arc tending to form when the circuit is interrupted (see contactor No. 1, Fig. 67). This interruption occurs when the contactor coils become de-energized, allowing the metallic finger to drop down, due to the force of gravity and the spring action of the finger. The contactors are usually arranged under the floor of the car near the side, so that parts subject to burning and wear may be readily replaced. The contactor system for closing and opening heavy circuits is far superior to the sliding contact method, as the action of the contactor is rapid and positive, the contact surface large, and the extinguishing of arcs certain.

G. E. No. C. 6 Controller. — This type of controller, type M system, consists of a movable drum operated by a main controller handle *A*, Fig. 68. Before turning this handle it is customary to press down the spring *C*, which closes the auxiliary contacts *D* through the medium of *C'*. As previously mentioned, if the motorman should remove his hand from the controller handle the spring *C* would open the power line of the controller. The controller drum, *H*, is composed of four metallic sections, insulated from the frame and from each other, Figs. 67 and 68. Upon each section of the drum are mounted metallic strips. Upon these strips press contact fingers *G*, when the controller drum is moved. When two contact fingers press upon the same section of the controller drum, current may pass from one finger to the other. The controller is provided with a blow-out coil to extinguish arcs formed by the contact fingers, preventing the arcs from jumping to the me-

tallic case, which is naturally grounded. The case is insulated by the lining *F*.

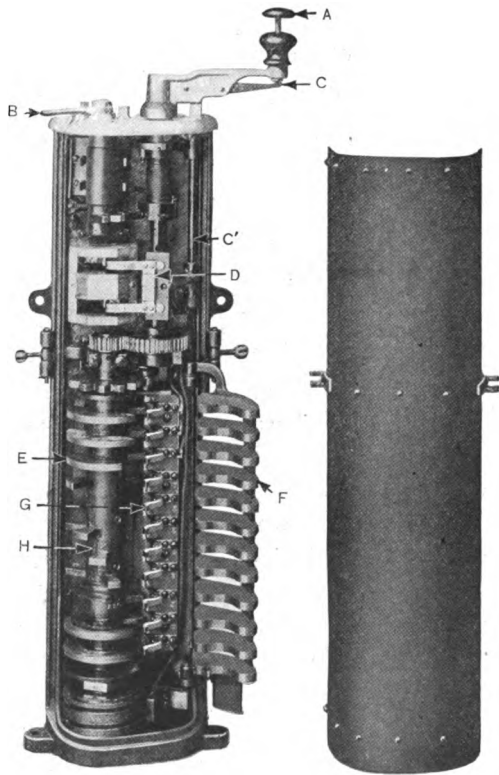

Fig. 68. — MASTER CONTROLLER (OPEN).

The control circuit is separate from the power circuit of the train. With a continued motion of the controller

handle, successive contactors are energized, reducing step by step the resistance in series with the motors.

Reverser. — The function of the reverser (Fig. 69), used in connection with the type M system, is to perform the proper connections of armature and field terminals, depending upon whether a forward or backward motion of the car is desired. The reverser is operated by means of an electromagnet, which, when energized, closes the field

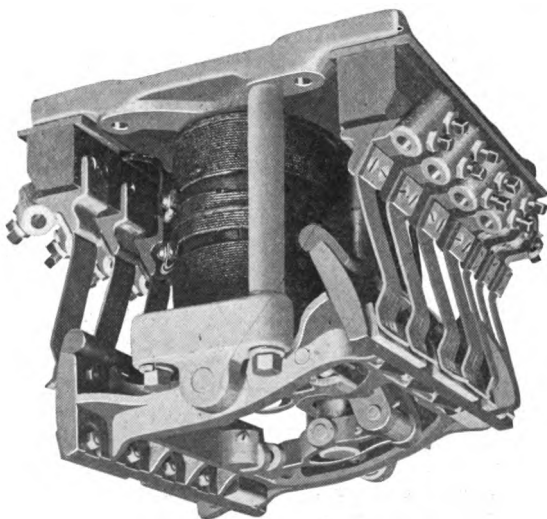

Fig. 69. — REVERSER, TYPE M CONTROL.

and armature circuits, as illustrated in Fig. 67. Associated with the reverser is a blow-out coil to interrupt arcs formed by the contact fingers.

Operation of Type M Control. — Referring to the diagram, Fig. 67, with the controller in the first position, current enters the control circuit through the control switch, fuse,

blow-out coil, to the auxiliary blow-out coil in the top of the controller. Pressing down the spring on the handle of the controller, and turning the handle on the first notch, the auxiliary contacts are closed, allowing current to enter the controller at the second contact *A*, Fig. 68. From *A* the current passes to *B*, to 8. Assume reverse cylinder forward, the circuit continues to terminal 8 of connecting board, to line wire 8, to reverser, where 8 connects to line wire 15, energizing contactors 1, 2, 3, 11, through solid

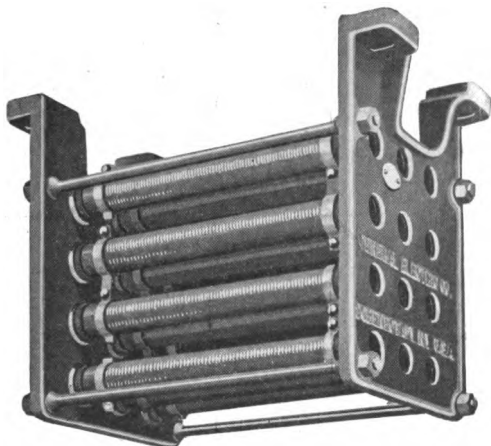

Fig. 70. — CONTROL CIRCUIT RHEOSTAT.

contact on contactor 12, to line wire 1, to controller cylinder, to ground. The line current then passes through resistances R_1, R_3, R_4, R_7 , to A_1 of motor No. 1, to AA_1 , to F_1 , to E_1 , to 11, to C , to A_2, AA_2, F_2, E_2 , to ground. The two motors in this case are in series with resistances R_1, R_3, R_4, R_7 , and the line circuit. The control circuit being separate from the power circuit, control circuit rheostats (Fig. 70) are provided to limit the current input.

With the controller handle in the second position, current enters the second section of the controller at *C* (Fig. 68), and passes out of this section at contact 3, through the control circuit rheostats to wire 31, energizing contactor 5. By continuing the motion of the controller handle to the various notches, the contactors are raised in the following order :

SERIES RESISTANCE CONTACTS.	POSITION.	CONTACTORS.
	1	1, 2, 3, 11
	2	5
	3	6
	4	7
Series running position	5	10, 9, 8 All resistance out. Both motors in series.

MULTIPLE RESISTANCE CONTACTS.	POSITION	CONTACTORS.
	6	13, 12, 4, 2, 1 Both motors in parallel with resistance. Contactor 13 grounding field of No. 1 motor.
	7	6, 5
	8	7
	9	8
Multiple running position	10	10, 9

When passing to the position 6 on the controller, or the first resistance multiple position, current enters the controller at contact 2 instead of contact 1, raising contactors 13, 12, 4, 2, 1, connecting the field terminal E_1 of motor No. 1 to ground, and forming a circuit between R_7 and A , connecting both motors in parallel with resistance and ground, as indicated in position 6 of Fig. 71. This type of control has two running positions: the series position, No. 5, and the multiple position, No. 10.

The various combinations of motors and resistances are as follows :

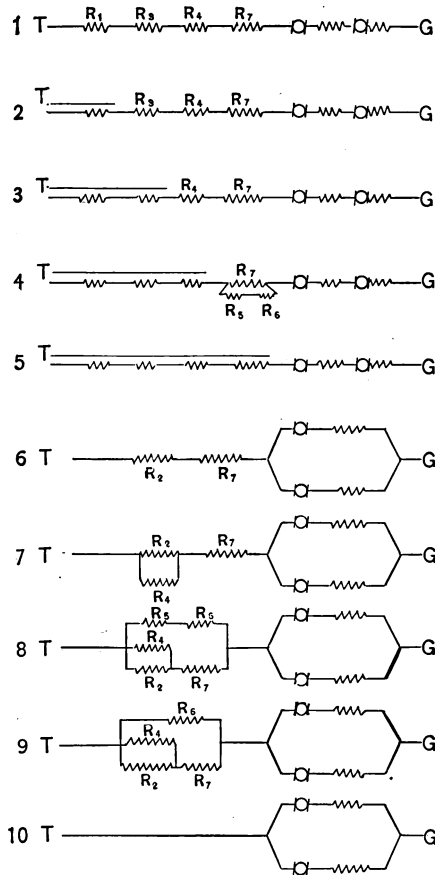

Fig. 71.—RESISTANCE COMBINATIONS TYPE M CONTROL.

HAND CONTROL.

G. E. K 10 Control.— The K 10 series parallel control (Fig. 72) is used extensively for trolley operation. There are many forms of hand control, but as the K 10 control, manufactured by the G. E. Company, is used extensively for trolley car operation, a description of it is considered

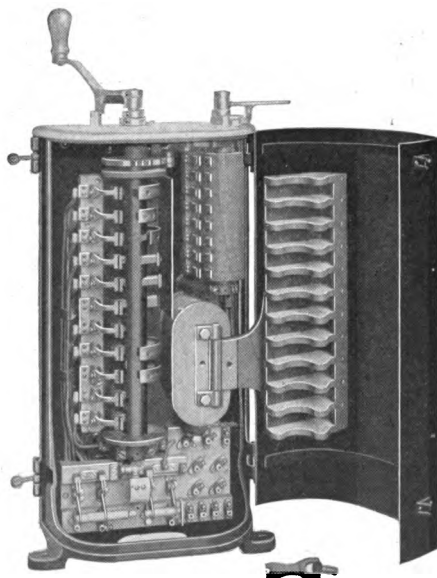

Fig. 72. — HAND CONTROLLER FOR TROLLEY SERVICE.

sufficient. There are many types of K control, the main difference being in the wiring, but the principle of operation is similar to that of the K 10. The controller is operated by hand, the current entering the controller drum at the top

finger, *T*, to the left of the controller cylinder, as shown diagrammatically in Fig. 73. The process of resistance manipu-

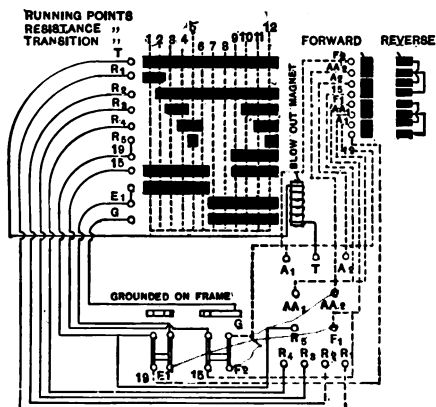

Fig. 73. — CONTROLLER CIRCUITS, K 10 CONTROL SYSTEM.

lation is accomplished by turning the controller handle to the various notches. In the bottom of the controller case is a connecting board to which are attached the various line

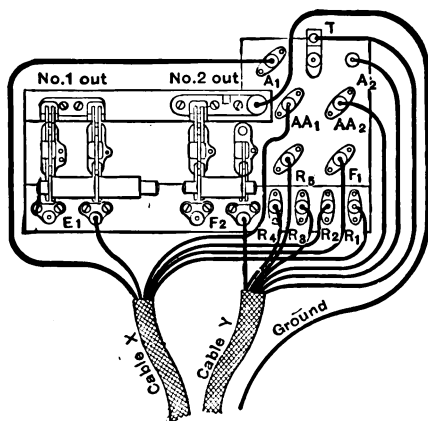

Fig. 74. — CONNECTING BOARD OF CONTROLLER.

TYPES OF CONTROL AND THEIR OPERATION. 117

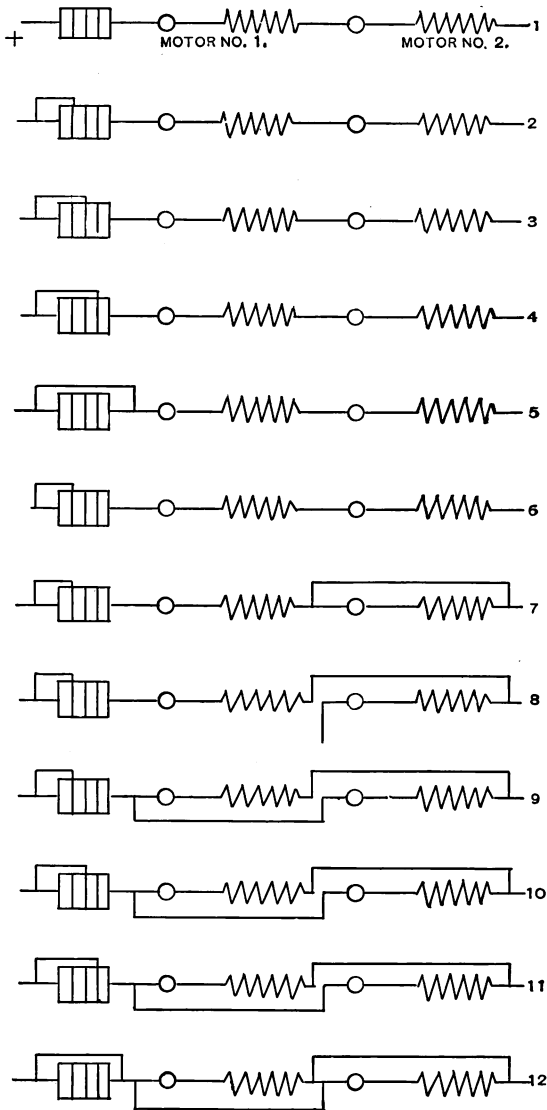

Fig. 75.—DIAGRAM OF K₁₀ MOTOR COMBINATIONS.

wires composing the car cable, these wires coming from the various resistances, armature and field terminals, trolley, and ground, Fig. 74. The various fingers of the controller are electrically connected to the connecting board by heavy insulated wires. The controller is equipped with reversing cylinder, connecting the armature and field terminals together in pairs, as illustrated in Fig. 73, depending upon the position of the reverse handle. A blow-out magnet is connected in series with the main line to extinguish arcs formed by the controller fingers. The frame of the controller case is one terminal of the magnet.

Circuits of K 10 Control. — Assume the reverse cylinder in the forward position and the main controller handle on the first notch. In this case current enters the connecting board located in the bottom of the controller case at the terminal T , Fig. 74. The circuit through the resistances and motors is then as follows. From T , connecting board to blow-out magnet, to top controller finger T , through the metal frame of the controller drum to R_1 , through the resistance to R_5 . From R_5 , the circuit continues to terminal 19 on the controller frame, which is a solid connection, to 19 on reverse cylinder connecting, in the forward position, to A_1 of motor No. 1.

Returning to A_1 of connecting board, to reverse cylinder to 15, from 15 reverse to 15 on controller, to E_1 through controller cylinder contact. From E_1 , which is one of the field terminals, of motor No. 1, to F_1 , the second field terminal, to reverse cylinder, to AA_2 of motor No. 2 to F_2 through field coils of motor No. 2 to ground. Turning the controller handle over the various notches, the resistances are short circuited by the frame of the controller cylinder,

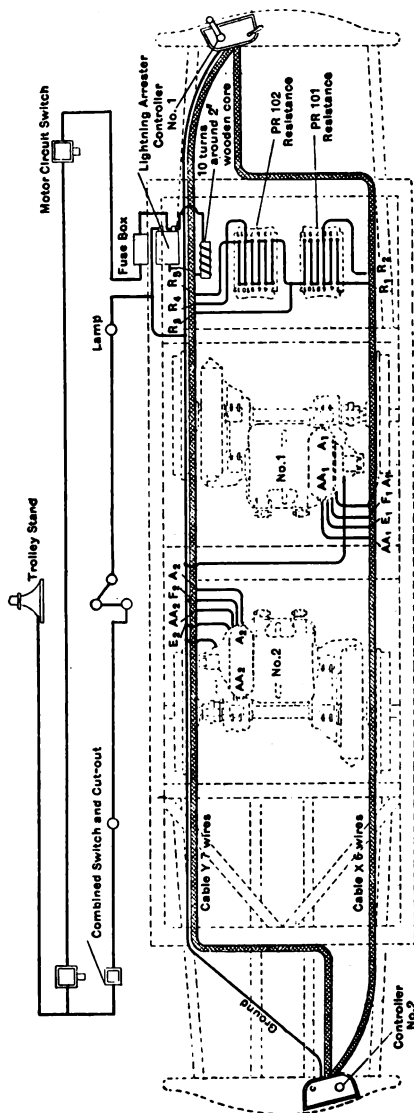

Fig. 6. — TROLLEY WIRING DIAGRAM.

until R_5 has been reached, at which point all resistance is removed from the motor circuit and the motors are operated on the 500-volt circuit in series. Position 5 is termed the series running position. Continuing the motion of the control handle, the various multiple resistance positions are passed over (Fig. 75), until the final or multiple running position is reached, in which case both motors operate in parallel on the 500-volt service. When tracing out the controller circuits, consideration must be taken of the fact that the controller cylinder is divided into sections insulated from each other as indicated. The difficulty encountered with this form of control is the burning of the control fingers due to the sliding form of contact necessary. Unless tested for partial grounds at reasonable intervals and kept thoroughly clean, dirt, oil, and grease will accumulate, and when a ground occurs, the controller will burn out.

Fig. 76 illustrates the method of wiring a trolley car with the K 10 control, the car equipped with two motors.

AUTOMATIC CONTROL.

G. E. Automatic Control.— The General Electric Company have equipped their standard type M control with a device providing for automatic acceleration for the Interborough Rapid Transit Railway cars for New York City service. The controller drum is connected to the controller handle through the medium of a heavy spiral spring. When the motorman throws the controller handle to the full multiple position the spiral spring tends to turn the controller drum.

The motion of the controller drum is governed by a

magnetic clutch operated by a current relay placed in the motor circuit. This relay is set for a predetermined cur-

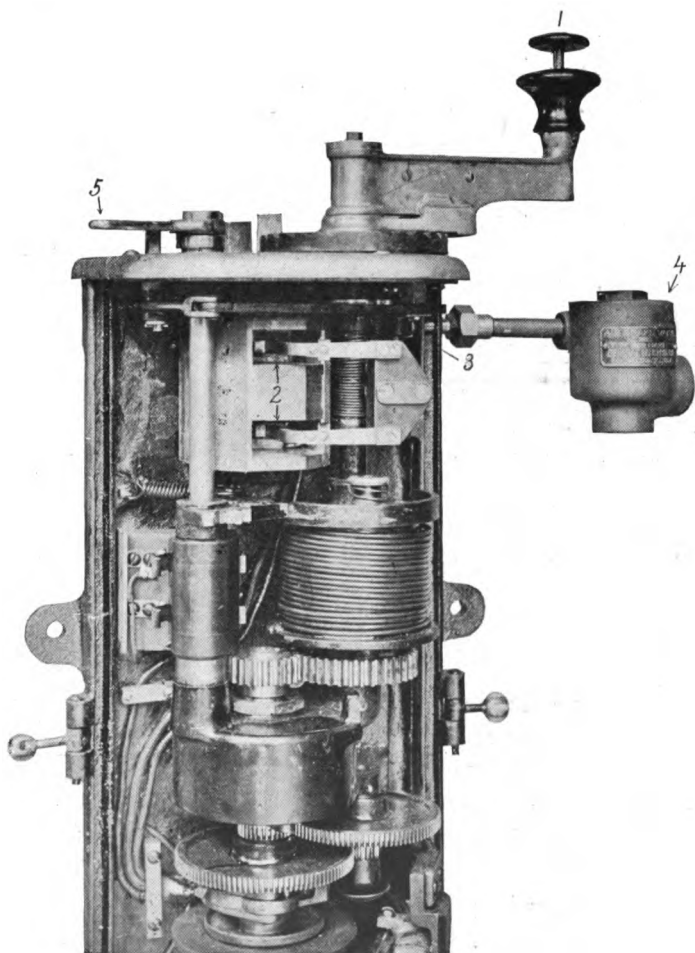

Fig. 77.—G. E. AUTOMATIC CONTROLLER.
(Installed in New York Subway Equipments.)

rent input into the car motors. The clutch holds the controller drum and prevents it from advancing until the current input has fallen to normal value, when the process of notching up continues. The controller handle may be advanced at any rate, but the controller drum will only follow as the relay permits. The controller cylinder may be notched up a few notches at a time when manipulating a car within the yards, as with the regular type M control, but in passenger service the handle is usually thrown over to the full multiple position at starting, permitting the train to make its maximum schedule rate of acceleration.

In addition the controller is equipped with an automatic attachment providing against sickness or death of motorman. Referring to Fig. 77, No. 1 is a button on the controller handle, which must be pressed down at all times while the motors are receiving power. It requires but small pressure to force this button down, and by so doing auxiliary contacts No. 2 are closed, completing the controller circuit. The controller is also provided with a direct connection to the air train line through the medium of the pilot valve No. 3 and the emergency brake valve No. 4. A small pipe connects from the upper part of the emergency valve to the pilot valve in the controller. The projection on the right hand side of the emergency valve is connected directly to the train line of the air brake system. The valve opens to atmosphere at the same time that the button on the controller handle is released, and the auxiliary contacts cut off the power from the motors. A cam bears against the stem of the pilot valve at No. 3 and allows air to escape from the upper part of the emergency valve. The train line pressure forces up the piston in the emergency valve and allows the air in the train

from which the motorman is operating. If the train should part, the coils of the circuit breaker on the rear platform are deenergized, opening the breaker.

THE WESTINGHOUSE MULTIPLE TRAIN CONTROL.

This form of control consists primarily of the usage of compressed air to move the controlling apparatus. The

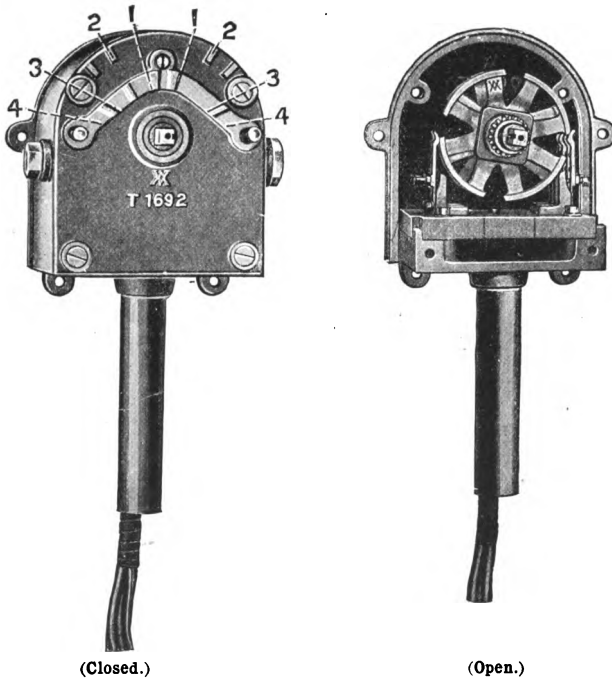

Fig. 79.—MULTIPLE CONTROL SWITCH.

system is similar to the series multiple type of control, employing the same method for resistance manipulation as provided for by the standard hand control. With the Westinghouse system, air is admitted to cylinders by

electromagnetic valves. The coils of the electromagnets are energized by low voltage circuits supplied by storage batteries. The system in detail, Fig. 78, embodies a combination of two multiple control switches, Fig. 79, one located on each platform, a series parallel control combined with an operating head, 14 cells of storage battery, and a limit switch providing for automatic acceleration at a predetermined current input through the motors. The three principal operating parts are, namely, the operating head, the reversing cylinder, and the circuit breaker.

Circuit Breaker.—The circuit breaker is operated with compressed air by means of a toggle joint mechanism. When the circuit breaker magnet is energized, it opens a valve admitting air to cylinder *A*, Fig. 78, moving forward the piston, compressing the piston spring, releasing the lower end of the circuit breaker handle. When air is admitted through the pipe connection *K* to the cylinder *D*, the circuit breaker arm is thrown through the arc represented diagrammatically in the figure. The arm of the circuit breaker is connected to the arm of the interlocking switch, which is therefore set with a forward motion of the circuit breaker. When the C. B. magnet *f*-6 is deenergized, the mechanism in cylinder *A* trips the circuit breaker. The interlocking switch set by the circuit breaker is in series with the operating magnet *F*.

Reverse Magnets.—There are two reverse magnets, *f*¹ and *f*², corresponding to the "ahead" and "back" positions of the reversing drum. These magnets become energized when the multiple control switch forms stationary contact 2 or 1. With the multiple control switch in position 2, *f*¹

is energized in the "ahead" position or f^2 in the "back" position, depending upon the direction of motion of the multiple switch handle.

Westinghouse Controller with Operating Head.—The controller (Fig. 80) consists of two drums, termed the main

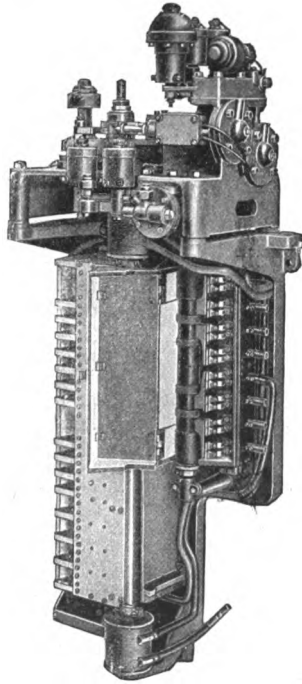

Fig. 80.

CONTROLLER COMPLETE, SHOWING SMALL DRUM AND OPERATING HEAD.

controller cylinder and the reversing cylinder. The main cylinder contains metallic contact strips upon which press stationary contact fingers when the cylinder revolves, forming the various resistance and motor combinations. The

function of the reversing cylinder is to transpose the armature terminals of the motors, reversing their direction of rotation. The operating head (Fig. 81) consists of an oper-

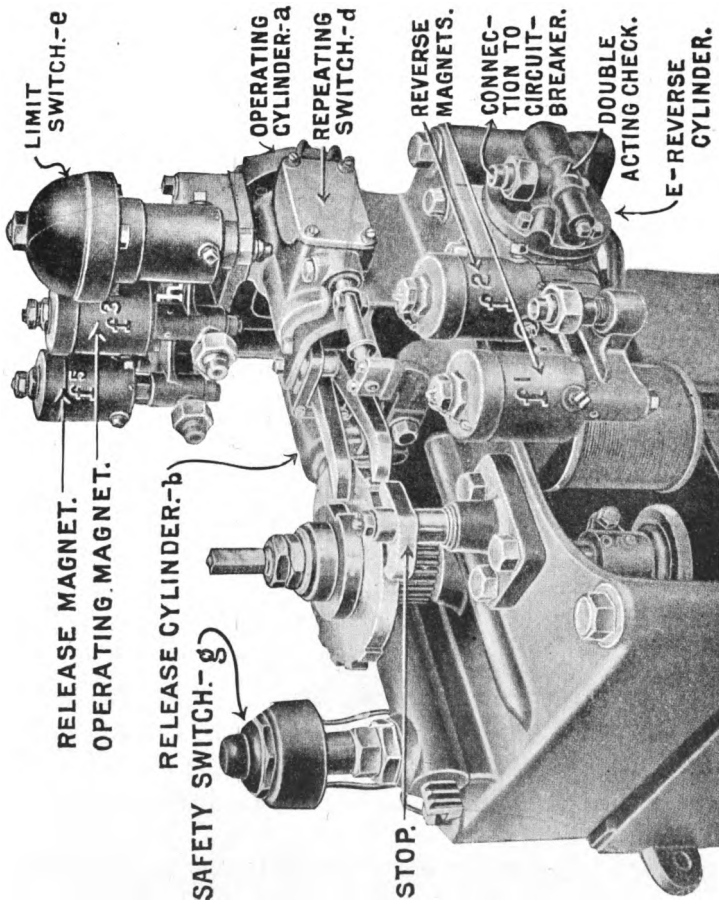

Fig. 81. — OPERATING HEAD.

ating cylinder, (*a*), a release cylinder, (*b*), two reverse cylinders, *E E'*, a repeating switch, (*d*), a limit switch, (*e*),

and four electromagnets, f^3, f^2, f^1, f^5 , controlling the admission of air to the various cylinders.

Operating Cylinder. — The piston of this cylinder is provided with two pawls (see Fig. 78), which engage two ratchet plates fastened to the end of the shaft of the main controller drum. With the admission of air to the operating cylinder, a forward stroke of the piston occurs, throwing the controller on the first notch. Constructing the cylinder with two ratchets enables the controller to be moved through a greater or a less angle, depending upon the relative position of the drum contacts. When the valve admitting air to the cylinder is closed, and connection is made between the atmosphere and the cylinder, a heavy spiral spring returns the piston to normal position.

Operating Magnet. — The function of the operating magnet, namely, that of admitting air to the operating cylinder, is controlled in several ways. Referring to the multiple switch, consider the controller handle in position 4 (ahead). Contactor M' will then be connected to B_+ . This is equivalent to connecting the positive battery terminal to lead No. 4 of the train line. The path of the current, or the circuit from B_+ to B_- of the battery, would thus be — from train line wire No. 4 to “ G ” of interlocking switch, to J' of repeating switch, to wire x of interlocking switch, to safety switch “ h ,” to operating magnet f^3 , to circuit breaker, to B_- . It is obvious that this circuit, which energizes the operating magnet, may be interrupted at four points, namely, the multiple control switch, the repeating switch, the safety switch, “ h ,” or by the circuit breaker.

The safety switch, “ h ,” will be closed only when the release cylinder is in the “off” position, in which case air

pressure in the release cylinders "b," is practically atmospheric. The limit switch, when closed, short circuits the repeating switch and prevents the continuance of the automatic notching until the current input in the motors has fallen to normal value. The limit switch circuit is then automatically opened, the operating magnet deenergized, and the air supply to operating cylinder cut off. The operating cylinder spring then returns piston to the off position, in which case the repeating switch "d" is closed and the operation of notching up continues. The circuit through the operating magnet is closed in position 3 of multiple switch.

Multiple Control Switch Circuits.—*Position 1* of multiple control switch connects B_+ of battery to the control stationary contact 6. This energizes C. B. magnet No. 6, releasing circuit breaker magnet, by admitting air to cylinder A , so that when air is admitted to D , circuit breaker will be set. This cannot occur until air enters pipe connection K from the reverse magnet cylinders E or E' .

Position 2.—In this position stationary contacts 6, 1, and 5 are connected to B_+ , energizing magnets f^6, f^1, f^5 . Energizing f^1 admits air to reverse cylinder E , moving reversing drum to the "ahead" position. The air under pressure continues, through the uncovered port in cylinder E to circuit breaker pipe K , to cylinder D , setting the circuit breaker. It is obvious that it is impossible to set the circuit breaker unless the reversing drum is either in the "ahead" or "back" position, as the ports to pipe K are only uncovered with a forward motion of reverse cylinder piston heads. Air is prevented from passing from one reversing cylinder to the other by a double check valve.

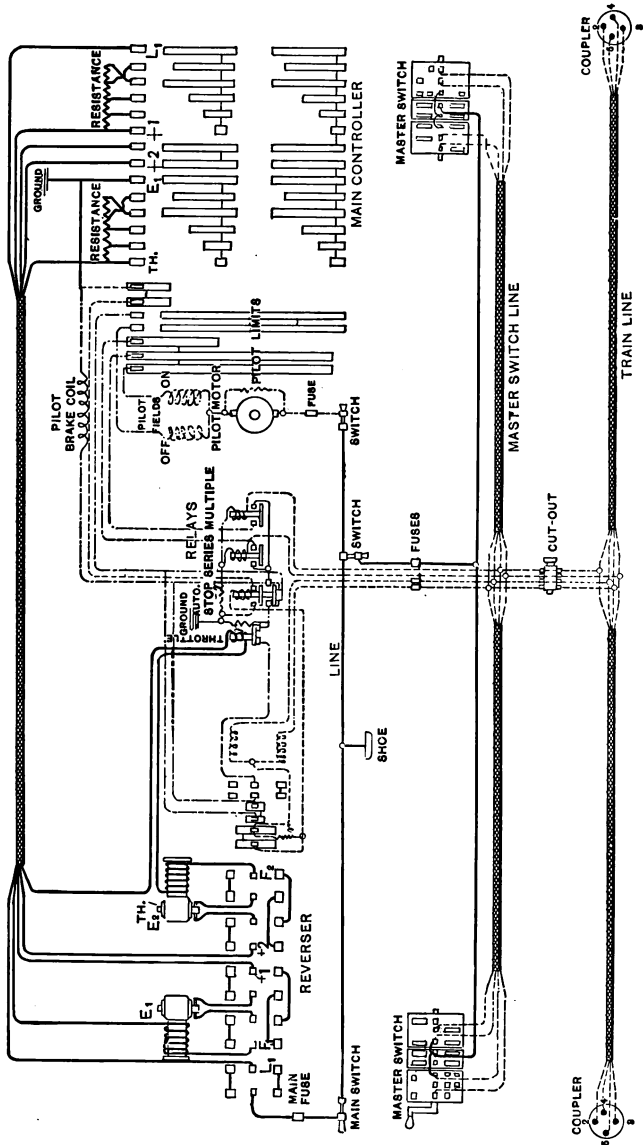

Fig. 82. — SPRAGUE WIRING DIAGRAM.

Position 3. — Moving the multiple control switch to position 3, *S* and *M* are connected to B_+ . Terminal *S* is connected to lead *Y* of interlocking switch, and terminal *M* to lead *G* of interlocking switch, also to the operating magnet circuit. When the interlocking switch corresponds to the series position, a metal strip *S* short circuits the repeating switch. Upon moving the control hands to *Position 4*, the circuit to *S* is broken at the multiple switch and the operating magnet is energized through contact *M'* until the full multiple position is reached, when the interlocking switch short circuits leads *X* and *G* corresponding to the repeating switch. The operating magnet thus remains energized, notching up discontinues, and piston of operating cylinder remains forward until controller handle is turned off.

When the multiple switch is in *Position 3* the reverse magnets are deenergized, the air supply to circuit breaker cylinder *D* is cut off so that when the circuit through C. B. No. 6 is interrupted, the circuit breaker may be thrown. This is arranged so the cylinder *A* will not work against cylinder *D* of circuit breaker.

This type of control is remarkable for the great number of safety devices it contains. It has been employed extensively by the Brooklyn Rapid Transit Company, but is now being superseded by the Westinghouse Unit Switch Control.

SPRAGUE SYSTEM.

The Sprague System is claimed to be the first method of multiple unit control put into successful operation. It therefore seems appropriate to consider it, although the patent rights are controlled by the General Electric Com-

pany, who have embodied the important elements of this system in what is known as the Sprague General Electric Type M Control, previously described.

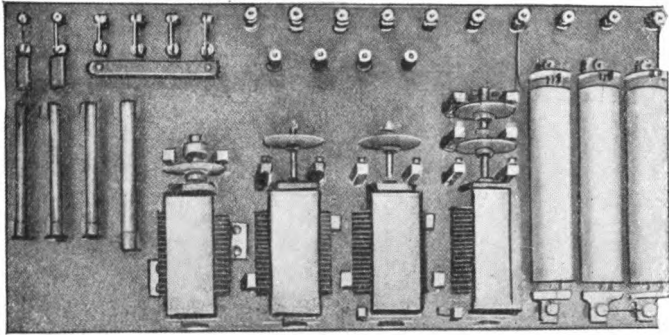

Fig. 83.—RELAY BOARD, SPRAGUE SYSTEM.

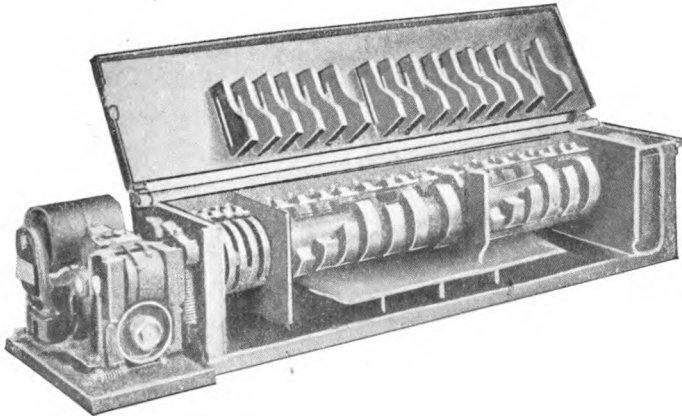

Fig. 84.—REVERSER, SPRAGUE SYSTEM.

The Sprague System was installed on the Chicago Elevated and the Boston Elevated Railroad, where it has operated satisfactorily. It is primarily automatic in its

operation, the motorman simply throwing the control handle to the full multiple position, the controller notching up automatically. The current input to motors is regulated by a throttle valve located in the motor circuit, which regulates the motion of a turret motor that turns the controller cylinder. This system was fully described in the "Street Railway *Journal*." Referring to Fig. 82, the system consists of the main controller, the reverser, and the master switch. The resistances are cut out step by step, as with the ordinary form of control. The various relays regulating the movement of the turret motor are represented in Fig. 83. This method of making contact is superior to the sliding contact method, and is characteristic of the General Electric Control. Fig. 84 illustrates the reverser open for inspection.

WESTINGHOUSE STANDARD UNIT SWITCH CONTROL SYSTEM.

This type of control is a direct departure from the Westinghouse Multiple Unit Control System. It retains in the Unit Switch Control, the pneumatic system employing electromagnets energized by storage batteries to operate needle valves, which is characteristic of the Westinghouse Multiple Unit System. The operating head, however, is eliminated, a device, circular in shape, called a switch group being substituted in its place. The switch group, composed of a control reservoir into which air is compressed, is located under the floor of the car. The electromagnets are mounted radially in the switch group, and they permit air to enter valves which force down pistons that are attached to horizontal levers. These levers have copper contacts on their other extremities, the fulcrum being

situated approximately midway. The contact end of the lever is divided into two parts, which are held up by a heavy spiral connecting the two segments together, where they are held by a pin. When the contact of the lever is forced up into position, the contact is first made by the copper tip of the movable arm. The spring slides this tip across the stationary contact until the two surfaces of contact are flush with each other. This combines the advantages of the sliding contact, and the perpendicular break contact characteristic of the General Electric Control. Additional features of this control are that the limit switch, consisting of a solenoid, is placed directly in series with the line circuit of motor No. 2, in preference to shunting the field coils of one of the motors, as with the Westinghouse Multiple Unit System. The system of contacts is such that when passing from full series position to full multiple position the control circuit is not opened, a bridge connection being formed. When contactor No. 5 is closed, both motors are operating in series on the 500 volt circuit. The values of the resistances on the various notches as installed on the cars of the B. R. T. Co., N. Y., are as follows :

	Notch	
$R^1 - R^2 = .96$ ohms.	No. 1 = 2.48 ohms.	
$R^2 - R^3 = .24$ "	2 = 1.36 "	
$R^3 - R^4 = .24$ "	3 = 0.88 "	
$R^4 - R^5 = .20$ "	4 = 0.40 "	
	5 = 0.00 "	Full Series
$R^6 - R^7 = .16$ "	6 = 0.68 "	
$R^7 - R^8 = .24$ "	7 = 0.44 "	
$R^8 - R^9 = .24$ "	8 = 0.20 "	
$R^9 - R^{10} = 20$ "	9 = 0.00 "	Full Multiple.

The multiple unit control has two running notches, No. 5 and No. 9. The acceleration obtained with the unit

switch control, as installed on the Brooklyn Rapid Transit, is very smooth and uniform.

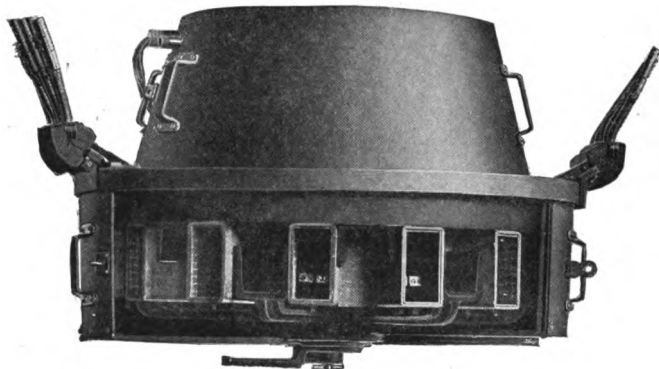

Fig. 85a. — THE SWITCH GROUP. (Covers Closed.)

The Switch Group. — The switch group consists of a number of independent or unit switches, grouped together

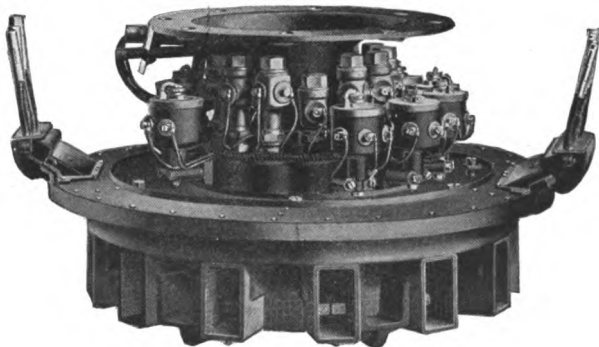

Fig. 85b. — THE SWITCH GROUP. (Covers Removed.)

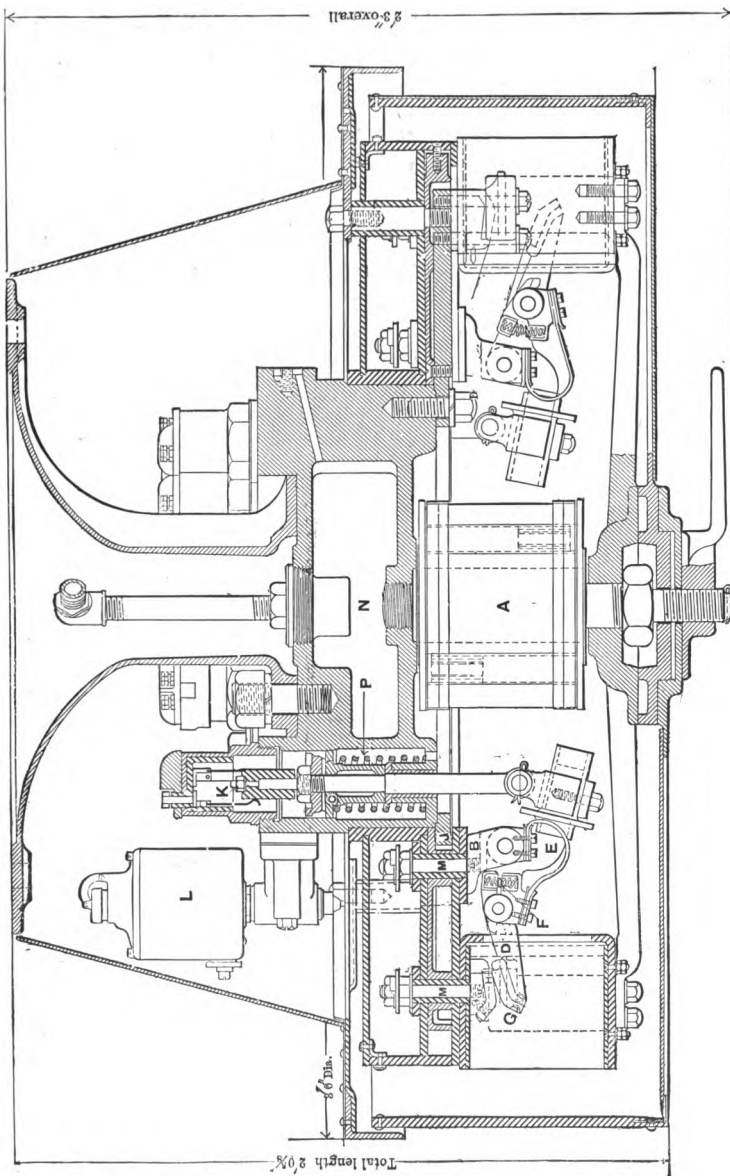

Fig. 86. — SECTION VIEW OF UNIT SWITCH GROUP.

radially around an air reservoir (Fig. 85), and operated by means of small air cylinders controlled by electromagnetic valves.

Referring to section drawing (Fig. 86), in the center below the air reservoir, there is a single blow-out coil (*A*) which gives a powerful field at the point of switch contacts (*H*).

A switch group for two 200 H.P. motors is made up of thirteen (13) unit switches to effect the necessary motor and resistance combinations.

The switch arm rotates upon the support (*B*) by motion of the piston (*C*). Upon the switch arm are carried the contact fingers (*D*). These contact fingers have independent motion upon the contact arm (*E*), which is affected by springs (*F*). The operation of these secures the initial contact at the point of the removable contact tips (*G*), and the final or resting position at the surface (*H*). The wiping or rocking motion of the fingers maintains positive contact upon which the deterioration is a minimum. The piston of each cylinder is connected to the insulated switch arm (*E*), and carries at its other end the interlock switch, (*K*), which follows the movement of the piston. Upon the outer edge of the cylinder casting are bolted the magnet valves (*L*), eight in number. These are iron-clad and thoroughly protected. To the cylinder casting is bolted the supporting plate (*J*) which forms the top spider for the magnetic blow-out. Supported by this plate, but thoroughly insulated therefrom, are the switch contact studs (*M*), serving as connection points for the various motor leads. These studs with their connecting wires are enclosed in a tight insulating box, which has sealed outlets for the connecting wires. The box protects the studs and connecting wires from dust and moisture.

The interlock switches (K), above mentioned, are electrically connected with the magnet valves in such manner that the closing of one switch energizes the magnet of the next succeeding one, thus producing an automatic progressive action. When the magnet is energized its armature is attracted, opening a valve affording passage from the air chamber (N) to the operating cylinder. This supplies the cylinder with air from the auxiliary control reservoir at a pressure of 70 pounds per square inch. The piston

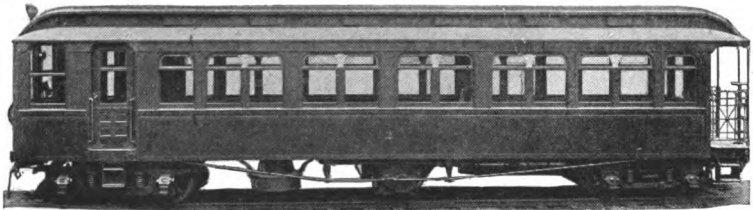
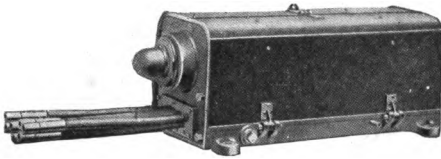

Fig. 87. — CAR SHOWING SWITCH GROUP IN POSITION.

makes its downward stroke, compressing the piston spring (P), closing the switch, closing or opening the contacts (Q) on the interlock. When the magnet circuit is opened the armature is released, exhausting the cylinder to atmosphere, and arresting the supply to the air reservoir.

The use of compressed air for the switches affords a powerful and reliable medium which acts with great uniformity. A larger factor of safety is claimed for this system than is practicable if the switches were actuated by solenoids. With systems operated by solenoids, the pull of the magnets varies greatly with the voltage. Moreover, they require a continuous expenditure of energy to keep the switches closed.

The normal position of the switches is open, and the failure of the air supply or the interruption of the operating circuit opens all the unit switches.



(Closed.)

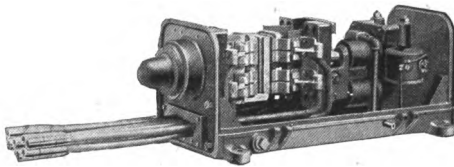

(Open.)

Fig. 88.—REVERSE SWITCH.

The unit switch group is mounted under a car, as illustrated in Fig. 87.

The Reverse Switch.—The function of the reverse switch (Fig. 88) is to interchange the armature polarities of the motors with respect to the field. It consists essentially of an insulating block provided with two sets of contact

strips, and arranged to make contact with stationary fingers by simple straight line motion. The block is moved in one direction or the other by means of two pneumatic cylinders; the admission of air being controlled by electromagnetic valves similar to those on the switch group, and likewise energized from the controller.

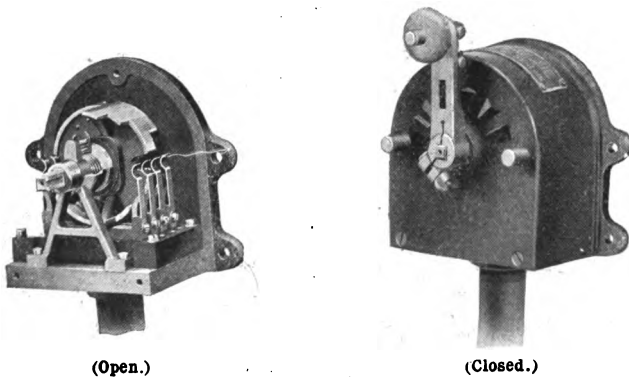

Fig. 89.—CONTROL SWITCH.

An electrical interlock is provided on the reverse switch so that the switch group cannot be operated unless the reverse switch is fully thrown in the direction indicated by the controller.

The Controller.—The controller, which governs the action of the switch groups throughout the train, is located in the motorman's cab. It is of simple and compact construction, measuring approximately 7 in. high, 6 in. wide, and 4 in. deep. It consists (Fig. 89) of a movable drum and stationary contact fingers which are electrically connected to

the various magnet valves. On the exterior is an operating handle and a dial, indicating three positions for each direction of the car, the "off" position being in the center.

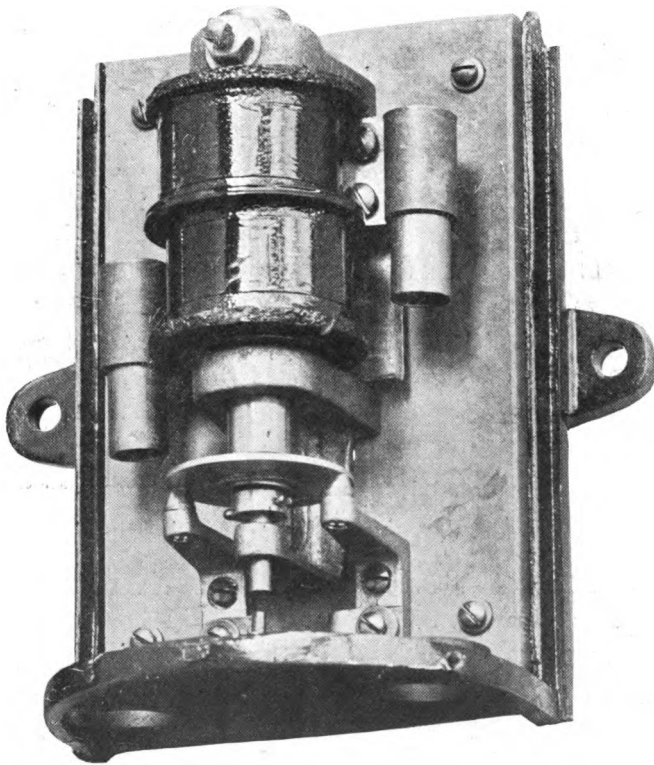

Fig. 90.—LIMIT SWITCH.

The operating circuit is supplied from a 14 volt storage battery, and includes the controller as the operating device, and the armatures of the magnet valves on the switch groups as the parts actuated.

In the "off" position of the controller all unit switches are open. The first position throws the reverse switch forward or reverse, according to which side of the center the operating handle is moved, and connects the motors in series with four steps of resistance, giving a position for shifting or slow speed running.

The second position closes the unit switches in such a manner that the four steps of resistance are successively cut out by means of the automatic action of the interlocks, this action continuing until the motors are in series with no resistance.

No further changes will take place until the handle is moved to the third position. Then the change from series to multiple connection of the motors, with three steps of resistance in series, is smoothly made by the closing of the appropriate unit switches. These steps are then successively cut out, leaving the motors finally in multiple with no resistance. Switches will remain in this condition until the handle is thrown to the "off" position.

Limit Switch. — The rate at which the resistance is cut out of circuit is such as to give a practically uniform accelerating current, which is effected by means of the limit switch (Fig. 90). This feature is valuable, as it gives a smooth, uniform acceleration, and prevents the motorman from turning on the power in excess of a predetermined rate. It also results in a considerable saving in energy over that required with acceleration by hand.

The limit switch consists of a small solenoid connected in series with the plus side of the field of No. 2 motor, through the coil of which current from one motor passes. When this current exceeds a predetermined limit, its armature is

attracted against gravity, opening a pair of contacts in the operating circuit and holding these open so that no additional switches can close (those already closed, however, being suitably retained) until the accelerating current falls below the predetermined limit. The armature then drops, completing the operating circuit again, which allows the unit switches to continue their progression of closing. They are thus interrupted at each step of resistance.

The handle of the master switch may be thrown to the

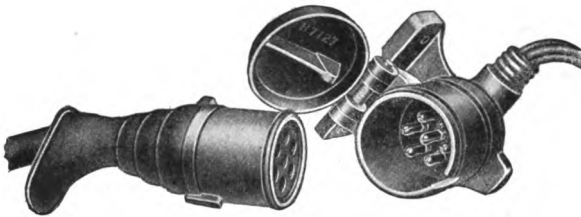

Fig. 91. — CAR COUPLERS.

extreme advance position (and this will be the ordinary service condition) with the car at a standstill, when the car will accelerate at constant current until all resistance is cut out and the full voltage applied to motors.

The progressive action of the unit switches can be arrested and held at any point by moving the controller handle back to the first position.

Storage Battery. — The current for the operation of the magnet valves is secured by a storage battery of seven cells, having a capacity of 40 ampere hours. Each car has two sets of battery; one being on charge with the lighting circuit, while the other is on the operating circuit.

The positive side of the battery is connected to the controller and is carried through the entire train as one of the seven wires of the train line. The negative is connected on each car to the negative side of the magnet valves. This arrangement localizes the current demand from a battery to its own car.

The use of a low voltage battery to operate the electromagnetic valves is one of the advantages of the system

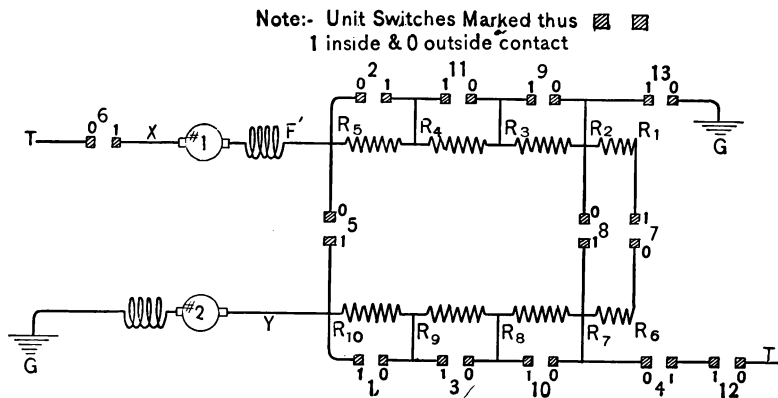

Fig. 92.—ELEMENTARY DIAGRAM OF CIRCUITS OF UNIT SWITCH CONTROL.

obviating the necessity of running high voltage circuits through the train, and making the operation of the control independent of fluctuations of the line voltage.

Car Connectors.—The connectors employed to establish the electrical connection between the cars in one train consist essentially of two sockets and a pair of plugs connected by a short cable. The sockets, which are mounted on the end of the motor car, are provided with seven split pins mounted on insulating bases; these pins, being

located in the interior of the socket, are effectually protected from injury (Fig. 91).

The plugs consist of a cast iron shell surrounded by a piece of insulating material in which are set seven small brass sockets corresponding to the split pins in the main sockets mounted on the car. In designing these sockets and plugs great care has been taken to make them thoroughly substantial, so that they may be able to stand the rough handling to which a piece of apparatus of this kind may be subjected.

Circuit-Breaker Trip. — In case of an abnormally great current, due to a short circuit or otherwise, the device known as the Circuit-Breaker Trip operates to open a pair of contacts normally closed, breaking the common negative battery return of the magnets opening all the switches. This safety device has proven most effective, opening the severest short circuits without damage to the switch contacts.

Line Relay. — There is also provided a device, the Line Relay, to open all unit switches should the current supply fail. It consists of a magnet connected across the current supply mains with resistance in series, the armature of which holds two contacts in the operating circuit closed against the tension of a spring.

Operation of Unit Switch Group. — Diagram, Fig. 92, with the addition of the line switch between No. 6 switch and trolley, shows the motor and resistance connection of all unit switches.

The sequence in which these switches close is as follows :

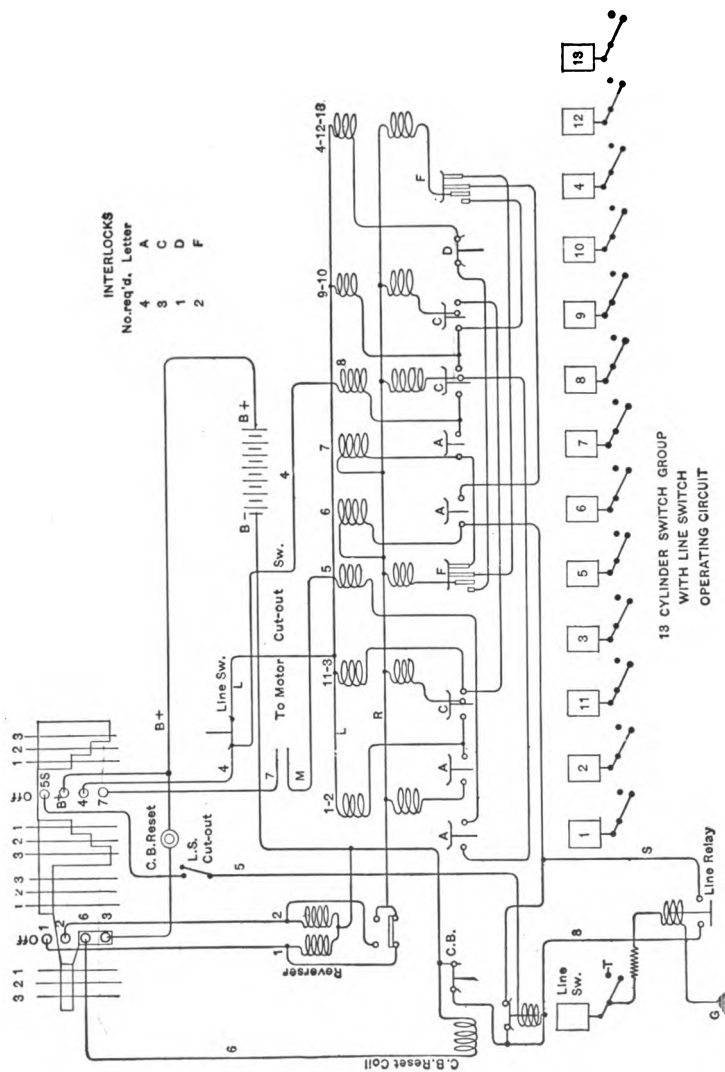

Fig. 93. — CONTROLLER CIRCUITS UNIT SWITCH SYSTEM.

Sequence.	Notch No.	Line Switch,		Switches No.
1st,	1,	6,	7.	
2d,	2,	6,	7, 8.	
3d,	3,	6,	7, 8, 9-10.	
4th,	4,	6,	7, 8, 9-10, 11-3.	
5th,	5,	6,	7, 8, 9-10, 11-3, 1-2	(Full Series).
6th,		6,	7, 8, 9-10, 11-3, 1-2, 5.	
7th,		6,	5.	
8th,		6,	5, 4-12-13.	
9th,	6,	6,	4-12-13.	
10th,	7,	6,	4-12-13, 9-10.	
11th,	8,	6,	4-12-13, 9-10, 11-3.	
12th,	9,	6,	4-12-13, 9-10, 11-3, 1-2	(Full Multiple).

Operation of Low Voltage Magnet Circuits. — Refer to sketch, Fig. 93; with the master switch in the "off" position, all the unit switches are open; reverser in "forward" or "back" position; interlocks on 1, 2, 11, 6, 7, 8 and 9 switches open; that on No. 10 closed, and the long contacts closed on the high contacts of Nos. 4 and 5 interlocks.

Moving the master switch handle to the first position connects fingers 5s and either 1 or 2 to "B+", completing the circuit from battery plus, through magnet of line switch, to "B-." This admits air to its operating cylinder, closing the line switch, by which the circuit is completed from trolley, through magnets of line relay, a series resistance, and fuse, to ground, thereby closing contacts on line relay. Circuit is also completed from "B+" of battery through coils No. 1 or No. 2 on the reverser; No. 1 for moving car

forward, or No. 2 for moving backward, to "B-", throwing reverser in "forward" or "back" position by operation of the magnet valves No. 1 or No. 2. When the reverser is fully thrown, wire-lettered "R" is connected to "B+" of the master switch.

It will be noted that the reverser must be fully thrown to the "forward" or "back" position before "R" is connected to "B+", and this serves as a safety device, in that the unit switches cannot be operated until the reverser is fully thrown in the direction indicated by the master switch. Current now flows from the car wiring, through No. 6 magnet coil, to the common "B-" return, closing switch No. 6. By the closing of its interlock, circuit is established from the "R" wire through No. 7 magnet; through high and long contacts of interlocks No. 5 and No. 4; through No. 6 interlock to "B-" return, thereby closing switch No. 7. Motors are then in series with resistance.

Upon moving the master switch to the second position, No. 8 switch immediately closes, as "B+" is put on the "L" wire, which is the plus side of pick-up coils on magnets Nos. 8, 9-10, 11-3, 1-2, and 4-12-13. When No. 8 switch has closed, the interlock completes the circuit of its retaining coil and closes "B-" on pick-up coil of No. 9-10 magnet, which picks up switches Nos. 9 and 10. Closing No. 9 switch closes its interlock, and No. 10 switch closing, opens its interlock. No. 9 switch is held by its retaining coil which receives its "B+" from the "R" wire and its "B-" through Nos. 8, 7, 5, 4 and 6 interlocks. When No. 9 switch is closed, its interlock closes "B-" on No. 11-3 magnet pick-up coil, which raises switches Nos. 11 and 3. These switches are held by their retaining coil, which

obtains its "B—" through interlocks Nos. 11, 9, 8, 7, 5, 4 and 6.

When No. 11 switch is closed, its interlock closes the "B—" on pick-up coil of No. 1-2 magnet, which picks up switches Nos. 1 and 2. These switches are held by the retaining coil of No. 1-2 magnet, which gets its "B+" from the "R" wire and its "B—" through interlocks Nos. 2, 11, 9, 8, 7, 5, 4 and 6. Motors are now in full series, all resistance having been cut out.

On moving the master switch to the third position, "B+" is thrown on the "M" wire, which closes the pick-up coil of magnet No. 5 through Nos. 1, 8, 7, 5, 4 and 6 interlocks, to "B—". Switch No. 5 closing, puts on its retaining coil through the long and low contacts on No. 5 interlock, and thence through No. 4 and No. 6 interlocks to "B—". It next breaks the high contact on No. 5 interlock, opening "B—" return on both pick-up and retaining coils Nos. 7, 8, 9-10, 11-3 and 1-2, hence opening these switches. When No. 5 switch is fully closed, its interlock completes the circuit through pick-up coil of 4-12-13 after switch No. 10 is opened. No. 10 switch must be entirely opened and its interlock closed before switches 4, 12 and 13 can be picked up. The series switches must also be raised, opening at the same time as No. 10, before the multiple switches can be closed.

When piston of No. 4 switch has travelled downward $\frac{3}{16}$ "', the long contact in its interlock completes the circuit through the low contact, energizing the retaining coil of 4-12-13, which obtains its "B+" from the "R" wire and its "B—" through No. 6 interlock. When No. 4 switch is nearly closed, its interlock breaks the high contact from the long contact, taking "B—" from both coils of No. 5 switch,

thereby opening it. Motors are now in multiple with resistance in.

When No. 4 switch has fully closed, its interlock connects the short contact to "B-". This applies "B-" to pick-up coil of magnet No. 9-10, which raises switches Nos. 9 and 10. No. 9 switch closing causes the successive closing of 11-3 and 1-2 in exactly the same manner that has been described for the series positions. Motors are now in full multiple, all resistance having been cut out. Switches will remain closed until the master switch is thrown to the "off" position.

A complete wiring diagram for a two-motor equipment is illustrated in Plate I.

SPRAGUE GENERAL ELECTRIC AUTOMATIC RELAY TRAIN
CONTROL.— THE STANDARD BRIDGE SYSTEM.

This control employs magnetic switches or contactors of the standard General Electric form for producing the motor circuit combinations. The action of these contactors is controlled from the master controller, but governed by a current relay or "throttle" in the motor circuit so that the accelerating current of the motors is substantially constant. This is accomplished by having small auxiliary interlocking contacts on certain of the contactors, so arranged and connected that the contactors will be always energized in a definite succession, starting with the motors in series with all resistance in circuit, the resistance then cut out step by step. The motors are then connected in parallel with all resistance in, and the resistance again cut out step by step. This succession is always followed, whether the master controller is turned on slowly or thrown directly to the full "on" position. The progression can be arrested at any

Resistances with 2 #109 Motors
Notch*

.96	1	2.48	} Total external resistance to half speed
.24	2	1.36	
.24	3	.88	
.20	4	.40	
.16	5	.00	} External resistance in each motor, half speed to full speed
.24	6	.68	
.24	7	.44	
.20	8	.20	
	9	.00	

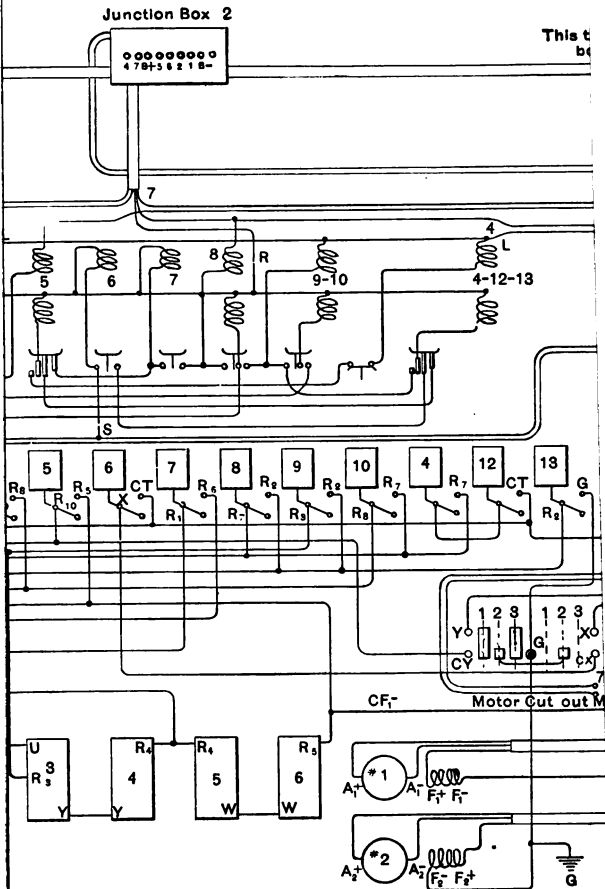

CTIONS OF WESTINGHOUSE UNIT SWITCH CONTROL.

point, however, by the master controller, and is never beyond the point indicated thereby. The rate of the progression is governed by the relay, so that the advance is not made faster than will keep the current in the motors within the prescribed limit.

A relay is provided with each car equipment, so that while the contactors on each car of a train are controlled from the master switch at the head of the train as to the application and removal of power, the rate of progression through the successive steps is limited by the relays on each car independently, according to the adjustment and current requirements of that particular car.

A particularly noteworthy feature of the control is the method of accomplishing the series parallel connection of the motors. This is by the so-called "Bridge" method of connections, which is so arranged that the circuit through the motors is not opened during the transition from series to parallel, and the full torque of both motors is preserved at all times from the series to the full parallel connection. The result is a perfectly smooth acceleration and entire absence of the jerk noticeable in ordinary series parallel controls when passing from series to parallel, especially with as large motors as are used on these cars. This feature is also embodied in the Westinghouse Unit Switch Control as previously mentioned.

Operation of G. E. Bridge Control.—The circuit combinations of the motors are shown in Fig. 94, which illustrates clearly the manner in which the above result is accomplished. The connections are the same as usual with separate resistances for each motor, up to the full series position A. The next combination places a "bridge" connection between the motors inside of the resistances, and

opens the shunts around the resistances, is in "Full Series B." The succeeding step forms a ground connection on No. 1 motor and a trolley connection on No. 2 motor resistances, which places each motor

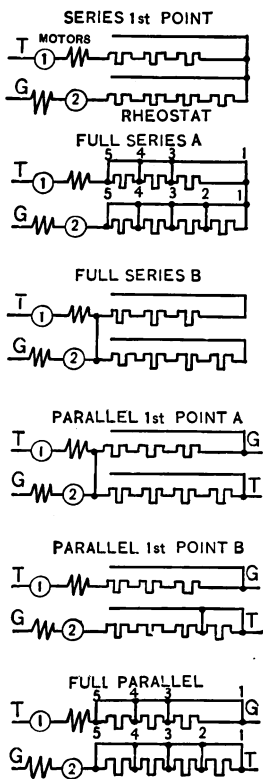

Fig. 94.—DIAGRAM OF MOTOR CONTROL COMBINATIONS. (BRIDGE SYSTEM.)

across line potential with resistance in each circuit, giving parallel connection. The bridge connection becomes an equalizer between points of substantially equal potential. This bridge connection is then opened and resistance cut out as usual.

Fig. 95 shows the connections of the control in simplified form, and Plate 2 gives the complete car connections. This diagram exhibits in detail the method of producing the automatic action of the contactors.

Description of G. E. Bridge Control.—The master controller consists of a single cylinder, with handle directly connected thereto. The handle is moved in one direction to give forward movement of the car, and has four positions in this direction, corresponding to, 1st, switching position in series

giving a slow movement; 2d, accelerating position series; 3d, lap position in parallel; and 4th, accelerating position parallel. There are but two positions in the reverse direc-

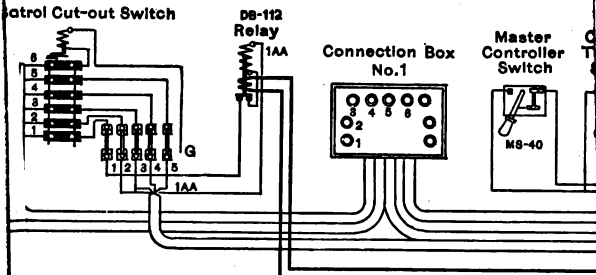

From this Cable
 No. 4 Wire connects to No. 5
 No. 5 " " " No. 4
 at Connection Box No. 2

Contractor Number	Interlocks	Type
1	DI-61	
4	DI-61	
6	DI-61	
10	DI-61	
11	DI-61	
12,13,14,& 15	DI-61	

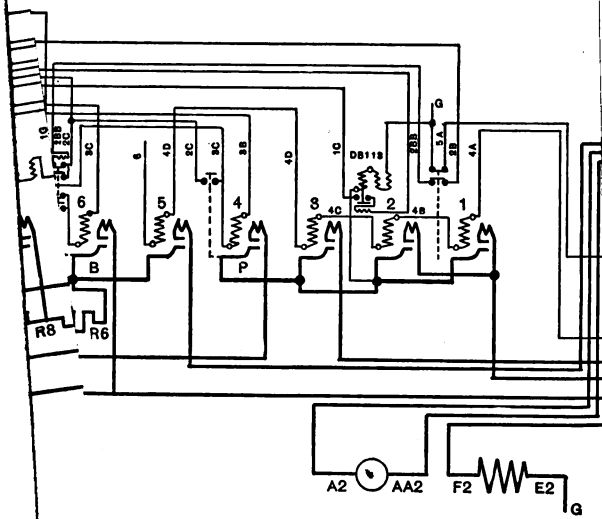

AL ELEC. TYPE M, FORM A, WITH C-26 CONTROLLERS AND
 FOR RAILWAY.



tion corresponding to the two first mentioned for forward. The handle is returned to the central or off position by a

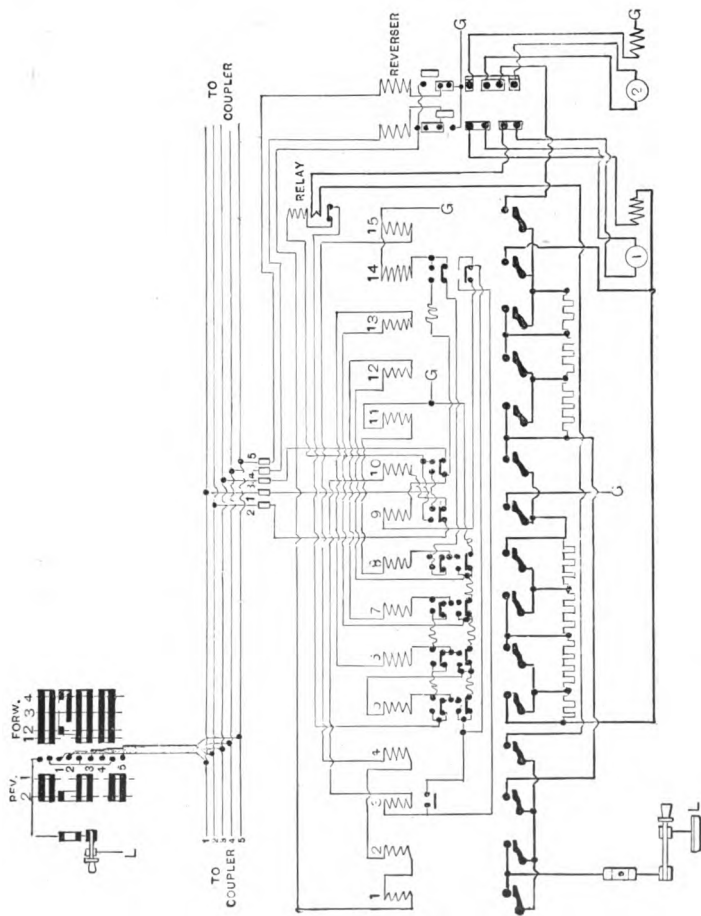

Fig. 95. — ELEMENTARY DIAGRAM OF CIRCUITS OF G. E. AUTOMATIC RELAY TRAIN CONTROL SYSTEM.

spring, so that the power is cut off whenever the motor-man releases the handle.

There are five circuits leading from the master con-

trolley, and five corresponding train wires for the control proper. There is also a sixth circuit in the train line, which is used for an emergency cut-off, which will be described later. The five circuits comprise one for forward direction, one for reverse, one each for series and parallel, and the fifth for controlling the acceleration.

When the master controller is moved to its first position (say forward), the forward direction wire is energized, which throws the reverser to its forward position, and when so thrown, energizes contactors in the main or trolley leads to the motors. At the same time the series contactor is energized and the circuit through the motors is completed in series, with all resistance in circuit giving a slow speed forward. In this position no further action is produced. When the master controller is moved to its second position, circuit is completed through the accelerating wire (No. 1) in addition to the above circuits, which energizes the contactor, shunting the first resistance step, and current also passes through the fine wire coil and the contacts of the throttle relay. The plunger in this relay has a lost motion, so that an appreciable time is required to move it, and this time is made the same as that required by the contactor in closing its contact. These two devices thus operate simultaneously. The contactor being lifted, shifts its operating coil by means of the auxiliary contacts carried on its stem into the circuit through the series contactor above mentioned, which maintains it in the closed position independent of the circuit that has lifted it. At the same time the relay has opened the lifting or actuating circuit. The shunting of the resistance step by the contactor causes an increased current to flow through the motor circuit and through the heavy coil of the relay,

which is sufficient to hold the relay plunger in its raised position, and so keep the actuating circuit open until the motors, by speeding up, cause the current to diminish enough to allow the relay plunger to drop and again close the actuating wire. Circuit is now established through the contactors shunting the second resistance step (the first contactor having shifted this circuit also), and these contactors are energized and the relay again lifted and held up by the increased current, and so on until all the resistance is cut out.

When the master controller is moved to the third position, the parallel circuit is established, followed by the closing of the bridge contactor and the parallel contactors. The motors are then in multiple arrangement. When the master controller is moved to its fourth or full-on position, the resistance is cut out step by step, as in series. These same successive actions are produced if the master controller is thrown to the full-on position directly, as the interlocking contacts prevent an advance circuit being established before the proper preliminary action has taken place.

If at any point during the acceleration the master controller is moved to its "lap" position, the existing position of the contactors is maintained, but the further progression is arrested so that the motorman can limit the acceleration

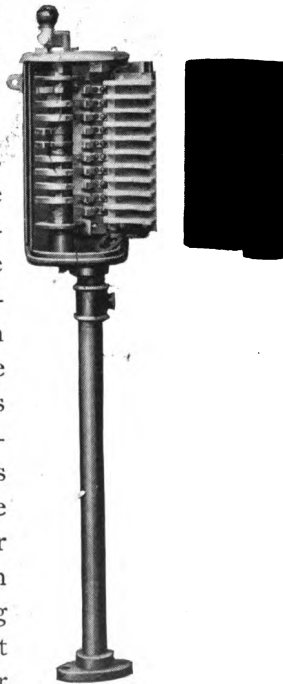

Fig. 96.—MASTER CONTROLLER.

to as slow a rate as desired, but he cannot exceed the pre-determined rate for which the relay is adjusted.

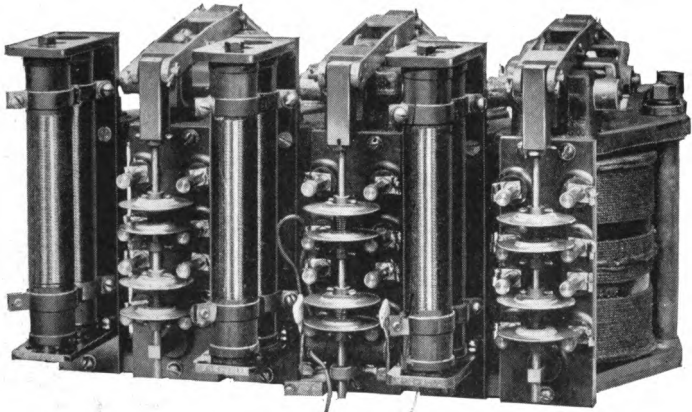

Fig. 97.—CONTACTOR WITH INTERLOCKING CONTACTS. (Front View.)

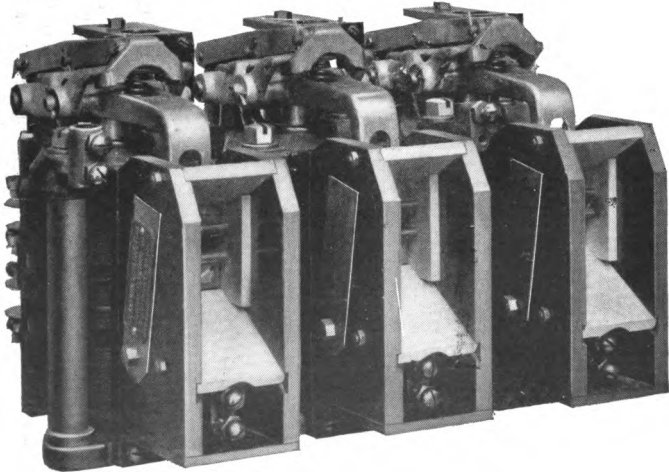

Fig. 98.—CONTACTOR WITH INTERLOCKING CONTACTS. (Rear View.)

The sixth wire in the train line above referred to, providing an emergency cut-off, is connected to a switch in

the motorman's cab and to trip-magnets on the cut-out switches on each car of the train. All of the control circuits for each car pass through its respective cut-out switch, and when the motorman operates the emergency switch in his cab all of the cut-out switches on the train are opened, thus cutting off power on all the cars.

A further automatic protection is provided by a second relay, shown in Plate 2. This relay has its coil connected to the lead from the collecting shoes of the respective car, and its contacts are so connected in the contactor circuits that in case of failure of power to any car, such as would be caused by passing over a dead section of rail, this relay is de-energized and causes the control circuits on that car to be thrown back to series position with resistance in, and when power is restored the control progresses step by step to its former advanced position. This prevents any surging or overloading in such contingencies.

The master controller illustrated in Fig. 96 is of small dimensions, and occupies but very little space in the cab. One of the contactor units, with interlocking contacts, is shown in Figs. 97 and 98. The cut-out switch with attached trip-magnet and the throttle relay (Fig. 99) are mounted on a panel board, which is placed in a cabinet in the motorman's cab.

Seventy-four new cars have been recently installed on

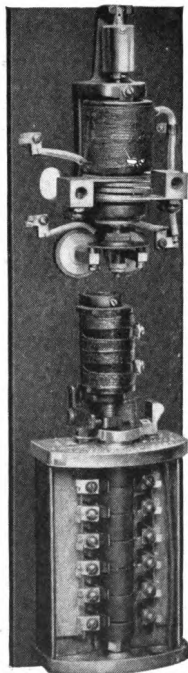

Fig. 99.—CUT-OUT SWITCH, TRIP MAGNET, AND THROTTLE RELAY.

the Boston Elevated equipped with this form of control. The cars weigh, approximately, 35 tons, and are provided with two G. E. 68 motors, geared to a maximum speed of about 40 miles per hour. The acceleration is adjusted to, approximately, $1\frac{1}{2}$ miles per hour per second.

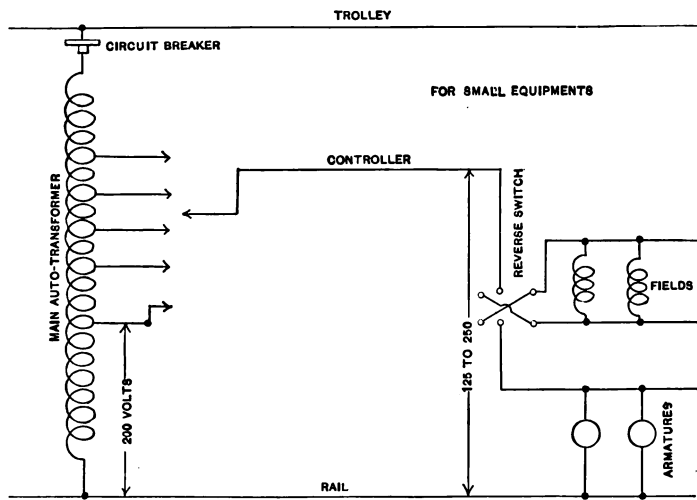

Fig. 100. — ELEMENTARY DIAGRAM A. C. CONTROL SYSTEM.

Alternating Current Control. — With the development of alternating current railway apparatus for the operation of trunk line service, a new type of train control has been introduced. The Westinghouse Company has developed a system (Fig. 100), which consists primarily of an auto-transformer to reduce the line voltage to that necessary for the motors. In circuit with the motors and the auto-transformer is an induction regulator by means of which the voltage on the motor terminals is gradually raised from zero to normal value.

Twin Wiring

<i>Insulation</i>
<i>107.</i>
<i>178.</i>
<i>10.</i>

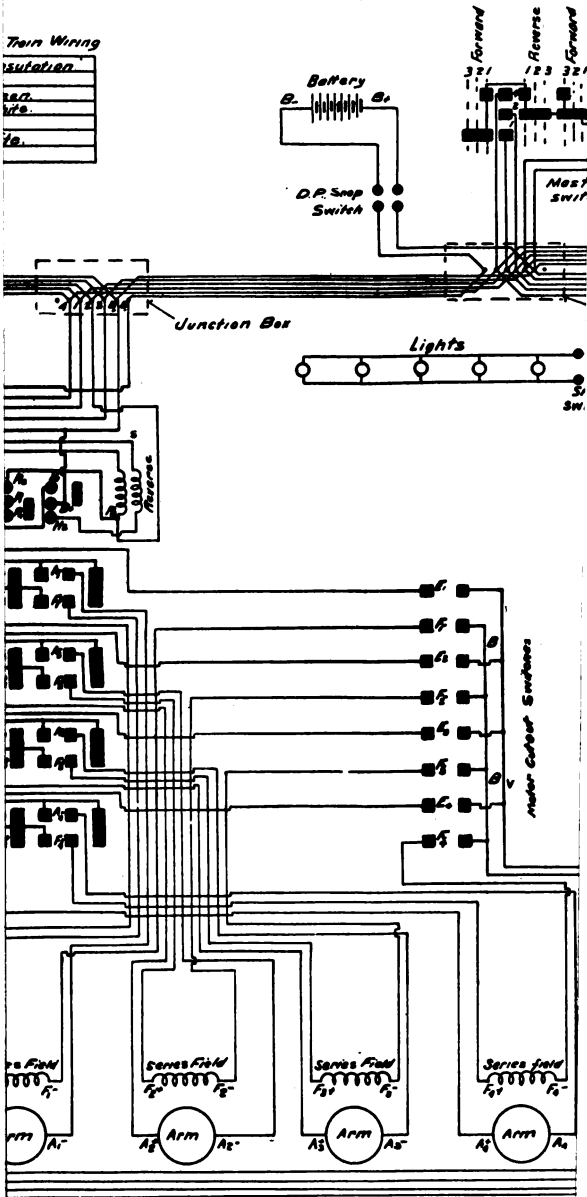

Plate III.

The high efficiency of the induction regulator increases the commercial value of this system, as its energy consumption is quite low compared with the direct current multiple unit system with its large I^2R loss. The regulator consists of two coils (see Plate III), termed a primary and secondary. These coils are wound upon separate cores, which are capable of angular adjustment, changing the direction of flux from the primary through the secondary. The voltage therefore generated in the secondary coil may increase or decrease the auto-transformer voltage which supplies the motors, depending upon the relative angular position of the secondary coil to the primary. Plate III illustrates the connections for a four-motor equipment. The four motors are arranged in groups of two, the field coils connected in a series parallel combination as illustrated. The armatures are connected in a series parallel system to an equalizing transformer, which produces a uniform voltage upon all the armature terminals simultaneously. By means of a reversing switch the direction of the current through the field coils may be changed, reversing the motion of the car. The electric pneumatic system is employed in connection with this form of control, compressed air operating the circuit breakers, induction regulator, and reversing switch. The equipment also includes a master controller somewhat similar to that associated with the Westinghouse direct current system of control. By means of the master controller, electro-pneumatic valves are operated by current supplied by storage cells. This system is designed to operate with a trolley potential of from 1,000 to 1,200 volts, which is reduced by auto-transformers on the car to 300 volts for motor operation. With this system every point of the controller may

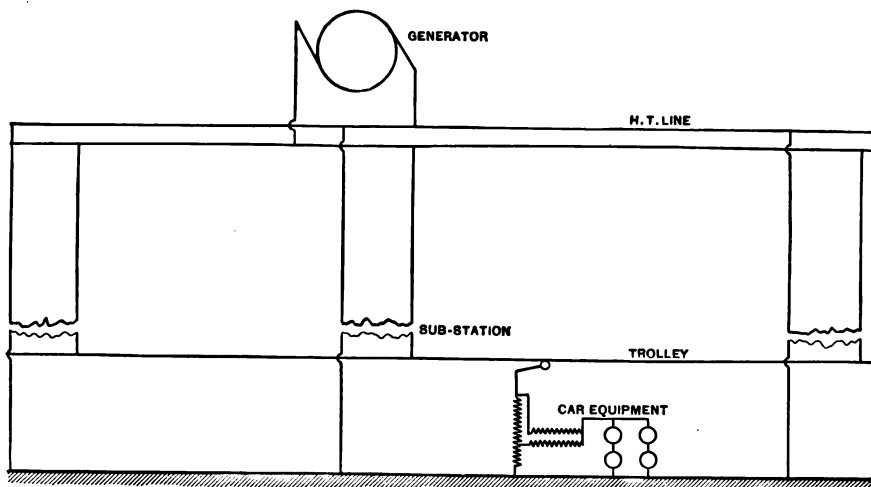

Fig. 101.—DIAGRAM SHOWING GENERAL ARRANGEMENT OF APPARATUS IN THE ALTERNATING CURRENT LINES RAILWAY SYSTEM.

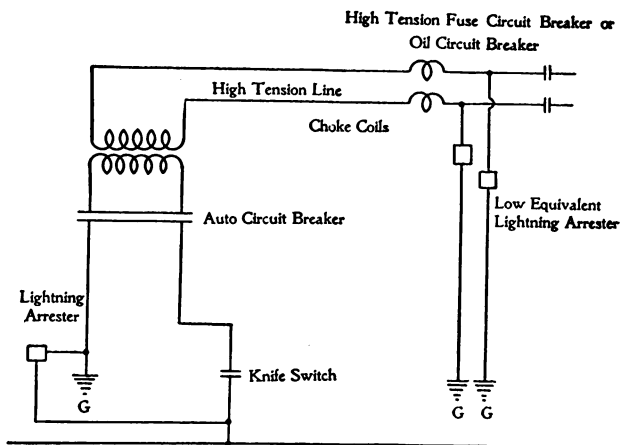

Fig. 102.—ALTERNATING CURRENT SUBSTATION CIRCUITS.

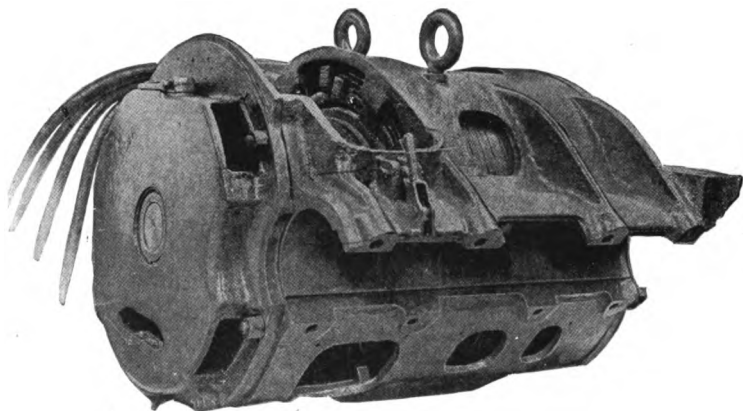

Fig. 103. — ALTERNATING CURRENT MOTOR.

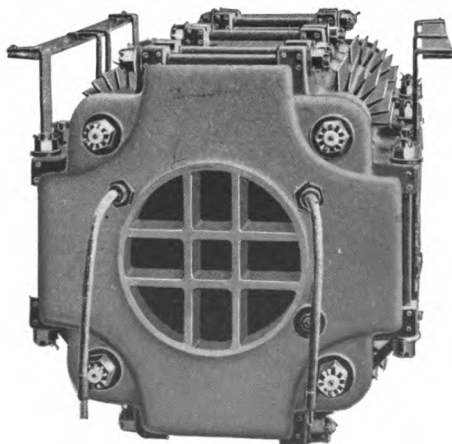

Fig. 104. — CONTROL CIRCUIT TRANSFORMER.

be used as a running point, producing efficient operation at all speeds, due to the absence of large I^2R losses. The energy consumption is practically proportional to the speed. The various protective devices employed in the circuit from the high tension line through the sub-station to the trolley are illustrated in Fig. 101. This is also an elementary diagram of the complete system of generator, sub-station, and car equipment. A more complete diagram of the sub-station circuits is found in Fig. 102, the various protective devices being readily observed.

In connection with this system, motors of 150 H. P., Fig. 103, have been developed, being of the compensated type with laminated field circuit. The means employed for car illumination and to operate the pump motor of the car is obvious from Plate III, the circuits being tapped off from a 100-volt transformer.

In connection with the equipment of the Ballston Division of the Schenectady Railway Company, the General Electric Company have developed a special type of transformer, Fig. 104. A noteworthy feature in connection with this transformer is its large ventilating surface.

Controller Troubles.— Many troubles of minor importance occur with the operation of hand control. These troubles include arching and burning of controller fingers due to sliding contacts, short circuiting of blow-out magnet, imperfect condition of controller fingers when pressing upon cylinder contacts, leads becoming loose, and sticking of controller drum due to accumulated gritty matter. The most serious trouble, however, resulting sometimes in almost complete destruction of the controller, is what is termed "burning out." This phenomena is usually accompanied by a rumbling noise, followed almost instantly by a

burst of flame and smoke from the controller case engulfing the motorman's handles. In several instances witnessed by the author (S. A.), the flames were almost two feet in length. In a recent case, when the display was over three holes, about three inches in diameter were found burned through the controller casing; the holes being opposite the controller resistance fingers. The only satisfactory explanation appears to be that arcs form when turning the controller off. These arcs are normally extinguished by a hinged blow-out magnet located directly over the controller drum, protected therefrom by an insulated cover (see illustration of K_{10} control). However, it sometimes happens that when a heavy current is passing through the motors that the motorman starts turning the controller handle off; when the handle, moving backwards, reaches the resistance points, arcs form and are sucked by the blow-out magnet to the controller casing, which is grounded.

If, for instance, this occurs at contact finger R_5 , there would be an arc from R_5 to the controller casing back to the controller cylinder. The instant this occurs the blow-out magnet quickly extinguishes that portion of the arc between the controller cylinder and the casing. This occurs because the blow-out magnet is located directly over the controller cylinder, whereas the other portion of the arc forms a circuit from R_5 to the casing. This forms a circuit from the trolley, through the controller cylinder to contact finger R_4 , through section of the resistance R_5 to ground. In which case there would be one section of resistance, R_5 , in series with the circuit breaker, fuse, and trolley. The current which would flow in this arc would be sufficient to destroy the controller casing, and still not be of sufficient magnitude to open the circuit breaker, set

for about 200 amperes, until the arc had destroyed the resistance fingers and sprung to the trolley finger, in which case the circuit breaker would open. In the recent case previously mentioned, the circuit breaker, after the accident, was in normal working condition, the motors and motor wiring were intact, and controller fingers *T* and *R*₅ were melted completely off. In addition, three holes about three inches in diameter were found in the controller casing, opposite the resistance contact fingers, the wiring to the controller fingers and the trolley fingers in the controller was completely baked, and the controller drum contacts *T* and *R*₅ were burned.

CHAPTER VII.

CAR BODIES.

THE car bodies used in electric railway service have been gradually evolved from the bodies used in horse car service, and, except for greater size and weight, they adhere closely to the general characteristics of the type in which they originated.

A common type of trolley car floor framing is shown at Fig. 105. On the half side elevation the wheels are shown in outline and the other parts of the truck omitted to clearly show the body bolster which is given in more detail on the right. The main truss rod is shown (provided with a turn-buckle for adjustment) carrying the long span of the car body. The upward pressure of this truss is transmitted at only one point, that is the middle of the car where the truss rod passes under the needle beam. The truss rod is anchored just back of the car body bolster. The framing plan of this car, given at the bottom of Fig. 105, shows the method of strengthening the car transversely by $\frac{5}{8}$ inch tie rods connecting the $\frac{1}{2}$ by 5 inch sill plates which are run the length of the wooden side sills of the car.

At Fig. 106 a novel type of electric car is shown; this is a sleeping car built for inter-urban service in Ohio and Indiana. It is arranged as a parlor car during the day, as shown in the upper half of the plan. Each pair of the revolving chairs may be folded into the form of a bed, and

the beds separated from one another and from the aisle by wooden roller screens.

An inter-urban car of ordinary construction is illustrated in Figs. 107, 108, and Plate IV. The cuts are made from working drawings of the car, and require little explanation, the interesting mechanical feature being the standard method of supporting the car by truss rods under the sills and the deep truss, clearly shown in Plate IV, which is formed in the side of the car. This figure well illustrates the close similarity between a car body and a truss bridge.

Seats. — Trolley cars operating in city service with constantly changing load (that is, relatively short-ride passengers) are usually equipped with longitudinal seats, which give the greatest facility for ingress and egress of passengers, and also afford a maximum standing capacity during the hours of congested traffic.

Cars operated in city service, under the condition of relatively infrequent stops, also suburban and inter-urban cars, are usually equipped with cross-seats. These seats are more comfortable than longitudinal seats, as the passenger is supported by the seat back against displacement towards the rear of the car during acceleration, and by the foot rail against movement in the opposite direction during braking. With longitudinal seats the passenger is urged continually forward and backward, by the starting and stopping of the car, and no fixed points are available against which he can brace himself.

Also with cross-seats the passenger can face in the direction in which the car is moving. It is naturally necessary to secure greater seating capacity per foot of car length, and desirable to provide seats giving greater comfort, in the

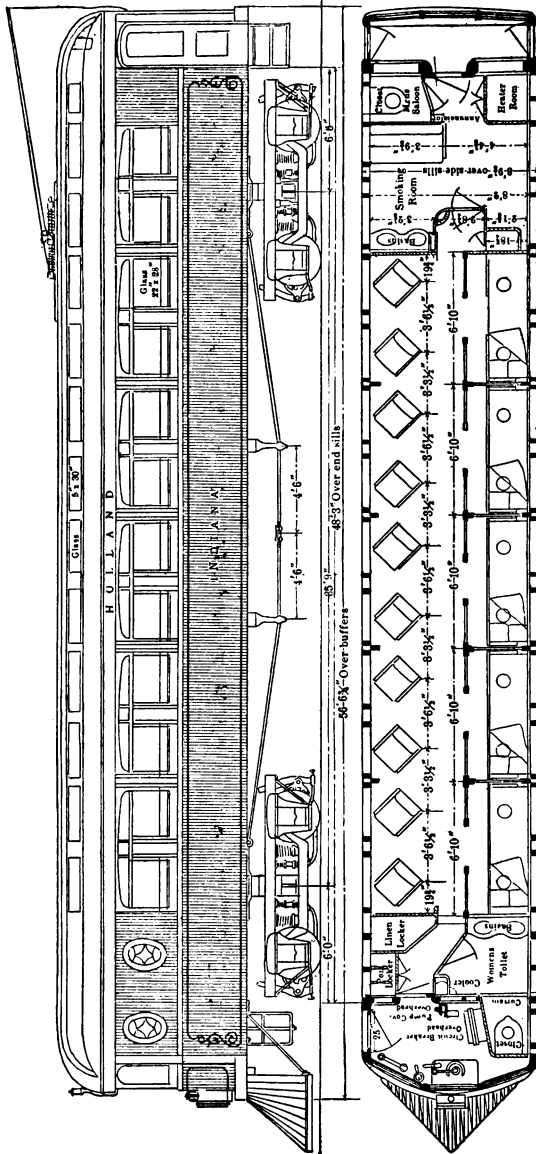
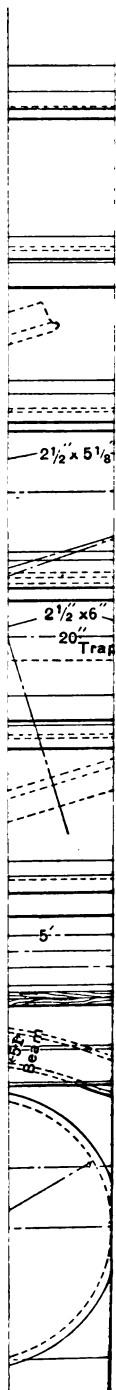

FIG. 106. — INTER-URBAN SLEEPING CAR.



case of long-distance riders who patronize inter-urban cars than for the short riders using street cars. For both requirements the cross-seat is superior to the longitudinal type.

The combination of longitudinal and cross-seats is frequently met with on elevated roads where cars are run in trains; are entered from both ends; and are operated in both directions. Under these conditions cross-seats in the middle third of the car and longitudinal seats near the ends of the car have been found to make a very satisfactory combination. This is because the cross-seats give the comfortable accommodation desired by passengers riding long distances, while longitudinal seats are convenient of access from the door for ingress and egress of passengers, and the wide aisle at each end of the car, between the longitudinal seats, provides the space necessary for the rapid loading and unloading of cars, which is essential to the operation of the high schedule speeds frequently required.

Doors. — The design, arrangement, and fittings of car doors depend entirely upon the service conditions under which the car is to be operated. For an inter-urban car making infrequent stops, which receives and carries only a steady load, and discharges passengers at points well distributed along its line, a single door opening approximately 30 inches is sufficient for all purposes. In cars operating in congested districts, with constantly changing passenger loads, such a door would be wholly inadequate, and it is found necessary to use double doors connected together by chain or other device, causing either door to actuate the other, and giving a clear opening of $3\frac{1}{2}$ to 4 feet. For cars which must be rapidly loaded at one end of the line and unloaded at the

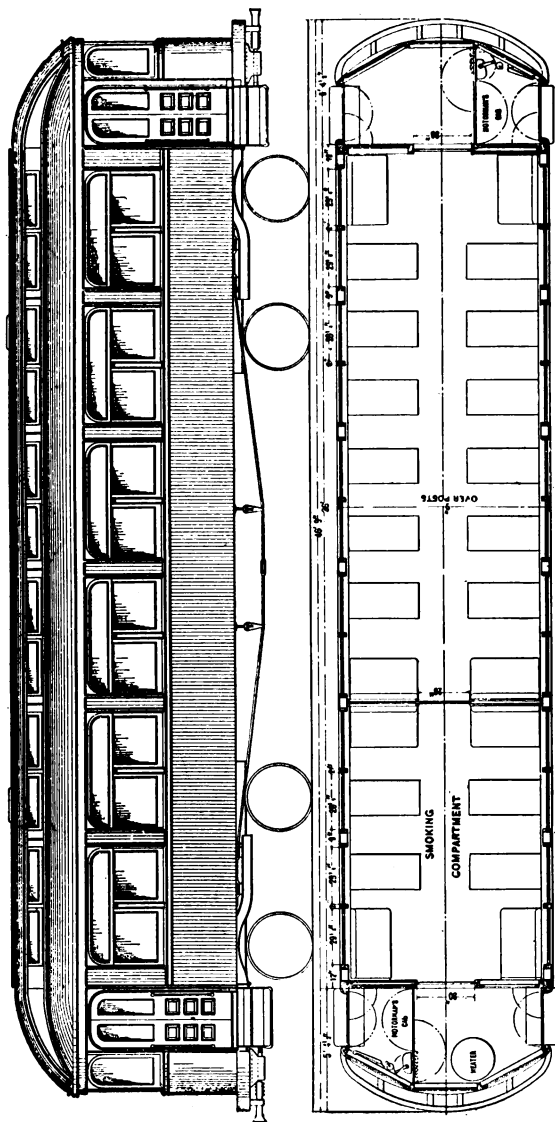

Figs. 107 and 108. — INTER-URBAN CAR.

other, carrying frequently the same passengers throughout, even the door above described has been found inadequate, and many cars operated under such conditions are equipped, in addition to the end doors, with wide side doors located about the middle of the car. An extreme case is where large numbers of passengers have to be handled rapidly between fixed points (that is, where all the passengers make the entire trip), and where it is desirable, on account of limited terminal facilities or for some other controlling reason, to load and unload the cars with the greatest possible rapidity. In such cases cars have been constructed with a number of side doors, opened either by a train guard operating mechanical devices connecting the several doors with a lever on the car platform, or else opened by platform men stationed at the several termini between which such cars are operated.

Weight of Cars.—The question of car weights, which is a most important one, rarely receives the attention to which it seems entitled.

In the case of steam railroads, safe construction (giving high resistance to telescoping or other form of wrecking) tends to keep the weight up, while the existence of severe gradient or light motive power tends to keep it down, the general tendency of first class roads being towards constantly increasing weight of rolling stock.

In the case of electric cars, the question has a different aspect, because the effect of the weight of cars on the first cost and operating cost of the road is immediately apparent and can be quite accurately determined. In all classes of electric cars the dead weight of cars varies from

about 70 per cent to 90 per cent of the told weight plus the weight of seated passengers, and the power required for the operation of a given service varies directly as the weight of the cars moved. It is evident that the cost of the power plant and transmission system would be approximately proportional to the weight of the cars if electric heaters were not used.

The ratio between dead weight and told weight of cars varies between wide limits; and on account of the indefinite character of the load, due to standing passengers, it would be difficult to give even approximate figures; however, a rough general statement of the amount of dead weight of car *per seated passenger* would be as follows:

Closed trolley car, longitudinal seats, 600 to 700 lbs. per seated passenger; open trolley car, full cross-seats, 400 to 500 lbs. per seated passenger; and suburban closed car, cross-seats and center aisle, 1,000 to 1,200 lbs. per seated passenger.

Heaters. — There are several systems of heating electric cars, but as the heaters peculiar to electric service are electric heaters, no others will be here considered. There are many varieties of electric heaters, and many methods of connecting them in order to secure the desirable variation in the amount of energy used for heating to suit the varying conditions of temperature differences between car and outside atmosphere.

Fig. 109 shows a six heater equipment in which one-half of the coils in each heater may be turned on at a time. The two coils in each heater are of different sizes, and so proportioned that when the set having the higher resistance is connected across the line, the energy turned into

heat is about one-half the amount which is obtainable with the other set of coils of lower resistance. The heat developed when both sets of coils are connected between

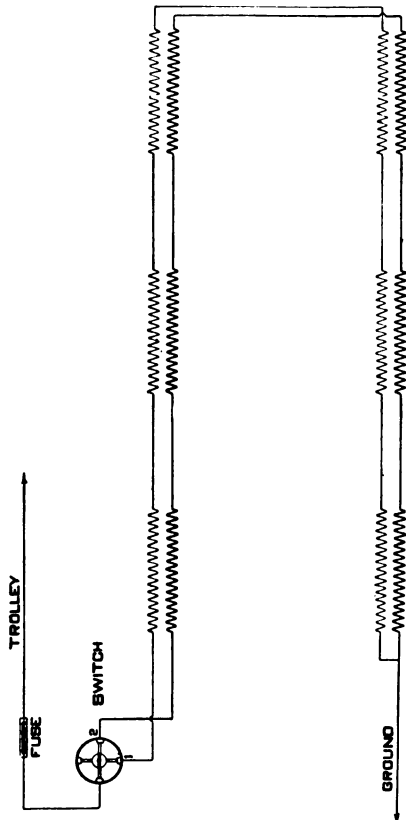

Fig. 109.—CAR HEATER WIRING DIAGRAM FOR 6-HEATER EQUIPMENT.

trolley and ground would be equivalent to the sum of the amounts due to each set of coils alone.

This arrangement distributes the heat quite uniformly

throughout the car, and admits of three variations in the quantity of heat furnished.

The resistance wire used in electric heaters may be wound on metal rods covered with an insulating coating, (see Fig. 110). Another arrangement is shown in Fig. 111, consisting of a resistance wire first wound in the form of a helix; the helix is then wound upon a core of fire-proof insulating material, such as porcelain, the whole being then mounted in a metallic case, and the terminals of the coils led out through suitable insulating bushings. The heater here shown is known as a panel heater, that is,

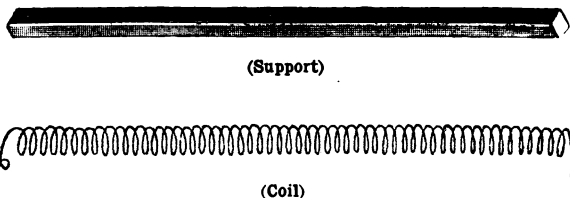

Fig. 110.—HEATER COIL AND ENAMELED IRON SUPPORT.

one which sets flush with the general surface of the riser under the car seat.

Heater wiring is often the cause of car fires, and it is important that great care be used in the installation of this apparatus. Also, panel heaters are often installed in risers so near the edge of seats that the heaters become closed by clothing of passengers resting against the perforated front of heater case. When the circulation of air is thus cut off, the heaters may rise to a dangerously high temperature. The seat risers should be placed well back from the edge of the seats (see Fig. 112) to avoid danger from this source.

The amount of energy required to heat a given car

varies widely with the conditions of service. For a vestibule car (running in inter-urban service) 28 to 30 ft. body, 7 or 8 kilowatts would be a fair expenditure of

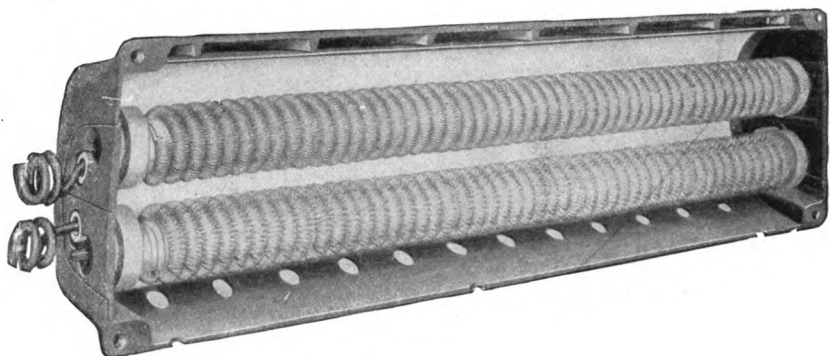

Fig. 111.—ELECTRIC HEATER COILS AND CASE.

energy where the temperature difference between the car and surrounding air should be kept at as high as 40 to 50 deg. Fahr. This, of course, applies only to inter-

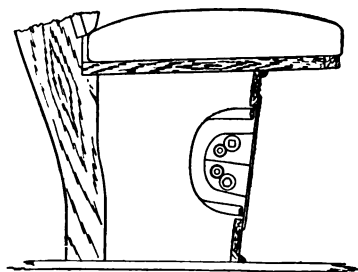

Fig. 112.—SECTION THROUGH RISER.

urban operation, where stops are two or three minutes apart, and where the front door of the car is never open. In a similar car in city service, stopping eight or nine

times per mile, and running at about 10 miles per hour, schedule speed, a smaller expenditure of energy would be necessary to maintain the same temperature difference, because of the lower speed protection, afforded by building and more crowded condition of car. Relatively large amounts of energy are required for the heating of trains such as are operated on elevated roads, where both doors of the car are opened at intervals of a minute, a minute and a half, and not closed until after the train has reached considerable headway on account of the necessity of announcing stations. The heater loads on street car and inter-urban systems compose a very formidable item of the total energy consumption. This load does not fluctuate, but is steady, causing an increase in both average and peaks, in the power station load. Many roads have to supply for heat and light during extremely cold weather over 20 per cent of the power that is required for the purpose of traction.

The question of cost of electrical heating *v.s.* heating directly from combustion of coal or other fuel is one upon which there is room for much discussion. This is principally because of the important influence of local conditions on this question.

On single-ended cars operating on loop lines, the same end always being ahead under conditions in which the car crew can operate the heater plant, there is little doubt as to the economy of heating by some other system than electric heaters. On the other hand, it is practically out of the question to utilize any other means of heating electric cars in heavy city service, especially where vestibules are not used and cars are reversible, operating as frequently in one direction as the other.

To determine the amount of power required to heat the

cars operating in a given service, the following local conditions must be considered :

Average temperature, lowest temperature, line conditions (that is, whether exposed or sheltered by buildings), construction of car, frequency and duration of stops, average passengers per car.

Car heaters, as a rule, are manipulated by the conductors or inspectors who are especially detailed for this purpose. Obviously, it would be desirable to use some form of automatic control for the regulation of the temperature of the car, but no satisfactory device of this sort is known to be in use. A large maker of electric heaters has compiled from extensive data a table showing roughly the energy consumption commonly in actual use for cars of various sizes, in city service.

Length of Car Body.		Kilowatts.	
14 to 20 feet	} (average conditions)	{ 3 1/2	
20 to 28 "			{ 4 1/2
28 to 34 "			
18 to 24 feet	} (severe conditions)	{ 5 1/2	
28 to 34 "			{ 7

In the above, the supply of power is assumed to be taken from the line, but several electric heaters have been developed in which the source of heat is waste power developed in the rheostatic control of motors or electric brakes. Such apparatus is open to objection on the score of not being susceptible of adjustment, and also of complicated wiring and switches. As none of these methods are in very general use, a more detailed description of them is omitted.

Lighting. — The question of lighting electric cars is largely a matter of taste and judgment rather than of engineering design. Usually the cars are lighted by single lamps installed around the car at a convenient height above seats in addition to one or more clusters of lights hung from the middle of the ceiling of the car. As to the amount of power required for proper illumination of cars, roughly a little less than 1 kilowatt per 10 feet length of car body is required. This is an average figure, and frequently varies on account of local conditions, certain classes of service requiring very high illumination, and others very much less.

The connections to the lights in trolley cars and inter-urban cars operated singly are very much the same as in the case of ordinary house lighting, except for the platform light and headlight. As a rule, the light on each platform is wired in series with the headlight on the other end of the car, a change-over switch being conveniently located so that by the single operation of throwing the switch whenever the car changes direction, the proper headlight and platform light are cut into circuit.

Incandescent lamps are almost universally used in car-lighting for both interior illumination and for headlights. The necessities of many high speed inter-urban roads operating along highways or over frequent grade-crossings have caused the development of several efficient types of arc lamps for car headlights. These lamps throw a powerful beam of light ahead of the car, but are very much more difficult to maintain than ordinary incandescent lamps.

Fireproof Cars. — There are many passenger coaches in service at the present time which are semi-fireproof, but it is only recently that a car completely fireproof has been

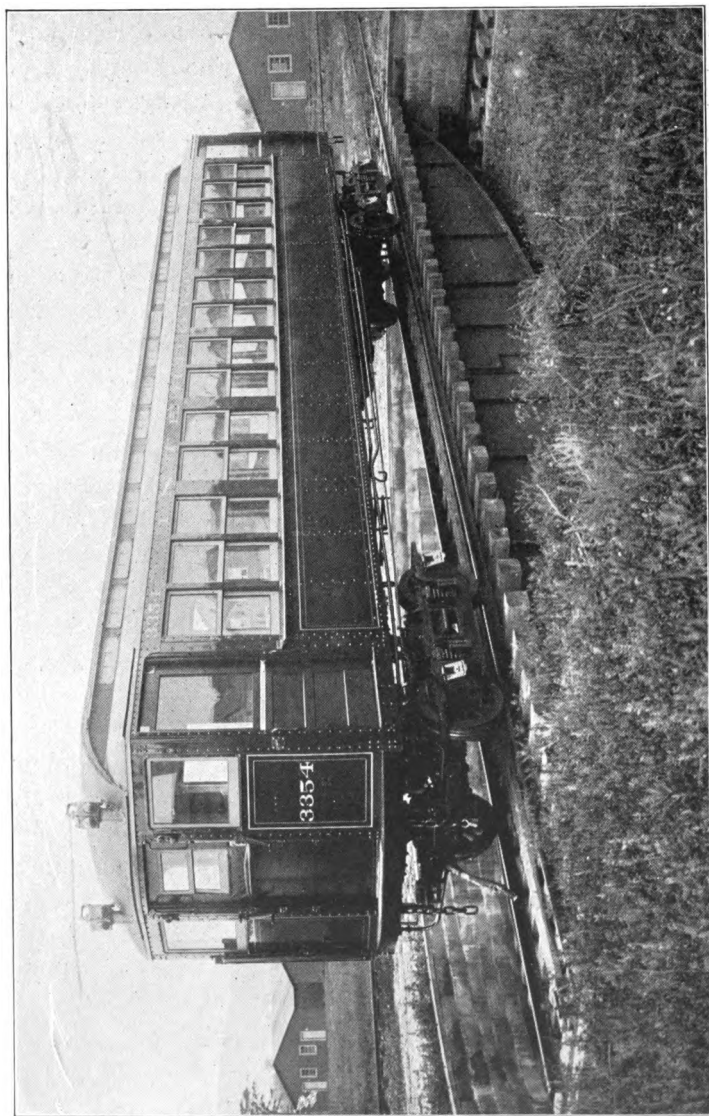

Fig. 113.—GIBBS' FIREPROOF CAR.

successfully constructed. These cars were designed by Mr. George Gibbs for the Interborough Railway Co. of New York. These cars have a steel framing, aluminum trim, and are completely fireproof in every respect. They are completely sheathed with sheet-iron, as is evidenced by Figs. 113, 114. The only combustible materials used in their construction are the wicker seats.

The problem which presented itself in the construction of these cars was to produce a passenger coach, which would have a low tunnel clearance, which would have a weight not exceeding that of a wooden car of similar dimensions, and in addition, which would operate with no vibration or noise, and be comfortable in all kinds of weather.

The steel frame construction adopted may be observed by Fig. 115. Fig. 117 shows the floor framing and the method of reinforcing the side and end sills. Fig. 116 illustrates the roof framing, and Fig. 115 the complete car framing ready for the side sheathing. About 700 lbs. of wood is used in the construction of one of these cars. This wood, however, is completely fireproofed before being employed.

The weight of a car body is 34,000 lbs., the motor truck weighing 12,240 lbs., and the trailer truck 8,400 lbs. It was found necessary to use a lining in the walls which would deaden sound and resist the transmission of heat. The floors are composed of a triple layer, corrugated sheet-iron composing the first layer. This is covered with a fireproof flooring of a composition material termed "Monolith." Ash strips cover this flooring to form a good wearing surface.

The cars are provided with vestibules at each end, which

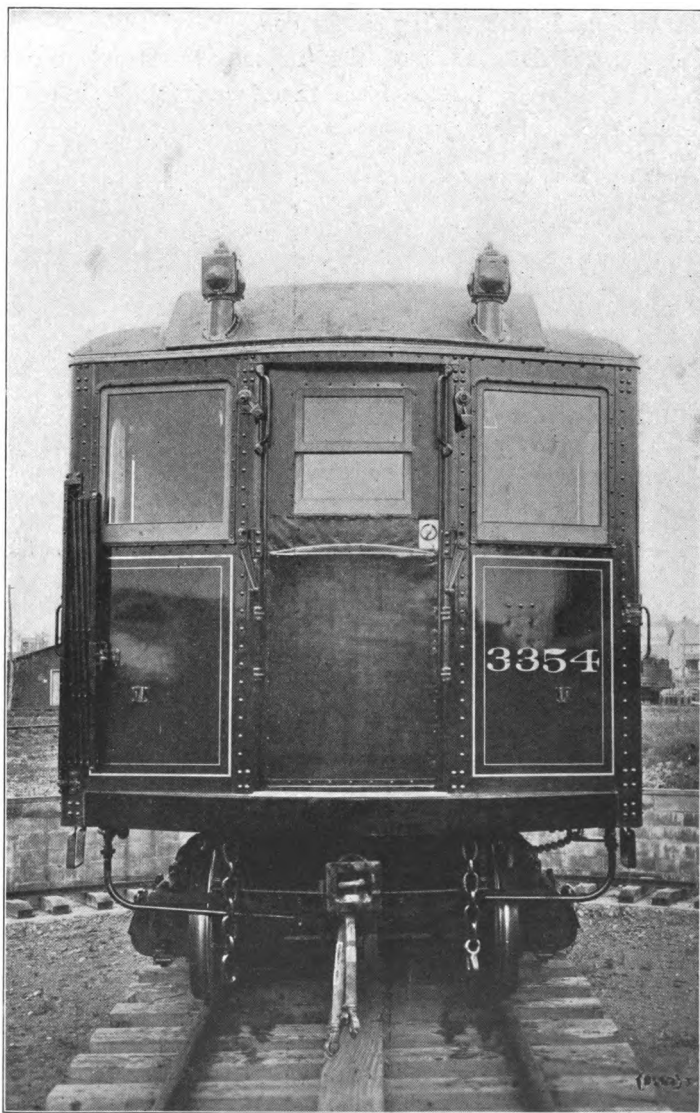

Fig. 114.—END VIEW FIREPROOF CAR.

are equipped with sliding doors covered with sheet-iron. The general dimensions of the car may be found in the following table, extracted from the *American Engineer & Railroad Journal*:

Length over body corner posts 41 ft. $\frac{1}{2}$ in.
Length over buffers	51 ft. 2 ins.
Length over draw bars	51 ft. 5 ins.
Width over side sills	8 ft. $6\frac{3}{4}$ ins.
Width over side plates	8 ft. 7 ins.
Width over sheathing	8 ft. 7 ins.
Width over eaves of upper deck	5 ft. $7\frac{1}{2}$ ins.
Width over eaves of lower deck	8 ft. 8 ins.
Width over window sills	9 ft. $\frac{1}{2}$ in.
Width over batteries	8 ft. $7\frac{1}{2}$ ins.
Width over platform floor	8 ft. 10 ins.
Height under face of sill to top of plate	7 ft. 1 in.
Height under face of center sill to top of roof	8 ft. $9\frac{7}{8}$ ins.
Height of rail to top of truck center plate	2 ft. 6 ins.
Height of rail to under face of side sill	3 ft. $2\frac{1}{8}$ ins.
Height of rail to top of roof (car light)	12 ft. 0 in.
Side sill angles	5 x 3 x $\frac{1}{2}$ in., 12.8 lbs.
Platform end sill angles	6 x $3\frac{1}{2}$ x $\frac{1}{2}$ in., 15.3 lbs.
Side plate angles	$4\frac{1}{2}$ x 3 x $\frac{5}{16}$ in., 7.7 lbs.
Carline angles	$1\frac{3}{4}$ x $1\frac{1}{4}$ x $\frac{3}{16}$ in., 1.8 lbs.
Purlin angles	$1\frac{1}{8}$ x $1\frac{1}{4}$ x $\frac{1}{8}$ in., 1.3 lbs.
Cross-truss, horizontal angles	4 x 3 x $\frac{3}{8}$ in., 8.5 lbs.
Cross-truss, diagonal	$4\frac{1}{2}$ x 3 x $\frac{5}{16}$ in., 7.7 lbs.
Window sill angles	$1\frac{1}{2}$ x $1\frac{1}{2}$ x $\frac{3}{16}$ in., 1.8 lbs.
Wainscot furring angle	2 x $1\frac{3}{8}$ x $\frac{3}{16}$ in., 2.1 lbs.
Upper deck eaves angle	$\frac{1}{2}$ x $1\frac{1}{2}$ x $\frac{3}{16}$ in., 1.8 lbs.
Floor support angles	$1\frac{1}{2}$ x $1\frac{1}{2}$ x $\frac{3}{8}$ in., 3.4 lbs.
Floor support angles	$1\frac{1}{4}$ x $1\frac{1}{4}$ x $\frac{3}{16}$ in., 1.5 lbs.
Belt rails (bulb angles)	$4\frac{1}{2}$ x $2\frac{3}{4}$ in., special
Center sill T beams	6 in., 17.25 lbs.
Body end sill channels	4 x $1\frac{3}{8}$ in., 6.25 lbs.
Body end sill channels	3 x $1\frac{3}{8}$ in., 6.0 lbs.
Body end post channels	6 x 1.92 in., 8.0 lbs.
Single post T	3 x 3 x $\frac{1}{2}$ in., special
Cross-truss T	4 x 4 in., 10.9 lbs.
Platform floor T	2 x 2 x $\frac{3}{8}$ in., 4.4 lbs.

Each car seats fifty-two persons, the cross-seats accommodating sixteen individuals, and the longitudinal seats providing for thirty-six passengers. Each car is lighted with twenty-six 10-c.p. lamps, arranged in two rows of ten on each side, the center of the roof being lighted with six lamps.

Fig. 118 is a view of bottom of car observed from a pit in the tracks. This view shows the corrugated sheet-iron flooring, the motor rheostats, the brake apparatus, and the forward truck. These cars are now operated in the New York subway and have proven satisfactory in many respects. The peculiar interior aluminum finish is not as conducive to comfort as a highly varnished Pullman coach, but they have a moral influence upon passengers which is desirable in case of accident. A complete description of this car, with section drawings, may be found in the *American Engineer & Railroad Journal* of October, 1904.

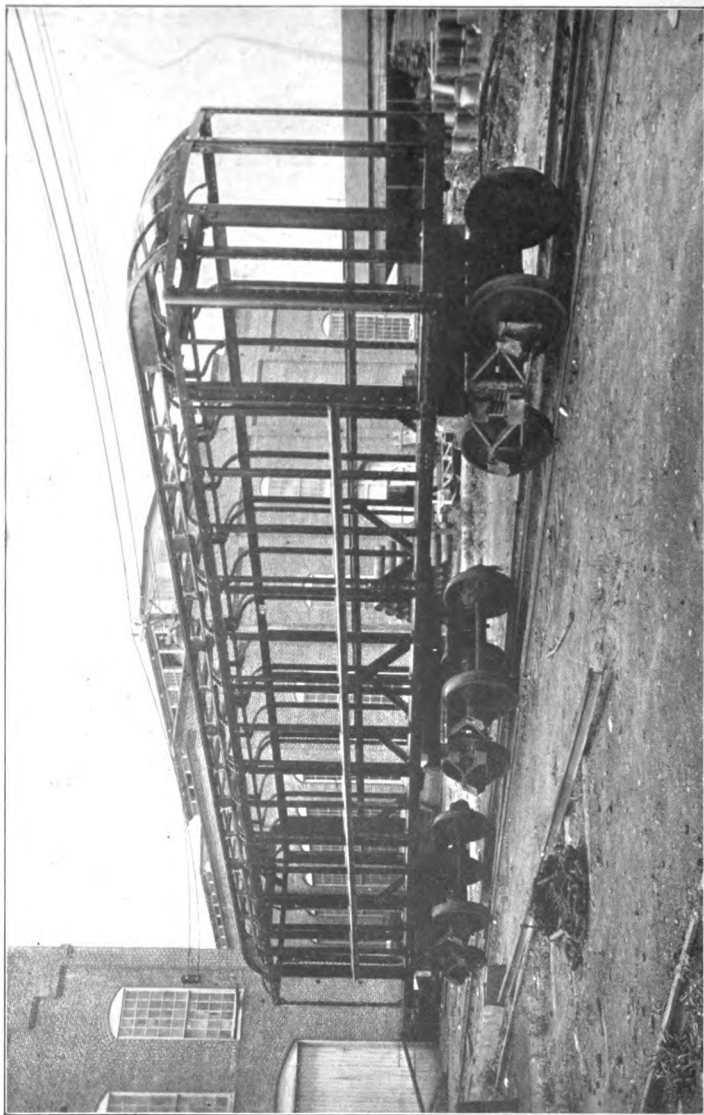

Fig. 115.—STEEL FRAMING, GIBBS' CAR.



Fig. 116. — STEEL ROOF FRAMING.

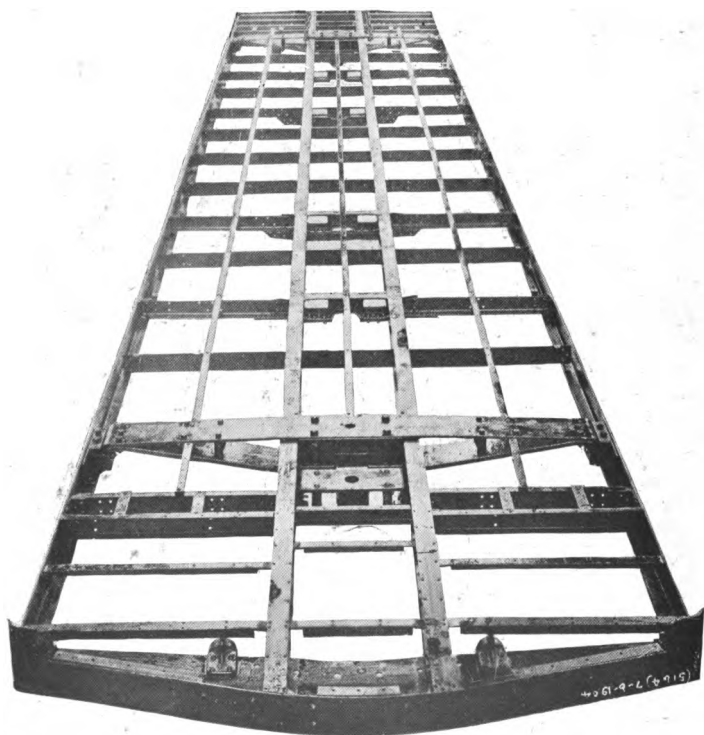

Fig. 117.—STEEL FLOOR FRAMING.

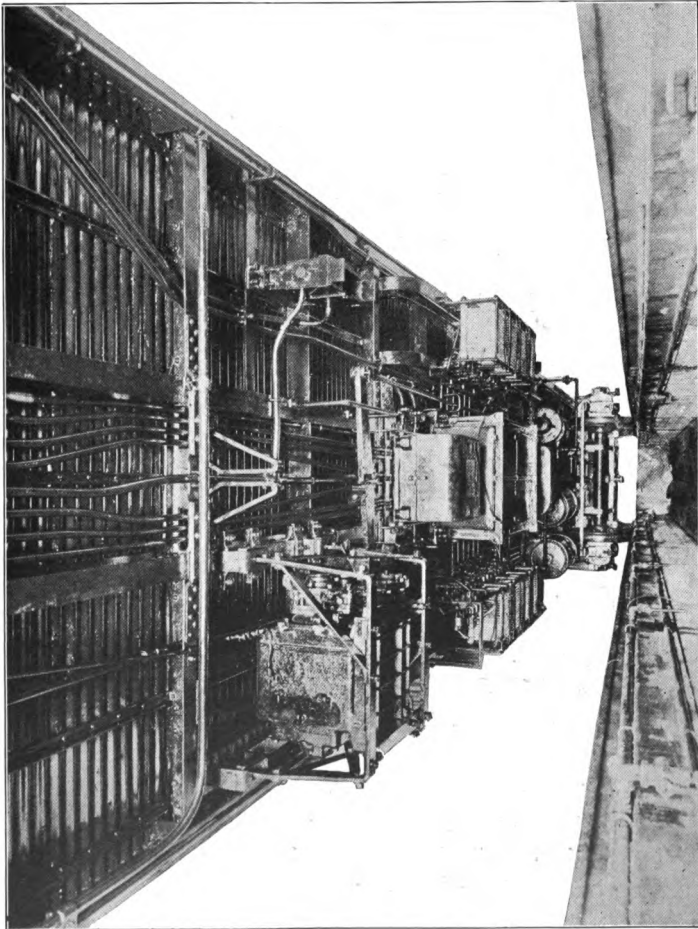

Fig. 118. — UNDER BODY OF CAR, OBSERVED FROM PIT.

CHAPTER VIII.

TRUCKS.

Trucks.—Two general types of truck construction are employed under electric cars.

1st. A truck in which the car body rests upon the truck bolster or side bearings which are spring-supported from side frames which are carried by the axle journal boxes.

2d. A truck in which the car body rests upon the truck

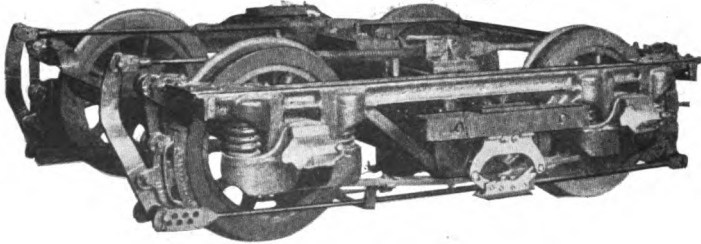

Fig. 119.—HEDLEY TRUCK.

bolster (which may be spring-borne), the bolster being supported from the truck frame, which in turn rests upon springs carried by bars resting on the axle journal boxes. This type of construction closely approximates in electric trucks the construction followed in steam railroad practice, and trucks of this sort are commonly known as of the "Master Car-Builders' Type," on account of the use of equalizing bars and springs.

The first class of trucks may be sub-divided into trucks in which the load is carried midway between the axle centers, and trucks in which the load is placed off center, in

order to secure an unequal distribution of weight upon the wheels for tractive purposes. Trucks of the first class mentioned are illustrated in Fig. 119, which shows a truck used in heavy elevated service, and Figs. 120 and 121, which show a truck used extensively in street car service (commonly called "Maximum traction trucks"), on account of the unequal distribution of weight, making it possible

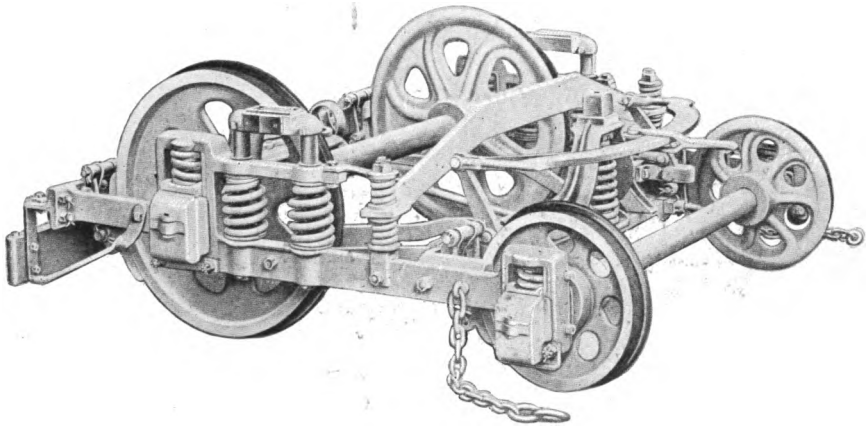

Fig. 120. — BRILL TRUCK.

to secure greater traction where one axle only is equipped with motive power than if the truck were centrally loaded.

A truck of the Master Car-Builders' type is shown in Fig. 122. The truck illustrated in Fig. 120 is shown again in Plate V, also a list of the names by which the various parts of the truck are commonly known.

The maximum traction trucks are very largely used in city service, where the great frequency of stops required necessitates a high rate of acceleration; and to secure this the

weight of the car body is supported between the center of the truck and the axle, which is equipped with a motor giving approximately 75 per cent of total weight on the driving wheel of the truck. Furthermore, the idle wheel (commonly called the pony or guiding wheel) is usually made materially smaller in diameter than the driving wheel in order to make it possible for the guiding or pony wheel to clear the under frame of the car when the truck swivels on curves. This displacement of the center about which

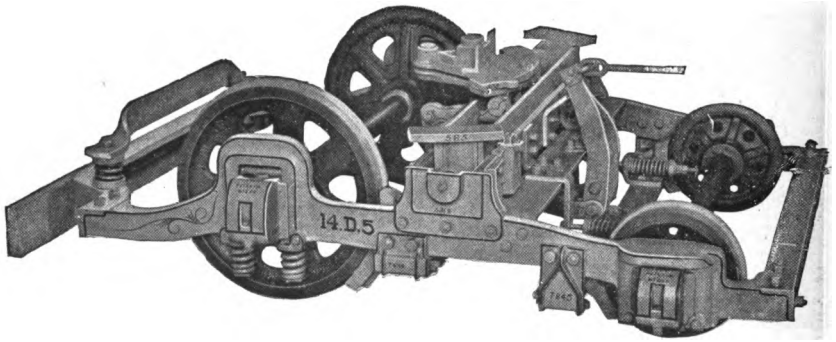
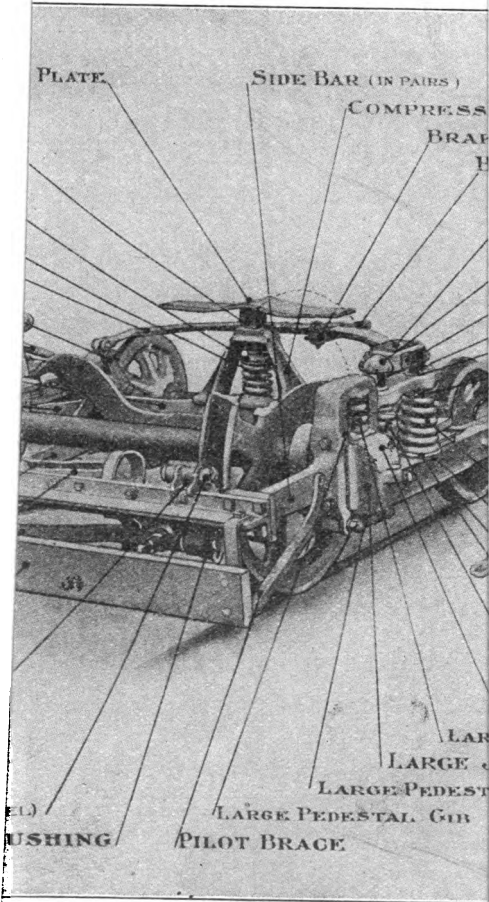
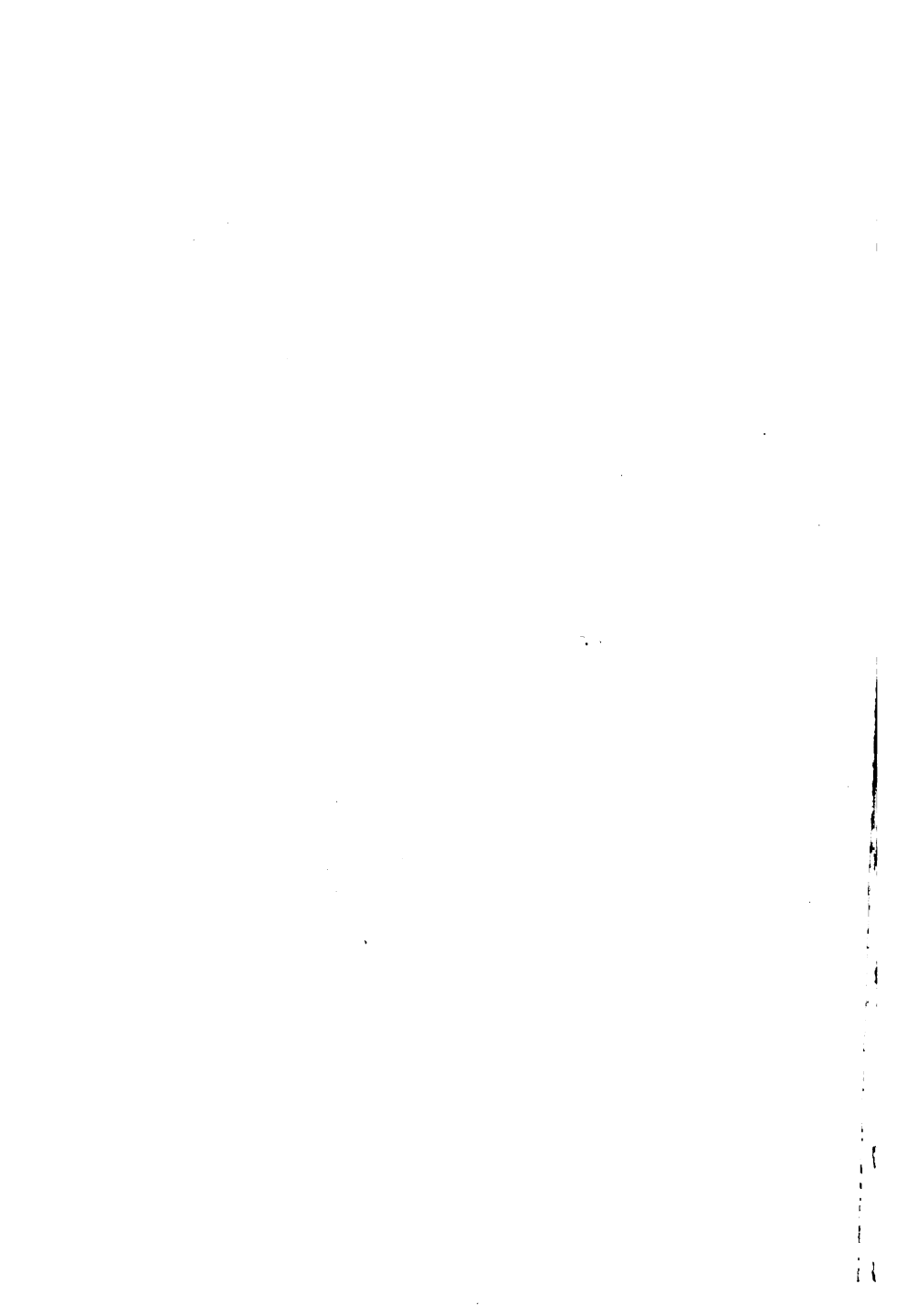

Fig. 121. — MAXIMUM TRACTION TRUCK.

the truck rotates when entering or leaving a curved track results in a much larger lateral displacement of the idle wheel than if the location of the point about which the truck rotates were midway between the axle centers. A difficulty which is incident to this method of truck construction is that on account of the light weight resting on the idle or pony wheels, trucks of this type are much more liable to derailment, both on straight line and curves, than trucks symmetrically loaded, and the danger of derailment is much greater in the truck traveling on curved track than



— MAXIMUM TRACTION TRUCK.



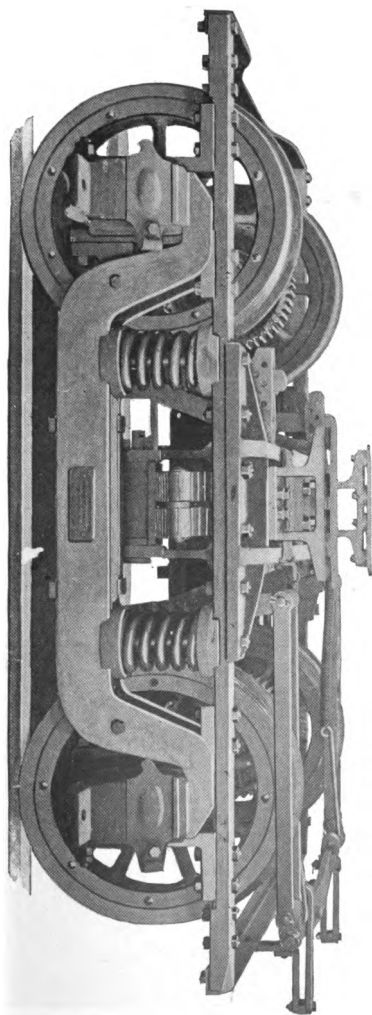

Fig. 122. — M. C. B. TYPE ELECTRIC TRUCK.

on straight line. For this reason a device is employed to increase the proportion of weight carried by the pony axle when the truck swivels on curves. A plate (see Plate V), known as the "compression plate," is fixed in the car body, directly over the "compression block," which is supported from the truck frame at a point near the pony axle. When on tangent the compression block enters the recess in the compression plate, and bears on it only sufficiently to prevent the parts from rattling. When, however, a curve is reached and the truck swivels, the compression plate travels out over the compression block, which rides down from the recess on to the lower surface of the compression plate and takes a considerable amount of the weight of the car, which is transmitted to the pony axle in addition to the 25 per cent already carried by it. A truck of this type, when properly adjusted, operates almost as safely on curved track at moderate speed as would a truck centrally loaded.

Before leaving the subject of maximum traction type of trucks, it should be noticed that with trucks shown in Fig. 119

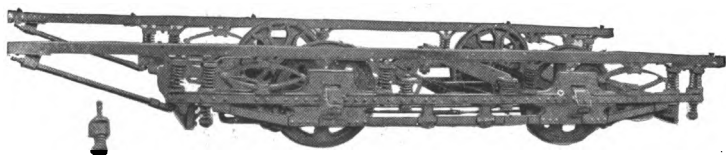

Fig. 123. — RIGID TRUCK.

and Plate V, the weight of the car body is carried on side-bearing plates, the central portion of the truck being left entirely clear for the accommodation of the motor, which is suspended between the axles of the truck (known as the method of inside suspension). When this truck swivels on a curve, its center of rotation is at an imaginary point.

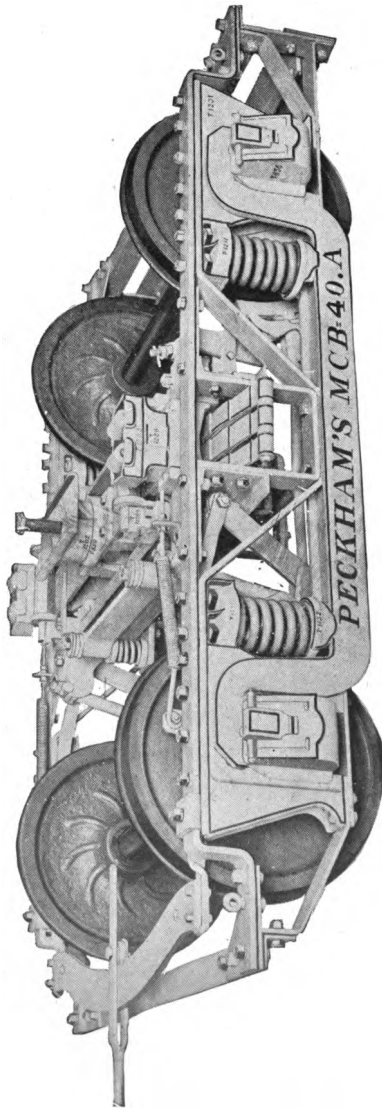

Fig. 124.—M. C. B. TYPE ELECTRIC TRUCK.

In the type of truck illustrated at Fig. 121, the weight of the car body is carried on a bearing plate over the middle part of the truck, and the truck swivels about an actual pin, which is clearly shown in Fig. 121.

On account of the location of these bars between the truck axles, the motors in this truck are suspended from extensions of the frame on the outside of the driving axle. This is known as the method of outside suspension.

The truck illustrated at Fig. 119 does not require special treatment, because it is practically a similar case to the trucks just described, *i.e.*, the load is carried over the center of the truck, the truck rotates about its geometrical center and around the actual pin (the king pin), and in many ways the treatment of this truck is involved with many less difficulties than in the case of the maximum traction type.

The above applies to swiveling trucks, of which two are required per car. Only passing mention will be made of the single, or rigid, truck, which is rapidly disappearing, on account of the increasing length of car bodies. This type of truck is shown at Fig. 123, usually of 8 feet wheel base, and used under short car bodies. When running at speed, the oscillations of the car, due to the short wheel

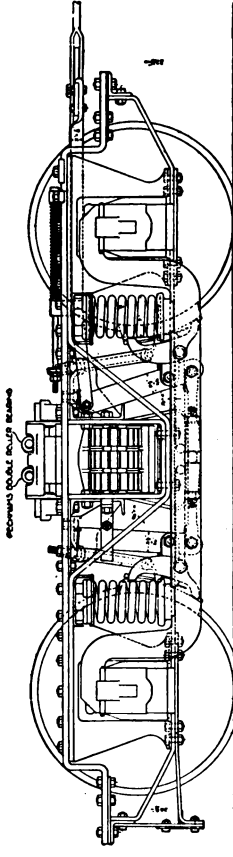

Fig. 125. — MASTER CAR-BUILDERS' TRUCK.

base, are most unpleasant and dangerous ; and also the long, rigid wheel base passes sharp curves with difficulty.

Equalizer Bar Truck, Master Car-Builders' Type. —

This type of truck, which is quite similar in operation to the designs which have been fully tried out in steam railway service, is rapidly gaining favor in electric service. A general view of the Master Car-Builders' type of electric truck is shown at Fig. 124, and outline drawings of this truck are also given. See Figs. 125, 126, 127. In this truck it is obvious that the weight is carried upon center plates on the truck bolster, which transmits the weight to elliptic springs (Fig. 126), which are supported by links from the truck transom, the whole frame being carried upon the equalizer springs, which rest upon the equalizer bars, the latter being supported at each end by the axle journal boxes.

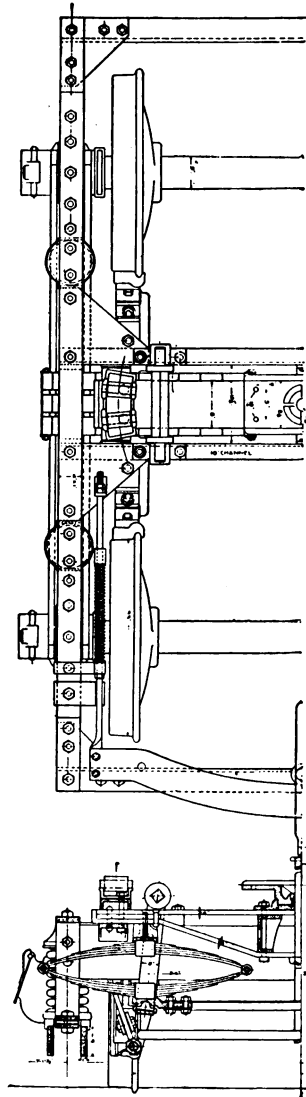

FIG. 127. — HORIZONTAL SECTION.

FIG. 126. — VERTICAL SECTION.

Attached to the truck frame are the castings (known as pedestals), which serve as guides for the journal boxes to hold them in correct alignment. The journal boxes are thus free to move vertically in the pedestal jaws.

The method of motor suspension is not very clearly shown in these figures, but may be seen in the end view of a similar truck given at Fig. 128, which shows a form

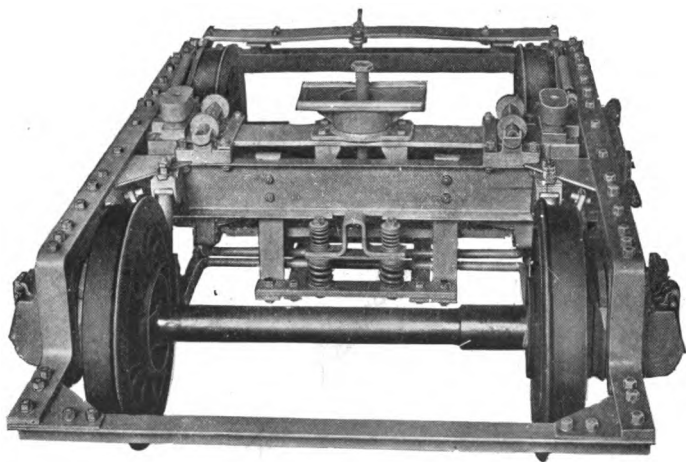

Fig. 128. — MOTOR SUSPENSION.

of motor suspension which has been used with trucks of this type.

A special modification of this type of truck is shown in Plate VI. It will be noted that the equalizing springs are in stirrups, the load being applied from below the spring by means of a hanger depending from the spring cap.

Gears. — The railway motor is usually mounted directly on the axle which it drives, and the motor given one other

practice in early trucks was to use the outside-hung brake shoes, on account of the desirability of reserving as much space as possible near the middle of the truck for the motors. A serious objection to this type of brake rigging is that the brake shoes are being hung from the end of the truck frame, exerting a considerable leverage when brakes are applied, tending to tilt the truck, *i.e.*, to draw down one end and push the other end up, a very objectionable feature, on account of the racking of all parts of the truck and its connection to the car body, due to this

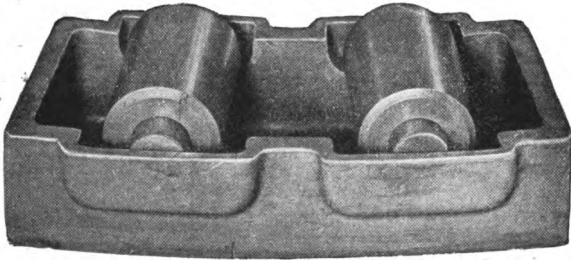

Fig. 131. — ROLLER SIDE BEARING.

tilting action produced by the outside-hung brake shoes. For this reason the designers of electric trucks have devised forms of construction which make possible the use of inside-hung brake shoes in very nearly all cases. By this means the tilting of trucks is almost eliminated, because the inside-hung brake shoes are supported from points near the center of the truck, and usually near the equalizer spring base.

Side Bearings. — The car bodies are carried on plates at the center of the truck bolster, and the car body is in contact with the truck only at this point. In order to prevent more

than a slight departure from the vertical, side bearings are installed over the side frames of trucks. These side bearings are adjusted so that there is sufficient space between the side bearings on the truck and the plate on the gear to take up the maximum compression of springs due to fully loading the car without bringing the side bearings into contact on a straight track. Frequently from a lack of adjustment, or from the displacement of the car body from the vertical when rounding curves due to the superelevation of the outside rail, the side bearings on one side of the

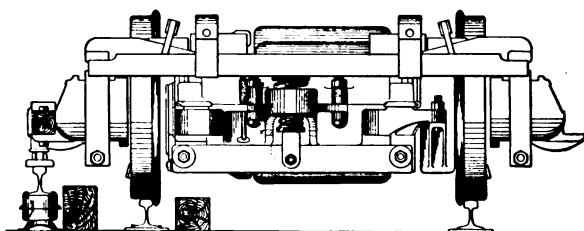

Fig. 132. — CRADLE SUSPENSION (Front Elevation).

truck may come quite solidly into contact with the car body. In order to facilitate the swiveling of trucks when rounding curves, some form of roller side bearing is frequently used in preference to plates which it has been found difficult to properly lubricate.

A form of roller side bearing is shown in Fig. 131. This is the form of side bearing shown on the truck illustrated in Fig. 124.

Motor Suspension. — The forms of motor suspension most commonly used for railway motors are known as nose type suspension and cradle type suspension.

Nose Suspension.— With this form of motor suspension a lug is cast on the motor frame on the side farthest from the axle bearing. In small sizes of motors, a hole in this lug receives a bolt which connects it to a spring suspended link, thus giving a flexible suspension to the motor, excepting that part of the weight coming directly upon the axle bearing. (See Fig. 42.)

In the large types of railway motors no hole is drilled in the suspension lug, but a recess is formed to receive this lug, which is strongly made of forgings or of structural

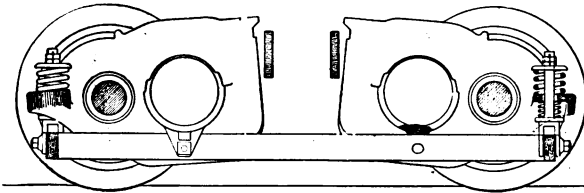

Fig. 133.—CRADLE SUSPENSION (Side Elevation).

shapes rigidly put together and spring suspended from the truck transom. (See Fig. 128.)

The other form of suspension, known as the cradle suspension, is much less commonly used. It consists in general of a bar on either end of the motor, hung from the frame of the truck, which engages lugs on the motor shell.

A special form of cradle suspension, and one which has been used where two motors are installed upon the truck, is shown in Figs. 132, 133, 134. Here the suspension bars are hung through coiled springs from brackets which are cast upon the motor shell and extend on the side of the axle bearing farthest from that on which the motor itself is placed. The cradle thus forms a support for the motors, and is con-

nected to them by pins or bolts through lugs cast on the bottom of the motor shell, preventing upward lifting of the

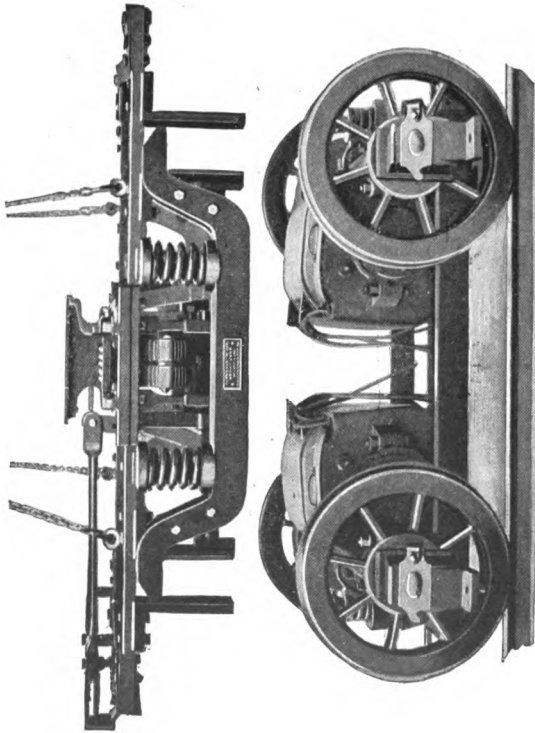

Fig. 134. — GIBBS CRADLE SUSPENSION.

rear motor of the truck during acceleration. In this form of cradle suspension there is no connection between the

motors and the truck frame, hence the truck frame can be lifted clear from the motors and wheels. The claim made for this form of suspension is the facility with which motors, wheels, and axles can be removed from the truck if it is desired to replace them for any reason, also for the facility with which inspection can be made of the motors, gears, etc.

CHAPTER IX.

BRAKES AND BRAKING.

THE subject of braking is of the utmost importance in the case of electric as well as of steam or other power driven vehicles. In electric train or street cars it is also of greater moment than in the case of horse cars, on account of the higher running speeds as well as the greater weights of the cars used in electric service.

The braking of a car is, from a purely mechanical viewpoint, very much the same sort of phenomenon as the acceleration of the same vehicle; the treatment of the subject involves similar mathematical terms and symbols (differing only in sign), and the physical processes employed are very much the same, that is, the motion of the vehicle (except cable or horse-drawn cars) upon the track on which it runs is derived from the force of friction between driving wheels and the rails, and obviously the amount of force available in a given case and the resultant amount of change in motion are limited by the frictional resistance which can be set off between the vehicle and the track on which it runs, and this in turn is governed by the properties of the materials of which the contact surfaces of wheels and tracks are made and of their coefficient of friction.

This horizontal force between car and track is often referred to as the tractive effort, and the amount of this tractive effort available in any given case for increasing motion, or acceleration, is of great importance in develop-

ing the rate of acceleration which will insure the particular mechanical cycle of acceleration, uniform running and de-celeration, which calls for the most economical use of power, that is, the expenditure of the minimum amount of energy to perform the service required.

In practice, however, the problem of securing a force producing negative acceleration or braking is of far greater importance, and there is a greater necessity both to secure a high *braking effort* and to provide a reliable and unfailing means of producing it than is the case with the mechanically similar problem of acceleration.

This is evident because the inability to provide the requisite tractive effort to produce the rate of acceleration giving the most economical use of power would result only in a slightly greater operating cost due to higher cost for motive power, and the sudden failure or entire breakdown of the apparatus producing acceleration would in general be attended by no serious consequences, while on the other hand the sudden failure of the braking apparatus would probably result in collision or other form of accident, entailing damage to property, personal injury, or even loss of life.

Two kinds of duty are required of car brakes : first, the ordinary control of the car in making schedule stops and slow-downs required in service ; and second, brakes are called upon to stop the car within the shortest possible distance for the purpose of avoiding an accident.

For the first class of service the braking effort required usually amounts to less than 200 pounds per ton weight of car, while for the second class of service above described a braking effort amounting to as much as 300 pounds per ton weight of car is frequently employed.

It should be mentioned in passing that some designers

have endeavored to introduce types of brake intended for emergency use only and independent of the brakes used for ordinary service, but brakes of this character have found only a limited field of usefulness under special conditions, and as they have but an unimportant bearing on the general subject, they will not be given further consideration.

Disregarding the class of brakes mentioned in the preceding paragraph the broad statement may be made that the ordinary direct current electric car has at least two and sometimes three sets of appliances for bringing it to rest.

The two sets of appliances always present are :

(1) The motors, which will stop the car without power from the line where the controller is reversed and the handle is moved to the position for parallel or multiple running. This use of the motor equipment is well known to all properly instructed electric railway operatives, and consists simply in throwing the controller handle into the position for full speed ahead after cutting off the supply of power from the line by opening the motorman's switch, or opening the circuit breaker, by hand or under over-load. Under these circumstances one of the motors will begin to generate current and tend to drive the other motor in the opposite direction, thus setting off resistance to the motion of the car through both of the driving axles.

(2) The second kind of brake always installed is the hand brake. This device is too well known to require elaborate description. It consists in a vertical shaft at the dash board of the car, having on its upper end a crank or wheel by means of which it is turned by the motorman, causing the brake chain attached to its lower end to be wound upon the shaft (or brake staff), and exert a pull on the brake levers to which the other end of the brake chain

is fastened. Through the system of brake levers the force of the pull on the chain is multiplied in amount and transferred to the desired direction and points of application to the brake shoes which press upon the car wheels.

(3) The third form of brake which is frequently added to the others is some one of the many forms of so-called power brakes. Power brakes might be sub-divided into many classes, but for simplicity we have considered them under three general headings, as follows: First, those which apply the braking pressure to the same brake shoes and through the same mechanical connection as are used by the hand brakes; second, power brakes which apply a resistance or reverse torque directly to the driving axles, as, for instance, by means of friction disks mounted on the axles; and third, power brakes in which the friction between wheel and rail due to brake shoe pressure on the tires or torque transmitted through the axles is supplemented by frictional resistance between the track and special blocks or "rail shoes" sliding on the rails. These "rail shoes" derive their necessary contact pressure from either a mechanical thrust downward from the running gear of the car or from an electromagnetic pull exerted between the rail shoes and the rails.

FUNDAMENTAL PRINCIPLES.

Friction. — The resistance to motion brought into play between their contact surfaces, when two bodies are moved one upon the other, is termed the friction between those bodies at their contact surfaces.

In mechanical literature these three laws of friction are usually stated as follows:

(1) The friction is directly proportional to the normal pressure between the surfaces.

(2) The friction is independent of the area of the contact surfaces.

(3) The friction is independent of velocity when one of the bodies is in motion with regard to the other.

(4) The friction between two surfaces is greater when they are at rest than when they are in motion.

For a long period of time these laws were believed to be closely in harmony with the phenomena of friction, but modern investigation and experiment have shown that they are of but approximate accuracy even when applied to dry surfaces at moderate pressures and low velocities.

Coefficient of Friction.—The ratio that the friction between two surfaces bears to the normal pressure between them is called the coefficient of friction, and is usually represented by the symbol μ .

That is, if a body weighing 100 pounds on a horizontal surface requires a horizontal pull of 25 pounds to move it, then the coefficient of friction between the surfaces in contact is equivalent to

$$\frac{\text{Friction}}{\text{Pressure}} = \frac{25 \text{ lbs.}}{100 \text{ lbs.}} = 0.25.$$

For these surfaces

$$\mu = 0.25.$$

The following table gives approximately the coefficients of friction of some common materials; the figures are given merely to show roughly the amounts of the forces involved.

MATERIAL.	COEFFICIENT OF FRICTION VARIES BETWEEN
Wood and Wood	0.25 and 0.50
Metal and Wood	0.20 and 0.60
Metal and Metal	0.15 and 0.30
Stone and Stone	0.40 and 0.65

The ordinary laws of friction as outlined above, were quite generally applied, prior to the investigation of the subject of railway braking conducted by Galton and Westinghouse in 1878, the results of which were published in the proceedings of the Institution of Mechanical Engineers for April, 1879.

The results described in this paper clearly demonstrated the fallacy of the laws of friction as applied to railroad braking, and also furnished comprehensive data which has not been superseded, and to which, indeed, comparatively little has been added by the work of other investigators during the period of twenty-five years which has elapsed since the publication of the results of these classic experiments.

Some of the results given by Messrs. Galton and Westinghouse are inserted in Tables A and B, Table A illustrating the variation with speed of the coefficient of friction, and Table B, the variation of the same quantity with time.

The term Coefficient of Static Friction is often used to denote the coefficient of friction between two surfaces which are not moving relatively to each other, and the term Coefficient of Dynamic Friction, for the case of surfaces which are moving with respect to each other.

As has been shown (see Table A), the former is always the greater of these two quantities, and for this reason it is

TABLE A.—COEFFICIENT OF FRICTION AT VARIOUS SPEEDS, WITH CAST IRON BRAKE BLOCKS ON STEEL TIRES.

No. of Experiments from which the <i>Mean</i> is Taken.	VELOCITY.		COEFFICIENT OF FRICTION.		
	Miles per Hour.	Feet per Second.	Extremes Observed.		Mean.
			Maximum.	Minimum.	
12	60	88	.123	.058	.074
67	55	81	.136	.060	.111
55	50	73	.153	.050	.116
77	45	66	.179	.080	.127
70	40	59	.194	.088	.140
80	35	51	.197	.087	.142
94	30	44	.196	.098	.164
70	25	36½	.205	.108	.166
69	20	29	.240	.133	.192
78	15	22	.280	.131	.223
54	10	14½	.281	.161	.242
28	7½	11	.325	.123	.244
20	Under 5 Just Moving.	Under 7 Just Moving.	.340	.156	.273 .330

TABLE B.—COEFFICIENT OF FRICTION AS AFFECTED BY TIME.

SPEED.	COEFFICIENT OF FRICTION.				
	Miles per Hour.	Commencement of Experiment.	After 5 Seconds.	After 10 Seconds.	After 15 Seconds.
20	.182	.152	.133	.116	.099
27	.171	.130	.119	.081	.072
37	.152	.096	.083	.069	
47	.132	.080	.070		
60	.072	.063	.058		

most important to avoid locking or skidding wheels by excessive brake shoe pressure. While a wheel is revolving (and hence its rail contact surface is at rest with respect to the rail) it may be made to develop a frictional resistance to the

motion of the car up to, but not exceeding, the product of its coefficient of static friction into the weight on the wheel. When a wheel becomes locked or skidded, its contact surface is moving with respect to the rail, and the resistance which it can be made to oppose to the motion of the car is equal to the product of the coefficient of dynamic friction into the weight on the wheel. Hence, when wheels are skidded, the available retarding force is less than when they are revolving, and the efficiency of braking is reduced.

Energy.— The amount of energy stored in a moving train which must be dissipated in braking is often very large. As an aid to obtaining an idea of the magnitude of this quantity for high speeds, a method of comparison sometimes employed is to state for a given train speed the vertical distance it would be necessary for a body of the same weight to fall in order to acquire an equal amount of kinetic energy, this comparative height having been named by Mr. Wellington the “velocity head.” Table C gives the velocity heads corresponding to several speeds.

TABLE C.

MILES PER HOUR.	VELOCITY HEAD.
20	13.4
40	53.5
60	120.4
80	214.
100	334.

Brake Apparatus.— Immediately after the application of brake shoes to the wheels of a car the motion of the vehicle is retarded by the frictional resistance set up between the wheels and the rails. As this horizontal originating

at the lowest point of the wheels must be made to act horizontally upon the center of gravity of the moving mass, it is evident that the distribution of weight upon the several wheels of the car cannot be the same during braking as it is when the car is running at uniform speed or standing at rest, because the transfer of the retarding force from the level of the track up to the center of gravity of the moving mass tends to rotate the mass and throw more weight on its front and less on its rear supports. Furthermore, as the force available for braking depends upon the weight on the wheels (in fact, is proportional to the weight) during the process of braking, it is evidently most important to determine how and by what amount the static distribution of weight on the car wheels is affected in order to adjust the braking apparatus to secure the most efficient results.

As the complete car is not a rigidly connected structure, except in the special case of the single truck car, it will be necessary to consider car bodies and trucks separately in this connection, and after investigating the braking conditions peculiar to each component part of the equipment independently we can apply the results thus obtained to the braking of the complete car.

The Car Body.—In Fig. 135 is given a diagram of a car body, which is supported on trucks at the points marked 1 and 2; the direction of motion is indicated by an arrow and the following symbols are used:

W = weight of car body.

h_1 and h_2 = retarding forces of front and rear trucks, respectively, acting at the points of support.

l = distance between points of support.

k = distance of center of gravity of car body
above points of support.

a = the retardation or deceleration of the car.

g = the acceleration of gravity.

Then, the total retarding force on the car body is $h_1 + h_2$, which equals $\frac{W}{g}a$.

In Fig. 135, $\frac{W}{g}a$ which is applied at the center of gravity of the car body, is taken as acting in the direction of motion, since $\frac{W}{g}a$ is the force due to the inertia of the car which is overcome by the retarding forces h_1 and h_2 .

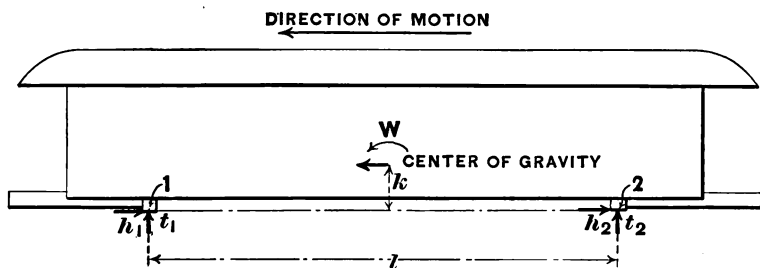

Fig. 135.—DIAGRAM OF FORCES ACTING UPON CAR BODY.

(Witham Trucks.)

If the points of support of the car body on the trucks were in the same horizontal line with the center of gravity, then during retardation the weight of the car body would be equally distributed between the trucks; but as the center of gravity of the car body is always located at some distance above the points of support, it becomes necessary to determine the effect of the action of the retarding forces on the distribution of the weight of the car body between the trucks if we would avail ourselves of the total weight of the car body for producing friction between wheels and track.

The amount by which the distribution of weight between the trucks is affected is most directly obtained by determining the moments of all the forces acting around the points 1 and 2 (Fig. 135) and equating them to zero.

The moments of forces taken around point 2 are,

$t_1 l$, the moment of the supporting force of the front truck.

$-\frac{W}{g} a k$, the moment of the force $\frac{W}{g} a$ acting horizontally at the center of gravity, and

$-W \frac{l}{2}$ the moment of the total weight of the car body acting vertically at the center of gravity.

Since the algebraic sum of the moments of all the forces acting around a point must equal zero, we may write,

$$t_1 l - \frac{W}{g} a k - W \frac{l}{2} = 0.$$

Whence

$$t_1 = \frac{W}{2} + \frac{Wk}{gl} a \quad \dots \dots \dots (1)$$

And similarly, considering the other point, 1, we obtain the equation

$$t_2 = \frac{W}{2} - \frac{Wk}{gl} a \quad \dots \dots \dots (2)$$

From these two equations (1) and (2) we may readily calculate for any given rate of retardation the pressure exerted by a given car body on the front and rear trucks respectively, during braking, if we know the weight of the car body, the height of its center of gravity above the points of support of body on trucks, and the distance between such points of support.

The Car Body and Trucks. — Having considered the result of braking upon the external stresses produced by the car body, we may take up the complete structure of body and trucks.

Referring to Fig. 136, the following quantities are to be considered :

- a = rate of retardation assumed.
- g = the acceleration of gravity.
- W = weight of car body.
- T_1 and T_2 = weights of front and rear trucks.
- l = distance between points of support of body.
- k = distance of center of gravity of car body above points of support.
- b = height of point of support of car body above the truck.
- c_1 and c_2 = height of center of gravity of truck above the track.
- r = wheel base of each truck.
- t_1 and t_2 = vertical pressures between car body and truck at front and rear points of support.
- h_1 and h_2 = reactions on the trucks resulting from the application to the car body of the retarding forces h_1 and h_2 as indicated in Fig. 138.
- w_1, w_2, w_3 and w_4 = vertical pressures between wheels and track taken in numerical order from front to rear.
- F_1, F_2, F_3 and F_4 = horizontal retarding forces (of friction) applied at points of contact between wheels and track, taken in numerical order from front to rear.

The forces exerting turning moments around the point of contact of the rear wheel of the front truck are the following five: w_1 , T_1 , h_1 , t_1 and the resistance offered by the mass of the truck to retardation, which is the force $\frac{T_1}{g}a$ exerted horizontally at the center of gravity of the truck.

The moments of these forces around the point in question are :

$$w_1 r, T_1 \frac{r}{2}, h_1 b, t_1 \frac{r}{2}, \text{ and } \frac{T_1 a c_1}{g},$$

and as the algebraic sum of these moments must equal zero, we may write :

$$w_1 r - \frac{T_1 r}{2} - h_1 b - \frac{t_1 r}{2} - \frac{T_1 a c_1}{g} = 0,$$

or,

$$w_1 = \frac{T_1}{2} + \frac{t_1}{2} + \frac{T_1 a c_1}{g r} + \frac{h_1 b}{r} \dots \dots (3)$$

and similarly for the rear wheel of the front truck :

$$w_2 r - \frac{T_1 r}{2} + h_1 b - \frac{t_1 r}{2} + \frac{T_1 a c_1}{g} = 0,$$

or,

$$w_2 = \frac{T_1}{2} + \frac{t_1}{2} - \frac{T_1 a c_1}{g r} - \frac{h_1 b}{r}.$$

The wheels of the rear truck treated in a similar manner give the equations :

$$w_3 = \frac{T_2}{2} + \frac{t_2}{2} + \frac{T_2 a c_2}{g r} + \frac{h_2 b}{r}$$

$$w_4 = \frac{T_2}{2} + \frac{t_2}{2} - \frac{T_2 a c_2}{g r} - \frac{h_2 b}{r}$$

For convenient reference these four equations are put in the following form :

$$w_1 = \frac{T_1 + t_1}{2} + \frac{T_1 a c_1 + h_1 b g}{g r} \dots \dots (3)$$

$$w_2 = \frac{T_1 + t_1}{2} - \frac{T_1 a c_1 + h_1 b g}{g r} \dots \dots (4)$$

$$w_3 = \frac{T_2 + t_2}{2} + \frac{T_2 a c_2 + h_2 b g}{g r} \dots \dots (5)$$

$$w_4 = \frac{T_2 + t_2}{2} - \frac{T_2 a c_2 + h_2 b g}{g r} \dots \dots (6)$$

These four equations express the pressure upon the track at each wheel contact in terms of known constants except the quantities t_1 , t_2 , h_1 and h_2 . Repeating equations (1) and (2) :

$$t_1 = \frac{W}{2} + \frac{Wka}{gl} \dots \dots \dots (1)$$

$$t_2 = \frac{W}{2} - \frac{Wka}{gl} \dots \dots \dots (2)$$

and considering that the forces h_1 and h_2 are in proportion to the weights t_1 and t_2 and equal to $\frac{W}{g} a$, we obtain

$$\frac{W}{g} a = h_1 + h_2 = (t_1 + t_2) \frac{a}{g} = \frac{t_1}{g} a + \frac{t_2}{g} a,$$

or,
$$h_1 = \frac{t_1}{g} a \text{ and } h_2 = \frac{t_2}{g} a.$$

Substituting these values of t_1 , t_2 , h_1 and h_2 in equations (3), (4), (5) and (6), we obtain

$$w_1 = \frac{T_1}{2} + \frac{W}{4} + \frac{Wka}{2lg} + \frac{T_1 c_1 a}{rg} + \frac{Wba}{2rg} + \frac{Wkba^2}{rlg^2}$$

or,

$$w_1 = \frac{2T_1 + W}{4} + \frac{Wa}{2g} \left(\frac{b}{r} + \frac{k}{l} + \frac{2kba}{rlg} \right) + \frac{T_1 c_1 a}{rg} \quad (7)$$

$$w_2 = \frac{2T_1 + W}{4} - \frac{Wa}{2g} \left(\frac{b}{r} - \frac{k}{l} + \frac{2kba}{rlg} \right) - \frac{T_1 c_1 a}{rg} \quad (8)$$

$$w_3 = \frac{2T_2 + W}{4} + \frac{Wa}{2g} \left(\frac{b}{r} - \frac{k}{l} - \frac{2kba}{rlg} \right) + \frac{T_2 c_2 a}{rg} \quad (9)$$

and

$$w_4 = \frac{2T_2 + W}{4} - \frac{Wa}{2g} \left(\frac{b}{r} + \frac{k}{l} - \frac{2kba}{rlg} \right) - \frac{T_2 c_2 a}{rg} \quad (10)$$

When the highest rate of retardation is required to be produced by braking each wheel in proportion to its contact pressure on the rail, we can calculate by means of these equations the contact pressure of each wheel, and so proportion the brake shoe pressures as to secure the maximum result.

It should be noted that equations (7), (8), (9) and (10) do not assume the trucks to be of equal weight or of similar dimensions, but the trucks are assumed to be symmetrical. In the particular case where trucks are similar as well as symmetrical and equal pressures are applied to both trucks, the equations are simplified. Since in this case

$$h_1 = h_2 = \frac{Wa}{2g},$$

$$T_1 = T_2 = T,$$

and

$$2T + W = \text{Total weight of car} = M.$$

The four equations reduce to the form

$$w_1 = \frac{M}{4} + \frac{W_a}{2g} \left(\frac{b}{r} + \frac{k}{l} \right) + \frac{Tca}{rg} \quad \dots \quad (11)$$

$$w_2 = \frac{M}{4} - \frac{W_a}{2g} \left(\frac{b}{r} - \frac{k}{l} \right) - \frac{Tca}{rg} \quad \dots \quad (12)$$

$$w_3 = \frac{M}{4} + \frac{W_a}{2g} \left(\frac{b}{r} - \frac{k}{l} \right) + \frac{Tca}{rg} \quad \dots \quad (13)$$

$$w_4 = \frac{M}{4} - \frac{W_a}{2g} \left(\frac{b}{r} + \frac{k}{l} \right) - \frac{Tca}{rg} \quad \dots \quad (14)$$

The derivation of formulæ (1) and (2) for the downward pressures on the points of support of the car body may be considered as applying to the special case of a single-truck car, or formulæ for the wheel pressures of a single-truck car in terms of the mechanical constants of the car, the rate of retardation and the gravitation constant may be readily derived from the four equations (7), (8), (9) and (10) by substituting zero for the weights and dimensions of the two trucks and considering the wheel pressures of the two wheels of each truck to be consolidated. Substituting zero for the value of the quantities T_1 , T_2 , c_1 , c_2 , r and b in equations (7), (8), (9) and (10), we get

$$w_1 = \frac{W}{4} + \frac{Wka}{2lg} \quad \dots \quad (15)$$

$$w_2 = \frac{W}{4} + \frac{Wka}{2lg} \quad \dots \quad (16)$$

$$w_3 = \frac{W}{4} - \frac{Wka}{2lg} \quad \dots \quad (17)$$

$$w_4 = \frac{W}{4} - \frac{Wka}{2lg} \quad \dots \quad (18)$$

But as w_1 and w_2 coincide, and w_3 and w_4 coincide, we may add the right hand members of the first and second pair of equations respectively to obtain the contact pressures of front and rear wheels of a single truck car; representing these quantities by W_1 and W_2 ($w_1 + w_2 = W_1$ and $w_3 + w_4 = W_2$), we have

$$W_1 = \frac{W}{2} + \frac{Wka}{lg} \quad \dots \dots \dots (19)$$

$$W_2 = \frac{W}{2} - \frac{Wka}{lg} \quad \dots \dots \dots (20)$$

If μ = coefficient of static friction, then

$$w_1 \mu = F_1, \quad \text{or } w_1 = \frac{F_1}{\mu},$$

$$w_2 \mu = F_2, \quad \text{“ } w_2 = \frac{F_2}{\mu},$$

$$w_3 \mu = F_3, \quad \text{“ } w_3 = \frac{F_3}{\mu},$$

$$w_4 \mu = F_4, \quad \text{“ } w_4 = \frac{F_4}{\mu},$$

and by substituting these values in equations (11) to (14), we get the maximum rail friction available,

$$F_1 = \frac{M\mu}{4} + \frac{W\alpha\mu}{2g} \left(\frac{b}{r} + \frac{k}{l} \right) + \frac{Tc\alpha\mu}{rg} \quad \dots \dots (21)$$

$$F_2 = \frac{M\mu}{4} - \frac{W\alpha\mu}{2g} \left(\frac{b}{r} - \frac{k}{l} \right) - \frac{Tc\alpha\mu}{rg} \quad \dots \dots (22)$$

$$F_3 = \frac{M\mu}{4} + \frac{W\alpha\mu}{2g} \left(\frac{b}{r} - \frac{k}{l} \right) + \frac{Tc\alpha\mu}{rg} \quad \dots \dots (23)$$

$$F_4 = \frac{M\mu}{4} - \frac{W\alpha\mu}{2g} \left(\frac{b}{r} + \frac{k}{l} \right) - \frac{Tc\alpha\mu}{rg} \quad \dots \dots (24)$$

Since $F_1 + F_2 + F_3 + F_4 =$ the total horizontal effort applied to the car to produce the retardation a , we have the relation

$$F_1 + F_2 + F_3 + F_4 = \frac{M}{g} a,$$

where $M =$ total weight of car and trucks. From this relation, the value of a can be substituted in equations (21) to (24), and the resulting equations may be solved for the four quantities, F_1 , F_2 , F_3 , and F_4 , giving the conditions of maximum efficiency.

The equations which have been discussed afford a means of determining the distribution of weight upon the wheels of a car during retardation in terms of the contact pressures between wheels and rail, and as this contact pressure of each wheel, together with the respective coefficient of friction between wheel and rail, and between brake shoe and wheel, determine the permissible brake shoe pressure, it appears that by means of formulæ 11 to 14 the brake shoe pressure on the wheels of a car may be adjusted to give any desired rate of retardation up to the maximum available rate under any given set of conditions.

Equations 11 to 14 and 19 and 20 are of practical use in determining the amount of braking pressure which it is desirable to apply to the brake shoes of each pair of wheels of either a four or an eight-wheeled car in order to secure maximum results. In applying these formulæ to conditions usually met with, in which the available power for braking is derived from a single source, such as an air pressure cylinder, we have to consider the design of the levers by which this pressure is distributed, and in addition take into account the reaction between the force of friction at the

brake shoes and the fixed points upon the truck frames from which the brake shoes are supported.

Considering the case of a "double-truck," or eight-wheeled car, and confining our attention to one of the trucks, it appears from equations 11 and 12 (or 13 and 14), that in order to make available for braking all of the adhesion between the wheels and rails, it is necessary to produce greater pressure on the brake shoes of the front or leading wheels of the truck than upon the shoes of the rear or trailing wheels. If the car were operated in but one direction, that is, if the same pair of wheels of each truck were always leading, then this result would be readily accomplished by a simple arrangement of levers. Under the conditions usually met with, that is, operation in either direction indifferently, the

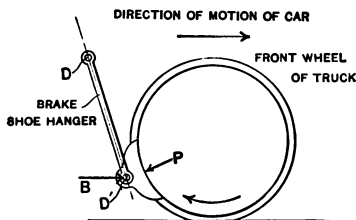

Fig. 137.

desired result cannot be obtained by any such simple means, and it becomes necessary to introduce into the chain of connections between the source of power and the brake shoes, some factor acting upon the resultant brake shoe pressure which varies with the direction of motion of the car.

This is usually accomplished by suspending the brake shoe by a link or hanger which is not parallel with the tangent to the wheel circumference at the point of contact of the shoe. By this means the reaction to the force of friction tangential to the wheel acting upon the point of support of the brake shoe hanger is given a component acting at right angles to the tangent at the point of con-

tact of the shoe, which of course must be added to the brake shoe pressure derived directly from the source of braking power on the car.

A diagram showing a brake shoe suspended by a link or hanger parallel with the tangent at the point of contact of shoe, is given at Fig. 137. Assuming a pressure P of brake shoe against wheel to be applied to the shoes and that the wheels are revolving in the direction indicated by the arrow, the force of friction exerted at the contact surface between shoe and wheel will be transmitted through the link or hanger, and act as an upward pressure at " D ," the point of support. The reaction of this force, being in the direction of the hanger DD' which is parallel to the tangent to the wheel at the point of contact of the shoe, has no effect upon the pressure of the shoe upon the wheel.

If, however, the pin supporting the brake shoe hanger be moved further away from the wheel, as shown in Fig. 138, so that the brake shoe hanger is not parallel with the tangent at the point of application of the braking pressure, but makes an angle ϕ with the tangent, then the total pressure of brake shoe upon the wheel will exceed the applied pressure B by an amount depending on the angle ϕ , and the coefficient of friction between wheel and brake shoe.

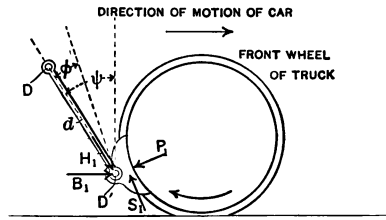

Fig. 138.

Referring to Fig. 138, let

B_1 = Applied braking pressure, horizontal.

S_1 = Force of friction exerted upon shoe by wheel, tangential to wheel circumference at point of contact.

P_1 = Pressure between wheel and shoe, radial to wheel, *i.e.*,
at right angles to S_1 .

H_1 = Reaction of brake shoe hanger, in the direction DD' ,
 d = length of brake shoe hanger.

The moments of all these forces taken around the point D , at which the brake shoe hanger is supported, are as follows :

$$B_1 d \cos \phi$$

$$S_1 d \sin \phi,$$

and $-P_1 d \cos \phi$ opposing the other two. The sum of the moment of all the forces acting about a point being equal to zero, we may write

$$B_1 d \cos \phi + S_1 d \sin \phi - P_1 d \cos \phi = 0,$$

or,

$$B_1 \cos \phi + S_1 \sin \phi - P_1 \cos \phi = 0 \dots (25)$$

Using the symbols B_2 , S_2 , P_2 , and H_2 for the rear wheels, and noting that for the rear wheels the conditions are similar to those met with in the case of the front wheels, we may write,

$$B_2 \cos \phi - S_2 \sin \phi - P_2 \cos \phi = 0 \dots (26)$$

Let μ' = the coefficient of friction of wheel and brake shoe, then

$$S_1 = \mu' P_1 \text{ and } S_2 = \mu' P_2,$$

or,

$$P_1 = \frac{S_1}{\mu'} \quad \text{“} \quad P_2 = \frac{S_2}{\mu'}.$$

Substituting these values in equations (25) and (26), we get

$$B_1 \cos \phi + S_1 \sin \phi - \frac{S_1}{\mu'} \cos \phi = 0 \dots (27)$$

$$B_2 \cos \phi - S_2 \sin \phi - \frac{S_2}{\mu'} \cos \phi = 0 \dots (28)$$

and assuming $B_1 = B_2 = B$ (the condition commonly met with in practice), the equations may be solved for ϕ and B as follows :

$$\tan \phi = \frac{1}{\mu'} \frac{S_1 - S_2}{S_1 + S_2} \dots \dots \dots (29)$$

and

$$B = \frac{(S_1 + S_2) \cos \phi - \mu_1 (S_1 - S_2) \sin \phi}{2 \mu' \cos \phi} \dots \dots (30)$$

The braking effort, F_1 , available at the point of contact of this wheel with the rail depends, as has been indicated, upon the weight on the wheel w_1 and the coefficient of static rail friction, μ

$$w_1 \mu = F_1,$$

and this force produces a retardation a where

$$F_1 = \frac{w_1}{g} a.$$

The quantity F_1 would immediately determine the desired brake shoe pressure if the brake were called upon to produce retardation of the motion of translation only of the car body and trucks. In addition to this, however, the brakes are required to retard the rotary motion of the wheels and armatures. In order to determine the total amount of friction which must be developed at the periphery of the wheel, it is necessary to add to the quantities F_1 , F_2 , F_3 , and F_4 , respectively, the forces necessary to secure a peripheral retardation of the wheels equal to a (the retardation of the car), and also the force due to peripheral retardation of the armatures equal to the product of " a " and the gear reduction ratio between the car axle and the armature shaft.

Let

R = Wheel radius.

- R_1 = Radius of gyration of wheels and axle.
 n = Weight of each pair of wheels and axle.
 R_2 = Radius of gyration of the armature.
 m = Weight of armature.
 G = Gear ratio.
 a = Rate of retardation of car.

Then the force of friction necessary to secure a retardation of the wheel rotation equivalent to " a " at the periphery would be

$$\frac{n}{g} \left(\frac{R_1}{R} \right)^2 a$$

for the wheels, and

$$\frac{m}{g} \left(\frac{R_2 G}{R} \right)^2 a$$

for the armatures.

The sum of these two quantities and the force F_1 required for the retardation of the motion of translation of the car give the total friction which must be developed at the point of contact of the brake shoe with the wheel; that is, for the front wheel, if P_1 = resultant pressure of brake shoe and μ' = coefficient of friction, then

$$S_1 = P_1 \mu' = F_1 + \frac{n}{g} \left(\frac{R_1}{R} \right)^2 a + \frac{m}{g} \left(\frac{R_2 G}{R} \right)^2 a,$$

or,

$$P_1 = \frac{F_1}{\mu'} + \frac{n}{g} \frac{a}{\mu'} \left(\frac{R_1}{R} \right)^2 + \frac{m}{g} \frac{a}{\mu'} \left(\frac{R_2 G}{R} \right)^2. \quad (31)$$

and similarly for P_2 , P_3 , and P_4 .

In any given case the conditions of efficiency can readily be computed from equations (21) to (24), and the resultant brake shoe pressure required may then be computed as indicated in equation (31) above.

Brake Testing.

The methods and apparatus used in testing train brakes in steam service are well known and have been frequently described, such tests being usually conducted on an elaborate scale. The efficiency of brakes commonly used in electric service (on single cars or short trains) may be determined with considerable accuracy with simple apparatus and a small number of observers.

The only phase of the extensive subject of brake testing considered here will be the question of the ability of the brake to stop a car or train with a high average rate of retardation. It must be noted, however, that in comparing different types of brake apparatus, there are other characteristics to be considered which are of almost as great importance, including reliability, durability, facility of inspection and repair, first cost and operating cost.

A simple method used for determining the braking characteristics of street car brakes was described by one of the authors in a paper presented at the Dec. 19th, 1902, meeting of the American Institute of Electrical Engineers; a summary of this paper, together with the results of tests with various types of brake apparatus are given below.

The apparatus used has already been described at page 47, the only records taken being of speed and time.

In all tests, cars of the same type were used, mounted on similar trucks, and all cars were put in as nearly the same condition as possible and loaded to the same gross weight by an amount equivalent to a heavy passenger load. The cars were run in the same direction over the same section of track on a uniform grade; wind and humidity conditions being as nearly uniform as possible, and

great care was taken to determine with accuracy in each case the speed of car at brake signal and the actual distance traversed between brake signal and the stopping of the car. An axle of the car was fitted with a drum carrying a contact plate which momentarily closed a battery circuit once in each revolution: this circuit energized an electro-magnet operating one of two recording pencils, under which a strip of paper was drawn at uniform speed by a very accurately governed spring motor. The operating magnet of the other pencil of the two was energized by a circuit which was closed every half second by a contact maker actuated by a standard clock mechanism. It will be readily seen that with this apparatus a sheet could be obtained containing a clear record of wheel revolutions and time; from this the number of revolutions during any interval, or the duration of any particular wheel revolution, could be determined with great accuracy; the method of using this apparatus to obtain the data desired was as follows:

DIAGRAM SHOWING METHOD OF DETERMINING DISTANCE
FROM BRAKE SIGNAL TO STOP.

When the Arrow Mark (Fig. 139) on Wheel was in contact with rail, the revolution counter circuit was closed by contact on axle. Each run started with this mark in contact; at the stop the point of contact between wheel and rail was marked on rail, and the car was rolled on until the arrow mark on the wheel again came in contact with rail, giving the final fractional part of a revolution to be used in getting the total length of run by wheel revolutions, which was subtracted from the length of run by tape measurement to get the distance skidded.

A—Position of wheel at start.

B—Position of wheel at stop.

C—Position to which wheel was rolled to get last fractional part of a revolution.

S—Point at which brake signal was given, determined by record of revolution counter.

A B—Tape measurement; total distance run.

A S—Computed from Revolution Record.

A B—A S = Distance to stop = S B.

The car was placed near the starting point and moved

backward or forward until the contact on the axle drum was closed, then the point of contact between the wheel and rail was chalk-marked both on wheel and rail. Then the record paper was put in motion, the car started, and brought up to speed very gradually to avoid the possibility of slipping of the wheels. When the desired speed was attained, an electric bell was rung as a signal for an emergency stop. The circuit of this bell traversed the operating magnet of the chronograph pencil, and by drawing this pencil farther than it was ordinarily drawn by the clock circuit, produced a clearly defined record of the

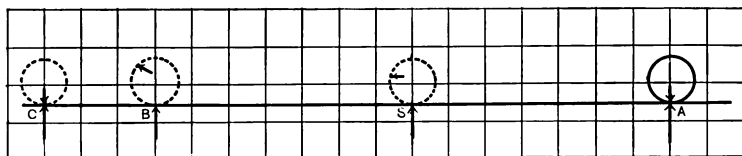

Fig. 139. — METHOD OF TAPE MEASUREMENT OF DISTANCE.

exact time at which the signal bell was rung. When the car was brought to a full stop, the bell was rung again in order to make a record of the time elapsed between brake signal and stop. The position of the point of contact of the front wheel was then carefully marked on the track, and the car moved slowly along until the first chalk mark made on the wheel was brought again in contact with the rail, and the rail was marked at this point. A tape measurement was then made between the first and second marks, giving accurately the total length of run; and between the second and third marks, to determine the distance traversed in the final fractional part of a wheel revolution. The distance from start to brake signal determined by the wheel revolution record on the chrono-

graph chart was calculated; this distance deducted from the total length of run (a tape measurement), gave an accurate measure of the distance from brake signal to stop. Futhermore, where there was a difference between the total distance run by tape measurement and the total distance indicated by the wheel revolution chart [such differ-

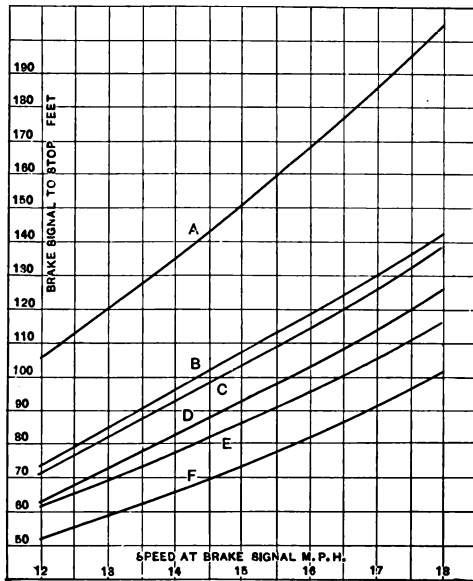

Fig. 140.—BRAKE TESTS.

ence only occurred in case of skidding], then the difference was the measure of the distance skidded.

It should be noted that by the use of the methods outlined, the measurement of the two quantities whose accurate determination is essential to a brake test—namely, the speed at brake signal and the distance to stop—are obtained with a high degree of accuracy and with appa-

tus which can be readily attached to any car. This apparatus is complete in itself, no stops, signals, or other special appliances being required on the track or roadbed.

The time elapsing between brake signal and stop, may for the present purpose of tests of emergency stops be divided into three parts :

1. Duration of time between brake signal and beginning of movement of brake handle or lever by motorman ; that is, the personal equation of motorman.

2. Duration of time between beginning of movement of brake handle or lever and setting of the brake shoes.

3. Duration of time between the setting of the brake shoes and stopping of the car.

The first interval of time above depends on the motorman, the second on the brake mechanism, and the third on the amount of the frictional resistance which can be developed between the car and the rails, for a stop from a given speed. The first and second intervals of time are practically constant for a given motorman and brake apparatus and independent of speed ; the third interval will vary with the speed at brake signal.

From a number of test stops made as above described the curves given in Fig. 140, were plotted. In this curve sheet each curve represents the relation between speed at brake signal and distance to stop of one of the types of brake tested. Speed-time and distance curves for individual tests were also plotted, and typical test sheets are given in Fig. 141. From these curves, which are lettered for identification with the characteristic curves given at Fig. 140, the rates of retardation and the interval of time required after brake signal to commence retardation may readily be approximated.

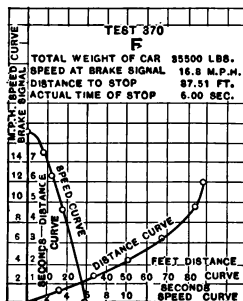
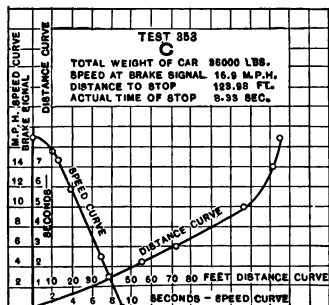
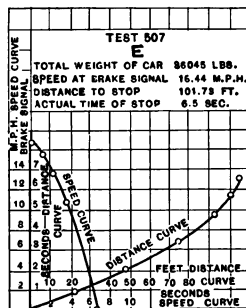
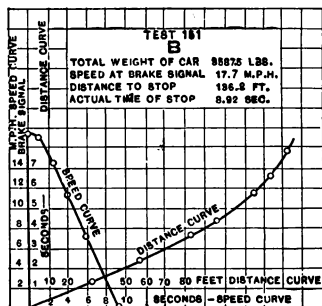
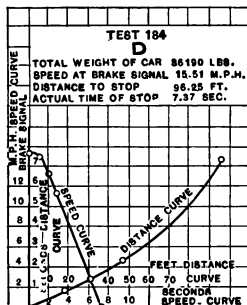
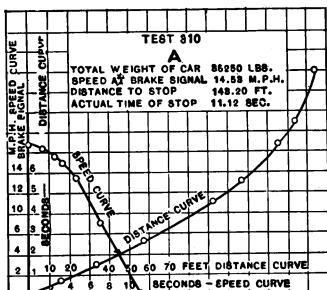

Fig. 141. — BRAKE TESTS.

By means of several coasting runs, the retardation due to friction and air resistance was found for the tests in question, to be approximately 0.16 miles per hour per second, within the range of speeds at which tests were made; and for convenience in comparing the results obtained with the several brakes throughout the range of speeds employed, the curves of Fig. 141 were plotted from equations determined as follows: for a given brake and motorman the distance run by a car from time of brake signal to time of full application of brake shoe would be,

$$\left(S - \frac{0.16 T}{2}\right) 1.467 T = d \text{ (distance in feet),}$$

where S = speed at break signal in miles per hour.

T = time from brake signal to application of brake shoes.

0.16 miles per hour per second = rate of retardation of car before applying brakes.

1.467 = ratio between ft. per second and miles per hour.

At the end of time T the car would have run a distance d and would have a speed of $(S - 0.16 T)$ miles per hour, and from this point to the point of stop, the distance d' would be:

$$\frac{(S - 0.16 T) 1.467}{2} \times \frac{S - 0.16 T}{R} = d',$$

or

$$(S - 0.16 T) \frac{1.467}{2 R} = d',$$

where R = retardation in miles per hour per second from setting of brake shoes to stop.

The total distance being the sum of $d + d'$, we may write

$$\left(S - \frac{0.16 T}{2}\right) 1.467 T + (S - 0.16 T)^2 \frac{1.467}{2 R} = D,$$

where D = total distance from brake signal to stop. Collecting the coefficients of S and S^2 , we get the following equation, showing the relation between D and S :

$$D = L S^2 + M S + N,$$

$$\text{where } L = \frac{0.733}{R},$$

$$M = \left(1.467 - \frac{0.235}{R}\right) T,$$

$$N = \left(\frac{0.0188}{R} - 0.117\right) T^2,$$

L , M and N being practically constant for each equipment.

From test stops, with each brake, curves were plotted showing speed on a time-base from the brake signal to time of stop. From these curves may be obtained values for T and R , and from these the values of the coefficients of S^2 and S in the above equation may be computed. From this equation with D and S as variables, we may compute the values of D (distance) corresponding to several values of S (speed), and plot a curve showing for different speeds the distances run from brake signal to stop for each of the equipments tested.

To get the time elapsed from brake signal to stop from different speeds at brake signal, we have the following relations:

T = 1st and 2d parts of time above referred to.

$$\frac{S - 0.16T}{R} = 3\text{d part.}$$

Hence, the total time from brake signal to stop from a given speed at brake signal will be :

$$t = T + \frac{S - 0.16 T}{R},$$

where t = time in seconds from brake signal to stop.

T = time from brake signal to setting of shoe.

S = speed at brake signal.

R = rate of braking in miles per hour per second

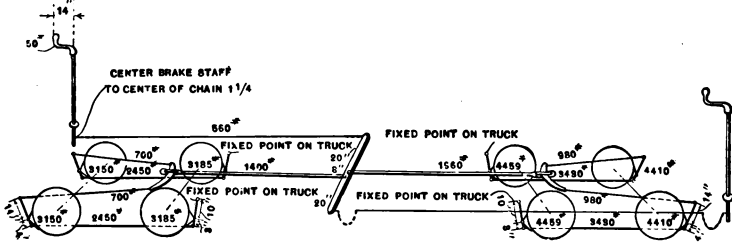

Fig. 142. — HAND BRAKE SYSTEM.

from setting of shoes to stop. The coefficients of this equation for any equipment may be obtained as noted above from the speed curves, and these coefficients once determined, the values of t for several values of S may be computed ; and from these values a curve may be plotted, showing for different speeds at brake signal the time from brake signal to stop for each of the equipments tested.

TYPES OF BRAKE APPARATUS IN COMMON USE WITH ELECTRIC CARS.

Hand Brake. — The hand brake usually consists of a vertical brake staff which is rotated by the motorman by means

the leverages employed at the several points in the system illustrated.

Assuming (Fig. 142) the motorman to exert a pressure of 50 lbs. effective in a direction at right angles to the horizontal arm of the brake handle, the pressures on the several brake shoes may be readily calculated: the brake shoe pressures and the tension in each of the several connec-

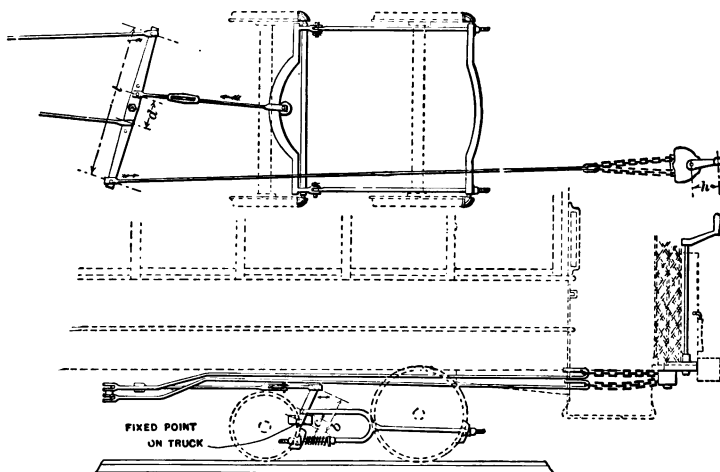

Fig. 144.—GEARED BRAKE.

tions of the brake system under the assumed conditions are indicated in the diagram.

The characteristic feature of the arrangement illustrated is the use of a single brake lever (often called the floating lever, or sway bar), and this is the usual construction with hand brakes on electric cars.

An objection which at once suggests itself is that with this arrangement the greater pressure is necessarily applied to the truck or wheels at the rear end of the car, while to secure the most effective braking, as has been

shown, the greater pressure should be applied to the front truck or wheels.

This result may be secured by the use of two floating levers: such an arrangement is illustrated at Fig. 143, which is reproduced from working drawings, for a system of levers capable of adjustment to any desired excess of braking pressure on the front truck over the rear truck of a difference of 19 per cent.

A modification of the hand brake is the geared brake, of which Fig. 144 illustrates a form in common use. In this brake a pinion on the lower end of the brake staff engages a gear which is made in one piece with a double sprocket wheel. Each of these sprocket wheels engages a loop of chain attached to the brake rod. Either two hooks are formed on the end of the brake rod for the two chains, or as in the case illustrated in Fig. 144, two separate brake rods are used, attached at the same point on the floating lever. Only the upper one of the two chains and rods is used in braking, the other being left slack as a reserve in case of failure of the working set.

It should be noted that in Fig. 144, which shows the brake apparatus applied to a car mounted on maximum traction trucks, that the difference in pressure between the shoes or the driving wheels and those on the pony wheels is secured by the interposition of a spring between the brake system and the pony wheel shoes. This arrangement is simple, requiring a small number of parts and occupies but little space on the truck, but it is open to the objection of not being susceptible of the close adjustment of the relative brake shoe pressures which is possible where a lever system is employed for this purpose.

Track Brakes. — A form of hand brake which has been

used to a very limited extent has, in addition to the customary wheel shoes an additional set of shoes which are forced into contact with the rail during braking. The principle of this brake is illustrated in Fig. 145, in which the parts peculiar to this type of brake are shown. The operation of the wheel and track shoes in connection with the

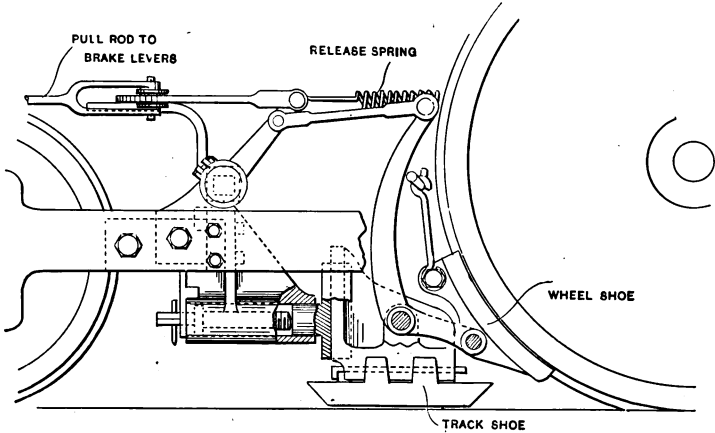

Fig. 145.—TRACK BRAKE.

brake levers previously described will be readily understood.

Power Brakes.— Power brakes may be divided into two general groups, 1st, brakes in which the power required for braking is derived from the kinetic energy of the car; and 2d, brakes in which the power necessary for braking is derived from some source other than the energy stored in the car during acceleration.

Momentum or Friction Brake.— Fig. 146 shows the general arrangement of a momentum or friction brake in which the power for braking is derived directly from the energy expended on the car during acceleration. A sleeve

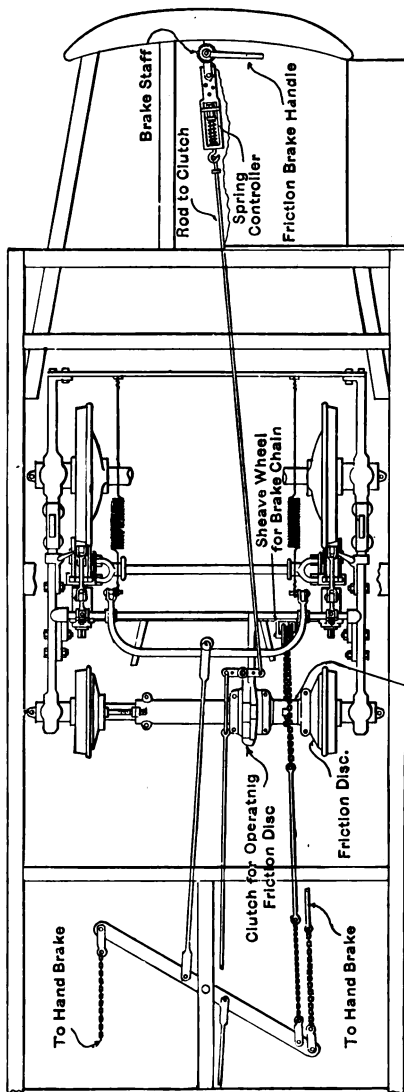

Fig. 146. — FRICTION OR MOMENTUM BRAKE.

mounted loosely on axle near one of the wheels carries on its end a friction disc which may be made to engage a wearing surface cast upon the rear face of the wheel by the operation of a clutch mounted on the axle. To the sleeve the brake chain is attached. In applying brakes the motorman moves the brake handle through $\frac{1}{8}$ to $\frac{1}{4}$ turn, thereby operating the clutch by means of the connecting rod which is attached to the lower end of the brake staff by a bell crank. The operation of the clutch throws the friction disc into contact with the wheel, and the motion of

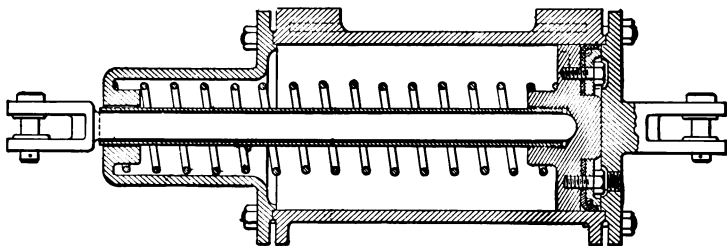

Fig. 147. — BRAKE CYLINDER.

the wheel being imparted to the friction disc, the brake chain is wound upon the sleeve to which it is attached and the brake levers operated by the chain. The amount of braking pressure developed depends of course upon the pressure between the friction disc and wheel, and this is regulated by the amount of pull exerted by the motorman on the brake handle.

The rapid action of this brake, as well as the possibility of readily increasing the braking pressure with the load or speed, makes it a highly effective brake.

In brakes of the type above described the friction mechanism actuates the wheel shoes; a variation of this arrangement which has been used to a very limited extent

consists in the addition to the system of rail shoes such as were described above in connection with the track brake.

Air Brakes. — The air brake is in universal use in steam railroad practice and is more extensively used than any other form of power brake for electric cars.

In an air brake equipment the power is applied to the brake levers by means of the "brake cylinder," a section of which is shown at Fig. 147.

In applying brakes, air is admitted through the post in the cylinder head and the piston forced out, actuating the

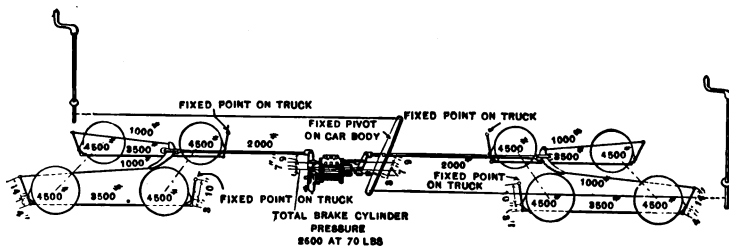

Fig. 148. —BRAKE CYLINDER AND LEVERS.

brake levers. When brakes are released, the coil spring returns the piston head to its original position in the cylinder. It will be noticed that the piston shown is of two parts, a solid rod, and a hollow shaft which receives it. This is to facilitate the application of brakes by hand power, the hand brake chain being attached to the lever connected to the piston; and where brakes are operated by hand, the solid piston rod slips easily from the hollow part and it is not necessary to pull out the piston head against friction and the retarding spring.

The general arrangement of brake cylinders and levers is illustrated in the diagram of Fig. 148, together with the attachment to the hand brake staff.

A detailed drawing of the levers shown in Fig. 148 is given in Fig. 149; this is a form of leverage extensively used with air brakes on electric cars.

Two methods are in use for admitting air to the brake cylinder.

1st. The air from the reservoir is piped to the motor-man's valve, which is so designed that when turned to the position for applying brakes, the air is admitted to a pipe

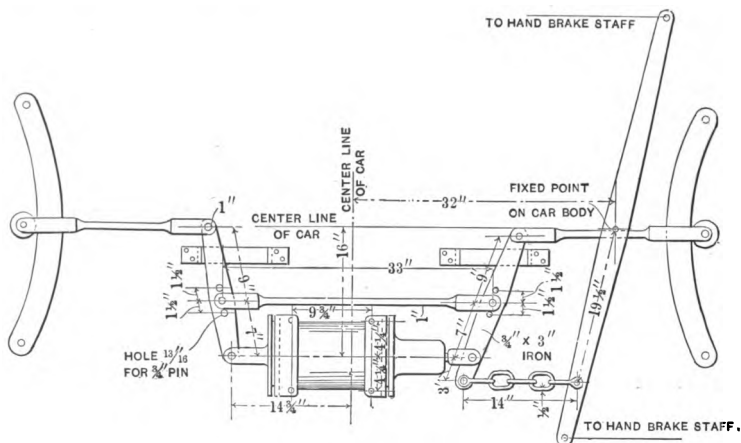

Fig. 149. — AIR BRAKE LEVERS.

running directly to the brake cylinder. This is known as the "Straight Air" system and is adapted to single cars or short trains, but not to long trains because of the time which would be required to supply the quantity of air necessary to fill the brake cylinders.

2d. Air from the reservoirs is admitted to smaller (auxiliary) reservoirs which are connected to the brake cylinders through a special device known as the triple valve. The operation of these devices is as follows: when the motorman turns his valve to the position allow-

ing air from the main reservoir into the train pipe (which is run continuously through the train, the several cars being connected by flexible hose couplings), the triple valves permit the air to flow into the auxiliary reservoirs; when the motorman moves his valves to the position for applying brakes, air is permitted to escape from the train pipe and the reduction of pressure in the train pipe causes the triple valves to open a connection between the auxiliary reservoirs and the brake cylinders, thus admitting air to the cylinders and setting the brakes. When the motorman again turns his valve to the position admitting air from the main reservoirs to the train pipe, the triple

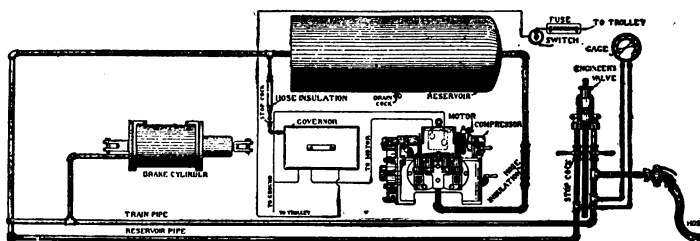

Fig. 150.

valves take a position admitting air from the train pipe to the auxiliary reservoirs and at the same time open a connection between the brake cylinders and the atmosphere, thus releasing the brakes.

The apparatus used in straight and automatic air brake systems are illustrated in the diagrams of Figs. 150 and 151 respectively.

In addition to the parts above referred to, the air compressor and pump governor are important pieces of apparatus. The electric air compressor consists of an electric motor driving an air compressor either directly connected to its shaft or connected through gearing or chain and

sprocket wheels; Figs. 152, 153 and 154 illustrate the three types of apparatus. The compressor shown in Fig. 153, is partly dismantled, exposing the armature and pinion.

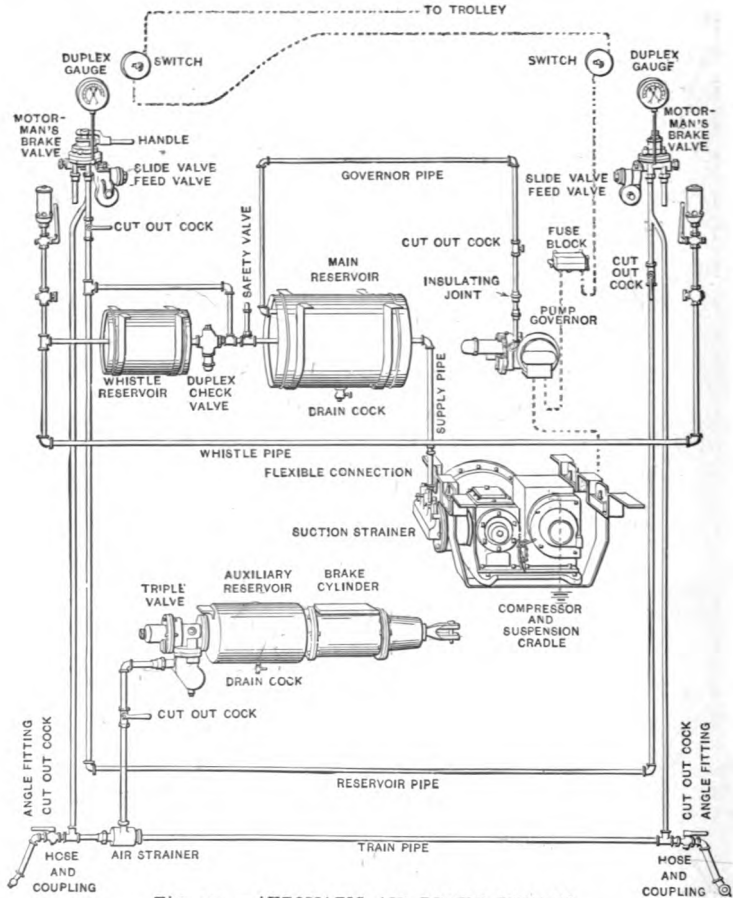

Fig. 151.—AUTOMATIC AIR BRAKE SYSTEM.
(Installed on Interborough R. R., N.Y.)

The pump governor is a device inserted in the motor circuit for the purpose of automatically maintaining the

main reservoir above a predetermined point. In the pump governor the motor switches are controlled by a relay actuated by a contact mounted on the arm of an ordinary Bourdon pressure gauge or by contacts mounted on the piston of a swell air cylinder acting against an adjustable spring. In the case of train service it is usual to have the pump governors of the several cars of a train interconnected, so that all pumps on the train may cut in and cut out at the same time; the necessity for this is evident since without such a device the pump having the lowest set

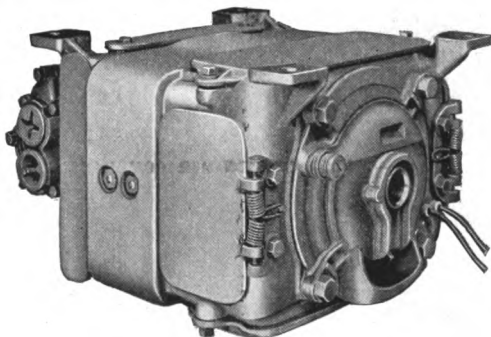

Fig. 152. — G. E. MOTOR DRIVEN AIR COMPRESSOR.

governor would pump air for the train, and deteriorate rapidly on account of being constantly overloaded.

In addition to the above these two other methods in general are for supplying compressed air to the brake apparatus of electric cars. Under certain conditions it is found expedient to compress the air at stationary air compressor stations to a high pressure, and charge large

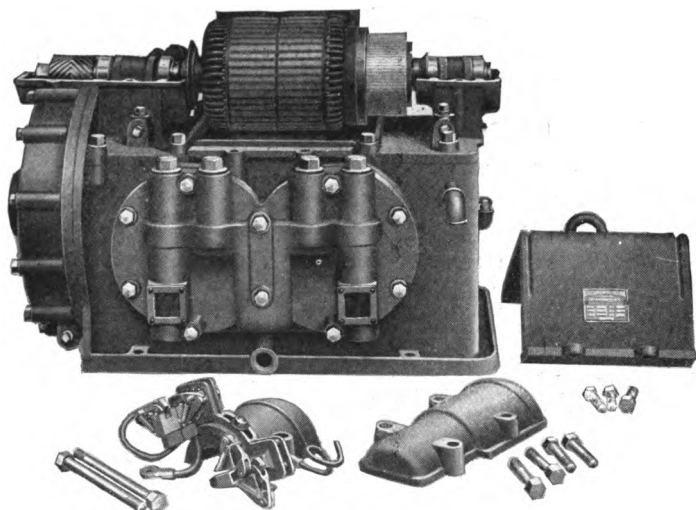
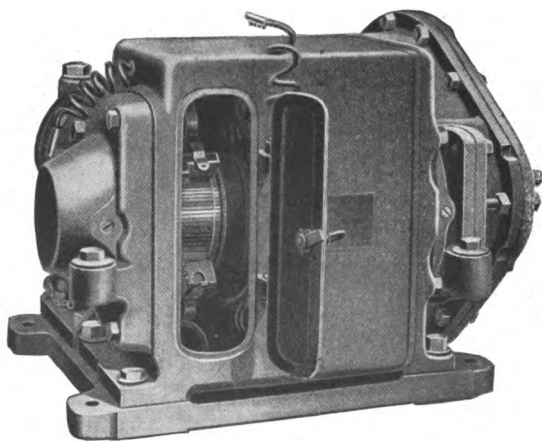

Fig. 153.—MOTOR DRIVEN AIR COMPRESSOR.



(Chain Drive.)

Fig. 154.—AIR COMPRESSOR.
(West. Traction Brake Co.)

tanks on the cars with this compressed air. In service the air is taken from these tanks at ordinary main reser-

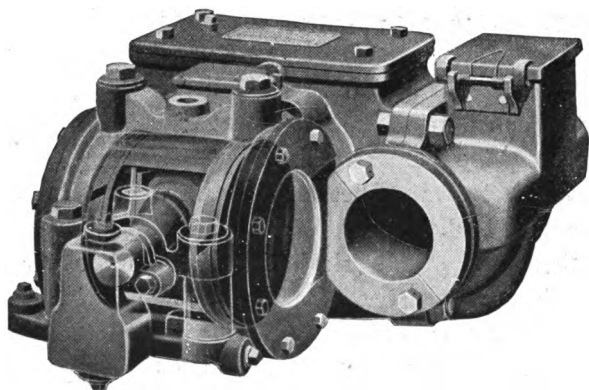

Fig. 155.—AIR COMPRESSOR AXLE DRIVER.
(West. Traction Brake Co.)

voir pressure by means of reducing valves. The other source of supply of compressed air which should be men-

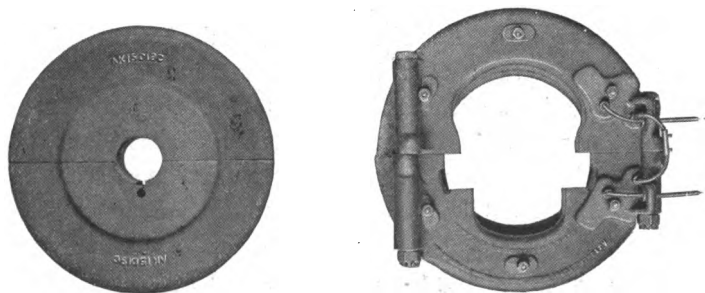

Fig. 156.—G. E. ELECTRIC BRAKE SHOE.

tioned is the "Axle Driven Compressor" (see Fig. 155), which consists of an air compressor geared to the car axle.

The Electric Brake.—In the electric brake the car motors are used as generators, and the braking effect is produced by the torque required to drive the generators, by the drag due to eddy currents set at the brake disc attached to the wheels as it revolves in the magnetic field of the electric brake shoe, which is a circular electro-magnet attached to the motor frame (see Fig. 156) and is energized by the motors acting as generators, and also by the mechanical friction between the revolving brake disc and the fixed brake shoe.

Another form of electric brake which has never been extensively used consists of a solenoid and a plunger acting in a very similar manner to the air brake cylinder.

The type of brake most recently developed is the electro-magnetic track brake illustrated in Fig. 157, where it is shown installed on a four-wheeled car. As will be seen from the illustration, this brake consists of an electro-magnet in which the track rails form part of the magnetic circuit. The horizontal thrust delivered by the position of this magnet hung from the running gear is transmitted by suitable levers to the brake shoes acting on the car wheels. By means of this apparatus it is possible to secure through the braking of wheel shoes the amount of retardation available due to the adhesion between the wheels and the track, and in addition to this the retardation due to the horizontal force required to drag the energized electro-magnetic shoe along the track. The current required for energizing the electro-magnet is derived from the motors used as generators.

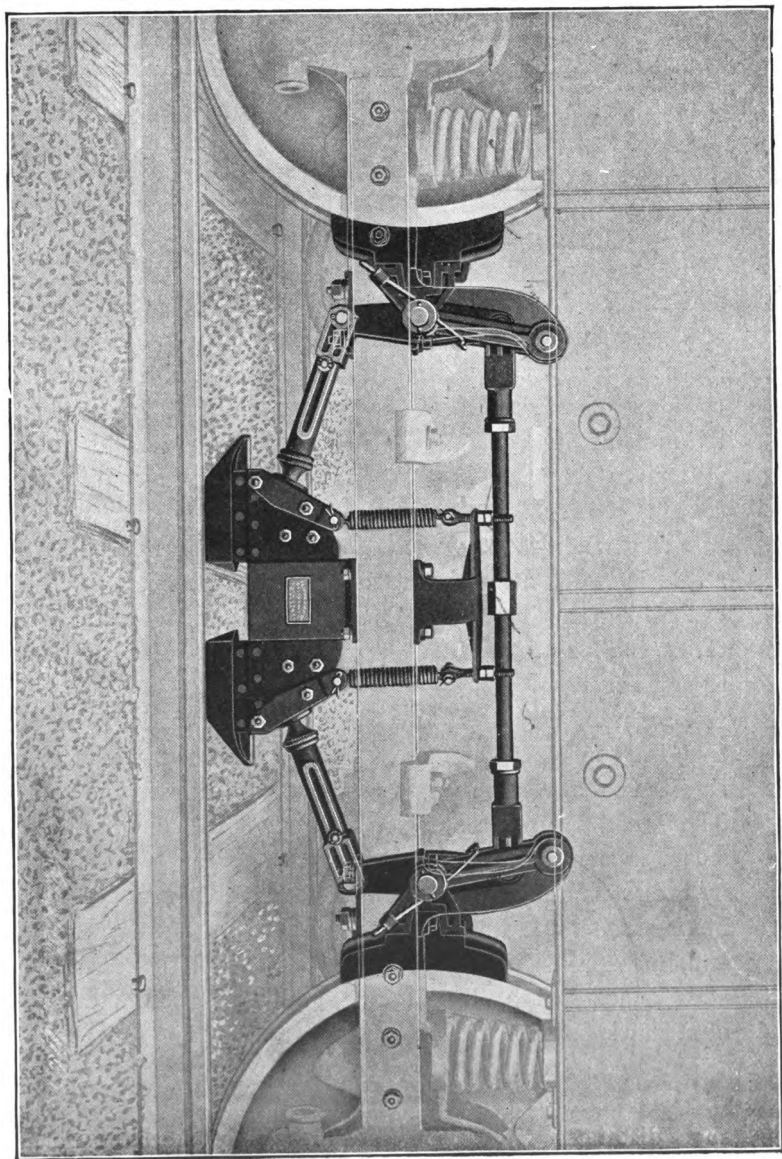

FIG. 157. — ELECTRO-MAGNET BRAKE.

CHAPTER X.

ELECTRIC LOCOMOTIVES.

ELECTRIC locomotives have reached such a stage of development that they are now used quite extensively for commercial purposes. In detail an electric locomotive usually consists of a supporting body containing two or more motors suitably connected to the truck axles upon which the motor body rests. The locomotive body also contains a cab, in which is the controlling mechanism. There are, however, many forms of locomotives which do not possess a cab, in which cases other arrangements are made for the controlling mechanism. When operated by storage batteries, the locomotive must be provided with suitable racks to contain them.

To obtain maximum traction with an electric locomotive, the construction must be founded on laws which are similar to those governing the design of steam locomotives. The great difference between an electric locomotive and a steam locomotive lies in the many advantages possessed by the former. The operation of an electric locomotive is much simpler and quicker; the acceleration more smooth, and, in comfort, the electric locomotive is free from escaping steam, excessive heat, coal dust, and ashes, characteristic of steam locomotives.

Until quite recently electric locomotives were limited to what is termed "short-haul traction," or operating over short distances. With the electrification of the New York

Central Railroad, new departures were made in the traction field, heavy electric locomotives superseding the steam locomotives for express service within approximately 34 miles of the city center.

Electric locomotives may be divided into two distinct classes, depending upon their usage. They are employed for surface work, such as switching trains, in tunnels where smoke is objectionable, and for industrial purposes, or they are used for subsurface work such as mining. Considering surface-railway locomotives, their general design may be

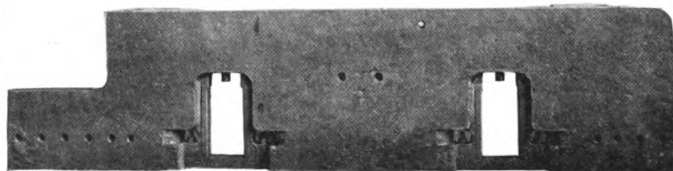

Fig. 158. — LOCOMOTIVE FRAME.

further classified into heavy railroad or trunk-line service and into light railway practice.

Mining Locomotives.— Electric locomotives for mining purposes should be of a compact design, making them adaptable to low and narrow entries met with in this class of service. They should be well framed and built in a substantial manner, having no movable parts exposed which could be injured by obstructions or by falling debris. As the cost of attendance is the chief item of saving with mining locomotives, they should be as simple in design as possible, the running parts being readily accessible.

THE WESTINGHOUSE-BALDWIN MINING LOCOMOTIVE. —
The Westinghouse Manufacturing Company and the Bald-

win Locomotive Works have, in conjunction, developed a variety of types of mining locomotives. The general design of these locomotives is as follows (extracted from companies' bulletins):

"The locomotive frame Fig. 158 consists of heavy cast-iron side and end pieces securely bolted together and kept square by mechanical joints and shoulders accurately fitted. These frame pieces are planed, top, bottom, and ends, to ensure perfect accuracy both in fitting up and in the interchangeability of parts. The pedestal caps are forgings made to template, and accurately fitted so as to relieve the frame from breaking strains in case of severe shocks. The frame is placed either inside or outside of the wheels, in accordance with the limiting requirements of track gauge and width of mine entries.

"All larger sizes of locomotives are provided with separate shoes in the pedestals to permit taking up excessive lost motion in the boxes and to protect the frames from wear.

"Heavy wooden doors and perforated metal plates are laid on top of the frames, thoroughly protecting all electrical parts, but also permitting perfect ventilation as well as access for inspection. The entire machine, with electrical apparatus, is supported on the journal boxes by a double system of helical springs, which prevents destructive pounding on the track and relieves the machinery from shock.

"The locomotive is driven by two motors, separately spring supported, one geared to each axle by single reduction gearing, the gears being enclosed in tight casings. These motors are designed especially for mine service, and are of the four-pole type, steel clad, and enclosed.

The armature is iron clad, the coils being held in slots below the surface, as in the most approved railway practice.”

Special attention has been given to the capacity of the motor rheostat, in order to avoid overheating, as it has been found that the working capacity of electric mine locomotives is in many cases seriously impaired by failure

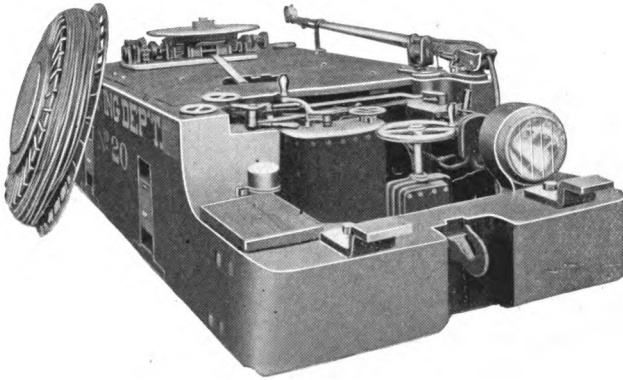

Fig. 159. —ELECTRIC MINING LOCOMOTIVE.

to provide sufficient resistance to take care of the various operations of switching and light load running.

GENERAL ELECTRIC MINING LOCOMOTIVE. — Another form of mining locomotive is that built by the General Electric Company. This locomotive resembles in general appearance the locomotive just described. The locomotive frames are made of cast iron, built up in rectangular form, enclosing the working mechanism. The locomotives are designed to operate upon either 250-volt or 500-volt circuits. A General Electric locomotive exerting a draw-bar pull of 7,500 pounds, will have a normal speed of 8 miles

per hour and will have an approximate power consumption of 160 kilowatts. Such a locomotive will have a total length of 178 inches over all, and a maximum width of 58 inches when operating upon tracks with a 36-inch gauge. The height of frame above rail is 39 inches, the wheel base 64 inches, and the diameter of the wheels 33 inches. Such a locomotive will weigh 40,000 pounds.

Among special features of the General Electric mining locomotive are a "cable-reel device" and their system of braking. Referring to Fig. 159, the cable reel is shown removed from normal position, to exhibit its working mechanism. When operative, the reel is mounted on the top of the locomotive at the end opposite the controller. The reel has a relatively large diameter and contains a flexible insulated cable, one end of which is connected to the trolley service. By means of this cable, which is electrically connected to the controller, current may enter the motors through the controller when the trolley pole is down and not in contact with the line wire. The locomotive may, therefore, enter new developments or new cuts where the trolley wire has not been strung. The reel mechanism is operated from one of the locomotive axles, being driven by a sprocket chain. As the locomotive proceeds, the cable unwinds from the reel, a tension of 30 pounds being automatically maintained upon it, thus preventing kinks. Upon reversing the motion of the car from a forward to a backward direction, the cable-reel mechanism rewinds the cable, the same tension of 30 pounds being maintained.

With the type of brake rigging employed with these locomotives, the tension applied to the brake chains, which are connected to the brake levers, is produced by a

vertical screw. The pressure upon the brake shoes may, therefore, be gradually applied and the brake handle may be left in any position.

Trunk-Line Service. — Owing to the high efficiency of electric motors, electric locomotives may be designed, which, for conditions similar in all respects, will be far superior ~~than~~^{to} steam locomotives. Due to the compactness of electric motors, the car body will lend itself readily to that design which will reduce air resistance to a minimum, making them especially applicable to high-speed service. The weight of the electric locomotive may also be so distributed as to lower the center of gravity of the locomotive considerably, resulting in the maintenance of high speeds around curves. The absence of escaping steam, dirt, oil, and ashes are also desirable features of the electric locomotive. The weight of the body of the locomotive may be readily distributed so as to produce a maximum weight upon the driving wheels, resulting in greater tractive force exerted at the base of the car wheel.

Comparing electric locomotive service to multiple unit train service, it is obvious that the rate of acceleration of electric locomotives will be much smaller than that of the multiple unit service, owing to the distributed motor service of the latter and its increased permissible tractive force. If the coefficient of friction be 0.25, the dead weight upon the drivers would necessarily be four times the tractive force exerted, increasing, therefore, the total train weight, due consideration being taken of the absence of motor equipment of the cars. Accelerating at 0.7 m. per h. per s. is considered satisfactory for locomotive

service, whereas with the multiple unit system an acceleration of 1.40 is common, and some of the later railway developments will be operated at an acceleration of 2. m. per. h. per. s. High rates of acceleration are essential for interurban railway practice, whereas with trunk-line service, where stops are infrequent, the time element of acceleration is not so important, as it involves a consideration of from 20 to 30 seconds. More stress is given with this class of service, to the maintenance of a high schedule running speed.

A notable example of the conditions to be met with in trunk-line service, when adapting it to an electric system, is that of the New York Central Railroad. A brief account of these conditions, and a description of a locomotive designed to meet them, follows :

The New York Central & Hudson River Railroad Electric Locomotives. — These locomotives were constructed by the General Electric Company in conjunction with the American Locomotive Company. The distances over which these locomotives are to operate are, respectively, 34 miles and 24 miles, namely, to Croton, on the Hudson River Division, and to North White Plains on the Harlem Division.

The traffic conditions necessitated an electric locomotive capable of a performance of two regular trips between Grand Central Station and Croton Station, running time one hour, with a total train weight of 550 tons. This included a single stop in each direction, with a lay-over not exceeding 20 minutes. This run was also to be made with more frequent stops, but lighter trains.

It was also decided that the electric locomotive should

perform a service similar to that of the Empire State Express, with the exception that the train weight should be 435 tons, which is slightly heavier than the Empire State Express. This service specifies a run from Grand Central Station to Croton, without stop, in 44 minutes, and with one hour lay-over to keep this service up continuously.

These locomotives (Fig. 160) have a total length of 37 feet over all, the wheel base consisting of four pairs of



Fig. 160.—ELECTRIC LOCOMOTIVE, N. Y. C. & H. R. R.R.

motor wheels and two pairs of pony-truck wheels, having a total length of 27 feet. The diameter of the driving wheels is 44 inches and that of the pony-truck wheels 36 inches. The length of the rigid wheel base, consisting of the four motor wheels, is 13 feet. Owing to the great weight of the locomotive, approximately 190,000 pounds, it is equipped with driving axles having a diameter of $8\frac{1}{2}$ inches.

The locomotive is what is termed a double-ender, and is constructed with frames of cast steel, the side and end

frames being bolted together and stiffened by cast steel cross transoms. The whole of the superstructure is composed of sheet steel with angle iron framing, the general contour being such as to reduce train resistance to a minimum. The cab is located so as to afford a clear view in both directions, and is provided with fireproof windows and doors.

Motor Equipment. — The motor equipment consists of four 600-volt direct current gearless motors, each having a rating of 550 horse-power. These motors are of special design, a description of which may be found on page 84. The armatures are mounted directly upon the axles, obviating the gear losses. The weight resting upon each of the driving wheels is 17,000 pounds, proper distribution of which is accomplished by swinging the main frames from a system of elliptical springs and equalizing levers of forged steel. The whole supporting system is so arranged as to cross-equalize the load, and furnish three points of support.

Control System. — The locomotive is equipped with the Sprague General Electric Multiple Unit Control, two master controllers being provided, one for each end of the cab. The control system will permit of two or three locomotives being coupled together, and they may be operated from one master controller. The acceleration is automatic, and the motorman may, in addition, notch up his controller point by point if he so desires. The control system is designed for a minimum voltage of 300 volts and for a maximum of 750 volts. As a safety device, should the locomotives when operating together

become separated, the current is instantly cut off in other than the controlling locomotive.

Performance. — These locomotives can operate up to a speed of 70 miles an hour with a light train, their tractive effort being greater, it is claimed, than any passenger

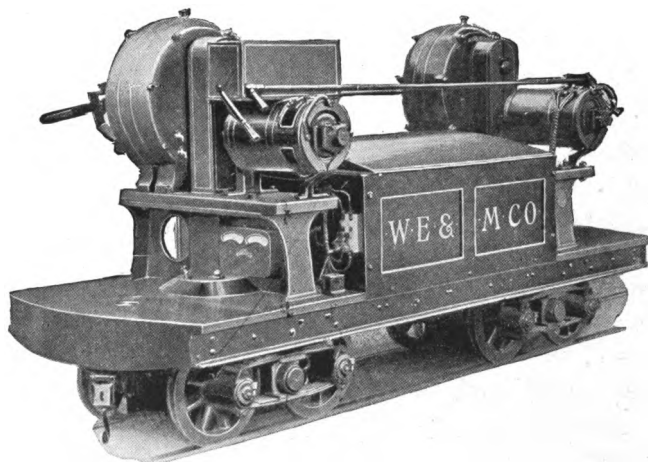

Fig. 161. — INDUSTRIAL NARROW-GAUGE LOCOMOTIVE.

locomotive hitherto placed in service. The motors have a large current capacity, the design of all working parts is simple and accessible, and the depreciation and cost of maintenance should therefore be extremely small. The locomotives are provided with all the accessories of steam locomotives, namely, air compressors for the brakes, whistle, bell, heaters, and pneumatic sanding device, all of which are operated by electric power.

Industrial Locomotives. — An industrial locomotive is usually designed to operate upon narrow-gauge tracks

at very low speed and to exert a small draw-bar pull, which implies small dead weight. As a source of power, storage batteries are often employed, the dead weight of the batteries correspondingly decreasing the necessary net weight of the truck to produce a given traction. The use of storage batteries as a source of power elim-

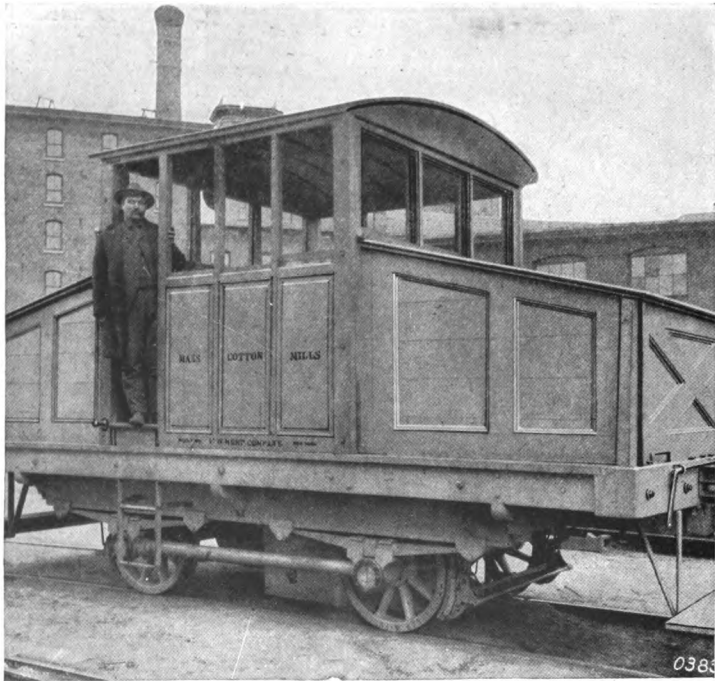

Fig. 162. — STORAGE-BATTERY LOCOMOTIVE.

inates the overhead trolley with its accompanying supporting structure, which would be a serious objection in machine shops. Consideration must be taken of the objectionable features of storage batteries, such as fumes,

moisture, heavy depreciation, necessary care, etc. Figs. 161 and 162 represent two types of industrial storage-battery locomotives built by the C. W. Hunt Company.

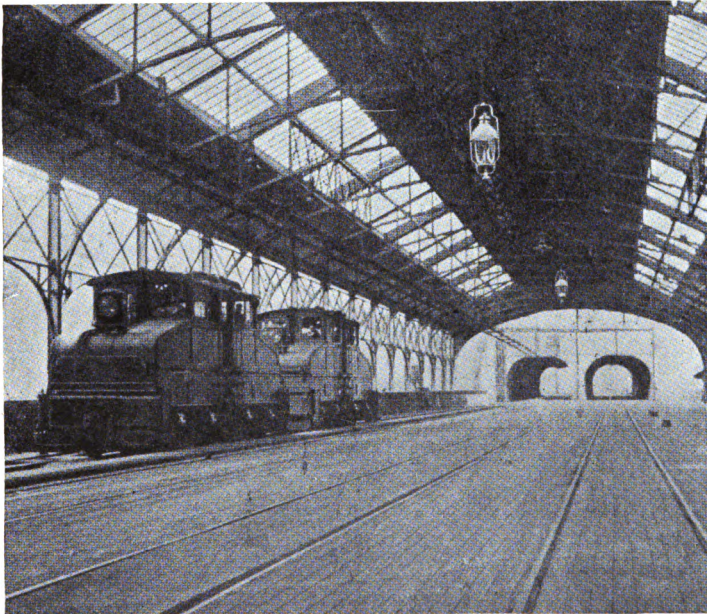

Fig. 163. — SWITCHING LOCOMOTIVE.

Switching Locomotives. — These locomotives must be of large capacity, with motor equipment designed for low-speed service, such as 10 miles per hour. A notable example of the use of switching locomotives is that of the electric locomotives used in the Baltimore tunnel. The locomotives draw trains weighing 1,600 tons, at a speed of 10 miles per hour up a grade of 0.8 of 1%, and also moving up a grade of $1\frac{1}{2}\%$ at a speed of 9

miles per hour, returning light. This service is maintained hourly.

The locomotives are composed of two units coupled together, each weighing 75 tons. The motor equipment consists of four General Electric No. 65 Railway Motors of 225 horse-power apiece, making a total capacity of 1,800 horse-power to a combined unit. The motors are designed to operate upon a 625-volt circuit. The cab and locomotive body is well framed and built in a substantial manner. Two of the first locomotives put into service are illustrated in Fig. 163. The locomotives are equipped with the Sprague General Electric Type M Control, one or more units being operated by the master controller.

CHAPTER XI.

ELECTRICAL MEASUREMENTS.

THE following methods of testing have been selected by the authors, from intimate association with the electric railway field, as being especially applicable to traction purposes.

All of these methods may be readily modified to suit the conditions at hand, and they are therefore outlined in elementary form.

A set of small storage batteries, a few portable voltmeters and ammeters, and a bank of lamps are all the apparatus that is essential for ordinary purposes. Where greater accuracy is desired, and especially where calibrations of instruments are to be made, a galvanometer, a standard resistance box built up in the form of a compensation set, and a standard cell are desirable additions to the equipment.

Such a testing set has been employed extensively at the Brooklyn Polytechnic Institute for the calibration of standard voltmeters and ammeters. It has always yielded reliable results.

MEASUREMENT OF RESISTANCE.

Determination of the Resistance of a Voltmeter.— Many methods of resistance measurement involve a consideration of the resistance of a voltmeter. This resistance may be rapidly determined by the drop in voltage method, Fig. 164.

To employ this method the following apparatus is desirable: an adjustable resistance box containing high resistances, a low voltage circuit equivalent to that upon which the voltmeter will register normally (500 volts for a 750 volt-meter), and the voltmeter whose resistance is to be determined. Form a series circuit of the voltmeter, the source of potential and the resistance box. With all of the plugs inserted in the box, equivalent to practically zero resistance in the circuit, note the voltmeter reading. Without interrupting the circuit, remove the plugs from the box, gradually increasing the resistance of the circuit until the voltmeter indicates a deflection one half as great as before. Note the total resistance added to the circuit. This will be equivalent to the resistance of the voltmeter.

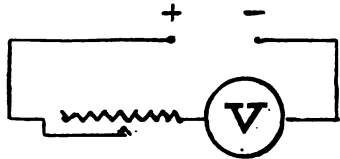

Fig. 164.

When two resistances connected in series are traversed by the same current strength, the distribution of voltage across their terminals is directly proportional to their respective resistances.

Voltmeter Method.—A high resistance voltmeter furnishes a means of measuring resistances varying in magnitude between 5,000 and 150,000 ohms. The voltmeter is connected in series with x , the unknown, and the supply circuit. The voltmeter reading, A , is observed. The resistance is then short circuited and the voltmeter reading, B , observed. If R be the resistance of the voltmeter, then

$$x : R :: B - A : A \therefore x = R \frac{B - A}{A}.$$

The maximum accuracy occurs when the voltage drops one half, or when $x=R$.

Ammeter and Voltmeter Method.—Resistances of ordinary magnitudes (.1 ohm to 500 ohms) may be measured

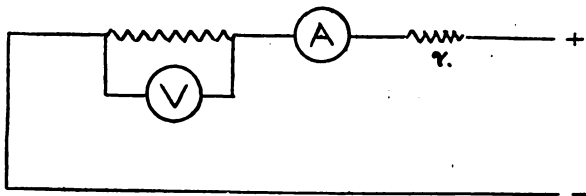

Fig. 166.

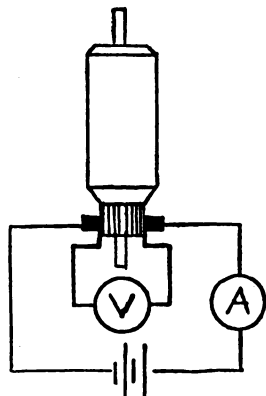

Fig. 165.

by means of an ammeter and a voltmeter.

A current, I , of known magnitude may be passed through the resistance, R , and the drop in voltage, E , across its terminals measured with a voltmeter.

Then

$$R = \frac{E}{I}$$

If the resistance be small, such as a motor armature, Fig. 165, a storage battery may be used as a source of voltage. If the resistance be large, a higher source of voltage should be employed and a regulating resistance r , Fig. 166, inserted to limit the current flow and protect the ammeter. This method is especially applicable for commercial purposes, due to portability of instruments.

Wheatstone Bridge Method.—A more accurate means of measuring resistances than the voltmeter-ammeter method,

consists in the use of the Wheatstone Bridge. The accuracy of this method is so great that it is employed to a large extent in locating grounds upon telephone circuits. In such cases it is necessary to measure the resistance of the line wire from a given station up to the point where the line is grounded. Then with a knowledge of the resistance of the wire per foot, the ground may be easily located. The Wheatstone Bridge consists of four resistances including the unknown, connected together into a closed series circuit, Fig. 167.

A galvanometer is connected to two diametrically opposite junctions through a switch, and a battery circuit attached to the two remaining opposite junctions. Two adjoining arms, a and b , Fig. 167, may be taken as ratio arms and resistance inserted in the ratio of 100:100. In the fourth arm of the bridge R , is an adjustable resistance whereby the circuit may be balanced. When no deflection of the galvanometer occurs upon pressing the key, the same potential exists at points m and n , showing that the same ratio of distribution of voltage has been produced in resistance R and x , as exists in a and b . Therefore the distribution of voltage being proportional to the resistance,

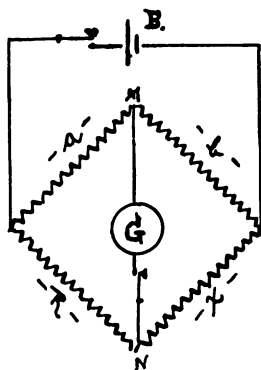

Fig. 167.

$$a : b :: R : x.$$

$$100 : 100 :: R : x.$$

Where greater accuracy is desired, a ratio of 10 : 100 or 10 : 1000 may be produced in the arms a and b .

Thompson Double Bridge Method.—Where small resistances are to be measured with great accuracy, such as resistances of .01 of an ohm, with an accuracy of at least

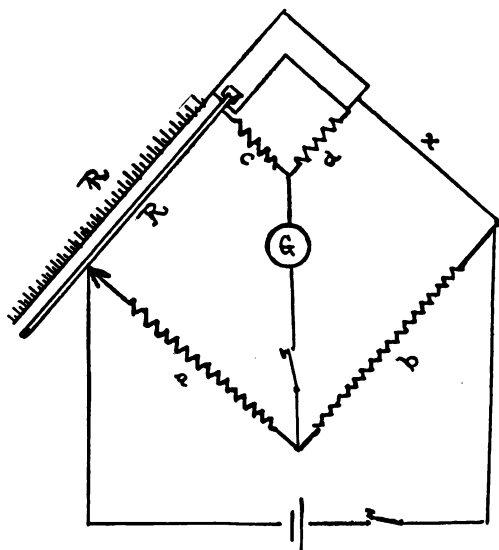

Fig. 168.

$\frac{1}{10}$ of 1 per cent., the Thompson Double Bridge may be employed. The bridge is a modification of the Wheatstone Bridge. It is composed primarily of four arms, two of which are ratio arms, a and b , Fig. 168. The small resistances x the unknown, and R a standard slide wire resistance with an adjustable contact and graduated scale, complete the primary circuit. The resistances R and x are joined together through a contact strip of exceedingly

low resistance. The standard resistance R , is mounted upon knife edges at one extremity into this connecting strip. Tapped off from both sides of this contact are a pair of resistances, c , d , in the ratio $c : d :: a : b$, to the junction of which is joined one of the galvanometer terminals. This arrangement is equivalent to placing the galvanometer terminal on such a part of this contact piece that its resistance will be distributed proportionally between R and x . When balanced, the arms are in the ratio

$$a : b :: c : d :: R : x.$$

When a , b , c , and d are at the proper ratio, R is adjusted until a balance occurs.

Insulation Test. — The insulation properties of a train equipment may be tested as follows. Using the voltmeter method previously described, connecting the voltmeter in series with the line circuit, the insulation undergoing test and the frame of the car, the insulation resistance may be quickly calculated with a knowledge of the resistance of the voltmeter, and by observing the drop indicated by the voltmeter.

Calibration of a Voltmeter — Potentiometer Method. — This method employs a potentiometer, consisting primarily of a standard resistance box containing resistances whose values in ohms have been very accurately determined. These resistances usually have a negligible temperature co-efficient. In conjunction with this box a standard cell, a sensitive galvanometer having a small period of vibration and a source of constant *E.M.F.* form the complete potentiometer testing set.

A convenient form of potentiometer is that manufactured by Hartmann and Braun of Germany and standardized by the German Standardization Bureau, the Reichsanstalt. This box contains single resistances of a range of 1 ohm to 40,000 ohms.

With the potentiometer method, the *E.M.F.* of a standard cell is balanced against an external *E.M.F.* through the medium of a common resistance. Both sources of *E.M.F.* are connected to this resistance, Fig. 169, in such a manner that both will produce the same distribution of voltage. A galvanometer placed in series with the stand-

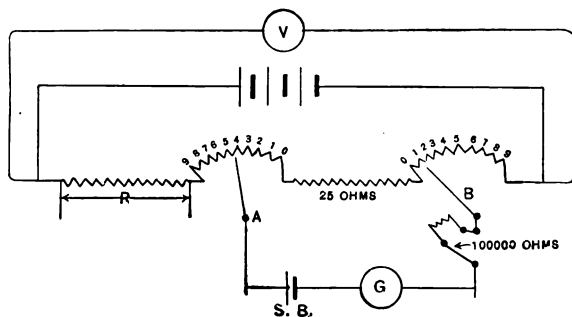

Fig. 169.

ard cell indicates by a zero deflection when a balance occurs. A convenient unit of resistance to employ is 1,000 ohms per volt, producing a distribution of voltage of 1 volt for each 1,000 ohms included. The method of procedure with a potentiometer is as follows :

The standard cell is provided with a thermometer, giving the temperature of its electrolyte and an accompanying scale indicating the voltage for all reasonable working temperatures. Consulting the thermometer and scale, the voltage of the cell to four decimal places is determined. Assume, as an example, that the voltage is 1.425 volts.

By arrangement of the Hartman and Braun potentiometer box, the standard cell may be connected in series with a galvanometer through a two-point switch. One switch contact point places 100,000 ohms in series with the galvanometer, and the second contact point eliminates this resistance from the circuit. Referring to the diagram of connections, Fig. 169, the standard cell, the galvanometer, and the two-point switch are connected in series with the appropriate resistance, 1,425 ohms in this case, producing

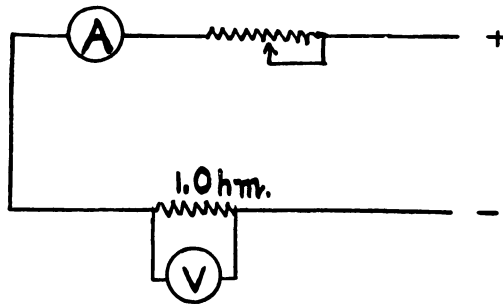

Fig. 170.

a distribution of voltage of 1 volt per 1,000 ohms. The voltmeter, the external source of *E.M.F.*, and the resistance box are then connected in multiple, such a resistance being taken out in the box as would include 1,000 ohms for every volt of the external *E.M.F.* This resistance should include the resistance previously taken out for the standard cell circuit. The standard cell circuit enters the external *E.M.F.* circuit through the medium of two movable switch arms, secured at one extremity, switches *A* and *B* in the diagram. Each of these switches with their nine auxiliary contacts form a rheostat, one *A*, having a resistance of 9×100 or 900 ohms, and the other *B*, having a resistance of $9 \times 1,000$ or 9,000 ohms. To include 1,425 ohms in

the standard cell circuit, switch *B* is moved to the 1,000 point, switch *A* to the 400 point, and an additional 25 ohms is inserted by withdrawing plugs between switches *A* and *B*. It is obvious that when all the plugs are in their proper places in the box, irrespective of the position of switches *A* and *B*, there is always $(9 \times 100) + (9 \times 1,000)$ ohms in the external *E.M.F.* circuit.

Assume that the voltmeter when connected to the set-up indicates a voltage of 25.2 volts, necessitating a resistance in series with the source of external *E.M.F.* of 25,200 ohms to produce the desired voltage distribution. The total resistance already in the circuit would then consist of $9,000 + 900 + 25$ ohms, indicating an additional resistance of 15,275 ohms. Without disturbing the standard cell circuit, this resistance should be inserted in the circuit at *R* (see diagram). Care should be taken to note that the positive terminal of the standard cell corresponds to the positive terminal of the external source of *E.M.F.*, so that both sources of potential will oppose each other. When the proper adjustments have been made, throw galvanometer switch on first point and note if any deflection occurs.

If a deflection does occur, adjust resistance in *R*, until zero deflection takes place. Then throw galvanometer switch to the second point, and adjust small resistances in *R* until no deflection occurs. The circuit is then balanced and the total resistance included in the external circuit, that is, between *B +* and *B -*, divided by 1,000 ohms will yield the true voltage of the external circuit. This voltage should be compared with the voltmeter reading when the circuit is balanced.

As the resistance of this box is limited to approximately 100,000 ohms, it is obvious that some other ratio than

1,000 ohms per volt must be chosen to make high voltage calibrations and also extremely low voltage calibrations.

Calibration of an Ammeter. — In commercial practice it is preferable to carefully calibrate a standard voltmeter, and to check ammeters against it through the medium of a standard ohm. The ammeter is placed in series with the

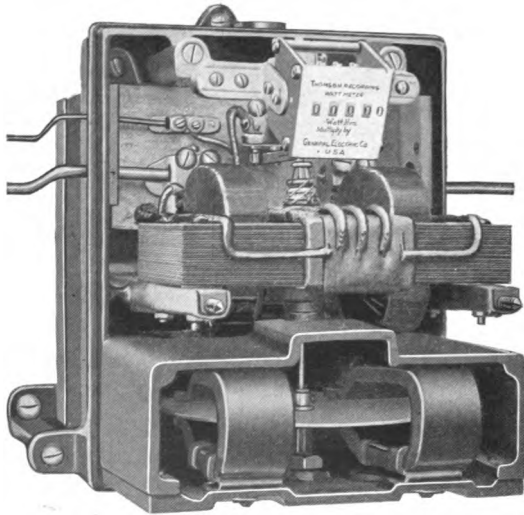

Fig. 171.—RAILWAY TYPE RECORDING WATTMETER.

standard ohm, and an adjustable source of *E.M.F.*, the voltmeter shunting the standard ohm. It is obvious that the voltmeter and ammeter readings should correspond for each set of readings when both instruments are in perfect condition, as

$$I = \frac{E}{R}$$

$R = 1$ ohm, therefore, $I = E$.

Thompson Recording Wattmeter. — This wattmeter consists of a delicate compound wound motor whose armature shaft is connected to a train of wheels registering its motion upon a dial similar to that of a gas meter. The armature of the motor in series with a high resistance is connected across the service wires. As the resistance of the armature and the series resistance is constant, the current passing through the armature will be proportional to the

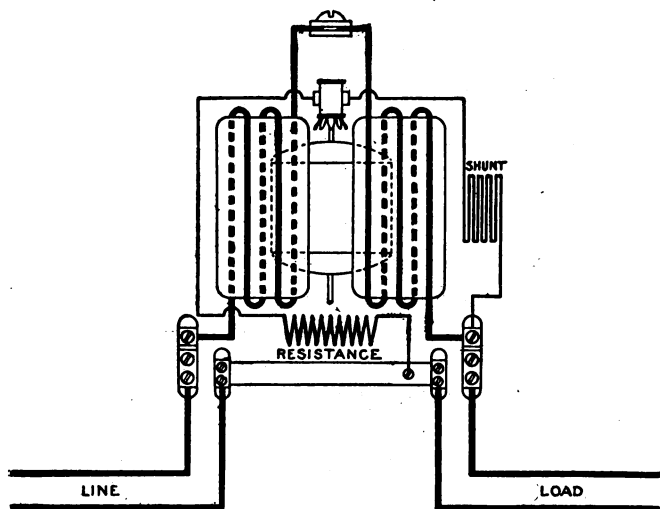

Fig. 172. — THOMPSON RECORDING WATTMETER.

pressure of the service. The field coils of the meter are connected in series with the service wires, producing a magnetic field whose intensity is directly proportional to the current input, owing to the absence of iron. The torque of the armature of the meter is therefore proportional to the watts supplied to the meter. The meter is provided with an additional shunt coil placed in series with

the armature. This coil is adjustable, and with the armature forms a magnetic circuit similar to a series motor. This shunt coil is used to compensate for the frictional resistance of the moving elements. It is adjusted so that the armature is on the point of moving when no load is upon the meter. This enables the meter to register on light loads.

Mounted near the bottom of the armature shaft is a copper or aluminum disc which passes between electro-magnets as the armature rotates, reducing its motion due to Foucault currents. These magnets are adjustable and can change the speed of the armature about 16 per cent.

Calibration of T. R. Wattmeter. — The meter may be readily calibrated by connecting an ammeter in series with its line wire and a voltmeter across both service wires and consuming the energy passing through the meter by a non-inductive load. Fig. 172 illustrates the connections for a 50-ampere 500-volt Thompson Recording Wattmeter, and Fig. 171 shows a Thompson Recording Wattmeter of the railway type with its heavy closed magnetic circuits.

ELECTROLYSIS.

Electrolysis of underground pipes depends largely upon the nature of the soil surrounding the pipes. It obviously varies with the magnitude of the current carried by the piping system.

Where the current traversing a pipe emanates from a direct current railway system with a grounded return circuit, obviously the only method of reducing electrolysis to a minimum is to provide a low resistance return circuit. This means heavy rails, well bonded for surface systems; and for elevated systems, the whole supporting structure should

be bonded and used as a return circuit. Considering elevated systems, one case is known to the writer where the joints in the rails of the ground return circuit were well bonded. These rails were then bonded at convenient distances to the supporting metallic structure, the joints of the structure being also well bonded. In another case of an elevated system not well bonded, a voltage difference amounting to 17 volts was found to exist at the approach of a train, between ground rails and supporting structure. In this instance there was no bonding between joints of structure, between structure and ground rails, and the bonding between rail joints was defective in many cases. A stranded bond had been employed, and in the majority of cases many strands were broken. The result of this condition was that nearly the whole return current was carried by the joint plates and retaining bolts in the joints. The bolts had become burned, and in many cases had worked loose and fallen out of place. With alternating current systems there is small tendency towards electrolysis; this tendency decreasing as the frequency of the circuit increases, electrolysis becoming negligible at about 30 cycles per second.

Test of Current Flow in Pipes or Return Circuit. — Quite frequently it is necessary in railway practice, to determine the magnitude of the current flow in a water pipe, or the grounded return rail circuit, by some means other than that of placing an ammeter in series. One method is that employing a low range voltmeter, from 3 to 5 volts, and a 50 ampere ammeter. If a water pipe is under consideration, such a length is chosen as will yield a reasonable voltmeter deflection, care being taken to see that both volt-

meter terminals are connected to the same pipe. Note the voltmeter reading e . Without interrupting the voltmeter circuit, shunt the same length of pipe with the ammeter and note the second voltmeter reading e_1 . At the same instant, record the ammeter reading i .

If I be the current carried by the water pipe, its resistance when the voltmeter alone is connected to it, may be expressed as,

$$R = \frac{e}{I};$$

when both ammeter and voltmeter are connected to it, its resistance is practically equal to,

$$R = \frac{e_1}{I - i}.$$

Placing these two equations equal to each other, and solving for I , we obtain,

$$\frac{e}{I} = \frac{e_1}{-i},$$

$$I = \frac{e i}{e - e_1}.$$

As such a current flow I , is usually fluctuating in nature, several sets of readings should be obtained and their final results averaged, to obtain reasonable values. With a little care, fairly accurate values may be obtained.

Bond Testing. — The resistance of a rail joint may be measured in terms of the resistance of an equivalent number of feet of track by means of a low-reading voltmeter.

If a current of electricity traverse several resistances in series, the relative magnitude of those resistances is directly proportional to the drop in voltage across their

terminals. The same current I , passing through the resistances, their relation may be expressed,

$$I = \frac{E}{R} = \frac{E_1}{R_1},$$
$$E : E_1 :: R : R_1.$$

Applying this principle to the rail joint, the drop across the joint is measured with a low-reading voltmeter. The voltmeter terminals are then placed upon a straight track and one of the terminals moved along the track until such a length of track is included between the terminal as will yield the same drop. The resistances of the rail joint is then equivalent to this length of track. Some manufacturers have developed a combined instrument, in which the relation between the joint and a given length of track may be readily compared.

Test of Heating Capacity of Motor. — A standard method of testing armature coils and field coils of motors as to their temperature rise when subject to load is by measuring their increase of resistance during a run. As motors cool off slowly, especially when their temperature is slightly above atmospheric conditions, the car must be laid up in the yards for several days before the test is made. A satisfactory method for making this test is to utilize a storage battery with an ammeter in series attached to two long, flexible terminals, with good flat contacts on their extremities so that these contacts may be readily inserted between the brushes and the commutator surface of one of the motors. Attached to these flat contacts must also be the terminals of a low-reading voltmeter. This will enable the IR drop and the current passing through the armature to be observed. Employing Ohm's law, and the temperature

coefficient of copper (.0042), the resistance of the coils at zero, R_0 , is easily determinable from the formula,

$$R = R_0 (1 + .0042 t),$$

where R is the resistance before the run at the temperature t , of the atmosphere. The final temperature, t_1 , of the coils is obtained by remeasuring their respective resistances, R_1 , after the test, and employing the formula

$$R_1 = R_0 (1 + .0042 t_1).$$

Inserting the value for R_0 , as previously determined, and solving for t_1 , the resultant temperature is obtained. The temperature of the field coils and armature coils should never be allowed to rise more than 75° C. above the temperature of the atmosphere, which is assumed to be about 25° C. A curve exhibiting the rise of temperature of the field coils may be easily determined from a series of resistance values obtained by shunting the field terminals with a voltmeter, and having a large range ammeter in series with the ground side of the field coil connections. The resistance may then be determined at any instant when the motors are receiving power, and the rise of temperature calculated by the method previously described. This method of performing temperature tests was described by one of the authors in the Street Railway Journal of May 21, 1904. For other methods of test, see paragraphs on motor ratings.

INDEX.

- Abscissa, definition of, 6.
Absolute units of electricity, 2.
Acceleration, 1, 17.
 effect of grades and curves on, 21.
 motor, 20.
 of coasting, 27.
 train, 26.
Accelerometer, mercury, 51.
 Sheldon's, 52.
A. I. E. E. motor rating, 35.
Air brakes, 243.
 compressor, 245, 249.
Alternating current single phase motor, 86.
 control of, 158.
Ammeter, and voltmeter method of resistance measurement, 267.
 calibration of, 274.
 recording, 54.
Ampere, definition of, 2.
 turns, 70.
Analysis of train performance, 13.
Armature, 62.
 development of mechanical H.P. in, 74.
 torque, 73.
 windings, 63.
Automatic air brake system, 246.
Available braking effort, 226.
Axle driven air compressor, 249.
Baldwin - Westinghouse mining locomotive, 253.
Bond testing, 278.
Box frame type of motor, 80.
Brake, air, 243.
 electric, 250.
 friction or momentum, 240.
 hand, 206, 236.
 power, 207, 240.
 rigging, 198.
 shoe suspension, 223.
 testing, 228.
 track, 239.
 types of, 206, 238.
Braking, 204.
 as represented on a speed-time curve, 16, 45.
 consideration of car bodies in, 212.
 deceleration of, 27, 219.
 distribution of car weight on wheels during, 222.
 efficiency of, 222, 227.
 energy dissipated in, 211.
 equations of, effort, 212.
 principles of, 207.
 total effort required in, 227.
 use of motors in, 206, 250.
Bridge system of control, 150.
Brill truck, 196.
British thermal unit, 4.
Brushes for railway motors, 70.

- Cable reel of G. E. mining locomotive, 256.
- Calibration of ammeter, 274.
of recording wattmeter, 276.
of voltmeter, 270.
- Calorie, definition of, 3.
- Car bodies :
consideration of, in braking, 212.
construction and arrangement of, 165.
side bearings for, 199.
connectors, 144.
fireproof, 178.
heaters, 172.
lighting, 178.
- C. G. S. units of electricity, 2.
- Change of gear or voltage, effect of, 29.
- Circuit breaker, 125.
- Coasting, acceleration or deceleration of, 27.
as represented on a speed time curve, 16, 45.
- Coefficient of friction, 208.
- Commutator, 67.
- Comparison of steam and electric traction, 59.
- Compensating coil in single phase motor, 88.
- Compressors, air :
axle driven, 249.
electric, 245.
- Contactors in type M control, 107.
- Control system, 102.
A. C. single phase motor, 158.
G. E. bridge, 150.
C 6, 109.
K 10, 115.
type M, 120.
multiple unit, 105, 131.
- Control system of N. Y. C. & H. R. R. electric locomotive, 260.
Sprague G. E. type M, 107, 111.
troubles in, 162.
Westinghouse multiple train, 124.
unit switch, 133.
- Coördinates of curves, 6.
- Counter E. M. F. of A. C. motor, 89.
of D. C. motor, 72.
- Current curve, 30.
effective or heating value of, 33.
heat developed by, 3.
unit of, 2.
- Curves, distance time, 13.
of current input, 30, 46.
of motors, 36, 38.
of power, 32, 46.
of train resistance, 24.
of voltage, 31, 46.
plotting of, 6.
railway, equivalent tractive effort of, 22.
speed time, 15, 37.
velocity, 15.
- Deceleration, 21.
due to braking, 27, 219.
to coasting, 27.
- Determination of distance from brake signal to stop, 229.
equation for, 234.
- Direct current series railway motor, 61.
- Distance time curve, 13.
- Distribution of car weight on wheels during braking, 222.
- Drum armature, 63.
- Dynamometer car, 59.
- Dyne, definition of, 1.
- Effect of change of gear or voltage, 29.

- Effect of curves on acceleration, 22.
of grades on acceleration, 21.
- Effective current value, 33.
- Efficiency of braking, 222, 227.
- Eichemeyer A. C. motor, 98.
winding, 66.
- Electric air compressor, 245.
and steam traction compared,
59.
brake, 250.
locomotive, 252.
- Electrical H. P. consumed by arma-
ture, 74.
measurements, 265.
units, 2.
- Electrolysis of pipes, 276.
- E. M. F., counter, of A. C. motor,
89.
counter, of D. C. motor, 72.
generated in wire moving in
magnetic field, 71.
of self-induction in A. C. motor,
89.
unit of, 2.
- Energy, definition of, 2.
dissipated in braking, 211.
of moving train, 28.
- Equalizer bar truck, 195.
- Equations of braking effort, 212.
- Equipment, selection of motor, 34.
- Erg, definition of, 1.
- Field magnet and frame of motor,
69.
- Fireproof cars, 178.
- Flux in magnetic circuit, 70.
- Foot-pound, definition of, 1.
- Force, definition of, 1.
- Formed armature coils, 67.
- Formulæ for train resistance, 23.
- Friction, 207.
or momentum brake, 240.
- Function of a controller, 162.
- Gear, effect of change of, 29.
- Gearless motor, 84.
- Gears for motors, 76, 196.
- General Electric bridge control,
150.
C 6 control, 109.
gearless motor, 84.
K 10 control, 115.
mining locomotive, 255.
No. 66 railway motor, 80.
recording ammeter, 54.
reverser, 111.
type M. control, 120.
- Governor, pump, 246.
- Grades, equivalent tractive effort
of, 21.
- Hand brake, 206, 236.
- Hartman Braun potentiometer,
271.
- Heat developed by electric current,
3.
- Heaters for cars, 172.
- Heating capacity of motor, test of,
279.
of motors, 35.
value of current, 33.
- Horse power, 2, 74.
- Hunt storage battery locomotive,
263.
- Indicating instruments, 47.
- Industrial electric locomotives, 261.
- Insulation test, 270.
- Joule, definition of, 2.
- Joule's coefficient, 3.
- Keiley recorder, 47.
- Kinetic energy, 2.
- Lamme single phase motor, 98.

- Lap armature winding, 64.
 Lighting of cars, 178.
 Locomotive, electric, 252.
- Magnet, field, of motor, 69.
 Magneto-motive force, 70.
 Master car builders' truck, 188.
 Maximum traction truck, 189.
 Measurement of areas with planimeter, 8.
 of resistance, 265.
 Mechanical H. P. developed by armature, 74.
 Mercury accelerometer, 51.
 Mining locomotives, 253.
 Momentum brake, 240.
 Motor acceleration, 20.
 A. I. E. E. rating of, 35.
 alternating current, 86.
 counter E. M. F. of, 72, 89.
 curves of, 36, 38.
 direct current railway, 61.
 gearless, 84.
 gears for, 76, 196.
 G. E. No. 66 railway, 80.
 heating of, 35.
 selection of for given service, 34.
 suspension of, 75, 200.
 test of heating capacity of, 279.
 Westinghouse No. 56, 82.
 No. 91 A. C., 98.
 Multiple unit control, 105, 131.
- N. Y. Central electric locomotive, 258.
 motor for, 84.
- Ohm, definition of, 2.
 Ohm's law, 3.
 Ordinate, definition of, 6.
- Performance of train, analysis of, 13
- Pinion on armature shaft, 76.
 Pipes, electrolysis of, 276.
 Planimeter, 8.
 Plotting of curves, 6.
 Pole piece, 70.
 Potential energy, 2.
 Potentiometer method of calibrating voltmeter, 270.
 Power brakes, 207, 240.
 curve, 32, 46.
 definition of, 2.
 factor, 89.
 Principles of braking, 207.
 Pump governor, 246.
- Railway curves, equivalent tractive effort of, 22.
 Rating of motors A. I. E. E., 35.
 Recording ammeter, 54.
 instruments, 47.
 wattmeter, Thompson, 275.
- Reluctance, 70.
 Repulsion motor, 95.
 Resistance measurements, 265.
 train, 23.
 unit of electrical, 2.
- Resultant brake shoe pressure, 227.
 Reverser, G. E., 111.
 Westinghouse, 125.
- Ring armature, 63.
 Rotation of wheels and armature, retardation of in braking, 226.
- Selection of motor equipment, 34.
 Self-induction, counter E.M.F. of in A. C. motor, 89.
 Series motor, alternating current, 86.
 direct current, 61.
 speed variation of, 75.
- Sheldon's accelerometer, 52.
 Side bearings for car bodies, 199.
 Single phase motor, 86.

- Slide rule, 4.
- Speed time curve, 15.
 representation of braking and coasting on, 16, 45.
 theoretical, 37.
- Spiral armature winding, 64
- Sprague G. E. type M. control, 107, 111.
 multiple unit control, 131.
- Steam and electric traction compared, 59.
- Steel cars for N. Y. Subway, 178.
- Storage battery locomotive, 262.
- Straight air brake system, 244.
 out armature winding, 66.
 series A. C. motor, 90.
- Suspension of brake shoe, 223.
 of motors, 75, 200
- Switching locomotive, 263.
- Test of bonds, 278.
 of current flow in pipes, 277.
 of heating capacity of motor, 279.
 of insulation, 270.
- Testing brakes, 228.
- Theoretical speed time curve, plotting of, 37.
- Thompson, double bridge, 269.
 recording wattmeter, 275.
 repulsion motor, 95.
- Time from brake signal to stop, 236.
- Torque, 18.
 of armature, 73.
- Track brake, 239.
- Tractive effort, 18, 74.
- Train acceleration, 26.
 energy of a moving, 28.
 performance, analysis of, 13.
- Train resistance, 23.
- Transformer series motor, 93.
- Trucks, 188.
 consideration of in braking, 215, 223.
 equalizer bar, 195.
 master car builder's, 188.
 maximum traction, 189.
- Trunk line electric locomotive, 257.
- Type M control, 107, 120.
- Types of brakes, 206, 238.
 of control, 102.
- Units, 1.
- Use of motors in braking, 206, 250.
- Velocity, 1, 15, 16.
 curve, 15.
- Volt, definition of, 2.
- Voltage curve, 31, 46.
 effect of change of, 29.
- Voltmeter, calibration of, 270.
 measurement of resistance of, 265.
 method of resistance measurement, 266.
- Watt, definition of, 2, 3.
- Wattmeter, Thompson recording, 275.
- Wave armature winding, 65.
- Westinghouse A. C. motor control, 158.
 Baldwin mining locomotive, 253.
 multiple train control, 124.
 No. 56 railway motor, 82.
 No. 91 A. C. motor, 98.
 reverser, 125.
 unit switch control, 133.
- Wheatstone bridge, 267.
- Winding of armatures, 63.

