

VIEW OF GENERATOR ROOM AND SWITCHBOARD, NATIONAL BUREAU OF STANDARDS
These Generators Supply All the Various Types of Current for Electrical Testing. Harmonic Alternator Set at the Left

ELECTRIC WIRING AND LIGHTING

A HANDBOOK OF APPROVED MODERN METHODS
OF LIGHTING BY ELECTRICITY, AND OF
INSTALLING CONDUCTORS FOR THE
TRANSMISSION AND UTILIZATION
OF ELECTRICITY FOR POWER,
LIGHTING, HEATING,
AND OTHER USES

Part I—ELECTRIC WIRING

By CHARLES E. KNOX, E. E.
CONSULTING ELECTRICAL ENGINEER

Part II—ELECTRIC LIGHTING

By GEORGE E. SHAAD, E. E.
PROFESSOR OF ELECTRICAL ENGINEERING, UNIVERSITY OF KANSAS

ILLUSTRATED

AMERICAN TECHNICAL SOCIETY
CHICAGO
1916

TK 1033
K5

Copyright 1908, 1913 by
AMERICAN TECHNICAL SOCIETY

Copyright Great Britain
All Rights Reserved

CONTENTS

PART I

ELECTRIC WIRING

	PAGE
Wires run concealed in conduits	1
Wires run in rigid conduit.....	1
Wires run in flexible metal conduit.....	4
Wires run in moulding	9
Fibrous tubing	15
Wires run exposed on insulators	16
Two-wire and three-wire systems	20
Calculation of sizes of conductors	25
Planning a wiring installation	29
Wiring methods	29
Wiring systems	30
Location of outlets	30
Location of distributing centers.....	31
Branch circuits	32
Voltage drop in conductors.....	34
Feeders and mains.....	36
Testing circuits	36
Alternating-current circuits	40
Comparison with direct-current circuits.....	40
Skin effect	42
Mutual induction	42
Line capacity	43
Calculation of drop in a. c. lines.....	44
Single-phase circuits	48
Polyphase circuits	53

CONTENTS

	PAGE
Wiring an office building	54
Current supply	54
Switchboard	55
Load	55
Feeders and mains	55
Wiring plans for each floor	56
Interconnection system	58
Outlet-boxes, cut-out panels and accessories	63
Overhead linework	68
Poles	69
Pole guying	72
Corners	75
Cross arms	75
Service mains	77
Lightning arresters	78
Lamp supports on poles	79
Underground linework	79
Iron pipe	80
Vitrified tile conduit	80
Laying conduit	82
Fibre conduit	83

PART II

ELECTRIC LIGHTING

	PAGE
History and development	1
Classification	2
Incandescent lamps	2
Manufacture of carbon filament lamps	3
Voltage and candle-power	5
Efficiency	6
Selection of lamps	8
Distribution curves	11
Gem metallized-filament lamp	12
Metallic filament lamps	14
Helion lamp	21
Nernst lamp	21
Comparison of different types	25

CONTENTS

	PAGE
Special lamps	27
Mercury vapor lamp.....	27
Moore tube light.....	29
Arc lamps	32
Control mechanisms	33
Types of	38
Direct-current arcs	38
Alternating-current arcs	39
Flaming arcs	42
Power distribution systems	46
Illumination	53
Residence lighting	56
Types of lamps	56
Illumination calculations	56
Intensity constants for incandescent lamps.....	59
Intensity constants for arc lamps.....	59
Arrangements of lamps.....	59
Lighting of public halls, offices, etc.	64
Street lighting	67
Shades and reflectors	72
Frosted globes	73
Holophane globes	74
Opal enclosed globes.....	76
Photometry	76
Light standards	76
Photometers	79
Lummer-Brodhun	80
Weber	83
Portable	85
Integrating	86
Incandescent lamp photometry	88
Arc light photometry	93

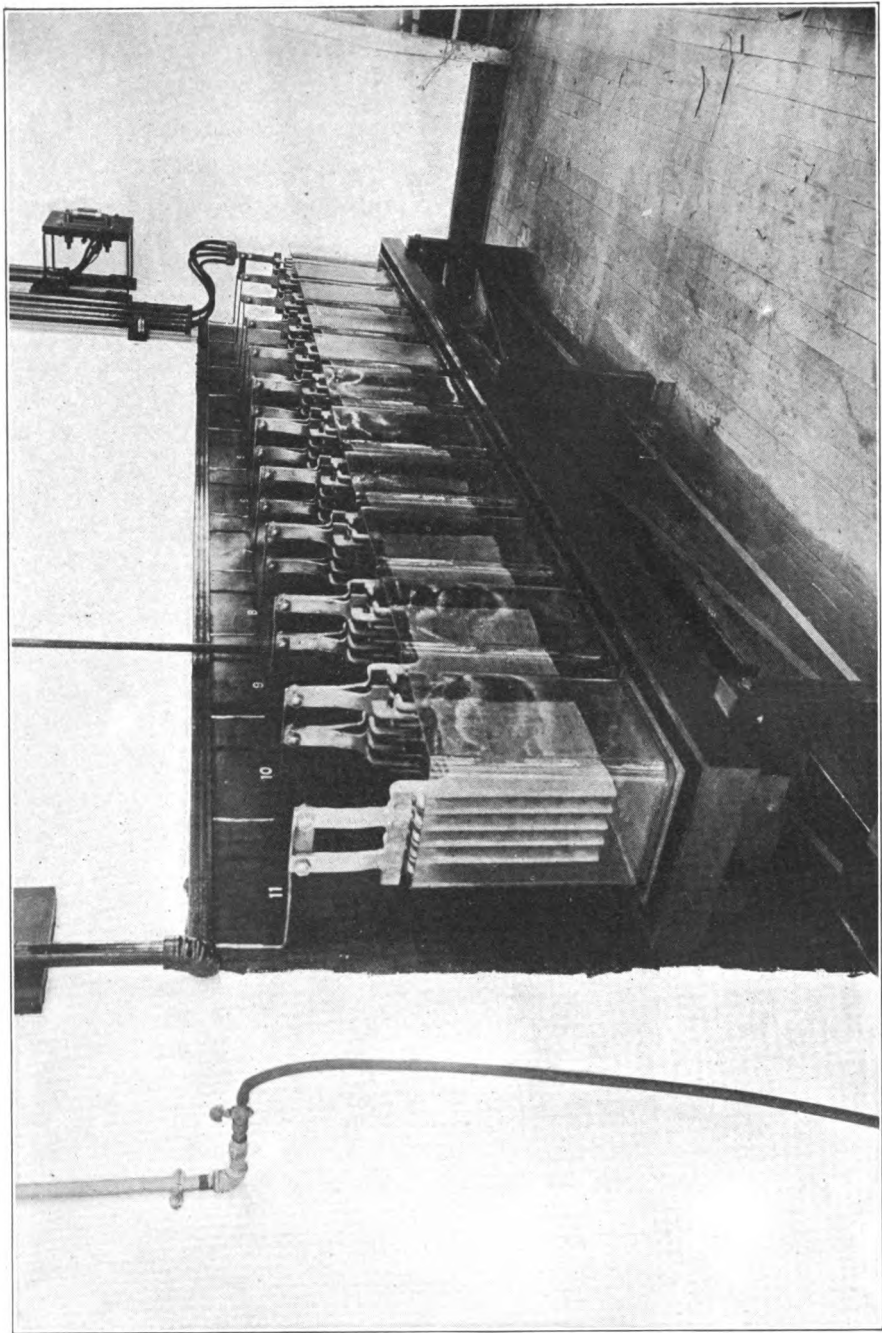

WESTERN ELECTRIC COMPANY BATTERY ROOM AT MONMOUTH, ILLINOIS

INTRODUCTION

ELECTRIC lighting virtually started with the invention of the Edison incandescent lamp in 1878, the discovery of this very useful and flexible lighting unit marking an epoch not only in home lighting, but also in the actual development of the electrical industry itself. This invention had been preceded by the invention of the higher powered but less flexible arc lamp, and these two fundamental lighting sources have been the standards of electrical illumination since that time.

¶ The last few years have seen many notable improvements, not only in the methods of lighting but in the light units themselves. The enclosed arc, the flaming arc, the Moore tubes, and the Nernst lamp have all contributed to this wonderful development, but the recent improvement in metallic filament lamps, notably the Tungsten, has given an impetus which is second only to the original invention of the incandescent lamp itself. To cut the energy consumption per candle-power from 3.5 watts to 1.25 watts is certainly a triumph, and this improvement has opened up many fields of activity hitherto closed to incandescent lighting. It has even made the beautifully effective, but criminally inefficient, method of indirect lighting economically possible.

¶ In addition to the progress in the lighting phases of this interesting subject, the many precautions and safeguards which the building departments of our cities and the National Board of Fire Underwriters demand in connection with lighting and power circuits, make it all the

more necessary that everyone actively engaged or interested in lighting and wiring should have a reliable handbook giving standard specifications and requirements as to materials and methods, and adequate descriptions of recommended devices.

¶ The material in this volume is especially adapted for purposes of self-instruction and home study. The utmost care has been used to make the treatment of each subject appeal not only to the technically trained expert, but also to the beginner and the self-taught practical man who wishes to keep abreast of modern progress. The language is simple and clear; heavy technical terms and the formulæ of the higher mathematics have been avoided, yet without sacrificing any of the requirements of practical instruction.

¶ For purposes of ready reference and timely information when needed, it is believed that this handbook will be found to meet every requirement.

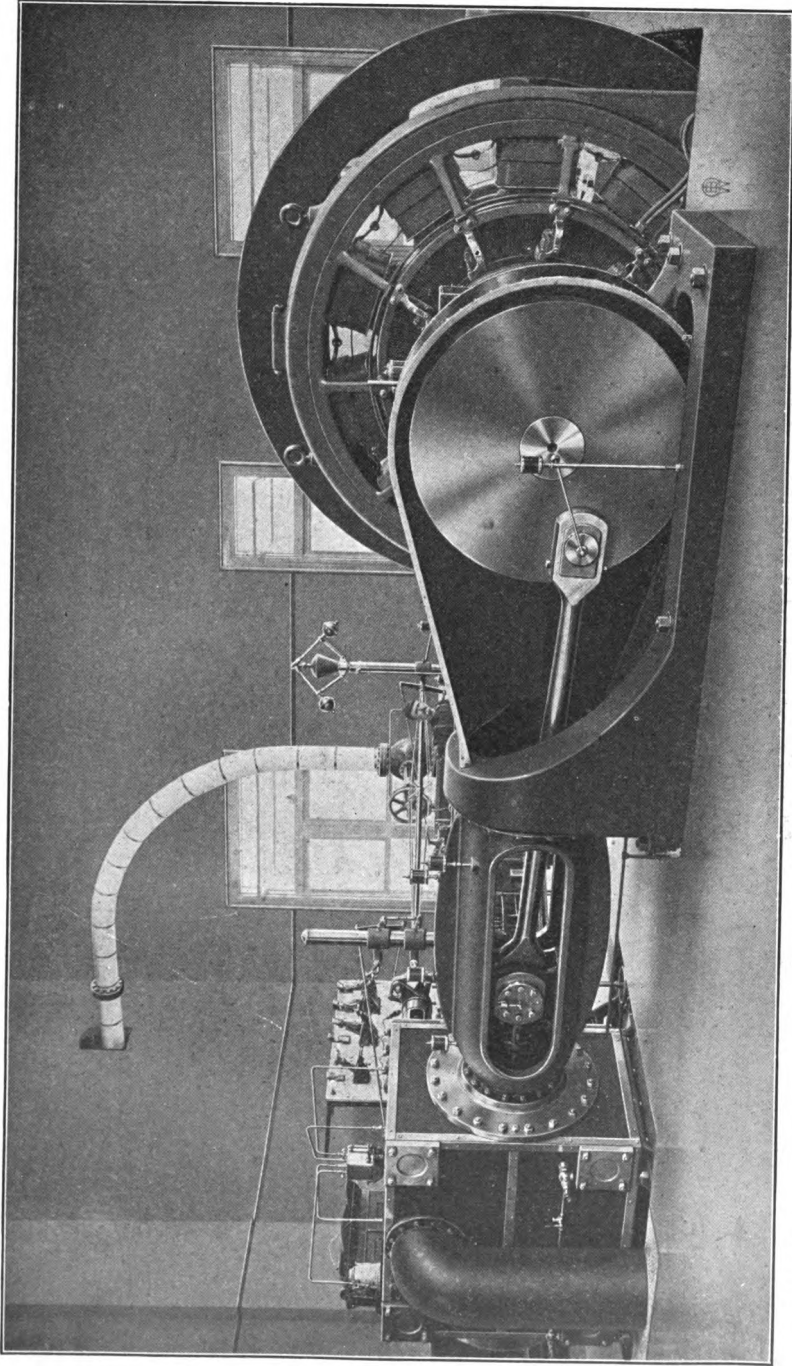

DIRECT-CURRENT VERTICALLY SPLIT GENERATOR DIRECT CONNECTED TO CROSS-COMPOUND HAMILTON-CORLISS ENGINE

Port Wayne Electric Works

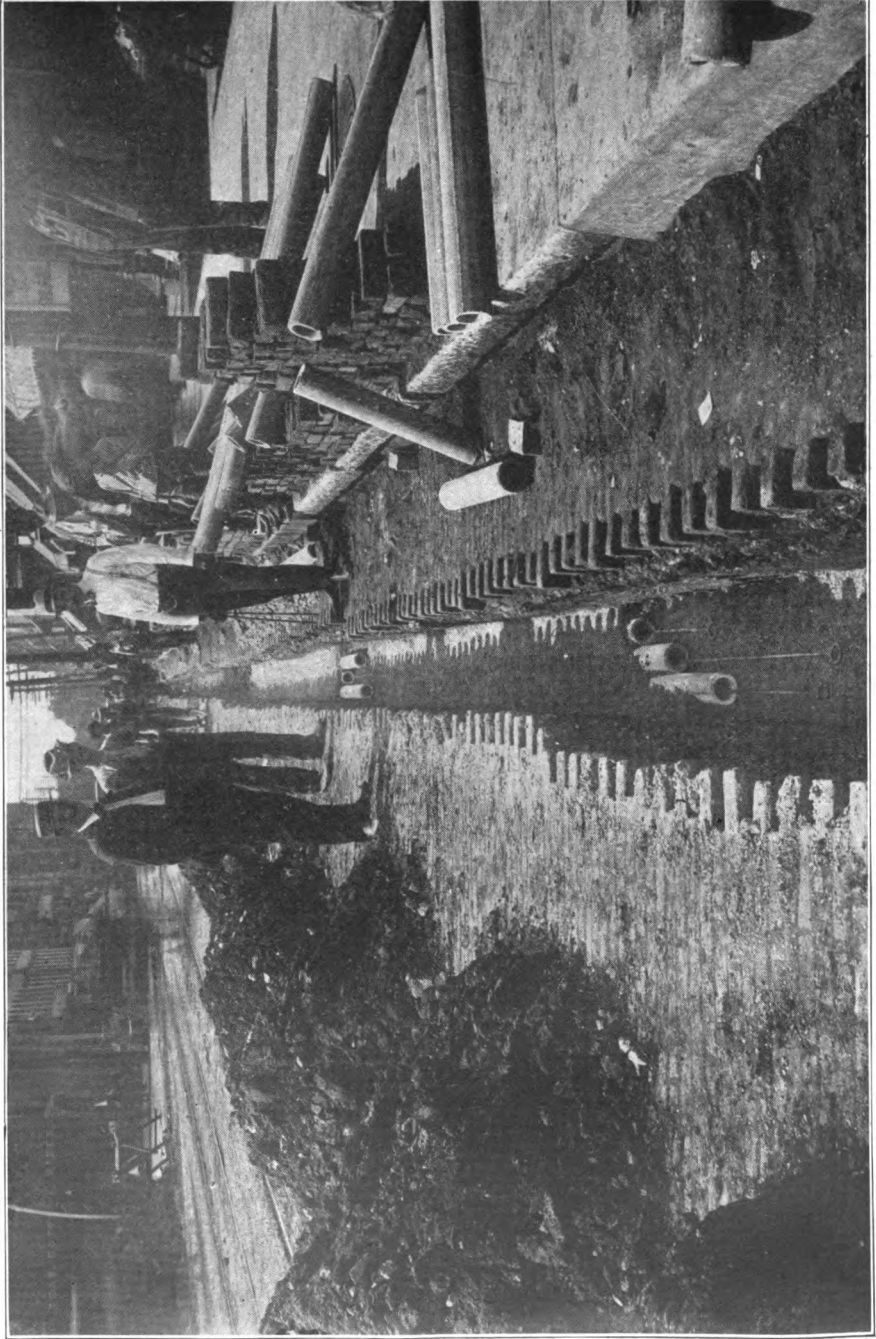

CONSTRUCTION OF TELEPHONE CONDUIT USING CEMENT PIPE FOR DUCT MATERIAL

ELECTRIC WIRING

METHODS OF WIRING

The different methods of wiring which are now approved by the National Board of Fire Underwriters, may be classified under four general heads, as follows:

1. WIRES RUN CONCEALED IN CONDUITS.
2. WIRES RUN IN MOULDING.
3. CONCEALED KNOB AND TUBE WIRING.
4. WIRES RUN EXPOSED ON INSULATORS.

WIRES RUN CONCEALED IN CONDUITS

Under this general head, will be included the following:

- (a) Wires run in rigid conduits.
- (b) Wires run in flexible metal conduits.
- (c) Armored cable.

Wires Run in Rigid Conduit. The form of rigid metal conduit now used almost exclusively, consists of plain iron gaspipe the interior surface of which has been prepared by removing the scale and by removing the irregularities, and which is then coated with flexible enamel. The outside of the pipe is given a thin coat of enamel in some cases, and, in other cases, is galvanized. Fig. 1 shows one make of enameled (unlined) conduit.



Fig. 1. Rigid Enameled Conduit, Unlined.
Courtesy of American Conduit Mfg. Co., Pittsburg, Pa.

Another form of rigid conduit is that known as the *armored conduit*, which consists of iron pipe with an interior lining of paper impregnated with asphaltum or similar compound. This latter form of conduit is now rapidly going out of use, owing to the unlined pipe being cheaper and easier to install, and owing also to improved methods of protecting the iron pipe from corrosion, and to the introduction of additional braid on the conductors, which partly compensates for the

pipe being unlined. The introduction of improved devices—such as outlet insulators, for protecting the conductors from the sharp edges of the pipe, at outlets, cut-out cabinets, etc.—also decreases the necessity of the additional protection afforded by the interior paper lining.

Rigid conduits are made in gaspipe sizes, from one-half inch to three inches in diameter. The following table gives the various data relating to rigid, enameled (unlined) conduit:

TABLE I
Rigid, Enameled Conduit—Sizes, Dimensions, Etc.

STANDARD PIPE SIZE	THICKNESS	NOMINAL WEIGHT PER 100 FEET	NUMBER OF THREADS PER INCH OF SCREW	ACTUAL OUTSIDE DIAMETER. INCHES	NOMINAL INSIDE DIAMETER. INCHES
$\frac{1}{2}$.109	84	14	.84	.62
$\frac{3}{4}$.113	112	14	1.05	.82
1	.134	167	11 $\frac{1}{2}$	1.31	1.04
1 $\frac{1}{4}$.140	224	11 $\frac{1}{2}$	1.66	1.38
1 $\frac{1}{2}$.145	268	11 $\frac{1}{2}$	1.90	1.61
2	.154	361	11 $\frac{1}{2}$	2.37	2.06
2 $\frac{1}{2}$.204	574	8	2.87	2.46
3	.217	754	8	3.50	3.06

Tables II, III, and IV give the various sizes of conductors that may be installed in these conduits. Caution must be exercised in

TABLE II
Single Wire in Conduit

SIZE WIRE, B. & S. G.	LORICATED CONDUIT, UNLINED; D. B. WIRE
No. 14-4	$\frac{1}{2}$ inch
" 2	$\frac{3}{4}$ "
" 1	$\frac{3}{4}$ "
" 0	$\frac{3}{4}$ inch or 1 "
" 00	1 "
" 000	1 "
" 0000	1 "
250,000 C. M.	1 $\frac{1}{4}$ "
300,000 C. M.	1 $\frac{1}{4}$ "
350,000 C. M.	1 $\frac{1}{4}$ "
400,000 C. M.	1 $\frac{1}{2}$ " or 1 $\frac{1}{2}$ "
450,000 C. M.	1 $\frac{1}{2}$ "
500,000 C. M.	1 $\frac{1}{2}$ "
600,000 C. M.	1 $\frac{1}{2}$ " or 2 "
700,000 C. M.	2 "
800,000 C. M.	2 "
900,000 C. M.	2 "
1,000,000 C. M.	2 " or 2 $\frac{1}{2}$ "
1,500,000 C. M.	2 $\frac{1}{2}$ "
1,700,000 C. M.	3 "
2,000,000 C. M.	3 "

TABLE III
Two Wires in One Conduit

SIZE WIRE, B. & S. G.		LORICATED CONDUIT, UNLINED; D. B. WIRE	
No. 14			$\frac{1}{2}$ inch.
" 12			$\frac{3}{4}$ " "
" 10		$\frac{1}{2}$ inch or	$\frac{3}{4}$ " "
" 8			1 " "
" 6			1 " "
" 5		1 " or	$1\frac{1}{4}$ " "
" 4			$1\frac{1}{2}$ " "
" 3			$1\frac{1}{2}$ " "
" 2		$1\frac{1}{2}$ " or	$1\frac{1}{2}$ " "
" 1			$1\frac{1}{2}$ " "
" 0			$1\frac{1}{2}$ " "
" 00		$1\frac{1}{2}$ " or	2 " "
" 000			2 " "
" 0000			2 " "
250,000 C. M.		2 " or	$2\frac{1}{2}$ " "
300,000 C. M.			$2\frac{1}{2}$ " "
350,000 C. M.			$2\frac{1}{2}$ " "
400,000 C. M.		$2\frac{1}{2}$ " or	3 " "
450,000 C. M.			3 " "
500,000 C. M.			3 " "
600,000 C. M.			3 " "
700,000 C. M.			3 " "

TABLE IV
Three Wires in One Conduit

SIZE WIRE, B. & S. G.		LORICATED TUBE, UNLINED; D. B. WIRE	
Outside	Center		
No. 14	No. 12		$\frac{3}{4}$ inch
" 12	" 10		$\frac{1}{2}$ " "
" 10	" 8		1 " "
" 8	" 6		1 " "
" 6	" 4		$1\frac{1}{4}$ " "
" 5	" 2		$1\frac{1}{4}$ " "
" 4	" 1	$1\frac{1}{4}$ inch or	$1\frac{1}{2}$ " "
" 3	" 0		$1\frac{1}{2}$ " "
" 2	" 2/0	$1\frac{1}{2}$ " or	2 " "
" 1	" 3/0		2 " "
" 0	" 4/0		2 " "
" 2/0	250 M.	2 " or	$2\frac{1}{2}$ " "
" 3/0	300 M.		$2\frac{1}{2}$ " "
" 4/0	400 M.		$2\frac{1}{2}$ " "
250 M.	450 M.	$2\frac{1}{2}$ " or	3 " "
250 M.	500 M.		3 " "
300 M.	600 M.		3 " "
350 M.	700 M.		3 " "
400 M.	800 M.		3 " "
450 M.	900 M.		3 " "

using these tables, for the reason that the sizes of conductors which may be safely installed in any run of conduit depend, of course, upon the length of and the number of bends in the run. The tables are based on average conditions where the run does not exceed 90 to 100 feet, without more than three or four bends, in the case of the smaller sizes of wires for a given size of conduit; and where the run does not exceed 40 to 50 feet, with not more than one or two bends, in the case of the larger sizes of wires, for the same sizes of conduit.

Unlined conduit can be bent without injury to the conduit, if the conduit is properly made and if proper means are used in making the bends. Care should be exercised to avoid flattening the tube as a result of making the bend over a sharp curve or angle.

In installing iron conduits, the conduits should cross sleepers or beams at right angles, so as to reduce the amount of cutting of the beams or sleepers to a minimum.

Where a number of conduits originate at a center of distribution, they should be run at right angles for a distance of two or three feet from the cut-out box, in order to obtain a symmetrical and workman-like arrangement of the conduits, and so as to have them enter the cabinet in a neat manner. While it is usual to use red or white lead at the joints of conduits in order to make them water-tight, this is frequently unnecessary in the case of enameled conduit, as there is often sufficient enamel on the thread to make a water-tight joint.

When iron conduits are installed in ash concrete, in Keene cement, or, in general, where they are subject in any way to corrosive action, they should be coated with asphaltum or other similar protective paint to prevent such action.

While the cost of circuit work run in iron conduits is usually greater than any other method of wiring, it is the most permanent and durable, and is strongly recommended where the first cost is not the sole consideration. This method of wiring should always be used in fireproof buildings, and also in the better class of frame buildings. It is also to be recommended for exposed work where the work is liable to disturbance or mechanical damage.

Wires Run in Flexible Metal Conduit. This form of conduit, shown in Fig. 2, is described by the manufacturers as a conduit composed of "concave and convex metal strips wound spirally upon each other in such a manner as to interlock several concave surfaces and

present their convex surfaces, both exterior and interior, thereby securing a smooth and comparatively frictionless surface inside and out."

The field for the use of this form of conduit is rapidly increasing. Owing to its flexibility, conduit of this type can be used in numerous cases where the rigid conduit could not possibly be employed. Its use is to be recommended above

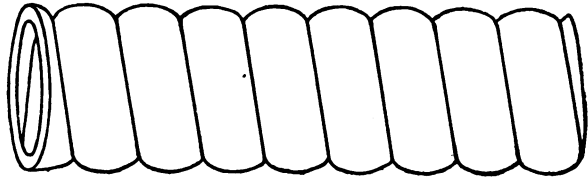

Fig. 2. Flexible Steel Conduit.
Courtesy of Sterling Electric Co., Troy, N. Y.

all the other forms of wiring, except that installed in rigid conduits. For new fireproof buildings, it is not so durable as the rigid conduit, because not so water-tight; and it is very difficult, if not impossible, to obtain as workmanlike a conduit system with the flexible as with the rigid type of conduit. For completed or old frame buildings, however, the use of the flexible conduit is superior to all other forms of wiring.

Table V gives the inside diameter of various sizes of flexible conduit, and the lengths of standard coils. The inside diameter of this conduit is the same as that of the rigid conduit; and the table given for the maximum sizes of conductors which may be installed in the various sizes of conduits, may be used also for flexible steel conduits, except that a little more margin should be allowed for flexible steel conduits than for the rigid conduits, as the stiffness of the latter makes it possible to pull in slightly larger sized conductors.

TABLE V
Greenfield Flexible Steel Conduit

INSIDE DIAMETER	APPROXIMATE FEET IN COIL
$\frac{3}{8}$ inch	200
"	200
"	100
"	50
1 "	50
$1\frac{1}{4}$ inches	50
$1\frac{1}{2}$ "	50
2 "	Random Lengths
$2\frac{1}{2}$ "	" "
3 "	" "

This conduit should, of course, be first installed without the conductors, in the same manner as the rigid conduit. Owing to the flexibility of this conduit, however, it is absolutely essential to fasten it securely at all elbows, bends, or offsets; for, if this is not done, considerable difficulty will be experienced in drawing the conductors in the conduit.

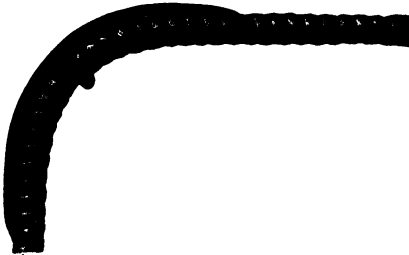

Fig. 3. Use of Elbow-Clamp for Fastening Flexible Conduit in Place.

The rules governing the installation of this conduit are the same as those covering rigid conduits. Double-braided conductors are required, and the conduit should be grounded

as required by the *Code Rules*. As already stated, the conduit should be securely fastened (in not less than three places) at all elbows; or else the special elbow clamp made for this purpose, shown in Fig. 3, should be used.

In order to cut flexible steel conduit properly, a fine hack saw should be employed. Outlet-boxes are required at all outlets, as well as bushing and wires to rigid conduit. Fig. 4 shows a coil of flexible steel conduit. Figs. 5, 6, and 7 show, respectively, an outlet box and cover, outlet plate, and bushing used for this conduit.

Armored Cable. There are many cases where it is impossible to install a conduit system. In such cases, probably the next best results may be obtained by the use of *steel armored cable*. The rules governing the installation of armored cable are given in the *National Electric Code*, under Section 24-A, and Section 48; also in 24-S. This cable is shown in Fig. 8.

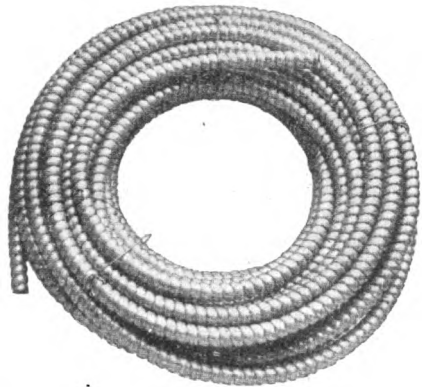

Fig. 4. A 100-Foot Coil of Flexible Steel Conduit. Courtesy of Sprague Electric Co., New York, N. Y.

Steel armored cable is made by winding formed steel strips over the insulated conductors. The steel strips are similar to those used

for the steel conduit. Care is taken in forming the cable, to avoid crushing or abraiding the insulation on the conductors as the steel

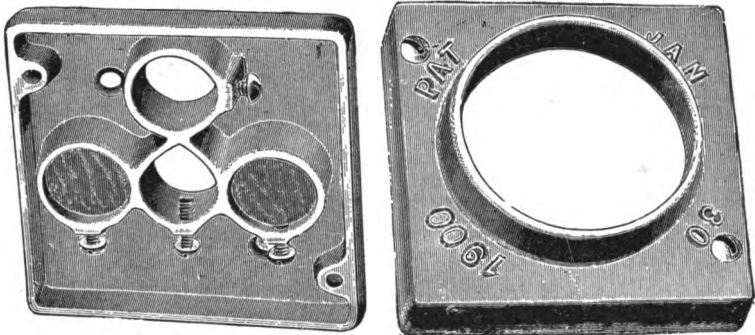

Fig. 5. Outlet Box for Flexible Steel Conduit.

strips are fed and formed over the same. In the process of manufacture, the spools of steel ribbon are of irregular length, and when a

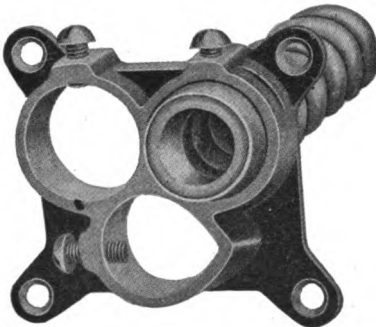

Fig. 6. Outlet Plate for Flexible Steel Conduit.

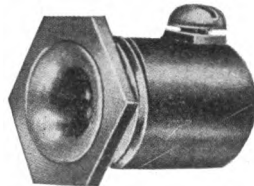

Fig. 7. Outlet Bushing.
Courtesy of Sprague Electric Co., New York, N. Y.

spool is empty, the machine is stopped, and the ribbon is started on the next spool, the process being continued. There is no reason why



Fig. 8. Flexible Armored Cable. Twin Conductors.
Courtesy of Sprague Electric Co., New York, N. Y.

the conduit cables could not be made of any length; but their actual lengths as made are determined by convenience in handling. Armored

cable is made in *single conductors* from No. 1 to No. 10 B. & S. G.; in *twin conductors*, from No. 6 to No. 14 B. & S. G.; and *three-conductor* cable, from No. 10 to No. 14 B. & S. G. Table VI gives various data relating to armored conductors:

TABLE VI
Armored Conductors—Types, Dimensions, Etc.

SIZE B. & S GAUGE	TYPE AND NUMBER OF CONDUCTORS	OUTSIDE DIAMETER (INCHES)
No. 14	BX twin conductor	.63
" 12	" " "	.685
" 10	" " "	.725
" 8	" " "	.875
" 6	" " "	1.3125
" 14	BM twin conductor (for marine work—ship wiring)	.725
" 12	" " "	.725
" 10	" " "	.73
" 14	BX3 three conductor	.71
" 12	" " "	.725
" 10	" " "	.73
" 14	BXL twin conductor, leaded	.725
" 12	" " " "	.725
" 10	" " " "	.87
" 14	BXL3 three conductor, leaded	.90
" 12	" " " "	.90
" 10	" " " "	.94
" 10	Type D single conductor, stranded	.550
" 8	" " " " "	.550
" 6	" " " " "	.575
" 4	" " " " "	.700
" 2	" " " " "	.900
" 1	" " " " "	.965
" 10	Type DL single conductor, stranded, leaded	.625
" 8	" " " " " "	.710
" 6	" " " " " "	.700
" 4	" " " " " "	.760
" 2	" " " " " "	.920
" 1	" " " " " "	.910
STEEL ARMORED FLEXIBLE CORD		
" 18	Type E twin conductor	.40
" 16	" " " "	.40
" 14	" " " "	.47
" 18	Type EM twin conductor, re-inforced	.575
" 16	" " " "	.585
" 14	" " " "	.595

In Table VI, Types D (single), BX (twin), and BX3 (3 conduc-

tors) are armored cable adapted for ordinary indoor work. Type BM (twin conductors) is adapted for marine wiring. Types DL (single), BXL (twin), and BXL 3 (3 conductors) have the conductors lead-encased, with the steel armor outside, and are especially adapted for damp places, such as breweries, stables, and similar places.

Type E is used for flexible-cord pendants, and is suitable for factories, mills, show windows, and other similar places. Type EM is the same as Type E; but the flexible cord is reinforced, and is suitable for marine work, for use in damp places, and in all cases where it will be subject to very rough handling.

While this form of wiring has not the advantage of the conduit system—namely, that the wires can be withdrawn and new wires inserted without disturbing the building in any way whatever—yet it has many of the advantages of the flexible steel conduit, and it has some additional advantages of its own. For example, in a building already erected, this cable can be fished between the floors and in the partition walls, where it would be impossible to install either rigid conduit or flexible steel conduit without disturbing the floors or walls to an extent that would be objectionable.

Armored conductors should be continuous from outlet to outlet, without being spliced and installed on the loop system. Outlet boxes should be installed at all outlets, although, where this is impossible, outlet plates may be used under certain conditions. Clamps should be provided at all outlets, switch-boxes, junction-boxes, etc., to hold the cable in place, and also to serve as a means of grounding the steel sheathing.

Armored cable is less expensive than the rigid conduit or the flexible steel conduit, but more expensive than cleat wiring or knob and tube wiring, and is strongly recommended in preference to the latter.

WIRES RUN IN MOULDING

Moulding is very extensively used for electric circuit work, in extending circuits in buildings which have already been wired, and also in wiring buildings which were not provided with electric circuit work at the time of their erection. The reason for the popularity of moulding is that it furnishes a convenient and fairly good-looking runway for the wires, and protects them from mechanical injury.

It seems almost unwise to place conductors carrying electric current, in wood casing; but this method is still permitted by the *National Electric Code*, although it is not allowed in damp places or in places

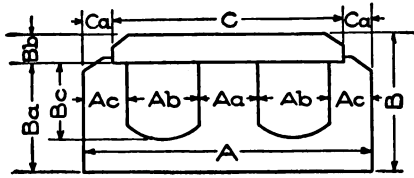

Fig. 9. Two-Wire Wood Moulding.

where there is liability to dampness, such as on brick walls, in cellars, etc.

The dangers from the use of moulding are that if the wood becomes soaked with water, there will be a liability to leakage

of current between the conductors run in the grooves of the moulding, and to fire being thereby started, which may not be immediately discovered. Furthermore, if the conductors are overloaded, and consequently overheated, the wood is likely to become charred and finally ignited. Moreover, the moulding itself is always a temptation as affording a good "round strip" in which to drive nails, hooks, etc. However, the convenience and popularity of moulding cannot be denied; and until some better substitute is found, or until its use is forbidden by the *Rules*, it will continue to be used to a very great extent for running circuits outside of the walls and on the ceilings of existing buildings. Figs. 9, 10, 11, and 12 show two- and three-wire moulding respectively; and Table VII gives complete data as to sizes of the moulding required for various sizes of conductors.

While the *Rules* recommend the use of hardwood moulding, as a matter of fact probably 90 per cent of the moulding used is of white-wood or other similar cheap, soft wood. Georgia pine or oak ordinarily

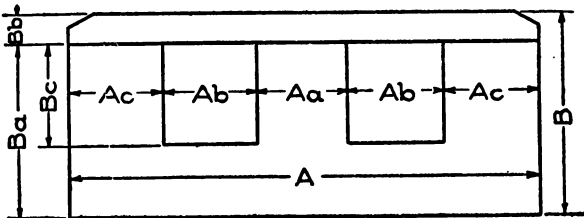

Fig. 10. Two-Wire Wood Moulding.

costs about twice as much as the soft wood. In designing moulding work, if appearance is of importance, the moulding circuits should be laid out so as to afford a symmetrical and complete design. For

example, if an outlet is to be located in the center of the ceiling, the moulding should be continued from wall to wall, the portion beyond the outlet, of course, having no conductors inside of the moulding. If four outlets are to be placed on the ceiling, the rectangle of moulding should be completed on the fourth side, although, of course, no con-

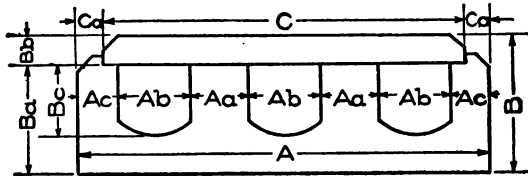

Fig. 11. Three-Wire Wood Moulding.

ductors need be placed in this portion of the moulding. Doing this increases the cost but little and adds greatly to the appearance.

Moulding is frequently used in combination with other methods of wiring, including armored cable, flexible steel tubing, and fibrous tubing. In many instances, it is possible to fish tubing between beams or studs running in a certain direction; but when the conductors are to run in another direction or at right angles to the beams or studs, exposed work is necessary. In such cases, a junction-box or outlet-box must be placed at the point of connection between the moulding and the armored cable or steel tubing.

Where circuits are run in moulding, and pass through the floor, additional protection must be provided, as required by the *Code Rules*,

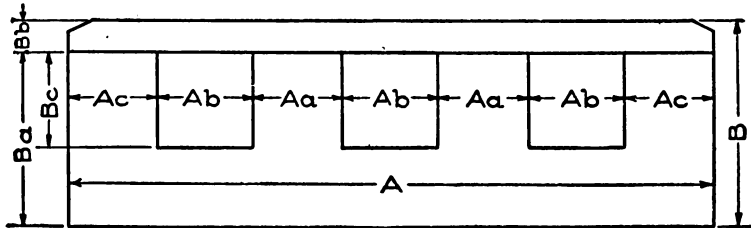

Fig. 12. Three-Wire Wood Moulding.

to protect the moulding. As a rule, it is better to use conduit for all portions of moulding within six feet of the floor, so as to avoid the possibility of injury to the circuits. Where a combination of iron conduit or flexible steel tubing is used with moulding, it is well to use double-braided conductors throughout, because, although only single-

TABLE VII

Sizes of Mouldings Required for Various Sizes of Conductors

FIG. No.	TYPE OF Moulding	NUMBER OF WIRES	MAXIMUM SIZE OF WIRE BAND S. GAUGE		DIMENSIONS IN INCHES										
			SOLID	STRANDED	A	Aa	Ab	Ac	B	Ba	Bb	Bc	C	Ca	
9	A-2	2	12	14	$\frac{1}{2}$	$\frac{1}{2}$	$\frac{1}{4}$	$\frac{1}{4}$	$\frac{27}{32}$	$\frac{5}{8}$	$\frac{7}{32}$	$\frac{1}{4}$	$\frac{1}{8}$	$\frac{3}{16}$	
9	A-4	2	8	10	$\frac{11}{16}$	$\frac{1}{2}$	$\frac{5}{16}$	$\frac{9}{32}$	$\frac{29}{32}$	$\frac{11}{16}$	$\frac{7}{32}$	$\frac{5}{16}$	$\frac{5}{16}$	$\frac{3}{16}$	
9	A-6	2	4	5	2	$\frac{1}{2}$	$\frac{7}{16}$	$\frac{5}{16}$	$\frac{1}{16}$	$\frac{13}{16}$	$\frac{1}{4}$	$\frac{7}{16}$	$\frac{9}{16}$	$\frac{7}{32}$	
9	A-8	2	1	2	$2\frac{3}{8}$	$\frac{1}{2}$	$\frac{9}{16}$	$\frac{3}{8}$	$\frac{1}{16}$	$\frac{15}{16}$	$\frac{1}{4}$	$\frac{9}{16}$	$\frac{13}{16}$	$\frac{9}{32}$	
9	A-9	2	-	3/0	3	$\frac{5}{8}$	$\frac{3}{4}$	$\frac{7}{16}$	$\frac{13}{32}$	$\frac{1}{8}$	$\frac{9}{32}$	$\frac{3}{4}$	$2\frac{7}{16}$	$\frac{9}{32}$	
10	A-10	2	-	250000 C.M.	$3\frac{15}{16}$	$\frac{11}{16}$	$\frac{7}{8}$	$\frac{3}{4}$	$\frac{1}{16}$	$\frac{3}{8}$	$\frac{5}{16}$	$\frac{7}{8}$	-	-	
10	A-11	2	-	400000 C.M.	$4\frac{7}{8}$	$\frac{15}{16}$	1	$\frac{31}{32}$	$2\frac{3}{16}$	$\frac{17}{8}$	$\frac{5}{16}$	1	-	-	
11	B-2	3	12	14	$2\frac{3}{16}$	$\frac{7}{16}$	$\frac{1}{4}$	$\frac{9}{32}$	$\frac{27}{32}$	$\frac{5}{8}$	$\frac{7}{32}$	$\frac{1}{4}$	$\frac{13}{16}$	$\frac{3}{16}$	
11	B-4	3	8	10	$2\frac{1}{2}$	$\frac{15}{32}$	$\frac{5}{16}$	$\frac{5}{16}$	$\frac{29}{32}$	$\frac{11}{16}$	$\frac{7}{32}$	$\frac{5}{16}$	$2\frac{1}{8}$	$\frac{3}{16}$	
11	B-6	3	4	5	$2\frac{7}{8}$	$\frac{13}{32}$	$\frac{7}{16}$	$\frac{3}{8}$	$\frac{1}{16}$	$\frac{13}{16}$	$\frac{1}{4}$	$\frac{7}{16}$	$2\frac{3}{8}$	$\frac{1}{4}$	
11	B-8	3	1	2	$3\frac{5}{8}$	$\frac{19}{32}$	$\frac{9}{16}$	$\frac{3}{8}$	$\frac{1}{16}$	$\frac{15}{16}$	$\frac{1}{4}$	$\frac{9}{16}$	$3\frac{1}{16}$	$\frac{9}{32}$	
11	B-9	3	-	3/0	$4\frac{5}{16}$	$\frac{9}{16}$	$\frac{3}{4}$	$\frac{15}{32}$	$\frac{13}{32}$	$\frac{1}{8}$	$\frac{9}{32}$	$\frac{3}{4}$	$3\frac{3}{4}$	$\frac{9}{32}$	
12	B-10	3	-	250000 C.M.	$5\frac{1}{2}$	$\frac{23}{32}$	$\frac{7}{8}$	$\frac{23}{32}$	$\frac{11}{16}$	$\frac{3}{8}$	$\frac{5}{16}$	$\frac{7}{8}$	-	-	
12	B-11	3	-	400000 C.M.	$6\frac{3}{4}$	$\frac{15}{16}$	1	$\frac{15}{16}$	$2\frac{3}{16}$	$\frac{7}{8}$	$\frac{5}{16}$	1	-	-	

braided conductors are required with moulding, double-braided conductors are required with unlined conduit, and if double-braided conductors were not used throughout, it would be necessary to make a joint at the outlet-box where the moulding stopped and the conduit work commenced. Where the conductors pass through floors, in moulding work, and where iron conduit is used, the inspection authorities, in order to protect the wire, usually require that a fibrous tubing be used as additional protection for the conductors inside of the iron pipe, although, if double-braided wire is used, this will not usually be required. Fig. 13 shows a fuseless cord rosette for use with moulding work. Fig. 14 shows a device for making a tap in moulding wiring.

Moulding work, under ordinary conditions, costs about one-half as much as circuit run in rigid conduit, and about 75 per cent, under

ordinary conditions, of the cost of armored cable. Where the latter method of wiring or the conduit system can be employed, one or the other of these two methods should be used in preference to moulding,

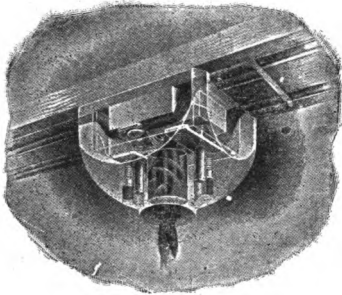

Fig. 13. Fuseless Cord
Rosette.
Courtesy of Crouse-Hinds Co.,
Syracuse, N. Y.

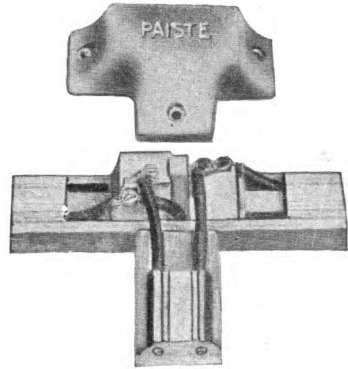

Fig. 14. Device for Making "Tap" in
Moulding.
Courtesy of H. T. Paiste Co.,
Philadelphia, Pa.

as the work is not only more substantial, but also safer. Various forms of metal moulding have been introduced, but up to the present time have not met with the success which they deserve.

CONCEALED KNOB AND TUBE WIRING

This method of wiring is still allowed by the *National Electric Code*, although many vigorous attempts have been made to have it abolished. Each of these attempts has met with the strongest opposition from contractors and central stations, particularly in small towns and villages, the argument for this method being, that it is the cheapest method of wiring, and that if it were forbidden, many places which are wired according to this method would not be wired at all, and the use of electricity would therefore be much restricted, if not entirely done away with, in such communities. This argument, however, is only a temporary makeshift obstruction in the way of inevitable progress, and in a few years, undoubtedly, the concealed knob and tube method will be forbidden by the *National Electric Code*.

The cost of wiring according to this method is about one-third of the cost of circuits run in rigid conduit, and about one-half of the cost of circuits run in armored cable. The latter method of wiring

is rapidly replacing knob and tube wiring, and justly so, wherever the additional price for the latter method of wiring can be obtained. As the name indicates, this method of wiring employs *porcelain knobs*

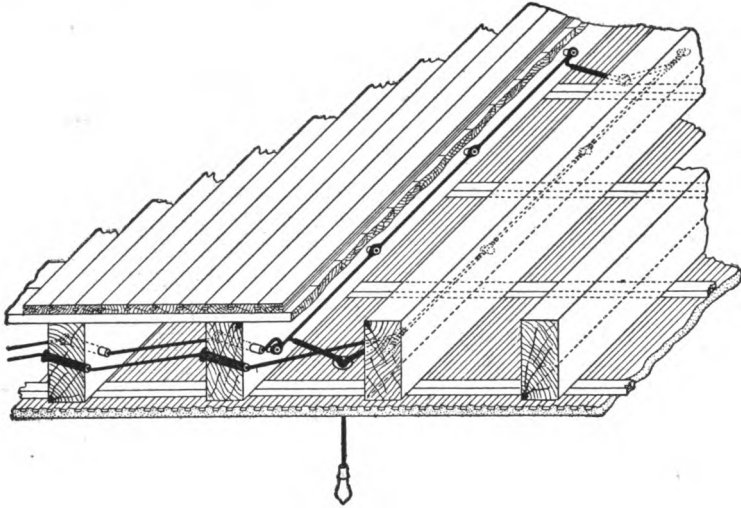

Fig. 15. Knob and Tube Wiring.

and tubes, the circuit work being run *concealed* between the floor beams and studs of a frame building. The knobs are used when the circuits run parallel to the floor beams; and the porcelain tubes are used when the circuits are run at right angles to the floor beams.

Fig. 15 shows an example of knob and tube wiring. In concealed knob and tube wiring, the wires must be separated at least five inches from one another, and at least one inch from the surface wired over, that is, from the beams, flooring, etc., to which the insulator is fastened. Fig. 16 shows a good type of porcelain knob for this class of wiring. For knob and tube wiring, it will be noted that, owing to the fact that the wiring is concealed, the conductors

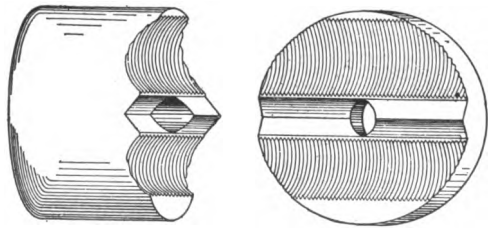

Fig. 16. Porcelain Knob.

must be kept further apart than in the case of exposed or open wiring on insulators, where, except in damp places, the wires may be run on cleats or on insulators only one-half inch from the surface wired over,

Fibrous Tubing. Fibrous tubing is frequently used with knob and tube wiring, and the regulations governing its use are given in Rule 24, Section S, of the *National Electric Code*. This tubing, as stated in this *Rule*, may be used where it is impossible and impracticable to employ knobs and tubes, provided the difference in potential between the wires is not over 300 volts, and if the wires are not sub-

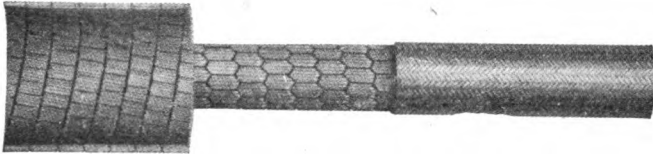

Fig. 17. Flexible Tubing, "Flexduct" Type.
Courtesy of National Metal Molding Co., Pittsburg, Pa.

ject to moisture. The cost of wiring in flexible fibrous tubing is approximately about the same as the cost of knob and tube wiring. Duplex conductors, or two wires together are not allowed in fibrous tubing.

Fibrous tubing is required at all outlets where conduit or armored cable is not used (as in knob and tube wiring); and, as required by the *Rules*, it must extend back from the last porcelain support to one inch beyond the outlet. Fig. 17 shows one make of fibrous tubing.

Table VIII gives the maximum sizes of conductors (double-braided) which may be installed in fibrous conduit.

TABLE VIII
Sizes of Conductors in Fibrous Conduit

OUTSIDE DIAMETER	INSIDE DIAMETER	ONE WIRE IN TUBE
1 7/8 inch	1 inch	No. 12
1 7/8 "	1 "	" 8
1 7/8 "	1 "	" 6
1 7/8 "	1 "	" 4
1 7/8 "	1 "	" 3
1 7/8 "	1 "	" 2
1 7/8 "	1 "	" 1
1 7/8 "	1 "	" 2/0
1 7/8 "	1 "	250,000 C. M.
1 7/8 "	1 1/4 "	400,000 C. M.
1 7/8 "	1 1/2 "	750,000 C. M.
1 7/8 "	1 3/4 "	1,000,000 C. M.
2 "	2 "	1,500,000 C. M.
2 "	2 1/4 "	2,000,000 C. M.

WIRES RUN EXPOSED ON INSULATORS

This method of wiring has the advantages of cheapness, durability, and accessibility.

Cheapness. The relative cost of this method of wiring as compared with that of the concealed conduit system, is about fifty per cent of the latter if rubber-covered conductors are used, and about forty per cent of the latter if weatherproof slow-burning conductors are used. As the *Rules* of the Fire Underwriters allow the use of weatherproof slow-burning conductors in dry places, considerable saving may be effected by this method of wiring, provided there is no objection to it

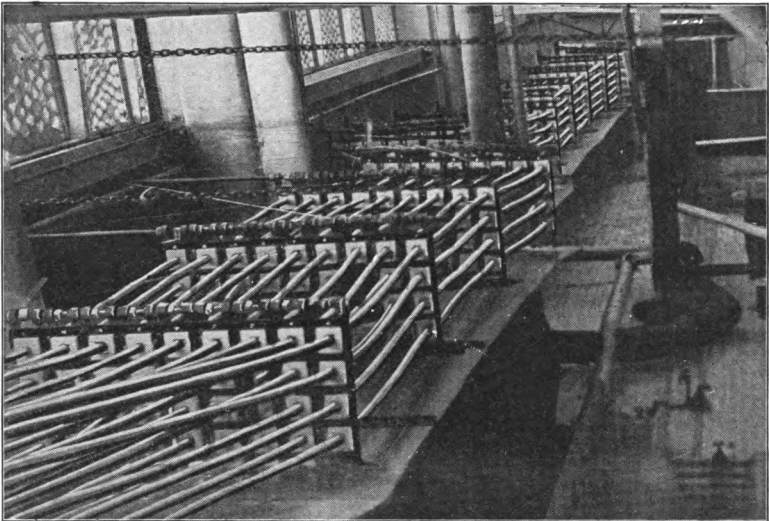

Fig. 18. Large Feeders Run Exposed on Insulators.

from the standpoint of appearance, and also provided that it is not liable to mechanical injury or disarrangement.

Durability. It is a well-known fact that rubber insulation has a relatively short life. Inasmuch as in this method of wiring, the insulation does not depend upon the insulation of the conductors, but on the insulators themselves, which are of glass or porcelain, this system is much more desirable than any of the other methods. Of course, if the conductors are mechanically injured, or the insulators broken, the insulation of the system is reduced; but there is no gradual deterioration as there is in the case of other methods of wiring, where

rubber is depended upon for insulation. This is especially true in hot places, particularly where the temperature is 120° F. or above. For such cases, the weatherproof slow-burning conductors on porcelain or glass insulators are especially recommended.

Accessibility. The conductors being run exposed, they may be readily repaired or removed, or connections may be made to the same.

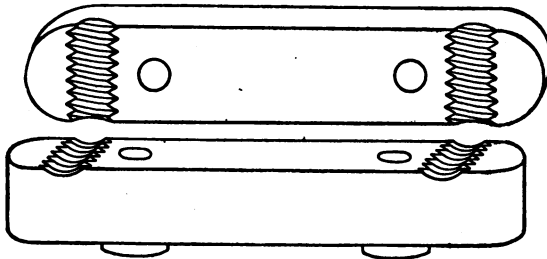

Fig. 19. Two-Wire Cleat.

This method of wiring is especially recommended for mills, factories, and for large or long feeder conductors. Fig. 18 shows examples of exposed large feeder con-

ductors, installed in the New York Life Insurance Building, New York City. For small conductors, up to say No. 6 B. & S. Gauge each, porcelain cleats may be used to support one, two, or three conductors, provided the distance between the conduc-

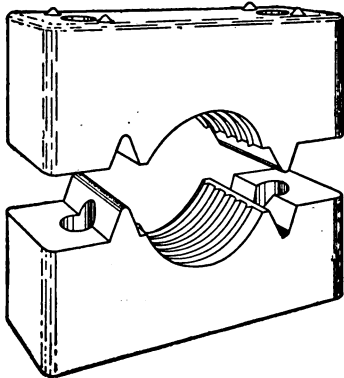

Fig. 20. One-Wire Cleat.

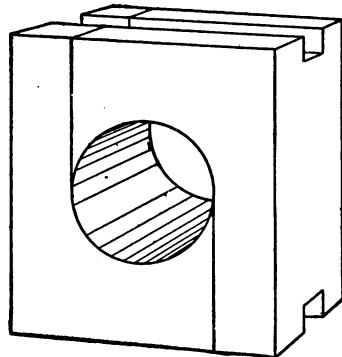

Fig. 21. Porcelain Insulator for Large Conductors.

tors is at least $2\frac{1}{2}$ inches in a two-wire system, and $2\frac{1}{2}$ inches between the two outside conductors in a three-wire system where the potential between the outside conductors is not over 300 volts. The cleat must hold the wire at least one-half inch from the surface to which the cleat is fastened; and in damp places the wire must be held at least one inch from the surface wired over. For larger conductors,

from No. 6 to No. 4/0 B. & S. Gauge, it is usual to use single porcelain cleats or knobs. Figs. 19 and 20 show a good form of two-wire

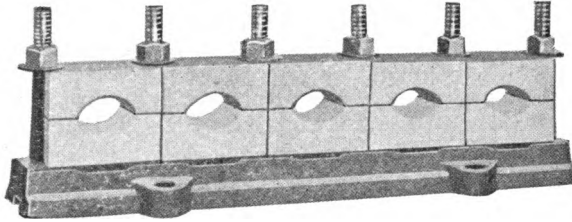

Fig. 22. Iron Rack and Insulators for Large Conductors.
Courtesy of General Electric Co., Schenectady, N. Y.

cleat and single-wire cleat, respectively.

For large feeder or main conductors from No. 4/0 B. & S. Gauge upward, a more substantial form of porcelain insulator should be used, such as shown in Fig. 21. These insulators are held in iron racks or angle-iron frames, of which two forms are shown in Figs. 22 and 23. The latter form of rack is particularly desirable for heavy conductors and where a number of conductors are run together. In this form of rack, any length of conductor can be removed without disturbing the other conductors.

As a rule, the porcelain insulators should be placed not more than $4\frac{1}{2}$ feet apart; and if the wires are liable to be disturbed, the distance between supports should be shortened, particularly for small conductors. If the beams are so far apart that supports cannot be obtained every $4\frac{1}{2}$ feet, it is necessary to provide a running board as shown in Fig. 24, to which the porcelain cleats and knobs can be fastened. Figs. 25 and 26 show two methods of supporting small conductors. For conductors of No. 8 B. & S.

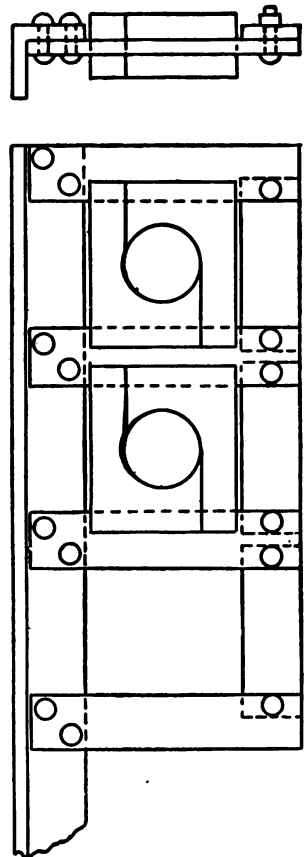

Fig. 23. Elevation and Plan of Insulators Held in Angle-Iron Frames.

Gauge, or over, it is not necessary to break around the beams, provided they are not liable to be disturbed; but the supports may be placed on each beam.

Where the distance between the supports, however, is greater than $4\frac{1}{2}$ feet, it is usually necessary to provide intermediate supports, as shown in

Fig. 27, or else to provide a running-board. Another method which may be used, where beams are further than $4\frac{1}{2}$ feet apart, is to

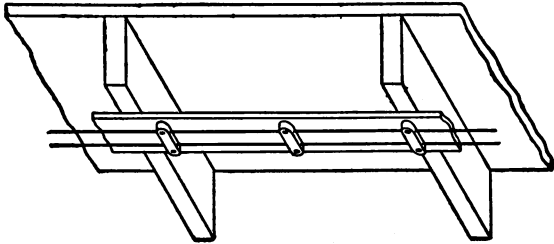

Fig. 24. Insulators Mounted on Running-Board across Wide-Spaced Beams.

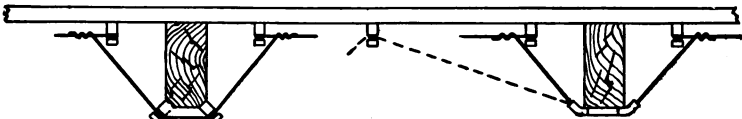

Fig. 25. Method of Supporting Small Conductors.

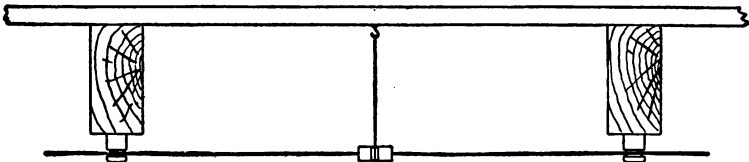

Fig. 27. Intermediate Support for Conductor between Wide-Spaced Beams.

run a main along the wall at right angles to the beams, and to have the individual circuits run between and parallel to the beams.

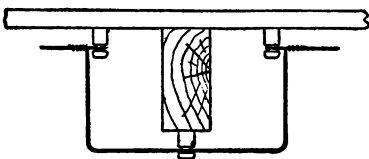

Fig. 26. Method of Supporting a Small Conductor.

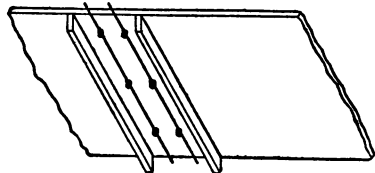

Fig. 28. Conductors Protected by Wooden Guard-Strips on Low Ceiling.

In low-ceiling rooms, where the conductors are liable to injury, it is usually required that a wooden guard strip be placed on each side of the conductors, as shown in Fig. 28.

Where the conductors pass through partitions or walls, they must

be protected by porcelain tubes, or, if the conductors be of rubber, by means of fibrous tubing placed inside of iron conduits.

All conductors on the walls for a height of not less than six feet from the ground, either should be boxed in, or, if they be rubber-covered, should (preferably) be run in iron conduits; and in conductors having single braid only, additional protection should be provided by means of flexible tubing placed inside of the iron conduit.

Where conductors cross each other, or where they cross iron pipes, they should be protected by means of porcelain tubes fastened with tape or in some other substantial manner that will prevent the tubes from slipping out of place.

TWO-WIRE AND THREE-WIRE SYSTEMS

As both the two-wire and the three-wire system are extensively used in electric wiring, it will be well to give some consideration to the advantages and disadvantages of each system, and to explain them somewhat in detail.

Relative Advantages. The choice of either a two-wire or a three-wire system depends largely upon the source of supply. If, for example, the source of supply will always probably be a 120-volt, two-wire system, there would be no object in installing a three-wire system for the wiring. If, on the other hand, the source of supply is a 120-240-volt system, the wiring should, of course, be made three-wire. Furthermore, if at the outset the supply were two-wire, but with a possibility of a three-wire system being provided later, it would be well to adapt the electric wiring for the three-wire system, making the neutral conductor twice as large as either of the outside conductors, and combining the two outside conductors to make a single conductor until such time as the three-wire service is installed. Of course, there would be no saving of copper in this last-mentioned three-wire system, and in fact it would be slightly more expensive than a two-wire system, as will be shortly explained.

The object of the three-wire system is to reduce the amount of copper—and consequently the cost of wiring—necessary to transmit a given amount of electric power. As a rule, the proposition is usually one of lighting and not of power, for the reason that by means of the three-wire system we are able to increase the potential at which the current is transmitted, and at the same time to take advantage of the

greater efficiency of the lower voltage lamp. If current for power (motors, etc.) only were to be transmitted, it would be a simple matter to wind the motors, etc., for a higher voltage, and thereby reduce the weight of copper.

If, however, we increase the voltage of lamps, we find that they are not so efficient, nor is their life so long. With the standard carbon

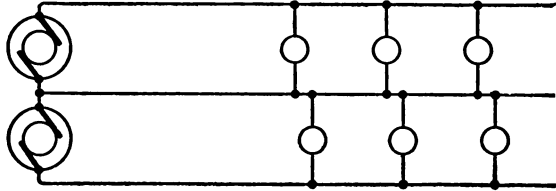

Fig. 29. Three-Wire System, with Neutral Conductor between the Two Outside Conductors.

lamp, it has been found that the 240-volt lamp, with the same life, requires about 10 to 12 per cent more current than the corresponding 120-volt lamp. Furthermore, in the case of the more efficient lamps recently introduced (such as the Tantalum lamp, Tungsten lamp, etc.), it has been found impracticable, if not impossible, to make them for pressures above 125 volts. For this reason the three-wire system is employed, for by this method we can use 240 volts across the outside conductors, and by the use of a neutral conductor obtain 120 volts between the neutral and the outside conductor, and thereby be enabled to use 120-volt lamps. Furthermore, if a 240-volt lamp should ever be placed on the market that was as economical as the lower voltage lamp, the result would be that the 240-480-volt system would be introduced, and 240-volt lamps used.

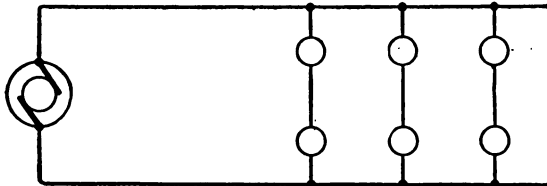

Fig. 30. Lamps Arranged in Pairs in Series, Dispensing with Necessity for Third or Neutral Conductor.

As a matter of fact, this has been tried in several cities—and particularly in Providence, Rhode Island. As a rule, however, the 120-volt lamp has been found so much more satisfactory as regards life, efficiency, etc., that it is nearly always employed.

The two-wire system is so extremely simple that no explanation whatever is required concerning it.

The three-wire system, however, is somewhat confusing, and will now be considered.

Details of Three-Wire System. The three-wire system may be considered as a two-wire system with a third or neutral conductor placed between the two outside conductors, as shown in Fig. 29. This neutral conductor would not be required if we could always have the lamps arranged in pairs, as shown in Fig. 30. In this case, the two lamps would burn in series, and we could transmit the current at double the usual voltage, and thereby supply twice the number of lamps with one-quarter the weight of copper, allowing the same loss in pressure in the lamps. The reason for this is, that, having the lamps arranged in series of pairs, we reduce the current to one-half, and, as the pressure at which the current is transmitted is doubled, we can again reduce the copper one-half without increasing the loss in lamps. We therefore see that we have a double saving, as the current is reduced one-half, which reduces the weight of copper one-half, and we can again reduce the copper one-half by doubling the loss in volts without increasing the percentage loss. For example, if in one case we had a straight two-wire system transmitting current to 100 lamps at a potential of 100 volts, and this system were replaced by one in which the lamps were placed in series of pairs, as shown in Fig. 30, and the potential increased to 200 volts—100 lamps still being used—we should find, in the latter case, that we were carrying current really for only 50 lamps, as we would require only the same amount of current for two lamps now that we required for one lamp before. Furthermore, as the potential would now be 200 instead of 100 volts, we could allow twice as much loss as in the first case, because the loss would now be figured as a percentage of 200 volts instead of a percentage of 100 volts. From this, it will readily be seen that in the second case mentioned, we would require only one-quarter the weight of copper that would be required in the first case.

It will readily be seen, however, that a system such as that outlined in the second scheme having two lamps, would be impracticable for ordinary purposes, for the reason that it would always require the lamps to be burned in pairs. Now, it is for this very reason that the third or neutral conductor is required; and, if this conductor be added, it will no longer be necessary to burn the lamps in pairs. This, then, is the object of the three-wire system—to enable us to reduce the amount of copper required for transmitting current, without increasing the electric pressure employed for the lamps.

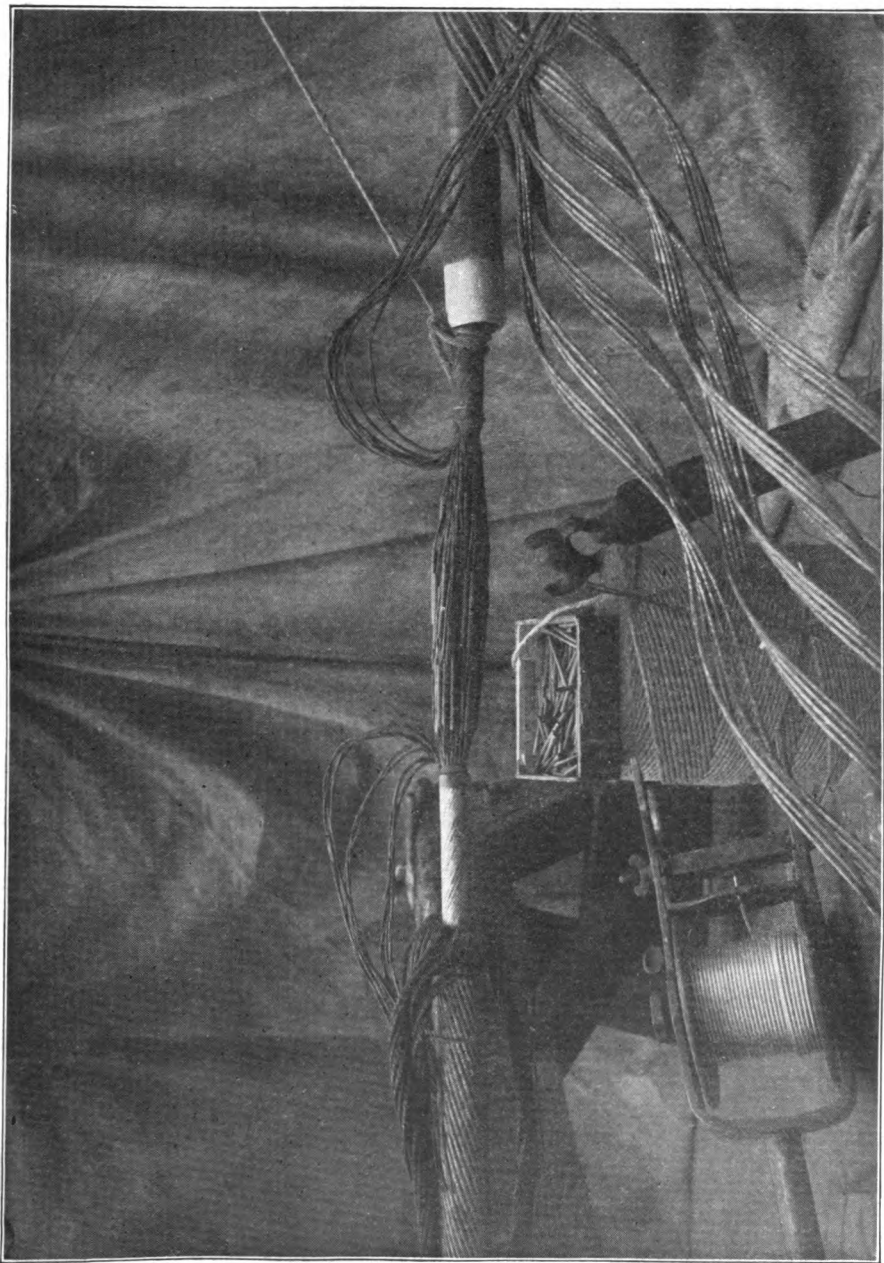

**SPLICING A 50-PAIR, PAPER-INSULATED, NO. 19 B. & S. GAUGE-ARMORED SUBMARINE CABLE
ACROSS SAN FRANCISCO BAY**

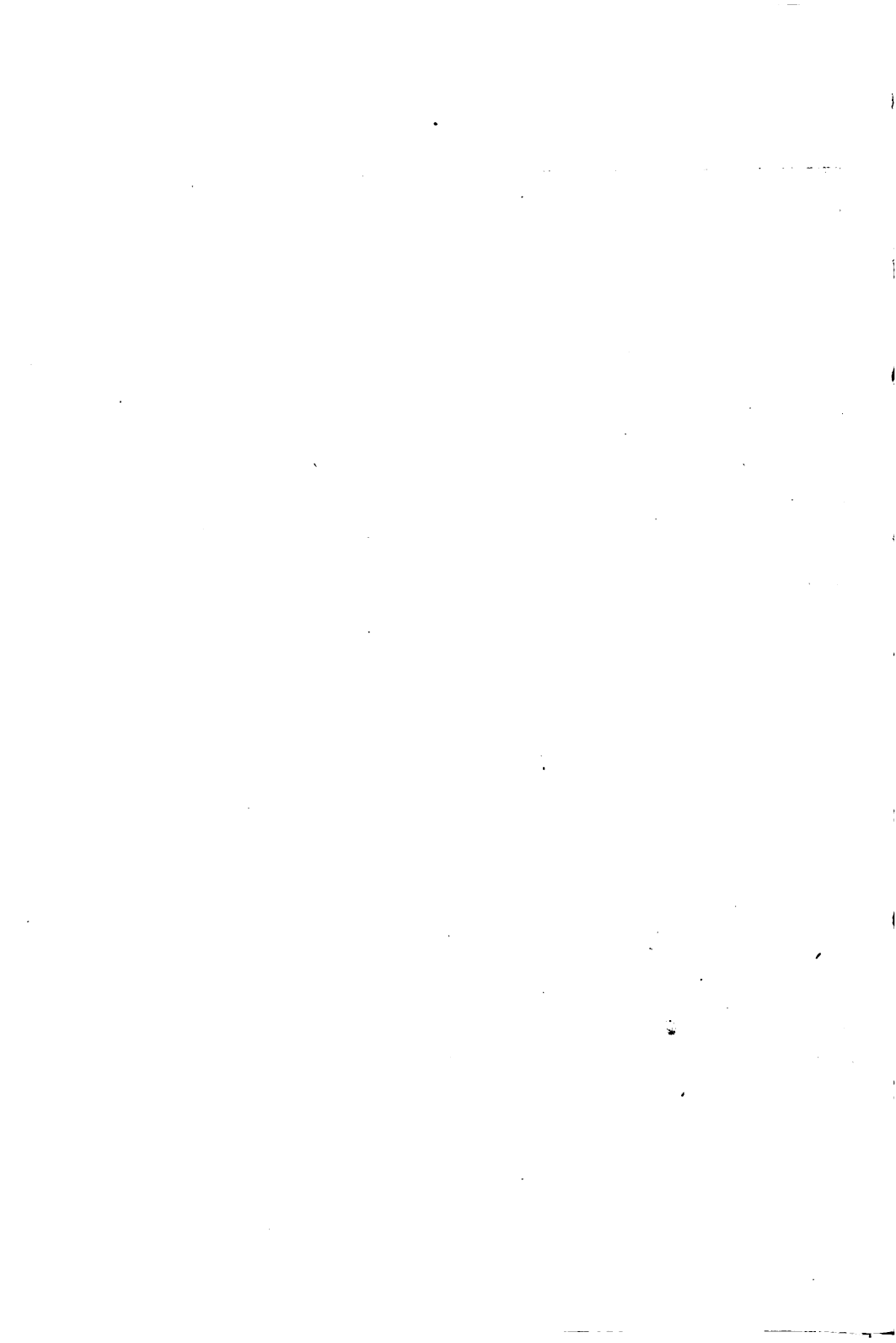

With regard to the size of the neutral conductor, one important point must be borne in mind; and that is, that the *Rules of the National Electric Code* require the neutral conductor in all interior wiring to be made at least as large as either of the two outside conductors. The reasons for this from a fire standpoint are obvious, because, if for any reason either of the outside conductors became disconnected, the neutral wire might be required to carry the same current as the outside conductors, and therefore it should be of the same capacity. Of course, the chances of such an event happening are slight; but, as the fire hazard is all-important, this rule must be complied with for interior wiring or in all cases where there would be a probability of fire. For outside or underground work, however, where the fire hazard would be relatively unimportant, the neutral conductor might be reduced in size; and, as a matter of fact, it is made smaller than the outside conductors.

The three-wire system is sometimes installed where it is desired to use the system as a two-wire, 125-volt system, or to have it arranged so that it may be used at any time also as a three-wire, 125-250-volt system. Of course, in order to do this, it is necessary to make the neutral conductor equal to the combined capacity of the outside conductors, the latter being then connected together to form one conductor, the neutral being the return conductor. This system is not recommended except in such instances, for example, as where an isolated plant of 125 volts is installed, and where there is a possibility of changing over at some future time to the three-wire, 125-250-volt system. In such a case as this, however, it would be better, where possible, to design the isolated plant for a three-wire, 125-250-volt system originally, and then to make the neutral conductor the same size as each of the two outside conductors.

The weight of copper required in a three-wire system where the neutral conductor is the same size as either of the two outside conductors, is $\frac{2}{3}$ of that required for a corresponding two-wire system using the same voltage of lamps.* It is obvious that this is true, because,

*NOTE.—If, in the two-wire system, we represent the weight of each of the two conductors by $\frac{1}{2}$, the weight of each of the outside conductors in a three-wire system would be represented by $\frac{1}{3}$; and if we had three conductors of the same size, we would have $\frac{1}{3} + \frac{1}{3} + \frac{1}{3} = \frac{1}{1}$ of the weight of copper required in a three-wire system, which would be required in a corresponding two-wire system having the same percentage of loss and using the same voltage of lamps.

If the neutral conductor were made $\frac{1}{2}$ of the size of each of the outside conductors, $\frac{2}{3}$ is sometimes done in underground work, the total weight of copper required would be $\frac{1}{3} + \frac{1}{3} + \frac{1}{2} = \frac{2}{3}$ of that required in the corresponding two-wire system.

as the discussion proved concerning the arrangement shown in Fig. 30, where the lamps were placed in series of pairs, we found that the weight of copper for the two conductors was one-quarter the weight of the regular two-wire system. It is then of course true, that, if we had another conductor of the same size as each of the outside conductors, we increase the weight of copper one-half, or one-quarter plus one-half of one-quarter—that is, three-eighths.

In the three-wire system frequently used in isolated plants in which the two outside conductors are joined together and the neutral conductor made equal to their combined capacity, there is no saving of copper, for the reason that the same voltage of transmission is used, and, consequently, we have neither reduced the current nor increased the potential. Furthermore, though the weight of copper is the same, it is now divided into three conductors, instead of two, and naturally it costs relatively more to insulate and manufacture three conductors than to insulate and manufacture two conductors having the same total weight of copper. As a matter of fact, the three-wire system, having the neutral conductor equal to the combined capacity of the two outside ones, the latter being joined together, is about 8 to 10 per cent more expensive than the corresponding straight two-wire system.

In interior wiring, as a rule, where the three-wire system is used for the mains and feeders, the two-wire system is nearly always employed for the branch circuits. Of course, the two-wire branch circuits are then balanced on each side of the three-wire system, so as to obtain as far as possible at all times an equal balance on the two sides of the system. This is done so as to have the neutral conductor carry as little current as possible. From what has already been said, it is obvious that in case there is a perfect balance, the lamps are virtually in series of pairs, and the neutral conductor does not carry any current. Where there is an unbalanced condition, the neutral conductor carries the difference between the current on one side and the current on the other side of the system. For example, if we had five lamps on one side of the system and ten lamps on the other, the neutral conductor would carry the current corresponding to five lamps.

In calculating the three-wire system, the neutral conductor is disregarded, the ~~outer~~ wires being treated as a two-wire circuit, and the calculation is for one-half the total number of lamps, the per-

centage of loss being based on the potential across the two outside conductors.

The three-wire system is very generally employed in alternating-current secondary wiring, as nearly all transformers are built with three-wire connections.

While unbalancing will not affect the total loss in the outside conductors, yet it does affect the loss in the lamps, for the reason that the system is usually calculated on the basis of a perfect balance, and the loss is divided equally between the two lamps (the latter being considered in series of pairs). If, however, there is unbalancing to a great degree, the loss in lamps will be increased; and if the entire load is thrown over on one side, the loss in the lamps will be doubled on the remaining side, because the total loss in voltage will now occur in these lamps, whereas, in the case of perfect balance, it would be equally divided between the two groups of lamps.

CALCULATION OF SIZES OF CONDUCTORS

The formula for calculating the sizes of conductors for direct currents, where the length, load, and loss in volts are given, is as follows:

The size of conductor (in circular mils) is equal to the current *multiplied* by the distance (one way), *multiplied by 21.6*, *divided by* the loss in volts; or,

$$CM = \frac{C \times D \times 21.6}{V} \dots \dots \dots (1)$$

in which C = Current, in amperes;

D = Distance or length of the circuit (one way, in feet);

V = Loss in volts between the beginning and end of the circuit.

The constant (21.6) of this formula is derived from the resistance of a mil foot of wire of 98 per cent conductivity at 25° Centigrade or 77° Fahrenheit. The resistance of a conductor of one mil diameter and one foot long, is 10.8 at the temperature and conductivity named. We multiply this figure (10.8) by 2, as the length of a circuit is usually given as the distance one way, and in order to obtain the resistance of both conductors in a two-wire circuit, we must multiply by 2. The formula as above given, therefore, is for a two-wire circuit; and in calculating the size of conductors in a three-wire system, the calculation should be made on a two-wire basis, as explained hereinafter.

Formula 1 can be transformed so as to obtain the loss in a given circuit, or the current which may be carried a given distance with a stated loss, or to obtain the distance when the other factors are given, in the following manner:

Formula for Calculating Loss in Circuit when Size, Current, and Distance are Given.

$$V = \frac{C \times D \times 21.6}{CM} \dots \dots \dots (2)$$

Formula for Calculating Current which may be Carried by a Given Circuit of Specified Length, and with a Specified Loss

$$C = \frac{CM \times V}{D \times 21.6} \dots \dots \dots (3)$$

Formula for Calculating Length of Circuit when Size, Loss, and Current to be Carried are Given

$$D = \frac{CM \times V}{C \times 21.6} \dots \dots \dots (4)$$

Formulæ are frequently given for calculating sizes of conductors, etc., where the load, instead of being given in amperes, is stated in lamps or in horse-power. It is usually advisable, however, to reduce the load to amperes, as the efficiency of lamps and motors is a variable quantity, and the current varies correspondingly.

It is sometimes convenient, however, to make the calculation in terms of watts. It will readily be seen that we can obtain a formula expressed in watts from Formula 1. To do this, it is advisable to express the loss in volts in percentage, instead of actual volts lost. It must be remembered that, in the above formulæ, V represents the volts lost in the circuit, or, in other words, the difference in potential between the beginning and the end of the circuit, and is not the applied E. M. F. The loss in percentage, in any circuit, is equal to the actual loss expressed in volts, *divided by* the line voltage, *multiplied by* 100; or,

$$P = \frac{V}{E} \times 100.$$

From this equation, we have:

$$V = \frac{P E}{100}.$$

If, for example, the calculation is to be made on a loss of 5 per cent, with an applied voltage of 250, using this last equation, we would have:

$$V = \frac{5 \times 250}{100} = 12.5 \text{ volts.}$$

Substituting the equation $V = \frac{P E}{100}$ in Formula 1, we have:

$$\begin{aligned}
 CM &= \frac{C \times D \times 21.6}{\frac{PE}{100}} \\
 &= \frac{C \times D \times 21.6 \times 100}{PE} \\
 &= \frac{C \times D \times 2,160}{PE}
 \end{aligned}$$

This equation, it should be remembered, is expressed in terms of applied voltage. Now, since the power in watts is equal to the applied voltage *multiplied by* the current ($W = EC$), it follows that

$$C = \frac{W}{E}$$

By substituting this value of C in the equation given above ($CM = \frac{C \times D \times 2,160}{PE}$), the formula is expressed in terms of watts instead of current, thus:

$$CM = \frac{W \times D \times 2,160}{EPE}, \dots\dots\dots(5)$$

in which W = Power in watts transmitted;

D = Length of the circuit (one way)—that is, the length of one conductor;

P = Figure representing the percentage loss;

E^* = Applied voltage.

All the above formulæ are for calculations of two-wire circuits. In making calculations for three-wire circuits, it is usual to make the calculation on the basis of the two outside conductors; and in three wire calculations, the above formulæ can be used with a slight modification, as will be shown.

In a three-wire circuit, it is usually assumed in making the calculation, that the load is equally balanced on the two sides of the neutral conductor; and, as the potential across the outside conductors is double that of the corresponding potential across a two-wire circuit, it is evident that for the same size of conductor the total loss in volts could be doubled without increasing the percentage of loss in lamps. Furthermore, as the load on one side of the neutral conductor, when the system is balanced, is virtually in series with the load on the third side, the current in amperes is usually one-half the sum of the current required by all the lamps. If C be still taken as the total

*NOTE. Remember that V in Formulæ 1 to 4 represents the volts lost, but that E in Formula 5 represents the applied voltage.

current in amperes (that is, the sum of the current required by all of the lamps) in Formula 1, we shall have to divide this current by 2, to use the formula for calculating the two outside conductors for a three-wire system. Furthermore, we shall have to multiply the voltage lost in the lamps by 2, to obtain the voltage lost in the two outside conductors, for the reason that the potential of the outside conductors is double the potential required by the lamps themselves. In other words, Formula 1 will become:

$$CM = \frac{C \times D \times 21.6}{2 \times V \times 2}$$

$$= \frac{C \times D \times 21.6}{4 V}, \dots \dots \dots (6)$$

in which C = Sum of current required by all of the lamps on both sides of the neutral conductor;
 D = Length of circuit—that is, of any one of the three conductors;
 V = Loss allowed in the lamps, i. e., one-half the total loss in the two outside conductors.

In the same manner, all of the other formulæ may be adapted for making calculations for three-wire systems. Of course the calculation of a three-wire system could be made as if it were a two-wire system, by taking one-half the total number of lamps supplied, at one-half the voltage between the outside conductors.

It is understood, of course, that the size of the conductor in Formula 6 is the size of each of the two outside ones; but, inasmuch as the *Rules of the National Electric Code* require that for interior wiring the neutral conductor shall be at least equal in size to the outside conductors, it is not necessary to calculate the size of the neutral conductor. It must be remembered, however, that, in a three-wire system where the neutral conductor is made equal in capacity to the combined size of the two outside conductors, and where the two outside conductors are joined together, we have virtually a two-wire system arranged so that it can be converted into a three-wire system later. In this case the calculation is exactly the same as in the case of the two-wire circuits, except that one of the two conductors is split into two smaller wires of the same capacity. This is frequently done where isolated plants are installed, and where the generators are wound for 125 volts and it may be desired at times to take current from an outside three-wire 125-250-volt system.

METHOD OF PLANNING A WIRING INSTALLATION

The first step in planning a wiring installation, is to gather all the data which will affect either directly or indirectly the system of wiring and the manner in which the conductors are to be installed. These data will include: Kind of building; construction of building; space available for conductors; source and system of electric-current supply; and all details which will determine the method of wiring to be employed. These last items materially affect the cost of the work, and are usually determined by the character of the building and by commercial considerations.

Method of Wiring. In a modern fireproof building, the only system of wiring to be recommended is that in which the conductors are installed in rigid conduits; although, even in such cases, it may be desirable, and economy may be effected thereby, to install the larger feeder and main conductors exposed on insulators using weatherproof slow-burning wire. This latter method should be used, however, only where there is a convenient runway for the conductors, so that they will not be crowded and will not cross pipes, ducts, etc., and also will not have too many bends. Also, the local inspection authorities should be consulted before using this method.

For mills, factories, etc., wires exposed on cleats or insulators are usually to be recommended, although rigid conduit, flexible conduit, or armored cable may be desirable.

In finished buildings, and for extensions of existing outlets, where the wiring could not readily or conveniently be concealed, moulding is generally used, particularly where cleat wiring or other exposed methods of wiring would be objectionable. However, as has already been said, moulding should not be employed where there is any liability to dampness.

In finished buildings, particularly where they are of frame construction, flexible steel conduits or armored cable are to be recommended.

While in new buildings of frame construction, knob and tube wiring are frequently employed, this method should be used only where the question of first cost is of prime importance. While armored cable will cost approximately 50 to 100 per cent more than knob and

tube wiring, the former method is so much more permanent and is so much safer that it is strongly recommended.

Systems of Wiring. The system of wiring—that is, whether the two-wire or the three-wire system shall be used—is usually determined by the source of supply. If the source of supply is an isolated plant, with simple two-wire generators, and with little possibility of current being taken from the outside at some future time, the wiring in the building should be laid out on the two-wire system. If, on the other hand, the isolated plant is three-wire (having three-wire generators, or two-wire generators with balancer sets), or if the current is taken from an outside source, the wiring in the building should be laid out on a three-wire system.

It very seldom happens that current supply from a central station is arranged with other than the three-wire system inside of buildings, because, if the outside supply is alternating current, the transformers are usually adapted for a three-wire system. For small buildings, on the other hand, where there are only a few lights and where there would be only one feeder, the two-wire system is used. As a rule, however, when the current is taken from an outside source, it is best to consult the engineer of the central station supplying the current, and to conform with his wishes. As a matter of fact, this should be done in any event, in order to ascertain the proper voltage for the lamps and for the motors, and also to ascertain whether the central station will supply transformers, meters, and lamps—for, if these are not thus supplied, they should be included in the contract for the wiring.

Location of Outlets. It is not within the scope of this treatise to discuss the matter of *illumination*, but it is desirable, at this point, to outline briefly the method of procedure.

A set of plans, including elevation and details, if any, and showing decorative treatment of the various rooms, should be obtained from the Architect. A careful study should then be made by the Architect, the Owner, and the Engineer, or some other person qualified to make recommendations as to illumination. The location of the outlets will depend: *First*, upon the decorative treatment of the room, which determines the æsthetic and architectural effects; *second*, upon the type and general form of fixtures to be used, which should be previously decided on; *third*, upon the tastes of the owners or

occupants in regard to illumination in general, as it is found that tastes vary widely in regard to amount and kind of illumination.

The location of the outlets, and the number of lights required at each, having been determined, the outlets should be marked on the plans.

The Architect should then be consulted as to the location of the centers of distribution, the available points for the risers or feeders, and the available space for the branch circuit conductors.

In regard to the *rising points for the feeders and mains*, the following precautions should be used in selecting chases:

1. The space should be amply large to accommodate all the feeders and mains likely to rise at that given point. This seems trite and unnecessary, but it is the most usual trouble with chases for risers. Formerly architects and builders paid little attention to the requirements for chases for electrical work; but in these later days of 2-inch and 2½-inch conduit, they realize that these pipes are not so invisible and mysterious as the force they serve to distribute, particularly when twenty or more such conduits must be stowed away in a building where no special provision has been made for them.

2. If possible, the space should be devoted solely to electric wiring. Steam pipes are objectionable on account of their temperature; and these and all other pipes are objectionable in the same space occupied by the electrical conduits, for if the space proves too small, the electric conduits are the first to be crowded out.

The chase, if possible, should be continuous from the cellar to the roof, or as far as needed. This is necessary in order to avoid unnecessary bends or elbows, which are objectionable for many reasons.

In similar manner, the location of *cut-out cabinets or distributing centers* should fulfil the following requirements:

1. They should be accessible at all times.
2. They should be placed sufficiently close together to prevent the circuits from being too long.
3. Do not place them in too prominent a position, as that is objectionable from the Architect's point of view.
4. They should be placed as near as possible to the rising chases, in order to shorten the feeders and mains supplying them.

Having determined the system and method of wiring, the location of outlets and distributing centers, the next step is to lay out the *branch circuits* supplying the various outlets.

Before starting to lay out the branch circuits, a drawing showing the floor construction, and showing the space between the top of the beams and girders and the flooring, should be obtained from the Architect. In fire-proof buildings of iron or steel construction, it is almost the invariable practice, where the work is to be concealed, to run the

conduits over the beams, under the rough flooring, carrying them between the sleepers when running parallel to the sleepers, and notching the latter when the conduits run across them (see Fig. 31). In wooden frame buildings, the conduits run parallel to the beams and to the furring (see Fig. 32); they are also sometimes run below the

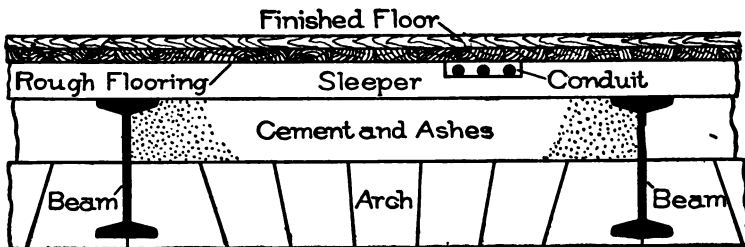

Fig. 31. Running Conductors Concealed under Floor in Fireproof Building.

beams. In the latter case the beams have to be notched, and this is allowable only in certain places, usually near the points where the beams are supported. The Architect's drawing is therefore necessary in order that the location and course of the conduits may be indicated on the plans.

The first consideration in laying out the branch circuit is the *number of outlets* and *number of lights* to be wired on any one branch circuit. The *Rules of the National Electric Code* (Rule 21-D) require that "no set of incandescent lamps requiring more than 660 watts, whether grouped on one fixture or on several fixtures or pendants, will be dependent on one cut-out." While it would be possible to have branch circuits supplying more than 660 watts, by placing various cut-outs at different points along the route of the branch circuit, so as to subdivide it into small sections to comply with the rule, this method is not recommended, except in certain cases, for exposed wiring in factories or mills. As a rule, the proper method is to have the cut-outs located at the center of distribution, and to limit each branch circuit to 660 watts, which corresponds to twelve or thirteen 50-watt lamps, twelve being the usual limit. Attention is called to the fact that the inspectors usually allow 50 watts for each socket connected to a branch circuit; and although 8-candle-power lamps may be placed at some of the outlets, the inspectors hold that the standard lamp is approximately 50 watts, and for that reason there is always the likelihood of a lamp of that capacity being used, and their inspec-

tion is based on that assumption. Therefore, to comply with the requirements, an allowance of not more than twelve lamps per branch circuit should be made.

In ordinary practice, however, it is best to reduce this number still further, so as to make allowance for future extensions or to increase the number of lamps that may be placed at any outlet. For this reason, it is wise to keep the number of the outlets on a circuit at the lowest point consistent with economical wiring. It has been proven by actual practice, that the best results are obtained by limiting the number to five or six outlets on a branch circuit. Of course, where all the outlets have a single light each, it is frequently necessary, for reasons of economy, to increase this number to eight, ten, and, in some cases, twelve outlets.

We have already referred to the location of the wires or conduits. This question is generally settled by the peculiarities of the construction of the building. It is necessary to know this, however, before laying out the circuit work, as it frequently determines the course of a circuit.

Now, as to the course of the circuit work, little need be said, as it is largely influenced by the relative position of the outlets, cut-

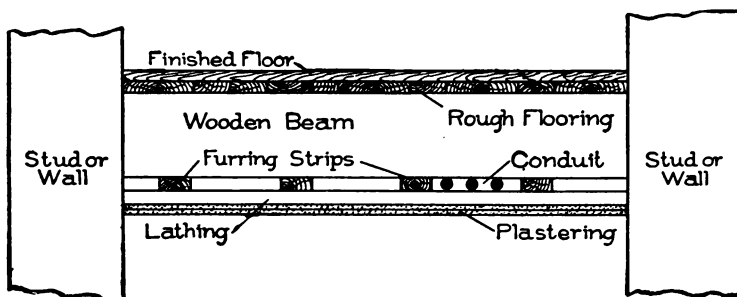

Fig. 32. Running Conductors Concealed under Floor in Wooden Frame Building.

outs, switches, etc. Between the cut-out box and the first outlet, and between the outlets, it will have to be decided, however, whether the circuits shall run at right angles to the walls of the building or room, or whether they shall run direct from one point to another, irrespective of the angle they make to the sleepers or beams. Of course, in the latter case, the advantages are that the cost is somewhat less and the number of elbows and bends is reduced. If the

tubes are bent, however, instead of using elbows, the difference in cost is usually very slight, and probably does not compensate for the disadvantages that would result from running the tubes diagonally. As to the number of bends, if branch circuit work is properly laid out and installed, and a proper size of tube used, it rarely happens that there is any difference in "pulling" the branch circuit wires. It may happen, in the event of a very long run or one having a large number of bends, that it might be advisable to adopt a short and most direct route.

Up to this time, the location of the distribution centers has been made solely with reference to architectural considerations; but they must now be considered in conjunction with the branch circuit work.

It frequently happens that, after running the branch circuits on the plans, we find, in certain cases, that the position of centers of distribution may be changed to advantage, or sometimes certain groups may be dispensed with entirely and the circuits run to other points. We now see the wisdom of ascertaining from the Architect where cut-out groups may be located, rather than selecting particular points for their location.

As a rule, wherever possible, it is wise to limit the length of each branch circuit to 100 feet; and the number and location of the distributing centers should be determined accordingly.

It may be found that it is sometimes necessary and even desirable to increase the limit of length. One instance of this may be found in hall or corridor lights in large buildings. It is generally desirable, in such cases, to control the hall lights from one point; and, as the number of lights at each outlet is generally small, it would not be economical to run mains for sub-centers of distribution. Hence, in instances of this character, the length of runs will frequently exceed the limit named. In the great majority of cases, however, the best results are obtained by limiting the runs to 90 or 100 feet.

There are several good reasons for placing such a limit on the length of a branch circuit. To begin with, assuming that we are going to place a limit on the loss in voltage (drop) from the switchboard to the lamp, it may be easily proven that up to a certain reasonable limit it is more economical to have a larger number of distributing centers and shorter branch circuits, than to have fewer centers and longer circuits. It is usual, in the better class of work, to limit the

loss in voltage in any branch circuit to approximately one volt. Assuming this limit (one volt loss), it can readily be calculated that the number of lights at one outlet which may be connected on a branch circuit 100 feet long (using No. 14 B. & S. wire), is *four*; or in the case of outlets having a single light each, *five* outlets may be connected on the circuit, the first being 60 feet from the cut-out, the others being 10 feet apart.

These examples are selected simply to show that if the branch circuits are much longer than 100 feet, the loss must be increased to more than one volt, or else the number of lights that may be connected to one circuit must be reduced to a very small quantity, provided, of course, the size of the wire remains the same.

Either of these alternatives is objectionable—the first, on the score of regulation; and the second, from an economical standpoint. If, for instance, the loss in a branch circuit with all the lights turned on is four volts (assuming an extreme case), the voltage at which a lamp on that circuit burns will vary from four volts, depending on the number of lights burning at a time. This, of course, will cause the lamp to burn below candle-power when all the lamps are turned on, or else to diminish its life by burning above the proper voltage when it is the only lamp burning on the circuit. Then, too, if the drop in the branch circuits is increased, the sizes of the feeders and the mains must be correspondingly increased (if the total loss remains the same), thereby increasing their cost.

If the number of lights on the circuit is decreased, we do not use to good advantage the available carrying capacity of the wire.

Of course, one solution of the problem would be to increase the size of the wire for the branch circuits, thus reducing the drop. This, however, would not be desirable, except in certain cases where there were a few long circuits, such as for corridor lights or other special control circuits. In such instances as these, it would be better to increase the sizes of the branch circuit to No. 12 or even No. 10 B. & S. Gauge conductors, than to increase the number of centers of distribution for the sake of a few circuits only, in order to reduce the number of lamps (or loss) within the limit.

The method of calculating the loss in conductors has been given elsewhere; but it must be borne in mind, in calculating the loss of a branch circuit supplying more than one outlet, that separate calcu-

lations must be made for each portion of the circuit. That is, a calculation must be made for the loss to the first outlet, the length in this case being the distance from the center of distribution to the first outlet, and the load being the total number of lamps supplied by the circuit. The next step would be to obtain the loss between the first and second outlet, the length being the distance between the two outlets, and the load, in this case, being the total number of lamps supplied by the circuit, *minus* the number supplied by the first outlet; and so on. The loss for the total circuit would be the sum of these losses for the various portions of the circuit.

Feeders and Mains. If the building is more than one story, an elevation should be made showing the height and number of stories. On this elevation, the various distributing centers should be shown diagrammatically; and the current in amperes supplied through each center of distribution, should be indicated at each center. The next step is to lay out a tentative system of feeders and mains, and to ascertain the load in amperes supplied by each feeder and main. The estimated length of each feeder and main should then be determined, and calculation made for the loss from the switchboard to each center of distribution. It may be found that in some cases it will be necessary to change the arrangement of feeders or mains, or even the centers of distribution, in order to keep the total loss from the switchboard to the lamps within the limits previously determined. As a matter of fact, in important work, it is always best to lay out the entire work tentatively in a more or less crude fashion, according to the "cut and dried" method, in order to obtain the best results, because the entire layout may be modified after the first preliminary layout has been made. Of course, as one becomes more experienced and skilled in these matters, the final layout is often almost identical with the first preliminary arrangement.

TESTING

Where possible, two tests of the electric wiring equipment should be made, one after the wiring itself is entirely completed, and switches, cut-out panels, etc., are connected; and the second one after the fixtures have all been installed. The reason for this is that if a ground or short circuit is discovered before the fixtures are installed, it is more easily remedied; and secondly, because there is no division of

the responsibility, as there might be if the first test were made only after the fixtures were installed. If the test shows no grounds or short circuits before the fixtures are installed, and one does develop after they are installed, the trouble, of course, is that the short circuit or ground is one or more of the fixtures. As a matter of fact, it is a wise plan always to make a separate test of each fixture after it is delivered at the building and before it is installed.

While a *magneto* is largely used for the purpose of testing, it is at best a crude and unreliable method. In the first place, it does not give an indication, even approximately, of the total insulation resistance, but merely indicates whether there is a ground or short circuit, or not. In some instances, moreover, a magneto test has led to serious errors, for reasons that will be explained. If, as is nearly always the case, the magneto is an alternating-current instrument, it may sometimes happen—particularly in long cables, and especially where there is a lead sheathing on the cable—that the magneto will ring, indicating to the uninitiated that there is a ground or short circuit on the cable. This may be, and usually is, far from being the case; and the cause of the ringing of the magneto is not a ground or short circuit, but is due to the capacity of the cable, which acts as a condenser under certain conditions, since the magneto producing an alternating current repeatedly charges and discharges the cable in opposite directions, this changing of the current causing the magneto to ring. Of course, this defect in a magneto could be remedied by using a commutator and changing it to a direct-current machine; but as the method is faulty in itself, it is hardly worth while to do this.

A portable *galvanometer* with a resistance box and Wheatstone bridge, is sometimes employed; but this method is objectionable because it requires a special instrument which cannot be used for many other purposes. Furthermore, it requires more skill and time to use than the *voltmeter* method, which will now be described.

The advantage of the voltmeter method is that it requires merely a direct-current voltmeter, which can be used for many other purposes, and which all engineers or contractors should possess, together with a box of cells having a potential of preferably over 30 volts. The voltmeter should have a scale of not over 150 volts, for the reason that if the scale on which the battery is used covers too wide a range (say 1,000 volts) the readings might be so small as to make the test inac-

curate. A good arrangement would be to have a voltmeter having two scales—say, one of 60 and one of 600—which would make the voltmeter available for all practical potentials that are likely to be used inside of a building. If desired, a voltmeter could be obtained with three connections having three scales, the lowest scale of which would be used for testing insulation resistances.

Before starting a test, all of the fuses should be inserted and switches turned on, so that the complete test of the entire installation can be made. When this has been done, the voltmeter and battery should be connected, so as to obtain on the lowest scale of the voltmeter the electromotive force of the entire group of cells. This connection is shown in Fig. 33.

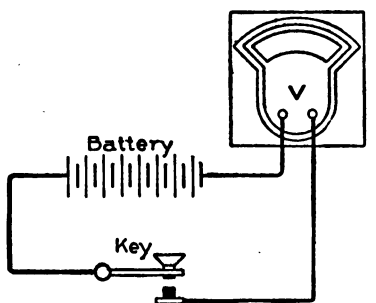

Fig. 33. Connections of Voltmeter and Battery for Testing Insulation Resistance.

Immediately after this has been done, the insulation resistance to be tested is placed in circuit, whether the insulation to be tested is a switch-board, slate panel-board, or the entire wiring installation; and the connections are made as shown in Fig. 34. A reading should then again be taken of the voltmeter; and the leakage is in proportion to the difference between the first and second readings of the voltmeter. The explanation given below

will show how this resistance may be calculated: It is evident that the resistance in the first case was merely the resistance of the voltmeter and the internal resistance of the battery. As a rule, the internal resistance of the battery is so small in comparison with the resistance of the voltmeter and the external resistance, that it may be entirely neglected, and this will be done in the following calculation. In the second case, however, the total resistance in circuits is the resistance of the voltmeter and the battery, *plus* the entire insulation resistance on all the wires, etc., connected in circuit.

To put this in mathematical form, the voltage of the cells may be indicated by the letter E ; and the reading of the voltmeter when the insulation resistance is connected by the circuit, by the letter E' . Let R represent the resistance of the voltmeter and R_x represent the insulation resistance of the installation which we wish to measure.

It is a fact which the reader undoubtedly knows, that the E. M. F. as indicated by the voltmeter in Fig. 34 is inversely proportional to the resistance: that is, the greater the resistance, the lower will be the reading on the voltmeter, as this reading indicates the leakage or current passing through the resistance. Putting this in the shape of a formula, we have from the theory of proportion:

$$E : E' :: R + R_x : R ;$$

or,

$$E' R + E' R_x = E R .$$

Transposing,

$$E' R_x = E R - E' R = R (E - E') ,$$

and

$$R_x = \frac{R (E - E')}{E'}$$

Or, expressed in words, the insulation resistance is equal to the resistance of the voltmeter *multiplied by* the difference between the first reading (or the voltage in the cells) and the second reading (or the reading of the voltmeter with the insulation resistance in series with the voltmeter), *divided by* this last reading of the voltmeter.

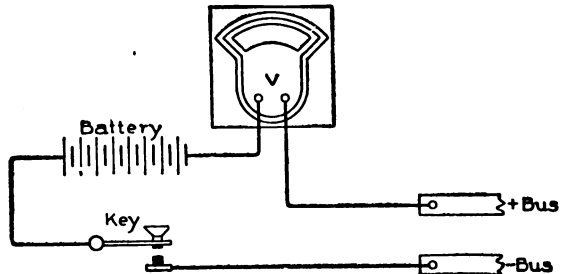

Fig. 34. Insulation Resistance Placed in Circuit, Ready for Testing.

Example. Assume a resistance of a voltmeter (R) of 20,000 ohms, and a voltage of the cells (E) of 30 volts; and suppose that the insulation resistance test of a wiring installation, including switchboard, feeders, branch circuits, panel-boards, etc., is to be made, the insulation resistance being represented by the letter R_x . By substituting in the formula

$$R_x = \frac{R (E - E')}{E'}$$

and assuming that the reading of the voltmeter with the insulation resistance connected is 5, we have:

$$R_x = \frac{20,000 \times (30 - 5)}{5} = 100,000 \text{ ohms.}$$

If the test shows an excessive amount of leakage, or a ground or

short circuit, the location of the trouble may be determined by the process of elimination—that is, by cutting out the various feeders until the ground or leakage disappears, and, when the feeder on which the trouble exists has been located, by following the same process with the branch circuits.

Of course, the larger the installation and the longer and more numerous the circuits, the greater the leakage will be; and the lower will be the insulation resistance, as there is a greater surface exposed for leakage. The *Rules of the National Electric Code* give a sliding scale for the requirements as to insulation resistance, depending upon the amount of current carried by the various feeders, branch circuits, etc. The rule of the *National Electric Code* (No. 66) covering this point, is as follows:

“The wiring in any building must test free from grounds; *i. e.*, the complete installation must have an insulation between conductors and between all conductors and the ground (not including attachments, sockets, receptacles, etc.) not less than that given in the following table:

Up to	5 amperes	4,000,000 ohms
“	10 “	2,000,000 “
“	25 “	800,000 “
“	50 “	400,000 “
“	100 “	200,000 “
“	200 “	100,000 “
“	400 “	50,000 “
“	800 “	25,000 “
“	1,600 “	12,500 “

“The test must be made with all cut-outs and safety devices in place. If the lamp sockets, receptacles, electroliers, etc., are also connected, only one-half of the resistances specified in the table will be required.”

ALTERNATING-CURRENT CIRCUITS

It is not within the province of this chapter to treat the various alternating-current phenomena, but simply to outline the modifications which should be made in designing and calculating electric light wiring, in order to make proper allowance for these phenomena.

The most marked difference between alternating and direct current, so far as wiring is concerned, is the effect produced by self-induction, which is characteristic of all alternating-current circuits. This self-induction varies greatly with conditions depending upon the arrangement of the circuit, the medium surrounding the circuit, the devices or apparatus supplied by or connected in the circuit, etc.

For example, if a coil having a resistance of 100 ohms is included in the circuit, a current of one ampere can be passed through the coil with an electric pressure of 100 volts, if direct current is used; while it might require a potential of several hundred volts to pass a current of one ampere if alternating-current were used, depending upon the number of turns in the coil, whether it is wound on iron or some other non-magnetic material, etc.

It will be seen from this example, that greater allowance should be made for self-induction in laying out and calculating alternating-current wiring, if the conditions are such that the self-induction will be appreciable.

On account of self-induction, the two wires of an alternating-current circuit must never be installed in separate iron or steel conduits, for the reason that such a circuit would be virtually a *choke coil* consisting of a single turn of wire wound on an iron core, and the self-induction would not only reduce the current passing through the circuit, but also might produce heating of the iron pipe. It is for this reason that the *National Electric Code* requires conductors constituting a given circuit to be placed in the same conduit, if that conduit is iron or steel, whenever the said circuit is intended to carry, or is liable to carry at some future time, an alternating current. This does not mean, in the case of a two-phase circuit, that all four conductors need be placed in the same conduit, but that the two conductors of a given phase must be placed in the same conduit. If, however, the three-wire system be used for a two-phase system, all three conductors should be placed in the same conduit, as should also be the case in a three-wire three-phase system. Of course, in a single-phase two- or three-wire system, the conductors should all be placed in the same conduit.

In calculating circuits carrying alternating current, no allowance usually should be made for self-induction when the conductors of the same circuit are placed close together in an iron conduit. When, however, the conductors are run exposed, or are separated from each other, calculation should be made to determine if the effects of self-induction are great enough to cause an appreciable inductive drop. There are several methods of calculating this drop due to self-induction—one by formula, and one by means of chart and table which will be described.

Skin Effect. Skin effect in alternating-current circuits is caused by an incorrect distribution of the current in the wire, the current tending to flow through the outer portion of the wire, it being a well-known fact that in alternating currents, the current density decreases toward the center of the conductor, and that in large wires, the current density at the center of the conductor is relatively quite small.

The skin effect increases in proportion to the square of the diameter, and also in direct ratio to the frequency of the alternating current.

For conductors of No. 0000 B. & S. Gauge, and smaller, and for frequencies of 60 cycles per second, or less, the skin effect is negligible and is less than one-half of one per cent.

For very large cables and for frequencies above 60 cycles per second, the skin effect may be appreciable; and in certain cases, allowance for it should be made in making the calculation. In ordinary practice, however, it may be neglected. Table IX, taken from *Alternating-Current Wiring and Distribution*, by W. R. Emmet, gives the data necessary for calculating the skin effect. The figures given in the first and third columns are obtained by multiplying the size of the conductor (in circular mils) by the frequency (number of cycles per second); and the figures in the second and fourth columns show the factor to be used in multiplying the ohmic resistance, in order to obtain the combined resistance and skin effect.

TABLE IX
Data for Calculating Skin Effect

PRODUCT OF CIRCULAR MILS × CYCLES PER SEC.	FACTOR	PRODUCT OF CIRCULAR MILS × CYCLES PER SEC.	FACTOR
10,000,000	1.00	70,000,000	1.13
20,000,000	1.01	80,000,000	1.17
30,000,000	1.03	90,000,000	1.20
40,000,000	1.05	100,000,000	1.25
50,000,000	1.08	125,000,000	1.34
60,000,000	1.10	150,000,000	1.43

The factors given in this table, *multiplied by* the resistance to direct currents, will give the resistance to alternating currents for copper conductors of circular cross-section.

Mutual Induction. When two or more circuits are run in the same vicinity, there is a possibility of one circuit inducing an electromotive force in the conductors of an adjoining circuit. This effect may result in raising or lowering the E. M. F. in the circuit in which a

mutual induction takes place. The amount of this induced E. M. F. set up in one circuit by a parallel current, is dependent upon the current, the frequency, the lengths of the circuits running parallel to each other, and the relative positions of the conductors constituting the said circuits.

Under ordinary conditions, and except for long circuits carrying high potentials, the effect of mutual induction is so slight as to be negligible, unless the conductors are improperly arranged. In order to prevent mutual induction, the conductors constituting a given circuit should be grouped together. Figs. 35 to 39, inclusive, show

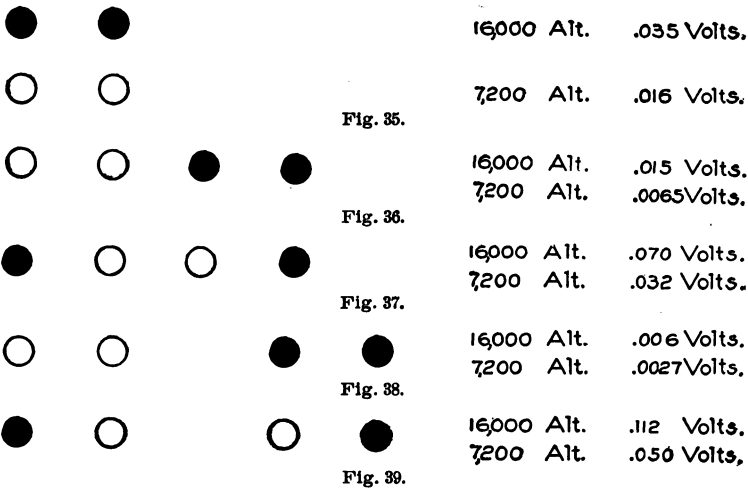

Various Groupings of Conductors in Two Two-Wire Circuits, Giving Various Effects of Induction.

five arrangements of two two-wire circuits; and show how relatively small the effect of first induction is when the conductors are properly arranged, as in Fig. 38, and how relatively large it may be when improperly arranged, as in Fig. 39. These diagrams are taken from a publication of Mr. Charles F. Scott, entitled *Polyphase Transmission*, issued by the Westinghouse Electric & Manufacturing Company.

Line Capacity. The effect of capacity is usually negligible, except in long transmission lines where high potentials are used; no calculations or allowance need be made for capacity, for ordinary circuits.

Calculation of Alternating-Current Circuits. In the instruction paper on "Power Stations and Transmission," a method is given for calculating alternating-current lines by means of formulæ, and data are given regarding power factor and the calculation of both single-phase and polyphase circuits. For short lines, secondary wiring, etc., however, it is probably more convenient to use the chart method devised by Mr. Ralph D. Mershon, described in the *American Electrician* of June, 1897, and partially reproduced as follows:

DROP IN ALTERNATING-CURRENT LINES

When alternating currents first came into use, when transmission distances were short and the only loads carried were lamps, the question of *drop* or *loss of voltage* in the transmitting line was a simple one, and the same methods as for direct current could without serious error be employed in dealing with it. The conditions existing in alternating practice to-day—longer distances, polyphase circuits, and loads made up partly or wholly of induction motors—render this question less simple; and direct-current methods applied to it do not lead to satisfactory results. Any treatment of this or of any engineering subject, if it is to benefit the majority of engineers, must not involve groping through long equations or complex diagrams in search of practical results. The results, if any, must be in available and convenient form. In what follows, the endeavor has been made to so treat the subject of drop in alternating-current lines that if the reader be grounded in the theory the brief space devoted to it will suffice; but if he do not comprehend or care to follow the simple theory involved, he may nevertheless turn the results to his practical advantage.

Calculation of Drop. Most of the matter heretofore published on the subject of drop treats only of the inter-relation of the E. M. F.'s involved, and, so far as the writer knows, there have not appeared in convenient form the data necessary for accurately calculating this quantity. Table X (page 47) and the chart (page 46) include, in a form suitable for the engineer's pocketbook, everything necessary for calculating the drop of alternating-current lines.

The chart is simply an extension of the vector diagram (Fig. 40), giving the relations of the E. M. F.'s of line, load and generator. In

Fig. 40, E is the generator E. M. F.; e the E. M. F. impressed upon the load; c , that component of E which overcomes the back E. M. F. due to the impedance of the line. The component c is made up of two components at right angles to each other. One is a , the component overcoming the IR or back E. M. F. due to resistance of the line. The other is b , the component overcoming the reactance E. M. F. or back E. M. F. due to the alternating field set up around the wire by the current in the wire. The drop is the difference between E and e . It is d , the radial distance between two circular arcs, one of which is drawn with a radius e , and the other with a radius E .

The chart is made by striking a succession of circular arcs with O as a center. The radius of the smallest circle corresponds to e , the E. M. F. of the load, which is taken as 100 per cent. The radii of the succeeding circles increase by 1 per cent of that of the smallest circle; and, as the radius of the last or largest circle is 140 per cent

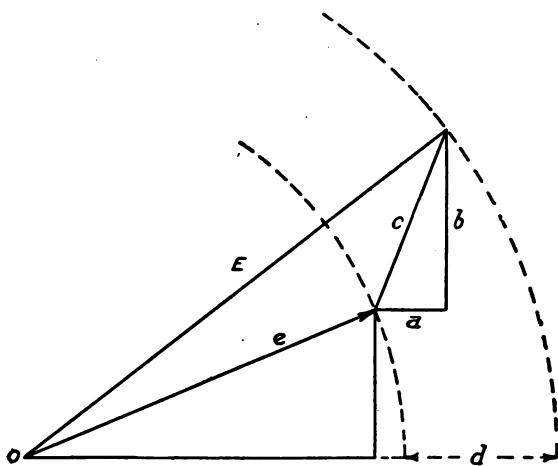

Fig. 40. Vector Diagram.

of that of the smallest, the chart answers for drops up to 40 per cent of the E. M. F. delivered.

The terms *resistance volts*, *resistance E. M. F.*, *reactance volts*, and *reactance E. M. F.*, refer, of course, to the voltages for overcoming the back E. M. F.'s due to resistance and reactance respectively. The figures given in the table under the heading "Resistance-Volts for One Ampere, etc." are simply the resistances of 2,000 feet of the various sizes of wire. The values given under the heading "Reactance-Volts, etc.," are, a part of them, calculated from tables published some time ago by Messrs. Houston and Kennelly. The remainder were obtained by using Maxwell's formula.

The explanation given in the table accompanying the chart

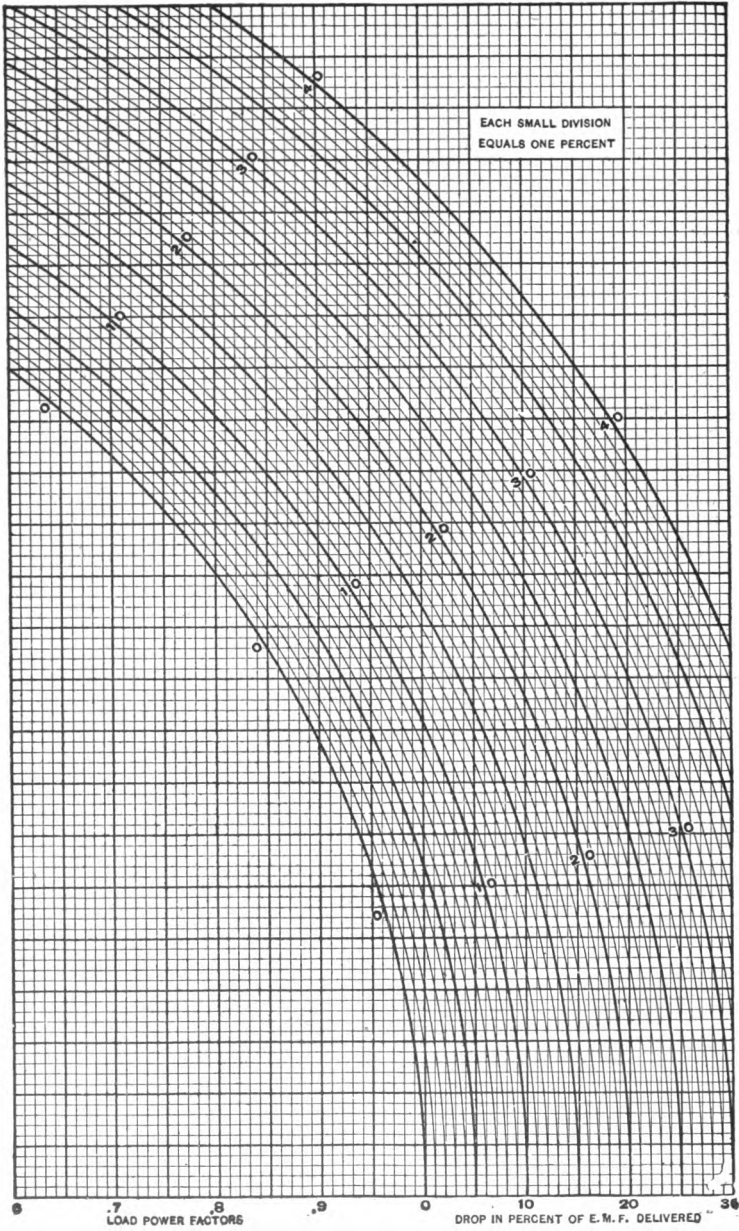

Chart for Calculating Drop in Alternating-Current Lines.

TABLE X
Data for Calculating Drop in Alternating-Current Lines

To be used in conjunction with Chart on opposite page.

By means of the table, calculate the *Resistance-Volts* and the *Reactance-Volts* in the line, and find what per cent each is of the E. M. F. delivered at the end of the line. Starting from the point on the chart where the vertical line corresponding with the power-factor of the load intersects the smallest circle, lay off in per cent the resistance E. M. F. horizontally and to the right; from the point thus obtained, lay off upward in per cent the reactance-E. M. F. The circle on which the last point falls gives the drop, in per cent, of the E. M. F. delivered at the end of the line. Every tenth circle arc is marked with the per cent drop to which it corresponds.

Size of wire—B. & S.	Upper figures are Weight in Lbs. per 1,000 ft. Single Wire	Upper figures are RESISTANCE-VOLTS in 1,000 ft. of Line (2,000 ft. of wire) for One Ampere	Throughout the table the lower figures in the squares give values for ONE MILE of line, corresponding to those of the upper figures for 1,000 feet of line.											
			Upper figures are REACTANCE-VOLTS in 1,000 ft. of Line (= 2,000 ft. of Wire) for One Ampere at 7,200 Alternations per Minute (60 Cycles per Second) for the distance given between Centers of Conductors.											
			½"	1"	2"	3"	6"	9"	12"	18"	24"	30"	36"	
0000	639 3,376	.098 .518	.046 .243	.079 .417	.111 .586	.130 .687	.161 .850	.180 .951	.193 1.02	.212 1.12	.225 1.19	.235 1.24	.244 1.29	
000	507 2,677	.124 .653	.052 .275	.085 .449	.116 .613	.135 .713	.167 .882	.185 .977	.199 1.05	.217 1.15	.230 1.22	.241 1.27	.249 1.32	
00	402 2,123	.156 .824	.057 .301	.090 .475	.121 .639	.140 .739	.172 .908	.190 1.00	.204 1.08	.222 1.17	.236 1.25	.246 1.30	.254 1.34	
0	319 1,685	.197 1.04	.063 .332	.095 .502	.127 .671	.145 .766	.177 .935	.196 1.04	.209 1.10	.228 1.20	.241 1.27	.251 1.33	.259 1.37	
1	253 1,335	.248 1.31	.068 .359	.101 .533	.132 .687	.151 .797	.183 .966	.201 1.06	.214 1.13	.233 1.23	.246 1.30	.256 1.35	.265 1.40	
2	201 1,059	.313 1.65	.074 .391	.106 .560	.138 .728	.156 .824	.188 .993	.206 1.09	.220 1.16	.238 1.26	.252 1.33	.262 1.38	.270 1.43	
3	159 840	.394 2.08	.079 .417	.112 .591	.143 .755	.162 .856	.193 1.02	.212 1.12	.225 1.19	.244 1.29	.257 1.36	.267 1.41	.275 1.45	
4	126 666	.497 2.63	.085 .449	.117 .618	.149 .787	.167 .882	.199 1.05	.217 1.15	.230 1.22	.249 1.32	.262 1.38	.272 1.44	.281 1.48	
5	100 528	.627 3.31	.090 .475	.121 .639	.154 .813	.172 .908	.204 1.08	.223 1.18	.236 1.25	.254 1.34	.268 1.42	.278 1.47	.286 1.51	
6	79 419	.791 4.18	.095 .502	.127 .671	.158 .834	.178 .940	.209 1.10	.228 1.20	.241 1.27	.260 1.37	.272 1.44	.283 1.49	.291 1.54	
7	63 332	.997 5.27	.101 .533	.132 .697	.164 .866	.183 .966	.214 1.13	.233 1.23	.246 1.30	.265 1.40	.278 1.47	.288 1.52	.296 1.56	
8	50 263	1.260 6.64	.106 .560	.138 .729	.169 .893	.188 .993	.220 1.16	.238 1.26	.252 1.33	.270 1.43	.284 1.50	.293 1.55	.302 1.60	

(Table X) is thought to be a sufficient guide to its use, but a few examples may be of value.

Problem. Power to be delivered, 250 K.W.; E. M. F. to be delivered, 2,000 volts; distance of transmission, 10,000 feet; size of wire, No. 0; distance between wires, 18 inches; power factor of load, .8; frequency, 7,200 alternations per minute. Find the line loss and drop.

Remembering that the power factor is that fraction by which the apparent power of volt-amperes must be multiplied to give the true power, the apparent power to be delivered is

$$\frac{250 \text{ K.W.}}{.8} = 312.5 \text{ apparent K.W.}$$

The current, therefore, at 2,000 volts will be

$$\frac{312,500}{2,000} = 156.25 \text{ amperes.}$$

From the table of reactances under the heading "18 inches," and corresponding to No. 0 wire, is obtained the constant .228. Bearing the instructions of the table in mind, the reactance-volts of this line are, 156.25 (amperes) \times 10 (thousands of feet) \times .228 = 356.3 volts, which is 17.8 per cent of the 2,000 volts to be delivered.

From the column headed "Resistance-Volts" and corresponding to No. 0 wire, is obtained the constant .197. The resistance-volts of the line are, therefore, 156.25 (amperes) \times 10 (thousands of feet) \times .197 = 307.8 volts, which is 15.4 per cent of the 2,000 volts to be delivered.

Starting, in accordance with the instructions of the table, from the point where the vertical line (which at the bottom of the chart is marked "Load Power Factor" .8) intersects the inner or smallest circle, lay off horizontally and to the right the resistance-E. M. F. in per cent (15.4); and *from the point thus obtained*, lay off vertically the reactance-E. M. F. in per cent (17.8). The last point falls at about 23 per cent, as given by the circular arcs. This, then, is the drop, in per cent, of *the E. M. F. delivered*. The drop, in per cent, of the *generator E. M. F.* is, of course,

$$\frac{23}{100+23} = 18.7 \text{ per cent.}$$

The percentage *loss of power* in the line has not, as with direct current, the same value as the percentage drop. This is due to the fact that the line has reactance, and also that the apparent power

delivered to the load is not identical with the true power—that is, the load power factor is less than unity. The loss must be obtained by calculating $I^2 R$ for the line, or, what amounts to the same thing, by multiplying the resistance-volts by the current.

The resistance-volts in this case are 307.8, and the current 156.25 amperes. The loss is $307.8 \times 156.25 = 48.1$ K. W. The percentage loss is

$$\frac{48.1}{250 + 48.1} = 16.1 \text{ per cent.}$$

Therefore, for the problem taken, the *drop* is 18.7 per cent, and the *loss* is 16.1 per cent. If the problem be to find the size wire for a given drop, it must be solved by trial. Assume a size of wire and calculate the drop; the result in connection with the table will show the direction and extent of the change necessary in the size of wire to give the required drop.

The effect of the line reactance in increasing the drop should be noted. If there were no reactance, the drop in the above example would be given by the point obtained in laying off on the chart the resistance-E. M. F. (15.4) only. This point falls at 12.4 per cent, and the drop in terms of the generator E. M. F. would be

$$\frac{12.4}{112.4} = 11 \text{ per cent, instead of 18.7 per cent.}$$

Anything therefore which will reduce reactance is desirable.

Reactance can be reduced in two ways. One of these is to diminish the distance between wires. The extent to which this can be carried is limited, in the case of a pole line, to the least distance at which the wires are safe from swinging together in the middle of the span; in inside wiring, by the danger from fire. The other way of reducing reactance is to split the copper up into a greater number of circuits, and arrange these circuits so that there is no inductive interaction. For instance, suppose that in the example worked out above, two No. 3 wires were used instead of one No. 0 wire. The resistance-volts would be practically the same, but the reactance-volts would be less in the ratio $\frac{1}{2} \times \frac{.244}{.228} = .535$, since each circuit would bear half the current the No. 0 circuit does, and the constant for No. 3 wire is .244, instead of .228—that for No. 0. The effect of subdividing the copper is also shown if in the example given it is desired to reduce the drop

to, say, one-half. Increasing the copper from No. 0 to No. 0000 will not produce the required result, for, although the resistance-volts will be reduced one-half, the reactance-volts will be reduced only in the ratio $\frac{.212}{.228}$. If, however, *two* inductively independent circuits of No. 0

wire be used, the resistance- and reactance-volts will both be reduced one-half, and the drop will therefore be diminished the required amount.

The component of drop due to reactance is best diminished by subdividing the copper or by bringing the conductors closer together. It is little affected by change in size of conductors.

An idea of the manner in which changes of power factor affect drop is best gotten by an example. Assume distance of transmission, distance between conductors E. M. F., and frequency, the same as in the previous example. Assume the *apparent* power delivered the same as before, and let it be constant, but let the power factor be given several different values; the true power will therefore be a variable depending upon the value of the power factor. Let the size of wire be No. 0000. As the apparent power, and hence the current, is the same as before, and the line resistance is one-half, the resistance-E. M. F. will in this case be

$$\frac{15.4}{2}, \text{ or } 7.7 \text{ per cent of the E. M. F. delivered.}$$

Also, the reactance-E. M. F. will be

$$\frac{.212 \times 17.8}{.228} = 16.5 \text{ per cent.}$$

Combining these on the chart for a power factor of .4, and deducing the drop, in per cent, of the generator E. M. F., the value obtained is 15.3 per cent; with a power factor of .8, the drop is 14 per cent; with a power factor of unity, it is 8 per cent. If in this example the *true* power, instead of the *apparent* power, had been taken as constant, it is evident that the values of drop would have differed more widely, since the current, and hence the resistance- and reactance-volts, would have increased as the power factor diminished. The condition taken more nearly represents that of practice.

If the line had resistance and no reactance, the several values of drop, instead of 15.3, 14, and 8, would be 3.2, 5.7, and 7.2 per cent respectively, showing that for a load of lamps the drop will not

be much increased by reactance; but that with a load, such as induction motors, whose power factor is less than unity, care should be taken to keep the reactance as low as practicable. In all cases it is advisable to place conductors as close together as good practice will permit.

When there is a transformer in circuit, and it is desired to obtain the combined drop of transformer and line, it is necessary to know the resistance- and reactance-volts of the transformer. The resistance-volts of the combination of line and transformer are the sum of the resistance-volts of the line and the resistance-volts of the transformer. Similarly, the reactance-volts of the line and transformer are the sum of their respective reactance-volts. The resistance- and reactance-E. M. F.s of transformers may usually be obtained from the makers, and are ordinarily given in per cent.* These percentages express the values of the resistance- and reactance-E. M. F.'s when the transformer delivers its normal *full-load* current; and they express these values in terms of the normal *no-load* E. M. F. of the transformer.

Consider a transformer built for transformation between 1,000 and 100 volts. Suppose the resistance- and reactance-E. M. F.'s given are 2 per cent and 7 per cent respectively. Then the corresponding voltages when the transformer delivers full-load current, are 2 and 7 volts or 20 and 70 volts according as the line whose drop is required is connected to the low-voltage or high-voltage terminals. These values, 2—7 and 20—70, hold, no matter at what voltage the trans-

* When the required values cannot be obtained from the makers, they may be measured. Measure the resistance of both coils. If the line to be calculated is attached to the high-voltage terminals of the transformer, the equivalent resistance is that of the high-voltage coil, *plus* the resistance obtained by *increasing* in the square of the ratio of transformation the measured resistance of the low-voltage coil. That is, if the ratio of transformation is 10, the equivalent resistance referred to the high-voltage circuit is the resistance of the high-voltage coil, *plus* 100 times that of the low-voltage coil. This equivalent resistance multiplied by the high-voltage current gives the transformer resistance-volts referred to the high-voltage circuit. Similarly, the equivalent resistance referred to the low-voltage circuit is the resistance of the low-voltage coil, *plus* that of the high-voltage coil *reduced* in the square of the ratio of transformation. It follows, of course, from this, that the values of the resistance-volts referred to the two circuits bear to each other the ratio of transformation. To obtain the reactance-volts, short-circuit one coil of the transformer and measure the voltage necessary to force through the other coil its normal current at normal frequency. The result is, nearly enough, the reactance-volts. It makes no difference which coil is short-circuited, as the results obtained in one case will bear to those in the other the ratio of transformation. If a close value is desired, subtract from the square of the voltage reading the square of the *resistance-volts*, and take the square root of the difference as the reactance-volts.

former is operated, since they depend only upon the strength of current, providing it is of the normal frequency. If any other than the full-load current is drawn from the transformer, the reactance- and resistance-volts will be such a proportion of the values given above as the current flowing is of the full-load current. It may be noted, in passing, that when the resistance- and reactance-volts of a transformer are known, its regulation may be determined by making use of the chart in the same way as for a line having resistance and reactance.

As an illustration of the method of calculating the drop in a line and transformer, and also of the use of table and chart in calculating low-voltage mains, the following example is given:

Problem. A single-phase induction motor is to be supplied with 20 amperes at 200 volts; alternations, 7,200 per minute; power factor, .78. The distance from transformer to motor is 150 feet, and the line is No. 5 wire, 6 inches between centers of conductors. The transformer reduces in the ratio $\frac{2,000}{200}$, has a capacity of 25 amperes at 200 volts, and, when delivering this current and voltage, its resistance-E. M. F. is 2.5 per cent, its reactance-E. M. F. 5 per cent. Find the drop.

The reactance of 1,000 feet of circuit consisting of two No. 5 wires, 6 inches apart, is .204. The reactance-volts therefore are

$$.204 \times \frac{150}{1,000} \times 20 = .61 \text{ volts.}$$

The resistance-volts are

$$.627 \times \frac{150}{1,000} \times 20 = 1.88 \text{ volts.}$$

At 25 amperes, the resistance-volts of the transformer are 2.5 per cent of 200, or 5 volts. At 20 amperes, they are $\frac{20}{25}$ of this, or 4 volts.

Similarly, the transformer reactance-volts at 25 amperes are 10, and at 20 amperes are 8 volts. The combined reactance-volts of transformer and line are $8 + .61 = 8.61$, which is 4.3 per cent of the 200 volts to be delivered. The combined resistance-volts are $1.88 + 4$, or 5.88, which is 2.94 per cent of the E. M. F. to be delivered. Combining these quantities on the chart with a power factor of .78, the drop is 5 per cent of the delivered E. M. F.,

$$\text{or } \frac{5}{105} = 4.8 \text{ per cent}$$

of the impressed E. M. F. The transformer must be supplied with

$$\frac{2,000}{.952} = 2,100 \text{ volts,}$$

in order that 200 volts shall be delivered to the motor.

Table X (page 47) is made out for 7,200 alternations, but will answer for any other number if the values for reactance be changed in direct proportion to the change in alternations. For instance, for 16,000 alternations, multiply the reactances given by $\frac{16,000}{7,200}$.

For other distances between centers of conductors, interpolate the values given in the table. As the reactance values for different sizes of wire change by a constant amount, the table can, if desired, be readily extended for larger or smaller conductors.

The table is based on the assumption of sine currents and E. M. F.'s. The best practice of to-day produces machines which so closely approximate this condition that results obtained by the above methods are well within the limits of practical requirements.

Polyphase Circuits. So far, single-phase circuits only have been dealt with. A simple extension of the methods given above adapts them to the calculation of polyphase circuits. A four-wire *quarter-phase* (two-phase) transmission may, so far as loss and regulation are concerned, be replaced by two single-phase circuits identical (as to size of wire, distance between wires, current, and E. M. F.) with the two circuits of the quarter-phase transmission, provided that in both cases there is no inductive interaction between circuits. Therefore, to calculate a four-wire, quarter-phase transmission, compute the single-phase circuit required to transmit one-half the power at the same voltage. The quarter-phase transmission will require two such circuits.

A three-wire, *three-phase* transmission, of which the conductors are symmetrically related, may, so far as loss and regulation are concerned, be replaced by two single-phase circuits having no inductive interaction, and identical with the three-phase line as to size, wire, and distance between wires. Therefore, to calculate a three-phase transmission, calculate a single-phase circuit to carry one-half the load at the same voltage. The three-phase transmission will require three wires of the size and distance between centers as obtained for the single-phase.

A three-wire, two-phase transmission may be calculated

exactly as regards loss, and *approximately* as regards drop, in the same way as for three-phase. It is possible to exactly calculate the drop, but this involves a more complicated method than the approximate one. The error by this approximate method is generally small. It is possible, also, to get a somewhat less drop and loss with the same copper by proportioning the cross-section of the middle and outside wires of a three-wire, quarter-phase circuit to the currents they carry, instead of using three wires of the same size. The advantage, of course, is not great, and it will not be considered here.

WIRING AN OFFICE BUILDING

The building selected as a typical sample of a wiring installation is that of an office building located in Washington, D. C. The figures shown are reproductions of the plans actually used in installing the work.

The building consists of a basement and ten stories. It is of fireproof construction, having steel beams with terra-cotta flat arches. The main walls are of brick and the partition walls of terra-cotta blocks, finished with plaster. There is a space of approximately five inches between the top of the iron beams and the top of the finished floor, of which space about three inches was available for running the electric conduits. The flooring is of wood in the offices, but of concrete, mosaic, or tile in the basement, halls, toilet-rooms, etc.

The electric current supply is derived from the mains of the local illuminating company, the mains being brought into the front of the building and extending to a switchboard located near the center of the basement.

As the building is a very substantial fireproof structure, the only method of wiring considered was that in which the circuits would be installed in iron conduits.

Electric Current Supply. The electric current supply is direct current, two-wire for power, and three-wire for lighting, having a potential of 236 volts between the outside conductors, and 118 volts between the neutral and either outside conductor.

Switchboard. On the switchboard in the basement are mounted wattmeters, provided by the local electric company, and the various switches required for the control and operation of the lighting and power feeders. There are a total of ten triple-pole switches for lighting, and eighteen for power. An indicating voltmeter and ampere meter are also placed in the switchboard. A voltmeter is provided with a double-throw switch, and so arranged as to measure the potential across the two outside conductors, or between the neutral conductor and either of the outside conductors. The ampere meter is arranged with two shunts, one being placed in each outside leg; the shunts are connected with a double-pole, double-throw switch, so that the ampere meter can be connected to either shunt and thus measure the current supplied on each side of the system.

Character of Load. The building is occupied partly as a newspaper office, and there are several large presses in addition to the usual linotype machines, trimmers, shavers, cutters, saws, etc. There are also electrically-driven exhaust fans, house pumps, air-compressors, etc. The upper portion of the building is almost entirely devoted to offices rented to outside parties. The total number of motors supplied was 55; and the total number of outlets, 1,100, supplying 2,400 incandescent lamps and 4 arc lamps.

Feeders and Mains. The arrangement of the various feeders and mains, the cut-out centers, mains, etc., which they supply, are shown diagrammatically in Fig. 41, which also gives in schedule the sizes of feeders, mains, and motor circuits, and the data relating to the cut-out panels.

Although the current supply was to be taken from an outside source, yet, inasmuch as there was a probability of a plant being installed in the building itself at some future time, the three-wire system of feeders and mains was designed, with a neutral conductor equal to the combined capacity of the two outside conductors, so that 120-volt two-wire generators could be utilized without any change in the feeders.

Basement. The plan of the basement, Fig. 42, shows the branch circuit wiring for the outlets in the basement, and the location of the main switchboard. It also shows the trunk cables for the interconnection system serving to provide the necessary wires for telephones,

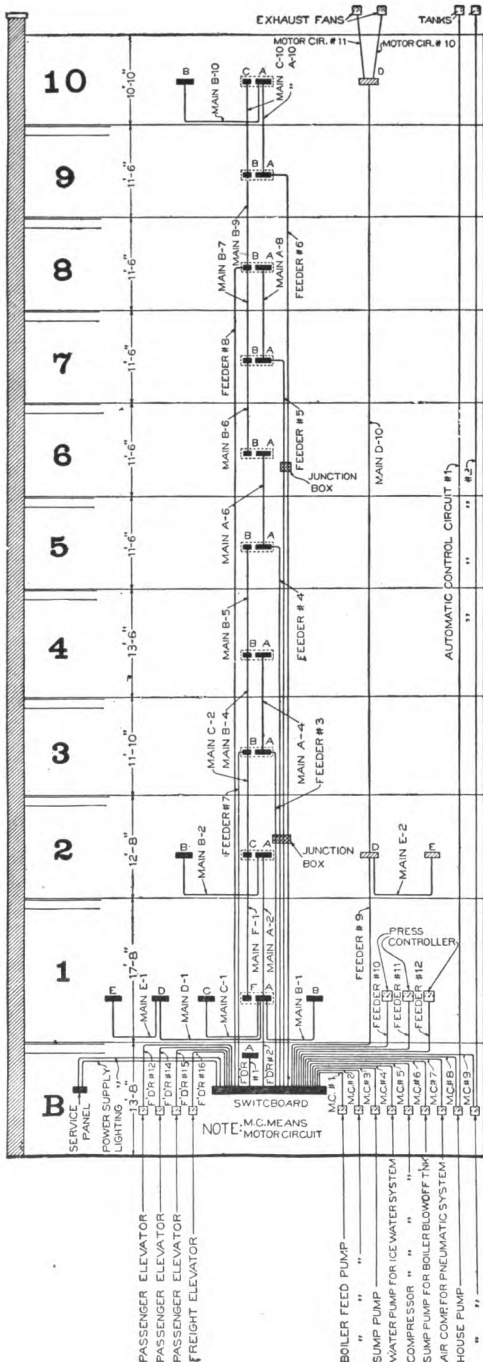

FEEDERS

NO.	END AT	BRANCH	LENGTH-FT	NO. LIGHTS	NO. MIDDLE CONDOR	NO. OUTSIDE CONDOR	INSIDE DIAM OF CONDUIT ALLOWED
1	BASMT	A	115	48	0	4-0	1.25
2	1	B	18	11	0	2-0	1.25
3	RD	A	118	14	0	4-0	1.25
4	RD	B	168	2	0	2-0	1.25
5	TH	A	173	17	0	4-0	1.25
6	TH	B	172	30	0	2-0	1.25
7	TH	A	176	16	0	4-0	1.25
8	TH	B	178	18	0	2-0	1.25
9	TH	A	181	18	0	4-0	1.25
10	TH	B	183	18	0	2-0	1.25
11	FRST	A	148	0	2000000	4-0	1.25
12	FRST	B	138	0	2000000	4-0	1.25
13	PASS. ELV.	A	58	0	0	2-0	1.25
14	PASS. ELV.	B	4	0	0	2-0	1.25
15	FRST ELV.	A	148	0	2000000	4-0	1.25
16	FRST ELV.	B	138	0	2000000	4-0	1.25

* ALL CONDUCTORS IN ONE CONDUIT.
 ** SEPARATE CONDUIT FOR EACH CONDUCTOR
 *** THIS FEEDER IS TO BE DIVIDED INTO FOUR (4)
 **** CONDUCTORS OF #2000000 G.M. EACH.
 ***** EACH CONDUCTOR IS TO BE INSTALLED IN A SEPARATE 3" (INSIDE DIAM) CONDUIT
 L-5= LIGHTING SUPPLY
 P-5= POWER
 ***** SEPARATE 3" (INSIDE DIAM) CONDUIT FOR EACH CONDUCTOR

MAINS

NO.	SUPPLIED BY	FLOOR	LENGTH-FT	NO. LIGHTS	NO. MIDDLE CONDOR	NO. OUTSIDE CONDOR	INSIDE DIAM OF CONDUIT ALLOWED
A-1	FEEDER #1	1	18	11	0	2-0	1.25
A-2	FEEDER #2	2	14	0	0	4-0	1.25
A-3	FEEDER #3	3	14	0	0	4-0	1.25
A-4	FEEDER #4	4	14	0	0	4-0	1.25
A-5	FEEDER #5	5	14	0	0	4-0	1.25
A-6	FEEDER #6	6	14	0	0	4-0	1.25
A-7	FEEDER #7	7	14	0	0	4-0	1.25
A-8	FEEDER #8	8	14	0	0	4-0	1.25
A-9	FEEDER #9	9	14	0	0	4-0	1.25
A-10	FEEDER #10	10	14	0	0	4-0	1.25
B-1	FEEDER #11	1	18	11	0	2-0	1.25
B-2	FEEDER #12	2	14	0	0	4-0	1.25
B-3	FEEDER #13	3	14	0	0	4-0	1.25
B-4	FEEDER #14	4	14	0	0	4-0	1.25
B-5	FEEDER #15	5	14	0	0	4-0	1.25
B-6	FEEDER #16	6	14	0	0	4-0	1.25
B-7	FEEDER #17	7	14	0	0	4-0	1.25
B-8	FEEDER #18	8	14	0	0	4-0	1.25
B-9	FEEDER #19	9	14	0	0	4-0	1.25
B-10	FEEDER #20	10	14	0	0	4-0	1.25
C-1	FEEDER #21	1	18	11	0	2-0	1.25
C-2	FEEDER #22	2	14	0	0	4-0	1.25
C-3	FEEDER #23	3	14	0	0	4-0	1.25
C-4	FEEDER #24	4	14	0	0	4-0	1.25
C-5	FEEDER #25	5	14	0	0	4-0	1.25
C-6	FEEDER #26	6	14	0	0	4-0	1.25
C-7	FEEDER #27	7	14	0	0	4-0	1.25
C-8	FEEDER #28	8	14	0	0	4-0	1.25
C-9	FEEDER #29	9	14	0	0	4-0	1.25
C-10	FEEDER #30	10	14	0	0	4-0	1.25
D-1	FEEDER #31	1	18	11	0	2-0	1.25
D-2	FEEDER #32	2	14	0	0	4-0	1.25
D-3	FEEDER #33	3	14	0	0	4-0	1.25
D-4	FEEDER #34	4	14	0	0	4-0	1.25
D-5	FEEDER #35	5	14	0	0	4-0	1.25
D-6	FEEDER #36	6	14	0	0	4-0	1.25
D-7	FEEDER #37	7	14	0	0	4-0	1.25
D-8	FEEDER #38	8	14	0	0	4-0	1.25
D-9	FEEDER #39	9	14	0	0	4-0	1.25
D-10	FEEDER #40	10	14	0	0	4-0	1.25

MOTOR CIRCUITS

NO.	SUPPLIED BY	FLOOR	HP	SUPPLIED CURRENT IN AMP.	LENGTH IN FT	NO. WIRE	SIZE OF WIRE (ONE WAY)	INSIDE DIAM OF CONDUIT ALLOWED
1	BSMT	1	15	6.0	7-4	3	#8	1.25
2	1	2	15	6.0	3-0	2	#8	1.25
3	2	3	15	6.0	3-0	2	#8	1.25
4	3	4	15	6.0	3-0	2	#8	1.25
5	4	5	15	6.0	3-0	2	#8	1.25
6	5	6	15	6.0	3-0	2	#8	1.25
7	6	7	15	6.0	3-0	2	#8	1.25
8	7	8	15	6.0	3-0	2	#8	1.25
9	8	9	15	6.0	3-0	2	#8	1.25
10	9	10	15	6.0	3-0	2	#8	1.25
11	10	10	15	6.0	3-0	2	#8	1.25
12	11	11	15	6.0	3-0	2	#8	1.25

CUT - OUTS

NAME	FLOOR	HAS CONNECTIONS FOR				METERS	KNIFE SWITCHES			D.P.S.T.
		MAINS	CIRCUITS	SWITCHES	25AMP		50 "	150 "		
A	BSMT	1	4	20	10	2	1	1		
B	1	1	10	10	10	2	1	1		
C	2	1	10	10	10	2	1	1		
D	3	1	10	10	10	2	1	1		
E	4	1	10	10	10	2	1	1		
F	5	1	10	10	10	2	1	1		
G	6	1	10	10	10	2	1	1		
H	7	1	10	10	10	2	1	1		
I	8	1	10	10	10	2	1	1		
J	9	1	10	10	10	2	1	1		
K	10	1	10	10	10	2	1	1		
L	11	1	10	10	10	2	1	1		

* MAIN SWITCH

Fig. 41. Wiring of an Office Building. Diagram Showing Arrangement of Feeders and Mains, Cut-Out Centers, etc.

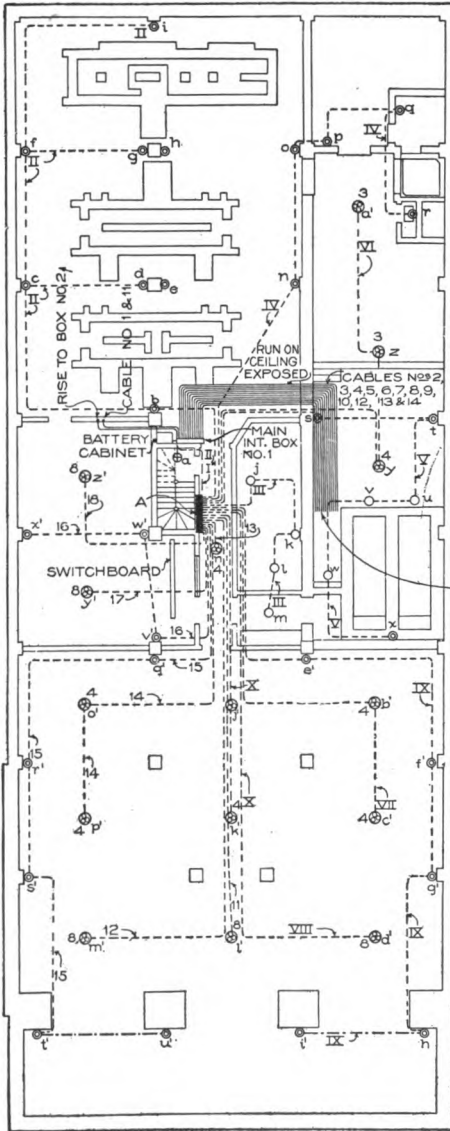

SCHEDULE OF CIRCUITS

CIRCUIT NO.	SUPPLIED BY	OUTLET NO. OR MAIN BRANCHES	OUTLETS SUPPLIED	TOTAL	AT WHAT POINT CONTROLLED
				OUTLETS	
I	A	1	a	1	1
II	"	3	bcdefghl	8	8
III	"	1	iklm	4	4
IV	"	1	nopqr	7	7
V	"	1	stuvw	6	6
VI	"	1	yz'a	5	Sat Δ
VII	"	1	b'c'	2	" " "
VIII	"	1	d'e'f'g'h'i'	5	" " "
IX	"	1	j'k'l'	3	Sat Δ
X	"	1	m'	1	" " "
XI	"	1	n'	1	" " "
12	"	1	m'	1	" " "
13	"	1	h'	1	" " "
14	"	1	o'p	2	" " "
15	"	1	q'r's't'u'	5	" " "
16	"	1	v'w'x	3	" " "
17	"	1	y'	1	Sat Δ
18	"	1	z'	1	" " "
				52	15

CABLE NO. 2 RISES TO 2ND FLOOR
 " " " " 3RD " "
 " " " " 4TH " "
 " " " " 5TH " "
 " " " " 6TH " "
 " " " " 7TH " "
 " " " " 8TH " "
 " " " " 9TH " "
 " " " " 10TH " "
 " " " " 2ND " "
 " " " " 5TH " "
 " " " " 8TH " "

- Key Showing Explanation of Various Symbols used in Figs. 41 to 46 Inclusive
- ◇-----Ceiling Chandelier
 - Wall Bracket
 - Gooseneck Bracket
 - ⊙-----Wall Socket
 - Drop Cord
 - ⊙-----Arc Lamp
 - ⊙-----Cooper-Hewitt Lamp
 - ⊙-----Cluster
 - ⊙-----Floor Outlet
 - ⊙-----Desk Light
 - ⊙-----Extension Outlet
 - ⊙-----Push Button Switch
 - ⊙-----Snap Switch
 - ⊙-----Junction Box
 - ⊙-----Electric Clock
 - ⊙-----Master Clock
 - ⊙-----Motor Starter
 - ⊙-----CutOut Panel
 - ⊙-----Interconnection Box
 - ⊙-----Power Panel
 - ⊙-----Pull Box
 - ⊙-----Circuit under Floor
 - ⊙-----" " above
 - ⊙-----" " on Ceiling Exposed
 - ⊙-----Service Line under Floor

Fig. 42. Wiring an Office Building. Basement Plan Showing Branch Circuit Wiring for Outlets in Basement, Location of Main Switchboard, and Trunk Cables of the Interconnection System Providing Wires for Telephone, Ticker, and Messenger Call Service, etc.

tickers, messenger calls, etc., in all the rooms throughout the building, as will be described later.

To avoid confusion, the feeders were not shown on the basement plan, but were described in detail in the specification, and installed in accordance with directions issued at the time of installation. The electric current supply enters the building at the front, and a service switch and cut-out are placed on the front wall. From this point, a two-wire feeder for power and a three-wire feeder for lighting, are run to the main switchboard located near the center of the basement. Owing to the size of the conduits required for these supply feeders, as well as the main feeders extending to the upper floors of the building, the said conduits are run exposed on substantial hangers suspended from the basement ceiling.

First Floor. The rear portion of the building from the basement through the first floor, Fig. 43, and including the mezzanine floor, between the first and second floors, at the rear portion of the building only, is utilized as a press room for several large and heavy, modern newspaper presses. The motors and controllers for these presses are located on the first floor. A separate feeder for each of these press motors is run directly from the main switchboard to the motor controller in each case. Empty conduits were provided, extending from the controllers to the motor in each case, intended for the various control wires installed by the contractor for the press equipments.

One-half of the front portion of the first floor is utilized as a newspaper office; the remaining half, as a bank.

Second Floor. The rear portion of the second floor, Fig. 44, is occupied as a composing and linotype room, and is illuminated chiefly by means of drop-cords from outlets located over the linotype machines and over the compositors' cases. Separate $\frac{1}{2}$ -horse-power motors are provided for each linotype machine, the circuits for the same being run underneath the floor.

Upper Floors. A typical plan (Fig. 45) is shown of the upper floors, as they are similar in all respects with the exception of certain changes in partitions, which are not material for the purpose of illustration or for practical example. The circuit work is sufficiently intelligible from the plan to require no further explanation.

Interconnection System. Fig. 46 is a diagram of the interconnection system, showing the main interconnection box located in the

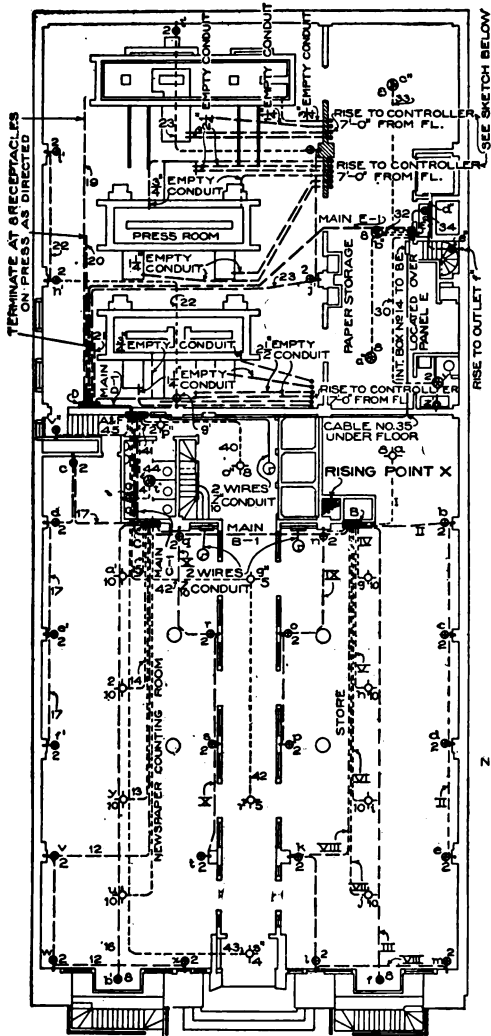

NOTE: ALL CONDUITS FOR THE PRESSES MUST COME THROUGH THE CONTROLLER PLATFORM 21" FROM THE WALL.
 ALL CONDUITS ARE TO TERMINATE IN PRESS AS DIRECTED.

SCHEDULE OF CIRCUITS

NO.	SUPPLIED	OUTLET	BRANCHES	OUTLETS SUPPLIED	TOTAL	AT WHAT POINT	CONTROLLED
I	B	OUT	1	a	1	8	Safe B
II	"	"	1	bcde	4	8	"
III	"	"	1	f	1	8	"
IV	"	"	1	g	1	10	"
V	"	"	1	h	1	10	"
VI	"	"	1	i	1	10	"
VII	"	"	1	klm	3	10	"
VIII	"	"	1	nop	3	10	"
X	C	C-1	qrst	4	8	Safe C	
11	"	"	u	1	10	"	
12	"	"	vwx	3	6	"	
13	"	"	y	1	10	"	
14	"	"	z	1	10	"	
15	"	"	a'	1	10	"	
16	"	"	b'	1	8	"	
17	"	"	c'de'f'	4	8	"	
					16	70	
19	D	D-1	8 Receptacles	8	8		
20	"	"	1	1	8		
21	"	"	1	1	8		
22	"	"	ghj	3	6		
23	"	"	klm	3	6	Safe D	
24	"	"	nop	3	6	"	
25							
26							
27							
28							
29							
30	E	E-1	vz'	2	3	Safe E	
31	"	"	a'	1	8	"	
32	"	"	b'	1	8	"	
33	"	"	c'	1	8	"	
34	"	"	d'e'f'g'	4	8	"	
35							
36							
37							
38							
39							
40	F	F	1 o'	1	8	Safe F	
41	"	"	p'	1	2	"	
42	"	"	q'r	1	2	"	
43	"	"	s'	1	4	"	
44	"	"	t'u'	2	6	"	
45	"	"	v'	1	11	"	
					8	31	

NOTE: THE CLOCKS IN STORE AND COUNTING ROOM ARE TO BE LOCATED AS DIRECTED BY ARCHITECT.

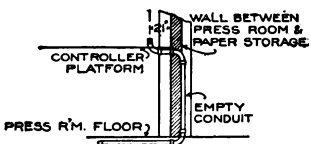

SKETCH SHOWING ROUTE OF EMPTY CONDUITS RISING TO CONTROLLER PLATFORM IN PRESS ROOM.

Fig. 43. Wiring of an Office Building.
 First-Floor Plan, Showing Press Room in Rear, Containing Motors and Controllers for Newspaper Presses, Fed Directly from Main Switchboard in Basement; also, in front, Newspaper Counting Room and Bank Offices.

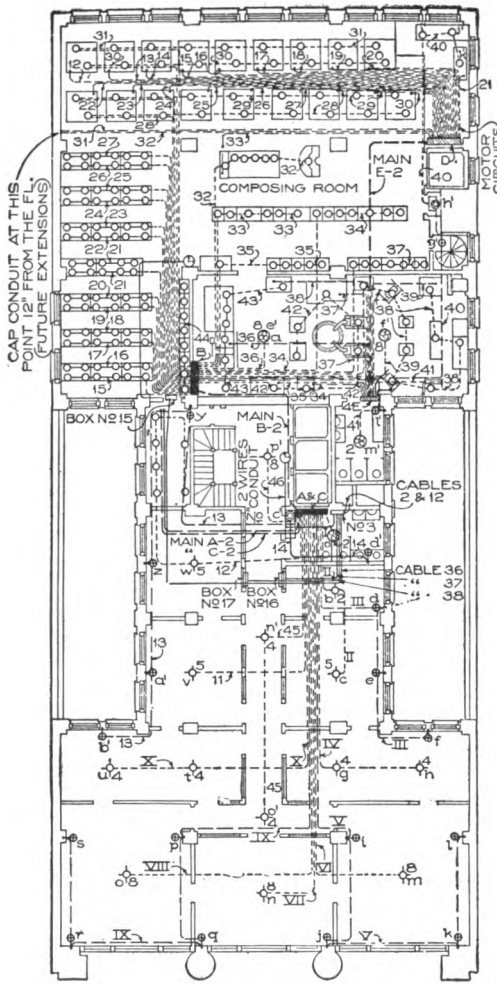

SCHEDULE OF CIRCUITS

NO.	SUPPLIED BY		OUTLETS SUPPLIED	TOTAL OUTLETS	WHAT POINT CONTROLLED
	CUT-OUT	BRANCHES			
I	A	A2	a	2	at A
II	"	"	bc	2	"
III	"	"	def	3	"
IV	"	"	gh	4	"
V	"	"	ijkl	4	"
VI	"	"	kl	2	"
VII	"	"	m	1	"
VIII	"	"	n	1	"
IX	"	"	o	1	"
X	"	"	pqr	4	"
XI	"	"	s	1	"
XII	"	"	t	1	"
XIII	"	"	u	1	"
XIV	"	"	v	1	"
XV	"	"	w&e Drop Cds	7	"
XVI	"	"	x&f	4	"
XVII	"	"	y,z	2	"
XVIII	"	"	a'b	2	"
XIX	"	"	c'd	2	"
20	B	B2	Drop Cords	6	"
21	"	"	"	1	"
22	"	"	"	1	"
23	"	"	"	1	"
24	"	"	"	1	"
25	"	"	"	1	"
26	"	"	"	1	"
27	"	"	"	1	"
28	"	"	"	1	"
29	"	"	"	1	"
30	"	"	"	1	"
31	"	"	"	1	"
32	"	"	"	1	"
33	"	"	"	1	"
34	"	"	"	1	"
35	"	"	"	1	"
36	"	"	"	1	"
37	"	"	"	1	"
38	"	"	"	1	"
39	"	"	"	1	"
40	"	"	"	1	"
41	"	"	"	1	"
42	"	"	"	1	"
43	"	"	"	1	"
44	"	"	"	1	"
45	C	C2	n'o	2	at B
46	"	"	p	1	"

TERMINATE ALL MOTOR CIRCUITS AT MOTOR CONTROLLER AS DIRECTED

MOTOR CIRCUITS

NO.	FEEDER NO.	SUPPLIED BY	CUT-OUT	FLOOR	HP SUPPLIED	CURRENT IN AMPERES	LENGTH IN FT.	INSIDE DIA. OF CONDUIT	SIZE OF WIRE	ALLOWED *
12	D	2ND	*				98	10	10	
13	"	"	"				90	"	"	
14	"	"	"				90	"	"	
15	"	"	"				90	"	"	
16	"	"	"				90	"	"	
17	"	"	"				90	"	"	
18	"	"	"				90	"	"	
19	"	"	"				90	"	"	
20	"	"	"				90	"	"	
21	"	"	"				90	"	"	
22	"	"	"				90	"	"	
23	"	"	"				90	"	"	
24	"	"	"				90	"	"	
25	"	"	"				90	"	"	
26	"	"	"				90	"	"	
27	"	"	"				90	"	"	
28	"	"	"				90	"	"	
29	"	"	"				90	"	"	
30	"	"	"				90	"	"	
31	"	"	"				90	"	"	
32	"	"	"				90	"	"	
33	"	"	"				90	"	"	
34	"	"	"				90	"	"	
35	"	"	"				90	"	"	
36	"	"	"				90	"	"	
37	"	"	"				90	"	"	
38	"	"	"				90	"	"	
39	"	"	"				90	"	"	
40	"	"	"				90	"	"	
41	"	"	"				90	"	"	
42	"	"	"				90	"	"	

* BOTH CONDUCTORS IN ONE CONDUIT
 ** 1/2 H.P. REDUCED TO 1/4 H.P.

Fig. 44. Wiring of an Office Building. Plan of Second Floor. Rear Portion Occupied as a Composing and Linotype Room.

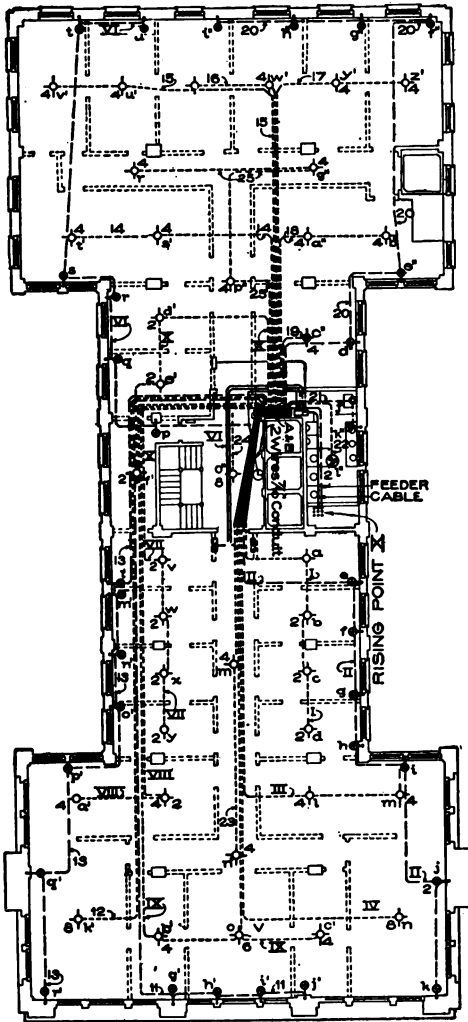

SCHEDULE OF CIRCUITS

NO.	SUPPLIED BY	OUTLET MAIN BRANCHES	OUTLETS SUPPLIED	TOTAL	AT WHAT POINT CONTROLLED	
				OUTLETS		
I	A	1	abcd	4	8	
II	"	"	efghijk	7	7	
III	"	"	lm	2	8	
IV	"	"	n	1	8	
V	"	"	o	1	6	
VI	"	"	pqrstu	6	6	
VII	"	"	vwxxy	4	8	
VIII	"	"	z	2	8	
IX	"	"	bc'	2	8	
X	"	"	de'f'	3	6	
11	"	"	gh'i'j'	4	4	
12	"	"	k	1	8	
13	"	"	l'm'n'o'p'q'r'	7	7	
14	"	"	s't'	2	8	
15	"	"	u'v'w'	2	8	
16	"	"	x'y'z'	2	8	
17	"	"	a''b''	2	8	
18	"	"	c''	1	4	
19	"	"	d'e'f'g'h'i'j'	6	6	
20	"	"	j' k'	2	2	
21	"	"	l'	1	2	Ser A
22	"	"		64	46	
23	B	1	m'n'	2	8	Ser B
24	"	"	o'	1	8	S "
25	"	"	p'q'r'	3	12	S "
				6	28	

Fig. 45. Wiring of an Office Building.

Typical Plan of Upper Floors, Showing Circuit Work, Schedule, etc. All the Floors above the Second are Similar to One Another in Plan, Differing Only in Comparatively Unimportant Details of Partitions.

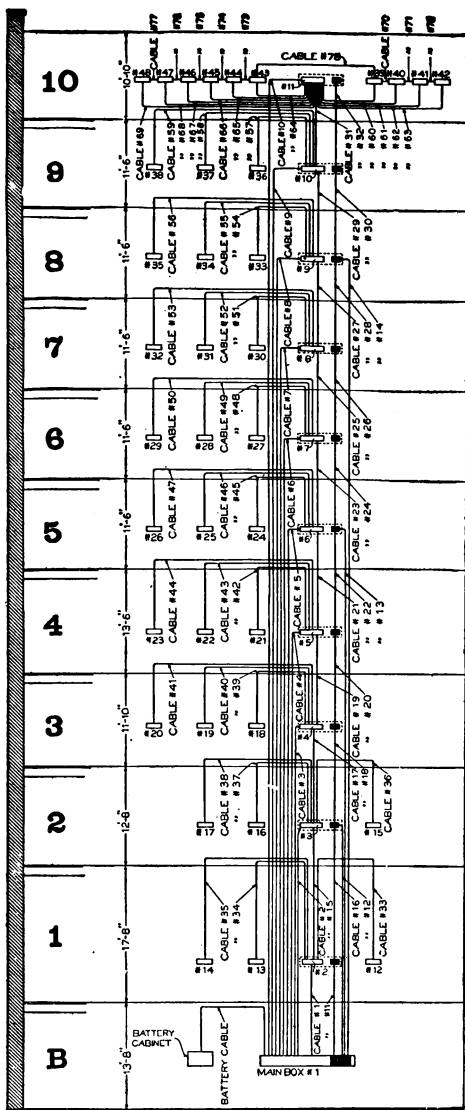

- FIXTURES. -

LOCATION	BATTERIES	BATTERY CABINET	CLOCKS	MASTER CLOCK
BASEMENT	28			
1	1			
2	1			
3	1			
4	1			
5	1			
6	1			
7	1			
8	1			
9	1			
10	1			
TOTALS	28	1	16	

SECTION OF INTERCONNECTION BOX FOR TICKETS, MESSAGER CALLS, ETC.

SECTION OF INTERCONNECTION BOX FOR TELEPHONES, BELL CALLS, ETC.

- CABLES. -

NO.	START AT		END AT		INSIDE DIA. IN FEET	CONDUIT ALLOWED
	BOX NO.	FLOOR	BOX NO.	FLOOR		
1						
2						
3						
4						
5						
6						
7						
8						
9						
10						
11						
12						
13						
14						
15						
16						
17						
18						
19						
20						
21						
22						
23						
24						
25						
26						
27						
28						
29						
30						
31						
32						
33						
34						
35						
36						
37						
38						
39						
40						
41						
42						
43						
44						
45						
46						
47						
48						
49						
50						
51						
52						
53						
54						
55						
56						
57						
58						
59						
60						
61						
62						
63						
64						
65						
66						
67						
68						
69						
70						
71						
72						
73						
74						
75						
76						
77						
78						
79						
80						
81						
82						
83						
84						
85						
86						
87						
88						
89						
90						
91						
92						
93						
94						
95						
96						
97						
98						
99						
100						
TOTALS	1	9	6	3	1	107

■ EMPTY CONDUIT ONLY

- BOXES. -

NO.	FLOOR	NO. REQUIRED OF VARIOUS SIZES			
		1/4"	1/2"	3/4"	1"
1	BASEMENT	1			
2	1				
3	2				
4	3				
5	4				
6	5				
7	6				
8	7				
9	8				
10	9				
11	10				
12	1	1			
13	"	"			
14	"	"			
15	2				
16	3				
17	"				
18	4				
19	"				
20	5				
21	6				
22	7				
23	8				
24	9				
25	10				
26	1				
27	2				
28	3				
29	4				
30	5				
31	6				
32	7				
33	8				
34	9				
35	10				
36	"				
37	"				
38	"				
39	1				
40	2				
41	3				
42	4				
43	5				
44	6				
45	7				
46	8				
47	9				
48	10				
TOTALS		1	9	6	3

Fig. 46. Wiring of an Office Building. Diagram of the Interconnection System.

basement; adjoining this main box is located the terminal box of the local telephone company. A separate system of feeders is provided for the ticker system, as these conductors require somewhat heavier insulation, and it was thought inadvisable to place them in the same conduits with the telephone wires, owing to the higher potential of ticker circuits. A separate interconnection cable runs to each floor, for telephone and messenger call purposes; and a central box is placed near the rising point at each floor, from which run subsidiary cables to several points symmetrically located on the various floors. From these subsidiary boxes, wires can be run to the various offices requiring telephone or other service. Small pipes are provided to serve as race-ways from office to office, so as to avoid cutting partitions. In this way, wires can be quickly provided for any office in the building without damaging the building in any way whatever; and, as provision is made for a special wooden moulding near the ceiling to accommodate these wires, they can be run around the room without disfiguring the walls. All the main cables and subsidiary wires are connected with special interconnection blocks numbered serially; and a schedule is provided in the main interconnection box in the basement, which enables any wire originating thereat, to be readily and conveniently traced throughout the building. All the main cables and subsidiary cables are run in iron conduits.

OUTLET-BOXES, CUT-OUT PANELS, AND OTHER ACCESSORIES

Outlet-Boxes. Before the introduction of iron conduits, outlet-boxes were considered unnecessary, and with a few exceptions were not used, the conduits being brought to the outlet and cut off after the walls and ceilings were plastered. With the introduction of iron conduits, however, the necessity for outlet-boxes was realized; and the *Rules* of the Fire Underwriters were modified so as to require their use. The *Rules of the National Electric Code* now require outlet-boxes to be used with rigid iron and flexible steel conduits, and with armored cables. A portion of the rule requiring their use is as follows:

All interior conduits and armored cables "must be equipped at every outlet with an approved outlet-box or plate.

"Outlet-plates must not be used where it is practicable to install outlet-boxes.

"In buildings already constructed, where the conditions are such that neither outlet-box nor plate can be installed, these appliances may be omitted by special permission of the inspection department having jurisdiction, providing the conduit ends are bushed and secured."

Fig. 47 shows a typical form of outlet-box for bracket or ceiling outlets of the *universal type*. When it is desired to make an opening

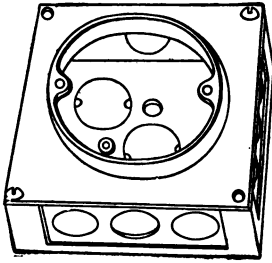

Fig. 47. Universal and Knock-Out Type of Outlet Box.

for the conduits, a blow from a hammer will remove any of the weakened portion of the wall of the outlet-box, as may be required. This form of outlet-box is frequently referred to as the *knock-out type*. Other forms of outlet-boxes are made with the openings cast in the box at the required points, this class being usually stronger and better made than the universal type. The advantages of the universal type of outlet-box are that one form of box will serve for any ordinary conditions, the openings being made according to the number of conduits and the directions in which they enter the box.

Fig. 48 shows a waterproof form of outlet-box used out of doors, or in other places where the conditions require the use of a water-tight and waterproof outlet-box.

It will be seen in this case, that the box is threaded for the con-

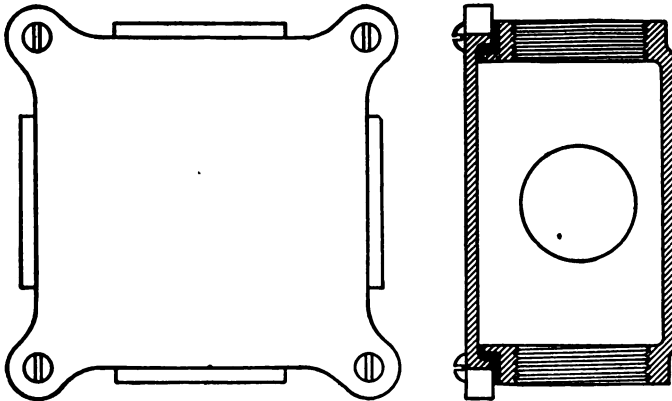

Fig. 48. Water-Tight Outlet Box.

Courtesy of H. Krantz Manufacturing Co., Brooklyn, N. Y.

duits, and that the cover is screwed on tightly and a flange provided for a rubber gasket.

Figs. 49 and 50 show water-tight floor boxes which are for outlets located in the floor. While the rules do not require that the floor outlet-box shall be water-tight, it is strongly recommended that a water-tight outlet be used in all cases for floor connections. In this case also, the conduit opening is threaded, as well as the stem cover through which the extension is made in the conduit to the desk or table. When the floor outlet connection is not required, the stem cover may be removed and a flat, blank cover be used to replace the same.

A form of outlet-box used for flexible steel cables and steel armored cable, has already been shown (see Fig. 5).

There is hardly any limit to the number and variety of makes of outlet-boxes on the market, adapted for ordinary and for special con-

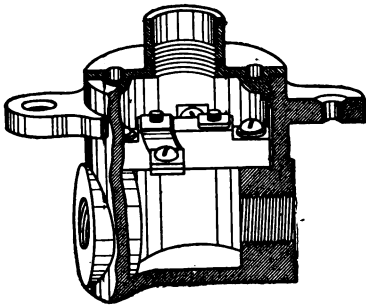

Fig. 49.

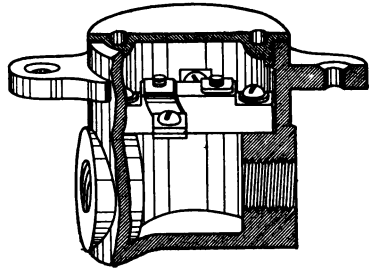

Fig. 50.

Types of Floor Outlet-Boxes.

ditions; but the types illustrated in these pages are characteristic and typical forms.

Bushings. The *Rules of the National Electric Code* require that conduits entering junction-boxes, outlet-boxes, or cut-out cabinets, shall be provided with approved *bushings*, fitted to protect the wire from abrasion.

Fig. 51 shows a typical form of conduit bushing. This bushing is screwed on the end of the conduit after the latter has been introduced into the outlet-box, cut-out cabinet, etc., thereby forming an insulated orifice to protect the wire at the point where it leaves the conduits, and to prevent abrasion, grounds, short circuits, etc. A lock-nut (Fig. 52) is screwed on the threaded end of the conduit before the conduit is placed in the outlet-box or cut-out cabinet, and this lock-nut and bushing clamp the conduit securely in position. Fig.

53 shows a terminal bushing for panel-boxes used for flexible steel conduit or armored cable.

The *Rules of the National Electric Code* require that the metal of conduits shall be permanently and effectually grounded, so as to

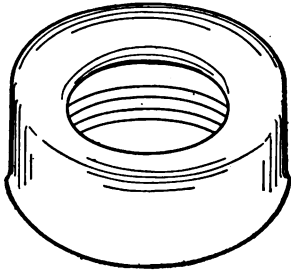
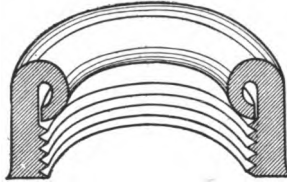

Fig. 51. Conduit Bushing.



insure a positive connection for grounds or leaking currents, and in order to provide a path of least resistance to prevent the current from finding a path

through any source which might cause a fire. At outlet-boxes, the conduits and gaspipes must be fastened in such a manner as to insure good electrical connection; and at centers of distribution, the conduits should be joined by suitable bond wires, preferably of copper, the said bond wires being connected to the metal structure of the building, or, in case of a building not having an iron or steel structure, being grounded in a permanent manner to water or gas piping.

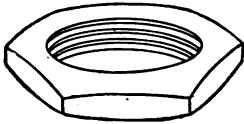

Fig. 52. Lock-Nut.

Fuse-Boxes, Cut-Out Panels, etc. From the very outset, the necessity was apparent of having a protective device in circuit with the conductor to protect it from overload, short circuits, etc. For this purpose, a fusible metal having a low melting point was employed. The form of this fuse has varied greatly. Fig. 54 shows a characteristic form of what is known as the *link fuse* with copper terminals, on which are stamped the capacity of the fuse.

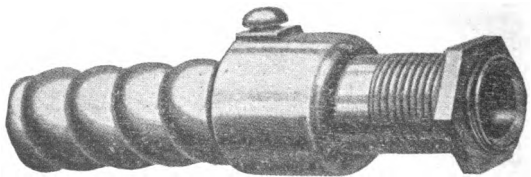

Fig. 53. Panel-Box Terminal Bushing.
Courtesy of Sprague Electric Co., New York, N. Y.

The form of fuse used probably to a greater extent than any other, although it is now being superseded by other more modern forms,

is that known as the *Edison fuse-plug*, shown in Fig. 55. A porcelain *cut-out block* used with the Edison fuse is shown in Fig. 56.

Within the last four or five years, a new form of fuse, known as the *enclosed fuse*, has been introduced and used to a considerable

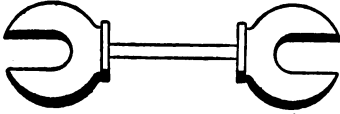

Fig. 54. Copper-Tipped Fuse Link.

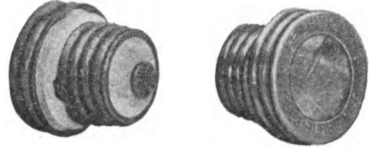

Fig. 55. Edison Fuse-Plug,
Courtesy of General Electric Co., Schenectady, N. Y.

extent. A fuse of this type is shown in Fig. 57. Fig. 58 gives a sectional view of this fuse, showing the porous filling surrounding the fuse-strips, and also the device for indicating when the fuse has blown.

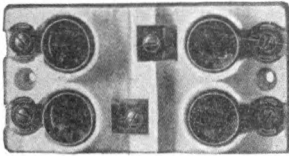

Fig. 56. Porcelain Cut-Out Block.
Courtesy of General Electric Co.,
Schenectady, N. Y.

This form of fuse is made with various kinds of terminals; it can be used with spring clips in small sizes, and with a post screw contact in larger sizes. For ordinary low potentials this fuse is desirable for currents up to 25 amperes; but it is a debatable question whether it is desirable to use an enclosed fuse for heavier currents. Fig. 59 shows a *cut-out box* with Edison plug

fuse-blocks used with knob and tube wiring. It will be seen that there is no connection compartment in this fuse-box, as the circuits enter directly opposite the terminals with which they connect.

Fig. 60 shows a *cut-out panel* adapted for enclosed fuses, and installed in a cabinet having a connection compartment. As will be seen from the cut, the tablet itself is surrounded on the four sides by slate,



Fig. 57. Enclosed or "Cartridge" Fuse.



Fig. 58. Section of Enclosed Fuse.

which is secured in the corners by angle-irons. The outer box may be of wood lined with sheet iron, or it may be of iron. Fig. 61 shows a door and trim for a cabinet of this type. It will be seen that

the door opens only on the center panel, and that the trim covers and conceals the connection compartment. The inner side of the door should be lined with slate, and the inner side of the trim should be lined with sheet iron. Fig. 62 shows a sectional view of the cabinet and panel. In this type of cabinet, the conduits may enter at any

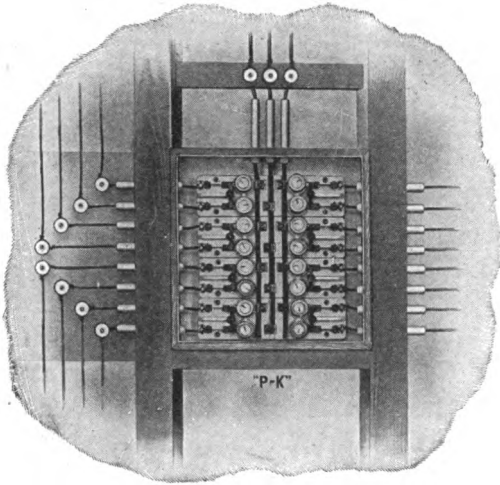

Fig. 59. Porcelain Cut-Outs in Wooden Box.
Courtesy of H. T. Paiste Co., Philadelphia, Pa.

point, the wires being run to the proper connectors in the connection compartment.

Figs. 63 and 64 illustrate a type of panel-board and cabinet having a push-button switch connected with each branch circuit and so arranged that the cut-out panel itself may be enclosed by locked doors, and access to the switches may be obtained through two separate doors provided with latches only.

This type of panel was arranged and designed by the author of this instruction paper.

OVERHEAD LINEWORK

The advantages of overhead linework as compared with underground linework are that it is much less expensive; it is more readily and more quickly installed; and it can be more readily inspected and repaired.

Its principal disadvantages are that it is not so permanent as underground linework; it is more easily deranged; and it is more unsightly.

For large cities, and in congested districts, overhead linework should not be used. However, the question of first cost, the question of permanence, and the municipal regulations, are usually the factors which determine whether overhead or underground linework shall be used.

The principal factors to be considered in overhead linework will be briefly outlined.

Placing of Poles. As a general rule, the poles should be set from 100 to 125 feet apart, which is equivalent to 53 to 42 poles per mile. Under certain conditions, these spacings given will have to be modified; but if the poles are spaced too far apart, there is danger of too great a strain on the poles themselves, and on the cross-arms, pins, and

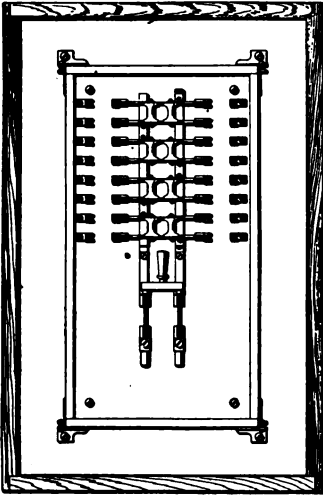

Fig. 60. Plan View, Cover, and Section of Double Cut-Out Box.

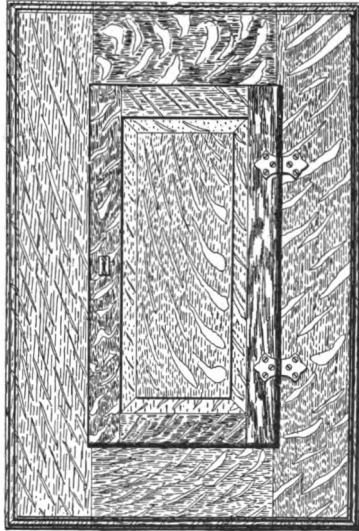

Fig. 61.

conductors. If, on the other hand, they are placed too close together, the cost is unnecessarily increased. The size and number of conductors, and the potential of the line-work, determine to a great extent the distance between the poles; the smaller the size, the less the number of conductors; and the lower the potential, the greater the distance between the poles may be made. Of course, the exact location of the poles is subject to variation because of trees, buildings, or other obstructions. The usual method employed in locating poles, is first to make a map on a fairly large scale, showing the course of the line-work, and then to locate the poles on the ground according to the actual conditions.

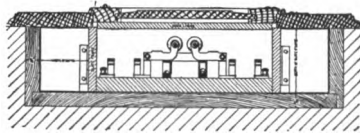

Fig. 62.

Poles. Poles should be of selected quality of chestnut or cedar, and should be sound and free from cracks, knots, or other flaws. Experience has proven that chestnut and cedar poles are the most durable and best fitted for linework. If neither chestnut nor cedar poles can be obtained, northern pine may be used, and even other timber in localities where these poles cannot be obtained; but it is found that the other woods do not last so long as those mentioned,

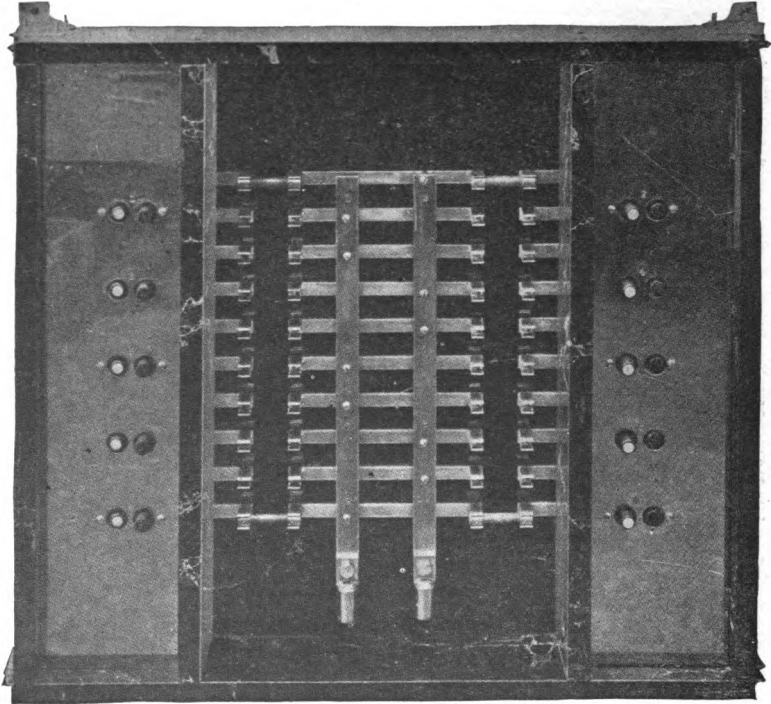
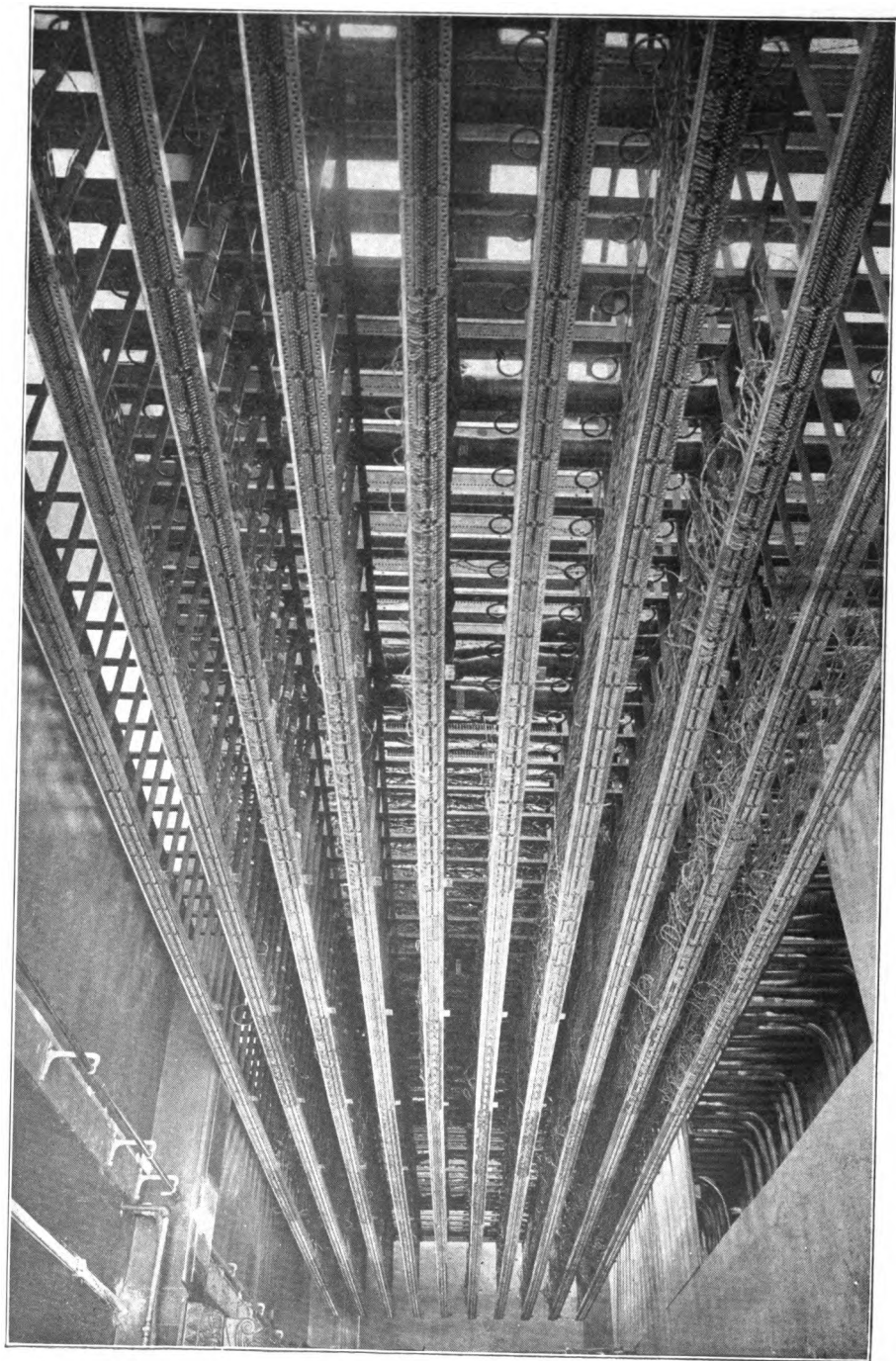

Fig. 63. Cut-Out Panel with Push-Button Switches. Cover Removed.

and some of the other woods are not only less strong initially, but are apt to rot much quicker at the "wind and water line"—that is, just above and below the surface of the ground.

The proper height of pole to be used depends upon conditions. In country and suburban districts, a pole of 25 to 30 feet is usually of sufficient height, unless there are more than two or three cross-arms required. In more densely populated districts and in cities where a great number of cross-arms are required, the poles may have to be





LINE SIDE OF LARGE MAIN DISTRIBUTING FRAME

40 to 60 feet, or even longer. Of course, the longer the pole, the greater the possibility of its breaking or bending; and as the length increases, the diameter of the butt end of pole should also increase. Table XI gives the average diameters required for various heights of poles, and the depth the poles should be placed in the ground. These data have been compiled from a number of standard specifications.

TABLE XI
Pole Data

LENGTH OF POLE	DIAMETER 6 IN. FROM BUTT	DIAMETER AT TOP	DEPTH POLE SHOULD BE PLACED IN GROUND
25 feet	9 to 10 in.	6 to 8 in.	5 feet
30 "	11 "	" "	5½ "
35 "	12 "	" "	5½ "
40 "	13 "	" "	6 "
45 "	14 "	" "	6½ "
50 "	15 "	" "	7 "
55 "	16 to 17 "	" "	7½ "
60 "	18 "	" "	7½ "
65 "	19 "	" "	8 "
70 "	20 "	" "	8 "
75 "	21 "	" "	8½ "
80 "	22 "	" "	9 "

As it is somewhat difficult, because of irregularities in size, to measure the diameter of some poles, the circumference may be measured instead: then, by multiplying the diameters given in the above table, by 3.1416, the measurements may be reduced to the circumference in inches.

The minimum diameters of the pole at the top, which should be allowed, will depend largely on the size of the conductors used, and on the potential carried by the circuits; the larger the conductors and the higher the potentials, the greater should be the diameter at the top of the pole.

Poles should be shaved, housed, and gained, also cleaned and ready for painting, before erection.

Poles should usually be painted, not only for the sake of appearance, but also in order to preserve them from the weather. It is particularly important that they should be protected at their butt end, not only where they are surrounded by the ground, but for a foot or two above the ground, as it is at this point that poles usually deteriorate most rapidly. Painting is not so satisfactory at this point as the use of tar, pitch, or creosote. The life of the pole can be increased considerably by treating it with one or another of these preservatives.

Before any poles are erected, they should be closely inspected for flaws and for crookedness or too great departure from a straight line.

Where appearance is of considerable importance, octagonal poles may be used, although these cost considerably more than round poles. *Gains* or notches for the cross-arms should be cut in the poles before they are erected, and should be cut square with the axis of the pole, and so that the cross-arms will fit snugly and tightly within the space thus provided. These gains should be not less than $4\frac{1}{2}$ inches wide,

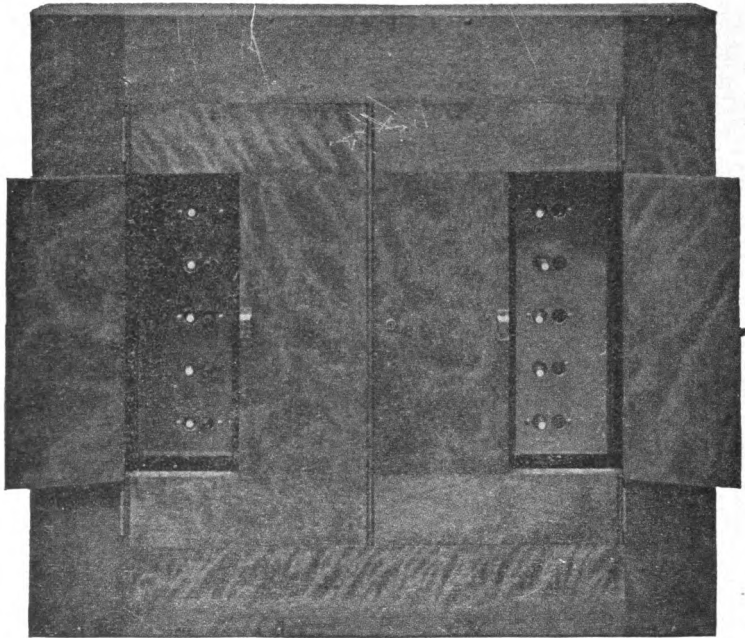

Fig. 64. Cut-Out Panel with Push-Button Switches. With Cover.

nor less than $\frac{1}{2}$ inch deep. Gains should not be placed closer than 24 inches between centers, and the top gains should be at least 9 inches from the apex of the pole.

Pole Guying. Where poles are subject to peculiar strains due to unusual stress of the wires, such as at corners, etc., *guys* should be employed to counteract the strain and to prevent the pole from being bent and finally broken, or from being pulled from its proper position.

Where there are a considerable number of wires on the poles, or in case of unusually long poles, or where the linework is subject to severe storms, it is frequently necessary to guy the poles even on straight linework. In such cases, the guys should extend from a point near the top of the pole to a point near the butt of the adjacent pole. Straight guying should also be employed at the terminal pole, the guy extending to a stub beyond the last pole, to counteract the strain of the wires pulling in the opposite direction. On particularly heavy lines, it is sometimes necessary to use straight guys for the second and even the third pole from the terminal pole, to prevent undue strain on the terminal pole itself, as shown in Fig. 65.

Where there are three or more cross-arms, either two sets of guys should be employed, or else a "Y" form of guy should be used. If a single guy is used on a long pole or on a pole carrying a number of cross-arms, or on which there is unusual strain, the pole is apt to break where the guy is attached. Figs. 66 and 67 show respectively a proper and an improper method of guying, and their effect.

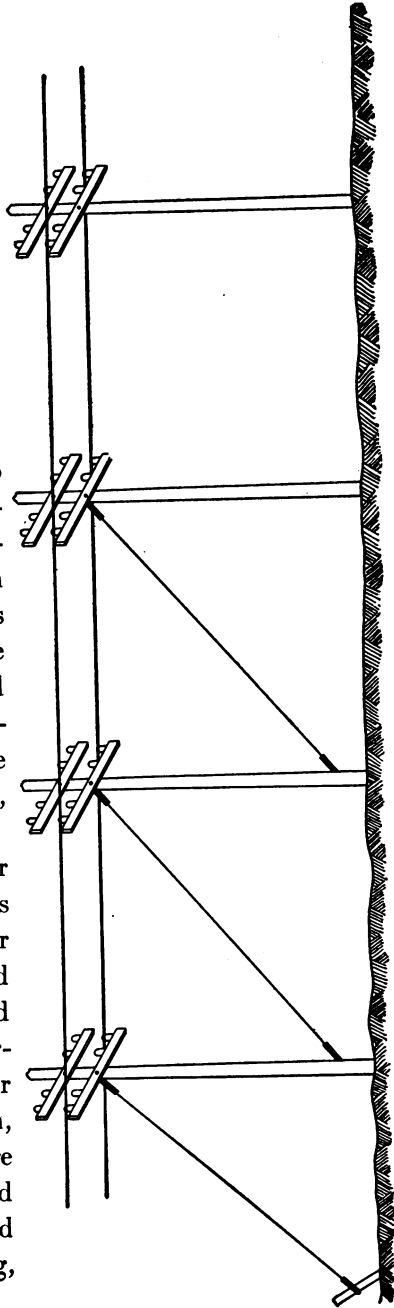

Fig. 65. Use of Straight Guys on Poles at Terminus of Heavy Line.

At corners, or wherever the direction of the linework changes, guys should be provided to counteract the strain due to the change in direction. Guys are also necessary at points where poles are set in other than a vertical position.

Where the soil is not firm or solid, or where poles are subject to unusual stress, it is sometimes necessary to obtain additional stiffness by what is known as *crib-bracing*, as may be seen from Fig. 68. This consists of placing two short logs at the butt of the pole. These logs need not be more than 4 to 5 feet long, or more than 8 to 9 inches

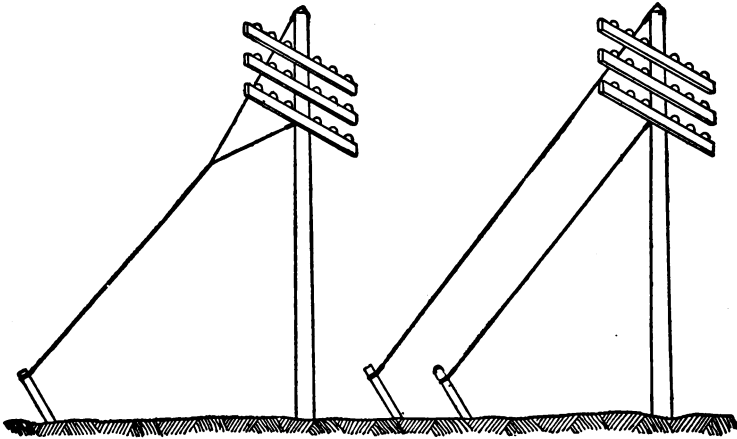

Fig. 66. Proper Method of Guying where there are Three or More Cross-Arms. A Y-form of Guy is Used at Left; Double Guy at Right.

in diameter. This crib-bracing is sometimes also necessary to give greater stability to stubs or short poles to which guys are fastened.

While, as a rule, it is not advisable to use trees for guy supports, it is sometimes necessary to do this, but the trees should be sound and should be protected in a proper manner from injury. On private property, permission should first be obtained from the owner to use the tree for such purpose.

The guy itself should be of standard cable, consisting of 7 strands of No. 12 B. & S. Gauge iron or steel wire. This is the standard *guy cable*, and should be used in all cases, except for very light poles and light linework, where a smaller cable having a minimum diameter of $\frac{1}{4}$ inch may be used. The guy wires should be fastened at the ends by means of suitable clamps. All guy cables and clamps should be heavily galvanized, to prevent rusting.

Corners. In cases of heavy linework where there are a considerable number of wires and cross-arms, the turns should be made,

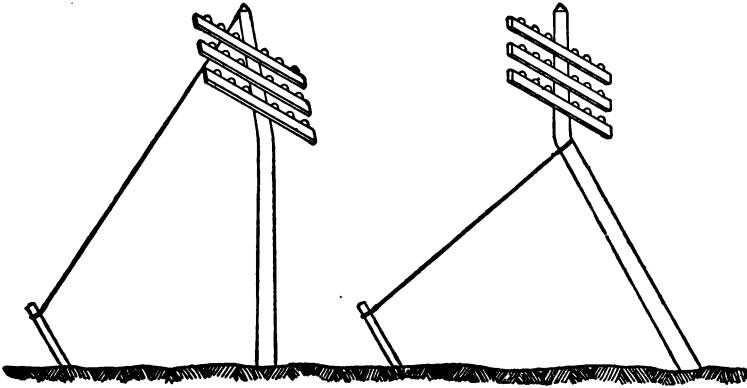

Fig. 67. Improper Method of Guying where there are Three or More Cross-Arms. Strain is Concentrated at one Point, Causing Rupture of Pole.

if possible, by the use of two poles. In cases where there are only a few wires, a double cross-arm may be employed, using a single pole. The two methods are illustrated in Figs. 69 and 70.

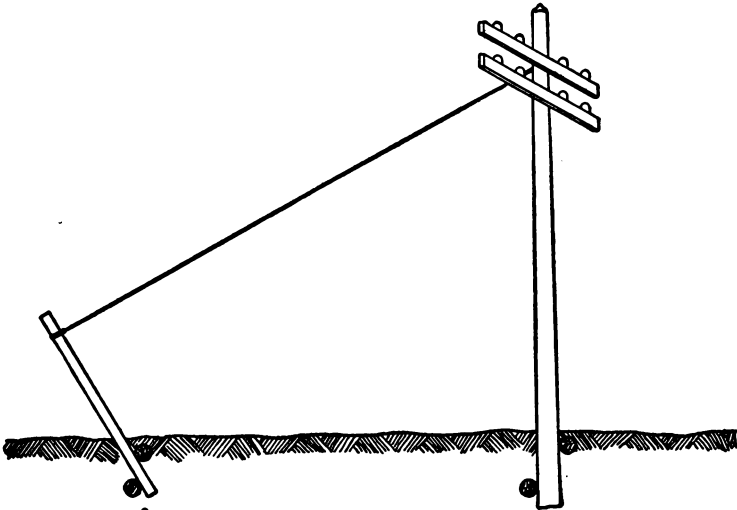

Fig. 68. Additional Stiffness Secured by Use of Crib-Bracing.

Cross-Arms. Cross-arms, where possible, should be of long leaf yellow pine, or of Oregon or Washington fir, of sound wood,

thoroughly seasoned and free from sap, cracks, or large knots. They should be not less than $3\frac{1}{4}$ inches thick by $4\frac{1}{4}$ inches deep, the length depending upon the number of pins required.

Cross-arms, after being properly seasoned, should be painted with two coats of lead paint before erection. They should then be snugly fitted into the gain of the pole, and securely fastened with a bolt not less than $\frac{5}{8}$ inch in diameter driven through a hole of slightly less diameter previously bored in the pole. A galvanized-iron washer not less than 2 inches in diameter should be placed under the head and nut of

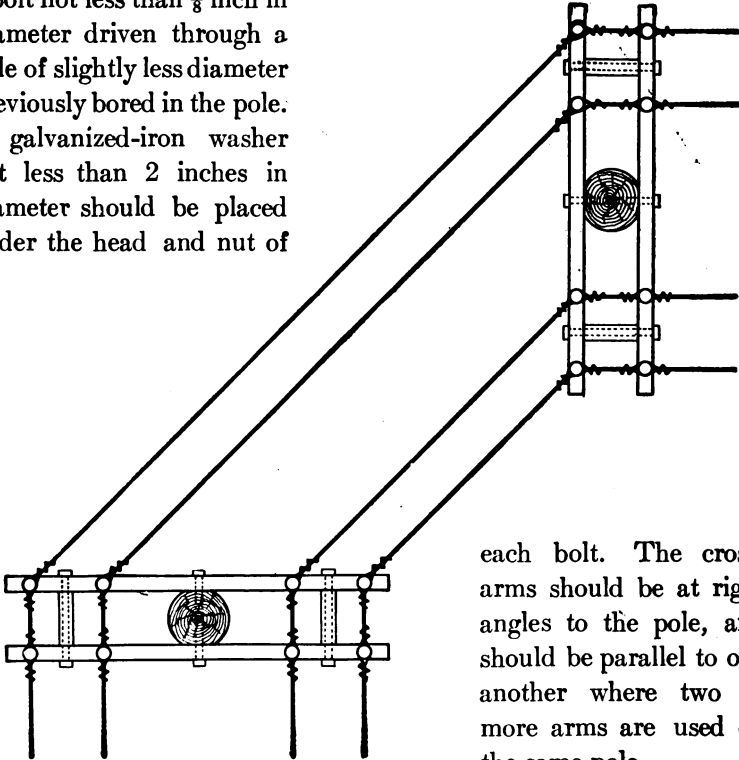

Fig. 69. Two-Poles Used in Making Turn on Heavy Line.

each bolt. The cross-arms should be at right angles to the pole, and should be parallel to one another where two or more arms are used on the same pole.

The cross-arms should be braced with galvanized-iron *braces* approximately $1\frac{1}{4}$ inches wide, $\frac{1}{4}$ inch thick, and from 18 to 30 inches in length. The braces should be fastened to the cross-arm by means of $\frac{3}{8}$ -inch galvanized-iron bolts passing through the brace and the cross-arm, washers being used under the nut and head of each bolt. Guys should be provided for the cross-arms in case of unusual strain. The dimensions of cross-arms required for various numbers of pins, are given very completely in a

paper read by Mr. Paul Spencer before the Atlantic City Convention of the National Electric Light Association in 1906, and reprinted in a number of the technical journals.

Wherever practicable, cross-arms should be placed on the poles before the poles are erected, as not only can they be more securely fastened when the poles are on the ground, but the cost of erection is thereby considerably reduced.

Pins. Pins should be of selected locust, not less than $\frac{3}{4}$ inch diameter at the shank portion, and not less than $1\frac{1}{2}$ inches in diameter at the point where they rest upon the cross-arm. For potentials of 20,000 volts or over, the pins should be of metal, to avoid carbonization of the wood due to static leakage. The top portion of the pin (if of wood) should be not less than one inch in diameter. The length of both the shank and the upper portion

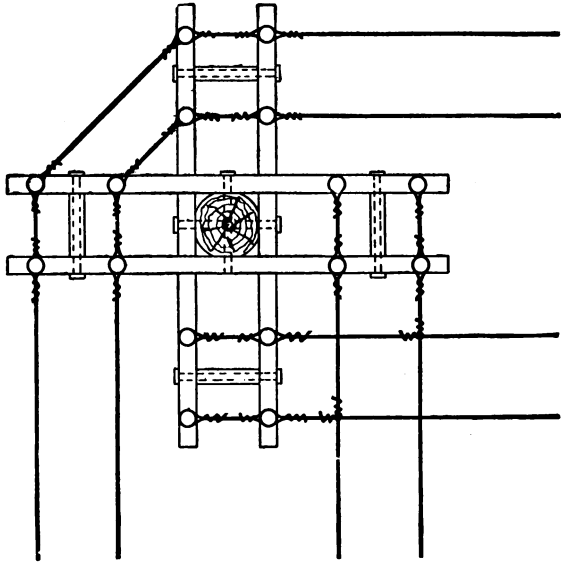

Fig. 70. Double Cross-Arm Used on Single Pole to Make Turn in Heavy Line Carrying Only a Few Wires.

should be each approximately $4\frac{1}{2}$ inches, making the total length approximately 9 inches. The pin should be threaded and tapered, and accurately cut. The pin should fit the hole in the cross-arm snugly, and should be nailed to the cross-arm with a sixpenny galvanized-iron wire nail driven **straight** through the center of the shank of the pin.

Insulators. For potentials of 3,000 volts or less, insulators should be of flint glass, of double-petticoat, deep-grooved type. For potentials of over 3,000 volts, they should be of the triple-petticoat type, and preferably of porcelain, and should be of special pattern adapted for the potential.

Service Mains, Pole Wiring, etc. For service connections—

that is, for the mains run to service switches in consumers' residences or other buildings, conductors of not less than No. 8 B. & S. Gauge should be used in order to obtain the necessary tensile strength. Where possible, the circuits should be arranged in such a manner as to have the service main connect with the line on the lowest cross-arm, in order to prevent crossing of wires. The transformers should be installed either on poles or in vaults outside of the building, or, where this is impracticable, in a fireproof vault or other enclosed space inside of the building itself. Small transformers may be fastened to a pair of cross-arms secured to the pole itself. For transformers of 25 K.W. and over, it is usually best to provide special poles. It is inadvisable to place transformers on building walls.

Where appearance is of importance, when the transformer is placed underground, or when the wires enter the lower portion of a building, the conductors must be run underground. In such cases, a splice should be made between the weatherproof conductors and rubber-insulated lead-sheathed conductors, at a height of about 15 to 20 feet above the ground, and the mains run in iron pipe down the pole to a point underground, where they may be continued either in iron pipe or in vitrified or fiber conduits underground to the point of entrance.

All circuit wiring on poles should be so arranged as to leave one side free for the linemen to climb the poles without injuring the conductors. As a rule, all poles on which transformers, lightning arresters, or fuse-boxes are located, should be provided with steps.

In order to limit the area of disturbance of a short circuit or overload, fuses should be inserted in each leg of a primary circuit in making connections to transformers, or where tap or branch connections are made. The fuses should have a capacity of approximately 50 per cent greater than the transformer or conductor which they protect. Of course, it would be undesirable to have an excessive number of fuses, and for short branch lines they might frequently be undesirable; but for important branch lines, they should be employed in order to prevent the fuse on the main feeder from being *blown* in case of disturbance on the branch line.

Lightning arresters should be placed on the linework in places particularly exposed to lightning discharges, and at all points where connections are made to enter a building. The location and number

of lightning arresters will depend upon local conditions, the likelihood and frequency of thunderstorms, etc. Where lightning arresters are provided, it is essential that a good ground connection be obtained. The ground connection should be made by a fairly good-sized insulated rubber conductor, not less than No. 6 B. & S. Gauge, connecting either with a water pipe to which it should be clamped, or fastened in such a manner as to obtain a good electric contact, or else to a ground-plate of copper embedded in crushed charcoal or coke.

The neutral wire of a three-wire of both secondary alternating-current systems and direct-current systems, should be properly grounded as required by the *National Electric Code* (see Rules 12, 13, and 13-A).

Lamps on Poles. Fig. 71 shows the method of wiring to and supporting a lamp located on a pole.

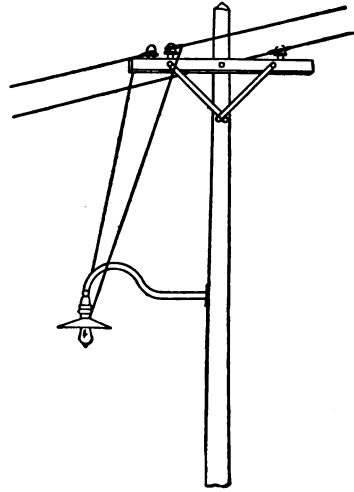

Fig. 71. Method of Wiring to and Supporting Lamp on Pole.

UNDERGROUND LINWORK

In large cities, or in congested districts, or where the appearance of overhead linework is objectionable, it is generally necessary to place the conductors underground instead of overhead.

The advantages of underground linework are—*first*, that of appearance; *second*, it is more permanent and less liable to interruption than overhead work.

The principal disadvantage of underground work is the greater first cost. In overhead linework, conductors having weatherproof insulators consisting of cotton dipped in a special compound similar to pitch, are used, the cost of which is relatively small. For underground linework, however, the conductors must not only have rubber insulation, but also a lead sheathing for mechanical protection.

Furthermore, the cost of the ducts, trenching, concrete work, laying the ducts, etc., is much greater than the cost of poles, cross-arms, etc.

As in the case of inside wiring, underground linework should be so arranged that the conductors may be readily removed and replaced without disturbing the underground conduits or ducts. The system should be arranged with *manholes*, and in such a manner that changes or additions or branches may be readily and conveniently made. In order to provide for the removal and replacing of conductors, and also for growth in the system, the method formerly in vogue, of embedding the conductors in wooden boxes, or in trenches underground, has been abandoned; and the conductors are now placed in *conduits* or *ducts*. A number of different forms of ducts and conduits have been introduced, some of which have been dropped as cheaper and better forms have been introduced. The forms of conduits or ducts now most generally employed include *iron pipe*, *vitrified conduits*, and *fibre conduit*. As all three of these forms of conduit are very generally employed, they will now be described, as well as the method of installing them.

Iron Pipe. Three-inch iron conduit is frequently used for underground linework, particularly for short runs or where there are not more than two or three ducts required, or where the soil is bad and where the longer lengths and more stable joints of the iron conduit would make it more desirable than vitrified duct or fibre conduit. This conduit, however, is generally undesirable on account of its greater first cost, and also on account of its liability to deterioration from rust or corrosion. Where iron conduit is used, and where it is subject to corrosion, it should be coated with asphaltum or other similar protective composition. While it is not necessary to have a concrete bed under iron pipe, it is better to provide such a bed, especially where the soil is shifting or not solid.

Vitrified Tile Conduit. This type of conduit in both the single- and multiple-duct form, is used more extensively than any other form of conduit for underground work. It is made in lengths of 18 inches for the single-duct form, and in considerably greater lengths in the multiple-duct form. Fig. 72 shows the single-duct conduit, and Fig. 73 shows a multiple-duct form of conduit.

Vitrified conduit requires less space for the same number of ducts than any other form, and is particularly desirable where a great

number of ducts are required in a small space. The advantages of this form of conduit are that it is cheap in first cost; after being laid, it is practically indestructible; it is not subject to corrosion or

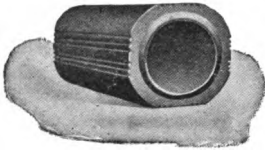

Fig. 72. Self-Centering Duct,
Vitrified Conduit.
*Courtesy of Standard Vitrified Conduit Co.,
New York, N. Y.*

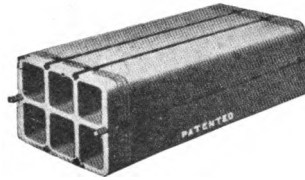

Fig. 73. Multiple Duct, Vitrified
Conduit.
*Courtesy of Standard Vitrified Conduit Co.,
New York, N. Y.*

deterioration; it is not combustible; it is fairly strong mechanically; and it does not require skilled labor to install.

Table XII gives the principal data of one of the well-known makes of vitrified conduit:

TABLE XII
Standard Vitrified Conduit

STYLE OF CONDUIT	DIMENSION OF SQUARE DUCT (INCHES)	DIMENSION OF ROUND DUCT (INCHES)	OUTSIDE DIMENSIONS OF END SEC- TION (IN.)	REG. STOCK LENGTHS (INCHES)	SHORT LENGTHS (INCHES)	APPROX. WEIGHT PER DUCT (FOOT)
2-duct multiple...	3 $\frac{3}{4}$ sq.	3 $\frac{1}{4}$	5 x 9	24	6, 9, 12	8 lbs.
3-duct multiple...	3 $\frac{3}{4}$ sq.	3 $\frac{1}{4}$	5 x 13	24	6, 9, 12	8 "
4-duct multiple...	3 $\frac{3}{4}$ sq.	3 $\frac{1}{4}$	9 x 9	36	6, 9, 12	8 "
6-duct multiple...	3 $\frac{3}{4}$ sq.	3 $\frac{1}{4}$	9 x 13	36	6, 9, 12	8 "
9-duct multiple...	3 $\frac{3}{4}$ sq.	3 $\frac{1}{4}$	13 x 13	36	6, 9, 12	8 "
Common single duct		3 $\frac{3}{4}$	5 x 5	18	6, 9, 12	8 "
Single duct, self- centering		3 $\frac{3}{4}$	5 x 5	18	6, 9, 12	10 "
Round single duct, self-centering...		3 $\frac{1}{4}$	5 in. round	18	6, 9, 12	10 "

In installing vitrified conduit, a trench following as straight lines as possible should be dug to such a depth that there will be a space of at least 18 inches from the top layer of the duct to the street surface. The bottom of the trench should be level; and a bed of good cement concrete not less than 3 inches thick should be laid. The following instructions* for installing vitrified conduit may be considered as typical of the best up-to-date practice:

*From the Catalogue of the Standard Underground Conduit Company.

Laying of Conduit. When the trench has been properly prepared and the concrete foundation set, the laying of conduit should be begun. The ends of the conduit should be butted against the shoulder of the conduit terminal brick; short length should be used for the breaking of joints.

Care should be taken, when each length of conduit is laid, that the duct hole is perfectly clear and the conduit level. The work may then proceed; and if the following instructions are carried out, no difficulty will be encountered after the duct are laid.

When the first piece of conduit is laid and the keys inserted, one on the top and one on the side of the duct, the burlap for joints should be slipped partly under the conduit, and the next piece brought up and connected. The burlap is then brought up and wrapped around the conduit. After this operation is completed, a thin layer of cement mortar is plastered around the burlap, extending over the edges, so as to cover the scarified portion of the conduit so that it may adhere to it, thus making the joint practically water-tight.

The burlap should be first prepared in strips of not less than 6 inches in width, and of suitable length to wrap around the conduit, overlapping about 6 inches. If possible, the burlap should be saturated in asphaltum or pitch; but if this is not convenient, it may be dipped in water so as to stick to the conduit until the joint has been cemented. The engineer or foreman in charge should personally oversee the making of the joint, and especially see that the keys are inserted, as in many instances they are left out by the workmen, causing considerable trouble and expense. Sufficient time should be allowed for the joints to harden.

After the duct are laid, the sides are filled in with either concrete or dirt, as specified, care being taken that the conduit are not forced out of alignment by the careless filling-in of the sides. The top layer of concrete may then be laid and leveled.

After this the trench is ready for filling in.

In the laying of our self-centering single-duct conduit, no dowel pins are used, the ducts being self-centering—one piece of conduit socketing into the other. Burlaping and cementing of joint is not necessary. Otherwise the instructions for the laying of multiple-duct should be followed. The use of a mandrel in laying self-centering conduit is superfluous.

As each section of the system—that is, from manhole to manhole—is completed, it should be rodded to insure the duct being clear. For this purpose wooden rods are employed, the rods being from 3 to 4 feet long by one inch in diameter and provided with brass couplings on the ends. The first rod is pushed into the duct chamber, the second one is then attached, and then the third and so on, until the first rod appears in the manhole at the opposite end.

A wooden mandrel about 10 inches long, made to conform to the shape of the duct, but about $\frac{1}{4}$ inch smaller in diameter, is attached to the last rod, and a galvanized-iron wire is then attached to the other end of the mandrel. The rods are drawn through the duct and uncoupled, until the mandrel has passed through the ducts. The wire is left remaining in the chamber, and secured in the manhole to prevent its being pulled out. The same operation is repeated until all the ducts are tested and wired. Should obstructions be met with and the mandrel bind, the location of the obstructions can readily be ascertained from the length of rod yet remaining in the duct, and can easily be removed. This method is far better than pulling the mandrel through as the ducts are laid, as in many cases the duct is obstructed or thrown out of alignment by the filling-in of the concrete or trench, and this would not be noticed until an attempt was made to draw the cable. The wire left in the duct is used in drawing the cables.

Fibre Conduit. This type of conduit consists of wood fibre formed into a tube over a mandrel under pressure. After the tube

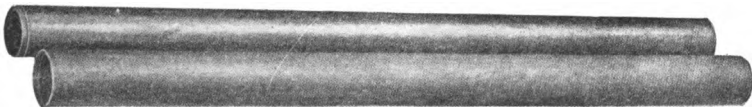

Fig. 74. Socket-Joint Fibre Conduit.

is formed on the mandrel, it is removed, and, after being dried in air, is placed in a tank of preservative and insulating compound.

Fibre conduits are made in three different styles—namely, the *socket-joint*, *sleeve-joint*, and *screw-joint* types, shown respectively in Figs. 74, 75, and 76. The forms of conduit here shown are made by the Fibre Conduit Company, of Orangeburg, New York.

In the socket-joint type, the connections between the lengths

of conduit are made by means of male and female joints turned on the ends of the conduit so that it is necessary only to push one length within the other to secure alignment without the use of a sleeve-coupling or other device. While this is the cheapest and simplest



Fig. 75. Sleeve-Joint Fibre Conduit.

form of fibre conduit, the joint is not so secure as in either of the other two types.

The sleeve-joint fibre conduit has the ends of each joint turned so that a sleeve may be slipped over the turned portion and butted up against the shoulder on the tubes. These sleeves are about 4 inches long and $\frac{3}{8}$ inch thick. While this form of joint is more secure than the socket type, it is not so secure as the screw-joint type.

The screw-joint type of fibre conduit is manufactured with a slightly thicker wall than the socket-joint type, in order to obtain the necessary thickness for getting the thread on the end of the pipe. The sleeve in this case is threaded; and, instead of being slipped on the conduit, as in the case of the sleeve-joint type, it is screwed on, and the thread may be filled with compound and a water-tight joint thereby obtained. Various special forms of elbows, bends, junction-boxes, tees, etc., are provided for this conduit, for special connections. Couplings are also made so that joints can be made between fibre conduit and iron pipe, where it is desirable to make such a connection.

The advantages of fibre conduit are—*first*, that it is lighter than any of the other forms of conduit, which reduces the cost of trans-

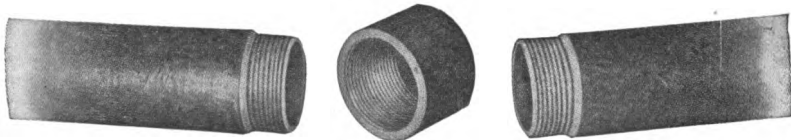

Fig. 76. Screw-Joint Fibre Conduit.

portation, carting, and handling; and *second*, that the cost of labor for installing it is less than in the case of iron pipe, and less than that of the single-duct tile pipe. Table XIII gives the principal data relating to fibre conduit.

TABLE XIII
Fibre Conduit

INSIDE DIAMETER (INCHES)	TYPE OF CONDUIT	LENGTH (FEET)	THICKNESS OF WALL (INCHES)	APPROX. WEIGHT PER FOOT (LBS.)
1	Socket-joint	2- $\frac{1}{2}$	$\frac{1}{4}$	0.50
1 $\frac{1}{2}$	" "	5	$\frac{1}{4}$	0.70
2	" "	5	$\frac{1}{4}$	0.85
2 $\frac{1}{2}$	" "	5	$\frac{1}{4}$	1.02
3	" "	5	$\frac{1}{4}$	1.20
3 $\frac{1}{2}$	" "	5	$\frac{1}{4}$	1.40
4	" "	5	$\frac{1}{4}$	1.60
1 $\frac{1}{2}$	Sleeve-joint	5	$\frac{1}{4}$	0.80
2	" "	5	$\frac{1}{4}$	0.95
2 $\frac{1}{2}$	" "	5	$\frac{1}{4}$	1.15
3	" "	5	$\frac{1}{4}$	2.40
3 $\frac{1}{2}$	" "	5	$\frac{7}{16}$	2.90
4	" "	5	$\frac{7}{16}$	3.33
1 $\frac{1}{2}$	Screw-joint	5	$\frac{5}{16}$	1.00
2	" "	5	$\frac{5}{16}$	1.45
2 $\frac{1}{2}$	" "	5	$\frac{5}{16}$	1.75
3	" "	5	$\frac{5}{16}$	2.40
3 $\frac{1}{2}$	" "	5	$\frac{7}{16}$	2.90
4	" "	5	$\frac{7}{16}$	3.33

Fig. 77 shows the method of laying fibre conduit in a trench.

A concrete bed should be provided for all three types of fibre conduit. Where the ground is moist or where there is likelihood of water getting in the joints, it is advisable to make a complete envelope around the conduit.

The joints should be carefully dipped in or coated with a special liquid compound provided for this purpose, so as to insure watertightness. The cables should be spaced about 1 $\frac{1}{2}$ inches apart, by means of wooden separators; and the spaces between the ducts, and between the walls of the trench and the outer ducts, should be filled with a thin grouting of cement and sand. If more than one horizontal row of ducts are installed, the grouting of each row should be smoothed over so as to prepare a base for the next row of ducts.

To fish the conductors in fibre conduit, it is not necessary to follow the method of rodding usually required with vitrified conduits; but it is found that by utilizing a solid No. 6 iron wire, and fishing from one manhole to the next, the mandrels and brush can be attached to the end of the wire and pulled through the conduits, thus insuring that the joints are smooth and that there are no obstructions in the conduit. To prevent accidental clogging of the ends of the con-

duit, wooden plugs should be installed in the openings of all unfinished conduit work, or in all unoccupied cable ducts at manholes.

Drawing In the Cables. After the conduits have been tested by means of the mandrel to ascertain that they are continuous and that the joints are smooth, the work of installing the cables may be started. Special precaution should be taken to prevent sharp bending of the cables, and thus to prevent injury to the lead sheathing of the rubber

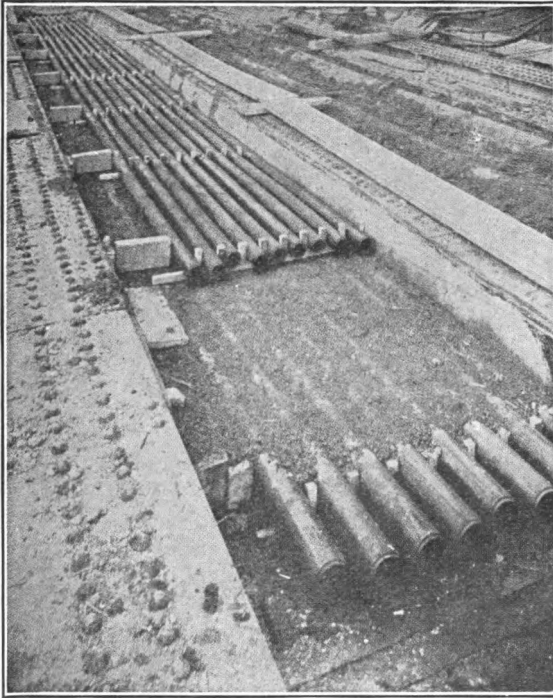

Fig. 77. Method of Laying Fibre Conduit in Trench.

insulation. If the cable is light and of small diameter, the distance not over 300 feet, and the run fairly straight, the cable can usually be pulled in by hand; but often other means must be provided so as to secure sufficient power. Precautions should be taken, however, to avoid placing too great a strain on the cables, as it is liable to injure them, and the injuries may

not show up immediately, but may cause trouble later. The remedy is to avoid placing the manholes too far apart, and to have the runs as straight as possible; also to properly test the conduits for continuity and smoothness before starting to install the cables. Enough slack should be left in each manhole to allow the cables to pass close to the side walls of the manhole, and to have the centers free and accessible for a man to enter the manhole. Where there are a great number of cables in a manhole, shelves or other supports should be

provided for holding the cables apart and in position. Where two or more conductors are placed in the same duct, they should always be pulled in at the same time, for otherwise the cables last pulled in are apt to injure those already installed.

Manholes. Manholes should be provided about every 300 feet, in order to facilitate the installation of the conductors in the duct. The exact distance between manholes should be determined by conditions; in some cases they should be placed even closer together than the figure given, while in other cases their distance apart might be slightly greater.

Manholes are built of concrete or brick, and provided with a cast-iron frame or cover. The manholes may be of square, round, rectangular, or oval section, the last-mentioned form of man-

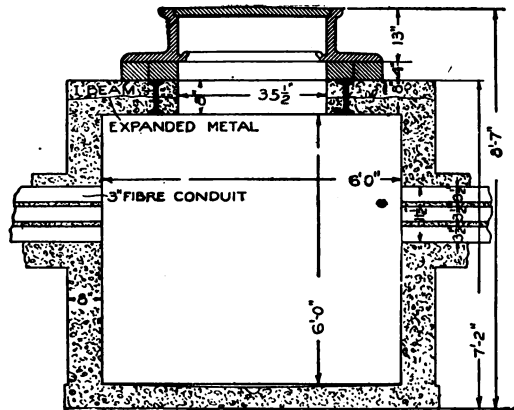
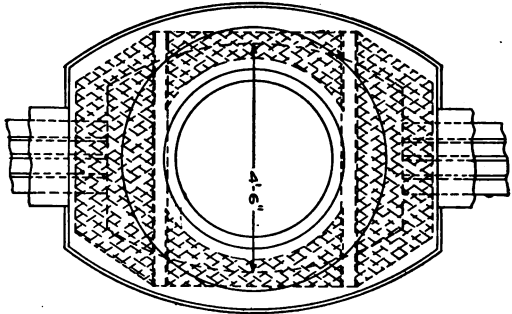
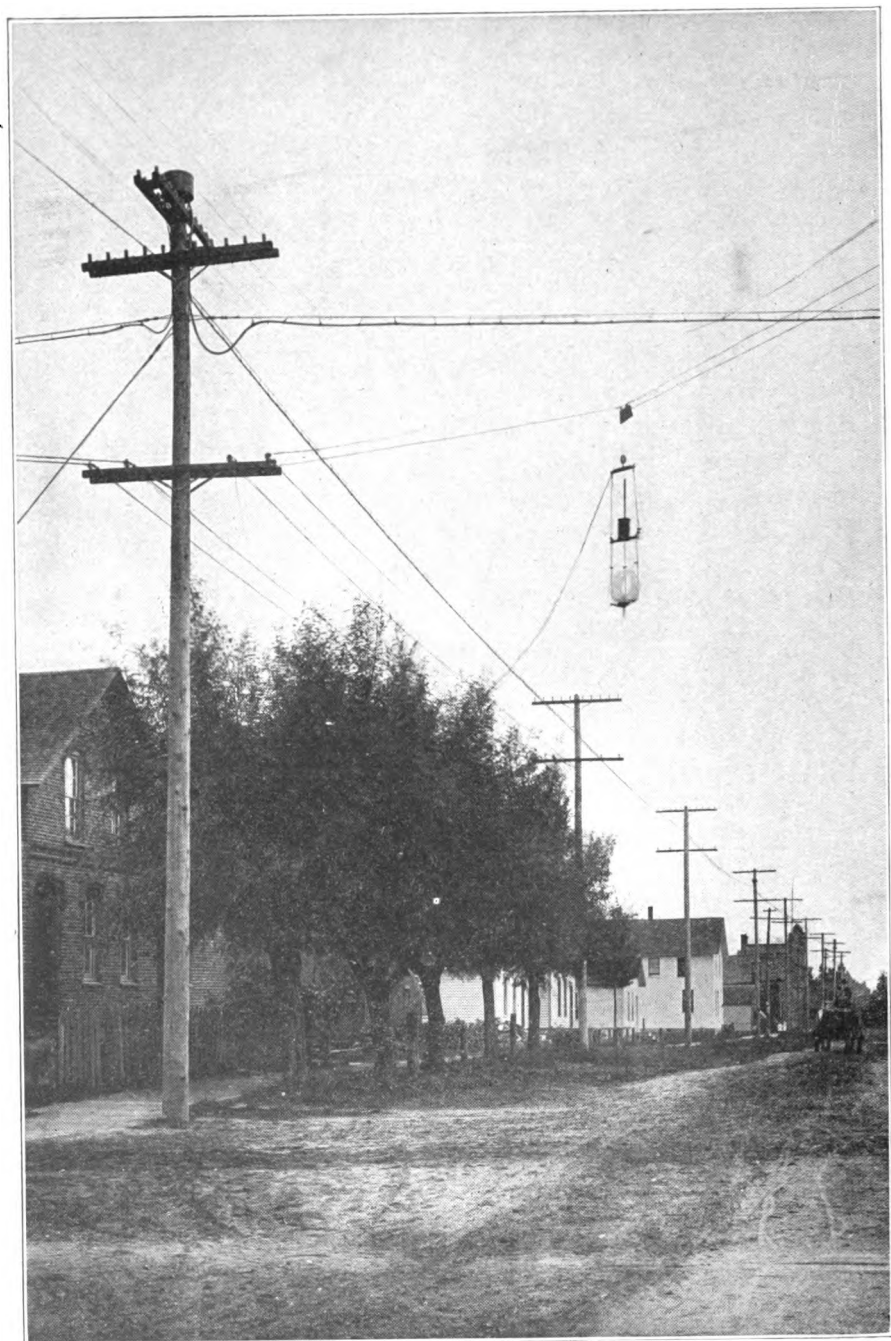

Fig. 78. Plan and Sectional Elevation of Standard Form of Manhole Used in New York City.

hole being probably the best, as it avoids the liability to sharp bends or kinks being made in the cable. The manhole cover may be of the same form as the manhole itself, or it may be of different form; but round or square covers are usually used. Fig. 78 shows a standard form of manhole used in New York City. This manhole is substantially built, and adapted for heavy traffic passing over the cover. For suburban or country work, manholes may be made of lighter construction.



JOINT AERIAL CONSTRUCTION
Telephone and Electric Light Wires.

ELECTRIC LIGHTING

HISTORY AND DEVELOPMENT

The history of electric lighting as a commercial proposition begins with the invention of the Gramme dynamo, by Z. J. Gramme, in 1870, together with the introduction of the Jablochhoff candle or light, which was first announced to the public in 1876, and which formed a feature of the International Exposition at Paris in 1878. Up to this time, the electric light was known to but few investigators, one of the earliest being Sir Humphrey Davy who, in 1810, produced the first arc of any great magnitude. It was then called the *voltaic arc*, and resulted from the use of two wood charcoal pencils as electrodes and a powerful battery of voltaic cells as a source of current.

From 1840 to 1859, many patents were taken out on arc lamps, most of them operated by clockwork, but these were not successful, due chiefly to the lack of a suitable source of current, since all depended on primary cells for their power. The interest in this form of light died down about 1859, and nothing further was attempted until the advent of the Gramme dynamo.

The incandescent lamp was but a piece of laboratory apparatus up to 1878, at which time Edison produced a lamp using a platinum spiral in a vacuum, as a source of light, the platinum being rendered incandescent by the passage of an electric current through it. The first successful carbon filament was made in 1879, this filament being formed from strips of bamboo. The names of Edison and Swan are intimately connected with these early experiments.

From this time on, the development of electric lighting has been very rapid, and the consumption of incandescent lamps alone has reached several millions each year. When we compare the small amount of lighting done by means of electricity twenty-five years ago with the enormous extent of lighting systems and the numerous applications of electric illumination as they are to-day, the growth and development of the art is seen to be very great, and the value of a study of this subject may be readily appreciated. While in many

cases electricity is not the cheapest source of power for illumination, its admirable qualities and convenience of operation make it by far the most desirable.

CLASSIFICATION

The subject of electric lighting may be classified as follows:

1. The type of lamps used.
2. The methods of distributing power to the lamps.
3. The use made of the light, or its application.
4. Photometry and lamp testing.

The types of lamps used may be subdivided into:

1. Incandescent lamps: Carbon, metallic filament, Nernst.
2. Special lamps: Exhausted bulb without filament, such as the Cooper-Hewitt lamp and Moore tube lamp.
3. Arc lamps: Ordinary carbon, flaming arc.

INCANDESCENT LAMPS

The *incandescent lamp* is by far the most common type of lamp used, and the principle of its operation is as follows:

If a current I is sent through a conductor whose resistance is R , for a time t , the conductor is heated, and the heat generated = $I^2R t$, $I^2R t$ representing joules or watt-seconds.

If the current, material, and conditions are so chosen that the substance may be heated in this way until it gives out light, becomes incandescent, and does not deteriorate too rapidly, we have an incandescent lamp. Carbon was the first successful material to be chosen for this conductor and for ordinary lamps it is formed into a small thread or filament. Very recently metallic filament lamps have been introduced commercially with great success but the carbon incandescent lamp will continue to be used for some time, especially in the low candle-power units operated at commercial voltages. Carbon is a successful material for two reasons:

1. The material must be capable of standing a very high temperature, $1,280^\circ$ to $1,330^\circ$ C., or even higher.
2. It must be a conductor of electricity with a fairly high resistance.

Platinum was used in an early stage of the development, but, as we shall see, its temperature cannot be maintained at a value high enough to make the lamp as efficient as when carbon or a metal

having a melting point higher than that of platinum, is used. Nearly all attempts to substitute another substance in place of carbon have failed until recently, and the few lamps which are entirely or partially successful will be treated later. The nature of the carbon employed in incandescent lamps has, however, been much improved over the first forms, and owing to the still very great importance of this lamp, the method of manufacture will be considered.

Manufacture of Carbon Incandescent Lamps. *Preparation of the Filament.* Cellulose, a chemical compound rich in carbon, is prepared by treating absorbent cotton with zinc chloride in proper proportions to form a uniform, gelatine-like mass. It is customary to stir this under a partial vacuum in order to remove bubbles of air which might be contained in it and destroy its uniformity. This material is then forced, "squirted," through steel dies into alcohol, the

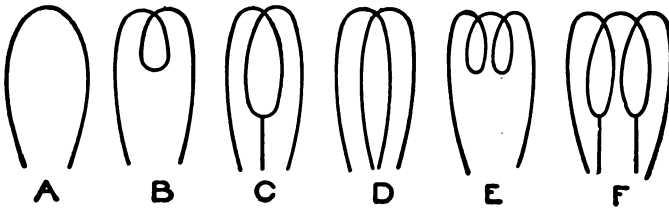

Fig. 1. Forms of Filaments now in Use.

alcohol serving to harden the soft, transparent threads. These threads are then thoroughly washed to remove all trace of the zinc chloride, dried, cut to the desired lengths, wound on forms, and carbonized by heating to a high temperature away from air. During carbonization, the cellulose is transformed into pure carbon, the volatile matter being driven off by the high temperature to which the filaments are subjected. The material becomes hard and stiff, assuming a permanent form, shrinking in both length and diameter—the form being specially constructed so as to allow for this shrinkage. The forms are made of carbon blocks which are placed in plumbago crucibles and packed with powdered carbon. The crucibles, which are covered with loosely fitting carbon covers, are gradually brought to a white heat, at which temperature the cellulose is changed to carbon, and then allowed to cool. After cooling, the filaments are removed, measured, and inspected, and the few defective ones discarded.

In the early days, these filaments were made of cardboard or bamboo, and later, of thread treated with sulphuric acid.

A few of the shapes of filaments now in use are shown in Fig. 1, the different shapes giving a slightly different distribution of light. As here shown they are designated as follows: A, U-shaped; B, single-curl; C, single-curl anchored; D, double-loop; E, double-curl; F, double-curl anchored.

Mounting the Filament. After carbonization, the filaments are mounted or joined to wires leading into the globe or bulb. These wires are made of platinum—platinum being the only substance, so far as known, that expands and contracts the same as glass, with change in temperature and which, at the same time, will not be melted by the heat developed in the carbon. Since the bulb must remain air-tight, a substance expanding at a different rate from the glass cannot be used. Several methods of fastening the filament to the *leading in* wires have been used, such as forming a socket in the end of the wire, inserting the filament, and then squeezing the socket tightly against the carbon; and the use of tiny bolts when cardboard filaments were used; but the pasted joint is now used almost exclusively. Finely powdered carbon is mixed with some adhesive compound, such as molasses, and this mixture is used as a paste for fastening the carbon to the platinum. Later, when current is sent through the joint, the volatile matter is driven off and only the carbon remains. This makes a cheap and, at the same time, a very efficient joint.

Flashing. Filaments, prepared and mounted in the manner just described, are fairly uniform in resistance, but it has been found that their quality may be much improved and their resistance very closely regulated by depositing a layer of carbon on the outside of the filament by the process of *flashing*. By flashing is meant heating the filament to a high temperature when immersed in a hydrocarbon gas, such as gasoline vapor, under partial vacuum. Current is passed through the filament in this process to accomplish the heating. Gas is used, rather than a liquid, to prevent too heavy a deposit of the carbon. Coal gas is not recommended because the carbon, when deposited from this, has a dull black appearance. The effects of flashing are as follows:

1. The diameter of the filament is increased by the deposited carbon and hence its resistance is decreased. The process must be

discontinued when the desired resistance is reached. Any little irregularities in the filament will be eliminated since the smaller sections, having the greater resistance, will become hotter than the remainder of the filament and the carbon is deposited more rapidly at these points.

2. The character of the surface is changed from a dull black and comparatively soft nature to a bright gray coating which is much harder and which increases the life and efficiency of the filament.

Exhausting. After flashing, the filament is sealed in the bulb and the air exhausted through the tube *A* in Fig. 2, which shows the lamp in different stages of its manufacture. The exhaustion is accomplished by means of mechanical air pumps, supplemented by Sprengle or mercury pumps and chemicals. Since the degree of exhaustion must be high, the bulb should be heated during the process so as to drive off any gas which may cling to the glass. When chemicals are used, as is now almost universally the case, the chemical is placed in the tube *A* and, when heated, serves to take up much of the remaining gas. Exhaustion is necessary for several reasons:

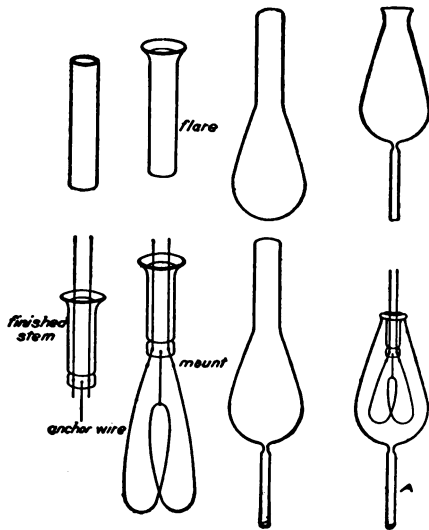

Fig. 2. Different Stages in Lamp Manufacture.

1. To avoid oxidization of the filament.
2. To reduce the heat conveyed to the globe.
3. To prevent wear on the filament due to currents or eddies in the gas.

After exhausting, the tube *A* is sealed off and the lamp completed for testing by attaching the base by means of plaster of Paris. Fig. 3 shows some of the forms of completed incandescent lamps.

Voltage and Candle-Power. Incandescent lamps of the carbon type vary in size from the miniature battery and candelabra lamps to those of several hundred candle-power, though the latter are very seldom used. The more common values for the candle-power are

8, 16, 25, 32, and 50, the choice of candle-power depending on the use to be made of the lamp.

The voltage will vary depending on the method of distribution of the power. For what is known as *parallel distribution*, 110 or 220 volts are generally used. For the higher values of the voltage, long and slender filaments must be used, if the candle-power is to be low; and lamps of less than 16 candle-power for 220-volt circuits are not practical, owing to difficulty in manufacture. For series distribution, a low voltage and higher current is used, hence the filaments may be quite heavy. Battery lamps operate on from 4 to 24 volts, but the vast majority of lamps for general illumination are operated at or about 110 volts.

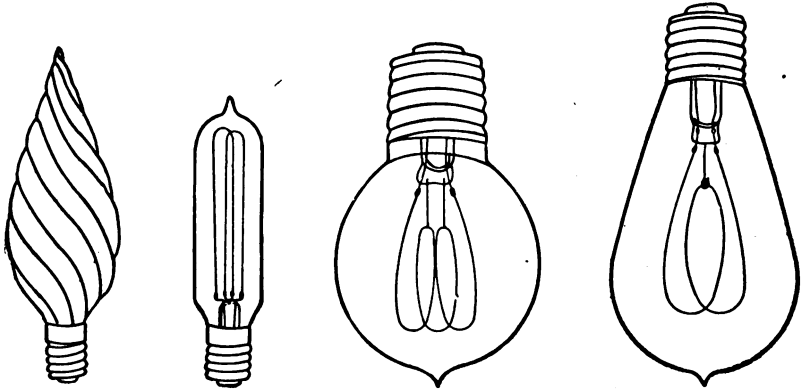

Fig. 3. Several Forms of Completed Lamps.

Efficiency. By the efficiency of an incandescent lamp is meant the power required at the lamp terminals per candle-power of light given. Thus, if a lamp giving an average horizontal candle-power of 16 consumes $\frac{1}{2}$ an ampere at 112 volts, the total number of watts consumed will be $112 \times \frac{1}{2} = 56$, and the watts per candle-power will be $56 \div 16 = 3.5$. The efficiency of such a lamp is said to be 3.5 watts per candle-power, or simply watts per candle. *Watts economy* is sometimes used for *efficiency*.

The efficiency of a lamp depends on the temperature at which the filament is run. In the ordinary lamp this temperature is between $1,280^{\circ}$ and $1,330^{\circ}$ C, and the curve in Fig. 4 shows the increase of efficiency with the increase of temperature. The temperature attained

by a filament depends on the rate at which heat is radiated and the amount of power supplied. The rate of radiation of heat is proportional to the area of the filament, the elevation in temperature, and the emissivity of the surface.

By emissivity is meant the number of heat units emitted from unit surface per degree rise in temperature above that of surrounding bodies. The bright surface of a flashed filament has a lower emissivity than the dull surface of an unheated filament, hence less energy is lost in heat radiation and the efficiency of the filament is increased.

As soon as incandescence is reached, the illumination increases much more rapidly than the emission of heat, hence the increase in

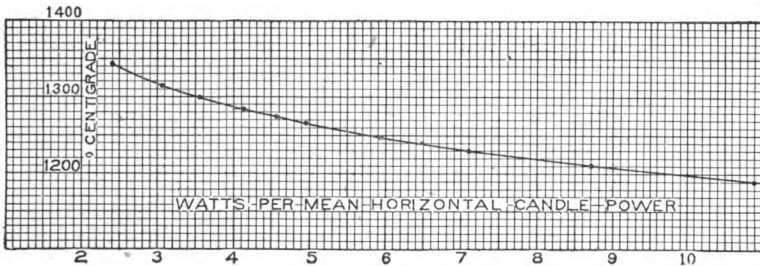

Fig. 4. Efficiency Curve for Incandescent Lamp.

efficiency shown in Fig. 4. Were it not for the rapid disintegration of the carbon at high temperature, an efficiency higher than 3.1 watts could be obtained.

By a special treatment of the carbon filaments, the nature of the carbon is so changed that the filaments may be run at a higher temperature and the lamps still have a life comparable to that of the 3.1-watt lamp. Lamps using these special carbon filaments are known as *gem metallized filament lamps*, or merely as *gem lamps*, and they will be described more fully later.

Relation of Life to Efficiency. Ordinary Carbon Lamp. By the useful life of a lamp is meant the length of time a lamp will burn before its candle-power has decreased to such a value that it would be more economical to replace the lamp with a new one than to continue to use it at its decreased value. A decrease to 80% of the initial candle-power of carbon lamps is now taken as the point at which a lamp should be replaced, and the normal life of a lamp is in the

neighborhood of 800 hours. To obtain the most economical results, such lamps should always be replaced at the end of their useful life.

In Table I are given values of efficiency and life of a 3.5-watt, 110-volt carbon lamp for various voltages impressed on the lamp. These values are plotted in Fig. 5. The curves show that a 3% increase of voltage on the lamp reduces the life by one-half, while an increase of 6% causes the useful life to fall to one-third its normal value. The effect is even greater when 3.1-watt lamps are used, but not so great with 4-watt lamps. From this we see that the regulation of the voltage used on the system must be very good if high efficiency lamps are to be used, and this regulation will determine the efficiency of the lamp to be installed.

Selection of Lamps. Ordinary Carbon Type. Lamps taking 3.1 watts per candle-power will give satisfaction only when the regulation of voltage is the best—practically a constant voltage maintained at the normal voltage of the lamp.

TABLE I
Effects of Change in Voltage

Standard 3.5-Watt Lamp

VOLTAGE PER CENT. OF NORMAL	CANDLE-POWER PER CENT. OF NORMAL	WATTS PER CANDLE-POWER	LIFE PER CENT. OF NORMAL	DETERIORATION PER CENT. OF NORMAL
90	53	5.36		
91	56	5.09		
92	61	4.85		
93	65	4.63		
94	69	4.44	394	25
95	73	4.26	310	32
96	78	4.09	247	44
97	83	3.93	195	51
98	88	3.78	153	65
99	94	3.64	126	79
100	100	3.5	100	100
101	106	3.38	84	118
102	111	3.27	68	146
103	116	3.16	58	173
104	123	3.05	47	211
105	129	2.95	39	253
106	137	2.85	31	316
107	143	2.76	26	380
108	152	2.68	21	474
109	159	2.60	17	575
110	167	2.53	16	637

Lamps of 3.5 watts per candle-power should be used when the regulation is fair, say with a maximum variation of 2% from the normal voltage.

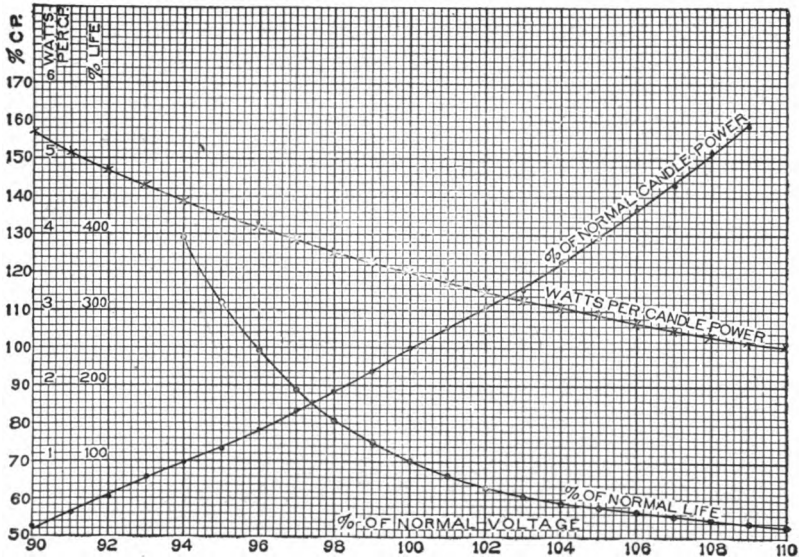

Fig. 5. Curves of Efficiency and Life of Carbon Filament Lamps.

Lamps of 4 watts per candle-power should be installed when the regulation is poor. These values are for 110-volt lamps. A 220-volt lamp should have a lower efficiency to give a long life. This is on

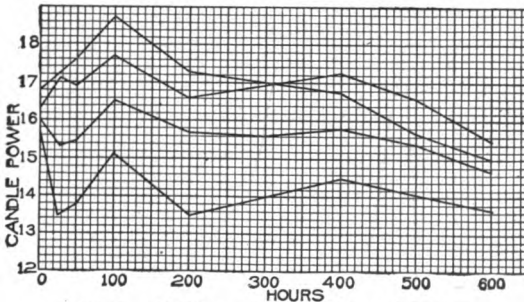

Fig. 6. Life Curves of Incandescent Lamps.

account of the fact that, for the same candle-power, the 220-volt lamp must be constructed with a filament which is long and slender compared to that of the 110-volt lamp, and if such a filament is run at a high temperature its life is short. The 220-volt lamp is used to some considerable extent abroad but it is not employed extensively in the United States. It is customary to operate such lamps at an efficiency of about 4 watts per candle-power.

Lamps should always be renewed at the end of their useful life, this point being termed the *smashing-point*, as it is cheaper to replace the lamp than to run it at the reduced candle-power. Some recommend running these lamps at a higher voltage, but that means at a reduced life, and it is not good practice to do this.

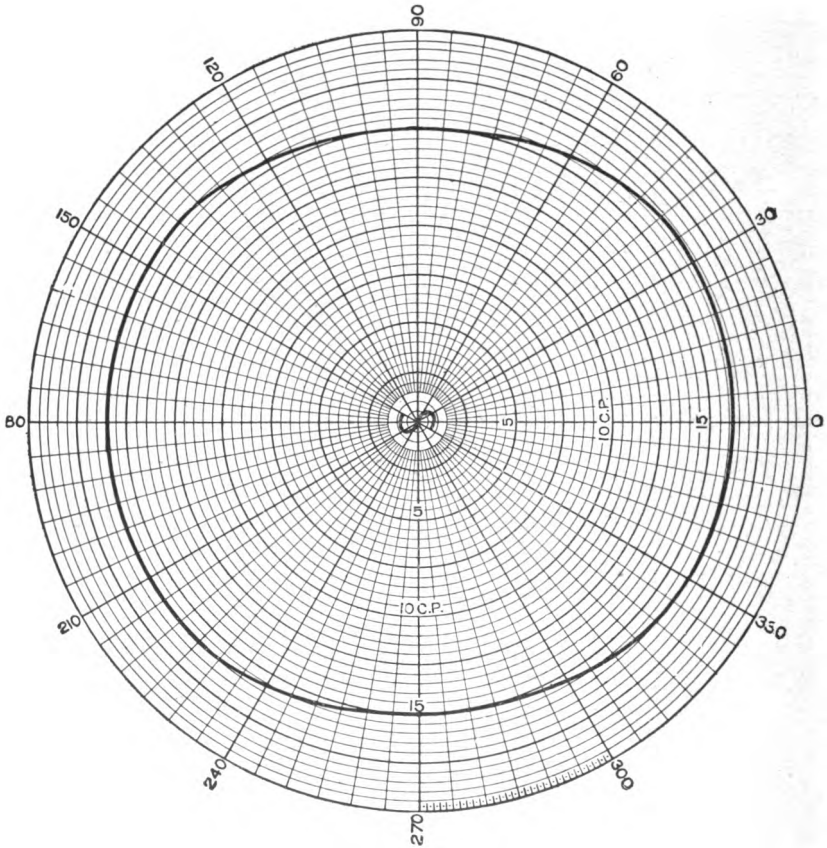

Fig. 7. Horizontal Distribution Curve for Single-Loop Filament.

Fig. 6 shows the life curves of a series of incandescent lamps. These curves show that there is an increase in the candle-power of some of the lamps during the first 100 hours, followed by a period during which the value is fairly constant, after which the light given by the lamp is gradually reduced to about 80% of the initial candle-power.

Distribution of Light. In Fig. 1 are shown various forms of filaments used in incandescent lamps, and Figs. 7 and 8 show the distribution of light from a single-loop filament of cylindrical cross-section. Fig. 7 shows the distribution of light in a horizontal plane, the lamp being mounted in a vertical position, and Fig. 8 shows the dis-

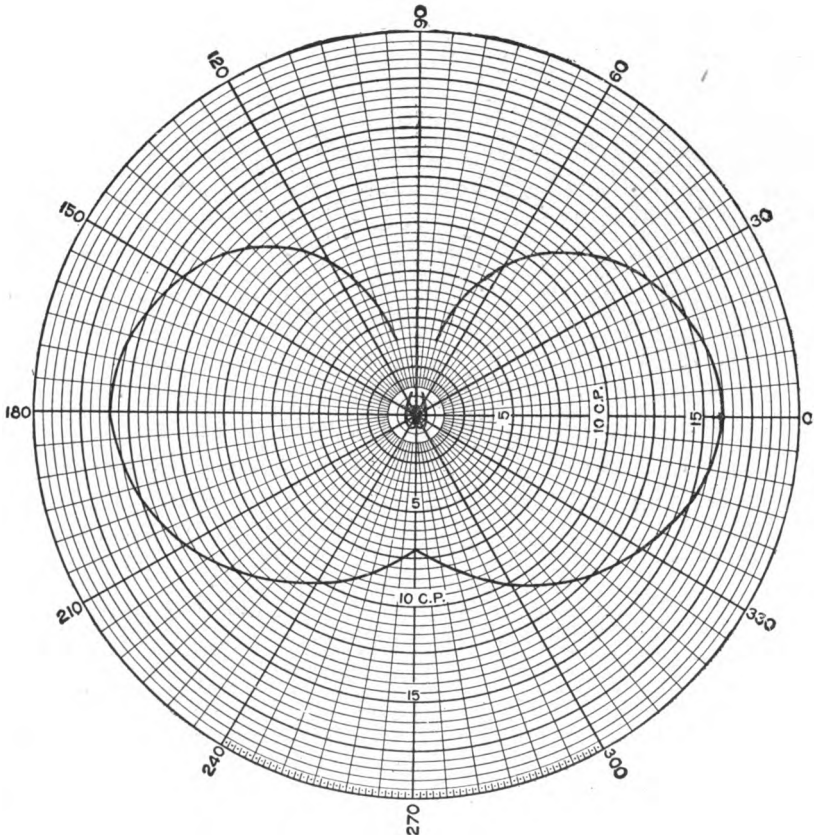

Fig. 8. Vertical Distribution Curve for Single-Loop Filament.

tribution in a vertical plane. By changing the shape of the filament, the light distribution is varied. A mean of the readings taken in the horizontal plane forms the *mean horizontal candle-power*, and this candle-power rating is the one generally assumed for the ordinary incandescent lamp. A mean of the readings taken in a vertical plane gives us the *mean vertical candle-power*, but this value is of little use.

Mean Spherical Candle-Power. When comparing lamps which give an entirely different light distribution, the mean horizontal candle-power does not form a proper basis for such comparison, and the mean spherical or the mean hemispherical candle-power is used instead. By *mean spherical candle-power* is meant a mean value of the light taken in all directions. The methods for determining this will be taken up under *photometry*. The mean hemispherical candle-power has reference, usually, to the light given out below the horizontal plane.

The Gem Metallized Filament Lamp. When the incandescent lamp was first well established commercially, the useful life of a unit, when operated at 3.1 watts per candle, was about 200 hours. The improvements in the process of manufacture have been continuous from that time until now, and the useful life of a lamp operated at that efficiency to-day is in the neighborhood of 500 hours. Experiments in the treatment of the carbon filament have led to the introduction of the *gem metallized filament lamp*. This lamp should not be confused with the metallic filament lamps, to be described later, because the material used is carbon, not a metal. As a result of special treatment the carbon filament assumes many of the characteristics of a metallic conductor, hence the term *metallized filament*. The word *graphitized* has been proposed in place of metallized.

TABLE II
* Data on the Gem Metallized Filament Lamp

WATTS	HORIZONTAL C. P.	WATTS PER CANDLE	†SPHERICAL REDUCTION FACTOR	§USEFUL LIFE
30	16	2.5	.816	450 hrs.
50	20	2.5	.825	450 "
80	32	2.5	.816	450 "
100	40	2.5	†	460 "
125	50	2.5	†	450 "
187.5	75	2.5	†	450 "
250	100	2.5	†	450 "

* These lamps are normally rated at three voltages, 114, 112, and 110 volts, but data referring to the highest voltage only are given.

† By spherical reduction factor is meant the factor by which the horizontal candle-power must be multiplied to obtain the mean spherical candle-power.

‡ The larger units are almost invariably used with reflectors, hence no spherical reduction factor is given.

§ The life of the lamps when operated at the lower voltage is increased to about 950 hours, and the efficiency is changed to 2.83 watts per candle.

When a filament, as treated in the ordinary manner, is run at a high temperature in a lamp there is no improvement of the filament, but it was discovered that, if the treated filaments were subjected to the extremely high temperature of the electric resistance furnace—3,000 to 3,700 degrees C.—at atmospheric pressure, the physical nature of the carbon was changed and the resulting filament could be operated at a higher temperature in the lamp and a higher efficiency,

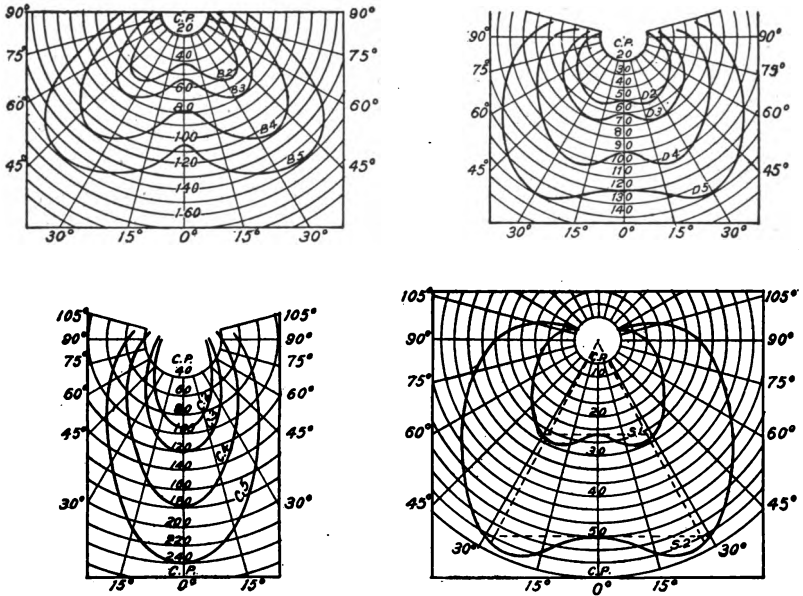

Fig. 9. Typical Distribution Curves of Gem Lamp with Different Types of Reflectors.

and still maintain a life comparable to that of a 3.1-watt lamp. This special heating of the filament, which is applied to the base filament before it is flashed, as well as to the treated filament, causes the cold resistance of the carbon to be very materially decreased and the filament, as used in the lamp, has a positive temperature coefficient—rise in resistance with rise in temperature—a desirable feature from the standpoint of voltage regulation of the circuit from which the lamps are operated. The high temperature also results in the driving off of considerable of the material which, in the ordinary lamp, causes the globe to blacken after the lamp has been in use for some time. The blackening of the bulb is responsible to a considerable degree

for the decrease in candle-power of the incandescent lamp. The metallized filament lamp is operated at an efficiency of 2.5 watts per candle with a useful life of about 500 hours. The change in candle-power with change in voltage is less than in the ordinary lamp on account of the positive temperature coefficient of the filament. These lamps are not manufactured for very low candle-powers, owing to the

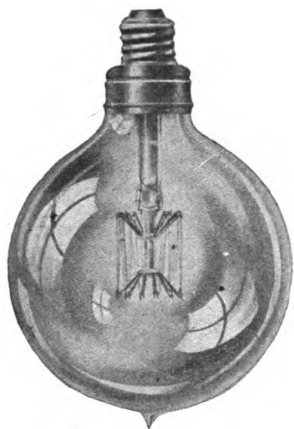

Fig. 10. Round Bulb Tantalum Lamp.

difficulty of treating very slender filaments, but they are made in sizes consuming from 40 to 250 watts. Table II gives some useful information in connection with metallized filament lamps. The filaments are made in a variety of shapes and the distribution curves are usually modified in practice by the use of shades and reflectors. The general appearance of the lamp does not differ from that of the ordinary carbon lamp. Fig. 9 shows typical distribution curves of the metallized filament lamp as it is installed in practice.

Metallic Filament Lamps. *The Tantalum Lamp.* The first of the metallic filament lamps to be introduced to any considerable extent commercially was the tantalum lamp. Dr. Bolton of the Siemens & Halske Company first discovered the methods of obtaining the pure metal tantalum. This metal is rendered ductile and drawn into slender filaments for incandescent lamps. Tantalum has a high tensile strength and high melting point, and tantalum filaments are operated at temperatures much higher than those used with the carbon filament lamp. On account of the comparatively low specific resistance of this material



Fig. 11. Tantalum Filament Before and After 1,000 Hours' Use.

the filaments for 110-volt lamps must be long and slender, and this necessitates a special form of support. Figs. 10, 11, and 12 show some interesting views of the tantalum lamp and the filament. This lamp is operated at the efficiency of 2 watts per

candle-power, with a life comparable to that of the ordinary lamp. By special treatment it is possible to increase the resistance of the filaments so that they may be shorter and heavier than those used in

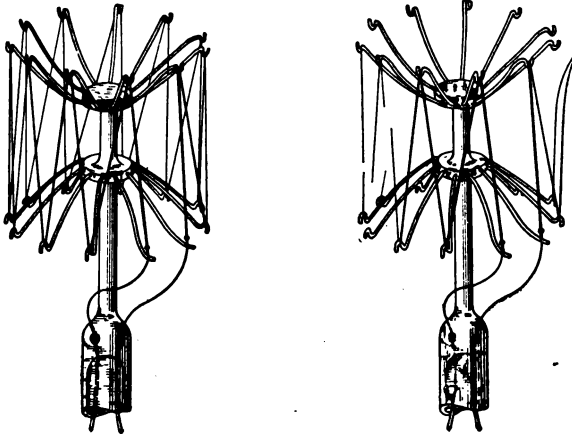

Fig. 12.

Appearance of Filament After
Having Been Used.

Filament Frame Showing
Broken Filament.

the first of the tantalum lamps. It should be noted that the life of this type of lamp on alternating-current circuits is somewhat uncertain; it is much more satisfactory for operation on direct-current circuits. Tables III and IV give some general data on the tantalum lamp, and Figs. 13 and 14 show typical distribution curves for the units as installed at present.

TABLE III

Data on Tantalum Lamp

GENERAL ELECTRIC CO., MFTRS.

SIZE OF BULB		DIAMETER OF BULB IN INCHES	ESTIMATED LIFE	
REGULAR	ROUND		ON A. C.	ON D. C.
40 watt		$2\frac{5}{8}$	350	800
50 "		$2\frac{7}{8}$	350	800
80 "		$3\frac{1}{4}$	400	800
	40 watt	$3\frac{1}{4}$	350	800
	80 "	5	400	800

TABLE IV
Data on the Life of a 25-C. P. Unit.

NO. OF HOURS BURNED	CANDLE-POWER	WATTS PER CANDLE
0	19.8	2.17
25	23.6	1.865
50	23.1	1.90
125	22.3	1.98
225	22.4	1.96
350	22.3	1.97
450	22.2	1.98
550	21.2	2.05
650	19.6	2.20

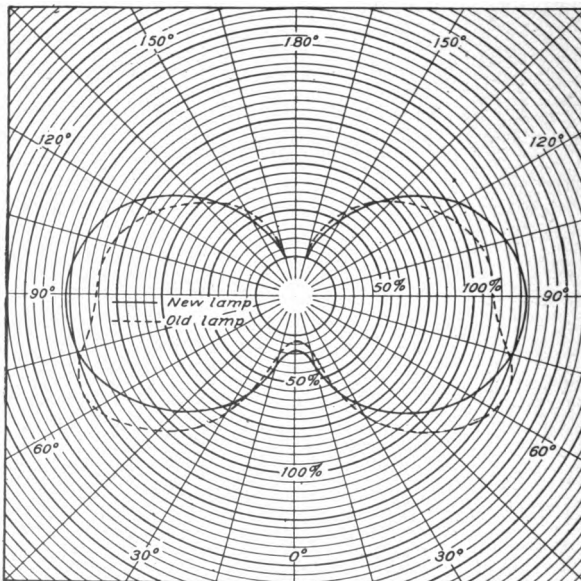

Fig. 13. Vertical Distribution Curve Without Reflector.

The Tungsten Lamp. Following closely upon the development of the tantalum lamp came the tungsten lamp. Tungsten possesses a very high melting point and an indirect method is employed in forming filaments for incandescent lamps. There are several of these methods in use. In one method a fine carbon filament is flashed in an atmosphere of tungsten oxychloride mixed with just the proper proportion of hydrogen, in which case the filament gradually changes

to one of tungsten. A second method consists of the use of powdered tungsten and some binding material, sometimes organic and in other cases metallic. The powdered tungsten is mixed with the binding material, the paste squirted into filaments, and the binding material is then expelled, usually by the aid of heat. Another method of manufacture consists of securing tungsten in colloidal form, squirting it

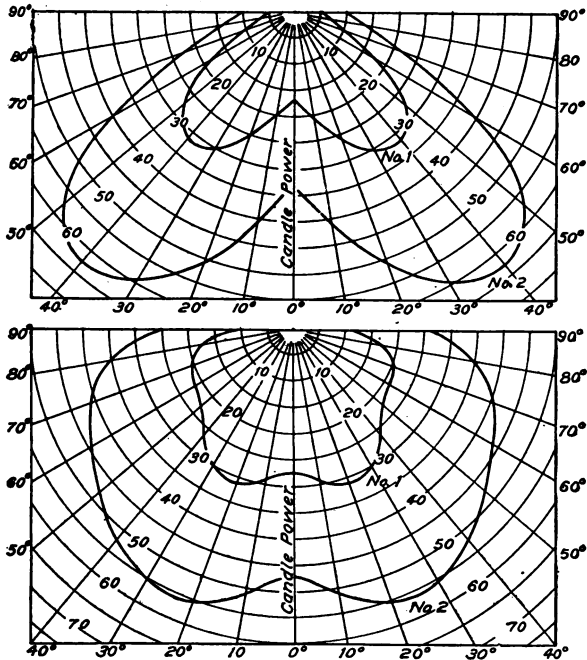

Fig. 14. Distribution Curves for Tantalum Lamp. No. 1, 40 Watts; No. 2, 80 Watts.

into filaments, and then changing them to the metallic form by passing electric current through the filaments.

The tungsten lamp has the highest efficiency of any of the commercial forms of metallic filament lamps now in use, about 1.25 watts per candle-power when operated so as to give a normal life, and lamps for 110-volt service and consuming but 40 watts have recently been put on the market. A 25-watt lamp for this same voltage appears to be a possibility. The units introduced at first were of high candle-power because of the difficulty of manufacturing the slender filaments required for the low candle-power lamps.

The advantages of these metals, tantalum and tungsten, for incandescent lamps are in the improved efficiency of the lamps and the good quality of the light, white or nearly white in both cases. In either case the change in candle-power with change in voltage is less than the corresponding change in an ordinary carbon lamp. The disadvantage lies in the fact that the filaments must be made long and slender, and hence are fragile, for low candle-power units to be used

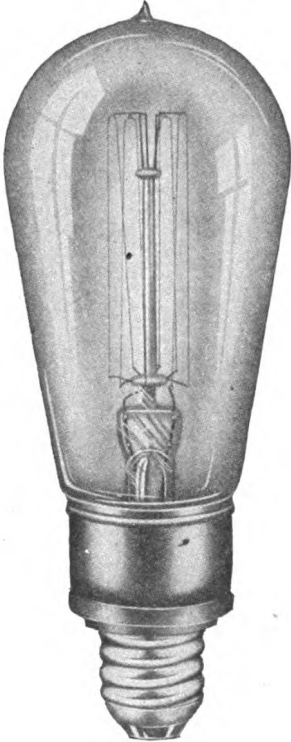

Fig. 15. Multiple Tungsten Lamp.

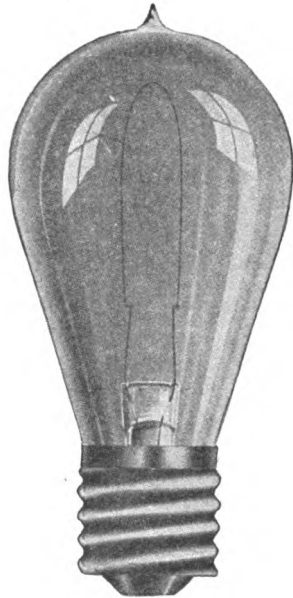

Fig. 16. Series Tungsten Lamp.

on commercial voltages. In some cases tungsten lamps are constructed for lower voltages and are used on commercial circuits through the agency of small step-down transformers. Improvements in the process of manufacture of filaments and of the method of their support have resulted in the construction of 110-volt lamps for candle-powers lower than was once thought possible. Figs. 15 and 16 show the appearance of the tungsten lamp, and Figs. 17 and 18 give some

typical distribution curves. Tables V and VI give data on this lamp as it is manufactured at present. One very considerable application

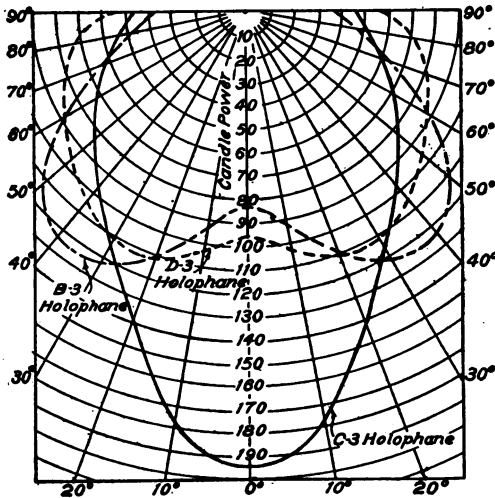

Fig. 17. C. P. Distribution Curves of 100-Watt Gen. Elec. Tungsten Incandescent Units with B-3, C-3, and D-3 Holophanes.

of the tungsten lamp is to incandescent street lighting on series circuits, in which case the lamp may be made for a low voltage across its terminals and the filament may be made comparatively short and

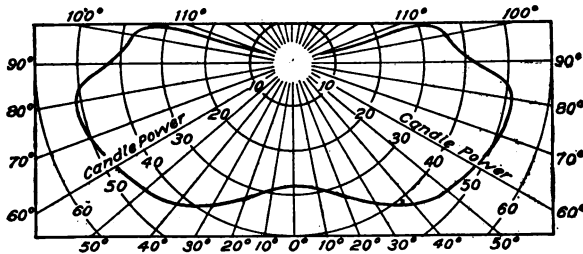

Fig. 18. Candle-Power Distribution Given with 40 c. p. Gen. Elec. Tungsten Series Lamp and Radial Wave Reflector.

heavy. The tungsten lamp is also being introduced as a low voltage battery lamp.

The Just lamp, the Z lamp, the Osram lamp, the Zircon-Wolfram lamp, the Osmin lamp, etc., are all tungsten lamps, the filaments being prepared by some of the general methods already described or modifications of them.

TABLE V
Tungsten Lamps
MULTIPLE

WATTS	VOLTS	CANDLE-POWER	WATTS PER C. P.	TIP CANDLE-POWER	SPHERICAL REDUCTION FACTOR
40	100	32	1.25	5	76.3
60	125	40	1.25	5.6	76.3

TABLE VI
Tungsten Lamps
SERIES

AMPERES	VOLTS	CANDLE-POWER	WATTS PER C. P.
4	13.5	40	1.35
	20.25	60	
5.5	9.8	40	1.35
	14.7	60	
6.6	8.2	40	1.35
	12.3	60	
7.5	7.2	40	1.35
	10.8	60	

The Osmium Lamp. Very efficient incandescent lamps have been constructed using osmium for the filament. An indirect method is resorted to in the formation of these filaments. Osmium lamps have not been successful for commercial voltages because the filament is too fragile if it is made to have a high resistance, so these lamps must be operated in series or through the agency of reducing transformers if they are to be applied to 110-volt circuits. At 25 volts, lamps are constructed giving an efficiency of about 1.5 watts per candle-power with a life comparable to that of a 3.5-watt carbon lamp. Owing to the introduction of the tungsten lamp, the osmium lamp will probably never be used to any great extent.

Other Metallic Filament Lamps. Table VII gives the melting points of several metals which are highly refractory and those already mentioned are not the only ones which have been successfully used in incandescent lamps. Titanium, zirconium, iridium, etc., have been successfully employed, but the tantalum and tungsten lamps are the only ones which are used to any extent in the United States.

TABLE VII
Melting Point of Some Metals

METAL	APPROXIMATE MELTING POINT IN DEGREES C.
Tungsten	3080-3200
Titanium	3000
Tantalum	2900
Osmium	2500
Platinum	1775
Zirconium	1500
Silicon	1200
Carbon (not a metal)	3000

The Helion Lamp. The helion lamp, which gives considerable promise of commercial development, is a compromise between the carbon lamp and the metallic filament lamp. A slender filament of carbon is flashed in a compound of silicon (gaseous state) and a filament composed of a carbon core more or less impregnated with silicon and coated with a metallic layer is formed. The emissivity of such a filament is high, the light is white in color, and the filament is strong. The efficiency of the helion filament as far as it has been developed is higher than that of a carbon filament when operated at the same temperature. At 1,500 degrees C. the efficiency of the helion filament is 2.15 watts per candle-power, while for a carbon filament it is about 3.5 watts per candle-power. Filaments of this type have been made which may be heated to incandescence in open air without immediate destruction. This lamp is not yet on the market.

The Nernst Lamp. The Nernst lamp is still another form of incandescent lamp, several types of which are shown in Figs. 19, 20, 21, and 22. This lamp uses for the incandescent material certain oxides of the rare earths, the oxides being mixed in the form of a paste, then squirted through a die into a string which is subjected to a roast-

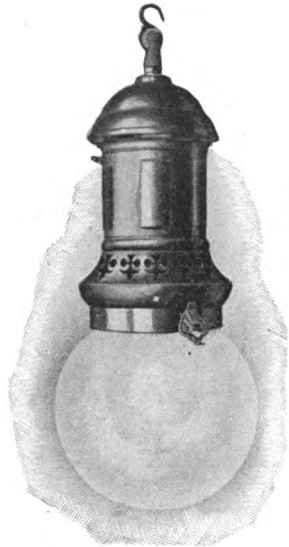

Fig. 19. Westinghouse Nernst
Multiple-Glower Lamp.

ing process forming the filament or *glower* material of the lamp as represented by the lower white line in Fig. 23. The more recent glowers are made hollow instead of solid. The glowers are cut to the desired length and platinum terminals attached. The attachment of these terminals to the glowers is an important process in the manufacture of the lamp. The recent discovery of additional oxides has led to the construction of glowers which show a considerable gain in efficiency over those previously used. The glowers are heated to incandescence in open air, a vacuum not being required.

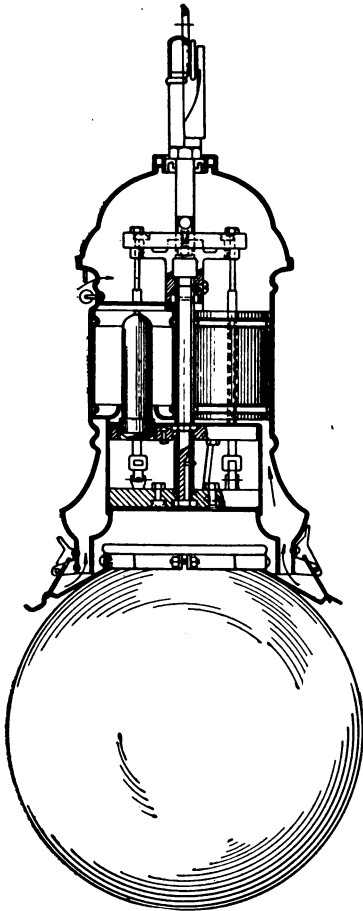

Fig. 20. Sectional View of Multiple-Glower Westinghouse Nernst Lamp.

As the glower is a non-conductor when cold, some form of *heater* is necessary to bring it up to a temperature at which it will conduct. Two forms of heater have been used. One of them consists of a porcelain tube shown just above the glower, Fig. 23, about which a fine platinum wire is wound; the wire is in turn coated with a cement. Two or more of these tubes are mounted directly over the glower, or glowers, and serve as a reflector as well as a heater. The second form of heater consists of a slender rod of refractory material about which a platinum wire is wound, the wire again being covered with

a cement. This rod is then formed into a spiral which surrounds the glower in the vertical glower type, or is formed into the *wafer heater*, Fig. 24, now universally employed in the Westinghouse Nernst lamp with horizontal glowers. The wafer heater is bent so that it can be mounted with several sections parallel to the glower or glowers.

The heating device is connected across the circuit when the lamp is first turned on, and it must be cut out of circuit after the glowers become conductors in order to save the energy consumed by the

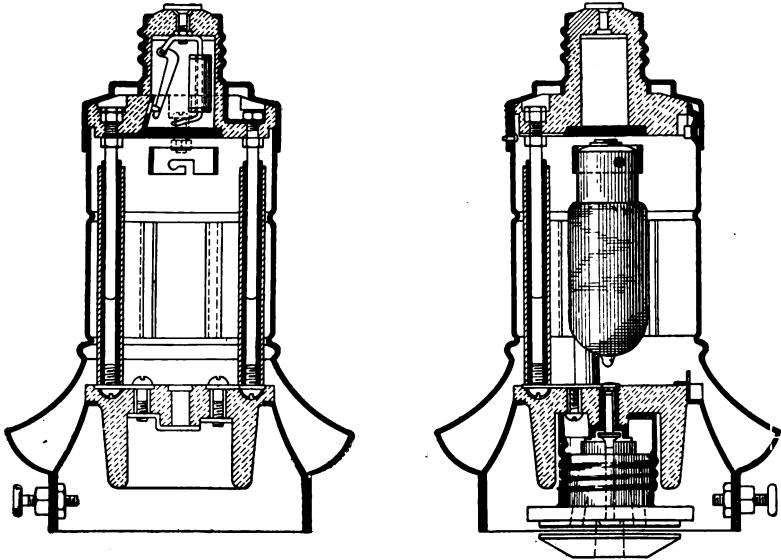

Fig. 21. Sectional Views of Single-Glower Westinghouse Nernst Lamp.

heater and to prolong the life of the heater. The automatic *cut-out* is operated by means of an electromagnet so arranged that current flows through this magnet as soon as the glower becomes a conductor, and contacts in the heater circuit are opened by this magnet. The contacts in the heater circuit are kept normally closed, usually by the force of gravity.

The conductivity of the glower increases with the increase of temperature—the material has a negative temperature coefficient—hence if it were used on a constant potential circuit directly, the current and temperature would continue to rise until the glower was destroyed. To prevent the current

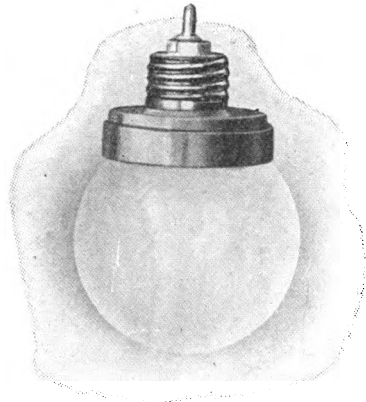

Fig. 22. Westinghouse Nernst Screw Burner.

from increasing beyond the desired value, a *ballast resistance* is used in series with the glower. As is well known, the resistance of iron wire increases quite rapidly with increase in temperature, and

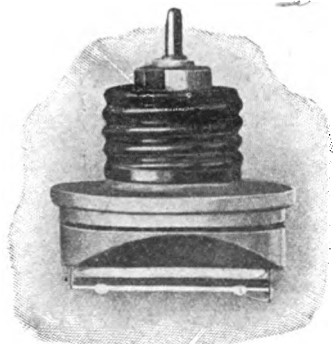

Fig. 23. Westinghouse Nernst Screw Burner with Globe Removed, Showing Glower and Tubular Heater.

the resistance of a fine pure iron wire is so adjusted that the resistance of the combined circuit of the glower and the ballast becomes constant at the desired temperature of the glower. The iron wire must be protected from the air to prevent oxidization and too rapid temperature changes, and, for this reason, it is mounted in a glass bulb filled with hydrogen. Hydrogen has been selected for this purpose because it is an inert gas and conducts the heat from the ballast to the walls of the bulb better than other gases which might be used.

All of the parts enumerated, namely, glower, heater, cut-out, and ballast, are mounted in a suitable manner; the smaller lamps have but one glower and are arranged to fit in an incandescent lamp socket, while the larger types are constructed at present with four glowers

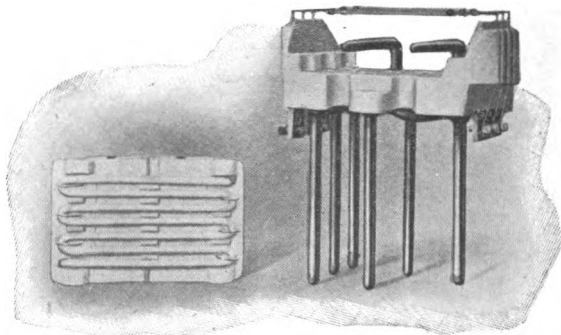

Fig. 24. Wafer Heater and Mounting.

and are arranged to be supported in special fixtures, or the same as small arc lamps. All parts are mechanically arranged so that renewals may be easily made when necessary and it is not possible to insert a part belonging to one type of lamp into a lamp of a different type.

The advantages claimed for the Nernst lamp are: High efficiency; a good color of light; a good distribution of light without the use of reflectors; a long life with low cost of maintenance; and a complete series of sizes of units, thus allowing its adaption to practically all classes of illumination.

The lamp is constructed for both direct- and alternating-current service and for 110 and 220 volts. When the alternating-current lamp is used on a 110-volt circuit a small transformer, commonly called a *converter coil*, Fig. 25, is utilized to raise the voltage at the lamp terminals to about 220 volts.

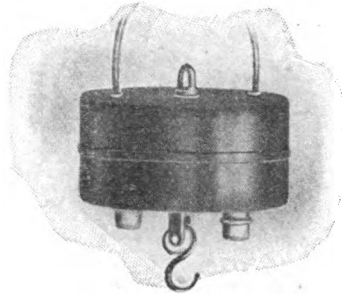

Fig. 25. Converter Coil.

Data on the Nernst lamp in its present form are given in Table VIII, and Figs. 26 and 27 show the form of distribution curves.

TABLE VIII

General Data on the Nernst Lamp

LAMP RATING IN WATTS	VOLTAGE	CURRENT IN AMPERES	MAX. CANDLE-POWER	MEAN HEMISPHERICAL C. P.	WATTS PER M. H. S. C. P. FROM TEST	
66	110	.6	74	50	1.38	} 1-Glower A.C. or D.C.
88	220	.4	105	77	1.2	
110	110	1.0	131	96.4	1.2	
	220	.5				
132	110	1.2	156	114	1.2	} 2-Glower A.C. or D.C. } 3-Glower } 4-Glower
	220	.6				
264	220	1.2	345	231	1.2	
396	220	1.8	528	359	1.15	
528	220	2.4	745	504	1.09	

Comparison of the Different Types of Incandescent Lamps. A direct comparison of the different types of incandescent lamps cannot be made but it is desirable at this time to note the following points: The lamps which are considered commercial in the United States at the present time are the carbon, gem, tantalum, tungsten, and Nernst lamp. The efficiencies ordinarily accepted run in the order

given, approximately 3.1, 2.5, 2, 1.25, and 1.2 watts per candle respectively. The figure of 1.2 watts per candle for the Nernst lamp is based upon the mean hemispherical candle-power and it should not be compared directly with the other efficiencies. The color of the light in all of the above cases is suitable for the majority of classes of illumination, the light from the higher efficiency units being somewhat whiter than that from the carbon lamp. All of these lamps are constructed for commercial voltages and for either direct or alternating current. The use of the tantalum lamp on alternating current is not

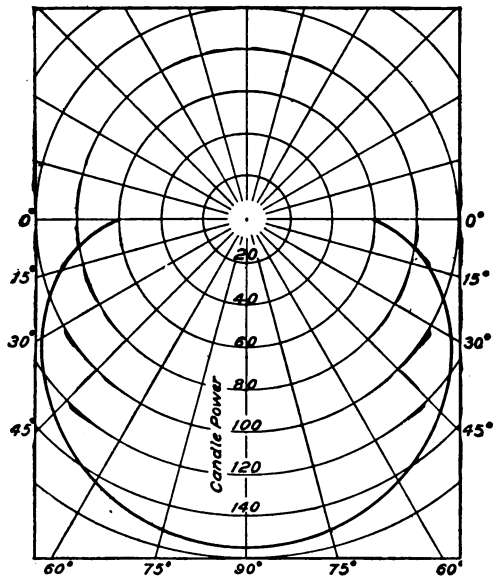

Fig. 26. Distribution Curve of 132-Watt Type Westinghouse Nernst Lamp. Single Glower.

always to be recommended as the service is unsatisfactory in some cases. The minimum size of units for 110 volts is about 4 candle-power for the carbon lamp, 20 candle-power for the metallic filament lamp, and 50 candle-power (mean hemispherical) for the Nernst lamp. Some of the metallic filament lamps are constructed for a consumption of as high as 250 watts, while the largest size of the Nernst lamp uses 528 watts. The light distribution of any of the units is subject to considerable variation through the agency of reflectors, but the Nernst lamp is ordinarily installed without a reflector.

tor. Practically all of the other units of high candle-power use reflectors and only a few of the typical curves of light distribution curves with reflectors have been shown in connection with the description of the lamps. The life of all of the commercial lamps described is considered as satisfactory. The minimum life is seldom less than 500 hours and the useful life is generally between 500 and 1,000 hours. On account of the slender filaments employed in the metallic filament

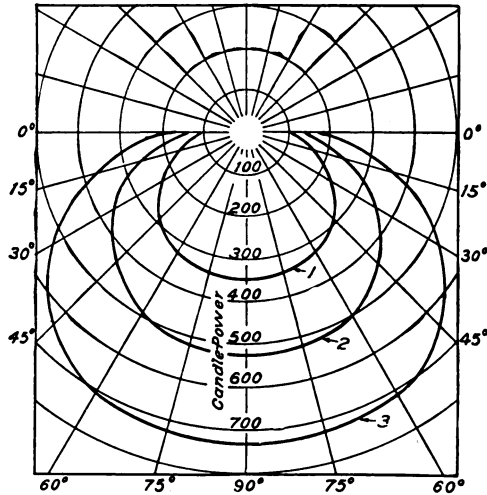

Fig. 27. Distribution of Light from Multiple-Glower Westinghouse Nernst Lamps with 8" Clear Globes. No. 1, 2 Glowler; No. 2, 3 Glowler; No. 3, 4 Glowler.

lamps they are not made for low candle-powers at commercial voltages. The introduction of transformers for the purpose of changing the circuit voltage to one suitable for low candle-power units has not become at all general as yet in this country.

SPECIAL LAMPS

The Mercury Vapor Lamp. The mercury vapor lamp in this country is put on the market by the Cooper-Hewitt Electric Company and it is being used to a considerable extent for industrial illumination. In this lamp mercury vapor, rendered incandescent by the passage of an electric current through it, is the source of light. In its standard form this lamp consists of a long glass tube from which the air has been carefully exhausted, and which contains a small amount of metallic mercury. The mercury is held in a large bulb at one end of

the tube and forms the negative electrode in the direct-current lamp. The other electrode is formed by an iron cup and the connections between the lamp terminals and the electrodes are of platinum where this connection passes through the glass. Fig. 28 gives the general appearance of a standard lamp having the following specifications:

Total watts (110 volts, 3.5 amperes) = 385

Candle-power (M. H. with reflector) = 700

Watts per candle = 0.55

Length of tube, total = 55 in.

Length of light-giving section = 45 in.

Diameter of tube = 1 in.

Height from lowest point of lamp to ceiling plate = 22 in.

For 220-volt service two lamps are connected in series.

The mercury vapor, at the start, may be formed in two ways: First, the lamp may be tipped so that a stream of mercury makes

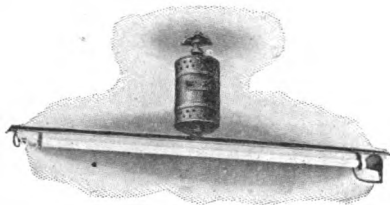

Fig. 28. Cooper-Hewitt Mercury Vapor Lamp.

contact between the two electrodes and mercury is vaporized when the stream breaks. Second, by means of a high inductance and a quick break switch, a very high voltage sufficient to pass a current from one electrode to the other through the vacuum, is induced and the conducting vapor

is formed. The tilting method of starting is preferred and this tilting is brought about automatically in the more recent types of lamp. Fig. 29 shows the connections for automatically starting two lamps in series. A steadying resistance and reactance are connected as shown in this figure.

The mercury vapor lamp is constructed in rather large units, the 55-volt, 3.5-ampere lamp being the smallest standard size. The color of the light emitted is objectionable for some purposes as there is an entire absence of red rays and the light is practically *monochromatic*. The illumination from this type of lamp is excellent where sharp contrast or minute detail is to be brought out, and this fact has led to its introduction for such classes of lighting as silk mills and cotton mills. On account of its color the application of this lamp is limited to the lighting of shops, offices, and drafting rooms, or to dis-

play windows where the goods shown will not be changed in appearance by the color of the light. It is used to a considerable extent in photographic work on account of the actinic properties of the light. Special reactances must be provided for a mercury arc lamp operating on single-phase, alternating-current circuits.

The Moore Tube Light. The Moore light makes use of the familiar Geissler tube discharge—discharge of electricity through a vacuum tube—as a source of illumination. The practical application of this discharge to a system of lighting has involved a large amount

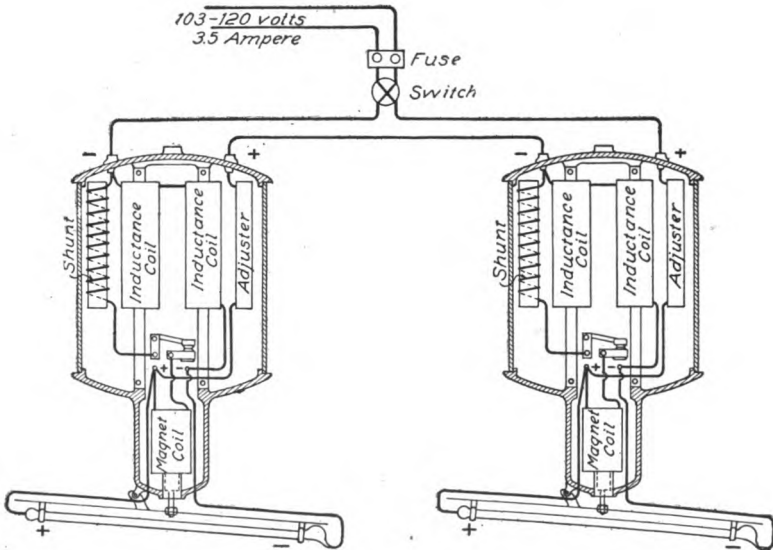

Fig. 29. Wiring Diagram. Two H Automatic Lamps in Series.

of consistent research on the part of the inventor and it has now been brought to such a stage that several installations have been made. The system has many interesting features.

In the normal method of installation, a glass tube $1\frac{3}{4}$ inches in diameter is made up by connecting standard lengths of glass tubing together until the total desired length is reached, and this continuous tube, which forms the source of light when in operation, is mounted in the desired position with respect to the plane of illumination. In many cases the tube forms a large rectangle mounted just beneath the ceiling of the room to be lighted. The tube may be of any reasonable length, actual values running from 40 to 220 feet. In order to

provide an electrical discharge through this tube it is customary to lead both ends of the tube to the high tension terminals of a transformer, the low tension side of which may be connected to the alternating-current lighting mains. This transformer is constructed so that the high tension terminals are not exposed and the current is led into the tube by means of platinum wires attached to carbon electrodes. The electrodes are about eight inches in length. The ends of the tube and the high tension terminals are enclosed in a steel casing so as to effectually prevent anything from coming in contact with the high potential of the system. As stated, the low tension side

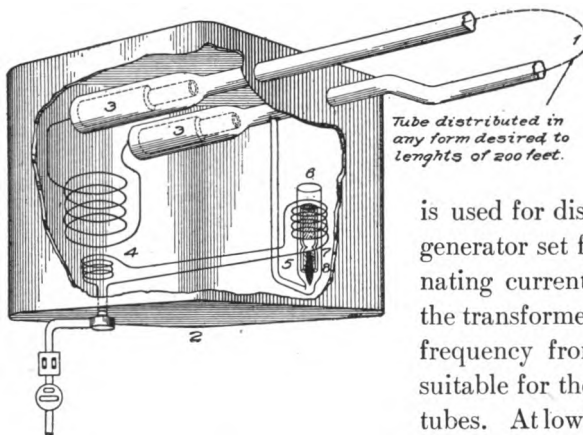

Fig. 30. Diagram Showing Essential Features of the Moore Light. 1. Lighting Tube; 2. Transformer Case; 3. Lamp Terminals; 4. Transformer; 5, 6, 7, 8, Regulators.

of the transformer is connected to the usual 60-cycle lighting mains.

If direct current

is used for distribution, a motor-generator set for furnishing alternating current to the primary of the transformer is required. Any frequency from 60 cycles up is suitable for the operation of these tubes. At lower frequencies there is some appreciable variation of the light emitted. One other device is necessary for the suitable operation of this form of light and

this is known as the *regulator*. In order to maintain a constant pressure inside the tube, and such a constant pressure is necessary for its satisfactory operation, there must be some automatic device which will allow a small amount of gas to enter the tube at intervals while it is in operation. The regulator accomplishes this purpose. Fig. 30 shows a diagram of the very simple connections of the system and gives the relative positions occupied by the transformer, tube, and regulator. Fig. 31 gives an enlarged view of the regulator, a description of which and its method of operation is given as follows:

A piece of $\frac{7}{8}$ -inch glass tubing is supported vertically and its bottom end is contracted into a $\frac{3}{8}$ -inch glass tube which extends to the main lighting tube.

At the point of contraction at the bottom of the $\frac{7}{8}$ -inch tube there is sealed by means of cement a $\frac{1}{4}$ -inch carbon plug, the porosity of which is not great enough to allow mercury to percolate through it but which will permit gases easily to pass, due to the high vacuum of the lighting tube connected to the lower end of the plug, and approximately atmospheric pressure above it. This carbon plug is normally completely covered with what would correspond to a thimbleful of mercury which simply seals the pores of the carbon plug, and therefore has nothing whatever to do with the conducting properties of the gas in the main tube which produces the light. Partly immersed in the mercury and concentric with the carbon plug, is another smaller and movable glass tube, the upper end of which is filled with soft iron wire, which acts as the core of a small solenoid connected in series with the transformer. The action of the solenoid is to lift the concentric glass tube partly out of the mercury, the surface of which falls and thereby causes the minute tip of the conical shaped carbon plug to be slightly exposed for a second or two.

This exposure is sufficient to allow a small amount of gas to enter the tube, the current decreases slightly, and the carbon plug is again sealed. The process above described takes place at intervals of about one minute when the tube is in operation.

The color of the light emitted by the tube depends upon the gas used in it. The regulator is fitted with some chemical arrangement whereby the proper gas is admitted to it when the tube is in operation. Nitrogen is employed when the tube gives the highest efficiency and the light emitted when this gas is used is yellowish in color. Air gives a pink appearance to the tube and carbon dioxide is employed when a white light is desired.

Table IX gives general data on the Moore tube light. The advantages claimed for this light are: High efficiency, good color, and low intrinsic brilliancy.

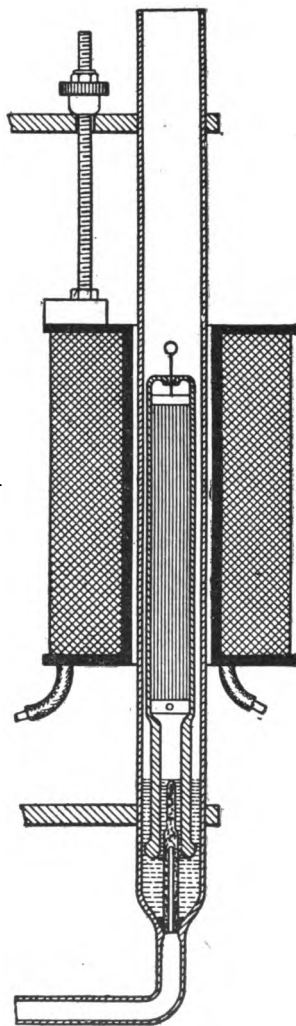

Fig. 31. Regulating Valve.

TABLE IX
Data on the Moore Tube Light

LENGTH OF TUBE	TRANSFORMER CAPACITY	POWER FACTOR OF CIRCUIT	VOLTAGE AT LAMP TERMINALS
40-70 ft.	2 kw.	65-84%	3,146 for 40-ft. tube, at 12 hefners per ft.
80-125 "	2.75 "		
130-180 "	3.5 "		
190-220 "	4.5 "		12,441 for 220-ft. tube, at 12 hefners per ft.

Pressure in tube, about $\frac{1}{16}$ mm. of mercury.

Watts per hefner, 3.2 for 20-foot tube including transformer.

Watts per hefner, 1.4 for 180-foot tube including transfo.mer.

Hefner per foot, normal, 12.

Note that one hefner equals 0.88 candle-power.

ARC LAMPS

The Electric Arc. Suppose two carbon rods are connected in an electric circuit, and the circuit closed by touching the tips of these rods together; on separating the carbons again the circuit will not be broken, provided the space between the carbons be not too great,

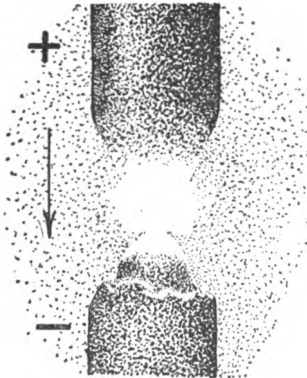

Fig. 32. The Electric Arc between Carbon Terminals.

but will be maintained through the arc formed at these points. This phenomenon, which is the basis of the arc light, was first observed on a large scale by Sir Humphrey Davy, who used a battery of 2,000 cells and produced an arc between charcoal points four inches apart.

As the incandescence of the carbons across which an arc is maintained, together with the arc itself, forms the source of light for a large portion of arc lamps, it will be well to study the nature of the arc. Fig. 32 shows the general appearance of an arc maintained by direct current.

Here the current is assumed as passing from the top carbon to the bottom one as indicated by the arrow and signs. We find, in the direct-current arc, that the most of the light issues from the tip of the positive carbon, or electrode, and this portion is known as the *crater* of the arc. This crater has a temperature of from $3,000^{\circ}$ to $3,500^{\circ}$ C., the temperature at which the carbon vaporizes, and gives fully 80 to 85% of the light furnished by the arc. The negative carbon becomes pointed at the same time that the positive one is hollowed out to form the crater, and it is also incandescent but not to as great a degree as the positive carbon. Between the electrodes there is a band of violet light, the *arc proper*, and this is surrounded by a luminous zone of a golden yellow color. The arc proper does not furnish more than 5% of the light emitted when pure carbon electrodes are used.

[The carbons are worn away or consumed by the passage of the current, the positive carbon being consumed about twice as rapidly as the negative.

The light distribution curve of a *direct-current arc*, taken in a vertical plane, is shown in Fig. 33. Here it is seen that the maximum amount of light is given off at an angle of about 50° from the vertical, the negative carbon shutting off the rays of light that are thrown directly downward from the crater.

If alternating current is used, the upper carbon becomes positive and negative alternately, and there is no chance for a crater to be formed, both carbons giving off the same amount of light and being consumed at about the same rate. The light distribution curve of an *alternating-current arc* is shown in Fig. 34.

Arc-Lamp Mechanisms. In a practical lamp we must have not only a pair of carbons for producing the arc, but also means for supporting these carbons, together with suitable arrangements for leading

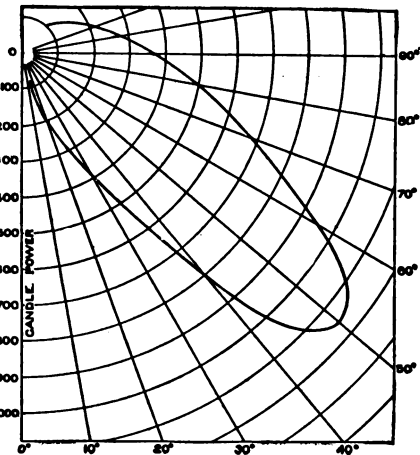

Fig. 33. Distribution Curve for D. C. Arc Lamp (Vertical Plane).

the current to them and for maintaining them at the proper distance apart. The carbons are kept separated the proper distance by the operating mechanisms which must perform the following functions:

1. The carbons must be in contact, or be brought into contact, to start the arc when the current first flows.
2. They must be separated at the right distance to form a proper arc immediately afterward.

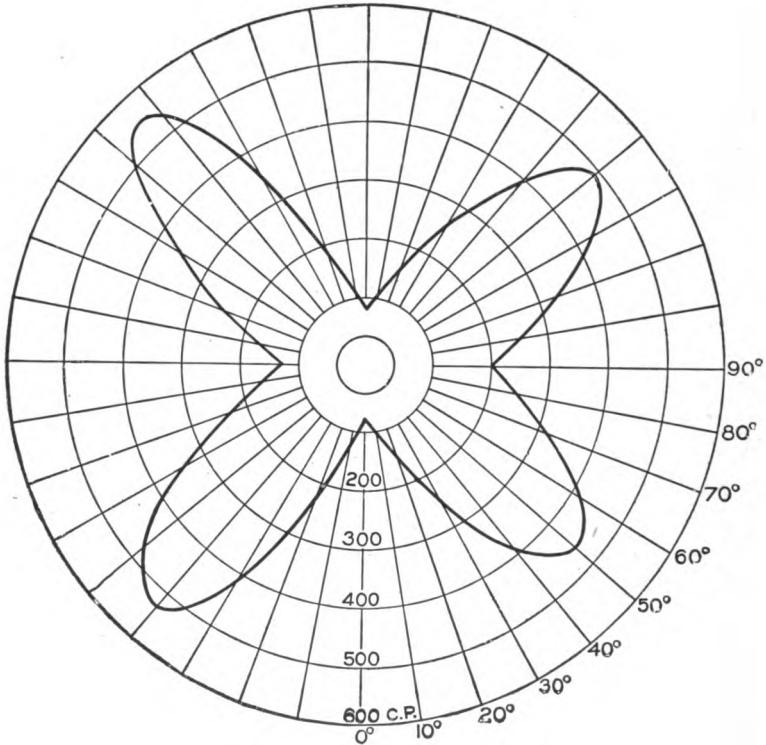

Fig. 34. Distribution Curve for A. C. Arc Lamp (Vertical Plane).

3. The carbons must be fed to the arc as they are consumed.
4. The circuit should be open or closed when the carbons are entirely consumed, depending on the method of power distribution.

The feeding of the carbons may be done by hand, as is the case in some stereopticons using an arc, but for ordinary illumination the striking and maintaining of the arc must be automatic. It is made so in all cases by means of solenoids acting against the force of gravity or against springs. There are an endless number of such mechanisms,

but a few only will be described here. They may be roughly divided into three classes:

1. Shunt mechanisms.
2. Series mechanisms.
3. Differential mechanisms.

Shunt Mechanisms. In shunt lamps, the carbons are held apart before the current is turned on, and the circuit is closed through a solenoid connected in across the gap so formed. All of the current must pass through this coil at first, and the plunger of the solenoid is arranged to draw the carbons together, thus starting the arc. The pull of the solenoid and that of the springs are adjusted to maintain the arc at its proper length.

Such lamps have the disadvantage of a high resistance at the start—450 ohms or more—and are difficult to start on series circuits, due to the high voltage required. They tend to maintain a constant voltage at the arc, but do not aid the dynamo in its regulation, so that the arcs are liable to be a little unsteady.

Series Mechanisms. With the series-lamp mechanism, the carbons are together when the lamp is first started and the current, flowing in the series coil, separates the electrodes, striking the arc. When the arc is too long, the resistance is increased and the current lowered so that the pull of the solenoid is weakened and the carbons feed together. This type of lamp can be used only on constant-potential systems.

Fig. 35 shows a diagram of the connection of such a lamp. This diagram is illustrative of the connection of one of the lamps manufactured by the Western Electric Company, for use on a direct-current,

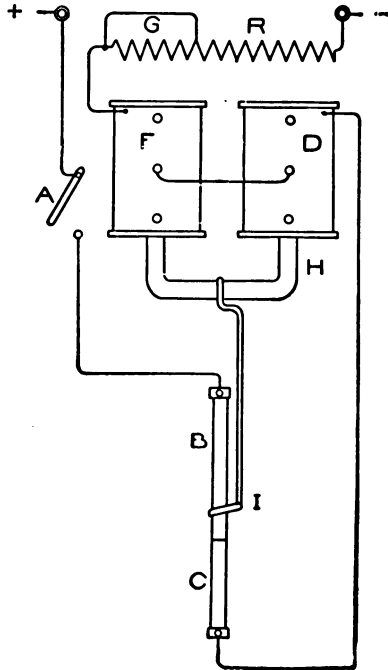

Fig. 35. Series Mechanism for D. C. Arc Lamp.

constant-potential system. The symbols + and - refer to the terminals of the lamp, and the lamp must be so connected that the current flows from the top carbon to the bottom one. R is a series resistance, adjustable for different voltages by means of the shunt G . F and D are the controlling solenoids connected in series with the arc. B and C are the positive and negative carbons respectively, while A is the switch for turning the current on and off. H is the plunger of the solenoids and I the carbon clutch,

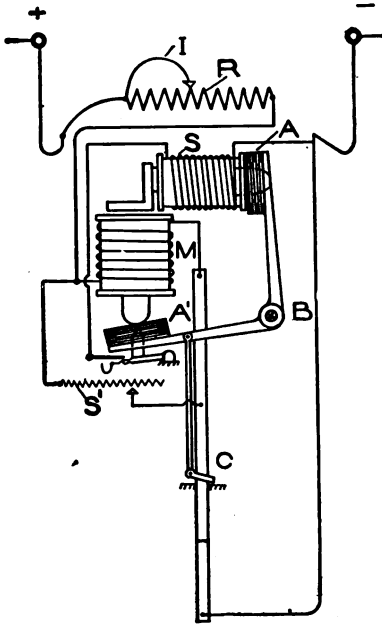

Fig. 36. Differential Mechanism for D. C. Arc Lamp.

this being what is known as a *carbon-feed lamp*. The carbons are together when A is first closed, the current is excessive, and the plunger is drawn up into the solenoids, lifting the carbon B until the resistance of the arc lowers the current to such a value that the pull of the solenoid just counterbalances the weight of the plunger and carbon. G must be so adjusted that this point is reached when the arc is at its normal length.

Differential Mechanisms. In the differential lamp, the series and shunt mechanisms are combined, the carbons being together at the start, and the series coil arranged so as to separate them while the shunt coil is connected across the

arc, as before, to prevent the carbons from being drawn too far apart. This lamp operates only over a low-current range, but it tends to aid the generator in its regulation.

Fig. 36 shows a lamp having a differential control, this also being the diagram of a Western Electric Company arc lamp for a direct-current, constant-potential system. Here S represents the shunt coil and M the series coil, the armature of the two magnets A and A' being attached to a bell-crank, pivoted at B , and attached to the carbon clutch C . The pull of coil S tends to lower the carbon while that of M raises the carbon, and the two are so adjusted that equilibrium is

reached when the arc is of the proper length. All of the lamps are fitted with an air dashpot, or some damping device, to prevent too rapid movements of the working parts.

The methods of supporting the carbons and feeding them to the arc may be divided into two classes:

1. Rod-feed mechanism.
2. Carbon-feed mechanism.

Rod-Feed Mechanism.

Lamps using a rod feed have the upper carbons supported by a conducting rod, and the regulating mechanism acts on this rod, the current being fed to the rod by means of a sliding contact. Fig. 37 shows the arrangement of this type of feed. The rod is shown at *R*, the sliding contact at *B*, and the carbon is attached to the rod at *C*.

These lamps have the advantage that carbons, which do not have a uniform cross-section or smooth exterior, may be used, but they possess the disadvantage of being very long in order to accommodate the rod. The rod must also be kept clean so as to make a good contact with the brush.

Carbon-Feed Mechanism. In carbon-feed lamps the controlling mechanism acts on the carbons directly through some form of clutch such as is shown at *C* in Fig. 38. This clamp being lifted grips the carbon, but allows the carbon to slip through it when the tension is released. For this type of feed the carbon must be straight and have a uniform cross-section as well as a smooth exterior. The current may be led to the carbon by means of a flexible lead and a short carbon holder

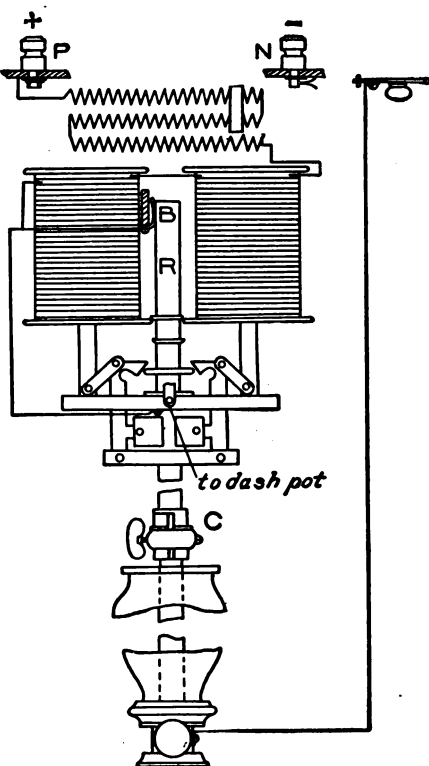

Fig. 37. Rod-Feed Mechanism.

TYPES OF ARC LAMPS

Arc lamps are constructed to operate on *direct-current* or *alternating-current* systems when connected in *series* or in *multiple*. They are also made in both the *open* and the *enclosed* forms.

By an *open arc* is meant an arc lamp in which the arc is exposed to the atmosphere, while in the *enclosed arc* an inner or enclosing

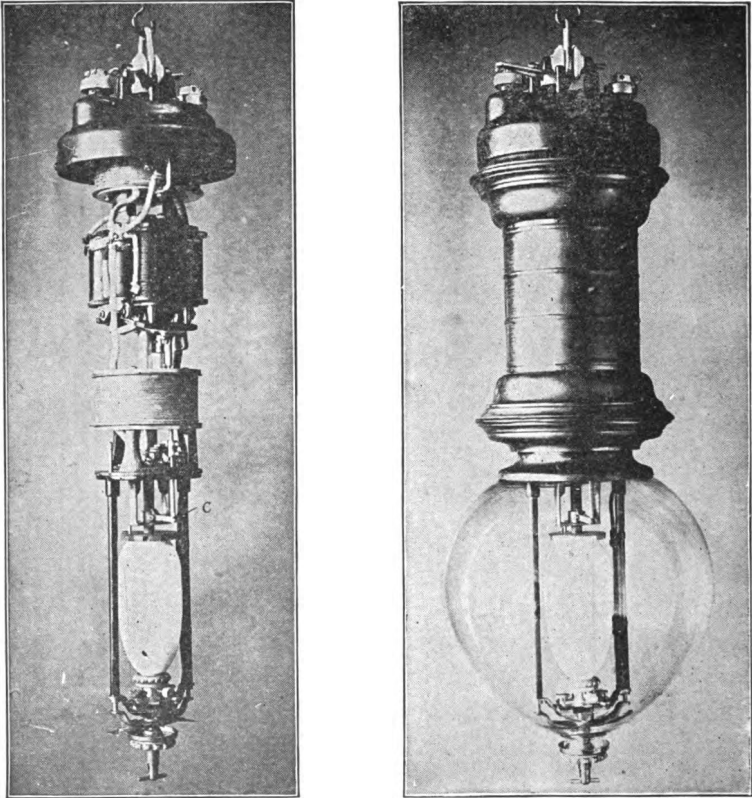

Fig. 38. Enclosed Arc Lamp with Carbon-Feed Mechanism.

globe surrounds the arc, and this globe is covered with a cap which renders it nearly air-tight. Fig. 38 is a good example of an enclosed arc as manufactured by the General Electric Company.

Direct-Current Arcs. *Open Types of Arcs* for direct-current systems were the first to be used to any great extent. When used they are always connected in series, and are run from some form of

special arc machine, a description of which may be found in "Types of Dynamo Electric Machinery."

Each lamp requires in the neighborhood of 50 volts for its operation, and, since the lamps are connected in series, the voltage of the system will depend on the number of lamps; therefore, the number of lamps that may be connected to one machine is limited by the maximum allowable voltage on that machine. By special construction as many as 125 lamps are run from one machine, but even this size of generator is not so efficient as one of greater capacity. Such generators are usually wound for 6.6 or 9.6 amperes. Since the carbons are exposed to the air at the arc, they are rapidly consumed, requiring that they be renewed daily for this type of lamp.

Double-carbon arcs. In order to increase the life of the early form of arc lamp without using too long a carbon, the double-carbon type was introduced. This type uses two sets of carbons, both sets being fed by one mechanism so arranged that when one pair of the electrodes is consumed the other is put into service. At present nearly all forms of the open arc lamp have disappeared on account of the better service rendered by the enclosed arc.

Enclosed arcs for series systems are constructed much the same as the open lamp, and are controlled by either shunt or differential mechanism. They require a voltage from 68 to 75 at the arc, and are usually constructed for from 5 to 6.8 amperes. They also require a constant-current generator or a rectifier outfit if used on alternating-current circuits.

Constant-potential arcs must have some resistance connected in series with them to keep the voltage at the arc at its proper value. This resistance is made adjustable so that the lamps may be used on any circuit. Its location is clearly shown in Fig. 38, one coil being located above, the other below the operating solenoids.

Alternating-Current Arcs. These do not differ greatly in construction from the direct-current arcs. When iron or other metal parts are used in the controlling mechanism, they must be laminated or so constructed as to keep down induced or eddy currents which might be set up in them. For this reason the metal spools, on which the solenoids are wound, are slotted at some point to prevent them from forming a closed secondary to the primary formed by the solenoid winding. On constant-potential circuits a reactive coil is used

in place of a part of the resistance for cutting down the voltage at the arc.

Interchangeable Arc. Interchangeable arcs are manufactured which may be readily adjusted so as to operate on either direct or alternating current, and on voltages from 110 to 220. Two lamps may be run in series on 220-volt circuits.

The distribution of light, and the resulting illumination for the different lamps just considered, will be taken up later. Aside from the distribution and quality of light, the enclosed arc has the advantage that the carbons are not consumed so rapidly as in the open lamp because the oxygen is soon exhausted from the inner globe and the combustion of the carbon is greatly decreased. They will burn from 80 to 100 hours without retrimming.

TABLE X
Rating of Enclosed Arcs

D. C. LAMP	CURRENT	WATTS CONSUMED			MEAN INTENSITY IN H. U.			MEAN WATTS		
		IN LAMP	IN ARC	MECHANISM	SPHERICAL		LOWER HEMI-SPHERICAL CAL.	SPHERICAL H. U.		LOWER HEMI-SPHERICAL CAL.
					OPAL OUTER	CLEAR OUTER		OPAL OUTER	CLEAR OUTER	
1	5.01	551	401	150	172	235	332	3.10	2.37	1.66
3	5.08	559	406	150	195	216	282	2.85	2.60	1.99
4	4.76	524	381	143	127	139	208	4.12	3.76	2.52
5	4.16†	458	333	125	154	174	221	2.96	2.63	2.07
7	4.76	524	381	143	203	333	317	2.63	2.20	1.65
9	4.84	532	387	145	182	226	281	2.83	2.38	1.89
10	4.99	549	399	150	202	242	309	2.74	2.24	1.77
12	4.87	536	350	146	178	195	230	3.05	2.66	2.33
Mean	4.9	529	384	144	176	207	272	3.03	2.60	1.98

A. C. LAMP	CURRENT	IN LAMP	POWER FACTOR LAMP	IN ARC	POWER FACTOR ARC	MECHANISM						
101	6.40	448	.63	340	.82	108	127	141	206	3.52	3.17	2.17
102	6.79	459	.61	375	.73	84	146	203	236		2.26	1.94
103	5.89	424	.65	344	.75	80	116	176†	226†	3.31	2.60†	1.72†
105	6.20	414	.61	382	.80	32	128	130	147	3.66	3.15	2.88
								187	219	3.24	2.20	1.89
								153	169		2.56	2.23
106	6.12	378	.56	298	.70	80	132	182†	284	2.82	2.19†	1.48†
108	6.48	457	.64	383	.80	74.5	133	175	211	3.20	2.61	2.16
110	6.18	339	.49	276	.72	63	140*	126	143	2.41*	2.68	2.37
Mean	6.29	417	.60	342	.76	74.5	130	159	190	3.31	2.66	2.23

*Condition of no outer globe. †Condition with shade on lamp. H. U. Hefner Units.

Rating of Arc Lamps. Open arcs have been classified as follows:

Full Arcs, 2,000 candle-power taking 9.5 to 10 amps. or 450-480 watts.
Half Arcs, 1,200 candle-power taking 6.5 to 7 amps. or 325-350 watts.

These candle-power ratings are much too high, and run more nearly 1,200 and 700, respectively, for the point of maximum intensity and less than this if the mean spherical candle-power be taken. For this reason, the ampere or watt rating is now used to indicate the power of the lamp. It is now recommended that specifications for street lighting should be based upon the illumination produced. This point is considered later under the topic of street lighting. Enclosed arcs use from 3 to 6.5 amperes, but the voltage at the arc is higher than for the open lamp. Table X gives some data on enclosed arcs on constant-potential circuits.

Efficiency. The efficiency of arc lamps is given as follows:

Direct-Current Arc (enclosed) 2.9 watts per candle-power.

Alternating-Current Arc (enclosed) 2.95 watts per candle-power.

Direct-Current Arc (open) .6-1.25 watts per candle-power.

Carbons for Arc Lamps. Carbons are either moulded or forced from a product known as *petroleum coke* or from similar materials such as *lampblack*. The material is thoroughly dried by heating to a high temperature, then ground to a fine powder, and combined with some substance such as pitch which binds the fine particles of carbon together. After this mixture is again ground it is ready for moulding. The powder is put in steel moulds and heated until it takes the form of a paste, when the necessary pressure is applied to the moulds. For the forced carbons, the powder is formed into cylinders which are placed in machines which force the material through a die so arranged as to give the desired diameter. The forced carbons are often made with a core of some special material, this core being added after the carbon proper has been finished. The carbons, whether moulded or forced, must be carefully baked to drive off all volatile matter. The forced carbon is always more uniform in quality and cross-section, and is the type of carbon which must be used in the carbon-feed lamp. The adding of a core of a different material seems to change the quality of light, and being more readily volatilized, keeps the arc from wandering.

Plating of carbons with copper is sometimes resorted to for moulded forms for the purpose of increasing the conductivity, and, by protecting the carbon near the arc, prolonging the life.

The Flaming Arc. In the carbon arc the arc proper gives out but a small percentage of the total amount of light emitted. In order to obtain a light in which more of the source of luminosity is in the arc itself, experiments have been made with the use of electrodes impregnated with certain salts, as well as with electrodes of a material different than carbon. The result of these experiments has been to place upon the market the flaming arc lamps and the luminous arc lamps—lamps of high candle-power, good efficiency, and giving various colors of light. These lamps may be put in two classes: One class uses carbon electrodes, these electrodes being impregnated with certain

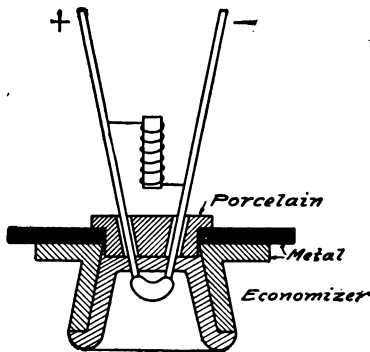

Fig. 39. Diagram of Bremer Flaming Arc.

salts which add luminosity to the arc, or else fitted with cores which contain the required material; the other class covering lamps which do not employ carbon, the most notable example being the magnetite arc which uses a copper segment as one electrode and a magnetite stick as the other electrode.

Flaming arcs of the first class are made in two general types: One in which the electrodes are placed at an angle, and the other in which the carbons are placed one above the other as in the ordinary arc lamp. The term luminous arc is usually applied to arcs of the flaming type in which the electrodes are placed one above the other. The minor modifications as introduced by the various manufacturers are numerous and include such features as a magazine supply of electrodes by which a new pair may be automatically introduced when one pair is consumed; feed and control mechanisms; etc. The flaming arc presents a special problem since the vapors given off by the lamp may condense on the glassware and form a partially opaque coating, or they may interfere with the control mechanism.

Bremer Arc. The Bremer flaming arc lamp was introduced commercially in 1899, and since some of its principles are incorporated in many of the lamps on the market to-day, it will be briefly described here. The diagram shown in Fig. 39 illustrates the main features of

this lamp. The electrodes are mounted at an angle and an electromagnet is placed above the arc for the purpose of keeping the arc from creeping up and injuring the economizer, and also for the purpose of spreading the arc out and increasing its surface. The vapor from the arc is condensed on the economizer and this coating acts as a reflector, throwing the light downward. The economizer serves to limit the air supplied to the arc and thus increases the life of the electrodes. The inclined position of the carbons was suggested by the fact that in the impregnated carbons a slag was formed which gave trouble when the electrodes were mounted in the usual manner. By using the electrodes in this position there is little if any obstruction to the light which passes directly downward from the arc.

Bremer's original electrodes contained compounds of calcium, strontium, magnesium, etc., as well as boracic acid. Electrodes as employed in the various lamps to-day differ greatly in their make-up. Some use impregnated

carbons, others use carbons with a core containing the flaming materials, and metallic wires are added in some cases. The life of electrodes for flaming lamps is not great, depending upon their length and somewhat upon the type of lamp. The maximum life of the treated carbons is in the neighborhood of 20 hours.

The color of the light from the flaming arc is yellow when calcium salts are used as the main impregnating compound, and the majority of the lamps installed use electrodes giving a yellow light. By employing more strontium, a red or pink light is produced, while if a white light is wanted, barium salts are used. Calcium gives the most efficient service and strontium comes between this and barium. The distribution curves in Fig. 40 illustrate the relative economies

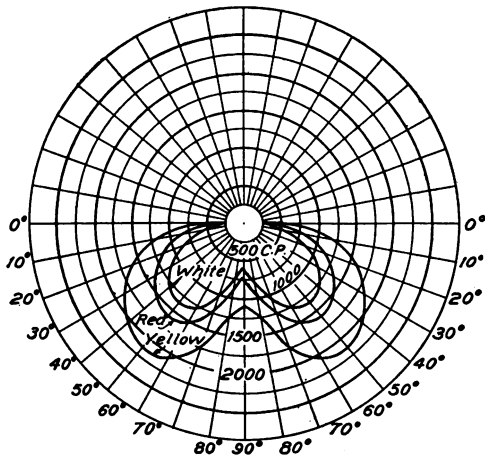

Fig. 40. Distribution Curves of a Luminous Arc.

of the different materials. Modern electrodes contain not more than 15% of added material and it is customary to find the salts applied as a core to the pure carbon sticks. The electrodes are made of a small diameter in order to maintain a steady light and this partially accounts for their short life.

The feeding mechanisms employed differ greatly. They may be classified as: Clock, gravity-feed, clutch, motor, and hot-wire mechanisms. Fig. 41 illustrates a clock mechanism. This is a differential

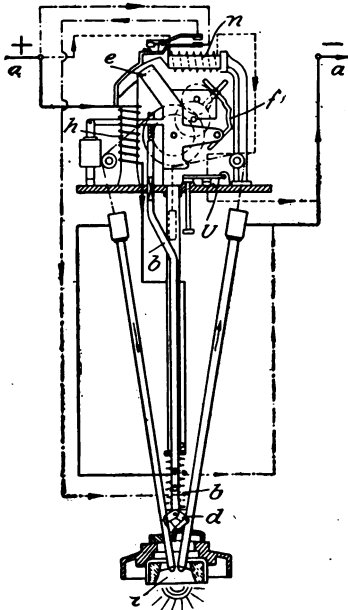

Fig. 41. Clock Feeding Mechanism for Luminous Arc Lamp.

differential mechanism in which the shunt coils act to release a detent *f* which allows the electrodes to feed down and when they come in contact the series coils separate them to the proper extent for maintaining a suitable arc. In the gravity feed an electromagnet is used to operate one carbon in springing the arc and the other carbon is fed by gravity, it being prevented from dropping too far by means of a special rib formed on the electrode which comes in contact with a part of the lamp structure. Gravity feed is also employed in the clutch mechanism but here the carbons are held in one position by an electrically operated clutch which releases them only when the current is sufficiently reduced by the lengthening of the arc. In the

hot-wire lamp, the wire is usually in series with the arc; the contraction and expansion of this wire is balanced against a spring and the arc is regulated by such contraction or expansion of the wire. Such a lamp is suitable for either direct or alternating current. In the motor mechanism, as applied to alternating-current lamps, a metallic disk is actuated by differential magnets and its motion is transmitted to the electrodes to lengthen or shorten the arc accordingly as the force exerted by the series or shunt coils predominates.

Magnetite Arc. The magnetite arc employs a copper disk as

one electrode; and a magnetite stick—formed by forcing magnetite, to which titanium salts are usually added, into a thin sheet steel tube—is used as the other electrode. This lamp gives a luminous arc of good efficiency and the magnetite electrode is not consumed as rapidly as the treated carbons with the result that magnetite lamps do not require trimming as frequently. The life of the magnetite electrode as at present manufactured is from 170 to 200 hours. A diagram of the connections of this lamp as manufactured by the General Electric

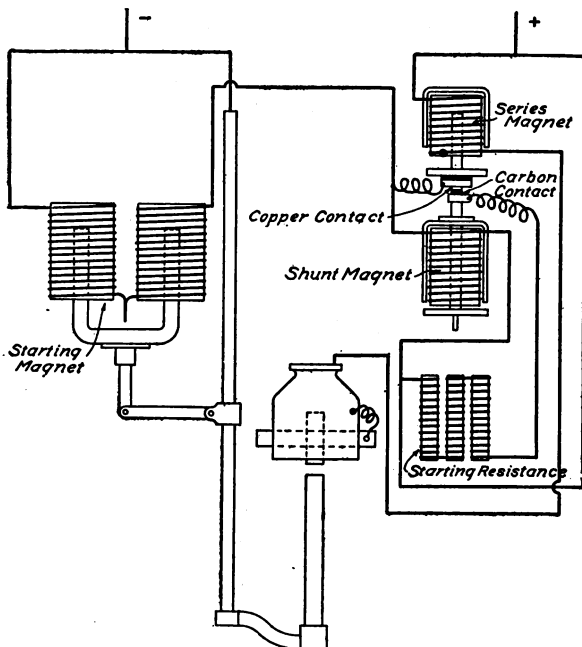

Fig. 42. Diagram of Connections for Magnetite Arc Lamp.

Company is shown in Fig. 42. The magnetite electrode is placed below. The copper electrode has just the proper dimensions to prevent its being destroyed by the arc and yet it is not large enough to cause undue condensation of the arc vapor. Direct current must be used with this lamp, the current passing from the copper to the magnetite.

Table XI gives some general data on the flaming arc, while Figs. 43 and 44 give typical distribution curves. The advantages of the flaming arc over lamps using pure carbon electrodes are: High efficiency; better light distribution; and better color of light for some

purposes. A greater amount of light can be obtained from a single unit than is practical with the carbon arc. The disadvantages lie in the frequent trimming required and the expense of electrodes. Flaming arcs have been introduced abroad, especially in Germany, to a much greater extent than in the United States.

TABLE XI
General Data on Flaming Arcs

VOLTS	AMPERES	WATTS	MEAN SPHERICAL CANDLE-POWER	WATTS PER MEAN SPHERICAL C. P.
55	6	330	480	.68
	8	440	800	.55
	10	550	1100	.5
	12	660	1300	.5
	15	825	1700	.49
	20	1100	2250	.48

POWER DISTRIBUTION

The question of power distribution for electric lamps and other appliances is taken up fully in the section on that subject, therefore it will be treated very briefly here. The systems may be divided into:

1. Series distribution systems.
2. Multiple-series or series-multiple systems.
3. Multiple or parallel systems.

They apply to both alternating and direct current.

The Series System. This is the most simple of the three; the lamps, as the name indicates, are connected in series as shown in Fig. 45. A constant load is necessary if a constant potential is to be used. If the load is variable, a constant-current generator, or a special regulating device is necessary. Such devices are constant-current transformers and constant-current regulators as applied to alternating-current circuits.

The series system is used mostly for arc and incandescent lamps when applied to street illumination. Its advantages are simplicity and saving of copper. Its disadvantages are high voltage, fixed by the number of lamps in series; the size of the machines is limited since they cannot be insulated for voltage above about 6,000; a single open circuit shuts down the whole system.

Alternating-current series distribution systems are being used to a very large extent. By the aid of special transformers, or regulators,

any number of circuits can be run from one machine or set of bus bars, and apparatus can be built for any voltage and of any size. It is not customary, however, to build transformers of this type having a capac-

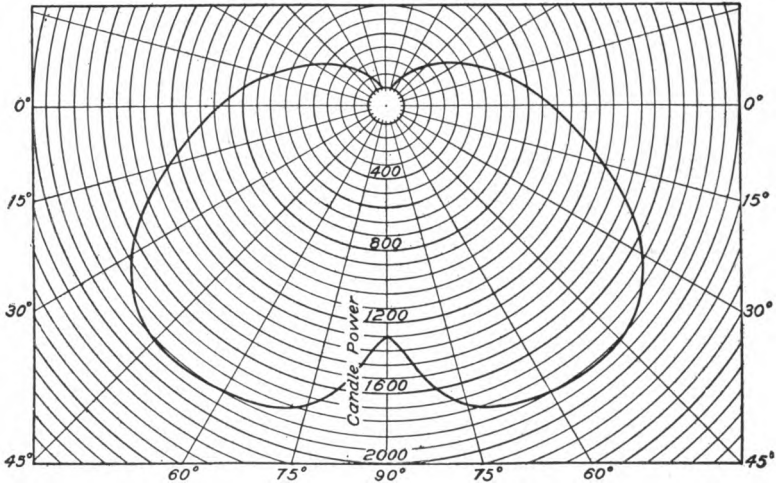

Fig. 43. Distribution Curve for Flaming Arc Lamp.

ity greater than one hundred 6.6-ampere lamps because of the high voltage which would have to be induced in the secondary for a larger number of lamps.

Fig. 45 gives a diagram of the connection of a single-coil transformer in service. The constant-current transformer most in use for lighting purposes is the one manufactured by the General Electric Company and commonly known as a *tub transformer*. Fig. 46 shows such a transformer (double-coil type) when removed from the case.

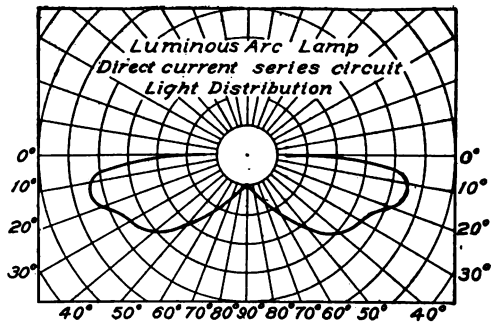

Fig. 44. Distribution Curve for a 4-Ampere, 75-Volt, Magnetite Luminous Arc Lamp.

Referring to Fig. 46, the fixed coils *A* form the primaries which are connected across the line; the movable coils *B* are the secondaries

connected to the lamps. There is a repulsion of the coils *B* by the coils *A* when the current flows in both circuits and this force is balanced by means of the weights at *W*, so that the coils *B* take a position such that the normal current will flow in the secondary. On light loads, a low voltage is sufficient, hence the secondary coils are close

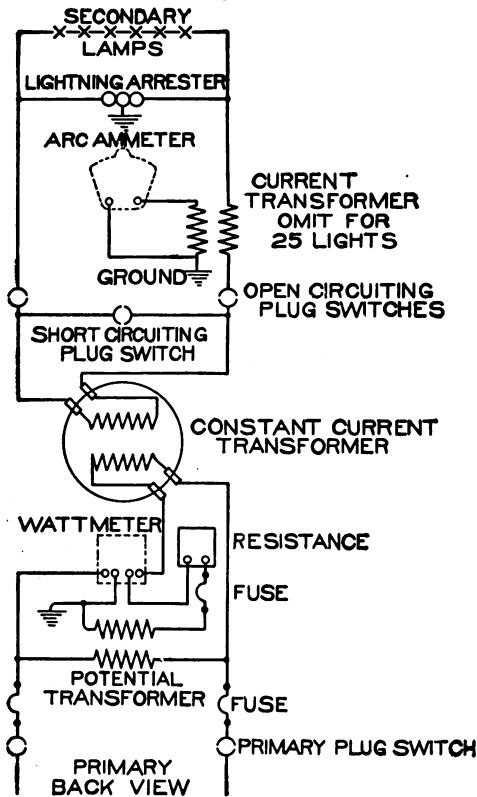

Fig. 45. Wiring Diagram for Single-Coil Transformer.

together near the middle of the machine and there is a heavy magnetic leakage. When all of the lamps are on, the coils take the position shown when the leakage is a minimum and the voltage a maximum. When first starting up, the transformer is short-circuited and the secondary coils brought close together. The short circuit is then removed and the coils take a position corresponding to the load on the line.

These transformers regulate from full load to $\frac{1}{3}$ rated load within $\frac{1}{10}$ ampere of normal current, and can be run on short circuit for several hours without overheating. The efficiency is given as 96% for 100-light transformers and 94.6% for 50-light transformers at full

load. The power factor of the system is from 76 to 78% on full load, and, owing to the great amount of magnetic leakage at less than full load—the effect of leakage being the same as the effect of an inductance in the primary—the power factor is greatly reduced, falling to 62% at $\frac{3}{4}$ load, 44% at $\frac{1}{2}$ load, and 24% at $\frac{1}{4}$ load.

Standard sizes are for capacities of 25-, 35-, 50-, 75-, and 100-6.6 ampere enclosed arcs, and they are also made for lower currents in

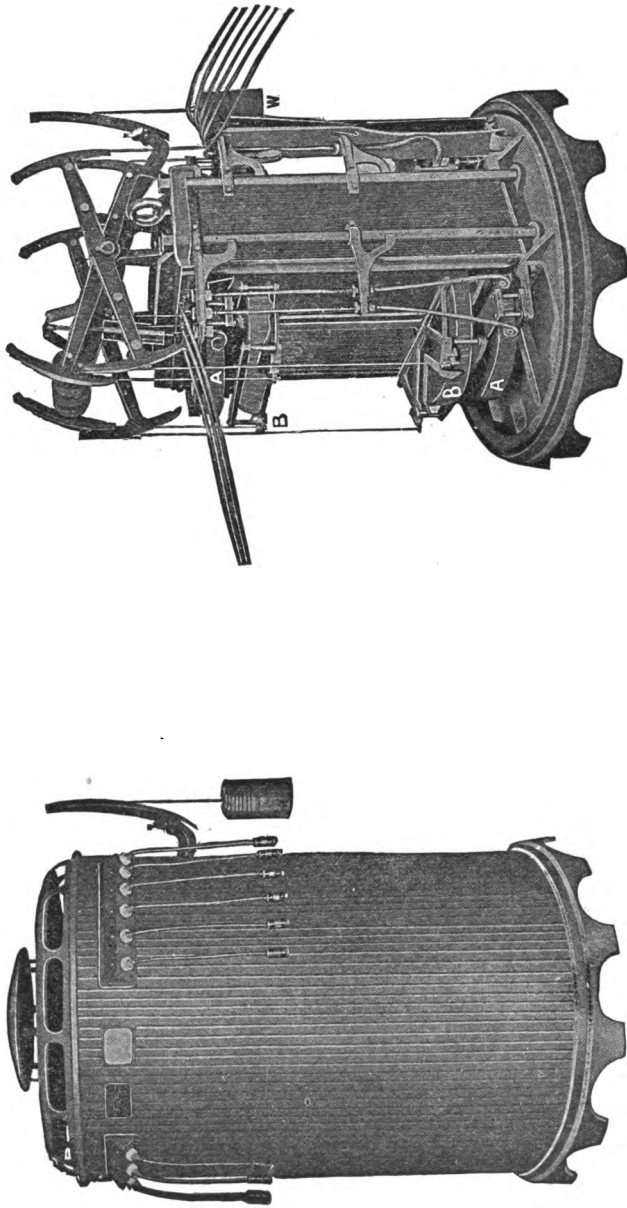

Fig. 46. Double-Coil Transformer (second view with case removed).

the neighborhood of 3.3 amperes for incandescent lamps. The low power factor of such a system on light loads shows that a transformer should be selected of such a capacity that it will be fully or nearly fully loaded at all times. The primary winding can be constructed for any voltage and the open circuit voltages of the secondaries are as follows:

25 light transformer, 2,300 volts.	75 light transformer, 6,900 volts.
35 " " 3,200 "	100 " " 9,200 "
50 " " 4,600 "	

The 50-, 75-, and 100-light transformers are arranged for multiple circuit operation, two circuits used in series, and the voltages at full load reach 4,100 for each circuit on the 100-light machine.

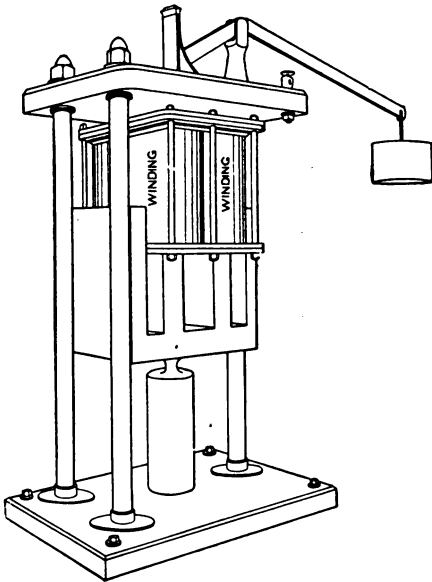

Fig. 47. Current Regulator for A. C. Series Distribution Systems.

The second system, used for series distribution on alternating-current circuits consists of a constant-potential transformer, stepping down the line voltage to that required for the total number of lamps on the system, allowing 83 volts for each lamp, and in series with the lamps is a reactive coil, the reactance of which is automatically regulated, as the load is increased or decreased, in order to keep the current in the line constant. Fig. 47 shows such a regulator and Fig. 48 shows this regulator connected in circuit. The inductance is varied by the movement of the coil so as to include more or less iron in the magnetic circuit. Since the inductance in series with the lamps is high on light loads, the power factor is greatly reduced as in the constant-current transformer; and the circuits should, preferably, be run fully loaded. 60 to 65 lamps on a circuit is the usual maximum limit.

While used primarily for arc-light circuits, the same systems,

designed for lower currents, are very readily applied to series incandescent systems.

The introduction of certain flaming or luminous arcs requiring direct current for their operation has led to the use of the *mercury arc rectifier* in connection with series circuits on alternating-current systems. A constant-current transformer is used to regulate for the proper constant current in its secondary winding, and this secondary current is rectified by means of the mercury arc rectifier for the lamp circuit. In the recent outfits the rectifier tubes are immersed in oil for cooling. While this rectifier was first introduced for the operation of luminous arc lamps, there is no reason why it should not be used with any series lamp requiring direct current, provided the system is designed for the current taken by such lamps. With this system any commercial frequency may be used. Sets are constructed for 25-, 50-, and 75-light circuits. They have a combined efficiency, transformer and rectifier tube, of 85% to 90%, and operate at a power factor of from 65% to 70%. Fig. 49 gives a diagram of the circuit and rectifier connections used with a single-tube outfit.

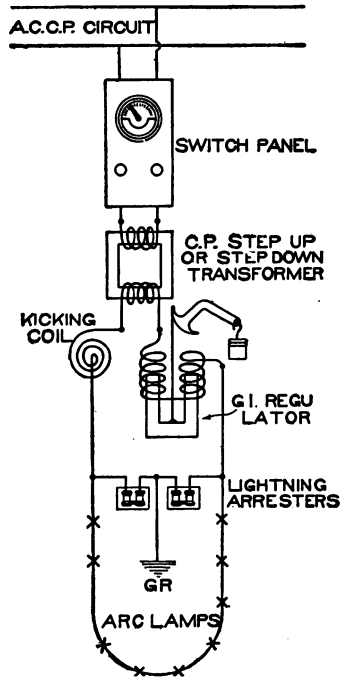

Fig. 48. Wiring Diagram Showing Introduction of the Current Regulator.

Multiple-Series or Series-Multiple Systems. These combine several lamps in series, and these series groups in multiple, or several lamps in multiple and these multiple groups in series, respectively. They have but a limited application.

Multiple or Parallel Systems of Distribution. By far the largest number of lamps in service are connected to parallel systems of distribution. In this system, the units are connected across the lines leading to the bus bars at the station, or to the secondaries of constant-potential transformers. Fig. 50 shows a diagram of ten lamps connected in parallel. The current delivered by the machine de-

pends directly on the number of lamps connected in service, the voltage of the system being kept constant.

Inasmuch as the flow of current in a conductor is always accom-

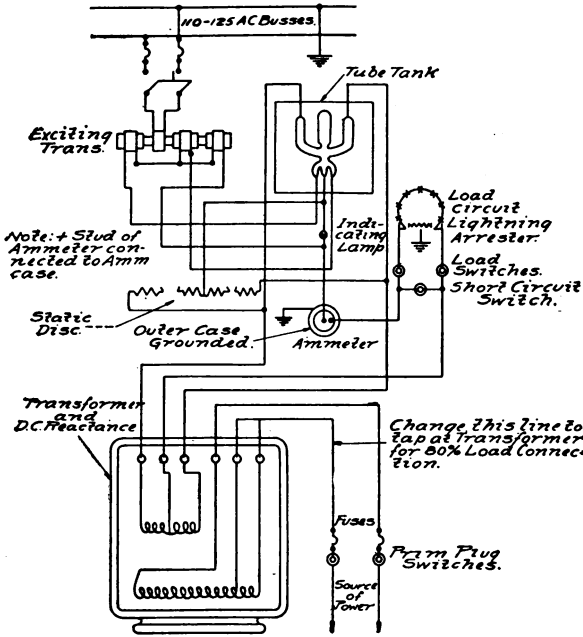

Fig. 49. Wiring Diagram for A. C. System Showing Introduction of Mercury Arc Rectifier.

panied by a fall of potential equal to the product of the current flowing into the resistance of the conductor, the lamps at the end of the system shown will not have as high a voltage impressed upon them as those nearer the machine. This drop in potential is the most serious obstacle that we have to overcome in multiple systems, and

various schemes have been adopted to aid in this regulation. The systems may be classified as:

1. Cylindrical conductors, parallel feeding.
2. Conical " " "
3. Cylindrical " anti-parallel feeding.
4. Conical " " "

In the cylindrical conductor, parallel-feeding system, the conductors, *A, B, C, D*, Fig. 50, are of the same size throughout and are fed at the same end by the generator. The voltage is a minimum at the lamps *E* and a maximum at the lamps *F*; the value of the voltage at any lamp being readily calculated.

By a conical or tapering conductor is meant a conductor whose diameter is so proportioned throughout its length that the current, divided by the cross-section, or the current density, is a constant

quantity. Such a conductor is approximated in practice by using smaller sizes of wire as the current in the lines becomes less.

In an anti-parallel system, the current is fed to the lamps from opposite ends of the system, as shown in Fig. 51.

Multiple-Wire Systems. In order to take advantage of a higher voltage for distribution of power to the lighting circuits, three- and five-wire systems have been introduced, the three-wire system being used to a very large extent. In this system, three conductors are used, the voltage from each outside conductor to the middle neutral conductor being the same as for a simple parallel system. Fig. 52 gives a diagram of this. By this system the amount of copper required for a given number of lamps is from five-sixteenths to three-eighths of the amount required for a two-wire distribution, depending on the size of the neutral conductor. The saving of copper together with the disadvantages of the system is more fully treated in the paper on "Power Transmission."

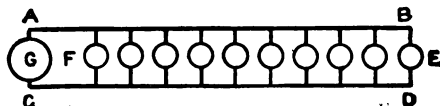

Fig. 50. Parallel Feeding System.

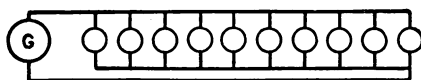

Fig. 51. Anti-parallel Feeding System.

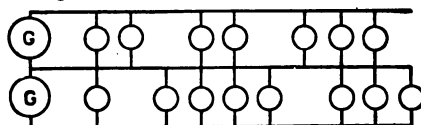

Fig. 52. Three-wire System.

ILLUMINATION

Illumination may be defined as the quality and quantity of light which aids in the discrimination of outline and the perception of color. Not only the quantity, but the quality of the light, as well as the arrangement of the units, must be considered in a complete study of the subject of illumination.

Unit of Illumination. The unit of illumination is the *foot-candle* and its value is the amount of light falling on a surface at a distance of one foot from a source of light one candle-power in value. The law of inverse squares—namely, that the illumination from a given source varies inversely as the square of the distance from the source—shows that the illumination at a distance of two feet from a

single candle-power unit is .25 foot-candles. For further consideration of the law of inverse squares, see "Photometry."

Illumination may be classified as *useful*—when used for the ordinary purposes of furnishing light for carrying on work, taking the place of daylight; and *scenic*—when used for decorative lighting such as stage lighting, etc. The two divisions are not, as a rule, distinct, but the one is combined with the other.

Intrinsic Brightness. By intrinsic brightness is meant the amount of light emitted per unit surface of the light source. Table XII gives the intrinsic brightness of several light sources.

TABLE XII
Intrinsic Brilliances in Candle-Power per Square Inch

SOURCE	BRILLIANCY	NOTES
Sun in zenith	600,000	Rough equivalent values, taking account of absorption
Sun at 30 degrees elv.	500,000	
Sun on horizon	2,000	
Arc light	10,000 to 100,000	Maximum about 200,000 in crater
Calcium light	5,000	Unshaded
Nernst "glower"	1,000	
Incandescent lamp	200-300	Depending on efficiency
Enclosed arc	75-100	Opalescent inner globe
Acetylene flame	75-100	
Welsbach light	20 to 25	
Kerosene light	4 to 8	Variable
Candle	3 to 4	Variable
Gas flame	3 to 8	
Incandescent (frosted)	2 to 5	
Opal shaded lamps, etc.	0.5 to 2	

Regular Reflection. Regular reflection is the term applied to reflection of light when the reflected rays are parallel. It is of such a nature that the image of the light source is seen in the reflection. The reflection from a plane mirror is an example of this. It is useful in lighting in that the direction of light may be changed without complicating calculations aside from deductions necessary to compensate for the small amount of light absorbed.

Irregular Reflection. Irregular reflection, or diffusion, consists of reflection in which the reflected rays of light are not parallel but take various directions, thus destroying the image of the light source. Rough, unpolished surfaces give such reflection. Smooth, unpolished surfaces generally give a combination of two kinds of reflection.

Diffused reflection is very important in the study of illumination inasmuch as diffused light plays an important part in the lighting of interiors. This form of reflection is seen in many photometer screens. Light is also diffused when passing through semi-transparent shades or screens.

In considering reflected light, we find that, if the surface on which the light falls is colored, the reflected light may be changed in its nature by the absorption of some of the colors. Since, as has been said, in interior lighting the reflected light forms a large part of the source of illumination, this illumination will depend upon the nature and the color of the reflecting surfaces.

Whenever light is reflected from a surface, either by direct or diffused reflection, a certain amount of light is absorbed by the surface. Table XIII gives the amount of white light reflected from different materials.

TABLE XIII
Relative Reflecting Power

MATERIAL	%
White blotting paper.....	82
White cartridge paper.....	80
Chrome yellow paper.....	62
Orange paper.....	50
Yellow wall paper.....	40
Light pink paper.....	36
Yellow cardboard.....	30
Light blue cardboard.....	25
Emerald green paper.....	18
Dark brown paper.....	13
Vermilion paper.....	12
Blue-green paper.....	12
Black paper.....	5
Black cloth.....	1.2
Black velvet.....	.4

From this table it is seen that the light-colored papers reflect the light well, but of the darker colors only yellow has a comparatively high coefficient of reflection. Black velvet has the lowest value, but this only holds when the material is free from dust. Rooms with dark walls require a greater amount of illuminating power, as will be seen later.

Useful illumination may be considered under the following heads:

1. Residence Lighting.
2. Lighting of Public Halls, Offices, Drafting Rooms, Shops, etc.
3. Street Lighting.

RESIDENCE LIGHTING

Type of Lamps. The lamps used for this class of lighting are limited to the less powerful units—namely, incandescent or Nernst lamps varying in candle-power from 8 to 50 per unit. These should always be shaded so as to keep the intrinsic brightness low. The intrinsic brilliancy should seldom exceed 2 to 3 candle-power per square inch, and its reduction is usually accomplished by appropriate shading. Arc lights are so powerful as to be uneconomical for small rooms, while the color of the mercury-vapor light is an additional objection to its use.

Plan of Illumination. Lamps may be selected and so located as to give a brilliant and fairly uniform illumination in a room; but this is an uneconomical scheme, and the one more commonly employed is to furnish a uniform, though comparatively weak, ground illumination, and to reinforce this at points where it is necessary or desirable. The latter plan is satisfactory in almost all cases and the more economical of the two.

While the use of units of different power is to be recommended, where desirable, lights differing in color should not be used for lighting the same room. As an exaggerated case, the use of arc with incandescent lamps might be mentioned. The arcs being so much whiter than the incandescent lamps, the latter appear distinctly yellow when the two are viewed at the same time.

Calculation of Illumination. In determining the value of illumination, not only the candle-power of the units, but the amount of reflected light must be considered for the given location of the lamps. Following is a formula based on the coefficient of reflection of the walls of the room, which serves for preliminary calculations:

$$I = \frac{c.p. \cdot \frac{1}{1-k}}{d^2}$$

I = Illumination in foot-candles.

$c.p.$ = Candle-power of the unit.

k = Coefficient of reflection of the walls.

d = distance from the unit in feet.

Where several units of the same candle-power are used this formula becomes:

$$I = c.p. \left(\frac{1}{d^2} + \frac{1}{d_1^2} + \frac{1}{d_2^2} + \text{-----} \right) \frac{1}{1-k}$$

or,

$$c.p. = \frac{I}{\left(\frac{1}{d^2} + \frac{1}{d_1^2} + \frac{1}{d_2^2} + \text{-----} \right) \frac{1}{1-k}}$$

where d, d_1, d_2 , etc., equal the distances from the point considered to the various light sources. If the lamps are of different candle-power, the illumination may be determined by combining the illumination from each source as calculated separately. An example of calculation is given under "Arrangement of Lamps."

The above method is not strictly accurate because it does not take account of the angle at which the light from each one of the sources strikes the assumed plane of illumination. If the ray of

light is perpendicular to the plane, the formula $I = \frac{c.p.}{d^2}$ gives cor-

rect values. If a is the angle which the ray of light makes with a line drawn from the light source perpendicular to the assumed plane,

then the formula becomes $I = \frac{c.p. \times \text{cosine } a}{d^2}$. Therefore, by

multiplying the candle-power value of each light source in the direction of the illuminated point by the cosine of each angle a , a more accurate result will be obtained.

It is readily seen that the effect of reflected light from the ceilings is of more importance than that from the floor of a room. The value of k , in the above formula, will vary from 60% to 10%, but for rooms with a fairly light finish 50% may be taken as a good average value.

The amount of illumination will depend on the use to be made of the room. One foot-candle gives sufficient illumination for easy reading, when measured normal to the page, and probably an illumination of .5 foot-candle on a plane 3 feet from the floor forms a sufficient ground illumination. The illumination from sunlight reflected from white clouds is from 20 foot-candles up, while that due to moonlight is in the neighborhood of .03 foot-candles. It is not possible to produce artificially a light equivalent to daylight on account of the

great amount of energy that would be required and the difficulty of obtaining proper diffusion.

The method of calculating the illumination of a room that has just been described is known as the *point-by-point* method and it gives very accurate results if account is taken of the angle at which the light from each source strikes the plane of illumination and if the light distribution curves of the units, and the value of k , have been carefully determined. Under these conditions the calculations become extended and complicated and methods only approximate, but simpler in their application, are being introduced. One method, which gives good results when applied to fairly large interiors, makes the flux of light from the light sources the basis of calculation of the average illumination.

Flux of light is measured in lumens and a *lumen* may be defined as the amount of light which must fall on one square foot of surface in order to produce a uniform illumination of an intensity of one foot-candle. A source of light giving one candle-power in every direction and placed at the center of a sphere of one foot radius would give an illumination of one foot-candle at every point in the surface of the sphere and the total flux of light would be 4π , or 12.57, lumens since the area of the sphere would be 4π , or 12.57, sq. ft. A lamp giving one mean spherical candle-power gives a flux of 12.57 lumens and the total flux of light from any source is obtained by multiplying its mean spherical candle-power by 12.57. In calculating illumination it is customary to determine the illumination on a plane about 30 inches from the floor for desk work, and about 42 inches from the floor for the display of goods on counters. If we determine the total number of lumens falling on this plane and divide this number by the area of the plane, we obtain the average illumination in foot-candles. This of course tells us nothing about the maximum or minimum value of the illumination and such values must be obtained by other methods if they are desired. Reflected light, other than that covered by the distribution curve of the light unit including its reflector, is usually neglected in this method of calculation.

We may assume that in large rooms the light coming from the lamp within an angle of 75 degrees from the vertical reaches the plane of illumination. In smaller rooms this angle should be reduced to about 60 degrees. In order to determine the flux of light within this

angle a Rousseau diagram, which is described later, should be drawn. By the means of this diagram the average candle-power of the light source within the angle assumed may be readily determined and this mean value, multiplied by 12.57, will give the flux of light in lumens. This method of calculation, together with some guides for its rapid application, is described by Messrs. Cravath and Lansingh in the "Transactions of the Illuminating Engineering Society, 1908." The same authorities give the following useful data:

To determine the watts required per square foot of floor area, multiply the intensity of illumination desired by the constants given as follows:

INTENSITY CONSTANTS FOR INCANDESCENT LAMPS

Tungsten lamps rated at 1.25 watts per horizontal candle-power; clear prismatic reflectors, either bowl or concentrating; large room; light ceiling; dark walls; lamps pendant; height from 8 to 15 feet	.25
Same with very light walls	.20
Tungsten lamps rated at 1.25 watts per horizontal candle-power; prismatic bowl reflectors enameled; large room; light ceiling; dark walls; lamps pendant, height from 8 to 15 feet	.29
Same with very light walls	.23
Gem lamps rated at 2.5 watts per horizontal candle-power; clear prismatic reflectors either concentrating or bowl; large room; light ceiling; dark walls; lamps pendant; height from 8 to 15 feet	.55
Same with very light walls	.45
Carbon filament lamps rated at 3.1 watts per horizontal candle-power; clear prismatic reflectors either bowl or concentrating; light ceiling; dark walls; large room; lamps pendant; height from 8 to 15 feet	.65
Same with very light walls	.55
Bare carbon filament lamps rated at 3.1 watts per horizontal candle-power; no reflectors; large room; very light ceiling and walls; height from 10 to 14 feet	.75 to 1.5
Same; small room; medium walls	1.25 to 2.0
Carbon filament lamps rated at 3.1 watts per horizontal candle-power; opal dome or opal cone reflectors; light ceiling; dark walls; large room; lamps pendant; height from 8 to 15 feet	.70
Same with light walls	.60

INTENSITY CONSTANTS FOR ARC LAMPS

5-ampere, enclosed, direct-current arc on 110-volt circuit; clear inner, opal outer globe; no reflector; large room; light ceiling; medium walls; height from 9 to 14 feet	.50
--	-----

Arrangement of Lamps. An arrangement of lamps giving a uniform illumination cannot be well applied to residences on account of the number of units required, and the inartistic effect. We are

limited to chandeliers, side lights, or ceiling lights, in the majority of cases, with table or reading lamps for special illumination.

When ceiling lamps are used and the ceilings are high, some form of reflector or reflector lamp is to be recommended. In any case where the coefficient of reflection of the ceilings is less than 40%, it is more economical to use reflectors. When lamps are mounted on chandeliers, the illumination is far from uniform, being a maximum in the neighborhood of the chandelier and a minimum at the corners of the room. By combining chandeliers with side lights it is generally possible to get a satisfactory arrangement of lighting for small or medium-sized rooms.

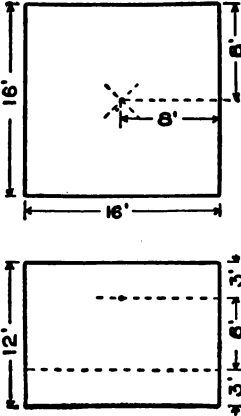

Fig. 53. Diagram Showing Method of Calculating Room Illumination.

As a check on the candle-power in lamps required, we have the following:

For brilliant illumination allow one candle-power per two square feet of floor space. In some particular cases, such as ball rooms, this may be increased to one candle-power per square foot.

For general illumination allow one candle-power for four square feet of floor space, and strengthen this illumination with the aid of special lamps as required. The location of lamps and the height of ceilings will modify these figures to some extent.

As an example of the calculation of the illumination of a room with different arrangements of the units of light, assume a room 16 feet square, 12 feet high, and with walls having a coefficient of reflection of 50%. Consider first the illumination on a plane 3 feet above the floor when lighted by a single group of lights mounted at the center of the room 3 feet below the ceiling. If a minimum value of .5 foot-candle is required at the corner of the room, we have the equation (first method outlined):

$$.5 = c. p. \frac{1}{12.8^2} \times \frac{1}{1 - .5}$$

Since $d = \sqrt{8^2 + 8^2 + 6^2} = 12.8$ (see Fig. 53)

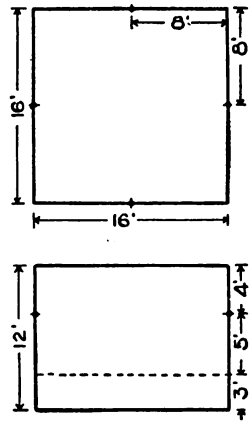

Fig. 54. Diagram for Four 8-c. p. Lamps on Side Wall.

Solving the above for the value of $c. p.$, we have

$$c. p. = \frac{.5}{\frac{1}{164} \times \frac{1}{.5}} = .5 \times 82 = 41$$

Three 16-candle-power lamps would serve this purpose very well.

Determining the illumination directly under the lamp, we have:

$$I = 48 \times \frac{1}{6^2} \times \frac{1}{1-.5} = \frac{48}{36} \times 2 =$$

2.7 foot-candles, or five times the value of the illumination at the corners of the room.

Next consider four 8-candle-power lamps located on the side walls 8 feet above the floor, as shown in Fig. 54. Calculating the illumination at the center of the room on a plane three feet above the floor, we have:

$$I = 8 \left(\frac{1}{89} + \frac{1}{89} + \frac{1}{89} + \frac{1}{89} \right) \frac{1}{1-.5}$$

$$d^2 = 8^2 + 5^2 = 64 + 25 = 89$$

$$I = 8 \times \frac{4}{89} \times 2 = .72 \text{ foot-candles}$$

The illumination at the corner of the room would be:

$$I = 8 \left(\frac{1}{89} + \frac{1}{89} + \frac{1}{345} + \frac{1}{345} \right) \frac{1}{1-.5}$$

$$= 8 \left(\frac{2}{89} + \frac{2}{345} \right) \times 2 = .45 \text{ foot-candles.}$$

In a similar manner the illumination may be calculated for any point in the room, or a series of points may be taken and curves plotted showing the distribution of the light, as well as the areas having the same illumination. Where refined calculations are desired, the distribution curve of the lamp must be used for determining the candle-power in different directions. Fig. 55 shows illumination curves for the Meridian lamp as manufactured by the General Electric Company. This is a form of reflector lamp made in two sizes, 25 or 50 candle-power. Fig. 56 gives the distribution curves for the 50-candle-power unit. Similar incandescent lamps are now being manufactured by other companies.

Table XIV gives desirable data in connection with the use of the Meridian lamp.

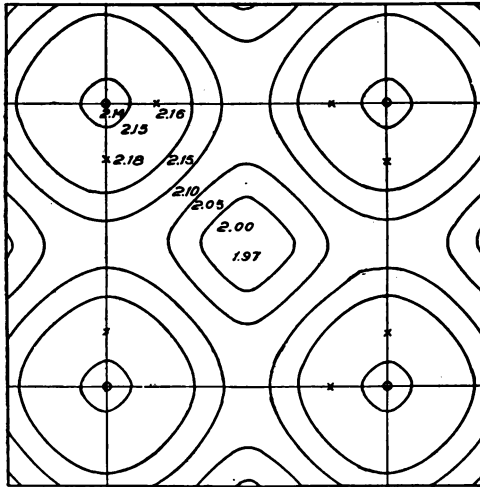

Fig. 55. Illumination Curves for a G. E. Meridian Lamp.

TABLE XIV
Illuminating Data for Meridian Lamps

Class Service	Light Intensity in Foot-candles	No. 1 Lamp (60 Watts)		No 2 Lamp (120 Watts)		Watts per Sq. Ft. of Area Lighted with either Lamp
		Height of Lamp and Diameter of Uniformly Lighted Area	Distance between Lamps when Two or more are Used	Height of Lamp and Diameter of Uniformly Lighted Area	Distance between Lamps when Two or more are Used	
Desk or Reading Table	3	2.9 feet	4.9 feet	4 feet	7 feet	2.50
	2	3.5 "	6 "	5 "	8.5 "	1.66
	1½	4 "	7 "	5.75 "	9.8 "	1.25
General Lighting	1	5 "	8.5 "	7 "	12 "	0.83
	¾	5.75 "	9.8 "	8.2 "	13.9 "	0.62
	½	7 "	12 "	10 "	11 "	0.41

By means of the Weber, or some other form of portable photometer, curves as plotted from calculations may be readily checked after the lamps are installed. When lamps are to be permanently located, the question of illumination becomes an important one, and it may be desirable to determine, by calculation, the illumination curves for each room before installing the lamps. This applies to the lighting of large interiors more particularly than to residence lighting. The point-by-point method of calculation is used for

very accurate work when the system of illumination admits of this method. Other methods are often simpler and sufficiently accurate for practical work.

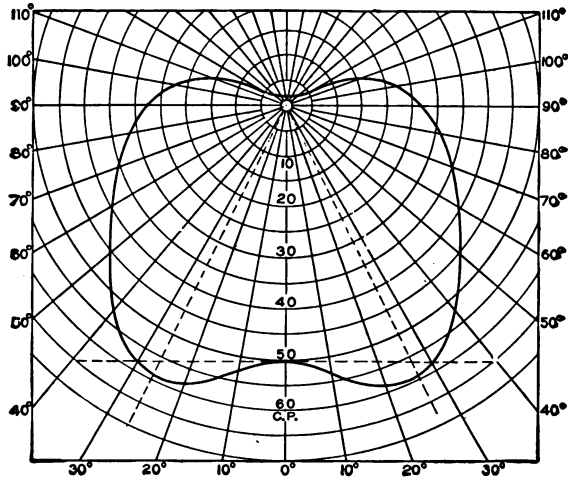

Fig. 56. Distribution Curve for a G. E. 50-c. p. Meridian Lamp.

Dr. Louis Bell gives the following in connection with residence lighting:

TABLE XV
Residence Lighting Data

ROOM	8 C. P.	16 C. P.	32 C. P.	Sq. FT. PER C.P.	REMARKS
Hall, 15' × 20'	8			4.7	
Library, 20' × 20'	12		1	3.1	8-c.p. reflector lamps
Reception room, 15' × 15' ..	4			7.0	
Music room, 20' × 25'	12		2	3.0	
Dining room, 15' × 20'	14			2.7	8 reflector lamps
Billiard room, 15' × 20'			4	2.3	32-c.p. with reflectors
Porch			1		
Bedrooms (6), 15' × 15'		14		7.0	
Dressing rooms (2), 10' × 15' ..		4		4.7	
Servants' rooms (3), 10' × 15'		3		9.4	
Bathrooms (3), 8' × 10'		3		5.0	
Kitchen, 15' × 15' }		3			
Pantry, 10' × 15' }		3			
Halls }					
Cellar }	10	3			
Closets (4)	4				Reflector lamps
Total	64	30	8		

LIGHTING OF PUBLIC HALLS, OFFICES, ETC.

Lighting of public halls and other large interiors differs from the illumination of residences in that there is usually less reflected light, and, again, the distance of the light sources from the plane of illumination is generally greater if an artistic arrangement of the lights is to be brought about. This in turn reduces the direct illumination. The primary object is, however, as in residence lighting, to produce a fairly uniform ground illumination and to superimpose a stronger illumination where necessary. An illumination of .5 foot-candle for the ground illumination may be taken as a minimum.

In the lighting of large rooms it is permissible to use larger light units, such as arc lamps and high candle-power Nernst or incandescent units, while for factory lighting and drafting rooms, where the color of the light is not so essential, the Cooper-Hewitt lamp is being introduced. High candle-power reflector lamps, such as the tungsten lamp, are being used to a large extent for offices and drafting rooms.

The choice of the type of lamp depends on the nature of the work. Where the light must be steady, incandescent or Nernst lamps are to be preferred to the arc or vapor lamps, though the latter are often the more efficient. When arcs are used, they must be carefully shaded so as to diffuse the light, doing away with the strong shadows due to portions of the lamp mechanism, and to reduce the intrinsic brightness. Such shading will be taken up under the heading "Shades and Reflectors." Arcs are sometimes preferable to incandescent lamps when colored objects are to be illuminated, as in stores and display windows.

In locating lamps for this class of lighting, much depends on the nature of the building and on the degree of economy to be observed. For preliminary determination of the location of groups, or the illumination when certain arrangement of the units is assumed, the principles outlined under "Residence Lighting" may be applied. It has been found that actual measurements show results approximating closely such calculated values.

When arcs are used they should be placed fairly high, twenty to twenty-five feet when used for general illumination and the ceilings are high. They should be supplied with reflectors so as to utilize the light ordinarily thrown upwards. When used for drafting-room

work, they should be suspended from twelve to fifteen feet above the floor, and special care must be taken to diffuse the light.

Incandescent lamps may be arranged in groups, either as side lights or mounted on chandeliers, or they may be arranged as a frieze running around the room a few feet below the ceiling. The last named arrangement of lights is one that may be made artistic, but it is uneconomical and when used should serve for the ground illumination only. Reflector lights may be used for this style of work and the lights may be entirely concealed from view, the reflecting property of the walls being utilized for distributing the light where needed.

Ceiling lights should preferably be supplied with reflectors, especially when the ceilings are high.

Indirect lighting is employed to some extent. By indirect lighting we mean a system of illumination in which the light sources are concealed and the light from them is reflected to the room by the walls, or ceilings, or other surfaces; or in which the light sources are placed above a diffusing panel. In the latter case the diffusing plate appears to be the source of light. In some cases the walls themselves are shaped and constructed so as to form the reflectors for the light units (cove lighting), but in others all of the reflecting surfaces, except the side walls and ceiling, are made portions of the lamp fixtures.

Tables XVI and XVII give data on arc and mercury-vapor lamps for lighting large rooms. Table XVII refers to arc lights as actually installed.

TABLE XVI
Cooper-Hewitt Lamps

SERVICE	HEIGHT OF LAMP	C. P. OF UNIT	AV. AREA PER LAMP IN SQUARE FEET
Foundry	10-15 ft.	300	900
"	20-25 "	700	2250
Machine shop	10-15 "	300	500
Erecting shop	20-30 "	700	1250
Drafting room	15 "	300	300
" "	20 "	700	400
Offices	10-15 "	300	400
"	20-25 "	700	750
Ordinary labor	10-15 "	300	1100
" "	20-25 "	700	2750

TABLE XVII
Lighting Data for Arc Lamps

PLACE LIGHTED	CLOTHING STORE	WEAVE ROOM	ERECTING ROOM	MACHINE SHOP	DRAFTING ROOM	DRAFTING ROOM	SHIP SHED	CATALOGING DEPT.	JEWELRY STORE
No. of sq. ft. place lighted	4000	14400	281600	42250	6275	5660	68000	4136	4000
No. lamps used	12	50	200	42	27	24	50	17	6
Circuit	A. C. Mult.	D. C. Mult.	D. C. Mult.	D. C. Mult.	A. C Series	D. C. Mult.	D. C. Mult.	D. C. Mult.	D. C. Mult.
Cycles	60	60	60	60	60	60	60	60	60
Volts line	104	110	120	120	7.5	120	220	110	110
Amperes	6	31	6.2	6.2	4	4	6	4 1/2	5
Volts at arc	72	75	80	80	72	80	80	80	80
Power factor of lamp6986
Watts per lamp	430	357	744	744	490	480	660	495	550
Watts per sq. ft. (term.)	1.29	1.24	.53	.74	2.11	2.02	.478	2.03	.825
Kw. at term. (whole installation)	5.16	17.8	148.8	31.25	13.22	11.52	33	8.42	3.3
Kw. at arc (whole installation)	4.62	12.28	99.2	20.8	12.42	7.68	24	6.12	2.4
Sq. ft. lighted per lamp	333	288	1408	1006	232	237	1380	243	667
Sq. ft. lighted per amp	55.6	88.6	227	162	31	59.2	230	54.1	133.5
Enclosing globe	Opal.	Saw Toothed	Opal.	Opal.	Opal.	Opal.	Trussed	Opal.	Opal.
Height and style of ceiling	12' white steel	Opal.	Trussed	Trussed	12' White	Trussed	160'	13' 9"	16' 10"
Reflector system used	Concentric Diffuser	Toothed Adjust. Diffuser	9" Mirror	9" Mirror	Concentric Diffuser	16 Adj. Dif. 8 Con. Dif.	Trussed 12" Mirror	Concentric Diffuser	White Concentric Diffuser
Height of arc from floor	9' 6"	12' to 15'	46'	47'	9'	15'	150'	10' 7"	13' 2"
Distance between lamps	14' to 18'	24'	32' to 38'	30' 9"	15'	12' to 25'	17' to 20'	14' to 18'	16' to 25'

Measurements taken in well-lighted rooms having a floor space of from 1,000 to 5,000 square feet show an average of 3 to 3.5 square feet per candle-power. About 2.5 square feet per candle-power should be allowed when brilliant lighting is required or the ceilings are very high, while 3.75 square feet per candle-power will give good illumination when lights are well distributed and there is considerable reflected light.

In factory and drafting room lighting, the lamps must be arranged to give a strong light where most needed, and located to prevent such shadows as would interfere with the work.

STREET LIGHTING

In studying the lighting of streets and parks, we find that, except in special cases, such as narrow streets and high buildings, there is no reflected light which aids the illumination aside from that due to special shades or reflectors on the lamp itself. Such reflectors are necessary if the light ordinarily thrown above the horizontal plane is to be utilized.

In calculating the illumination due to any type of lamp at a given point it is necessary to know the distribution curve of the lamp used and the distance to the point illuminated. The approximate illumination of a plane normal to the rays of light is given by the formula,

$$I = \frac{c.p.}{h^2 + d^2}$$

when I = illumination in foot-candles.

$c.p.$ = candle-power of the unit, determined from the distribution curve of the lamp.

h = distance the lamp is mounted above the ground, in feet, and d = distance from the base of the pole supporting the lamp to the point where the illumination is being considered, Fig. 57.

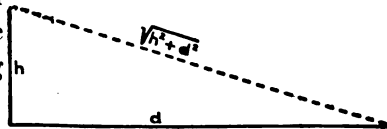

Fig. 57. Street Light Illumination Diagram.

While this will give the illumination in foot-candles, the nature of the lighting cannot be decided from this alone, but the total amount of light must also be considered. Thus, a street lighted with powerful units and giving a minimum

illumination of .05 foot-candles would be considered better illuminated than one having smaller units so distributed as to give the same minimum value.

Since a uniform distribution of light is desirable, for economic reasons, the ideal distribution curve of a lamp for street lighting would be a curve which shows a low value of candle-power thrown directly downward, but with the candle-power increasing as we approach the horizontal. Such an ideal distribution curve is shown in Fig. 58.

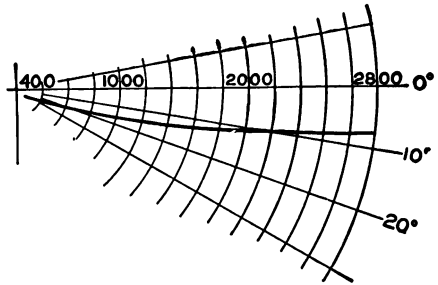

Fig. 58. Ideal Distribution Curve for a Street Light.

Actual distribution curves taken from commercial arc lamps are given in Fig. 59, in which

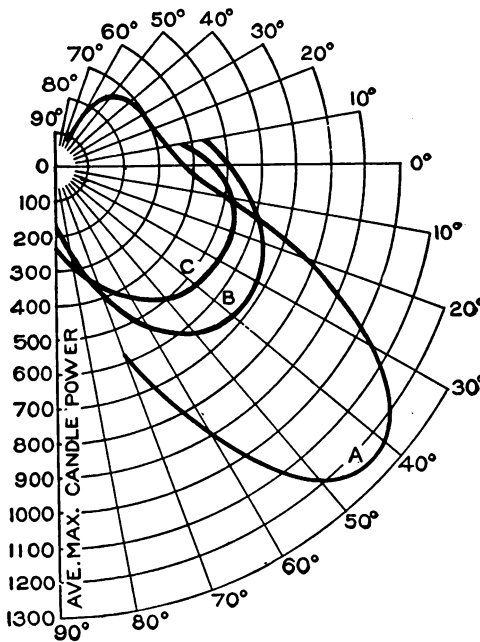

Fig. 59. Distribution Curves for Commercial Arc Lamps Used in Street Lighting.

Curve A shows distribution curve for a 9.6-ampere, open, direct-current arc.

Curve B shows distribution curve for a 6.6-ampere, D.C. enclosed arc

Curve C shows distribution curve for a 7.5-ampere, A.C. enclosed arc.

Globes used with B and C are opal inner globes, clear outer globes.

Globes used with A are clear outer globes.

A street reflector was used with the enclosed arcs.

Typical curves for flaming and luminous arc lamps are shown in Figs. 40, 43, and 44.

A series of curves known as *illumination curves* may be readily calculated showing the illumination in foot-candles at given distance

from the foot of the pole supporting the lamp. Illumination curves corresponding to the distribution curves in Fig. 59 are given in Fig. 60 where A' , B' , and C' correspond to A , B , and C in Fig. 59. These curves correspond to actual readings taken with commercial lamps. Similar curves for incandescent lamps fitted with suitable reflectors are shown in Fig. 61. A value of .03 foot-candles is about the min-

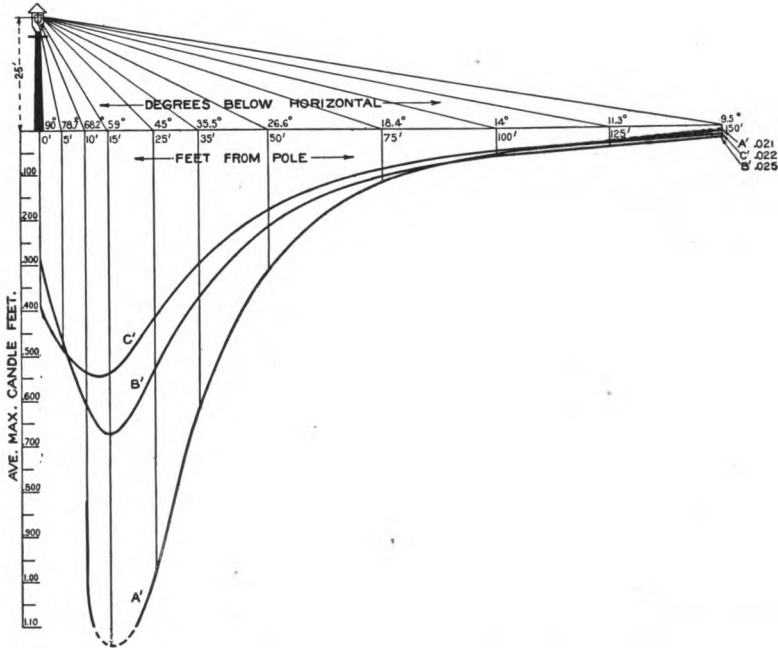

Fig. 60. Illumination Curves Drawn to Data given in Fig. 59.

imum for street lighting. Open arcs should be placed at least 25 feet above the ground; 30 to 40 feet is better, especially if the space to be illuminated is quite open. With enclosed arcs it is often advantageous to place them as low as 18 to 20 feet from the ground. Table XVIII gives the distance between lights for different types of arcs for fair illumination.

In considering the type of arc light to be used we must turn to the illumination curves as shown in Fig. 60. These curves show that the illumination from a direct-current open arc in its present form is superior to that from a direct-current enclosed arc, taking the

TABLE XVIII

KIND OF LIGHT	DISTANCE BETWEEN LIGHTS	LIGHTS PER MILE
6.6-ampere enclosed D.C. arc	340 feet	15
9.6-ampere open D.C. arc	315 "	17
6.6-ampere enclosed A.C. arc	275 "	19
6.6-ampere open D.C. arc	260 "	20

same amount of power, in the vicinity of the pole; but at a distance of 100 feet, the illumination from the enclosed arc is better. This

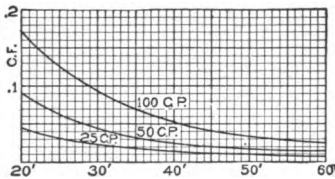

Fig. 61. Illumination Curves for Street Incandescent Lamps.

illumination is still more effective on account of the absence of such strong light as is given by the open arc near the pole. The pupil of the eye adjusts itself to correspond to the brightest light in the field of vision, and we are unable to see as well in the dimly-lighted section as when the maximum intensity is less. The characteristics

of the open and enclosed direct-current arc lamps are as follows:

The mean spherical candle-power and energy required at the arc are variable with the open arc.

Fluctuations of light are marked, due to wandering of the arc, flickering due to the wind and lack of uniformity of the carbons.

Dense shadows are cast by the side rods and the lower carbon, while the light is objectionably strong in the vicinity of the pole.

With the enclosed arc the mean spherical candle-power and the watts consumed at the arc are fairly constant.

No shadows are cast by the lamps, and the illumination is not subject to such wide variations. The enclosed arc is much superior to the open arc using the same amount of energy. This applies to the open arc as it is now used. With proper reflection and diffusion of the light such as might be accomplished by extensive or special shading, we ought to be able to get as good distribution from the open arc with a greater total amount of illumination.

In comparing the direct-current with the alternating-current enclosed arc, we see that the direct-current arc gives slightly more light than the alternating lamp, but this may be more than counterbalanced by the better distribution of light from the alternating-current lamp. The selection of A.C. or D.C. enclosed lamps will usually depend on other conditions, such as method of distribution of power, efficiency of plant, etc.

TABLE XIX
Street-Lamp Data

LAMP	AMPERES	APPROX. WATTS AT LAMP TERMINALS	APPROX. VALUE OF X AS PROPOSED
D. C. Series, open arc, clear globe	{ 6.6	330	3.5
	{ 9.6	450	4
D. C. Series, enclosed, clear outer globe	{ 5.0	370	3.5
	{ 6.6	480	4
	{ 5.5	345	3
Opalescent inner globe, street reflectors	{ 6.6	430	3.5
A. C. Series as above	{ 7.5	480	4
D. C. Series "Magnetite"	4.0	310	5.5

The question of street lighting has been given considerable attention by the National Electric Light Association and this society recommends the following form of specification for street lights:

1. Under ordinary conditions of street lighting, with lamps spaced 200 to 600 feet apart, specifications for street lamps should define the mean illumination thrown by the individual lamp, in position in the street, as measured at the height of the observer's eye and perpendicular to the rays, at some point not less than 200 feet nor more than 300 feet distant, along a level street, from a position immediately below the lamp, with all extraneous light screened off and with no reflection from surrounding objects not forming part of the lamp equipment.

2. When using smaller units of light, such as series incandescent lamps spaced shorter distances apart, a correspondingly shorter distance from the lamp should be chosen in measuring the illumination.

3. The lamp contracted for should give a mean normal illumination at the test point (selected as in Sections 1 and 2) not less than the illumination given by the stationary standard incandescent lamp of 16 candle-power at $1/X$ of the distance. The said standard incandescent lamp should be a standardized seasoned lamp having a determined candle-power in a fixed direction.

4. When the lamp tested fluctuates in intensity, a number of observations of the maximum normal illumination should be made at a distance of not less than 200 feet horizontally from beneath the lamp, and the average of these measurements should be taken as the average maximum illumination. A similar number of observations of the minimum normal illumination should be made, the average of which should be taken as the average minimum illumination. The arithmetical mean of the said average maximum and minimum illuminations should be taken as the mean normal illumination called for in Section 1.

5. A reasonable number of the lamps covered by the contract should be tested.

6. For measuring the mean normal illumination of a lamp, comparison with the standard incandescent lamp may be made either with a suitable portable

photometer or with a reading distance instrument, such as the so-called *luminometer*.

7. The unobstructed mean normal illumination must not be less at shorter distances than at the point of test.

8. An approximate value of the mean normal illuminations thrown by street lamps of standard manufacture, at horizontal distances within the 200–300-foot range, hung approximately 20 feet above the observer's eye, may be determined from Table XIX.

Series incandescent lamps are used considerably for lighting the streets in residence sections of cities or where shade trees make it impracticable to use arcs. These vary in candle-power from 16 to 50 or even higher, and are usually constructed so as to take from two to four amperes. The best arrangement of these is to mount them on brackets a few feet from the curb, with alternate lamps on opposite sides of the street. The distance between the lamps depends on their power. 50 candle-power lamps spaced 100 feet between lamps, give a minimum illumination of .02 foot-candle. 25 candle-power lamps spaced 75 feet between lamps will serve where economy is necessary.

TABLE XX

	PER CENT
Clear glass.....	10
Alabaster glass.....	15
Opaline glass.....	20–40
Ground glass.....	25–30
Opal glass.....	25–60
Milky glass.....	30–60
Ground glass.....	24.4
Opal glass.....	32.2
Opaline glass.....	23

SHADES AND REFLECTORS

Lamps, as ordinarily constructed, do not always give a suitable distribution of light, while the intrinsic brightness is often too high for interior lighting. Shades are intended to modify the intensity of the light, while reflectors are used for the purpose of changing its direction. Frequently the two are combined in various ways. Shades are also used for decorative purposes, but, if possible, these should be of such a nature as to aid illumination rather than to reduce its efficiency.

A considerable amount of light is absorbed by the material used for the construction of shades. Table XX shows the approximate amount absorbed by some materials.

Of the great number of styles of shades and reflectors in use, only a few of the more important will be considered here.

Frosted Globes. One of the simplest methods of shading incandescent lamps is by the use of frosted bulbs. These serve to reduce the intrinsic brightness of the lamp, and should be freely used for residence lighting when separate shades are not installed. Frosted globes are also used in connection with reflectors for the purpose of diffusing the reflected light. The *McCreary shade* as shown in Fig. 62, is an example of such a combined shade and reflector. Fig. 63 shows the distribution curve taken from an incandescent lamp using a McCreary shade. Fig. 64 shows the distribution of light from a conical shade. Fig. 56 shows the distribution of light brought about by means of a spiral filament and a reflector as used in the Meridian lamp.

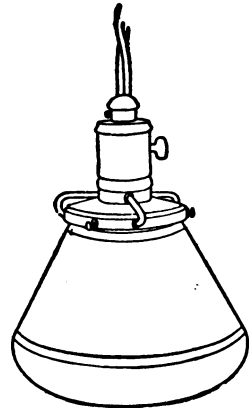

Fig. 62. McCreary Shade.

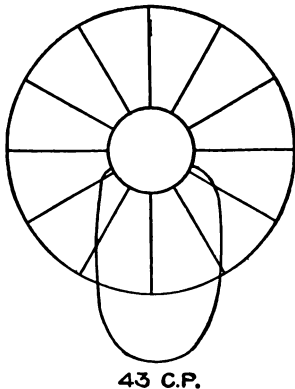

Fig. 63. Distribution Curve for Incandescent Lamp Provided with McCreary Shade.

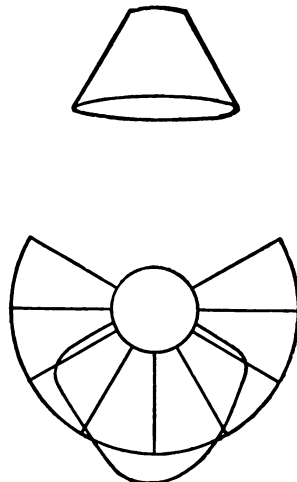

Fig. 64. Distribution Curve for Incandescent Lamp Provided with Conical Shade.

Holophane Globes. These are made for both reflecting and diffusing the light, and they can be made to bring about almost any desired distribution with but a small amount of absorption of light. These consist of shades of clear glass having horizontal grooves forming surfaces which change the direction of light by refraction or total reflection as is necessary. The diffusion of light is effected by means of deep, rounded, vertical grooves on the interior surface of the globe. While these globes are of clear glass and absorb an amount of light corresponding to clear glass, the light is so well diffused that the filament of the lamp cannot be seen, and the globe appears as if

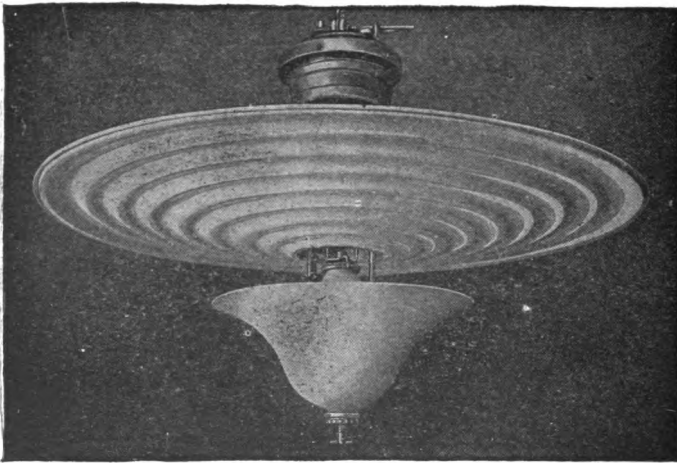

Fig. 65. Enclosed Arc Lamp Fitted with Shade and Concentric Diffuser.

made of some semi-transparent material. The holophane glassware is made in a large variety of artistic designs and for all types of incandescent lamps. By the proper selection of a reflector the distribution of the light of the unit used may be made that which is best suited to the particular case of lighting in hand. Figs. 9, 13, 14, 15, 16, 17, and 18 give some idea of what can be accomplished by these shades.

Fig. 65 shows an enclosed arc lamp fitted with a shade and a concentric *diffuser*. The effect of this combination is best shown in Fig. 66. Fig. 67 shows the change in the illumination curve produced by such shading. Inverted arcs have some application where

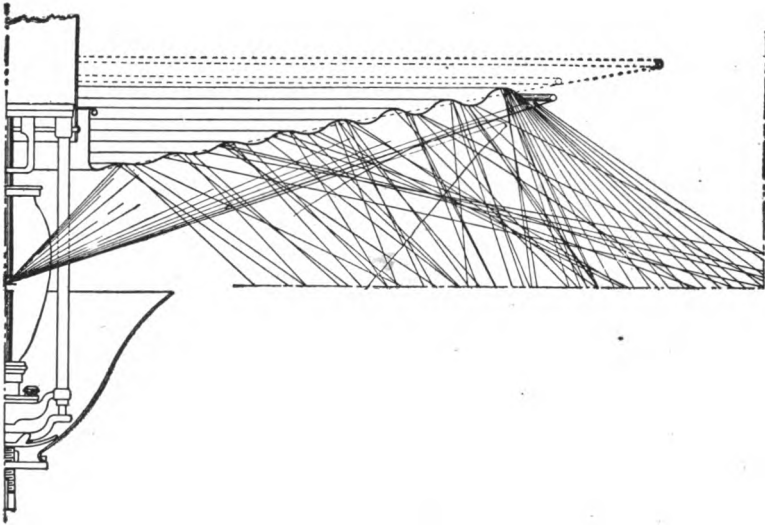

Fig. 66. Diagram Showing Effect of the Concentric Diffuser.

the light may be readily reflected and diffused as in lighting large rooms with light finish. Reflectors of this general type are now being manufactured in such a form that they may be built in and become part of the ceiling of the room to be illuminated.

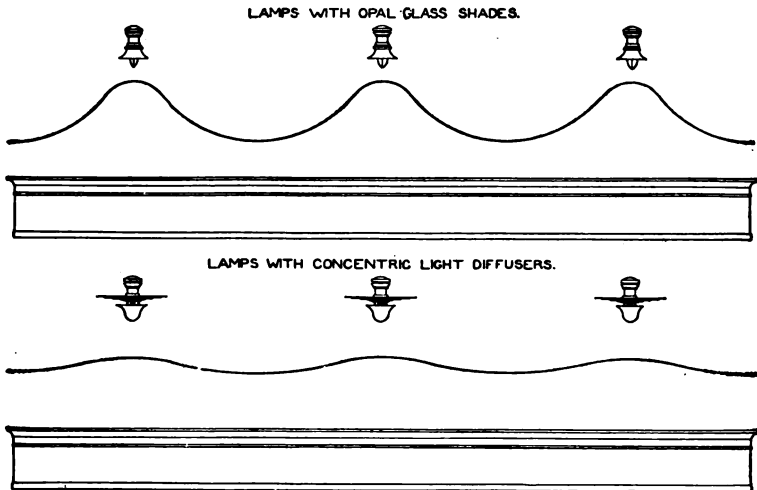

Fig. 67. Illumination Curves for Lamps with and without Light Diffusers.

Opal Enclosing Globes. The use of opal enclosing globes is recommended for arc lamps used for street lighting for the reason that they change the distribution of the light so that it covers a greater area, and the light is so diffused as to obliterate shadows in the vicinity of the lamp. Table XXI gives the efficiency of different globe combinations for street lighting assuming the opal inner and the clear outer globes as 100%.

TABLE XXI

Opal enclosing and clear outer	100	per cent
Clear " " clear "	91.2	"
" " " opal "	85.1	"
Opal " " opal "	82.7	"

PHOTOMETRY

Photometry is the art of comparing the illuminating properties of light sources, and forms one branch of scientific measurement. Its use in electric illumination is to determine the relative values of different types of lamps as sources of illumination, together with their efficiency; also by means of the principles of photometry, we are able to study the distribution of illumination for any given arrangement of light sources.

LIGHT STANDARDS

Inasmuch as sources of light are compared with one another in photometry, we must have some standard, or unit, to which all light sources are reduced. This unit is usually the candle-power and the rating of most lamps is given in candle-power.

While the candle-power remains the unit and is based on the standard English candle, other light standards have been introduced and are much more desirable.

The English Candle. The English candle is made of spermaceti extracted from crude sperm oil, with the addition of a small quantity of beeswax to reduce the brittleness. Its length is ten inches, and its diameter .9 inch at the bottom and .8 inch at the top, and its weight is one-sixth of a pound. Great care is taken in the preparation of the wick and spermaceti. This candle burns with a normal height of flame of 45 millimeters and consumes 120 grains per hour when

burning in dry air at normal atmospheric pressure. Under these conditions, the light given by a single candle is one candle-power.

When used for measurements, the candle should be allowed to burn at least fifteen minutes before taking any readings. At the end of this period the wick should be trimmed, if necessary, and when the flame height reaches 45 millimeters, readings can be taken. The candle should not require trimming when the proper height of flame has been reached. It is best to weigh the amount of material consumed by balancing the candle on a properly arranged balance when the first reading is taken, and again balancing at the end of a suitable period—ten to fifteen minutes. The candle-power of the unit is then, practically, directly proportional to the amount of the material consumed.

The objections to the candle as a unit are that it burns with an open flame which is subject to variation in height and to the effect of air currents. The color of the light is not satisfactory, being too rich in the red rays, and the composition of the spermaceti is more or less uncertain.

The **German Candle** is made of very pure paraffine, burns with a normal flame height of 50 millimeters, and is subject to the same disadvantages as the English candle. It may be necessary to trim the wick to keep the flame height at 50 millimeters. The light given is a trifle greater than for the spermaceti candle.

The **Carcel Lamp** is built according to very careful specifications and burns colza (rape seed) oil. It has been used to a large extent in France, but its present application is limited.

The **Pentane Lamp** is a specially constructed lamp burning pentane, prepared by the distillation of gasoline between narrow limits of temperature. This standard is not extensively used.

The **Amyl Acetate Lamp**. This lamp, known also as the *Hefner lamp*, is at present the most desirable standard. It is a lamp built to very careful specifications, especially with regard to the dimension of the wick tube. It burns pure amyl acetate and the flame height should be 40 millimeters. This flame height must be very carefully adjusted by means of gauges furnished with the lamp. Amyl acetate is a colorless hydrocarbon prepared from the distillation of amyl alcohol obtained from fusel oil, with a mixture of acetic and sulphuric acids, or by distillation of a mixture of amyl acetate, sulphuric acid,

and potassium acetate. It has a definite composition, and must be pure for this use.

The most serious disadvantage of this standard is the color of the light, inasmuch as it has a decidedly red tinge and is not readily compared with whiter lights. Its value is affected somewhat by the moisture in the air and the atmospheric pressure, but it excels all other standards in that it is quite readily reproduced.

Table XXII gives the value of the candle-power units of different laboratories in terms of the unit of the Bureau of Standards and also the values of the units of the Carcel and Vernon-Harcourt in terms of the Hefner, as accepted by the International Photometric Commission.

TABLE XXII
Photometric Units

Bureau of Standards Unit, United States	1.000		
Reichsanstalt Unit, Germany	0.998 × 0.88		
National Physical Laboratory Unit, England	0.984		
Laboratoire Central Unit, France	0.982		
	CARCEL	HEFNER	VERNON-HARCOURT
Carcel	1.00	10.75	0.980
Hefner	0.0930	1.00	0.0915
Vernon-Harcourt (pentane)	1.020	10.95	1.0

The above values are at a barometric pressure of 760 mm. of mercury and a humidity for the Carcel and Vernon-Harcourt standards of 10.0 liters of water per cubic meter of dry air. The humidity for the Hefner unit is 8.8 liters of water to one cubic meter of dry air.

Working Standards. Incandescent Lamp. The units just described, together with some others, form reference standards, but an incandescent lamp is generally used as the working standard in all photometers. An incandescent lamp, when used for this work, should be burned for about two hundred hours, or until it has reached the point in the life curve where its value is constant, and it should then be checked by means of some standard when in a given position and at a fixed voltage. It then serves as an admirable working standard if the applied voltage is carefully regulated. Two such lamps should always be used—the one to serve as a check on the other; the checking lamp to be used for very short intervals only.

PHOTOMETERS

Two light sources are compared by means of a photometer which, in one of its simplest forms, consists of what is known as a *Bunsen screen* mounted on a carriage between the two lights being compared, with its plane at right angles to a line passing through the light sources, and arranged with mirrors or prisms so that both sides of the screen may be observed at once. The Bunsen screen consists of a disk of paper with a portion of either the center, or a section around the center, treated with paraffine so as to render it translucent. If the light falling on one side of this screen is in excess, the translucent spot will appear dark on that side of the screen and light on the opposite side.

Care must be taken to see that the two sides of the screen are exactly alike, otherwise there will be an error introduced in using the screens. It is well to reverse the screen and check readings whenever a new lot of lamps are to be tested. When the light falling on the two sides of the screen is the same, the transparent spot disappears. The values of the two light sources are then directly proportional to the square of their distances from the screen.

As an example, consider a 16 candle-power lamp being compared with a standard candle on a photometer with a 300-centimeter bar. Say the translucent spot disappears when the screen is distant 60 centimeters from the standard candle, we then have the proportion,

$$x : 1 = (240)^2 : (60)^2 = 16 : 1,$$

showing that the lamp gives 16 candle-power.

The above law is known as the law of inverse squares, and holds true only when the dimensions of the light sources are small compared with the distance between them, and when there are no reflecting surfaces present as when the readings are taken in a dark room.

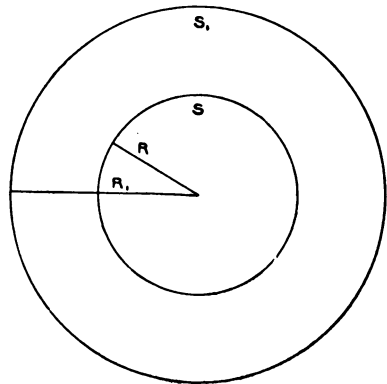

Fig. 68. Proof of the Law of Inverse Squares by the Method of Concentric Spheres.

The proof that the light varies inversely with the square of distance from the source is as follows:

Consider two spherical surfaces, Fig. 68, illuminated by a source of light at the center. The same quantity of light falls on both surfaces.

$$\text{Area of } S = 4\pi R^2 \text{ sq. ft. (} R \text{ is in feet.)}$$

$$\text{Area of } S_1 = 4\pi R_1^2 \text{ sq. ft.}$$

Let Q = total quantity of light and q = light falling on unit surface. Then,

$$q = \frac{Q}{4\pi R^2}$$

$$q_1 = \frac{Q}{4\pi R_1^2}$$

$$q : q_1 = \frac{Q}{4\pi R^2} : \frac{Q}{4\pi R_1^2}$$

$$= 4\pi R_1^2 : 4\pi R^2$$

$$\frac{q}{q_1} = \frac{R_1^2}{R^2}$$

Fig. 69 shows the relation in another way. The area of C , distant two units from the source of light A , is four times that of B which is distant one unit.

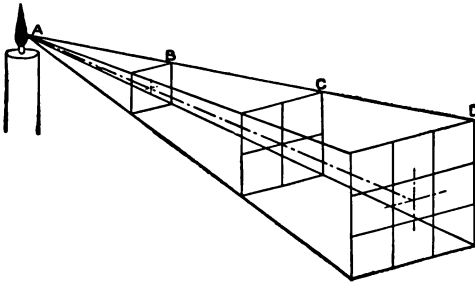

Fig. 69. Proof of the Law of Inverse Squares by Method of Screen Shadow.

The Lummer-Brodhun Photometer. In addition to the Bunsen screen described, there are several other forms of photometers, the most important of which is the Lummer-Brodhun. The essential

feature of this instrument is the optical train which serves to bring into contrast the portions of the screen illuminated by the two sources of light. Referring to Fig. 70 the screen S is an opaque screen which

reflects the light falling upon it from L , to the mirror M , when it is again reflected to the pair of glass prisms A, B . The surfaces sr are ground to fit perfectly and any light falling on this surface will pass through the prisms. Light falling on the surface ar or bs will be reflected as shown by the arrows. We see then that the light from L , which falls on ar and bs , is reflected to the eye piece or telescope T , while that falling on sr is transmitted to and absorbed by the black interior of the containing box. Likewise, the light from the screen

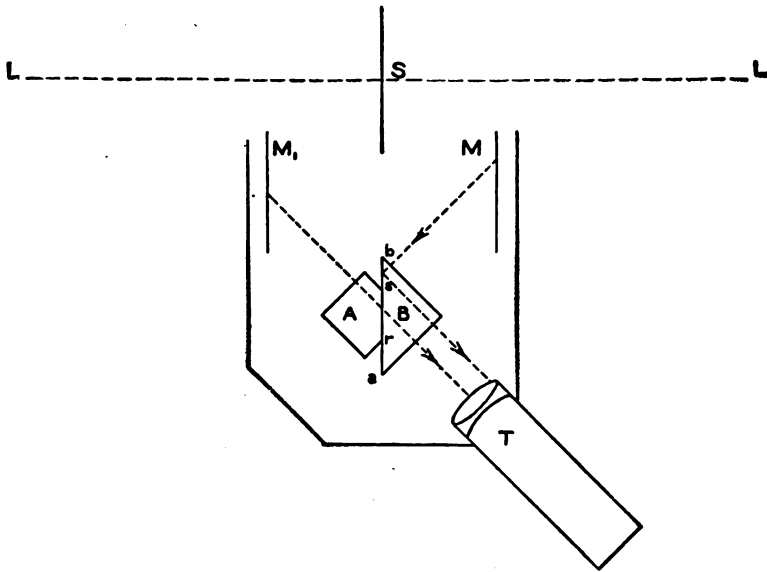

Fig. 70. Diagram of Lummer-Brodhun Screen.

L_1 is reflected by the screen M_1 to the pair of prisms A, B . The rays falling on the surface sr pass through to the telescope T , while the rays falling on ar and bs are reflected and absorbed by the black lining of the case. The field of light, as then viewed through the telescope, appears as a disk of light produced by the screen L_1 , surrounded by an annular ring of light produced by L . When the illumination on the two sides of the screen is the same, the disk and ring appear alike and the dividing circle disappears.

In using this screen, it is mounted the same as the Bunsen screen and readings are taken in the same manner. The screen and prisms are arranged so that they can be reversed readily and two readings

should always be taken to compensate for any inequalities in the sides of the screen and the reflecting surfaces, a mean of the two readings

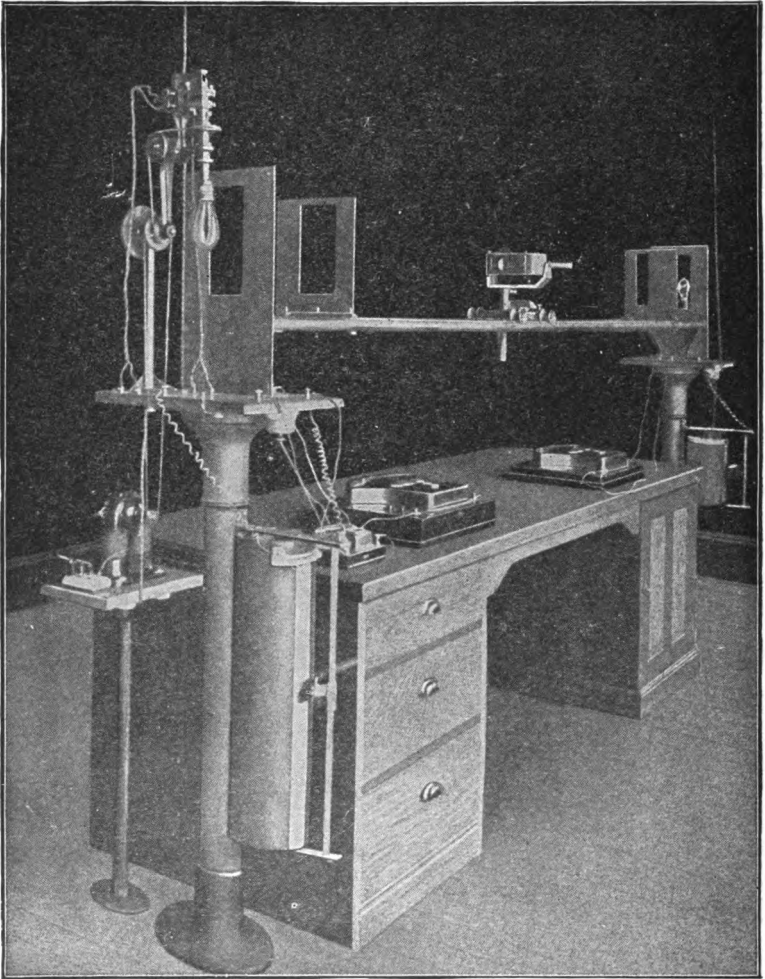

Fig. 71. Complete Photometer with Lummer-Brodhun Screen.

serving as the true reading. This form of screen is used when especially accurate comparisons are required.

Fig. 71 shows a complete photometer with a Lummer-Brodhun screen, while Fig. 72 shows a Bunsen screen and sight box. In Fig. 71, the lamps are shaded by means of curtains so as to leave only a

small opening toward the screen. If the lights are properly screened photometric measurements may be made in rooms having light-colored walls.

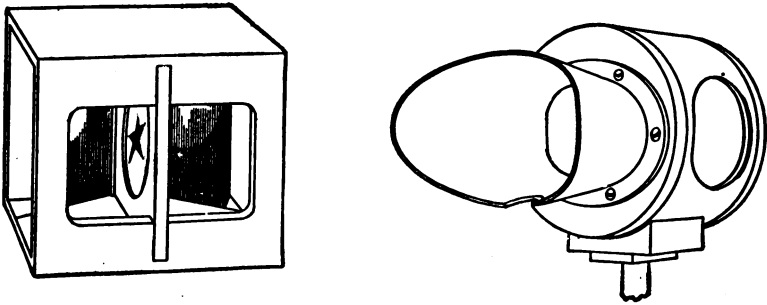

Fig. 72. Bunsen Screen and Sight Box.

The Weber Photometer. As an example of a portable type of photometer, we have the Weber. This photometer, shown in Fig. 73, is very compact and is especially adapted to measuring intensity of illumination as well as the value of light sources; it may be used for exploring the illumination of rooms or the lighting of streets.

This apparatus consists of a tube *A*, Fig. 74, which is mounted horizontally and contains a circular, opal glass plate *f*, which is movable by means of a rack and pinion. To this screen is attached an index finger which moves over a scale attached to the outside of the tube. A lamp *L*, burning benzine, is mounted at the end of this tube. The benzine used should be as pure as possible, and the flame height should be

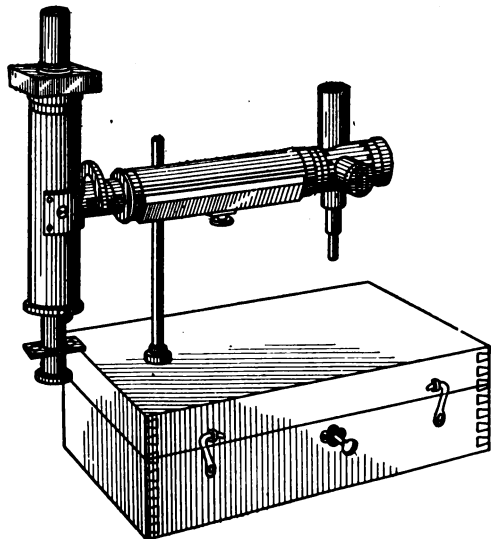

Fig. 73. Weber Portable Photometer.

carefully adjusted to 20 mm. when taking readings. At right angles to the tube *A* is mounted the tube *B* which contains an eye piece at *O*, a Lummer-Brodhun contrast prism at *p*, and a support for opal or colored glass plates at *g*.

Operation. The tube *B* is turned toward the source of light to be measured, the distance from the light to the screen at *g* being noted. The light from this source is diffused by the screen at *g*, while that from the standard is diffused by the screen *f*. By moving the screen *f*, the light falling on either side of the prism *p* can be equalized. The value of the unknown source can be determined from the reading of the screen *f*, the photometer having previously been calibrated by

means of a standard lamp in place of the one to be measured. The calibration may be plotted in the form of a curve or it may be denoted by a constant *C*, when we have the formula,

$$I' = C \frac{L^2}{l^2}$$

C corresponds to a particular plate at *g*, *l* = distance of screen *f* from the benzine lamp, and *L* = distance from the screen *g* to the light source being measured. Screens of different densities may be used at *g*, depending on

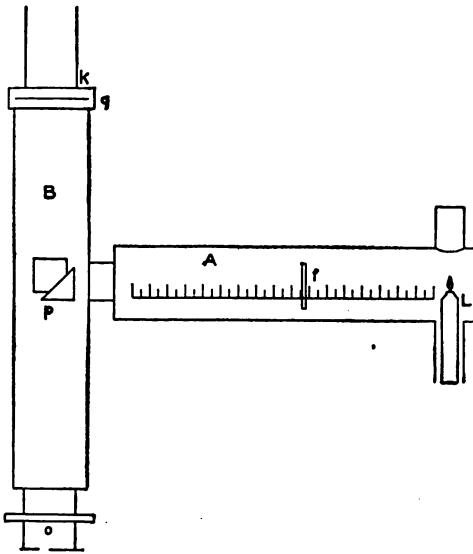

Fig. 74. Diagram of Weber Photometer.

the strength of the light source.

When used for measuring illumination, a white screen is used in connection with this photometer. The screen is mounted in front of the opening at *g*, and turned so that it is illuminated by the source being considered. Readings of the screen *f* are taken as before. A calibration curve is plotted for the instrument, using a known light source at a known distance from the white screen when the instrument is mounted in a dark room.

Portable Photometers. There is a large variety of portable photometers available and giving more or less satisfactory results. An instrument especially designed with a view to portability and to overcoming some of the defects of instruments already on the market has recently been introduced. The instrument referred to is called a *Universal photometer* but it is more commonly known as the *Sharp-Millar photometer* from the names of its inventors. Views of this instrument are shown in Figs. 75 and 76. It is adapted to the measurement of the intensity of light sources as well as to the illumination at any point, as is the Weber photometer. The photometer screen or photometric device is shown at *B*, and consists of a special form of

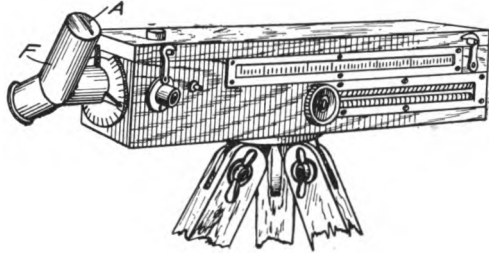

Fig. 75. Universal Photometer.

Lummer-Brodhun optical screen. A standardized incandescent lamp *C* is used as the photometric standard and this may be connected to a battery, or be adapted to use on the mains supplying the lamps in the room where measurements are to be taken. All stray light is carefully screened from the interior of the box by a series of screens *G*. The instrument scale is calibrated in foot-candles and in candle-powers.

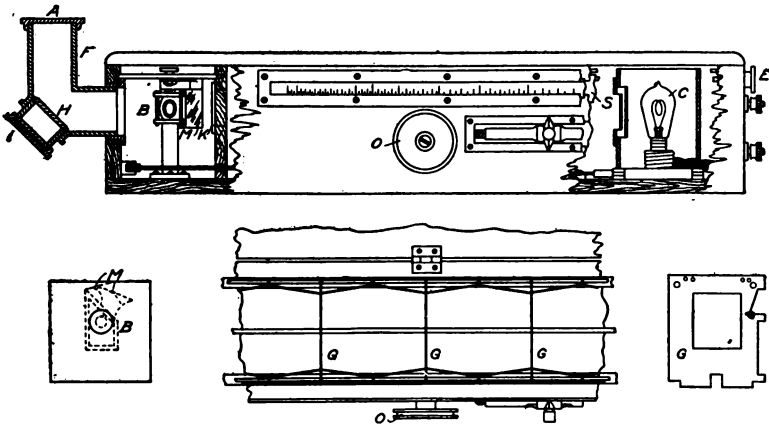

Fig. 76. Sectional View of Universal Photometer.

Lummer-Brodhun optical screen. A standardized incandescent lamp *C* is used as the photometric standard and this may be connected to a battery, or be adapted to use on the mains supplying the lamps in the room where measurements are to be taken. All stray light is carefully screened from the interior of the box by a series of screens *G*. The instrument scale is calibrated in foot-candles and in candle-powers.

When illumination is to be measured, a specially selected translucent screen is placed at *A* and the illumination of this plate, which is placed at the point and in the plane where the value of the illumination is desired, is reflected to the photometric device by the mirror at *H*. A second plate *K* is mounted so as to be illuminated by the standard lamp and the photometer is balanced by making the illumination of *A* and *K* the same. When the intensity of a light source is to be determined, the screen at *A* is replaced by a small aperture and a diffusing surface *I* is put in place of the mirror *H*. The illumination of *I* is now compared with the illumination of *K*, and when the two are made equal, the photometer reads the candle-power of the light source, or some multiple of this candle-power. The range of this instrument is increased by the use of suitably arranged absorbing screens which may be readily inserted or removed, and as ordinarily equipped, the range in foot-candles is approximately from .004 to 2,000. The variety of uses which can be made of such a photometer is large, and some idea of its portability can be obtained from the dimensions of the box, 24" x 4½" x 5", and its weight, fully equipped, of 8 pounds. It is very accurate considering its compactness.

Integrating Photometers. *Matthews.* This photometer is used to some extent and a very good idea of its construction can be obtained from Fig. 77. By means of a system of mirrors, the light given by the lamp in several directions may be integrated and thrown on the photometer screen for comparison with the standard, the result giving the mean spherical candle-power from one reading. By covering all but one pair of screens, the light given in any one direction is easily determined.

Another type of integrating photometer is known as the *integrating sphere* or *globe photometer*. If a light source is placed within a sphere, the interior walls of which are coated with a white diffusing surface, the illumination of that surface at any point is due partly to the light falling on it directly, and partly to the light reflected from the remainder of the surface of the sphere. The reflected light is proportional to the total flux of light from the light source and so, if the direct light is screened from the point considered, its illumination is proportional to the total flux of light, and hence to the mean spherical candle-power of the light source.

The practical application of this principle is to so arrange our

properly coated sphere that the lamp to be tested may be readily inserted; to replace a small portion of the sphere by a piece of unpolished white glass; to shut off the direct rays of the lamp to be

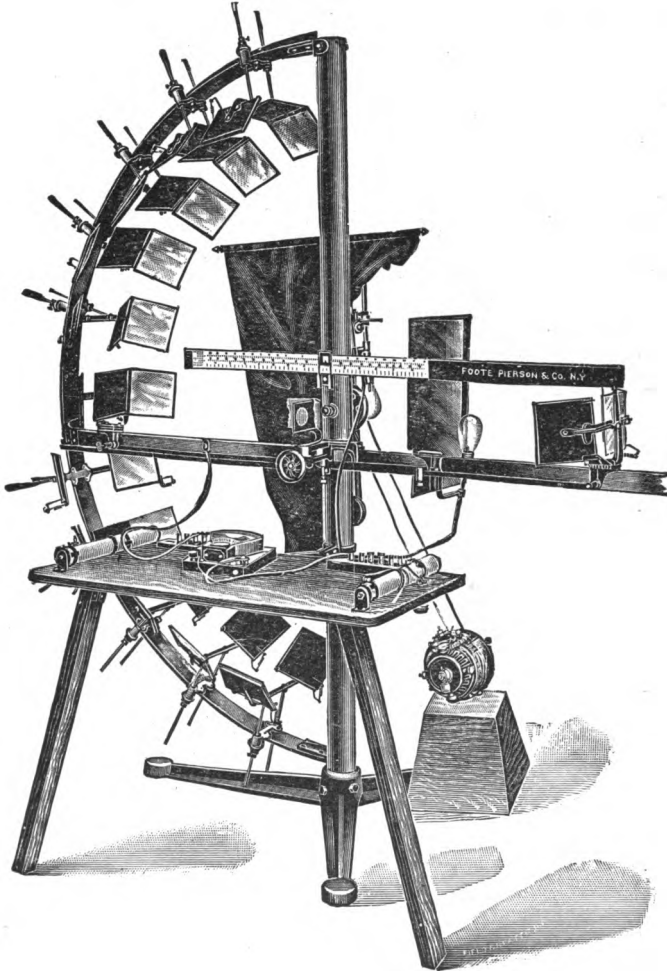

Fig. 77. Integrating Photometer.

measured from this glass surface; and to so mount a photometer screen and standard lamp that the illumination of the glass section can be measured. Under these conditions the illumination of the glass screen is proportional to the mean spherical candle-power of the lamp under test. A substitution method is used in practice. A

standardized lamp of the general type of the one to be tested is mounted in the sphere and the constant of the instrument for this type of lamp is determined. The unknown lamps are then put in place and their candle-power is readily determined, once the constant of the instrument is known. Figs. 78 and 79 give some views of the integrating

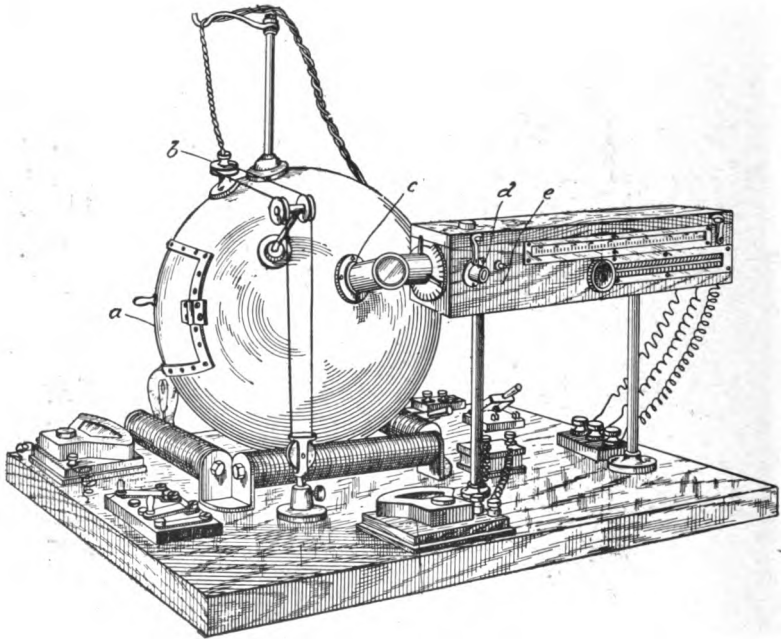

Fig. 78. Eighteen-Inch Integrating Sphere Equipped with Photometer.

sphere and indicate the range of the sizes in which it may be constructed.

INCANDESCENT LAMP PHOTOMETRY

Apparatus. Some sort of screen, either the Bunsen type or the Lummer-Brodhun screen preferred, should be mounted on a carriage moving on a suitable scale, and the lamp holders, one for the standard, the other for the lamp to be tested, are mounted at the ends of this scale. There are several types of so-called station photometers arranged so as to be very convenient for testing incandescent lamps. Fig. 80 shows one form of station photometer manufactured by Queen & Co. The controlling rheostats and shielding curtains are not shown here. Fig. 81 shows a form of portable photometer for

incandescent lamps. The length of scale should not be less than 100 centimeters, and 150 to 200 centimeters is preferred. This scale may be divided into centimeters or, for the purpose of doing away with much of the calculation, the scale may be a *proportional scale*. This scale is based on the law of inverse squares and reads the inverse ratio of the squares of the distances from the two lights being compared.

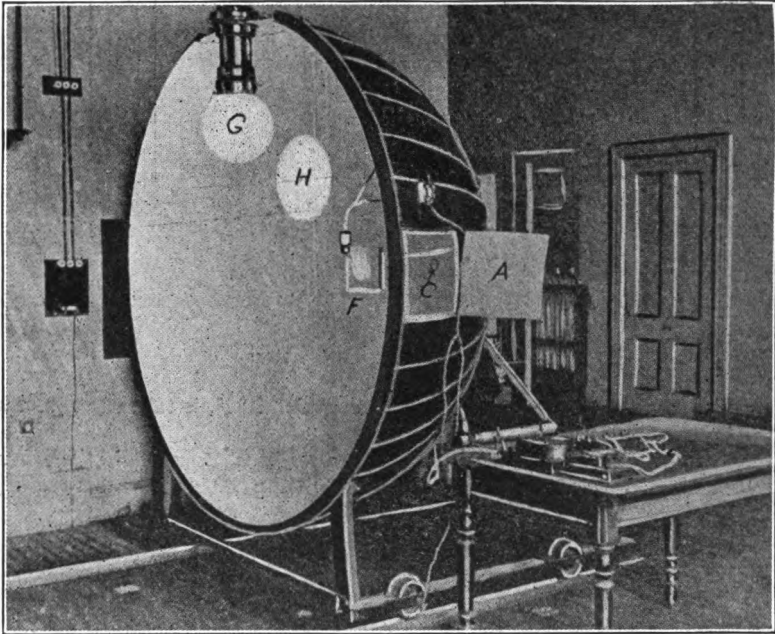

Fig. 79. Interior of 80-Inch Integrating Sphere.

If the standard used always has the same value, the scale may be made to read in candle-powers directly.

For mean horizontal candle-power measurements, the lamp should be rotated at 180 revolutions per minute, when mounted in a vertical position.

For distribution curves a universal lamp holder which will allow the lamp to be placed in any position, and which indicates this position, is used.

For mean spherical candle-power, the following method is used when the Matthews photometer is not available:

The lamp is placed in an adjustable holder and readings taken with the lamp in thirty-eight positions, as follows:

The measurement of the spherical intensity. For convenience the tip of the lamp and its base may be termed the north and south poles respectively.

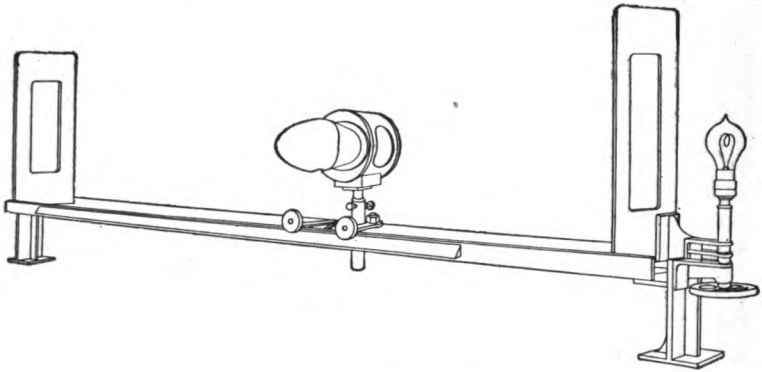

Fig. 80. Station Photometer.

The mean of 13 readings taken at intervals of 30° , is taken to give the mean horizontal candle-power.

Beginning again at 0° azimuth, thirteen readings are made in the prime meridian or vertical circle, the interval again being 30° , and the last reading checking the first.

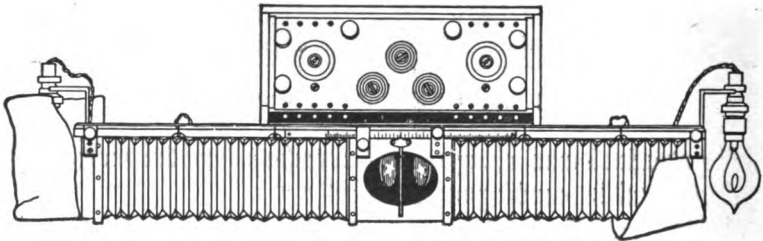

Fig. 81. Portable Photometer for Incandescent Lamps.

It will be noticed that four readings, two being check readings, have been made at 0° azimuth in each case. The mean of the four is taken as the *standard reading*, it being the value of the intensity, in this position, should the lamp be used as a standard.

Additional sets of thirteen readings each—the last reading checking the first one—are similarly made on each of the vertical circles through 45° , 90° , and 135° azimuth.

In combining the readings for the mean spherical intensity, a note is taken of the repetitions.

Neglecting the repetitions, which may also be omitted in part, in the practice of the method, there remain thirty-eight points, as follows:

	DISTRIBUTED VALUES
The mean of four measurements at the north pole of the lamp.....	1
Four measurements on each of the vertical circles through 0° and 90° azimuth at vertical circle readings of 60°, 120°, 240°, and 300°....	8
Four measurements on each of the vertical circles through 0°, 45°, 90°, and 135° azimuth at vertical circle readings of 30°, 150°, 210°, and 330°.....	16
Twelve measurements 30° apart at the equator.....	12
Four null values at the south pole of lamp.....	1
Total number of effective measurements.....	38

The points thus laid off on the reference sphere are approximately equidistant, being somewhat closer together at the equator than at the poles.

When the lamp is rotated, readings are taken for each 15° or 30° in inclination, from 0° to 90°, and from 0° to 270°. These are integrated values for their corresponding parallels of latitude on the unit sphere.

The mean spherical candle-power from these readings may best be obtained by plotting a distribution curve from the readings, determining the area of this closed curve by means of a planimeter and taking the radius of an equivalent circle as the value for the mean spherical candle-power.

The *Rousseau diagram* may be used for determining the mean spherical candle-power of a lamp when its vertical distribution curve is known. Fig. 82 shows such a diagram made up for a *gem lamp* with a bowl reflector. Where the horizontal distribution curve of the lamp is not uniform the values for the vertical distribution curve should be taken with the lamp rotating so as to give average values at each angle. One-half of the distribution curve is drawn to scale *A* and a circle *B* is drawn with the source of light *O* as a center. Radii *C* are drawn at equal angles about the light source and extended until they intersect the circle *B*. The points of intersection of these lines with the circle are projected upon the straight line *D E*. Distances from this line are laid off on the verticals *F* equal to the distances from the center of the circle to the points where the corresponding radii cut the distribution curve. The area enclosed between the straight line *D E* and a curve drawn through the points just determined, *G H*, divided by the base line, is equal to the mean spherical

candle-power of the lamp. If the mean candle-power of the lamp within a certain angle is desired, it is only necessary to find the area of the diagram within the space indicated by that angle and divide by the corresponding base.

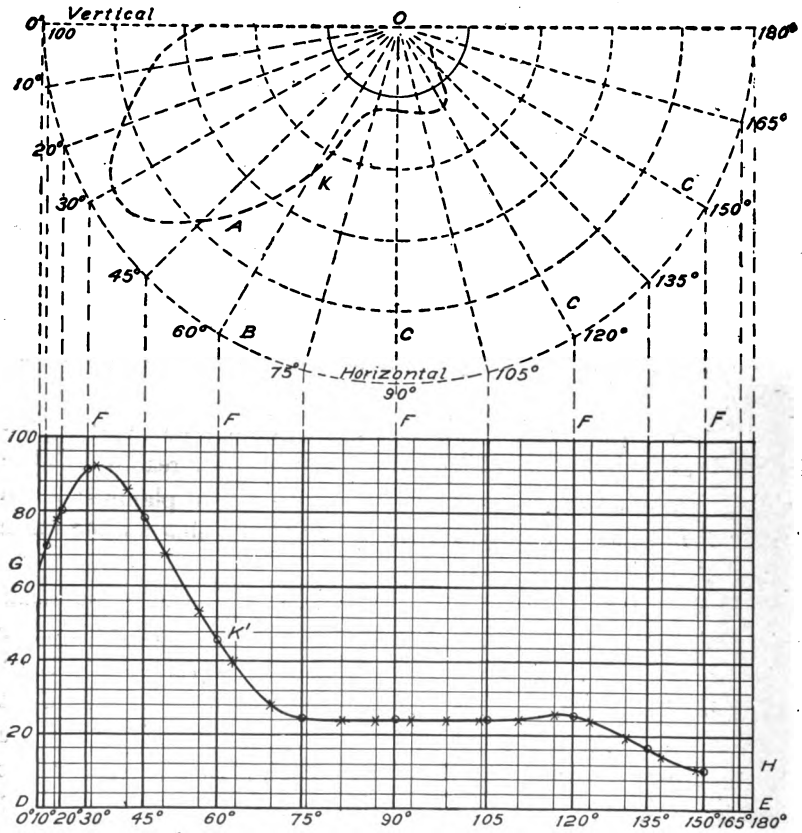

Fig. 82. Rousseau Diagram for Gem Lamp with Bowl Reflector.

In all tests the voltage of the lamp must be very closely regulated. A storage battery forms the ideal source of current for such purposes. In testing incandescent lamps, a standard similar to the lamp being tested is desirable and it should, preferably, be connected to the same leads. Any variation in the voltage of the mains then affects both lamps and the error introduced is slight.

ARC LIGHT PHOTOMETRY

Owing to the variation of the amount of light given out by an arc lamp in one direction at any time, due to variation of the qualities of the carbons, position of the arc, and also on account of the color of the light, etc., the photometry of arc lamps is much more difficult than that of incandescent lamps. The curves shown in Figs. 33 and 34 are average distribution curves taken from several lamps and will vary considerably for any one lamp. If the arc is enclosed, this variation is not so great.

The working standard should be an incandescent lamp run at a voltage above the normal so that the quality of the light will compare favorably with that of the arc. Since an incandescent lamp deteriorates rapidly when run at over voltage, the standard can be used only for short intervals and must be frequently checked.

Since an arc lamp can be mounted in one position only, mirrors must be used to obtain distribution curves. A mirror is used mounted at 45° with the axis of the photometer, and arranged so as to reflect the arc when in different positions. A mirror absorbs a certain per cent of the light falling upon it and this percentage must be determined by using lamps previously standardized. The length of the photometer bar must include the distance from the mirror to the arc.

The Weber photometer is well adapted to arc-light measurements inasmuch as appropriate screens may be used to cut down the intensity of the light.

A special form of the Matthews photometer is also used for testing arc lamps.

For the comparison of the illumination from arc lamps as installed in service, an instrument known as an *illuminometer* is sometimes used. This consists of a light wooden box, readily portable, having a black interior and arranged with two openings. One of these openings is for the purpose of admitting light from the source being considered, to a printed card. The other opening is for the purpose of viewing this card when illuminated by the light source. The printing on the card is made up from type of different sizes, and the smallest size which is legible, together with the distance from the light source, is noted. Another method of application is to select some definite size of type and then to move the instrument from the

light source to a point where this type is just legible and note the distance. From similar measurements taken on different lamps a good comparison may be obtained. Such an instrument is very convenient to use, and results obtained by different observers check very closely.

The *flicker photometer* is used for the comparison of different colored lights, the basis for comparison being that each light, though different in color, shall produce light sensations equally intense for the purpose of distinguishing outlines. It consists, in one form, of an arrangement by means of which a sectored disk is rotated in front of each light source, these disks being so arranged that the light from one source is cut off while the other falls on the screen, and *vice versa*, any form of screen being used for making the comparison. The disks must be revolved at such a rate that the light, viewed from the opposite side, will appear continuous. When the illumination of the two sides of the screen, under these conditions, is not the same, there will be a perceptible flicker and the screen should be so adjusted that this flicker disappears. The value of the light source can then be calculated from the screen reading in the usual manner. Another device consists of the use of a special lens mounted in front of a wedge-shaped screen, the lens being constructed so as to reverse the image of the two sides of the screen, as viewed by the eye, when such lens is in front of the screen. The lens is so mounted that it can be oscillated rapidly in front of the screen, giving the same result as would be obtained were it possible to reverse the screen at such a rapid rate as to cause the illumination on the two sides to appear continuous. The setting of this screen is accomplished as with the more simple forms.

Still another flicker photometer, the Simmance-Abady, makes use of a rotating wheel. This wheel is made of a white material having a diffusing surface, and its edge is so beveled that during part of a revolution a surface illuminated by one of the light sources is viewed through the eye-piece of the instrument, and during the other part of the revolution a surface viewed by the second light source is observed. The flicker occasioned by this change disappears when the screen is brought to a point where it is equally illuminated by the two light sources.

By the use of such forms of photometers it is found that results with different colored lights can be obtained, which are comparable with results obtained with lights of the same color.

INDEX

A

	PART	PAGE
Alternating-current circuits	I,	40
calculation of	I,	44
line capacity	I,	43
mutual induction	I,	42
skin effect	I,	42
Alternating-current lines, drop in	I,	44
Amyl acetate lamp	II,	17
Arc lamps	II,	32
carbons for	II,	41
efficiency	II,	41
electric arc	II,	32
flaming arc	II,	42
Bremer	II,	42
magnetite	II,	44
mechanisms	II,	33
carbon-feed	II,	37
rod-feed	II,	37
series	II,	35
shunt	II,	35
rating of	II,	40
types of	II,	38
alternating-current	II,	39
direct-current	II,	38
interchangeable	II,	40
Arc light photometry	II,	93

B

Bremer arc lamp	II,	42
Bushings	I,	65

C

Carbon incandescent lamps, manufacture of	II,	3
Carcel lamp	II,	77
Concealed knob and tube wiring	I,	13
Conductors, calculation of sizes of	I,	25
Cross-arms	I,	75
Cut-out panels	I,	66

INDEX

E		PART	PAGE
Electric lighting	II,		1-94
arc lamps	II,		32
arc light photometry.....	II,		93
classification	II,		2
history and development.....	II,		1
illumination	II,		53
incandescent lamp photometry.....	II,		88-
incandescent lamps	II,		2
light standards	II,		76
lighting of public halls, offices, etc.....	II,		64
photometers	II,		79
photometry	II,		76
power distribution	II,		46
residence lighting	II,		56
shades and reflectors.....	II,		72
special lamps	II,		27
street lighting	II,		67
Electric wiring	I,		1-87
alternating-current circuits	I,		40
alternating-current lines, drop in.....	I,		44
concealed knob and tube wiring.....	I,		13
conductors, calculation of sizes.....	I,		25
methods of wiring	I,		1
outlet-boxes, cut-out panels, and other accessories.....	I,		63
overhead linework	I,		68
testing	I,		36
two-wire and three-wire systems.....	I,		20
underground linework	I,		79
wires run concealed in conduits.....	I,		1
wires run exposed on insulators.....	I,		16
wires run in moulding.....	I,		9-
wiring installation	I,		29
wiring an office building.....	I,		54
English candle	II,		76
F			
Fibre conduit	I,		83
Fibrous tubing	I,		15
Frosted globes	II,		73
Fuse-boxes	I,		66
G			
Gem metallized filament lamp.....	II,		12
German candle	II,		77

INDEX

iii

H

	PART	PAGE
Helion lamp	II,	21
Holophane globes	II,	74

I

illumination	II,	53
intrinsic brightness	II,	54
irregular reflection	II,	54
regular reflection	II,	54
unit of	II,	53
Incandescent lamp photometry.....	II,	88
Incandescent lamps	II,	2
comparison of types.....	II,	25
distribution of light.....	II,	11
efficiency	II,	6
gem metallized filament lamp.....	II,	12
helion lamp	II,	21
manufacture of carbon incandescent lamps.....	II,	3
mean spherical candle-power.....	II,	12
metallic filament lamps.....	II,	14
Nernst lamp	II,	21
selection of lamps	II,	8
voltage and candle-power.....	II,	5
Insulators	I,	77

L

Light standards	II,	76
amyl acetate lamp.....	II,	77
carcel lamp	II,	77
English candle	II,	76
German candle	II,	77
pentane lamp	II,	77
working standards	II,	78
Lighting of public halls, offices, etc.....	II,	64
Lightning arresters	I,	78
Lummer-Brodhun photometer	II,	80

M

Mercury vapor lamp.....	II,	27
Metal conduit, wires run in.....	I,	4
Metallic filament lamps.....	II,	14
Moore tube light	II,	29
Mutual induction	I,	42

INDEX

N		PART	PAGE
Nernst lamp		II,	21
O			
Opal enclosing globes.....		II,	76
Osmium lamp		II,	20
Outlet-boxes		I,	63
Overhead linework		I,	68
corners		I,	75
cross-arms		I,	75
insulators		I,	77
lamps on poles.....		I,	79
lightning arresters		I,	78
pins		I,	77
poles		I,	70
guying of		I,	72
placing of		I,	69
service mains, pole wiring, etc.....		I,	77
P			
Pentane lamp		II,	77
Photometers		II,	79
integrating		II,	86
Lummer-Brodhun		II,	80
portable		II,	85
Weber		II,	83
Photometry		II,	76
arc light		II,	93
incandescent lamp		II,	88
light standards		II,	76
photometers		II,	79
Poles		I,	70
Polyphase circuits		I,	53
Power distribution		II,	46
multiple or parallel systems of distribution.....		II,	51
multiple-series or series-multiple systems.....		II,	51
multiple-wire systems		II,	53
series system		II,	46
R			
Residence lighting		II,	56
arrangement of lamps.....		II,	59
calculation of illumination.....		II,	56
plan of illumination		II,	56
types of lamps.....		II,	56
Rigid conduit, wires run in.....		I,	1

INDEX

v

S

	PART	PAGE
Shades and reflectors.....	II,	72
frosted globes	II,	73
holophane globes	II,	74
opal enclosing globes.....	II,	76
Skin effect	I,	42
Special lamps	II,	27
mercury vapor lamp.....	II,	27
Moore tube light	II,	29
Street lighting	II,	67

T

Table

absorption loss for different shades.....	II,	72
arc lights per mile.....	II,	70
armored conductors—types, dimension, etc.....	I,	8
change in voltage, effects of.....	II,	8
conductors in fibrous conduit, sizes of.....	I,	15
Cooper-Hewitt lamps	II,	65
drop in alternating-current lines, data for calculating.....	I,	47
efficiency of transmission of arc light globes.....	II,	76
flaming arcs, general data on.....	II,	46
gem metallized filament lamp data.....	II,	12
Greenfield flexible steel conduit.....	I,	5
illuminating data for meridian lamps.....	II,	62
intrinsic brilliancies in candle-power per square inch..	II,	54
life of a 25 c. p. unit data.....	II,	16
lighting data for arc lamps.....	II,	66
melting point of some metals.....	II,	21
Moore tube light data.....	II,	32
mouldings, sizes of required for various sizes of con- ductors	I,	12
Nernst lamp data	II,	25
photometric units	II,	78
pole data	I,	71
relative reflecting power.....	II,	55
residence lighting data	II,	63
rigid, enameled conduit—sizes, dimensions, etc.....	I,	2
single wire in conduit.....	I,	2
standard vitrified conduit.....	I,	81
street-lamp data	II,	71
tantalum lamp data	II,	15
three wires in one conduit.....	I,	3
tungsten lamps (multiple and series).....	II,	20
two wires in one conduit.....	I,	3
Testing electric wiring	I,	36

INDEX

	PART	PAGE
Three-wire system, details of	I,	22
Tungsten lamp	II,	16
Two-wire and three-wire systems	I,	20
details of three-wire system	I,	22
relative advantages	I,	20
U		
Underground linework	I,	79
fibre conduit	I,	83
iron pipe	I,	80
laying of conduit	I,	82
vitrified tile conduit	I,	80
W		
Weber photometer	II,	83
Wires run concealed in conduits	I,	1
armored cable	I,	6
in flexible metal conduit	I,	4
in rigid conduit	I,	1
Wires run exposed on insulators	I,	16
accessibility	I,	17
cheapness	I,	16
durability	I,	16
Wires run in mouldings	I,	9
Wiring installation	I,	29
feeders and mains	I,	36
location of outlets	I,	30
method of wiring	I,	29
systems of wiring	I,	30
Wiring an office building	I,	54
basement	I,	55
character of load	I,	55
electric current supply	I,	54
feeders and mains	I,	55
first floor	I,	58
interconnection system	I,	58
second floor	I,	58
switchboard	I,	55
upper floors	I,	58

