

QC

534

B91



Electrical . . .

Measurements

FOR

AMATEURS

BY EDWARD TREVERT. *Bubier*

—••—
ILLUSTRATED.
—••—

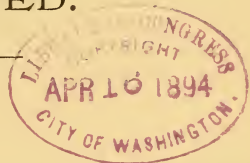

1894.

BUBIER PUBLISHING COMPANY

LYNN, MASS.

153472

A

COPYRIGHTED BY
BUBIER PUBLISHING COMPANY,
LYNN, MASS.
1894.

534

1391

PREFACE.

It frequently happens that persons experimenting with electricity and electrical apparatus, have need of making measurements of the different factors concerned.

For those who are working on a small scale, and who have not been in a position to acquire a practical familiarity with the subject, this presents many difficulties, and it is some of the most important of these which it is the object of this book to explain and clear away.

The book therefore is intended simply as an introduction to the subject of electrical measurements, and no attempt has been made to enter upon any refinements.

The author believes, however, that it contains all that is essential for ordinary work, and trusts that those for whom the book was written, viz. the amateurs, will find in it all the aid they require in taking up this branch of the study of electricity.

EDWARD TREVERT.

LYNN, MASS., April 3d, 1894.

CONTENTS.

CHAPTER I.

	PAGE
Electrical Units	7

CHAPTER II.

The Measurement of Resistance	14
---	----

CHAPTER III.

Current Measurements	71
--------------------------------	----

CHAPTER IV.

Potential Measurement	99
---------------------------------	----

THE LATEST AND BEST
Electrical Books
 For Amateurs and Students.

TREVERT'S WORKS.

	PRICE.
Experimental Electricity	\$1.00
Everybody's Hand-Book of Electricity50
Paper Edition, 25 Cents.	
How to Make Electric Batteries at Home25
Dynamos and Electric Motors and all about them50
Armature and Field Magnet Winding	1.50
How to Make a Dynamo10
Electric Railway Engineering	2.00
Electricity and its Recent Applications	2.00
A Practical Treatise on Electro Plating50
How to Make and Use Induction Coils50
Electric Bell Fitting and Electric Gas Lighting Hand-Book50
Electrical Measurements for Amateurs	1.00
How to Build Dynamo Electric Machinery	2.50

Miscellaneous Authors.

Questions and Answers about Electricity50
Edited by E. T. Bubier, 2d.	
A Hand-Book of Wiring Tables, A. E. Watson75
A Practical Treatise on the Incandescent Lamp50
J. E. Randall.	
Electric Motor Construction for Amateurs	1.00
C. D. Parkhurst.	
How to Make a 1 Horse-Power Motor or Dynamo50
A. E. Watson, Paper Edition, 25 Cents.	
A Practical Hand-Book of Modern Photography for Amateurs, E. T. Bubier, 2d.50
Arithmetic of Magnetism and Electricity	1.00
John T. Morrow and Thorburn Reid.	
How to Make and Use a Telephone, George H. Cary	1.00
Transformers; their Theory, Construction and Application Simplified, by Caryl D. Haskins	1.25
What is Electricity? Elihu Thomson25

Bubier Publishing Co.,

P. O. Box 309, Lynn, Mass.

Send money by P. O. Order or Registered Letter at our risk.

ELECTRICAL MEASUREMENTS FOR AMATEURS.

CHAPTER I.

ELECTRICAL UNITS.

BEFORE entering upon the subject of measurements and measuring instruments, we will take a hasty survey of the units used and the manner of their derivation.

When the matter of electrical measurements was first introduced, which was about the year 1830 A. D., there was naturally a great deal of vagueness and uncertainty as to the proper method of expressing the results. Resistance was expressed in a number of ways and a number of standards were suggested, being usually expressed as the resistance of a wire of solid pure metal under specified conditions. These standards in time came to be looked upon as untrustworthy, as it was found that wires of

pure metal which were apparently similar in every respect, would often vary considerably in resistance, and that the resistance of any given wire depended largely upon its previous history. Matters were in this stage when Dr. Siemens proposed as the unit of resistance, the resistance of a column of pure mercury one metre long, one square millimetre in cross section, and at a temperature of 0° centigrade.

This had the advantage of being readily reproduced at any place on account of the uniformity of the molecular condition of pure mercury and the ease and accuracy with which the measurements of length and weight can be made. It is in this form that the present unit is defined, that is, as so many centrimetres of pure mercury with a cross section of one square millimetre.

In 1851 Webber proposed a system of electrical units, based upon the absolute system of Gauss, and this suggestion was subsequently taken up by the British Association for the Advancement of Science. The subject was investigated by the aid of an apparatus devised by Thomson, con-

sisting of a coil of wire which was caused to rotate in the earth's magnetic field and a magnetic needle suspended at its centre. The induced current in the coil distorted the magnetic field and so deflected the needle. The great value of the apparatus lies in the fact that it is independent of the strength of the earth's field although it is affected by changes in its direction.

After an extended series of experiments, what is called the British Association Unit or B. A. U. was produced. Its accuracy according to its C. G. S. definition, was questioned later on and a re-determination of the value of the ohm shows that the B. A. U. is about 1.3 per cent too small. At a meeting of the Electrical Congress in Paris in 1884, it was decided to adopt for the time being, the value of the ohm as the resistance offered by a column of pure mercury, 106 centimetres long, one square millimetre in cross section, and at a temperature of 0° centigrade. The most careful recent experiments show that the true value of the ohm is very nearly given by a column of mercury 106.3 c. m. long, under the above conditions.

The unit recommended by the Paris Congress is called the legal ohm, and has caused much confusion at present on account of the existence of the two standards, results being sometimes expressed in B. A. units and sometimes in legal ohms. The unit used should always be designated. It should be remembered in making reductions, that the B. A. U. is .9867 of the legal ohm.

The absolute system above referred to, grew out of the necessity of having the results of physical researches in some form in which they could be easily compared among themselves.

In it three fundamental units are chosen and from them are derived the others. The centimetre, gramme and second are the units most commonly used in physical work, but a number of other units have been suggested, depending on the physical properties of various bodies, on which other "absolute" systems might be founded. The centimetre is the hundredth part of the length of a certain platinum bar, kept in the National Archives of France and measured under certain specified conditions. The length of this bar, called the metre, was supposed

when it was constructed, to be the ten millionth part of the quadrant of a meridian circle of the earth measured from the equator to the pole. Later determinations have shown that this is incorrect, so that now the meter is never defined as a portion of the earth's quadrant but as the length of a certain platinum bar as above.

The gramme likewise is the one thousandth part of the mass of a piece of platinum also in the National Archives of France, which piece of platinum was made as nearly as possible, equal to the mass of a cubic decimetre of pure water at 4° centigrade, its point of greatest density. What variation there is between the platinum standard and the cubic decimetre of water is at present uncertain, but the error is so small that the definition of the gramme as the mass of a cubic centimetre of pure water at 4°C. is close enough for all practical purposes. The mean solar second is the unit of time, and is defined as the $\frac{1}{86400}$ part of the mean solar day.

From these units are derived all others used in dynamics. Thus the unit of force, the dyne is the force of which acting for one second on a

gramme of matter will impart to it a velocity of one centimetre a second. The unit of work or erg is the work necessary to overcome the force of one dyne through the space of one centimetre. As this is extremely small the practical unit is taken as 10,000,000 ergs, and is called the Joule. The practical unit of the rate of working is the Watt, and is equivalent to one Joule per second. The units used in electrical measurements are all derived from these same fundamental units in a manner which need not be entered upon here.

The C. G. S. units are usually far out of the range of practical observations, and in order to avoid the use of large numbers the practical units chosen are multiples of the C. G. S. units. Thus the ohm is 1,000,000,000 C. G. S. units, the volt 100,000,000 C. G. S. units, the ampere is $\frac{1}{10}$ of a C. G. S. unit, the Coulomb also $\frac{1}{10}$ the C. G. S. unit, and so on through the list.

Only three of these units enter to any great extent into most practical measurements, the volt or unit of electromotive force, the ampere or unit of current and the ohm or unit of resistance, and

only measurements of these three quantities and of the activity, or rate of doing work in a given system, will be considered here.

CHAPTER II.

THE MEASUREMENT OF RESISTANCE.

RESISTANCE measurements are made in a number of different ways, by taking the volts and amperes of a current passing over the resistance to be measured, by a Wheatstone's bridge, by comparing the drop in potential around two resistances over which the same current is passing, the value of one resistance being known, and by a number of special instruments which are modifications of one or more of the above methods.

The first method of course depends upon the relation

$$\text{Ohm} = \text{Volts} \div \text{Amperes}$$

$$\text{or } R = \frac{E}{C}$$

It is often of advantage to be able to get a resistance this way in cases where the resistance is different when the current is on from what it is when the current is off. The resistance of a bank of incandescent lamps where the hot resistance is

about half that of the cold is a case of this kind.

The usual method of measuring resistances where they are neither very low nor very high is by means of the Wheatstone's bridge. This is a zero method and depends upon the ability to so adjust the resistances of a system of conductors,

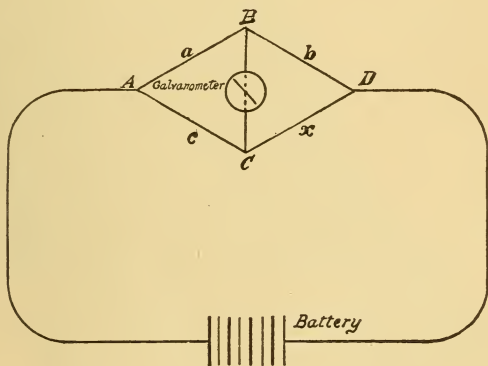

FIG. 1.

that the current through one of them is null. A galvanometer is placed in series with this conductor and when it shows no deflection, the resistance measured can be calculated by simple proportion from the known values of the others.

Suppose in Fig. 1 that a current from the battery is flowing around through the conductors.

It will divide at A , one part going over the conductor $A B D$ and the other over the conductor $A C D$. They will unite again at D , and from thence return to the battery. The fall in potential over the two branches must be the same,

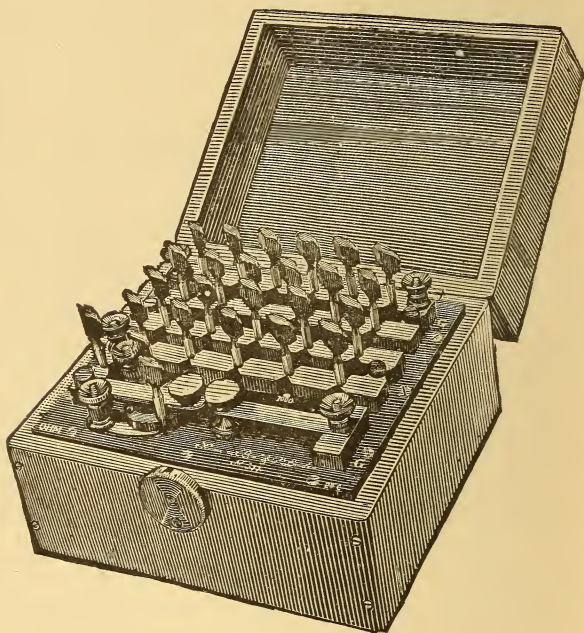

FIG. 2.

since the potential at A is the same for both as is also the potential at D . The fall of potential over

any particular portion of either branch will bear the same proportion to the fall of potential over the whole branch that the resistance of this portion bears to the resistance of the whole branch—from Ohm's law. Therefore, if the resistance of a portion, $A B$, of one branch bears the same ratio to the resistance of the branch as the resistance of $A C$ does to the resistance of its branch, the fall of potential over $A B$ and $A C$ will be the same, although their resistances may be very different. As no current passes over a conductor where there is no difference of potential and as the potential of the points B and C is the same, it is easily seen that no current passes over the conductor $B C$, which includes the galvanometer and that, therefore, there is no deflection of the galvanometer when a current is supplied by the battery. This, then, is the principle of the Wheatstone's bridge. The resistances of any three sides, a , b and c , of the quadrilateral, whose resistances are known, are adjusted until a balance is obtained, when the resistance of the unknown side x , which was to be measured, is found from the proportions,

$$a : b : : c : x,$$

$$\text{or } a : c : : b : x.$$

A form of Wheatstone's bridge, much used in making resistance measurements, is called the resistance box and is shown in Fig. 2 and is

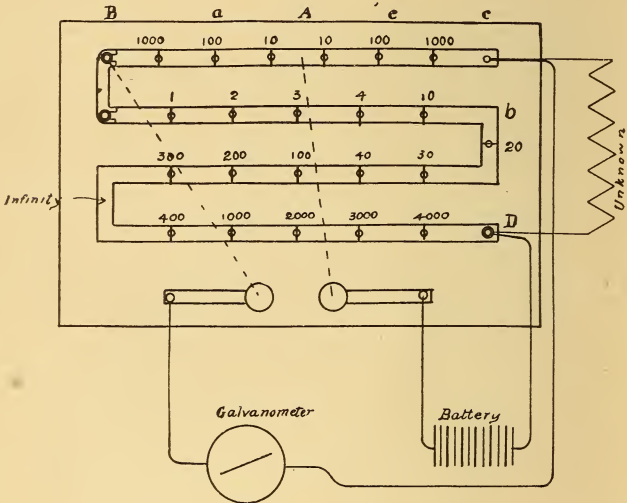

FIG. 3.

represented diagrammatically in Fig. 3. On the top of the box is a series of brass blocks spaced at small distances apart and with slightly taper holes between them, in which a brass plug can be inserted, and make a metallic connection between

the two. Between each two adjacent blocks is connected a coil of wire of known resistance, which, when the plug is in its socket between the blocks, is short-circuited, but which is thrown into the circuit again by removing the plug. (See Fig. 4.) The blocks are under-cut at each end so that the dust between them on the top of the box may be easily cleared off, and also so as to make the

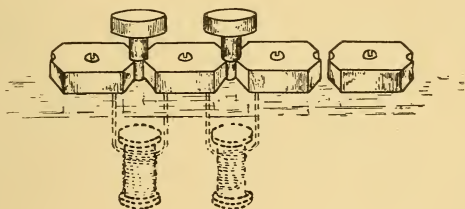

FIG. 4.

insulation resistance between the two blocks as great as possible. (See Fig. 5.)

The lettering on the diagram of the box corresponds to that on the skeleton diagram, preceding, of the bridge. The arms, AB and AC , are called the proportional arms, and contain coils with resistances in them as indicated. The plugs pulled out of them will indicate the ratio of the resistance being measured to that unplugged

in the rheostat arm, or arm of adjustable resistance. It is usually best to make this ratio, unity, by unplugging the same amount in each of the proportional arms and the resistance in each proportional arm should be as near as is possible to that you are going to measure. For instance, if you are measuring something in the neighborhood of 80 or 90 ohms, unplug the 100 coils in the proportional arms. In such cases as this the unknown resistance will be equal to the resist-



FIG. 5.

ance in the rheostat arm when balance is obtained, and can be read off directly.

In some cases it is convenient to make the proportion greater or less than unity. For instance, a 100-coil may be unplugged from one side and a 10-coil from the other, in which case, the reading on the rheostat will have to be multiplied or divided by 10, according to the way the ratio arms are arranged. The rheostat arm is connected with one of the proportional arms by a

heavy brass or copper connection. The resistance coils in this arm are arranged in series from 1 ohm to 4 ohms, from 10 ohms to 40 ohms, from 100 ohms to 400 ohms, etc. Any resistance within the limit of the set, in the case shown in the figure from 1 ohm to 11,110 ohms, can be obtained by a proper combination of the different coils.

The most economical arrangement of the coils or the method by which the fewest number of coils can be made to cover a certain range of resistances is in a geometrical progression with a common ratio of two. It is rather more unhandy than the former arrangement to figure out just what resistance you may have unplugged or how to unplug for a given resistance, and the author thinks that the difference in cost is more than compensated by the inconvenience.

The dial form of bridge is a vast improvement over either of the other forms in point of convenience. There is one dial for each digit, generally for thousands, hundreds, tens and units and sometimes for tenths. The dial is composed of a central block of brass surrounded by ten other

blocks numbered from zero to nine, there being a plug hole between each outside block and the middle one. Between the adjoining outside blocks are resistance coils of 1 ohm each on the unit dial, of 10 ohms each on the tens dial, etc. The central block of the unit dial is connected to the zero outside block of the tens and the central block of the tens to the zero outside block of the hundreds, and so on. Inserting the plug in any of the plug holes will throw into the circuit all the coils between that block and zero of that dial and, as the blocks are all numbered, it is easy to read off at once what the resistance is by taking the figures on the blocks where the plugs are. The proportional arms are the same as for the ordinary bridge.

What is known as the slide wire or metre bridge is another form of the Wheatstone arrangement. The lettering in Figure 6 corresponds to that of the skeleton diagram given previously. The connections between the different parts of the apparatus are made by heavy copper strips, to reduce the resistance as much as possible. Between the copper strips, *A* and *D*, is stretched

a wire, generally of platinoid, which is soldered firmly to the strips. This wire is stretched above a graduated scale. A convenient length for the wire is about a yard or a metre, and it is usually made this latter length from the points of connection with the copper strips, and a metric scale placed beneath it. A rider of some convenient

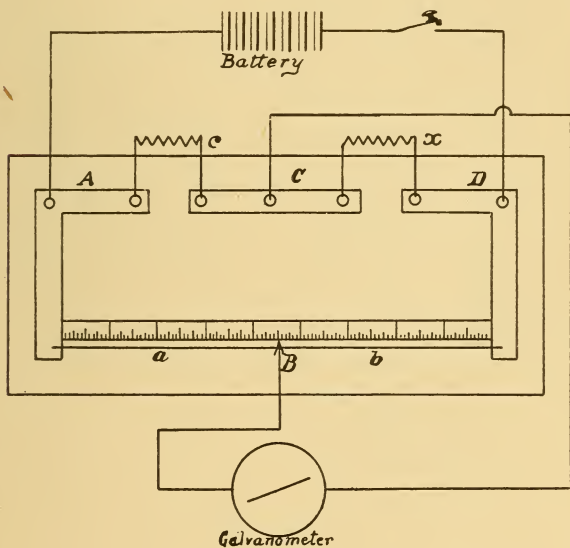

FIG. 6.

form is made to slide parallel to the wire and has a contact piece which, upon pressing a button or

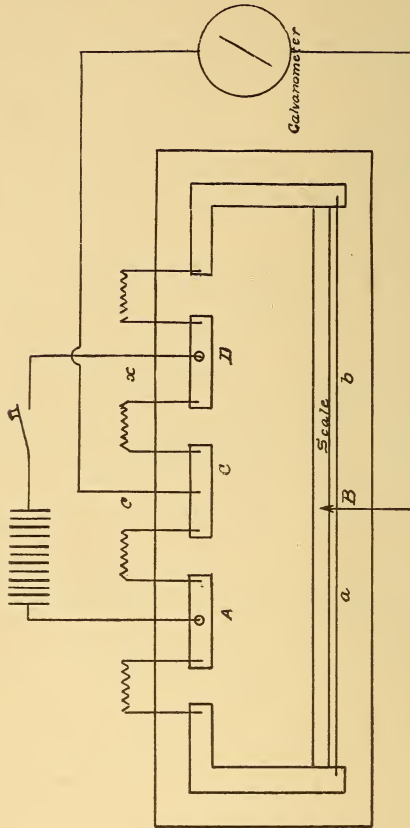

FIG. 7.

key, is made to touch the wire. In connection with the rider is some form of index for reading off its position on the metre scale. In many cases a vernier is used.

The gaps in the copper strips are provided with binding posts for the purpose of connecting in the known and unknown resistances. Let the unknown resistance be connected in at x , as shown in the diagram, and a known resistance at c . The battery is connected as shown. The galvanometer has one terminal connected at C and the other at B , to the slider. The position of the slider is altered until the resistances on the two sides of the wire, on each side of the slider, are proportional to the resistances of the known and unknown coils. Then, assuming that the resistance of the slide wire is uniform, the resistance of the unknown coil can be obtained at once from that of the known coil and the scale reading. It is customary to number the scale from each end, so that the length of the wire on each side of the slider may be read off more easily. Within certain limits, lengthening the slide wire will increase the delicacy with which the measurements can be

made. As an increase in the actual length of the wire itself would make a very awkward instrument, it is customary in most commercial instruments to leave the additional gaps in the copper connection strips into which may be inserted resistance coils which have the effect of adding to the slide wire resistance, just as though it had been lengthened. These resistances are selected so as to be nearly proportional to the known and unknown resistances. The point *B*, at which the galvanometer connection must be made, will then lie on the slide wire. (See Fig. 7.)

Slide wire bridges are made in special forms for special purposes. Where portability is an object, the wire is sometimes wound spirally about a cylinder. A stem projecting from the cylinder has threads of the same pitch as that of the wire on the cylinder and carries a radial arm, on the end of which is the contact piece. The scale is, of course, placed on one end of the cylinder, and divides the circle decimally, and marks on the radial arm indicate the number of turns of wire. (See Fig. 8). It is made up with binding posts on the base to suit the convenience

of the user. As the pitch of the wires will often be too great to thread the stem with, it is usual to double-thread the latter. The material for the cylinder on which the wire is wound should be

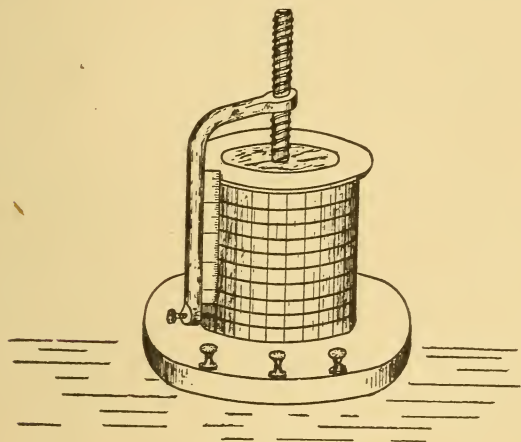

FIG. 8.

something not liable to alter its form. Wood, unless hard and thoroughly seasoned, is apt to warp and shrink, and leave the wire hanging loosely on it. I once saw a bridge, the cylinder of which was made of marble, and an excellent one it was too, but a trifle too heavy for carrying conveniently. The marble can be turned in any lathe which can be used for iron.

Another very convenient form is one devised by Cardew, called his lightning conductor bridge. It was described in our "Electricity and its Recent Applications," and only a brief explanation of its

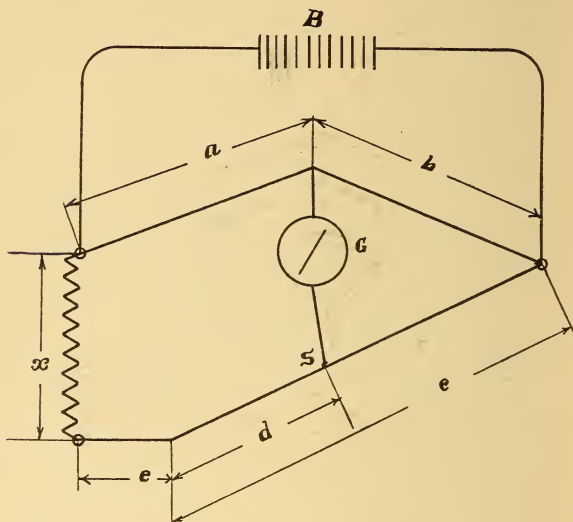

FIG. 9.

working will be given here. Fig. 9 is a skeleton diagram of the connections, in which B is the battery and G the galvanometer. One terminal of the galvanometer is connected to the slider, which works along the slide wire d ; a and b are the proportional arms, e is the wire connecting the

binding post to the slide wire and x , as usual, the the unknown resistance. The slide wire, d , is stretched above a scale, divided decimally and numbered from right to left, as the diagram stands. The advantage of this bridge is that the resistances are read off directly after the bridge has been calibrated, thus obviating the calculation necessary on the ordinary slide wire bridge.

We will give, briefly, the method of determining the lengths of the various arms of the bridge, leaving it to the ingenuity of the reader to arrange them most conveniently on the board. You will have to know three quantities in order to make your calculations, the range of readings you desire for x , the resistance of the wire d , which is governed by its length, size and material, and the resistance of e . We have, when the maximum resistance is at x and the slider at its extreme left hand position,

$$\frac{b}{a} = \frac{c}{e+x}$$

and when the resistance is at $x = 0$ (supposing you have chosen 0 for your lowest limit)

$$\frac{b}{a} = \frac{c-d}{d+e} \dots$$

$$\frac{c}{e+x} = \frac{c-d}{d+e} \text{ and}$$

$$cd + ce = ce + cx - de - dx,$$

$$c = \frac{d(e+x)}{x-d} \text{ which gives}$$

$$\frac{b}{a} = \frac{d}{x-d}$$

thus determining the value of the ratio of the proportional arms. We see from this that the value of d must be less than x , or the bridge will not work. Of course, the best value for d is one-half of that of x , but this is impracticable in cases where the unknown resistance is too high. The value of c is found from the equation

$$c = \frac{b}{a} (x + e)$$

and can be measured off on the wire with another bridge. The remaining portion of the wire is then divided up in the portion $\frac{b}{a}$. To gain length, the wire $c - d$ and a and b can be carried up and down the length of the board several times, or even made into coils, which can be placed in a false bottom in the base board. It is best to standardize the bridge by comparison with coils whose values have already been determined.

By inserting them at x you can accurately mark

the points corresponding to them on the scale and then divide up the intervals decimally. As a slide wire will rarely be found to be uniform in resistance over its whole length, the more of these points that can be located in this way the better.

We will now consider the practice followed in making resistance measurements with the instruments above described and then refer to a few other methods adapted to special cases.

In making resistance measurements we generally have some freedom in the choice of the resistances of the different arms of the bridge and by altering them to vary the sensibility of the arrangement, that is, vary the amount of "throw" of the galvanometer for a given difference in the resistance of the adjustable arm. It may therefore be of considerable importance in some cases to know what is the most sensitive arrangement of the resistances. Prof. Thomas Gray has worked this out with the results given below.

In Figure 10 as shown, let r_1 and r_2 be the resistances of the proportional arms, r_3 , that of the adjustable arm; r_4 , that of the unknown resistance; r_5 , that of the galvanometer, and r_6 , that

of the battery. Then, if the battery and galvanometer resistances are fixed, the other resistances are to be chosen so that

$$r_1 = \sqrt{r_5 r_6} \quad r_3 = \sqrt{r_4 r_6 \frac{r_4 + r_5}{r_4 + r_6}}$$

$$\text{and } r_2 = \sqrt{r_4 r_5 \frac{r_4 + r_6}{r_4 + r_5}}$$

r_4 having been roughly determined previously.

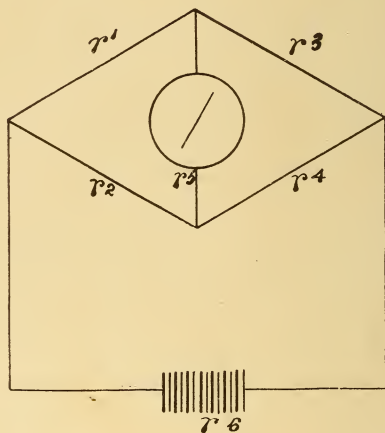

FIG. 10.

If the resistances of the battery and the galvanometer are capable of variation, then the different resistances should all be equal to r_4 . Of course, on the supposition that its E. M. F. remains

constant, the lower the resistance of the battery the greater will be the deflection of the galvanometer for any given adjustment of the bridge. In general, however, such a degree of refinement is unnecessary.

The resistances of r_1 and r_2 may be chosen at almost any convenient values and the galvanometer and battery then connected so that the greater of the two connects the junction of the two arms with the greatest resistances to that of the two arms with the least resistances. The connections should be arranged with keys in both battery and galvanometer circuit, which are closed by simply pressing down. Two separate keys can be used, but interfere somewhat with rapid work if they require both hands to work them. A key can be arranged so that depressing it a short distance closes the battery circuit and still further depressing closes the galvanometer circuit. In this way one hand is left free to manipulate the plugs or slider of the bridge. Figure 11 shows such a key. It is mounted on an ebonite block and pillars. The key itself is made of spring brass and has an ebonite button on the end.

Silver contacts are placed between the first two arms and between the second and third are ebonite insulators, then silver contacts again between the last arm and the block. It is better to mount the arms for the battery and that for the galvanometer on separate pillars so as to decrease the liability to leakage between them.

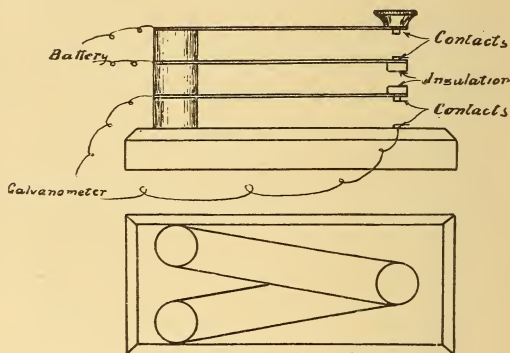

FIG. II.

The insulating pieces should be kept carefully cleaned. Suitable binding posts may, of course, be provided for the galvanometer and battery connections. The battery should consist of two or three cells. Gravity and Leclanche are both good for this purpose, the latter especially so for

general work, where the current is only needed for short periods at long intervals.

There are now a number of good dry batteries on the market which are excellent for portable testing sets. The styles of galvanometers used for resistance measurement are as various as the makers. They usually consist of a coil of wire within which is suspended a magnetized needle. The needle is usually cemented to a thin, plane mirror, about $\frac{3}{8}$ of an inch in diameter, which is used either to reflect a spot of light upon a darkened scale, or in connection with a telescope in reading an illuminated scale. It is customary to have a directing magnet fixed to the galvanometer for regulating the strength and direction of the field in which the needle works. It usually consists of a bar of magnetized steel mounted in a horizontal position upon a vertical rod on which it can slide up and down or rotate. (See Figure 12.) By raising or lowering this magnet we change the strength of the field. Thus, if, as in some cases it is desirable, we want a very weak field, so that the needle will be deflected by a feeble current in the galvanometer coil, we

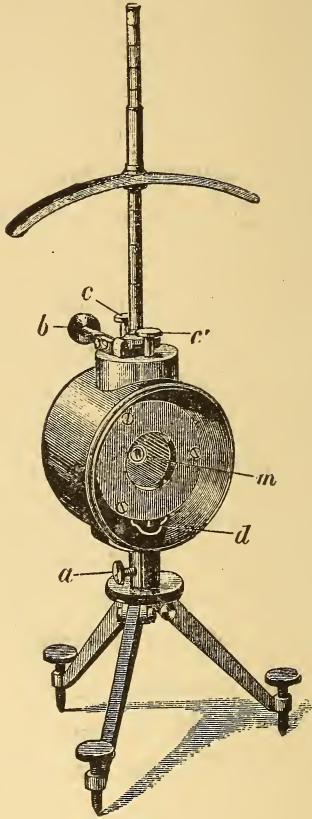

FIG. 12.

turn the north seeking pole of the directing magnet to the north and then bring it nearer to the needle until the earth's magnetic force is almost neutralized. If on the contrary we want a very strong field, either to reduce the disturbing effect of some outside force, or to make the needle take up its position more quickly, we turn the north seeking pole of the directing magnet

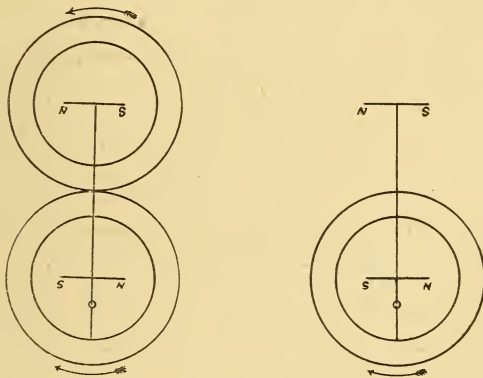

FIG. 13.

south and bring it down to the needle until the desired effect is obtained.

Galvanometers are sometimes made with two separate needles or sets of needles, one inside and one outside the coil or, as sometimes constructed, in another coil. (See Figure 13.)

The two systems of needles are rigidly connected and have their north poles turned in opposite directions. The result of this would be, if the needles were exactly similar in dimensions and magnetic strength, that they would tend to take up no particular position in a uniform magnetic field. Practically, they never are the same. One is always slightly stronger than the other and determines the position assumed. The directing magnet also acts more strongly on the needle nearest it. The effect of reversing the needles, however, does not weaken the effect of the coils upon them, but increases it. The one outside of the single coil will, of course, tend to turn in the opposite direction to that of the needle inside, if both are headed in the same direction, and therefore reversing their poles makes them both turn in the same direction. Where two coils are used, the current in the lower one goes in the opposite direction to that in the upper coil.

Some galvanometers are arranged with coils of different resistances which can be interchanged at will. A very useful form of galvanometer is

that of d' Arsonval. In it the coil is made movable and what corresponds to the needle, stationary. The coil is wound in a rectangular form and is suspended between two wires by

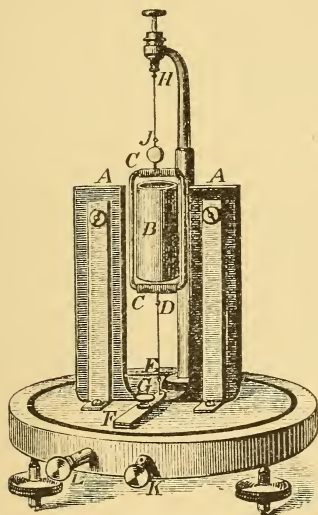

FIG. 14.

which the current is carried to and from it. (See Figure 14.) The mirror is attached to the coil. The field is supplied by strong, permanent horse-shoe magnets and is strengthened by a soft iron core in the inside of the coil, to which, however,

it is not attached. This form of galvanometer has several excellent features. It can be made very sensitive and it is not influenced by outside magnetic disturbances. On account of the strong artificial field, it comes to rest almost at once and it makes a good portable instrument. The galvanometer deflections are usually read from a spot of light reflected on a darkened scale or by

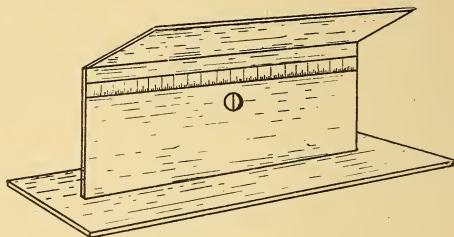

FIG. 15.

means of a telescope in conjunction with a scale.

Where the first method is used we have a scale mounted, something as shown in Figure 15. The scale is about two feet long and is graduated in millimetres. Zero is placed in the middle and the graduations are numbered to the right and left of this. The board to which the scale is glued is about ten inches high and supports a shade which

is sometimes made so as to turn up or down. Below the scale is a hole about $\frac{3}{4}$ of an inch in diameter, across which is stretched vertically a fine wire. A paraffine lamp is set up behind the scale with its flame opposite the hole and its light passing through the hole falls on the galvanometer mirror and is reflected back to the scale. By means of a suitable lens between the lamp and galvanometer, the image of the wire across the hole is focused on the scale. The deflection of the galvanometer is thus readily indicated on the scale and is moreover multiplied by two, since according to the well-known law of optics the angle between the incident and reflected ray of light is double that between either ray and a normal to the mirror, and the galvanometer deflection is the angle between the incident ray and the normal to the mirror. When telescopic readings are taken we have an ordinary reading telescope with cross hairs in it and generally some means of clamping a metre scale to its base. The scale must, of course, be at right angles to the axis of the telescope and with its zero in a vertical line with this axis. The galvanometer is set up at

about a metre's distance from the scale, and when it is properly levelled and adjusted, its mirror is in such a position that when looking through the telescope the scale can be seen reflected in it. (See Figure 16.)

The scales for reading telescopes are made with the zero in the middle and the figures are printed

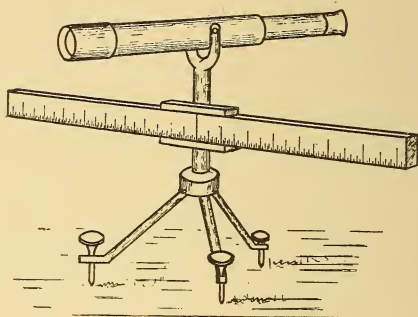

FIG. 16.

backwards so as to come right in the telescope, as it is customary to make them without an erecting lens. It will be found necessary in most cases to illuminate the scale with a row of small gas jets in front of it. When no current is passing through the galvanometer the telescope is so adjusted that the zero of the scale coincides with the vertical

cross hair. A galvanometer deflection is shown in the telescope, by the scale apparently moving past the cross hairs. More accurate readings may be taken in this manner than by the other, but such refinements are usually out of place in resistance measurements and as this method is so much more cumbersome and unhandy than the other, it is generally discarded.

The location of the instrument should be carefully chosen. It should be as free as possible from vibration. The galvanometer, especially, should be set upon a firm foundation, a pier, if possible, which has no connection with the floor of the room. It is not necessary that the scale and lamp should be so carefully placed, but even with them it will be found of advantage to place them in as quiet a spot as possible. Every cause of magnetic disturbance should be removed. While it is best to be away as far as possible from all masses of iron, stationary masses are not objectionable, providing they do not change in their magnetic strength, for instance, as do the fields of a dynamo. Wires carrying heavy currents should be avoided. Magnetic shields around the galvanometer are some-

times suggested, but are not much good practically, as they are too apt to become variably magnetized themselves. The galvanometer scale should be set up in a darkened corner so that the light spot may be clearly seen upon it.

In setting up the galvanometer our first care is to get it levelled and the plane of its coils in the magnetic meridian. This last is best accomplished with a prismatic compass, by the aid of which we make a north and south chalk mark on the slab on which the galvanometer rests. Then by the aid of a long, straight stick clamped to the face of the coils, we set the coils parallel to this chalk mark. The position of the galvanometer levelling screws should now be marked on the slab and the galvanometer removed. Make a small hole or depression just large enough to receive the end of one of the screws where one of the marks is, a slot just wide enough for the point of another screw and leave the third plane. By the aid of the hole and slot you can always put your galvanometer back again in exactly the same place whenever it has been necessary to remove it. Two holes would be sufficient were it not for the

expansion of the metal from changes of temperature. Now put the galvanometer in place and level it and on a line perpendicular to the coil and one metre away place the scale which must also be perpendicularly intersected by this line at its centre or zero mark. Set up your lamp behind it and fasten a piece of mirror to the middle of the front of the coil by an elastic band, and see if the image reflected on the scale is on the zero mark. If not, the scale must be moved until it is. Take off this piece of mirror and also the controlling magnet and raise the needle until it swings freely at the centre of the coil. If the supporting fibre has not been twisted the image reflected from its mirror should coincide with the zero mark of the scale. If it does not, the fibre should be twisted so as to bring it there. In making this adjustment be careful that all movable iron or steel is removed, even articles of that kind in your pockets. I have known men who claimed that their instruments were so sensitive in this state that the iron in a man's blood was sufficient to deflect them. I have learned, however, that the statements of all electricians are not to be trusted implicitly. The

controlling magnet may now be replaced and the galvanometer is ready for work. We must first, however, speak of the galvanometer-shunt. Figure 17 shows a plan of a familiar form.

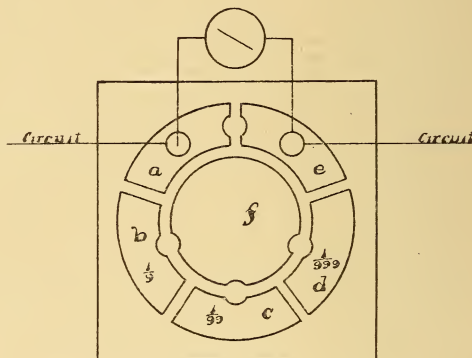

FIG. 17.

The galvanometer terminals are connected to the binding posts on *a* and *e*, from which are also the lead wires to the circuit in which the galvanometer is placed. *e* and *f* are connected together by a wire of low resistance, and between *a* and *b*, *a* and *c* and *a* and *d* are coils whose resistances are respectively $\frac{1}{9}$, $\frac{1}{99}$ and $\frac{1}{999}$ that of the galvanometer. Leaving all the plug holes open puts the galvanometer directly in the circuit. Plugging

a and e , short circuits it. Plugging f and b shunts the galvanometer with $\frac{1}{9}$ of its own resistance and so cuts down its current to $\frac{1}{10}$ of what it was formerly. Likewise plugging between f and c and f and d cuts down the galvanometer current to $\frac{1}{100}$ and $\frac{1}{1000}$ of its value when the shunt is open. The shunts are, of course, to reduce the sensibility of the instrument and are used when making the first adjustments of the bridge when the resistance to be measured is not known very closely beforehand, so as to keep the galvanometer needle from swinging excessively or banging itself to pieces if there are stops. We are now ready to connect up our bridge. The galvanometer and scale are supposed to be on or a little below the level of the eye, and the resistance box or bridge may be set on a table of convenient height between them. Make the connections as indicated in the previous bridge diagram.

We will suppose first that your bridge is a box of resistance coils. Put a small resistance between the "unknown," binding posts and unplug — say 10 from each of the proportional arms and leave the rheostat or adjustable arm entirely

plugged in. Plug in the $\frac{1}{999}$ galvanometer-shunt and then depress the key, closing the battery first and galvanometer second. This is a very important step, as the self-induction in the resistance to be measured is often very great, especially if it is a heavy magnet and this self-induction will cause the galvanometer light spot to fly all over the scale if its connection is made too soon after the battery circuit is closed. Then on pressing the galvanometer key the light spot should move off to one side of the scale or something is wrong with the connections. Next, with everything else the same as before, unplug infinity in the rheostat arm and on pressing battery and galvanometer keys the light spot should move off in the other direction. These directions should be noted and remembered, so that in the future you may be able to tell at once whether you have too little or too much resistance unplugged in the rheostat arm. Replacing the infinity plug, unplug what you think is about the resistance of the unknown and try that. The direction in which the light spot moves will tell you whether it is too much or too little. Keep on with your adjust-

ment until you have it about right and then remove the galvanometer-shunt and make the final adjustments, that is, get a resistance into the rheostat arm, such that the light spot does not move from zero, whether the keys are raised or depressed. The resistance unplugged will bear the same ratio to the unknown that the proportional arms do to each other. It will often happen that unplugging the smallest unit you have in the rheostat arm will cause the spot of light to go to one side of the zero and plugging it in will cause the spot to go to the other side of zero, thus indicating that the true value of the unknown resistance lies between these limits. If it is desired to go below this smallest unit it is generally sufficient to take the deflections on each side of zero as proportional to the difference of the true value from that indicated by the rheostat. Thus, if the galvanometer spot should be at $+ 15$ when 98 ohms were unplugged and $- 10$ with 97 ohms, we know that the true value of the unknown resistance lies somewhere between 97 and 98 , and that it is fair to assume it to be about 97.4 ohms.

It is not safe to divide differences of more than

one or two per cent by this method of deflections, as the galvanometers used for resistance measurements do not follow the tangent law except for a few degrees on each side of zero. If measurements are made of smaller quantities it is better to change the proportional arms to suit. Measurements of small resistances should, however, never be made on a box of resistance coils if accuracy is desired. There are too many chances of error in bad contacts, especially in the plug holes, and of contacts of variable resistance in the leads.

The lead wires should be measured after each resistance measurement and this measurement deducted from the value already obtained. This is done, of course, by simply disconnecting the object whose resistance was being measured and clamping the free ends of the leads together.

Whenever the resistance of an object in a different part of the room or building is to be measured and there is enough of this sort of work to make it worth while to put up permanent lead wires it is a good plan to introduce an additional resistance in them which will bring up the total to some even number of ohms. This makes the

calculations simpler for getting at the unknown resistance and thus lessens the liability of errors. Of course, if very accurate results are desired, the leads must be measured each time, on account of the error introduced by variations of temperature. If the wires are made large, however, this

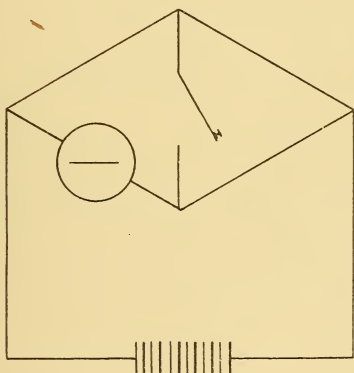

FIG. 18.

error will be so small a percentage of the whole that it may in most cases be neglected.

It is desirable in some cases to know the resistance of the galvanometer which is used with the bridge, and often there is no other galvanometer which can be used to measure it in the ordinary way. A second galvanometer may be dispensed

with, if Thomson's method is employed. Figure 18 shows the arrangement. The galvanometer is connected in the x or "unknown" arm of the bridge the same as any other unknown resistance would be and in the place where the galvanometer usually would be is a key. It is easily seen that when perfect balance is obtained in the four resistance arms, opening or closing the key can have no effect on the current passing through these arms. The idea is, then, to pass a current through the bridge which will give a readable deflection on the galvanometer and then adjust the resistance arms until opening or closing the key makes no change in the galvanometer deflection. It will be necessary to cut down the battery current, by shunting it otherwise the current will be much too great to work with. A resistance should be included between the battery and the shunt in order to keep the battery current constant. Now press the battery key and putting the directing magnet low so as to strengthen the earth's field, turn it about until the deflected light spot is brought back on the scale. Then press the key which is in the former galvanometer circuit and

adjust your rheostat arm until opening or closing this key has no effect on the galvanometer. It is suggested that in the case of differential galvanometers, it is a good plan to measure only one coil at a time and to send a current from another battery through the other coil, which will nearly balance the current in the coil being measured.

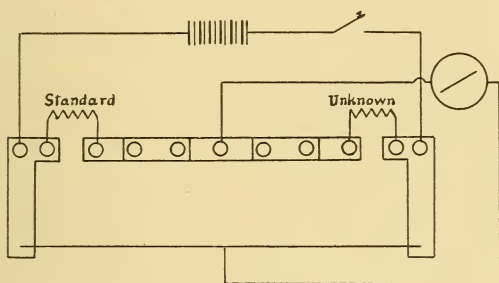

FIG. 19.

This increases the delicacy with which the measurements may be made, as it is then unnecessary to lower the directing magnet.

The principle of the Slide Wire Bridge has been explained above, and it only remains to give a brief account of the method of working it.

When only rough measurements are desired, the resistances of the connecting copper strips may

be disregarded and the connections made as shown in Figure 19. A standard or known resistance will be required to compare the unknown resistance with. The operations are similar to those with the box of coils except that in this case the proportional arms are altered instead of the arm in opposition to the unknown. The battery key should always be pressed first, as in the other case. The slider contact serves for the galvanometer key in this case. When balance is obtained, the lengths of the slide wire on both sides of the contact are used to form a ratio which is equal to that of the known and unknown resistances. When our measurements are to be made more exact a number of corrections and allowances must be made. The thermo current from the junction of the platinum contact with the bridge wire, notwithstanding the fact that it is so small, will noticeably affect a galvanometer which is at all sensitive when it is connected as shown in Figure 19. By interchanging the battery and galvanometer connections, we do away with the evil at this point, and while it may exist now at the soldered connections of the wire to the copper strips, it is to a much

smaller extent and may be made insignificant if we use care in keeping the two ends of the bridge at a uniform temperature. Wrapping them around with some non-conducting material will do this. By pressing the contact key when the galvanometer is connected, as at first it can be seen if the error will be sufficiently great to make the change

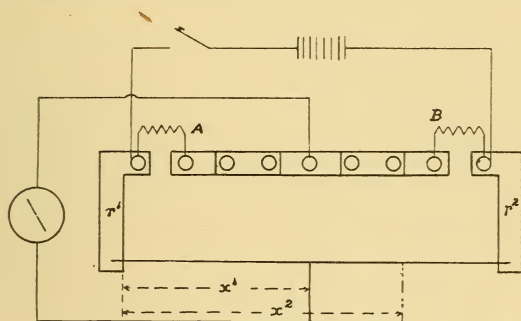

FIG. 20.

advisable as indicated above. It may happen that the contact piece does not touch the wire at the point indicated on the scale. This may be corrected by making two measurements, the second with the known and unknown resistances interchanged. The resistances of the end pieces, although small, cannot be entirely neglected.

In Figure 20 let $r_1 =$ the resistance of the

copper strip to the right and $r_2 =$ the resistance of the left hand strip. Let A and B be the resistances which we are comparing. Also suppose the scale to be in error by a quantity d , that is to say that the reading from the slider does not correspond with the point of contact on the wire. All resistances are expressed in terms of divisions of the slide wire, which we will suppose is divided into 1000 equal parts.

Now, on balancing up in the usual way, let x_1 be the reading obtained. The true reading will then be $x_1 + d$ and the ratio of the resistances A and B will be

$$\frac{A}{B} = \frac{r_1 + x_1 + d}{r_2 + 1000 - (x_1 + d)}$$

Interchange A and B and a new reading will be obtained, say x_2 . The new ratio will then be

$$\frac{A}{B} = \frac{r_2 + 1000 - (x_2 + d)}{r_1 + x_2 + d}$$

Adding the numerators and denominators of the fractions together, we get a ratio,

$$\frac{A}{B} = \frac{1000 + r_1 + r_2 + (x_1 - x_2)}{1000 + r_1 + r_2 - (x_1 - x_2)}$$

which is free from d and in which r_1 and r_2 which

are small quantities are added to large ones, and since they are small and their values not definitely known, we may, without great error, omit them from the equation and use the formula proposed by Siemens.

$$\frac{A}{B} = \frac{1000 + (x_1 - x_2)}{1000 - (x_1 - x_2)}$$

This formula will be most nearly exact when the quantities x_1 and x_2 are nearest equal. To determine the values of r_1 and r_2 let the coils A and B be two whose values are known and whose ratio is about 100 to 1. Supposing there is no scale error

$$\frac{A}{B} = \frac{r_1 + x_1}{r_1 + 1000 - x_1}$$

and after interchanging A and B

$$\frac{A}{B} = \frac{r_2 + 1000 - x_2}{r_1 + x_2}$$

Solving these equations for r_1 and r_2 we get

$$r_1 = \frac{B x_1 - A x_2}{A - B}$$

and

$$r_2 = \frac{B (1000 - x_2) - A (1000 - x_1)}{A - B}$$

The sensitiveness of the bridge may be greatly increased as stated above, by lengthening the slide wire, or (what amounts to the same thing) by adding resistances in series with it. (See Fig. 21.)

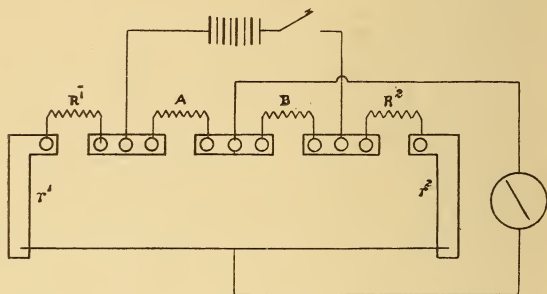

FIG. 21.

These resistances are shown above as R_1 and R_2 . The ratio A to B when these resistances are in, is

$$\frac{A}{B} = \frac{r_1 + R_1 + x_1}{r_2 + R_2 + 1000 - x_1}$$

Interchanging A and B the equation becomes

$$\frac{A}{B} = \frac{r_2 + R_2 + 1000 - x_2}{r_1 + R_1 + x_2}$$

Adding numerators and denominators together we obtain

$$\frac{A}{B} = \frac{r_1 + r_2 + R_1 + R_2 + 1000 + (x_1 - x_2)}{r_1 + r_2 + R_1 + R_2 + 1000 - (x_1 - x_2)}$$

With any given values of R_1 and R_2 , the range over which readings may be taken is reduced from what it would be if they were omitted entirely, but at the same time the sensitiveness of the bridge is increased. Of course, it is only necessary to make a proper choice of R_1 and R_2 to obtain any readings we desire. The values of R_1 and R_2 must be determined in terms of bridge-wire divisions before they can be inserted in the formula. To do this remove R_2 from the bridge and close the opening by the copper connection. With A and B known the value of R_1 will be

$$R_1 = \frac{A}{B} (1000 - x_1 + r\sqrt{2}) - x_1 - r_1$$

So also with R_1 bridged, the value of R_2 will be

$$R_2 = \frac{B}{A} (r_1 + x_2) - r_2 - 1000 + x_2$$

Mercury cups are used in making the connections to the coils when careful work is to be done. These cups are simply holes bored in blocks of wood and filled with mercury. In the bottom of each cup is placed a disk of copper which has been amalgamated. In making connections it is only necessary to dip the ends of the wires (which

have previously been amalgamated) into the cups, making sure that they touch the bottom.

For making comparisons of resistance, a number of coils should be on hand whose resistance and temperature coefficient is accurately known.

The commercial form of standard ohm found in

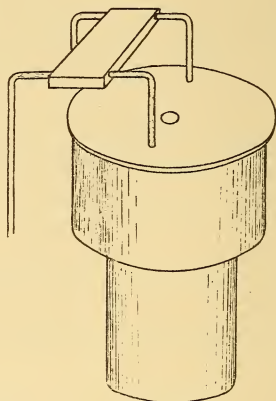

FIG. 22.

most laboratories is shown in Figure 22. The standard coil is wound within the lower cylinder which, when being used is placed in water up to the shoulder. The ends of the coils are attached to the thick copper wires coming up through the top and which are dipped into the

mercury cups spoken of above, when the coil is being used. A therm meter is introduced through the hole in the top to take the temperature.

There are often cases when it is desirable to get the resistance of some object while a current is passing through it, as, for instance, an incandescent lamp whose resistance when "hot" is about half of what it is when cold. About the only way this can be done is to take the volts and amperes of the current passing through the lamp and calculate the resistance from these.

Professors Ayrton and Perry have designed an instrument called an ohmmeter for measuring the resistance of a circuit over which a current is passing. There are two coils in the instrument whose centres are coincident and whose planes are at right angles. A small needle is suspended at the centre of the coils so as to revolve about the line of intersection of the planes of the two coils as an axis. This needle moves an index over a scale above, graduated to read in ohms. One of the coils is of thick wire and is placed in series with the circuit whose resistance is to be measured, the other is of fine wire and is placed in

parallel to the circuit. When a current is flowing through the instrument in the manner indicated, the resultant direction of the magnetic field in the centre of the coils will depend upon the relative intensities of the currents in the coarse and fine wires and as any variation of the strength of current in the main circuit will change the two currents in the instrument in the same proportion, it follows that each deflection of the needle will correspond to a particular resistance, since this resistance is the only thing that changes the relative value of the currents.

We will now take up briefly some special cases of resistance measurements.

Neither very high or very low resistances can be measured by ordinary methods with any approach to accuracy. The resistances of the contacts in making low resistance measurements is often greater than the resistance of the object itself. We have then in general, to adopt some method by which this contact resistance way does not enter into question. One of these methods is with a differential galvanometer. Figure 23 shows the arrangement.

A B is the low resistance to be measured. C D is a standard bar graduated decimally and joined to A B by B C. A current is passed over the standard and unknown resistances in series. From two points on A B between which it is desired to take the resistance, two wires are led to one coil of a differential galvanometer and the other coil is connected to E and D on the standard

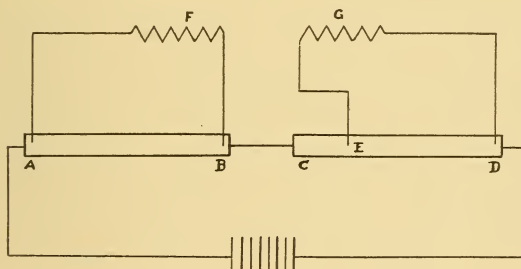

FIG. 23.

bar. The contact *E* is arranged so as to slide along the bar.

The differential galvanometer is one with two coils insulated from each other and acting upon a magnetic needle placed on their axis between them. If a current is passed through one coil and in such a direction as to oppose an equal cur-

rent in the other coil there will be no effect upon the needle at the centre.

Before using the galvanometer, its coils should be coupled in parallel in such a manner that the currents will oppose each other. There should be no deflection of the galvanometer-needle with the current on or off; but if there is a deflection a sufficient resistance should be inserted in one of them to bring the needle back to zero.

In making measurements by this method the sliding galvanometer connection on the standard rod should be moved backwards or forwards until there is no galvanometer deflection, when the unknown resistance will be equal to the resistance included between the galvanometer terminals on the standard bar, since the same current is passing over each, and the fall of potential is shown by the galvanometer to be the same for both resistances. This method evidently gets around the difficulty with the contact resistances, since the only contact resistances we have to deal with are those of the galvanometer connections and they are so small in comparison with the resist-

ance of the galvanometer itself that they may be safely neglected.

The current used must not be strong enough to raise the temperature of the resistances noticeably, as this might introduce a very considerable error in the results.

The standard resistance should be somewhere near in value to the resistance to be measured and may be made with same apparatus.

A one-ohm resistance will be required to start with, which is placed between the terminals $E D$ in the diagram. The total resistance in the circuit of the galvanometer coil connected to this side is then increased ten times. The points $A B$ on a thick wire of convenient length are then determined and the resistance between them will, of course, be one-tenth of an ohm. With this wire as the standard, the same process may be used to lay off one one-hundredth of an ohm on thicker wire. Then with the terminals on the standard fixed a short distance apart, find a length corresponding on the other wire which balances it and see if this length is the same for every part of the wire. If it is, then the wire may be divided

up evenly on a decimal scale. But if the resistance of the last wire is not the same for each equal division of its length, then a definite resistance must be taken on the auxiliary wire and the length for the corresponding resistance determined for each portion of the other wire. The lengths of the decimal divisions at the different parts of the wire will then be proportional to the lengths just determined.

There are a number of other methods for making low resistance measurements, but the above is sufficiently general to cover most cases met with in practice.

For very high resistances a special method is also necessary. The one we will describe requires a sensitive galvanometer and a large battery—say 100 or 200 cells, which should be well insulated.

The galvanometer, battery and resistance to be measured are joined in series and the deflection of the galvanometer noted. The unknown resistance is then removed and in its place is inserted a high known resistance.

In Fig. 23 $\frac{1}{2}$ let E represent the battery E. M. F., B , its resistance; X , the unknown resistance; G ,

that of the galvanometer; S , that of the galvanometer-shunt; R , the resistance inserted in series with the galvanometer; D , the galvanometer deflec-

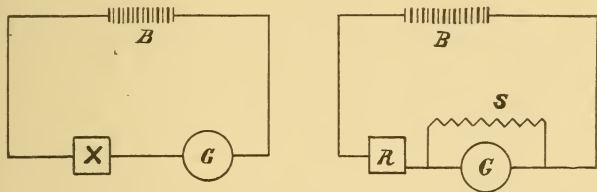

FIG. 23½.

tion, and c a constant by which this deflection must be multiplied to give volts, we have the following equations:

$$\frac{E G}{G + B + X} = c D$$

for the first case, and

$$\frac{E \frac{S G}{S + G}}{B + R + \frac{S G}{S + G}} = \frac{E S G}{(B + R)(S + G) + S G} = c D$$

and from these two equations we find that

$$X = \frac{D_1}{D} \left(B + R + G + \frac{(B + R) G}{S} \right) - (B + G)$$

where if X be great in comparison with the rest of the circuit, $(B + G)$ may be dropped.

Everything must be carefully insulated in making this test. The methods of making connections to the specimens will, of course, vary in every case. For insulators of the cup-shaped variety, such as are used in telegraph work, they may be filled with

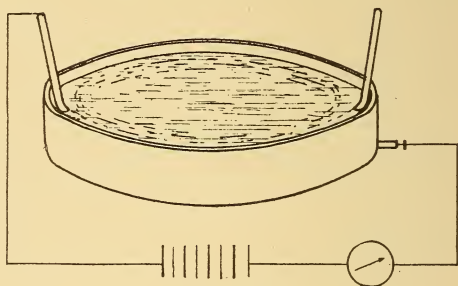

FIG. 24.

mercury within half an inch of the top and placed in a vessel containing mercury up to within half an inch of their brim and the connections made in the mercury. The rims should be coated with paraffine.

Cables may be coiled up in a zinc trough full of water. The two ends are brought out and dried. One is carefully insulated and the other connected to one of the galvanometer terminals,

and the other terminal goes to the zinc trough. (See Fig. 24.)

Leaks in lighting installations may be detected by an ordinary voltmeter if their resistance is not too great compared to that of the voltmeter. The voltmeter is first placed directly on the dynamo or battery and then in series with the leak and from these readings and the known resistance of the voltmeter, the leak resistance is calculated. Letting L = leak resistance, R = voltmeter resistance, V = reading of voltmeter direct from dynamo or battery, and v = voltmeter reading when in series with leak. Then

$$\frac{V}{v} = \frac{L + R}{R} \text{ or}$$

$$L = \frac{R V}{v} - R$$

We will close this chapter with a short description of the method of measuring the resistance of a battery.

Battery-resistance is rather an indefinite term, as it changes somewhat with the strength of the current and is also apt to increase after the current has been passing for a while.

What we generally want to know, however, is what is the resistance for a given external resistance.

Suppose E to represent the battery E. M. F. on open circuit; R , the external resistance, and B , the battery resistance, and suppose V to be the voltage at the poles of the battery when it is working on the given external resistance. Then

$$\frac{E}{R + B} = \frac{V}{R} \text{ or}$$

$$B = \frac{E - V}{V} R$$

Therefore with a potential galvanometer or high resistance voltmeter, measure the battery E. M. F. on an open circuit, and again when it is working on the given resistance. The values obtained substituted in the above formula will give B .

CHAPTER III.

CURRENT MEASUREMENTS.

THE practical measurement of current is usually made by means of some instrument which has been calibrated to read directly in amperes by means of a graduated scale and a pointer.

Instruments of this sort in general do not work according to any well defined law by which their indications may be predicted accurately beforehand and must be compared with some standard.

The two methods of checking up an instrument most commonly used are with an absolute tangent galvanometer and by a copper or silver voltmeter. The former method, although not so much used as the latter, will be outlined here.

It is rather cumbersome, as an accurate knowledge of both the constants of the instrument and the strength of the magnetic field in which it works is required. This magnetic field will, in general, be the horizontal component of the earth's magnetism, commonly designated as H . It must

be determined in the place in which the galvanometer is to be used, as a small variation in locality may materially change its value. This is especially true when there is any iron about. Iron itself is not very objectionable if it is stationary and does not change its magnetic strength.

To measure the value of H , a magnetometer will be necessary. (See Figure 25.) It consists

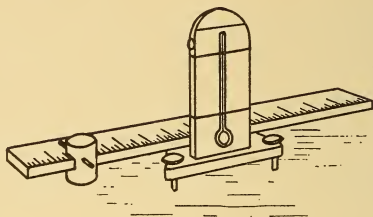

FIG. 25.

of an upright piece of wood about 6 inches high and $\frac{1}{2}$ " thick by $1\frac{1}{2}$ " wide, mounted on a triangular base $\frac{3}{4}$ of an inch thick and 5 inches on a side, which is provided with three levelling screws. An inch from the lower end of the upright an opening is cut about the diameter of a five-cent piece and twice as deep as the five-cent piece is thick.

From this opening to the top of the upright a small groove is cut, and at the top of the groove

an adjusting brass pin is fitted. This pin takes a fibre of cocoon silk, by which is suspended at the circular opening below a small galvanometer mirror, with a bit of magnetized sewing needle cemented to its back.

The deflections of this needle are to be observed by means of a spot of light on a scale placed at a metre's distance, as described in the chapter on Resistance Measurements, or with a telescope.

To prevent the needle being disturbed by vagrant currents of air, a strip of glass is placed in the front of the upright piece and held by rubber bands.

Of course, no iron must be used in constructing the magnetometer.

A wooden scale graduated in centimetres is clamped to the base board in the rear, and on it slides a cork through which the magnet to be tested is thrust at right angles to the scale.

The test magnets are made of knitting needles about 7 centimetres long. (The metric system is used in designating lengths which occur in calculations, so as to avoid trouble in changing from one system to another.)

They are first annealed by heating and then straightened and smoothed up on the ends.

Half a dozen are then bound into a bundle with iron wire and again heated to a cherry red and plunged vertically into cold water. Select those

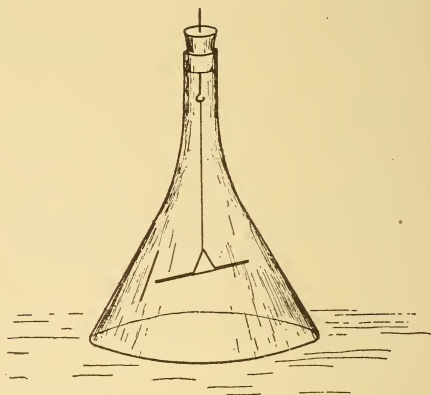

FIG. 26.

which appear to be straight and magnetize them in a helix.

The magnets are to be suspended under a glass shade by means of a silk fibre and a paper stirrup. A bottle with the bottom cut off makes a good shade, and a convenient one is made by inverting a glass funnel. (See Fig. 26.)

The opening at the top is stopped by a cork, through which passes a hook from which the fibre is suspended.

The needles are caused to vibrate around the fibre as an axis by means of a magnet, without however, any pendulum motion, and their times of vibration noted. This is done by noting the instant of passage in front of an ink mark on the surface of the glass. The mark should be placed so that the needle when at rest points to it.

The time taken for 10 swings should be noted, then for the next 10, and so on, and the results averaged up to give the time for a single oscillation. The swings should not be excessive in amplitude. Then, taking the length, diameter and weight of the magnets in C. G. S. units calculate the moment of inertia by the following formula :

$$I = \left(\frac{l^2}{12} + \frac{r^2}{4} \right) w$$

where l = length in centimetres, r = $\frac{1}{2}$ diameter in centimeters and w = weight in grammes.

Let M = moment of the magnet, *i. e.*, the strength of one of its poles multiplied by the

distance between them, and $T =$ the time in seconds of a single vibration, then

$$M H = \frac{4 \pi^2 I}{T^2}$$

The magnetometer should now be set up in front of a scale on which a spot of light is reflected from its mirror. The scale should, of course, be at

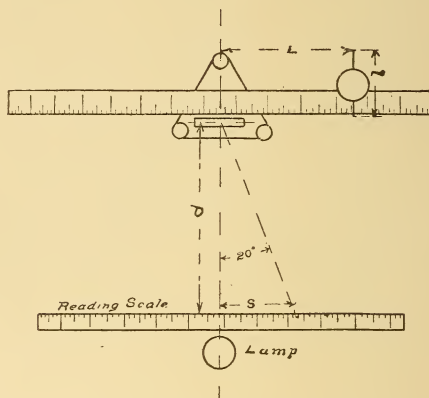

FIG. 27.

right angles to the line of light when the mirror is at rest, and should be a known distance away, preferably an even number of its scale divisions, say 100. A plan of magnetometer arrangement is shown in Fig. 27.

Place one of the magnets in the cork on the

wooden scale as shown, with its middle on a line with the magnetometer needle, and observe the deflection on the reading scale, which call S . Then letting d equal the distance from the magnetometer mirror to the reading scale, and a , the angle through which the mirror turns, we have

$$\tan 2 a = \frac{S}{d}$$

from which, with a table of natural tangents, we easily find a . We also note this distance L of the magnet from the needle, and get the value

$\frac{M}{H}$ from the formula

$$\left(\frac{M}{H} = L^2 + \frac{l^2}{4}\right)^{\frac{3}{2}} \tan a$$

We now have the value $M H$ and $\frac{M}{H}$, and by dividing the first by the second we get the value of H^2 , from which H is easily derived. Knowing this, we proceed with our tangent galvanometer. This is a galvanometer consisting of a coil of wire, whose dimensions are accurately known, which acts upon a needle at its centre. The tangent of the deflection of this needle is proportional to the current passing around the coil. If neither the

breadth nor the depth of the coil is greater than $\frac{1}{10}$, the mean diameter of the coil and the needle is short in comparison with the diameter, the following equation holds true with a very small error

$$C = \frac{H r}{2 \pi H} \tan a$$

where C is the current passing through the coil in C. G. S. units (ten times the practical unit or ampere), H is the intensity of the horizontal component of the earth's magnetism as given above, r is the mean radius of the coil in centimetres, N the number of turns in the coil, a the angle through which the needle turns. The diameter and number of turns of each layer of wire must be carefully taken as it is wound on, and great care used to make the wire lie smoothly and evenly and to prevent contacts between the adjacent coils.

The angle may be read off by a beam of light reflected from a mirror attached to the needle, upon a scale or by a pointer attached to the needle and moving over a scale divided into degrees or better, tangents. In the latter arrangements the scale

from which the readings are taken should be pasted on a mirror, and when making an observation the eye should be brought into such a position that the pointer hides its image, and any error due to parallax is avoided. The pointer should be made as light as possible to avoid the effects of inertia when you wish it to come to rest. A glass tube drawn out to a thin straight thread is often used, as is also an aluminum wire flattened at the ends in a vertical plane. The suspension of the needle may be made by means of a jewel resting on a hardened steel point as in a compass or by means of a silk fibre, the latter preferably, to eliminate the error due to friction. It is well to make all parts of the galvanometer which can be made so, of wood. Brass may and must be used in certain places, such as for screws and rigid supports, but it is difficult to get it entirely free from iron, and this makes it a bad thing to use. Wood is very liable to warp out of shape, but if it is perfectly dry and is "built up" of a number of pieces whose grain crosses, this difficulty may be almost entirely avoided.

It is often convenient to vary the range over

which the galvanometer may be used by winding it with a number of coils of different sized wire. A single strip of copper makes a good coil for heavy currents. The galvanometer must be set up on the spot where the magnetometer measurements of H were made, and with the plane of its coil in the magnetic meridian. The needle and pointer—if a pointer be used—should be at right angles to each other, although this is not strictly necessary, and the pointer when the current is off should stand exactly over zero on the scale. Then try if equal currents passed through the galvanometer in opposite directions deflect the pointer by equal amounts. If they do not, the galvanometer coil is not exactly on the magnetic meridian, and it must be revolved until it is, the scale being shifted at the same time to keep its zero under the pointer.

As the most sensitive point for making a galvanometer reading is at 45° , the current should be arranged so as to give about this reading. This may often be done by means of shunts when their resistance and that of the galvanometer is accu-

rately known. When the galvanometer constants are not known the value of

$$\frac{H r}{2 \pi N}$$

in the formula may be determined by calibration, from some other source. One of the best methods for doing this and likewise for calibrating any current measuring instrument is by means of the copper voltometer.

The subject has been investigated pretty thoroughly and it has been found that with ordinary commercial copper sulphate and good water, (not necessarily distilled, but such as can usually be had from the city mains,) results may be obtained which have only a small percentage of error, if ordinary care is taken in making the experiments. Silver will give more accurate results, but besides being very expensive it requires very careful manipulation by a trained experimenter. The copper sulphate is dissolved in the water until it gives a density of from 1.15 to 1.18. The solution should give a distinctly acid reaction, and if it does not do so when it is first made a few drops of sulphuric acid should be added. The plates are to be made

of sheet copper, the thinner the better, that from which dynamo brushes are made is very good. For currents up to 15 amperes, they should be made something as shown in Figure 28.

The long tongue is to fasten them into a clip with, and allows the square part which is to be

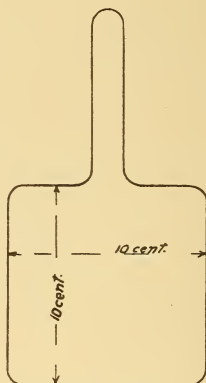

FIG. 28.

plated on to be entirely submerged. The corners are all to be carefully rounded and the edges smoothed. Great care must be taken after the plates are once made ready, not to touch them with the fingers as a greasy mark will be left which will not be plated on. The preparation of the plates is a matter demanding some care. The sur-

face must be scoured bright with sand-paper and then washed off in running water. The plate is then placed lightly upon a blotting pad to remove the surplus of water, and then dried before a fire or over a spirit flame, care being taken that the plate does not get sensibly heated.

If the surface is much oxidized it may be immersed for a few seconds in strong nitric acid and then rinsed off and dried as above. The plates are to be held by their tongues by stiff springs, clips of brass or platinoid wire, which are attached to a wooden frame over the top of the cell. There must be a loss plate on each side of each gain plate. In cells which have only one gain plate there will be two loss plates, and in cells with two gain plates there will be three loss plates and so on. The plates are to be held rigidly parallel to each other and for the size plate mentioned above about 15 m m. apart.

The area of the plates is governed by the current to be measured. The gain plate may be almost anything from 20 sq. cm. per ampere upwards, about 50 sq. cm. per ampere is a good ratio. If the loss plate area is allowed to get much below

40 sq. cm. per ampere the current is apt to fluctuate. If the current strength is too great for one plate a number of them may be coupled up in parallel. It is also a good plan where the current is not large to couple up similar voltameters in series so that you may check the results obtained from one by those from the other.

After having placed the plates in the solution the current is turned on and adjusted by means of a variable resistance in the circuit to some even reading on the instrument. This done, stop the current and remove the gain plates and quickly rinse and dry them. Then weigh them carefully and replace them in the bath and turn on the current. Note the time carefully, by a stop watch if possible. The current should be nearly right but will probably need a little adjustment which should be made quickly. The instrument should be carefully watched and any variation in the current quickly corrected.

The current should be left on for about two hours, and after carefully noting the time, be turned off and the plates quickly removed, carefully washed in running water and dried. Then weigh

the gain plates, and from the increase in weight calculate the current. One coulomb of electricity will deposit .000329 gramme of copper. Hence the number of amperes equals the weight of copper deposited, divided by the number of seconds, times .000329.

The gain plate should have a bright flesh colored appearance, and if it has not there is something wrong with the solution or the current strength. There is sometimes a tendency for the deposit to become rough and granular about the edges of the plate. In case it does, care must be taken not to lose any of it in washing. This tendency however generally indicates too great current strength, and may be corrected by proper attention to this detail.

Larger currents will in general, require special arrangements of plates, clips, etc., which may be left to the ingenuity of the reader. We will briefly describe the principles of a few commercial instruments, and close our chapter on current measurements.

Many, if not most of the instruments used for current measurements, can be adapted to potential

measurements by a change in the winding so that many things will be said here which will not need repetition in the next chapter. The Ayrton & Perry spring ammeter and voltmeter, consists of a vertical solenoid, which sucks into its middle a light piece of soft iron. (See Fig. 29.)

This iron is attached to the lower end of a spring, made of a flat strip of phosphor bronze and

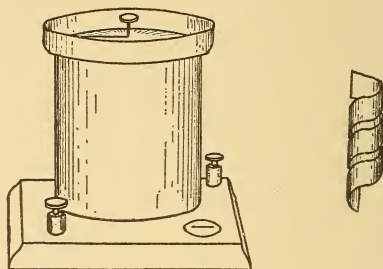

FIG. 29.

which when extended causes a large rotary movement of the free end. The other end is attached to a milled head on the top of the instrument by which the pointer is adjusted to zero.

A small compass in one corner of the base indicates the direction of flow of the current. This instrument is not graduated along the lower part of the scale, as the core does not become fully

saturated with small currents, and hence does not give a very sure indication. Another ammeter on a somewhat similar principle is made by surrounding a tube containing water with a coil, the current in which acts upon a piece of iron in a sort of hydrometer floating in the water. (See Fig. 30.) The iron is high enough out of the coil so that

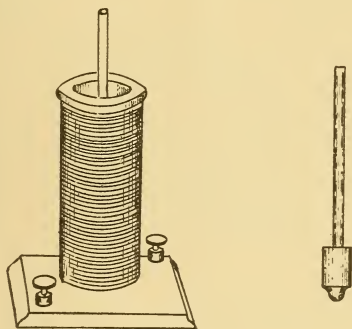

FIG. 30.

it is pulled down as the current increases, and the indications are read off like those of an hydrometer.

A number of instruments depend upon the repulsion of two similarly magnetized pieces of soft iron. (See Fig. 31.)

The two pieces are enclosed in the same coil of wire, one of them being fixed and the other hung

from a pivot to which is also attached the pointer. When the current passes, the north and south poles of each are opposite the same poles on the other, and consequently exert a repulsion, which is arranged so as to work the pointer and which is in general balanced by gravity. These instruments, and to some extent all instruments which depend at all upon the magnetization of

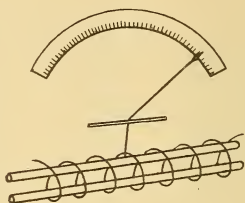

FIG. 31.

soft iron, suffer somewhat from the effects of persistent magnetism, that is to say, the readings are not always the same with a rising current as with a falling current, as after the iron has been highly magnetized and the current gradually lowered the magnetism is retained and does not fall until the current has been greatly reduced. This can sometimes be helped by tapping the instrument lightly, (which is a bad thing to do if the instrument is

jewelled,) or by opening the current before taking a reading, if a voltmeter, or short circuiting the instrument if an ammeter. You then get all your readings on a rising current, the way in which the instrument was probably calibrated.

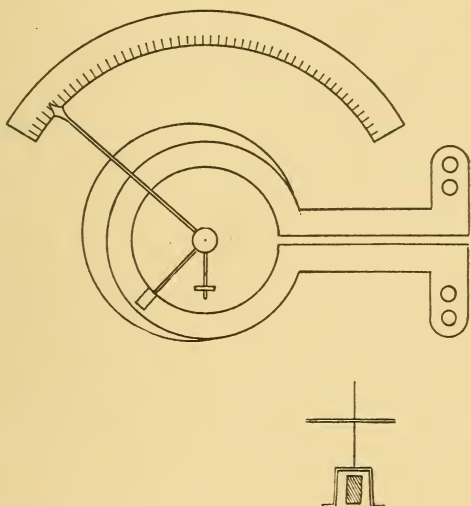

FIG. 32.

An instrument made by the General Electric Company, is shown in Fig. 32.

The current is led around in a circular ring which is nearly enclosed on three sides by a stirrup of thin iron. This stirrup is suspended from a

pivot which is a little to the left of the centre of the ring, so that when the pointer travels across the scale the stirrup approaches the ring. When the current is turned on the iron stirrup, according to the well known law, tries to shorten the lines of force around the ring as much as possible, and in order to do this it moves up closer to the ring and thus moves the pointer.

The peculiar shape to the "fin" on the ring is for the purpose of making a proper spacing of the division marks on the scale.

There are a number of instruments working on the galvanometer principle, that is, they have a magnetic needle which tends to set itself at right angles to a coil carrying a current. Some of these have an artificial and some a natural magnetic field to balance the effect of the coil, and some have a spring. The artificial field may be produced either by a permanent or electro-magnet. The former is better adapted for voltmeters than the latter, since it takes too much current to saturate the magnets and increases the liability to a heating error. This heating error, by the way, is one which is only introduced into volt-

meters. An increase of the temperature of the wire due to the current passing or to local causes increases the resistance of the wire and thus reduces the current of a voltmeter and makes it read wrong. In an ammeter all the current has to pass through its coils, so the heating effect is not important. For this reason, then, the electromagnetic field is not so bad for ammeters, although even then there is a chance for persistent magnetism errors, and the possibility that if the magnets get overheated it may change their susceptibility.

Permanent magnets are frowned upon in many quarters on account of their liability to change. If however, they are properly made in the first place and are "aged" after magnetizing, by being boiled in water and roughly handled and jarred, they will be pretty constant. An instrument of this sort must be very carefully handled and not jolted or jarred, or brought near any other strong magnets such as dynamo fields, but with proper care it will remain quite constant. It should however be frequently checked to see what change there is

in it. A notable example of this kind of instrument is the Thomson graded galvanometer.

This is a galvanometer made with the usual coil of wire and needle, the latter being pivoted on a jewel and having a long aluminum pointer. The box containing the needle may be slid along the axis of the coil, and marks are made upon the base board by which to locate the box. By bringing the box nearer to or farther away from the coil it is possible to get a great range of readings. Attached to the compass box is a semi-circular magnet which makes the controlling field, and the strength of the magnet is marked upon it.

Siemens makes a neat little galvanometer with a long vertical coil and a little bell magnet suspended within it.

The turning of the magnet is balanced by a spring attached to a milled head by which the magnet is brought back to its zero position.

It is used for measuring only small currents and has a resistance box to go in series with it, by which it may be made to measure potentials. It is rather too sensitive to external influences to be of much use outside of a laboratory.

The d'Arsonval instrument is a very satisfactory one to work with. It consists of a permanent magnetic field, within which is suspended a movable coil through which the current passes. By properly shaping the pole pieces of the permanent magnet and the core inside the coil, a scale can be obtained in which the divisions are nearly equal.

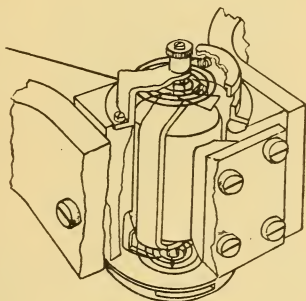

FIG. 33.

The Weston ammeters and voltmeters are made on this principle. The movement of the coil is balanced by a spring through which the current is led to the coil. This necessarily limits the amount of current which may be taken into the coil, and renders it necessary where large currents are to be measured, to use a low resistance and attach the ends of the coil to the ends of the re-

sistance. For measuring high potentials a resistance is introduced in series with the coil. It is thus possible with a little shifting of connections,

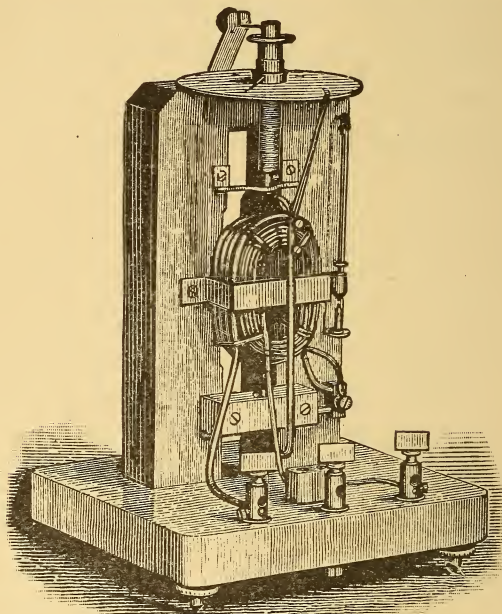

FIG. 34.

to make the same instrument serve for both ammeter and voltmeter. (See Fig. 33.)

The Siemens dynamometer is a very useful and accurate instrument for current measurement. (See Fig. 34.)

It consists of two approximately rectangular coils, whose planes are at right angles to each other and with their centre lines coincident. One coil is fixed and the other is suspended from a fibre and is controlled by a spring attached to a milled head. The ends of the wire of the movable coil dip into mercury cups for the current.

The current is sent in series through the two coils and their tendency is to place themselves in the same plane. This tendency is resisted by the spring, and by the aid of the milled head the movable coil is brought back to its initial position. The distance through which the milled head is turned is shown by a pointer, and is a measure of the force acting on the coil. This force is proportional to the product of the currents in the two coils, since these currents are identical to the square of the current. A printed table accompanies each instrument, giving the value in amperes for different deflections.

This instrument has the advantage which few others have of being applicable to the measurement of alternating currents, as the direction of the current has no effect on the direction in which

the movable coil turns, and there is no iron magnet about it.

A special form of this instrument is called the wattmeter. It is the same as the other with the exception that one coil is wound with fine wire. The instrument is used to determine the energy consumed by a piece of electrical apparatus, by

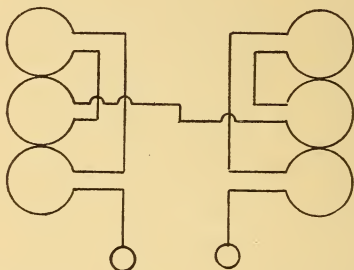

FIG. 35.

giving the product of the potential by the current going through it. The fine wire coil is connected in parallel with the apparatus, and the thick wire in series with it. The force tending to turn the movable coil is then proportional to the products of the two currents, which are themselves proportional to the current and potential of the apparatus, and we thus get a reading proportional to the watts consumed.

Lord Kelvin's electric balances are upon a somewhat similar principle. They have a movable coil between, and parallel to two other coils which are stationary. The current is sent through all three in such a way that the movable coil is attracted by one of the stationary coils and repelled by the other. The movable coil is attached

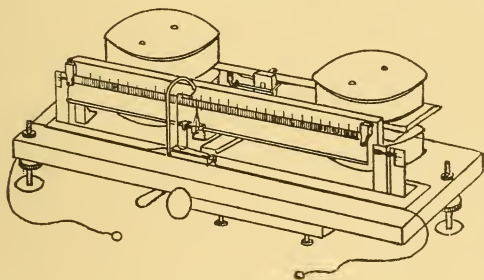

FIG. 36.

to one arm of a balance, and there is a similar system of coils on the other arm. (See Fig. 35.)

The adjustments are made by shifting a little slider along the balance arm until balance is obtained, and the current is then known from the position of the slider. To reduce friction to a minimum and still secure a free passage for the electricity into the movable coils, the balance arm is

suspended by a number of very fine copper wires. Their cross section is not great, but their superficial area is so great that they readily radiate the heat generated by the current. (See Fig. 36.)

CHAPTER IV.

POTENTIAL MEASUREMENT.

THE primary standard for potential measurements nowadays is generally the standard cell. This cell is constructed with great care, and gives under certain conditions, an E. M. F. which is nearly constant. A brief description will be given of two forms and the method of using them.

The standard Daniell cell, as its name indicates, is one whose elements are copper and zinc in a liquid composed of zinc and copper sulphates. There are a number of forms of this cell, one of the best being made as shown in Fig. 37.

It is a U shaped glass tube with a stop cock in one side near the bottom. The elements are a copper and a zinc rod which pass through rubber stoppers in the ends of the tube and are connected to the wires outside. These rods are of the purest metal obtainable, the copper rod being made by plating thickly upon a copper wire, and the zinc rod is made of redistilled zinc and is amalgamated

with pure mercury. The solutions are pure zinc and copper sulphates and are nearly saturated, although the matter of density is not important so long as it does not vary much from the above and is the same for both liquids.

The zinc sulphate is first poured in until it

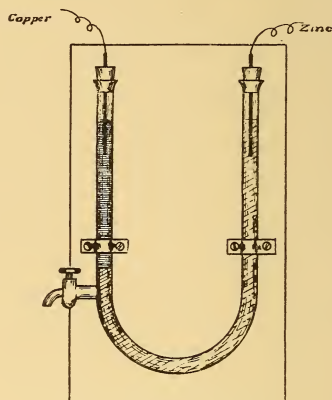

FIG. 37.

stands a little above the stop cock opening, and then both liquids are poured together, zinc sulphate in the right hand tube and copper sulphate in the left hand. This must be done as gently as possible in order that they may not mix, and the tube is canted to the right side occasionally until the line of separation of the liquids is opposite the cock

and the mixed liquids drawn off until the line is distinct. The copper must be perfectly clean on its surface and show no signs of oxidation. The E. M. F. is about 1.1 true volt at ordinary temperatures.

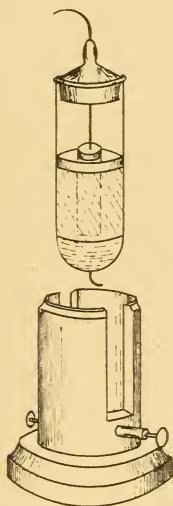

FIG. 38.

Fresh liquid should be used every time as the E. M. F. varies considerably with different solutions. A feeble current should be allowed to pass through it before using, to give a fresh coat of copper to the copper element. The cell will not

polarize perceptibly, if the resistance in the external circuit is above 7000 ohms.

A form of the Latimer Clark cell is shown in Fig. 38.

A small test tube is used for the cell. A platinum wire is passed in at the bottom and sealed for one of the terminals. Pure mercury is poured into the bottom of the tube and covers the platinum wire and forms one of the plates. Above this is a paste of mercurous sulphate and zinc carbonate. In this paste is a rod of zinc, which is connected by a gutta-percha covered wire to the outside of the cell.

Lord Rayleigh's description of the method of charging the cell is as follows: "Pour in sufficient mercury to cover the platinum wire sealed through the bottom of the tube. The best mercury for the purpose is that which has been distilled in *vacuo*. The paste should next be introduced, care being taken not to soil the sides above the proper level. To prepare this paste it is first necessary to make a solution of zinc sulphate. Mix in a flask, distilled water with about twice its weight of crystals of pure zinc sulphate, and add a little pure

zinc carbonate to neutralize the free acid. Effect the solution with *gentle* heat. Allow the mixture to stand to precipitate any iron that may be present. Filter the solution in a warm place into a stock bottle. When it is intended for use, expose the solution to a gentle heat for some time and draw off the solution from near the crystals at the *bottom of the bottle*, in order that there may be certainty of the solution being saturated. To prepare the paste, rub together in a mortar 150 grammes of pure mercurous sulphate, 5 grammes of zinc carbonate, and as much of the saturated zinc sulphate as is required to make a thick paste. [Care should be taken to get *mercurous* and not *mercuric* sulphate. The former is white, while the latter may be detected by its turning yellow on the addition of water.] It is best to leave the paste in a mortar for two or three days, rubbing it at intervals with additions of zinc sulphate until all carbonic anhydrite has disappeared. The paste should then be transferred to a well stoppered bottle, where it should be kept for several months. Before pouring out for use the bottle should be well shaken.

The zincs are cut from rods sold as redistilled

zinc. A copper wire insulated with gutta-percha, should be soldered to the top of each zinc, after which the zinc should be cleaned by dipping it in sulphuric acid, and then washed with distilled water and dried with filtering paper. To support the zinc centrally in the tube, it is passed through a ring of cork (nicked to allow the escape of air) that just fits within the tube. The cork is pushed down until its lower surface nearly touches the paste, in order that as much air as possible may be excluded. Above the cork a layer of marine glue should be poured in order to seal the cell."

A cell thus made, if used on only very weak currents, never short circuited and not exposed to large variations of temperature, will have an E. M. F. given by the formula,

$$E=1.435 \{1 - .00077 (t - 15)\}$$

where E is the E. M. F. in true volts, and t the temperature in degrees centigrade.

The Daniell cell may be used to compare the E. M. F. of another cell or a battery by the following arrangement. (See Fig. 39.)

S represents the standard cell, B the cell or battery whose E. M. F. is to be measured, G a

sensitive galvanometer with a key, and R_1, R_2 resistances which may be varied. These resistances should be high in order to reduce the current to a minimum, and are adjusted until the galvanometer is not deflected upon closing its key. Under these circumstances, letting r_1 and r_2 represent the re-

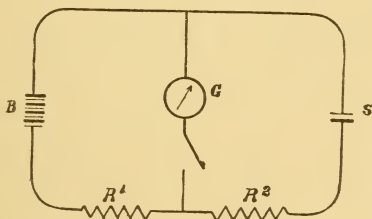

FIG. 39.

sistances respectively of the cell under test and the standard, and E_1 and E_2 their E. M. F's we have the equation

$$\frac{E_1}{E_2} = \frac{R_1 + r_1}{R_2 + r_2}$$

By making another adjustment and finding a new set of values for the adjustable resistances, which call R_3, R_4 we have

$$\frac{E_1}{E_2} = \frac{R_3 + r_1}{R_4 + r_2}$$

By combining the two equations to eliminate r_1 and r_2 which are supposed unknown, we get

$$\frac{E_1}{E_2} = \frac{R_1 - R_3}{R_2 - R_4}$$

from which we easily get the value of E_2 .

If the resistances R_1 and R_2 are made large enough to be so that the battery resistances are negligible, but one measurement will be necessary which will give the equation

$$\frac{E_1}{E_2} = \frac{R_1}{R_2} \therefore E_2 = \frac{E_1 R_1}{R_2}$$

This method may be applied to calibrating a potential galvanometer by replacing the resistance R_1 by it.

In using the Clark's cell, it is necessary that only an infinitesimal current be used, and Poggen-dorf devised a method in which when balance is obtained, the current from the standard cell is null.

In Figure 40 a battery B supplies the current which passes over the resistances R_1 and R_2 ; the standard is connected as indicated in series with a galvanometer, a key and a high resistance, the

latter for the purpose of preventing a dangerously high current from passing through the standard in case of accident. E_1 equals the battery E. M. F. around the two known resistances R_1 and R_2 and

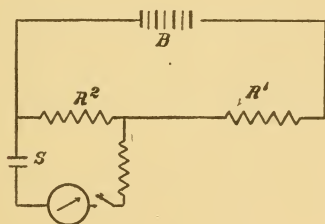

FIG. 40.

E_2 the E. M. F. of the standard cell, then if when the key is depressed

$$\frac{E_1}{E_2} = \frac{R_1 + R_2}{R_2}$$

the potential around R_2 due to the current passing over it will be the same as that due to the standard cell, and there will be no current through the galvanometer. A wire when arranged like that of a slide wire bridge, may be used instead of the two resistances, and if of uniform resistance throughout, the drop of potential between any two points on it will be proportional to the length included between them.

By measuring the length between the terminals of a standard cell which has been applied to the wire as above, and forming a proportion between this length and that between the terminals of a cell whose E. M. F. is desired under similar circumstances, we get the ratio between the E. M. F. of the standard and the unknown cell.

The same arrangement may be used as shown

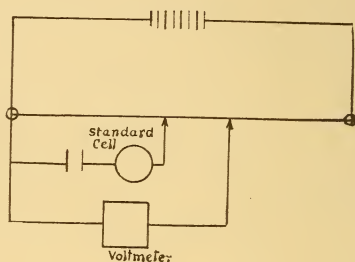

FIG. 41.

in Figure 41 for calibrating voltmeters. The voltmeter terminals are applied so as to include the standard cell between them, and when the adjustments are made so that no current passes through the standard cell circuit, the potentials around the cell and around the voltmeter are proportional to the lengths or resistances of the wire included between them. The practical application

of this method to voltmeter calibration, may be made by means of a Wheatstone's Bridge box of coils.

The connections are made as shown in the diagram, (See Fig. 42,) where S is the standard cell, G a sensitive galvanometer, $V.M.$ the voltmeter

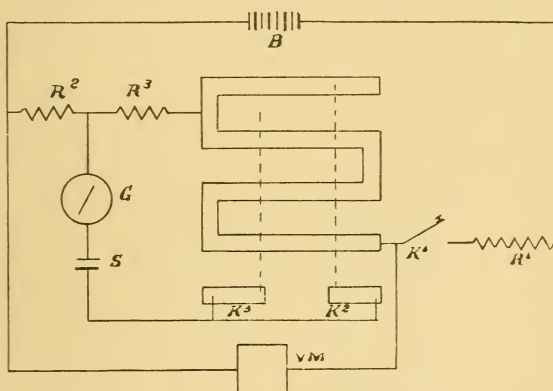

FIG. 42.

to be tested, R_4 an adjustable resistance to regulate the current from the battery B , R_3 a resistance equal to the E.M.F. of the standard multiplied by 100 if the voltmeter is to be tested in the neighborhood of 100 volts. (For a temperature of 20°C ., this would be nearly 142.9 ohms.) R_2 a resistance which when added to R_3 will make an even

number; say 200 ohms, (in the above instance this would be 57.1 ohms.)

Pull out all the plugs in the ratio arm of the bridge between the middle and the point at which R_3 is connected and make the resistance of the rheostat arm such that when added to $R_2 + R_3$ the result will be the number of volts desired on the voltmeter multiplied by 100. For 50 volts this would be 4800 ohms.

Then touching down the key marked K_1 , adjust R_1 until upon tapping K_2 the deflection of the galvanometer G is very small, then make a final adjustment of R_1 using K_3 instead of K_2 . The idea in using K_2 is to keep a large resistance in series with the standard cell to prevent a dangerous current passing over it, until the first rough adjustment of R_1 is made. The main objection to this method given by Mr. Swinburn, who describes it, is that as we get to higher potentials it puts a large strain on the coils in the box, which being wound with doubled wires have their starting and finishing ends close together. The writer however has used this method a number of times without damaging his resistance box and believes

that most of them are made well enough to stand the test. The battery is made of storage cells, which, as they are required for potential mainly and need give only a small current, may be made quite small.

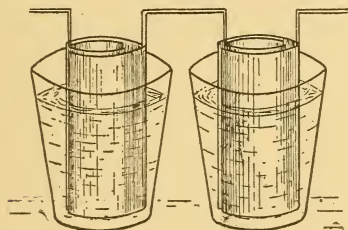
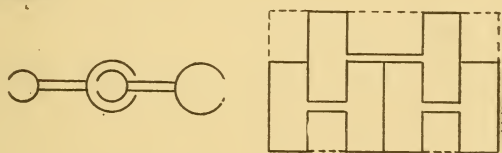

FIG. 43.

A convenient cell may be made up of small glass tumblers and sheet lead, cut and bent into the form shown. (See Fig. 43.)

They are placed in the glasses so that the inside plate in one cell becomes the outside plate in the next, and are kept from touching by three or four

small wedges between the plates in each cell. The liquid is sulphuric acid and water mixed beforehand and allowed to cool. Its specific gravity should be 1.170. A little non-evaporating oil poured over the surface of the liquid in each cell will prevent loss of this liquid by spraying.

The cells should be charged from a dynamo, in parallel if there is not the E. M. F. to do it in series, for a few hours in one direction and then discharged, and charged for a few hours in the other direction and again discharged. This is repeated four or five times, when the cells will be ready for use.

A more convenient way of getting the E. M. F. for calibrating, if a dynamo is available, is to use the dynamo and separately excite the fields. By putting an adjustable resistance in the field circuit of the dynamo you can get a very convenient adjustment. This is especially convenient when large numbers of voltmeters are to be compared with a standard. For use with the standard cell it would be well to wind a number of resistance coils to take the place of the resistance box, if there is any likelihood of there being enough testing to justify the

outlay. You would thus save your bridge from possible damage and could make up the few coils required into a more portable form.

The voltmeter can be calibrated of course by comparison with a standard galvanometer which measures currents. If the galvanometer is wound so that it will measure currents as small as the voltmeter uses, they may be placed in series and the current measured, and the potential calculated from the voltmeter resistance, taken at its working temperature. Or, if the galvanometer measures only large currents, put it in series with a known resistance at each end of which the voltmeter terminals are placed, and we get the potential from the formula

$$E = C \frac{Rr}{R + r}$$

where E is the potential on the voltmeter, C the current measured by the galvanometer, R the voltmeter resistance and r the shunt resistance. (See Fig. 44.)

Another method of making potential measurements is by means of the quadrant electrometer, which depends upon the attraction exerted upon

each other by two adjacent metal plates which are charged at different potentials. It will not be described here however, as the electrometer is an expensive instrument and requires expert manipulation to give satisfactory results.

We will close the chapter with the description of a few instruments specially adapted for potential measurement. The electrostatic voltmeter of

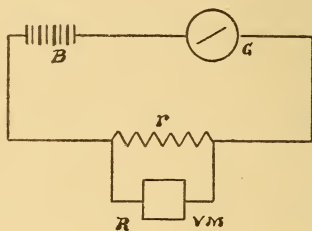

FIG. 44.

Lord Kelvin depends upon the electrometer principle just mentioned, of the attraction of two electrified plates. (See Fig. 45.)

The movable plate is suspended on knife edges between two vertical stationary plates, and has a pointer attached to it which passes over the scale above. When the inside and outside plates are oppositely electrified, the inside plate is drawn in

between the other two increasing its capacity as a condenser at the same time. The value of the scale division is changed by hanging a little weight to the lower end of the movable plate, one division on the scale having a range of from 50 volts to 200 volts by changing the weights.

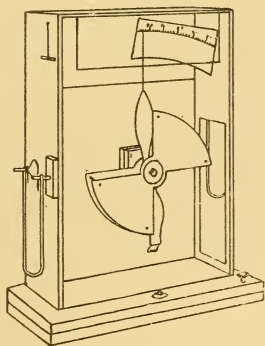

FIG. 45.

As a matter of safety the electrical connection between the terminals of the instrument and the plates is made through a fine copper wire enclosed in a U shaped glass tube. The wire will fuse should any short circuit occur, and the long passage through the tube will prevent the formation of an arc. This instrument is of course applicable to the measurement of the potential of alternating

currents as well as that of direct currents. The same instrument in a somewhat different form, is the multicellular voltmeter, which may be used for potentials from 40 to 800 volts.

The movable plate instead of working in a vertical plane, works horizontally and is suspended by a platinum wire from a milled torsion head, by which the pointer is adjusted to zero. Instead of being composed of but one vane however, the movable plate is made up of a number of them, each working between two fixed plates. A needle attached to the spindle, on which the vanes are fastened, moves over a scale which reads directly in volts.

The Cardew voltmeter is an instrument which depends upon the expansion of a fine wire heated by the passage of a current over it.

Figure 46 shows diagrammatically the arrangement of the instrument. The fine wire is attached rigidly at a and b to the frame of the instrument and runs over the ivory pulleys at P, P, P .

Pulleys P, P , are fastened to the end of a tube through which the wires pass, and pulley P , is fastened to a wire which passes around a wheel W

and is then attached to a spring S which keeps everything taut. Of course any movement of the wire will cause the wheel W to turn, and this through a small gear and pinion magnifies the motion and transmits it to the pointer.

The frame which connects the pulleys P, P , with the rest of the instrument is made of rods composed of steel and brass in such proportions,

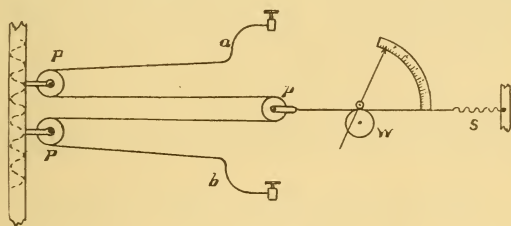
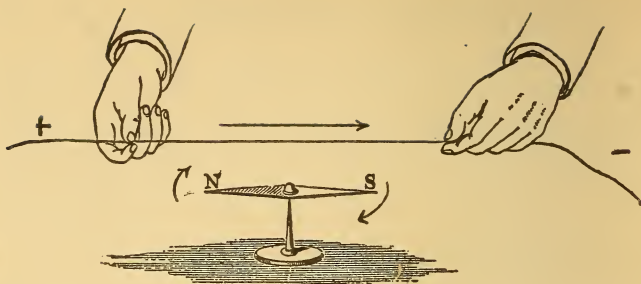

FIG. 46.

that they have the same temperature coefficient of expansion as the wire, and the instrument will thus come to zero when both are at the same temperature. The majority of the other instruments used in potential measurement are identical in principle with those used in current measurement, and as the most important of these has been referred to there, they need not be mentioned again here.



BUBIER'S Popular Electrician.

A SCIENTIFIC ILLUSTRATED MONTHLY

For the Amateur and Public at Large.

Containing descriptions of all the new inventions as fast as they are patented; also lists of patents filed each month at the Patent Office in Washington, D. C. Interesting articles by popular writers upon scientific subjects written in a way that the merest beginner in science can understand. Also a Question and Answer Column free to all subscribers.

Price, Postpaid, 50c. a Year.

SAMPLE COPY 5 CENTS.

☛ Send for it. You will be more than pleased.

Bubier Publishing Co., Lynn, Mass.

Practical Directions

—FOR—

ARMATURE

—AND—

Field-Magnet Winding.

BY EDWARD TREVERT.

ILLUSTRATED with nearly 50 Engravings and contains a vast amount of valuable information, both in theory and practice upon this subject. It also contains working directions for Winding Dynamos and Motors, with additional Descriptions of some of the apparatus made by the several leading Electrical Companies in the U. S.

—CONTENTS.—

INTRODUCTION.

CHAPTER 1.—The Armature in Theory.

CHAPTER 2.—Forms of Armatures.

CHAPTER 3.—Drum Winding.

CHAPTER 4.—Field Winding.

CHAPTER 5.—Field Formulae.

CHAPTER 6.—General Methods of Winding.

CHAPTER 7.—Field Winding—concluded.

CHAPTER 8.—Dynamos.

CHAPTER 9.—Motors.

PRICE, \$1.50, Postpaid.

BUBIER PUBLISHING COMPANY,

LYNN, - MASS.

New and Practical Book.

Dynamos and Electric Motors,

And All About Them.

By EDWARD TREVERT.

Nearly 100 Illustrations.

This volume not only gives practical directions for building Dynamos and Electric Motors, but also contains a large quantity of information about them.

It is particularly adapted to beginners in this absorbing science.

- CHAP. I. What is a dynamo?—What is a motor?
CHAP. II. Some different types of dynamos.
CHAP. III. How to construct a dynamo.
CHAP. IV. Some different types of electric motors.
CHAP. V. How to build an electric motor.
CHAP. VI. A cheaply constructed electric motor.
CHAP. VII. How to make an electric battery for running electric motors.
-

PRICE, CLOTH, 50 CENTS.

POSTAGE PAID.

Bubier Publishing Company,

LYNN, - MASS.

X 931





LIBRARY OF CONGRESS

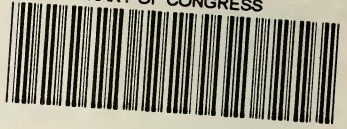

0 003 708 937 0

